



**CoreMed** 

**CoreMed Reusable  
Instruments Portfolio**



**CONTENTS**

**PAGE**

---

**1. OTOLOGY . . . . . 3-102**

**2. RHINOLOGY . . . . . 103-186**

**3. SINUS INSTRUMENTS . . . . . 187-262**

**4. ORAL CAVITY . . . . . 263-342**

**5. ENDOSCOPY . . . . . 343-374**

**6. COAGULATION . . . . . 375-406**

**7. LARYNGOLOGY . . . . . 407-442**

# Otologie Instrumentarium

## Otology Instruments









# Über uns

---

# About Us

## Geschichte

**SPIGGLE & THEIS Medizintechnik GmbH** wurde 1994 von den Geschäftsführern **David Spiggle** und **Detlef Theis** gegründet. Bis heute haben wir uns vom reinen Vertriebsunternehmen zu einem renommierten Hersteller von Medizinprodukten im Bereich der HNO-Chirurgie weiterentwickelt. Weltweit exportieren wir in über 75 Länder und in Deutschland zählen mehr als 700 Kliniken zu unseren Kunden.

## Das Maß der Dinge

Im chirurgischen Instrumentenbau gilt das Siegel **“Made in Germany“** auch heute noch als Inbegriff von Qualität. Unsere chirurgischen Instrumente werden in allen Produktionsstufen unter strengsten Qualitätsanforderungen nahezu komplett in Deutschland produziert und sind somit noch größtenteils echt **“Made in Germany“**. Zur Verarbeitung wird ausschließlich Instrumentenstahl bester Güte verwendet, welcher den hohen Anforderungen moderner Chirurgie auch dauerhaft gerecht wird.

## Sicherheit

Die Gesundheit der Patienten und somit die Sicherheit und Qualität unserer Produkte stehen im Mittelpunkt unseres Handelns. In diesem Sinne ist **SPIGGLE & THEIS Medizintechnik GmbH** bereits seit 1997 **ISO-zertifiziert** und sind unsere Produkte nach der strengen europäischen Richtlinie für Medizinprodukte CE-gekennzeichnet. Alle unsere Produkte unterliegen einer permanenten Qualitätskontrolle - von der Auswahl des Rohmaterials über die einzelnen Fertigungsschritte bis zum Versand.

## Erfahrung

Unsere Mitarbeiter haben zum Teil mehr als 30 Jahre Berufserfahrung im Umgang mit chirurgischen Instrumenten. Durch dieses umfassende Know-How sowie den langjährigen und individuellen Kontakt mit den Anwendern, besitzen wir nicht nur theoretisches Wissen, sondern kennen auch deren Bedürfnisse und Ansprüche. Dies hilft uns bei der steten, praxisorientierten Weiterentwicklung unserer Produkte. Somit garantieren wir hohe Kompetenz und individuellen Service bei der Betreuung unserer Kunden.

## History

**SPIGGLE & THEIS Medizintechnik GmbH** was founded in 1994 by the managing directors **David Spiggle** and **Detlef Theis**. The company has evolved from being purely a distributor to the established manufacturer of medical products in the area of ENT that it is today. We can count over 700 clinics amongst our German customers and export to over 75 countries world-wide.

## The Seal Of Highest Quality

The stamp **“Made in Germany“** is still the epitome of quality standards in the production of surgical instruments in the world today. The majority of our surgical instruments is subjected to the strictest quality requirements at every step of their production, in the truest sense of the words, **“Made in Germany“**. Only the highest standard of instrument steel, capable of consistently meeting the demands of modern surgery, is used in the production.

## Safety First

The health of our patients and therefore the safety and quality of our products plays the central role in our decisions. **SPIGGLE & THEIS Medizintechnik GmbH** has been **ISO certified**. Our products are CE-marked in accordance with the strict European guideline for medical products since 1997. All our products undergo continual quality checks, from the selection of raw materials, to the individual stages of production and finally their dispatch.

## Experience

Our colleagues in instrument development can look back on over 30 years of professional practical experience with ENT surgical instruments. We offer more than theoretical knowledge – we understand our customer needs. We enjoy close, personal contact to many of the best surgeons world-wide. This enables us to continually develop innovative products. We guarantee the highest level of competence and individual service in meeting our customer requirements.



## Inhaltsverzeichnis

### Table of contents

01	Ambulantes Ohr-Instrumentarium / Diagnostic Ear Instruments .....	5 - 26
02	Antrotomie / Antrotomy .....	27 - 31
03	Rotierende Instrumente / Rotary Instruments .....	32
04	Wundsperrer / Retractors .....	33 - 36
05	Pinzetten / Dressing Forceps .....	37 - 41
06	Scheren / Scissors .....	42 - 45
07	Mikrochirurgische Instrumente / Microsurgery Instruments .....	46 - 55
07a	Titan-Instrumente nach Prof. Wollenberg / Prof. Wollenberg Titanium Instruments .....	56 - 57
07b	Endoskopische / Mikroskopische Instrumente nach Prof. Panetti Endoscopic / Microscopic Instruments by Prof. Panetti.....	58 - 64
08	Ohrzängchen / Ear Forceps .....	65 - 70
09	Mess- und Kürzinstrumente / Measuring and Shortening Instruments .....	71 - 73
10	Allgemeines / Miscellaneous .....	74 - 80
11	Sterilisationssysteme / Sterilization Systems .....	81 - 85
12	Sets .....	86 - 92
	Index .....	94 - 97

#### Attention:

Not every instrument is available in all markets. Availability depends on local regulations. Please contact your SPIGGLE & THEIS representative or distributor, if you have any questions about the availability of our products in your region.

## 01 Ambulantes Ohr-Instrumentarium

### Diagnostic Ear Instruments

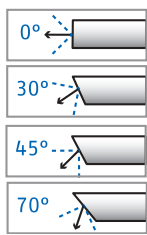

#### Otoskop, HD, autoklavierbar / Otoscope, HD, autoclavable

Art.-Nr. Art.-No.	Größe Size (mm)	Länge Length (cm)	Winkel Angle
10-102-00	2,7	5,0	0°
10-102-30	2,7	5,0	30°
10-104-00	2,4	9,8	0°
10-104-30	2,4	9,8	30°

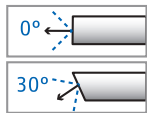

#### Gehörgangs-Endoskop, HD, autoklavierbar, AD 4 mm, 5 cm Ear canal endoscope, HD, autoclavable, OD 4 mm, 5 cm

Art.-Nr./No.	Winkel / Angle
10-106-00	0°
10-107-30	30°

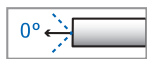

#### Gehörgangs-Endoskop mit Ohrspekulum, HD, autoklavierbar, AD 4 mm, 5 cm Ear canal endoscope with ear speculum, HD, autoclavable, OD 4 mm, 5 cm

Art.-Nr./No.	Winkel / Angle
10-108-00	0°
10-108-99	Ersatzspekulum für 10-108-00 spare speculum for 10-108-00

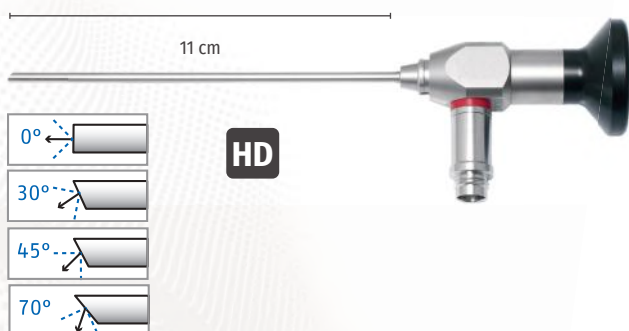

#### Otoskop, HD, Großbild, autoklavierbar, AD 3 mm, 11 cm Otoscope, HD, large picture, autoclavable, OD 3 mm, 11 cm

Art.-Nr./No.	Winkel / Angle
10-109-00	0°
10-109-30	30°
10-109-45	45°
10-109-70	70°

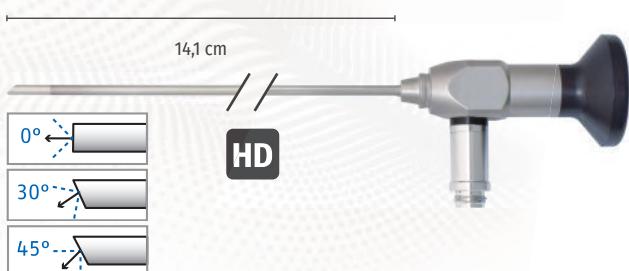

#### Otoskop, HD, Großbild, autoklavierbar, AD 3 mm, 14,1 cm Otoscope, HD, large picture, autoclavable, OD 3 mm, 14.1 cm

Art.-Nr./No.	Winkel / Angle
10-090-00	0°
10-090-30	30°
10-090-45	45°



## 01 Ambulantes Ohr-Instrumentarium

### Diagnostic Ear Instruments

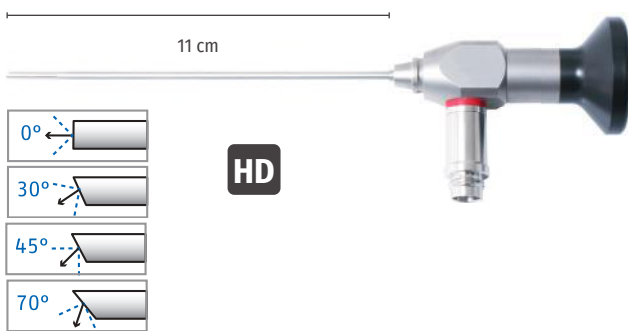

**Otoskop, HD, Großbild, autoklavierbar, AD 2,4 mm, 11 cm**

**Otoscope, HD, large picture, autoclavable, OD 2.4 mm, 11 cm**

Art.-Nr./No.	Winkel / Angle
10-111-00	0°
10-111-30	30°
10-111-45	45°
10-111-70	70°

### Asas de luz LED / LED light handles

Art.-Nr./No.

70-211-00 LED-Hochleistungs-Leuchtgriff, 230 V, bestehend aus: (70-211-10, 70-211-20, 70-211-30, 70-211-40)  
LED high performance light-handle, 230 V, consisting of:  
(70-211-10, 70-211-20, 70-211-30, 70-211-40)

70-211-01 LED-Hochleistungs-Leuchtgriff, 120 V, bestehend aus: (70-211-10, 70-211-20, 70-211-30, 70-211-50)  
LED high performance light-handle, 120 V, consisting of:  
(70-211-10, 70-211-20, 70-211-30, 70-211-50)

70-211-10 LED-Handgriff, schwarz, mit Helligkeitsdimmer, Ausschaltautomatik, 3 W, 5500° K, 17500 Lux, zur Verwendung mit Li-Io-Akku 3,5 V und Endoskop-Adapter, 50 Std. Brenndauer  
LED light handle, black, with brightness dimmer, automatic switch-off, 3 W, 5500° K, 17500 lux, to use with Li-ion chargeable battery 3.5 V and endoscope adapter, 50 hours run-time

70-211-20 Li-Ionen-Akku, 3,5 V, für LED-Handgriff  
Li-ion rechargeable battery, 3.5 V, for LED light-handle

70-211-30 Endoskopie-Adapter für LED-Handgriff, passend für Standardgewinde an Endoskopen (AcMI-Gewinde)  
Endoscope adapter for LED light-handle, fits standard endoscope threads (AcMi-thread)

70-211-40 Ladegerät für bis zu 2 LED-Handgriffe, 3,5 V, 230 V, Standgerät, Wandhalterung  
Charging base for up to 2 LED light-handles, 3.5 V, 230 V, table model, with wall holder

70-211-50 Ladegerät für bis zu 2 LED-Handgriffe, 3,5 V, 120 V, Standgerät, Wandhalterung  
Charging base for up to 2 LED light-handles, 3.5 V, 120 V, table model, with wall holder



## 01 Ambulantes Ohr-Instrumentarium

### Diagnostic Ear Instruments



**Halogen Super Spot Stirnlampe  
mit integriertem Lichtleitkabel, Kabellänge 2,30 m**  
Halogen Super Spot headlight with integrated light cable,  
length of cable 2.30 m

10-110-00

**Lichtleiter mit Irisblende für Kaltlicht-Stirnlampe  
10-110-00 (ohne Stirnreifen), mit Storz-Adapter**  
Light cable with iris, for headlight 10-110-00  
(without headband), with Storz adapter

10-110-03



**Kabellose Hochleistungs- LED Stirnlampe  
"HighLite" mit Komfort-Stirnreifen, Ladegerät**  
Cordless high definition LED headlight "HighLite",  
comfortable headband, transformer and charger

Art.-Nr./No.	Beschreibung / Description
10-120-00	Mit integriertem Akku-Pack with integrated battery pack
10-122-00	Mit mobilem Akku-Pack with mobile battery pack



**HR-Binokularlupe 2,5 x / 340 mm mit Spritzschutz und  
schwenkbarem Lupenträger, Nachrüstsatz für "HighLite"**  
HR binocular loupe 2.5 x / 340 mm with cover and  
loupe holder, attachment for "HighLite"

10-120-01



**Stirnlampen-Ladestation, EN50 unplugged**  
Headlight transformer, EN50 unplugged

10-120-10





## 01 Ambulantes Ohr-Instrumentarium

### Diagnostic Ear Instruments



**ENTERVIEW III, Kabellose- LED Stirnleuchte**  
ENTERVIEW III, cordless LED headlight

10-126-01

**Akkuladegerät und Stirnleuchtenhalter für ENTERVIEW III**  
Battery charger and headlight rest for ENTERVIEW III

80-729-01



**Kombi-Tasche für LED-Leuchte**  
Bag for LED headlight

10-120-99

## 01 Ambulantes Ohr-Instrumentarium

### Diagnostic Ear Instruments



**Binokularlupe, 2,5x Vergrößerung, 34 cm Arbeitsabstand**  
Binocular loupe, 2.5x magnification, working distance 34 cm

10-140-00



**Blessing Nystagmusbrille, mit Batteriegriff, weiß**  
Blessing Nystagmus spectacles, integrated battery handle, white

10-142-00

10-141-00



**Frenzel Nystagmusbrille, schwarz**  
Frenzel Nystagmus spectacles, black



10-141-01

Art.-Nr./No.	Beschreibung / Description
10-141-00	mit Kabelanschluss / with cable connection
10-141-01	mit Batteriehandgriff / with battery handle
10-141-99	Steckernetzteil für Nystagmusbrille 10-141-00 power supply for Nystagmus spectacles 10-141-00



**Mini Otoskop 3000, mit Batteriegriff 2,5 V, Batterien,**  
4 Dauergebrauchs-Ohrtrichter, 10 Einmal-Ohrtrichter, Etui  
Mini otoscope 3000, with battery handle 2.5 V, batteries,  
4 multi use ear specula, 10 disposable ear specula, cover

10-143-00



## 01 Ambulantes Ohr-Instrumentarium

### Diagnostic Ear Instruments



**XHL Xenon Ersatzlampe, 2,5 V, für Mini Otoskop 3000**  
**XHL xenon spare bulb, 2.5 V, for Mini otoscope 3000**

**10-143-99**



**HNO Fiber Otoskop Beta 200, USB Ladegriff mit USB Kabel, Steckernetzteil, 4 Dauergebrauchs-Ohrtrichter, 10 Einmal-Ohrtrichter, Ersatzlampe, Etui**  
**ENT fibre otoscope Beta 200, usb rechargeable handle with usb cable, power supply, 4 multi use ear specula, 10 disposable ear specula, spare bulb, case**

**10-145-80**



**XHL Xenon Ersatzlampe, 2,5 V, für Beta 200**  
**XHL xenon spare bulb, 2.5 V, for Beta 200**

**10-145-98**



**XHL Xenon Ersatzlampe, 3,5 V, für Beta 200**  
**XHL xenon spare bulb, 3.5 V, for Beta 200**

**10-145-99**

**Dauergebrauchs-Ohrtrichter, autoklavierbar, für beta 200 und Mini Otoskop 3000, schwarz**

**Multi use ear specula, autoclavable, for Beta 200 and Mini Otoscope 3000, black**



Art.-Nr./No.	Größe / Size (mm)
10-145-24	2,4
10-145-30	3,0
10-145-40	4,0
10-145-50	5,0
10-145-01	Set bestehend aus / contains: 2,4 mm, 3,0 mm, 4,0 mm, 5,0 mm

## 01 Ambulantes Ohr-Instrumentarium

### Diagnostic Ear Instruments



**Einmal-Ohrtrichter für Otoskope Beta 200 und Mini Otoskop 3000, schwarz, 1000 Stück/Box**  
**Ear specula, disposable, for otoscopes Beta 200 and Mini otoscope 3000, black, 1000 pieces/box**

Art.-Nr./No.	Größe / Size (mm)
10-148-25	2,5
10-148-40	4,0



**Politzer Luftdusche bestehend aus: Gummibirne, Einsteckkonus, Ohrolive, Nasenolive (15, 17 und 22 mm)**  
**Politzer air bag consists of: rubber bulb, connecting nozzle, ear olive, nose olive (15, 17 und 22 mm)**

**10-151-00**



**Politzer Ohrolive / Politzer ear olive**

**10-151-03**



**Politzer Nasenolive / Politzer nose olive**

Art.-Nr./No.	Größe / Size (mm)
10-151-15	15
10-151-17	17
10-151-22	22



**Politzer Einsteckkonus / Politzer connecting nozzle**

**10-151-01**



**Politzer Gummibirne / Politzer rubber bulb**

**10-151-02**



## 01 Ambulantes Ohr-Instrumentarium

### Diagnostic Ear Instruments



**Kabierske Pulverbläser, komplett mit drei Kanülen für Ohr, Nase, Rachen, Hals; mit Glas und Ventilball**

**Kabierske powder blower, complete with three cannulae for ear, nose, pharynx, larynx; with bottle and rubber ball**

**10-155-00**



**Kabierske Ersatzglas, 30 ccm**

**Kabierske spare bottle, 30 ccm**

**10-155-01**



**Kabierske Ventilball / Kabierske rubber ball**

**10-155-02**

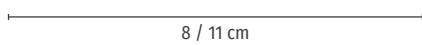

**Kabierske Kanüle, gerade / Kabierske cannula, straight**

Art.-Nr./No.	Länge / Length (cm)
10-155-08	8
10-155-11	11



**Kabierske Kanüle, gebogen, 13 cm**

**Kabierske cannula, curved, 13 cm**

**10-155-13**



## 01 Ambulantes Ohr-Instrumentarium

### Diagnostic Ear Instruments



**Stimmgabel mit Fuß, a1 = 440 Hz**  
Tuning fork with foot, a1 = 440 Hz

10-171-01



10-170-00 10-170-01 10-170-02 10-170-03 10-170-04 10-170-05

**Lucae Stimmgabel mit Fuß / Lucae tuning fork with foot**

Art.-Nr./No.

10-170-00	c = 128 Hz
10-170-01	c1 = 256 Hz
10-170-02	c2 = 512 Hz
10-170-03	c3 = 1024 Hz
10-170-04	c4 = 2048 Hz
10-170-05	c5 = 4096 Hz



10-172-00 10-172-01 10-172-02 10-172-03 10-172-04 10-172-05

**Hartmann Stimmgabel / Hartmann tuning fork**

Art.-Nr./No.

10-172-00	c = 128 Hz
10-172-01	c1 = 256 Hz
10-172-02	c2 = 512 Hz
10-172-03	c3 = 1024 Hz
10-172-04	c4 = 2048 Hz
10-172-05	c5 = 4096 Hz
10-179-00	Set aus c - c4, mit Etui Set containing c - c4, with case



**Brünings anastigmatische Ohrlupe**  
Set mit Ohrlupe, Gummiball, 4 Trichtern, Etui  
Brünings anastigmatic aural magnifier  
set with magnifier, rubber bulb, 4 specula, case

10-180-00



**Brünings Gummiball, inklusive Schlauch und Steckkonus**  
Brünings rubber bulb, including tube and cone

10-182-01



## 01 Ambulantes Ohr-Instrumentarium

### Diagnostic Ear Instruments



10-182-02



10-182-04

#### Brünings Lupe, geschlossen / Brünings loupe head, closed

Art.-Nr./No.	Vergrößerung / Magnification
10-182-02	2,5 x
10-182-04	0

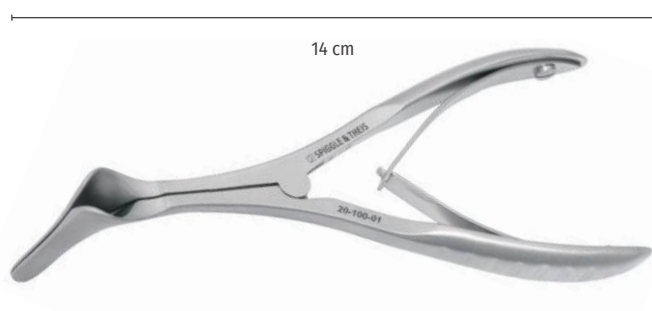

14 cm

#### Hartmann Nasenspekulum für Erwachsene, zerlegbar, 14 cm Hartmann nasal speculum for adults, dismountable, 14 cm

20-100-01



10-183-10

10-183-01

10-183-02

10-183-03

10-183-04

#### Brünings Ohrtrichter / Brünings ear speculum

Art.-Nr./No.	
10-183-10	0
10-183-01	1
10-183-02	2
10-183-03	3
10-183-04	4



#### Hartmann Ohrtrichter / Hartmann ear speculum

Art.-Nr./No.	Größe / Size	ID / ID (mm)	AD / OD (mm)
10-200-00	0	2,0	3,3
10-200-01	1	3,2	4,3
10-200-02	2	4,0	5,2
10-200-03	3	5,2	6,5
10-200-04	4	6,5	7,8



#### Hartmann Ohrtrichter zur Nachbehandlung, matt Hartmann ear speculum for post treatment, satin finished

Art.-Nr./No.	Größe / Size	ID / ID (mm)	AD / OD (mm)
10-201-01	1	8	9
10-201-02	2	9	10

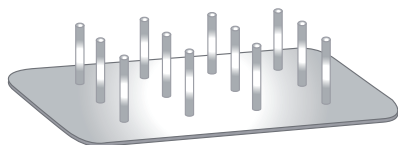

**Metallständer mit 12 Aufnahmen für Ohrtrichter**  
**Metal stand with 12 seatings for ear speculum**

10-204-99

**Farrior Ohrtrichter, rund / Farrior ear speculum, round**



Art.-Nr./No.	Größe / Size	ID / ID (mm)	AD / OD (mm)
10-186-01	1	3,3	4,3
10-186-02	2	4,3	5,1
10-186-03	3	4,8	5,6
10-186-04	4	5,3	6,1
10-186-05	5	5,8	6,6
10-186-06	6	6,3	7,1
10-186-07	7	6,7	7,5
10-186-08	8	7,2	8,0
10-186-09	9	7,7	8,7

**Farrior Ohrtrichter, oval, schwarz, 20°**

**Farrior ear speculum, oval, black, 20°**



Art.-Nr./No.	Größe / Size	ID / ID (mm)	AD / OD (mm)
10-188-01	1	3,0 x 4,0	4,0 x 5,0
10-188-02	2	4,0 x 5,0	5,0 x 6,0
10-188-03	3	4,5 x 5,5	5,5 x 6,5
10-188-04	4	5,0 x 6,0	6,0 x 7,0
10-188-05	5	5,5 x 6,5	6,5 x 7,5
10-188-06	6	6,0 x 7,0	7,0 x 8,0
10-188-07	7	6,5 x 7,5	7,5 x 8,5
10-188-08	8	7,0 x 8,0	8,0 x 9,0
10-188-09	9	7,5 x 8,5	8,5 x 9,5

**Farrior Ohrtrichter, oval, schwarz, 35°**

**Farrior ear speculum, oval, black, 35°**



Art.-Nr./No.	Größe / Size	ID / ID (mm)	AD / OD (mm)
10-190-01	1	3,0 x 4,0	4,0 x 5,0
10-190-02	2	4,0 x 5,0	5,0 x 6,0
10-190-03	3	4,5 x 5,5	5,5 x 6,5
10-190-04	4	5,0 x 6,0	6,0 x 7,0
10-190-05	5	5,5 x 6,5	6,5 x 7,5
10-190-06	6	6,0 x 7,0	7,0 x 8,0
10-190-07	7	6,5 x 7,5	7,5 x 8,5
10-190-08	8	7,0 x 8,0	8,0 x 9,0
10-190-09	9	7,5 x 8,5	8,5 x 9,5



## 01 Ambulantes Ohr-Instrumentarium

### Diagnostic Ear Instruments



#### Zöllner Ohrtrichter, Leichtmetall, schwarz

Zöllner ear speculum, light metal, black

Art.-Nr./No.	Größe / Size	ID / ID (mm)	AD / OD (mm)
10-192-01	1	4,5 x 5,5	5,5 x 6,5
10-192-02	2	5,5 x 6,5	6,5 x 7,5
10-192-03	3	6,5 x 7,5	7,5 x 8,5
10-192-04	4	7,5 x 8,5	8,5 x 9,5
10-192-05	5	8,5 x 9,5	9,5 x 10,5
10-192-06	6	9,5 x 10,5	10,5 x 11,5



#### Politzer Ohrtrichter für Kinder / Politzer ear speculum for infants

Art.-Nr./No.	Größe / Size	ID / ID (mm)	AD / OD (mm)
10-202-01	1	2,0	3,0
10-202-02	2	3,0	4,5
10-202-03	3	4,0	5,5



#### Holmgren Ohrtrichter, spreizbar, schwarz

Holmgren ear speculum, expandable, black

Art.-Nr./No.	Größe / Size	ID / ID (mm)	AD / OD (mm)
10-203-05	1	4	5
10-203-06	2	5	6
10-203-07	3	6	7



#### Toynbee Ohrtrichter

Toynbee ear speculum

Art.-Nr./No.	Größe / Size	ID / ID (mm)	AD / OD (mm)
10-194-01	1	3,2	4
10-194-02	2	4	5
10-194-03	3	5,3	6



#### Gruber Ohrtrichter, oval

Gruber ear speculum, oval

Art.-Nr./No.	Größe / Size	ID / ID (mm)
10-195-01	1	3,8 x 4,8
10-195-02	2	5 x 6,2
10-195-03	3	6 x 7,2

## 01 Ambulantes Ohr-Instrumentarium

### Diagnostic Ear Instruments



**Watteträger, Spitze 1,2 mm, 12 cm, 5 Stück**  
Cotton carrier, tip 1.2 mm, 12 cm, 5 pieces



Art.-Nr./No.	Beschreibung / Description
10-205-01	gerieft / serrated
10-205-02	dreikant, glatt / triangular, smooth
10-205-03	dreikant, gerieft / triangular, serrated

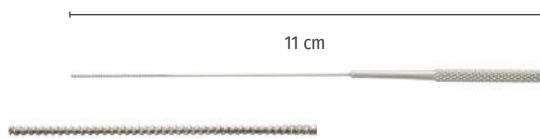

**Attik Watteträger, extra fein, gerieft, Ø 0,8 mm, 11 cm, 5 Stück**  
Attic cotton carrier, very fine, serrated, Ø 0.8 mm, 11 cm, 5 pieces

10-205-04

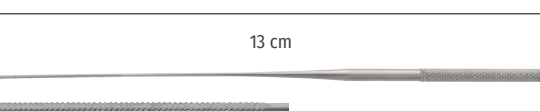

**Watteträger, dreikant, gerieft, Ø 0,9 mm, 13 cm**  
Cotton carrier, triangular, serrated, Ø 0.9 mm, 13 cm

10-206-13-05

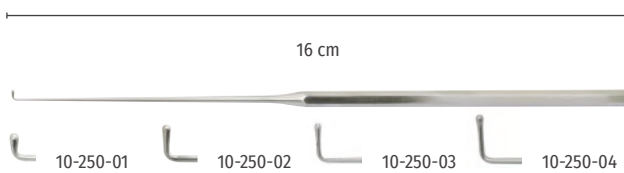

**Lucae Cerumenhäkchen, 16 cm / Lucae cerumen hook, 16 cm**

Art.-Nr./No.	Größe / Size
10-250-01	1 (2 mm)
10-250-02	2 (3 mm)
10-250-03	3 (4 mm)
10-250-04	4 (5 mm)

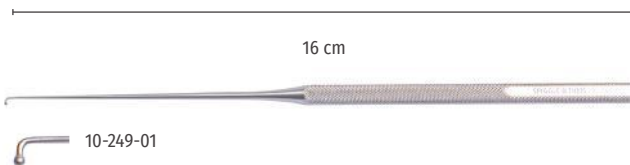

**Wagener Cerumenhäkchen, Kugelform, 16 cm /**  
Wagener cerumen hook, spherical shape, 16 cm

Art.-Nr./No.	Größe / Size
10-249-01	1 (2 mm)
10-249-02	2 (3 mm)
10-249-03	3 (4 mm)
10-249-04	4 (5 mm)
10-249-05	5 (6 mm)

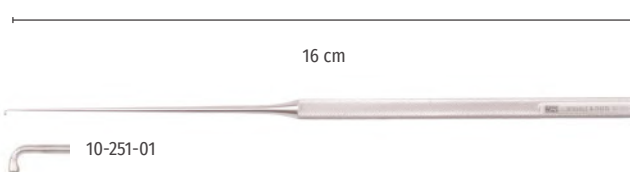

**Wagener Cerumenhäkchen, Tropfenform, 16 cm /**  
Wagener cerumen hook, teardrop shape, 16 cm

Art.-Nr./No.	Größe / Size
10-251-01	1 (2 mm)
10-251-02	2 (3 mm)
10-251-03	3 (4 mm)
10-251-04	4 (5 mm)
10-251-05	5 (6 mm)





## 01 Ambulantes Ohr-Instrumentarium

### Diagnostic Ear Instruments

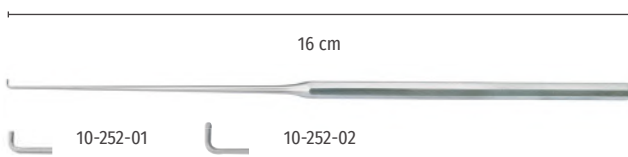

**Day Cerumenhäkchen, 16 cm / Day cerumen hook, 16 cm**

Art.-Nr./No.	Größe / Size
10-252-01	1 (2,5 mm)
10-252-02	2 (3,5 mm)

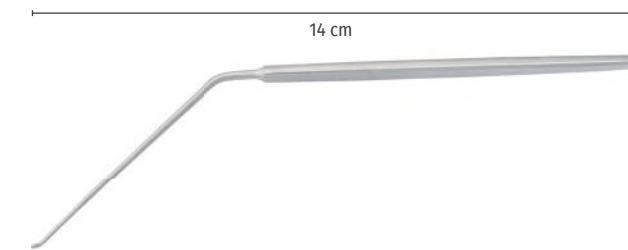

**Ohrkürette, Schaft kniegebogen, 14 cm / Ear curette, shaft angled, 14 cm**

Art.-Nr. Art.-No.	Größe Size	Winkel Angle
10-258-00	0	Ring 35° aufwärts, stumpf / upwards, blunt
10-258-01	1	Ring 35° aufwärts, stumpf / upwards, blunt
10-258-02	2	Ring 35° aufwärts, stumpf / upwards, blunt
10-258-03	3	Ring 35° aufwärts, stumpf / upwards, blunt
10-259-00	0	Ring gerade, stumpf / straight, blunt
10-259-01	1	Ring gerade, stumpf / straight, blunt
10-259-02	2	Ring gerade, stumpf / straight, blunt
10-259-03	3	Ring gerade, stumpf / straight, blunt

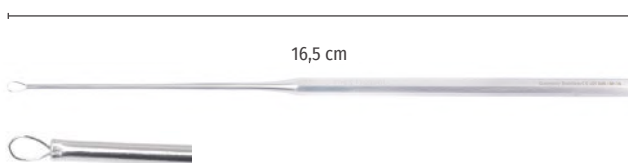

**Billeau Ohrschlinge, gerade, 16,5 cm / Billeau ear loop, straight, 16,5 cm**

Art.-Nr./No.	Größe / Size
10-263-01	1
10-263-02	2
10-263-03	3

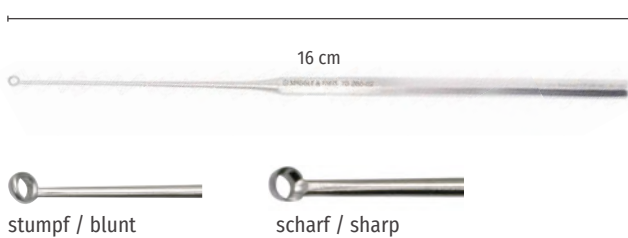

**Buck Ohrkürette, leicht gebogen, 16 cm / Buck ear curette, slightly curved, 16 cm**

Art.-Nr./No.	Größe / Size	Beschreibung / Description
10-260-20	00 (1,5 mm)	stumpf / blunt
10-260-10	0 (2,0 mm)	stumpf / blunt
10-260-01	1 (2,5 mm)	stumpf / blunt
10-260-02	2 (3,0 mm)	stumpf / blunt
10-260-03	3 (4,0 mm)	stumpf / blunt
10-261-20	00 (1,5 mm)	scharf / sharp
10-261-10	0 (2,0 mm)	scharf / sharp
10-261-01	1 (2,5 mm)	scharf / sharp
10-261-02	2 (3,0 mm)	scharf / sharp
10-261-03	3 (4,0 mm)	scharf / sharp



**Gehörgangskürette, scharf, 17 cm / Ear canal curette, sharp, 17 cm**

Art.-Nr./No.	Größe / Size (mm)
10-669-01	1,8
10-669-02	2,1

## 01 Ambulantes Ohr-Instrumentarium

### Diagnostic Ear Instruments

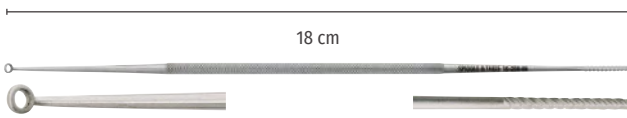

**Jobson Watteträger / Kürette, 18 cm**  
**Jobson cotton carrier / curette, 18 cm**

10-208-00

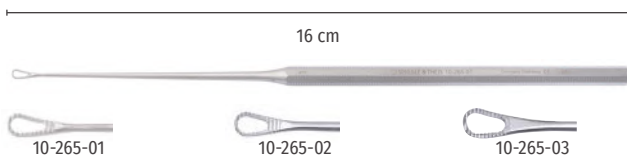

**Snellen Ohrschlinge, gebogen, gerieft, 16 cm**  
**Snellen ear loop, curved, serrated, 16 cm**

Art.-Nr./No.	Größe / Size (mm)
10-265-01	1
10-265-02	2
10-265-03	3

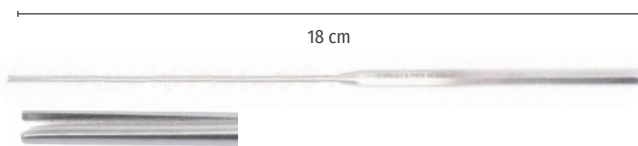

**Ohr-Tamponade-Stopfer Modell Großhadern, 18 cm**  
**Gauze applicator type Großhadern, 18 cm**

10-268-18



**Hartmann Tamponadezängchen, Schaft 6 cm**  
**Hartmann ear tampon forceps, shaft 6 cm**

Art.-Nr./No.	Beschreibung / Description
10-269-01	fein / fine
10-269-02	extra fein / extra fine



**Tilley Ohrtamponadezängchen, Schaft 7 cm**  
**Tilley dressing and sponge holding forceps, shaft 7 cm**

10-271-14

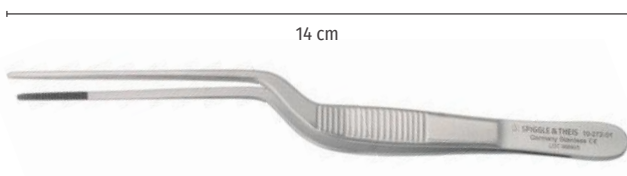

**Lucae Ohrpinzette, bajonett, 14 cm**  
**Lucae dressing forceps, bayonet, 14 cm**

Art.-Nr./No.	Beschreibung / Description
10-272-01	2 mm, fein / 2 mm, fine
10-272-02	1 mm, extra fein / 1 mm, extra fine

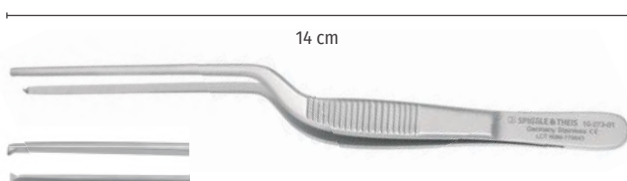

**Lucae Ohrpinzette, bajonett, fein, 1:2 Zähne, 2 mm, 14 cm**  
**Lucae dressing forceps, bayonet, fine, 1:2 teeth, 2 mm, 14 cm**

10-273-01



## 01 Ambulantes Ohr-Instrumentarium

### Diagnostic Ear Instruments

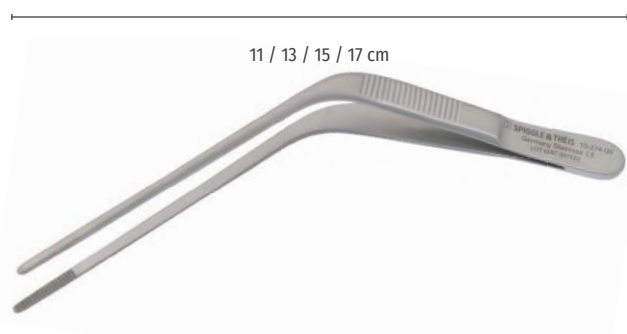

**Troeltsch Ohrpinzette, kniegebogen, 2 mm**  
Troeltsch dressing forceps, angled, 2 mm

Art.-Nr./No.	Länge / Length (cm)
10-274-00	13
10-274-01	11
10-274-02	15
10-274-03	17

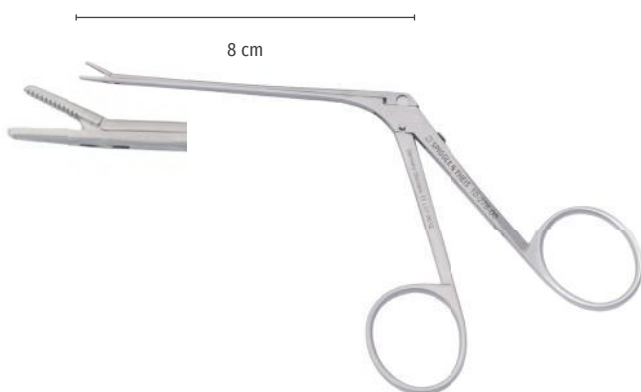

**Hartmann Ohrzängchen, gerade, gerieft, 8 x 1,8 mm, 8 cm**  
Hartmann ear forceps, straight, serrated, 8 x 1.8 mm, 8 cm

**10-276-00**



**Hartmann Ohrzängchen, gerieft, gerade, 1:2 Zähne, 2,5 x 10 mm, 8,5 cm**

Hartmann ear forceps, serrated, straight, 1:2 teeth, 2.5 x 10 mm, 8.5 cm

**10-276-01**

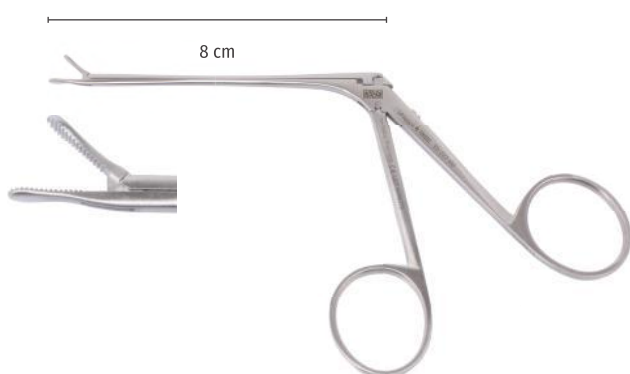

**Duckbill Ohrzängchen, schnabelförmig, gerieft, 8 cm**  
Duckbill ear forceps, flat jaws, serrated, 8 cm

**10-277-00**

## 01 Ambulantes Ohr-Instrumentarium

### Diagnostic Ear Instruments

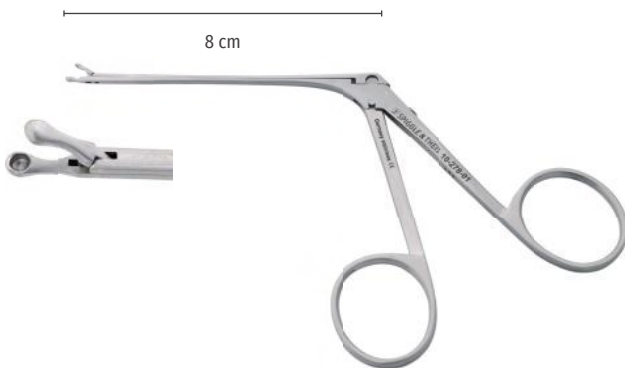

**Hartmann Ohrzängchen, runde Löffel, 8 cm**

Hartmann ear forceps, round cups, 8 cm

Art.-Nr./No.	Größe / Size
10-278-01	1 (1,5 mm)
10-278-02	2 (2,0 mm)
10-278-03	3 (2,5 mm)
10-278-04	4 (3,0 mm)



**Hoffmann Ohrzängchen, durchschneidend, rund, 8 cm**

Hoffmann ear forceps, throughcutting, round, 8 cm

Art.-Nr. Art.-No.	Größe Size (mm)	Winkel Angle
10-279-00	2,5	gerade / straight
10-279-01	2,0	gerade / straight
10-279-45	2,0	45° aufwärts / 45° upwards

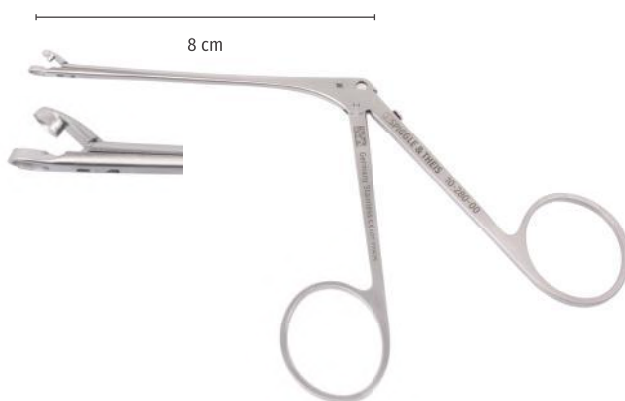

**Hoffmann Ohrzängchen, durchschneidend, oval, 1,8 x 3,4 mm, 8 cm**

Hoffmann ear forceps, throughcutting, oval, 1,8 x 3,4 mm, 8 cm

**10-280-00**

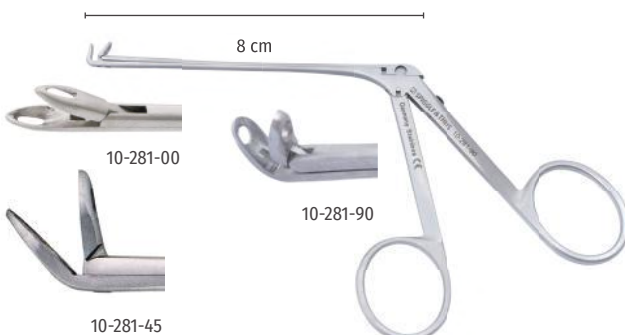

**Strümpel Ohrzängchen, oval, gefenestert**

Strümpel ear forceps, oval, fenestrated

Art.-Nr. Art.-No.	Größe Size (mm)	Winkel Angle
10-281-00	7,0 x 2,5 mm, 8,0 cm	0°
10-282-45	6,5 x 2,5 mm, 8,7 cm	45°
10-282-90	6,0 x 2,5 mm, 8,7 cm	90°



## 01 Ambulantes Ohr-Instrumentarium

### Diagnostic Ear Instruments

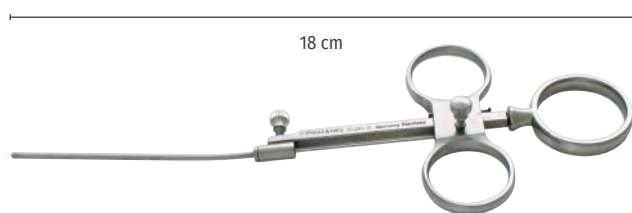

**Krause Ohrpolypenschnürer, 18 cm**  
Krause ear polyp snare, 18 cm

10-283-18



**Führungsrohr für Krause Ohrpolypenschnürer, 8,5 cm**  
Cannula for Krause ear polyp snare, 8.5 cm

10-283-98



**Schlingenführer für Krause Ohrpolypenschnürer, 16 cm**  
Stylet for Krause ear polyp snare, 16 cm

10-283-99



**Schlingen für Krause Ohrpolypenschnürer, 0,2 mm, 9,5 cm**  
Wire loops for Krause ear polyp snare, 0.2 mm, 9.5 cm

Art.-Nr./No.	Stück / Pieces
10-284-12	12
10-284-00	100

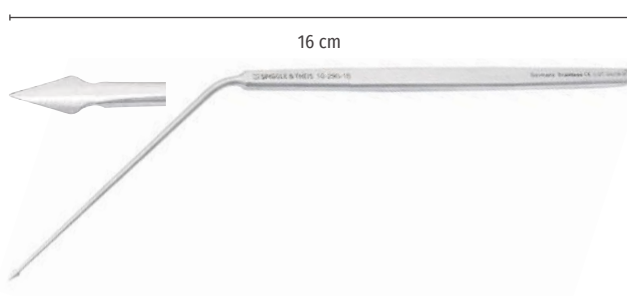

**Politzer Parazentesemesser, kniegebogen, 16 cm**  
Politzer myringotomy blade, angled, 16 cm

10-290-16

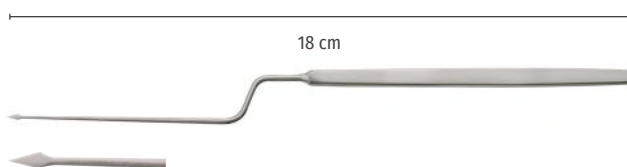

**Lucae Parazentesemesser, bajonett, gebogen, 18 cm**  
Lucae myringotomy blade, bayonet, angled, 18 cm

10-291-18

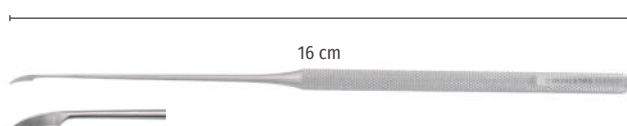

**Wullstein Sichelmesser, leicht gebogen, fein, 16 cm**  
Wullstein sickle knife, slightly curved, delicate, 16 cm

10-618-01



## 01 Ambulantes Ohr-Instrumentarium

### Diagnostic Ear Instruments



**Saugrohr, kniegebogen, zylindrisch**  
Suction tube, angled, cylindrical

Art.-Nr./No.	AD / OD (mm)	Länge / Length (cm)
10-300-10	1,0	9
10-300-15	1,5	9
10-300-20	2,0	9
10-300-25	2,5	11
10-300-30	3,0	11
10-300-40	4,0	11
10-300-50	5,0	11



**Saugrohr, kniegebogen, konisch**  
Suction tube, angled, conical

Art.-Nr./No.	AD / OD (mm)	Länge / Length (cm)
10-302-30	3,0	11
10-302-35	3,5	11
10-302-45	4,5	13



**Saugrohr, gerade, biegsam, konisch, 3,0 mm, 19,5 cm**  
Suction tube, straight, bendable, conical, 3.0 mm, 19.5 cm

10-303-18



**Wollstein Saughandgriff mit Unterbrecher, 10,5 cm**  
Woolstone suction handle with suction control, 10.5 cm

10-305-11

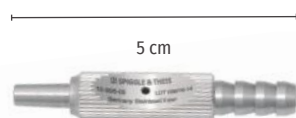

**House Saughandgriff mit Unterbrecher, 5 cm**  
House suction handle with suction control, 5 cm

10-306-05

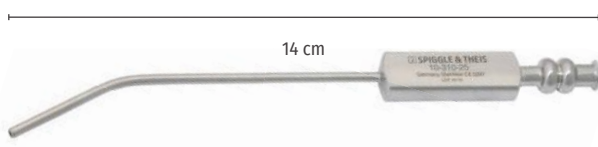

**Zöllner Saugrohr, gewinkelt, 2,5 mm, 14 cm**  
Zöllner suction tube, angled, 2.5 mm, 14 cm

10-310-25



## 01 Ambulantes Ohr-Instrumentarium

### Diagnostic Ear Instruments

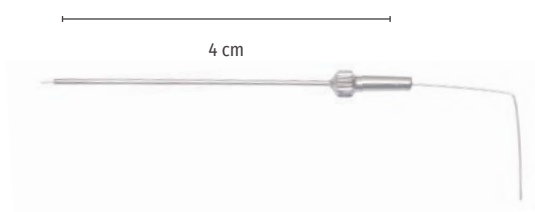

**Zöllner Aufsatzsauger mit Mandrin, 0,7 mm, 4 cm**  
Zöllner suction tip with stylet, 0.7 mm, 4 cm

10-310-07

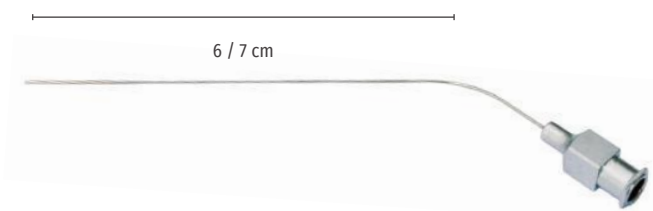

**House Nadelsauger, Luer-Lock, 5 Stück/Box**  
House suction cannula, Luer-Lock, 5 pieces/box

Art.-Nr./No.	AD / OD (mm)		Länge / Length (cm)
10-308-06-05	0,6	◦	7
10-308-08-05	0,8	◦	7
10-308-10-05	1,0	◦	7
10-308-12-05	1,2	◦	7
10-308-15-05	1,5	◦	7
10-308-18-05	1,8	○	7
10-308-20-05	2,0	○	7
10-308-22-05	2,2	○	7
10-308-25-05	2,5	○	7
10-308-30-05	3,0	○	7
10-309-06-05	0,6	◦	6
10-309-08-05	0,8	◦	6
10-309-10-05	1,0	◦	6
10-309-12-05	1,2	◦	6

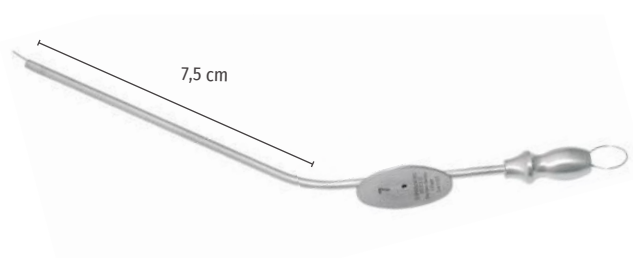

**Baron Saugrohr mit Griffplatte und Unterbrecher, 7,5 cm**  
Baron suction tube with suction control, 7.5 cm

Art.-Nr./No.	AD / OD (mm)
10-312-10	1,0
10-312-17	1,5
10-312-23	2,3

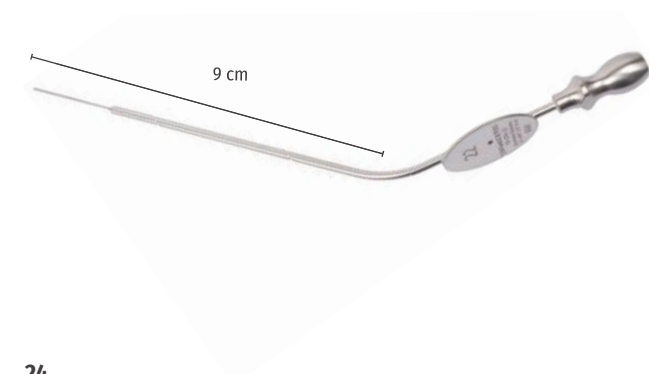

**Schuknecht Saugrohr mit Unterbrecher, 45°, 9 cm**  
Schuknecht suction tube with suction control, 45°, 9 cm

Art.-Nr./No.	ID / ID (mm)
10-314-20	0,9
10-314-22	0,7
10-314-24	0,6

## 01 Ambulantes Ohr-Instrumentarium

### Diagnostic Ear Instruments

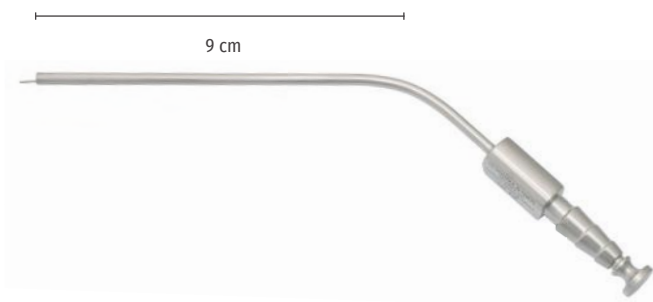

**Frazier Saugrohr, mit Griffplatte und Unterbrecher, 9 cm**  
Frazier suction tube, with suction control, 9 cm

Art.-Nr. Art.-No.		AD / OD Ch/Fr = mm
30-080-05	○	5 = 1,6
30-080-06	○	6 = 2,0
30-080-07	○	7 = 2,3
30-080-08	○	8 = 2,7
30-080-09	○	9 = 3,0
30-080-10	○	10 = 3,3
30-080-12	○	12 = 4,0
30-080-15	○	15 = 5,0



**Frazier Saugrohr, konisch, mit tränenförmigem Unterbrecher, 8 cm**  
Frazier suction tube, conical, with tear shaped suction control, 8 cm

Art.-Nr. Art.-No.		AD / OD Ch/Fr = mm
30-105-06	○	6 = 2,0
30-105-08	○	8 = 2,7
30-105-10	○	10 = 3,3

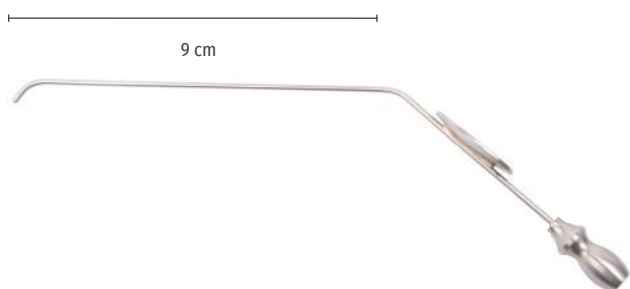

**Verhoeven Saugrohr mit Griffplatte, abwärts gebogen, 9 cm**  
Verhoeven suction tube with finger plate, downwards curved, 9 cm

Art.-Nr./No.		AD / OD
10-314-15	○	1,5
10-313-24	○	2,0



**Verhoeven Saugrohr mit Griffplatte, aufgebogen, 9 cm**  
Verhoeven suction tube with finger plate, upcurved, 9 cm

Art.-Nr./No.		AD / OD
10-314-14	○	1,5
10-313-23	○	2,0



## 01 Ambulantes Ohr-Instrumentarium

### Diagnostic Ear Instruments

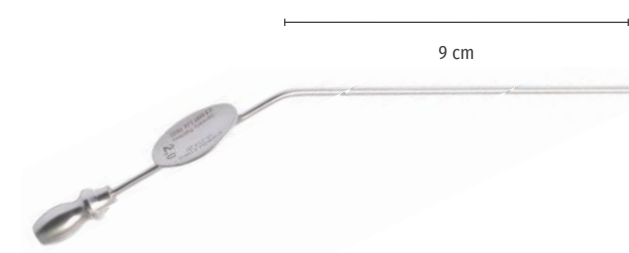

**Verhoeven Saugrohr mit Griffplatte, 9 cm, gerade**  
**Verhoeven suction tube with finger plate, 9 cm, straight**

Art.-Nr./No.		ID / ID (mm)
10-313-12	○	1,2
10-314-13	○	1,5
10-313-20	○	2,0

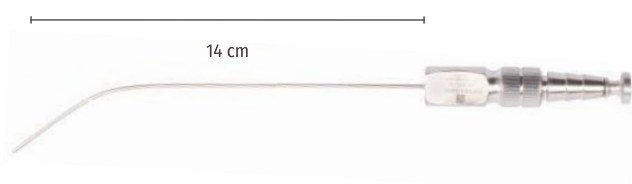

**Plester Saugrohr mit Griffplatte und Unterbrecher, 14 cm**  
**Plester suction tube with suction control, 14 cm**

Art.-Nr./No.		ID / ID (mm)
10-315-15	○	1,5
10-315-20	○	2,0
10-315-25	○	2,5
10-315-30	○	3,0

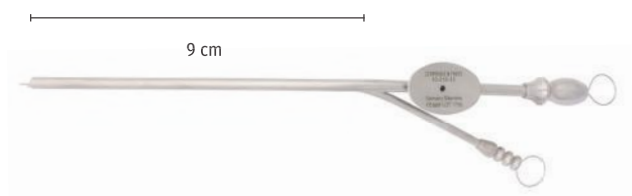

**House Saug- und Spülrohr mit Unterbrecher, zylindrisch, 9 cm**  
**House suction and irrigation tube with suction control, cylindrical, 9 cm**

Art.-Nr./No.	ID / ID (mm)
10-318-14	1,3 x 1,0
10-318-15	1,6 x 1,4
10-318-23	2,3 x 1,5
10-318-33	3,3 x 2,3
10-318-45	4,0 x 2,5





**Langenbeck Raspatorium, Breite 16 mm, 19,5 cm**  
Langenbeck raspatory, width 16 mm, 19.5 cm

10-348-19



**Farabœuf Periost Raspatorium, Breite 13 mm, 15 cm**  
Farabœuf periost raspatory, width 13 mm, 15 cm

Art.-Nr./No.	Beschreibung / Description
10-350-13	gebogen / curved
10-351-13	gerade / straight



**Fisch Raspatorium, Breite 10 mm, 15,5 cm**  
Fish raspatory, width 10 mm, 15.5 cm

10-347-17

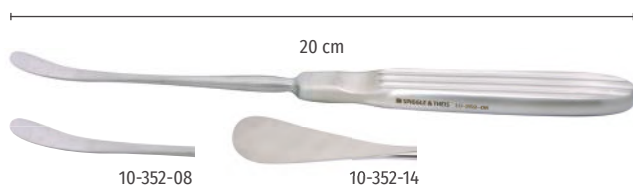

**Cottle Raspatorium, gebogen, 20 cm / Cottle raspatory, curved, 20 cm**

Art.-Nr./No.	Größe / Size (mm)
10-352-08	8
10-352-14	14

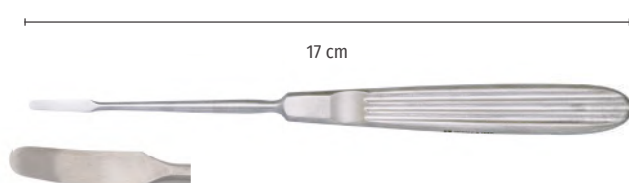

**Lempert Raspatorium, 17 cm / Lempert raspatory, 17 cm**

Art.-Nr. Art.-No.	Größe Size (mm)	Beschreibung Description
10-353-02	2	leicht gebogen / slightly curved
10-353-03	3	leicht gebogen / slightly curved
10-353-04	4	leicht gebogen / slightly curved
10-353-05	5	leicht gebogen / slightly curved
10-353-07	7	sehr leicht gebogen very slightly curved
10-354-03	3	stark gebogen / strongly curved



**Plester Gehörgangsraspatorium, flach gebogen, 8 mm, 18 cm**  
Plester raspatory, slightly curved, 8 mm, 18 cm

10-355-08

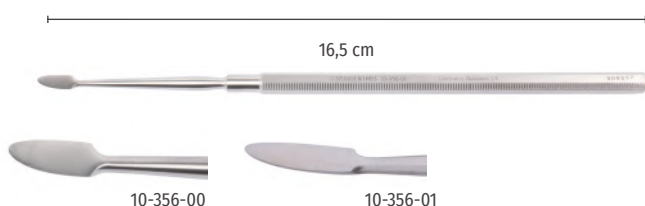

**Wullstein Raspatorium, 16,5 cm / Wullstein raspatory, 16.5 cm**

Art.-Nr./No.	Größe / Size (mm)
10-356-00	4,0
10-356-01	2,5



## 02 Antrotomie

### Antrotomy

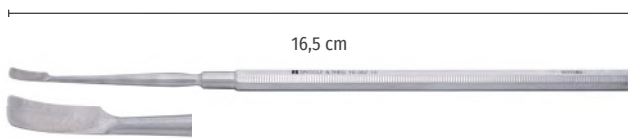

**Wullstein Raspatorium, abgerundete Ecken, 4 mm, 16,5 cm**  
Wullstein raspatory, with rounded edges, 4 mm, 16.5 cm

10-357-18



**Shambough-Derlacki Duckbill-Raspatorium, leicht gebogen, 3 mm, 14,5 cm**

Shambough-Derlacki duckbill raspatory, slightly curved, 3 mm, 14.5 cm

10-358-15

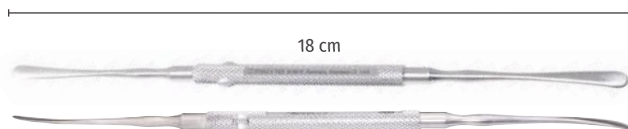

**Freer Doppellevatorium, scharf/stumpf, 18 cm**

Freer elevator, double ended, sharp/blunt, 18 cm

20-305-18

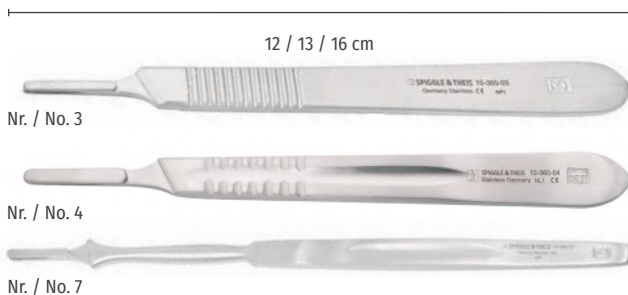

**Skalpelle-Griff / Scalpel handle**

Art.-Nr./No.	Nr. / No.	Länge / Length (cm)
10-360-03	3	12
10-360-04	4	13
10-360-07	7	16

**Skalpelle-Klingen, einzeln steril verpackt, 100 Stück**

Scalpel blades, single sterile packed, 100 pieces

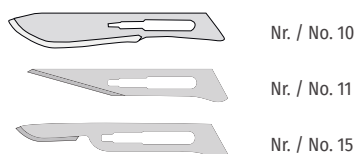

Art.-Nr./No.	Nr. / No.	Beschreibung / Description
10-360-10	10	gerundet / rounded
10-360-11	11	spitz / pointed
10-360-15	15	gerundet / rounded



**Trautmann Hohlmeißel, 14 cm / Trautmann gouge, 14 cm**

Art.-Nr./No.	Größe / Size (mm)
10-365-02	2
10-365-04	4
10-365-06	6
10-365-08	8



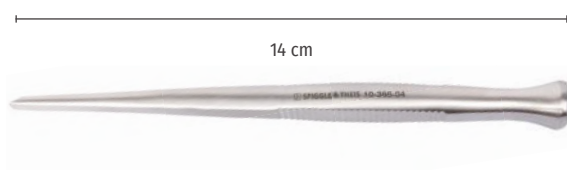

**Trautmann Flachmeißel, 14 cm / Trautmann chisel, 14 cm**

Art.-Nr./No.	Größe / Size (mm)	
10-366-02	2	┌
10-366-04	4	┌
10-366-06	6	┌
10-366-08	8	┌

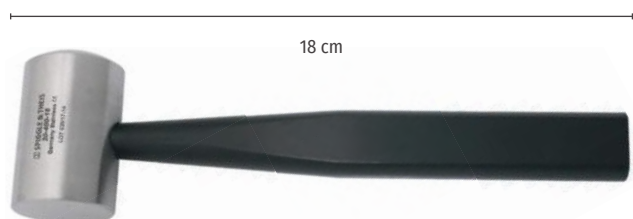

**Cottle Hammer, 18 cm / Cottle mallet, 18 cm**

**20-400-18**

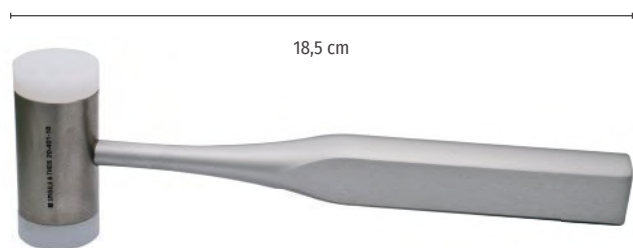

**Metallhammer mit auswechselbaren Nylonbacken, 18,5 cm  
Metal mallet with convertible nylon facings, 18.5 cm**

**20-401-18**



**Nylon-Ersatzbacken für Metallhammer, 25 mm, Paar  
Nylon spare facings for metal mallet, 25 mm, pair**

**20-401-99**

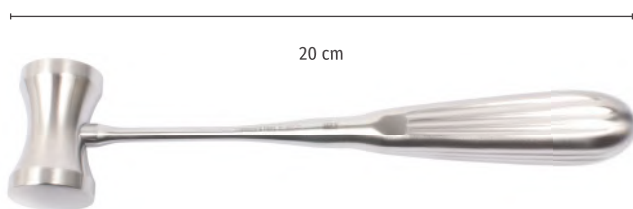

**Hajek Metallhammer, 200 g, 20 cm**

**Hajek metal mallet, 200 g, 20 cm**

**20-402-21**

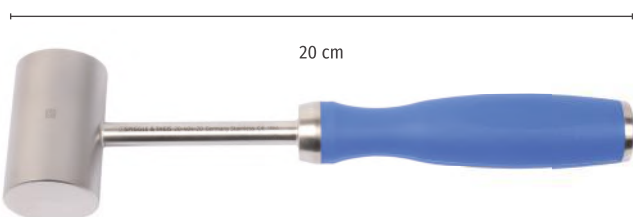

**Hammer mit Silikongriff, 20 cm**

**Mallet with silicone handle, 20 cm**

**20-404-20**



## 02 Antrotomie

### Antrotomy

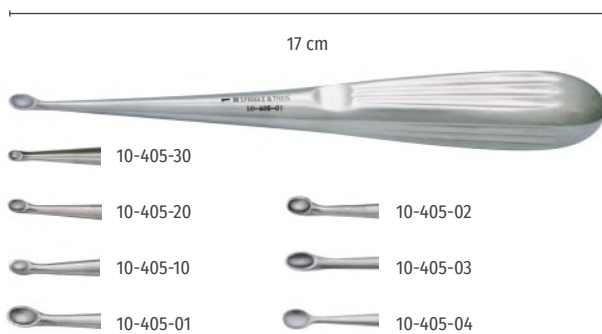

#### Spratt Mastoid-Löffel, 17 cm / Spratt mastoid curette, 17 cm

Art.-Nr./No.	Größe / Size
10-405-30	000
10-405-20	00
10-405-10	0
10-405-01	1
10-405-02	2
10-405-03	3
10-405-04	4

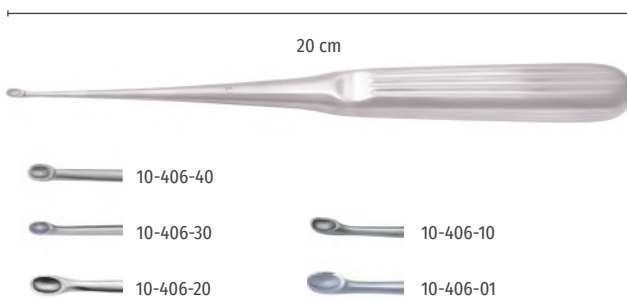

#### Lempert Mastoid-Löffel, 20 cm / Lempert mastoid curette, 20 cm

Art.-Nr./No.	Größe / Size
10-406-40	0000
10-406-30	000
10-406-20	00
10-406-10	0
10-406-01	1

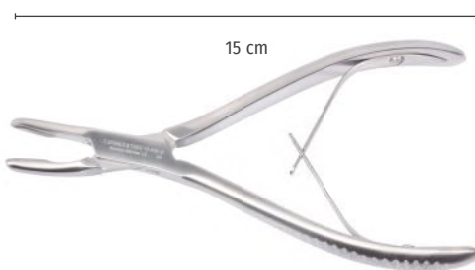

#### Luer Knochenzange, gebogen, 15 cm

Luer rongeur, curved, 15 cm

10-408-15

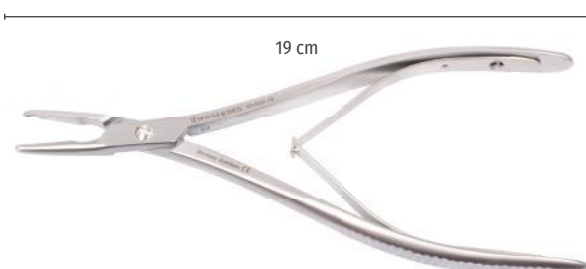

#### Lempert Knochenzange, 19 cm / Lempert rongeur, 19 cm

Art.-Nr./No.	Beschreibung / Description
10-409-19	gerade / straight
10-410-19	gebogen / curved

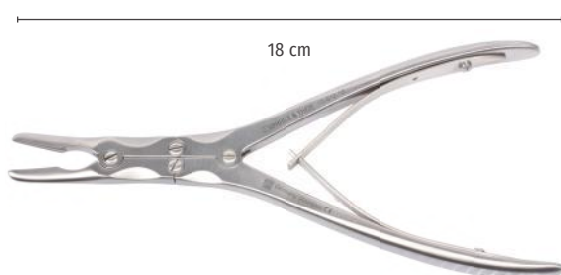

**Beyer Knochenzange, gebogen, Doppelgelenk, 18 cm**  
**Beyer rongeur, curved, double joint 18 cm**

10-412-18



**Citelli Knochenstanze, 8,7 cm / Citelli bone punch, 8.7 cm**

Art.-Nr./No.

Größe / Size

10-415-02

2 (2 mm)

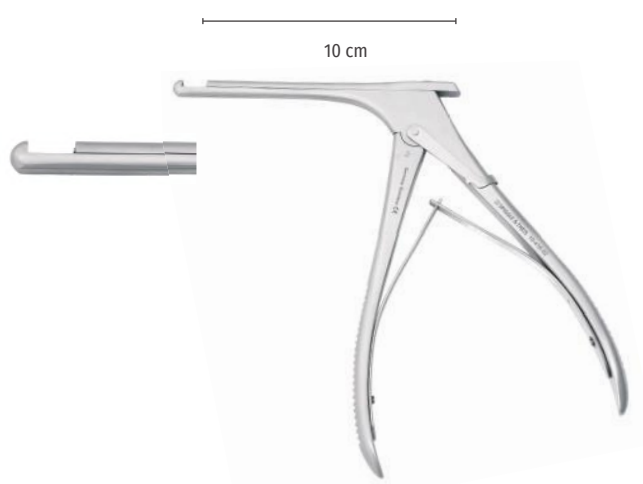

**Kerrison Knochenstanze, komplett zerlegbar, 10 cm**  
**Kerrison bone punch, fully detachable, 10 cm**

Art.-Nr./No.

Größe / Size

10-416-01

1 (4,0 mm)

10-416-02

2 (4,5 mm)

10-416-03

3 (5,0 mm)



# Präzision - Schärfe - Sicherheit

## Precision - Sharpness - Safety

Low- and HighSpeed		Osteotomiebohrer, Hartmetall oder Stahl, 70 mm Osteotomy burs, carbide or steel, 70 mm
Low- and HighSpeed		Osteotomiebohrer, Cross-Cut, Hartmetall oder Stahl, 70 mm Osteotomy burs, Cross-Cut, carbide or steel, 70 mm
Low- and HighSpeed		Osteotomiebohrer, A-Verzahnung, Stahl, Hartmetall nur LS, 70 mm Osteotomy burs, A-toothing, steel, carbide LS only, 70 mm
Low- and HighSpeed		Diamantbohrer, mittlere Körnung, 70 mm Diamond burs, medium grain, 70 mm
Low- and HighSpeed		Diamantbohrer, extra grobe Körnung, 70 mm Diamond burs, extra-coarse grain, 70 mm
Low- and HighSpeed		Diamantbohrer, super grobe Körnung, 70 mm Diamond burs, super coarse grain, 70 mm

Bitte beachten Sie, dass es im Bereich der Rotierenden Instrumente eine Vielzahl an Schaftanschliffen, Längen, Kopfformen und anderen Details gibt. Aus diesem Grund ist es nicht möglich, alle Varianten an dieser Stelle abzubilden.

Eine Übersicht über das komplette Produktsortiment erhalten Sie auf **Anfrage unter: +49 (0) 2206 90 81 - 0**

#### Vorteile unserer Rotierenden Instrumente:

- Minimierte Vibrationen
- Weiche Drehbewegungen, die sowohl Bohrer als auch Handstücke schonen
- Effiziente Materialabtragung durch optimal designte Bohrköpfe

Please notice that there are many standards of shank, length, head form and various other details in the range of rotary instruments. For this reason it is impossible to show all available variations on this page.

For a complete overview of our entire bur assortment **please ask your local distributor.**

#### Advantages of our rotary instruments:

- Minimum vibration
- Smooth rotary action protects burs and handpieces
- Efficient removal of tissue due to optimized bur head design

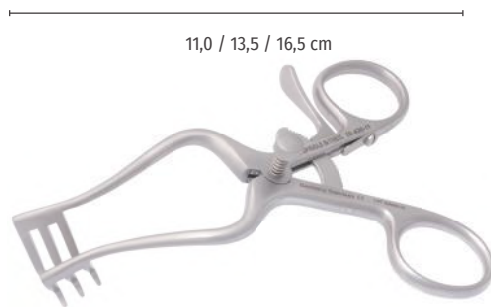

11,0 / 13,5 / 16,5 cm

**Wullstein Wundsperrer, 3:3 Zähne, halbscharf, zerlegbar**  
**Wullstein retractor, 3:3 prongs, semi-sharp, dismountable**

Art.-Nr./No.	Länge / Length (cm)
10-420-11	11,0
10-420-13	13,5
10-420-16	16,0

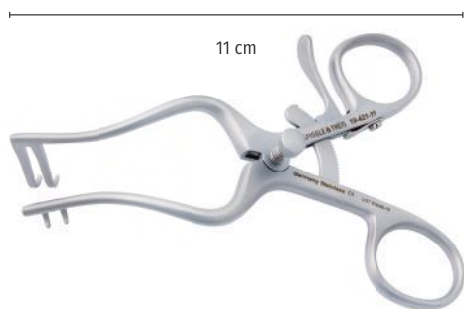

11 cm

**Plester Wundsperrer, 2:2 Zähne, halbscharf, extra fein, 11 cm, zerlegbar**

**Plester retractor, 2:2 prongs, semi-sharp, extra fine, 11 cm, dismountable**

**10-421-11**



11 / 13,5 cm

**Plester Wundsperrer, 2:2 Zähne, halbscharf, zerlegbar**

**Plester retractor, 2:2 prongs, semi-sharp, dismountable**

Art.-Nr./No.	Länge / Length (cm)
10-422-11	11,0
10-422-13	13,5



13,5 cm

**Schuknecht-Fisch Wundsperrer, gewinkelt, 3:3 Zähne, halbscharf, 13,5 cm, zerlegbar**

**Schuknecht-Fisch retractor, angled, 3:3 prongs, semi-sharp, 13.5 cm, dismountable**

**10-423-13**

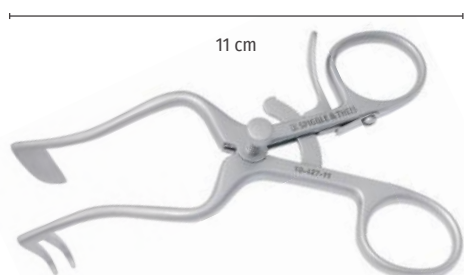

11 cm

**Plester Wundsperrer, 11 cm, zerlegbar**

**Plester retractor, 11 cm, dismountable**

Art.-Nr./No.	Beschreibung / Description
10-426-11	2 Zähne rechts, Blatt links 2 prongs right, blade left
10-427-11	2 Zähne links, Blatt rechts 2 prongs left, blade right



## 04 Wundsperrer

### Retractors



**Plester Wundsperrer, 3 Zähne rechts, Blatt links, 13,5 cm, zerlegbar**  
**Plester retractor, 3 prongs right, blade left, 13.5 cm, dismantlable**

**10-426-13**

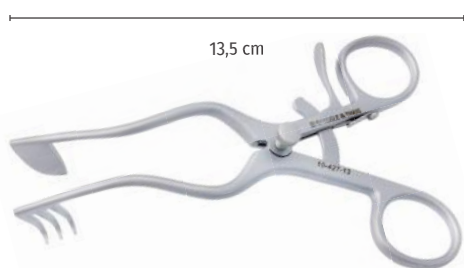

**Plester Wundsperrer, 3 Zähne links, Blatt rechts, 13,5 cm, zerlegbar**  
**Plester retractor, 3 prongs left, blade right, 13.5 cm, dismantlable**

**10-427-13**



**Helms Wundsperrer, 11 cm, zerlegbar**  
**Helms retractor, 11 cm, dismantlable**

Art.-Nr./No.	Beschreibung / Description
10-428-11	2 Zähne rechts, Blatt mit Noppen links 2 prongs right, studded blade left
10-429-11	2 Zähne links, Blatt mit Noppen rechts 2 prongs left, studded blade right

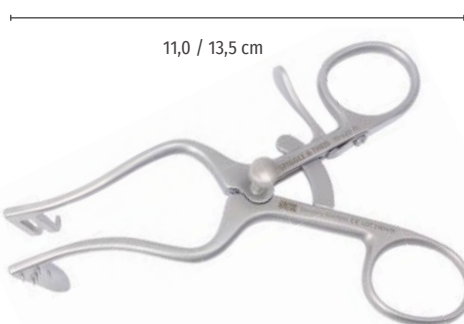

**Perkins Wundsperrer, 2 Zähne rechts, gezahntes Blatt links, zerlegbar**  
**Perkins retractor, 2 prongs right, pointed blade left, dismantlable**

Art.-Nr./No.	Länge / Length (cm)
10-432-11	11,0
10-432-13	13,5

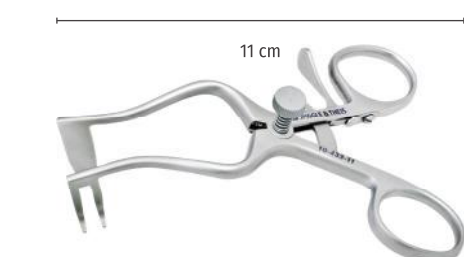

**Perkins Wundsperrer, 2 Zähne links, gezahntes Blatt rechts, 11 cm, zerlegbar**  
**Perkins retractor, 2 prongs left, pointed blade right, 11 cm, dismantlable**

**10-433-11**

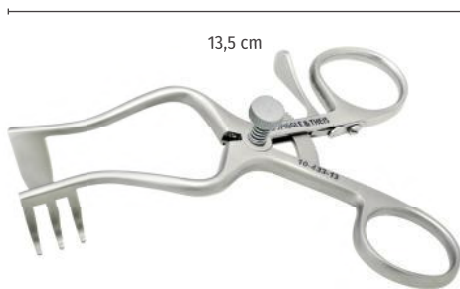

**Perkins Wundsperrer, 3 Zähne links, gezahntes Blatt rechts, 13,5 cm, zerlegbar**  
Perkins retractor, 3 prongs left, pointed blade right, 13.5 cm, dismountable

10-433-13



**Weitlaner Wundsperrer, 3:4 Zähne, stumpf, zerlegbar, gerade, 13,5 cm**  
Weitlaner retractor, 3:4 prongs, blunt, dismountable, straight, 13.5 cm

10-437-13



**Weitlaner Wundsperrer, 2:3 Zähne, stumpf, zerlegbar**  
Weitlaner retractor, 2:3 prongs, blunt, dismountable

Art.-Nr./No.	Länge / Length (cm)
10-434-11	11,0
10-434-13	13,5



**Wigand endauraler Wundsperrer, 11 cm, zerlegbar**  
Wigand endaural retractor, 11 cm, dismountable

Art.-Nr./No.	Beschreibung / Description
10-430-11	2 Zähne rechts, geriefte Platte links 2 prongs right, serrated plate left
10-431-11	2 Zähne links, geriefte Platte rechts 2 prongs left, serrated plate right

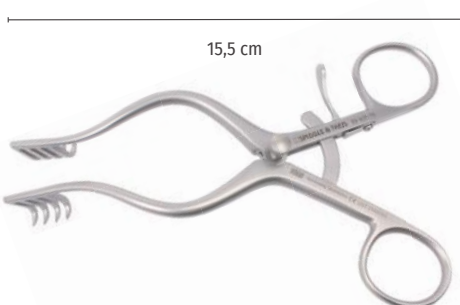

**Mollison Wundsperrer, 4:4 Zähne, 15,5 cm, zerlegbar**  
Mollison retractor, 4:4 prongs, 15.5 cm, dismountable

10-435-15





## 04 Wundsperrer

### Retractors



**Fisch Wundsperrer mit Gelenken,  
3:3 Zähne, halbscharf, 16,5 cm, zerlegbar**  
Fish retractor, with joint, 3:3 prongs, semi-sharp,  
16.5 cm, dismantlable

10-438-17

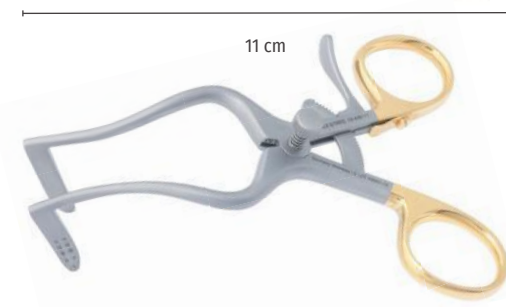

**Preyer Wundsperrer, schmales Blatt, Griff vergoldet,  
beidseits mit Noppen, 11 cm, zerlegbar**  
Preyer retractor, slim blade, gold plated grip,  
studded on both sides, 11 cm, dismantlable

10-446-11

**Black Line**  
Ultimate Edition



**Preyer Wundsperrer Black Line, schmales Blatt, Griff vergoldet,  
beidseits mit Noppen, 11 cm, zerlegbar**  
Preyer retractor Black Line, slim blade, gold plated grip,  
studded on both sides, 11 cm, dismantlable

10-446-11B

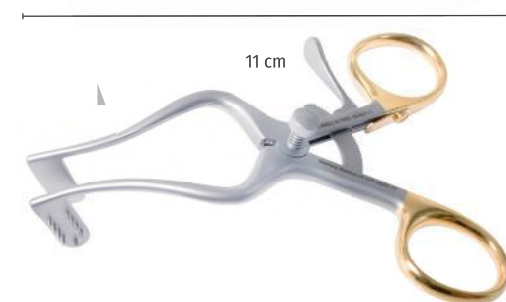

**Dazert Wundsperrer, beidseits mit langen Noppen,  
Griff vergoldet, zerlegbar, 11 cm**  
Dazert retractor, long studs on both sides,  
gold plated grip, dismantlable, 11 cm

10-447-11



**Williger Wundhaken, 4 scharfe Zähne, 13,5 cm**  
Williger retractor, 4 sharp prongs, 13.5 cm

10-466-13



**Williger Wundhaken, 3 scharfe Zähne, 13,5 cm**  
Williger retractor, 3 sharp prongs, 13.5 cm

10-467-13

## 05 Pinzetten

### Dressing Forceps

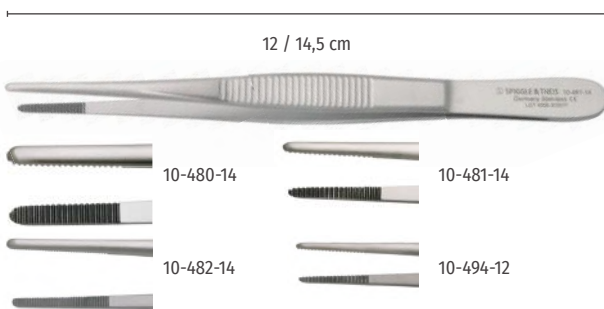

#### Pinzette, anatomisch, gerade

#### Dressing forceps, anatomical, straight

Art.-Nr./No.	Spitze / Tip (mm)	Länge / Length (cm)
10-480-14	3,5	14,5
10-481-14	2,0	14,5
10-482-14	1,7	14,5
10-494-12	1,3	12,0

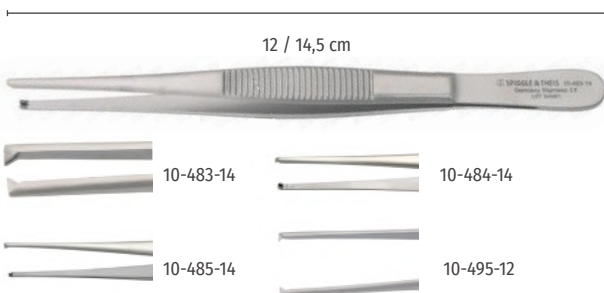

#### Pinzette, chirurgisch, 1:2 Zähne, gerade

#### Dressing forceps, 1:2 teeth, straight

Art.-Nr./No.	Spitze / Tip (mm)	Länge / Length (cm)
10-483-14	2,3	14,5
10-484-14	1,7	14,5
10-485-14	1,4	14,5
10-495-12	1,5	12,0

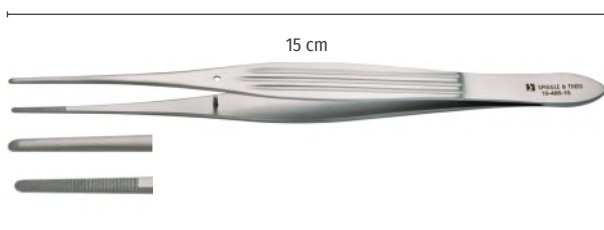

#### McIndoe Pinzette, anatomisch, gerade, 2 mm, 15 cm

#### McIndoe dressing forceps, anatomical, straight, 2 mm, 15 cm

10-485-15

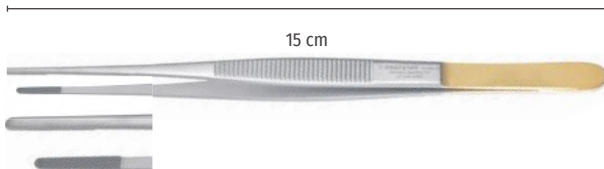

#### Pinzette, Hartmetall, anatomisch, gerade, 1,5 mm, 15 cm

#### Dressing forceps, tungsten carbide, anatomical, straight, 1,5 mm, 15 cm

10-488-15

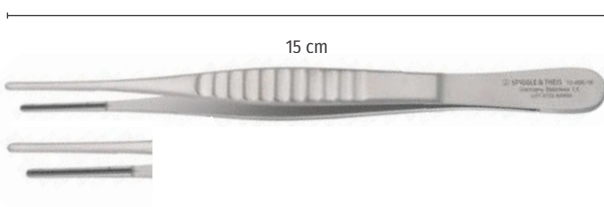

#### DeBakey Pinzette, atraumatisch, gerade, 15 cm

#### DeBakey dressing forceps, atraumatic, straight, 15 cm

Art.-Nr./No.	Spitze / Tip (mm)
10-486-16	2,0
10-487-16	1,5

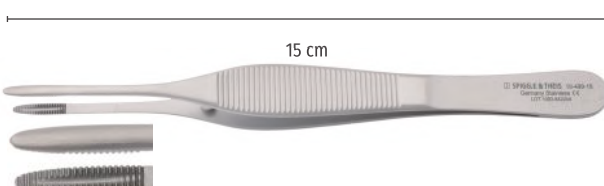

#### Helms Pinzette, anatomisch, gerade, 2,8 mm, 15 cm

#### Helms dressing forceps, anatomical, straight, 2.8 mm, 15 cm

10-489-15



## 05 Pinzetten

### Dressing Forceps

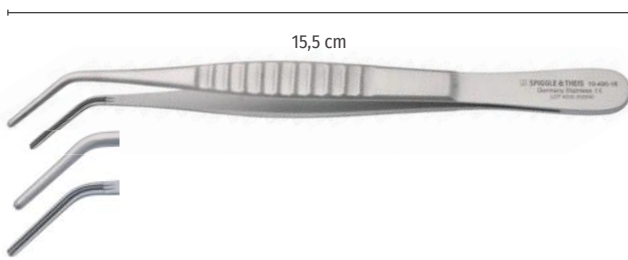

**DeBakey Pinzette, atraumatisch, gewinkelt, 15,5 cm**  
DeBakey dressing forceps, atraumatic, angled, 15.5 cm

Art.-Nr./No.	Spitze / Tip (mm)
10-490-16	2,0

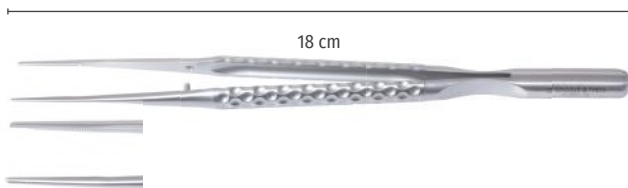

**Atrauma-Mikro-Pinzette, mit Gewicht, gerade, Führungsstift, Golfball-Design, 1,2 mm, 18 cm**  
Atrauma micro forceps, with counterweight & guide pin, straight, golfball-design, 1.2 mm, 18 cm

**10-491-18**

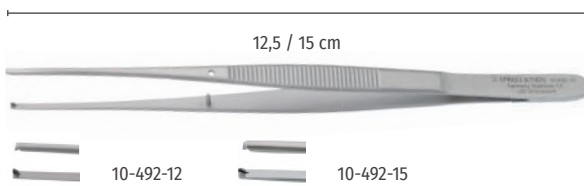

**Semken Pinzette, fein, 1:2 Zähne**  
Semken dressing forceps, fine, 1:2 teeth

Art.-Nr./No.	Länge / Length (cm)
10-492-12	12,5
10-492-15	15,0

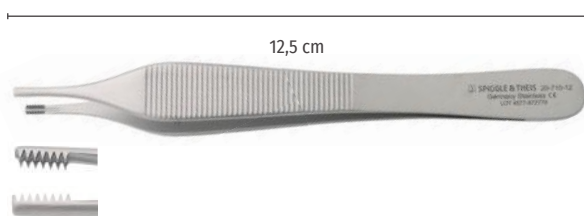

**Adson-Brown Pinzette, 7:8 Zähne, 12,5 cm**  
Adson-Brown forceps, 7:8 teeth, 12.5 cm

**20-710-12**

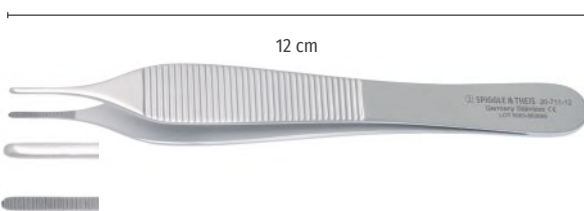

**Adson Pinzette, anatomisch, 12 cm**  
Adson dressing forceps, anatomical, 12 cm

**20-711-12**

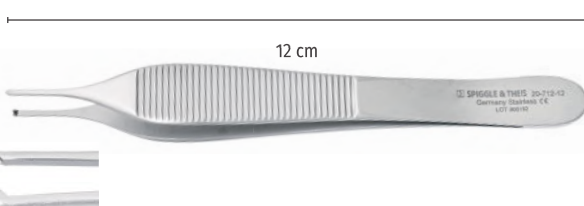

**Adson Pinzette, chirurgisch, 1:2 Zähne, 12 cm**  
Adson dressing forceps, 1:2 teeth, 12 cm

**20-712-12**

## 05 Pinzetten

### Dressing Forceps

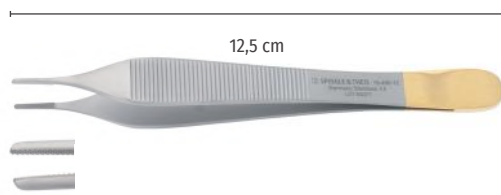

**Adson Pinzette, Hartmetall, anatomisch, 12,5 cm**  
Adson dressing forceps, tungsten carbide, anatomical, 12.5 cm

10-496-12



**Derlacki Gehörknöchelchen-Pinzette, 7:8 Zähne, 12,5 cm**  
Derlacki ossicle holding forceps, 7:8 teeth, 12.5 cm

10-497-12

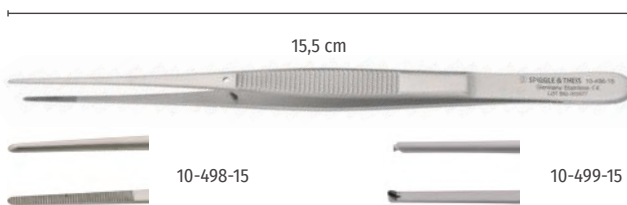

**Wullstein Pinzette, gerade, 1 mm, 15,5 cm**  
Wullstein dressing forceps, straight, 1 mm, 15.5 cm

Art.-Nr./No.	Beschreibung / Description
10-498-15	anatomisch / anatomical
10-499-15	chirurgisch / 1:2 teeth

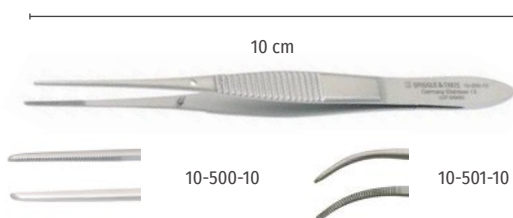

**Graefe Pinzette, anatomisch, 0,7 mm, 10 cm**  
Graefe dressing forceps, anatomical, 0.7 mm, 10 cm

Art.-Nr./No.	Beschreibung / Description
10-500-10	gerade / straight
10-501-10	gebogen / curved

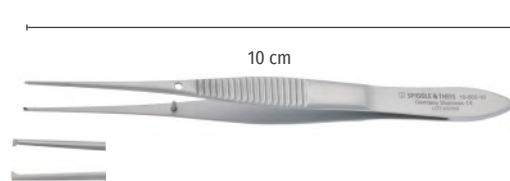

**Graefe Pinzette, chirurgisch, 1:2 Zähne, gerade, 0,7 mm, 10 cm**  
Graefe dressing forceps, 1:2 teeth, straight, 0.7 mm, 10 cm

10-502-10

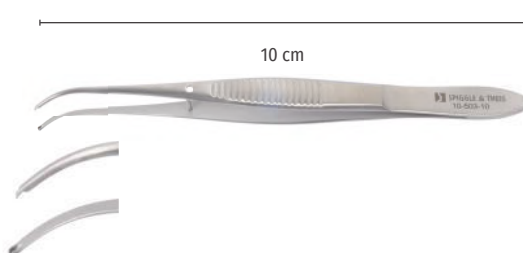

**Graefe Pinzette, chirurgisch, 1:2 Zähne, gebogen, 0,7 mm, 10 cm**  
Graefe dressing forceps, 1:2 teeth, curved, 0.7 mm, 10 cm

10-503-10



## 05 Ring-Pinzetten

### Ring Forceps



Dr. med. Rainer Zimmermann  
Leitender Oberarzt der Universitäts-  
HNO-Klinik Tübingen

Dr. Rainer Zimmermann M.D.,  
Senior consultant at the ENT clinic,  
University of Tübingen, Germany

Operative Zugänge zum inneren Gehörgang, insbesondere auch zur Akustikusneurinom-Chirurgie, sind meist sehr klein. Häufig vermisst der HNO-Chirurg ein geeignetes Instrument, um zum Beispiel beim Fundus des inneren Gehörganges um die "Ecke" greifen zu können. Hierzu eignen sich Ringpinzetten mit verschiedenen Winkeln und verschiedenen Größen, sowohl mit als auch ohne Koagulationsmöglichkeit. In der Praxis haben sich die neu konstruierten Pinzetten hervorragend bewährt.

Operative access to the inner ear, particularly during acoustic neurinoma surgery is often very small. It would be helpful for the surgeon if, when working in the inner ear canal, he had an instrument with which he can reach around corners. Ring forceps meet this need. They are available in various angles and sizes, as well as with and without coagulation facilities. In practice, the newly constructed ring forceps have proved themselves to be an excellent solution.

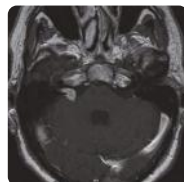

Intra-extrameatales AN links  
(Grad II)

Intra-extrameatal  
AN left (2nd degree)

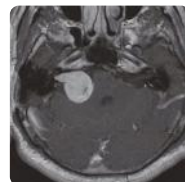

Intra-extrameatales AN rechts  
(Grad IV-V)

Intra-extrameatal  
AN right (4th - 5th degree)

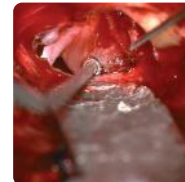

Transtemporale AN-Operation  
links

Transtemporal  
AN surgery left



Translabrynthäre AN-Operation  
rechts

Translabrynthine  
AN surgery right



#### sehr fein, 16 cm / very fine, 16 cm

Art.-Nr./No.	AD / OD (mm)
80-201-01	1,0
80-201-02	2,0
80-201-03	3,0



#### Zimmermann Akustikusneurinom, sehr fein, 16 cm

#### Zimmermann Acoustic neurinoma, very fine, 16 cm

Art.-Nr./No.	Winkel / Angle	AD / OD (mm)
80-202-01	70°-80° aufwärts 70°-80° upwards	1,0
80-202-02	45° aufwärts 45° upwards	2,0

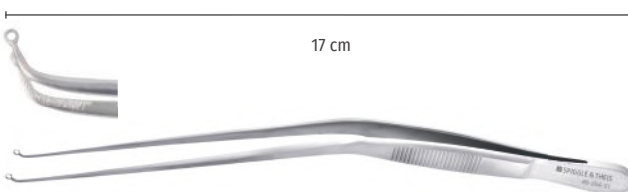

#### Zimmermann Akustikusneurinom,

#### 80° aufwärts, AD 2 mm, ID 1 mm, 17 cm

#### Zimmermann Acoustic neurinoma,

#### 80° upwards, OD 2 mm, ID 1 mm, 17 cm

#### 80-204-01

## 05 Pinzetten

### Dressing Forceps

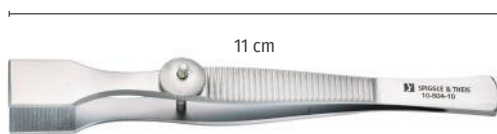

**Hildmann Knorpelpinzette, gerade, 11 cm**  
Hildmann cartilage forceps, straight, 11 cm

10-504-10

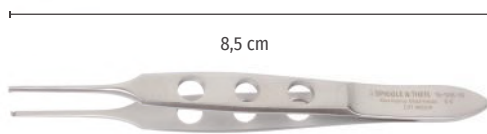

**Pinzette nach Bishop-Harmon, 1 : 2 Zähne, Länge 8,5 cm**  
Forceps by Bishop-Harmon, 1 : 2 teeth, length 8.5 cm

Art.-Nr./No.	Spitze / Tip (mm)
10-506-05	0,5
10-506-10	1,0

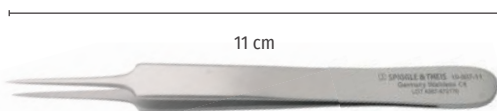

**Uhrmacherpinzette, spitz, 11 cm**  
Jeweller forceps, pointed, 11 cm

10-507-11

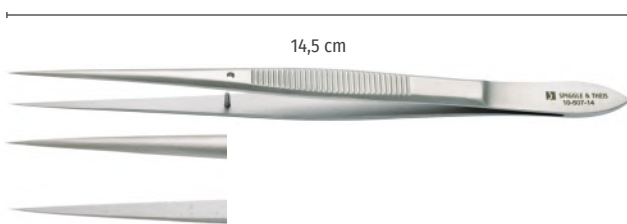

**Uhrmacherpinzette, spitz, 14,5 cm**  
Jeweller forceps, pointed, 14.5 cm

10-507-14

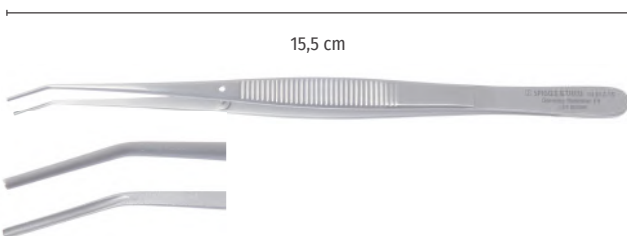

**Einführpinzette, gewinkelt, Längsnut, 15,5 cm**  
Insertion forceps, angled, longitudinal groove, 15.5 cm

10-512-15



**06 Scheren**  
**Scissors**

Linkshänder Scheren  
auf Anfrage  
Left handed scissors  
on request



**Schere, gerade, spitz-spitz**  
**Scissors, straight, pointed**

Art.-Nr./No.	Länge / Length (cm)	Beschreibung / Description
10-530-10	10,5	sehr fein / very fine
10-530-12	11,5	

10 teeth/mm  
SUPER cut



**Schere, supercut, spitz-spitz, sehr fein, 11,5 cm**  
**Scissors, supercut, pointed, very delicate, 11.5 cm**

Art.-Nr./No.	Beschreibung / Description
10-531-12	gerade / straight
10-534-12	gebogen / curved

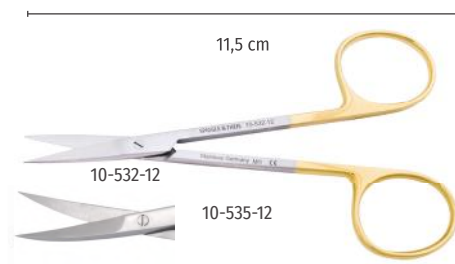

**Schere, Hartmetall, spitz-spitz, 11,5 cm**  
**Scissors, tungsten carbide, pointed, 11.5 cm**

Art.-Nr./No.	Beschreibung / Description
10-532-12	gerade / straight
10-535-12	gebogen / curved

**Black Line**  
Ultimate Edition



**Schere Black Line, Hartmetall, spitz-spitz, 11,5 cm**  
**Scissors Black Line, tungsten carbide, pointed, 11.5 cm**

Art.-Nr./No.	Beschreibung / Description
10-532-12B	gerade / straight
10-532-12WB	gerade, Wellenschliff / straight, wavy
10-535-12B	gebogen / curved
10-535-12WB	gebogen, Wellenschliff / curved, wavy

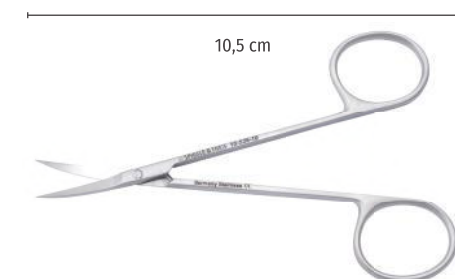

**Schere, gebogen, spitz-spitz, extra fein, 10,5 cm**  
**Scissors, curved, pointed, very fine, 10.5 cm**

**10-536-10**





**Schere, gebogen, spitz-spitz, fein**  
**Scissors, curved, pointed, delicate**

Art.-Nr./No.	Länge / Length (cm)
10-533-10	10,5
10-533-12	11,5



**Joseph Schere, spitz-spitz, 14,5 cm**  
**Joseph scissors, pointed, 14.5 cm**

Art.-Nr./No.	Beschreibung / Description
20-600-14	gerade / straight
20-601-14	gebogen / curved

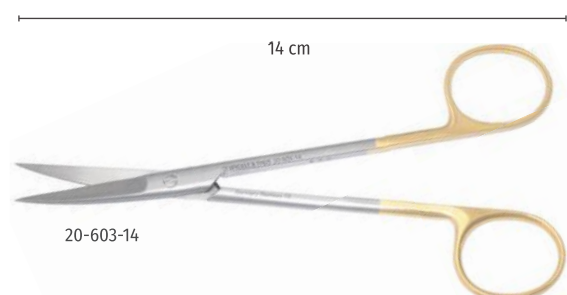

**Joseph Schere, Hartmetall, spitz-spitz, 14 cm**  
**Joseph scissors, tungsten carbide, pointed, 14 cm**

Art.-Nr./No.	Beschreibung / Description
20-602-14	gerade / straight
20-603-14	gebogen / curved

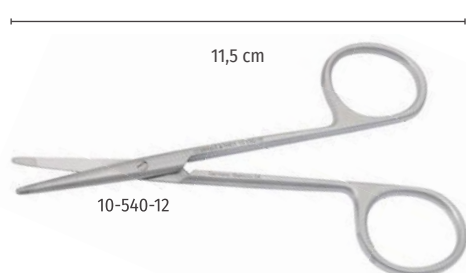

**Schere, stumpf-stumpf, 11,5 cm**  
**Scissors, blunt, 11.5 cm**

Art.-Nr./No.	Beschreibung / Description
10-540-12	gerade / straight
10-543-12	gebogen / curved

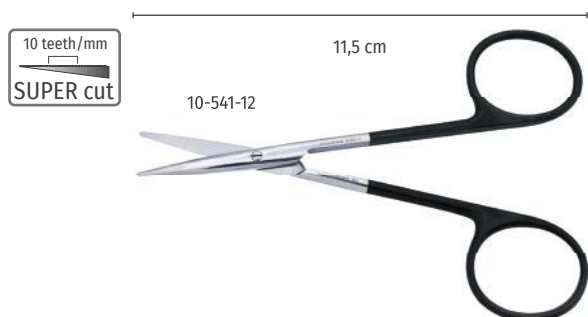

**Schere, supercut, stumpf-stumpf, 11,5 cm**  
**Scissors, supercut, blunt, 11.5 cm**

Art.-Nr./No.	Beschreibung / Description
10-541-12	gerade / straight
10-544-12	gebogen / curved



## 06 Scheren

### Scissors



11,5 cm

**Schere, Hartmetall, gerade, stumpf-stumpf, 11,5 cm**  
**Scissors, tungsten carbide, straight, blunt, 11.5 cm**

**10-542-12**



11,5 cm

**Schere, Hartmetall, gebogen, stumpf-stumpf, 11,5 cm**  
**Scissors, tungsten carbide, curved, blunt, 11.5 cm**

**10-545-12**



15 cm

**Reynolds Schere, stumpf-stumpf, gebogen, verjüngte Spitzen, 15 cm**  
**Reynolds scissors, blunt, curved, tapered tips, 15 cm**

**20-610-15**



14,5 cm

**Metzenbaum Schere, stumpf-stumpf, 14,5 cm**  
**Metzenbaum scissors, blunt, 14.5 cm**

Art.-Nr./No.	Beschreibung / Description
20-612-14	gebogen / curved
20-612-15	gerade / straight
20-614-15	gebogen, fein / curved, fine



14,5 cm

**Metzenbaum Schere, Hartmetall, stumpf-stumpf, 14,5 cm**  
**Metzenbaum scissors, tungsten carbide, blunt, 14.5 cm**

Art.-Nr./No.	Beschreibung / Description
20-613-15	gerade / straight
20-615-15	gebogen / curved

20-613-15

20-615-15

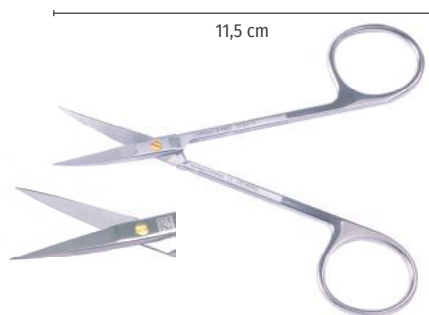

**Schere, spitz-spitz, Premium Line, 11,5 cm**  
**Scissor, pointed, Premium Line, 11,5 cm**

Art.-Nr./No.	Beschreibung / Description
20-647-12	gerade, straight
20-648-12	gebogen, curved

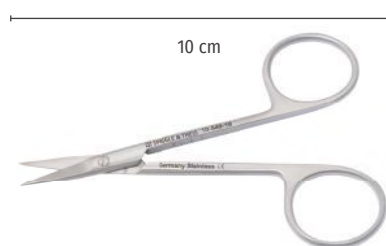

**Schuknecht Drahtschneidescherchen, gezahnt, gerade, 10 cm**  
**Schuknecht wire cutting scissors, serrated, straight, 10 cm**

10-549-10



**Universalschere, gebogen, spitz-stumpf, 13 cm**  
**Universal scissors, curved, pointed-blunt, 13 cm**

10-550-13



**Cooper-Schere, gebogen, spitz-stumpf, 14,5 cm**  
**Cooper scissors, curved, pointed-blunt, 14.5 cm**

80-448-15



**Spencer Drahtschneideschere, 11 cm**  
**Spencer wire cutting scissors, 11 cm**

10-552-11

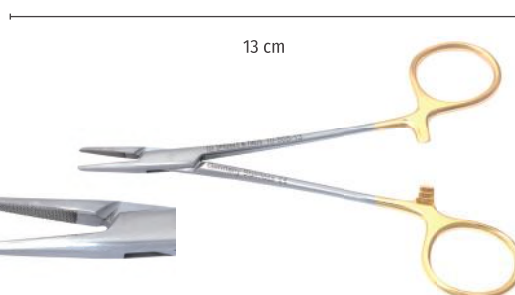

**Halsey Nadelhalter, Hartmetall, fein, 13 cm**  
**Halsey needle holder, tungsten carbide, delicate, 13 cm**

Art.-Nr./No.	Beschreibung / Description
10-555-13	
10-556-13	ohne Sperre / without ratchet



## 07 Mikrochirurgische Instrumente

### Microsurgery Instruments

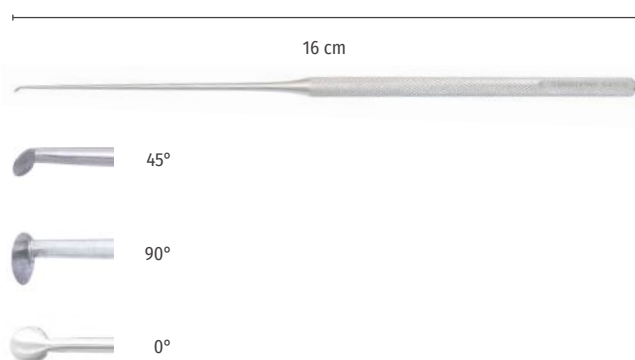

#### Rosen Rundschnittmesser, 16 cm / Rosen round knife, 16 cm

Art.-Nr./No.	Größe / Size (mm)	Winkel / Angle
10-610-10	1,0	45°
10-610-12	1,2	45°
10-610-15	1,5	45°
10-610-18	1,8	45°
10-610-20	2,0	45°
10-610-23	2,3	45°
10-610-25	2,5	45°
10-610-30	3,0	45°
10-611-06	0,6	90°
10-611-10	1,0	90°
10-611-15	1,5	90°
10-611-20	2,0	90°
10-611-25	2,5	90°
10-612-10	1,0	0°
10-612-15	1,5	0°
10-612-20	2,0	0°
10-612-25	2,5	0°
10-612-30	3,0	0°



#### Rosen Raspatorium, oval, 45°, 16 cm

Rosen raspatory, oval, 45°, 16 cm

10-613-00

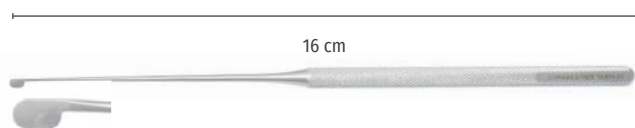

#### Plester Rundschnittmesser, vertikal, oval, 3,5 x 2,5 mm, 16 cm

Plester flap knife, vertical, oval, 3,5 x 2,5 mm, 16 cm

10-614-25

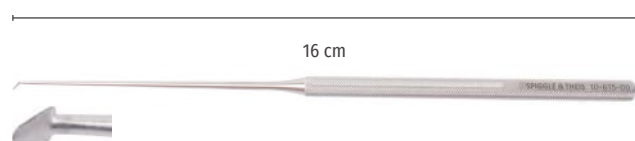

#### Rosen Lanzettmesser, dreieckig, 45°, 16 cm

Rosen lancet knife, triangular, 45°, 16 cm

10-615-00

## 07 Mikrochirurgische Instrumente

### Microsurgery Instruments



**Plester Sichelmesser, gerade, fein, 16 cm**  
Plester sickle knife, straight, delicate, 16 cm

10-616-00



**Fisch Tenotom, 16 cm**  
Fisch sickle knife, 16 cm

10-619-00

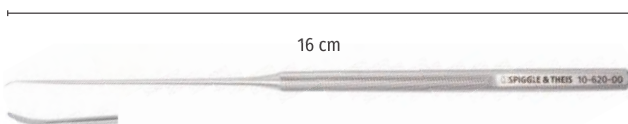

**Stapesgelenk-Messer, 2,2 mm, 20°, 16 cm**  
Incudostapedial joint knife, 2.2 mm, 20°, 16 cm

10-620-00

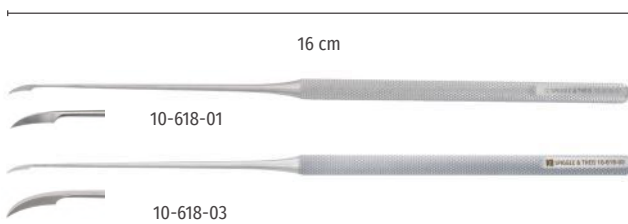

**Wullstein Sichelmesser, fein, 16 cm**  
Wullstein sickle knife, delicate, 16 cm

Art.-Nr./No.	Beschreibung / Description
10-618-01	leicht gebogen / slightly curved
10-618-03	stark gebogen / strongly curved



**Wullstein Sichelmesser, leicht gebogen, sehr fein, 16 cm**  
Wullstein sickle knife, very delicate, slightly curved, 16 cm

10-618-02

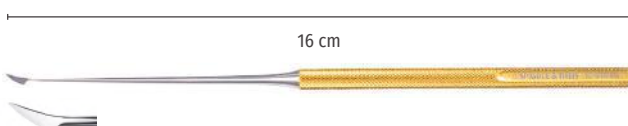

**Teschner Sichelmesser, leicht gebogen, Schneide konvex, 16 cm**  
Teschner sickle knife, slightly curved, convex blade, 16 cm

10-618-04

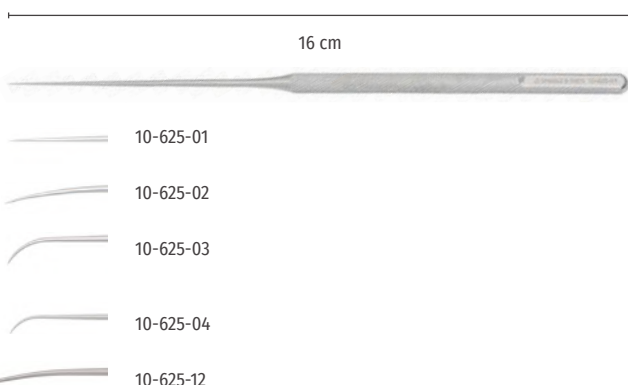

**Wullstein Mikronadel, 16 cm / Wullstein micro needle, 16 cm**

Art.-Nr./No.	Beschreibung / Description
10-625-01	gerade, spitz / straight, pointed
10-625-02	sehr leicht gebogen, spitz / very slightly curved, pointed
10-625-03	stark gebogen, spitz / strongly curved, pointed
10-625-04	leicht gebogen, spitz / slightly curved, pointed
10-625-12	sehr leicht gebogen, stumpf / very slightly curved, blunt



## 07 Mikrochirurgische Instrumente

### Microsurgery Instruments

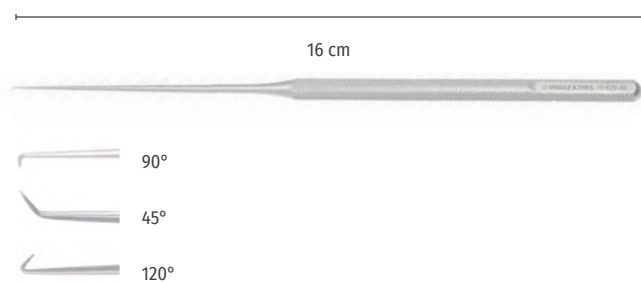

#### Wullstein Mikrohäkchen, 16 cm / Wullstein micro hook, 16 cm

Art.-Nr. Art.-No.	Hakenlänge Length of hook (mm)	Winkel Angle
10-628-02	0,2	90°
10-628-04	0,4	90°
10-628-05	0,5	90°
10-628-06	0,6	90°
10-628-08	0,8	90°
10-628-10	1,0	90°
10-628-12	1,2	90°
10-628-15	1,5	90°
10-628-20	2,0	90°
10-628-25	2,5	90°
10-628-30	3,0	90°
10-628-40	4,0	90°
10-630-02	0,2	45°
10-630-04	0,4	45°
10-630-06	0,6	45°
10-630-08	0,8	45°
10-630-10	1,0	45°
10-630-12	1,2	45°
10-630-15	1,5	45°
10-630-20	2,0	45°
10-630-25	2,5	45°
10-631-18	1,8	120°



## Wullstein Mikrohäkchen "Colour Line", 16 cm

## Wullstein Microhook "Colour Line", 16 cm

Die Verwendung von Etiketten oder Aufklebern zur Kennzeichnung von Instrumenten gilt inzwischen als überholt. Beschriftungsverlust, Klebereste und Hygienrisiken gehören mit der "Colour Line" von SPIGGLE & THEIS der Vergangenheit an. Die Farbcodierung bei unserer Wullstein Mikrohäkchen "Colour Line"-Serie ermöglicht eine schnelle und sichere Identifizierung von Winkel und Länge.

The use of labels or stickers for marking instruments is now considered obsolete. Caption loss, adhesive residue and hygiene risks are now no more inevitable concomitants of the unique instrument identification.

The colour coding of SPIGGLE & THEIS leads to a rapid and reliable identification of angle and length of the Wullstein microhooks from the "Colour Line" series.

### Vorteile:

- Biokompatibel
- Autoklavierbar
- Hohe Haft-, Stoß- und Abriebbeständigkeit
- Kein Verblassen durch gängige Desinfektionsverfahren oder maschinelle Reinigungsmethoden

### Advantages:

- Biocompatible
- Autoclavable
- Non-conductive
- No fading by continuous disinfection process or mechanical cleaning methods



### Schnelle Identifizierung von Winkel und Länge des Häkchens:

#### Fast identification of angle and length of the hook:

Farbcodierung grün / Colour coding green = 45°

Farbcodierung rot / Colour coding red = 90°

Längenidentifizierung pro Ring / Length per ring = 0,2 mm

Art.-Nr. Art.-No.	Ringe Rings	Hakenlänge Length of hook (mm)	Winkel Angle
10-626-02	1 roter / red	0,2	90°
10-626-04	2 rote / red	0,4	90°
10-626-06	3 rote / red	0,6	90°
10-626-08	4 rote / red	0,8	90°
10-626-10	5 rote / red	1,0	90°
10-627-02	1 grüner / green	0,2	45°
10-627-04	2 grüne / green	0,4	45°
10-627-06	3 grüne / green	0,6	45°
10-627-08	4 grüne / green	0,8	45°
10-627-10	5 grüne / green	1,0	45°



## 07 Mikrochirurgische Instrumente

### Microsurgery Instruments



Prof. Dr. Marco Caversaccio  
Chefarzt, Inselspital, HNO-Klinik  
der Universität-Bern

Prof. Dr. Marco Caversaccio  
Department of ORL, Head and Neck Surgery,  
University Inselspital Bern, Switzerland

Die Ausmessung der Perforationsgröße einer Trommelfellperforation ist essentiell. Durch drei verschiedene Größen kann das Gewebe optimal zurechtgeschnitten und zur Deckung der Trommelfellperforation eingesetzt werden. In der Praxis haben sich die verschiedenen Tympanosizer sehr bewährt und zu einer qualitativen Verbesserung des zurechtzuschneidenden Gewebes geführt, was auch zu einer Operationszeitreduktion geführt hat.

The measurement of the perforation size of an eardrum perforation is essential. By three different sizes, the tissue can be optimally trimmed and used to cover the eardrum perforation. In practice, the various tympanosizers have proven to be very useful and lead to a qualitative improvement in the tissue to be cut, which has also led to an operation time reduction.

**Caversaccio Tympano Sizer,  
kniegebogen, geschwärzt**  
**Caversaccio Tympano Sizer,  
shaft angled, black coated**



Art.-Nr./No.	Größe / Size (mm)
10-609-02 TAN	2,0
10-609-04 TAN	4,0
10-609-06 TAN	6,0



## 07 Mikrochirurgische Instrumente

### Microsurgery Instruments

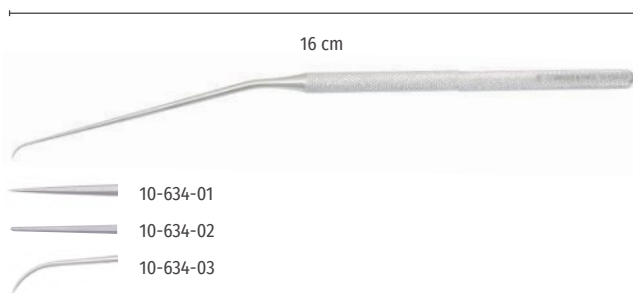

**Schuknecht Mikronadel, Schaft gewinkelt, Nadel gerade, 16 cm**  
**Schuknecht micro needle, shaft angled, straight needle, 16 cm**

Art.-Nr./No.	Beschreibung / Description
10-634-01	scharf / sharp
10-634-02	stumpf / blunt
10-634-03	stark abwärts gebogen strongly curved downwards

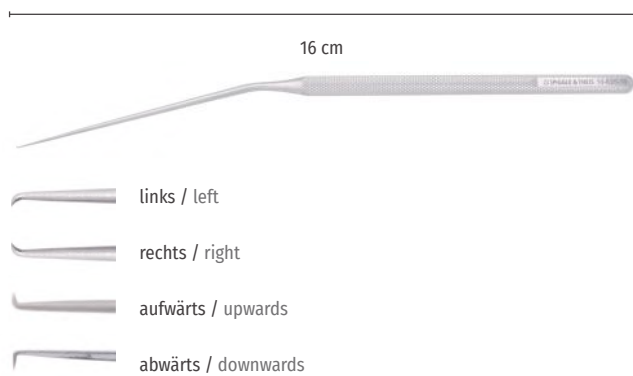

**Schuknecht Mikrohäkchen, Schaft kniegebogen, 16 cm**  
**Schuknecht micro hook, angled shaft, 16 cm**

Art.-Nr. Art.-No.	Hakenlänge Length of hook (mm)	Winkel Angle
10-635-02	0,2	90° aufwärts / upwards
10-635-04	0,4	90° aufwärts / upwards
10-635-06	0,6	90° aufwärts / upwards
10-635-08	0,8	90° aufwärts / upwards
10-635-10	1,0	90° aufwärts / upwards
10-635-12	0,2	90° links / left
10-635-14	0,4	90° links / left
10-635-16	0,6	90° links / left
10-635-18	0,8	90° links / left
10-635-22	0,2	90° rechts / right
10-635-24	0,4	90° rechts / right
10-635-26	0,6	90° rechts / right
10-635-28	0,8	90° rechts / right
10-636-02	0,2	90° abwärts / downwards
10-636-04	0,4	90° abwärts / downwards
10-636-06	0,6	90° abwärts / downwards
10-636-08	0,8	90° abwärts / downwards
10-636-10	1,0	90° abwärts / downwards



## 07 Mikrochirurgische Instrumente

### Microsurgery Instruments

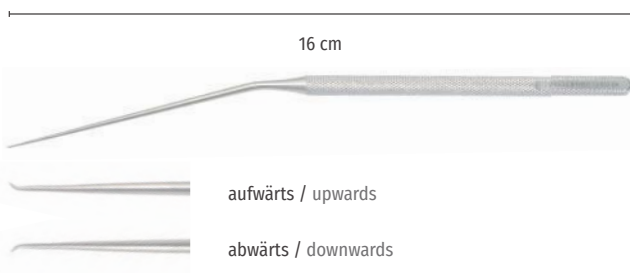

#### Schuknecht Mikrohäkchen, Schaft gewinkelt, 16 cm Schuknecht micro hook, angled shaft, 16 cm

Art.-Nr. Art.-No.	Hakenlänge Length of hook (mm)	Winkel Angle
10-637-02	0,2	45° aufwärts / upwards
10-637-04	0,4	45° aufwärts / upwards
10-637-06	0,6	45° aufwärts / upwards
10-637-08	0,8	45° aufwärts / upwards
10-637-10	1,0	45° aufwärts / upwards
10-637-62	0,2	45° rechts / right
10-638-02	0,2	45° abwärts / downwards
10-638-04	0,4	45° abwärts / downwards
10-638-06	0,6	45° abwärts / downwards
10-638-08	0,8	45° abwärts / downwards
10-638-10	1,0	45° abwärts / downwards

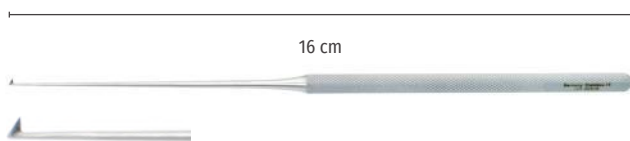

#### Plester Häkchen retrograd, 2 mm, zum Anrauen des Trommelfells, 16 cm Plester hook, retrograde, 2 mm, to abrade the tympanic membrane, 16 cm

10-640-00

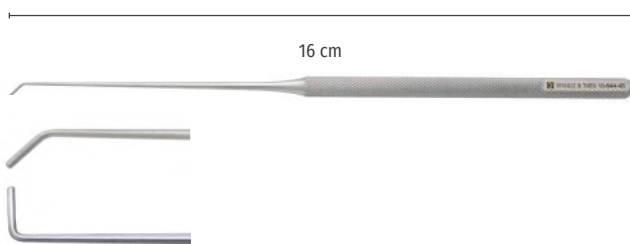

#### Plester Antrumhäkchen, 4 mm, stumpfes Ende, 16 cm Plester antrum hook, 4 mm, blunt tip, 16 cm

Art.-Nr./No.	Winkel / Angle
10-644-45	45°
10-644-90	90°

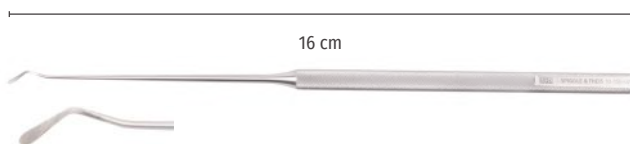

#### Austin Dissektor, 16 cm / Austin dissector, 16 cm

Art.-Nr./No.	Winkel / Angle
10-158-01	rechts gebogen / right curved
10-158-02	links gebogen / left curved

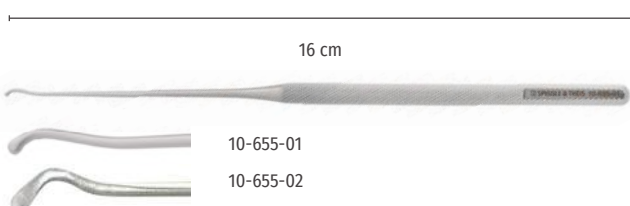

#### Fisch Dissektor, doppelt gebogen, 16 cm Fisch dissector, double curved, 16 cm

Art.-Nr./No.	Winkel / Angle
10-655-01	rechts / right
10-655-02	links / left

## 07 Mikrochirurgische Instrumente

### Microsurgery Instruments

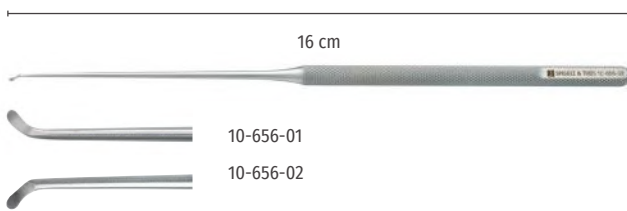

**Fisch Dissektor, einfach gebogen, 16 cm**  
Fisch dissector, single curved, 16 cm

Art.-Nr./No.	Winkel / Angle
10-656-01	rechts / right
10-656-02	links / left

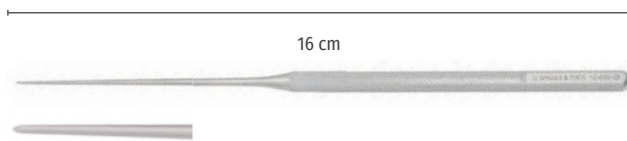

**Fisch Fußplatten-Perforator, 16 cm**  
Fisch footplate perforator, 16 cm

Art.-Nr./No.	AD / OD (mm)
10-658-03	0,3
10-658-04	0,4
10-658-05	0,5
10-658-06	0,6
10-658-08	0,8

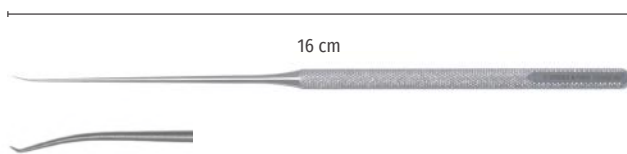

**Zenner Fußplattenhäkchen, 90°, 0,6 mm, gebogener Schaft, 16 cm**  
Zenner footplate hook, 90°, 0.6 mm, curved shaft, 16 cm

10-632-00

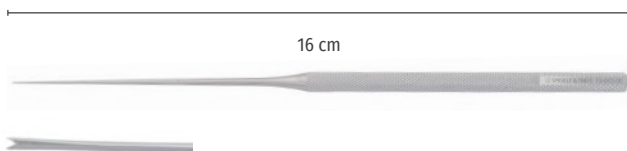

**Plester Einführungsgabel für Stapes-Prothesen, 16 cm**  
Plester guiding fork for stapes prostheses, 16 cm

10-647-00

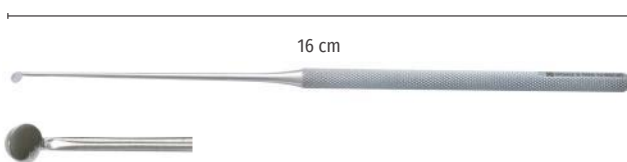

**Paukenspiegel, 3 mm, 16 cm**  
Atticus mirror, 3 mm, 16 cm

10-662-30

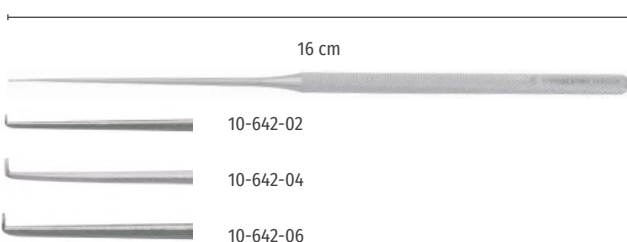

**Plester Fußplattenhäkchen, 16 cm**  
Plester footplate hook, 16 cm

Art.-Nr./No.	Hakenlänge / Length of hook (mm)
10-642-02	0,2
10-642-04	0,4
10-642-06	0,6



## 07 Mikrochirurgische Instrumente

### Microsurgery Instruments

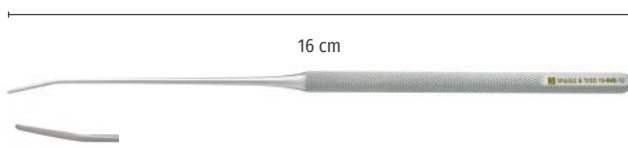

**Rosen Raspatorium, 1 x 12 mm, 16 cm**  
Rosen raspatory, 1 x 12 mm, 16 cm

10-648-12

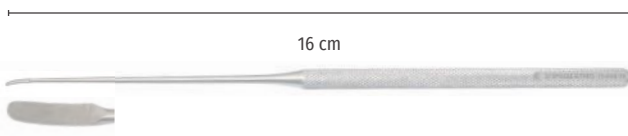

**Beales Elevatorium, 1,5 x 5,5 mm, 16 cm**  
Beales elevator, 1.5 x 5.5 mm, 16 cm

10-649-18

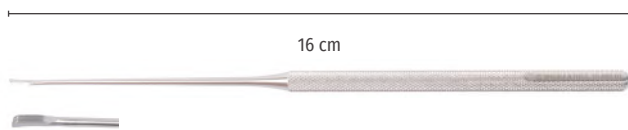

**Mikro-Ritz-Instrument zur Anthelix-Plastik, leicht gebogen, 1,5 x 5 mm, 3 konkave Schneiden, 16 cm**  
Micro scratching instrument for anthelixplasty, slightly curved, 1.5 x 5 mm, 3 concave blades, 16 cm

10-663-01

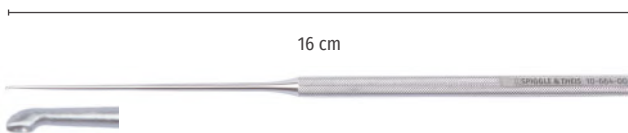

**Mikrolöffel für Cochleostomie, oval, gerade, Schaft gerade, 0,8 x 1,2 mm, 16 cm**  
Curette for cochleostomy, oval cup, straight, straight shaft, 0.8 x 1.2 mm, 16 cm

10-664-00

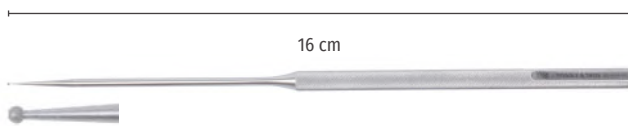

**Handbohrer, Diamant, fein, 0,7 mm, 16 cm**  
Hand burr, diamond, fine, 0.7 mm, 16 cm

10-659-07



**Mikrolöffel, oval, 1,5 x 2,5 mm, 16 cm**  
Curette, oval cup, 1.5 x 2.5 mm, 16 cm

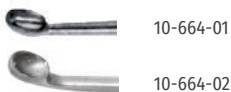

Art.-Nr./No.	Schaft / Shaft	Winkel / Angle
10-664-01	gerade / straight	gerade / straight
10-664-02	gerade / straight	45°
10-664-03	gewinkelt / angled	gerade / straight
10-664-04	gewinkelt / angled	45°

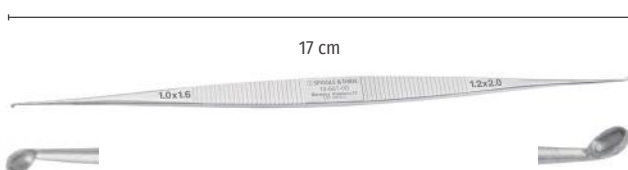

**House Doppellöffel, leicht gebogen, 17 cm**  
House curette, double ended, slightly curved, 17 cm

Art.-Nr./No.	Größe / Size (mm)
10-667-00	1,0 x 1,6 / 1,2 x 2,0 (Gr. / Sz. 0)
10-667-01	1,5 x 2,5 / 1,8 x 2,8 (Gr. / Sz. 1)
10-667-02	2,2 x 3,0 / 2,5 x 3,2 (Gr. / Sz. 2)
10-667-03	2,6 x 3,2 / 2,8 x 3,5 (Gr. / Sz. 3)

## 07 Mikrochirurgische Instrumente

### Microsurgery Instruments



Prof. Dr. med. Serena Preyer  
Chefärztin der HNO-Klinik des  
Diakonissenkrankenhauses Karlsruhe

Prof. Dr. med. Serena Preyer  
Chief physician of the ENT Clinic  
Diakonissenkrankenhauses,  
Karlsruhe, Germany

Der durchschnittliche Durchmesser des Incus beträgt 0,7 mm, der genaue Durchmesser kann jedoch von Patient zu Patient variieren. Aus diesem Grund wurde in Zusammenarbeit mit Prof. Serena Preyer eine Incusgabel mit 0,7 mm Durchmesser entwickelt, um die richtige Größe von Stapes-Prothesen zu ermitteln. Die Größe des Hakens wird bestimmt, indem einfach die Incusgabel über den Incus gelegt wird.

The average diameter of the incus is 0.7 mm, but the exact diameter can vary from patient to patient. For this reason an incus fork with 0.7 mm diameter was developed in collaboration with Prof. Serena Preyer, to ascertain the proper size of stapes prostheses. The size of the hook is determined by simply placing the incus fork over the incus.

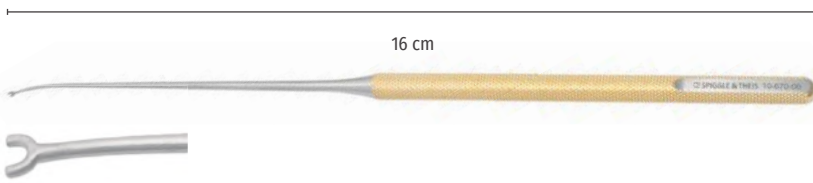

#### Preyer Ambossgabel

Preyer incus fork

10-670-00

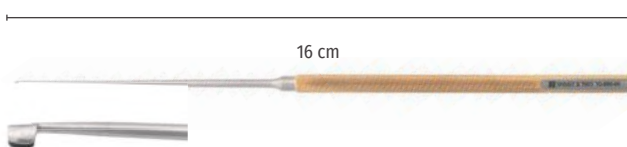

#### Müller Einführungsinstrument für Cochlea Implantate, gerade, vergoldeter Griff, 16 cm

Müller insertion fork for cochlea implants,  
straight, gold plated handle, 16 cm

10-660-00



#### Tisch Mikrolöffel / Tisch micro curette

Art.-Nr./No.	Größe / Size (mm)	Winkel / Angle
10-665-00	universal	Handgriff / handle
10-665-01	(1) 1,5 x 2,3	gerade / straight
10-665-02	(2) 2,0 x 3,5	gerade / straight
10-665-03	(3) 3,0 x 5,0	gerade / straight
10-665-04	(1) 1,5 x 2,3	15° gewinkelt / angled
10-665-05	(2) 2,0 x 3,5	15° gewinkelt / angled
10-665-06	(3) 3,0 x 5,0	15° gewinkelt / angled





## 07a Titan Instrumente nach Prof. Wollenberg

### Prof. Wollenberg Titanium Instruments



Prof. Dr. med. B. Wollenberg  
Direktorin der Klinik und Poliklinik für Hals-, Nasen- und Ohrenheilkunde, Lehrstuhl für Hals-, Nasen- und Ohrenheilkunde der Technischen Universität München (TUM)

Prof. Dr. med. B. Wollenberg  
Director of the clinic and polyclinic for ear, nose and throat medicine, Chair of Otorhinolaryngology at the Technical University Munich (TUM), Germany

Die Implantation der Vibrant Soundbridge (VSB) hat sich in der Therapie der sensorineuralen und der kombinierten Schwerhörigkeiten in z.B. voroperierten Ohren oder bei komplexeren Missbildungen des Mittelohres bewährt. Die Ankopplung der VSB an die vorhandenen anatomischen Strukturen kann durch den Einsatz nicht magnetischer Titan Instrumente erheblich erleichtert werden. Mithilfe der vorgestellten Instrumente, die frequent bei solchen Operationen zum Einsatz kommen, kann die VSB leicht positioniert werden und wird nicht mehr versehentlich von magnetischer Geisterhand bewegt.

Vibrant Soundbridge (VSB) implantation is well established in the surgical treatment of sensorineural as well as combined hearing loss in eg revision middle ear surgery or complex atresia cases. Coupling the VSB to existing anatomical structures can be greatly facilitated using non magnetic Titanium instruments. With the help of the presented instruments frequently used during such operations, the VSB can be easily positioned and will no longer be displaced by a magnetic ghost hand.

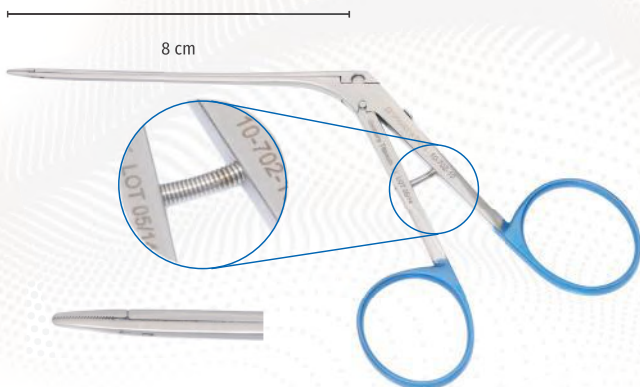

**Hartmann Ohrzängchen, Titan, blau, gerieft, gerade, fein, selbstschließend, 8 cm**

**Hartmann ear forceps, titanium, blue, serrated, straight, delicate, self closing, 8 cm**

Art.-Nr./No.	Größe / Size (mm)
10-702-10	1,0 x 6,0
10-702-11	1,0 x 6,0

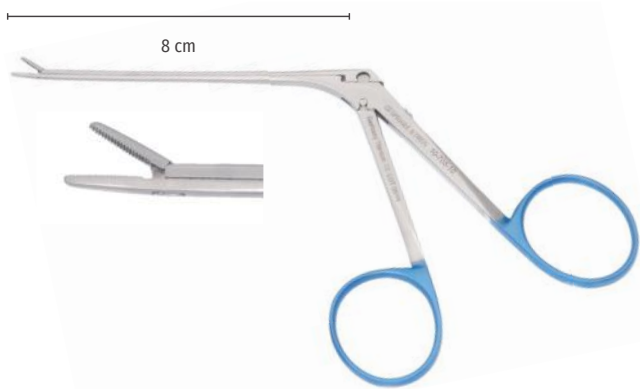

**Hartmann Ohrzängchen, Titan, blau, gerieft, gerade, fein, 1,0 x 6,0 mm, 8 cm**

**Hartmann ear forceps, titanium, blue, serrated, straight, fine, 1.0 x 6.0 mm, 8 cm**

**10-703-10**

## 07a Titan Instrumente nach Prof. Wollenberg

### Prof. Wollenberg Titanium Instruments

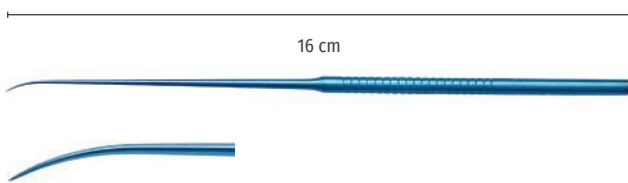

**Mikro-Nadel, Titan, blau, nicht magnetisch, 16 cm**  
**Micro needle, titanium, blue, non-magnetic, 16 cm**

Art.-Nr./No.	Beschreibung / Description
10-600-00	kurze Biegung, leicht gebogen short curve, slightly curved
10-601-00	lange Biegung, sehr leicht gebogen long curve, very slightly curved

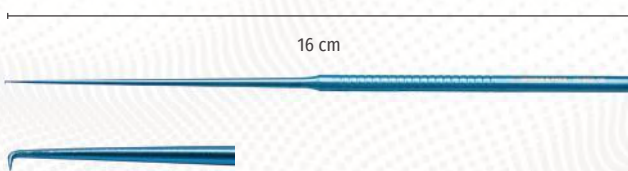

**Mikro-Häkchen, Titan, blau, scharf, nicht magnetisch, 1 mm, 16 cm**  
**Micro hook, titanium, blue, sharp, non-magnetic, 1 mm, 16 cm**

Art.-Nr./No.	Winkel / Angle
10-603-10	90°
10-604-10	45°

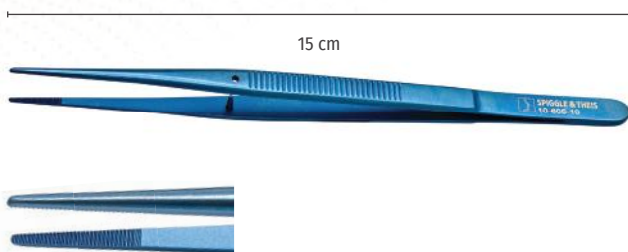

**Mikro-Pinzette, Titan, blau, anatomisch, nicht magnetisch, 1 mm, 15 cm**  
**Micro forceps, titanium, blue, anatomical, non-magnetic, 1 mm, 15 cm**

**10-605-10**





Prof. Giuseppe Panetti,  
Neapel/Naples, Italy

» Die Saugfunktion ermöglicht gleichzeitiges Schneiden und Absaugen mit nur einem Instrument, wodurch die Effizienz deutlich erhöht wird. «

Jedes Instrument besitzt einen Saugkanal mit Sogsteuerung im Handstück. Die Arbeitsteile der Instrumente entsprechen in Form und Funktion denen klassischer Schneidinstrumente für die Mittelohrchirurgie. Die Saugfunktion ermöglicht gleichzeitiges Schneiden und Absaugen

mit nur einem Instrument. Durch die Saugfunktion des Instruments wird die Effizienz spürbar erhöht. Das Beschlagen der Optik wird deutlich verringert, Gewebeablagerungen an der Endoskopspitze können leicht mit Kochsalzlösung entfernt werden.

#### Vorteile der Endoskopischen/Mikroskopischen Instrumente Prof. Panetti:

- Zeitsparend
- Weniger traumatisch für den Patienten
- Vereinfacht das Entfernen versteckter Cholesteatome
- Präparieren und Schneiden bei gleichzeitiger, integrierter Absaugung
- Effektive Sogsteuerung
- Autoklavierbar

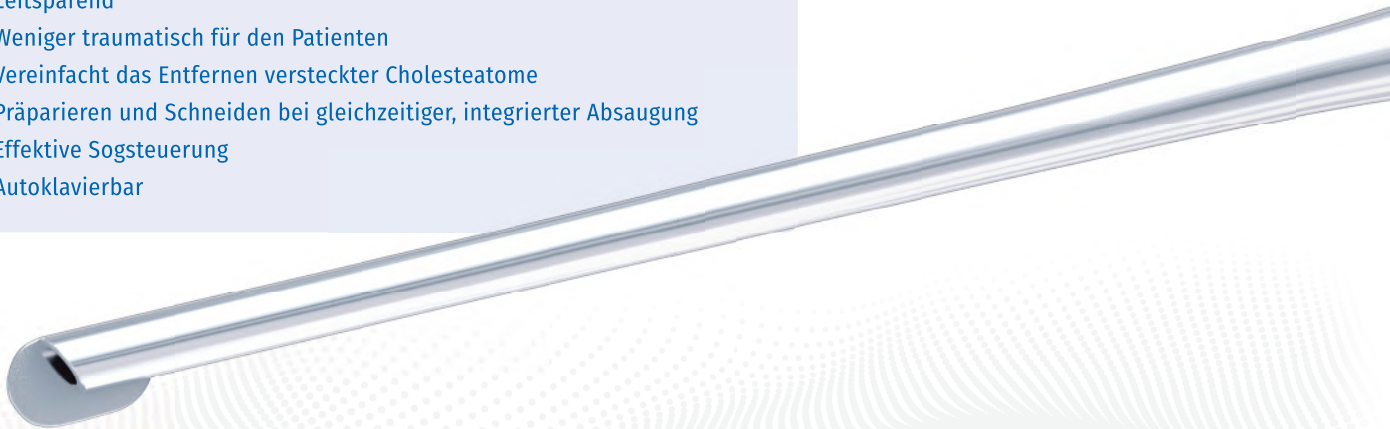

#### Advantages of the Endoscopic/Microscopic Instruments Prof. Panetti:

- Time saving
- Less traumatic for the patient
- Enables easier removal of residual cholesteatoma
- Dissection and preparation with concurrent suction
- Effective suction control
- Autoclavable



»» *The suction function enables simultaneous suction and dissection with just one instrument for which efficiency is significantly increased* ««

Combined suction and dissection makes a more sufficient and precise working process. Each instrument has a suction duct with suction control on the handpiece; despite being newly developed the tips of the instruments are the tried and tested forms classically used in middle ear dis-











section. The suction function enables simultaneous suction and dissection. Dissection is more effective when supported by the suction facility. Any otoendoscopic fogging or blood stains around the tip of the endoscope can be easily removed by rinsing with a hydro-saline solution.





## 07b Endoskopische/Mikroskopische Instrumente nach Prof. Panetti

### Endoscopic/Microscopic Instruments by Prof. Panetti

		<b>Saug-Dissektor für Trommelfell, einfach gebogen, 3 mm, 13 cm, Luer-Lock</b> <b>Suction dissector for ear drum, single curved, 3 mm, 13 cm, Luer-Lock</b>	
10-800-12			
10-801-12		Art.-Nr./No.	Richtung / Direction
		10-800-12	links / left
		10-801-12	rechts / right
		<b>Saug-Dissektor für Sinus Tympani, doppelt gebogen, 6 mm, 13 cm, Luer-Lock</b> <b>Suction dissector for sinus tympani, double curved, 6 mm, 13 cm, Luer-Lock</b>	
10-802-12			
10-803-12		Art.-Nr./No.	Richtung / Direction
		10-802-12	rückwärts links / backward left
		10-803-12	rückwärts rechts / backward right
		<b>Saug-Dissektor für Attik, doppelt gebogen, 6 mm, 13 cm, Luer-Lock</b> <b>Suction dissector for atticus, double curved, 6 mm, 13 cm, Luer-Lock</b>	
10-804-12			
10-805-12		Art.-Nr./No.	Richtung / Direction
		10-804-12	vorwärts links / forward left
		10-805-12	vorwärts rechts / forward right
		<b>Saug-Mikrohäkchen, 45°, 13 cm, Luer-Lock</b> <b>Suction micro hook, 45°, 13 cm, Luer-Lock</b>	
10-806-12			
10-867-12		Art.-Nr./No.	Haken / Hook (mm)
		10-806-12	1,0
		10-867-12	1,5
		10-807-12	2,0
		<b>Saug-Rundschnittmesser, 45°, 13 cm, Luer-Lock</b> <b>Suction separator, 45°, 13 cm, Luer-Lock</b>	
		Art.-Nr. Art.-No.	Größe Size (mm)
			Beschreibung Description
10-808-12		10-808-12	2,5 Saugöffnung innen suction inner side
10-809-12		10-809-12	2,0 Saugöffnung außen suction outer side
10-811-12		10-811-12	2,5 Saugöffnung außen suction outer side

**Saug-Messer, oval, 13 cm, Luer-Lock**  
**Suction knife, oval, 13 cm, Luer-Lock**

10-810-12



Art.-Nr./No. Beschreibung / Description

10-810-12 seitliche Öffnung links / lateral opening left

10-812-12



10-812-12 seitliche Öffnung rechts / lateral opening right

**Saug-Dissektor für Trommelfell, einfach gebogen, sehr fein, 13 cm, Luer-Lock**  
**Suction dissector for ear drum, single curved, very delicate, 13 cm, Luer-Lock**

10-813-12



Art.-Nr./No. Beschreibung / Description

10-813-12 seitliche Öffnung links / lateral opening left side

10-814-12



10-814-12 seitliche Öffnung rechts / lateral opening right side

**Saug-Sichelmesser, gebogen, 13 cm, Luer-Lock**  
**Suction sickle knife, curved, 13 cm, Luer-Lock**



10-815-12

**Saug-Kürette, gebogen, 13 cm, Luer-Lock**  
**Suction curette, curved, 13 cm, Luer-Lock**



10-816-12

**Saug-Dissektor, stumpf, 13 cm, Luer-Lock**  
**Suction dissector, blunt, 13 cm, Luer-Lock**

10-817-12



Art.-Nr./No. Beschreibung / Description

10-817-12 links aufgebogen / upcurved left

10-818-12



10-818-12 rechts aufgebogen / upcurved right

**Preyer Saug-Finder, stumpf, 13 cm, Luer-Lock**  
**Preyer Suction finder, blunt, 13 cm, Luer-Lock**



10-819-12



Maßstab / scale 1:1 (13 cm Länge)



## 07b Endoskopische/Mikroskopische Instrumente nach Prof. Panetti

### Endoscopic/Microscopic Instruments by Prof. Panetti

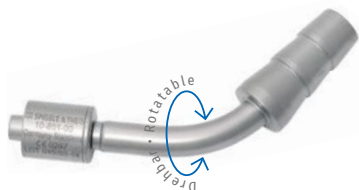

**Saugadapter, drehbar, 55° gebogen,  
Luer-Lock männlich, Schlauchansatz**  
Suction adapter, rotatable, 55° curved,  
luer-lock male, hose connector

**10-851-00**



**Hochleistungs-Fiberglas-Lichtleitkabel,  
Ø 3,5 mm, 90° abgewinkelt, autoklavierbar**  
High definition fibre light cable,  
Ø 3.5 mm, 90° angled, autoclavable

Art.-Nr./No.	Länge / Length (mm)
70-266-02	1800
70-267-03	3000



**System-Siebkorb für Panetti-Instrumentarium**  
System Screen Basket for Panetti Instruments

Art.-Nr./No.	Beschreibung / Description
10-840-01	
10-841-01	klein / small



**Spülkomponente für System-Siebkorb für Panetti-Instrumentarium**  
Irrigation component for System Screen Basket  
for Panetti Instruments

**10-845-01**



## 07b Endoskopische/Mikroskopische Instrumente nach Prof. Panetti

### Endoscopic/Microscopic Instruments by Prof. Panetti

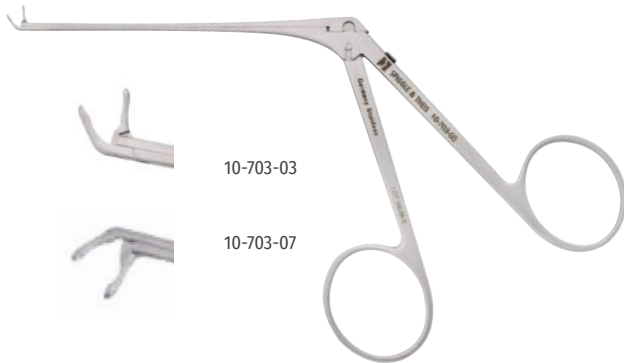

**Mikro-Ohrzängchen, ovale Löffel, fein, 0,8 x 1,3 mm, 8 cm**  
**Micro ear forceps, oval cups, fine, 0.8 x 1.3 mm, 8 cm**

Art.-Nr./No.	Beschreibung / Description
10-703-03	aufwärts gebogen / curved upwards
10-703-07	abwärts gebogen / curved downwards



**Mikro-Ohrzängchen, ovale Löffel, gerade, extrafein, 0,5 x 1,0 mm, 8 cm**  
**Micro ear forceps, oval cups, straight, extrafine, 0.5 x 1.0 mm, 8 cm**

**10-703-04**



**Saug-Sichelmesser für Akustikus-Neurinom, gebogen, Luer-Lock, 17 cm**  
**Suction sickle knife for acoustic neuroma, curved, Luer-Lock, 17 cm**

**10-830-17**



**Saug-Kürette für Akustikus-Neurinom, gebogen, Luer-Lock, 17 cm**  
**Suction curette for acoustic neuroma, curved, Luer-Lock, 17 cm**

**10-831-17**



**Saug-Dissektor für Akustikus-Neurinom, links gebogen, Luer-Lock, 17 cm**  
**Suction dissector for acoustic neuroma, left curved, Luer-Lock, 17 cm**

**10-832-17**



**Saug-Dissektor für Akustikus-Neurinom, rechts gebogen, Luer-Lock, 17 cm**  
**Suction dissector for acoustic neuroma, right curved, Luer-Lock, 17 cm**

**10-833-17**



## 07b Endoskopische/Mikroskopische Instrumente nach Prof. Panetti

### Endoscopic/Microscopic Instruments by Prof. Panetti

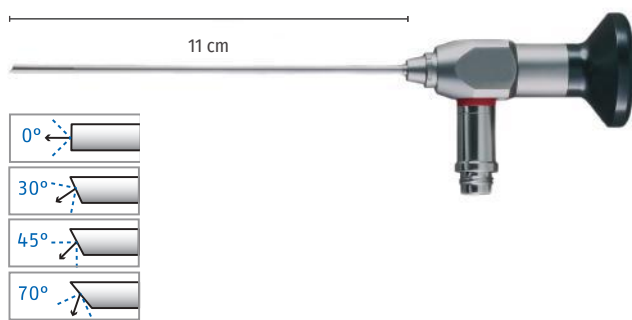

**Otoskop, Großbild, HD, 3 mm, 11 cm**  
**Otoscope, large picture, HD, 3 mm, 11 cm**

Art.-Nr./No.	Winkel / Angle
10-109-00	0°
10-109-30	30°
10-109-45	45°
10-109-70	70°

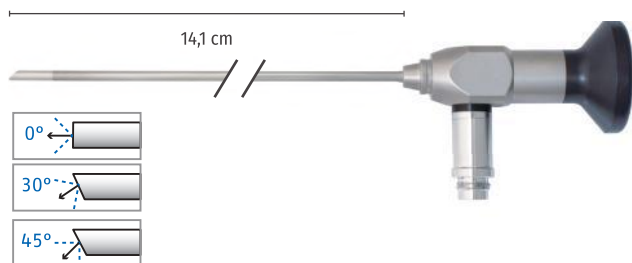

**Otoskop, HD, Großbild, autoklavierbar, AD 3 mm, 14,1 cm**  
**Otoscope, HD, large picture, autoclavable, OD 3 mm, 14.1 cm**

Art.-Nr./No.	Winkel / Angle
10-090-00	0°
10-090-30	30°
10-090-45	45°

Unsere Ohrzängchen werden in drei unterschiedlichen Ausführungen angeboten. Um sie leichter unterscheiden zu können, wurden sie wie folgt markiert:

**Beide Griffe blank: fein (1,8 mm)**

**Ein Griff geschwärzt: extrafein (1,5 mm)**

**Beide Griffe geschwärzt: superfein (1,3 mm)**

Alle Ohrzängchen sind zur besseren Reinigung zerlegbar.

Our ear forceps are available in three different models.

For ease of recognition they are marked as follows:

**delicate (both grips are shiny, 1.8 mm)**

**extra delicate (one grip is blackened, 1.5 mm)**

**super delicate (both grips are blackened, 1.3 mm)**

All our ear forceps are dismountable for cleaning purposes.



**Hartmann Ohrzängchen, gerieft, gerade, fein, 0,8 x 6 mm, 8 cm**  
**Hartmann ear forceps, serrated, delicate, straight, 0.8 x 6 mm, 8 cm**

**10-276-02**



**Hartmann Ohrzängchen, gerieft, gerade, fein, 0,8 x 7 mm, 8 cm**  
**Hartmann ear forceps, serrated, delicate, straight, 0.8 x 7 mm, 8 cm**

**10-700-00**

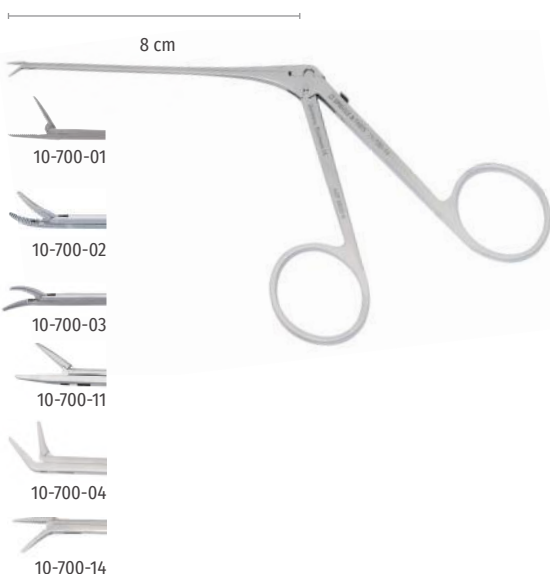

**Hartmann Ohrzängchen, fein, 0,8 x 4 mm, 8 cm**  
**Hartmann ear forceps, delicate, 0.8 x 4 mm, 8 cm**

Art.-Nr./No.	Beschreibung / Description
10-700-01	gerade, gerieft / straight, serrated
10-700-11	gerade, glatt / straight, smooth
10-700-02	rechts gebogen, gerieft / curved right, serrated
10-700-03	links gebogen, gerieft / curved left, serrated
10-700-04	aufwärts gebogen, gerieft curved upwards, serrated
10-700-08	rechts, gerieft, horizontal öffnend right, serrated, horizontally opening
10-700-09	links, gerieft, horizontal öffnend left, serrated, horizontally opening
10-700-14	abwärts gebogen, gerieft curved downwards, serrated



## 08 Ohrzängchen

### Ear forceps



**Hartmann Ohrzängchen, gerieft, extrafein, gerade, 0,6 x 4 mm, Schafthöhe 1,5 mm, 8 cm**  
Hartmann ear forceps, serrated, extra delicate, straight, 0.6 x 4 mm, shaft height 1.5 mm, 8 cm

10-700-05



**Hartmann Ohrzängchen, gerieft, superfein, gerade, 0,6 x 4 mm, Schafthöhe 1,3 mm, 8 cm**  
Hartmann ear forceps, serrated, super delicate, straight, 0.6 x 4 mm, shaft height 1.3 mm, 8 cm

10-700-06

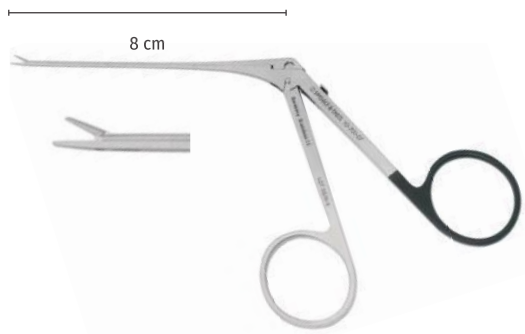

**Fisch Ohrzängchen, extrafein, glatt, 0,6 x 3,5 mm, 8 cm**  
Fisch ear forceps, extra delicate, smooth, 0.6 x 3.5 mm, 8 cm

10-700-07



**Hartmann Ohrzängchen, gerieft, gerade, fein, selbst schließend, 0,8 x 4 mm, 8 cm**  
Hartmann ear forceps, serrated, delicate, straight, self closing, 0.8 x 4 mm, 8 cm

10-701-00

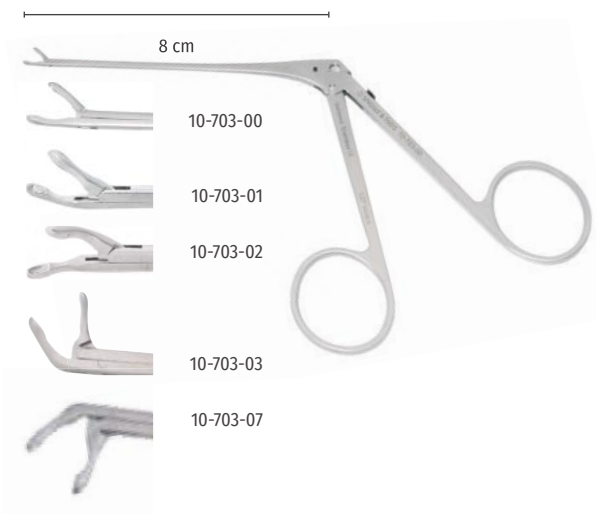

**Mikro Ohrzängchen, ovale Löffel, fein, 0,8 x 1,3 mm, 8 cm**  
**Micro ear forceps, oval cups, delicate, 0.8 x 1.3 mm, 8 cm**

Art.-Nr./No.	Beschreibung / Description
10-703-00	gerade / straight
10-703-01	rechts gebogen / curved right
10-703-02	links gebogen / curved left
10-703-03	aufwärts gebogen / curved upwards
10-703-07	abwärts gebogen / curved downwards



**Mikro Ohrzängchen, ovale Löffel, gerade, extrafein, 0,5 x 1 mm, 8 cm**  
**Micro ear forceps, oval cups, straight, extra delicate, 0.5 x 1 mm, 8 cm**

**10-703-04**

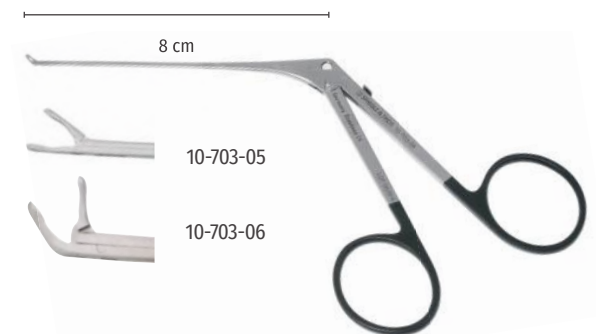

**Mikro Ohrzängchen, superfein, ovale Löffel, 0,5 x 1 mm, 8 cm**  
**Micro ear forceps, super delicate, oval cups, 0.5 x 1 mm, 8 cm**

Art.-Nr./No.	Beschreibung / Description
10-703-05	gerade / straight
10-703-06	aufwärts gebogen / curved upwards

## 08 Ohrzängchen

### Ear forceps

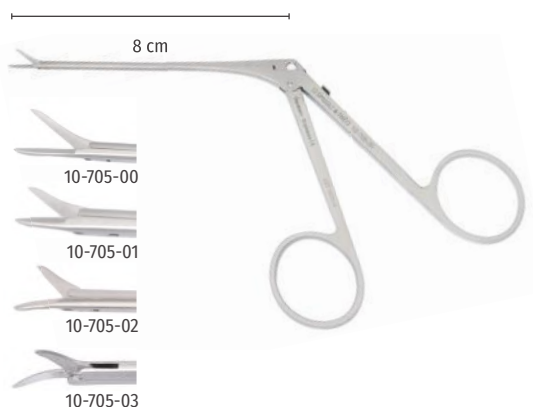

**Bellucci Ohrscherchen, fein, 8 cm**  
**Bellucci ear scissors, delicate, 8 cm**

Art.-Nr. Art.-No.	Größe Size (mm)	Beschreibung Description
10-705-00	8	gerade / straight
10-705-01	4	gerade / straight
10-705-02	4	rechts gebogen / curved right
10-705-03	4	links gebogen / curved left
10-705-04	4	aufwärts gebogen / curved upwards
10-705-08	8	rechts gebogen / curved right
10-705-09	8	links gebogen / curved left

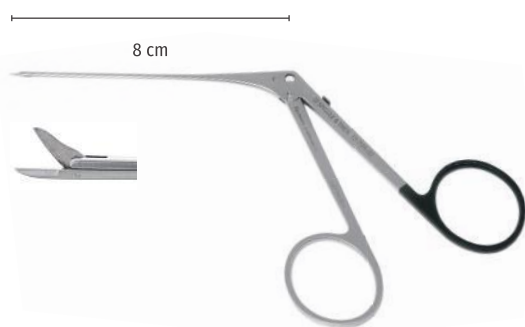

**House-Bellucci Ohrscherchen, gerade, extrafein,  
 3 x 1,5 mm, 8 cm**  
**House-Bellucci ear scissors, straight, super delicate,  
 3 x 1.5 mm, 8 cm**

**10-705-05**



**House-Bellucci Ohrscherchen, gerade, superfein,  
 2 x 1,3 mm, 8 cm**  
**House-Bellucci ear scissors, straight, super delicate,  
 2 x 1.3 mm, 8 cm**

**10-705-06**

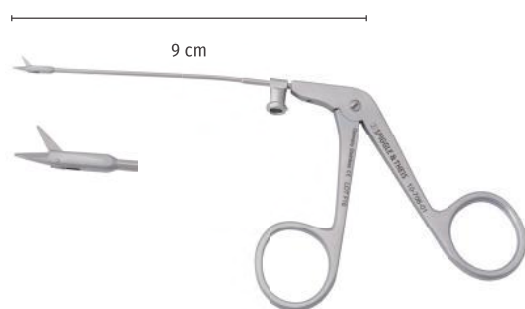

**Wullstein Rohrschaft Ohrscherchen,  
 leicht gebogen, Spülkanal, 4 mm Schneidenlänge, 9 cm**  
**Wullstein tubular shaft micro scissors,  
 slightly curved, irrigation channel, 4 mm blade, 9 cm**

Art.-Nr./No.	Beschreibung / Description
10-706-01	gerade / straight
10-706-02	aufwärts gebogen / curved upwards
10-706-03	rechts gebogen / curved right
10-706-04	links gebogen / curved left

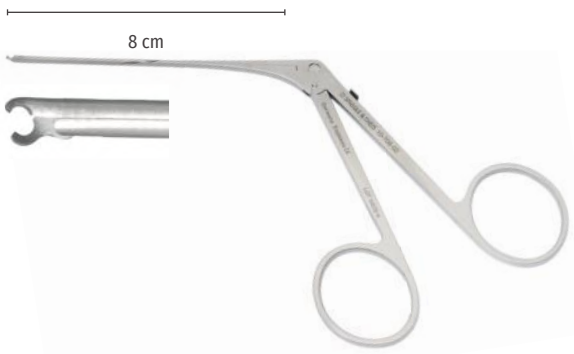

**Fisch Crurotomie Scherchen, 8 cm**

**Fisch crurotomy scissors, 8 cm**

Art.-Nr./No.	Beschreibung / Description
10-708-01	rechts gebogen / curved right
10-708-02	links gebogen / curved left

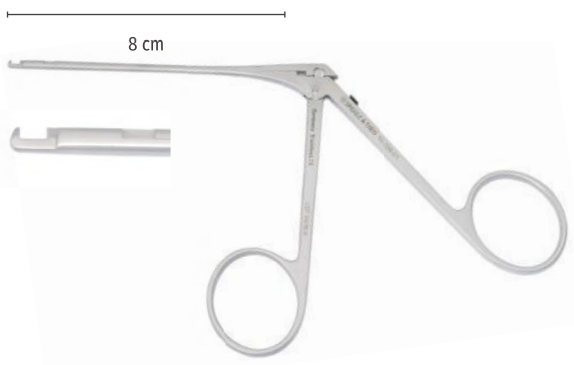

**Dieter Hammerkopfstanze, 8 cm**

**Dieter malleus nipper, 8 cm**

Art.-Nr./No.	Beschreibung / Description
10-709-01	aufwärts schneidend / upwards cutting
10-709-02	abwärts schneidend / downwards cutting

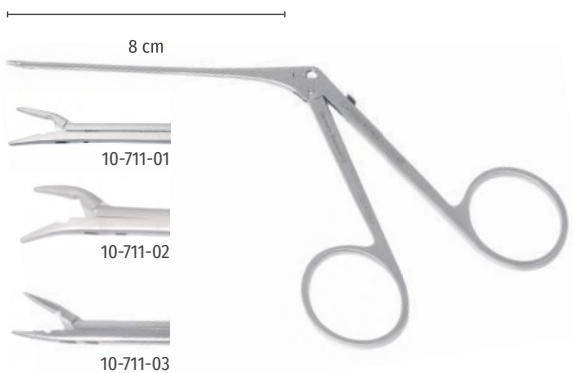

**McGee Drahtschließzängchen, 0,8 x 3,5 mm, 8 cm**

**McGee wire closing forceps, 0,8 x 3.5 mm, 8 cm**

Art.-Nr./No.	Beschreibung / Description
10-711-01	gerade / straight
10-711-02	rechts gebogen / curved right
10-711-03	links gebogen / curved left





## 08 Ohrzängchen

### Ear forceps

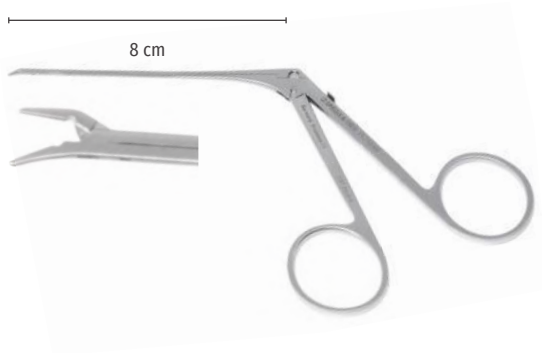

**Fisch-McGee Drahtschließzängchen, gerade, 0,6 x 3,5 mm, 8 cm**  
Fisch-McGee wire closing forceps, straight, 0.6 x 3.5 mm, 8 cm

10-712-00

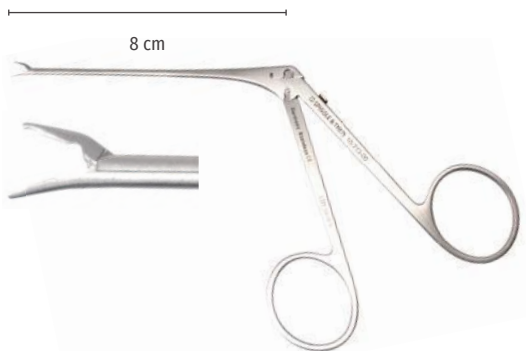

**Müller Drahtschließzängchen,  
0,8 x 3,5 mm, gerade, bogenförmiges Maulteil, 8 cm**  
Müller wire closing forceps, straight,  
0.8 x 3.5 mm, rounded tip, 8 cm

10-713-00



**Greven Drahtschließzängchen, gerade, 0,8 x 5 mm, 8 cm**  
Greven wire closing forceps, straight, 0.8 x 5 mm, 8 cm

10-714-00

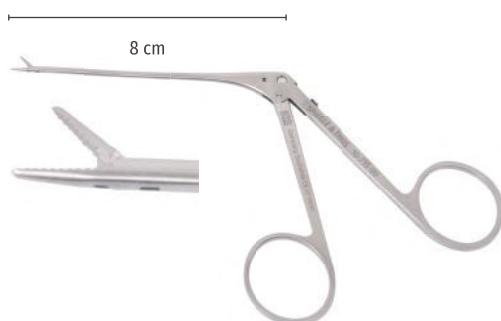

**Kürzzängchen für Mittelohr-Implantate,  
gerade, 1,4 x 4 mm, 8 cm**  
Shortening forceps for middle ear implants,  
straight, 1.4 x 4 mm, 8 cm

10-715-00

## 09 Mess- und Kürzinstrumente

### Measuring and Shortening Instruments

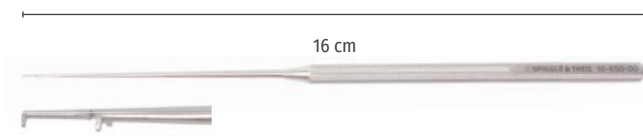

**Referenz-Instrument für Stapes-Prothesen,  
3,5 / 4,0 / 4,5 mm, 16 cm**

Reference instrument for stapes prostheses,  
3.5 / 4.0 / 4.5 mm, 16 cm

10-650-00

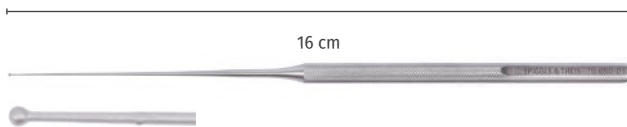

**Referenz-Instrument für Stapes-Prothesen, Typ Tübingen**

Reference instrument for stapes prostheses, type Tübingen

10-650-01

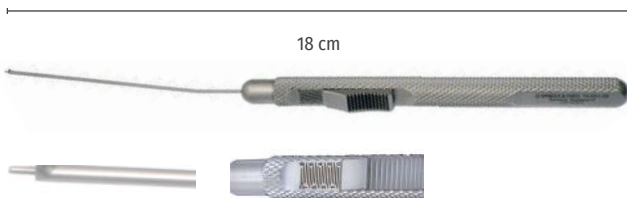

**Referenz-Instrument für Mittelohrprothesen,  
verschiebbar von 0-8 mm, 18 cm**

Reference instrument for middle ear prostheses,  
slide button control from 0-8 mm, 18 cm

Art.-Nr./No.	Beschreibung / Description
10-651-00	nicht zerlegbar / non-dismountable
10-652-00	zerlegbar / dismountable

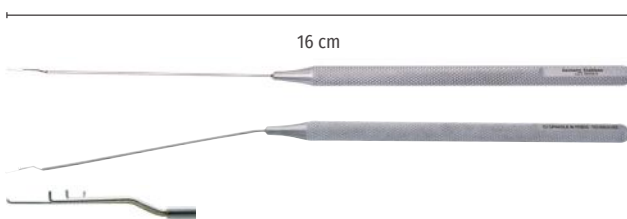

**Fisch Referenz-Instrument für Stapes-Prothesen,  
3,5 / 4,0 / 4,5 mm, 16 cm**

Fisch reference instrument for stapes prostheses,  
3.5 / 4.0 / 4.5 mm, 16 cm

Art.-Nr./No.	Beschreibung / Description
10-653-01	gerade / straight
10-653-02	gebogen / curved

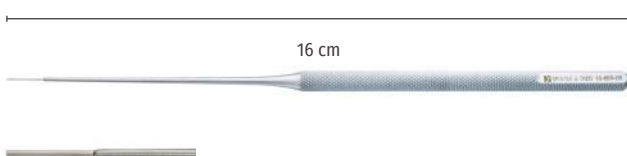

**Fisch Referenz-Zylinder für Stapes-Prothesen, 16 cm**

Fisch reference caliper for stapes prostheses, 16 cm

Art.-Nr./No.	AD / OD (mm)
10-659-04	0,4
10-659-06	0,6
10-659-08	0,8



## 09 Mess- und Kürzinstrumente

### Measuring and Shortening Instruments

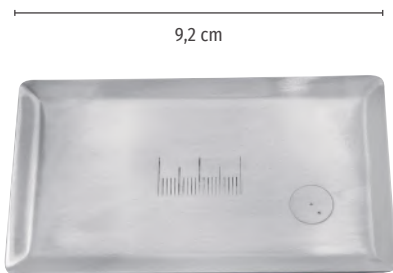

**Präparier-Tablett aus Edelstahl, mit Skala, 92 x 54 mm**  
Preparation tray, stainless steel, with scale, 92 x 54 mm

**10-735-00**



**Fisch Schneide- und Präparierblock für PTFE-Stapes-Prothesen**  
Fish cutting and preparation jig for PTFE stapes prostheses

Art.-Nr./No.	Größe / Size (mm)
10-738-04	0,4
10-738-06	0,6

## 09 Mess- und Kürzinstrumente

### Measuring and Shortening Instruments



**Schneidblock für PTFE Stapesprothesen, 0,4 und 0,6 mm**  
**Piston cutting jig for PTFE stapes prostheses, 0.4 and 0.6 mm**

10-740-01



**Schuknecht Drahtbiegegerät für Stapes-Prothesen, zerlegbar**  
**Schuknecht wire bending die for stapes prostheses, dismantlable**

10-742-00



**PTFE-Schutzhülse mit Fenster für Ohrzängchen,**  
**11,5 cm, autoklavierbar, 10 Stück pro Box**  
**PTFE protective sleeve for ear forceps, with window,**  
**11.5 cm, autoclavable, 10 pieces per box**

10-719-00



## 10 Allgemeines

### Miscellaneous

Geschützte Oberfläche für alle SPIGGLE & THEIS Instrumente macht das Instrument weitgehend resistent gegen mechanische und chemische Einflüsse. Reduziert Licht- und Laser-Reflektion. Einfach bei Ihrer Bestellung "TAN" hinter die jeweilige Artikel-Nummer setzen.



A protective surface for all SPIGGLE & THEIS instruments makes the instruments resistant to mechanical and chemical influences whilst reducing light and laser reflections. Order by simply adding "TAN" behind the respective article number.



**Heermann Ohrzängchen, Rohrschaft leicht gebogen, Spülkanal, gerieft, 9,6 cm**  
**Heermann ear forceps, tubular model, shaft slightly curved, irrigation channel, serrated, 9.6 cm**

Art.-Nr. Art.-No.	Größe Size (mm)	Maulteil Jaws
10-716-00	9 x 2	gerade / straight
10-716-02	9 x 2	links gebogen / left curved
10-716-03	9 x 2	rechts gebogen / right curved



**Metallständer für 6 Ohrzängchen**  
**Metal stand for 6 ear forceps**

**10-718-00**

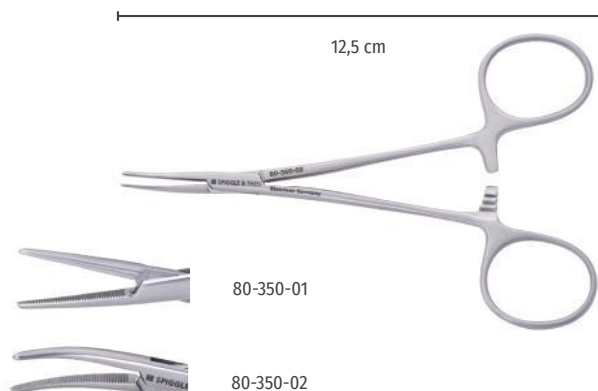

**Halsted Mosquito-Klemme, anatomisch, 12,5 cm**  
**Halsted-Mosquito haemostatic forceps, anatomical, 12.5 cm**

Art.-Nr./No.	Beschreibung / Description
80-350-01	gerade / straight
80-350-02	gebogen / curved

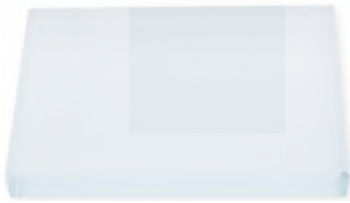

**Präparierplatte aus Glas, eine Seite angeraut, 9,5 x 7 x 0,5-0,6 cm**  
**Cutting block, glass, one side silk finished, 9.5 x 7 x 0.5-0.6 cm**

10-733-09



**Präparierblock aus Teflon, 8 x 4 x 1 cm**  
**Cutting block, PTFE, 8 x 4 x 1 cm**

10-733-10

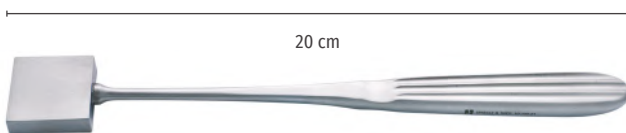

**Heermann Hammer, 20 cm / Heermann mallet, 20 cm**

10-720-21



**Heermann Handgriff, schwarz / Heermann handle, black**

Art.-Nr./No.	Größe / Size
10-722-13	13 cm, groß / large
10-723-09	9 cm, klein / small

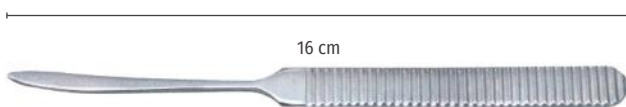

**Williger Elevatorium, gebogen, 16 cm**  
**Williger elevator, curved, 16 cm**

1-1010/05



**Heermann Hohlmeißel, gebogen, mit Fähnchen, 12 cm**  
**Heermann gouge, curved, with tab, 12 cm**

Art.-Nr./No.	Größe / Size (mm)
10-726-10	1,0
10-726-15	1,5
10-726-30	3,0



## 10 Allgemeines

### Miscellaneous



**Heermann Mikrohäkchen, mit Fähnchen, 12,5 cm**  
**Heermann micro hook, with tab, 12,5 cm**

Art.-Nr./No.	Größe / Size
10-727-01	1
10-727-02	2
10-727-03	3
10-727-04	4



**Shea Venenpresse / Shea vein press**

Art.-Nr./No.	Größe / Size (mm)
10-730-16	16
10-730-30	30

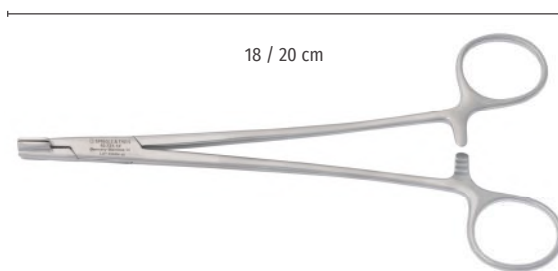

**House Quetsch-Zange / House pressure forceps**

Art.-Nr./No.	Länge / Length (cm)	Größe / Size (mm)
10-731-14	18	11 x 14
10-731-30	20	30 x 30

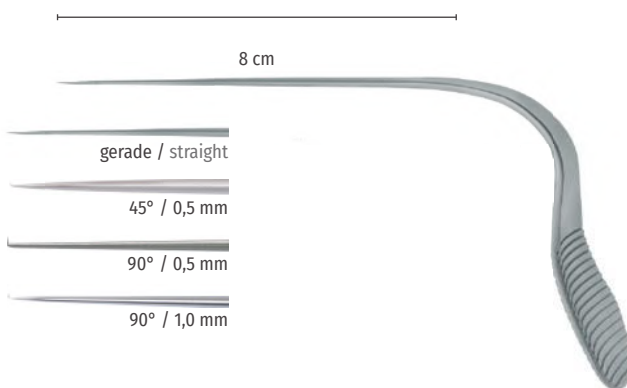

**Zöllner Mikroinstrumente, 8 cm / Zöllner micro instruments, 8 cm**

Art.-Nr. Art.-No.	Hakenlänge Length of hook (mm)	Winkel Angle
10-639-01		Nadel gerade, spitz needle straight, pointed
10-639-02	0,5	45° aufwärts / upward
10-639-03	0,5	45° abwärts / downwards
10-639-04	0,5	90° aufwärts / upward
10-639-05	0,5	90° abwärts / downwards
10-639-06	1,0	90° aufwärts / upward
10-639-07	1,0	90° abwärts / downwards





**Drahtbiege- und Schneideschere,  
Hartmetall, gezahnt, gewinkelt, 12 cm**  
Wire bending and cutting scissors,  
tungsten carbide, with teeth, angled, 12 cm

10-745-12



**Arkansas Ölstein, keilförmig, 9 x 4 cm,  
zum Schleifen von feinen Instrumenten und Meißeln**  
Arkansas oil whetstone, wedge-shaped, 9 x 4 cm,  
for sharpening delicate instruments and chisels

10-747-00



**Flexibler Spannarm zur Verwendung mit selbsthaltenden  
NNH-Spekula, mit Verlängerungsstange**  
Flexible holding arm for use with self retaining nasal specula,  
including holding rods

30-700-00



**Gelenkkloben zur Befestigung am OP-Tisch,  
passend für 30-700-00 und 40-337-00**  
Rotation clamp for fixation to operating table,  
for 30-700-00 and 40-337-00

30-700-01



**Ohrspekulumhalter für flexiblen Spannarm,  
passend für alle Ohrtrichter**  
Ear speculum clamp for flexible holding arm,  
suitable for all ear specula

10-750-00



**Endoskophalter für flexiblen Spannarm,  
passend für alle Endoskope**  
Endoscope clamp for flexible holding arm,  
suitable for all endoscopes

10-751-00

## 10 Allgemeines

### Miscellaneous



**Felsenbeinhalter Modell Würzburg,  
Wanne aus rostsicherem Edelstahl, Kunststoffrahmen;  
Felsenbein in jeder Position einstellbar**  
Würzburg temporal bone holder, stainless steel bowl, plastic  
frame; temporal bone can be set in all positions

10-755-00



**Universal-Einführungszängchen für Paukenröhrchen, mit Spülkanal**  
Universal ventilation tube inserter, with irrigation channel

10-758-00



**Einführungszängchen für Kunststoff-Paukenröhrchen  
mit je einem Mandrin für PR 1,0 mm und 1,2 mm Ø**  
Ventilation tube insertion forceps with mandrin  
for both VT 1.0 mm and 1.2 mm Ø

10-759-00



**T-Tube Einführungsinstrument, zerlegbar,  
für T-Tubes mit 5 mm und 12 mm Länge**  
T-tube insertion instrument, dismountable,  
for t-tubes with 5 mm and 12 mm length

10-760-00



**Spezial Ölspray, Pflegespray für Instrumente sowie für  
Hand- und Winkelstücke, UN 1950, Klasse 2, 5 F  
(Druckgasflaschen), 500 ml**

Special Oilspray, Maintenance Spray for Instruments  
and Drill Handpieces, UN 1950, Class 2, 5 F  
(compressed gas cylinders), 500 ml

00-108-005

**Metallschale / Metal bowl**

Art.-Nr. Art.-No.		Durchmesser Diameter (mm)	Höhe Height (mm)	Fassungs- vermögen Capacity (ml)
80-501-01	B1	Ø 40	H=19	20
80-501-02	B2	Ø 60	H=39	60
80-501-03	B3	Ø 85	H=40	160
80-501-04	B4	Ø 110	H=55	400

**Metallbecher, mit Griff  
Metal cup, with handle**

Art.-Nr. Art.-No.		Durchmesser Diameter (mm)	Höhe Height (mm)	Fassungs- vermögen Capacity (ml)
80-500-00		Ø 69	H=95	350

**Medizinbecher, Edelstahl, graduert  
Medicine cup, stainless steel, graduated**

Art.-Nr. Art.-No.		Durchmesser Diameter (mm)	Höhe Height (mm)	Fassungs- vermögen Capacity (ml)
80-503-03		Ø 50	H=25	30
80-504-05		Ø 53	H=45	50

**Lösungsschale, Edelstahl  
Solution bowl, stainless steel**

Art.-Nr. Art.-No.		Durchmesser Diameter (mm)	Höhe Height (mm)	Fassungs- vermögen Capacity (ml)
80-505-10		Ø 72	H=33	100
80-505-20		Ø 87	H=50	200
80-506-30	B1	Ø 95	H=60	300
80-507-40	B2	Ø 120	H=70	500
80-509-75	B3	Ø 150	H=75	750

**Tablettenschale, Edelstahl, Ø 65 mm, H=20 mm  
Tablet dish, stainless steel, Ø 65 mm, H=20 mm**

80-512-00

**Petrishale, Klarglas, mit Deckel / Petri dish, clear glass, with lid**

Art.-Nr./No.	AD / OD (mm)	Höhe / Height (mm)
80-515-06	60	15
80-515-08	80	15
80-515-10	150	20



## 10 Misceláneos

### Miscellaneous

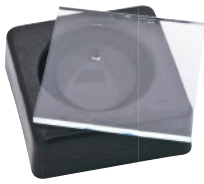

**Medikamenten-Schälchen, Glas, schwarz, mit Deckel, 4 x 4 cm**  
Medication dish, glass, black, with lid, 4 x 4 cm

**80-517-00**



80-519-00



80-519-01



80-519-02



80-519-03

**Medikamenten-Schälchen, Dappenglas, farbig, Ø 3,2 cm**  
Medication dish, dappen-glass, colored, Ø 3.2 cm

Art.-Nr./No.	Farbe / Color
80-519-00	kristall / crystal
80-519-01	grün / green
80-519-02	rosa / pink
80-519-03	topas / topaz



**Porzellan-Schälchen, rund, mit Ausguss**  
China bowl, round, with spout

Art.-Nr./No.	Durchmesser / Diameter (cm)
80-520-06	Ø 8
80-520-08	Ø 10



**Nierenschale, Edelstahl / Kidney bowl, stainless steel**

Art.-Nr./No.	Größe / Size (cm)
80-525-17	17,5
80-525-25	25,0



**Kornzangen-Behälter, Edelstahl**  
Forceps holder, stainless steel

Art.-Nr. Art.-No.	Durchmesser Diameter (cm)	Höhe Height (cm)
80-528-13	Ø 5,0	13,5
80-528-18	Ø 5,0	18,0
80-528-20	Ø 9,5	20,0



**Kornzangen-Behälter,  
Glas, Edelstahldeckel mit Ausschnitt, Ø 8 cm, Höhe 20 cm**  
Forceps holder, glass, stainless steel lid with opening,  
Ø 8 cm, height 20 cm

**80-530-20**



#### Norm-Sterilisations-Container, Boden geschlossen

##### Norm sterilization container, bottom closed

Art.-Nr. Art.-No.	Größe Size	Dimension (außen) Dimension (outside) (mm)
80-631-10	1/2	297 x 274 x 88
80-631-12	1/2	297 x 274 x 123
80-631-14	1/2	297 x 274 x 138
80-631-21	1/2	297 x 274 x 188
80-641-14	3/4	462 x 274 x 138
80-661-12	1	585 x 274 x 123
80-661-14	1	585 x 274 x 138
80-661-21	1	585 x 274 x 188

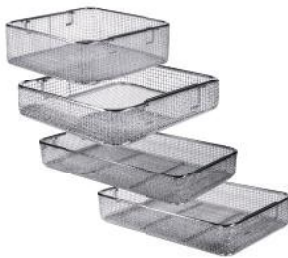

#### Ventildeckel für Norm-Sterilisations-Container

##### Valve lid for norm sterilization container

Art.-Nr./No. 1/2 299 x 278 mm	Art.-Nr./No. 3/4 462 x 278 mm	Art.-Nr./No. 1 585 x 278 mm
80-632-00 ●	80-642-00 ●	80-662-00 ●
80-632-01 ●	80-642-01 ●	80-662-01 ●
80-632-02 ●	80-642-02 ●	80-662-02 ●
80-632-03 ●	80-642-03 ●	80-662-03 ●
80-632-04 ●	80-642-04 ●	80-662-04 ●
80-632-05 ●	80-642-05 ●	80-662-05 ●

#### Edelstahl-Siebkorb, Geflecht, Fallgriffe

##### Stainless-steel wire basket, sliding handles

Art.-Nr./No.	Größe / Size (mm)
80-671-20	255 x 245 x 50
80-671-25	255 x 245 x 70
80-671-40	405 x 255 x 70
80-671-60	485 x 255 x 70

#### Aluminium-Kennzeichnungs-Schild, 20 Zeichen, 56 x 17 mm

##### Coding label, 20 characters, 56 x 17 mm

Art.-Nr./No.	Farbe / Color
80-681-01	schwarz / black
80-681-02	rot / red
80-681-03	braun / brown
80-681-04	grün / green
80-681-05	gelb / yellow
80-681-06	lila / purple
80-681-07	blau / blue



#### Einweg-Container-Siegel, blau, 100 Stück/Box

##### Container seal, disposable, blue, 100 pieces/box

80-683-10

#### Indikator-Klebe-Etikett, Lasche rechts, 100 Stück/Box

##### Adhesive indicator label, latch right side, 100 pieces/box

80-684-10

#### Silikonmatte, blau, perforiert, 440 x 230 mm

##### Silicon mat, blue, perforated, 440 x 230 mm

80-675-00

#### Klemmschild aus Edelstahl, hitzebeständig, 6 x 4 cm, 25 Stück/Box

##### Label holder with clip, stainless steel, heat resistant, 6 x 4 cm, 25 pieces/box

80-688-00



## 11 Sterilisationssysteme

### Sterilization Systems



**Endoskopie-Siebkorb mit Deckel, Edelstahl, elektroliert**  
Endoscope container with lid, stainless steel, e-polished

Art.-Nr./No.	Größe / Size (cm)
80-690-01	29 x 8 x 5,2 für 1 Endoskop 29 x 8 x 5,2 for 1 endoscope
80-690-02	29 x 8 x 5,2 für 2 Endoskope 29 x 8 x 5,2 for 2 endoscopes



**Endoskopie-Siebkorb mit Deckel, Edelstahl, elektroliert**  
Endoscope container with lid, stainless steel, e-polished

Art.-Nr./No.	Größe / Size (cm)
80-691-01	46 x 8 x 5,2 für 1 Endoskop 46 x 8 x 5,2 for 1 endoscope
80-692-01	67 x 8 x 5,2 für 1 Endoskop 67 x 8 x 5,2 for 1 endoscope



**Sterilisations-System "Instru-Safe" für  
Mikro-Ohr-Instrumentarium komplette Ausstattung / 2 Boxen:**  
Sterilizing & protection system "Instru-Safe"  
for micro ear surgery complete equipment / 2 boxes

**80-600-00**

#### Bestehend aus:

- Instrumentenbox für feine Instrumente
- Instrumentenbox für große Instrumente
- 2 Module "Ohrzängchen" (Art.-Nr. 80-601-01)
- 2 Module "Häkchen/Messer" (Art.-Nr. 80-601-08)
- 1 Modul "Ohrtrichter" (Art.-Nr. 80-601-03)
- 1 Modul "Mikroaugröhrchen" (Art.-Nr. 80-601-04)

#### Consisting of:

- Instrument box for delicate instruments
- Instrument box for larger instruments
- 2 trays "ear forceps" (Art.-No. 80-601-01)
- 2 trays "hooks and knives" (Art.-No. 80-601-08)
- 1 tray "ear specula" (Art.-No. 80-601-03)
- 1 tray "micro suction tubes" (Art.-No. 80-601-04)



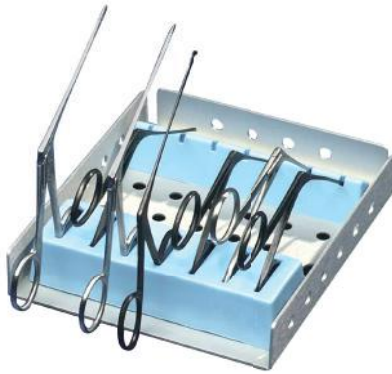

**Modul "Ohrzängchen", 14,8 x 13,0 x 2,5 cm**

Tray "Ear forceps", 14.8 x 13.0 x 2.5 cm

80-601-01



**Modul "Häkchen/Messer", 19,4 x 13,0 x 2,5 cm**

Tray "Hooks and knives", 19.4 x 13.0 x 2.5 cm

80-601-02



**Modul "Ohrtrichter", 8,9 x 13,0 x 2,5 cm**

Tray "Ear specula", 8.9 x 13.0 x 2.5 cm

80-601-03



**Modul "Mikroaugröhrchen", 8,9 x 13,0 x 2,5 cm**

Tray "Micro suction tubes", 8.9 x 13.0 x 2.5 cm

80-601-04

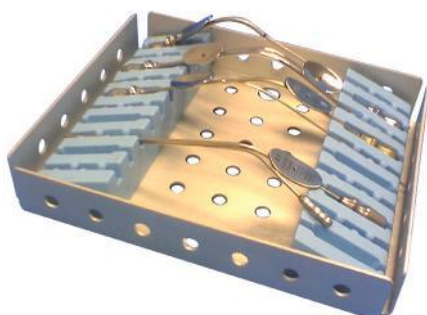

**Modul "Baron Saugrohre", 14,9 x 13,0 x 2,5 cm**

Tray "Baron suction tubes", 14.9 x 13.0 x 2.5 cm

80-601-05





## 11 Sterilisationssysteme

### Sterilization Systems



**Modul "Häkchen/Messer II", 19,4 x 11,7 x 2,5 cm**  
**Tray "Hooks and knives II", 19.4 x 11.7 x 2.5 cm**

**80-601-08**



**Instrumentenbox für feine Instrumente, 50,0 x 24,5 x 8,0 cm**  
**Instrument box for delicate instruments, 50.0 x 24.5 x 8.0 cm**

**80-602-30**

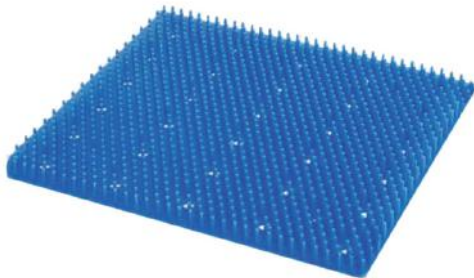

**Noppenmatte, fein, zuschneidbar, 48,3 x 33,0 x 1,8 cm**  
**Finger mat, fine, custom cut, 48.3 x 33.0 x 1.8 cm**

**80-602-32**



**Instrumenten Box mit Deckel**  
**für 20 Häkchen/Messer, 27,9 x 22,2 x 3,8 cm**  
**Instrument box with lid**  
**for 20 hooks and knives, 27.9 x 22.2 x 3.8 cm**

**80-603-01**

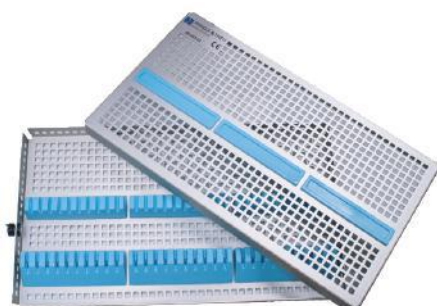

**Instrumenten Box mit Deckel**  
**für 30 Häkchen/Messer, 38,1 x 22,2 x 3,8 cm**  
**Instrument box with lid**  
**for 30 hooks and knives, 38.1 x 22.2 x 3.8 cm**

**80-603-02**

## 11 Sterilisationssysteme

### Sterilization Systems



#### Instrumenten Box mit Deckel

für 10 Håkchen/Messer, 12,7 x 22,2 x 3,8 cm

Instrument box with lid for 10 hooks and knives, 12.7 x 22.2 x 3.8 cm

80-603-03



#### Instrumenten Box mit Deckel für

15 Mikro-Instrumente, 21,5 x 22,2 x 3,8 cm

Instrument box with lid for 15 micro instruments,  
21.5 x 22.2 x 3.8 cm

80-603-04



#### Sterilisations-System "Instru-Safe"

für Parazentese-Set zur Aufnahme von Ohrtrichtern,  
Ohrzångchen, Håkchen und Nadeln

Sterilizing and protection set "Instru-Safe" for myringotomy set,  
holds ear-specula, forceps, knives and hooks

80-605-00



HNO-Spülkorb, Edelstahl mit abnehmbarem Deckel,  
Kleinteilekorb und Instrumentenaufnahmen,  
epoliert, 480 x 250 x 40 mm

ENT instrument tray, stainless steel with removable lid, small parts  
basket and instrument holders, e-polished, 480 x 250 x 40 mm

80-695-00



#### Spül- und Sterilisierkorb

für Mikro-Endoskope, Edelstahl, 24,5 x 24,5 cm

Irrigation- and sterilization basket

for micro endoscopes, stainless steel, 24.5 x 24.5 cm

Configuration  
upon request



## 12 Endoskopische/Mikroskopische Instrumente Set nach Prof. Panetti 10-890-00

### Endoscopic/Microscopic Instrument Set by Prof. Panetti 10-890-00

#### Bestehend aus / Consisting of:

- |           |  |           |  |
|-----------|--|-----------|--|
| 10-800-12 | 1x Saug-Dissektor für Trommelfell, einfach links gebogen, 3 mm<br>1x Suction dissector for ear drum, single curved, left side, 3 mm                              | 10-703-03 | 1x Mikro-Ohrzängchen, ovale Löffel, fein, 0,8 x 1,3 mm, aufgebogen, 8 cm / 1x Micro ear forceps, oval cups, fine, 0.8 x 1.3 mm, upwards curved, 8 cm                                       |
| 10-801-12 | 1x Saug-Dissektor für Trommelfell, einfach rechts gebogen, 3 mm<br>1x Suction dissector for ear drum, single curved, right side, 3 mm                            | 10-703-04 | 1x Mikro Ohrzängchen, ovale Löffel, gerade, extrafein, 0,5 x 1,0 mm, 8 cm / 1x Micro ear forceps, oval cups, extra fine, 0.5 x 1.0 mm, straight, 8 cm                                      |
| 10-802-12 | 1x Saug-Dissektor für Sinus Tympani, doppelt rückwärts links gebogen, 6 mm / 1x Suction dissector for sinus tympani, double curved, backwards, left side, 6 mm   | 10-703-07 | 1x Mikro-Ohrzängchen, ovale Löffel, fein, 0,8 x 1,3 mm, abgebogen, 8 cm / 1x Micro ear forceps, oval cups, fine, 0.8 x 1.3 mm, downwards curved 8 cm                                       |
| 10-803-12 | 1x Saug-Dissektor für Sinus Tympani, doppelt rückwärts rechts gebogen, 6 mm / 1x Suction dissector for sinus tympani, double curved, backwards, right side, 6 mm | 10-446-11 | 1x Preyer Wundsperrer, schmales Blatt beidseits mit Noppen, 11 cm, zerlegbar Griff vergoldet / 1x Preyer retractor, slim blade, gold plated grip, studded on both sides, 11 cm, detachable |
| 10-804-12 | 1x Saug-Dissektor für Attik, doppelt vorwärts links gebogen, 6 mm<br>1x Suction dissector for atticus, double curved, forwards, left side, 6 mm                  | 10-109-30 | 1x Otoskop, Großbild, HD, 3 mm, 30° (wahlweise 0°, 45° oder 70°), 110 mm / 1x Otoloscope, large picture, HD, 3 mm, 30° (optional 0°, 45° or 70°), 110 mm                                   |
| 10-805-12 | 1x Saug-Dissektor für Attik, doppelt vorwärts rechts gebogen, 6 mm<br>1x Suction dissector for atticus, double curved, forwards, right side, 6 mm                |           |  |
| 10-806-12 | 1x Saug-Mikrohäkchen, 45°, 1,0 mm<br>1x Suction micro hook, 45°, 1.0 mm  |           |  |
| 10-807-12 | 1x Saug-Mikrohäkchen, 45°, 2,0 mm<br>1x Suction micro hook, 45°, 2.0 mm  |           |  |
| 10-808-12 | 1x Saug-Rundschnittmesser, 45°, Saugöffnung links, 2,5 mm<br>1x Suction separator, 45°, suction left side, 2.5 mm  |           |  |
| 10-811-12 | 1x Saug-Rundschnittmesser, 45°, Saugöffnung rechts, 2,5 mm<br>1x Suction separator, 45°, suction right side, 2.5 mm  |           |  |
| 10-810-12 | 1x Saug-Messer oval, seitliche Öffnung links, 2,5 mm<br>1x Suction oval knife, lateral opening left side, 2.5 mm   |           |  |
| 10-813-12 | 1x Saug-Dissektor, einfach gebogen, links, sehr fein, Luer-Lock<br>1x Suction dissector lateral opening left side, very fine                                     |           |  |
| 10-814-12 | 1x Saug-Dissektor, einfach gebogen, rechts, sehr fein, Luer-Lock<br>1x Suction dissector lateral opening right side, very fine                                   |           |  |
| 10-816-12 | 1x Saug-Kürette, gebogen / 1x Suction curette, curved  |           |  |
| 10-851-00 | 2x Saugadapter, drehbar, 55° gebogen, Luer-Lock männlich, Schlauchansatz / 2x Rotatable suction adapter, 55° curved, luer-lock male, hose connector              |           |  |

#### Ergänzung 10-890-99

#### Supplement 10-890-99

- |           |  |
|-----------|--|
| 10-840-01 | 1x System-Siebkorb für Panetti-Instrumentarium /<br>1x System screen basket for Panetti instruments  |
| 10-845-01 | 2x Spülkomponente für System-Siebkorb Panetti-Instrumentarium<br>2x Irrigation component for system screen basket Panetti instruments  |
| 70-266-02 | 1x Hochleistungs-Fiberglas-Lichtleitkabel, 3,5 mm, 1800 mm, endoskopseitig 90° abgewinkelt, Storz/Storz-Adapter, autoklavierbar / High definition fibre light cable, 3.5 mm, 1800 mm, endoscope side angled 90°, Storz/Storz connections, autoclavable |

Supplement for sales in EU (outside the EU only on request)

## 12 Endoskopische/Mikroskopische Instrumenten-Set nach Prof. Panetti 10-895-00

### Endoscopic/Microscopic Instrument Set by Prof. Panetti 10-895-00

**Prof. Panetti Set für Endoskopische/Mikroskopische Instrumente, wie 10-890-00, jedoch ohne Otoskop**

**Prof. Panetti Endoscopic/Microscopic Instrument Set, as 10-890-00, yet without Otoloscope**

#### Ergänzung 10-895-99

#### Supplement 10-895-99

- |           |   |
|-----------|---|
| 10-840-01 | 1x System-Siebkorb für Panetti-Instrumentarium /<br>1x System screen basket for Panetti instruments                                   |
| 10-845-01 | 2x Spülkomponente für System-Siebkorb Panetti-Instrumentarium<br>2x Irrigation component for system screen basket Panetti instruments |

Supplement for sales in EU (outside the EU only on request)

## 12 Endoskopische/Mikroskopische Instrumente Set nach Prof. Panetti 10-896-00

### Endoscopic/Microscopic Instrument Set by Prof. Panetti 10-896-00

#### Bestehend aus / Consisting of:

- |           |   |           |  |
|-----------|---|-----------|--|
| 10-800-12 | 1x Saug-Dissektor für Trommelfell, einfach links gebogen, 3 mm<br>1x Suction dissector for ear drum, single curved, left side, 3 mm                       | 10-703-04 | 1x Mikro Ohrzängchen, ovale Löffel, gerade, extrafein,<br>0,5 x 1,0 mm, 8 cm / 1x Micro ear forceps, oval cups, extra fine,<br>0.5 x 1.0 mm, straight, 8 cm  |
| 10-801-12 | 1x Saug-Dissektor für Trommelfell, einfach rechts gebogen, 3 mm<br>1x Suction dissector for ear drum, single curved, right side, 3 mm                     | 10-109-30 | 1x Otoskop, Großbild, HD, 3 mm, 30° (wahlweise 0°,<br>45° oder 70°), 110 mm / 1x Otoscope, large picture, HD, 3 mm,<br>30° (optional 0°, 45° or 70°), 110 mm |
| 10-807-12 | 1x Saug-Mikrohäkchen, 45°, 2,0 mm<br>1x Suction micro hook, 45°, 2.0 mm   |           |  |
| 10-808-12 | 1x Saug-Rundschnittmesser, 45°, Saugöffnung links, 2,5 mm<br>1x Suction separator, 45°, suction left side, 2.5 mm   |           |  |
| 10-812-12 | 1x Saug-Messer oval, seitliche Öffnung rechts, 2,5 mm<br>1x Suction oval knife, lateral opening right side, 2.5 mm  |           |  |
| 10-815-12 | 1x Saug-Sichelmesser gebogen, 13 cm<br>1x Suction sickle knife, curved, 13 cm   |           |  |
| 10-851-00 | 1x Saugadapter, drehbar, 55° gebogen, Luer-Lock männlich,<br>Schlauchansatz / 1x Rotatable suction adapter, 55° curved,<br>luer-lock male, hose connector |           |  |

#### Ergänzung 10-890-99

#### Supplement 10-890-99

- |           |  |
|-----------|--|
| 70-266-02 | 1x Hochleistungs-Fiberglas-Lichtleitkabel, 3,5 mm, 1800 mm,<br>endoskopseitig 90° abgewinkelt, Storz/Storz-Adapter, autokla-<br>vierbar / High definition fibre light cable, 3.5 mm, 1800 mm,<br>endoscope side angled 90°, Storz/Storz connections, autocla-<br>vable |
| 10-841-01 | 1x System-Siebkorb für Panetti-Instrumentarium, klein<br>1x System screen basket for Panetti instruments, small  |
| 10-845-01 | 1x Spülkomponente für System-Siebkorb Panetti-Instru-<br>mentarium / 1x Irrigation component for system screen<br>basket Panetti instruments   |

Supplement for sales in EU (outside the EU only on request)



## 12 Bohrer-Set LowSpeed 10-908-00

### Burs Set LowSpeed 10-908-00

#### Bestehend aus / Consisting of:

DR070010691	1x Diamant-Bohrer, mittlere Körnung, Ø 0,6 mm 1x Diamond bur, medium grain, Ø 0.6 mm	CR070010806	1x Osteotomie-Bohrer, HM, Ø 0,8 mm, 6 Schneiden 1x Osteotomy bur, TC, Ø 0.8 mm, 6 blades
DR070010891	1x Diamant-Bohrer, mittlere Körnung, Ø 0,8 mm 1x Diamond bur, medium grain, Ø 0.8 mm	CR070011006	1x Osteotomie-Bohrer, HM, Ø 1,0 mm, 6 Schneiden 1x Osteotomy bur, TC, Ø 1.0 mm, 6 blades
DR070011091	1x Diamant-Bohrer, mittlere Körnung, Ø 1,0 mm 1x Diamond bur, medium grain, Ø 1.0 mm	CR070011206	1x Osteotomie-Bohrer, HM, Ø 1,2 mm, 6 Schneiden 1x Osteotomy bur, TC, Ø 1.2 mm, 6 blades
DR070011491	1x Diamant-Bohrer, mittlere Körnung, Ø 1,4 mm 1x Diamond bur, medium grain, Ø 1.4 mm	CR070011606	1x Osteotomie-Bohrer, HM, Ø 1,6 mm, 6 Schneiden 1x Osteotomy bur, TC, Ø 1.6 mm, 6 blades
DR070011891	1x Diamant-Bohrer, mittlere Körnung, Ø 1,8 mm 1x Diamond bur, medium grain, Ø 1.8 mm	CR070012106	1x Osteotomie-Bohrer, HM, Ø 2,1 mm, 6 Schneiden 1x Osteotomy bur, TC, Ø 2.1 mm, 6 blades
DR070012191	1x Diamant-Bohrer, mittlere Körnung, Ø 2,1 mm 1x Diamond bur, medium grain, Ø 2.1 mm	CR070012708	1x Osteotomie-Bohrer, HM, Ø 2,7 mm, 8 Schneiden 1x Osteotomy bur, TC, Ø 2.7 mm, 8 blades
DR070012791	1x Diamant-Bohrer, mittlere Körnung, Ø 2,7 mm 1x Diamond bur, medium grain, Ø 2.7 mm	CR070013508	1x Osteotomie-Bohrer, HM, Ø 3,5 mm, 8 Schneiden 1x Osteotomy bur, TC, Ø 3.5 mm, 8 blades
DR070013191	1x Diamant-Bohrer, mittlere Körnung, Ø 3,1 mm 1x Diamond bur, medium grain, Ø 3.1 mm	CR070014510	1x Osteotomie-Bohrer, HM, Ø 4,5 mm, 10 Schneiden 1x Osteotomy bur, TC, Ø 4.5 mm, 10 blades
DR070014091	1x Diamant-Bohrer, mittlere Körnung, Ø 4,0 mm 1x Diamond bur, medium grain, Ø 4.0 mm	CR070015012	1x Osteotomie-Bohrer, HM, Ø 5,0 mm, 12 Schneiden 1x Osteotomy bur, TC, Ø 5.0 mm, 12 blades
DR070015091	1x Diamant-Bohrer, mittlere Körnung, Ø 5,0 mm 1x Diamond bur, medium grain, Ø 5.0 mm	CR070016014	1x Osteotomie-Bohrer, HM, Ø 6,0 mm, 14 Schneiden 1x Osteotomy bur, TC, Ø 6.0 mm, 14 blades
DR070016091	1x Diamant-Bohrer, mittlere Körnung, Ø 6,0 mm 1x Diamond bur, medium grain, Ø 6.0 mm	CR070017016	1x Osteotomie-Bohrer, HM, Ø 7,0 mm, 16 Schneiden 1x Osteotomy bur, TC, Ø 7.0 mm, 16 blades
DR070017091	1x Diamant-Bohrer, mittlere Körnung, Ø 7,0 mm 1x Diamond bur, medium grain, Ø 7.0 mm	BS23507034	1x Bohrerständer für 34 rotierende Instrumente der Länge 70 mm 1x Stand for 34 rotary instruments, length: 70 mm
CR070010506	1x Osteotomie-Bohrer, HM, Ø 0,5 mm, 6 Schneiden 1x Osteotomy bur, TC, Ø 0.5 mm, 6 blades		





#### Bestehend aus / Consisting of:

10-420-11	2x Wullstein Wundsperrer, 3:3 Zähne, 11 cm, halbscharf 2x Wullstein retractor, 3:3 prongs, 11 cm, semi-sharp	10-642-04	1x Plester Fußplattenhäkchen, rund, 0,4 mm / 1x Plester footplate hook, round, 0.4 mm
10-428-11	1x Helms Wundsperrer, 2 Zähne rechts, Blatt mit Noppen links, 11,5 cm 1x Helms retractor, 2 prongs right, blade with studs, 11.5 cm	10-652-00	1x Referenz-Instrument, 0-8 mm, zerlegbar 1x Reference instrument, 0-8 mm, dismountable
10-429-11	1x Helms Wundsperrer, 2 Zähne links, Blatt mit Noppen rechts, 11,5 cm 1x Helms retractor, 2 prongs left, blade with studs right, 11.5 cm	10-658-03	1x Fußplatten-Perforator, 0,3 mm / Footplate-perforator, 0.3 mm
10-438-17	1x Fisch Wundsperrer mit Gelenken, 3:3 Zähne, halbscharf, 16,5 cm 1x Fisch retractor, adjustable, 3:3 prongs, semi-sharp, 16.5 cm	10-658-05	1x Fußplatten-Perforator, 0,5 mm / Footplate-perforator, 0.5 mm
20-100-01	1x Hartmann Nasen-Spekulum, für Erwachsene 1x Hartmann nose specula, for adults	10-738-04	1x Präparierblock für Stapesprothesen, 0,4 mm 1x Preparation jig for stapes prostheses, 0.4 mm
20-601-14	1x Joseph Schere, spitz-spitz, gebogen, 14,5 cm 1x Joseph scissors, pointed, curved, 14.5 cm	10-733-09	1x Präparierblock für Fascie und Knorpel, Glas 1x Preparation jig for fascie and cartilage, glass
20-610-15	1x Reynolds Schere, stumpf-stumpf, gebogen, verjüngte Spitze, 16 cm 1x Reynolds scissors, blunt-blunt, curved, tapered tips, 16 cm	10-700-05	1x Hartmann Ohrzängchen, gerieft, gerade, extrafein 1x Hartmann ear forceps, serrated, straight, extra delicate
10-534-12	1x Supercut Schere für Fascie, spitz-spitz, gebogen, 11,5 cm, extrafein 1x Supercut scissors for fascie, pointed, curved, 11.5 cm, extra delicate	10-703-00	1x Mikro-Ohrzängchen, ovale Löffel, gerade, fein 1x Micro ear forceps, oval curette, straight, delicate
10-482-14	1x Pinzette, anatomisch, 1,7 mm, 14,5 cm / Forceps, anatomical, 1.7 mm, 14.5 cm	10-705-00	1x Shea-Bellucci Ohrscherchen, gerade / Shea-Bellucci ear forceps, straight
10-485-14	1x Pinzette, chirurgisch, 1,4 mm, 14,5 cm / Forceps, surgical, 1.4 mm, 14.5 cm	10-701-00	1x Mikro-Ohrzängchen, gerieft, gerade, fein, selbstschließend 1x Micro ear forceps, serrated, straight, delicate, self-closing
10-489-15	1x Helms Pinzette, anatomisch, 15 cm / Helms forceps, anatomical, 15 cm	10-709-01	1x Dieter Hammerkopfstanze, gerade, aufwärts schneidend, fein 1x Dieter malleus nipper, straight, upwards cutting, delicate
10-504-10	1x Hildmann Knorpel-Pinzette, gerade, 11 cm 1x Hildmann cartilage forceps, straight, 11 cm	10-711-01	1x McGee Drahtschließzängchen, gerade / McGee wire closing forceps, straight
10-200-01	1x Hartmann Ohrtrichter, Gr. 1 / Hartmann speculum, size 1	10-719-00	1x PTFE Schutzhülse für Ohrzängchen, 6 Stück/Box 1x PTFE cover for ear forceps, 6 pieces/box
10-200-02	1x Hartmann Ohrtrichter, Gr. 2 / Hartmann speculum, size 2	10-731-14	1x House Quetschzange, 11 x 14 mm / House pressure forceps, 11 x 14 mm
10-200-03	1x Hartmann Ohrtrichter, Gr. 3 / Hartmann speculum, size 3	10-481-14	1x Pinzette, anatomisch, 14,5 cm, 2 mm / Forceps, anatomical, 14.5 cm, 2 mm
10-200-04	1x Hartmann Ohrtrichter, Gr. 4 / Hartmann speculum, size 4	10-555-13	1x Halsey Nadelhalter, Hartmetall, 13 cm, fein 1x Halsey needle holder, tungsten carbide, 13 cm, delicate
10-466-13	1x Williger Wundhaken, 4-zinkig, scharf / Williger retractor, 4 prongs, sharp	10-550-13	1x Universalschere, 13 cm, spitz-stumpf, gebogen 1x Universal scissors, 13 cm, blunt / pointed, curved
10-355-08	1x Plester Gehörgangsraspatorium, 8 mm / Plester raspatory, 8 mm	80-100-16	1x Bipolare Pinzette, 16 cm, gerade, 0,5 mm 1x Bipolar forceps, 16 cm, straight, 0.5 mm
10-356-00	1x Wullstein Raspatorium, schmal (Schippchen) / Wullstein raspatory, slender	80-501-01	1x Metallschale B1, Ø 40 mm, Volumen 0,02 l, Höhe 19 mm 1x Metal bowl B1, 40 mm Ø, 20 ml, 19 mm height
10-261-10	1x Buck Ohrkürette, scharf, Gr. 0 / Buck ear curette, sharp, size 0	80-501-02	1x Metallschale B2, Ø 60 mm, Volumen 0,06 l, Höhe 39 mm 1x Metal bowl B2, 60 mm Ø, 60 ml, 39 mm height
10-261-02	1x Buck Ohrkürette, scharf, Gr. 2 / Buck ear curette, sharp, size 2	80-501-04	1x Metallschale B6, Ø 110 mm, Volumen 0,40 l, Höhe 55 mm 1x Metal bowl B6, 110 mm Ø, 400 ml, 55 mm height
30-105-06	1x Frazier Saugrohr, 6 Ch., konisch, tränenförmige Sogsteuerung, AL 80 mm 1x Frazier suction tube, 6 Fr., conical, tearform suction control, WL 80 mm	1710001-B	1x Silikonfolie Miltheis, blau, steril, 0,13 x 40 x 6 mm, 10 x 3 Stück 1x Silicone foil Miltheis, blue, sterile, 0.13 x 40 x 6 mm, 10 x 3 pieces
30-105-10	1x Frazier Saugrohr, 10 Ch., konisch, tränenförmige Sogsteuerung, AL 80 mm 1x Frazier suction tube, 10 Fr., conical, tearform suction control, WL 80 mm	80-600-00	1x Sterilisations-System "Instru-Safe" für Mikro-Ohr-Instrumentarium 1x Sterilizing & protection system "Instru-Safe" for micro ear surgery
10-321-20	1x Wullstein Silber-Saugrohr, zylindrisch, 2 mm, biegebar 1x Wullstein silver suction tube, cylindrical, 2 mm, bendable	80-318-50	1x Bipolares Anschlusskabel, 5 m, passend für Erbe/Storz 1x Bipolar connecting cable, 5 m, comp. w. Erbe/Storz
10-305-11	1x Wullstein Saughandgriff mit Unterbrecher, 10,5 cm 1x Wullstein suction handle with suction control, 10.5 cm		
10-308-08-05	1x House Nadelsauger, Luer, 0,8 mm / House suction cannula, Luer lock, 0.8 mm		
10-308-12-05	1x House Nadelsauger, Luer, 1,2 mm / House suction cannula, Luer lock, 1.2 mm		
10-308-15-05	1x House Nadelsauger, Luer, 1,5 mm / House suction cannula, Luer lock, 1.5 mm		
10-308-20-05	1x House Nadelsauger, Luer, 2,0 mm / House suction cannula, Luer lock, 2.0 mm		
10-665-00	1x Tisch Handgriff für Mikrolöffel / Tisch handle for micro curette		
10-665-04	1x Tisch Mikrolöffel, 15°, Gr. 1 / Tisch micro curette, 15°, size 1		
10-665-05	1x Tisch Mikrolöffel, 15°, Gr. 2 / Tisch micro curette, 15°, size 2		
10-665-06	1x Tisch Mikrolöffel, 15°, Gr. 3 / Tisch micro curette, 15°, size 3		
10-729-18	1x Seiffert Speichelgangsonde, Silber / Seiffert salivary duct probe, silver		
10-644-90	1x Plester Antrum-Häkchen, stumpf, 90°, 4 mm 1x Plester antrum hook, blunt, 90°, 4 mm	10-733-09	1x Präparierplatte aus Glas, eine Seite angeraut, 9,5 x 7 x 0,5-0,6 cm 1x Cutting block, glass, one side satin finished, 9.5 x 7 x 0.5-0.6 cm
10-648-12	1x Rosen Raspatorium, 1,2 x 12 mm / Rosen raspatory, 1.2 x 12 mm	10-747-00	1x Arkansas-Öl-Stein zum Schleifen von Instrumenten 1x Arkansas oil whetstone for sharpening instruments
10-610-12	1x Rosen Rundschnittemesser, 1,2 mm, 45° / Rosen round knife, 1.2 mm, 45°	80-661-14	1x Norm-Sterilisations-Container Boden geschlossen, 585x274x138 mm Maße mit Deckel: 585x278x155 mm 1x Norm sterilization container bottom closed, 585x274x138 mm, dimensions with fitted lid: 585x278x155 mm
10-610-18	1x Rosen Rundschnittemesser, 1,8 mm, 45° / Rosen round knife, 1.8 mm, 45°	80-662-00	1x Ventildeckel silber, für Container 80-661-14, 585x278 mm 1x Valve lid silver, for container 80-661-14, 585x278 mm
10-610-25	1x Rosen Rundschnittemesser, 2,5 mm, 45° / Rosen round knife, 2.5 mm, 45°	80-671-60	1x Edelstahl-Siebkorb Geflecht, Fallgriffe 485x255x70 mm 1x Stainless steel wire basket Geflecht, sliding handles, 485x255x70 mm
10-614-25	1x Plester Rundschnittemesser, oval, seitlich / Plester round knife, oval	80-681-07	1x Aluminium-Kennzeichnungs-Schild blau, 20 Zeichen, 56x17 mm 1x Aluminium tag blue, 20 letters, 56x17 mm
10-618-02	1x Wullstein Sichelmesser, leicht gebogen, sehr fein 1x Wullstein sickle knife, slightly curved, delicate		
10-625-02	2x Wullstein Mikronadel, sehr leicht gebogen, spitz 2x Wullstein micro needle, very slightly curved, pointed		
10-630-06	1x Wullstein Mikrohäkchen, 45°, 0,6 mm / Wullstein micro hook, 45°, 0.6 mm		
10-630-08	1x Wullstein Mikrohäkchen, 45°, 0,8 mm / Wullstein micro hook, 45°, 0.8 mm		
10-628-06	1x Wullstein Mikrohäkchen, 90°, 0,6 mm / Wullstein micro hook, 90°, 0.6 mm		
10-628-08	1x Wullstein Mikrohäkchen, 90°, 0,8 mm / Wullstein micro hook, 90°, 0.8 mm		
10-628-15	1x Wullstein Mikrohäkchen, 90°, 1,5 mm / Wullstein micro hook, 90°, 1.5 mm		

#### Ergänzung 10-900-99

#### Supplement 10-900-99

10-733-09	1x Präparierplatte aus Glas, eine Seite angeraut, 9,5 x 7 x 0,5-0,6 cm 1x Cutting block, glass, one side satin finished, 9.5 x 7 x 0.5-0.6 cm
10-747-00	1x Arkansas-Öl-Stein zum Schleifen von Instrumenten 1x Arkansas oil whetstone for sharpening instruments
80-661-14	1x Norm-Sterilisations-Container Boden geschlossen, 585x274x138 mm Maße mit Deckel: 585x278x155 mm 1x Norm sterilization container bottom closed, 585x274x138 mm, dimensions with fitted lid: 585x278x155 mm
80-662-00	1x Ventildeckel silber, für Container 80-661-14, 585x278 mm 1x Valve lid silver, for container 80-661-14, 585x278 mm
80-671-60	1x Edelstahl-Siebkorb Geflecht, Fallgriffe 485x255x70 mm 1x Stainless steel wire basket Geflecht, sliding handles, 485x255x70 mm
80-681-07	1x Aluminium-Kennzeichnungs-Schild blau, 20 Zeichen, 56x17 mm 1x Aluminium tag blue, 20 letters, 56x17 mm

Supplement for sales in EU (outside the EU only on request)



## 12 Parazentese-Set 10-901-00

### Paracentesis Set 10-901-00

#### Bestehend aus / Consisting of:

10-200-01	1x Hartmann Ohrtrichter, Gr. 1 / Hartmann ear specula, size 1	10-305-11	1x Wullstein Saughandgriff mit Unterbrecher, 10,5 cm, Luer-Lock 1x Wullstein suction handle with interruptor, 10.5 cm, Luer lock
10-200-02	1x Hartmann Ohrtrichter, Gr. 2 / Hartmann ear specula, size 2	10-308-10-05	1x House Nadelsauger, Luer-Lock, 7 cm, 1,0 mm, 5 Stück 1x House suction cannula, Luer lock, 7 cm, 1.0 mm, 5 pieces
10-200-03	1x Hartmann Ohrtrichter, Gr. 3 / Hartmann ear specula, size 3	10-308-12-05	1x House Nadelsauger, Luer-Lock, 7 cm, 1,2 mm, 5 Stück 1x House suction cannula, Luer lock, 7 cm, 1.2 mm, 5 pieces
10-200-04	1x Hartmann Ohrtrichter, Gr. 4 / Hartmann ear specula, size 4	10-308-15-05	1x House Nadelsauger, Luer-Lock, 7 cm, 1,5 mm, 5 Stück 1x House suction cannula, Luer lock, 7 cm, 1.5 mm, 5 pieces
10-260-01	1x Buck Ohrkürette, stumpf, leicht gebogen, Gr. 1 1x Buck ear curette, blunt, slightly curved, size 1	10-308-20-05	1x House Nadelsauger, Luer-Lock, 7 cm, 2,0 mm, 5 Stück 1x House suction cannula, Luer lock, 7 cm, 2.0 mm, 5 pieces
10-618-01	1x Wullstein Sichelmesser, leicht gebogen, fein, 16 cm 1x Wullstein sickle knife, slightly curved, fine, 16 cm	10150	1x Titan-Paukenröhrchen, Typ Kragenknopf, 1,5 mm, 10 Stück/Box 1x Titanium ventilation tube, type collar-button, 1.5 mm, 10 pieces/box
10-700-00	1x Hartmann Ohrzängchen, gerieft, gerade, fein, 0,8 x 7,0 mm, 8 cm 1x Hartmann ear forceps, serrated, straight, fine, 0.8 x 7.0 mm, 8 cm	80-605-00	1x Systemkomponente "Instru-Safe" für Parazentese-Set zur Aufnahme von Ohrtrichtern, Ohrzängchen, Häkchen und Nadeln 1x System module "Instru-Safe" for myringotomy set, holds earspecula, forceps, knives and hooks
10-628-08	1x Wullstein Mikrohäkchen, 90°, 0,8 mm, 16 cm 1x Wullstein micro hook, 90°, 0.8 mm, 16 cm		
10-625-02	1x Wullstein Mikronadel, sehr leicht gebogen, spitz, 16 cm 1x Wullstein micro needle, very slightly curved, pointed, 16 cm		

## 12 Ohrmuschel-Set 10-905-00

### Otoplasty Set 10-905-00

#### Bestehend aus / Consisting of:

10-360-03	1x Skalpellgriff Nr. 3, 12,5 cm / 1x Scalpel handle no. 3, 12.5 cm	80-350-02	6x Halsted-Mosquito-Klemme gebogen, anatomisch, 12,5 cm 6x Halsted-Mosquito artery forceps, curved, anatomical, 12.5 cm
10-533-12	1x Schere, gebogen, spitz-spitz, 11,5 cm / 1x Scissors, curved, pointed, 11.5 cm	80-360-14	1x Präparierklemme ohne Sperre, leicht gebogen, anat., 14,5 cm 1x Artery Forceps without ratchet, anatomical, slightly curved, 14.5 cm
20-601-14	1x Joseph Schere, spitz-spitz, gebogen, 14,5 cm 1x Joseph scissors, pointed, curved, 14.5 cm	80-365-14	1x Pean Arterienklemme gerade, anatomisch, fein, 14 cm 1x Pean artery forceps anatomical, fine, straight, 14 cm
10-543-12	1x Schere, gebogen, stumpf-stumpf, 11,5 cm / 1x Scissors, curved, blunt, 11.5 cm	80-392-11	6x Backhaus Tuchklemme, gebogen, scharf, 11 cm 6x Backhaus towel clamp, sharp, curved, 11 cm
80-448-15	1x Cooper Schere, gebogen, spitz-stumpf, 14,5 cm 1x Cooper scissors, curved, sharp/blunt, 14.5 cm	10-555-13	1x Halsey Nadelhalter, Hartmetall, fein, 13 cm 1x Halsey needle holder TC, delicate, 13 cm
10-502-10	1x Graefe Pinzette, chirurgisch, 1:2 Zähne, gerade, 0,7 mm, 10 cm 1x Graefe dressing forceps, 1:2 teeth, straight, 0.7 mm, 10 cm	80-123-16	1x Bipolare Pinzette, NON-STICK, kniegebogen, extra fein, Spitze 8 mm lang, 0,2 mm breit, Führungsstift, 16,5 cm 1x Bipolar forceps, NON-STICK, angled, extra fine, tip length 8 mm, 0.2 mm wide, guide pin, 16.5 cm
20-710-12	1x Adson-Brown Pinzette, 7:8 Zähne, 12,5 cm 1x Adson-Brown forceps, 7:8 teeth, 12.5 cm	80-318-50	1x Bipolares Anschlusskabel, 5 m, passend für Erbe/Storz/Wolf, geräteseitig 1x Bipolar connecting cable, 5 m, comp. w. Erbe/Storz/Wolf, unit-side
10-481-14	1x Pinzette, anatomisch, gerade, 2 mm, 14,5 cm 1x Dressing forceps, anatomical, straight, 2 mm, 14.5 cm		
10-484-14	1x Pinzette, chirurgisch, 1:2 Zähne, gerade, 1,7 mm, 14,5 cm 1x Dressing forceps, surgical, 1:2 teeth, straight, 1.7 mm, 14.5 cm		
10-206-13-05	1x Watteträger, dreikant, gerieft, 0,9 mm Ø, 13 cm, 5 Stück/Box 1x Cotton carrier, triangular, serrated, 0.9 mm Ø, 13 cm, 5 pieces/box		
20-500-13	1x Cottle Septum-Messer, 14 cm / 1x Cottle septum knife, 14 cm		
20-305-18	1x Freer Doppelevatorium, scharf/stumpf, 18,5 cm 1x Freer elevator, double ended, sharp/blunt, 18.5 cm		
20-311-20	1x Freer-Joseph Doppel-Raspatorium, 20 cm 1x Freer-Joseph raspatory, double-ended, 20 cm		
10-356-00	1x Wullstein Raspatorium, 4 mm breit, 16,5 cm 1x Wullstein raspatory, 4 mm wide, 16.5 cm		
20-577-16	1x Cottle Hauthäkchen, 1-zinkig, gebogen, scharf, 14,5 cm 1x Cottle skin hook, 1-zinkig, curved, sharp, 14.5 cm		
20-582-05	1x Joseph Doppel-Häkchen, 2-zinkig, scharf, 6 mm, 16 cm 1x Joseph double hook, 2 prongs, sharp, 6 mm, 16 cm		
20-584-17	1x Fomon Nasenflügelhaken, 2-zinkig, stumpf, 12 mm, 16 cm 1x Fomon ala hook, 2 prongs, blunt, 12 mm, 16 cm		
80-503-03	1x Medizinbecher Edelstahl, graduert, Ø 50 mm, 30 ml 1x Medicine cup, stainless steel, graduated, Ø 50 mm, 30 ml		
40-553-01	1x Injektionskanüle, gerade, 0,8 mm, 12 cm, Luer-Lock 1x Injection cannula straight, 0.8 mm, 12 cm, Luer-lock		
30-080-08	1x Frazier Saugrohr mit Griffplatte und Unterbrecher, 8 Ch., 9 cm 1x Frazier suction tube with suction control, 8 Fr., 9 cm		
30-080-10	1x Frazier Saugrohr mit Griffplatte und Unterbrecher, 10 Ch., 9 cm 1x Frazier suction tube with suction control, 10 Fr., 9 cm		

### Ergänzung 10-905-99

#### Supplement 10-905-99

10-360-11	1x Skalpell-Klingen, Nr. 11, 100 Stück / 1x Scalpel blades, no. 11, 100 pieces
10-360-15	1x Skalpell-Klingen, Nr. 15, 100 Stück / 1x Scalpel blades, no. 15, 100 pieces
80-631-14	1x Norm-Sterilisations-Container Boden geschlossen, 297x274x138 mm Maße mit Deckel: 299x278x155 mm 1x Norm sterilization container bottom closed, 297x274x138 mm, dimensions with fitted lid: 299x278x155 mm
80-632-00	1x Ventildeckel, silber, für Container 80-631-14, 299x278 mm 1x Valve lid, silver, for container 80-631-14, 299x278 mm
80-671-20	1x Edelstahl-Siebkorb, Geflecht, Fallgriffe, 255x245x50 mm 1x Stainless steel wire basket, sliding handles, 255x245x50 mm
80-681-06	1x Aluminium-Kennzeichnungs-Schild, lila, 20 Zeichen 1x Aluminium tag, purple, 20 letters

Supplement for sales in EU (outside the EU only on request)



## 12 Instrumenten-Set für Retroaurikuläre Ohr-Chirurgie 10-906-00

### Retroauricular ear Set 10-906-00

#### Bestehend aus / Consisting of:

77HW001	1x Bohrhandstück 1,1, gewinkelt für Bohrer L. 70mm 1x Osteo-handpiece, 1,1, angled, for 70 mm burs	10-308-15-05	1x House suction cannula, Luer-Lock, 7 cm, 1,2 mm, 5 pieces/box 1x House Nadelsauger, Luer-Lock, 7 cm, 1,5 mm, 5 Stück/Box
BS23507034	1x Bohrerstander für 34 rotierende Instrumente der L 70 mm 1x Stand for 34 rotary instruments, length: 70 mm	10-308-20-05	1x House suction cannula, Luer-Lock, 7 cm, 1,5 mm, 5 pieces/box 1x House Nadelsauger, Luer-Lock, 7 cm, 2,0 mm, 5 Stück/Box
CR070010506	1x Osteotomie-Bohrer, HM, Ø 0,5 mm, 6 Schneiden 1x Osteotomy bur, TC, Ø 0.5 mm, 6 blades	10-648-12	1x House suction cannula, Luer-Lock, 7 cm, 2.0 mm, 5 pieces/box 1x Rosen Raspatorium, 1,0 x 12 mm, 16 cm
CR070010806	1x Osteotomie-Bohrer, HM, Ø 0,8 mm, 6 Schneiden 1x Osteotomy bur, TC, Ø 0.8 mm, 6 blades	10-610-18	1x Rosen raspatory, 1.0 x 12 mm, 16 cm 1x Rosen Rundsnittmesser, 45°, 1,8 mm, 16 cm
CR070011006	1x Osteotomie-Bohrer, HM, Ø 1,0 mm, 6 Schneiden 1x Osteotomy bur, TC, Ø 1.0 mm, 6 blades	10-610-25	1x Rosen round knife, 45°, 1.8 mm, 16 cm 1x Rosen Rundsnittmesser, 45°, 2,5 mm, 16 cm
CR070011206	1x Osteotomie-Bohrer, HM, Ø 1,2 mm, 6 Schneiden 1x Osteotomy bur, TC, Ø 1.2 mm, 6 blades	10-614-25	1x Rosen round knife, 45°, 2.5 mm, 16 cm 1x Plester Rundsnittmesser, vertikal, oval, 3,5 x 2,5 mm, 16 cm
CR070011406	1x Osteotomie-Bohrer, HM, Ø 1,4 mm, 6 Schneiden 1x Osteotomy bur, TC, Ø 1.4 mm, 6 blades	10-625-02	1x Plester flap knife, vertical, oval, 3.5 x 2.5 mm, 16 cm 1x Wullstein Mikronadel, sehr leicht gebogen, spitz, 16 cm
CR070011606	1x Osteotomie-Bohrer, HM, Ø 1,6 mm, 6 Schneiden 1x Osteotomy bur, TC, Ø 1.6 mm, 6 blades	10-630-08	1x Wullstein micro needle, very slightly curved, pointed, 16 cm 1x Wullstein Mikrohäkchen, 45°, 0,8 mm, 16 cm
CR070011806	1x Osteotomie-Bohrer, HM, Ø 1,8 mm, 6 Schneiden 1x Osteotomy bur, TC, Ø 1.8 mm, 6 blades	10-628-08	1x Wullstein micro hook, 45°, 0.8 mm, 16 cm 1x Wullstein Mikrohäkchen, 90°, 0,8 mm, 16 cm
CR070012106	1x Osteotomie-Bohrer, HM, Ø 2,1 mm, 6 Schneiden 1x Osteotomy bur, TC, Ø 2.1 mm, 6 blades	10-628-15	1x Wullstein micro hook, 90°, 0.8 mm, 16 cm 1x Wullstein Mikrohäkchen, 90°, 1,5 mm, 16 cm
CR070012708	1x Osteotomie-Bohrer, HM, Ø 2,7 mm, 8 Schneiden 1x Osteotomy bur, TC, Ø 2.7 mm, 8 blades	10-701-00	1x Wullstein micro hook, 90°, 1.5 mm, 16 cm 1x Hartmann Ohrzängchen, gerieft, gerade, fein, 0,8 x 4,0 mm, 8 cm
CR070013508	1x Osteotomie-Bohrer, HM, Ø 3,5 mm, 8 Schneiden 1x Osteotomy bur, TC, Ø 3.5 mm, 8 blades	10-703-00	1x Hartmann ear forceps, serrated, fine, straight, 0.8 x 4.0 mm, 8 cm 1x Mikro Ohrzängchen, ovale Löffel, gerade, fein, 0,8 x 1,3 mm, 8 cm
CR070014510	1x Osteotomie-Bohrer, HM, Ø 4,5 mm, 10 Schneiden 1x Osteotomy bur, TC, Ø 4.5 mm, 10 blades	10-705-00	1x Micro ear forceps, oval cups, straight, fine, 0.8 x 1.3 mm, 8 cm 1x Shea-Bellucci Ohrschere, gerade, 8 mm, 8 cm
CR070015012	1x Osteotomie-Bohrer, HM, Ø 5,0 mm, 12 Schneiden 1x Osteotomy bur, TC, Ø 5.0 mm, 12 blades	10-719-00	1x Shea-Bellucci ear scissors, straight, 8 mm, 8 cm 3x PTFE-Schutzhülse mit Fenster, für Ohrzängchen, 11,5 cm, autokl., 10 Stk.
CR070016014	1x Osteotomie-Bohrer, HM, Ø 6,0 mm, 14 Schneiden 1x Osteotomy bur, TC, Ø 6.0 mm, 14 blades	10-731-14	3x PTFE-protecting sleeve for ear forceps, 11.5 cm, 10 pieces/box 1x House Quetsch-Zange, 11 x 14 mm, 18 cm
CR070017016	1x Osteotomie-Bohrer, HM, Ø 7,0 mm, 16 Schneiden 1x Osteotomy bur, TC, Ø 7.0 mm, 16 blades	10-481-14	1x House pressure forceps, 11 x 14 mm, 18 cm 1x Pinzette, anatomisch, gerade, 2 mm, 14,5 cm
DR070010691	1x Diamant-Bohrer, mittlere Körnung, Ø 0,6 mm 1x Diamond bur, medium grain, Ø 0.6 mm	10-555-13	1x Dressing forceps, anatomical, straight, 2 mm, 14.5 cm 1x Halsey Nadelhalter, Hartmetall, fein, 13 cm
DR070010791	1x Diamant-Bohrer, mittlere Körnung, Ø 0,7 mm 1x Diamond bur, medium grain, Ø 0.7 mm	10-550-13	1x Halsey needle holder, TC, delicate, 13 cm 1x Universalschere, gebogen, spitz-stumpf, 13 cm
DR070010891	1x Diamant-Bohrer, mittlere Körnung, Ø 0,8 mm 1x Diamond bur, medium grain, Ø 0.8 mm	80-123-16	1x Universal scissors, curved, blunt-sharp, 13 cm 1x Bipolare Pinzette, NON-STICK, kniegebogen, extra fein, 0,2 mm, 16,5 cm
DR070011291	1x Diamant-Bohrer, mittlere Körnung, Ø 1,2 mm 1x Diamond bur, medium grain, Ø 1.2 mm	80-318-50	1x Bipolar forceps, NON-STICK, angled, extra fine, 0.2 mm, 16.5 cm 1x Bipolares Anschlusskabel, 5 m, passend für Erbe/Storz/Wolf, geräteseitig
DR070011691	1x Diamant-Bohrer, mittlere Körnung, Ø 1,6 mm 1x Diamond bur, medium grain, Ø 1.6 mm	80-501-01	1x Bipolar connecting cable, 5 m, comp. w. Erbe/Storz/Wolf, unit-side 1x Metallschale B1, Ø 40 mm, Volumen 0,02 l, Höhe 19 mm
DR070012191	1x Diamant-Bohrer, mittlere Körnung, Ø 2,1 mm 1x Diamond bur, medium grain, Ø 2.1 mm	80-501-02	1x Metal bowl B1, 40 mm Ø, height 19 mm, 20 ml 1x Metallschale B2, Ø 60 mm, Volumen 0,06 l, Höhe 29 mm
DR070012591	1x Diamant-Bohrer, mittlere Körnung, Ø 2,5 mm 1x Diamond bur, medium grain, Ø 2.5 mm	80-501-04	1x Metal bowl B2, 60 mm Ø, height 29 mm, 60 ml 1x Metallschale B4, Ø 110 mm, Volumen 0,4 l, Höhe 55 mm
DR070012991	1x Diamant-Bohrer, mittlere Körnung, Ø 2,9 mm 1x Diamond bur, medium grain, Ø 2.9 mm	80-392-09	1x Metal bowl B4, 110 mm Ø, height 55 mm, 400 ml 1x Backhaus Tuchklemme, gebogen, scharf, 9 cm
DR070013591	1x Diamant-Bohrer, mittlere Körnung, Ø 3,5 mm 1x Diamond bur, medium grain, Ø 3.5 mm	80-350-02	1x Backhaus towel clamp, sharp, curved, 9 cm 1x Halsted-Mosquito-Klemme, gebogen, anatomisch, 12,5 cm
DR070014591	1x Diamant-Bohrer, mittlere Körnung, Ø 4,5 mm 1x Diamond bur, medium grain, Ø 4.5 mm		1x Halsted-Mosquito artery forceps, curved, anatomical, 12.5 cm
DR070016091	1x Diamant-Bohrer, mittlere Körnung, Ø 6,0 mm 1x Diamond bur, medium grain, Ø 6.0 mm		
DR070017091	1x Diamant-Bohrer, mittlere Körnung, Ø 7,0 mm 1x Diamond bur, medium grain, Ø 7.0 mm		
SR070095012	1x Osteotomie-Bohrer, rostfr. Stahl, Omni E, Ø 5,0 mm, 12 Schn., Knospe 1x Osteotomy bur, stainless steel, Omni E, Ø 5.0 mm, 12 bl., bud shape		
10-420-11	2x Wullstein Wundsperrer, 3:3 Zähne, halbscharf, 11 cm 2x Wullstein retractor, 3:3 prongs, semi-sharp, 11 cm		
10-438-17	1x Fisch Wundsperrer mit Gelenken, 3:3 Zähne, halbscharf, 16,5 cm 1x Fish retractor, with joint, 3:3 prongs, semi-sharp, 16.5 cm		
20-601-14	1x Joseph Schere, spitz-spitz, gebogen, 14,5 cm 1x Joseph scissors, pointed, curved, 14.5 cm		
20-610-15	1x Reynolds Schere, stumpf-stumpf, gebogen, verjüngte Spitze, 16 cm 1x Reynolds scissors, blunt-blunt, tapered tips, curved, 16 cm		
10-482-14	1x Pinzette, anatomisch, gerade, 1,7 mm, 14,5 cm 1x Dressing forceps, anatomical, straight, 1.7 mm, 14.5 cm		
10-485-14	1x Pinzette, chirurgisch, 1:2 Zähne, gerade, 1,4 mm, 14,5 cm 1x Dressing forceps, surgical, 1:2 teeth, straight, 1.4 mm, 14.5 cm		
10-489-15	1x Helms Pinzette, anatomisch, gerade, 2,8 mm, 15 cm 1x Helms dressing forceps, surgical, straight, 2.8 mm, 15 cm		
10-504-10	1x Hildmann Knorpelpinzette, gerade, 11 cm 1x Hildmann cartilage forceps, straight, 11 cm		
10-466-13	1x Williger Wundhaken, 4 scharfe Zähne, 13,5 cm 1x Williger retractor, 4 sharp prongs, 13.5 cm		
10-355-08	1x Plester Gehörgangsraspatorium, flach gebogen, 8 mm, 18 cm 1x Plester raspatory, curved, 8 mm, 18 cm		
10-356-00	1x Wullstein Raspatorium, 4 mm, 16,5 cm 1x Wullstein raspatory, 4 mm, 16.5 cm		
10-261-10	1x Buck Ohrkürette, scharf, leicht gebogen, Gr. 0, 2,0 mm, 16 cm 1x Buck ear curette, sharp, slightly curved, size 0, 2.0 mm, 16 cm		
10-261-02	1x Buck Ohrkürette, scharf, leicht gebogen, Gr. 2, 3,0 mm, 16 cm 1x Buck ear curette, sharp, slightly curved, size 2, 3.0 mm, 16 cm		
10-305-11	1x Wullstein Saughandgriff mit Unterbrecher, 10,5 cm 1x Wullstein suction handle with suction control, 10.5 cm		
10-308-08-05	1x House Nadelsauger, Luer-Lock, 7 cm, 0,8 mm, 5 Stück/Box 1x House suction cannula, Luer-Lock, 7 cm, 0.8 mm, 5 pieces/box		
10-308-12-05	1x House Nadelsauger, Luer-Lock, 7 cm, 1,2 mm, 5 Stück/Box 1x House suction cannula, Luer-Lock, 7 cm, 1.2 mm, 5 pieces/box		

#### Ergänzung 10-906-99

#### Supplement 10-906-99

10-733-09	1x Präparierplatte aus Glas, eine Seite angeraut, 9,5 x 7 x 0,5-0,6 cm 1x Cutting block, glas, one side satin finished, 9.5 x 7 x 0.5-0.6 cm
10-747-00	1x Arkansas Ölstein, keilförmig, 90 x 40 mm 1x Arkansas oil whet stone, wedge-shaped, 90 x 40 mm
80-661-14	1x Norm-Sterilisations-Container, Boden geschlossen, 585 x 274 x 138 mm 1x Norm sterilization container, bottom closed, 585 x 274 x 138 mm
80-662-00	1x Ventildeckel, silber, für Container 80-661-14, 585 x 278 mm 1x Valve lid, silver, for container 80-661-14, 585 x 278 mm
80-671-60	1x Edelstahl-Siebkorb, Geflecht, Fallgriffe, 485 x 255 x 70 mm 1x Stainless steel wire basket, sliding handles, 485 x 255 x 70 mm
80-681-05	1x Aluminium-Kennzeichnungs-Schild, gelb, 20 Zeichen 1x Aluminium tag, yellow, 20 letters

Supplement for sales in EU (outside the EU only on request)

Bohrerlänge: 70 mm  
Bur length: 70 mm





## 12 Tympanoplastik-Set 10-909-00

### Tympanoplasty Set 10-909-00

#### Bestehend aus / Consisting of:

10-450-11	2x Wullstein Wundsperrer, 3:3 Zähne, 11 cm 2x Wullstein retractor, 3:3 prongs, 11 cm	10-610-25	1x Rosen Rundschnittmesser, 2,5 mm, 45°, 16 cm 1x Rosen round knife, 2.5 mm, 45°, 16 cm
10-458-11	1x Helms Wundsperrer, 2 Zähne rechts, Blatt mit Noppen links, 11 cm 1x Helms retractor, 2 prongs right, blade with studs, 11 cm	10-614-25	1x Plester Rundschnittmesser, oval, vertikal, 16 cm 1x Plester round knife, oval, vertical, 16 cm
10-459-11	1x Helms Wundsperrer, 2 Zähne links, Blatt mit Noppen rechts, 11,5 cm 1x Helms retractor, 2 prongs left, blade with studs right, 11.5 cm	10-618-02	1x Wullstein Sichelmesser, leicht gebogen, sehr fein, 16 cm 1x Wullstein sickle knife, slightly curved, delicate, 16 cm
10-468-17	1x Fisch Wundsperrer mit Gelenken, 3:3 Zähne, halbscharf, 16,5 cm 1x Fisch retractor, adjustable, 3:3 prongs, semi-sharp, 16.5 cm	10-625-02	2x Wullstein Mikronadel, sehr leicht gebogen, spitz, 16 cm 2x Wullstein micro needle, very slightly curved, pointed, 16 cm
20-100-01	1x Hartmann Nasenspekulum, zerlegbar, für Erwachsene 1x Hartmann nose specula, dismantable, for adults	10-627-02	1x Wullstein Mikrohäkchen "Color line", 45°, 0,2 mm, 16 cm 1x Wullstein micro hook "Color line", 45°, 0.2 mm, 16 cm
20-601-14	1x Joseph Schere, spitz-spitz, gebogen, 14,5 cm 1x Joseph scissors, pointed, curved, 14.5 cm	10-627-04	1x Wullstein Mikrohäkchen "Color line", 45°, 0,4 mm, 16 cm 1x Wullstein micro hook "Color line", 45°, 0.4 mm, 16 cm
20-610-15	1x Reynolds Schere, stumpf-stumpf, gebogen, verjüngte Spitze, 16 cm 1x Reynolds scissors, blunt, curved, tapered tips, 16 cm	10-627-06	1x Wullstein Mikrohäkchen "Color line", 45°, 0,6 mm, 16 cm 1x Wullstein micro hook "Color line", 45°, 0.6 mm, 16 cm
10-534-12	1x Supercut Schere für Fascie, spitz-spitz, gebogen, 11,5 cm, extrafein 1x Supercut scissors for fascie, pointed, curved, 11.5 cm, extra delicate	10-626-06	1x Wullstein Mikrohäkchen "Color line", 90°, 0,6 mm, 16 cm 1x Wullstein micro hook "Color line", 90°, 0.6 mm, 16 cm
10-482-14	1x Pinzette, anatomisch, gerade, 1,7 mm, 14,5 cm 1x Forceps, anatomical, straight, 1.7 mm, 14.5 cm	10-626-08	1x Wullstein Mikrohäkchen "Color line", 90°, 0,8 mm, 16 cm 1x Wullstein micro hook "Color line", 90°, 0.8 mm, 16 cm
10-485-14	1x Pinzette, chirurgisch, 1:2 Zähne, gerade, 1,4 mm, 14,5 cm 1x Forceps, 1:2 teeth, straight, 1.4 mm, 14.5 cm	10-626-10	1x Wullstein Mikrohäkchen, "Color line" 90°, 1,0 mm, 16 cm 1x Wullstein micro hook "Color line", 90°, 1.0 mm, 16 cm
10-489-15	1x Helms Pinzette, anatomisch, gerade, 2,8 mm, 15 cm 1x Helms forceps, anatomical, straight, 2.8 mm, 15 cm	10-700-01	1x Hartmann Ohrzangchen, gerieft, fein, gerade, 8 cm 1x Hartmann ear forceps, serrated, delicate, straight, 8 cm
20-710-12	1x Adson Brown Pinzette, 7:8 Zähne, 12,5 cm 1x Adson Brown forceps, 7:8 teeth, 12.5 cm	10-703-00	1x Mikro-Ohrzangchen, ovale Löffel, gerade, fein, 8 cm 1x Micro Ear forceps, oval curette, straight, delicate, 8 cm
10-504-10	1x Hildmann Knorpelpinzette, gerade, 11 cm 1x Hildmann cartilage forceps, straight, 11 cm	10-705-01	1x Bellucci Ohr Schere, gerade, fein, 4,0 mm, 8 cm 1x Bellucci ear forceps, straight, delicate, 4.0 mm, 8 cm
10-200-01	1x Hartmann Ohrtrichter, Gr. 1 / Hartmann speculum, size 1	10-719-00	3x PTFE-Schutzhülse mit Fenster, für Ohrzangchen, 11,5 cm, autoklavierbar, 10 Stück/Box 3x PTFE-protecting sleeve with window, for ear forceps, 11.5 cm, autoclavable, 10 pieces/box
10-200-02	1x Hartmann Ohrtrichter, Gr. 2 / Hartmann speculum, size 2	10-555-13	1x Halsey Nadelhalter, Hartmetall, fein, 13 cm 1x Halsey needle holder, tungsten carbide, delicate, 13 cm
10-200-03	1x Hartmann Ohrtrichter, Gr. 3 / Hartmann speculum, size 3	10-550-13	1x Universalschere, spitz-stumpf, gebogen, 13 cm 1x Universal scissors, blunt / pointed, curved, 13 cm
10-200-04	1x Hartmann Ohrtrichter, Gr. 4 / Hartmann speculum, size 4	80-501-01	1x Metallschale B1, Ø 40 mm, Volumen 0,02 l, Höhe 19 mm 1x Metal bowl B1, 40 mm Ø, 20 ml, 19 mm height
10-466-13	1x Williger Wundhaken, 4-zinkig, scharf, 13,5 cm 1x Williger retractor, 4 prongs, sharp, 13.5 cm	80-501-02	1x Metallschale B2, Ø 60 mm, Volumen 0,06 l, Höhe 29 mm 1x Metal bowl B2, 60 mm Ø, 60 ml, 29 mm height
10-355-08	1x Plester Gehörgangraspatorium, 8 mm, 18 cm 1x Plester raspatory, 8 mm, 18 cm	80-501-04	1x Metallschale B4, Ø 110 mm, Volumen 0,40 l, Höhe 55 mm 1x Metal bowl B4, 110 mm Ø, 400 ml, 55 mm height
10-356-00	1x Wullstein Raspatorium, 4 mm, 16,5 cm 1x Wullstein raspatory, 4 mm, 16.5 cm	80-123-16	1x Bipolare Pinzette, NON-STICK, kniegebogen, extra fein, Spitze 8 mm lang, 0,2 mm breit, Führungsstift, 16,5 cm 1x Bipolar forceps, NON-STICK, angled, extra fine, tip length 8 mm, 0.2 mm wide, guide pin, 16.5 cm
10-261-10	1x Buck Ohrkürette, Gr. 0, scharf, leicht gebogen, 2,0 mm, 16 cm 1x Buck ear curette, size 0, sharp, slightly curved, 2.0 mm, 16 cm	80-318-50	1x Bipolares Anschlusskabel, 5 m, passend für Erbe/Storz/Wolf, geräteseitig 1x Bipolar connecting cable, 5 m, comp. w. Erbe/Storz/Wolf, unit-side
10-261-02	1x Buck Ohrkürette, Gr. 2, scharf, leicht gebogen, 3,0 mm, 16 cm 1x Buck ear curette, size 2, sharp, slightly curved, 2.0 mm, 16 cm		
30-105-06	1x Frazier Saugrohr, 6 Ch., konisch, tränenförmige Sogsteuerung, AL 80 mm 1x Frazier suction tube, 6 Fr., conical, tearform suction control, WL 80 mm		
30-105-10	1x Frazier Saugrohr, 10 Ch., konisch, tränenförmige Sogsteuerung, AL 80 mm 1x Frazier suction tube, 10 Fr., conical, tearform suction control, WL 80 mm		
10-305-11	1x Wullstein Saughandgriff mit Unterbrecher, 10,5 cm 1x Wullstein suction handle with suction control, 10.5 cm		
10-308-08-05	1x House Nadelsauger, Luer Lock, 0,8 mm, 5 Stück/Box 1x House suction cannula, Luer lock, 0.8 mm, 5 pieces/box		
10-308-12-05	1x House Nadelsauger, Luer Lock, 1,2 mm, 5 Stück/Box 1x House suction cannula, Luer lock, 1.2 mm, 5 pieces/box		
10-308-15-05	1x House Nadelsauger, Luer Lock, 1,5 mm, 5 Stück/Box 1x House suction cannula, Luer lock, 1.5 mm, 5 pieces/box		
10-308-20-05	1x House Nadelsauger, Luer Lock, 2,0 mm, 5 Stück/Box 1x House suction cannula, Luer lock, 2.0 mm, 5 pieces/box		
10-667-00	1x Doppellöffel nach House, Gr.0, leicht gebogen, 17 cm 1x House curette, double ended, size 0, slightly curved, 17 cm	80-661-14	1x Norm-Sterilisations-Container, Boden geschlossen, 585 x 274 x 138 mm 1x Norm sterilization container, bottom closed, 585 x 274 x 138 mm
10-667-01	1x Doppellöffel nach House, Gr.1, leicht gebogen, 17 cm 1x House curette, double ended, size 1, slightly curved, 17 cm	80-662-00	1x Ventildeckel, silber, für Container 80-661-14, 585 x 278 mm 1x Valve lid, silver, for container 80-661-14, 585 x 278 mm
10-667-02	1x Doppellöffel nach House, Gr.2, leicht gebogen, 17 cm 1x House curette, double ended, size 2, slightly curved, 17 cm	80-671-60	1x Edelstahl-Siebkorb, Geflecht, Fallgriffe, 485 x 255 x 70 mm 1x Stainless steel wire basket, sliding handles, 485 x 255 x 70 mm
10-610-12	1x Rosen Rundschnittmesser, 1,2 mm, 45°, 16 cm 1x Rosen round knife, 1.2 mm, 45°, 16 cm	80-681-07	2x Aluminium-Kennzeichnungs-Schild, blau, 20 Zeichen 2x Aluminium tag, blue, 20 letters
10-610-18	1x Rosen Rundschnittmesser, 1,8 mm, 45°, 16 cm 1x Rosen round knife, 1.8 mm, 45°, 16 cm		

#### Ergänzung 10-909-99

#### Supplement 10-909-99

80-661-14	1x Norm-Sterilisations-Container, Boden geschlossen, 585 x 274 x 138 mm 1x Norm sterilization container, bottom closed, 585 x 274 x 138 mm
80-662-00	1x Ventildeckel, silber, für Container 80-661-14, 585 x 278 mm 1x Valve lid, silver, for container 80-661-14, 585 x 278 mm
80-671-60	1x Edelstahl-Siebkorb, Geflecht, Fallgriffe, 485 x 255 x 70 mm 1x Stainless steel wire basket, sliding handles, 485 x 255 x 70 mm
80-681-07	2x Aluminium-Kennzeichnungs-Schild, blau, 20 Zeichen 2x Aluminium tag, blue, 20 letters

Supplement for sales in EU (outside the EU only on request)



# Alphabetisches Inhaltsverzeichnis

Adson Pinzetten.....	38 - 39	Holmgren Ohrtrichter, spreizbar.....	16	Politzer Ohrtrichter.....	16
Adson-Brown Pinzette.....	38	House Doppellöffel.....	54	Politzer Parazentesemesser.....	22
Akustikusneurinom-Ringpinzette.....	40	House Nadelsauger.....	24	Politzer Einsteckkonus.....	11
Arkansas Ölstein.....	77	House Quetsch-Zange.....	76	Politzer Gummibirne.....	11
Ambossgabel nach Preyer.....	55	House Saug- und Spülrohr.....	26	Porzellanschälchen.....	80
Attik Watteträger.....	16	House Saughandgriff.....	23	Präparierplatte aus Glas.....	75
Baby-Metzenbaum-Schere.....	44	House-Bellucci Ohrscherchen.....	68	Präparier-Tablett aus Edelstahl.....	72
Baron Saugrohr.....	24	Indikator-Klebeetikett.....	81	Preyer Wundsperrerr / Preyer Wundsperrerr Blackline.....	35 - 36
Beales Elevatorium.....	54	Instrumentenboxen.....	84 - 85	Reynolds Schere.....	44
Bellucci Ohrscherchen.....	68	Instrumentenset f. Retroaurikuläre Ohrchirurgie.....	90	Rosen Raspatorium.....	46
Beyer Knochenzange.....	31	Jobson Watteträger.....	19	Rosen Rundschnittmesser, Lanzettmesser.....	46
Billeau Ohrschlinge.....	18	Joseph Schere.....	43	Saugrohre.....	23
Binokularlupe.....	9	Kabierske Ersatzglas.....	12	Scheren.....	42 - 45
Bipolare Ringpinzette.....	40	Kabierske Kanülen.....	12	Schere Black Line.....	42
Blessing Nystagmusbrille.....	9	Kabierske Pulverbläser.....	12	Schlingen für Krause Ohrpolypenschnürer.....	22
Brünings anastigmatische Ohrlupe.....	13	Kabierske Ventilball.....	12	Schlingenführer für Krause Ohrpolypenschnürer.....	22
Brünings Gummiball.....	13	Kerrison Knochenstanze.....	31	Schuknecht Drahtbiegegerät.....	73
Brünings Lupe.....	14	Klemmschild aus Edelstahl.....	81	Schuknecht Drahtschneidescherchen.....	45
Brünings Ohrtrichter.....	14	Kombi-Tasche.....	8	Schuknecht Mikrohäkchen / Mikronadel.....	51
Buck Ohrkürette.....	18	Kornzangenbehälter, Edelstahl / Glas.....	80	Schuknecht-Fisch Wundsperrerr.....	33
Caversaccio Tympano Sizer.....	50	Krause Ohrpolypenschnürer.....	22	Schuknecht Saugrohr.....	24
Citelli Knochenstanze.....	31	Kürzängchen für Mittelohr-Implantate.....	70	Seiffert Speichelgangsonde.....	76
Codierschild.....	81	Langenbeck Raspatorium.....	27	Semken Pinzette.....	38
Containersiegel.....	81	LED-Leuchtgriffe.....	6	Shea Venenpresse.....	76
Cooper Schere.....	45	Lempert Knochenzange.....	30	Siebkorb.....	81
Cottle Hammer.....	29	Lempert Mastoid-Löffel.....	30	Skalpell-Griff / -Klingen.....	28
Cottle Raspatorium.....	27	Lempert Raspatorium.....	27	Snellen Ohrschlinge.....	19
Dauergebrauchs-Ohrtrichter.....	10	Lösungsschale.....	79	Spencer Drahtschneideschere.....	45
Day Cerumenhäkchen.....	18	Lucae Cerumenhäkchen.....	17	Spezial-Ölspray.....	78
Dazert Wundsperrerr.....	35	Lucae Ohrpinzette.....	19	Spratt Mastoid-Löffel.....	30
DeBakey Pinzette.....	37	Lucae Parazentesemesser.....	22	Spritzschutz für Stirnlampe.....	7
Derlaci Gehörknöchelchen-Pinzette.....	39	Lucae Stimmgabeln mit Fuß.....	13	Stapes Längen-Mess-Instrumente.....	71
Diamantbohrer.....	32	Luer Knochenzange.....	30	Stapesgelenk-Messer.....	47
Dieter Hammerkopfstanze.....	69	McGee Drahtschließzängchen.....	69	Steckdosen-Schnell-Ladegerät.....	7
Doppelgelenk für Stirnreifen.....	9	McIndoe Pinzette.....	37	Sterilisations-System "Instru-Safe".....	82
Drahtbiege- und Schneideschere.....	77	Medikamentenschälchen, Glas.....	79	Stimmgabel mit Fuß.....	13
Duckbill Ohrzängchen.....	26	Medizinbecher.....	79	Stirnlampe, Stirnleuchte.....	7
Einführungszängchen für Paukenröhrchen.....	76	Mess- und Schneideblock für Stapesprothesen.....	72	Stirnlampen-Ladestation.....	7
Einmal-Ohrtrichter.....	10	Messinstrument für Mittelohrprothesen.....	71	Stirnreifen.....	7, 8
Endoskophalter.....	77	Metallhammer.....	29	Strümpel Ohrzängchen.....	21
Endoskopie-Siebkorb.....	82	Metallschale.....	79	Tablettenschale.....	79
Endoskopische Instrumente nach Panetti.....	58 - 62	Metallständer für Ohrtrichter.....	15	Teflon-Schutzhülse für Ohrzängchen.....	73
Elektroden-Einführungpinzette.....	41	Metallständer für Ohrzängchen.....	74	Teschner Sichelmesser.....	47
Entsorgungsmarke.....	81	Metzenbaum Scheren.....	44	Tilley Ohrtamponadezängchen.....	19
Ersatzspekulum.....	5	Mikrolöffel.....	54	Tisch Mikrolöffel.....	55
Farabœuf Periost Raspatorium.....	27	Mikro-Ohrzängchen.....	59	Titaninstrumente.....	56 - 57
Farrior Ohrtrichter.....	15	Mikro-Häkchen, Titan.....	57	Toynbee Ohrtrichter.....	16
Felsenbeinhalter Modell Würzburg.....	78	Mikro-Nadel, Titan.....	57	Trautmann Flachmeißel, Hohlmeißel.....	28
Fiber Otoskop beta 200.....	10	Mikro-Pinzette, Titan.....	57	Troeltsch Ohrpinzette.....	20
Fisch Crurotomie Scherchen.....	69	Mikro-Ritz-Instrument.....	54	T-Tube Einführungsinstrument.....	78
Fisch Dissektor.....	52	Mini-Otoskop 3000.....	9	Tubalstruments.....	63 - 64
Fisch Fußplatten-Perforator.....	53	Modul "Baron Saugrohre".....	83	Tympanoplastik / Stapesplastik-Set.....	88
Fisch Längen-Mess-Instrument.....	71	Modul "Häkchen/Messer".....	83	Uhrmacherpinzetten.....	41
Fisch Messzylinder.....	71	Modul "Mikrosaugröhrchen".....	83	Universal-Einführungszängchen.....	78
Fisch Ohrzängchen.....	66	Modul "Ohrtrichter", "Ohrzängchen".....	83	Universal-Endoskop.....	5
Fisch Schneide- und Präparierblock.....	71	Mollison Wundsperrerr.....	35	Universalschere.....	45
Fisch Wundsperrerr.....	36	Müller Drahtschließzängchen.....	70	Verhoeven Saugrohr.....	25
Fisch-McGee Drahtschließzängchen.....	70	Müller Einführungsinstrument.....	55	Watteträger.....	17
Flexibler Spannarm.....	77	Nierenschale, Edelstahl.....	80	Weitlaner Wundsperrerr.....	35
Frazier Saugrohr.....	25	Norm-Sterilisationscontainer.....	81	Wegener Cerumenhäkchen.....	17
Freer Doppelevatorium.....	28	Noppenmatte.....	84	Wigand endauraler Wundsperrerr.....	35
Frenzel Nystagmusbrille.....	9	Nylon-Ersatzbacken.....	29	Williger Elevatorium.....	75
Führungsrohr für Krause Ohrpolypenschnürer.....	22	Ölspray.....	78	Williger Wundhaken.....	36
Gehörgangs-Endoskop.....	5	Ohrkürette.....	18	Wullstein Mikrohäkchen, "Colour Line".....	48 - 49
Gehörgangskürette, scharf.....	18	Ohrmuschelset.....	89	Wullstein Mikronadel.....	47
Gehörgangs- u. Nasenspekulum.....	14	Ohrspekulumhalter.....	77	Wullstein Pinzette.....	39
Gelenkkloben.....	77	Ohr-Tamponade-Stopfer.....	19	Wullstein Raspatorium.....	27
Graefe Pinzetten.....	39	Otoskop.....	5, 59	Wullstein Saughandgriff.....	23
Greven Drahtschließzängchen.....	70	Osteotomiebohrer.....	32	Wullstein Saugrohr.....	26
Gruber Ohrtrichter.....	16	Panetti Set für Endo- / Mikroskopische Instrumente.....	86 - 87	Wullstein Sichelmesser.....	22, 47
Hajek Metallhammer.....	29	Parazentese-Set.....	89	Wullstein Wundsperrerr.....	33
Halstead Mosquito-Klemme.....	74	Paukenspiegel.....	53	XHL Xenon Ersatzlampe.....	10
Halsey Nadelhalter.....	45	Perkins Wundsperrerr.....	34	Zenner Fußplattenhäkchen.....	53
Hartmann Ohrtrichter.....	14	Petrischale.....	79	Ziegler Stirnspiegel.....	10
Hartmann Ohrzängchen.....	21, 56, 65 - 66	Pinzetten.....	37	Zimmermann-Akustikusneurinom-Ringpinzetten.....	40
Hartmann Stimmgabeln (einzeln, Set).....	13	Plester (Antrum-)Häkchen.....	52	Zöllner Aufsatzsauger.....	24
Hartmann Tamponadezängchen.....	19	Plester Einführungs-gabel.....	53	Zöllner Mikrohäkchen.....	76
Hartmetallbohrer.....	32	Plester Fußplattenhäkchen.....	53	Zöllner Mikronadel.....	76
Heermann Hammer, Handgriff.....	75	Plester Gehörgangsraspatorium.....	27	Zöllner Ohrtrichter.....	16
Heermann Hohlmeißel.....	75	Plester Rundschnittmesser.....	46	Zöllner Saugrohr.....	22
Heermann Mikrohäkchen.....	76	Plester Saugrohr.....	26		
Heermann Ohrzängchen.....	74	Plester Sichelmesser.....	47		
Helms Pinzette.....	37	Plester Wundsperrerr.....	33		
Helms Wundsperrerr.....	34	Politzer Luftdusche (Set).....	11		
Hildmann Knorpelpinzette.....	41	Politzer Nasenolive.....	11		
Hoffmann Ohrzängchen.....	21	Politzer Ohrlive.....	11		

Acoustic neurinoma ring forceps .....	40
Adhesive label .....	81
Adson dressing forceps .....	38 - 39
Adson-Brown forceps .....	38 - 39
Arkansas oil whetstone .....	77
Austin dissector .....	52
Attic cotton carrier .....	16
Baby Metzenbaum scissors .....	44
Bag for headlight .....	8
Barany sound apparatus .....	12
Baron suction tube .....	24
Basket .....	81
Beales elevator .....	54
Bellucci ear scissors .....	68
Beyer rongeur .....	31
Billeau ear loop .....	17
Binocular loupe .....	9
Bipolar ring forceps .....	40
Blessing nystagmus spectacles .....	9
Brünings anastigmatic aural magnifier .....	13
Brünings ear specula .....	14
Brünings loupe head .....	14
Brünings rubber bulb .....	13
Buck ear curette .....	18
Cannula for Krause ear polyp snare .....	21
Caversaccio Tympano Sizer .....	50
China bowl .....	80
Citelli bone punch .....	31
Coding label .....	81
Coding clamp .....	81
Combi bag for LED headlight .....	8
Container seal .....	81
Cooper scissors .....	45
Cordless LED headlight .....	8
Cottle mallet .....	29
Cottle raspatory .....	27
Cotton carrier .....	16
Cutting block (glass) .....	75
Curette .....	54
Day cerumen hook .....	17
Dazert retractor .....	35
DeBakey dressing forceps .....	37
Derlacki ossicle holding forceps .....	39
Diamond burs .....	32
Dieter malleus nipper .....	69
Double joint for head bands .....	9
Dressing forceps .....	37
Duckbill ear forceps .....	20
Ear canal and nasal specula .....	14
Ear canal curette .....	18
Ear canal endoscope .....	5
Ear curette, angled .....	18
Ear specula, disposable .....	11
Ear speculum clamp .....	77
Electrode insertion forceps .....	41
Endoscope clamp .....	77
Endoscope container .....	82
ENT instrument tray .....	85
Faraboeuf Periostr raspatory .....	27
Farrior ear specula .....	15
Fibre otoscope alpha 100 / beta 200 .....	10
Fisch caliper .....	71
Fisch crurotomy scissors .....	69
Fisch cutting and preparation jig .....	72
Fisch dissector .....	52
Fisch retractor .....	35
Fisch ear forceps .....	66
Fisch footplate perforator .....	3
Fisch reference instrument for stapes prostheses .....	71
Fisch-McGee wire closing forceps .....	70
Fingermat .....	84
Flexible holding arm .....	77
Forceps by Bishop-Harmon .....	41
Forceps holder .....	80
Frazier suction tube .....	25
Freer double elevator .....	28
Frenzel nystagmus spectacles .....	9
Gauze applicator .....	18
Graefe dressing forceps .....	39
Greven wire closing forceps .....	70
Hajek metal mallet .....	29
Halsey needle holder .....	45
Halstead mosquito clamp .....	74
Hartmann ear forceps .....	20, 56, 65-66
Hartmann ear tampon forceps .....	19
Hartmann ear specula .....	14
Hartmann tuning forks .....	13
Head band .....	8
Headlight (halogen / cordless) .....	7
Headlight transformer .....	7
Heermann ear forceps .....	74
Heermann gouge .....	75
Heermann handle / mallet .....	75
Heermann micro hook .....	77
Helms dressing forceps .....	37
Helms retractor .....	43
High definition fibre light cable .....	62
Hildmann cartilage forceps .....	41
Hoffmann ear forceps .....	21
Holmgren ear specula, expandable .....	16
House-Bellucci scissors .....	68
House curette .....	54
House pressure forceps .....	76
House suction- and irrigation tube .....	26
House suction cannula .....	24
House suction handle .....	23
Incudostapedial joint knife .....	47
Instrument boxes .....	84 - 85
Jeweller forceps .....	41
Jobson cotton carrier .....	18
Joseph scissors .....	43
Kabierske cannula .....	12
Kabierske powder blower .....	12
Kabierske rubber ball .....	12
Kabierske spare bottle .....	12
Kerrison rongeur .....	31
Kidney bowl .....	80
Krause ear polyp snare .....	21
Label holder with clip .....	81
Langenbeck raspatory .....	27
Lempert mastoid curette .....	30
LED light handle .....	6
Lempert raspatory .....	27
Lempert rongeur .....	30
Lucae cerumen hook .....	17
Lucae dressing forceps .....	19
Lucae myringotomy blade .....	22
Lucae tuning forks .....	13
Luer rongeur .....	30
McGee wire closing forceps .....	69
McIndoo dressing forceps .....	37
Medication cup .....	79
Metal bowl .....	79
Metal mallet with nylon facings .....	29
Metal stand for ear forceps .....	74
Metal stand for ear specula .....	15
Metzenbaum scissors .....	44
Micro ear forceps .....	59, 67
Micro forceps, titanium .....	57
Micro hook, titanium .....	57
Micro needle, titanium .....	57
Micro scratching instrument .....	54
Mini otoscopes .....	9
Mollison retractor .....	35
Multi use ear specula .....	10
Müller insertion fork for cochlea implants .....	55
Müller wire closing forceps .....	70
Norm sterilisation container .....	81
Nylon spare facings .....	29
Oil spray .....	78
Olive tip for Barany noise apparatus .....	12
Osteotomy burs .....	32
Otoscope .....	5, 58
Otoplasty set .....	90
Panetti Microscopic / Endoscopic Instruments .....	86 - 87
Paracentesis Set .....	90
Perkins retractor .....	34
Petri bowl .....	79
Piston measuring and cutting jig .....	73
Plester (antrum) hook .....	52
Plester flap knife .....	46
Plester footplate hook .....	53
Plester guiding fork for stapes prostheses .....	53
Plester hook .....	52
Plester raspatory .....	27
Plester retractor .....	33
Plester sickle knife .....	47
Plester suction tube .....	26
Politzer air bag (set) .....	11
Politzer connecting nozzle .....	11
Politzer ear specula for infants .....	16
Politzer ear olive .....	11
Politzer nose olive .....	11
Politzer myringotomy blade .....	22
Politzer rubber bulb .....	11
Preparation tray, stainless steel .....	72
Preyer retractor .....	36
Preyer incus forc .....	55
Removable ear specula .....	10
Retroauricular ear set .....	93
Reynolds scissors .....	44
Rosen lancet knife .....	46
Rosen raspatory .....	46
Rosen round knife .....	46
Rotation clamp .....	78
Scalpel blades and handle .....	28
Schuknecht micro hook / needle .....	51
Schuknecht-Fisch retractor .....	33
Schuknecht suction tube .....	24
Schuknecht wire bending die .....	73
Schuknecht wire cutting scissors .....	45
Scissors .....	42 - 45
Scissors Black Line .....	42
Seiffert salivary duct probe .....	76
Semken dressing forceps .....	38
Shambough-Derlacki duckbill raspatory .....	28
Shea vein press .....	76
Shortening forceps for middle ear implants .....	70
Snellen ear loop .....	18
Solution bowl .....	79
Spencer wire cutting scissors .....	45
Spratt mastoid curette .....	30
Stapes reference instruments .....	71
Sterilizing and protection system .....	82
Strümpel ear forceps .....	21
Styilet for Krause ear polyp snare .....	22
Suction tubes .....	23
Tablet dish .....	79
Teflon protection sleeve for ear forceps .....	73
Temporal bone holder Würzburg type .....	78
Tilley dressing and sponge holding forceps .....	19
Tisch micro curette .....	55
Titanium micro needle / hook / forceps .....	56 - 57
Trautmann chisel / gouge .....	28
Tray "Baron suction tubes" .....	83
Tray "Ear forceps" .....	83
Tray "Ear specula" .....	83
Tray "Hooks and knives" .....	83
Tray "Micro suction tubes" .....	83
Troeltsch dressing forceps .....	19
T-tube inserter .....	78
Tubal Instruments .....	63 - 64
Tuning forks .....	13
Tympanoplasty / Stapesplasty Set .....	94
Universal scissors .....	45
Universal insertion forceps .....	78
Valve lid for norm sterilization container .....	81
Ventilation tube insertion forceps .....	78
Verhoeven suction tube .....	25
Wall charger for "SuperLite" .....	8
Weitlaner retractor .....	35
Wegener Cerumen hook .....	17
Wigand endaural retractor .....	35
Williger retractor .....	35
Williger elevator .....	75
Wire bending and cutting scissors .....	77
Wire loops for Krause ear polyp snare .....	22
Wullstein dressing forceps .....	39
Wullstein micro hook, "Colour Line" .....	48 - 49
Wullstein micro needle .....	47
Wullstein raspatory .....	27
Wullstein retractor .....	33
Wullstein sickle knife .....	22, 47
Wullstein suction handle .....	23
Wullstein suction tube .....	26
XHL xenon spare bulb .....	10
Zenner footplate hook .....	53
Ziegler head mirror .....	10
Zimmermann acoustic neurinoma ring forceps .....	40
Zöllner ear specula .....	16
Zöllner micro needle .....	76
Zöllner micro hook .....	76
Zöllner suction tip .....	24
Zöllner suction tube .....	23



# Numerisches Inhaltsverzeichnis

## Numeric Content

10-102-00.....5	10-188-03.....15	10-269-01.....19	10-353-05.....27	10-499-15.....39
10-102-30.....5	10-188-04.....15	10-269-02.....19	10-354-03.....27	10-500-10.....39
10-104-00.....5	10-188-05.....15	10-271-14.....19	10-355-08.....27	10-501-10.....39
10-104-30.....5	10-188-06.....15	10-272-01.....19	10-356-00.....27	10-502-10.....39
10-106-00.....5	10-188-07.....15	10-272-02.....19	10-356-01.....27	10-503-10.....39
10-107-30.....5	10-188-08.....15	10-273-01.....19	10-357-18.....28	10-504-10.....41
10-108-00.....5	10-188-09.....15	10-274-00.....20	10-358-15.....28	10-506-05.....41
10-108-99.....5	10-190-00.....58	10-274-01.....20	10-360-03.....28	10-506-10.....41
10-090-00.....5, 64	10-190-01.....15	10-274-02.....20	10-360-04.....28	10-507-11.....41
10-090-30.....5, 64	10-190-02.....15	10-274-03.....20	10-360-07.....28	10-507-14.....41
10-090-45.....5, 64	10-190-04.....15	10-276-00.....20	10-360-11.....28	10-512-15.....41
10-109-00.....5, 64	10-190-05.....15	10-276-01.....20	10-360-10.....28	10-530-10.....42
10-109-30.....5, 64	10-190-06.....15	10-276-02.....65	10-360-15.....28	10-530-12.....42
10-109-45.....5, 64	10-190-07.....15	10-277-00.....20	10-365-02.....28	10-531-12.....42
10-109-70.....5, 64	10-190-08.....15	10-278-01.....21	10-365-04.....28	10-532-12.....42
10-111-00.....6	10-190-09.....15	10-278-02.....21	10-365-06.....28	10-532-12B.....42
10-111-30.....6	10-190-30.....58	10-278-03.....21	10-365-08.....28	10-532-12WB.....42
10-111-45.....6	10-190-45.....58	10-278-04.....21	10-366-02.....29	10-533-10.....42
10-111-70.....6	10-192-01.....16	10-279-00.....21	10-366-04.....29	10-533-12.....42
10-110-00.....7	10-192-02.....16	10-279-01.....21	10-366-06.....29	10-534-12.....42
10-110-03.....7	10-192-03.....16	10-279-45.....21	10-366-08.....29	10-535-12.....42
10-120-00.....7	10-192-04.....16	10-280-00.....21	10-405-01.....30	10-535-12B.....42
10-120-01.....7	10-192-05.....16	10-281-00.....21	10-405-02.....30	10-535-12WB.....42
10-120-10.....7	10-192-06.....16	10-281-45.....21	10-405-03.....30	10-536-10.....42
10-120-99.....8	10-194-01.....16	10-281-90.....21	10-405-04.....30	10-540-12.....43
10-122-00.....7	10-194-02.....16	10-283-18.....22	10-405-10.....30	10-541-12.....43
10-140-00.....9	10-194-03.....16	10-283-98.....22	10-405-20.....30	10-542-12.....44
10-141-00.....9	10-195-01.....16	10-283-99.....22	10-405-30.....30	10-543-12.....43
10-141-01.....9	10-195-02.....16	10-284-00.....22	10-406-01.....30	10-544-12.....43
10-141-99.....9	10-195-03.....16	10-284-12.....22	10-406-10.....30	10-545-12.....44
10-142-00.....9	10-200-00.....14	10-290-16.....22	10-406-20.....30	10-549-10.....45
10-143-00.....9	10-200-01.....14	10-291-18.....22	10-406-30.....30	10-550-13.....45
10-143-99.....10	10-200-02.....14	10-300-10.....23	10-406-40.....30	10-552-11.....45
10-145-80.....10	10-200-03.....14	10-300-15.....23	10-408-15.....30	10-555-13.....45
10-145-01.....10	10-200-04.....14	10-300-20.....23	10-409-19.....30	10-556-13.....45
10-145-24.....10	10-201-01.....14	10-300-25.....23	10-410-19.....30	10-600-00.....57
10-145-30.....10	10-201-02.....14	10-300-30.....23	10-412-18.....31	10-601-00.....57
10-145-40.....10	10-202-01.....16	10-300-40.....23	10-415-01.....31	10-603-10.....57
10-145-50.....10	10-202-02.....16	10-300-50.....23	10-415-02.....31	10-604-10.....57
10-145-98.....10	10-202-03.....16	10-302-30.....23	10-416-01.....31	10-605-10.....57
10-145-99.....10	10-203-05.....16	10-302-35.....23	10-416-02.....31	10-609-02 TAN.....51
10-148-25.....11	10-203-06.....16	10-302-45.....23	10-416-03.....31	10-609-04 TAN.....51
10-148-40.....11	10-203-07.....16	10-303-18.....23	10-420-11.....33	10-609-06 TAN.....51
10-151-00.....11	10-204-99.....15	10-305-11.....23	10-420-13.....33	10-610-10.....46
10-151-01.....11	10-205-01.....17	10-306-05.....23	10-420-16.....33	10-610-12.....46
10-151-02.....11	10-205-02.....17	10-308-06-05.....24	10-421-11.....33	10-610-15.....46
10-151-03.....11	10-205-03.....17	10-308-08-05.....24	10-422-11.....33	10-610-18.....46
10-151-15.....11	10-205-04.....17	10-308-10-05.....24	10-422-13.....33	10-610-20.....46
10-151-17.....11	10-206-13-05.....17	10-308-12-05.....24	10-423-13.....33	10-610-23.....46
10-151-22.....11	10-208-00.....19	10-308-15-05.....24	10-426-11.....33	10-610-25.....46
10-155-00.....12	10-249-01.....17	10-308-18-05.....24	10-426-13.....34	10-610-30.....46
10-155-01.....12	10-249-02.....17	10-308-20-05.....24	10-427-11.....33	10-611-06.....46
10-155-02.....12	10-249-03.....17	10-308-22-05.....24	10-427-13.....34	10-611-10.....46
10-155-08.....12	10-249-04.....17	10-308-25-05.....24	10-428-11.....34	10-611-15.....46
10-155-11.....12	10-249-05.....17	10-308-30-05.....24	10-429-11.....34	10-611-20.....46
10-155-13.....12	10-250-01.....17	10-309-06-05.....24	10-430-11.....35	10-611-25.....46
10-158-01.....52	10-250-02.....17	10-309-08-05.....24	10-431-11.....35	10-612-10.....46
10-158-02.....52	10-250-03.....17	10-309-10-05.....24	10-432-11.....34	10-612-15.....46
10-170-00.....13	10-250-04.....17	10-309-13-05.....24	10-432-13.....34	10-612-20.....46
10-170-01.....13	10-251-01.....17	10-310-07.....24	10-433-11.....34	10-612-25.....46
10-170-02.....13	10-251-02.....17	10-310-25.....24	10-433-13.....35	10-612-30.....46
10-170-03.....13	10-251-03.....17	10-312-10.....23	10-434-11.....35	10-613-00.....46
10-170-04.....13	10-251-04.....17	10-312-17.....24	10-434-13.....35	10-614-25.....46
10-170-05.....13	10-251-05.....17	10-312-23.....24	10-435-15.....33	10-615-00.....46
10-171-01.....13	10-252-01.....18	10-313-12.....26	10-437-13.....35	10-616-00.....47
10-172-00.....13	10-252-02.....18	10-313-20.....26	10-438-17.....36	10-618-01.....22, 47
10-172-01.....13	10-258-00.....18	10-313-23.....25	10-446-11.....36	10-618-02.....47
10-172-02.....14	10-258-01.....18	10-313-24.....25	10-446-11B.....36	10-618-03.....47
10-172-03.....12	10-258-02.....18	10-314-13.....26	10-447-11.....36	10-618-04.....47
10-172-04.....13	10-258-03.....18	10-314-14.....25	10-466-13.....36	10-619-00.....47
10-172-05.....13	10-259-00.....18	10-314-15.....25	10-467-13.....36	10-620-00.....47
10-179-00.....13	10-259-01.....18	10-314-20.....24	10-480-14.....37	10-625-01.....47
10-180-00.....13	10-259-02.....18	10-314-22.....24	10-481-14.....37	10-625-02.....47
10-182-01.....13	10-259-03.....18	10-314-24.....24	10-482-14.....37	10-625-03.....47
10-182-02.....14	10-260-01.....18	10-315-15.....26	10-483-14.....37	10-625-04.....47
10-182-04.....14	10-260-02.....18	10-315-20.....26	10-484-14.....37	10-625-12.....47
10-183-01.....14	10-260-03.....18	10-315-25.....26	10-485-14.....37	10-626-02.....49
10-183-02.....14	10-260-10.....18	10-315-30.....26	10-485-15.....37	10-626-04.....49
10-183-03.....14	10-260-20.....18	10-318-14.....26	10-486-16.....37	10-626-06.....49
10-183-04.....14	10-261-01.....18	10-318-15.....26	10-487-16.....37	10-626-08.....49
10-183-10.....14	10-261-02.....18	10-318-23.....26	10-488-15.....37	10-626-10.....49
10-186-01.....15	10-261-03.....18	10-318-33.....26	10-489-15.....37	10-627-02.....49
10-186-02.....15	10-261-10.....18	10-318-45.....26	10-490-16.....38	10-627-04.....49
10-186-03.....15	10-261-20.....18	10-348-19.....27	10-491-18.....38	10-627-06.....49
10-186-04.....15	10-263-01.....18	10-350-13.....27	10-492-12.....38	10-627-08.....49
10-186-05.....15	10-263-02.....18	10-351-13.....27	10-492-15.....38	10-628-02.....48
10-186-06.....15	10-263-03.....18	10-352-08.....27	10-494-12.....37	10-628-04.....48
10-186-07.....15	10-265-01.....19	10-352-14.....27	10-495-12.....37	10-628-06.....48
10-186-08.....15	10-265-02.....19	10-353-02.....27	10-496-12.....39	10-628-08.....48
10-188-01.....15	10-265-03.....19	10-353-03.....27	10-497-12.....39	10-628-10.....48
10-188-02.....15	10-268-18.....19	10-353-04.....27	10-498-15.....39	10-628-12.....48



10-628-15.....	48	10-665-04.....	55	10-800-12.....	60	80-448-15.....	45
10-628-20.....	48	10-665-05.....	55	10-801-12.....	60	80-501-01.....	79
10-628-25.....	48	10-665-06.....	55	10-802-12.....	60	80-501-02.....	79
10-628-40.....	48	10-667-00.....	54	10-803-12.....	60	80-501-03.....	79
10-630-02.....	48	10-667-01.....	54	10-804-12.....	60	80-501-04.....	79
10-630-04.....	48	10-667-02.....	54	10-805-12.....	60	80-503-03.....	79
10-630-06.....	48	10-667-03.....	54	10-806-12.....	60	80-504-05.....	79
10-630-08.....	48	10-669-01.....	18	10-867-12.....	60	80-506-30.....	79
10-630-10.....	48	10-669-02.....	18	10-807-12.....	60	80-507-40.....	79
10-630-12.....	48	10-670-00.....	55	10-808-12.....	60	80-509-75.....	79
10-630-15.....	48	10-700-00.....	65	10-809-12.....	60	80-512-00.....	79
10-630-20.....	48	10-700-01.....	65	10-810-12.....	61	80-515-06.....	79
10-631-18.....	48	10-700-02.....	65	10-811-12.....	60	80-515-08.....	79
10-632-00.....	53	10-700-03.....	65	10-812-12.....	61	80-515-10.....	79
10-634-01.....	51	10-700-04.....	65	10-813-12.....	61	80-517-00.....	79
10-634-02.....	51	10-700-05.....	66	10-814-12.....	61	80-519-00.....	80
10-634-03.....	51	10-700-06.....	66	10-815-12.....	61	80-519-01.....	80
10-635-02.....	51	10-700-07.....	66	10-816-12.....	61	80-519-02.....	80
10-635-04.....	51	10-700-08.....	65	10-817-12.....	61	80-519-03.....	80
10-635-06.....	51	10-700-09.....	65	10-818-12.....	61	80-520-06.....	80
10-635-08.....	51	10-700-11.....	65	10-819-12.....	61	80-520-08.....	80
10-635-10.....	51	10-700-14.....	65	10-830-17.....	63	80-525-17.....	80
10-635-12.....	51	10-701-00.....	66	10-831-17.....	63	80-525-25.....	80
10-635-14.....	51	10-702-10.....	56	10-832-17.....	63	80-528-13.....	80
10-635-16.....	51	10-703-10.....	56	10-833-17.....	63	80-528-18.....	80
10-635-18.....	51	10-703-00.....	67	10-840-01.....	62	80-528-20.....	80
10-635-22.....	51	10-703-01.....	67	10-845-01.....	62	80-530-20.....	80
10-635-24.....	51	10-703-02.....	67	10-851-00.....	62	80-600-00.....	82
10-635-26.....	51	10-703-03.....	63, 67	10-867-12.....	55	80-601-01.....	83
10-635-28.....	51	10-703-04.....	63, 67	10-890-00.....	86	80-601-02.....	83
10-636-02.....	51	10-703-05.....	67	10-895-00.....	86	80-601-03.....	83
10-636-04.....	51	10-703-06.....	67	10-896-00.....	87	80-601-04.....	83
10-636-06.....	51	10-703-07.....	63, 67	10-900-00.....	89	80-601-05.....	83
10-636-08.....	51	10-703-10.....	59	10-901-00.....	90	80-601-08.....	84
10-636-10.....	51	10-705-00.....	68	10-905-00.....	90	80-602-30.....	84
10-637-02.....	52	10-705-01.....	68	10-906-00.....	91	80-602-32.....	84
10-637-04.....	52	10-705-02.....	68	10-908-00.....	88	80-603-01.....	84
10-637-06.....	52	10-705-03.....	68	10-909-00.....	92	80-603-02.....	84
10-637-08.....	52	10-705-04.....	68	20-100-01.....	14	80-603-03.....	85
10-637-10.....	52	10-705-05.....	68	20-305-18.....	28	80-603-04.....	85
10-637-62.....	52	10-705-06.....	68	20-400-18.....	29	80-605-00.....	85
10-638-02.....	52	10-705-08.....	68	20-401-18.....	29	80-631-10.....	81
10-638-04.....	52	10-705-09.....	68	20-401-99.....	29	80-631-12.....	81
10-638-06.....	52	10-706-01.....	68	20-402-21.....	29	80-631-14.....	81
10-638-08.....	52	10-706-02.....	68	20-600-14.....	43	80-631-21.....	81
10-638-10.....	52	10-706-03.....	68	20-601-14.....	43	80-632-00.....	81
10-639-01.....	76	10-706-04.....	68	20-602-14.....	43	80-632-01.....	81
10-639-02.....	76	10-708-01.....	69	20-603-14.....	43	80-632-02.....	81
10-639-03.....	76	10-708-02.....	69	20-610-15.....	44	80-632-03.....	81
10-639-04.....	76	10-709-01.....	69	20-612-14.....	44	80-632-04.....	81
10-639-05.....	76	10-709-02.....	69	20-612-15.....	44	80-632-05.....	81
10-639-06.....	76	10-711-01.....	69	20-613-15.....	44	80-641-14.....	81
10-639-07.....	76	10-711-02.....	69	20-614-15.....	44	80-642-00.....	81
10-640-00.....	52	10-711-03.....	69	20-615-15.....	44	80-642-01.....	81
10-642-02.....	53	10-712-00.....	70	20-647-12.....	45	80-642-02.....	81
10-642-04.....	53	10-713-00.....	70	20-648-12.....	45	80-642-03.....	81
10-642-06.....	53	10-714-00.....	70	20-710-12.....	38	80-642-04.....	81
10-644-45.....	52	10-715-00.....	70	20-711-12.....	38	80-642-05.....	81
10-644-90.....	52	10-716-00.....	74	20-712-12.....	38	80-661-12.....	81
10-647-00.....	53	10-716-02.....	74	30-080-05.....	25	80-661-14.....	81
10-648-12.....	54	10-716-03.....	74	30-080-06.....	25	80-661-21.....	81
10-649-18.....	54	10-718-00.....	74	30-080-07.....	25	80-662-00.....	81
10-650-00.....	71	10-719-00.....	73	30-080-08.....	25	80-662-01.....	81
10-651-00.....	71	10-720-21.....	75	30-080-09.....	25	80-662-02.....	81
10-652-00.....	71	10-722-13.....	75	30-080-10.....	25	80-662-03.....	81
10-653-01.....	71	10-723-09.....	75	30-080-12.....	25	80-662-04.....	81
10-653-02.....	71	10-726-10.....	75	30-080-15.....	25	80-662-05.....	81
10-655-01.....	52	10-726-15.....	75	30-080-06.....	25	80-671-20.....	81
10-655-02.....	52	10-726-30.....	75	30-080-08.....	25	80-671-25.....	81
10-656-01.....	53	10-727-01.....	76	30-105-06.....	25	80-671-40.....	81
10-656-02.....	53	10-727-02.....	76	30-105-08.....	25	80-671-60.....	81
10-658-03.....	53	10-727-03.....	76	30-105-10.....	25	80-681-01.....	81
10-658-04.....	53	10-727-04.....	76	30-700-00.....	77	80-681-02.....	81
10-658-05.....	53	10-730-16.....	76	30-700-01.....	77	80-681-03.....	81
10-658-06.....	53	10-730-30.....	76	70-211-00.....	6	80-681-04.....	81
10-658-08.....	53	10-731-14.....	69	70-211-01.....	6	80-681-05.....	81
10-659-04.....	71	10-731-30.....	69	70-211-10.....	6	80-681-06.....	81
10-659-06.....	71	10-733-09.....	75	70-211-20.....	6	80-681-07.....	81
10-659-08.....	71	10-735-00.....	72	70-211-30.....	6	80-683-10.....	81
10-660-00.....	55	10-738-04.....	72	70-211-40.....	6	80-684-10.....	81
10-662-30.....	53	10-738-06.....	72	70-211-50.....	6	80-685-00.....	81
10-663-01.....	54	10-740-01.....	73	70-266-02.....	62	80-688-00.....	81
10-664-00.....	54	10-742-00.....	73	70-267-03.....	62	80-690-01.....	82
10-664-01.....	54	10-745-12.....	77	80-201-01.....	40	80-690-02.....	82
10-664-02.....	54	10-747-00.....	77	80-201-02.....	40	80-691-01.....	82
10-664-03.....	54	10-750-00.....	77	80-201-03.....	40	80-692-01.....	82
10-664-04.....	54	10-751-00.....	77	80-202-01.....	40	80-695-00.....	85
10-665-00.....	55	10-755-00.....	78	80-202-02.....	40	80-697-00.....	85
10-665-01.....	55	10-758-00.....	78	80-204-01.....	40		
10-665-02.....	55	10-759-00.....	78	80-350-01.....	74		
10-665-03.....	55	10-760-00.....	78	80-350-02.....	74		



## Umrechnungstabelle - Ch/Fr - mm - inch

### Conversion table - Ch/Fr - mm - inch

Charrière (CH) French (F)	mm	Inch
1	0,33	0,013
2	0,67	0,025
3	1,00	0,039
4	1,33	0,051
5	1,67	0,065
6	2,00	0,079
7	2,33	0,092
8	2,67	0,105
9	3,00	0,118
10	3,33	0,131
11	3,67	0,144
12	4,00	0,156
13	4,33	0,170
14	4,67	0,184
15	5,00	0,197
16	5,33	0,210
17	5,67	0,223
18	6,00	0,237
19	6,33	0,249
20	6,67	0,263
21	7,00	0,276
22	7,33	0,288
23	7,67	0,302
24	8,00	0,315
25	8,33	0,328
26	8,67	0,341
27	9,00	0,354
28	9,33	0,367
29	9,67	0,380
31	10,23	0,407
32	10,67	0,420
34	11,33	0,446
36	12,00	0,472
38	12,67	0,494
40	13,33	0,520
45	15,00	0,591







Burghof 14 · 51491 Overath · Germany  
Phone: +49 2206 90 81 - 0  
Fax: +49 2206 90 81 - 13  
info@spiggle-theis.com  
www.spiggle-theis.com

© 2022 by SPIGGLE & THEIS Medizintechnik GmbH

Änderungen und Irrtümer – einschließlich Bilder - vorbehalten.  
Produktsortiment kann pro Land abweichen.

Modifications and errors – including pictures – reserved.  
Product range might vary per country.



PO Box 3403, Erina, NSW, 2250, Australia

**P: +61 2 9810 6947**

admin@coremed.com.au

**www.coremed.com.au**

# Rhinologie Instrumentarium

## Rhinology Instruments







# Über Uns

---

# About Us

## Geschichte

**SPIGGLE & THEIS Medizintechnik GmbH** wurde 1994 von den Geschäftsführern **David Spiggle** und **Detlef Theis** gegründet. Bis heute haben wir uns vom reinen Vertriebsunternehmen zu einem renommierten Hersteller von Medizinprodukten im Bereich der HNO-Chirurgie weiterentwickelt. Weltweit exportieren wir in über 75 Länder und in Deutschland zählen mehr als 700 Kliniken zu unseren Kunden.

## Das Maß der Dinge

Im chirurgischen Instrumentenbau gilt das Siegel **“Made in Germany“** auch heute noch als Inbegriff von Qualität. Unsere chirurgischen Instrumente werden in allen Produktionsstufen unter strengsten Qualitätsanforderungen nahezu komplett in Deutschland produziert und sind somit noch größtenteils echt **“Made in Germany“**. Zur Verarbeitung wird ausschließlich Instrumentenstahl bester Güte verwendet, welcher den hohen Anforderungen moderner Chirurgie auch dauerhaft gerecht wird.

## Sicherheit

Die Gesundheit der Patienten und somit die Sicherheit und Qualität unserer Produkte stehen im Mittelpunkt unseres Handelns. In diesem Sinne ist **SPIGGLE & THEIS Medizintechnik GmbH** bereits seit 1997 **ISO-zertifiziert** und sind unsere Produkte nach der strengen europäischen Richtlinie für Medizinprodukte CE-gekennzeichnet. Alle unsere Produkte unterliegen einer permanenten Qualitätskontrolle - von der Auswahl des Rohmaterials über die einzelnen Fertigungsschritte bis zum Versand.

## Erfahrung

Unsere Mitarbeiter haben zum Teil mehr als 30 Jahre Berufserfahrung im Umgang mit chirurgischen Instrumenten. Durch dieses umfassende Know-How sowie den langjährigen und individuellen Kontakt mit den Anwendern, besitzen wir nicht nur theoretisches Wissen, sondern kennen auch deren Bedürfnisse und Ansprüche. Dies hilft uns bei der steten, praxisorientierten Weiterentwicklung unserer Produkte. Somit garantieren wir hohe Kompetenz und individuellen Service bei der Betreuung unserer Kunden.

## History

**SPIGGLE & THEIS Medizintechnik GmbH** was founded in 1994 by the managing directors **David Spiggle** and **Detlef Theis**. The company has evolved from being purely a distributor to the established manufacturer of medical products in the area of ENT that it is today. We can count over 700 clinics amongst our German customers and export to over 75 countries world-wide.

## The Seal Of Highest Quality

The stamp **“Made in Germany“** is still the epitome of quality standards in the production of surgical instruments in the world today. The majority of our surgical instruments is subjected to the strictest quality requirements at every step of their production, in the truest sense of the words, **“Made in Germany“**. Only the highest standard of instrument steel, capable of consistently meeting the demands of modern surgery, is used in the production.

## Safety First

The health of our patients and therefore the safety and quality of our products plays the central role in our decisions. **SPIGGLE & THEIS Medizintechnik GmbH** has been **ISO certified**. Our products are CE-marked in accordance with the strict European guideline for medical products since 1997. All our products undergo continual quality checks, from the selection of raw materials, to the individual stages of production and finally their dispatch.

## Experience

Our colleagues in instrument development can look back on over 30 years of professional practical experience with ENT surgical instruments. We offer more than theoretical knowledge – we understand our customer needs. We enjoy close, personal contact to many of the best surgeons world-wide. This enables us to continually develop innovative products. We guarantee the highest level of competence and individual service in meeting our customer requirements.



## Inhaltsverzeichnis

### Table of contents

01	Endoskopie / Endoscopy .....	5 - 10
02	Nasenspekula / Nasal Specula .....	11 - 14
03	Untersuchungsinstrumente / Examination Instruments .....	15 - 19
04	Nasenzangen/Nasenscheren / Nasal Forceps/Nasal Scissors .....	20 - 28
05	Elevatorien/Raspatorien / Elevators/Raspatories.....	29 - 32
06	Meißel/Osteotome/Hämmer / Chisels/Osteotomes/Mallets .....	33 - 39
07	Messer / Knives.....	40 - 41
08	Wundhaken / Retractors.....	42 - 45
09	Scheren / Scissors.....	46 - 57
10	Pinzetten/Nadelhalter / Forceps/Needle Holders .....	58 - 62
11	Raspeln / Rasps .....	63 - 66
12	Allgemeines / Miscellaneous .....	67 - 72
13	Sterilisationssysteme / Sterilizing Systems.....	73 - 74
14	Sets .....	75 - 77
	Index.....	78 - 81
	Umrechnungstabelle / Conversation table.....	82

#### Attention:

Not every instrument is available in all markets. Availability depends on local regulations. Please contact your SPIGGLE & THEIS representative or distributor, if you have any questions about the availability of our products in your region.

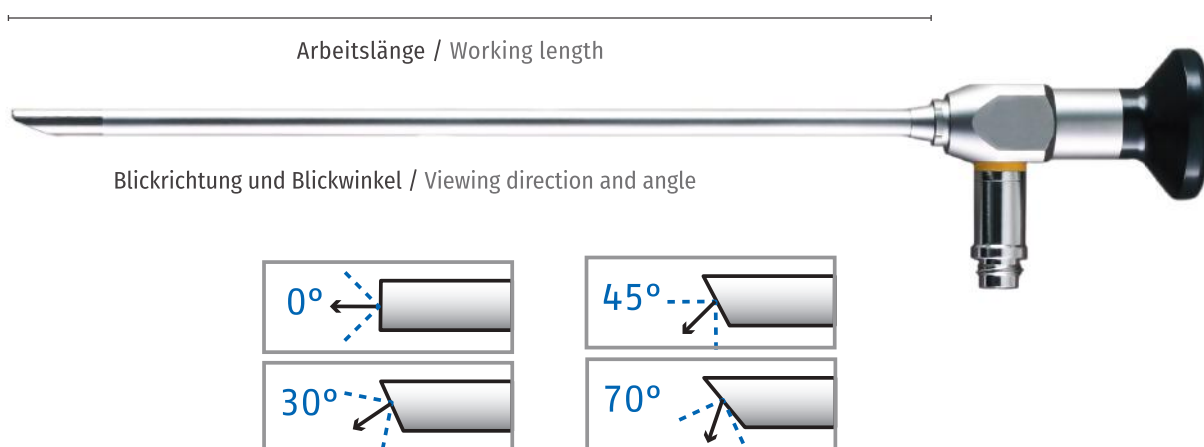
**Vorteile unserer Endoskope:**

- Kompatibel mit allen Lichtquellen auf dem Markt (universalkompatibel)
- Extrem robuste Rohrkonstruktion mit verstärktem 2-Rohr-Edelstahl-System
- Hochwertig vergütetes, hochauflösendes Linsen-System
- Optische Saphirglas-Frontlinse, kratzfest und hitzebeständig fixiert mit Epoxidharz
- Hitzebeständiges Polymer-Okular (PEEK)
- Hohe Dichtigkeit durch gelaserte Schnittstellen
- Mehr Bildinformation durch großen Öffnungswinkel
- Hohe Bildschärfe im gesamten Bildbereich
- Gleichmäßige Helligkeit bis zum Rand durch Lichtkonus
- Autoklavierbar
- 24 Monate Garantie

**Advantages of our endoscopes:**

- Compatible to all light sources available (universal camera compatible)
- Extremely robust stainless steel tube construction with reinforced outer tube
- High precision quality lens system
- Optical sapphire glass front lens, scratch resistant and fixed with heat-resistant epoxide
- Heat-resistant polymer ocular (PEEK)
- Tight sealing due to laser welded joints
- More image information due to wide viewing angle
- High focus quality in entire viewing area
- Constant brightness up to the edge of viewing area
- Autoclavable
- 24 months guarantee

Auch als  
semiflex-Endoskope  
erhältlich

Also available as  
semiflex endoscopes



**All unsere Endoskope sind aus Phynoxstahl**  
verbesserter Schutz gegen Verbiegen und Bruch

**All our endoscopes are made of phynox steel**  
for improved protection against bending or breaking





## 01 Endoskopie

### Endoscopy

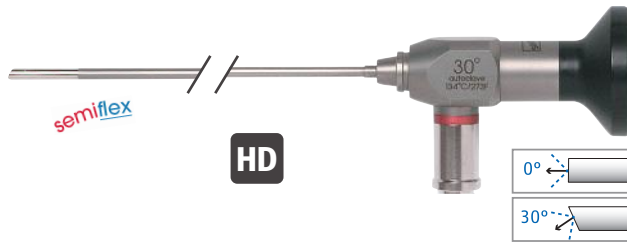

**Sinuskop, HD, semiflex, autoklavierbar, AD 2,7 mm, 11 cm**  
**Sinuscope, HD, semiflex, autoclavable, OD 2.7 mm, 11 cm**

Art.-Nr./No.	Winkel / Angle
30-135-00	0°
30-135-30	30°

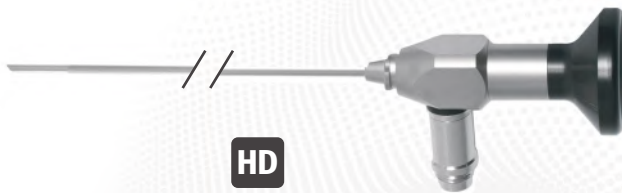

**Sinuskop HD, starr, autoklavierbar, AD 4,0 mm, 17,5 cm**  
**Sinuscope, HD, rigid, autoclavable, OD 4.0 mm, 17.5 cm**

Art.-Nr./No.	Winkel / Angle
30-142-45	45°
30-142-90	90°



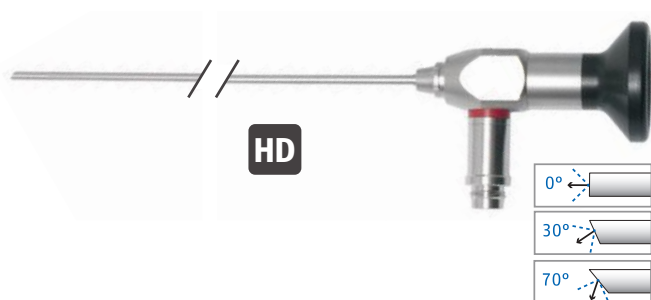

**Sinuskop, HD, starr, autoklavierbar, AD 2,7 mm, 18,75 cm**  
**Sinuscope, HD, rigid, autoclavable, OD 2.7 mm, 18.75 cm**

Art.-Nr./No.	Winkel / Angle
30-130-00	0°
30-130-30	30°
30-130-70	70°

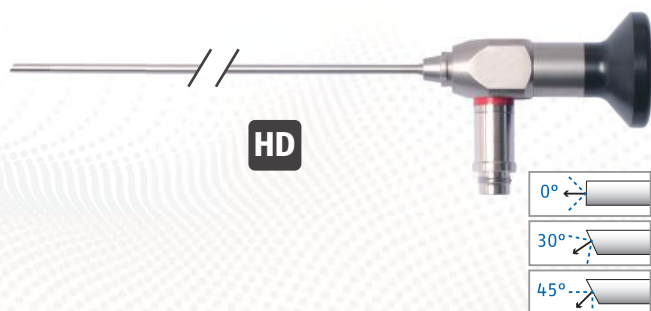

**Sinuskop, HD, starr, autoklavierbar, AD 2,7 mm, 14,1 cm**  
**Sinuscope, HD, rigid, autoclavable, OD 2.7 mm, 14.1 cm**

Art.-Nr./No.	Winkel / Angle
30-132-00	0°
30-132-30	30°
30-132-45	45°

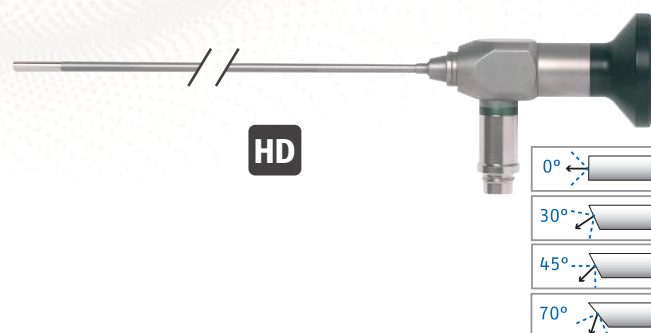

**Sinuskop, HD, starr, autoklavierbar, AD 2,7 mm, 11 cm**  
**Sinuscope, HD, rigid, autoclavable, OD 2.7 mm, 11 cm**

Art.-Nr./No.	Winkel / Angle
30-134-00	0°
30-134-30	30°
30-134-45	45°
30-134-70	70°



## 01 Endoskopie

### Endoscopy



#### Ultra-Stop Antibeschlagmittel

#### Ultra-Stop Anti-Fog solution

Art.-Nr./No.	Beschreibung / Description
30-160-01	25 ml Pipettenflasche, unsteril 25 ml pipette bottle, non-sterile
30-160-02	30 ml Durchstichflasche, steril 30 ml pierce bottle, sterile
30-160-03	15 ml Sprayflasche, unsteril 15 ml spray bottle, non-sterile



#### Dr. Fog original Antibeschlagmittel mit Schwamm, steril

#### Dr. Fog original anti-fog with sponge, sterile

30-160-04



#### Antifog Antibeschlag-Satz, steril, 48 Stück/Box

#### Antifog-Solution Kit, sterile, 48 pieces/box

30-160-05



#### Endoskop-Schutzhülse, 20,9 cm, verlängerbar, autoklavierbar, für ein Endoskop 40-110-xx oder 40-112-xx.

(Für 40-112-xx werden 2 Schutzhülsen benötigt)

Endoscope protective sleeve, 20.9 cm, extendable, autoclavable,  
for endoscope 40-110-xx or 40-112-xx.

(Two protective sleeves are needed for 40-112-xx)

30-182-21



#### Dichtigkeitstester für flexible Endoskope

#### Leak tester for flexible endoscopes

30-169-08

## LED-Leuchtgriffe / LED light handles



Art-Nr./No.

70-211-00 LED-Hochleistungs-Leuchtgriff, 230 V, bestehend aus: (70-211-10, 70-211-20, 70-211-30, 70-211-40)  
LED high performance light-handle, 230 V, consisting of: (70-211-10, 70-211-20, 70-211-30, 70-211-40)

70-211-01 LED-Hochleistungs-Leuchtgriff, 120 V, bestehend aus: (70-211-10, 70-211-20, 70-211-30, 70-211-50)  
LED high performance light-handle, 120 V, consisting of: (70-211-10, 70-211-20, 70-211-30, 70-211-50)

70-211-10 LED-Handgriff, schwarz, mit Helligkeitsdimmer, Ausschaltautomatik, 3 W, 5500°K, 17500 Lux, zur Verwendung mit Li-Io-Akku 3,5 V und Endoskop-Adapter, 50 Std. Brenndauer  
LED light handle, black, with brightness dimmer, automatic switch-off, 3 W, 5500°K, 17500 lux, to use with Li-ion chargeable battery 3.5 V and endoscope adapter, 50 hours run-time

70-211-20 Li-Ionen-Akku, 3,5 V, für LED-Handgriff  
Li-ion rechargeable battery, 3.5 V, for LED light-handle

70-211-30 Endoskopie-Adapter für LED-Handgriff, passend für Standardgewinde an Endoskopen (AcMI-Gewinde)  
Endoscope adapter for LED light-handle, fits standard endoscope threads (AcMi-thread)

70-211-40 Ladegerät für bis zu 2 LED-Handgriffe, 3,5 V, 230 V, Standgerät, mit Wandhalterung  
Charging base for up to 2 LED light-handles, 3.5 V, 230 V, table model, with wall holder

70-211-50 Ladegerät für bis zu 2 LED-Handgriffe, 3,5 V, 120 V, Standgerät, Wandhalterung  
Charging base for up to 2 LED light-handles, 3.5 V, 120 V, table model, with wall holder



## 01 Endoskopie

### Endoscopy

Arbeitslänge	32 cm
Working length	32 cm
Abwinkelung (auf / ab)	130°
Angle (up / down)	130°
Biegeradius	8 mm
Bending radius	8 mm
Blickfeld	80°
Field of vision	80°
Tiefenschärfe	1-50 mm
Depth of focus	1-50 mm
Gewicht	230 g
Weight	230 g



Art.-Nr./No.

30-170-28 2,8 mm

30-170-36 3,4 mm

30-171-40 4,0 mm mit Arbeitskanal  
4.0 mm with working channel

Die SPIGGLE & THEIS Nasopharyngoskope der neuen Generation sind intuitiv bedienbar und ergonomisch geformt. Sie wurden für die notwendige Feinfühligkeit im täglichen Routineeinsatz und für eine ermüdungsfreie Handhabung entwickelt. Hochwertige Bildleiter und ein leistungsfähiges optisches System liefern große und helle Bilder in bester Auflösung - die Voraussetzung für eine sichere Diagnose und Therapie. Dank solider Verarbeitung und konsequenter Verwendung moderner Hochleistungswerkstoffe sind SPIGGLE & THEIS Nasopharyngoskope robuster und langlebiger - trotz steigender Belastung durch moderne Aufbereitungsverfahren.

The new generation of SPIGGLE & THEIS nasopharyngoscopes impresses with intuitive operability and optimal ergonomics, designed for tactile sensation and non-tiring handling as required in daily routine operations.

High-end fibre-optic bundles and a high-capacity system produce large and bright images of the best quality - necessary for safe diagnosis and treatment. Due to the consistent use and reliable processing of high-class materials, the SPIGGLE & THEIS nasopharyngoscopes are robust and durable, in spite of the increasing stress of modern cleaning and sterilizing facilities.

#### Vorteile unserer Endoskope:

- Funktionelles Design für eine einfache und komfortable Handhabung
- Feinfühlig, aber robuste Steuerung
- Optimale Flexibilität und Torsionssteifigkeit des Einführungsschafts
- Leistungsfähiges optisches System: größere, hellere und schärfere Bilder

#### Geeignete Wiederaufbereitungsverfahren:

- Einlegbar in Reinigungs- und Desinfektionslösung
- STERIS
- NTDF-Sterilisation = Niedertemperatur-Dampf-Formaldehyd-Sterilisation
- Maschinelle Aufbereitung (RDG-E)

#### Advantages of our endoscopes:

- Functional design for easy and comfortable handling
- Sensitive yet robust control
- Optimal flexibility and torsional rigidity of the insertion channel
- High-performance optical system for larger, brighter and sharper images

#### Suitable reprocessing procedures:

- Fully immersible in cleaning and disinfectant solutions
- STERIS
- LTSF-sterilization = Low-Temperature Steam and Formaldehyde sterilization
- Machine reprocessing (RDG-E)



**Hartmann Nasenspekulum, zerlegbar**  
**Hartmann nasal speculum, dismountable**

Art.-Nr. Art.-No.		Größe Size (mm)	Länge Length (cm)
20-100-01	Für Erwachsene for adults	34	13,5
20-100-02	Für Jugendliche for juveniles	27	13,0



**Tieck-Halle Nasenspekulum, zerlegbar, 13 cm**  
**Tieck-Halle nasal speculum, dismountable, 13 cm**

Art.-Nr./No.		Größe / Size (cm)
20-101-00	Für Kinder / for children	2,10
20-101-01	Für Neugeborene / for newborn	1,75



**Nasenspekulum, Modell Wien, zerlegbar, 14 cm**  
**Nasal speculum type Vienna, dismountable, 14 cm**

Art.-Nr./No.		Größe / Size (cm)
20-102-01	Für Kinder / for children	2,60
20-102-02	Für Jugendliche / for juveniles	2,95
20-102-03	Für Erwachsene / for adult	3,30



**Hartmann-Halle Nasenspekulum, flaches Blatt, zerlegbar, 15,5 cm**  
**Hartmann-Halle nasal speculum, flat blade, dismountable, 15,5 cm**

Art.-Nr./No.		Größe / Size (mm)	Größe / Size
20-110-01	Für Kinder for children	2,9	1
20-110-02	Für Jugendliche for juveniles	3,2	2
20-110-03	Für Erwachsene for adult	3,6	3



**Hartmann Nasenspekulum, zerlegbar, 15 cm**  
**Hartmann nasal speculum, dismountable, 15 cm**

Art.-Nr./No.	Größe / Size (cm)	Größe / Size
20-112-01	2,7	1
20-112-02	3,0	2
20-112-03	3,4	3



## 02 Nasen-Spekula

### Nasal Specula



**Beckmann Nasenspekulum, seitlich gebogen, Größe 2,5 cm, 15 cm**  
Beckmann nasal speculum, curved to side, size 2.5 cm, 15 cm

20-115-00



**Killian Septumspekulum, 14 cm**  
Killian septum speculum, 14 cm

Art.-Nr./No.	Größe / Size (cm)
20-148-40	4,0
20-148-55	5,5
20-148-75	7,5
20-148-90	9,0



**Cottle Septumspekulum, Größe 5,2 cm, 13 cm**  
Cottle septum speculum, size 5.2 cm, 13 cm

20-149-55



**Killian-Struycken Septumspekulum, 14 cm**  
Killian-Struycken septum speculum, 14 cm

Art.-Nr./No.	Größe / Size (cm)
20-150-40	4,5
20-150-55	5,5
20-150-65	6,5
20-150-75	7,5
20-150-90	9,0





**Herberhold Septumspeculum, extra fein, geriefte Außenfläche, 13 cm**  
**Herberhold septum speculum, extra fine, serrated blades, 13 cm**

Art.-Nr./No.	Größe / Size (cm)
20-152-40	3,5
20-152-55	5,0
20-152-75	7,5
20-152-90	9,0
20-147-55*	5,2

\*mit Stellschraube/with setting screw



**Cottle Septumspeculum mit Stellschraube, 13 cm**  
**Cottle septum speculum with setting screw, 13 cm**

Art.-Nr./No.	Größe / Size (cm)
20-151-40	3,5
20-151-55	5,2
20-151-75	7,5
20-151-90	9,0



**Cottle Septumspeculum, schwarz, extra dünne Blätter, mit Stellschraube, 13 cm**  
**Cottle septum speculum, black, very thin blades, with setting screw, 13 cm**

Art.-Nr./No.	Größe / Size (cm)
20-153-40	3,5
20-153-45	4,5
20-153-55	5,0
20-153-75	7,5



**Killian Septumspeculum mit Lichtträger, 14 cm**  
**Killian septum speculum with fibre light carrier, 14 cm**

Art.-Nr./No.	Länge / Length (cm)	Größe / Size (cm)
20-155-40	14	4,0
20-155-55	14	5,5
20-155-75	14	7,5
20-155-90	14	9,0
20-155-00	16	Lichtträger allein fibre light carrier





## 02 Nasen-Spekula

### Nasal Specula



**Cottle selbsthaltendes Septumspekulum für flexiblen Spannarm, mit Stellschraube, 14 cm**  
**Cottle self-retaining septum speculum for flexible holding arm, with setting screw, 14 cm**

Art.-Nr./No.	Größe / Size (cm)
20-156-40	4,0
20-156-55	5,5
20-156-75	7,5
20-156-90	9,0



**Selbsthaltendes Spekulum mit Stellschraube, rechts und links gezahnt, 15 cm**  
**Self-retaining speculum with setting screw, teeth left and right, 15 cm**

30-711-00

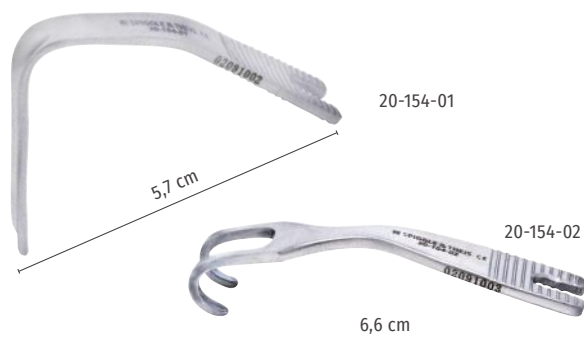

**Aufricht Haken für flexiblen Spannarm**  
**Aufricht retractor for flexible holding arm**

Art.-Nr./No.	Größe / Size (cm)	Beschreibung / Description
20-154-01	5,7	einfach / simple
20-154-02	6,6	Zwei Zähne / two teeth



**Flexibler Spannarm zur Verwendung mit selbsthaltenden NNH-Spekula, mit Verlängerungsstange**  
**Flexible holding arm for use with self retaining nasal specula, including holding rods**

30-700-00



**Gelenkkloben zur Befestigung am OP-Tisch, passend für 30-700-00 und 40-337-00**  
**Rotation clamp for fixation to operating table, for 30-700-00 and 40-337-00**

30-700-01

## 03 Untersuchungsinstrumente

### Examination Instruments

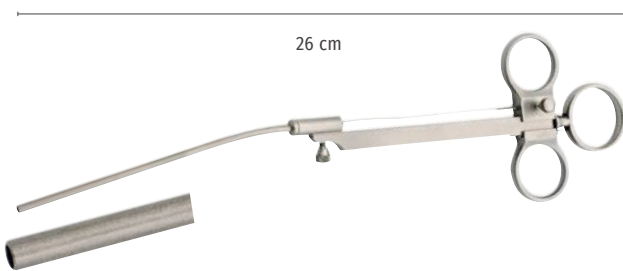

**Krause Nasen-Polypen-Schnürer, scharf, 26 cm**  
Krause nasal polyp snare, sharp, 26 cm

20-190-25

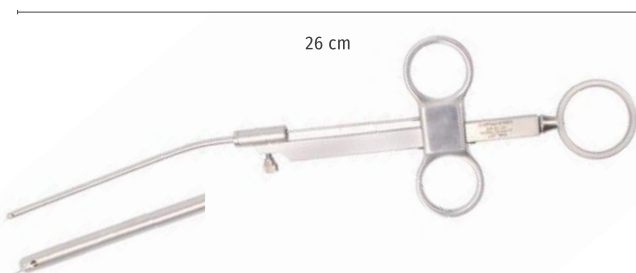

**Krause-Voss Nasen-Polypen-Schnürer, stumpf, 26 cm**  
Krause-Voss nasal polyp snare, blunt, 26 cm

20-191-25

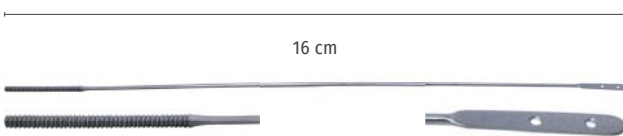

**Ziehstange für Nasen-Polypen-Schnürer, 16 cm,**  
passend für 20-190-25 und 20-191-25

Stylet for nasal polyp snares, 16 cm,  
compatible to 20-190-25 and 20-191-25

20-191-00

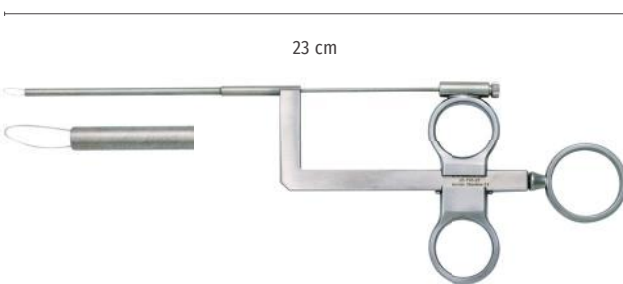

**Lange Nasen-Polypen-Schnürer, bajonett, scharf, 23 cm**  
Lange nasal polyp snare, bayonet, sharp, 23 cm

20-193-25



**Nasenpolypenschlingen, 0,35 mm, 10 cm, 100 Stück**  
Nasal polyp snare wires, 0.35 mm, 10 cm, 100 pieces

20-195-35



## 03 Untersuchungsinstrumente

### Examination Instruments

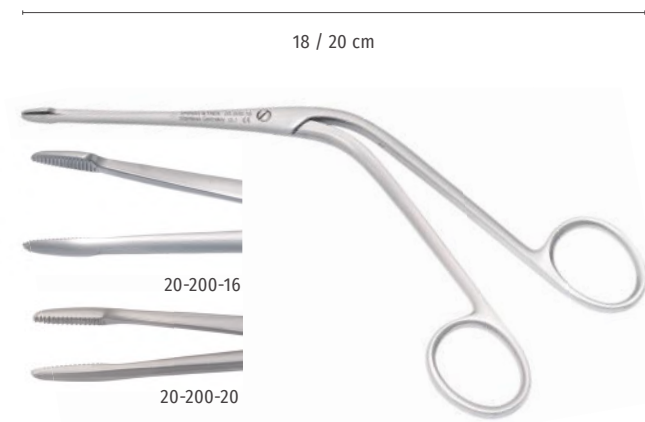

#### Hartmann Nasentamponadezange

#### Hartmann nasal dressing forceps

Art.-Nr./No.	Größe / Size (cm)	Beschreibung / Description
20-200-16	18	fein / delicate
20-200-20	20	



#### Westmacott Nasentamponadezange, schmal, 20 cm

#### Westmacott nasal sponge holding forceps, slender, 20 cm

20-207-20



#### Noyes Nasentamponadezange, fein gerieft, 13 cm

#### Noyes nasal sponge holding forceps, fine, 13 cm

20-208-20



**Kabierske Pulverbläser, komplett mit drei Kanülen für Ohr, Nase, Rachen, Hals; mit Glas und Ventilball**

Kabierske powder blower, complete with three cannulae for ear, nose, pharynx, larynx; with bottle and rubber ball

10-155-00



**Kabierske Ersatzglas, 30 ccm**

Kabierske spare bottle, 30 ccm

10-155-01



**Kabierske Ventilball**

Kabierske rubber ball

10-155-02



8 / 11 cm

**Kabierske Kanüle, gerade**

Kabierske cannula, straight

Art.-Nr./No.	Länge / Length (cm)
10-155-08	8
10-155-11	11



13,5 cm

**Kabierske Kanüle, gebogen, 13,5 cm**

Kabierske cannula, curved, 13.5 cm

10-155-13



Abbildung ähnlich / similar to illustration

**Glatzel Nasenspiegel, hochglänzend, 20 x 13 cm**

Glatzel nasal mirror, high gloss, 20 x 13 cm

20-198-00

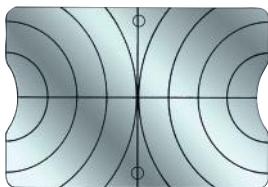

15,5 cm

**Saugrohr mit abgeflachtem Ende, Ø 5 mm, 15,5 cm**

Suction tube with flattened end, Ø 5 mm, 15.5 cm

20-199-05

## 03 Untersuchungsinstrumente

### Examination Instruments



16 / 19 / 21 cm

#### Jansen Nasenpinzette, bajonett, anatomisch

#### Jansen nasal forceps, bayonet, anatomical

Art.-Nr./No.	Länge / Length (cm)
20-730-16	16
20-730-19	19
20-730-21	21

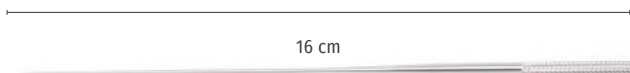

16 cm

#### Watteträger, Ø 1,2 mm, 16 cm, 5 Stück

#### Cotton carrier, Ø 1.2 mm, 16 cm, 5 pieces

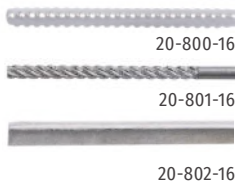

20-800-16

20-801-16

20-802-16

Art.-Nr./No.	Beschreibung / Description
20-800-16	dreikant, gerieft / triangle, serrated
20-801-16	rund, gerieft / round, serrated
20-802-16	dreikant, glatt / triangular, smooth



9 / 11 cm

#### Saugrohr, kniegebogen, zylindrisch

#### Suction tube, angled, cylindrical

Art.-Nr./No.	AD / OD (mm)	Länge / Length (cm)
10-300-10	1,0	9
10-300-15	1,5	9
10-300-20	2,0	9
10-300-25	2,5	11
10-300-30	3,0	11
10-300-40	4,0	11
10-300-50	5,0	11



11,5 / 13 cm

#### Saugrohr, kniegebogen, konisch

#### Suction tube, angled, conical

Art.-Nr./No.	AD / OD (mm)	Länge / Length (cm)
10-302-30	3,0	11,5
10-302-35	3,5	11,5
10-302-45	4,5	13,0



19,5 cm

#### Saugrohr, gerade, biegsam, konisch, 3,0 mm, 19,5 cm

#### Suction tube, straight, bendable, conical, 3.0 mm, 19.5 cm

10-303-18

## 03 Untersuchungsinstrumente

### Examination Instruments

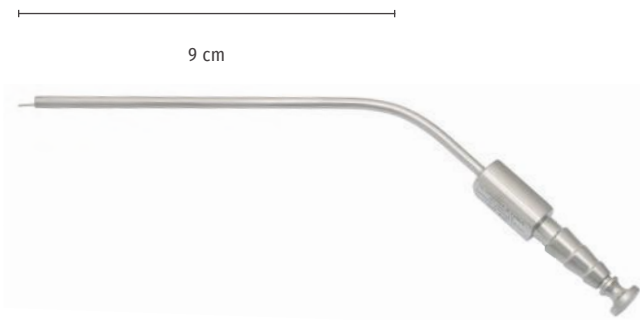

**Frazier Saugrohr, mit Griffplatte und Unterbrecher, 9 cm**  
**Frazier suction tube, with suction control, 9 cm**

Art.-Nr. Art.-No.	AD / OD Ch/Fr	AD / OD mm
30-080-05	5	1,7
30-080-06	6	2,0
30-080-07	7	2,3
30-080-08	8	2,7
30-080-09	9	3,0
30-080-10	10	3,3
30-080-12	12	4,0
30-080-15	15	5,0

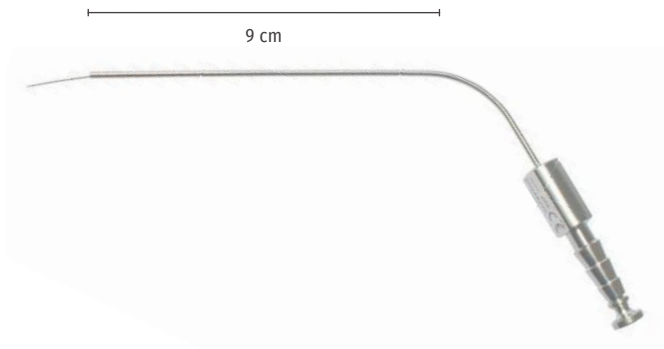

**Ferguson Saugrohr mit Griffplatte und Unterbrecher, 9 cm**  
**Ferguson suction tube with suction control, 9 cm**

Art.-Nr. Art.-No.	AD / OD Ch/Fr	AD / OD mm
30-081-06	6	2,0
30-081-08	8	2,7

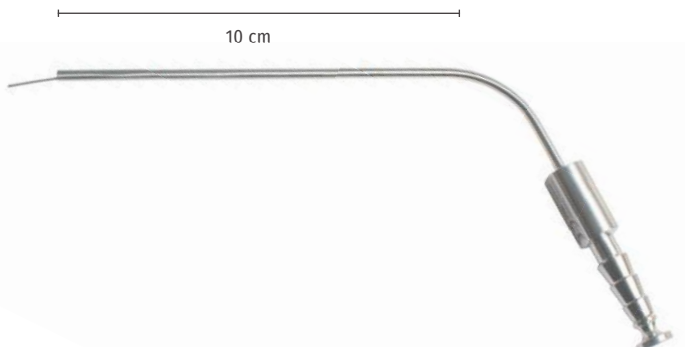

**Ferguson Saugrohr mit Griffplatte und Unterbrecher, 10 cm**  
**Ferguson suction tube with suction control, 10 cm**

Art.-Nr. Art.-No.	AD / OD Ch/Fr	AD / OD mm
30-081-09	9	3,0
30-081-10	10	3,3
30-081-12	12	4,0
30-081-15	15	5,0



**Frazier Saugrohr, konisch,  
mit tränenförmiger Saugsteuerung, 8 cm**  
**Frazier suction tube, conical,  
with tearform suction control, 8 cm**

Art.-Nr. Art.-No.	AD / OD Ch/Fr	AD / OD mm
30-105-06	6	2,3
30-105-08	8	2,8
30-105-10	10	3,3



## 04 Septum Instrumente, Blakesley Nasenzange, Premium Modell

### Septum Instruments Blakesley premium model nasal forceps



#### gerade / straight

Art.-Nr./No.	Größe Size (mm)		Länge Length (cm)
20-215-00	3,0		11,5
20-215-01	3,5		11,5
20-215-02	4,0		11,5
20-215-03	5,0		11,5
20-215-04	6,0		11,5
20-215-10	3,0		15,0
20-215-12	4,0		15,0
20-215-14	6,0		15,0

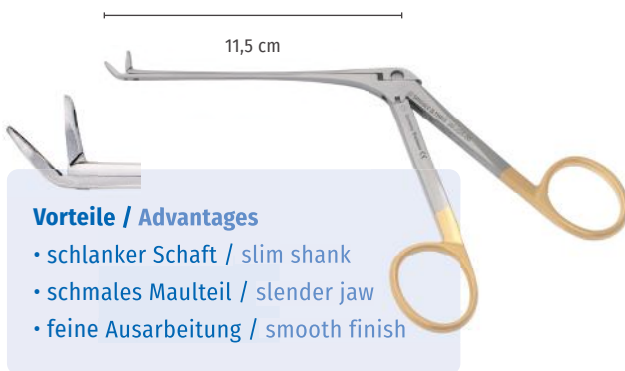

#### 45° aufgebogen, 11,5 cm / curved upwards 45°, 11.5 cm

Art.-Nr./No.	Größe / Size (mm)	
20-225-00	3,0	
20-225-01	3,5	
20-225-02	4,0	
20-225-03	5,0	
20-225-04	6,0	



#### 45° aufgebogen, 15 cm / curved upwards 45°, 15 cm

Art.-Nr./No.	Größe / Size (mm)	
20-225-11	3,5	
20-225-12	4,0	
20-225-14	6,0	



#### 90° aufgebogen, 11,5 cm / curved upwards 90°, 11.5 cm

Art.-Nr./No.	Größe / Size (mm)	
20-235-01	3,5	
20-235-02	4,0	
20-235-03	5,0	



## 04 Nasenzangen / Nasenscheren

### Nasal Forceps / Nasal Scissors

**Black Line**  
Ultimate Edition

#### Blakesley Nasenzange Black Line, DLC-Beschichtung Blakesley nasal forceps Black Line, DLC coating



Art.-Nr. Art.-No.	Länge Length (cm)	Größe Size (mm)	Winkel Angle
20-215-00B	12,0	3,0	gerade / straight
20-215-01B	12,0	3,5	gerade / straight
20-215-02B	12,0	4,0	gerade / straight
20-215-03B	12,0	5,0	gerade / straight
20-215-04B	12,0	6,0	gerade / straight
20-225-00B	12,0	3,0	45° aufgebogen curved upwards
20-225-01B	12,0	3,5	45° aufgebogen curved upwards
20-225-02B	12,0	4,0	45° aufgebogen curved upwards
20-225-03B	12,0	5,0	45° aufgebogen curved upwards
20-225-11B	15,0	3,5	45° aufgebogen curved upwards
20-225-12B	15,0	4,0	45° aufgebogen curved upwards
20-225-14B	15,0	6,0	45° aufgebogen curved upwards
20-235-01B	12,0	3,5	90° aufgebogen curved upwards
20-235-02B	12,0	4,0	90° aufgebogen curved upwards
20-235-03B	12,0	5,0	90° aufgebogen curved upwards



#### Strümpel-Voss Nasenzange, 45°, 11,5 cm Strümpel-Voss nasal forceps, 45°, 11,5 cm

20-238-00

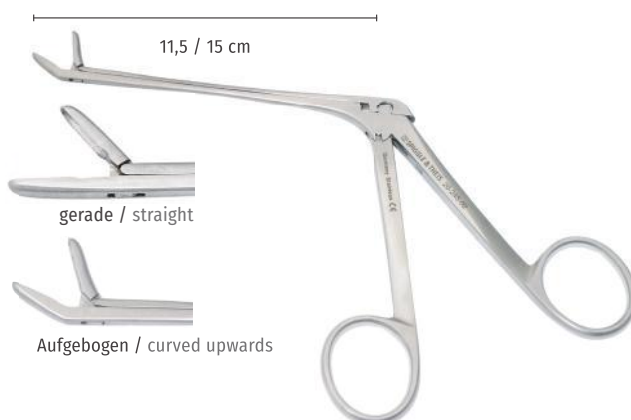

#### Takahashi Nasenzange / Takahashi nasal forceps

Art.-Nr. Art.-No.	Länge Length (cm)	Größe Size (mm)	Winkel Angle
20-245-01	11,5	2,5	gerade / straight
20-245-11	15,0	2,5	gerade / straight
20-246-01	11,5	4,0	gerade / straight
20-245-02	11,5	2,5	30° aufgebogen curved upwards
20-245-12	15,0	2,5	30° aufgebogen curved upwards
20-246-02	11,5	4,0	30° aufgebogen curved upwards



## 04 Nasenzangen / Nasenscheren

### Nasal Forceps / Nasal Scissors

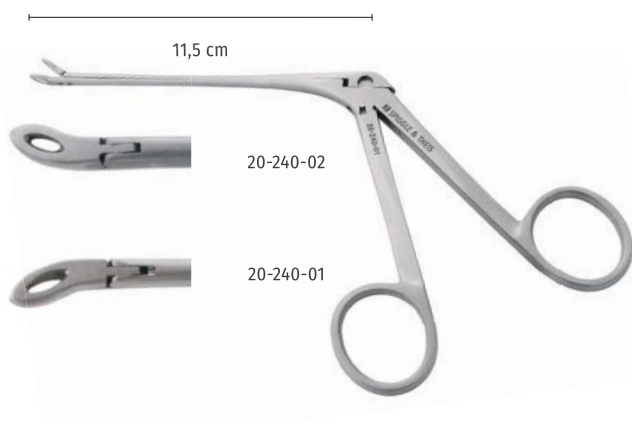

#### Blakesley Nasenzange / Blakesley nasal forceps

Art.-Nr./No.	Größe / Size (cm)	Beschreibung / Description
20-240-01	11,5	links gebogen / curved left
20-240-02	11,5	rechts gebogen / curved right



#### Watson-Williams Nasenzange, gerade, gezahnt, 11,5 cm

#### Watson-Williams nasal forceps, straight, serrated, 11.5 cm

20-248-00



#### Ferris-Smith Nasenzange, quergerieft, mit Loch, 11,5 cm

#### Ferris-Smith nasal forceps, serrated, with hole, 11.5 cm

20-249-00



#### Craig Septum-Zange, scharfe Löffel, gerade, 9,5 cm

#### Craig septum forceps, sharp cups, straight, 9.5 cm

20-258-00

## 04 Nasenzangen / Nasenscheren

### Nasal Forceps / Nasal Scissors



**Craig-Domnick Septum-Zange, scharfe Löffel, links gebogen, 10 cm**  
Craig-Domnick septum forceps, sharp cups, left curved, 10 cm

20-259-00



**Kazanjian Knochenzange, gerade, 19 cm**

Kazanjian rongeur, straight, 19 cm

20-270-19



**Rowland Nasenzange, Doppelgelenk, gerade, 14,5 cm**

Rowland rongeur, double joint, straight, 14.5 cm

20-274-18



**Caplan Nasenschere, Doppelgelenk, gebogen, 20,5 cm**

Caplan nasal scissors, double joint, angled, 20.5 cm

20-272-21



## 04 Nasenzangen / Nasenscheren

### Nasal Forceps / Nasal Scissors



**Struycken Nasenzange, durchschneidend, gerade, 1,0 mm, 11,5 cm Arbeitslänge**  
**Struycken nasal forceps, throughcutting, straight, 1.0 mm, 11.5 cm working length**

**20-250-00**



**Hartmann Conchotom, rund, 12 cm**  
**Hartmann cutting forceps, round, 12 cm**

Art.-Nr./No. Größe / Size Größe / Size (mm)

20-252-01 1 7

20-252-02 2 8

20-252-03 3 9

20-252-04 4 10



2259



**Schmeden Conchotom, dreieckig, 12 cm**  
**Schmeden cutting forceps, triangular, 12 cm**

Art.-Nr./No. Größe / Size Größe / Size (mm)

20-254-00 0 6

20-254-01 1 7

20-254-02 2 8

20-254-03 3 12







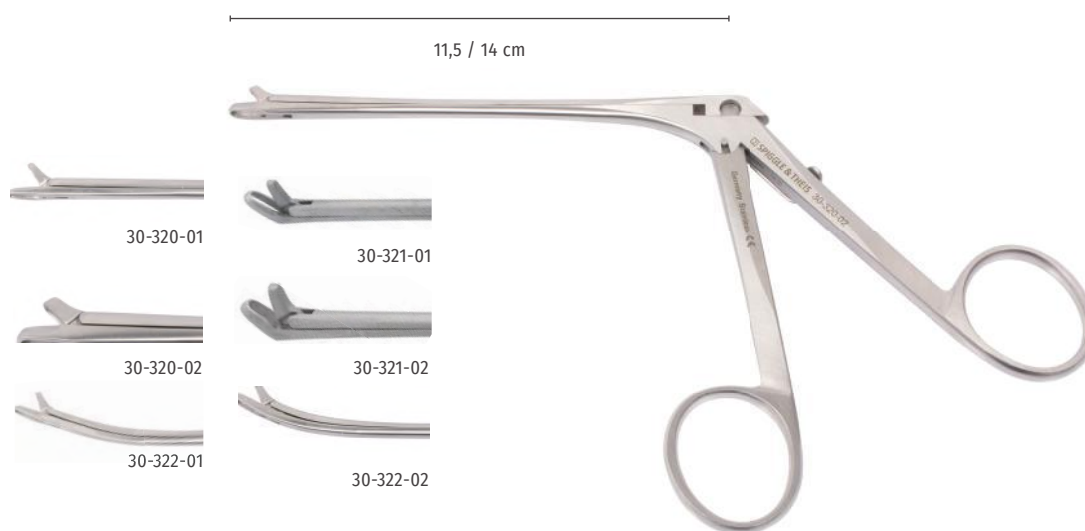

## 04 Nasenzangen / Nasenscheren

### Nasal Forceps / Nasal Scissors



#### Durchschneidende Nasenzange / Throughcutting nasal forceps

Art.-Nr. Art.-No.	Größe Size (mm)	Länge Length (cm)		Winkel Angle
30-320-01	5,0 x 1,5	14,0		gerade / straight
30-320-02	6,5 x 2,5	11,5		gerade / straight
30-321-01	5,0 x 1,5	14,0		45° gewinkelt / 45° angled
30-321-02	6,5 x 2,5	11,5		45° gewinkelt / 45° angled
30-322-01	5,0 x 1,5	14,0		aufgebogen / curved upwards
30-322-02	8,0 x 3,0	14,0		aufgebogen / curved upwards

#### Vorteile / Advantages

- Stumpfes Ende = Dura-Schutz  
Blunt end = dura protection



#### Wigand Polypen-Fasszange, aufgebogen 60°, 11,5 cm

Wigand polyp-grasping forceps, 60° angled, 11.5 cm

20-236-00



## 04 Nasenzangen / Nasenscheren

### Nasal Forceps / Nasal Scissors



Diese Scheren eignen sich hervorragend zur Eröffnung von Siebbeinzellen, unter weitgehender Erhaltung der Schleimhaut.

Ein „Anstechen“ und nicht „Vorschieben“ der Siebbeinschleimhaut ist mit der extra feinen und verlängerten, unteren Schneide gewährleistet.

Dr. med. Hohenhorst,  
Chefarzt der HNO Abteilung des  
Alfried Krupp Krankenhauses in Essen

These scissors are ideally suited for opening ethmoidal cells while keeping the mucous membrane largely intact.

The super-fine and elongated lower blade ensures that the mucous membrane of the ethmoid bone is “punctured” and not “pushed forward.”

Dr. med. Hohenhorst,  
Chief physician of the ENT department  
of the Alfred Krupp Clinic, Essen, Germany

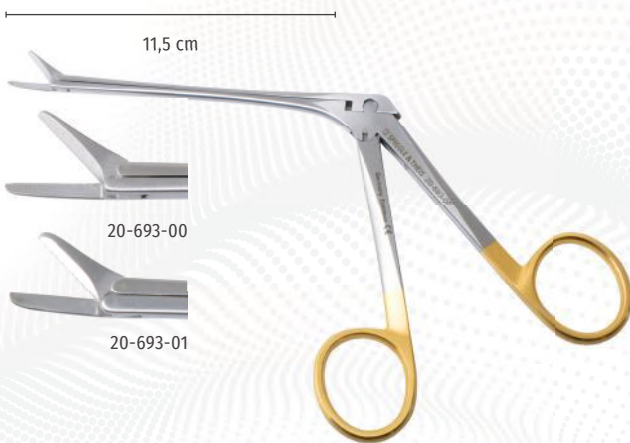

#### Conchotomie Schere, gerade, 11,5 cm

#### Conchotomy scissors, straight, 11.5 cm

Art.-Nr./No.	Beschreibung / Description
20-693-00	standard / standard
20-693-01	extra fein / extra delicate
20-693-02	extra fein, spitz, untere Schneide verlängert extra delicate, pointed, lower blade longer



#### Kressner Muschelquetschzange, gebogen, 3 mm, 22 cm

#### Kressner turbinate crushing forceps, curved, 3 mm, 22 cm

20-280-21



## 04 Nasenzangen / Nasenscheren

### Nasal Forceps / Nasal Scissors

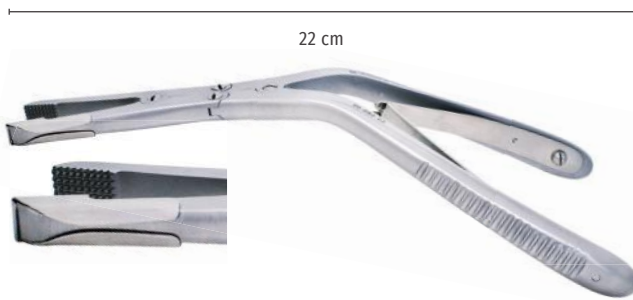

**Rubin Knorpelquetschzange, Doppelgelenk, gebogen, 22 cm**  
Rubin morcelizer forceps, double joint, curved, 22 cm

20-282-22



**Schutzhülse für Rubin Knorpelquetschzange 20-282-22**  
Sleeve for Rubin morcelizer forceps 20-282-22

20-282-99

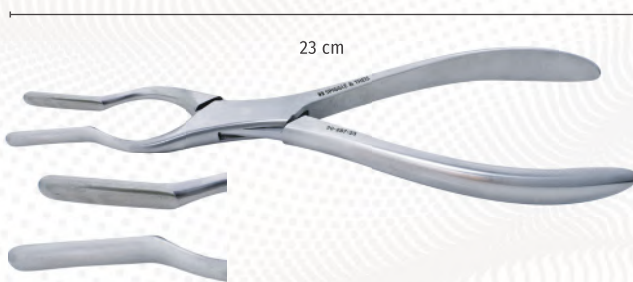

**Cottle-Walsham Septumrichtzange, gerade, 23 cm**  
Cottle-Walsham septum straightening forceps, straight, 23 cm

20-287-23



**Cottle-Walsham Septumrichtzange, zerlegbar, 22 cm**  
Cottle-Walsham septum straightening forceps,  
dismountable, 22 cm

20-288-23

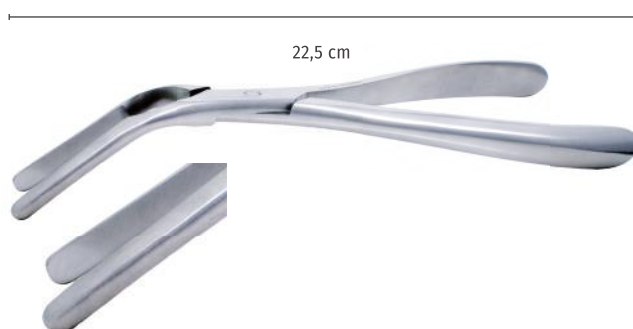

**Ash Septumrichtzange, gebogen, 22,5 cm**  
Ash septum straightening forceps, curved, 22.5 cm

20-290-22





## 04 Nasenzangen / Nasenscheren

### Nasal Forceps / Nasal Scissors



**Jansen-Middleton Septumzange, Doppelgelenk, gewinkelt**  
**Jansen-Middleton septum forceps, double action, angled**

Art.-Nr. Art.-No.	Breite Width (mm)	Beschreibung Description
25-100-05	5,0	mit Löffel / cupped jaws
25-100-46	4,6	durchschneidend throughcutting



**Becker Nasenschere, Doppelgelenk, abgewinkelt**  
**Becker nasal scissors, double action, angled**

25-100-21

## 05 Elevatoren / Raspatorien

### Elevators / Raspatories



**Masing Elevatorium/Raspatorium, 21 cm**

Masing elevator/raspatory, 21 cm

20-300-21



**Cottle Elevatorium/Raspatorium, 23 cm**

Cottle elevator/raspatory, 23 cm

20-301-23

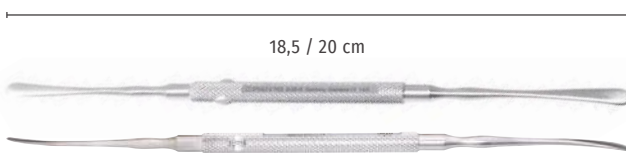

**Freer Doppelevatorium, scharf-stumpf**

Freer elevator, double ended, sharp-blunt

Art.-Nr./No.	Länge / length (cm)
20-305-18	18,5
20-306-20	20,0



**Weber Doppelevatorium, scharf/stumpf, 18,5 cm**

Weber elevator, double ended, sharp/blunt, 18.5 cm

20-307-18

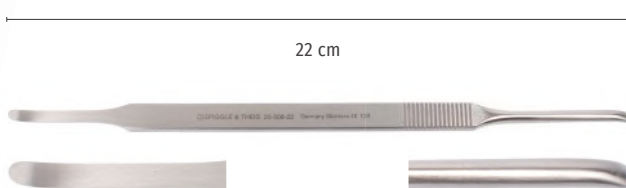

**McKenty Doppelraspatorium, leicht/stark gebogen, 22 cm**

McKenty raspatory, double ended, slightly/strongly curved, 22 cm

20-308-22

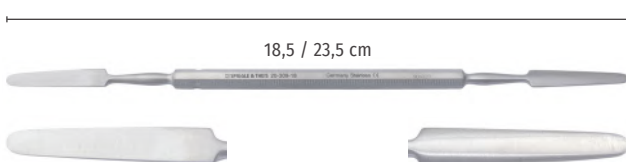

**Killian Raspatorium, doppelseitig, scharf/stumpf**

Killian raspatory, double ended, sharp/blunt

Art.-Nr./No.	Länge / length (cm)
20-309-18	18,5
20-309-20	23,5



**Freer Golfstock-Raspatorium, 19 cm**

Freer golf club raspatory, 19 cm

20-310-19



## 05 Elevatoren / Raspatorien

### Elevators / Raspatories

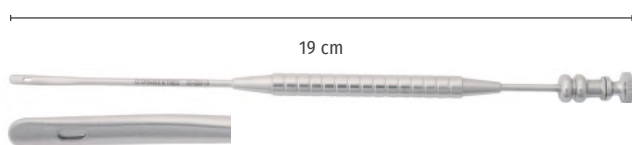

**Gourney Saugelevatorium, 3 mm, 19 cm**  
Gourney suction elevator, 3 mm, 19 cm

20-320-19

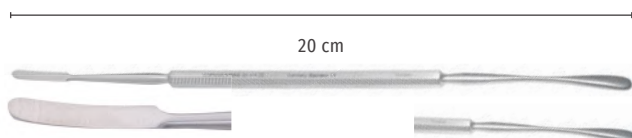

**Freer-Joseph Doppel-Raspatorium, 20 cm**  
Freer-Joseph raspatory, double-ended, 20 cm

20-311-20

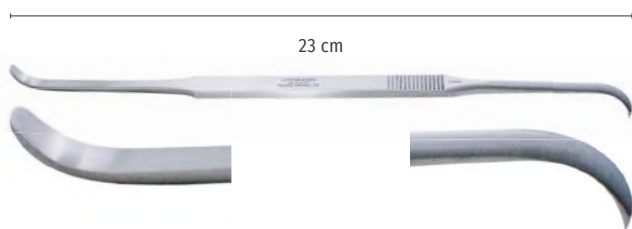

**Cottle Tunnel-Raspatorium, doppelseitig, leicht/stark gebogen, 23 cm**  
Cottle tunneling raspatory, double ended, slightly/strongly curved, 23 cm

20-312-23

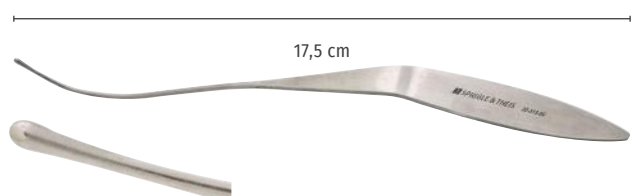

**Nasensonde, s-förmig gebogen, biegsam, 17,5 cm**  
Nasal probe, s-shaped, bendable, 17.5 cm

20-313-00

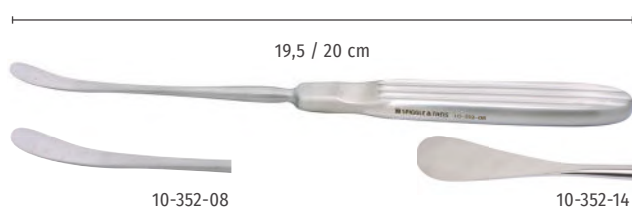

**Cottle Raspatorium, gebogen**  
Cottle raspatory, curved

Art.-Nr./No.	Länge / length (cm)	Größe / Size (mm)
10-352-08	20,0	8
10-352-14	19,5	14



**Lempert Raspatorium, gerade / Lempert raspatory, straight**

Art.-Nr./No.	Länge / length (cm)	Größe / Size (mm)
10-353-02	17	2
10-353-03	17	3
10-353-04	17	4
10-353-05	17	5
10-353-07	18	7

## 05 Elevatoren / Raspatorien

### Elevators / Raspatories

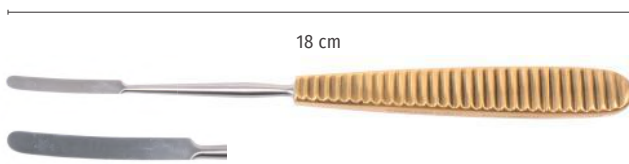

**Raspatorium, gerade, vergoldeter Griff, 18 cm**  
Raspatory, straight, golden handle, 18 cm

10-353-13



**Lempert Raspatorium, stark gebogen, 3 mm, 16,5 cm**  
Lempert raspatory, strongly curved, 3 mm, 16,5 cm

10-354-03

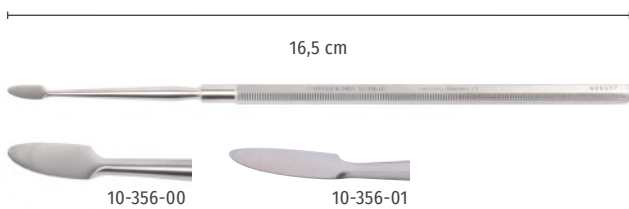

**Wullstein Raspatorium, 16,5 cm**  
Wullstein raspatory, 16.5 cm

Art.-Nr./No.	Größe / Size (mm)
10-356-00	4,0
10-356-01	2,5

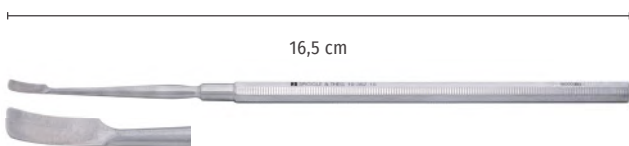

**Wullstein Raspatorium, abgerundete Ecken, 4 mm, 16,5 cm**  
Wullstein raspatory, with rounded edges, 4 mm, 16.5 cm

10-357-18



**McKenty Raspatorium, stark gebogen, 14 cm**  
McKenty raspatory, strongly curved, 14 cm

Art.-Nr./No.	Größe / Size (mm)
20-318-04	4,0
20-318-05	5,0



**Ulmer Raspatorium, stark gebogen, 4 mm, 16,5 cm**  
Ulmer raspatory, strongly curved, 4 mm, 16,5 cm

20-319-04



## 05 Elevatoren / Raspatorien

### Elevators / Raspatories



#### Guillen Saugraspatorium Guillen suction raspatory

Art.-Nr. Art.-No.	Größe Size (mm)	Länge Length (cm)	Beschreibung Description
20-322-01	4,0	20,0	gerade / straight
20-322-02	4,0	20,0	links gebogen curved left
20-322-03	4,0	21,5	rechts gebogen curved right
20-323-01	4,0	15,0	gerade / straight
20-323-02	4,5	15,0	links gebogen curved left
20-323-03	4,5	15,0	rechts gebogen curved right

**06 Meißel / Osteotome / Hämmer**  
**Chisels / Osteotomes / Mallets**

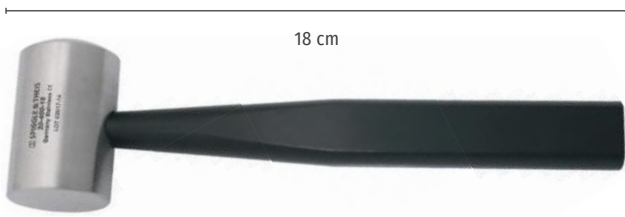

**Cottle Hammer, 18 cm**  
**Cottle mallet, 18 cm**

**20-400-18**



**Hajek Metallhammer, 200 g, 20 cm**  
**Hajek metal mallet, 200 g, 20 cm**

**20-402-21**

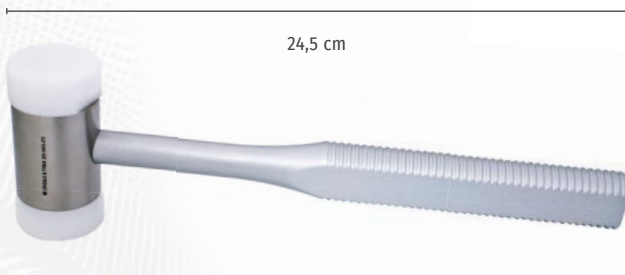

**Hammer mit Alugriff und Metallkopf, auswechselbare Nylon-Backen, 24,5 cm**  
**Mallet with aluminium handle, metal head, replaceable nylon facings, 24.5 cm**

**20-403-23**



**Hammer mit Silikongriff, 20 cm**  
**Mallet with silicone handle, 20 cm**

**20-404-20**



## 06 Meißel / Osteotome / Hämmer

### Chisels / Osteotomes / Mallets

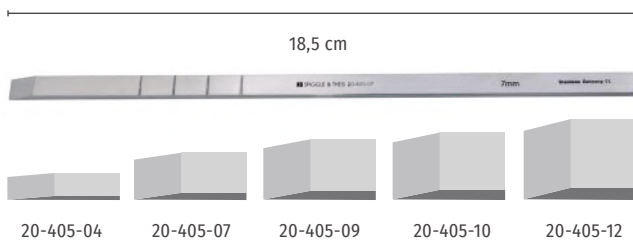

#### Cottle Meißel, flach, 18,5 cm

#### Cottle chisel, flat, 18.5 cm

Art.-Nr./No.	Größe / Size (mm)
20-405-04	4,0
20-405-06	6,0
20-405-07	7,0
20-405-09	9,0
20-405-10	10,0
20-405-12	12,0

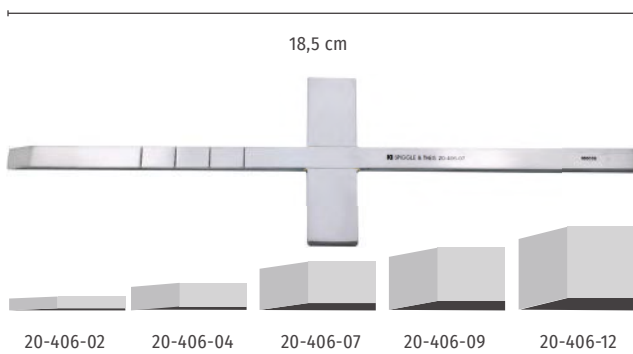

#### Cottle Meißel, flach, mit Querbalken, 18,5 cm

#### Cottle chisel, flat, with crossbar, 18.5 cm

Art.-Nr./No.	Größe / Size (mm)
20-406-02	2,0
20-406-04	4,0
20-406-07	7,0
20-406-09	9,0
20-406-12	12,0

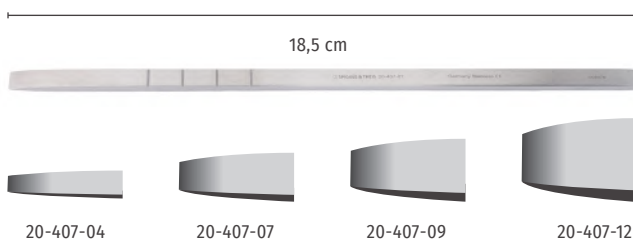

#### Cottle Osteotom, flach, 18,5 cm

#### Cottle osteotome, flat, 18.5 cm

Art.-Nr./No.	Größe / Size (mm)
20-407-04	4,0
20-407-07	7,0
20-407-09	9,0
20-407-12	12,0

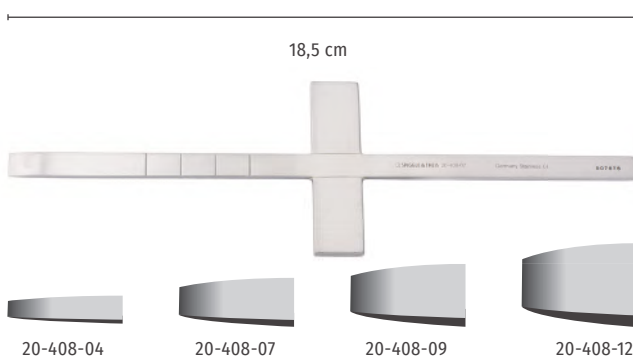

#### Cottle Osteotom, flach, mit Querbalken, 18,5 cm

#### Cottle osteotome, flat, with crossbar, 18.5 cm

Art.-Nr./No.	Größe / Size (mm)
20-408-04	4,0
20-408-07	7,0
20-408-09	9,0
20-408-12	12,0



## 06 Meißel / Osteotome / Hämmer

### Chisels / Osteotomes / Mallets

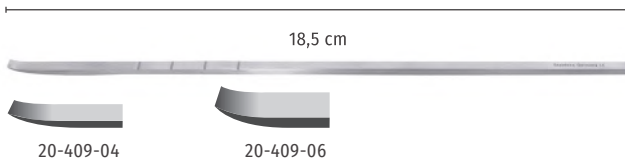

#### Cottle Meißel, flach, gebogen, 18,5 cm

#### Cottle chisel, flat, curved, 18.5 cm

Art.-Nr./No.	Größe / Size (mm)
20-409-04	4,0
20-409-06	6,0

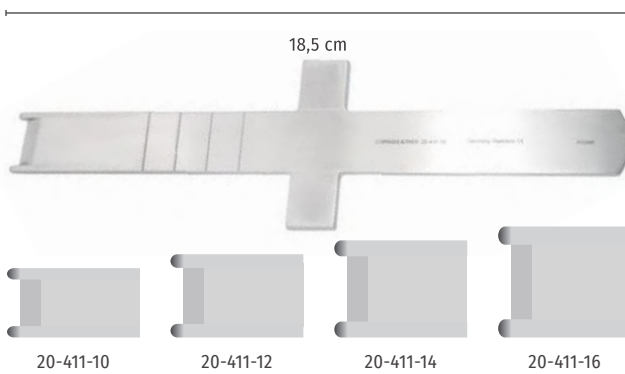

#### Cottle Osteotom, 2 Führungsdorne, mit Querbalken, 18,5 cm

#### Cottle osteotome, 2 guards, with crossbar, 18.5 cm

Art.-Nr./No.	Größe / Size (mm)
20-411-10	10,0
20-411-12	12,0
20-411-14	14,0
20-411-16	16,0

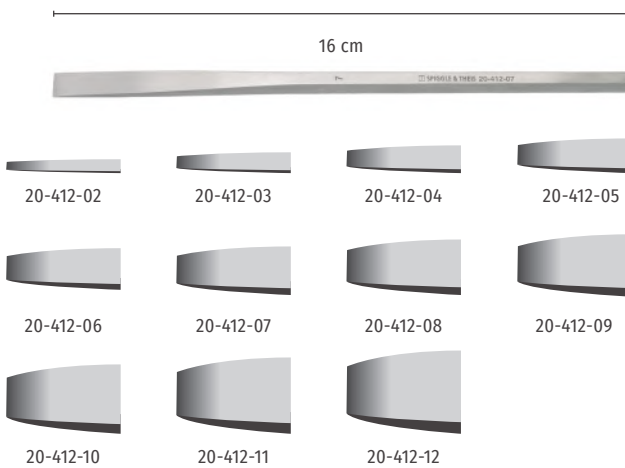

#### Rubin Osteotom, Sechskant-Griff, gerade, 16 cm

#### Rubin osteotome, hexagon handle, straight, 16 cm

Art.-Nr./No.	Größe / Size (mm)
20-412-02	2,0
20-412-03	3,0
20-412-04	4,0
20-412-05	5,0
20-412-06	6,0
20-412-07	7,0
20-412-08	8,0
20-412-09	9,0
20-412-10	10,0
20-412-11	11,0
20-412-12	12,0



**06 Meißel / Osteotome / Hämmer**  
**Chisels / Osteotomes / Mallets**

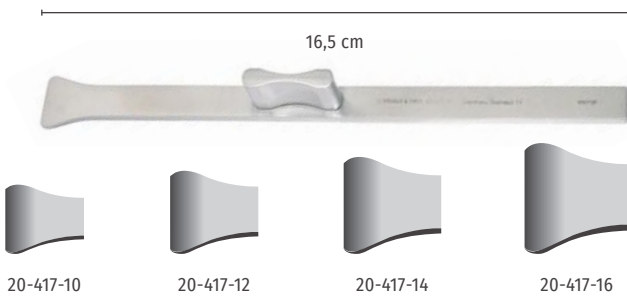

**Rubin Osteotom mit Halteknopf, 16,5 cm**  
**Rubin osteotome with stabilizer, 16.5 cm**

Art.-Nr./No.	Größe / Size (mm)
20-417-10	10,0
20-417-12	12,0
20-417-14	14,0
20-417-16	16,0

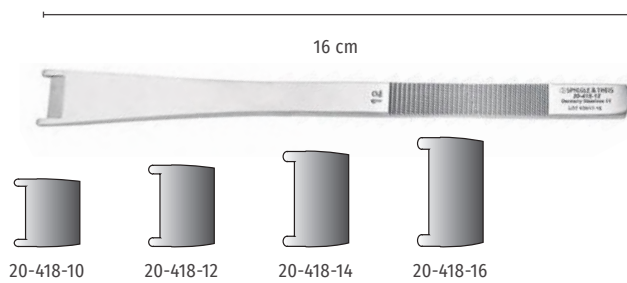

**Cinelli Osteotom, 2 Führungsdorne, 16 cm**  
**Cinelli osteotome, double guard, 16 cm**

Art.-Nr./No.	Größe / Size (mm)
20-418-10	10,0
20-418-12	12,0
20-418-14	14,0
20-418-16	16,0

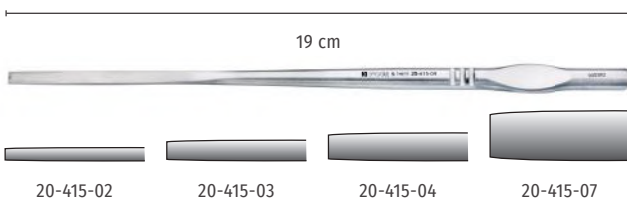

**Walter Osteotom, 19 cm**  
**Walter osteotome, 19 cm**

Art.-Nr./No.	Größe / Size (mm)
20-415-02	2,0
20-415-03	3,0
20-415-04	4,0
20-415-07	7,0

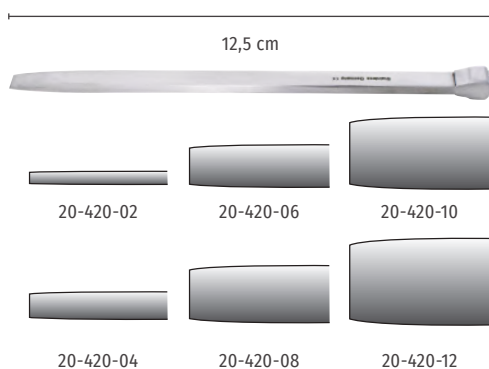

**Mini Osteotom, gerade, 12,5 cm**  
**Mini osteotome, straight, 12.5 cm**

Art.-Nr./No.	Größe / Size (mm)
20-420-02	2,0
20-420-04	4,0
20-420-06	6,0
20-420-08	8,0
20-420-10	10,0
20-420-12	12,0

## 06 Meißel / Osteotome / Hämmer

### Chisels / Osteotomes / Mallets

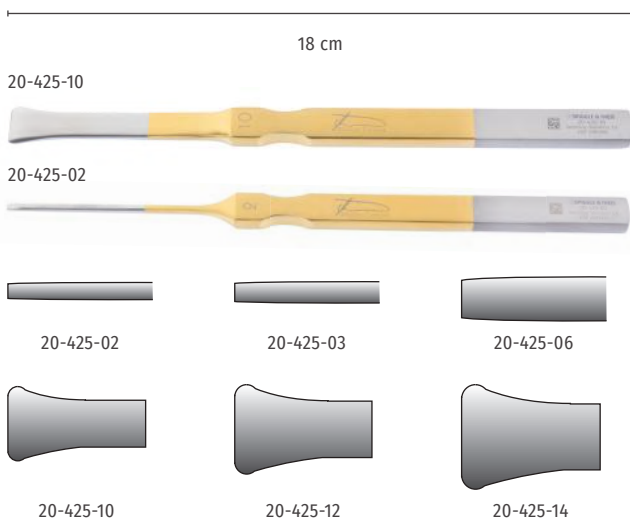

#### Osteotom Premium Line, goldener Griff

#### Osteotome Premium Line, golden handle

Art.-Nr./No.	Größe / Size (mm)	Länge / Length (cm)
20-425-02	2,0	18,0
20-425-25	2,5	18,0
20-425-03	3,0	18,0
20-425-04	4,0	18,0
20-425-06	6,0	18,0
20-425-10	10,0	18,0
20-425-12	12,0	18,0
20-425-14	14,0	18,0
20-425-16	16,0	18,0
20-425-18	18,0	18,0

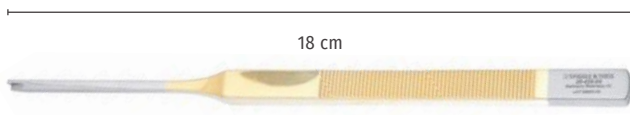

#### Osteotom Premium Line, goldener Griff, mit Schutzsonde

#### Osteotome Premium Line, golden handle, guarded

Art.-Nr./No.	Größe / Size (mm)	Länge / Length (cm)
20-426-00	2,2	18,0
20-426-01	3,0	18,0
20-426-02	4,0	18,0



#### Nasenraspel, doppelseitig, HM, 21 cm

#### Nasal rasp, double ended, TC, 21 cm

Art.-Nr. Art.-No.	Beschreibung Description (mm)	Länge (cm) Length (cm)
20-427-20	mittel / grob medium / coarse	21,0
20-427-19	fein / mittel fine / medium	21,0



#### Cottle Knochen- und Knorpelquetscher, mit Entnahmefeder,

#### Griffmulden, vergoldet, Fläche 5x1,5 cm

#### Cottle bone and cartilage crusher, with clamp, recessed grip,

#### golden, crusher size 5x1.5 cm

20-427-50



## 06 Meißel / Osteotome / Hämmer

### Chisels / Osteotomes / Mallets

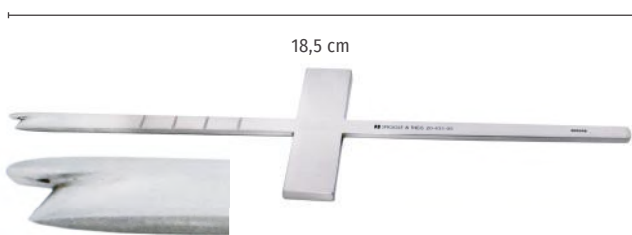

**Cottle Osteotom mit Führungsdorn, gerade, 5 mm, 18,5 cm**  
**Cottle osteotome with single guard, straight, 5 mm, 18.5 cm**

Art.-Nr./No.	Beschreibung / Description
20-430-05	ohne Querplatte / without crossbar
20-431-05	mit Querplatte / with crossbar

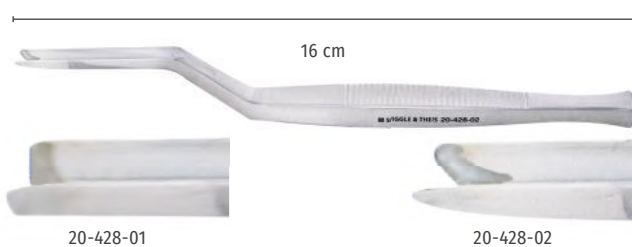

**Killian-Claus Hohlmeißel, bajonett, 5,5 mm, 16 cm**  
**Killian-Claus gouge, bayonet, 5.5 mm, 16 cm**

Art.-Nr./No.	Beschreibung / Description
20-428-01	gerade / straight
20-428-02	V-Form / V-shaped



**Walter Hohlmeißel, 19 cm / Walter gouge, 19 cm**

Art.-Nr./No.	Größe / Size (mm)
20-432-03	3,0
20-432-45	4,5

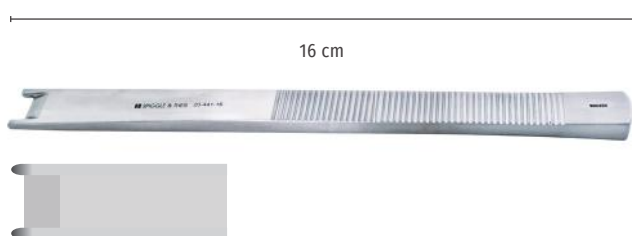

**Masing Osteotom, 2 Führungsdorne, 10 mm-Schneide, gerade, 16 cm**  
**Masing osteotome, 2 guards, 10 mm blade, straight, 16 cm**

**20-441-16**

## 06 Meißel / Osteotome / Hämmer

### Chisels / Osteotomes / Mallets



**Herberhold Osteotom zur lateralen Osteotomie, 4 mm-Schneide, 18 cm**  
**Herberhold osteotome for lateral osteotomy, 4 mm blade, 18 cm**

Art.-Nr./No.	Beschreibung / Description
20-435-01	2 Führungsdorne, gerade double guard, straight
20-435-02	1 Führungsdorn, links gebogen single guard, left curved
20-435-03	1 Führungsdorn, rechts gebogen single guard, right curved



**Wurm Osteotom, gerade, mit Schutzsonde, schmale Führungsschiene, Breite 4 mm, 2 mm, 18 cm**  
**Wurm osteotome, straight, with protecting probe, small guide bar, 4 mm width, 2 mm, 18 cm**

**20-439-01**



**Masing Osteotom zur lateralen Osteotomie, 1 Führungsdorn, 3 mm Schneide, 18 cm**  
**Masing osteotome for lateral osteotomy, single guard, 3 mm blade, 18 cm**

Art.-Nr./No.	Beschreibung / Description
20-440-01	gerade / straight
20-440-02	links gebogen / left curved
20-440-03	rechts gebogen / right curved

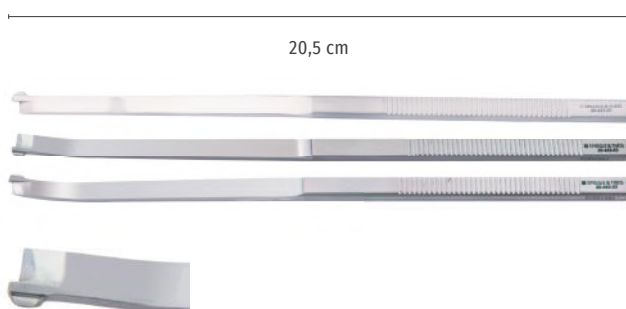

**Anderson-Neivert Osteotom zur lateralen Osteotomie, 1 Führungsdorn, 4 mm-Schneide, 20,5 cm**  
**Anderson-Neivert osteotome for lateral osteotomy, single guard, 4 mm blade, 20.5 cm**

Art.-Nr./No.	Beschreibung / Description
20-442-01	gerade / straight
20-442-02	links gebogen / left curved
20-442-03	rechts gebogen / right curved



## 07 Messer

### Knives



#### Skalpelle-Griff / Scalpel handle

Art.-Nr./No.	Nr./No.	Länge / Length (cm)
10-360-03	3	12,5
10-360-04	4	13,5
10-360-07	7	16,0
10-360-33	3L	21,0

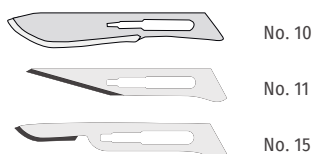

#### Skalpelle-Klingen, einzeln steril verpackt, 100 Stück Scalpel blades, single sterile packed, 100 pieces

Art.-Nr./No.	Nr./No.	Beschreibung / Description
10-360-10	10	gerundet / rounded
10-360-11	11	spitz / pointed
10-360-15	15	gerundet / rounded

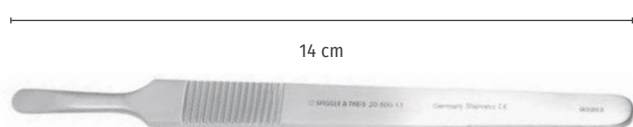

#### Cottle Septum-Messer, 14 cm / Cottle septum knife, 14 cm

20-500-13

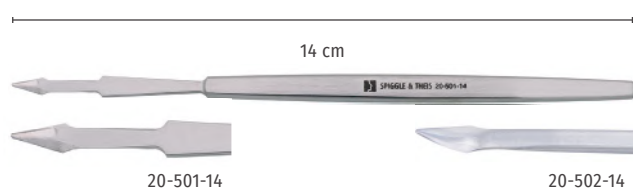

#### Masing Ritzmesser, 14 cm / Masing pointed knife, 14 cm

Art.-Nr./No.	Beschreibung / Description
20-501-14	mit Kerbe / grooved
20-502-14	glatt / smooth



#### Freer Septum-Messer, 15 cm / Freer septum knife, 15 cm

20-502-15

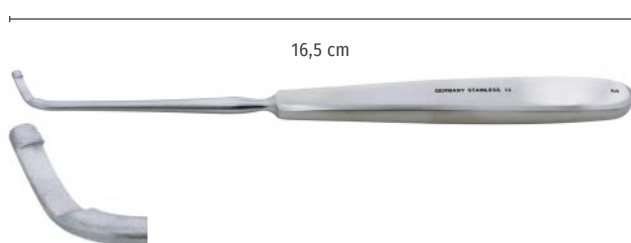

**Joseph Rhinoplastikmesser, geknöpft, gewinkelt, 16,5 cm**  
Joseph rhinoplasty knife, button-end, angled, 16.5 cm

20-503-15



**Mikro Handgriff, rund / Micro handle, round**

Art.-Nr./No.	Länge / Length (cm)
20-550-10	10
20-550-13	13

**Mikro-Klingen, gerade, 25 Stück / Micro blades, straight, 25 pieces**



Art.-Nr./No.	Beschreibung / Description
20-551-62	SM62, vierkant / SM62, square
20-551-64	SM64, abgerundet / SM64, rounded
20-551-65	SM65, spitz / SM65, pointed



**Panetti Saugraspatorium, gerade, mit Griffplatte, 15 cm, Luer-Lock**

Panetti suction raspatory, straight, with finger plate, 15 cm, Luer-Lock

20-000-15



**Panetti Septum Messer, 16,5 cm, Luer-Lock**

Panetti septum knife, 16.5 cm, Luer-Lock



Art.-Nr.	Größe	Winkel	Beschreibung
Art.-No.	Size (mm)	Angle	Description
20-001-15	5,0	45°	Saugöffnung Winkelinnenseite suction hole in angle
20-002-15	4,3	oval	Saugöffnung links suction hole left
20-003-15	4,3	oval	Saugöffnung rechts suction hole right



## 08 Wundhaken

### Retractors

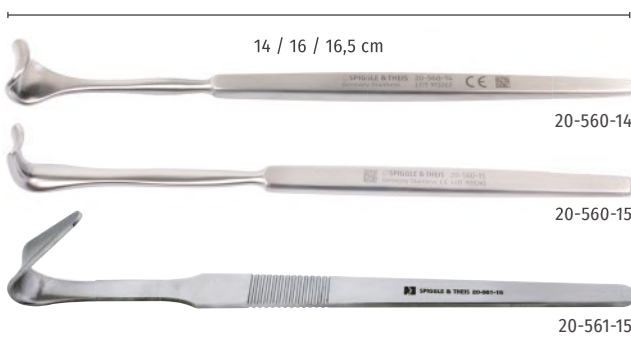

#### Cottle Nasenflügelhaken

##### Cottle alar retractor

Art.-Nr./No.	Länge / Length (cm)	Beschreibung / Description
20-560-14	14,0	schmales Blatt / narrow blade
20-560-15	16,5	kurzes Blatt / short blade
20-561-15	16,0	langes Blatt / long blade

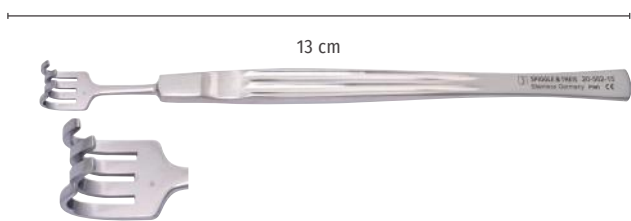

#### Cottle Nasenhaken, 4 Zähne, stumpf, 13 cm

##### Cottle nasal hook, 4 prongs, blunt, 13 cm

20-562-15

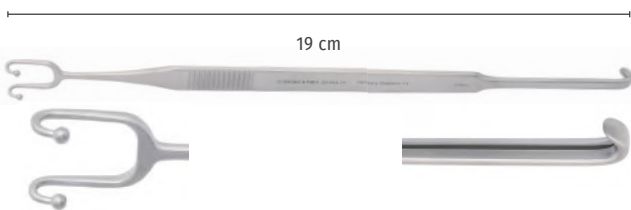

#### Cottle-Neivert Doppelhaken, 19 cm

##### Cottle-Neivert double hook, 19 cm

20-564-20



#### Neivert Draht-Doppelhaken, 18 cm

##### Neivert wire-shaped retractor, 18 cm

Art.-Nr./No.	Länge / Length (mm)
20-566-18	11,5
20-566-20	13,0



#### Converse Nasenflügel-Doppelhaken

##### Converse alar double hook

Art.-Nr./No.	Länge / Length (cm)
20-572-10	11,0, stumpf / blunt
20-573-10	11,5, scharf / sharp



**Aufricht Nasenrückenhaken**  
**Aufricht nasal retractor**

Art.-Nr. Art.-No.	Größe Size (mm)	Länge Length (cm)	Beschreibung Description
20-567-16	50	16,0	
20-568-16	45	15,5	extra fein, Goldgriff extra fine, golden handle



**Aufricht Nasenrückenhaken, mit Fiberglas Lichtträger, Goldgriff**  
**63 mm, 18,5 cm / Aufricht nasal retractor, with fibre-light carrier, golden handle 63 mm, 18.5 cm**

20-569-16



**Aufricht Doppelhaken, 11,5 cm / Aufricht double retractor, 11.5 cm**

20-570-13

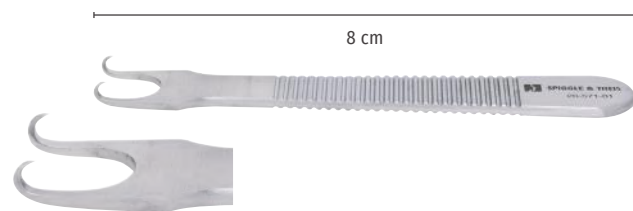

**Kilner Wundhäkchen, 2-zinkig, 8 cm / Kilner hook, 2 prongs, 8 cm**

Art.-Nr. Art.-No.	Größe Size (mm)	Beschreibung Description
20-571-01	10	scharf / sharp
20-571-02	10	stumpf / blunt
20-571-03	13	scharf / sharp

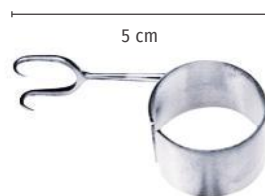

**Cottle Fingerring-Häkchen, scharf, 5 cm**

**Cottle thimble hook, sharp, 5 cm**

20-574-06

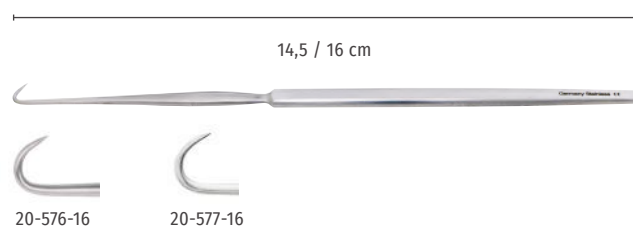

**Cottle Hauthäkchen, 1-zinkig, scharf**

**Cottle skin hook, 1 prong, sharp**

Art.-Nr. Art.-No.	Länge Length (cm)	Beschreibung Description
20-576-16	16,0	gewinkelt / angled
20-577-16	14,5	gebogen / curved



## 08 Wundhaken

### Retractors



**Cottle Doppel-Haken, 11 mm, 14,5 cm**

Cottle double hook, 11 mm, 14.5 cm

Art.-Nr./No.	Beschreibung / Description
20-579-01	rechts geknöpft, links scharf right prong blunt, left prong sharp
20-579-02	links geknöpft, rechts scharf left prong blunt, right prong sharp



**Cottle Doppel-Haken, rechts und links scharf**

Cottle double hook, left and right prong sharp

Art.-Nr. Art.-No.	Größe Size (mm)	Länge Length (cm)	Beschreibung Description
20-579-03	11,0	14,5	
20-579-04	10,0	12,0	extra fein, Goldgriff extra fine, golden handle

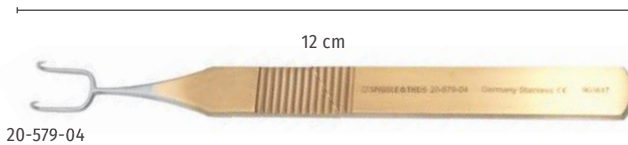

**Freer Wundhäkchen, 2-zinkig, scharf, 15 cm**

Freer hook, 2 prongs, sharp, 15 cm

20-580-15

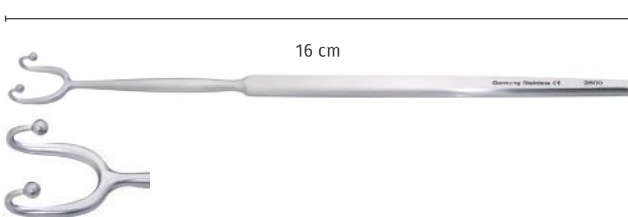

**Fomon Nasenflügelhaken, 2-zinkig, stumpf, 12 mm, 16 cm**

Fomon alar hook, 2 prongs, blunt, 12 mm, 16 cm

20-584-17

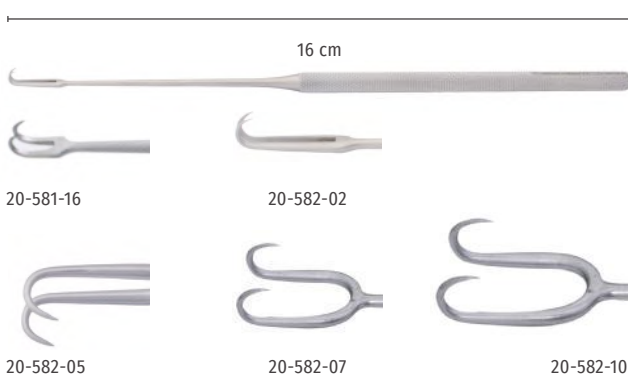

**Joseph Doppel-Häkchen, 2-zinkig, scharf, 16 cm**

Joseph double hook, 2 prongs, sharp, 16 cm

Art.-Nr. Art.-No.	Hakenbreite Hook width (mm)	Beschreibung Description
20-581-16	5	kurze Biegung short curve
20-582-02	3	
20-582-05	6	
20-582-07	8	
20-582-10	10	



**Gillies Hauthäkchen, 1-zinkig, scharf, sehr fein, 12,5 cm**  
**Gillies skin hook, 1 prong, sharp, very fine, 12.5 cm**

20-585-13



**Cottle Hauthäkchen, 1-zinkig, scharf, fein, 14,5 cm**  
**Cottle skin hook, 1 prong, sharp, fine, 14.5 cm**

20-587-15

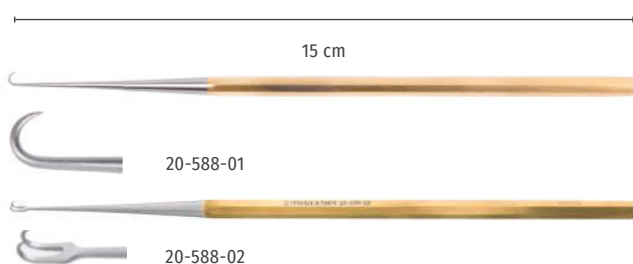

**Wundhäkchen, superfein, Goldgriff, 15 cm**  
**Skin hook, very fine, golden handle, 15 cm**

Art.-Nr./No.	Beschreibung / Description
20-588-01	einzinkig / one prong
20-588-02	zweizinkig / two prongs

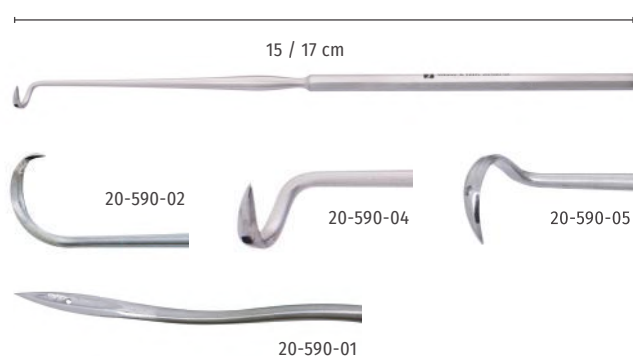

**Yankauer Septumnadel / Yankauer septum needle**

Art.-Nr. Art.-No.	Länge Length (cm)	Beschreibung Description
20-590-01	17	leicht gebogen, vorwärts slightly curved, forward
20-590-02	17	stark gebogen, rückwärts strongly curved, backward
20-590-04	17	rechts gebogen / right curved
20-590-05	17	links gebogen / left curved



## 09 Scheren

### Scissors



**Joseph Schere, spitz-spitz, 14,5 cm**  
**Joseph scissors, pointed, 14.5 cm**

Art.-Nr./No.	Beschreibung / Description
20-600-14	gerade / straight
20-601-14	gebogen / curved



**Joseph Schere, Hartmetall, spitz-spitz, 14,5 cm**  
**Joseph scissors, tungsten carbide, pointed, 14.5 cm**

Art.-Nr./No.	Beschreibung / Description
20-602-14	gerade / straight
20-603-14	gebogen / curved

**Black Line**  
 Ultimate Edition



**Joseph Schere, Black Line, Hartmetall, spitz-spitz, DLC-Beschichtung, 14,5 cm**  
**Joseph scissors Black Line, tungsten carbide, pointed, DLC coating, 14.5 cm**

Art.-Nr./No.	Beschreibung / Description
20-602-14B	gerade / straight
20-602-14WB	gerade, Wellenschliff / straight, wavy
20-603-14B	gebogen / curved
20-603-14WB	gebogen, Wellenschliff / curved, wavy

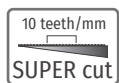

20-604-14



20-605-14

**Joseph Schere, supercut, spitz-spitz, 14,5 cm**  
**Joseph scissors, supercut, pointed, 14.5 cm**

Art.-Nr./No.	Beschreibung / Description
20-604-14	gerade / straight
20-605-14	gebogen / curved



20-607-18

**Metzenbaum-Fino Schere, spitz-spitz, gebogen**  
**Metzenbaum-Fino scissors, pointed, curved**

Art.-Nr./No.	Länge / Length (cm)
20-607-18	18,0
20-607-20	20,5



16 cm

**Reynolds Schere Black Line, Hartmetall, verjüngte Spitzen, DLC-Beschichtung, 16 cm**  
**Reynolds scissors Black Line, tungsten carbide, tapered tips, DLC coating, 16 cm**



Art.-Nr./No.	Beschreibung / Description
20-609-15B	gerade / straight
20-609-15WB	gerade, Wellenschliff / straight, wavy
20-610-15B	gebogen / curved
20-610-15WB	gebogen, Wellenschliff / curved, wavy





## 09 Scheren

### Scissors



**Reynolds Schere, stumpf-stumpf, gebogen, verjüngte Spitzen, 15 cm**  
**Reynolds scissors, blunt-blunt, curved, tapered tips, 15 cm**

20-610-15

10 teeth/mm  
**SUPER cut**



**Reynolds Schere, stumpf-stumpf, supercut, gebogen, 15,5 cm**  
**Reynolds scissors, blunt, supercut, curved, 15.5 cm**

20-611-15



**Metzenbaum Schere, stumpf-stumpf, fein**  
**Metzenbaum scissors, blunt, fine**

Art.-Nr. Art.-No.	Länge Length (cm)	Beschreibung Description
20-612-14	14,5	gebogen / curved
20-612-15	14,5	gerade / straight
20-612-16	16,5	gerade / straight
20-612-18	18,0	gerade / straight
20-612-20	20,0	gerade / straight
20-614-15	14,5	gebogen / curved
20-614-18	18,0	gebogen / curved
20-614-20	20,5	gebogen / curved



**Black Line**  
Ultimate Edition



**Metzenbaum Schere Black Line, Hartmetall, stumpf-stumpf, fein, DLC-Beschichtung**

**Metzenbaum scissors Black Line, tungsten carbide, blunt, fine, DLC coating**

Art.-Nr. Art.-No.	Länge Length (cm)	Beschreibung Description
20-613-15B	14,5	gerade / straight
20-613-15WB	14,5	gerade, Wellenschliff straight, wavelcut
20-613-18B	18,0	gerade / straight
20-613-18WB	18,0	gerade, Wellenschliff straight, wavelcut
20-613-20B	20,5	gerade / straight
20-613-20WB	20,5	gerade, Wellenschliff straight, wavelcut
20-615-15B	14,5	gebogen / curved
20-615-15WB	14,5	gerade, Wellenschliff straight, wavelcut
20-615-18B	18,0	gebogen / curved
20-615-18WB	18,0	gebogen, Wellenschliff curved, wavelcut
20-615-20B	20,0	gebogen / curved
20-615-20WB	20,0	gerade, Wellenschliff straight, wavelcut

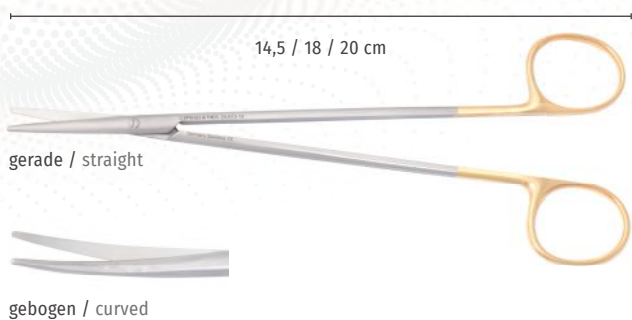

**Metzenbaum Schere, Hartmetall, stumpf-stumpf, fein**

**Metzenbaum scissors, tungsten carbide, blunt, fine**

Art.-Nr. Art.-No.	Länge Length (cm)	Beschreibung Description
20-613-15	14,5	gerade / straight
20-613-18	18,0	gerade / straight
20-613-20	20,5	gerade / straight
20-615-15	14,5	gebogen / curved
20-615-18	18,0	gebogen / curved
20-615-20	20,5	gebogen / curved



## 09 Scheren

### Scissors



**Metzenbaum Schere, supercut, stumpf-stumpf, fein, 14,5 cm**  
**Metzenbaum scissors, supercut, blunt, fine, 14.5 cm**

Art.-Nr./No.	Beschreibung / Description
20-616-15	gebogen / curved
20-618-15	gerade / straight



**Metzenbaum Schere, duracut-ceramic, gebogen, stumpf-stumpf, fein, 14,5 cm**  
**Metzenbaum scissors, duracut ceramic, curved, blunt, fine, 14.5 cm**

20-617-15

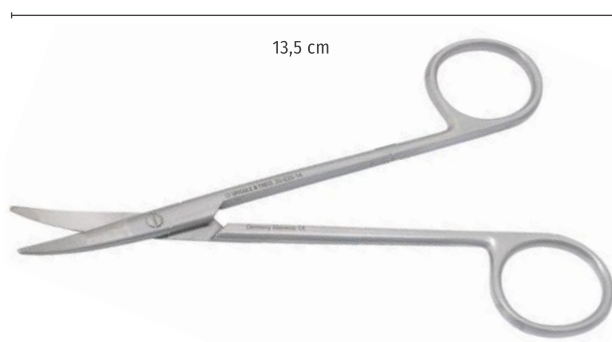

**Kilner Rhinoplastikschere, flache Spitze, stumpf, gebogen, 13,5 cm**  
**Kilner rhinoplasty scissors, flat end, blunt, curved, 13.5 cm**

20-620-14



**Kilner Rhinoplastikschere, supercut, flache Spitze, stumpf, gebogen, 13,5 cm**  
**Kilner rhinoplasty scissors, supercut, flat end, blunt, curved, 13.5 cm**

20-621-14



**Kilner Rhinoplastikschere, Hartmetall,  
flache Spitze, stumpf-stumpf, gebogen**  
Kilner rhinoplasty scissors, tungsten carbide,  
flat end, blunt, curved

Art.-Nr./No.	Länge / Length (cm)
20-622-13	13,5
20-622-15	15,0



**Kilner Rhinoplastikschere Black Line,  
flache Spitze, gebogen, stumpf-stumpf, DLC-Beschichtung**  
Kilner rhinoplasty scissors Black Line,  
flat end, blunt, curved, tungsten carbide, DLC coating



Art.-Nr./No.	Länge / Length (cm)	Beschreibung / Description
20-622-13B	13,5	
20-622-13WB	13,5	Wellenschliff / wavecut
20-622-15B	15,0	
20-622-15WB	15,0	Wellenschliff / wavecut



**Stevens Gefäßschere, verjüngte Spitzen, 11,5 cm**  
Stevens vascular scissors, small tips, blunt, 11,5 cm

Art.-Nr./No.	Beschreibung / Description
20-623-11	gerade / straight
20-624-11	gebogen / curved
20-625-11	gebogen, supercut / curved, supercut



**Stevens Gefäßschere Black Line,  
verjüngte Spitzen, DLC-Beschichtung, 11,5 cm**  
Stevens vascular scissors Black Line,  
tapered tips, DLC coating, 11.5 cm



Art.-Nr./No.	Beschreibung / Description
20-623-11B	gerade / straight
20-623-11WB	gerade, supercut / curved, supercut
20-624-11B	gebogen / curved
20-624-11WB	gebogen, supercut / curved, supercut



## 09 Scheren

### Scissors



**Siegert Unterminierschere, verjüngte Spitzen, außen/innen scharf, gebogen, duracut-ceramic, 11,5 cm**  
**Siegert undermining scissors, tapered tips, outside/inside sharp, curved, duracut-ceramic, 11.5 cm**  
**20-626-11**

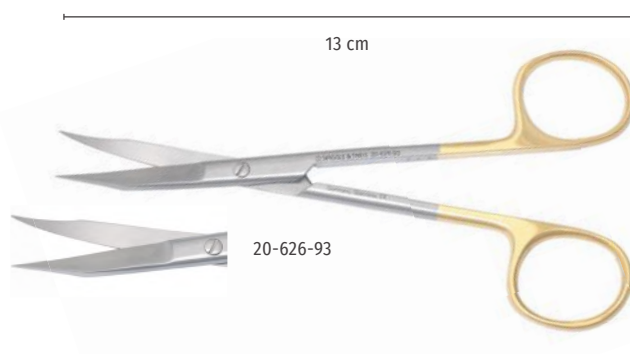

**Goldman-Fox Schere, verjüngte Spitzen, gebogen, unteres Blatt gezahnt, 13 cm**  
**Goldman-Fox scissors, small tips, curved, bottom blade serrated, 13 cm**

Art.-Nr./No.	Beschreibung / Description
20-626-93	Hartmetall / tungsten carbide
20-627-13	supercut
20-628-13	duracut ceramic



**Schere, gerade, spitz-spitz**  
**Scissors, straight, pointed**

Art.-Nr. Art.-No.	Länge Length (cm)	Beschreibung Description
10-530-10	10,5	sehr fein / very fine
10-533-12	11,5	

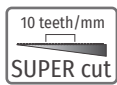

**Schere, supercut, spitz-spitz, sehr fein, 11,5 cm**  
**Scissors, supercut, pointed, very delicate, 11.5 cm**

Art.-Nr./No.	Beschreibung / Description
10-531-12	gerade / straight
10-534-12	gebogen / curved



**Schere, gebogen, spitz-spitz, extra fein, 10,5 cm**  
**Scissors, curved, pointed, very fine, 10.5 cm**  
**10-536-10**



**Schere, Hartmetall, spitz-spitz, 11,5 cm**  
**Scissors, tungsten carbide, pointed, 11.5 cm**

Art.-Nr./No.	Beschreibung / Description
10-532-12	gerade / straight
10-535-12	gebogen / curved

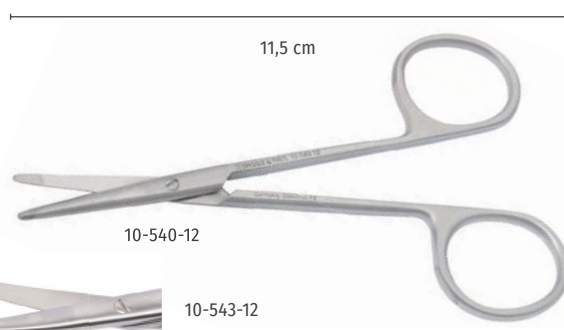

**Schere, stumpf-stumpf, 11,5 cm**  
**Scissors, blunt, 11.5 cm**

Art.-Nr./No.	Beschreibung / Description
10-540-12	gerade / straight
10-543-12	gebogen / curved

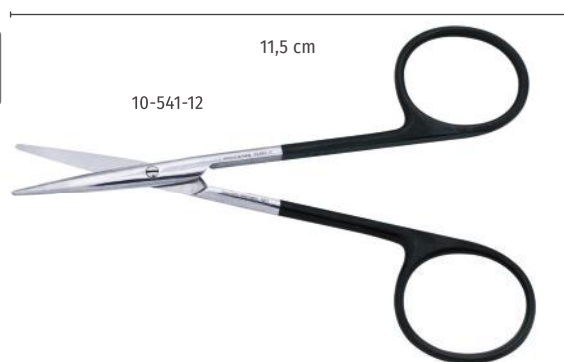
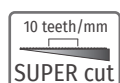

**Schere, supercut, stumpf-stumpf, 11,5 cm**  
**Scissors, supercut, blunt, 11.5 cm**

Art.-Nr./No.	Beschreibung / Description
10-541-12	gerade / straight
10-544-12	gebogen / curved

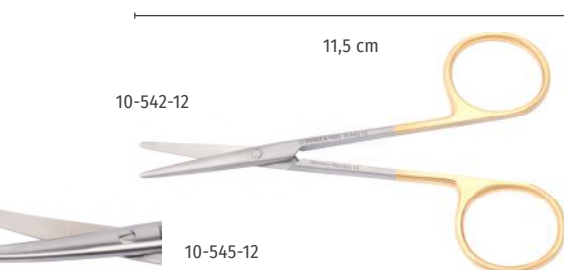

**Schere, Hartmetall, stumpf-stumpf, 11,5 cm**  
**Scissors, tungsten carbide, blunt, 11.5 cm**

Art.-Nr./No.	Beschreibung / Description
10-542-12	gerade / straight
10-545-12	gebogen / curved



## 09 Scheren

### Scissors



**Schuknecht Drahtschneidescherchen, gezahnt, gerade, 10 cm**  
Schuknecht wire cutting scissors, serrated, straight, 10 cm

**10-549-10**



**Universalschere, gebogen, spitz-stumpf, 13 cm**  
Universal scissors, curved, pointed-blunt, 13 cm

**10-550-13**



**Fomon Nasenschere, gebogen, Doppelblatt, 12 cm**  
Fomon nasal scissors, curved, double blade, 12 cm

**20-633-12**



**Walter Schere Black Line, abgewinkelt, DLC-Beschichtung, 10,5 cm**  
Walter scissors Black Line, angled, DLC coating, 10.5 cm

**20-630-10B**

**Black Line**  
Ultimate Edition



**Walter Schere, abgewinkelt / Walter scissors, angled**

Art.-Nr./No.	Beschreibung / Description
20-630-15	14,5 cm, Standardausführung 14.5 cm standard version
20-630-10	Vergoldeter Griff, 10 cm / golden handle



**Cottle Nasenflügelschere, stark gebogen, 12 cm**  
Cottle lower lateral scissors, strongly curved, 12 cm

20-632-12



**Cottle Nasenflügelschere Black Line, stark gebogen, DLC-Beschichtung, 12,5 cm**  
Cottle lower lateral scissors Black Line, strongly curved, DLC coating, 12.5 cm

20-632-12B

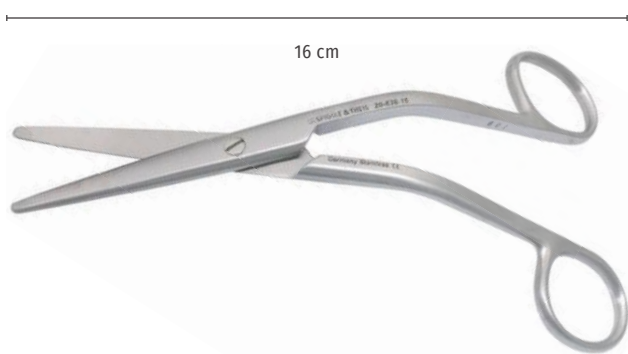

**Cottle Nasenschere, gezahnt, gewinkelt, kräftig, 16 cm**  
Cottle lower lateral scissors, serrated, angled, heavy, 16 cm

20-638-16





## 09 Scheren

### Scissors

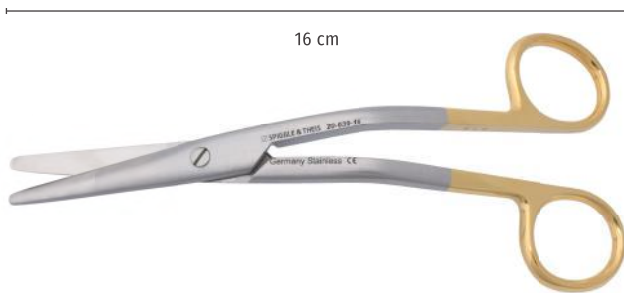

**Cottle Nasenschere, gewinkelt, kräftig, Hartmetall, 16 cm**  
Cottle nasal scissors, angled, strong, tungsten carbide, 16 cm

20-639-16

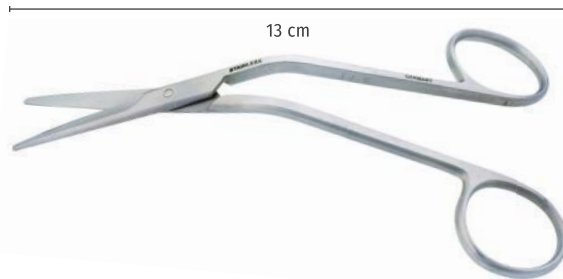

**Fomon Nasenschere, gezahnt, gewinkelt, fein, 13 cm**  
Fomon dorsal scissors, serrated, angled, fine, 13 cm

20-635-13



**Fomon Nasenschere Black Line, Wellenschliff, gewinkelt, fein, 14 cm**  
Fomon nasal scissors Black Line, wavecut, angled, fine, 14 cm

20-635-13WB

**Black Line**  
Ultimate Edition



**Heymann Nasenschere, gezahnt, gerade**  
Heymann nasal scissors, serrated, straight

Art.-Nr. Art.-No.	Länge Length (cm)	Beschreibung Description
20-680-16	16	fein / fine
20-683-18	18	kräftig / strong



**Heymann Nasenschere Black Line, Wellenschliff, gerade, DLC-Beschichtung**  
Heymann nasal scissors Black Line, wavecut, straight, DLC coating

Art.-Nr. Art.-No.	Länge Length (cm)	Beschreibung Description
20-680-16WB	16	fein / fine
20-683-18WB	18	kräftig / strong

**Black Line**  
Ultimate Edition

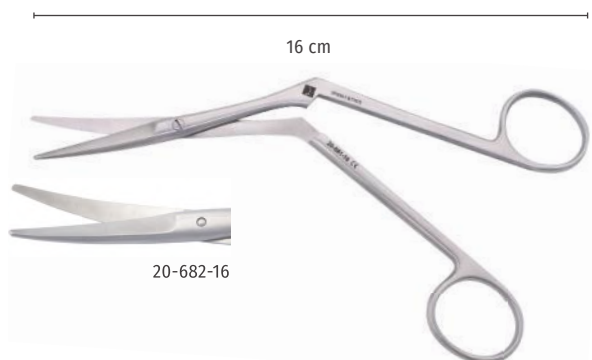

**Heymann Nasenschere, gezahnt, gebogen, fein, 16 cm**  
**Heymann nasal scissors, serrated, curved, fine, 16 cm**

Art.-Nr./No.	Beschreibung / Description
20-681-16	links gebogen / left curved
20-682-16	rechts gebogen / right curved

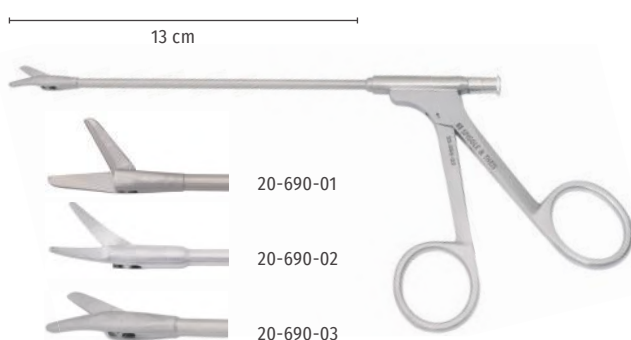

**Conchotomie Schere, gezahnt, Rohrschaft, mit Spülkanal, 13 cm**  
**Nasal conchotomy scissors, serrated, tubular model, with irrigation channel, 13 cm**

Art.-Nr./No.	Beschreibung / Description
20-690-01	gerade / straight
20-690-02	links gebogen / left curved
20-690-03	rechts gebogen / right curved



**Weber Nasenschere, extra fein, gerade, mit Spülkanal, 10,5 cm**  
**Weber nasal scissors, very fine, straight, with irrigation channel, 10.5 cm**

**20-691-01**



**Schere, Premium Line, spitz/spitz, 11,5 cm**  
**Scissors, Premium Line, pointed, 11.5 cm**

Art.-Nr.	Länge (cm)	Beschreibung
20-647-12	11,5	gerade
20-648-12	11.5	gebogen

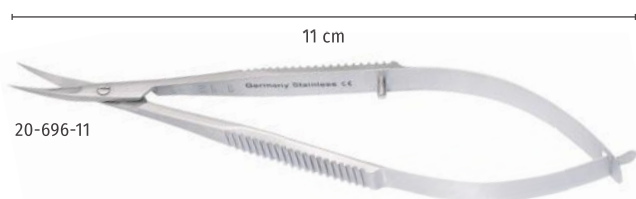

**Mikro-Gefäßschere, spitz-spitz, gebogen, 11 cm**  
**Micro vascular scissors, pointed, curved, 11 cm**

**20-696-11**



## 10 Pinzetten / Nadelhalter

### Forceps / Needle Holders

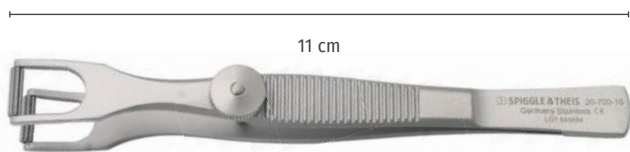

**Cottle Columella-Klemme, 11 cm**  
Cottle columella forceps, 11 cm

20-700-10

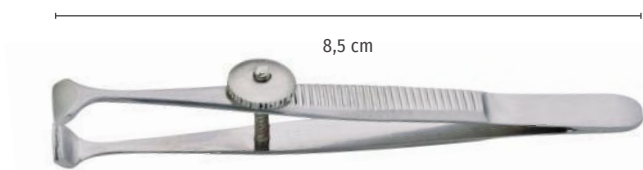

**Cottle Columella-Klemme für Kinder, 8,5 cm**  
Cottle columella forceps for children, 8.5 cm

20-701-08



**Herberhold Hautfazzzange, 2:2 Zähne, extra fein, 13,5 cm**  
Herberhold tissue forceps, 2:2 teeth, extra fine, 13.5 cm

20-705-14

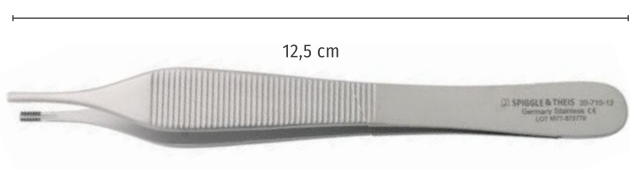

**Adson-Brown Pinzette, 7:8 Zähne, 12,5 cm**  
Adson-Brown forceps, 7:8 teeth, 12.5 cm

20-710-12

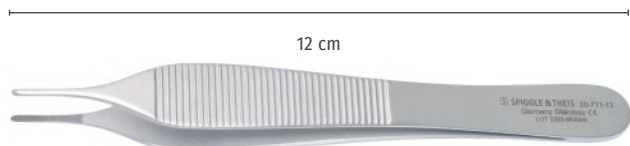

**Adson Pinzette, anatomisch, 12 cm**  
Adson dressing forceps, anatomical, 12 cm

20-711-12



**Pinzette nach Bishop-Harmon, 1:2 Zähne, Länge 8,5 cm**  
Forceps by Bishop-Harmon, 1:2 teeth, length 8.5 cm

Art.-Nr./No.	Spitze / Tip
10-506-05	0,5
10-506-10	1,0

## 10 Pinzetten / Nadelhalter

### Forceps / Needle Holders

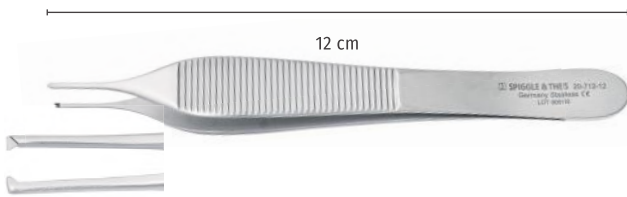

**Adson Pinzette, chirurgisch, 1:2 Zähne, 12 cm**  
Adson dressing forceps, 1:2 teeth, 12 cm

20-712-12

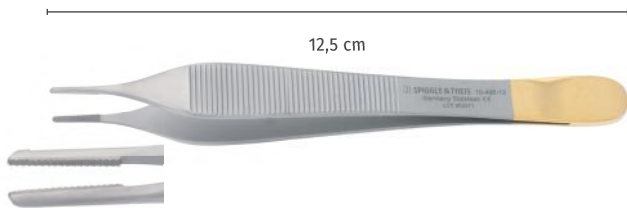

**Adson Pinzette, Hartmetall, anatomisch, 12,5 cm**  
Adson dressing forceps, tungsten carbide, anatomical, 12.5 cm

10-496-12

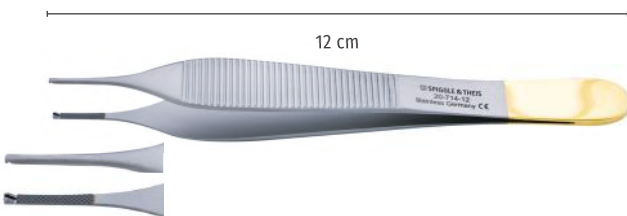

**Adson Pinzette, chirurgisch, Hartmetall, 1:2 Zähne, 12 cm**  
Adson dressing forceps, tungsten carbide, 1:2 teeth, 12 cm

20-714-12

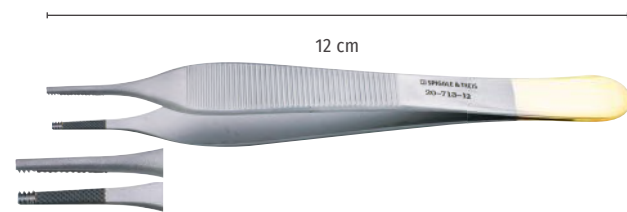

**Adson-Brown-Pinzette, Hartmetall, 7:8 Zähne, 12 cm**  
Adson-Brown dressing forceps, tungsten carbide, 7:8 teeth, 12 cm

20-713-12

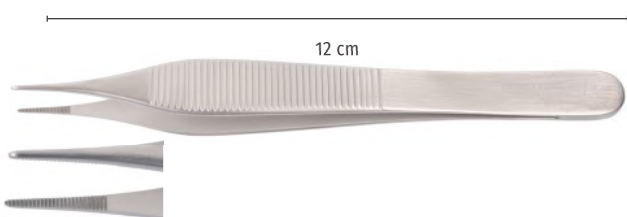

**Mikro-Adson-Pinzette, anatomisch, 12 cm**  
Micro Adson forceps, anatomical, 12 cm

20-715-12

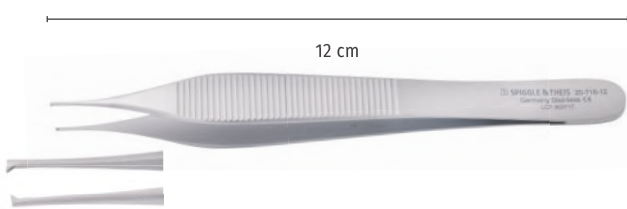

**Mikro-Adson-Pinzette, chirurgisch, 1:2 Zähne, 12 cm**  
Micro Adson forceps, 1:2 teeth, 12 cm

20-716-12

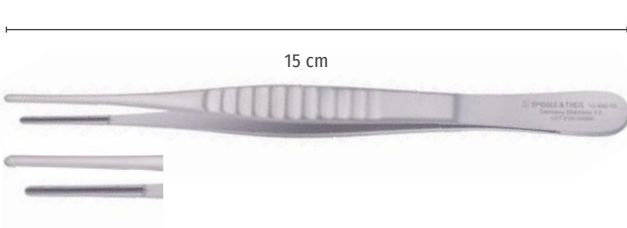

**DeBakey Pinzette, atraumatisch, gerade, 15 cm**  
DeBakey dressing forceps, atraumatic, straight, 15 cm

Art.-Nr./No.	Spitze / Tip
10-486-16	2,0
10-487-16	1,5



## 10 Pinzetten / Nadelhalter

### Forceps / Needle Holders

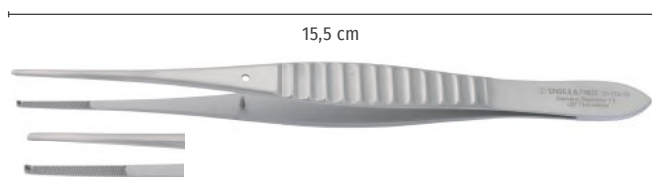

**Gillies Gewebepinzette, gerieft mit 1:2 Zähnen, 15,5 cm**  
Gillies tissue forceps, serrated with 1:2 teeth, 15.5 cm

20-722-15

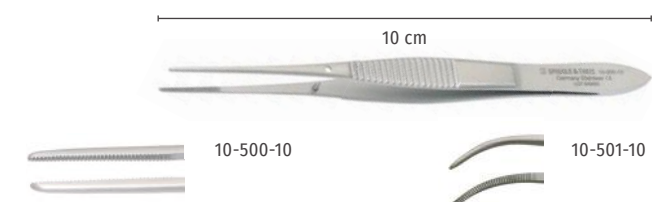

**Graefe Pinzette, anatomisch, 0,7 mm, 10 cm**

Graefe dressing forceps, anatomical, 0.7 mm, 10 cm

Art.-Nr./No.	Beschreibung / Description
10-500-10	gerade / straight
10-501-10	gebogen / curved

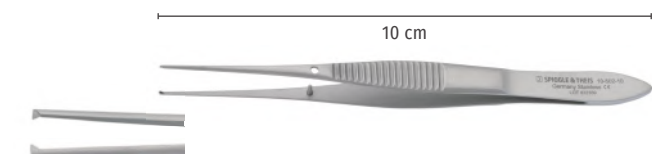

**Graefe Pinzette, chirurgisch, 1:2 Zähne, gerade, 0,7 mm, 10 cm**  
Graefe dressing forceps, 1:2 teeth, straight, 0.7 mm, 10 cm

10-502-10

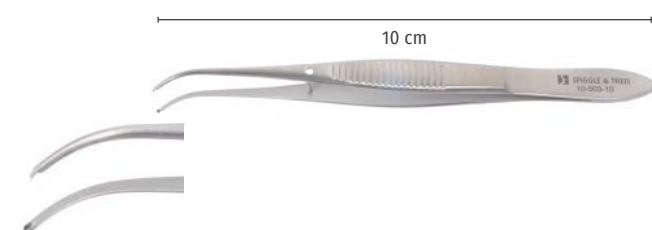

**Graefe Pinzette, chirurgisch, 1:2 Zähne, gebogen, 0,7 mm, 10 cm**  
Graefe dressing forceps, 1:2 teeth, curved, 0.7 mm, 10 cm

10-503-10

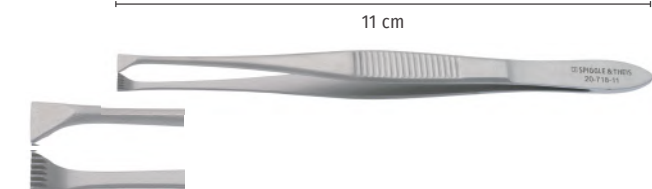

**Graefe Mäusezähnnchen Pinzette, 7:8 Zähne, 11 cm**  
Graefe tissue forceps, 7:8 teeth, 11 cm

20-718-11

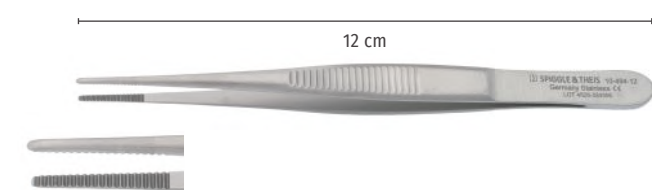

**Pinzette, anatomisch, gerade, 1,3 mm, 12 cm**

Dressing forceps, anatomical, straight, 1.3 mm, 12 cm

10-494-12

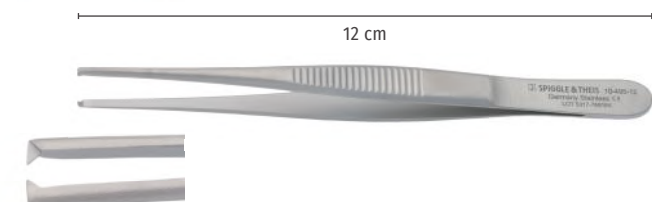

**Pinzette, chirurgisch, 1:2 Zähne, gerade, 1,5 mm, 12 cm**  
Dressing forceps, 1:2 teeth, straight, 1.5 mm, 12 cm

10-495-12



**Cottle Nasenpinzette, bajonett,**

mit Schraube, gerieft mit Dornen, 14,5 cm

Cottle lower lateral forceps, bayonet,  
with screw, serrated with thorns, 14.5 cm

20-720-14

## 10 Pinzetten / Nadelhalter

### Forceps / Needle Holders

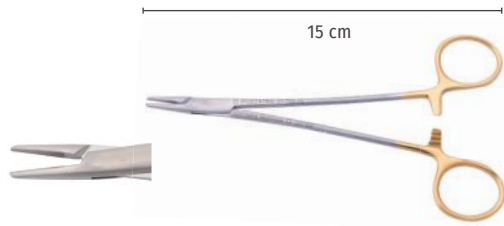

**Crile-Wood Nadelhalter, Hartmetall, 15 cm**  
Crile-Wood needleholder, tungsten carbide, 15 cm

20-740-15

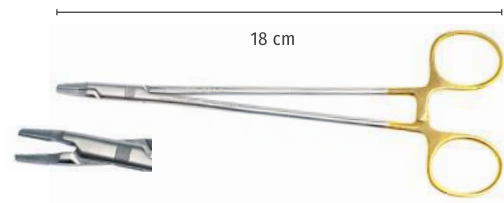

**Crile-Wood Ryder Nadelhalter, Hartmetall, verjüngte Spitzen 18 cm**  
Crile-Wood Ryder needleholder, tungsten carbide, small ends, 18 cm

40-745-18

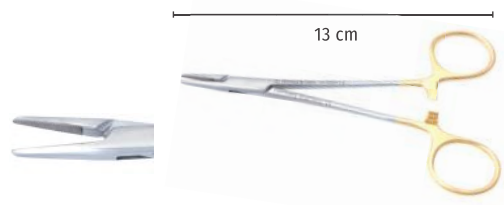

**Halsey Nadelhalter, Hartmetall, fein, 13 cm**  
Halsey needle holder, tungsten carbide, delicate, 13 cm

10-555-13

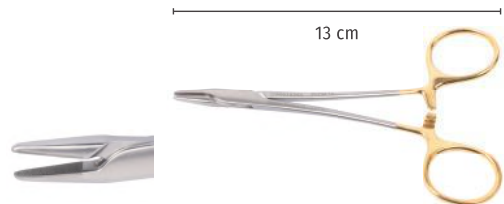

**Neivert Nadelhalter, Hartmetall, fein, 13 cm**  
Neivert needle holder, tungsten carbide, fine, 13 cm

20-742-13

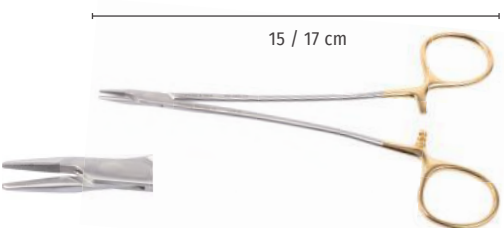

**Senning Nadelhalter, Hartmetall, extra schlank**  
Senning needle holder, tungsten carbide, slender shape

Art.-Nr./No.	Länge / Length (cm)
20-744-15	15
20-744-17	17

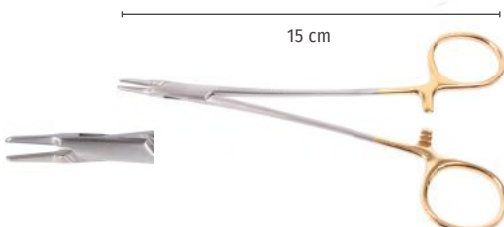

**Mikro-Ryder Nadelhalter, Hartmetall, verjüngte Spitzen, 15 cm**  
Micro-Ryder needle holder, tungsten carbide, small ends, 15 cm

20-745-15



**Converse Nadelhalter, Hartmetall, sehr fein, 12 cm**  
Converse needle holder, tungsten carbide, very fine, 12 cm

20-746-12





## 10 Pinzetten / Nadelhalter

### Forceps / Needle Holders

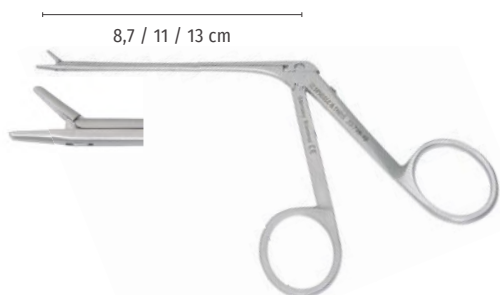

**Masing Nadelhalter, glatte Maul, abgewinkelter Daumenring**  
Masing needle holder, smooth jaws, angled thumb ring

Art.-Nr./No.	AL / WL (cm)
20-748-10	8,7
20-748-11	11,0
20-748-13	13,0



**Castroviejo Mikro-Nadelhalter, mit Sperre, glatt, flache Federgriffe**  
Castroviejo micro needle holder, with ratchet, smooth, flat type handles

Art.-Nr. Art.-No.	Länge Length (cm)	Beschreibung Description
20-764-09	9	gerade / straight
20-764-14	14	gerade / straight
20-765-14	14	gebogen / curved

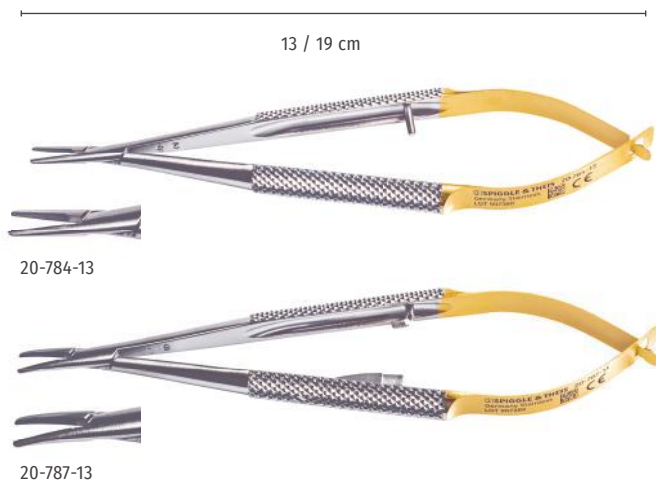

**Barraquer Mikro-Nadelhalter, Hartmetall, runde Federgriffe**  
Barraquer micro needle holder, tungsten carbide, round type handles

Art.-Nr. Art.-No.	Länge Length (cm)	Mit Sperre With ratchet	Beschreibung Description
20-784-13	13	Nein / No	gerade / straight
20-784-18	19	Nein / No	gerade / straight
20-785-13	13	Nein / No	gebogen / curved
20-785-18	19	Nein / No	gebogen / curved
20-786-13	13	Ja / Yes	gerade / straight
20-786-18	19	Ja / Yes	gerade / straight
20-787-13	13	Ja / Yes	gebogen / curved
20-787-18	19	Ja / Yes	gebogen / curved

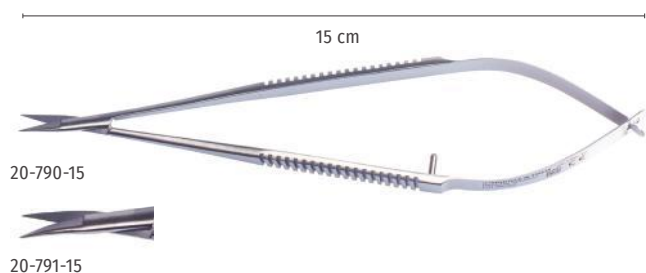

**Mikro-Federschere, gerade, Blattlänge 10mm, flache Federgriffe, 15 cm**

**Micro scissors, straight, length 10 mm, flat type handles, 15 cm**

Art.-Nr./ Art.-No.	Länge Length (cm)	Beschreibung Description
20-790-15	15	Blatt gerade/ blade straight
20-791-15	15	Blatt gebogen/ blade curved



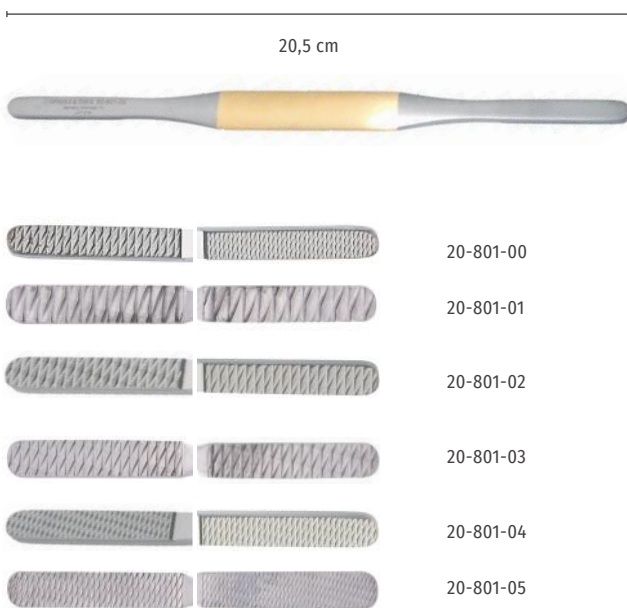

**Fomon Nasenraspel,**

**Hartmetall, doppelseitig, besonders flach, 20,5 cm**

**Fomon nasal rasp, tungsten carbide, double ended, very flat, 20.5 cm**

Art.-Nr./No.	Beschreibung / Description
20-801-00	Körnung 5/10 = grob/mittel grain size 5/10 = coarse/medium
20-801-01	Körnung 1/2 = grob / grain size 1/2 = coarse
20-801-02	Körnung 3/4 = grob/mittel grain size 3/4 = coarse/medium
20-801-03	Körnung 5/6 = mittel / grain size 5/6 = medium
20-801-04	Körnung 7/8 = mittel/fein grain size 7/8 = medium/fine
20-801-05	Körnung 9/10 = fein / grain size 9/10 = fine

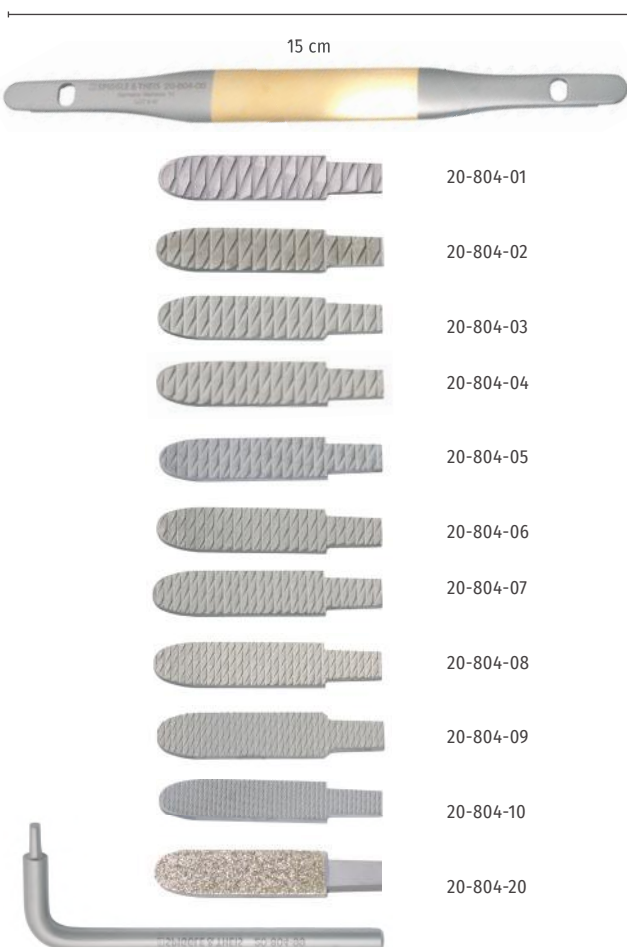

**Handgriff, doppelendig, für Hartmetall**

**Raspelplatten 20-804-01 bis -10, 15 cm**

**Handle, double ended, for tungsten carbide rasps 20-804-01 up to -10, 15 cm**

**20-804-00**

**Raspeleinsatz, Hartmetall**

**Insert for rasp, tungsten carbide**

Art.-Nr./No.	Körnung / Grain Size
20-804-01	1 = sehr grob / 1 = very coarse
20-804-02	2 = grob / 2 = coarse
20-804-03	3 = mittel-grob / 3 = medium-coarse
20-804-04	4 = mittel / 4 = medium
20-804-05	5 = mittel / 5 = medium
20-804-06	6 = mittel-fein / 6 = medium-fine
20-804-07	7 = fein / 7 = fine
20-804-08	8 = fein / 8 = fine
20-804-09	9 = sehr fein / 9 = very fine
20-804-10	10 = extra fein / 10 = extra fine
20-804-20	Diamant / diamond

**Schlüssel für "Handgriff, doppelendig" (20-804-00)**

**Key for "handle, double ended" (20-804-00)**

**20-804-99**



## 11 Raspeln

### Rasps



**Maltz Nasenraspel, Hartmetall, mit Blutrinne, einseitig, 17,5 cm**  
**Maltz nasal rasp, tungsten carbide, with blood groove, single ended, 17.5 cm**

Art.-Nr./No.	Beschreibung / Description
20-805-01	auf Zug schneidend / down-cutting
20-805-02	auf Druck schneidend / up-cutting

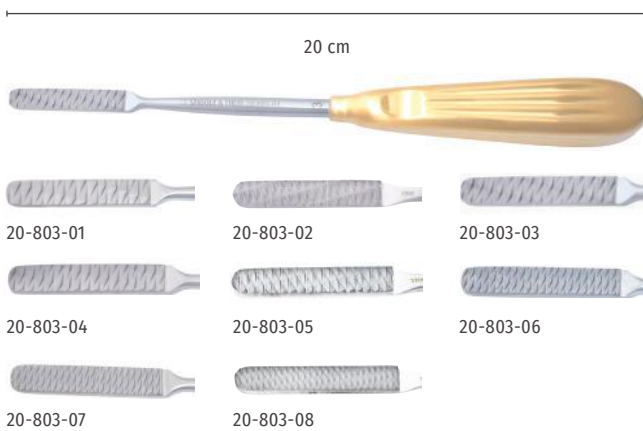

**Parkes Nasenraspel, Hartmetall, einseitig, 20 cm**  
**Parkes nasal rasp, tungsten carbide, single ended, 20 cm**

Art.-Nr./No.	Körnung / Grain Size
20-803-01	1 = grob / 1 = coarse
20-803-02	2 = grob / 2 = coarse
20-803-03	3 = grob / 3 = coarse
20-803-04	4 = mittel / 4 = medium
20-803-05	5 = mittel / 5 = medium
20-803-06	6 = mittel / 6 = medium
20-803-07	7 = fein / 7 = fine
20-803-08	8 = fein / 8 = fine

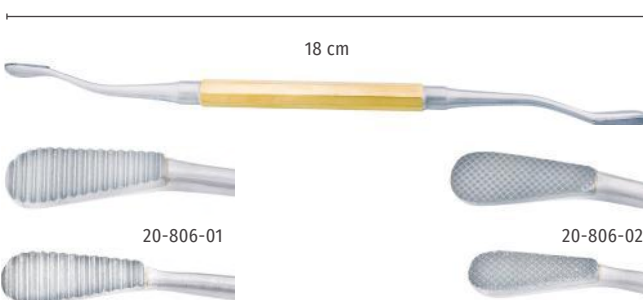

**Miller Nasenraspel, Hartmetall, doppelseitig, 18 cm**  
**Miller nasal rasp, tungsten carbide, double ended, 18 cm**

Art.-Nr./No.	Beschreibung / Description
20-806-01	quergerieft / cross cut
20-806-02	kärogerieft / square cut

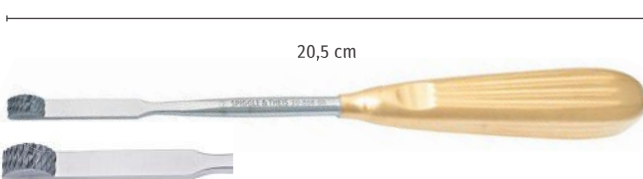

**Aufricht Glabella Raspel, Hartmetall, einseitig, 20,5 cm**  
**Aufricht glabella rasp, tungsten carbide, single ended, 20.5 cm**

**20-808-00**

## 11 Raspeln

### Rasps

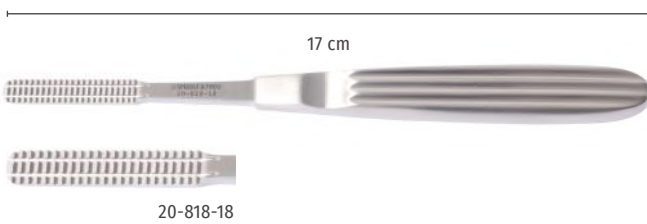

**Maltz Nasenraspel, mit 2 Blutrinnen, einseitig, 17 cm**  
**Maltz nasal rasp, with 2 blood grooves, single ended, 17 cm**

Art.-Nr./No.	Beschreibung / Description
20-818-18	auf Zug schneidend / down-cutting
20-819-18	auf Druck schneidend / up-cutting



**Cottle Nasenraspel, Diamant, einseitig, goldener Griff, 19 cm**  
**Cottle nasal rasp, diamond, single ended, golden handle, 19 cm**

Art.-Nr./No.	Beschreibung / Description
20-811-19	gerade / straight
20-812-19	gebogen / curved

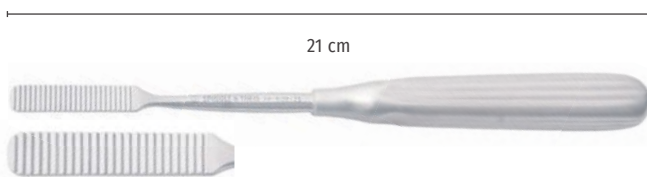

**Cottle Nasenraspel, einseitig, auf Zug schneidend, 21 cm**  
**Cottle nasal rasp, single ended, down cutting, 21 cm**

**20-820-21**



**Masing Nasenraspel, doppelseitig, 21,5 cm**  
**Masing nasal rasp, double ended, 21,5 cm**

Art.-Nr./No.	Beschreibung / Description
20-815-21	feiner Hieb / fine cut
20-816-21	grober Hieb / coarse cut

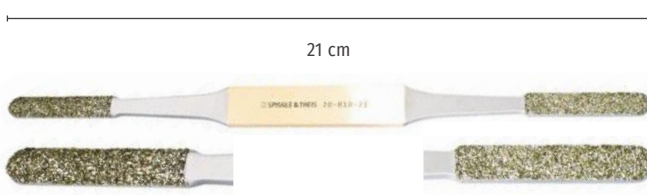

**Fomon Nasenraspel, Diamant, goldener Griff, doppelseitig, 21 cm**  
**Fomon nasal rasp, diamond, golden handle, double ended, 21 cm**

**20-810-21**



## 11 Raspeln

### Rasps



#### Aufricht Glabella Raspel, einseitig Aufricht glabella rasp, single ended

Art.-Nr. Art.-No.	Länge Length (cm)	Beschreibung Description
20-822-21	19,5	auf Zug und Druck schneidend up and down cutting
20-823-21	20,5	auf Zug schneidend down cutting
20-824-21	22,0	auf Druck schneidend up cutting

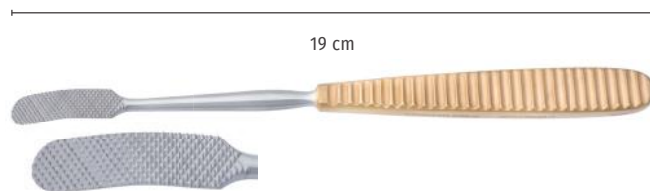

#### Aufricht Glabella Raspel, einseitig, auf Druck und Zug schneidend, vergoldeter Griff, 19 cm Aufricht glabella rasp, single ended, up and down cutting, golden handle, 19 cm

20-825-18

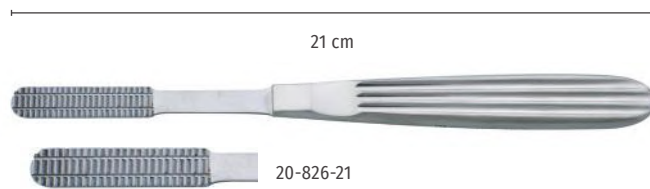

#### Anderson Nasenraspel, einseitig, 30° schräg gezahnt, 21 cm Anderson nasal rasp , single ended, 30° bevelled serrated, 21 cm

Art.-Nr./No.	Beschreibung / Description
20-826-21	auf Zug schneidend down-cutting
20-827-21	auf Druck schneidend up-cutting

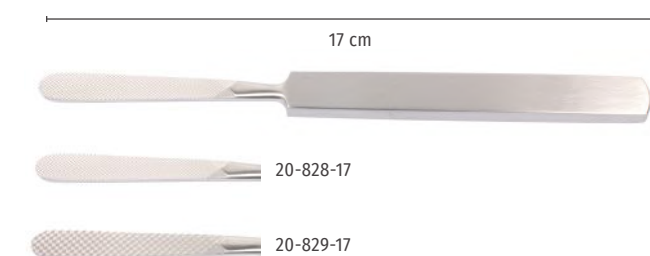

#### Joseph Nasenraspel, einseitig / Joseph nasal rasp, single ended

Art.-Nr./No.	Länge / Length (cm)	Beschreibung / Description
20-828-17	17	fein / fine
20-829-17	17	grob / coarse



#### Kleinert-Kutz Nasenraspel, doppelendig, vierseitig, mit je 2 Seiten fein (flach) und grob (konvex/flach) gerieft, 21,5 cm Kleinert-Kutz nasal rasp, double ended, 4-sided, with 2 sides each fine (flat) and coarse (convex/flat), serrated, 21.5 cm

20-830-21

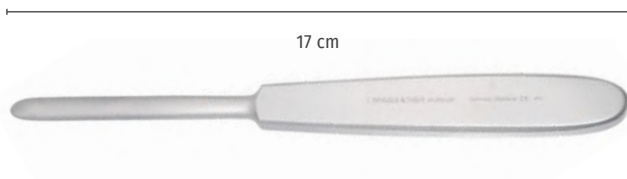

**Aufricht Nasenfraktur-Elevatorium, gerade, konisch, 17 cm**  
**Aufricht nasal fracture elevator, straight, conical, 17 cm**

20-850-17

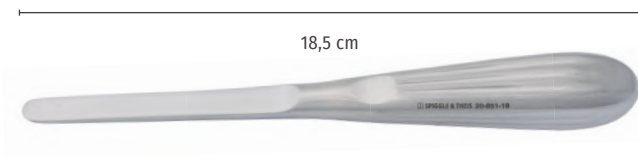

**Boies Elevatorium, gerade, oval, fein, 18,5 cm**  
**Boies elevator, straight, oval, fine, 18.5 cm**

20-851-18



**Castroviejo Nasenzirkel, 8 cm**  
**Castroviejo nasal caliper, 8 cm**

20-852-07

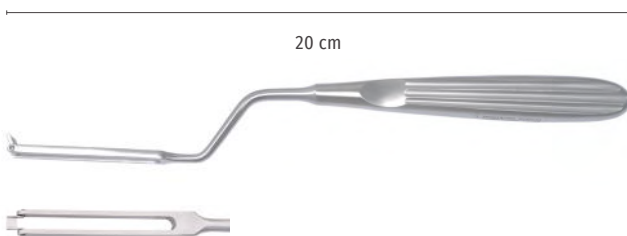

**Ballenger Schwingmesser, bajonett, 20 cm**  
**Ballenger swivel knife, bayonet, 20 cm**

Art.-Nr./No.	Größe / Size (mm)
20-853-03	3
20-853-04	4



## 12 Allgemeines

### Miscellaneous

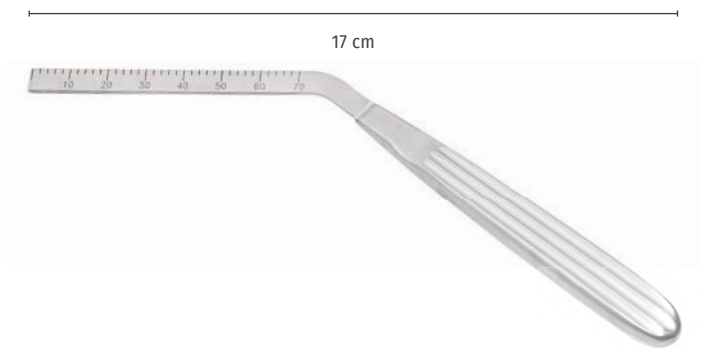

**Joseph Anlegeinstrument zur Rhinoplastik, gewinkelt, 17 cm**  
Joseph placing instrument for rhinoplasty, angled, 17 cm

20-856-17



**Joseph Nasensäge, 19 cm / Joseph nasal saw, 19 cm**

Art.-Nr./No.	Beschreibung / Description
20-860-01	gerade / straight
20-860-02	bajonett, rechts bayonet, right
20-860-03	bajonett, links bayonet, left



**Cottle Knochen- und Knorpelquetscher,  
mit Entnahmefeder, zerlegbar**

**Cottle bone and cartilage crusher, with clamp, dismantable**

Art.-Nr./No.	Breite / Width (cm)
20-865-30	2,4
20-865-50	6,0





**Tolsdorff Knochen- und Knorpelquetscher, rund, 4 cm, Parallelhub**  
**Tolsdorff bone and cartilage crusher, round, 4 cm, parallel lift**

Art.-Nr./No.	Beschreibung / Description
20-867-40	geriefte Schlagfläche / serrated surface
20-868-40	glatte Schlagfläche / even surface



**Non-Stick bipolare Pinzette, 1 mm, 16 cm**  
**Non-Stick bipolar forceps, 1 mm, 16 cm**

Art.-Nr./No.	Beschreibung / Description
80-101-16	gerade / straight
80-106-16	abgewinkelt / angled
80-111-16	bajonett / bayonet



**Spezial-Ölspray, Pflegespray für Instrumente und Bohrhandstücke, Dose 500 ml**  
**Special Oil Spray, Maintenance Spray for Instruments and Drill Handpieces, 500 ml**

**78PS01**



## 12 Allgemeines - Bipolare Anschlusskabel

### Miscellaneous - Bipolar Connecting Cable



**Geräteseitig, 22 mm, passend für / unit-side, 22 mm, compatible to Erbe / EMC / Dolly**

Art.-Nr./No.	Länge / Length (m)
80-316-50	5



**Geräteseitig, passend für / unit-side, compatible to Sutter/Martin/Berchtold/Aesculap/Integra/SPIGGLE & THEIS**

Art.-Nr./No.	Länge / Length (m)
80-317-30	3
80-317-50	5



**Geräteseitig, passend für / unit-side, compatible to Erbe/Storz/Wolf**

Art.-Nr./No.	Länge / Length (m)
80-318-30	3
80-318-50	5



**Geräteseitig, 29 mm, passend für / unit-side, 29 mm, compatible to Valleylab/Lamidey/EMC/Bowa/Olympus**

Art.-Nr./No.	Länge / Length (m)
80-319-30	3
80-319-50	5



**Für bipolare Scheren/Zangen, geräteseitig, passend für / for bipolar scissors/forceps, unit-side, compatible to Sutter/Martin/Berchtold/Aesculap/Integra**

Art.-Nr./No.	Länge / Length (m)
80-320-30	3
80-320-50	5



**Für bipolare Scheren, passend für / for bipolar scissors, compatible with Erbe/Storz/Wolf**

Art.-Nr./No.	Länge / Length (m)
80-322-30	3,0
80-322-50	5,0

**Metallschale / Metal bowl**

Art.-Nr. Art.-No.		Durchmesser Diameter (mm)	Höhe Height (mm)	Fassungs- vermögen Capacity (ml)
80-501-01	B1	Ø 40	H=19	20
80-501-02	B2	Ø 60	H=39	60
80-501-03	B3	Ø 85	H=40	160
80-501-04	B4	Ø 110	H=55	400

**Metallbecher, mit Griff  
Metal cup, with handle**

Art.-Nr. Art.-No.		Durchmesser Diameter (mm)	Höhe Height (mm)	Fassungs- vermögen Capacity (ml)
80-500-00		Ø 69	H=95	350

**Medizinbecher, Edelstahl, graduert****Medicine cup, stainless steel, graduated**

Art.-Nr. Art.-No.		Durchmesser Diameter (mm)	Höhe Height (mm)	Fassungs- vermögen Capacity (ml)
80-503-03		Ø 50	H=25	30
80-504-05		Ø 53	H=45	50

**Lösungsschale, Edelstahl****Solution bowl, stainless steel**

Art.-Nr. Art.-No.		Durchmesser Diameter (mm)	Höhe Height (mm)	Fassungs- vermögen Capacity (ml)
80-505-10		Ø 72	H=33	100
80-505-20		Ø 87	H=50	200
80-506-30	B1	Ø 95	H=60	300
80-507-40	B2	Ø 120	H=70	500
80-509-75	B3	Ø 150	H=75	750

**Tablettenschale, Edelstahl, Ø 65 mm, H=20 mm****Tablet dish, stainless steel, Ø 65 mm, H=20 mm****80-512-00****Petrishale, Klarglas, mit Deckel / Petri dish, clear glass, with lid**

Art.-Nr./No.	AD / OD (mm)	Höhe / Height (mm)
80-515-06	60	15
80-515-08	80	15
80-515-10	150	20



## 12 Allgemeines

### Miscellaneous



**Medikamenten-Schälchen, Glas, schwarz, mit Deckel, 4 x 4 cm**  
Medication dish, glass, black, with lid, 4 x 4 cm

**80-517-00**



80-519-00



80-519-01



80-519-02



80-519-03

**Medikamenten-Schälchen, Dappenglas, farbig, Ø 3,2 cm**  
Medication dish, dappen-glass, colored, Ø 3.2 cm

Art.-Nr./No.	Farbe / Color
80-519-00	kristall / crystal
80-519-01	grün / green
80-519-02	rosa / pink
80-519-03	topas / topaz



**Porzellan-Schälchen, rund, mit Ausguss**  
China bowl, round, with spout

Art.-Nr./No.	Durchmesser / Diameter (cm)
80-520-06	Ø 8
80-520-08	Ø 10



**Nierenschale, Edelstahl / Kidney bowl, stainless steel**

Art.-Nr./No.	Größe / Size (cm)
80-525-17	17,5
80-525-25	25,0



**Kornzangen-Behälter, Edelstahl**  
Forceps holder, stainless steel

Art.-Nr. Art.-No.	Durchmesser Diameter (cm)	Höhe Height (cm)
80-528-13	Ø 5,0	13,5
80-528-18	Ø 5,0	18,0
80-528-20	Ø 9,5	20,0



**Kornzangen-Behälter,**  
**Glas, Edelstahldeckel mit Ausschnitt, Ø 8 cm, Höhe 20 cm**  
Forceps holder, glass, stainless steel lid with opening,  
Ø 8 cm, height 20 cm

**80-530-20**





















**Norm-Sterilisations-Container, geschlossener Boden**  
Norm sterilization container, bottom closed

Art.-Nr. Art.-No.	Größe Size	Maße (aussen) Dimension (outside) (mm)
80-631-10	1/2	297 x 274 x 88
80-631-12	1/2	297 x 274 x 123
80-631-14	1/2	297 x 274 x 138
80-631-21	1/2	297 x 274 x 188
80-641-14	3/4	462 x 274 x 138
80-661-12	1	585 x 274 x 123
80-661-14	1	585 x 274 x 138
80-661-21	1	585 x 274 x 188



**Ventil-Deckel für Norm-Sterilisations-Container**  
Valve lid for norm sterilization container

Art.-Nr./No. 1/2 299 x 278 mm	Art.-Nr./No. 3/4 462 x 278 mm	Art.-Nr./No. 1 585 x 278 mm
80-632-00 	80-642-00 	80-662-00 
80-632-01 	80-642-01 	80-662-01 
80-632-02 	80-642-02 	80-662-02 
80-632-03 	80-642-03 	80-662-03 
80-632-04 	80-642-04 	80-662-04 
80-632-05 	80-642-05 	80-662-05 

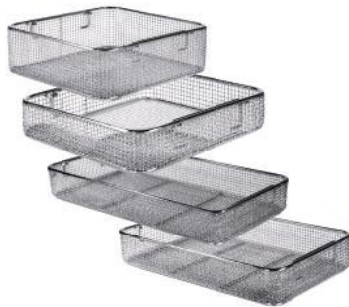

**Siebkorb, Edelstahl-Drahtgeflecht, Fallgriffe**  
Stainless-steel wire basket, sliding handles

Art.-Nr./No.	Größe / Size (mm)
80-671-20	255 x 245 x 50
80-671-25	255 x 245 x 70
80-671-40	405 x 255 x 70
80-671-60	485 x 255 x 70



**Cudier-Schild, 56 x 17 cm, 20 Zeichen**  
Coding label, 56 x 17 mm, 20 letters

Art.-Nr./No.	Farbe / Colour
80-681-01	schwarz / black
80-681-02	rot / red
80-681-03	braun / brown
80-681-04	grün / green
80-681-05	gelb / yellow
80-681-06	lila / purple
80-681-07	blau / blue

## 13 Zubehör - Sterilisationssysteme

### Accessories - Sterilization Systems

**Einweg-Container-Siegel, blau, 100 Stück/Box**  
 Container seal, disposable, blue, 100 pieces/box

80-683-10

**Silikonmatte, blau, perforiert, 440 x 230 mm**  
 Silicon mat, blue, perforated, 440 x 230 mm

80-675-00

**Indikator-Klebe-Etikett, Lasche rechts, 100 Stück/Box**  
 Adhesive indicator label, latch right side, 100 pieces/box

80-684-10

**Klemmschild aus Edelstahl, hitzebeständig,**  
**6 x 4 cm, 25 Stück/Box**  
 Label holder with clip, stainless steel, heat resistant,  
 6 x 4 cm, 25 pieces/box

80-688-00



**Endoskopie-Siebkorb mit Deckel, Edelstahl, elektropliert**  
 Endoscope container with lid, stainless steel, e-polished

Art.-Nr./No.	Größe / Size (cm)
80-690-01	29 x 8 x 5,2 für 1 Endoskop 29 x 8 x 5,2 for 1 endoscope
80-690-02	29 x 8 x 5,2 für 2 Endoskope 29 x 8 x 5,2 for 2 endoscopes



**Endoskopie-Siebkorb mit Deckel, Edelstahl, elektropliert**  
 Endoscope container with lid, stainless steel, e-polished

Art.-Nr./No.	Größe / Size (cm)
80-691-01	46 x 8 x 5,2 für 1 Endoskop 46 x 8 x 5,2 for 1 endoscope
80-692-01	67 x 8 x 5,2 für 1 Endoskop 67 x 8 x 5,2 for 1 endoscope

**Bestehend aus / Consisting of:**

- 20-425-02 Osteotom Premium Line, 2 mm, 18 cm, vergoldeter Griff  
Osteotome Premium Line, 2 mm, 18 cm, golden handle
- 20-425-03 Osteotom Premium Line, 3 mm, 18 cm, vergoldeter Griff  
Osteotome Premium Line, 3 mm, 18 cm, golden handle
- 20-425-06 Osteotom Premium Line, 6 mm, 18 cm, vergoldeter Griff  
Osteotome Premium Line, 6 mm, 18 cm, golden handle
- 20-425-10 Osteotom Premium Line, 10 mm, 18 cm, vergoldeter Griff  
Osteotome Premium Line, 10 mm, 18 cm, golden handle
- 20-425-12 Osteotom Premium Line, 12 mm, 18 cm, vergoldeter Griff  
Osteotome Premium Line, 12 mm, 18 cm, golden handle
- 20-425-14 Osteotom Premium Line, 14 mm, 18 cm, vergoldeter Griff  
Osteotome Premium Line, 14 mm, 18 cm, golden handle
- 20-425-25 Osteotom Premium Line, 2,5 mm, 18 cm, vergoldeter Griff  
Osteotome Premium Line, 2.5 mm, 18 cm, golden handle
- 20-426-00 Osteotom Premium Line, mit Schutzsonde, 2,2 mm, 18 cm, vergoldeter Griff  
Osteotome, Premium Line, guarded, 2.2 mm, 18 cm, golden handle
- 20-579-04 Cottle Doppel-Haken, beidseitig scharf, extra fein, 10 mm, 12 cm, vergoldeter Griff  
Cottle double hook, both prongs sharp, very fine, 10 mm, 12 cm, golden handle
- 20-588-01 Wundhäkchen, superfein, 1-zinkig, 15,5 cm, vergoldeter Griff  
Skin hook, very fine, 1 prong, 15.5 cm, golden handle
- 20-588-02 Wundhäkchen, superfein, 2-zinkig, 16 cm, vergoldeter Griff  
Skin hook, very fine, 2 prongs, 16 cm, golden handle
- 20-568-16 Nasenrückenhaken, extra fein, 45 mm, 15,5 cm, vergoldeter Griff  
Aufricht nasal retractor, extra fine, 45 mm, 15.5 cm, golden handle
- 10-532-12 Schere, Hartmetall, spitz-spitz, gerade, 11,5 cm, vergoldeter Griff  
Scissors, tungsten carbide, straight, pointed, 11.5 cm, golden handle
- 10-535-12 Schere, Hartmetall, sp-sp, gebogen, 11,5 cm, vergoldeter Griff  
Scissors, TC, curved, pointed, 11.5 cm, golden handle
- 20-631-10 Walter Schere, gewinkelt, 10 cm, vergoldeter Griff  
Walter scissors, angled, 10 cm, golden handle
- 20-713-12 Adson-Brown-Pinzette, Hartmetall, 7:8 Zähne, 12 cm, vergoldeter Griff  
Adson-Brown dressing forceps, TC, 7:8 teeth, 12 cm, golden handle
- 10-496-12 Adson-Pinzette, Hartmetall, anatomisch, 12 cm, vergoldeter Griff  
Adson dressing forceps, TC, anatomical, 12 cm, golden handle
- 20-714-12 Adson-Pinzette, Hartmetall, 1:2 Zähne, 12 cm, vergoldeter Griff  
Adson dressing forceps, TC, 1:2 teeth, 12 cm, golden handle
- 20-215-01 Blakesley Nasenzange, gerade, 3,5 mm, 11,5 cm, vergoldeter Griff  
Blakesley nasal forceps, 3.5 mm, 11.5 cm, straight, golden handle
- 20-622-13 Kilner Rhinoplastik Schere, Hartmetall, flache Spitze, stumpf, gebogen, 12,5 cm, vergoldeter Griff  
Kilner rhinoplasty scissors, TC, flat end, blunt, curved, 12.5 cm, golden handle
- 10-555-13 Nadelhalter, Hartmetall, fein, 13 cm, vergoldeter Griff  
Halsey needle holder, TC, delicate, 13 cm, golden handle
- 20-825-18 Aufricht Glabella Rassel, einseitig, auf Zug und Druck, 19 cm, vergoldeter Griff  
Aufricht Glabella rasp, single ended, up and down cutting, 19 cm, golden handle
- 10-353-13 Raspatorium, gerade, 4 mm, 18 cm, vergoldeter Griff  
Raspatory, straight, 4 mm, 18 cm, golden handle
- 20-801-03 Fomon Nasenraspel, Hartmetall, doppelseitig, Körnung 5/6 (mittel), 20,5 cm, vergoldeter Griff  
Fomon nasal rasp, TC, double ended, grain size 5/6 (medium), 20.5 cm, golden handle
- 20-801-04 Fomon Nasenraspel, Hartm., doppelseitig, Körnung 7/8 (mittel/fein), 20,5 cm, vergoldeter Griff  
Fomon nasal rasp, TC, double ended, grain size 7/8 (medium/fine), 20.5 cm, golden handle

**Ergänzung****Supplement**

- 80-631-14 Norm-Sterilisations-Container Boden geschlossen, 297x274x138 mm Maße mit Deckel: 585x278x155 mm  
Norm sterilization container, bottom closed, 297x274x138 mm, dimensions with fitted lid: 299x278x155mm
- 80-632-00 Ventildeckel silber, für Container 80-631-14, 299x278 mm  
Valve lid, silver, for container 80-631-xx, 299x278 mm
- 80-671-20 1x Edelstahl-Siebkorb, Geflecht, Fallgriffe, 255 x 245 x 50 mm  
1x Stainless steel wire basket, sliding handles, 255 x 245 x 50 mm
- 80-681-02 1x Aluminium-Kennzeichnungs-Schild, rot, 20 Zeichen, 56 x 17 mm  
1x Aluminium tag, red, 20 letter, 56 x 17 mm

[Supplement for sales in EU \(outside the EU only on request\)](#)





## 14 Rhinoplastik-Set

### Rhinoplasty set

#### Bestehend aus / Consisting of:

- 10-360-03 Skalpell-Griff / Scalpel handle  
20-500-13 Cottle Septum-Messer / Cottle septum knife  
20-501-14 Masing Ritzmesser / Masing pointed knife  
20-800-16 Watteträger / Cotton carrier  
20-601-14 Joseph Schere / Joseph scissors  
20-610-15 Reynolds Schere / Reynolds scissors  
20-615-15 Metzenbaum Schere / Metzenbaum scissors  
20-627-13 Goldman Fox Schere / Goldman Fox scissors  
20-630-10 Walter Schere / Walter scissors  
20-632-12 Cottle Nasenflügelschere / Cottle lower lateral scissors  
20-560-15 Cottle Nasenflügelhaken / Cottle alar retractor  
20-570-13 Aufricht Doppelhaken / Aufricht double retractor  
20-574-06 Cottle Fingerring-Häkchen / Cottle thimble hook  
20-577-16 Cottle Hauthäkchen / Cottle skin hook  
20-579-01 Cottle Doppel-Haken rechts geknöpft  
Cottle double hook, right prong blunt  
20-579-02 Cottle Doppel-Haken links geknöpft  
Cottle double hook, left prong blunt  
20-700-10 Cottle Columella-Klemme / Cottle columella forceps  
20-710-12 Adson-Brown Pinzette / Adson-Brown forceps  
20-705-14 Herberhold Hautfazzange / Herberhold tissue forceps  
20-720-14 Cottle Nasenpinzette / Cottle lower lateral forceps  
20-730-16 Jansen Nasenpinzette / Jansen nasal forceps  
20-199-05 Saugrohr mit abgeflachtem Ende / Suction tube with flattened end  
10-302-35 2x Saugrohr, kniegebogen, konisch / 2x Suction tube, angled, conical  
10-300-25 2x Saugrohr, kniegebogen, zylindrisch / 2x Suction tube, angled, cylindrical  
20-322-01 Guillen Saugraspatorium / Guillen suction raspatory  
20-300-21 Masing Elevatorium/Raspatorium / Masing elevator/raspatory  
20-305-18 Freer Doppelelevatorium / Freer elevator, double ended  
20-318-04 McKenty Raspatorium, stark gebogen  
McKenty raspatory, strongly curved  
20-312-23 Cottle Tunnel-Raspatorium, doppelseitig  
Cottle tunneling raspatory, double ended  
20-100-01 Hartmann Nasentamponadezange  
Hartmann nasal dressing forceps  
20-152-55 Herberhold Septum-Spekulum, 55 mm  
Herberhold septum speculum, 55 mm  
20-152-75 Herberhold Septum-Spekulum, 75 mm  
Herberhold septum speculum, 75 mm  
20-152-90 Herberhold Septum-Spekulum, 90 mm  
Herberhold septum speculum, 90 mm  
20-215-00 Blakesley Nasenzange Premium, gerade, 3,0 mm  
Blakesley Premium nasal forceps, straight, 3.0 mm  
20-215-02 Blakesley Nasenzange Premium, gerade, 4,0 mm  
Blakesley Premium nasal forceps, straight, 4.0 mm  
20-225-01 Blakesley Nasenzange Premium, 45°, aufgebogen  
Blakesley Premium nasal forceps, 45° upcurved  
20-270-19 Kazanjian Knochenzange / Kazanjian rongeur  
20-287-23 Cottle-Walsham Septum-Richtzange  
Cottle-Walsham septum straightening forceps  
20-400-18 Cottle Hammer / Cottle mallet  
20-865-30 Cottle Knochen- und Knorpelquetscher  
Cottle bone- and cartilage crusher  
20-425-02 Osteotom Premium Line, 2 mm / Osteotome Premium Line, 2 mm  
20-425-03 Osteotom Premium Line, 3 mm / Osteotome Premium Line, 3 mm  
20-425-06 Osteotom Premium Line, 6 mm / Osteotome Premium Line, 6 mm  
20-425-12 Osteotom Premium Line, 12 mm / Osteotome Premium Line, 12 mm  
20-435-02 Herberhold Osteotom zur lateralen Osteotomie, links  
Herberhold osteotome for lateral osteotomy, left  
20-435-03 Herberhold Osteotom zur lateralen Osteotomie, rechts  
Herberhold osteotome for lateral osteotomy, right  
20-801-02 Fomon Nasenraspel Größe 3/4 / Fomon nasal rasp, size 3/4  
20-801-05 Fomon Nasenraspel Größe 9/10 / Fomon nasal rasp, size 9/10  
20-810-21 Fomon Nasenraspel, Diamant, goldener Griff  
Fomon nasal rasp, diamond, golden handle  
20-808-00 Aufricht Glabella Raspel, Hartmetall  
Aufricht glabella rasp, tungsten carbide  
20-740-15 Crile-Wood Nadelhalter / Crile-Wood needleholder  
20-744-17 Senning Nadelhalter, extra schlank  
Senning needle holder, slender shape  
20-856-17 Joseph Anlegeinstrument zur Rhinoplastik, gewinkelt  
Joseph placing instrument for rhinoplasty, angled  
20-852-07 Castroviejo Nasenzirkel, 20 mm-Skala  
Castroviejo nasal caliper, 20 mm scale  
80-100-16 Non-Stick Bipolare Pinzette / Bipolar forceps  
80-318-50 Bipolares Anschlusskabel passend für Erbe/Storz/Wolf 5 m  
Bipolar connecting cable compatible with Erbe/Storz/Wolf 5 m  
80-503-03 Medizinbecher, graduiert, 30 ml / Medical cup, graduated, 30 ml  
80-504-05 Medizinbecher, graduiert, 50 ml / Medical cup, graduated, 50 ml

#### Ergänzung

#### Supplement

- 10-360-11 Skalpell-Klingen Nr. 11 / Scalpel blades No. 11  
10-360-15 Skalpell-Klingen Nr. 15 / Scalpel blades No. 15  
20-551-64 Mikro-Klingen SM64 / Micro blades SM64  
20-551-65 Mikro-Klingen SM65 / Micro blades SM65  
80-661-14 Norm-Sterilisations-Container Boden geschlossen, 585x274x138 mm  
Maße mit Deckel: 585x278x155 mm / Norm sterilization container  
bottom closed, 585x274x138 mm, dimensions with fitted  
lid: 585x278x155mm  
80-662-00 Ventildeckel silber, für Container 80-661-14 585x278 mm  
Valve lid silver, for container 80-661-xx, 585x278 mm  
80-671-60 Edelstahl-Siebkorb Geflecht, Fallgriffe 485x255x70 mm  
Stainless steel wire basket, sliding handles 485x255x70 mm  
80-681-04 Aluminium-Kennzeichnungs-Schild grün, 20 Zeichen 56x17 mm  
Aluminium tag green, 20 letters, 56x17 mm

Supplement for sales in EU (outside the EU only on request)



**Bestehend aus / Consisting of:**

- |           |  |           |  |
|-----------|--|-----------|--|
| 20-100-01 | Hartmann Nasenspekulum<br>Hartmann nasal speculum  | 20-720-14 | Cottle Nasenpinzette 2x<br>Cottle lower lateral forceps, 2x  |
| 20-152-55 | Herberhold Septum-Spekulum, extra fein, 55 mm<br>Herberhold septum speculum, extra fine, 55 mm           | 20-730-16 | Jansen Nasenpinzette<br>Jansen nasal forceps   |
| 20-152-75 | Herberhold Septum-Spekulum, extra fein, 75 mm<br>Herberhold septum speculum, extra fine, 75 mm           | 10-480-14 | Pinzette, anatomisch, gerade<br>Dressing forceps, anatomical, straight   |
| 20-190-25 | Krause Nasen-Polypen-Schnürer, scharf<br>Krause nasal polyp snare, sharp                                 | 10-483-14 | Pinzette, chirurgisch, 1:2 Zähne<br>Dressing forceps, 1:2 teeth, straight  |
| 20-195-35 | Nasenpolypenschlingen, 0,35 mm, 100 Stück<br>Nasal snare wires, 0.35 mm, 100 pieces                      | 20-740-15 | Crile-Wood Nadelhalter<br>Crile-Wood needleholder  |
| 20-200-20 | Hartmann Nasentamponadezange 20 cm<br>Hartmann nasal dressing forceps 20 cm                              | 20-800-16 | Watteträger, Ø 1,2 mm, 5 Stück<br>Cotton carrier, Ø 1.2 mm, 5 pieces   |
| 20-215-01 | Blakesley Nasenzange Premium, 3,5 mm, gerade<br>Blakesley premium nasal forceps, 3.5 mm, straight        | 20-850-17 | Aufricht Nasenfraktur-Elevatorium<br>Aufrecht nasal fracture elevator  |
| 20-215-03 | Blakesley Nasenzange Premium, 5 mm, gerade<br>Blakesley premium nasal forceps, 5 mm, straight            | 10-302-30 | Saugrohr, kniegebogen, konisch<br>Suction tube, angled, conical  |
| 20-225-02 | Blakesley Nasenzange Premium, 45° aufgebogen<br>Blakesley premium nasal forceps, 45° upcurved            | 10-300-40 | Saugrohr, kniegebogen, zylindrisch<br>Suction tube, angled, cylindrical  |
| 20-259-00 | Craig-Domnick Septum-Zange, scharf<br>Craig-Domnick septum forceps, sharp                                | 10-550-13 | Universalschere, gebogen, spitz-stumpf<br>Universal scissors, curved, sharp-blunt  |
| 20-300-21 | Masing Elevatorium/Raspatorium<br>Masing elevator/raspatory  | 30-082-12 | Frazier Saugrohr, kniegebogen<br>Frazier suction tube, angled  |
| 20-305-18 | Freer Doppelelevatorium, scharf/stumpf<br>Freer elevator, double ended, sharp/blunt                      | 80-111-16 | Non-Stick Bipolare Pinzette<br>Bipolar forceps   |
| 20-322-01 | Guillen Saugraspatorium<br>Guillen suction raspatory   | 80-318-50 | Bipolares Anschlusskabel passend für Erbe/Storz/Wolf 5 m<br>Bipolar connecting cable compatible with Erbe/Storz/Wolf 5 m |
| 20-318-05 | McKenty Raspatorium, stark gebogen<br>McKenty raspatory, strongly curved                                 | 80-503-03 | Medizinbecher, graduiert, 30 ml, 2x<br>Medical cup, graduated, 30 ml, 2x   |
| 20-312-23 | Cottle Tunnel-Raspatorium, doppelseitig<br>Cottle tunneling raspatory, double ended                      | 80-504-05 | Medizinbecher, graduiert, 50 ml, 2x<br>Medical cup, graduated, 50 ml, 2x   |
| 20-400-18 | Cottle Hammer<br>Cottle mallet   |           |  |
| 20-405-04 | Cottle Meißel, 4 mm<br>Cottle chisel, 4 mm   |           |  |
| 20-405-07 | Cottle Meißel, 7 mm<br>Cottle chisel, 7 mm   |           |  |
| 20-409-06 | Cottle Meißel, flach, gebogen, 6 mm<br>Cottle chisel, flat, curved, 6 mm                                 |           |  |
| 20-500-13 | Cottle Septum-Messer<br>Cottle septum knife  |           |  |
| 20-501-14 | Masing Ritzmesser<br>Masing pointed knife  |           |  |
| 20-560-15 | Cottle Nasenflügelhaken<br>Cottle alar retractor   |           |  |
| 20-569-16 | Aufricht Nasenrückenhaken mit Fiberglas Lichtträger<br>Aufrecht nasal retractor with fibre light carrier |           |  |
| 20-601-14 | Joseph Schere<br>Joseph scissors   |           |  |
| 20-615-15 | Metzenbaum Schere<br>Metzenbaum scissors   |           |  |
| 20-630-10 | Walter Schere<br>Walter scissors   |           |  |
| 20-680-16 | Heymann Nasenschere, gezahnt<br>Heymann nasal scissors, toothed  |           |  |
| 20-700-10 | Cottle Columella-Klemme, 11 cm, 2x<br>Cottle columella forceps, 11 cm                                    |           |  |
| 20-710-12 | Adson-Brown Pinzette, 2x<br>Adson-Brown forceps, 2x  |           |  |

**Ergänzung****Supplement**

- |           |  |
|-----------|--|
| 80-661-14 | Norm-Sterilisations-Container Boden geschlossen, 585x274x138 mm<br>Maße mit Deckel: 585x278x155 mm / Norm sterilization container<br>bottom closed, 585x274x138 mm, dimensions with fitted<br>lid: 585x278x155mm |
| 80-662-00 | Ventildeckel silber, für Container 80-661-xx, 585x278 mm<br>Valve lid silver, for container 80-661-xx, 585x278 mm  |
| 80-671-60 | Edelstahl-Siebkorb Geflecht, Fallgriffe 485x255x70 mm<br>Stainless steel wire basket, sliding handles 485x255x70 mm  |
| 80-681-03 | Aluminium-Kennzeichnungs-Schild braun, 20 Zeichen 56x17 mm<br>Aluminium tag brown, 20 letters, 56x17 mm  |

Supplement for sales in EU (outside the EU only on request)



## Alphabetisches Inhaltsverzeichnis

Adson Pinzetten .....	58 - 59	Freer-Joseph Doppel-Raspatorium .....	30	Mikro-Gefäßschere .....	56
Adson-Brown Pinzette .....	58 - 59	Freer Septum Messer .....	40	Mikro-Handgriff .....	41
Anderson Nasenraspel .....	66	Freer Wundhäkchen .....	44	Mikro-Klingen .....	41
Anderson-Neivert Osteotom .....	39	Gelenkkloben .....	14	Mikro-Ryder Nadelhalter .....	62
Antibeschlagmittel .....	8	Gillies Gewebepinzette .....	60	Miller Nasenraspel .....	64
Ash Septum-Richtzange .....	27	Gillies Hauthäkchen .....	45	Nasensonde .....	30
Aufricht Doppelhaken .....	43	Glatzel Nasenspiegel .....	18	Nasenspekulum Modell Wien .....	11
Aufricht Glabella Raspel .....	64, 66	Goldman-Fox Schere .....	52	Nasenpolypenschlingen .....	15
Aufricht Haken für flexiblen Spannarm .....	14	Graefe Mäusezähnen Pinzette .....	60	Neivert Draht-Doppelhaken .....	42
Aufricht Nasenfraktur-Elevatorium .....	67	Graefe Pinzetten .....	60	Neivert Nadelhalter .....	60
Aufricht Nasenrückenhaken .....	42	Rubin Knorpelquetschzange .....	25	Nierenschale, Edelmetall .....	72
Ballenger-Messer .....	67	Guillen Saugraspatorium .....	32	Noyes Nasentamponadezange .....	16
Barraquer Mikro-Nadelhalter .....	62	Hajek Metallhammer .....	33	Ölspray .....	69
Becker Nasenschere .....	28	Halsey Nadelhalter .....	60	Osteotom Nolst Trenité .....	37
Beckmann Naspekulum .....	12	Hammer mit Alugriff und Metallkopf .....	33	Parkes Nasenraspel .....	64
Bipolare Pinzette, Non-Stick .....	69	Hammer mit Silikongriff .....	33	Petrischale .....	71
Bipolares Anschlusskabel .....	70	Handgriff mit Raspelplatten .....	63	Pinzette, anatomisch .....	60
Blakesley Nasenzangen .....	20 - 21	Hartmann Conchotom .....	24	Pinzette, chirurgisch .....	60
Blakesley Nasenzangen Black Line .....	21	Hartmann Nasenspekulum .....	11	Porzellanschälchen .....	72
Boies Elevatorium .....	67	Hartmann Nasentamponadezange .....	16	Premium Rhinoplastik-Set .....	75
Caplan Nasenschere .....	23	Hartmann-Halle Nasenspekulum .....	11	Raspatorium, gerade .....	31
Castroviejo Mikro-Gefäß-Nadelhalter .....	62	Herberhold Hautfazzzange .....	58	Raspeleinsätze .....	63
Castroviejo Nasenzirkel .....	67	Herberhold Osteotom .....	39	Reynolds Scheren .....	48
Cinelli Osteotom .....	36	Herberhold Septum-Spekulum .....	13	Reynolds Scheren Black Line .....	47
Conchotomie Schere, gezahnt .....	57	Heymann Nasenschere .....	56 - 57	Rhinoplastik-Set .....	76
Codier-Schild .....	73	Heymann Nasenschere Black Line .....	56	Rowland Nasenzange .....	23
Converse Nadelhalter .....	62	Hohenhorst Conchotomie Schere .....	26	Rubin Knorpelquetschzange .....	27
Converse Nasenflügel-Doppelhaken .....	42	Jansen Nasenschere .....	28	Rubin Osteotome .....	35
Cottle Columella-Klemme .....	58	Jansen Nasenpinzette .....	18	Saugrohre .....	18 - 19
Cottle Doppel-Haken .....	44	Joseph Doppel-Häkchen .....	44	Schere, gerade .....	52
Cottle Elevatorium / Raspatorium .....	29	Joseph Anlegeinstrument .....	68	Schere, Hartmetall .....	53
Cottle Fingerring-Häkchen .....	43	Joseph Nasenraspel .....	67	Schere, spitz-spitz .....	52
Cottle Hammer .....	33	Joseph Nasensäge .....	68	Schere, supercut .....	52
Cottle Hauthäkchen .....	43 - 45	Joseph Rhinoplastikmesser .....	41	Schmeden Conchotom .....	24
Cottle Knochen- und Knorpelquetscher .....	68	Joseph Schere .....	46	Schuknecht Drahtschneidescherchen .....	54
Cottle Meißel .....	34	Joseph Scheren Black Line .....	46	Schutzhülse für Knorpelquetschzange .....	27
Cottle Nasenflügelhaken .....	42	Kabierske Kanüle .....	17	Selbsthaltendes Spekulum .....	14
Cottle Nasenflügelschere .....	55	Kabierske Pulverbläser .....	17	Senning Nadelhalter .....	62
Cottle Nasenhaken .....	42	Kazanjan Kochenzange .....	23	Septum-Set .....	77
Cottle Nasenpinzette .....	60	Killian Septum-Spekulum .....	12 - 13	Siebkorb .....	73
Cottle Nasenraspel .....	65	Killian Raspatorium, doppelseitig .....	29	Sinuskope .....	5 - 7
Cottle Nasenschere .....	55	Killian-Claus Hohlmeißel .....	38	Skalpell-Griff .....	40
Cottle Nasenschere Black Line .....	55	Killian-Struycken Septum-Spekulum .....	12	Skalpell-Klingen .....	40
Cottle Osteotom mit Führungsdorn .....	38	Kilner Rhinoplastikscheren .....	50 - 51	Stevens Gefäßscheren .....	51
Cottle Osteotom, 2 Führungsdorne .....	35	Kilner Rhinoplastikscheren Black Line .....	51	Stevens Gefäßscheren Black Line .....	51
Cottle Osteotom, flach .....	34	Kilner Wundhäkchen .....	43	Strümpel-Voss Nasenzange .....	21
Cottle Raspatorium .....	30	Kleinert-Kutz Nasenraspel .....	67	Struycken Nasenzange .....	24
Cottle Septum-Messer .....	40	Kornzangenbehälter .....	72	Tablettenschale .....	71
Cottle Septum-Spekula .....	12 - 14	Krause Nasen-Polypen-Schnürer .....	15	Takahashi Nasenzange .....	21
Cottle Tunnel-Raspatorium .....	30	Krause-Voss Nasen-Polypen-Schnürer .....	15	Tieck-Halle Nasenspekulum .....	11
Cottle-Neivert Doppelhaken .....	42	Kressner Muschelquetschzange .....	26	Tolsdorff Knochen- u. Knorpelquetscher .....	69
Cottle-Walsham Septum-Richtzange .....	27	Lange Nasen-Polypen-Schnürer .....	15	Ultra-Stop Antibeschlagmittel .....	8
Craig Septum-Zange .....	22	LED-Leuchtgriffe .....	9	Ulmer Raspatorium .....	31
Craig-Domnick Septum-Zange .....	23	Lempert Raspatorium .....	30, 31	Universalschere, gebogen .....	54
Crile-Wood Nadelhalter .....	61	Lösungsschale .....	71	Walter Hohlmeißel .....	38
Crile-Wood Ryder Nadelhalter .....	61	Maltz Nasenraspel .....	64 - 65	Walter Osteotom .....	36
DeBakey Pinzette .....	59	Masing Elevatorium/Raspatorium .....	29	Walter Schere .....	55
Dichtigkeitstester .....	8	Masing Nadelhalter .....	60	Walter Schere Black Line .....	54
Durchschneidende Nasenzange .....	25	Masing Nasenraspel .....	65	Watson-Williams Nasenzange .....	22
Endoskop-Schutzhülse .....	8	Masing Osteotome .....	38	Watteträger .....	18
Endoskopie Siebkorb .....	74	Masing Ritzmesser .....	40	Weber Doppellevatorium .....	29
Ferris-Smith Nasenzange .....	22	McKenty Raspatorien .....	31	Weber Nasenschere .....	57
Flexibler Spannarm .....	14	Mikro-Federschere .....	62	Westmacott Nasentamponadezange .....	16
Flexibles Endoskop .....	10	Medikamentenschälchen mit Deckel .....	72	Wigand Polypen-Fasszange .....	25
Fomon Nasenflügelhaken .....	44	Medikamentenschälchen, Dappenglas .....	72	Wundhäkchen, superfein .....	45
Fomon Nasenraspel .....	63	Medizinbecher .....	71	Wullstein Raspatorium .....	31
Fomon Nasenraspel, Diamant .....	65	Metallbecher mit Griff .....	71	Wurm Osteotom .....	37
Fomon Nasenscheren .....	54, 56	Metallschale .....	71	Yankauer Septumnadel .....	45
Frazier Saugrohr .....	19	Metzenbaum Scheren .....	47 - 50	Ziehstange für Nasen-Polypen-Schnürer .....	15
Freer Doppellevatorium .....	29	Metzenbaum Scheren Black Line .....	49	Zubehör .....	71 - 74
Freer Golfstock-Raspatorium .....	29	Mikro-Adson-Pinzette .....	59		

Accessories .....	71 - 74	Freer raspatory .....	29	Miller nasal rasp .....	64
Adson forceps .....	58 - 59	Freer-Joseph Raspatory, double ended .....	30	Nasal forceps.....	25
Adson-Brown forceps .....	58 - 59	Freer septum knife.....	40	Nasal probe .....	30
Anderson nasal rasp .....	66	Gillies skin hook.....	45	Nasal Speculum VIENNA.....	11
Anderson-Neivert osteotome.....	39	Gillies tissue forceps.....	60	Nasal polyp snares .....	15
Anti-Fog.....	8	Glatzel nasal mirror.....	18	Neivert needle holder .....	61
Ash septum straightening forceps .....	27	Goldman-Fox scissors.....	52	Neivert wire-shaped retractor.....	42
Aufricht double hook .....	43	Graefe forceps.....	60	Norm sterilisation container .....	74
Aufricht glabella rasp .....	64, 66	Guillen suction raspatory .....	32	Noyes nasal sponge holding forceps .....	16
Aufricht hook for flexible holding arm .....	14	Hajek metal mallet.....	33	Osteotomes .....	33 - 36
Aufricht nasal fracture elevator.....	67	Halsey needle holder.....	61	Osteotome Nolst Trenité.....	37
Aufricht nasal retractors.....	42	Handle for rasps.....	63	Parkes nasal rasp .....	64
Basket.....	73	Hartmann cutting forceps .....	24	Petri dish.....	71
Ballenger knife.....	67	Hartmann nasal dressing forceps .....	16	Premium Rhinoplasty Set .....	75
Barraquer micro needle holder .....	62	Hartmann nasal speculum.....	11	Raspatory .....	31
Becker nasal scissors.....	28	Hartmann-Halle nasal speculum.....	11	Reynolds scissors.....	48
Beckmann nasal speculum .....	12	Herberhold osteotome.....	39	Reynolds scissors Black Line.....	47
Bipolar connection cable.....	70	Herberhold septum speculum .....	13	Rhinoplasty set.....	76
Bipolar forceps .....	69	Herberhold tissue forceps.....	58	Rotation clamp .....	14
Blakesley nasal forceps.....	20 - 22	Heymann nasal scissors.....	56 - 57	Rowland nasal forceps .....	23
Blakesley nasal forceps Black Line .....	21	Heymann nasal scissors Black Line .....	56	Rubin morcelizer forceps.....	27
Boies Elevator .....	67	Höhenhorst nasal conchotomy scissors .....	26	Rubin osteotome .....	35
Caplan nasal scissors.....	23	Insert for rasp .....	63	Scalpel blades.....	40
Castroviejo micro vascular needle holder.....	62	Jansen Middleton septum forceps.....	28	Scalpel handle .....	40
Castroviejo nasal caliper .....	67	Jansen nasal forceps.....	18	Schmeden conchotome.....	24
China bowl .....	72	Joseph double hook .....	44	Schuknecht wire cutting scissors .....	54
Cinelli osteotome.....	36	Joseph placing instrument.....	68	Scissors, pointed.....	52
Coding label.....	73	Joseph nasal rasp .....	66	Scissors, straight.....	52
Converse alar double hook.....	42	Joseph nasal saw.....	68	Scissors, supercut.....	52
Converse needle holder.....	62	Joseph rhinoplasty knife.....	41	Scissors, tungsten carbide .....	53
Cotton carrier.....	18	Joseph scissors.....	46 - 47	Self holding speculum with set screw .....	14
Cottle alar retractor.....	42	Joseph scissors Black Line .....	46	Senning needle holder.....	62
Cottle bone- and cartilage crusher.....	68	Kabierske cannula .....	17	Septum set.....	77
Cottle chisel.....	34, 35	Kabierske powder blower.....	17	Sinusscopes.....	5 - 7
Cottle columella forceps.....	58	Kazanjian rongueur .....	23	Skin hook.....	45
Cottle double hook.....	45	Kidney bowl.....	72	Solution bowl.....	71
Cottle lower lateral forceps.....	61	Killian raspatory, double ended .....	29	Sleeve for rubin morcelizer forceps .....	27
Cottle lower lateral scissors .....	55	Killian-Claus gouge.....	38	Special oil spray .....	69
Cottle lower lateral scissors Black Line.....	55	Killian septum speculum .....	12 - 13	Stevens vascular scissors .....	51
Cottle mallet.....	33	Killian-Struycken nasal speculum.....	12	Stevens vascular scissors Black Line .....	51
Cottle nasal hook.....	42	Kilner hook .....	43	Strümpel-Voss nasal forceps.....	21
Cottle nasal rasp .....	65	Kilner rhinoplasty scissors.....	50 - 51	Struycken nasal forceps.....	24
Cottle nasal scissors .....	56	Kilner rhinoplasty scissors Black Line .....	51	Stylet for nasal snares.....	15
Cottle osteotome .....	34 - 38	Kleinert-Kutz nasal rasp .....	66	Suction tubes.....	18, 19
Cottle raspatory.....	30	Krause nasal polyp snare .....	15	Tablet dish .....	71
Cottle septum knife.....	40	Krause-Voss nasal polyp snare .....	15	Takahashi nasal forceps.....	21
Cottle septum speculum.....	12 - 14	Kressner turbinate crushing forceps.....	26	Tieck-Halle nasal speculum .....	11
Cottle skin hook .....	43 - 45	Lange nasal polyp snare .....	15	Tolsdorff bone- and cartilage crusher.....	69
Cottle thimble hook .....	43	Leak tester .....	8	Ulmer raspatory.....	31
Cottle tunnel raspatory.....	30	Lempert raspatory .....	30, 34	Ultra-Stop Anti-Fog solution.....	8
Cottle-Neivert double hook.....	42	LED-light handles.....	9	Universal scissors .....	54
Cottle-Walsham septum straightening forceps.....	27	Mallets.....	33	Watson-Williams nasal forceps.....	22
Craig septum forceps .....	22	Maltz nasal rasp.....	64 - 65	Walter gouge.....	38
Craig-Domnick septum forceps.....	23	Masing elevator/raspatory.....	29	Walter osteotome .....	36
Crile-Wood needle holder.....	61	Masing nasal rasp .....	65	Walter scissors.....	55
Crile-Wood Ryder needle holder.....	61	Masing needle holder.....	61	Walter scissors Black Line .....	54
DeBakey dressing forceps .....	59	Masing osteotome .....	38	Weber elevator, double ended.....	29
Endoscope container .....	74	Masing pointed knife.....	40	Weber nasal scissors.....	57
Endoscope protection sleeve .....	8	McKenty raspatory.....	29	Westmacott nasal dressing forceps.....	16
Ferris-Smith nasal forceps .....	22	Medicine cup.....	71	Wigand polyp-grasping forceps .....	25
Flexible endoscope.....	10	Medication dish.....	72	Wullstein raspatory .....	31
Flexible holding arm .....	14	Metal cup with handle.....	71	Wurm osteotome.....	39
Fomon alar hook.....	44	Metal bowl .....	71	Yankauer septum needle.....	45
Fomon nasal rasp.....	63	Metzenbaum scissors .....	47 - 50		
Fomon nasal scissors.....	54, 56	Metzenbaum scissors Black Line.....	49		
Forceps, anatomical .....	60	Micro blades .....	41		
Forceps, surgical.....	60	Micro scissors.....	62		
Forceps holder.....	72	Micro vascular scissors.....	57		
Frazier suction tubes.....	19	Micro Adson forceps.....	59		
Freer elevator, double ended .....	29	Micro handle.....	41		
Freer hook .....	45	Micro Ryder needle holder.....	62		



## Numerisches Inhaltsverzeichnis

### Numeric Content

78PS01 .....69	20-002-15.....41	20-215-03.....20	20-301-23.....29	20-415-07.....36
10-155-00.....17	20-003-15.....41	20-215-04.....20	20-305-18.....29	20-417-10.....36
10-155-01.....17	20-100-01.....11	20-215-00B.....21	20-306-20.....29	20-417-12.....36
10-155-02.....17	20-100-02.....11	20-215-01B.....21	20-307-18.....29	20-417-14.....36
10-155-08.....17	20-101-00.....11	20-215-02B.....21	20-308-22.....29	20-417-16.....36
10-155-11.....17	20-101-01.....11	20-215-03B.....21	20-309-18.....29	20-418-10.....36
10-155-13.....17	20-102-01.....11	20-215-04B.....21	20-309-20.....29	20-418-12.....36
10-300-10.....18	20-102-02.....11	20-215-10.....20	20-310-19.....29	20-418-14.....36
10-300-15.....18	20-102-03.....11	20-215-12.....20	20-311-20.....30	20-418-16.....36
10-300-20.....18	20-110-01.....11	20-215-14.....20	20-312-23.....30	20-420-02.....36
10-300-25.....18	20-110-02.....11	20-225-00.....20	20-313-00.....30	20-420-04.....36
10-300-30.....18	20-110-03.....11	20-225-01.....20	20-318-04.....31	20-420-06.....36
10-300-40.....18	20-112-01.....11	20-225-02.....20	20-318-05.....31	20-420-08.....36
10-300-50.....18	20-112-02.....11	20-225-03.....20	20-319-04.....31	20-420-10.....36
10-302-30.....18	20-112-03.....11	20-225-04.....20	20-320-19.....30	20-420-12.....36
10-302-35.....18	20-115-00.....12	20-225-00B.....21	20-322-01.....32	20-425-02.....37
10-302-45.....18	20-147-55.....13	20-225-01B.....21	20-322-02.....32	20-425-03.....37
10-303-18.....18	20-148-40.....12	20-225-02B.....21	20-322-03.....32	20-425-04.....37
10-352-08.....30	20-148-55.....12	20-225-03B.....21	20-323-01.....22	20-425-06.....37
10-352-14.....30	20-148-75.....12	20-225-11.....20	20-323-02.....22	20-425-10.....37
10-353-02.....30	20-148-90.....12	20-225-11B.....21	20-323-03.....22	20-425-12.....37
10-353-03.....30	20-149-55.....12	20-225-12.....20	20-400-18.....33	20-425-14.....37
10-353-04.....30	20-150-40.....12	20-225-12B.....21	20-402-21.....33	20-425-16.....37
10-353-05.....30	20-150-55.....12	20-225-14.....20	20-403-23.....33	20-425-18.....37
10-353-07.....30	20-150-65.....12	20-225-14B.....21	20-404-20.....33	20-425-25.....37
10-353-13.....31	20-150-75.....12	20-235-01.....20	20-405-04.....34	20-426-00.....37
10-354-03.....31	20-150-90.....12	20-235-02.....20	20-405-06.....34	20-426-01.....37
10-356-00.....31	20-151-40.....13	20-235-03.....20	20-405-07.....34	20-426-02.....37
10-356-01.....31	20-151-55.....13	20-235-01B.....21	20-405-09.....34	20-427-19.....37
10-357-18.....31	20-151-75.....13	20-235-02B.....21	20-405-10.....34	20-427-20.....37
10-360-03.....40	20-151-90.....13	20-235-03B.....21	20-405-12.....34	20-427-50.....37
10-360-04.....40	20-152-40.....13	20-236-00.....25	20-406-02.....34	20-428-01.....38
10-360-07.....40	20-152-55.....13	20-238-00.....21	20-406-04.....34	20-428-02.....38
10-360-10.....40	20-152-75.....13	20-240-01.....22	20-406-07.....34	20-430-05.....38
10-360-11.....40	20-152-90.....13	20-240-02.....22	20-406-09.....34	20-431-05.....38
10-360-15.....40	20-153-40.....13	20-245-01.....21	20-406-12.....34	20-432-03.....38
10-360-33.....40	20-153-45.....13	20-245-02.....21	20-407-04.....34	20-432-45.....38
10-486-16.....59	20-153-55.....13	20-245-11.....21	20-407-07.....34	20-435-01.....39
10-487-16.....59	20-153-75.....13	20-245-12.....21	20-407-09.....34	20-435-02.....39
10-494-12.....60	20-154-01.....14	20-246-01.....21	20-407-12.....34	20-435-03.....39
10-495-12.....60	20-154-02.....14	20-246-02.....21	20-408-04.....34	20-439-01.....39
10-496-12.....59	20-155-00.....13	20-248-00.....22	20-408-07.....34	20-440-01.....39
10-500-10.....60	20-155-40.....13	20-249-00.....22	20-408-09.....34	20-440-02.....39
10-501-10.....60	20-155-55.....13	20-250-00.....24	20-408-12.....34	20-440-03.....39
10-502-10.....60	20-155-75.....13	20-252-01.....24	20-409-04.....35	20-441-16.....38
10-503-10.....60	20-155-90.....13	20-252-02.....24	20-409-06.....35	20-442-01.....39
10-530-10.....52	20-156-40.....14	20-252-03.....24	20-411-10.....35	20-442-02.....39
10-531-12.....52	20-156-55.....14	20-252-04.....24	20-411-12.....35	20-442-03.....39
10-532-12.....53	20-156-75.....14	20-254-00.....24	20-411-14.....35	20-500-13.....40
10-533-12.....52	20-156-90.....14	20-254-01.....24	20-411-16.....35	20-501-14.....40
10-534-12.....52	20-190-25.....15	20-254-02.....24	20-412-02.....35	20-502-14.....40
10-535-12.....53	20-191-00.....15	20-254-03.....24	20-412-03.....35	20-502-15.....40
10-536-10.....52	20-191-25.....15	20-258-00.....22	20-412-04.....35	20-503-15.....41
10-540-12.....53	20-193-25.....15	20-259-00.....23	20-412-05.....35	20-550-10.....41
10-541-12.....53	20-195-35.....15	20-270-19.....23	20-412-06.....35	20-550-13.....41
10-542-12.....53	20-198-00.....17	20-272-21.....23	20-412-07.....35	20-551-62.....41
10-543-12.....53	20-199-05.....17	20-274-18.....23	20-412-08.....35	20-551-64.....41
10-544-12.....53	20-200-16.....16	20-280-21.....26	20-412-09.....35	20-551-65.....41
10-545-12.....53	20-200-20.....16	20-282-22.....27	20-412-10.....35	20-560-14.....42
10-549-10.....54	20-207-20.....16	20-282-99.....27	20-412-11.....35	20-560-15.....42
10-550-13.....54	20-208-20.....16	20-287-23.....27	20-412-12.....35	20-561-15.....42
10-555-13.....61	20-215-00.....20	20-288-23.....27	20-415-02.....36	20-562-15.....42
20-000-15.....41	20-215-01.....20	20-290-22.....27	20-415-03.....36	20-564-20.....42
20-001-15.....41	20-215-02.....20	20-300-21.....29	20-415-04.....36	20-566-18.....42

20-566-20.....42	20-614-15.....48	20-711-12.....58	20-805-01.....64	30-134-00.....7	80-517-00.....72
20-567-16.....43	20-614-18.....48	20-712-12.....59	20-805-02.....64	30-134-30.....7	80-519-00.....72
20-568-16.....43	20-614-20.....48	20-713-12.....59	20-806-01.....64	30-134-45.....7	80-519-01.....72
20-569-16.....42	20-615-15.....49	20-714-12.....59	20-806-02.....64	30-134-70.....7	80-519-02.....72
20-570-13.....43	20-615-18.....49	20-715-12.....59	20-808-00.....64	30-135-00.....6	80-519-03.....72
20-571-01.....43	20-615-20.....49	20-716-12.....59	20-810-21.....65	30-135-30.....6	80-520-06.....72
20-571-02.....43	20-615-15B.....49	20-718-11.....60	20-811-19.....65	30-142-45.....6	80-520-08.....72
20-571-03.....43	20-615-15WB.....49	20-720-14.....60	20-812-19.....65	30-142-90.....6	80-525-17.....72
20-572-10.....42	20-615-18B.....49	20-722-15.....60	20-815-21.....65	30-160-01.....8	80-525-25.....72
20-573-10.....42	20-615-18WB.....49	20-730-16.....18	20-816-21.....65	30-160-02.....8	80-528-13.....72
20-574-06.....43	20-615-20B.....49	20-730-19.....18	20-818-18.....65	30-160-03.....8	80-528-18.....72
20-576-16.....43	20-615-20WB.....49	20-730-21.....18	20-819-18.....65	30-160-04.....8	80-528-20.....72
20-577-16.....43	20-616-15.....50	20-740-15.....61	20-820-21.....65	30-160-05.....8	80-530-20.....72
20-579-01.....44	20-617-15.....50	20-742-13.....61	20-822-21.....66	30-169-08.....8	80-631-10.....73
20-579-02.....44	20-618-15.....50	20-744-15.....61	20-823-21.....66	30-170-28.....10	80-631-12.....73
20-579-03.....44	20-620-14.....50	20-744-17.....61	20-824-21.....66	30-170-36.....10	80-631-14.....73
20-579-04.....44	20-621-14.....50	20-745-15.....61	20-825-18.....66	30-171-40.....10	80-631-21.....73
20-580-15.....44	20-622-13.....51	20-746-12.....62	20-826-21.....66	30-182-21.....8	80-632-00.....73
20-581-16.....44	20-622-13B.....51	20-748-10.....61	20-827-21.....66	30-320-01.....25	80-632-01.....73
20-582-02.....44	20-622-13WB.....51	20-748-11.....61	20-828-17.....66	30-320-02.....25	80-632-02.....73
20-582-05.....44	20-622-15.....51	20-748-13.....61	20-829-17.....66	30-321-01.....25	80-632-03.....73
20-582-07.....44	20-622-15B.....51	20-764-09.....62	20-830-21.....66	30-321-02.....25	80-632-04.....73
20-582-10.....44	20-622-15WB.....51	20-764-14.....62	20-850-17.....67	30-322-01.....25	80-632-05.....73
20-584-17.....44	20-623-11.....51	20-765-14.....62	20-851-18.....67	30-322-02.....25	80-641-14.....73
20-585-13.....45	20-623-11B.....51	20-784-13.....62	20-852-07.....67	30-700-00.....14	80-642-00.....73
20-587-15.....45	20-623-11WB.....51	20-784-18.....62	20-853-03.....67	30-700-01.....14	80-642-01.....73
20-588-01.....45	20-624-11.....51	20-785-13.....62	20-853-04.....67	30-711-00.....14	80-642-02.....73
20-588-02.....45	20-624-11B.....51	20-785-18.....62	20-856-17.....68	40-745-18.....61	80-642-03.....73
20-590-01.....45	20-624-11WB.....51	20-786-13.....62	20-860-01.....68	70-211-00.....9	80-642-04.....73
20-590-02.....45	20-625-11.....51	20-786-18.....62	20-860-02.....68	70-211-01.....9	80-642-05.....73
20-590-04.....45	20-626-11.....52	20-787-13.....62	20-860-03.....68	70-211-10.....9	80-661-12.....73
20-590-05.....45	20-626-93.....52	20-787-18.....62	20-865-30.....68	70-211-20.....9	80-661-14.....73
20-600-14.....46	20-627-13.....52	20-790-15.....62	20-865-50.....68	70-211-30.....9	80-661-21.....73
20-601-14.....46	20-628-13.....52	20-791-15.....62	20-867-40.....69	70-211-40.....9	80-662-00.....73
20-602-14.....46	20-630-10B.....54	20-800-16.....18	20-868-40.....69	70-211-50.....9	80-662-01.....73
20-602-14B.....46	20-630-10.....55	20-801-00.....63	20-900-00.....76	80-316-50.....70	80-662-02.....73
20-602-14WB.....46	20-630-15.....55	20-801-01.....63	20-901-00.....77	80-317-30.....70	80-662-03.....73
20-603-14.....46	20-632-12.....55	20-801-02.....63	20-905-00.....75	80-317-50.....70	80-662-04.....73
20-603-14B.....46	20-632-12B.....55	20-801-03.....63	25-100-05.....28	80-318-30.....70	80-662-05.....73
20-603-14WB.....46	20-633-12.....54	20-801-04.....63	25-100-21.....28	80-318-50.....70	80-671-20.....73
20-604-14.....47	20-635-13.....56	20-801-05.....63	25-100-46.....28	80-319-30.....70	80-671-25.....73
20-605-14.....47	20-635-13WB.....56	20-801-16.....18	30-080-05.....19	80-319-50.....70	80-671-40.....73
20-607-18.....47	20-638-16.....55	20-802-16.....18	30-080-06.....19	80-320-30.....70	80-671-60.....73
20-607-20.....47	20-639-16.....56	20-803-01.....64	30-080-07.....19	80-320-50.....70	80-675-00.....74
20-609-15B.....47	20-647-12.....57	20-803-02.....64	30-080-08.....19	80-322-30.....70	80-681-01.....73
20-609-15WB.....47	20-680-16.....56	20-803-03.....64	30-080-09.....19	80-101-16.....69	80-681-02.....73
20-610-15B.....47	20-680-16WB.....56	20-803-04.....64	30-080-10.....19	80-106-16.....69	80-681-03.....73
20-610-15WB.....47	20-681-16.....57	20-803-05.....64	30-080-12.....19	80-111-16.....69	80-681-04.....73
20-610-15.....48	20-682-16.....57	20-803-06.....64	30-080-15.....19	80-500-00.....71	80-681-05.....73
20-611-15.....48	20-683-18.....56	20-803-07.....64	30-081-06.....19	80-501-01.....71	80-681-06.....73
20-612-14.....48	20-683-18WB.....56	20-803-08.....64	30-081-08.....19	80-501-02.....71	80-681-07.....73
20-612-15.....48	20-690-01.....57	20-804-00.....63	30-081-09.....19	80-501-03.....71	80-683-10.....74
20-612-16.....48	20-690-02.....57	20-804-01.....63	30-081-10.....19	80-501-04.....71	80-684-10.....74
20-612-18.....48	20-690-03.....57	20-804-02.....63	30-081-12.....19	80-503-03.....71	80-685-00.....74
20-612-20.....48	20-691-01.....57	20-804-03.....63	30-081-15.....19	80-504-05.....71	80-688-00.....74
20-613-15.....49	20-693-00.....26	20-804-04.....63	30-105-06.....19	80-505-10.....71	80-690-01.....74
20-613-18.....49	20-693-01.....26	20-804-05.....63	30-105-08.....19	80-505-20.....71	80-690-02.....74
20-613-20.....49	20-693-02.....26	20-804-06.....63	30-105-10.....19	80-506-30.....71	80-691-01.....74
20-613-15B.....49	20-695-11.....57	20-804-07.....63	30-130-00.....7	80-507-40.....71	80-692-01.....74
20-613-15WB.....49	20-696-11.....57	20-804-08.....63	30-130-30.....7	80-509-75.....71	
20-613-18B.....49	20-700-10.....58	20-804-09.....63	30-130-70.....7	80-512-00.....71	
20-613-18WB.....49	20-701-08.....58	20-804-10.....63	30-132-00.....7	80-515-06.....71	
20-613-20B.....49	20-705-14.....58	20-804-20.....63	30-132-30.....7	80-515-08.....71	
20-613-20WB.....49	20-710-12.....58	20-804-99.....63	30-132-45.....7	80-515-10.....71	



## Umrechnungstabelle - Ch/Fr - mm - inch

### Conversion table - Ch/Fr - mm - inch

Charrière (CH) French (F)	mm	Inch
1	0,33	0,013
2	0,67	0,025
3	1,00	0,039
4	1,33	0,051
5	1,67	0,065
6	2,00	0,079
7	2,33	0,092
8	2,67	0,105
9	3,00	0,118
10	3,33	0,131
11	3,67	0,144
12	4,00	0,156
13	4,33	0,170
14	4,67	0,184
15	5,00	0,197
16	5,33	0,210
17	5,67	0,223
18	6,00	0,237
19	6,33	0,249
20	6,67	0,263
21	7,00	0,276
22	7,33	0,288
23	7,67	0,302
24	8,00	0,315
25	8,33	0,328
26	8,67	0,341
27	9,00	0,354
28	9,33	0,367
29	9,67	0,380
31	10,23	0,407
32	10,67	0,420
34	11,33	0,446
36	12,00	0,472
38	12,67	0,494
40	13,33	0,520
45	15,00	0,591

# Größenvergleich der Blätter von Nasenspekula

## Specula blades size comparison

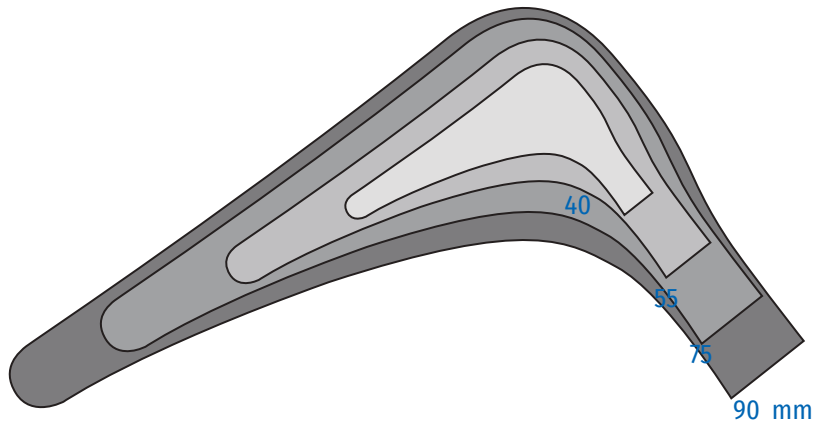





Burghof 14 · 51491 Overath · Germany

Phone: +49 2206 90 81 - 0

Fax: +49 2206 90 81 - 13

[info@spiggle-theis.com](mailto:info@spiggle-theis.com)

[www.spiggle-theis.com](http://www.spiggle-theis.com)

© 2022 by SPIGGLE & THEIS Medizintechnik GmbH

Änderungen und Irrtümer – einschließlich Bilder - vorbehalten.

Produktsortiment kann pro Land abweichen.

Modifications and errors - including pictures - reserved.

Product range might vary per country.



PO Box 3403, Erina, NSW, 2250, Australia

**P: +61 2 9810 6947**

[admin@coremed.com.au](mailto:admin@coremed.com.au)

[www.coremed.com.au](http://www.coremed.com.au)

# NNH-Instrumentarium

## Sinus Instruments







# Über uns

---

# About Us

## Geschichte

**SPIGGLE & THEIS Medizintechnik GmbH** wurde 1994 von den Geschäftsführern **David Spiggle** und **Detlef Theis** gegründet. Bis heute haben wir uns vom reinen Vertriebsunternehmen zu einem renommierten Hersteller von Medizinprodukten im Bereich der HNO-Chirurgie weiterentwickelt. Weltweit exportieren wir in über 75 Länder und in Deutschland zählen mehr als 700 Kliniken zu unseren Kunden.

## Das Maß der Dinge

Im chirurgischen Instrumentenbau gilt das Siegel **“Made in Germany”** auch heute noch als Inbegriff von Qualität. Unsere chirurgischen Instrumente werden in allen Produktionsstufen unter strengsten Qualitätsanforderungen nahezu komplett in Deutschland produziert und sind somit noch größtenteils echt **“Made in Germany”**. Zur Verarbeitung wird ausschließlich Instrumentenstahl bester Güte verwendet, welcher den hohen Anforderungen moderner Chirurgie auch dauerhaft gerecht wird.

## Sicherheit

Die Gesundheit der Patienten und somit die Sicherheit und Qualität unserer Produkte stehen im Mittelpunkt unseres Handelns. In diesem Sinne ist **SPIGGLE & THEIS Medizintechnik GmbH** bereits seit 1997 **ISO-zertifiziert** und sind unsere Produkte nach der strengen europäischen Richtlinie für Medizinprodukte CE-gekennzeichnet. Alle unsere Produkte unterliegen einer permanenten Qualitätskontrolle - von der Auswahl des Rohmaterials über die einzelnen Fertigungsschritte bis zum Versand.

## Erfahrung

Unsere Mitarbeiter haben zum Teil mehr als 30 Jahre Berufserfahrung im Umgang mit chirurgischen Instrumenten. Durch dieses umfassende Know-How sowie den langjährigen und individuellen Kontakt mit den Anwendern, besitzen wir nicht nur theoretisches Wissen, sondern kennen auch deren Bedürfnisse und Ansprüche. Dies hilft uns bei der steten, praxisorientierten Weiterentwicklung unserer Produkte. Somit garantieren wir hohe Kompetenz und individuellen Service bei der Betreuung unserer Kunden.

## History

**SPIGGLE & THEIS Medizintechnik GmbH** was founded in 1994 by the managing directors **David Spiggle** and **Detlef Theis**. The company has evolved from being purely a distributor to the established manufacturer of medical products in the area of ENT that it is today. We can count over 700 clinics amongst our German customers and export to over 75 countries world-wide.

## The Seal Of Highest Quality

The stamp **“Made in Germany”** is still the epitome of quality standards in the production of surgical instruments in the world today. The majority of our surgical instruments is subjected to the strictest quality requirements at every step of their production, in the truest sense of the words, **“Made in Germany”**. Only the highest standard of instrument steel, capable of consistently meeting the demands of modern surgery, is used in the production.

## Safety First

The health of our patients and therefore the safety and quality of our products plays the central role in our decisions. **SPIGGLE & THEIS Medizintechnik GmbH** has been **ISO certified**. Our products are CE-marked in accordance with the strict European guideline for medical products since 1997. All our products undergo continual quality checks, from the selection of raw materials, to the individual stages of production and finally their dispatch.

## Experience

Our colleagues in instrument development can look back on over 30 years of professional practical experience with ENT surgical instruments. We offer more than theoretical knowledge – we understand our customer needs. We enjoy close, personal contact to many of the best surgeons world-wide. This enables us to continually develop innovative products. We guarantee the highest level of competence and individual service in meeting our customer requirements.



## Inhaltsverzeichnis

### Table of contents

01	Ambulantes Nasen-Nebenhöhlen-Instrumentarium / Diagnostic Sinus Instruments .....	5 - 8
02	Endoskopie und Videodokumentation / Endoscopy and Video Documentation .....	9 - 17
03	Septum-Instrumente / Septum-Instruments .....	18 - 26
04	FESS-Instrumente / FESS-Instruments .....	27 - 38
05	Dieler bipolare Koagulationszangen / Dieler bipolar coagulation forceps .....	39 - 42
06	Stirnhöhlen- und Keilbeinhöhlen-Instrumente / Frontal and Sphenoidal Instruments .....	43 - 49
07	Mikroskopische / Endoskopische Instrumente für die Pansinus-Chirurgie Microscopic / Endoscopic Instruments for Pansinus Surgery .....	50 - 60
08	Allgemeines / Miscellaneous .....	61 - 65
09	Sterilisationssysteme / Sterilization Systems .....	66 - 67
10	Sets .....	68 - 70
	Index.....	71 - 74

#### Attention:

Not every instrument is available in all markets. Availability depends on local regulations. Please contact your SPIGGLE & THEIS representative or distributor, if you have any questions about the availability of our products in your region.

## 01 Ambulantes Nasen-Nebenhöhlen-Instrumentarium

### Diagnostic Sinus Instruments

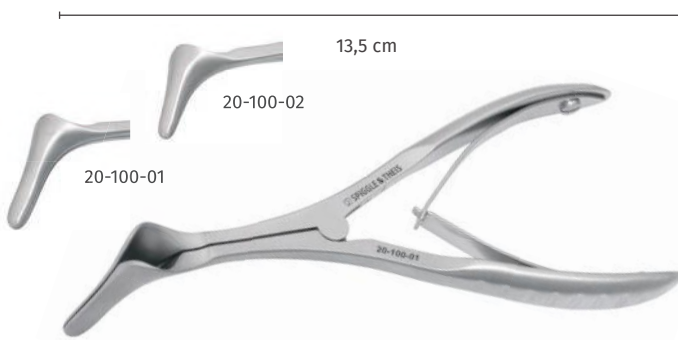

**Hartmann Nasenspekulum, 13,5 cm**  
Hartmann nasal speculum, 13.5 cm

Art.-Nr./No.		Länge / Length (cm)
20-100-01	Für Erwachsene for adult	13,5
20-100-02	Für Jugendliche & Kinder for juveniles & children	13,5

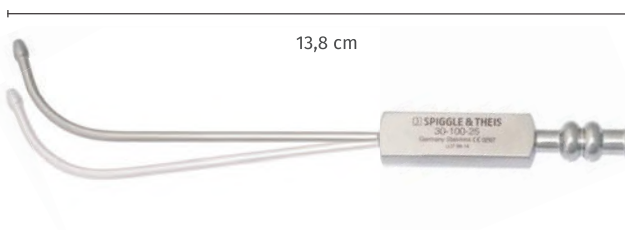

**Eicken Spülröhrchen, lange Biegung, biegsam, 13,8 cm**  
Eicken antrum cannula, long curve, bendable, 13.8 cm

Art.-Nr./No.	AD / OD (mm)
30-100-25	2,5
30-100-30	3,0
30-100-40	4,0

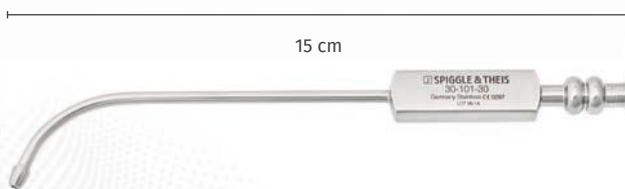

**Eicken Spülröhrchen, lange Biegung, 15 cm**  
Eicken antrum cannula, long curve, 15 cm

Art.-Nr./No.	AD / OD (mm)
30-101-25	2,5
30-101-30	3,0
30-101-40	4,0

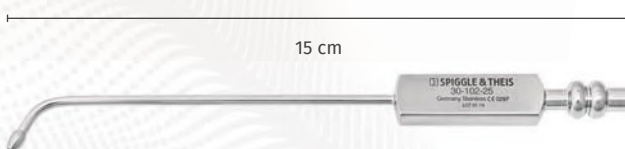

**Eicken Spülröhrchen, kurze Biegung, 15 cm**  
Eicken antrum cannula, short curve, 15 cm

Art.-Nr./No.	AD / OD (mm)
30-102-25	2,5
30-102-30	3,0
30-102-40	4,0





## 01 Ambulantes Nasen-Nebenhöhlen-Instrumentarium Frazier Saugrohr

### Diagnostic Sinus Instruments Frazier suction tube

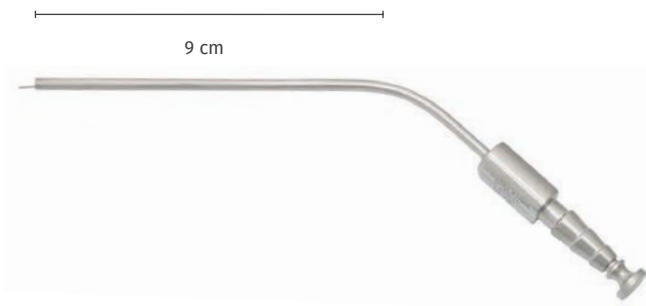

**mit Griffplatte und Unterbrecher, 9 cm**  
**with suction control, 9 cm**

Art.-Nr. Art.-No.	AD / OD Ch / Fr	AD / OD mm
30-080-05	5	1,7
30-080-06	6	2,0
30-080-07	7	2,3
30-080-08	8	2,7
30-080-09	9	3,0
30-080-10	10	3,3
30-080-12	12	4,0
30-080-15	15	5,0

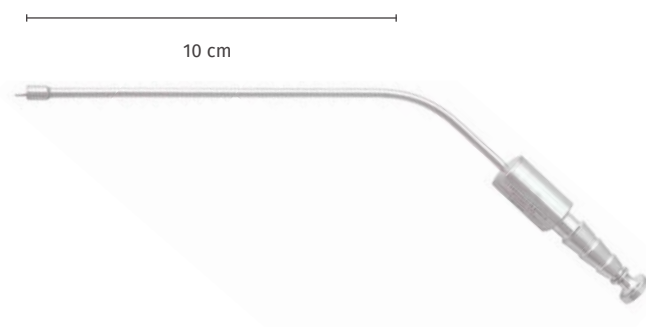

**kniegebogen, Knopfende, 10 cm / angled, ball ended, 10 cm**

Art.-Nr. Art.-No.	AD / OD Ch / Fr	AD / OD mm
30-082-08	8	2,7
30-082-10	10	3,3
30-082-12	12	4,0
30-082-15	15	5,0



**konisch, mit tränenförmiger Sogsteuerung, 8 cm**  
**conical, with tear formed suction control, 8 cm**

Art.-Nr. Art.-No.	AD / OD Ch / Fr	AD / OD mm
30-105-06	6	2,0
30-105-08	8	2,7
30-105-10	10	3,3

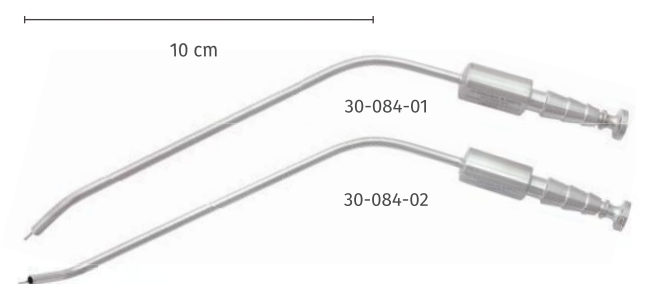

**mit Unterbrecher, 10 Ch (3,3 mm), 10 cm**  
**with suction control, 10 Ch (3,3 mm), 10 cm**

Art.-Nr./No.	Beschreibung / Description
30-084-01	rechts gebogen / curved right
30-084-02	links gebogen / curved left



## 01 Ambulantes Nasen-Nebenhöhlen-Instrumentarium

### Diagnostic Sinus Instruments



**Stirnhöhlen-Saugrohr, biegsam, 16,5 cm**  
**Frontal sinus suction tube, bendable, 16.5 cm**

Art.-Nr./No.	AD / OD (mm)
30-106-25	2,5
30-106-30	3,0
30-106-40	4,0



**Stirnhöhlen Saugraspatorium, gebogen, biegsam, mit Sogsteuerung, 10 cm**  
**Frontal sinus suction raspatory, curved, bendable, with suction control, 10 cm**

**30-108-00**

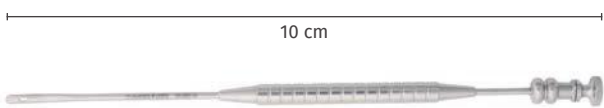

**Gourney Saugelevatorium, 3 mm, 19 cm**  
**Gourney suction elevator, 3 mm, 19 cm**

**20-320-19**



**Lichtwitz Punktionskanüle, 10 cm / Lichtwitz trocar needle, 10 cm**

Art.-Nr./No.	AD / OD (mm)
30-111-16	1,5
30-111-18	1,8



**Kieferhöhlen-Spülschlauch, 30 cm / Sinus irrigation tube, 30 cm**

Art.-Nr./No.	Beschreibung / Description
30-112-00	Silikon, mit Ansätzen silicone, with connectors



## 01 Ambulantes Nasen-Nebenhöhlen-Instrumentarium

### Diagnostic Sinus Instruments

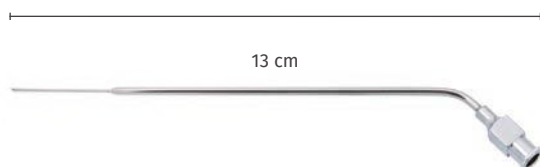

**Injektionskanüle, kniegebogen, AD 0,8 mm, 13 cm**

**Injection needle, angled, OD 0.8 mm, 13 cm**

**30-122-08**



**Ritter Stirnhöhlenbougie, 15,5 cm**

**Ritter frontal sinus bougie, 15.5 cm**

Art.-Nr./No.	AD / OD (mm)
30-121-25	2,5
30-121-30	3,0
30-121-40	4,0
30-121-50	5,0



**Biopsiezange, gerade, doppelbeweglich, Löffel 2x4 mm,**

**AD 2,5 mm, Arbeitslänge 15 cm, mit Spülkanal**

**Biopsy forceps, straight, double-action, cup 2x4 mm,**

**OD 2.5 mm, working length 15 cm, with irrigation channel**

**30-125-00**

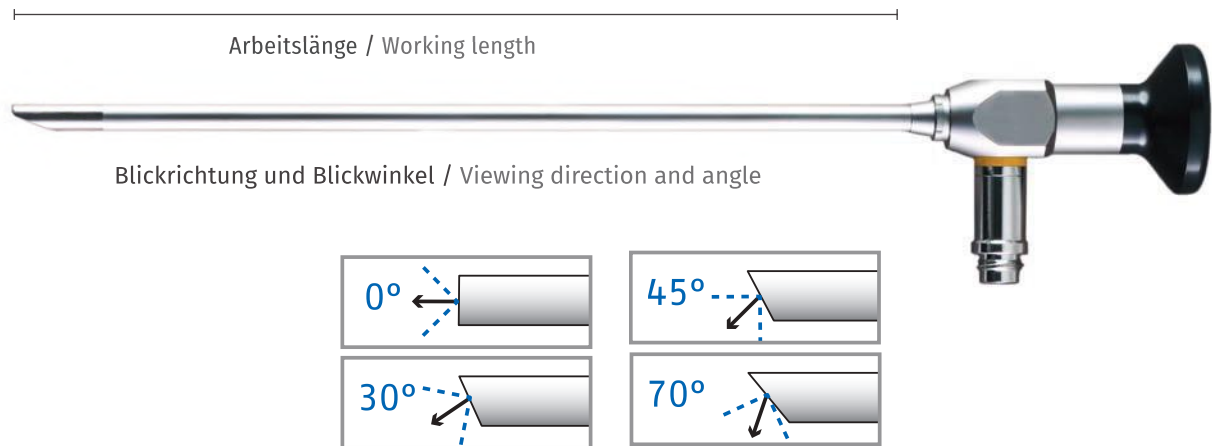

#### Vorteile unserer Endoskope:

- Kompatibel mit allen Lichtquellen auf dem Markt (universalkompatibel)
- Extrem robuste Rohrkonstruktion mit verstärktem 2-Rohr-Edelstahl-System
- Hochwertig vergütetes, hochauflösendes Linsen-System
- Optische Saphirglas-Frontlinse, kratzfest und hitzebeständig fixiert mit Epoxidharz
- Hitzebeständiges Polymer-Okular (PEEK)
- Hohe Dichtigkeit durch gelaserte Schnittstellen
- Mehr Bildinformation durch großen Öffnungswinkel
- Hohe Bildschärfe im gesamten Bildbereich
- Gleichmäßige Helligkeit bis zum Rand durch Lichtkonus
- Autoklavierbar
- 24 Monate Garantie

#### Advantages of our endoscopes:

- Compatible to all light sources available (universal camera compatible)
- Extremely robust stainless steel tube construction with reinforced outer tube
- High precision quality lens system
- Optical sapphire glass front lens, scratch resistant and fixed with heat-resistant epoxide
- Heat-resistant polymer ocular (PEEK)
- Tight sealing due to laser welded joints
- More image information due to wide viewing angle
- High focus quality in entire viewing area
- Constant brightness up to the edge of viewing area
- Autoclavable
- 24 months guarantee

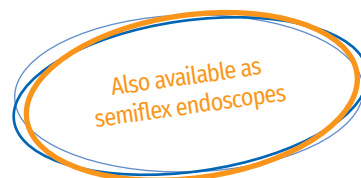

**All unsere Endoskope sind aus Phynoxstahl**  
für verbesserten Schutz gegen Verbiegen und Bruch

**All our endoscopes are made of phynox steel**  
for improved protection against bending or break

## 02 Endoskopie und Videodokumentation Sinuskop, HD

### Endoscopy and Video Documentation Sinuscope, HD

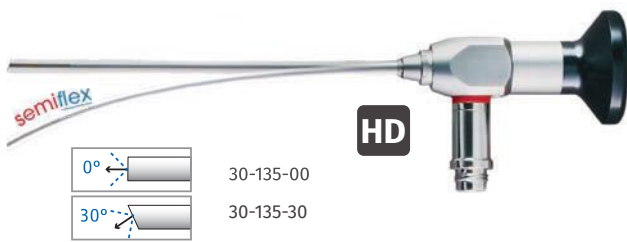

**semiflex, autoklavierbar, AD 2,7 mm, 11 cm**  
**semiflex, autoclavable, OD 2.7 mm, 11 cm**

Art.-Nr./No.	Winkel / Angle
30-135-00	0°
30-135-30	30°

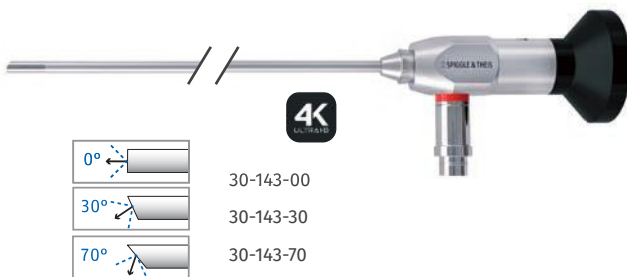

**4K, starr, autoklavierbar, AD 4,0 mm, 17,5 cm**  
**4K, rigid, autoclavable, OD 4.0 mm, 17.5 cm**

Art.-Nr./No.	Winkel / Angle
30-143-00	0°
30-143-30	30°
30-143-70	70°

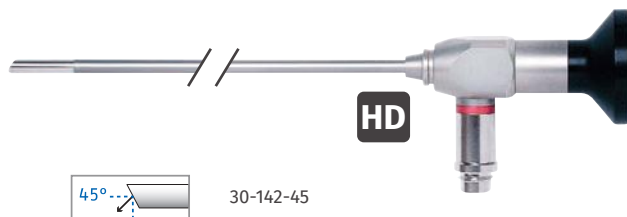

**starr, autoklavierbar, AD 4,0 mm, 17,5 cm**  
**rigid, autoclavable, OD 4.0 mm, 17.5 cm**

Art.-Nr./No.	Winkel / Angle
30-142-45	45°
30-142-90	90°

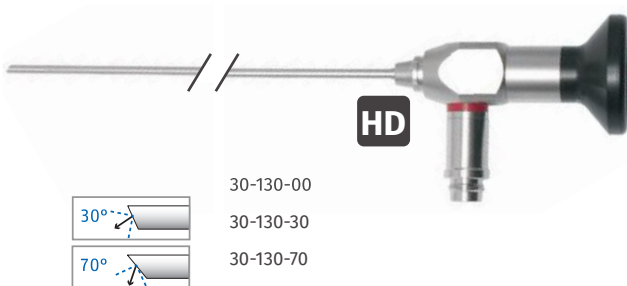

**starr, autoklavierbar, AD 2,7 mm, 18,75 cm**  
**rigid, autoclavable, OD 2.7 mm, 18.75 cm**

Art.-Nr./No.	Winkel / Angle
30-130-00	0°
30-130-30	30°
30-130-70	70°

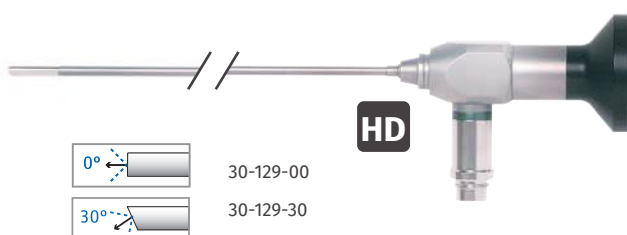

**starr, autoklavierbar, AD 2,7 mm, 11 cm**  
**rigid, autoclavable, OD 2.7 mm, 11 cm**

Art.-Nr./No.	Winkel / Angle
30-134-00	0°
30-134-30	30°

## 02 Endoskopie und Videodokumentation

### Endoscopy and Video Documentation

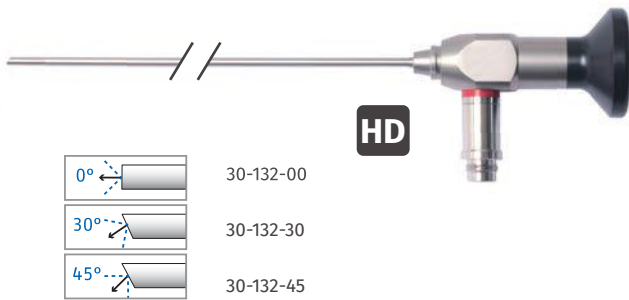

**starr, autoklavierbar, AD 2,7 mm, 14,1 cm**  
**rigid, autoclavable, OD 2.7 mm, 14.1 cm**

Art.-Nr./No.	Winkel / Angle
30-132-00	0°
30-132-30	30°
30-132-45	45°

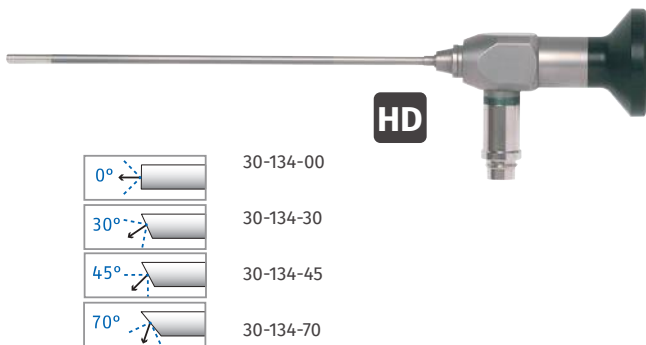

**starr, autoklavierbar, AD 2,7 mm, 11 cm**  
**rigid, autoclavable, OD 2.7 mm, 11 cm**

Art.-Nr./No.	Winkel / Angle
30-134-00	0°
30-134-30	30°
30-134-45	45°
30-134-70	70°



#### Sterilisations-Container für Endoskope

Ø 2,5 - 5,0 mm, Länge bis zu 19,5 cm

Sterilizing & protecting tray for endoscopes

Ø 2.5 - 5.0 mm, up to 19.5 cm length

Art.-Nr./No.	
80-621-05	für 2 Endoskope / for 2 endoscopes
80-622-56	für 6 Endoskope, 1 Lichtkabel for 6 endoscopes, 1 light-cable
80-623-22	für 2 Endoskope, 1 Lichtkabel, 1 Kamerakopf for 2 endoscopes, 1 light-cable, 1 camera head



## 02 Endoskopie und Videodokumentation

### Endoscopy and Video Documentation



**Endoskop-Handgriff, rund, Edelstahl, Griffmulde, 11 cm**

Endoscope handle, round, stainless steel, moulded grip, 11 cm

Art.-Nr./No.	Beschreibung / Description
30-151-27	für 2,7 mm Endoskope for 2.7 mm endoscopes
30-151-40	für 4,0 mm Endoskope for 4.0 mm endoscopes

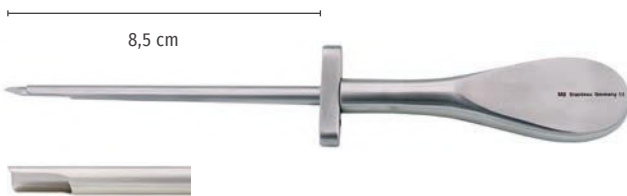

**Antrum-Trokar, schnabelförmig, 5,0 x 4,0 mm, AL 8,5 cm, für 4 mm Endoskope**

Antrum trocar, beaked, 5.0 x 4.0 mm, WL 8.5 cm, for 4 mm endoscopes

**30-155-50**

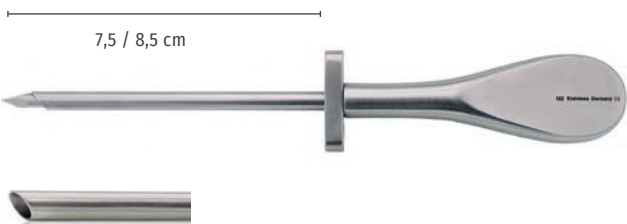

**Antrum-Trokar, schräges Ende, für Endoskope**

Antrum trocar, oblique tip, for endoscopes

Art.-Nr./No.	Beschreibung / Description
30-156-33	3,3 x 2,8 mm, AL 7,5 cm, für 2,7 mm Endoskope 3,3 x 2,8 mm, WL 7.5 cm, for 2.7 mm endoscopes
30-156-40	4,0 x 3,0 mm, AL 8,5 cm, für 3,0 mm Endoskope 4,0 x 3,0 mm, WL 8.5 cm, for 3.0 mm endoscopes
30-156-50	5,0 x 4,0 mm, AL 8,5 cm, für 4,0 mm Endoskope 5,0 x 4,0 mm, WL 8.5 cm, for 4.0 mm endoscopes



**Ultra-Stop Antibeschlagmittel / Ultra-Stop Anti-Fog solution**

Art.-Nr./No.	Beschreibung / Description
30-160-01	25 ml Pipettenflasche, unsteril 25 ml pipette bottle, non-sterile
30-160-02	30 ml Durchstichflasche, steril 30 ml pierce bottle, sterile
30-160-03	15 ml Sprayflasche, unsteril 15 ml spray bottle, non-sterile

## 02 Endoskopie und Videodokumentation

### Endoscopy and Video Documentation



**Dr. Fog original Antibeschlagmittel mit Schwamm, steril**  
**Dr. Fog original anti-fog with sponge, sterile**

**30-160-04**



**Antifog Antibeschlag-Satz, steril, 48 Stück/Box**  
**Antifog-Solution Kit, sterile, 48 pieces/box**

**30-160-05**



**Saug- und Spülhandgriff für Endoskope**  
**Suction- and irrigation handle for endoscopes**

**30-161-00**

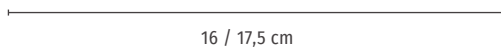

16 / 17,5 cm



**Saug- und Spülschaft für Endoskope**  
**Suction and irrigation sheath for endoscopes**

Art.-Nr. Art.-No.	Größe Size (mm)	Länge Length (cm)	Winkel Angle
30-164-00	4,0	16,0	0°
30-164-30	4,0	16,0	30°
30-164-45	4,0	16,0	45°
30-164-70	4,0	16,0	70°
30-167-00	2,7	17,5	0°
30-167-30	2,7	17,5	30°

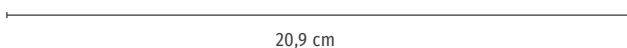

20,9 cm



**Endoskop-Schutzhülse, 20,9 cm, verlängerbar,**  
**autoklavierbar, für ein Endoskop 40-110-xx oder 40-112-xx.**  
**(Für 40-112-xx werden 2 Schutzhülsen benötigt)**

**Endoscope protective sleeve, 20.9 cm, extendable, autoclavable,**  
**for endoscope 40-110-xx or 40-112-xx.**  
**(Two protective sleeves are needed for 40-112-xx)**

**(Two protective sleeves are needed for 40-112-xx)**

**30-182-21**







#### LED-Leuchtgriffe / LED light handles

Art-Nr./No.

70-211-00 LED-Hochleistungs-Leuchtgriff, 230 V, bestehend aus: (70-211-10, 70-211-20, 70-211-30, 70-211-40)  
LED high performance light-handle, 230 V, consisting of: (70-211-10, 70-211-20, 70-211-30, 70-211-40)

70-211-01 LED-Hochleistungs-Leuchtgriff, 120 V, bestehend aus: (70-211-10, 70-211-20, 70-211-30, 70-211-50)  
LED high performance light-handle, 120 V, consisting of: (70-211-10, 70-211-20, 70-211-30, 70-211-50)

70-211-10 LED-Handgriff, schwarz, mit Helligkeitsdimmer, Ausschaltautomatik, 3 W, 5500° K, 17500 Lux, zur Verwendung mit Li-Io-Akku 3,5 V und Endoskop-Adapter, 50 Std. Brenndauer  
LED light handle, black, with brightness dimmer, automatic switch-off, 3 W, 5500° K, 17500 lux, to use with Li-ion chargeable battery 3.5 V and endoscope adapter, 50 hours run-time

70-211-20 Li-Ionen-Akku, 3,5 V, für LED-Handgriff  
Li-ion rechargeable battery, 3.5 V, for LED light-handle

70-211-30 Endoskopie-Adapter für LED-Handgriff, passend für Standardgewinde an Endoskopen (AcMI-Gewinde)  
Endoscope adapter for LED light-handle, fits standard endoscope threads (AcMi-thread)

70-211-40 Ladegerät für bis zu 2 LED-Handgriffe, 3,5 V, 230 V, Standgerät, Wandhalterung  
Charging base for up to 2 LED light-handles, 3.5 V, 230 V, table model, with wall holder

70-211-50 Ladegerät für bis zu 2 LED-Handgriffe, 3,5 V, 120 V, Standgerät, Wandhalterung  
Charging base for up to 2 LED light-handles, 3.5 V, 120 V, table model, with wall holder

## 02 Endoskopie und Videodokumentation, Flexibles Nasopharyngoskop

### Endoscopy and Video Documentation, Flexible Nasopharyngoscope

Arbeitslänge	32 cm
Working length	32 cm
Abwinkelung (auf / ab)	130°
Angle (up / down)	130°
Biegeradius	8 mm
Bending radius	8 mm
Blickfeld	80°
Field of vision	80°
Tiefenschärfe	1-50 mm
Depth of focus	1-50 mm
Gewicht	230 g
Weight	230 g



Art-Nr./No.

30-170-28

2,8 mm

30-170-36

3,4 mm

30-171-40

4,0 mm mit Arbeitskanal  
4.0 mm with working channel

Die SPIGGLE & THEIS Nasopharyngoskope der neuen Generation sind intuitiv bedienbar und ergonomisch geformt. Sie wurden für die notwendige Feinfühligkeit im täglichen Routineeinsatz und für eine ermüdungsfreie Handhabung entwickelt.

Hochwertige Bildleiter und ein leistungsfähiges optisches System liefern große und helle Bilder bester Auflösung - die Voraussetzung für eine sichere Diagnose und Therapie. Dank solider Verarbeitung und konsequenter Verwendung moderner Hochleistungswerkstoffe sind SPIGGLE & THEIS Nasopharyngoskope robuster und langlebiger - trotz steigender Belastung durch moderne Aufbereitungsverfahren.

The new generation of SPIGGLE & THEIS nasopharyngoscopes impresses with intuitive operability and optimal ergonomics, designed for tactile sensation and non-tiring handling as required in daily routine operations.

High-end fibre-optic bundles and a high-capacity system produce large and bright images of the best quality - necessary for safe diagnosis and treatment. Due to the consistent use and reliable processing of high-class materials, the SPIGGLE & THEIS nasopharyngoscopes are robust and durable, in spite of the increasing stress of modern cleaning and sterilizing facilities.

#### Vorteile unserer Endoskope:

- Funktionelles Design für eine einfache und komfortable Handhabung
- Feinfühlig, aber robuste Steuerung
- Optimale Flexibilität und Torsionssteifigkeit des Einführungsschafts
- Leistungsfähiges optisches System: größere, hellere und schärfere Bilder

#### Geeignete Wiederaufbereitungsverfahren:

- Einlegbar in Reinigungs- und Desinfektionslösung
- STERIS
- NTFD-Sterilisation = Niedertemperatur-Dampf-Formaldehyd-Sterilisation
- Maschinelle Aufbereitung (RDG-E)

#### Advantages of our endoscopes:

- Functional design for easy and comfortable handling
- Sensitive yet robust control
- Optimal flexibility and torsional rigidity of the insertion channel
- High-performance optical system for larger, brighter and sharper images

#### Suitable reprocessing procedures:

- Fully immersible in cleaning and disinfectant solutions
- STERIS
- LTFD-sterilization = Low-Temperature Steam and Formaldehyde sterilization
- Machine reprocessing (RDG-E)





**Dichtigkeitstester für flexible Endoskope**  
Leak tester for flexible endoscopes

30-169-08

**Flexible Biopsiezange, Ø 1 mm, ovaler Löffel,**  
für flexibles Endoskop 30-171-40

**Flexible biopsy forceps, Ø 1 mm, oval cups,**  
for flexible endoscope 30-171-40



Art.-Nr./No.	Länge / Length (cm)
30-172-40	120
30-172-41	40

**Flexible Alligator-Fasszange, Ø 1 mm,**  
gezahntes Maul, für flexibles Endoskop 30-171-40

**Flexible alligator forceps, Ø 1 mm,**  
serrated jaws, for flexible endoscope 30-171-40

Art.-Nr./No.	Länge / Length (cm)
30-173-40	120
30-173-41	40



**Reinigungsbürste mit Grifföse, AL 40 cm, Bürste Ø 2,0 mm, Besatzlänge 10 mm, für Arbeitskanal bis 1,5 mm, 10 Stück / Box, Einweg**  
Cleaning brush with loop, WL 40 cm, brush Ø 2.0 mm, length of edging 10 mm, for working channels up to 1.5 mm, 10 pieces/ box, single use

30-175-40



**MATRIX LED duo 2,**  
LED Hochleistungslichtquelle, 2 Lichtauslässe, 100-240 V  
MATRIX LED duo 2,  
LED high-performance light source, 2 light outputs, 100-240 V

70-203-00



**Hochleistungs-Fiberglas-Lichtleitkabel,**  
Ø 3,5 mm, 3000 mm, Endoskopseitig 90° abgewinkelt,  
Storz/Storz Anschlüsse, autoklavierbar

**High definition fibre light cable, Ø 3.5 mm, 3000 mm,**  
90° endoscope side angled, Storz/Storz connector,  
autoclavable

70-267-03

## 02 Endoskopie und Videodokumentation

### Endoscopy and Video Documentation



**Hochleistungs-Fiberglas-Lichtleitkabel,  
SPIGGLE & THEIS-Anschlüsse, autoklavierbar**  
High definition fibre light cable,  
SPIGGLE & THEIS connection, autoclavable

Art.-Nr./No.	AD / OD (mm)	Länge / Length (cm)
70-258-35	3,5	180
70-258-48	4,8	180
70-259-35	3,5	230
70-259-48	4,8	230
70-260-35	3,5	300
70-260-48	4,8	300



**Hochleistungs-Fiberglas-Lichtleitkabel,  
Ø 3,5 mm, 1800 mm, 90° abgewinkelt, autoklavierbar**  
High definition fibre light cable,  
Ø 3.5 mm, 1800 mm, 90° angled, autoclavable

Art.-Nr./No.	Beschreibung / Description
70-265-01	Wolf/Wolf-Adapter / connector Geräteseitig abgewinkelt / lightsource side angled
70-265-02	Storz/Storz-Adapter / connector Geräteseitig abgewinkelt / lightsource side angled
70-266-02	Storz/Storz-Adapter / connector Endoskopseitig abgewinkelt / endoscope side angled



**Desinfektionssystem für starre und flexible Endoskope,  
720 x 120 x 60-120 mm**  
Disinfection system for rigid and flexible endoscopes,  
720 x 120 x 60-120 mm

**70-470-00**



**Desinfektions-Wandhalterung für flexible Endoskope,  
4 Glasköcher, Aufhängung höhenverstellbar, Timer,  
233 x 750 x 60 mm (Lieferung ohne Endoskop)**  
Disinfection wall holder, for flexible endoscopes,  
4 glass tubes, hanging height adjustable, timer,  
233 x 750 x 60 mm (Delivery without endoscope)

**70-472-00**

**Weitere Lichtleitkabel und Adapter auf Anfrage**  
**More light cables and connectors on request**



## 03 Septum-Instrumente

### Septum Instruments



**Killian-Struycken Septumspeculum, 13,5 cm**  
**Killian-Struycken septum speculum, 13.5 cm**

Art.-Nr./No.	Größe / Size (cm)
20-150-40	40
20-150-55	55
20-150-65	65
20-150-75	75
20-150-90	90



**Joseph Schere, spitz-spitz, gebogen 14,5 cm**  
**Joseph scissors, pointed, curved, 14.5 cm**

**20-601-14**



**Reynolds Schere, stumpf-stumpf, gebogen, verjüngte Spitzen, 15 cm**  
**Reynolds scissors, blunt-blunt, curved, tapered tips, 15 cm**

**20-610-15**



**Walter Schere, abgewinkelt, 10 cm**  
**Walter scissors, angled, 10 cm**

**20-630-10**

## 03 Septum-Instrumente

### Septum Instruments



**Joseph Schere, Premium Line, spitz-spitz**  
**Joseph Scissor, premium scissor, pointed**

**Premium Line**

Art.-Nr.	Länge (cm)	Beschreibung
20-640-14	14,5	gerade
20-641-14	14,5	gebogen



**Reynolds Schere, Premium Line,**  
**stumpf-stumpf, gebogen, verjüngte Spitzen**  
**Reynolds scissors, premium line,**  
**blunt-blunt, curved, tapered tips**

**Premium Line**

Art.-Nr.	Länge (cm)
20-635-15	15,0
20-635-18	18,0





## 03 Septum-Instrumente

### Septum Instruments

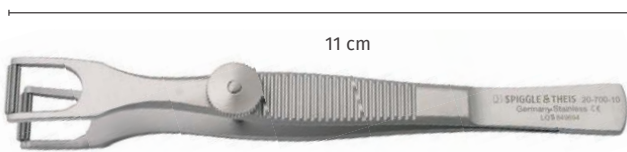

**Cottle Columella-Klemme, 11 cm / Cottle columella forceps, 11 cm**

**20-700-10**



**Adson-Brown Pinzette, 7:8 Zähne, 12,5 cm**

**Adson-Brown forceps, 7:8 teeth, 12.5 cm**

**20-710-12**

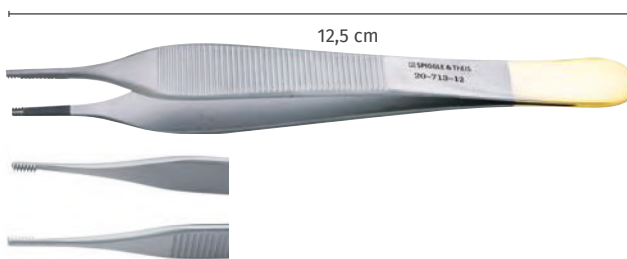

**Adson-Brown Pinzette, Hartmetall, 7:8 Zähne, 12,5 cm**

**Adson-Brown forceps, carbide, 7:8 teeth, 12.5 cm**

**20-713-12**

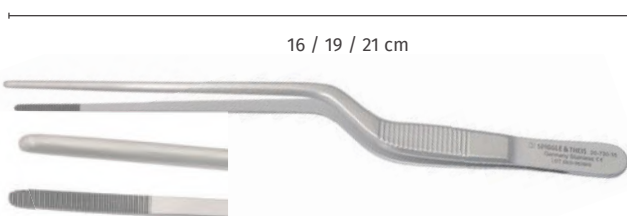

**Jansen Nasenpinzette, bajonett, anatomisch**

**Jansen nasal forceps, bayonet, anatomical**

Art.-Nr./No.	Länge / length (cm)	Beschreibung / Description
20-730-16	16	
20-730-19	19	
20-730-21	21	
20-731-16	16	1:2 Zähne/1:2 teeth

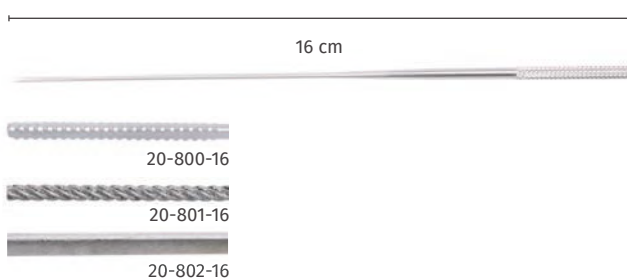

**Watteträger, Ø 1,2 mm, 16 cm, 5 Stück**

**Cotton carrier, Ø 1.2 mm, 16 cm, 5 pieces**

Art.-Nr./No.	Beschreibung / Description
20-800-16	dreikant, gerieft / triangle, serrated
20-801-16	rund, gerieft / round, serrated
20-802-16	dreikant, glatt / triangular, smooth





**Cottle Septum-Messer, 14 cm / Cottle septum knife, 14 cm**

**20-500-13**

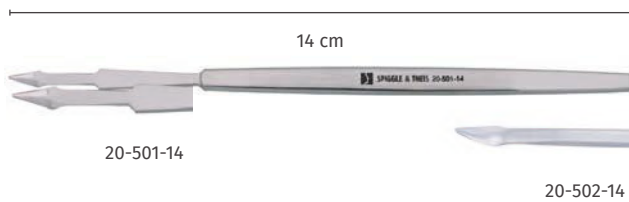

**Masing Ritzmesser, 14 cm / Masing pointed knife, 14 cm**

Art.-Nr./No.	Beschreibung / Description
20-501-14	mit Kerbe / grooved
20-502-14	glatt / smooth



**Masing Elevatorium/Raspatorium, 21 cm**

**Masing elevator/raspatory, 21 cm**

**20-300-21**

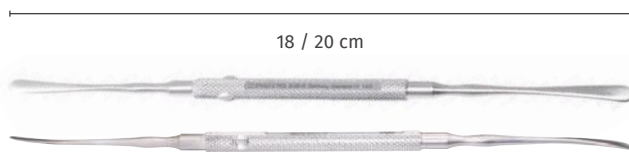

**Freer Doppelelevatorium, scharf-stumpf**

**Freer elevator, double ended, sharp-blunt**

Art.-Nr./No.	Länge / length (cm)
20-305-18	18
20-306-20	20



**Weber Doppelelevatorium, scharf/stumpf, 18,5 cm**

**Weber elevator, double ended, sharp/blunt, 18.5 cm**

**20-307-18**

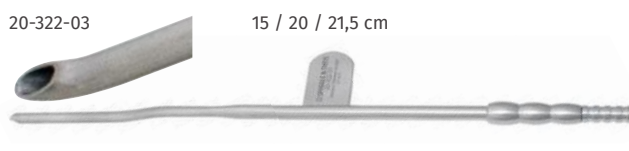

**Guillen Saugraspatorium, 4,5 mm**

**Guillen suction raspatory, 4.5 mm**



Art.-Nr./No.	Beschreibung / Description
20-322-01	20 cm, gerade / straight
20-322-02	20 cm, links gebogen / curved left
20-322-03	21,5 cm, rechts gebogen / curved right
20-323-01	15 cm, gerade / straight
20-323-02	15 cm, links gebogen / curved left
20-323-03	15 cm, rechts gebogen / curved right

## 03 Septum-Instrumente

### Septum Instruments

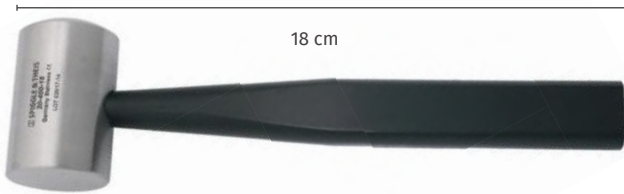

**Cottle Hammer, 18 cm**

Cottle mallet, 18 cm

**20-400-18**



**Hammer, mit Silikongriff, 20 cm**

Mallet, with silicone handle, 20 cm

**20-404-20**



**Cottle Meißel, flach, 18,5 cm / Cottle chisel, flat, 18.5 cm**

Art.-Nr./No.	Größe / Size (mm)
20-405-04	4,0
20-405-07	7,0
20-405-09	9,0
20-405-10	10,0
20-405-12	12,0

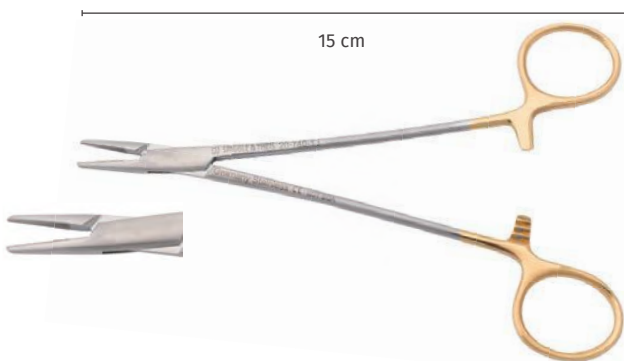
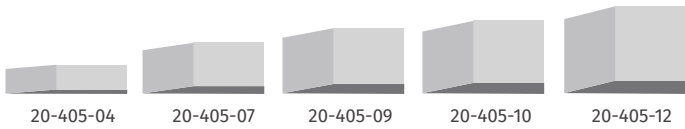

**Crile-Wood Nadelhalter, Hartmetall, 15 cm**

Crile-Wood needleholder, tungsten carbide, 15 cm

**20-740-15**

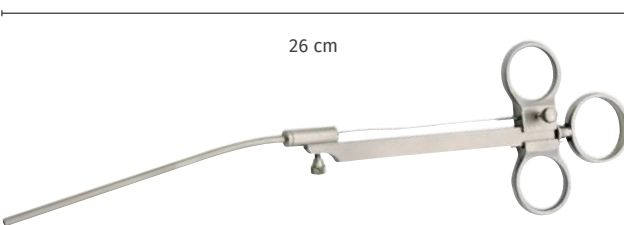

**Krause Nasen-Polypen-Schnürer, scharf, 26 cm**

Krause nasal polyp snare, sharp, 26 cm

**20-190-25**

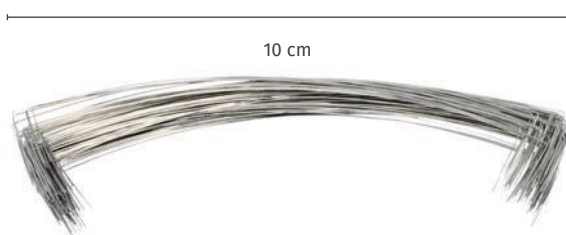

**Nasenpolypenschlingen, 0,35 mm, 10 cm, 100 Stück**

Nasal polyp snare wires, 0.35 mm, 10 cm, 100 pieces

**20-195-35**

## 03 Septum-Instrumente

### Septum Instruments

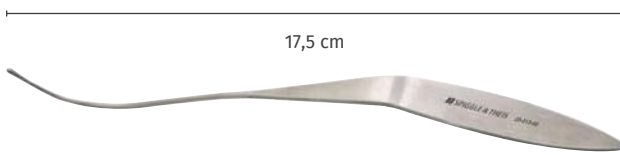

**Nasensonde, s-förmig gebogen, biegbare**, 17,5 cm  
**Nasal probe, s-shaped, bendable**, 17.5 cm

20-313-00



**Cottle Nasenflügelhaken**, 14 cm / **Cottle alar retractor**, 14 cm

20-560-14



**Bipolare Pinzette, NON-STICK, bajonett, Spitze 0,5 mm**, 16 cm  
**Bipolar forceps, NON-STICK, bayonet, tip 0.5 mm**, 16 cm

80-110-16



**Bipolare Pinzette, NON-STICK, bajonett, Spitze 0,7 mm**, 23 cm  
**Bipolar forceps, NON-STICK, bayonet, tip 0.7 mm**, 23 cm

80-126-23



**Geräteseitig, 22 mm, passend für** / **unit-side, 22 mm, compatible to Erbe / EMC / Dolly**

Art.-Nr./No.	Länge / Length (m)
80-316-50	5



**Geräteseitig, passend für** / **unit-side, compatible to Sutter/Martin/Berchtold/Aesculap/Integra/SPIGGLE & THEIS**

Art.-Nr./No.	Länge / Length (m)
80-317-30	3
80-317-50	5



**Geräteseitig, 29 mm, passend für** / **unit-side, 29 mm, compatible to Valleylab/Lamidey/EMC/Bowa/Olympus**

Art.-Nr./No.	Länge / Length (m)
80-319-30	3
80-319-50	5

\* Abbildungen der Kabel sind ähnlich / images similar to product



### 03 Septum-Instrumente Blakesley Nasenzange Premium Modell

#### Septum Instruments Blakesley premium model nasal forceps



**Vorteile / Advantages**

- schlanker Schaft / slim shank
- schmales Maulteil / slender jaw
- feine Ausarbeitung / smooth finish

**gerade / straight**

Art.-Nr. Art.-No.	Größe Size (mm)		Länge Length (cm)
20-215-00	3,0		11,5
20-215-01	3,5		11,5
20-215-02	4,0		11,5
20-215-03	5,0		11,5
20-215-04	6,0		11,5
20-215-10	3,0		15,0
20-215-12	4,0		15,0
20-215-14	6,0		15,0

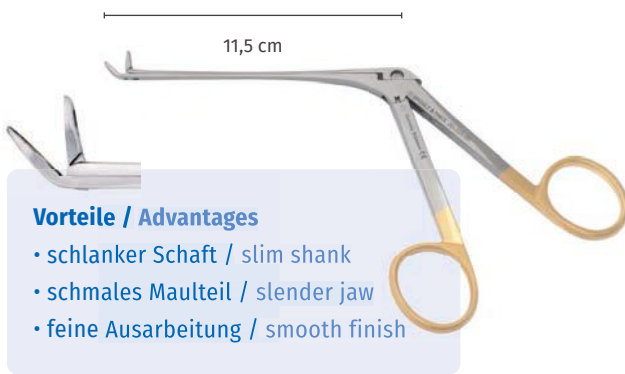

**Vorteile / Advantages**

- schlanker Schaft / slim shank
- schmales Maulteil / slender jaw
- feine Ausarbeitung / smooth finish

**45° aufgebogen, 11,5 cm / curved upwards 45°, 11.5 cm**

Art.-Nr./No.	Größe / Size (mm)	
20-225-00	3,0	
20-225-01	3,5	
20-225-02	4,0	
20-225-03	5,0	
20-225-04	6,0	

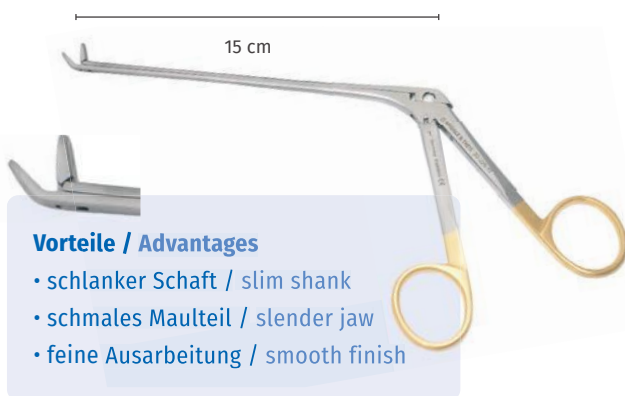

**Vorteile / Advantages**

- schlanker Schaft / slim shank
- schmales Maulteil / slender jaw
- feine Ausarbeitung / smooth finish

**90° aufgebogen, 11,5 cm / curved upwards 90°, 11.5 cm**

Art.-Nr./No.	Größe / Size (mm)	
20-235-01	3,5	
20-235-02	4,0	
20-235-03	5,0	

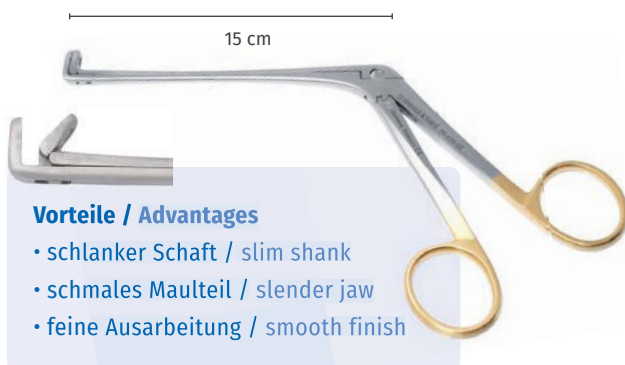

**Vorteile / Advantages**

- schlanker Schaft / slim shank
- schmales Maulteil / slender jaw
- feine Ausarbeitung / smooth finish

**45° aufgebogen, 15 cm / curved upwards 45°, 15 cm**

Art.-Nr./No.	Größe / Size (mm)	
20-225-11	3,5	
20-225-12	4,5	
20-225-14	6,0	



**Hartmann Nasentamponadezange**

**Hartmann nasal dressing forceps**

Art.-Nr./No.	Größe / Size (cm)	
20-200-16	16	fein / delicate
20-200-20	20	



**Wigand Polypen-Fasszange, 60° aufgebogen, 11,5 cm**

**Wigand polyp-grasping forceps, 60° angled, 11.5 cm**

**20-236-00**



**Strümpel-Voss Nasenzange, 45°, 11,5 cm**

**Strümpel-Voss nasal forceps, 45°, 11.5 cm**

**20-238-00**



## 03 Septum-Instrumente

### Septum Instruments



#### Blakesley Nasenzange / Blakesley nasal forceps

Art.-Nr./No.	Größe / Size (cm)	Winkel / Angle
20-240-01	12,5	links gebogen / curved left
20-240-02	12,5	rechts gebogen / curved right
20-240-11	16,0	links gebogen / curved left
20-240-12	16,0	rechts gebogen / curved right



#### Takahashi Nasenzange / Takahashi nasal forceps

Art.-Nr. Art.-No.	Länge Length (cm)	Größe Size (mm)	Winkel Angle
20-245-01	11,5	2,5	gerade / straight
20-245-11	15,0	2,5	gerade / straight
20-246-01	11,5	4,0	gerade / straight
20-245-02	11,5	2,5	30° aufgebogen 30° curved upwards
20-245-12	15,0	2,5	30° aufgebogen 30° curved upwards
20-246-02	11,5	4,0	30° aufgebogen 30° curved upwards

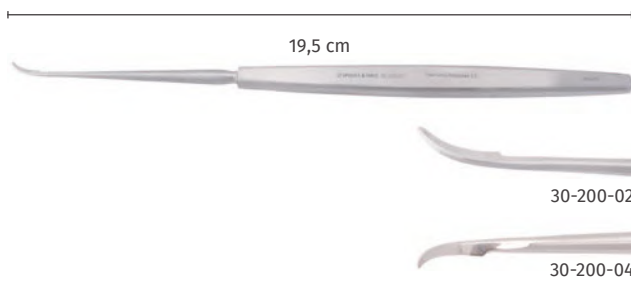

**Sichelmesser, gerader Schaft, 19,5 cm**

**Sickle knife, straight shaft, 19.5 cm**

Art.-Nr./No.	Beschreibung / Description
30-200-01	spitz / pointed
30-200-02	abgerundet / rounded
30-200-03	links gebogen, spitz curved left, pointed
30-200-04	rechts gebogen, spitz curved right, pointed

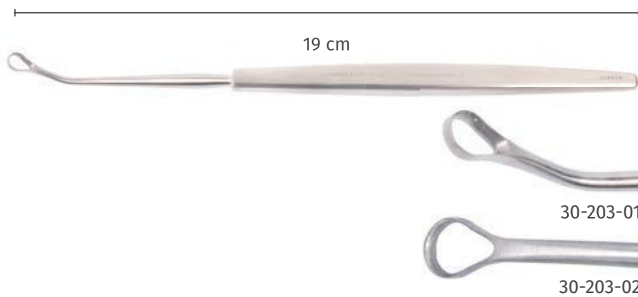

**Antrum-Kürette, gerader Schaft, 19 cm**

**Antrum curette, straight shaft, 19 cm**

Art.-Nr./No.	Beschreibung / Description
30-203-01	vorwärts schneidend / forward cutting
30-203-02	rückwärts schneidend / backward cutting



**Antrum-Löffel, oval, 7,0 x 10,5 mm, gebogen, 19,5 cm**

**Antrum curette, oval, 7.0 x 10.5 mm, curved, 19.5 cm**

**30-205-01**

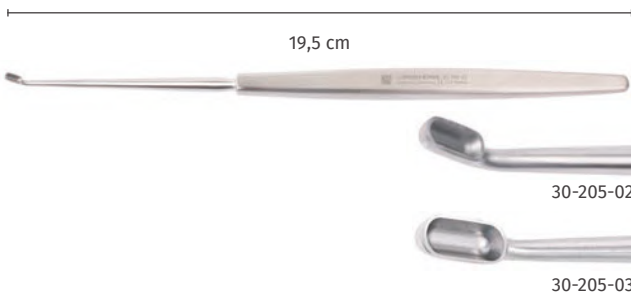

**Antrum-Löffel, längsoval, 45° gewinkelt, 19,5 cm**

**Antrum curette, oval, 45° angled, 19.5 cm**

Art.-Nr./No.	Beschreibung / Description
30-205-02	klein (2,5 x 6,0 mm) / small
30-205-03	groß (4,0 x 9,0 mm) / large





## 04 FESS-Instrumentarium

### FESS Instruments

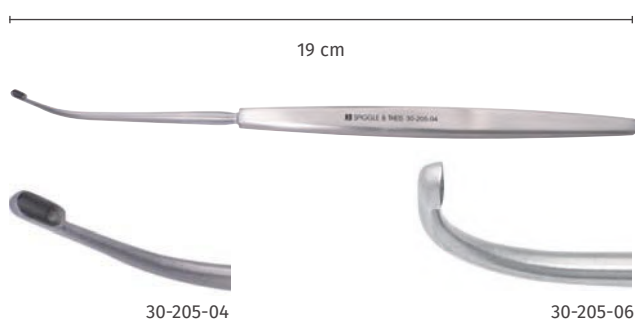

**Stirnhöhlen-Löffel, gerader Schaft, längsoval, Löffelgröße 2,5 x 6,0 mm, 19 cm**  
**Frontal sinus curette, straight shaft, oval, tip size 2.5 x 6.0 mm, 19 cm**

Art.-Nr./No.	Winkel / Angle
30-205-04	55° aufgebogen / 55° curved upwards
30-205-06	90° aufgebogen / 90° curved upwards
30-205-70	70° aufgebogen / 70° curved upwards



**Wigand Stirnhöhlenraspel, 21 cm**  
**Wigand frontal sinus rasp, 21 cm**

**30-209-01**

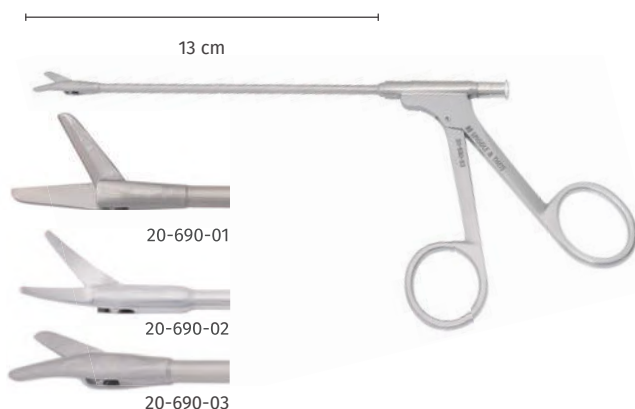

**Conchotomie Schere, gezahnt, Rohrschaft, mit Spülkanal, 13 cm**  
**Nasal conchotomy scissors, serrated, tubular model, with irrigation channel, 13 cm**

Art.-Nr./No.	Beschreibung / Description
20-690-01	gerade / straight
20-690-02	links gebogen / curved left
20-690-03	rechts gebogen / curved right



**Weber Nasenschere, extra fein, gerade, mit Spülkanal, 10,5 cm**  
**Weber nasal scissors, very fine, straight, with irrigation channel, 10.5 cm**

**20-691-01**



Diese Scheren eignen sich hervorragend zur Eröffnung von Siebbeinzellen unter weitgehender Erhaltung der Schleimhaut.

Ein „Anstechen“ und nicht „Vorschieben“ der Siebbeinschleimhaut ist mit der extra feinen und verlängerten unteren Schneide gewährleistet.

Dr. med. Hohenhorst,  
Chefarzt der HNO Abteilung des  
Alfried Krupp Krankenhauses in Essen

These scissors are ideally suited for opening ethmoidal cells while keeping the mucous membrane largely intact.

The super-fine and elongated lower blade ensures that the mucous membrane of the ethmoid bone is “punctured” and not “pushed forward.”

Dr. med. Hohenhorst,  
Chief physician of the ENT department  
of the Alfred Krupp Clinic, Essen, Germany



#### Conchotomie Schere, 11,5 cm

#### Nasal conchotomy scissors, 11.5 cm

Art.-Nr./No.	Beschreibung / Description
20-693-00	standard / standard
20-693-01	extra fein / extra delicate
20-693-02	extra fein, spitz, untere Schneide verlängert extra delicate, pointed, lower blade longer



#### Stirnhöhlensonde, doppelseitig, leicht gebogen, 20,5 cm

#### Frontal sinus probe, double ended, slightly curved, 20.5 cm

30-207-01

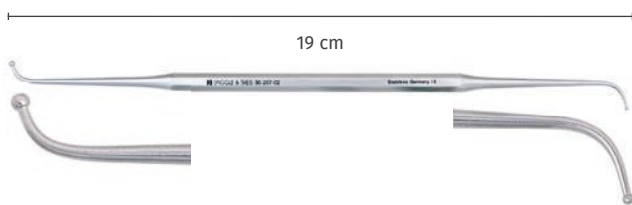

#### Kieferhöhlensonde, doppelseitig, 19 cm

#### Maxillary sinus probe, double ended, 19 cm

30-207-02

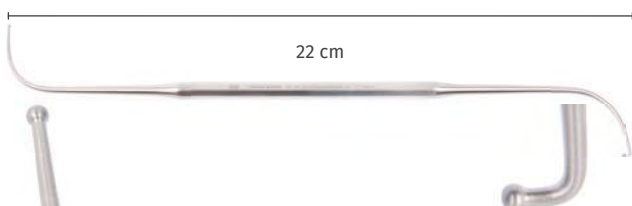

#### Stirnhöhlensonde, doppelseitig, stark gebogen, 22 cm

#### Frontal sinus probe, double ended, strongly curved, 22 cm

30-207-03



## 04 FESS-Instrumentarium

### FESS Instruments

SPIGGLE & THEIS Medizintechnik GmbH legt besonderen Wert darauf, dass alle Instrumente und Endoskope nach validierten Verfahren aufbereitet werden können. Dies bezieht sich sowohl auf die Reinigung als auch auf die Sterilisation der Produkte. Innovative Lösungen wie Spülkanäle in Rohrschaft-Instrumenten oder Zerlegbarkeit von Zangen und Stanzen belegen unsere Vorreiterrolle in diesem Bereich.

It is of special importance to SPIGGLE & THEIS Medizintechnik GmbH that all our instruments and endoscopes can be processed in accordance with accepted validation methods, regarding both the cleaning and the sterilization of the products. Our pioneering position in this field is supported by such innovative solutions as irrigation channels in tube-shaft instruments as well as detachable slide-bar instruments for forceps and punches.

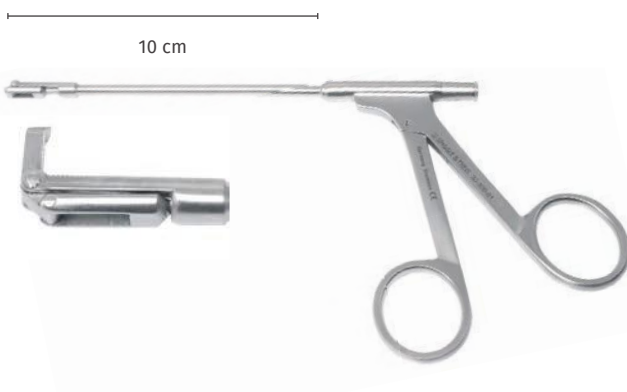

#### **Antrumstanze, rückwärts schneidend, 2,5 mm, mit Spülkanal, 10 cm**

**Antrum punch, backward cutting, 2.5 mm, with irrigation channel, 10 cm**

Art.-Nr./No.	Beschreibung / Description
30-300-01	Gerade schneidend / straight cutting
30-300-02	Links schneidend / left cutting
30-300-03	Rechts schneidend / right cutting

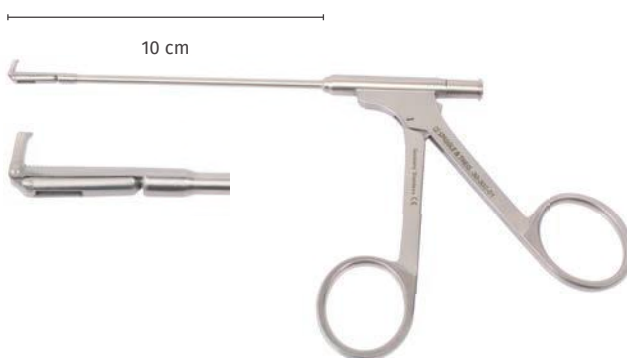

#### **Antrumstanze, rückwärts schneidend, gerade, 1,5 mm, 10 cm, mit Spülkanal**

**Antrum punch, backward cutting, straight, 1.5 mm, 10 cm, with irrigation channel**

Art.-Nr./No.	Beschreibung / Description
30-302-01	Gerade schneidend / straight cutting
30-302-02	Links schneidend / left cutting
30-302-03	Rechts schneidend / right cutting

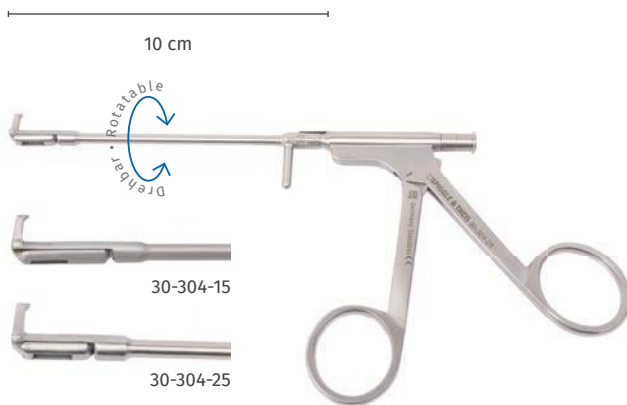

**Antrumstanze, rückwärts schneidend, drehbar, 2,5 mm, mit Spülkanal, 10 cm**  
**Antrum punch, backward cutting, rotatable, 2.5 mm, with irrigation channel, 10 cm**

Art.-Nr./No.	Größe / Size (mm)
30-304-15	1,5
30-304-25	2,5

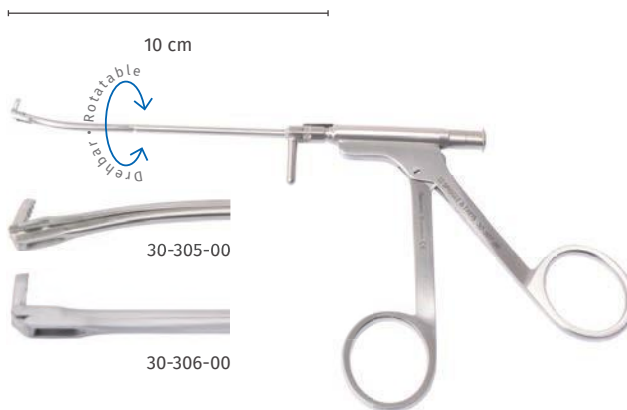

**Tobey Mikro-Antrumstanze, rückwärts schneidend, drehbar, mit Spülkanal, 10 cm**  
**Tobey micro antrum punch, backward cutting, rotatable, with irrigation channel, 10 cm**

Art.-Nr./No.	Beschreibung / Description
30-305-00	Schaft abwärts gebogen / downwards curved shaft
30-306-00	gerader Schaft / straight shaft
30-307-00	Schaft aufwärts gebogen / upwards curved shaft

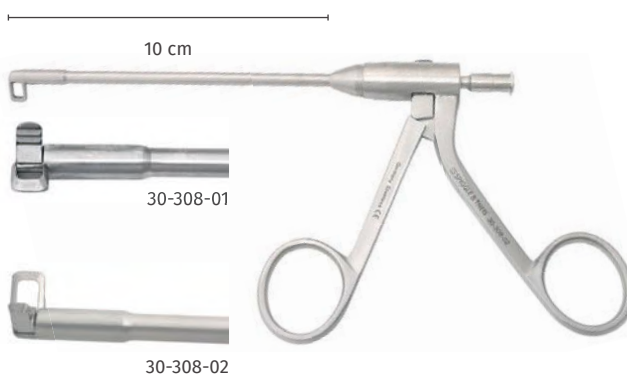

**Antrumstanze, seitwärts schneidend, 10 cm**  
**Antrum punch, sideways cutting, 10 cm**

Art.-Nr./No.	Beschreibung / Description
30-308-01	Links schneidend / left cutting
30-308-02	Rechts schneidend / right cutting



## 04 FESS-Instrumentarium

### FESS Instruments

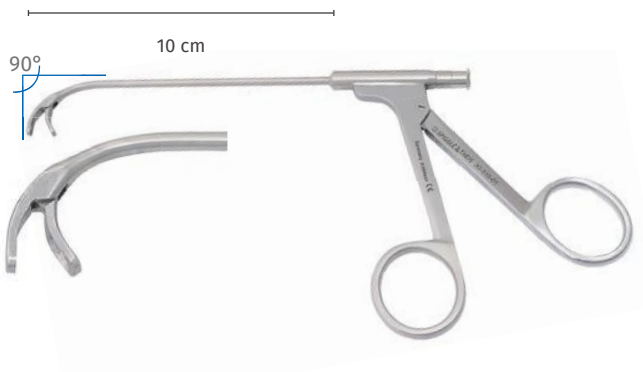

**Kieferhöhlen Polypen-Fasszange, rückwärts öffnend, mit Spülkanal, 10 cm**  
**Antrum polyp grasping forceps, retrograde opening, with irrigation channel, 10 cm**

**30-310-01**



**Kieferhöhlen Polypen-Fasszange, rückwärts öffnend, extra langer Schaftbogen, mit Spülkanal, 10 cm**  
**Antrum polyp grasping forceps, retrograde opening, extra long shaft curve, with irrigation channel, 10 cm**

**30-310-02**

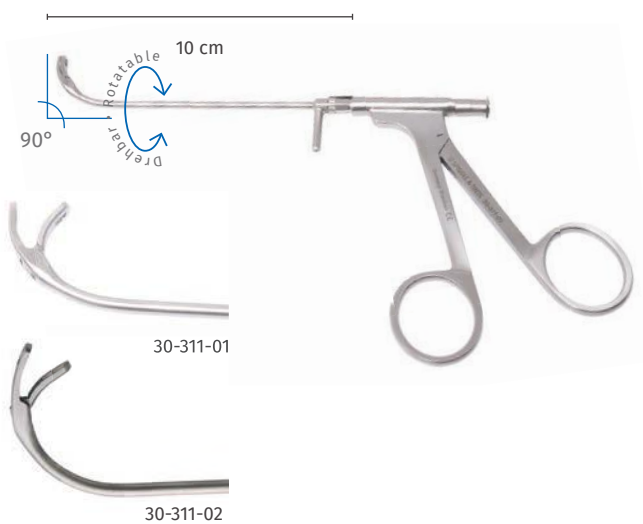





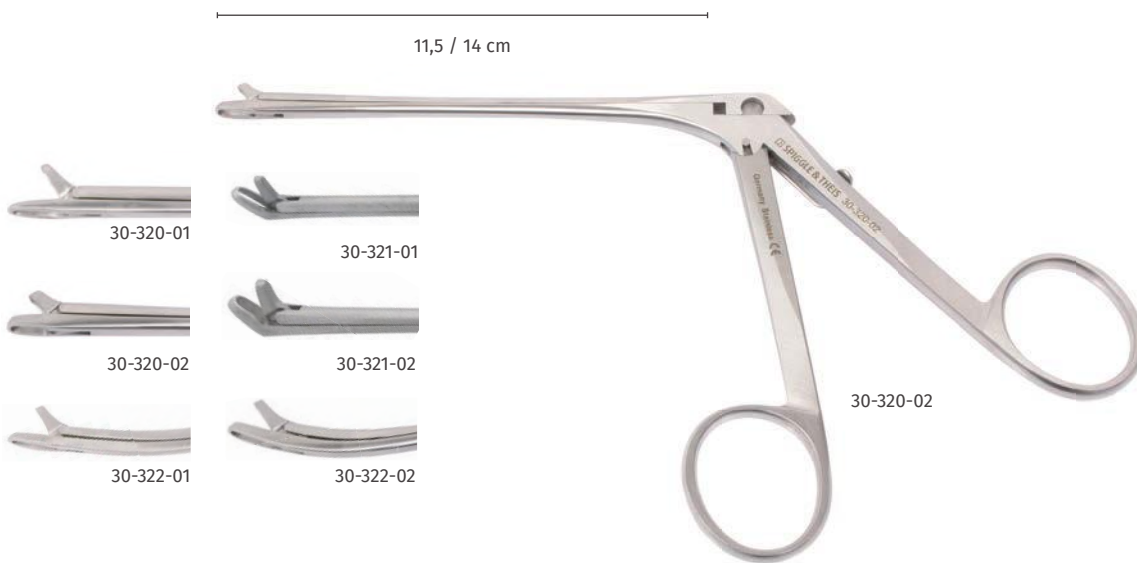

**Kieferhöhlen Polypen-Fasszange, rückwärts öffnend, drehbar, 10 cm**  
**Antrum polyp grasping forceps, retrograde opening, rotatable, 10 cm**

Art.-Nr./No.	Beschreibung / Description
30-311-01	normaler Schaft / normal shaft
30-311-02	extra langer Schaftbogen / extra long shaft curve



**Durchschneidende Nasenzange / Throughcutting nasal forceps**

Art.-Nr. Art.-No.	Größe Size (mm)	Länge Length (cm)		Winkel Angle
30-320-01	5,0 x 1,5	14,0		gerade / straight
30-320-02	6,5 x 2,5	11,5		gerade / straight
30-321-01	5,0 x 1,5	14,0		60° gewinkelt / 60° angled
30-321-02	6,5 x 2,5	11,5		60° gewinkelt / 60° angled
30-322-01	5,0 x 1,5	14,0		aufgebogen / curved upwards
30-322-02	8,0 x 3,0	14,0		aufgebogen / curved upwards

**Vorteile / Advantages**

Stumpfes Ende = Dura-Schutz  
Blunt end = dura protection



**Löffelzange, aufgebogen, kräftig, 6,5 x 2,5 mm, 14 cm**  
**Cup Forceps, curved upwards, robust, 6.5 x 2.5 mm, 14 cm**

**30-328-01**



## 04 FESS-Instrumentarium

### FESS Instruments

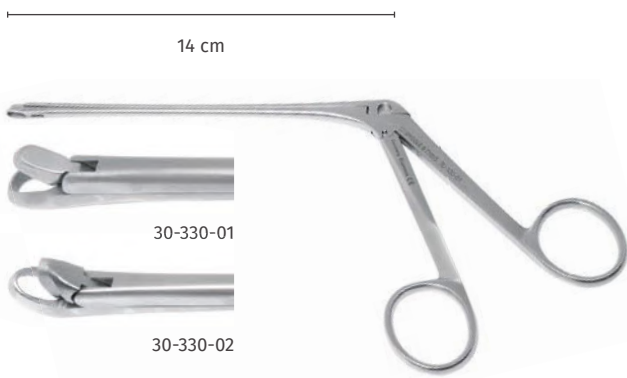

**Wigand durchschneidende Zange, flach, abgerundet, 14 cm**  
**Wigand throughcutting forceps, flat, rounded, 14 cm**

Art.-Nr. Art.-No.	Größe Size (mm)	Winkel Angle
30-330-01	4,0 x 3,0	gerade / straight
30-330-02	4,0 x 3,0	45° aufgewinkelt / 45° angled



**Herberhold cranial durchschneidende Zange, flach**  
**Herberhold cranial throughcutting forceps, flat**

Art.-Nr. Art.-No.	Größe Size (mm)	Länge Length (cm)	Winkel Angle
30-332-01	6,0 x 2,0	14	gerade / straight
30-332-02	11,5 x 2,5	14	gerade / straight
30-333-01	6,0 x 2,0	14	60° aufgebogen 60° curved upwards
30-333-02	11,5 x 2,5	14	60° aufgebogen 60° curved upwards

#### Vorteile:

- Stanzmaterial wird nach oben ausgeworfen
- Unterer Block (feststehend) kann als Trokar verwendet werden
- Zahnung verhindert Wegrutschen

#### Advantages:

- punched material is ejected upwards
- Lower block (fixed) can be used as trocar
- Serration prevents slipping

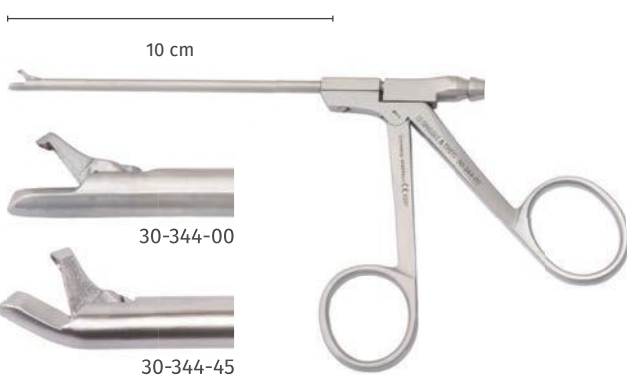

**Durchschneidende Saugzange, 10 cm**  
**Throughcutting suction forceps, 10 cm**

Art.-Nr./No.	Winkel / Angle
30-344-00	gerade / straight
30-344-45	30° aufgewinkelt / 30° angled



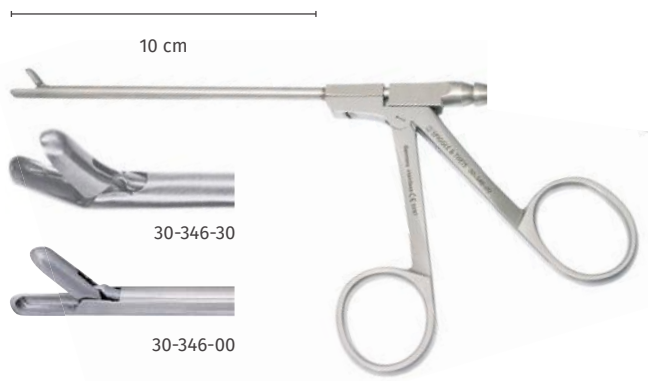

**Takahashi Nasenzange mit Saugkanal, 10 cm**  
**Takahashi suction forceps with suction tube, 10 cm**

Art.-Nr./No.	Winkel / Angle
30-346-00	gerade / straight
30-346-30	30° aufgewinkelt / 30° angled

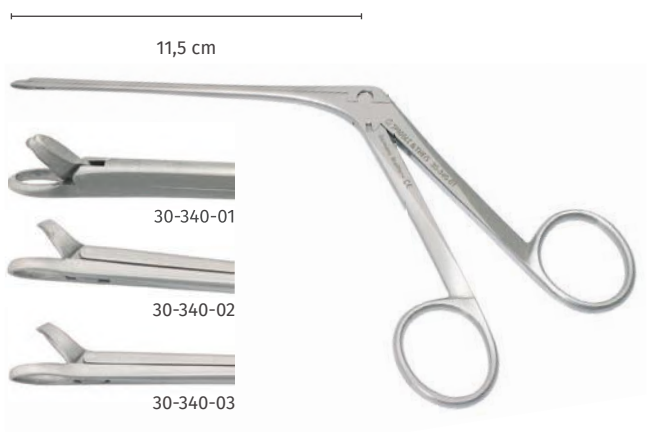

**Blakesley Nasenzange, durchschneidend, gerade, 11,5 cm**  
**Blakesley nasal forceps, throughcutting, straight, 11.5 cm**

Art.-Nr./No.	Größe / Size (mm)
30-340-01	5,0 x 2,0
30-340-02	6,0 x 2,5
30-340-03	7,0 x 3,0



**Blakesley Nasenzange, durchschneidend, 45° aufgebogen, 11,5 cm**  
**Blakesley nasal forceps, throughcutting, 45° curved upwards, 11.5 cm**

Art.-Nr./No.	Größe / Size (mm)
30-342-01	6,0 x 3,0
30-342-02	6,0 x 2,5
30-342-03	8,0 x 3,0



## 04 FESS-Instrumentarium

### FESS Instruments

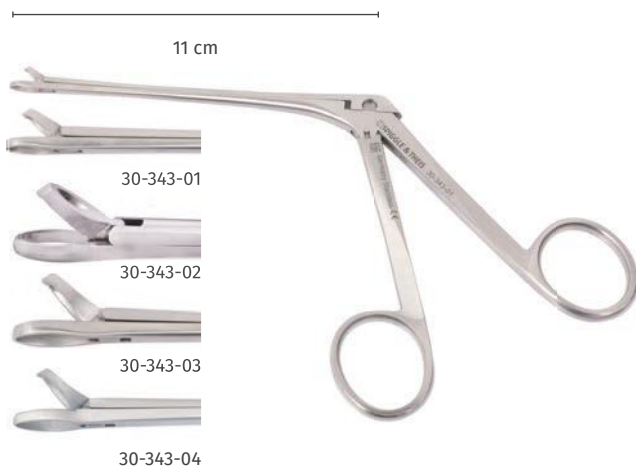

**Blakesley Nasenzange, durchschneidend, gerade, 11 cm**  
**Blakesley nasal forceps, throughcutting, straight, 11 cm**

Art.-Nr./No.	Größe / Size (mm)	Größe / Size
30-343-01	6,0 x 3,0	1
30-343-02	8,0 x 3,5	2
30-343-03	8,0 x 4,0	3
30-343-04	10,0 x 4,8	4

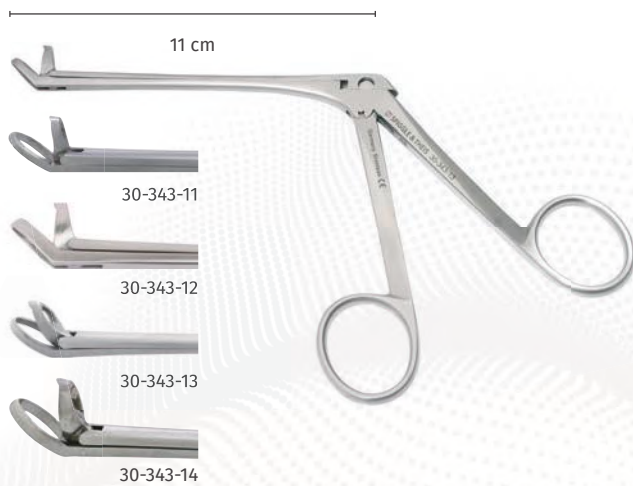

**Blakesley Nasenzange, durchschneidend, 45° aufgebogen, 11 cm**  
**Blakesley nasal forceps, throughcutting, 45° curved upwards, 11 cm**

Art.-Nr./No.	Größe / Size (mm)	Größe / Size
30-343-11	8,0 x 3,0	1
30-343-12	8,0 x 3,5	2
30-343-13	9,0 x 4,2	3
30-343-14	10,0 x 4,8	4

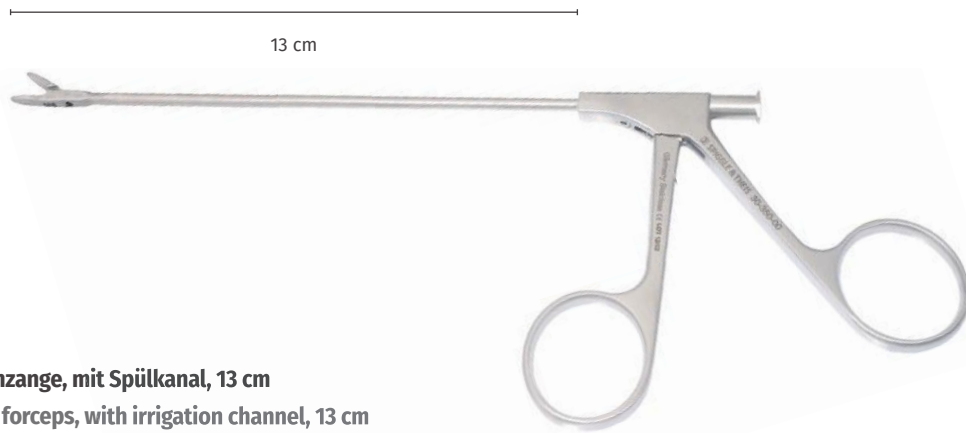
**Blakesley Nasenzange, mit Spülkanal, 13 cm****Blakesley nasal forceps, with irrigation channel, 13 cm**

Art.-Nr./No.	Größe / Size (mm)	Winkel / Angle
30-350-00	3,0	gerade / straight
30-350-01	3,5	gerade / straight
30-350-02	4,0	gerade / straight
30-350-03	5,0	gerade / straight
30-352-00	3,0	45° aufgebogen / 45° curved upwards
30-352-01	3,5	45° aufgebogen / 45° curved upwards
30-352-02	4,0	45° aufgebogen / 45° curved upwards
30-354-01	3,5	90° aufgebogen / 90° curved upwards
30-354-02	4,0	90° aufgebogen / 90° curved upwards
30-358-00	3,0	gerade, durchschneidend / straight, throughcutting
30-358-01	3,5	gerade, durchschneidend / straight, throughcutting
30-358-02	4,0	gerade, durchschneidend / straight, throughcutting
30-360-00	3,0	45° aufgebogen, durchschneidend / 45° curved upwards, throughcutting
30-360-01	3,5	45° aufgebogen, durchschneidend / 45° curved upwards, throughcutting
30-360-02	4,0	45° aufgebogen, durchschneidend / 45° curved upwards, throughcutting



## 04 FESS-Instrumentarium

### FESS Instruments



**Grünwald Rohrschaftzange, durchschneidend, 13 cm, mit Spülkanal**  
**Grünwald tubular forceps, throughcutting, 13 cm, with irrigation channel**

Art.-Nr. Art.-No.	Größe Size (mm)	Winkel Angle
30-370-15	1,5	gerade, Schaft gerade / straight, straight shaft
30-370-20	2,0	gerade, Schaft gerade / straight, straight shaft
30-370-25	2,5	gerade, Schaft gerade / straight, straight shaft
30-370-30	3,0	gerade, Schaft gerade / straight, straight shaft
30-371-15	1,5	45°, Schaft gerade / 45°, straight shaft
30-371-20	2,0	45°, Schaft gerade / 45°, straight shaft
30-371-25	2,5	45°, Schaft gerade / 45°, straight shaft
30-371-30	3,0	45°, Schaft gerade / 45°, straight shaft
30-372-15	1,5	gerade, Schaft 30° aufgebogen / straight, shaft 30° curved upwards
30-372-20	2,0	gerade, Schaft 30° aufgebogen / straight, shaft 30° curved upwards
30-372-25	2,5	gerade, Schaft 30° aufgebogen / straight, shaft 30° curved upwards
30-373-15	1,5	45°, Schaft 30° aufgebogen / 45°, shaft 30° curved upwards
30-373-20	2,0	45°, Schaft 30° aufgebogen / 45°, shaft 30° curved upwards
30-373-25	2,5	45°, Schaft 30° aufgebogen / 45°, shaft 30° curved upwards
30-374-20	2,0	gerade öffnend, Schaft 70° aufgebogen / straight opening, shaft 70° curved upwards
30-375-20	2,0	seitl. rechts öffnend, Schaft 70° aufgebogen / right side opening, shaft 70° curved upwards
30-376-20	2,0	seitl. links öffnend, Schaft 70° aufgebogen / left side opening, shaft 70° curved upwards

## 05 Dieler Bipolare Koagulationszangen

### Dieler bipolar coagulation forceps



Prof. Dr. med. Ralf Dieler  
Leitender Arzt, HNO-Abteilung,  
Rotkreuzklinik Würzburg

Prof. Dr. med. Ralf Dieler  
ENT-specialist  
Rotkreuzklinik Würzburg, Germany

Um den Gewebeschaden durch Koagulation arterieller Blutungen bei chirurgischen Eingriffen in der Nasennebenhöhle (A. ethmoidalis post. oder der A. sphenopalatina) möglichst gering zu halten, sind bipolare Zangen zu bevorzugen. Gegenüber der monopolaren Technik wird hierbei bis zu 30% weniger Leistung benötigt. Darüber hinaus entstehen keine relevanten elektrischen Interferenzen mit elektronischen Implantaten (z.B. Herzschrittmacher, Cochlear Implant) oder mit Geräten, die am Patienten angeschlossen sind (z.B. EKG, EEG).

Die Dieler Koagulations-Fasszange ist 30° gewinkelt, gefenestriert und 360° drehbar, so dass ein gezieltes Fassen der genannten Gefäße möglich ist. Für eine bessere Sicht im Situs können mit Hilfe eines Einmal-Schlauchsets Blut und Schmauch gleichzeitig abgesaugt werden.

Bipolar forceps should be used in order to minimize tissue damage caused by coagulation in arterial bleeding (post ethmoid artery or the sphenopalatine artery) during paranasal sinus surgery. Up to 30% less power is required in comparison with monopolar technology. A further advantage is that there will be no relevant electrical interference with electrical implants (e.g. cardiac pacemaker, cochlear implant) or bodily function supporting devices (e.g. EKG, EEG).

The Dieler bipolar coagulation forceps is 30° angled, fenestrated and 360° rotatable. This allows a controlled grasping of the mentioned vessels. For better viewing conditions in situs, the disposable attachable suction tube effectively evacuates blood and smoke.



## 05 Dieler Bipolare Koagulationszangen

### Dieler bipolar coagulation forceps

#### Basis-Komponenten / Basic components



**Ringgriff für Dieler Koagulationszange**  
Ring handle for Dieler coagulation forceps

80-090-00



**Schaft für Dieler Koagulationszange, 3 mm, 15 cm**  
Shaft for Dieler coagulation forceps, 3 mm, 15 cm

80-090-01



**Fasszange für Dieler Koagulationszange, 30° gewinkelt, gefenestert, 15 cm**

Grasping forceps for Dieler coagulation forceps, 30° angled, fenestrated, 15 cm

80-090-04



## 05 Dieler Bipolare Koagulationszangen

### Dieler bipolar coagulation forceps

#### Aufsätze / Add-ons



**Fasszange für Dieler Koagulationszange, gerade, gefenstert, 15 cm**  
Grasping forceps for Dieler coagulation forceps, straight, fenestrated, 15 cm

**80-090-03**



**Löffelzange für Dieler Koagulationszange, aufgebogen, 15 cm**  
Spoon forceps for Dieler coagulation forceps, upcurved, 15 cm

Art.-Nr./No.	Größe / Size (mm)
80-090-05	2,0
80-090-06	2,7



**Zange für Dieler Koagulationszange, gerieft, 15 cm**  
Forceps for Dieler coagulation forceps, serrated, 15 cm

Art.-Nr.	Beschreibung / Description
80-090-07	aufgebogen/upcurved
80-090-08	aufgewinkelt/upangled

**Flamingo-Zange für Dieler Koagulationszange, vertikal, 15 cm**  
Flamingo forceps for Dieler coagulation forceps, vertical, 15 cm



Art.-Nr./No.	Winkel / Angle	Länge / Length (mm)
80-090-09	15°	0,7
80-090-10	15°	1,2
80-090-11	15°	2,0
80-090-12	30°	0,7
80-090-13	30°	1,2
80-090-14	30°	2,0
80-090-15	45°	0,7
80-090-16	45°	1,2
80-090-17	45°	2,0





## 05 Dieler Bipolare Koagulationszangen

### Dieler bipolar coagulation forceps



Saugschlauch, steril, 10 Stück/Box  
Suction tube, sterile, 10 pieces/box

80-090-02



Bipolares Anschlusskabel, für Scheren/Zangen,  
3 m lang, geräteseitig, passend für:

Bipolar connecting cable for scissors/forceps,  
3 m, unit-side, compatible with:  
Sutter/Martin/ Berchtold/Aesculap/Integra

80-320-30



Bipolares Anschlusskabel, für Scheren/Zangen,  
3 m lang, geräteseitig, passend für:

Bipolar connecting cable for scissors/forceps,  
3 m, unit-side, compatible with:  
Valleylab

80-321-30



Bipolares Anschlusskabel, für Scheren/Zangen,  
3 m lang, geräteseitig, passend für:

Bipolar connecting cable for scissors/forceps,  
3 m, unit-side, compatible with:  
Erbe/Storz/Wolf

80-322-30



Bipolares Anschlusskabel für Scheren/Zangen,  
4 m lang, passend für:

Bipolar connecting cable for scissors/forceps,  
4 m, compatible with:  
U20

80-324-40

## 06 Stirnhöhlen- und Keilbeinhöhlen-Instrumente

### Frontal and Sphenoidal Instruments



**Stirnhöhlenstanze, 70° aufgebogen, 17 cm**

Frontal sinus punch, 70° curved upwards, 17 cm

Art.-Nr./No.	Größe / Size (mm)
30-400-00	3
30-400-01	2



**Rundkopfstanze für Stirnhöhle, mit Spülkanal, 16 cm**

Frontal sinus circular punch, with irrigation channel, 16 cm

Art.-Nr./No.	Größe / Size (mm)	Winkel / Angle
30-421-35	3,5	60°
30-421-45	4,5	60°



**Rundkopfstanze für Stirnhöhle,**

**eiförmig, 90° Schnitt, mit Spülkanal, 16 cm**

Frontal sinus circular punch, egg-form,

90° cutting, with irrigation channel, 16 cm

Art.-Nr./No.	Größe / Size (mm)	Winkel / Angle
30-428-35	3,5	60°
30-428-45	4,5	60°



## 06 Stirnhöhlen- und Keilbeinhöhlen-Instrumente

### Frontal and Sphenoidal Instruments

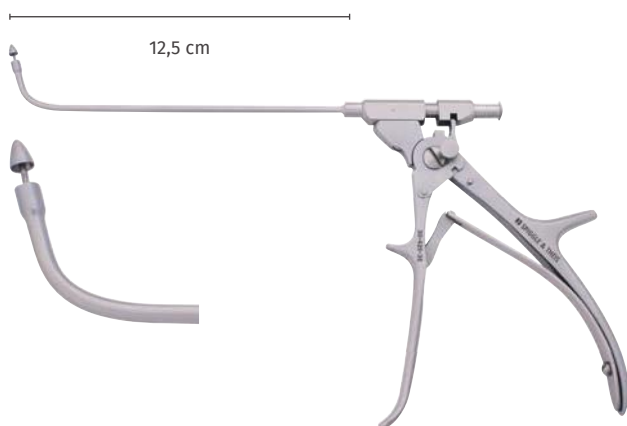

**Stirnhöhlen-Stanze, aufgebogen,  
stumpfes Ende, mit Spülkanal, 12,5 cm**  
Frontal sinus punch, curved upwards,  
blunt end, with irrigation channel, 12.5 cm

Art.-Nr./No. Größe / Size (mm)

30-425-35	3,5
30-425-45	4,5

#### Vorteile / Advantages:

- Rückwärts schneidend / Backwards cutting
- Geringer Kraftaufwand / Little force required
- Besonders leichtgängig / Runs smoothly

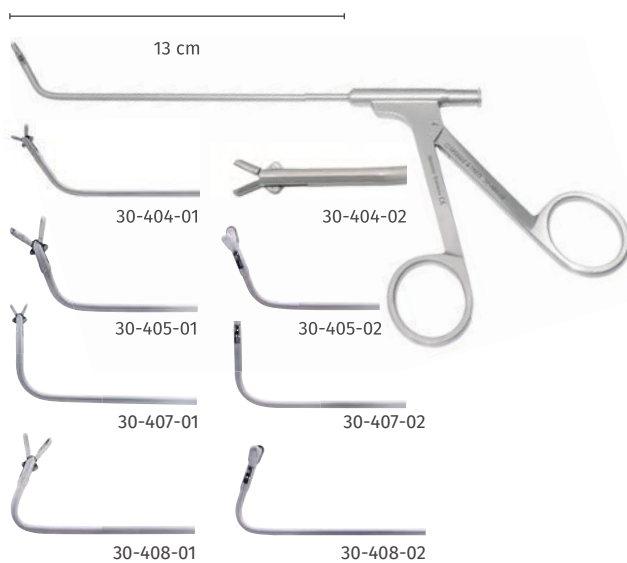

**Stirnhöhlen Löffelzange, oval, mit Spülkanal, 13 cm**  
Frontal sinus forceps, oval cups, with irrigation channel, 13 cm

Art.-Nr./No. Größe / Size (mm) Winkel / Angle

30-404-01	2	55°, vertikal / vertical
30-404-02	2	55°, horizontal
30-405-01	4	70°, vertikal / vertical
30-405-02	4	70°, horizontal
30-405-11	4	55°, vertikal / vertical
30-405-12	4	55°, horizontal
30-407-01	2	90°, vertikal / vertical
30-407-02	2	90°, horizontal
30-408-01	4	110°, vertikal / vertical
30-408-02	4	110°, horizontal

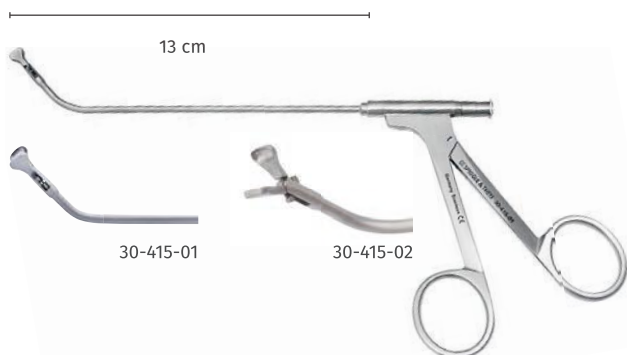

**Binner Polypenfasszange, 3 mm, mit Spülkanal, 13 cm**  
Binner polyp forceps, 3 mm, with irrigation channel, 13 cm

Art.-Nr./No. Winkel / Angle

30-415-01	45°, horizontal
30-415-02	80°, horizontal

## 06 Stirnhöhlen- und Keilbeinhöhlen-Instrumente

### Frontal and Sphenoidal Instruments

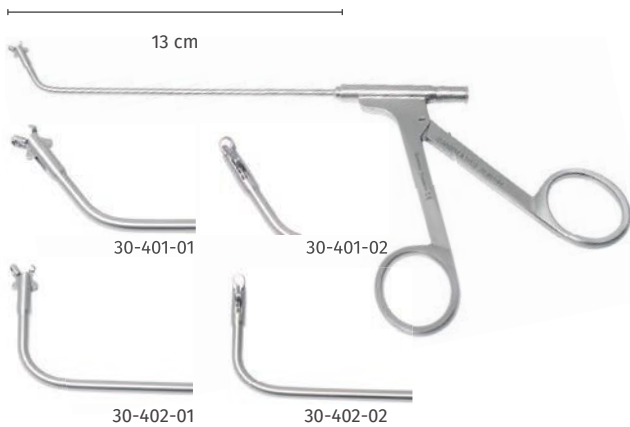

#### Stirnhöhlenzange, durchschneidend, 2 mm, mit Spülkanal

Frontal sinus forceps, throughcutting, 2 mm, with irrigation channel

Art.-Nr./No.	Größe / Size (cm)	Winkel / Angle
30-401-01	13	55°, vertikal / vertical
30-401-02	13	55°, horizontal
30-402-01	13	90°, vertikal / vertical
30-402-02	13	90°, horizontal

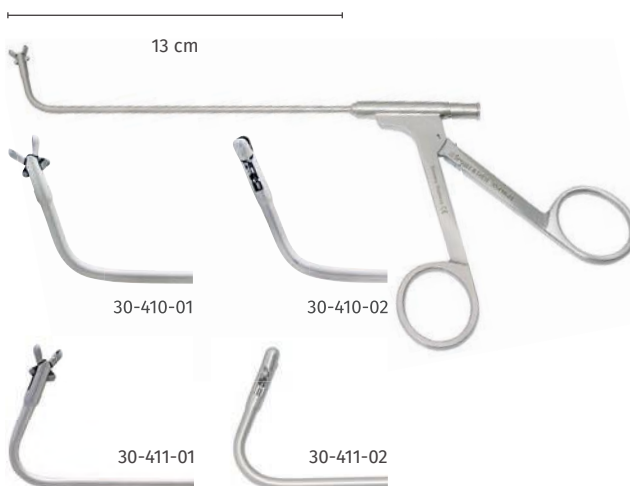

#### Stirnhöhlen Biopsiezange, 3 mm, mit Spülkanal, 13 cm

Frontal sinus biopsy forceps, 3 mm, with irrigation channel, 13 cm

Art.-Nr./No.	Winkel / Angle
30-410-01	70°, vertikal / vertical
30-410-02	70°, horizontal
30-411-01	110°, vertikal / vertical
30-411-02	110°, horizontal



#### Rundkopfstanze für Keilbeinhöhle,

eiförmig, 60° Schnitt, mit Spülkanal, 16 cm

Sphenoid sinus circular punch, egg-formed, 60° cutting, with irrigation channel, 16 cm

Art.-Nr./No.	Größe / Size (mm)	Beschreibung / Description
30-429-35	3,5	gerade / straight
30-429-45	4,5	gerade / straight



## 06 Stirnhöhlen- und Keilbeinhöhlen-Instrumente

### Frontal and Sphenoidal Instruments

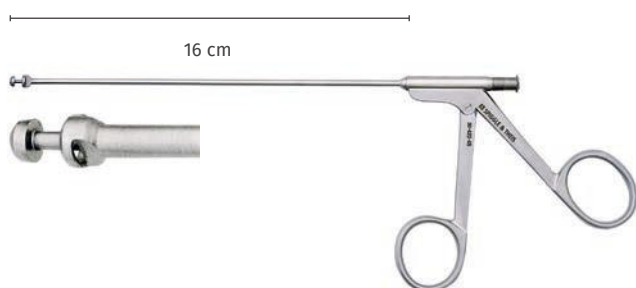

**Rundkopfstanze für Keilbeinhöhle, mit Spülkanal, 16 cm**  
**Sphenoid sinus circular punch, with irrigation channel, 16 cm**

Art.-Nr./No.	Größe / Size (mm)	Winkel / Angle
30-422-35	3,5	0°
30-422-45	4,5	0°



**Knochenstanze mit Reservoir, 2 mm, mit Mandrin, 19 cm**  
**Antrum punch with collector, 2 mm, with stylet, 19 cm**

**30-450-20**



**Mandrin zum Entfernen von Knochenmaterial aus Knochenstanzen**  
**Stylet for removal of bone residue from antrum punch**

**30-450-90**



**Knochenstanze mit Reservoir, 3 mm, mit Mandrin, 15 cm**  
**Antrum punch with collector, 3 mm, with stylet, 15 cm**

**30-450-30**

## 06 Stirnhöhlen- und Keilbeinhöhlen-Instrumente

### Frontal and Sphenoidal Instruments

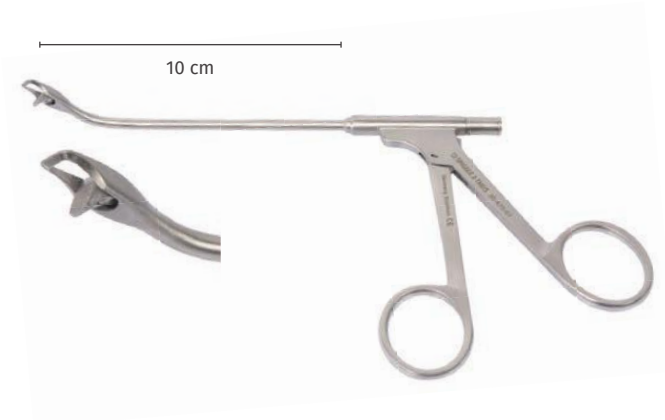

**Schwager Stanze für den Orbitaboden,  
mit Spülkanal, 45°, 3,5 mm, 10 cm**  
Schwager punch for orbita floor,  
with irrigation channel, 45°, 3.5 mm, 10 cm

Art.-Nr./No.	Beschreibung / Description
30-475-01	links / left
30-475-02	rechts / right

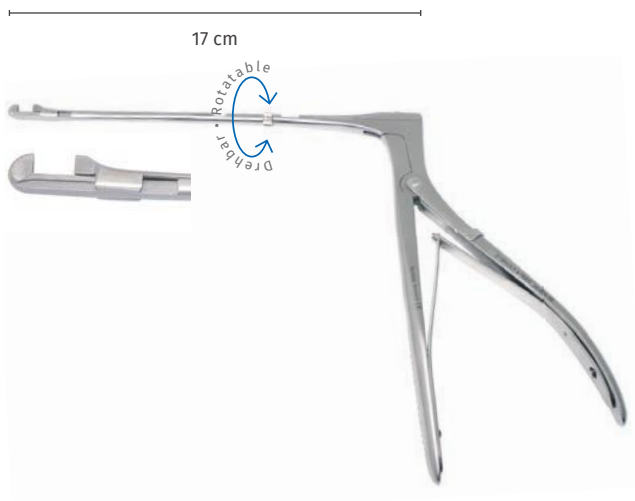

**Hajek-Kofler Keilbeinstanze, aufeinander schneidend,  
drehbar, 3 mm, 17 cm, zerlegbar**  
Hajek-Kofler sphenoid punch,  
rotatable, 3 mm, 17 cm, detachable

**30-456-32**



## 06 Stirnhöhlen- und Keilbeinhöhlen-Instrumente

### Frontal and Sphenoidal Instruments

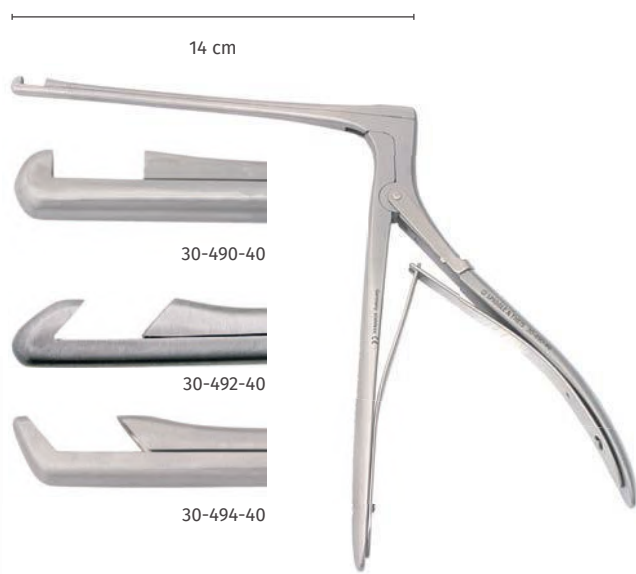

**Hajek-Kofler Keilbeinstanze, aufeinander schneidend, zerlegbar, 4 mm, 14 cm**

**Hajek-Kofler sphenoid punch, detachable, 4 mm, 14 cm**

Art.-Nr./No.	Winkel / Angle
30-490-40	90°, aufwärts / upwards
30-491-40	90°, abwärts / downwards
30-492-40	40°, aufwärts, rückwärts upwards, backwards
30-493-40	40°, abwärts, rückwärts downwards, backwards
30-494-40	40°, aufwärts, vorwärts upwards, forwards

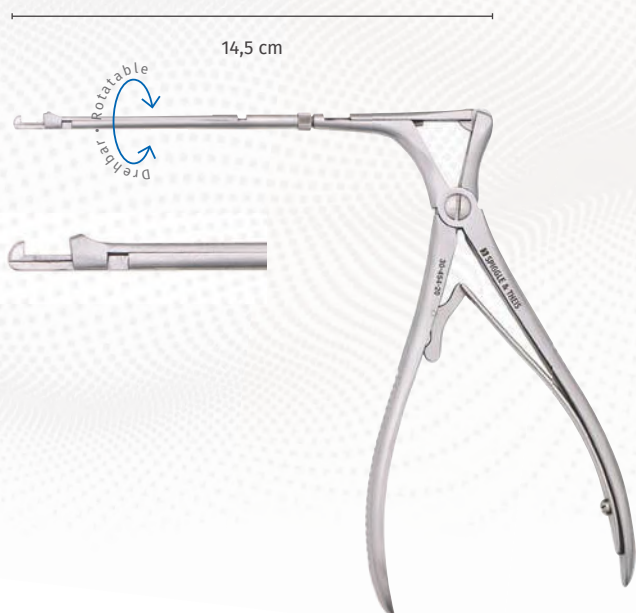

**McKenty Keilbeinstanze, durchschneidend, drehbar, 2 mm, 14,5 cm**

**McKenty sphenoid punch, throughcutting, rotatable, 2 mm, 14.5 cm**

**30-454-20**



## 06 Stirnhöhlen- und Keilbeinhöhlen-Instrumente

### Frontal and Sphenoidal Instruments

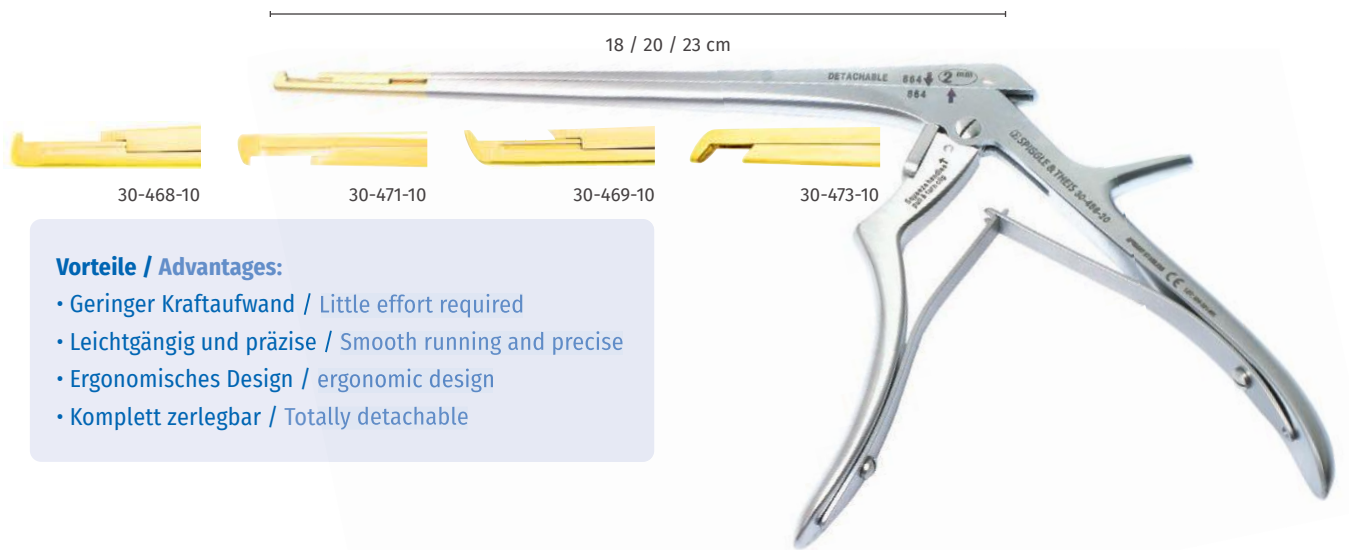

#### Vorteile / Advantages:

- Geringer Kraftaufwand / Little effort required
- Leichtgängig und präzise / Smooth running and precise
- Ergonomisches Design / ergonomic design
- Komplett zerlegbar / Totally detachable

#### Kerrison Keilbeinstanze / Kerrison sphenoid punch

Art.-Nr. Art.-No.	Größe Size (mm)	Länge Length (cm)	Winkel Angle	Art.-Nr. Art.-No.	Größe Size (mm)	Länge Length (cm)	Winkel Angle
30-468-10	1	18	90° aufwärts / upwards	30-479-10	1	23	90° abwärts / downwards
30-468-20	2	18	90° aufwärts / upwards	30-479-20	2	23	90° abwärts / downwards
30-468-30	3	18	90° aufwärts / upwards	30-479-30	3	23	90° abwärts / downwards
30-468-40	4	18	90° aufwärts / upwards	30-479-40	4	23	90° abwärts / downwards
30-468-50	5	18	90° aufwärts / upwards	30-479-50	5	23	90° abwärts / downwards
30-469-10	1	18	40° aufwärts / upwards	30-479-60	6	23	90° abwärts / downwards
30-469-20	2	18	40° aufwärts / upwards	30-483-10	1	20	40° aufwärts / upwards
30-469-30	3	18	40° aufwärts / upwards	30-483-20	2	20	40° aufwärts / upwards
30-469-40	4	18	40° aufwärts / upwards	30-483-30	3	20	40° aufwärts / upwards
30-469-50	5	18	40° aufwärts / upwards	30-483-40	4	20	40° aufwärts / upwards
30-471-10	1	18	90° abwärts / downwards	30-483-50	5	20	40° aufwärts / upwards
30-471-20	2	18	90° abwärts / downwards	30-483-60	6	20	40° aufwärts / upwards
30-471-30	3	18	90° abwärts / downwards	30-484-10	1	20	90° aufwärts / upwards
30-473-10	1	18	40° abwärts / downwards	30-484-20	2	20	90° aufwärts / upwards
30-473-20	2	18	40° abwärts / downwards	30-484-30	3	20	90° aufwärts / upwards
30-473-30	3	18	40° abwärts / downwards	30-484-40	4	20	90° aufwärts / upwards
30-477-10	1	23	40° aufwärts / upwards	30-484-50	5	20	90° aufwärts / upwards
30-477-20	2	23	40° aufwärts / upwards	30-484-60	6	20	90° aufwärts / upwards
30-477-30	3	23	40° aufwärts / upwards	30-485-10	1	20	90° abwärts / downwards
30-477-40	4	23	40° aufwärts / upwards	30-485-20	2	20	90° abwärts / downwards
30-477-50	5	23	40° aufwärts / upwards	30-485-30	3	20	90° abwärts / downwards
30-477-60	6	23	40° aufwärts / upwards	30-485-40	4	20	90° abwärts / downwards
30-478-10	1	23	90° aufwärts / upwards	30-485-50	5	20	90° abwärts / downwards
30-478-20	2	23	90° aufwärts / upwards	30-485-60	6	20	90° abwärts / downwards
30-478-30	3	23	90° aufwärts / upwards	30-485-10	1	20	90° abwärts, geschwärzt downwards, black coated
30-478-40	4	23	90° aufwärts / upwards	30-485-40	4	20	90° abwärts, geschwärzt downwards, black coated
30-478-50	5	23	90° aufwärts / upwards				
30-478-60	6	23	90° aufwärts / upwards				



## 07 Mikroskopische/Endoskopische Instrumente für die Pansinus-Chirurgie

### Microscopic/Endoscopic Instruments for Pansinus Surgery



**Flexibler Spannarm zur Verwendung mit selbsthaltenden NNH-Spekula, mit Verlängerungsstange**  
Flexible holding arm for use with self retaining nasal specula, inclusive holding rod

**30-700-00**



**Gelenkkloben zur Befestigung am OP-Tisch, passend für 30-700-00 und 40-337-00**  
Rotation clamp for fixation to operating table, for 30-700-00 and 40-337-00

**30-700-01**



13,5 cm

**NNH-Spekulum für Kinder, linkes Blatt 25 mm, 13,5 cm**  
Sinus speculum for children, left blade 25 mm, 13.5 cm

**30-702-25**

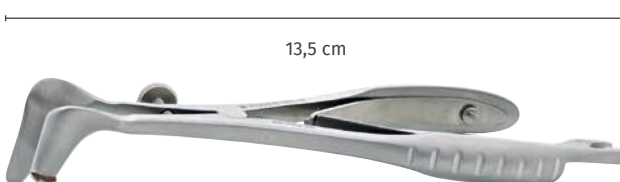

13,5 cm

**NNH-Spekulum für Kinder, rechtes Blatt 25 mm, 13,5 cm**  
Sinus speculum for children, right blade 25 mm, 13.5 cm

**30-703-25**



15 cm

**NNH-Spekulum für Erwachsene, 15 cm**  
Sinus speculum for adults, 15 cm

Art.-Nr. Art.-No.	Größe Size (mm)	Beschreibung Description
30-705-55	55	linkes Blatt / left blade
30-705-65	65	linkes Blatt / left blade
30-705-75	75	linkes Blatt / left blade
30-706-55	55	rechtes Blatt / right blade
30-706-65	65	rechtes Blatt / right blade
30-706-75	75	rechtes Blatt / right blade

## 07 Mikroskopische/Endoskopische Instrumente für die Pansinus-Chirurgie

### Microscopic/Endoscopic Instruments for Pansinus Surgery



#### Draf Siebbeinzängchen / Draf ethmoid forceps

Art.-Nr. Art.-No.	Größe Size (mm)	Länge Length (cm)	Winkel Angle
30-720-10	4,0 x 1,8	10	gerade / straight
30-720-13	4,0 x 1,8	13	gerade / straight
30-720-16	7,0 x 2,4	16	gerade / straight
30-720-19	7,0 x 2,4	19	gerade / straight
30-722-13	6,5 x 2,4	13	60° aufgebogen / angled
30-722-16	6,5 x 2,4	16	60° aufgebogen / angled
30-722-19	6,5 x 2,4	19	60° aufgebogen / angled
30-724-13	6,0 x 2,4	13	90° aufgebogen / angled
30-724-16	6,0 x 2,4	16	90° aufgebogen / angled
30-724-19	4,0 x 1,8	19	90° aufgebogen / angled
30-726-13	3,0 x 1,5	13	gerade / straight
30-726-16	3,0 x 1,5	16	gerade / straight



#### Draf Siebbeinzängchen, gerade, fein gerieft

#### Draf ethmoid forceps, straight, finely serrated

Art.-Nr./No.	Länge / Length (cm)
30-728-16	16
30-728-19	19



#### Draf Siebbeinzängchen, gerade, grob gerieft, 16 cm

#### Draf ethmoid forceps, straight, coarsely serrated, 16 cm

**30-729-16**



#### Draf Siebbeinscherchen / Draf ethmoid scissors

Art.-Nr. Art.-No.	Länge Length (cm)	Winkel Angle
30-732-13	13	gerade / straight
30-732-16	16	gerade / straight
30-732-19	19	gerade / straight
30-733-16	16	rechts gebogen / curved right
30-734-16	16	links gebogen / curved left
30-735-19	19	45° aufwärts gebogen 45° curved upwards



## 07 Mikroskopische/Endoskopische Instrumente für die Pansinus-Chirurgie

### Microscopic/Endoscopic Instruments for Pansinus Surgery

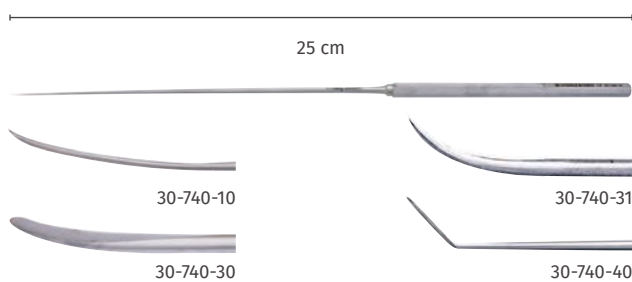

**Draf Mikroraspatorium, 25 cm / Draf micro raspatory, 25 cm**

Art.-Nr. Art.-No.	Größe Size (mm)	Beschreibung Description
30-740-10	1	leicht gebogen / slightly curved
30-740-30	3	leicht gebogen / slightly curved
30-740-31	3	stark gebogen / strongly curved
30-740-40	4	gewinkelt / angled

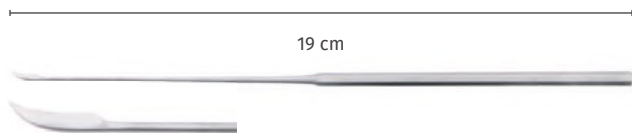

**Draf Sichelmesser, 19 cm, gebogen**

**Draf sickle knife, 19 cm, curved**

**30-742-19**



**Draf Rundschnittmesser, 1,5 mm, 19 cm**

**Draf round knife, 1.5 mm, 19 cm**

**30-743-19**



**Draf Incisionsmesser, 19 cm / Draf flap knife, 19 cm**

**30-744-19**

## 07 Mikroskopische/Endoskopische Instrumente für die Pansinus-Chirurgie

### Microscopic/Endoscopic Instruments for Pansinus Surgery

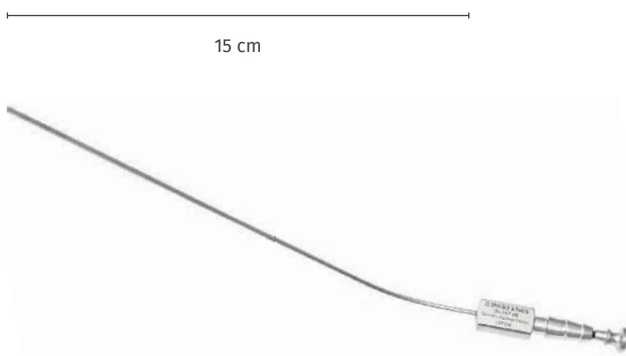

**Frazier Saugrohr, 15 cm / Frazier suction tube, 15 cm**

Art.-Nr./No.	Ch/Fr	mm
30-747-06	6	2,0
30-747-07	7	2,3
30-747-08	8	2,7
30-747-09	9	3,0
30-747-10	10	3,3
30-747-12	12	4,0
30-747-15	15	5,0

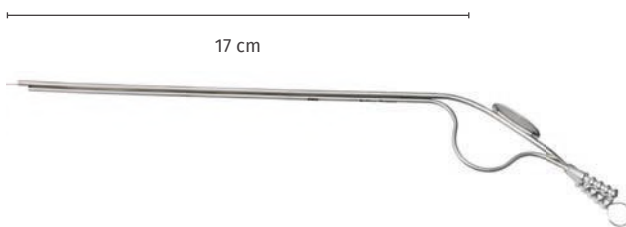

**Saug- und Spülrohr, Saugrohr 2,5 mm, Spülrohr 2,0 mm, 17 cm**  
Suction / irrigation tube, suction tube 2.5 mm,  
irrigation tube 2.0 mm, 17 cm

**30-749-15**

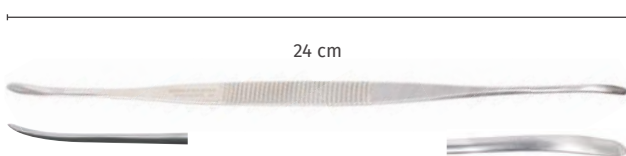

**Raspa Tönnis, Größen 3 mm & 5 mm, 24 cm**  
Tönnis raspator, sizes 3 mm & 5 mm, 24 cm

**30-759-21**

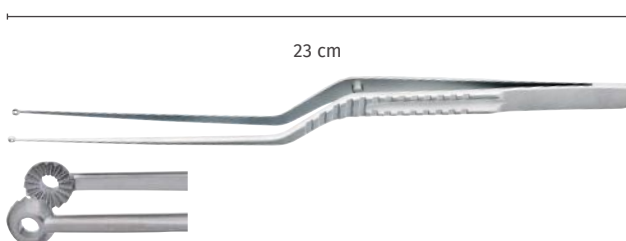

**Yasargil Pinzette, ringförmig, 23 cm**

**Yasargil dressing forceps, ring ended, 23 cm**

Art.-Nr./No.	Größe / Size (mm)
30-770-30	3
30-770-50	5



## 07 Mikroskopische/Endoskopische Instrumente für die Pansinus-Chirurgie

### Microscopic/Endoscopic Instruments for Pansinus Surgery



**Bipolare Koagulationspinzette, NON-STICK, bajonett, Führungsstift 22,5 cm**  
**Bipolar coagulation forceps, NON-STICK, bayonet, guide pin, 22.5 cm**

Art.-Nr./No.	Spitze / Tip (mm)
80-125-03	0,3
80-125-07	0,7
80-125-12	1,2

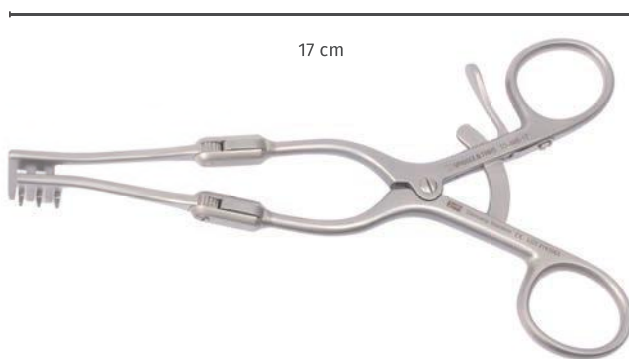

**Fisch Wundsperrer mit Gelenken, 17 cm**  
**Fisch retractor, jointed, 17 cm**

Art.-Nr./No.	3:3 Zähne, halbscharf 3:3 prongs, semi-sharp
10-468-17	

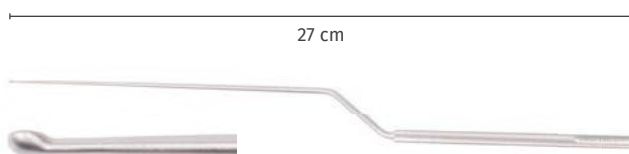

**Löffelkürette, halbscharf, bajonett, gerade, nach oben, 2 mm, 27 cm**  
**Spoon curette, semi-sharp, bayonet, straight, upwards, 2 mm, 27 cm**

**90-201-01**

## 07 Mikroskopische/Endoskopische Instrumente für die Pansinus-Chirurgie

### Microscopic/Endoscopic Instruments for Pansinus Surgery

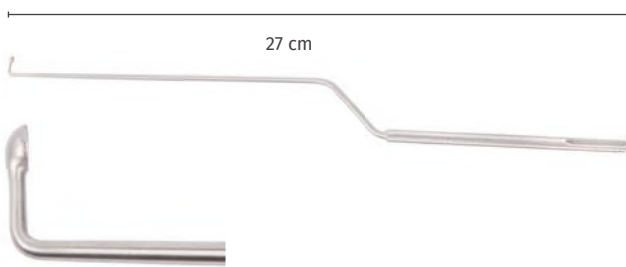

**Löffelkürette, halbscharf, bajonett, 90° nach oben gebogen, mit 5 mm Steg, 27 cm**

**Spoon curette, semi-sharp, bayonet, 90° curved upwards, with 5 mm bar, 27 cm**

Art.-Nr./No. Größe / Size (mm)

90-201-02	2
90-201-03	3

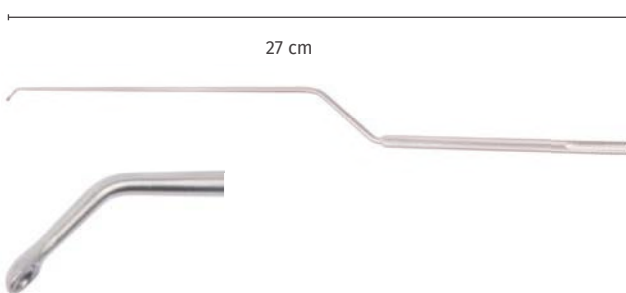

**Löffelkürette, halbscharf, bajonett, mit 5 mm Steg, 27 cm**

**Spoon curette, semi-sharp, bayonet, with 5 mm bar, 27 cm**

Art.-Nr. Größe Winkel  
Art.-No. Size (mm) Angle

90-201-04	2	45° nach unten gebogen 45° curved downwards
90-201-05	2	45° nach oben gebogen 45° curved upwards
90-201-06	4	45° nach unten gebogen 45° curved downwards
90-201-07	4	45° nach oben gebogen 45° curved upwards

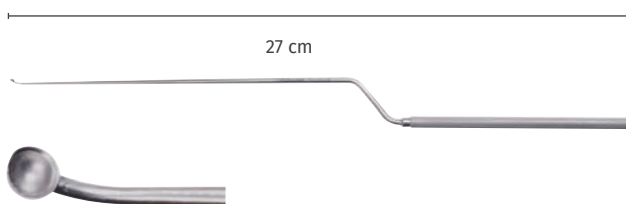

**Löffelkürette, halbscharf, bajonett,**

**45° leicht nach oben gebogen, mit 5 mm Steg, 27 cm**

**Spoon curette, semi-sharp, bayonet,**

**45° slightly curved upwards, with 5 mm bar, 27 cm**

Art.-Nr./No. Größe / Size (mm)

90-201-08	2
90-201-09	4





## 07 Mikroskopische/Endoskopische Instrumente für die Pansinus-Chirurgie

### Microscopic/Endoscopic Instruments for Pansinus Surgery

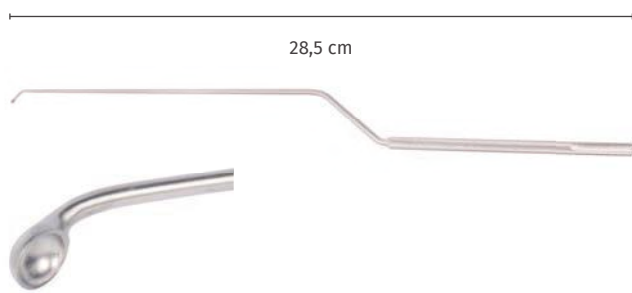

**Löffelkürette, halbscharf, bajonett, mit 5 mm Steg, 28,5 cm**  
**Spoon curette, semi-sharp, bayonet, with 5 mm bar, 28.5 cm**

Art.-Nr./No.	Größe / Size (mm)	Winkel / Angle
90-201-14	2	45° nach unten gebogen 45° curved downwards
90-201-15	2	45° nach oben gebogen 45° curved upwards
90-201-16	4	45° nach unten gebogen 45° curved downwards
90-201-17	4	45° nach oben gebogen 45° curved upwards

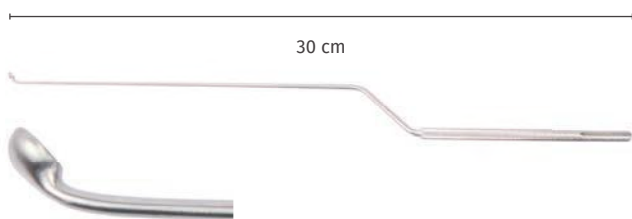

**Löffelkürette, halbscharf, bajonett, 30 cm**  
**Spoon curette, semi-sharp, bayonet, 30 cm**

Art.-Nr./No.	Größe / Size (mm)	Winkel / Angle
90-201-18	2	45° leicht nach oben gebogen 45° slightly curved upwards
90-201-19	4	45° leicht nach oben gebogen 45° slightly curved upwards
90-201-28	2	45° leicht nach unten gebogen 45° slightly curved downwards
90-201-29	4	45° leicht nach unten gebogen 45° slightly curved downwards

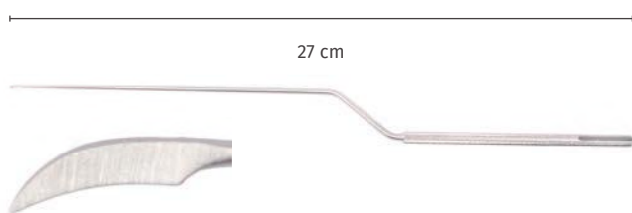

**Sichelmesser spitz, bajonett, 27 cm**  
**Sickle knife pointed, bayonet, 27 cm**

Art.-Nr./No.	Beschreibung / Description
90-202-01	nach rechts gebogen / curved right
90-202-02	nach links gebogen / curved left

## 07 Mikroskopische/Endoskopische Instrumente für die Pansinus-Chirurgie

### Microscopic/Endoscopic Instruments for Pansinus Surgery

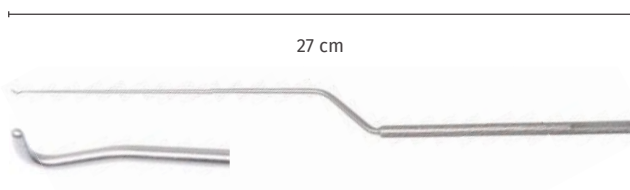

**Enucleator, Rändelgriff, bajonett, 27 cm**  
**Enucleator, knurled handle, bayonet, 27 cm**

Art.-Nr./No.	Beschreibung / Description
90-204-01	nach links gebogen / curved left
90-204-02	nach rechts gebogen / curved right

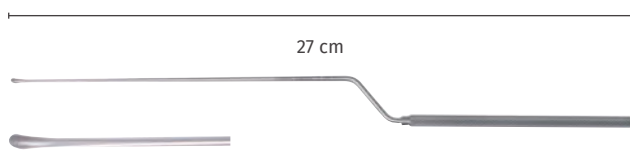

**Raspatorium, scharf, bajonett, 27 cm**  
**Raspatory, sharp, bayonet, 27 cm**

Art.-Nr./No.	Beschreibung / Description
90-206-01	nach links gebogen / curved left
90-206-02	nach rechts gebogen / curved right
90-206-03	nach unten gebogen / curved downwards
90-206-04	nach oben gebogen / curved upwards

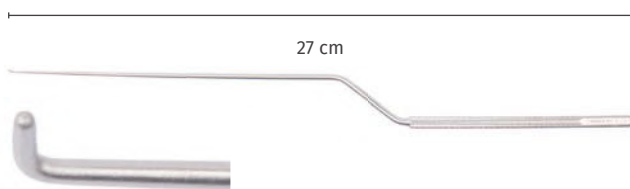

**Sondenhäkchen, stumpf, bajonett, 27 cm**  
**Probe hook, blunt, bayonet, 27 cm**

Art.-Nr./No.	Beschreibung / Description
90-208-01	nach links gebogen / curved left
90-208-02	nach rechts gebogen / curved right

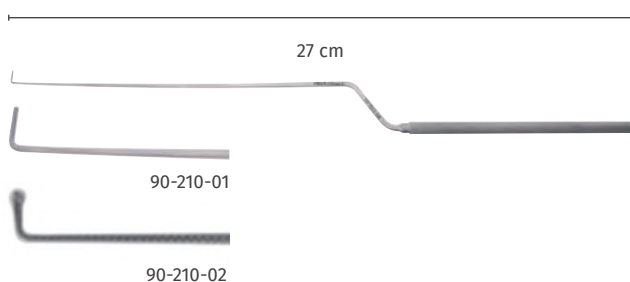

**Haken, nach oben gebogen, 90°, bajonett, 27 cm**  
**Hook, curved upwards, 90°, bayonet, 27 cm**

Art.-Nr. Art.-No.	Größe Size (mm)	Beschreibung Description
90-210-01		stumpf / blunt
90-210-02	1	mit Sondenknopf / with ball end



## 07 Mikroskopische/Endoskopische Instrumente für die Pansinus-Chirurgie

### Microscopic/Endoscopic Instruments for Pansinus Surgery



**Dissektor, stumpf, nach oben gebogen, 3 mm, bajonett, 27 cm**  
**Dissector, blunt, curved upwards, 3 mm, bayonet, 27 cm**

**90-210-03**

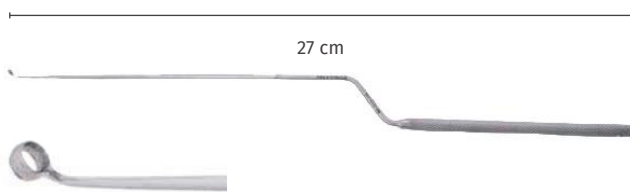

**Ringkürette, scharf, nach oben gebogen, bajonett, 27 cm**  
**Ring curette, sharp, curved upwards, bayonet, 27 cm**

Art.-Nr./No.	Größe / Size (mm)	Winkel / Angle
90-210-04	2	45°
90-210-05	2	90°
90-210-06	4	45°
90-210-07	4	90°
90-210-08	5	90°

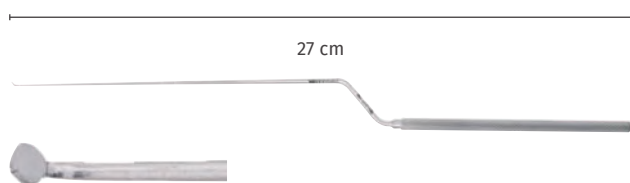

**Tellermesser, nach oben gebogen, 45°, bajonett, 27 cm**  
**Separator, curved upwards, 45°, bayonet, 27 cm**

Art.-Nr./No.	Größe / Size (mm)
90-210-09	1,5
90-210-10	3,5

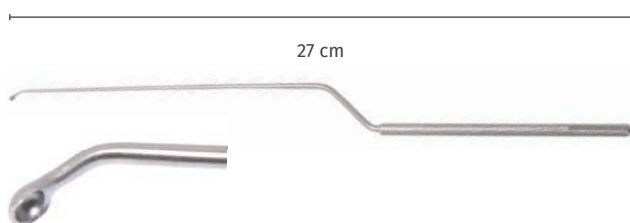

**Löffelkürette, halbscharf, nach unten gebogen, 2,5 mm, 45°, bajonett, 27 cm**  
**Spoon curette, semi-sharp, curved downwards, 2.5 mm, 45°, bayonet, 27 cm**

**90-211-01**

## 07 Mikroskopische/Endoskopische Instrumente für die Pansinus-Chirurgie

### Microscopic/Endoscopic Instruments for Pansinus Surgery

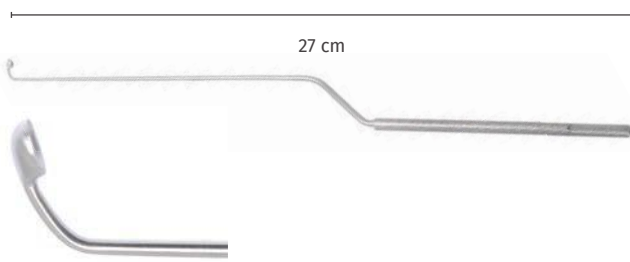

**Löffelkürette, halbscharf, bajonett, 27 cm**  
**Spoon curette, semi-sharp, bayonet, 27 cm**

Art.-Nr. Art.-No.	Größe Size (mm)	Winkel Angle
90-212-01	4,5	leicht nach oben gebogen slightly curved upwards
90-212-02	4,5	stark nach oben gebogen strongly curved upwards
90-212-03	4,5	45° nach oben gebogen 45° curved upwards

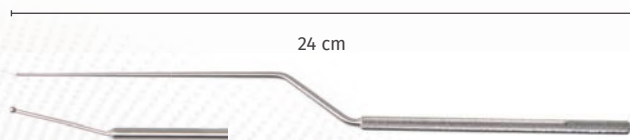

**Knopfsonde, bajonett, Sonde gewinkelt, 9,5 mm, 24 cm**  
**Ball-end probe, bayonet, probe angled, 9.5 mm, 24 cm**

**90-213-00**

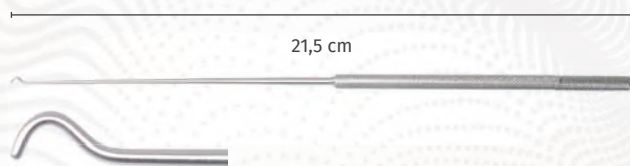

**Mikro-Häkchen, vorwärts/rückwärts, stumpf, gerade, 21,5 cm**  
**Micro hook, forward/backward, blunt, straight, 21.5 cm**

**90-214-00**

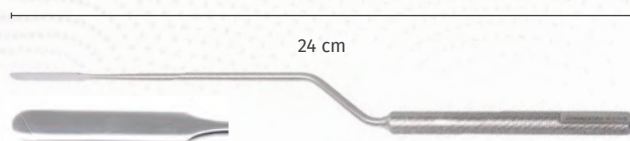

**Mukosa Dissektor, bajonett, 30 x 6 mm, 24 cm**  
**Mucosa dissector, bayonet, 30 x 6 mm, 24 cm**

**90-215-00**



## 07 Mikroskopische/Endoskopische Instrumente für die Pansinus-Chirurgie

### Microscopic/Endoscopic Instruments for Pansinus Surgery



**Spiegel-Griff, bajonett, rund gerändelt, 15,5 cm**  
**Mirror handle, bayonet, knurled, 15.5 cm**

**90-220-00**

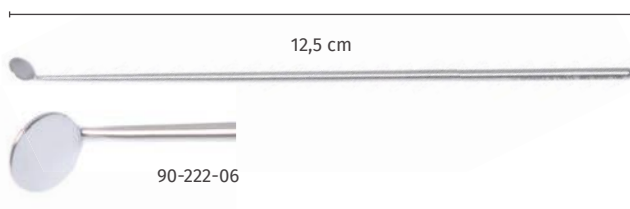

**Spiegel, rund, hochglanzpoliert, extra fein, 12,5 cm,**  
**zur Verwendung mit Handgriff 90-220-00**

**Mirror, round, polished, very fine, 12.5 cm,**  
**for use with handle 90-220-00**

Art.-Nr./No.	Größe / Size (mm)
90-222-04	4
90-222-05	5
90-222-06	6
90-222-08	8
90-222-10	10
90-222-12	12



**Halle Kieferhöhlenkürette, doppelseitig, 21 cm**  
**Halle antrum curette, double ended, 21 cm**

**30-805-00**

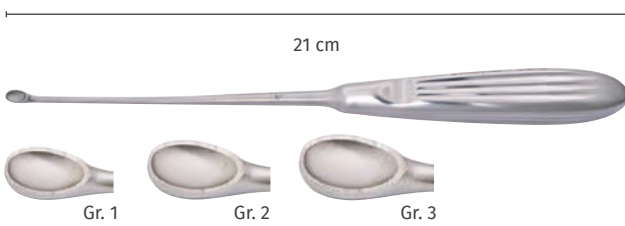

**Halle Kieferhöhlenlöffel, biegsam, 21 cm**  
**Halle antrum curette, bendable, 21 cm**

Art.-Nr./No.	Größe / Size (mm)
30-807-01	1
30-807-02	2
30-807-03	3

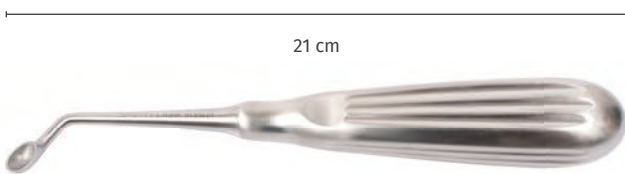

**Uffenorde Kieferhöhlenlöffel, 21 cm**  
**Uffenorde antrum curette, 21 cm**

Art.-Nr./No.	Beschreibung / Description
30-809-01	links gebogen / curved left
30-809-02	rechts gebogen / curved right



**Orbitaschützer, 23 cm / Orbita protector, 23 cm**

**30-812-24**

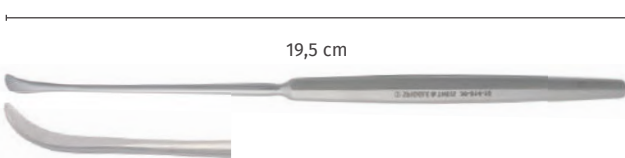

**Sewall Kieferhöhlenelevatorium, 19,5 cm**  
**Sewall antrum elevator, 19.5 cm**

**30-814-19**



**West Hohlmeißel, 4 mm, 18 cm / West gouge, 4 mm, 18 cm**

**30-816-40**



**08 Allgemeines**  
**Miscellaneous**



**West Flachmeißel, 4,5 mm, 18 cm / West chisel, 4.5 mm, 18 cm**

**30-817-40**



80-302-12      80-302-14      80-302-16

**Sternberg Lippenhaken / Sternberg lip retractor**

Art.-Nr./No.	Größe / Size (cm)
80-302-12	12
80-302-14	14
80-302-16	16



**Middeldorpf Wundhaken, 22 cm / Middeldorpf retractor, 22 cm**



80-306-17      80-306-22      80-306-30

Art.-Nr./No.	Größe / Size (mm)
80-306-17	14 x 17
80-306-22	20 x 22
80-306-30	26 x 30



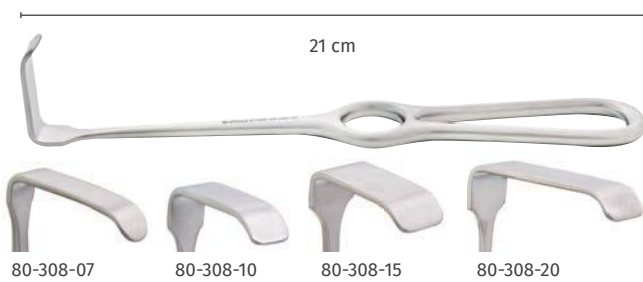

**Langenbeck Wundhaken, 21 cm / Langenbeck retractor, 21 cm**

Art.-Nr./No.	Größe / Size (mm)
80-308-07	35 x 7
80-308-10	35 x 10
80-308-15	35 x 15
80-308-20	60 x 20

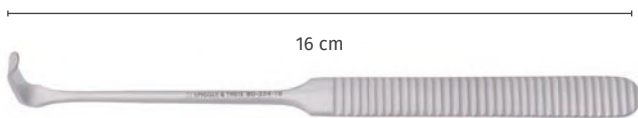

**Langenbeck-Green Wundhaken, Flachgriff, 24 x 6 mm, 16 cm**  
**Langenbeck-Green retractor, flat handle, 24 x 6 mm, 16 cm**

**80-334-16**



**Spezial Ölspray, Pflegespray für Instrumente sowie für Hand- und Winkelstücke, 500 ml**  
**Special Oilspray, Maintenance Spray for Instruments and Drill Handpieces, 500 ml**

**78PS01**





**Metallschale / Metal bowl**

Art.-Nr. Art.-No.	Durchmesser Diameter (mm)	Höhe Height (mm)	Fassungs- vermögen Capacity (ml)
80-501-01 B1	Ø 40	H=19	20
80-501-02 B2	Ø 60	H=39	60
80-501-03 B3	Ø 85	H=40	160
80-501-04 B4	Ø 110	H=55	400



**Medizinbecher, Edelstahl, graduiert**

**Medicine cup, stainless steel, graduated**

Art.-Nr. Art.-No.	Durchmesser Diameter (mm)	Höhe Height (mm)	Fassungs- vermögen Capacity (ml)
80-503-03	Ø 50	H=25	30
80-504-05	Ø 53	H=45	50



**Lösungsschale, Edelstahl / Solution bowl, stainless steel**

Art.-Nr. Art.-No.	Durchmesser Diameter (mm)	Höhe Height (mm)	Fassungs- vermögen Capacity (ml)
80-506-30 B1	Ø 100	H=60	300
80-507-40 B2	Ø 120	H=70	400
80-509-75 B3	Ø 150	H=75	750



**Tablettenschale, Edelstahl, Ø 65 mm, H=20 mm**

**Tablet dish, stainless steel, Ø 65 mm, H=20 mm**

**80-512-00**



**Petrischale, Klarglas, mit Deckel / Petri dish, clear glass, with lid**

Art.-Nr./No.	AD / OD (mm)	Höhe / Height (mm)
80-515-06	60	15
80-515-08	80	15
80-515-10	150	20



**Medikamenten-Schälchen, Glas, schwarz, mit Deckel, 4 x 4 cm**

**Medication dish, glass, black, with lid, 4 x 4 cm**

**80-517-00**

**Medikamenten-Schälchen, Dappenglas, farbig, Ø 3,2 cm****Medication dish, dappen-glass, colored, Ø 3.2 cm**

80-519-00



80-519-01



80-519-02



80-519-03

Art.-Nr./No.	Farbe / Color
80-519-00	kristall / crystal
80-519-01	grün / green
80-519-02	rosa / pink
80-519-03	topas / topaz

**Porzellan-Schälchen, rund, mit Ausguss****China bowl, round, with spout**

Art.-Nr./No.	Durchmesser / Diameter (cm)
80-520-06	Ø 8
80-520-08	Ø 10

**Nierenschale, Edelstahl / Kidney bowl, stainless steel**

Art.-Nr./No.	Größe / Size (cm)
80-525-17	17,5
80-525-25	25,0

**Kornzangen-Behälter, Edelstahl / Forceps holder, stainless steel**

Art.-Nr. Art.-No.	Durchmesser Diameter (cm)	Höhe Height (cm)
80-528-13	Ø 5,0	13,5
80-528-18	Ø 5,0	18,0
80-528-20	Ø 9,5	20,0

**Kornzangen-Behälter, Glas, Edelstahldeckel mit Ausschnitt,****Ø 8 cm, Höhe 20 cm****Forceps holder, glass, stainless steel lid with opening,****Ø 8 cm, height 20 cm****80-530-20**

## 09 Sterilisationssysteme

### Sterilization Systems



**Norm-Sterilisations-Container, Boden geschlossen**  
Norm sterilization container, bottom closed

Art.-Nr. Art.-No.	Größe Size	Dimension (außen) Dimension (outside) (mm)
80-631-10	1/2	297 x 274 x 88
80-631-12	1/2	297 x 274 x 123
80-631-14	1/2	297 x 274 x 138
80-631-21	1/2	297 x 274 x 188
80-641-14	3/4	462 x 274 x 138
80-661-12	1	585 x 274 x 123
80-661-14	1	585 x 274 x 138
80-661-21	1	585 x 274 x 188



**Ventildeckel für Norm-Sterilisations-Container**  
Valve lid for norm sterilization container

Art.-Nr./No. 1/2 299 x 278 mm	Art.-Nr./No. 3/4 462 x 278 mm	Art.-Nr./No. 1 585 x 278 mm
80-632-00 ●	80-642-00 ●	80-662-00 ●
80-632-01 ●	80-642-01 ●	80-662-01 ●
80-632-02 ●	80-642-02 ●	80-662-02 ●
80-632-03 ●	80-642-03 ●	80-662-03 ●
80-632-04 ●	80-642-04 ●	80-662-04 ●
80-632-05 ●	80-642-05 ●	80-662-05 ●



**Edelstahl-Siebkorb, Geflecht, Fallgriffe**  
Stainless-steel wire basket, sliding handles

Art.-Nr./No.	Größe / Size (mm)
80-671-20	255 x 245 x 50
80-671-25	255 x 245 x 70
80-671-40	405 x 255 x 70
80-671-60	485 x 255 x 70



**Aluminium-Kennzeichnungs-Schild, 20 Zeichen, 56 x 17 mm**  
Coding label, 20 letters, 56 x 17 mm

Art.-Nr./No.	Farbe / Color
80-681-01	schwarz / black
80-681-02	rot / red
80-681-03	braun / brown
80-681-04	grün / green
80-681-05	gelb / yellow
80-681-06	lila / purple
80-681-07	blau / blue

**Einweg-Container-Siegel, blau, 100 Stück/Box**  
 Container seal, disposable, blue, 100 pieces/box

**80-683-10**

**Indikator-Klebe-Etikett, Lasche rechts, 100 Stück/Box**  
 Adhesive indicator label, latch right side, 100 pieces/box

**80-684-10**

**Klemmschild aus Edelstahl, hitzebeständig,**  
**6 x 4 cm, 25 Stück/Box**  
 Label holder with clip, stainless steel, heat resistant,  
 6 x 4 cm, 25 pieces/box

**80-688-00**



**Endoskopie-Siebkorb mit Deckel, Edelstahl, elektroliert**  
 Endoscope container with lid, stainless steel, e-polished

Art.-Nr./No.	Größe / Size (cm)
80-690-01	29 x 8 x 5,2 für 1 Endoskop 29 x 8 x 5,2 for 1 endoscope
80-690-02	29 x 8 x 5,2 für 2 Endoskope 29 x 8 x 5,2 for 2 endoscopes



**Endoskopie-Siebkorb mit Deckel, Edelstahl, elektroliert**  
 Endoscope container with lid, stainless steel, e-polished

Art.-Nr./No.	Größe / Size (cm)
80-691-01	46 x 8 x 5,2 für 1 Endoskop 46 x 8 x 5,2 for 1 endoscope
80-692-01	67 x 8 x 5,2 für 1 Endoskop 67 x 8 x 5,2 for 1 endoscope



**Sterilisations- und Aufbewahrungssystem "Instru-Safe" für NNH-Set,**  
**270 x 245 x 152 mm**

**Sterilisation and protection system "Instru-Safe" for sinus surgery set,**  
**270 x 245 x 152 mm**

#### Vorteile / Advantages:

- Halterung für 20 Nasenzangen / Segments for 20 nasal forceps
- Leerraum für sperrige Instrumente / Space for bulky instruments
- Silikon-Noppen-Matte für feine Instrumente  
Silicone finger for delicate instruments

**80-611-10**



## 10 FESS - Basis-Set

### FESS - Basic-Set

#### Bestehend aus / Consisting of:

30-143-00	1x Sinuskop, HD, autoklavierbar, 4,0 mm, AL 175 mm, 0° 1x Sinuscope, HD, autoclavable, 4.0 mm, WL 175 mm, 0°	20-215-01	1x Blakesley Nasenzange, gerade, Gr. 1 1x Blakesley nasal forceps, straight, size 1
30-142-45	1x Sinuskop, HD, autoklavierbar, 4,0 mm, AL 175 mm, 45° 1x Sinuscope, HD, autoclavable, 4.0 mm, WL 175 mm, 45°	20-225-02	1x Blakesley Nasenzange, 45° aufgebogen, Gr. 2 1x Blakesley nasal forceps, 45° curved upwards, size 2
30-143-70	1x Sinuskop, HD, autoklavierbar, 4,0 mm, AL 175 mm, 70° 1x Sinuscope, HD, autoclavable, 4.0 mm, WL 175 mm, 70°	20-235-03	1x Blakesley Nasenzange, 90° aufgebogen, Gr. 3 1x Blakesley nasal forceps, 90° curved upwards, size 3
20-100-01	1x Hartmann Nasenspekulum für Erwachsene 1x Hartmann nasal speculum for adults	20-690-01	1x Conchotomie Schere, gerade 1x Nasal concha scissors, straight
20-150-75	1x Killian-Struycken Septumspikulum, 75 mm 1x Killian-Struycken nasal speculum, 75 mm	30-320-01	1x Durchschneidende Nasenzange, 5,0 x 1,5 mm, gerade 1x Throughcutting nasal forceps, 5.0 x 1.5 mm, straight
30-101-30	1x Eicken Spülröhrchen, kurze Biegung, Ø 3,0 mm 1x Eicken antrum cannula, short curve, Ø 3.0 mm	30-320-02	1x Durchschneidende Nasenzange, 6,0 x 2,5 mm, gerade 1x Throughcutting nasal forceps, 6.0 x 2.5 mm, straight
30-102-30	1x Eicken Spülröhrchen, kurze Biegung, Ø 3,0 mm 1x Eicken antrum cannula, short curve, Ø 3.0 mm	30-321-01	1x Durchschneidende Nasenzange, 60° gewinkelt, 5,0 x 1,5 mm 1x Throughcutting nasal forceps, 60° angled, 5.0 x 1.5 mm
30-122-08	1x Injektionskanüle, kniegebogen, 0,8 mm 1x Injection needle, angled, 0.8 mm	30-322-02	1x Durchschneidende Nasenzange, aufgebogen, 6,5 x 2,5 mm 1x Throughcutting nasal forceps, curved upwards, 6.5 x 2.5 mm
30-082-10	1x Frazier Saugrohr, Knopfende, 10 Ch/Fr 1x Frazier suction tube, ball ended, 10 Ch/Fr	30-304-25	1x Antrumstanze, rückwärts schneidend, drehbar, 2,5 mm 1x Antrum punch, backward cutting, rotatable, 2.5 mm
30-082-12	1x Frazier Saugrohr, Knopfende, 12 Ch/Fr 1x Frazier suction tube, ball ended, 12 Ch/Fr	30-468-20	1x Kerrison Keilbeinstanze, zerlegbar, 2 mm, 90° aufwärts 1x Kerrison sphenoid punch, detachable, 2 mm, 90° upwards
30-082-15	1x Frazier Saugrohr, Knopfende, 15 Ch/Fr 1x Frazier suction tube, ball ended, 15 Ch/Fr	30-333-02	1x Herberhold cranial durchschneidende Zange, 60° aufgebogen, flach, 11,5 x 2,5 mm 1x Herberhold cranial throughcutting forceps, 60° curved upwards, flat, 11.5 x 2.5 mm
20-305-18	1x Freer Doppellevatorium, scharf/stumpf 1x Freer elevator, double ended, sharp/blunt	30-308-01	1x Antrumstanze, links schneidend 1x Antrum punch, left cutting
30-155-50	1x Antrum Trokar, schnabelförmig, 5 mm AD 1x Antrum trocar, beaked, 5 mm OD	30-308-02	1x Antrumstanze, rechts schneidend 1x Antrum punch, right cutting
30-200-01	1x Sichelmesser, gerader Schaft, spitz 1x Sickle knife, straight shaft, pointed	30-422-45	1x Rundkopfstanze für Keilbeinhöhle, 0°, 4,5 mm, mit Spülkanal 1x Sphenoid sinus circular punch, 0°, 4.5 mm, with irrigation channel
30-205-02	1x Antrum-Löffel, längsoval, klein, 2,5 x 6,0 mm, 45° 1x Antrum curette, oval, small, 2.5 x 6.0 mm, 45°	30-425-45	1x Stirnhöhlen-Stanze, aufgebogen, stumpfes Ende, mit Spülkanal, 4,5 mm 1x Frontal sinus punch, curved upwards, blunt end, with irrigation channel, 4.5 mm
30-205-06	1x Stirnhöhlen-Löffel, gerader Schaft, längsoval, 90° aufgebogen 1x Frontal sinus curette, straight shaft, oval, 90° upcurved		
30-203-01	1x Antrum-Kürette, gerader Schaft, vorwärts schneidend 1x Antrum curette, straight shaft, forward cutting		
30-203-02	1x Antrum-Kürette, gerader Schaft, rückw. schneidend 1x Antrum curette, straight shaft, backward cutting		
30-410-01	1x Stirnhöhlen Biopsiezange, 70°, 3 mm, vertikal, mit Spülkanal 1x Frontal sinus biopsy forceps, 70°, 3 mm, vertical, with irrigation channel		
30-411-01	1x Stirnhöhlen Biopsiezange, 110°, 3 mm, vertikal, mit Spülkanal 1x Frontal sinus biopsy forceps, 110°, 3 mm, vertical, with irrigation channel		
30-311-02	1x Kieferhöhlen Polypen-Fasszange, rückwärts öffnend, drehbar 1x Antrum polyp grasping forceps, retrograde opening, rotatable		
30-207-01	1x Stirnhöhlen-Sonde, doppelseitig, leicht gebogen, 19 cm 1x Frontal sinus seeker, double ended, slightly curved, 19 cm		
30-207-02	1x Kieferhöhlensonde, doppelseitig, 19 cm 1x Maxillary sinus seeker, double ended, 19 cm		
30-207-03	1x Stirnhöhlensonde, doppelseitig, stark gebogen, 19 cm 1x Frontal sinus seeker, double ended, strongly curved, 19 cm		
30-402-02	1x Stirnhöhlezange, durchschneidend, 90°, 2 mm, horizontal 1x Frontal sinus forceps, throughcutting, 90°, 2 mm, horizontal		

#### Ergänzung

#### Supplement

30-160-02	1x Ultra-Stop Antibeschlagmittel, 30 ml, Durchstichflasche, steril 1x Ultra-Stop antifog solution, 30 ml, pierce bottle, sterile
80-661-14	1x Norm-Sterilisations-Container, Boden geschlossen, 585 x 274 x 138 mm 1x Norm sterilization container, bottom closed, 585 x 274 x 138 mm
80-662-00	1x Ventildeckel, silber, für Container 80-661-14, 585 x 278 mm 1x Valve lid, silver, for container 80-661-14, 585 x 278 mm
80-671-60	1x Edelstahl-Siebkorb, Geflecht, Fallgriffe, 485 x 255 x 70 mm 1x Stainless steel wire basket, sliding handles, 485 x 255 x 70 mm
80-681-01	1x Aluminium-Kennzeichnungs-Schild, schwarz, 20 Zeichen 1x Aluminium tag, black, 20 letter

Supplement for sales in EU (outside the EU only on request)



**Bestehend aus / Consisting of:**

20-100-02	1x Hartmann Nasenspekulum für Jugendliche 1x Hartmann nasal speculum for juveniles
30-101-25	1x Eicken Spülröhrchen, lange Biegung, 2,5 mm Durchmesser 1x Eicken antrum cannula, long curve, 2.5 mm diameter
30-102-25	1x Eicken Spülröhrchen, kurze Biegung, 2,5 mm Durchmesser 1x Eicken antrum cannula, short curve, 2.5 mm diameter
30-082-10	1x Frazier Saugrohr, Knopfende, 10 Ch (3,3 mm) 1x Frazier suction tube, ball ended, 10 Fr (3.3 mm)
30-130-00	1x Sinusskop, 187,5 mm AL, 2,7 mm AD, 0° 1x Sinusscope, 187.5 mm length, 2.7 mm OD, 0°
30-130-30	1x Sinusskop, 187,5 mm AL, 2,7 mm AD, 30° 1x Sinusscope, 187.5 mm length, 2.7 mm outer diameter, 30°
30-742-19	1x Draf Sichelmesser, 19 cm, gebogen 1x Draf sickle knife, 19 cm, curved
20-305-18	1x Freer Doppelevatorium, scharf/stumpf 1x Freer elevator, double ended, sharp/blunt
30-207-01	1x Stirnhöhlen-Sonde, doppelseitig, leicht gebogen 1x Frontal sinus seeker, double ended, slightly curved
30-207-02	1x Kieferhöhlen-Sonde, doppelseitig 1x Maxillary sinus seeker, double end
30-205-02	1x Antrum-Löffel, längsoval, klein, 2,5 x 6,0 mm, 45° gewinkelt 1x Antrum curette, oval, small, 2.5 x 6.0 mm, 45° angled
30-205-06	1x Antrum-Löffel, längsoval, klein, 2,5 x 6,0 mm, 90° gewinkelt 1x Antrum curette, oval, small, 2.5 x 6.0 mm, 90° angled
30-122-08	1x Injektionskanüle, kniegebogen, 0,8 mm 1x Injection needle, angled, 0.8 mm
20-215-00	1x Blakesley Nasenzange, gerade, Gr. 0 1x Blakesley nasal forceps, straight, size 0
20-225-00	1x Blakesley Nasenzange, 45° aufgebogen, Gr. 0 1x Blakesley nasal forceps, 45° upcurved, size 0
30-304-15	1x Antrumstanze, rückwärts schneidend, drehbar, 1,5 mm 1x Antrum punch, backward cutting, rotatable, 1.5 mm
30-330-01	1x Wigand durchschneidende Zange, flach, abgerundet, 4,0 x 3,0 mm, gerade, 14 cm 1x Wigand throughcutting forceps, flat, rounded, 4.0 x 3.0 mm, straight, 14 cm
30-330-02	1x Wigand durchschneidende Zange, flach, abgerundet, 4,0 x 3,0 mm, 5° aufgewinkelt, 14 cm 1x Wigand throughcutting forceps, flat, rounded, 4.0 x 3.0 mm, 45° angled, 14 cm
30-407-02	1x Stirnhöhlen Löffelzange, 90°, 2 mm, horizontal, mit Spülkanal 1x Frontal sinus forceps, oval cups, 90°, 2 mm, horizontal, with irrigation channel
30-720-16	1x Draf Siebbeinzängchen, gerade, 4 x 1,8 mm, 16 cm 1x Draf ethmoid forceps, straight, 4 x 1.8 mm, 16 cm

**Ergänzung****Supplement**

30-160-02	1x Ultra-Stop Antibeschlagmittel, 30 ml, Durchstichflasche steril 1x Ultra-Stop antifog solution, 30 ml, pierce bottle, sterile
80-661-14	1x Norm-Sterilisations-Container, Boden geschlossen, 585 x 274 x 138 mm 1x Norm sterilization container, bottom closed, 585 x 274 x 138 mm
80-662-00	1x Ventildeckel, silber, für Container 80-661-14, 585 x 278 mm 1x Valve lid, silver, for container 80-661-14, 585 x 278 mm
80-671-60	1x Edelstahl-Siebkorb, Geflecht, Fallgriffe, 485 x 255 x 70 mm 1x Stainless steel wire basket, sliding handles, 485 x 255 x 70 mm
80-681-04	1x Aluminium-Kennzeichnungs-Schild, grün, 20 Zeichen 1x Aluminium tag, green, 20 letter

Supplement for sales in EU (outside the EU only on request)





## 10 Schädelbasis-Set

### Skull base-Set

#### Bestehend aus / Consisting of:

77HW002	1x Bohrhandstück, gewinkelt, autoklavierbar, 1:1 1x Drill handpiece, angled, autoclavable, 1:1	30-732-16	1x Draf Siebbeinscherchen, gerade, 16 cm 1x Draf ethmoid scissors, straight, 16 cm
BS23509516	1x Bohrerständer für 16 rotierende Instrumente der L= 95 mm 1x Stand for 16 rotary instruments of length 95 mm	30-740-10	1x Draf Mikroraspatorium, 25 cm, 1 mm, leicht gebogen 1x Draf micro raspatory, 25 cm, 1 mm, angled
CR095011206	1x Osteotomie-Bohrer, HM, 95 mm, 1,2 mm, 6 Schneiden 1x Osteotomy bur, TC, 95 mm, 1.2 mm, 6 blades	30-740-30	1x Draf Mikroraspatorium, 25 cm, 3 mm, leicht gebogen 1x Draf micro raspatory, 25 cm, 3 mm, slightly curved
CR095011806	1x Osteotomie-Bohrer, HM, 95 mm, 1,8 mm, 6 Schneiden 1x Osteotomy bur, TC, 95 mm, 1.8 mm, 6 blades	30-740-31	1x Draf Mikroraspatorium, 25 cm, 3 mm, stark gebogen 1x Draf micro raspatory, 25 cm, 3 mm, strongly curved
CR095012306	1x Osteotomie-Bohrer, HM, 95 mm, 2,3 mm, 6 Schneiden 1x Osteotomy bur, TC, 95 mm, 2.3 mm, 6 blades	30-740-40	1x Draf Mikroraspatorium, 25 cm, 4 mm, gewinkelt 1x Draf micro raspatory, 25 cm, 4 mm, angled
CR095014008	1x Osteotomie-Bohrer, HM, 95 mm, 4,0 mm, 8 Schneiden 1x Osteotomy bur, TC, 95 mm, 4.0 mm, 8 blades	30-742-19	1x Draf Sichelmesser, 19 cm, gebogen 1x Draf sickle knife, 19 cm, curved
CR095016014	1x Osteotomie-Bohrer, HM, 95 mm, 6,0 mm, 14 Schneiden 1x Osteotomy bur, TC, 95 mm, 6.0 mm, 14 blades	30-743-19	1x Draf Rundschnittmesser, 19 cm, 1,5 mm 1x Draf round knife, 19 cm, 1.5 mm
DR095011891	1x Diamantbohrer, 95 mm, 1,8 mm mittel 1x Diamond bur, 95 mm, 1.8 mm, medium	30-744-19	1x Draf Incisionsmesser, 19 cm 1x Draf incision knife, 19 cm
DR095012791	1x Diamantbohrer, 95 mm, 2,7 mm mittel 1x Diamond bur, 95 mm, 2.7 mm, medium	30-747-06	1x Frazier Saugrohr, 15 cm, 6 Ch/Fr (2,0 mm) 1x Frazier suction tube, 15 cm, 6 Ch/Fr (2.0 mm)
DR095013591	1x Diamantbohrer, 95 mm, 3,5 mm mittel 1x Diamond bur, 95 mm, 3.5 mm, medium	30-747-08	1x Frazier Saugrohr, 15 cm, 8 Ch/Fr (2,7 mm) 1x Frazier suction tube, 15 cm, 8 Ch/Fr (2.7 mm)
DR095014591	1x Diamantbohrer, 95 mm, 4,5 mm mittel 1x Diamond bur, 95 mm, 4.5 mm, medium	30-748-10	1x Frazier Saugrohr, 15 cm, 10 Ch/Fr (3,3 mm) 1x Frazier suction tube, 15 cm, 10 Ch/Fr (3.3 mm)
DR095016091	1x Diamantbohrer, 95 mm, 6,0 mm mittel 1x Diamond bur, 95 mm, 6.0 mm, medium	30-749-15	1x Saug- und Spülrohr, 17 cm, 2,5 / 2,0 mm 1x Suction/irrigation tube, 17 cm, 2.5 / 2.0 mm
DR095013593	1x Diamantbohrer, 95 mm, 3,5 mm, grob 1x Diamond bur, 95 mm, 3.5 mm, coarse	30-770-30	1x Yasargil Pinzette, ringförmig, 22 cm 1x Yasargil dressing forceps, ring ended, 22 cm
DR095016093	1x Diamantbohrer, 95 mm, 6,0 mm, grob 1x Diamond bur, 95 mm, 6.0 mm, coarse	30-759-21	1x Tönnis Gefäßraspatorium, 21,5 cm 1x Tönnis raspatory, 21.5 cm
30-700-00	1x Flexibler Spannarm für Spekula, mit Verlängerung 1x Flexible holding arm for specula, incl. holding rods	80-125-07	1x Bipolare Koagulationspinzette, NON-STICK, bajonett, Führungsstift 22,5 cm, 0,7 mm 1x Bipolar coagulation forceps, NON-STICK, bayonet, guide pin, 22.5 cm, 0.7 mm
30-700-01	1x Gelenkkloben zur Befestigung am OP-Tisch 1x Rotation clamp for fixation to operating table	80-318-50	1x Bipolares Anschlusskabel passend für Erbe/Storz, 5 m 1x Bipolar cable, for Erbe/Storz, 5 m
30-705-55	1x NNH-Spekulum für Erw., 13,5 cm, 55 mm linkes Blatt 1x Sinus speculum f. adults, 13.5 cm, 55 mm left blade		
30-705-75	1x NNH-Spekulum f. Erw., 13,5 cm, 75 mm linkes Blatt 1x Sinus speculum f. adults, 13.5 cm, 75 mm left blade		
30-706-55	1x NNH-Spekulum f. Erw., 13,5 cm, 55 mm rechtes Blatt 1x Sinus speculum f. adults, 13.5 cm, 55 mm right blade		
30-706-75	1x NNH-Spekulum f. Erw., 13,5 cm, 75 mm rechtes Blatt 1x Sinus speculum f. adults, 13.5 cm, 75 mm right blade		
30-720-16	1x Draf Siebbeinzängchen, 4 x 1,8 mm, 16 cm, gerade 1x Draf ethmoid forceps, 4 x 1.8 mm, 16 cm, straight		
30-722-16	1x Draf Siebbeinzängchen, 4 x 1,8 mm, 16 cm, 45° aufgebogen 1x Draf ethmoid forceps, 4 x 1.8 mm, 16 cm, 45° angled		
30-724-16	1x Draf Siebbeinzängchen, 4 x 1,8 mm, 16 cm, 90° aufgebogen 1x Draf ethmoid forceps, 4 x 1.8 mm, 16 cm, 90° angled		
30-726-16	1x Draf Siebbeinzängchen, 3 x 1,5 mm, 16 cm, gerade 1x Draf ethmoid forceps, 3 x 1.5 mm, 16 cm, straight		
30-728-16	1x Draf Siebbeinzängchen, fein gerieft, 16 cm, gerade 1x Draf ethmoid forceps, fine serrated, 16 cm, straight		

#### Ergänzung

#### Supplement

80-661-14	1x Norm-Sterilisations-Container, Boden geschlossen, 585 x 274 x 138 mm 1x Norm sterilization container, bottom closed, 585 x 274 x 138 mm
80-662-00	1x Ventildeckel, silber, für Container 80-661-14, 585 x 278 mm 1x Valve lid, silver, for container 80-661-14, 585 x 278 mm
80-671-60	1x Edelstahl-Siebkorb, Geflecht, Fallgriffe, 485 x 255 x 70 mm 1x Stainless steel wire basket, sliding handles, 485 x 255 x 70 mm
80-681-06	1x Aluminium-Kennzeichnungs-Schild, lila, 20 Zeichen 1x Aluminium tag, purple, 20 letter

Supplement for sales in EU (outside the EU only on request)

Adson-Brown Pinzette.....	20	Jansen Nasenpinzette.....	20	Stirnhöhlenstanze .....	43
Antifog.....	13	Joseph Schere .....	18-19	Stirnhöhlenzange.....	44
Antrum-Kürette .....	27	Kerrison Keilbeinstanze .....	49	Strümpel-Voss Nasenzange .....	25
Antrum-Löffel.....	27	Kieferhöhlen Polypen-Fasszange .....	32	Spiegel .....	60
Antrum-Trokar.....	12	Kieferhöhlensonde.....	29	Spiegel-Handgriff.....	60
Antrumstanze, rückwärts schneidend .....	30-31	Kieferhöhlen-Spülschlauch.....	7	Tablettenschale .....	64
Antrumstanze, seitwärts schneidend.....	31	Killian-Struycken Septumspekulum.....	19	Takahashi Nasenzange .....	26, 35
Binner Polypenfasszange.....	44	Kornzangenbehälter.....	65	Tellermesser.....	58
Biopsiezange .....	8, 45	Knochenstanze mit Reservoir.....	46	Tobey Mikro-Antrumstanze .....	31
Bipolare Koagulationspinzette.....	54	Krause Nasenpolypenschnürer.....	22	Tönnis Gefäßraspatorium .....	53
Bipolare Pinzette.....	23	Langenbeck Wundhaken.....	63	Uffenorde Kieferhöhlenlöffel .....	61
Bipolares Anschlusskabel.....	23, 54	Langenbeck-Green Wundhaken .....	63	Ultra-Stop Antibeschlagmittel.....	12
Blakesley Nasenzange .....	24-26, 35-37	LED-Leuchtgriff.....	14	Walter Schere .....	19
Codierschild.....	66	Lichtleitkabel .....	17	Watteträger .....	20
Conchotomie Schere .....	28-29	Lichtwitz Punktionskanüle .....	7	Weber Doppelevatorium .....	21
Container-Siegel.....	67	Löffelkürette.....	54-59	Weber Nasenschere .....	28
Cottle Columella-Klemme.....	20	Löffelzange.....	33	West Flachmeißel.....	62
Cottle Hammer.....	22	Lösungsschale.....	64	West Hohlmeißel.....	61
Cottle Meißel.....	22	Mandrin .....	46	Wigand durchschneidende Zange.....	34
Cottle Nasenflügelhaken.....	23	Masing Elevatorium/Raspatorium .....	21	Wigand Polypen-Fasszange.....	25
Cottle Septum-Messer.....	20	Masing Ritzmesser.....	21	Wigand Stirnhöhlenraspel.....	28
Crile-Wood Nadelhalter .....	22	Matrix LED 100 duo.....	17	Yasargil Pinzette .....	53
Desinfektions Wandhalterung für Endoskope .....	18	McKenty Keilbeinstanze.....	48		
Desinfektions-System für Endoskope.....	18, 65	Medikamentenschälchen.....	64-65		
Dichtigkeitstester für flexible Endoskope .....	16	Medizinbecher .....	64		
Dissektor.....	58	Metallschale .....	63		
Dieler bipolare Koagulationszangen .....	39-42	Middeldorf Wundhaken .....	62		
Draf Incisionsmesser .....	52	Mikro-Häkchen .....	59		
Draf Mikroraspatorium .....	52	Mukosa Dissektor.....	59		
Draf Rundschnittmesser .....	52	Nasenpolypenschlingen.....	22		
Draf Sichelmesser .....	52	Nasensonde S-förmig.....	23		
Draf Siebbeinscherchen.....	51	Nierenschale.....	65		
Draf Siebbeinzängchen.....	51	NNH-Spekulum .....	50		
Durchschneidende Nasenzange .....	33	Norm-Sterilisationscontainer.....	66		
Durchschneidende Saugzange .....	34	Ölspray für Instrumente.....	63		
Eicken Spülröhrchen .....	5	Orbitaschützer .....	61		
Endoskope .....	9-11	Pädiatrisches FESS-SET.....	69		
Endoskop-Schutzhülse.....	13	Petrischale .....	64		
Enucleator.....	57	Porzellanschälchen .....	65		
FESS-Basis-Set.....	68	Raspatorium .....	57		
Fiberglas-Lichtleitkabel.....	17	Reynolds Schere.....	18-19		
Fisch Wundsperrer.....	54	Ritter Stirnhöhlenbougie.....	8		
Flexible Alligatorzange .....	16	Ringkürette .....	58		
Flexible Löffelzange.....	16	Rundkopfstanze für Keilbeinhöhle .....	45, 46		
Flexibler Spannarm .....	50	Rundkopfstanze für Stirnhöhle .....	43		
Flexibles Endoskop.....	15, 16	Saug- und Spülhandgriff.....	13		
Frazier Saugrohr .....	6, 53	Saug- und Spülrohr .....	53		
Freer Doppelevatorium .....	21	Saug- und Spülschaft .....	13		
Gelenkkloben .....	50	Schädelbasis-Set.....	70		
Grünwald Rohrschaftzange .....	38	Schwager Stanze .....	47		
Guillen Saugraspatorium .....	21	Sewall Kieferhöhlenelevatorium .....	61		
Haken .....	57	Sichelmesser .....	27, 56		
Handgriff für Endoskope.....	12	Siebkorb .....	66		
Hammer .....	22	Sinuskop.....	9-11		
Hajak-Kofler Keilbeinstanze .....	43-44	Sondenhäkchen.....	57		
Halle Kieferhöhlenkürette.....	61	Sterilisations-System "InstruSafe" .....	67		
Halle Kieferhöhlenlöffel.....	61	Sternberg Lippenhaken.....	62		
Hartmann Nasenspekulum .....	5	Stirnhöhlen Biopsiezange .....	45		
Hartmann Nasentamponadezange .....	25	Stirnhöhlen Löffel.....	28		
Herberhold cranial durchschneidende Zange .....	34	Stirnhöhlenlöffelzange.....	45		
Hochleistungs-Fiberglas-Lichtleitkabel.....	17	Stirnhöhlensaugraspatorium .....	7		
Indikator-Klebeetikett.....	67	Stirnhöhlensaugrohr.....	7		
Injektionskanüle .....	8	Stirnhöhlensonde .....	29		



## Alphabetical Index

Adhesive indicator label.....	67	Hartmann nasal dressing forceps .....	25	Suction- and irrigation sheath.....	13
Adson-Brown forceps .....	20	Hartmann nasal speculum .....	5	Tablet dish .....	64
Antifog.....	13	Herberhold cranial throughcutting forceps .....	34	Takahashi nasal forceps.....	26
Antrum curette.....	27	High definition fibre light cable .....	17	Takahashi suction forceps.....	35
Antrum polyp grasping forceps.....	32	Hook.....	57	Tobey micro antrum punch .....	31
Antrum punch with collector.....	46	Injection needle .....	8	Tönnis raspatory.....	53
Antrum punch .....	30-31, 46	Jansen nasal forceps.....	20	Throughcutting nasal forceps.....	33
Antrum trocar.....	12	Joseph scissors.....	18-19	Throughcutting suction forceps.....	34
Basket.....	66	Kerrison sphenoid punch.....	49	Uffendorfer antrum curette .....	61
Binner polyp forceps.....	44	Kidney bowl .....	65	Ultra-Stop anti-fog solution .....	12
Biopsy forceps .....	8	Killian-Struycken septum speculum .....	19	Valve lid for norm sterilization container.....	66
Bipolar cable.....	23, 54	Krause nasal polyp snare .....	22	Walter scissors.....	19
Bipolar coagulation forceps.....	54	Langenbeck-Green retractor.....	63	Weber elevator .....	21
Bipolar forceps .....	23	Langenbeck retractor.....	63	Weber nasal scissors.....	28
Blakesley nasal forceps.....	24-26, 35-37	Leak tester for flexible endoscopes .....	16	West chisel.....	62
China bowl .....	65	LED light handles .....	14	West gouge.....	61
Clip on coding clamp .....	67	Lichtwitz trocar needle.....	7	Wigand frontal sinus rasp.....	28
Coding labels.....	66	Mallet.....	22	Wigand polyp grasping forceps.....	25
Container seal .....	67	Masing elevator/raspatory .....	21	Wigand throughcutting forceps .....	34
Cottle alar retractor.....	23	Masing pointed knife .....	21	Yasargil dressing forceps .....	53
Cottle chisel.....	22	Matrix LED 100 duo.....	17		
Cottle columella forceps.....	20	Maxillary sinus seeker.....	29		
Cottle mallet.....	22	McKenty sphenoid punch .....	48		
Cottle septum knife.....	20	Medicine cup .....	64		
Cotton carrier .....	20	Medication dish.....	64-65		
Crile-Wood needleholder .....	22	Metal bowl .....	63		
Cup forceps.....	33	Micro hook .....	59		
Dissector.....	58	Middeldorpf antrum retractor.....	62		
Dieler bipolar Coagulation forceps.....	39-42	Mirror.....	60		
Disinfection wall holder for endoscopes.....	18	Mirror handle .....	60		
Draf ethmoid forceps.....	51	Mucosa dissector .....	59		
Draf ethmoid scissors.....	51	Nasal conchotomy scissors.....	28, 29		
Draf flap knife .....	52	Nasal polyp snare wires.....	22		
Draf micro raspatory.....	52	Nasal probe .....	23		
Draf round knife .....	52	Norm sterilization container .....	66		
Draf sickle knife.....	52	Oil spray for instruments.....	63		
Eicken antrum cannula.....	5	Orbita protector .....	61		
Endoscope.....	9-11	Pediatric FESS-Set.....	69		
Endoscope container with lid.....	67	Petri dish .....	64		
Endoscope handle .....	12	Probe hook.....	57		
Endoscope protection sleeve .....	13	Raspatory .....	57		
Endoscope sterilizing/protecting tray .....	13, 66	Reynolds scissors.....	18-19		
Enucleator .....	57	Ring curette .....	58		
FESS-Basic-Set .....	68	Ritter frontal sinus bougie.....	8		
Fibre light cable.....	17	Rotation clamp for fixation to operating table.....	50		
Fisch Retractor.....	54	Schwager punch .....	47		
Flexible alligator forceps .....	16	Seperator.....	58		
Flexible endoscope.....	15, 16	Sewall antrum elevator.....	61		
Flexible holding arm .....	60	Sickle knife.....	27, 56		
Forceps holder.....	65	Sinus irrigation tube .....	7		
Frazier suction tube.....	6, 53	Sinus speculum for adults .....	50		
Freer double elevator .....	21	Sinus speculum for children.....	50		
Frontal sinus biopsy forceps.....	45	Sinus suction tube.....	7		
Frontal sinus circular punch .....	43	Sinuscope.....	9-11		
Frontal sinus curette.....	28	Solution bowl.....	64		
Frontal sinus forceps.....	44	Skull base Set.....	70		
Frontal sinus punch.....	43	Sphenoid sinus circular punch .....	45, 46		
Frontal sinus probe .....	29	Spoon curette.....	54-59		
Frontal sinus suction raspatory .....	7	Sterilizing system "Instru Safe" .....	67		
Frontal sinus suction tube.....	7	Sternberg lip retractor.....	62		
Grünwald tubular forceps.....	38	Strümpel-Voss nasal forceps.....	25		
Guillen suction raspatory .....	21	Stylet .....	46		
Hajek-Kofler sphenoid punch .....	47, 48	Suction/Irrigation tube.....	53		
Halle antrum curette.....	61	Suction- and irrigation handle .....	13		

78PS01.....59	20-405-10.....22	30-121-25.....8	30-205-06.....28	30-358-00.....37
10-129-30.....10	20-405-12.....22	30-121-30.....8	30-205-70.....28	30-358-01.....37
10-129-70.....10	20-500-13.....20	30-121-40.....8	30-207-01.....29	30-358-02.....37
10-468-17.....50	20-501-14.....21	30-121-50.....8	30-207-02.....29	30-360-00.....37
20-100-01.....5	20-502-14.....21	30-122-08.....8	30-207-03.....29	30-360-01.....37
20-100-02.....5	20-560-14.....23	30-125-00.....8	30-209-01.....28	30-360-02.....37
20-150-40.....18	20-601-14.....18	30-129-00.....10	30-300-01.....30	30-370-15.....38
20-150-55.....18	20-610-15.....18	30-129-30.....10	30-300-02.....30	30-370-20.....38
20-150-65.....18	20-630-10.....18	30-130-00.....10	30-300-03.....30	30-370-25.....38
20-150-75.....18	20-635-15.....19	30-130-30.....10	30-302-01.....30	30-370-30.....38
20-150-90.....18	20-635-18.....19	30-130-70.....10	30-302-02.....30	30-371-15.....38
20-190-25.....22	20-640-14.....19	30-132-00.....11	30-302-03.....30	30-371-20.....38
20-195-35.....22	20-641-14.....19	30-132-30.....11	30-304-15.....31	30-371-25.....38
20-200-16.....25	20-690-01.....28	30-132-45.....11	30-304-25.....31	30-371-30.....38
20-200-20.....25	20-690-02.....28	30-134-00.....11	30-305-00.....31	30-372-15.....38
20-215-00.....24	20-690-03.....28	30-134-30.....11	30-306-00.....31	30-372-20.....38
20-215-01.....24	20-691-01.....28	30-134-45.....11	30-307-00.....31	30-372-25.....38
20-215-02.....24	20-693-00.....29	30-134-70.....11	30-308-01.....31	30-373-15.....38
20-215-03.....24	20-693-01.....29	30-135-00.....10	30-308-02.....31	30-373-20.....38
20-215-04.....24	20-693-02.....29	30-135-30.....10	30-310-01.....32	30-373-25.....38
20-215-10.....24	20-700-10.....20	30-142-45.....10	30-310-02.....32	30-374-20.....38
20-215-12.....24	20-710-12.....20	30-142-90.....10	30-311-01.....32	30-375-20.....38
20-215-14.....24	20-713-12.....20	30-143-00.....10	30-311-02.....32	30-376-20.....38
20-225-00.....24	20-730-16.....20	30-143-30.....10	30-320-01.....33	30-400-00.....43
20-225-01.....24	20-730-19.....20	30-143-70.....10	30-320-02.....33	30-400-01.....43
20-225-02.....24	20-730-21.....20	30-151-27.....12	30-321-01.....33	30-401-01.....45
20-225-03.....24	20-740-15.....22	30-151-40.....12	30-321-02.....33	30-401-02.....45
20-225-04.....24	20-800-16.....20	30-155-50.....12	30-322-01.....33	30-402-01.....45
20-225-11.....24	20-801-16.....20	30-156-33.....12	30-322-02.....33	30-402-02.....45
20-225-12.....24	20-802-16.....20	30-156-40.....12	30-328-01.....33	30-404-01.....44
20-225-14.....24	30-080-05.....6	30-156-50.....12	30-330-01.....34	30-404-02.....44
20-235-01.....24	30-080-06.....6	30-160-01.....12	30-330-02.....34	30-405-01.....44
20-235-02.....24	30-080-07.....6	30-160-02.....12	30-332-01.....34	30-405-02.....44
20-235-03.....24	30-080-08.....6	30-160-03.....12	30-332-02.....34	30-405-11.....44
20-236-00.....25	30-080-09.....6	30-160-04.....13	30-333-01.....34	30-405-12.....44
20-238-00.....25	30-080-10.....6	30-160-05.....13	30-333-02.....34	30-407-01.....44
20-240-01.....26	30-080-12.....6	30-161-00.....13	30-340-01.....35	30-407-02.....44
20-240-02.....26	30-080-15.....6	30-164-00.....13	30-340-02.....35	30-408-01.....44
20-240-11.....26	30-082-08.....6	30-164-30.....13	30-340-03.....35	30-408-02.....44
20-240-12.....26	30-082-10.....6	30-164-45.....13	30-342-01.....35	30-410-01.....45
20-245-01.....26	30-082-12.....6	30-164-70.....13	30-342-02.....35	30-410-02.....45
20-245-02.....26	30-082-15.....6	30-167-00.....13	30-342-03.....35	30-411-01.....45
20-245-11.....26	30-084-01.....6	30-167-30.....13	30-343-01.....36	30-411-02.....45
20-245-12.....26	30-084-02.....6	30-169-08.....16	30-343-02.....36	30-415-01.....44
20-246-01.....26	30-100-25.....5	30-170-28.....15	30-343-03.....36	30-415-02.....44
20-246-02.....26	30-100-30.....5	30-170-36.....15	30-343-04.....36	30-421-35.....43
20-300-21.....21	30-100-40.....5	30-171-40.....15	30-343-11.....36	30-421-45.....43
20-305-18.....21	30-101-25.....5	30-172-40.....16	30-343-12.....36	30-422-35.....46
20-306-20.....21	30-101-30.....5	30-172-41.....16	30-343-13.....36	30-422-45.....46
20-307-18.....21	30-101-40.....5	30-173-40.....16	30-343-14.....36	30-425-35.....44
20-313-00.....23	30-102-25.....5	30-173-41.....16	30-344-00.....34	30-425-45.....44
20-320-19.....7	30-102-30.....5	30-175-40.....16	30-344-45.....34	30-428-35.....43
20-322-01.....21	30-102-40.....5	30-182-21.....13	30-346-00.....35	30-428-45.....43
20-322-02.....21	30-105-06.....6	30-200-01.....27	30-346-30.....35	30-429-35.....45
20-322-03.....21	30-105-08.....6	30-200-02.....27	30-350-00.....37	30-429-45.....45
20-323-01.....21	30-105-10.....6	30-200-03.....27	30-350-01.....37	30-450-20.....46
20-323-02.....21	30-106-25.....7	30-200-04.....27	30-350-02.....37	30-450-30.....46
20-323-03.....21	30-106-30.....7	30-203-01.....27	30-350-03.....37	30-450-90.....46
20-400-18.....22	30-106-40.....7	30-203-02.....27	30-352-00.....37	30-454-20.....46
20-404-20.....22	30-108-00.....7	30-205-01.....27	30-352-01.....37	30-456-32.....47
20-405-04.....22	30-111-16.....7	30-205-02.....27	30-352-02.....37	30-468-10.....49
20-405-07.....22	30-111-18.....7	30-205-03.....27	30-354-01.....37	30-468-20.....49
20-405-09.....22	30-112-00.....7	30-205-04.....28	30-354-02.....37	30-468-30.....49



## Numerisches Inhaltsverzeichnis

### Numeric Content

30-468-40.....	49	30-705-65.....	50	70-258-35.....	17	80-519-00.....	65	90-201-04.....	55
30-468-50.....	49	30-705-75.....	50	70-259-35.....	17	80-519-01.....	65	90-201-05.....	55
30-469-10.....	49	30-706-55.....	50	70-260-35.....	17	80-519-02.....	65	90-201-06.....	55
30-469-20.....	49	30-706-65.....	50	70-265-01.....	17	80-519-03.....	65	90-201-07.....	55
30-469-30.....	49	30-706-75.....	50	70-265-02.....	17	80-520-06.....	65	90-201-08.....	55
30-469-40.....	49	30-720-13.....	51	70-266-02.....	17	80-520-08.....	65	90-201-09.....	55
30-469-50.....	49	30-720-16.....	51	70-267-03.....	16	80-525-17.....	65	90-201-14.....	56
30-471-10.....	49	30-720-19.....	51	70-470-00.....	17	80-525-25.....	65	90-201-15.....	56
30-471-20.....	49	30-722-13.....	51	70-472-00.....	17	80-528-13.....	65	90-201-16.....	56
30-471-30.....	49	30-722-16.....	51	80-090-00.....	40	80-528-18.....	65	90-201-17.....	56
30-473-10.....	49	30-722-19.....	51	80-090-01.....	40	80-528-20.....	65	90-201-18.....	56
30-473-20.....	49	30-724-13.....	51	80-090-02.....	42	80-530-20.....	65	90-201-19.....	56
30-473-30.....	49	30-724-16.....	51	80-090-03.....	41	80-611-10.....	67	90-201-28.....	56
30-475-01.....	47	30-724-19.....	51	80-090-04.....	41	80-621-05.....	11	90-201-29.....	56
30-475-02.....	47	30-726-13.....	51	80-090-05.....	41	80-622-56.....	11	90-202-01.....	56
30-477-10.....	49	30-726-16.....	51	80-090-07.....	40	80-623-22.....	11	90-202-02.....	56
30-477-20.....	49	30-728-16.....	51	80-090-08.....	41	80-631-10.....	66	90-204-01.....	57
30-477-30.....	49	30-729-16.....	51	80-090-09.....	41	80-631-12.....	66	90-204-02.....	57
30-477-40.....	49	30-732-13.....	51	80-090-10.....	41	80-631-14.....	66	90-206-01.....	57
30-477-50.....	49	30-732-16.....	51	80-090-11.....	41	80-631-21.....	66	90-206-02.....	57
30-477-60.....	49	30-732-19.....	51	80-090-12.....	41	80-632-00.....	66	90-206-03.....	57
30-478-10.....	49	30-733-16.....	51	80-090-13.....	41	80-632-01.....	66	90-206-04.....	57
30-478-20.....	49	30-734-16.....	51	80-090-14.....	41	80-632-02.....	66	90-208-01.....	57
30-478-30.....	49	30-735-19.....	51	80-090-15.....	41	80-632-03.....	66	90-208-02.....	57
30-478-40.....	49	30-740-10.....	52	80-090-16.....	41	80-632-04.....	66	90-210-01.....	57
30-478-50.....	49	30-740-30.....	52	80-090-17.....	41	80-632-05.....	66	90-210-02.....	57
30-478-60.....	49	30-740-31.....	52	80-110-16.....	23	80-641-14.....	66	90-210-03.....	58
30-479-10.....	49	30-740-40.....	52	80-125-03.....	54	80-642-00.....	66	90-210-04.....	58
30-479-20.....	49	30-742-19.....	52	80-125-07.....	54	80-642-01.....	66	90-210-05.....	58
30-479-30.....	49	30-743-19.....	52	80-125-12.....	54	80-642-02.....	66	90-210-06.....	58
30-479-40.....	49	30-744-19.....	52	80-126-23.....	23	80-642-03.....	66	90-210-07.....	58
30-479-50.....	49	30-747-06.....	53	80-302-12.....	62	80-642-04.....	66	90-210-08.....	58
30-479-60.....	49	30-747-07.....	53	80-302-14.....	62	80-642-05.....	66	90-210-09.....	58
30-483-10.....	49	30-747-08.....	53	80-302-16.....	62	80-661-12.....	66	90-210-10.....	58
30-483-20.....	49	30-747-09.....	53	80-306-17.....	62	80-661-14.....	66	90-211-01.....	58
30-483-30.....	49	30-747-10.....	53	80-306-22.....	62	80-661-21.....	66	90-212-01.....	59
30-483-40.....	49	30-747-12.....	53	80-306-30.....	62	80-662-00.....	66	90-212-02.....	59
30-483-50.....	49	30-747-15.....	53	80-308-07.....	63	80-662-01.....	66	90-212-03.....	59
30-483-60.....	49	30-749-15.....	53	80-308-10.....	63	80-662-02.....	66	90-213-00.....	59
30-484-10.....	49	30-759-21.....	53	80-308-15.....	63	80-662-03.....	66	90-214-00.....	59
30-484-20.....	49	30-770-30.....	53	80-308-20.....	63	80-662-04.....	66	90-215-00.....	59
30-484-30.....	49	30-770-50.....	53	80-320-30.....	42	80-662-05.....	66	90-220-00.....	60
30-484-40.....	49	30-805-00.....	61	80-321-30.....	42	80-671-20.....	66	90-222-04.....	60
30-484-50.....	49	30-807-01.....	61	80-322-30.....	42	80-671-25.....	66	90-222-05.....	60
30-484-60.....	49	30-807-02.....	61	80-324-40.....	42	80-671-40.....	66	90-222-06.....	60
30-485-10.....	49	30-807-03.....	61	80-334-16.....	63	80-671-60.....	66	90-222-08.....	60
30-485-20.....	49	30-809-01.....	61	80-416-45.....	23	80-681-01.....	66	90-222-10.....	60
30-485-30.....	49	30-809-02.....	61	80-417-45.....	23	80-681-02.....	66	90-222-12.....	60
30-485-40.....	49	30-812-24.....	61	80-419-45.....	23	80-681-03.....	66		
30-485-50.....	49	30-814-19.....	61	80-501-01.....	64	80-681-04.....	66		
30-485-60.....	49	30-816-40.....	61	80-501-02.....	64	80-681-05.....	66		
30-485-10TAN.....	49	30-817-40.....	62	80-501-03.....	64	80-681-06.....	66		
30-485-40TAN.....	49	30-900-00.....	68	80-501-04.....	64	80-681-07.....	66		
30-490-40.....	48	30-902-00.....	70	80-503-03.....	64	80-683-10.....	67		
30-491-40.....	48	30-905-00.....	69	80-504-05.....	64	80-684-10.....	67		
30-492-40.....	48	70-203-00.....	16	80-506-30.....	64	80-688-00.....	67		
30-493-40.....	48	70-211-00.....	14	80-507-40.....	64	80-690-01.....	67		
30-494-40.....	48	70-211-01.....	14	80-509-75.....	64	80-690-02.....	67		
30-700-00.....	50	70-211-10.....	14	80-512-00.....	64	80-691-01.....	67		
30-700-01.....	50	70-211-20.....	14	80-515-06.....	64	80-692-01.....	67		
30-702-25.....	50	70-211-30.....	14	80-515-08.....	64	90-201-01.....	54		
30-703-25.....	50	70-211-40.....	14	80-515-10.....	64	90-201-02.....	55		
30-705-55.....	50	70-211-50.....	14	80-517-00.....	64	90-201-03.....	55		

## Umrechnungstabelle - Ch/Fr - mm - inch

### Conversion table - Ch/Fr - mm - inch

Charrière (CH) French (F)	mm	Inch
1	0,33	0,013
2	0,67	0,025
3	1,00	0,039
4	1,33	0,051
5	1,67	0,065
6	2,00	0,079
7	2,33	0,092
8	2,67	0,105
9	3,00	0,118
10	3,33	0,131
11	3,67	0,144
12	4,00	0,156
13	4,33	0,170
14	4,67	0,184
15	5,00	0,197
16	5,33	0,210
17	5,67	0,223
18	6,00	0,237
19	6,33	0,249
20	6,67	0,263
21	7,00	0,276
22	7,33	0,288
23	7,67	0,302
24	8,00	0,315
25	8,33	0,328
26	8,67	0,341
27	9,00	0,354
28	9,33	0,367
29	9,67	0,380
31	10,23	0,407
32	10,67	0,420
34	11,33	0,446
36	12,00	0,472
38	12,67	0,494
40	13,33	0,520
45	15,00	0,591





**SPIGGLE & THEIS**  
Medizintechnik

Burghof 14 · 51491 Overath · Germany

Phone: +49 2206 90 81 - 0

Fax: +49 2206 90 81 - 13

info@spiggle-theis.com

www.spiggle-theis.com

© 2022 by SPIGGLE & THEIS Medizintechnik GmbH

Änderungen und Irrtümer – einschließlich Bilder - vorbehalten.

Produktsortiment kann pro Land abweichen.

Modifications and errors – including pictures – reserved.

Product range might vary per country.



PO Box 3403, Erina, NSW, 2250, Australia

**P: +61 2 9810 6947**

admin@coremed.com.au

**www.coremed.com.au**



# Mundhöhlen Instrumentarium

## Oral Cavity Instruments







# Über uns

---

# About Us

## Geschichte

**SPIGGLE & THEIS Medizintechnik GmbH** wurde 1994 von den Geschäftsführern **David Spiggle** und **Detlef Theis** gegründet. Bis heute haben wir uns vom reinen Vertriebsunternehmen zu einem renommierten Hersteller von Medizinprodukten im Bereich der HNO-Chirurgie weiterentwickelt. Weltweit exportieren wir in über 75 Länder und in Deutschland zählen mehr als 700 Kliniken zu unseren Kunden.

## Das Maß der Dinge

Im chirurgischen Instrumentenbau gilt das Siegel **“Made in Germany“** auch heute noch als Inbegriff von Qualität. Unsere chirurgischen Instrumente werden in allen Produktionsstufen unter strengsten Qualitätsanforderungen nahezu komplett in Deutschland produziert und sind somit noch größtenteils echt **“Made in Germany“**. Zur Verarbeitung wird ausschließlich Instrumentenstahl bester Güte verwendet, welcher den hohen Anforderungen moderner Chirurgie auch dauerhaft gerecht wird.

## Sicherheit

Die Gesundheit der Patienten und somit die Sicherheit und Qualität unserer Produkte stehen im Mittelpunkt unseres Handelns. In diesem Sinne ist **SPIGGLE & THEIS Medizintechnik GmbH** bereits seit 1997 **ISO-zertifiziert** und sind unsere Produkte nach der strengen europäischen Richtlinie für Medizinprodukte CE-gekennzeichnet. Alle unsere Produkte unterliegen einer permanenten Qualitätskontrolle - von der Auswahl des Rohmaterials über die einzelnen Fertigungsschritte bis zum Versand.

## Erfahrung

Unsere Mitarbeiter haben zum Teil mehr als 30 Jahre Berufserfahrung im Umgang mit chirurgischen Instrumenten. Durch dieses umfassende Know-How sowie den langjährigen und individuellen Kontakt mit den Anwendern, besitzen wir nicht nur theoretisches Wissen, sondern kennen auch deren Bedürfnisse und Ansprüche. Dies hilft uns bei der steten, praxisorientierten Weiterentwicklung unserer Produkte. Somit garantieren wir hohe Kompetenz und individuellen Service bei der Betreuung unserer Kunden.

## History

**SPIGGLE & THEIS Medizintechnik GmbH** was founded in 1994 by the managing directors **David Spiggle** and **Detlef Theis**. The company has evolved from being purely a distributor to the established manufacturer of medical products in the area of ENT that it is today. We can count over 700 clinics amongst our German customers and export to over 75 countries world-wide.

## The Seal Of Highest Quality

The stamp **“Made in Germany“** is still the epitome of quality standards in the production of surgical instruments in the world today. The majority of our surgical instruments is subjected to the strictest quality requirements at every step of their production, in the truest sense of the words, **“Made in Germany“**. Only the highest standard of instrument steel, capable of consistently meeting the demands of modern surgery, is used in the production.

## Safety First

The health of our patients and therefore the safety and quality of our products plays the central role in our decisions. **SPIGGLE & THEIS Medizintechnik GmbH** has been **ISO certified**. Our products are CE-marked in accordance with the strict European guideline for medical products since 1997. All our products undergo continual quality checks, from the selection of raw materials, to the individual stages of production and finally their dispatch.

## Experience

Our colleagues in instrument development can look back on over 30 years of professional practical experience with ENT surgical instruments. We offer more than theoretical knowledge – we understand our customer needs. We enjoy close, personal contact to many of the best surgeons world-wide. This enables us to continually develop innovative products. We guarantee the highest level of competence and individual service in meeting our customer requirements.



## Inhaltsverzeichnis

### Table of contents

01	Endoskopie / Endoscopy.....	5 - 9
02	Adenotomie / Adenotomy.....	10 - 12
03	Tonsillektomie / Tonsillectomy .....	13 - 30
04	Kehlkopf / Larynx .....	31 - 35
05	Speichelgang / Salivary Duct.....	36 - 37
06	Koagulation / Coagulation .....	38 - 48
07	Tracheotomie / Weichteile / Allgemeines Tracheotomy / Neck Dissection / Miscellaneous .....	49 - 63
08	Sets .....	64 - 72
	Index.....	74 - 77

#### Attention:

Not every instrument is available in all markets. Availability depends on local regulations. Please contact your SPIGGLE & THEIS representative or distributor, if you have any questions about the availability of our products in your region.

Arbeitslänge	32 cm
Working length	32 cm
Abwinkelung (auf / ab)	130°
Angle (up / down)	130°
Biegeradius	8 mm
Bending radius	8 mm
Blickfeld	80°
Field of vision	80°
Tiefenschärfe	1-50 mm
Depth of focus	1-50 mm
Gewicht	230 g
Weight	230 g



Art-Nr./No.

30-170-28

2,8 mm

30-170-36

3,4 mm

30-171-40

4,0 mm mit Arbeitskanal  
4.0 mm with working channel

Die SPIGGLE & THEIS Nasopharyngoskope der neuen Generation sind intuitiv bedienbar und ergonomisch geformt. Sie wurden für die notwendige Feinfühligkeit im täglichen Routineeinsatz und für eine ermüdungsfreie Handhabung entwickelt.

Hochwertige Bildleiter und ein leistungsfähiges optisches System liefern große und helle Bilder bester Auflösung - die Voraussetzung für eine sichere Diagnose und Therapie. Dank solider Verarbeitung und konsequenter Verwendung moderner Hochleistungswerkstoffe sind SPIGGLE & THEIS Nasopharyngoskope robuster und langlebiger - trotz steigender Belastung durch moderne Aufbereitungsverfahren.

The new generation of SPIGGLE & THEIS nasopharyngoscopes impresses with intuitive operability and optimal ergonomics, designed for tactile sensation and non-tiring handling as required in daily routine operations.

High-end fibre-optic bundles and a high-capacity system produce large and bright images of the best quality - necessary for safe diagnosis and treatment. Due to the consistent use and reliable processing of high-class materials, the SPIGGLE & THEIS nasopharyngoscopes are robust and durable, in spite of the increasing stress of modern cleaning and sterilizing facilities.

#### Vorteile unserer Endoskope:

- Funktionelles Design für eine einfache und komfortable Handhabung
- Feinfühlig, aber robuste Steuerung
- Optimale Flexibilität und Torsionssteifigkeit des Einführungsschafts
- Leistungsfähiges optisches System: größere, hellere und schärfere Bilder

#### Geeignete Wiederaufbereitungsverfahren:

- Einlegbar in Reinigungs- und Desinfektionslösung
- STERIS
- NTDF-Sterilisation = Niedertemperatur-Dampf-Formaldehyd-Sterilisation
- Maschinelle Aufbereitung (RDG-E)

#### Advantages of our endoscopes:

- Functional design for easy and comfortable handling
- Sensitive yet robust control
- Optimal flexibility and torsional rigidity of the insertion channel
- High-performance optical system for larger, brighter and sharper images

#### Suitable reprocessing procedures:

- Fully immersible in cleaning and disinfectant solutions
- STERIS
- LTSF-sterilization = Low-Temperature Steam and Formaldehyde sterilization
- Machine reprocessing (RDG-E)





**Flexible Biopsiezange, Ø 1 mm, ovaler Löffel, für flexibles Endoskop 30-171-40**

**Flexible biopsy forceps, Ø 1 mm, oval cups, for flexible endoscope 30-171-40**

Art.-Nr./No.	Länge / Length (cm)
30-172-40	120
30-172-41	40

**Flexible Alligator-Fasszange, Ø 1 mm, 120 cm, gezahntes Maul, für flexibles Endoskop 30-171-40**

**Flexible alligator forceps, Ø 1 mm, 120 cm, serrated jaws, for flexible endoscope 30-171-40**

Art.-Nr./No.	Länge / Length (cm)
30-173-40	120
30-173-41	40



**Reinigungsbürste mit Grifföse, AL 40 cm, Bürste Ø 2,0 mm, Besatzlänge 10 mm, für Arbeitskanal bis 1,5 mm, 10 Stück / Box, Einweg**

**Cleaning brush with loop, WL 40 cm, brush Ø 2.0 mm, length of edging 10 mm, for working channels up to 1.5 mm, 10 pieces/ box, single use**

**30-175-40**



**Ultra-Stop Antibeschlagmittel / Ultra-Stop Anti-Fog solution**

Art.-Nr./No.	Beschreibung / Description
30-160-01	25 ml Pipettenflasche, unsteril 25 ml pipette bottle, non-sterile
30-160-02	30 ml Durchstichflasche, steril 30 ml pierce bottle, sterile
30-160-03	15 ml Sprayflasche, unsteril 15 ml spray bottle, non-sterile

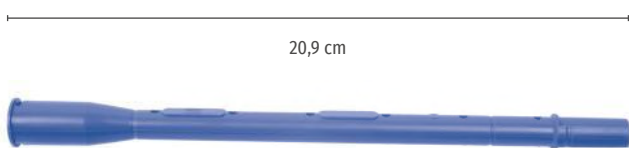

20,9 cm

**Endoskop-Schutzhülse, 20,9 cm, verlängerbar, autoklavierbar, für ein Endoskop 40-110-xx oder 40-112-xx. (Für 40-112-xx werden 2 Schutzhülsen benötigt)**

**Endoscope protective sleeve, 20.9 cm, extendable, autoclavable, for endoscope 40-110-xx or 40-112-xx. (Two protective sleeves are needed for 40-112-xx)**

**(Two protective sleeves are needed for 40-112-xx)**

**30-182-21**





#### Sterilisations-Container für Endoskope

Ø 2,5 - 5,0 mm, bis 19,5 cm Länge

Sterilizing and protecting tray for endoscopes

Ø 2.5 - 5.0 mm, up to 19.5 cm length

Art.-Nr./No.	Beschreibung / Description
80-621-05	für 2 Endoskope / for 2 endoscopes
80-622-56	für 6 Endoskope, 1 Lichtkabel for 6 endoscopes, 1 light-cable
80-623-22	für 2 Endoskope, 1 Lichtkabel, 1 Kamerakopf for 2 endoscopes, 1 light-cable, 1 camera head



#### Endoskopie-Siebkorb mit Deckel, Edelstahl, elektroliert

Endoscope container with lid, stainless steel, e-polished

Art.-Nr./No.	Größe / Size (cm)
80-691-01	46 x 8 x 5,2 für 1 Endoskop 46 x 8 x 5.2 for 1 endoscope
80-692-01	67 x 8 x 5,2 für 1 Endoskop 67 x 8 x 5.2 for 1 endoscope

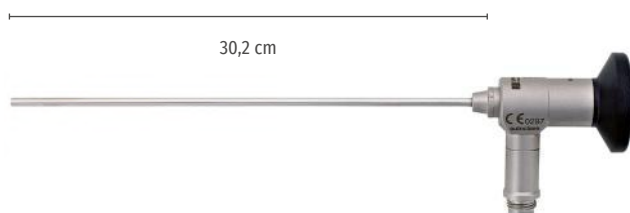

#### Laryngoskop, HD, autoklavierbar, 30,2 cm

Laryngoscope, HD, autoclavable, 30.2 cm

Art.-Nr. Art.-No.	Größe Size (mm)	Winkel Angle	
40-110-00	4,0	0°	○
40-110-30	4,0	30°	○
40-110-70	4,0	70°	○
40-112-00	4,0	0°	○
40-112-30	2,7	30°	○
40-112-70	2,7	70°	○



#### Mikro-Laryngoskop, 70°, HD, autoklavierbar

Micro-Laryngoscope, 70°, HD, autoclavable

40-111-70







**Dr. Fog original Antibeschlagmittel mit Schwamm, steril**

**Dr. Fog original anti-fog with sponge, sterile**

**30-160-04**



**Antifog Antibeschlag-Satz, steril, 48 Stück/Box**

**Antifog-Solution Kit, sterile, 48 pieces/box**

**30-160-05**



**LED-Leuchtgriffe / LED light handles**

Art.-Nr./No.

70-211-00 LED-Hochleistungs-Leuchtgriff, 230 V, bestehend aus: (70-211-10, 70-211-20, 70-211-30, 70-211-40)  
LED high performance light-handle, 230 V, consisting of: (70-211-10, 70-211-20, 70-211-30, 70-211-40)

70-211-01 LED-Hochleistungs-Leuchtgriff, 120 V, bestehend aus: (70-211-10, 70-211-20, 70-211-30, 70-211-50)  
LED high performance light-handle, 120 V, consisting of: (70-211-10, 70-211-20, 70-211-30, 70-211-50)

70-211-10 LED-Handgriff, schwarz, mit Helligkeitsdimmer, Ausschaltautomatik, 3 W, 5500°K, 17500 Lux, zur Verwendung mit Li-Io-Akku 3,5 V und Endoskop-Adapter, 50 Std. Brenndauer  
LED light handle, black, with brightness dimmer, automatic switch-off, 3 W, 5500°K, 17500 lux, to use with Li-ion rechargeable battery 3.5 V and endoscope adapter, 50 hours run-time

70-211-20 Li-Ionen-Akku, 3,5 V, für LED-Handgriff  
Li-ion rechargeable battery, 3.5 V, for LED light-handle

70-211-30 Endoskopie-Adapter für LED-Handgriff, passend für Standardgewinde an Endoskopen (AcMI-Gewinde)  
Endoscope adapter for LED light-handle, fits standard endoscope threads (AcMi-thread)

70-211-40 Ladegerät für bis zu 2 LED-Handgriffe, 3,5 V, 230 V, Standgerät, mit Wandhalterung  
Charging base for up to 2 LED light-handles, 3.5 V, 230 V, table model, with wall holder

70-211-50 Ladegerät für bis zu 2 LED-Handgriffe, 3,5 V, 120 V, Standgerät, Wandhalterung  
Charging base for up to 2 LED light-handles, 3.5 V, 120 V, table model, with wall holder



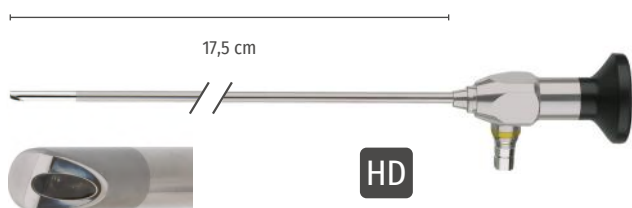

**Laryngoskop, HD, autoklavierbar, 17,5 cm**  
**Laryngoscope, HD, autoclavable, 17.5 cm**

Art.-Nr. Art.-No.	AD OD (mm)	Winkel Angle	
40-100-70	4	70°	<input type="radio"/>
40-100-90	4	90°	<input type="radio"/>



**Laryngoskop, HD, autoklavierbar, Handgriff, 19 cm**  
**Laryngoscope, HD, autoclavable, handle, 19 cm**

Art.-Nr. Art.-No.	AD OD (mm)	Winkel Angle	
40-103-70	10	70°	<input type="radio"/>
40-103-90	10	90°	<input type="radio"/>

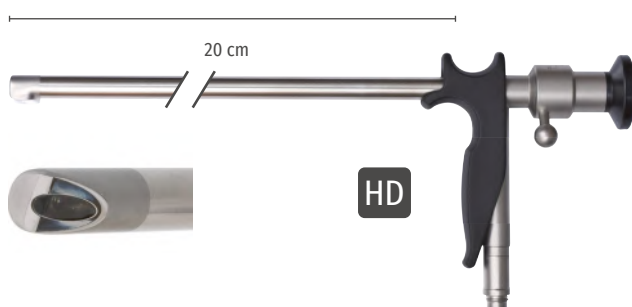

**Zoom Laryngoskop, HD, einlegbar, Handgriff, 20 cm**  
**Zoom laryngoscope, HD, soakable, handle, 20 cm**

Art.-Nr. Art.-No.	AD OD (mm)	Winkel Angle	
40-105-70	10	70°	<input type="radio"/>
40-105-90	10	90°	<input type="radio"/>



**Laryngoskop, HD, autoklavierbar, Handgriff, 19,8 cm**  
**Laryngoscope, HD, autoclavable, handle, 19.8 cm**

Art.-Nr. Art.-No.	AD OD (mm)	Winkel Angle	
40-107-70	8	70°	<input type="radio"/>



## 02 Adenotomie

### Adenotomy

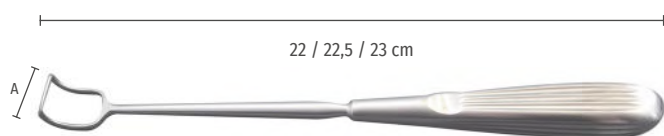

**Beckmann Ringmesser, gerade**  
Beckmann adenoid curette, straight

Art.-Nr. Art.-No.	Größe Size	Länge A Length A (mm)	Länge Length (cm)
40-200-00	0	10,5	22,0
40-200-01	1	13,0	22,0
40-200-02	2	14,5	22,0
40-200-03	3	16,5	22,5
40-200-04	4	18,0	23,0



**Negus Ringmesser, vorwärts gebogen, 21,5 cm**  
Negus adenoid curette, curved forwards, 21.5 cm

Art.-Nr. Art.-No.	Größe Size	Länge A Length A (mm)
40-203-00	0	11,0
40-203-01	1	13,0
40-203-02	2	15,0
40-203-03	3	17,0
40-203-04	4	18,0



**Stubbs Ringmesser, rückwärts gebogen, 22 cm**  
Stubbs adenoid curette, curved backwards, 22 cm

Art.-Nr. Art.-No.	Größe Size	Länge A Length A (mm)
40-206-00	0	10,0
40-206-01	1	12,0
40-206-02	2	16,0
40-206-03	3	18,0



**Vogel Ringmesser, gerade, 21,5 cm**  
Vogel adenoid curette, straight, 21.5 cm

Art.-Nr./No.	Länge A / Length A (mm)
40-211-07	7,0



**Jatho Nasenrachenzange, 70° aufgebogen, Rohrschaft, AL 15 cm**  
**Jatho epipharyngeal forceps, 70° upcurved, tubular model, WL 15 cm**

Art.-Nr./No.	Beschreibung / Description
40-220-01	vertikal öffnend / opens vertically
40-220-02	horizontal öffnend / opens horizontally

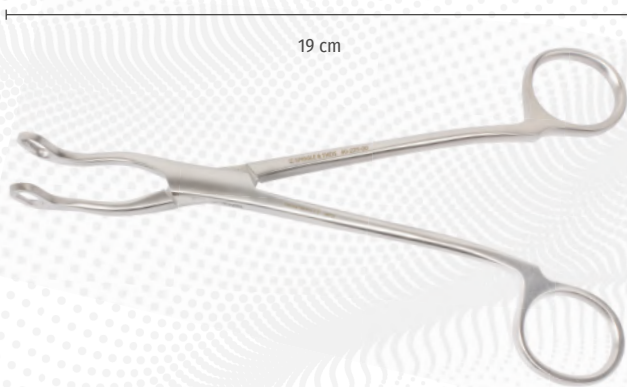

**Jurasz Nasenrachenzange, 19 cm**  
**Jurasz adenoid forceps, 19 cm**

40-225-00



**Hartmann Conchotom, rund, 12 cm**  
**Hartmann cutting forceps, round, 12 cm**

Art.-Nr./No.	Größe / Size	Größe / Size (mm)
--------------	--------------	-------------------

20-252-01	1	7
-----------	---	---



20-252-02	2	8
-----------	---	---



20-252-03	3	9
-----------	---	---



20-252-04	4	10
-----------	---	----



## 02 Adenotomie

### Adenotomy



**Schmeden Conchotom, dreieckig, 12 cm**  
Schmeden cutting forceps, triangular, 12 cm

Art.-Nr./No. Größe / Size Größe / Size (mm)

20-254-00	0	6	
20-254-01	1	7	
20-254-02	2	8	
20-254-03	3	12	



**Nager Gaumensegelhaken, 22 cm / Nager pillar retractor, 22 cm**

40-230-21

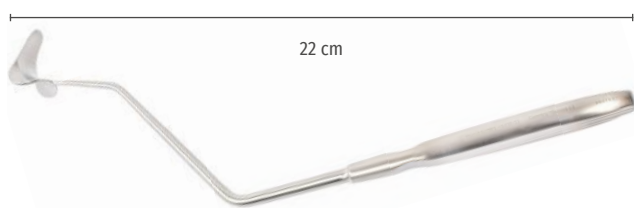

**Hofer Gaumenbogenhaken, 22 cm / Hofer palate retractor, 22 cm**

40-232-23



**Kabierske Pulverbläser, komplett mit drei Kanülen für Ohr, Nase, Rachen und Hals, mit Glas und Ventilball**

**Kabierske powder blower, set with three cannulae for ear, nose, pharynx and larynx, bottle and rubber ball**

Art.-Nr./No. Beschreibung / Description

10-155-00	Pulverbläser komplett / powder blower, set
10-155-01	Ersatzglas / spare bottle
10-155-02	Gummiball / rubber ball



#### Davis-Meyer Mundsperrer, verstellbare Zahnhaken

Davis-Meyer mouth gag, adjustable tooth hooks

Art.-Nr./No.	Beschreibung / Description
40-300-01	rechts offen / right side open
40-300-02	links offen / left side open



#### Davis-Boyle Mundsperrer / Davis-Boyle mouth gag

Art.-Nr./No.	Beschreibung / Description
40-302-01	rechts offen / right side open
40-302-02	links offen / left side open
40-302-03	rechts offen für Kinder right side open for children
40-302-04	links offen für Kinder left side open for children



#### Silikonschützer für Davis-Boyle Mundsperrer, 1 Stück

Silicone insert for Davis-Boyle mouth gags, 1 piece

40-303-00



#### Mclvor Mundsperrer / Mclvor mouth gag

Art.-Nr./No.	Beschreibung / Description
40-305-00	geschlossen / closed form
40-305-01	klein, geschlossen / small closed form



#### Silikonformschlauch, geschlitzt, für Mclvor Mundsperrer, wiederverwendbar, 5 Stück

Silicone tubing, slit, for Mclvor mouth gag, reuseable, 5 pieces

40-305-99



#### Mclvor Mundsperrer, Drahtbügel mit Silikonenschutz

Mclvor mouth gag, wire frame with silicone protection

40-305-10



## 03 Tonsillektomie

### Tonsillectomy



**Mclvor Zungenspatel, glatt / Mclvor tongue depressor, smooth**

Art.-Nr. Art.-No.	Größe Size	Größe Size (mm)
40-310-01	1	23,0 x 75,0
40-310-02	2	25,0 x 91,0
40-310-03	3	26,0 x 103,0



**Davis-Boyle Zungenspatel, mit beidseitigem Absaugrohr  
Davis-Boyle tongue depressor, double sided suction tubes**

Art.-Nr. Art.-No.	Größe Size	Größe Size (mm)
40-311-01	1	29,0 x 65,0
40-311-15	1½	29,0 x 70,0
40-311-02	2	30,5 x 75,0
40-311-25	2½	31,5 x 80,0
40-311-03	3	32,5 x 85,0
40-311-35	3½	33,5 x 95,0
40-311-04	4	34,0 x 105,0



**Davis-Boyle Zungenspatel / Davis-Boyle tongue depressor**

Art.-Nr. Art.-No.	Größe Size	Größe Size (mm)	Beschreibung Description
40-312-01	1	20,0 x 35,0	glatt / smooth
40-312-02	2	23,0 x 70,0	gerieft / serrated
40-312-03	3	24,0 x 85,0	gerieft / serrated
40-312-04	4	25,0 x 95,0	gerieft / serrated
40-312-05	5	26,0 x 110,0	gerieft / serrated
40-313-01	1	17,0 x 35,0	glatt für Kinder smooth for children
40-313-02	2	19,0 x 51,0	gerieft für Kinder serrated for children
40-313-03	3	20,0 x 60,0	gerieft für Kinder serrated for children
40-313-04	4	22,0 x 75,0	gerieft für Kinder serrated for children
40-313-05	5	22,0 x 84,0	gerieft für Kinder serrated for children



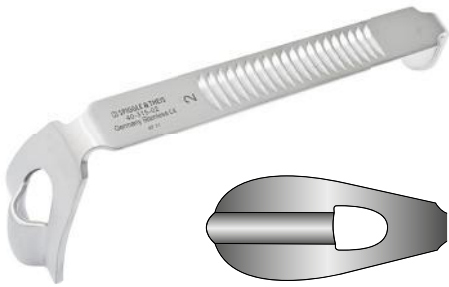

#### Russel-Davis Zungenspatel mit Rinne

Russel-Davis tongue depressor with central channel

Art.-Nr./No.	Größe / Size	Dimension / Dimension (mm)
40-315-01	1	30 x 70
40-315-02	2	34 x 80
40-315-03	3	39 x 85
40-315-04	4	42 x 98
40-315-05	5	46 x 107



#### Russel-Davis Zungenspatel mit Rinne, schmales Modell

Russel-Davis tongue depressor with central channel, slender model

Art.-Nr./No.	Größe / Size	Dimension / Dimension (mm)
40-316-01	1	18 x 61
40-316-02	2	22 x 71
40-316-03	3	25 x 80

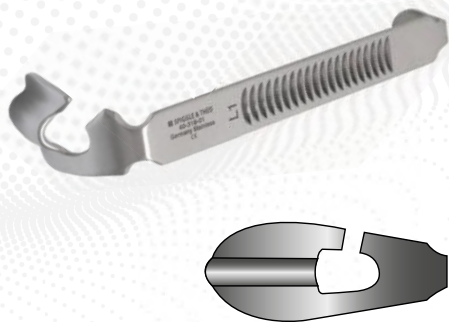

#### Russel-Davis Zungenspatel mit Rinne, Ausgang links

Russel-Davis tongue depressor with central channel, outlet left side

Art.-Nr./No.	Größe / Size	Dimension / Dimension (mm)
40-318-01	1	30 x 70
40-318-02	2	34 x 80
40-318-03	3	39 x 85
40-318-04	4	42 x 98
40-318-05	5	46 x 107



#### Zungenspatel, Würzburger Modell

Tongue depressor, Würzburg model

Art.-Nr./No.	Größe / Size	Dimension / Dimension (mm)
40-320-01	1	28 x 67
40-320-02	2	32 x 75
40-320-03	3	34 x 83
40-320-04	4	37 x 96
40-320-05	5	38 x 103



## 03 Tonsillektomie

### Tonsillectomy



#### Ring Zungenspatel / Ring tongue depressor

Art.-Nr. Art.-No.	Größe Size	Größe Size (mm)	Beschreibung Description
40-322-02	2	24 x 65	links / left
40-322-03	3	27 x 72	links / left
40-322-04	4	34 x 91	links / left
40-322-05	5	37 x 95	links / left
40-323-02	2	24 x 65	rechts / right
40-323-03	3	28 x 78	rechts / right
40-323-04	4	34 x 91	rechts / right
40-323-05	5	38 x 101	rechts / right



#### Herberhold Zungenspatel / Herberhold tongue depressor

Art.-Nr. Art.-No.	Größe Size	Größe Size (mm)
40-325-01	1	29 x 64
40-325-02	2	33 x 73
40-325-03	3	38 x 82
40-325-04	4	41 x 97



#### Dingmann Mundsperrer, Rahmen mit 2 Wangenhaltern, 2 Zahnhaken und 2 Fadenführern

Dingmann mouth gag, frame with 2 cheek retractors,  
2 tooth hooks and 2 thread guides

40-327-00

#### Dingmann Wangenhaken, verstellbar, 2 Stück

Dingmann cheek retractor, adjustable, 2 pieces

40-327-98

#### Dingmann Zahnhaken, verstellbar, 2 Stück

Dingmann tooth hooks, adjustable, 2 pieces

40-327-99



#### Dingmann Zungenspatel / Dingmann tongue depressor

Art.-Nr. Art.-No.	Größe Size	Größe Size (mm)
40-327-01	1	26 x 65
40-327-02	2	29 x 70
40-327-03	3	32 x 82



**Negus Bruststütze, mit Halteband**  
Negus chest support, with band

Art.-Nr. Art.-No.	Größe Size (cm)	Beschreibung Description
40-330-14	14,0	für Erwachsene / for adults
40-330-09	8,5	für Kinder / for children



**Draffin Mundsperrer-Aufhängung**  
Draffin bipod suspension for mouth gags

Art.-Nr./No.	Beschreibung / Description
40-335-00	für Erwachsene / for adults
40-335-01	für Kinder / for children
40-335-99	Magauran-Platte / Magauran plate

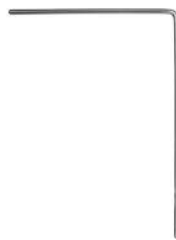

**Narkosebügel, L-Form, zur Aufhängung von Mundsperrern**  
Anesthesia frame L-form, for suspending mouth gags

40-337-00



**Gelenkkloben zur Befestigung am OP-Tisch, passend für flexiblen Spannarm 30-700-00 und Narkosebügel 40-337-00**

Rotation clamp for fixation to operating table, compatible with flexible holding arm 30-700-00 and anesthesia frame 40-337-00

30-700-01

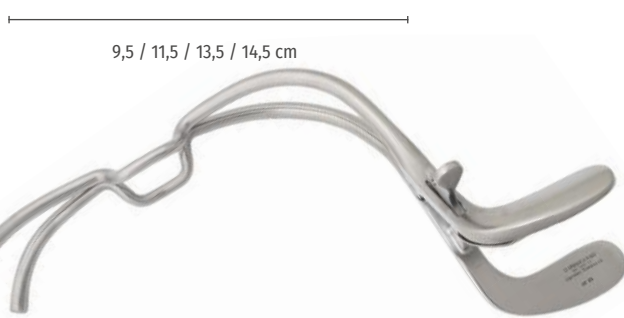

**Jennings Mundsperrer / Jennings mouth gag**

Art.-Nr./No.	Länge / Length (cm)
40-340-09	9,5
40-340-11	11,5
40-340-13	13,5
40-340-15	14,5



## 03 Tonsillektomie

### Tonsillectomy

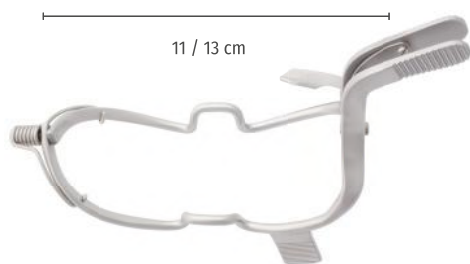

**Seemann-Seiffert Mundsperrer, Standard-Modell, selbsttätig nachspreizend**  
Seemann-Seiffert mouth gag, basic model, self retaining

Art.-Nr./No.	Länge / Length (cm)
40-341-11	11
40-341-13	13

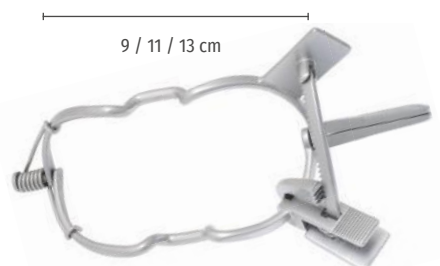

**Seemann-Seiffert Mundsperrer, selbsttätig nachspreizend**  
Seemann-Seiffert mouth gag, self retaining

Art.-Nr./No.	Länge / Length (cm)
40-342-09	9
40-342-11	11
40-342-13	13



**Molt Mundsperrer, 14 cm / Molt mouth gag, 14 cm**

**40-343-00**



**Dehnhardt Mundsperrer, 12,5 cm / Dehnhardt mouth gag, 12,5 cm**

**40-343-01**



**Sluder-Ballenger Tonsillotom, Simal-Ausführung, Handgriff**  
Sluder-Ballenger tonsillotome, simal model, handle

**40-350-10**

**Sluder-Ballenger Tonsillotom Spatel, Simal-Ausführung**  
Sluder-Ballenger tonsillotome blade, simal model

Art.-Nr./No.	Größe / Size
40-350-01	1
40-350-02	2
40-350-03	3





**Brünings Tonsillenschnürer, 29 cm / Brünings tonsil snare, 29 cm**

**40-355-28**



**Eves Tonsillenschnürer, 28,5 cm / Eves tonsil snare, 28.5 cm**

**40-357-28**

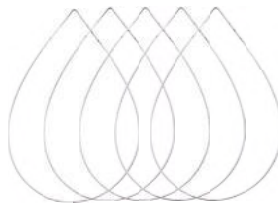

**Tonsillen-Schlingen für Brünings Tonsillenschnürer, Edelstahl, geschlossen, 100 Stück / Box**

**Tonsil wire loops for Brünings tonsil snare, stainless steel, closed, 100 pieces / box**

Art.-Nr./No.	Größe / Size
40-360-40	0,4 x 40
40-360-50	0,4 x 50



**Tonsillenschlingen, für Eves Tonsillenschnürer, rostfrei, offen, 0,45 mm, 100 Stück/Box**

**Tonsil loops for Eves tonsil snare, stainless, 0.45 mm, 100 pieces**

**40-361-45**

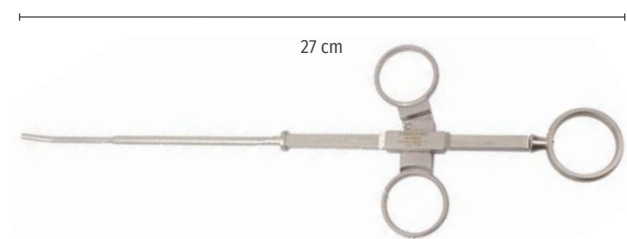

**Roeder Ligatur-Instrument, Form E, für Vicryl-Faden, 27 cm**

**Roeder ligature instrument, form E, for vicryle wire, 27 cm**

**40-359-27**



**Drahtbiede- und Schneideschere, Hartmetall, gezahnt, gewinkelt, 12 cm**

**Wire bending and cutting scissors, tungsten carbide, with teeth, angled, 12 cm**

**10-745-12**

## 03 Tonsillektomie

### Tonsillectomy

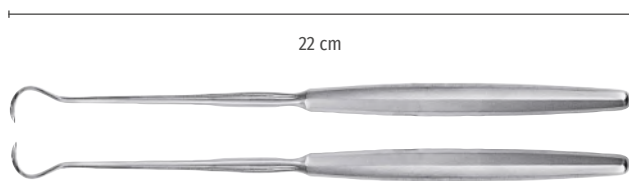

**Hurd Unterbindungsnadel, 22 cm**  
**Hurd tonsil suture needle, 22 cm**

Art.-Nr./No.	Beschreibung / Description
40-365-01	rechts gebogen / right curved
40-365-02	links gebogen / left curved



**Nager Unterbindungsnadel, gerade, 23,5 cm**  
**Nager tonsil suture needle, straight, 23.5 cm**

40-367-24



**Fadenhäkchen, spitz, rund, 90°, 20 cm**  
**Suture hook, pointed, round, 90°, 20 cm**

40-368-21



**Fadenhäkchen, stumpf, flach, 90°, 20 cm**  
**Suture hook, blunt, flat, 90°, 20 cm**

40-369-21

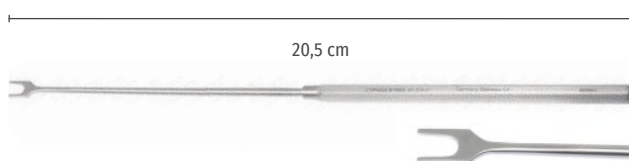

**Knotenführer, gabelförmig, stumpf, 20,5 cm**  
**Knot tier, forked, blunt, 20.5 cm**

40-370-21



**Henke Raspatorium, doppelseitig, schmal/breit, 24 cm**  
**Henke raspatory, double ended, slender/wide, 24 cm**

40-382-24



**Henke Raspatorium/Dissektor / Henke raspatory/dissector**

Art.-Nr. Art.-No.	Größe Size (mm)	Länge Length (cm)	Beschreibung Description
40-381-12	12	23,5	schmal / slender
40-381-15	15	24,0	breit / wide



**Hurd Raspatorium/Retraktor, 10 mm/14 mm, 22,5 cm**

Hurd dissector/retractor, 10 mm/14 mm, 22.5 cm

40-385-23



**Hurd Elevatorium/Retraktor, gefenstert, 11,5 mm, 23 cm**

Hurd elevator/retractor, fenestrated, 11.5 mm, 23 cm

40-386-23



**Raspatorium Würzburger Modell,**

eine Seite gezahnt, eine Seite Lanzett, 10 mm, 21,5 cm

Raspatory Würzburg type,

one side serrated, one side lancet, 10 mm, 21.5 cm

40-388-21





## 03 Tonsillektomie

### Tonsillectomy

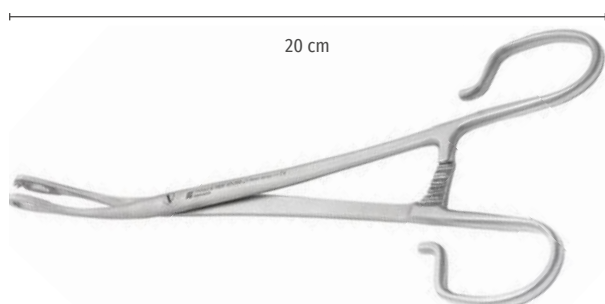

**Blohmke Fasszange, gebogen, 20 cm**  
**Blohmke tonsil forceps, curved, 20 cm**

**40-390-21**

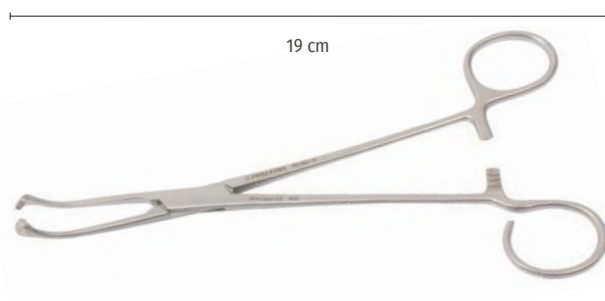

**Colver Fasszange, gebogen, 19 cm**  
**Colver tonsil forceps, curved, 19 cm**

**40-392-19**



**White Fasszange, gebogen / White tonsil forceps, curved**

Art.-Nr./No.	Länge / Length (cm)
40-394-18	18
40-394-23	23

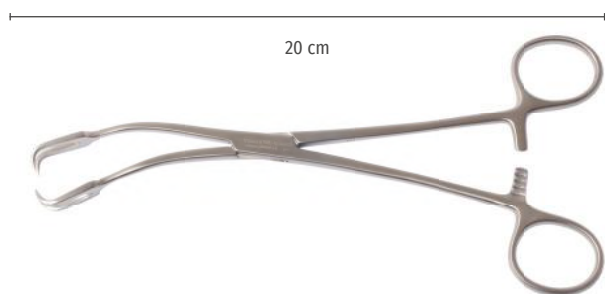

**Ballenger Fasszange, gebogen, 2:2 Zähne, 20 cm**  
**Ballenger tonsil forceps, curved, 2:2 teeth, 20 cm**

**40-395-22**

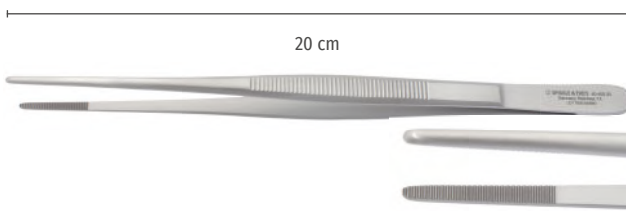

**Tonsillen-Pinzette, gerieft, fein, 2,2 mm, 20 cm**  
**Tonsil dressing forceps, serrated, fine, 2.2 mm, 20 cm**

40-400-20

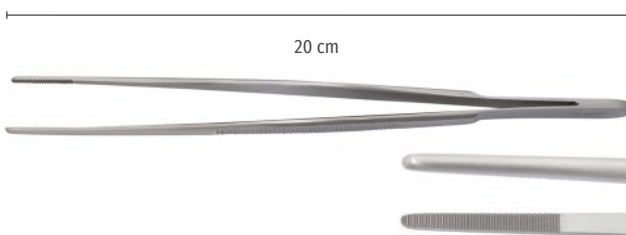

**Tonsillen-Pinzette, gerieft, breit, 3,5 mm, 20 cm**  
**Tonsil dressing forceps, serrated, wide, 3.5 mm, 20 cm**

40-401-20

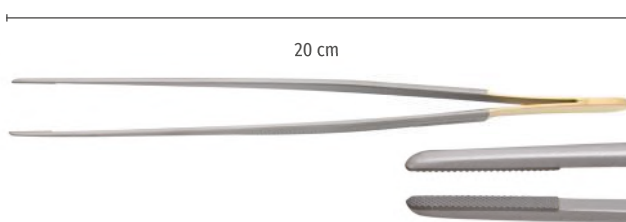

**Tonsillen-Pinzette, gerieft, Hartmetall, 2 mm, 20 cm**  
**Tonsil dressing forceps, serrated, tungsten carbide, 2 mm, 20 cm**

40-402-20

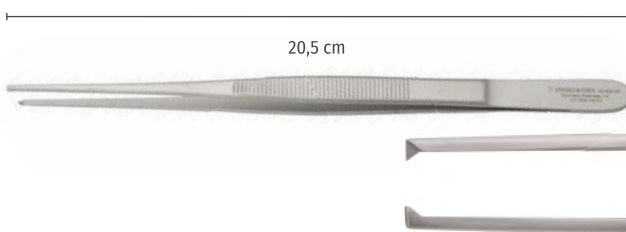

**Tonsillen-Pinzette, 1:2 Zähne, fein, 2 mm, 20,5 cm**  
**Tonsil dissecting forceps, 1:2 teeth, fine, 2 mm, 20.5 cm**

40-405-20

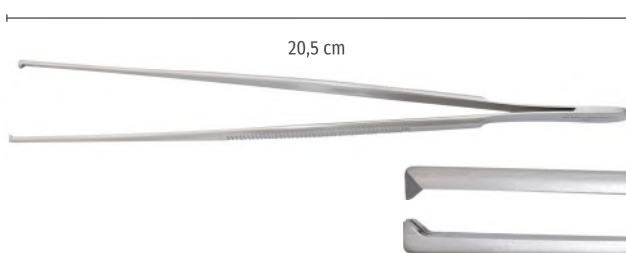

**Tonsillen-Pinzette, breit, 20,5 cm**  
**Tonsil dissecting forceps, wide, 20.5 cm**

Art.-Nr./No.	Größe / Size (mm)	Zähne / Teeth
40-406-20	2,5	1:2
40-407-20	3,5	2:3
40-408-20	4,5	3:4



## 03 Tonsillektomie

### Tonsillectomy

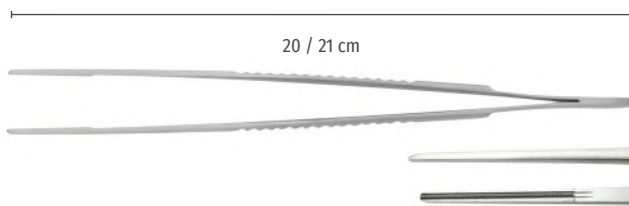

**DeBaakey Pinzette, atraumatisch**  
DeBaakey dressing forceps, atraumatic

Art.-Nr./No.	Länge / Length (cm)	Größe / Size (mm)
40-410-20	21	2,7
40-412-20	20	2,0



**Yankauer Saugrohr, abschraubbarer Ansatz**  
Yankauer Suction tube, detachable tip

Art.-No.	Länge Length (cm)	Öffnung Opening (mm)	Ø
40-420-29 für Erwachsene for adults	28,5	3,0	6,0
40-421-21 Für Kinder for children	21,5	2,0	5,0

**Abschraubbarer Ansatz, Ersatzteil für 40-420-29**  
Detachable attachment, spare part for 40-420-29

40-420-99



**Saugrohr, gerade, biegsam, konisch, 3,0 mm, 19,5 cm**  
Suction tube, straight, bendable, conical, 3.0 mm, 19.5 cm

10-303-18



**Good-Schweckendiek Tonsillenschere, gebogen, gezahnt, 19 cm**  
Good-Schweckendiek tonsil scissors, curved, serrated, 19 cm

40-430-19



**Good Tonsillenschere, gebogen, glatt, 19,5 cm**  
Good tonsil scissors, curved, smooth, 19.5 cm

40-431-19

## 03 Tonsillektomie

### Tonsillectomy



**Boettcher Tonsillenschere, gebogen, 18,5 cm**

**Boettcher tonsil scissors, curved, 18.5 cm**

Art.-Nr./No.	Beschreibung / Description
40-433-18	stumpf / blunt
40-434-18	spitz / pointed

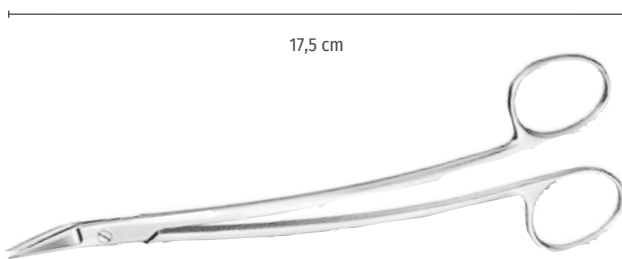

**Dean Tonsillenschere, doppelt gebogen, gezahnt, spitz, 17,5 cm**

**Dean tonsil scissors, double curved, serrated, pointed, 17.5 cm**

**40-436-17**

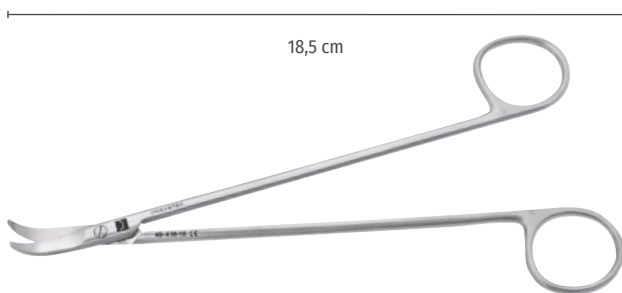

**Muck Tonsillenschere, stark gebogen, 18,5 cm**

**Muck tonsil scissors, strongly curved, 18.5 cm**

**40-438-18**

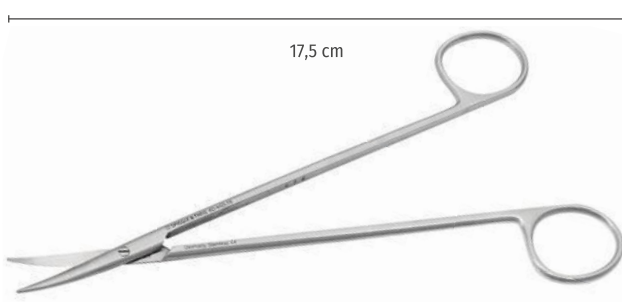

**Toennis-Adson Tonsillenschere, gebogen, stumpf, extra fein, 17,5 cm**

**Toennis-Adson tonsil scissors, curved, blunt, very fine, 17.5 cm**

**40-440-18**



## 03 Tonsillektomie

### Tonsillectomy



**Toennis-Adson Tonsillenschere, supercut, gebogen, stumpf, extra fein, 17,5 cm**

Toennis-Adson tonsil scissors, supercut, curved, blunt, very fine, 17.5 cm

40-441-18



**Toennis-Adson Tonsillenschere, Hartmetall, supercut, gebogen, stumpf, extra fein, 17,5 cm**

Toennis-Adson tonsil scissors, tungsten carbide, supercut, curved, blunt, very fine, 17.5 cm

40-442-18



**Metzenbaum Schere, stumpf-stumpf**

Metzenbaum scissors, blunt

Art.-No.	Länge	Beschreibung
Art.-No.	Length (cm)	Description
20-612-18	18,0	gerade / straight
20-612-20	20,0	gerade / straight
20-614-18	18,0	gebogen / curved
20-614-20	20,5	gebogen / curved



**Metzenbaum Schere, Hartmetall, stumpf-stumpf, fein**

Metzenbaum scissors, tungsten carbide, blunt, fine

Art.-No.	Länge	Beschreibung
Art.-No.	Length (cm)	Description
20-613-18	18,0	gerade / straight
20-613-20	20,5	gerade / straight
20-615-18	18,0	gebogen / curved
20-615-20	20,5	gebogen / curved

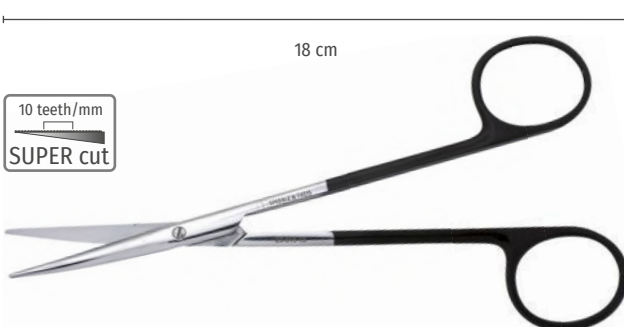

**Metzenbaum Schere, supercut, gebogen, stumpf-stumpf, fein, 18 cm**

20-616-18



**Metzenbaum Schere Black Line, Hartmetall, grade, stumpf-stumpf, fein, 20,5 cm**  
**Metzenbaum scissors Black Line, tungsten carbide, straight, blunt, fine, 20.5 cm**

Art.-Nr./No.	Beschreibung / Description
20-613-20B	
20-613-20WB	Wellenschliff / wave cut

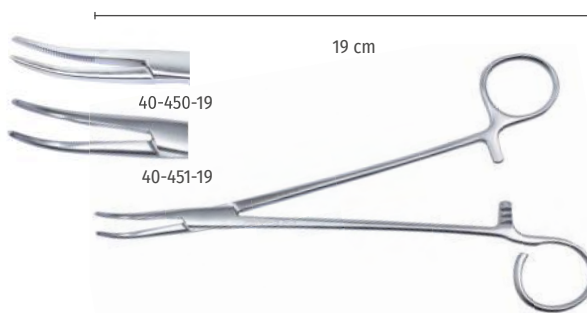

**Schmidt Tonsillenklemme, einseitig offener Ring, schlank, 19 cm**  
**Schmidt tonsil forceps, one ring open, slender, 19 cm**

Art.-Nr./No.	Beschreibung / Description
40-450-19	leicht gebogen / slightly curved
40-451-19	stark gebogen / strongly curved

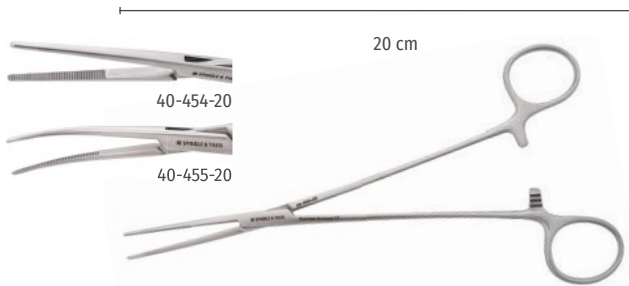

**Birkett Tonsillenklemme, schlank, 20 cm**  
**Birkett tonsil forceps, slender, 20 cm**

Art.-Nr./No.	Beschreibung / Description
40-454-20	gerade / straight
40-455-20	gebogen / curved

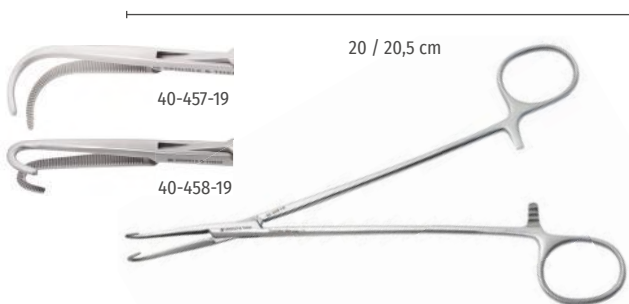

**Negus Tonsillenklemme, schlank / Negus tonsil forceps, slender**

Art.-No.	Länge Length (cm)	Beschreibung Description
40-457-19	20,0	stark gebogen wide curved
40-458-19	20,5	enger Bogen narrow curve



**Overholt-Geissdoerfer Tonsillenklemme, gebogen, 19 cm**  
**Overholt-Geissdoerfer tonsil forceps, curved, 19 cm**

**40-460-19**



## 03 Tonsillektomie

### Tonsillectomy



**Mikulicz Tonsillenklemme, gebogen, 1:2 Zähne, 18,5 cm**  
Mikulicz tonsil forceps, curved, 1:2 teeth, 18.5 cm

**40-462-18**

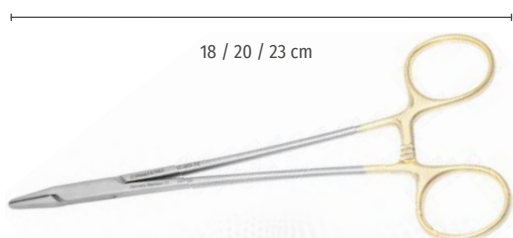

**Crile-Wood Nadelhalter, Hartmetall, schlank**  
Crile-Wood needle holder, tungsten carbide, slender

Art.-Nr./No.	Länge / Length (cm)
40-465-18	18
40-465-20	20
40-465-23	23



**Barraquer Mikro-Nadelhalter, Hartmetall, runde Federgriffe, ohne Sperre**  
Barraquer micro needle holder, tungsten carbide, round type handles, without ratchet

20-784-18



20-785-18

Art.-Nr. Art.-No.	Länge Length (cm)	Beschreibung Description
20-784-18	19	gerade / straight
20-785-18	19	gebogen / curved

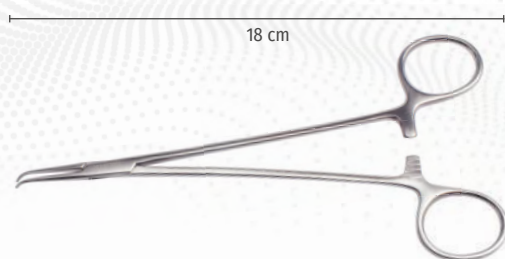

**Klemme, Typ Augsburg, sehr fein, gebogen, 18 cm**  
Artery forceps, type Augsburg, very fine, curved, 18 cm

**80-381-18**

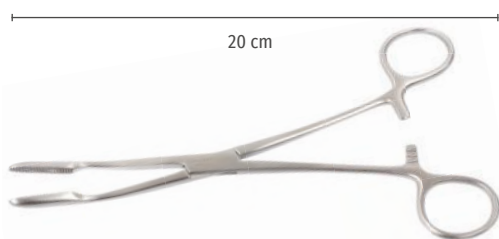

**Gross Kornzange, gebogen, 20 cm**  
Gross sponge forceps, curved, 20 cm

**40-474-20**

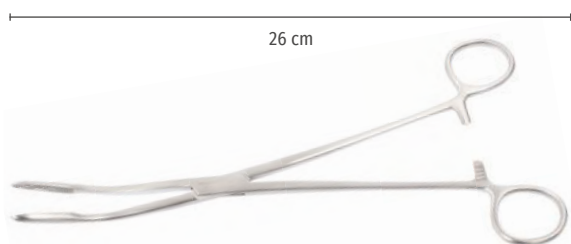

**Gross-Maier Kornzange, gebogen, 26 cm**  
Gross-Maier sponge forceps, curved, 26 cm

**40-475-26**





**Abraham Tonsillmesser, spitz, gebogen, 22 cm**  
Abraham tonsil knife, pointed, curved, 22 cm

40-480-22

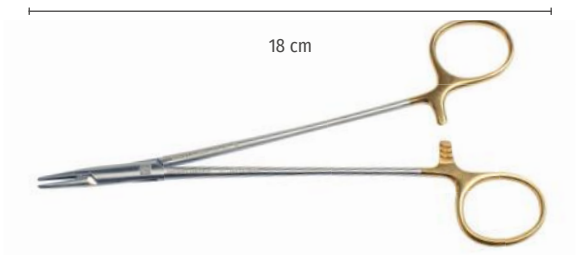

**De Bakey Nadelhalter, Hartmetall, 18 cm**  
De Bakey needle holder, tungsten carbide, 18 cm

40-481-18



**Brünings Tonsillmesser, spitz, gebogen, 22 cm**  
Brünings tonsil knife, pointed, curved, 22 cm

40-482-23



**Colver-Fischer Tonsillmesser, gewinkelt, gezahnt, 22 cm**  
Colver-Fischer tonsil knife, angled, serrated, 22 cm

40-484-22

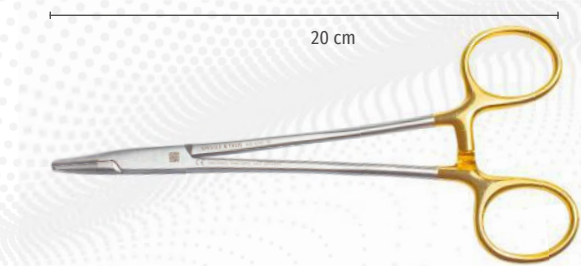

**Mayo-Hegar Nadelhalter, Hartmetall,**  
Mayo-Hegar needle holder, tungsten carbide

Art.-Nr. Art.-No.	Länge Length (cm)
40-490-16	16
40-490-18	18

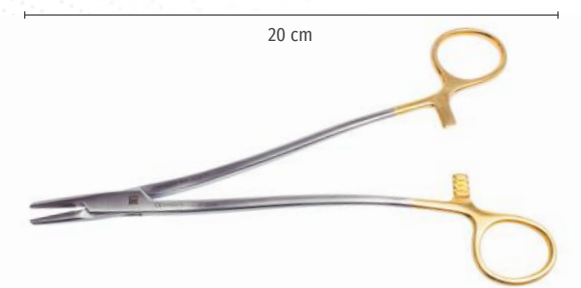

**Bozemann Nadelhalter, Hartmetall, 20 cm**  
Bozemann needle holder, tungsten carbide, 22 cm

40-491-20

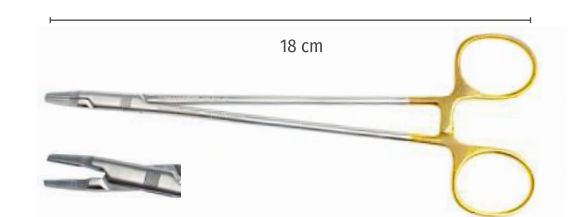

**Crile-Wood Ryder Nadelhalter, Hartmetall,**  
verjüngte Spitzen 18 cm  
Crile-Wood Ryder needleholder, tungsten carbide,  
small ends, 18 cm

40-745-18



## 03 Tonsillektomie

### Tonsillectomy



#### Skalpelle-Griff / Scalpel handle

Art.-Nr./No.	Nr. / No.	Länge / Length (cm)
10-360-03	3	12,0
10-360-04	4	13,5
10-360-07	7	16,0
10-360-33	3L	21,0

#### Skalpelle-Klingen, einzeln steril verpackt, 100 Stück

#### Scalpel blades, single sterile packed, 100 pieces



Art.-Nr./No.	Nr. / No.	Beschreibung / Description
10-360-10	10	
10-360-11	11	spitz / pointed
10-360-15	15	gerundet / rounded

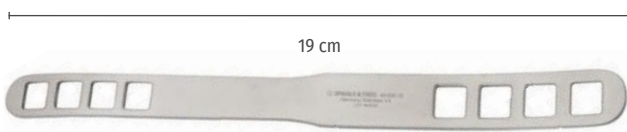

**Brünings Zungenspatel, gefenstert, 19 cm**  
**Brünings tongue depressor, fenestrated, 19 cm**

40-500-19



**Buchwald Zungenspatel, 19/23 mm, 18 cm**  
**Buchwald tongue depressor, 19/23 mm, 18 cm**

40-508-18

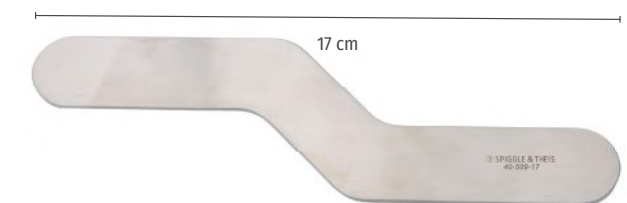

**Zungenspatel, S-förmig, 17 cm**  
**Tongue blade, s-shape, 17 cm**

40-509-17



**Moritz-Schmidt Zungenspatel, gefenstert, 19,5 cm**  
**Moritz-Schmidt tongue depressor, fenestrated, 19.5 cm**

40-506-19

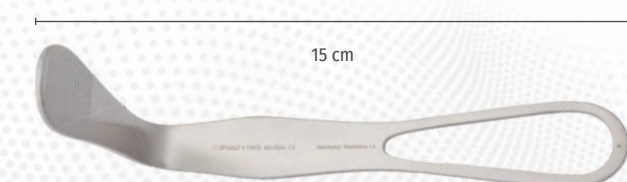

**Hartmann Zungenspatel, gewinkelt, 15 cm**  
**Hartmann tongue depressor, angled, 15 cm**

40-504-15

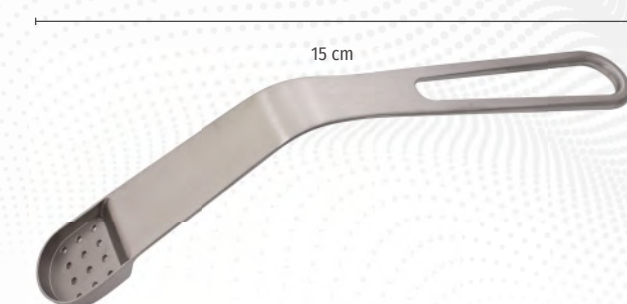

**Tapia Adenoid Spatel, 15 cm / Tapia adenoid spatula, 15 cm**

Art.-Nr./No.	Löcher / Holes
40-510-01	9
40-510-02	12
40-510-03	15



## 04 Kehlkopf

### Larynx

#### Kehlkopfspiegel, Rhodium beschichtet, ohne Griff, ohne Gewinde Laryngeal mirror, rhodium coated, without handle, without screw



Art.-Nr./No.	Größe / Size	Länge / Length (mm)	Ø (mm)
40-524-30	000	126	6,5
40-524-20	00	127	8,5
40-524-00	0	128	10,5
40-524-01	1	130	12,5
40-524-02	2	132	14,5
40-524-03	3	133	16,0
40-524-04	4	136	18,5
40-524-05	5	137	20,0
40-524-06	6	140	22,0
40-524-07	7	141	24,0
40-524-08	8	142	26,0
40-524-09	9	143	28,0
40-524-10	10	144	30,5

**Kehlkopfspiegel, Rhodium beschichtet, fester Sechskantgriff, 17 cm**  
**Laryngeal mirror, rhodium coated, fixed hexagonal handle, 17 cm**



Art.-Nr./No.	Größe / Size	Ø (mm)
40-525-30	000	6,0
40-525-20	00	8,0
40-525-00	0	10,0
40-525-01	1	12,0
40-525-02	2	14,0
40-525-03	3	16,0
40-525-04	4	18,0
40-525-05	5	20,0
40-525-06	6	22,0
40-525-07	7	24,0
40-525-08	8	26,0
40-525-09	9	28,0
40-525-10	10	30,0

**Griff für Kehlkopfspiegel, Zentralverschraubung, 11 cm**  
**Handle for laryngeal mirrors, central screw, 11 cm**



**40-520-00**

**Injektionskanüle, 0,8 mm, Luer-Lock**  
**Injection needle, 0.8 mm, Luer-Lock**

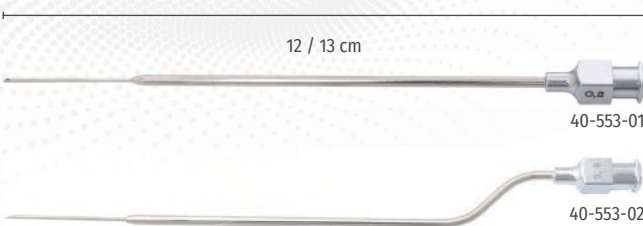

Art.-Nr./No.	Länge / Length (cm)	Beschreibung / Description
40-553-01	12	gerade / straight
40-553-02	13	bajonett / bayonet

**Kehlkopf-Kanüle, gebogen, Luer-Lock, 2,0 mm, 13 cm**  
**Laryngeal cannula, curved, Luer-Lock, 2.0 mm, 13 cm**

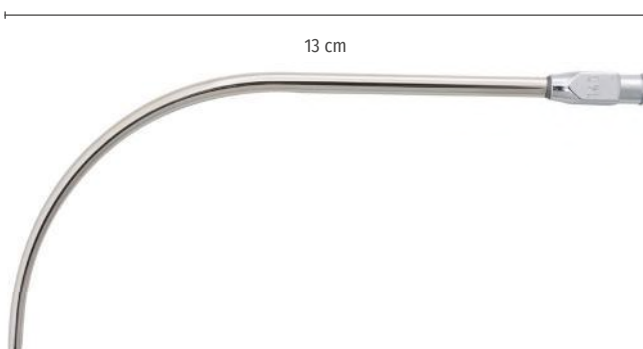

**40-554-13**





## 04 Kehlkopf

### Larynx



**Reichert Epiglottis Halter, gebogen, 23,5 cm**  
Reichert epiglottis holder, curved, 23.5 cm

40-558-24

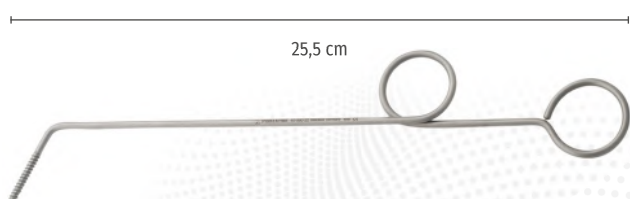

**Pelteson Kehlkopfwatteträger, gewinkelt, 2-Ring, 25,5 cm**  
Pelteson laryngeal cotton carrier, angled, 2 rings, 25.5 cm

40-560-22

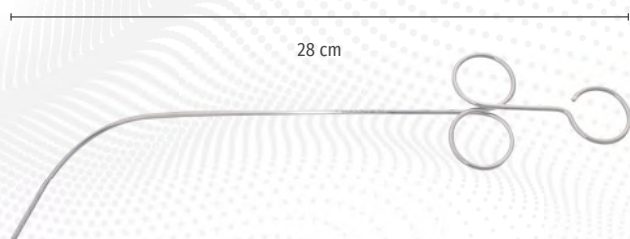

**Kehlkopfwatteträger, fein, gebogen, 3-Ring, 28 cm**  
Laryngeal cotton carrier, fine, curved, 3 rings, 28 cm

40-561-28

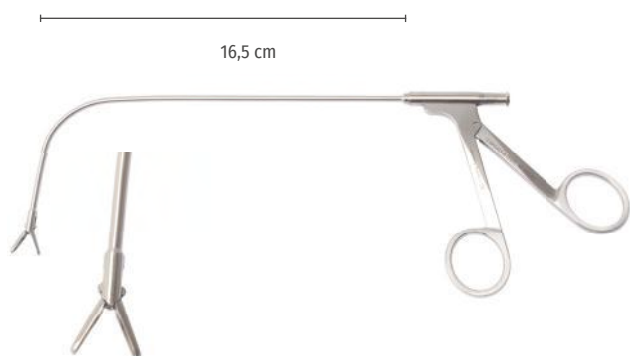

**Kehlkopffzange, Rohrschaft, gebogen, ovale Löffel, Spülkanal, AL 16,5 cm**  
Laryngeal forceps, tubular model, curved, oval cups, irrigation channel, WL 16.5 cm

Art.-Nr./No.	Beschreibung / Description
40-570-01	vertikal / vertical
40-570-02	horizontal

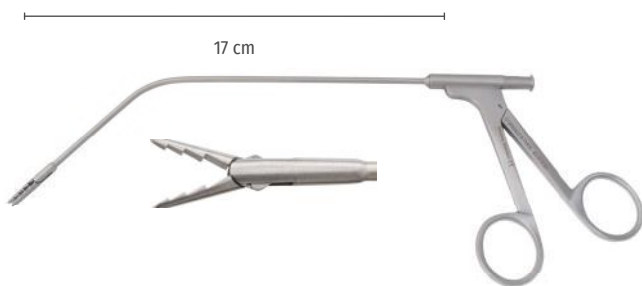

**Kehlkopfzange, Rohrschaft, gebogen, Hechtmaul, Spülkanal, AL 17 cm**

Laryngeal forceps, tubular model, curved, alligator jaws, irrigation channel, WL 17 cm

Art.-Nr./No.	Beschreibung / Description
40-572-01	vertikal / vertical
40-572-02	horizontal



**Huber Universal Handgriff, Standard**  
Huber universal handle, standard

40-575-00

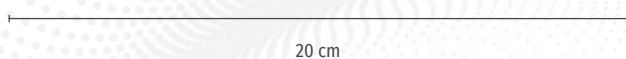

**Ansatzrohr, gebogen, 20 cm / Connecting tube, curved, 20 cm**

40-576-20



**Brünings Löffelansatz, rund, 3 mm**  
Brünings tip, round cups, 3 mm

Art.-Nr./No.	Beschreibung / Description
40-578-00	gerade / straight
40-579-00	nach oben gebogen / curved upwards



**Seiffert Hechtmaulansatz, gerade / Seiffert alligator tip, straight**

40-580-00



**Fraenkel Löffelansatz, oval, gerade, 4,5 mm**  
Fraenkel tip, oval cups, straight, 4.5 mm

40-581-00





## 05 Speichelgang

### Salivary Duct



**Speichelgang-Schere, gewinkelt, 11,5 cm**  
**Salivary duct scissors, angled, 11.5 cm**

Art.-Nr./No.	Beschreibung / Description
	mit Knopf / with ball end
40-601-12	ohne Knopf / without ball end

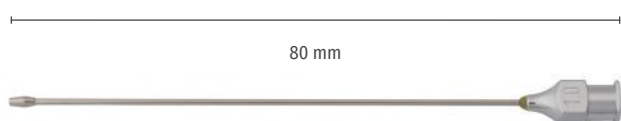

**Knopfkanüle, gerade, Luer-Lock, unsteril**  
**Cannula ball-ended, straight, Luer-lock, non-sterile**

Art.-Nr./No.	Größe / Size (mm)
40-604-08	0,8 x 80
40-604-10	1,0 x 80
40-604-12	1,2 x 80

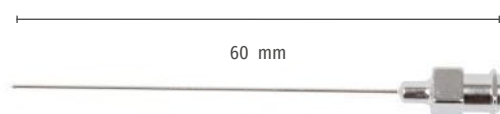

**Bangerter Tränenwegkanüle, unsteril**  
**stumpf, seitliche Öffnung, gerade, Luer-Lock**  
**Bangerter lacrimal duct cannula, non-sterile**  
**blunt, lateral opening, straight, Luer-lock**

Art.-Nr./No.	Größe / Size (mm)
40-606-06	0,6 x 60
40-606-08	0,8 x 60



**Tränenwegkanüle, stumpf, gebogen, 0,6 x 23,5 mm**  
**Lacrimal canula, blunt, curved, 0.6 x 23.5 mm**

**40-607-06**



**Bowman Speichelgangsonde, Silber, 12,5 cm**  
**Bowman salivary duct probe, silver, 12.5 cm**

Art.-Nr./No.	Größe / Size	Ø (mm)
40-609-40	(0000/000)	0,4 / 0,6
40-609-00	(00/0)	0,7 / 0,8
40-609-01	(0/1)	0,8 / 0,9
40-609-12	(1/2)	0,9 / 1,1
40-609-23	(2/3)	1,1 / 1,3
40-609-34	(3/4)	1,3 / 1,4
40-609-45	(4/5)	1,4 / 1,5
40-609-56	(5/6)	1,5 / 1,6
40-609-67	(6/7)	1,6 / 1,8
40-609-78	(7/8)	1,8 / 1,9

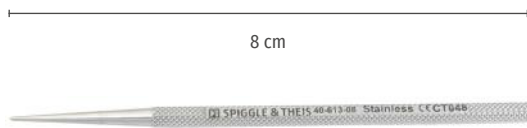

**Ruedemann Dilatator für Kleinkinder, 8 cm**  
**Ruedemann dilator for infants, 8 cm**

**40-613-08**

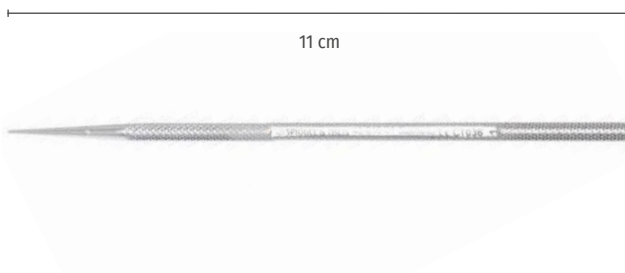

**Wilder Dilatator, 11 cm / Wilder dilator, 11 cm**

Art.-Nr./No.	Größe / Size
40-615-01	1
40-615-02	2
40-615-03	3



**Speichelgang-Sonden-Set, doppelseitig, biegsam, Nitinol,**  
**6 Größen (Ø 0,5/0,6 mm bis Ø 1,5/1,6 mm), 14 cm**  
**Salivary duct probe set, double ended, bendable, Nitinol,**  
**6 sizes (Ø 0.5/0.6 mm up to Ø 1.5/1.6 mm), 14 cm**

**40-617-00**



## 06 Koagulation

### Coagulation



**HF-Generator 1E, 100 Watt, 460 kHz, bipolar, monopolar, komplett mit Fußschalter, bipolarem Kabel 3 m, 2x Handgriff monopolar mit Kabel 3 m, 4 mm und 2,4 mm, Neutralelektrode mit Kabel 3 m**  
HF-generator 1E, 100 Watt, 460 kHz bipolar, monopolar, complete with footswitch, bipolar cable 3 m, 2x handle monopolar with cable 3 m, 4.0 mm and 2.4 mm neutral electrode with cable 3 m

**80-002-80**



**Silikon Neutral-Elektrode, 8 x 15 cm, 4 m Kabel, passend für silicone neutral electrode, 8 x 15 cm, 4 m cable, fitting to Micromed/Martin/Berchthold/Aesculap/ SPIGGLE & THEIS**

**80-010-40**



**Silikon Neutral-Elektrode, 17 x 30 cm, 4 m Kabel, passend für silicone neutral electrode, 17 x 30 cm, 4 m cable, fitting to Micromed/Martin/Berchthold/Aesculap/SPIGGLE & THEIS**

**80-011-40**



**Halteband für Neutralelektrode, Gummi, 75 cm**  
Holding band for neutral electrode, rubber, 75 cm

**80-012-75**



**Elektroden-Handgriffe, autoklavierbar, mit zwei Schaltern, schneiden und koagulieren, für abnehmbare Anschlusskabel**  
**Electrode Handle, autoclavable, with 2 switches, cutting and coagulating, for removable connecting cable**

Art.-Nr./No.	Ansatz / plug (mm)
80-406-01	4,0
80-406-02	2,4



**Elektroden-Handgriffe, autoklavierbar, mit fest verbundenem Anschlusskabel, 4 m, passend für Erbe**  
**Electrode Handle, autoclavable, with fixed connecting cable, 4 m, compatible to Erbe**

Art.-Nr./No.	Ansatz / plug (mm)
80-410-04	4,0
80-410-24	2,4



**Elektroden-Handgriffe, autoklavierbar, mit fest verbundenem Anschlusskabel, 4 m, passend für International**  
**Electrode Handle, autoclavable, with fixed connecting cable, 4 m, compatible to International**

Art.-Nr./No.	Ansatz / plug (mm)
80-411-04	4,0
80-411-24	2,4



**Elektroden-Handgriffe, autoklavierbar, mit fest verbundenem Anschlusskabel, 4 m, passend für Martin**  
**Electrode Handle, autoclavable, with fixed connecting cable, 4 m, compatible to Martin**

Art.-Nr./No.	Ansatz / plug (mm)
80-412-04	4,0
80-412-24	2,4



**Monopolares Anschlusskabel für Einmal Neutral-Elektrode, 4,5 m, passend für**  
**Monopolar connecting cable for single-use patient plates, 4.5 m, compatible to**  
**Micromed/Martin/Integra/Berchtold/Aesculap/Erbe ICC/ACC/T-Serie**

**80-413-00**



## 06 Monopolares Zubehör, monopolare Anschlusskabel, autoklavierbar

### Monopolar Accessory, monopolar connecting cable, autoclavable



Für SPIGGLE & THEIS Elektroden-Handgriffe, 4 m, passend für  
for SPIGGLE & THEIS electrode handles, 4 m, compatible to  
Sutter/Martin/Berchtold/Aesculap/Integra/SPIGGLE & THEIS

80-407-40



Für SPIGGLE & THEIS Elektroden-Handgriffe, 4 m, passend für  
for SPIGGLE & THEIS electrode handles, 4 m, compatible to  
Erbe ICC/ACC, Wolf/Storz

80-408-40



Für Erbe Elektroden-Handgriffe, 3 m, passend für  
for Erbe electrode handles, 3 m, compatible to  
Erbe ICC/ACC, Wolf/Storz

80-409-30



Für Instrumente, 4 mm, 5 m, passend für  
for instruments, 4 mm, 5 m, compatible to  
Sutter/Martin/Berchtold/Aesculap/Integra/SPIGGLE & THEIS

80-414-50



Für Instrumente, 4 mm, 5 m, passend für  
for instruments, 4 mm, 5 m, compatible to  
Erbe ICC/ACC, Wolf/Storz

80-415-50



Für Instrumente, 5 m, passend für  
for instruments, 5 m, compatible to  
Valleylab, Conmed/Bovie

80-445-15

## 06 Bipolares Zubehör, bipolare Anschlusskabel

### Bipolar Accessory, bipolar connecting cable



**passend für / compatible to**  
**Erbe/EMC/Dolly Stecker**

Art.-Nr./No.	Länge / Length (m)
80-316-50	5



**passend für / compatible to**  
**Sutter/Martin/Berchtold/Aesculap/Integra/SPIGGLE & THEIS**

Art.-Nr./No.	Länge / Length (m)
80-317-30	3
80-317-50	5



**passend für / compatible to**  
**Erbe/Storz/Wolf**

Art.-Nr./No.	Länge / Length (m)
80-318-30	3
80-318-50	5



**passend für / compatible to**  
**Valleylab/Lamidey/EMC/Bowa/Olympus**

Art.-Nr./No.	Länge / Length (m)
80-319-30	3
80-319-50	5



**für bipolare Scheren, passend für**  
**for bipolar scissors, compatible to**  
**Sutter/Martin/Berchtold/Aesculap/Integra/SPIGGLE & THEIS**

Art.-Nr./No.	Länge / Length (m)
80-320-30	3
80-320-50	5



**für bipolare Scheren/Zangen, passend für**  
**for bipolar scissors/forceps, compatible to**  
**Erbe/Storz/Wolf**

Art.-Nr./No.	Länge / Length (m)
80-322-30	3
80-322-50	5



## 06 Koagulation

### Coagulation



**Monopolare Messerelektrode, seitliche Spitze mit Schaft 4 mm, schwarz, 5 Stück/Box**

Monopolar knife electrode, cutting edge sideways with 4mm shaft, black, 5 pieces /box

80-053-01



**Monopolare Nadelelektrode, Ø 0,5 mm m. Schaft 4 mm, schwarz, 5 Stück/Box**

Monopolar needle electrode, Ø 0.5 mm with 4 mm shaft, black, 5 pieces /box

80-053-02



**Monopolare Drahtschlingen-Elektrode, Ø 5 mm mit Schaft 4 mm, schwarz, 5 Stück/Box**

Monopolar wire loop electrode, Ø 5 mm with 4 mm shaft, black, 5 pieces /box

80-053-03



**Monopolare Kugelelektrode, gerade Ø 4 mm mit Schaft 4 mm, schwarz, 5 Stück/Box**

Monopolar ball electrode, straight Ø 4 mm with 4 mm shaft , black, 5 pieces /box

80-053-04



**Monopolare Kugelelektrode, gerade Ø 2 mm mit Schaft 4 mm, schwarz, 5 Stück/Box**

Monopolar ball electrode, straight Ø 2 mm with 4 mm shaft , black, 5 pieces /box

80-053-05

13 / 14 / 17,5 / 18 cm

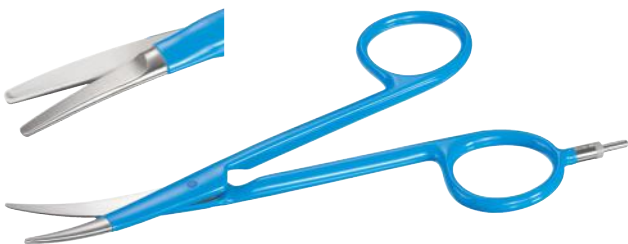

#### Bipolare Präparierschere

#### Bipolar dissecting scissors

Art.-Nr. Art.-No.	Beschreibung Description	Länge Length (cm)
80-180-13	feines Blatt delicate blade	13,0
80-181-14	feines Blatt delicate blade	14,0
80-182-17	feines Blatt delicate blade	17,5
80-183-18	standard Blatt standard blade	18,0



Bis heute stellt das Verkleben beim Koagulieren mit bipolaren Pinzetten ein verbreitetes Problem für den Operateur dar. **NON-STICK bipolare Pinzetten** lösen dieses Problem.

Punktuelle Überhitzungen werden vermieden. Das Gewebe löst sich leicht von der Pinzette.

Diese Eigenschaften bleiben bei ordnungsgemäßer Anwendung über die gesamte Lebensdauer des Instruments erhalten.

An adhesion when coagulating with bipolar forceps is a common problem for the surgeon. Our **NON-STICK bipolar forceps** solve this problem.

No punctual overheating. Tissue detaches easily from forceps.

With correct usage these characteristics remain over the entire life span of the instrument.



#### Vorteile:

- Kein Verkleben da Arbeitsteile aus massivem Silber mit Goldüberzug sind
- Präzises Arbeiten ohne Unterbrechungen
- Perfekte Parallelführung durch Stopp-Führungsstift
- Flächiges Koagulieren durch "Perfect-Grip"-Arbeitsteil
- Autoklavierbar
- Passend für alle gängigen HF-Systeme durch Standard-Anschluss

#### Advantages:

- No adhesion due to gold plated solid silver tips
- Precise working without interruptions
- Perfect parallel motion through guide pin
- Areal coagulation with "Perfect Grip" working part
- Autoclavable
- Standard adapter grants compatibility to all current HF-systems



## 06 Bipolare Pinzetten, X-FINE, NON-STICK, bajonett, Führungsstift

### Bipolar Forceps, X-FINE, NON-STICK, bayonet, guide pin



#### Spitze gerade / tip straight

Art.-Nr. Art.-No.	Länge Length (cm)	Spitze Tip (mm)
80-150-17	17	0,4 x 4,0
80-150-20	20	0,4 x 4,0
80-150-23	23	0,4 x 4,0
80-150-25	25	0,4 x 4,0
80-152-17	17	0,7 x 4,0
80-152-20	20	0,7 x 4,0
80-152-23	23	0,7 x 4,0



#### Spitze aufwärts gewinkelt / tip upwards angled

Art.-Nr. Art.-No.	Länge Length (cm)	Spitze Tip (mm)
80-156-20	20	0,4 x 4,0
80-156-23	23	0,4 x 4,0



#### Spitze abwärts gewinkelt / tip downwards angled

Art.-Nr. Art.-No.	Länge Length (cm)	Spitze Tip (mm)
80-158-20	20	0,4 x 4,0
80-158-23	23	0,4 x 4,0

## 06 Bipolare Pinzetten, NON-STICK, Führungstift

### Bipolar Forceps, NON-STICK, guide pin

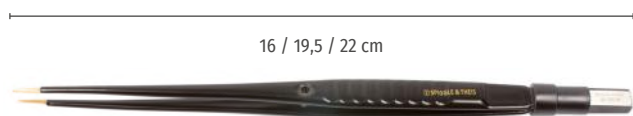

#### gerade / straight

Art.-Nr. Art.-No.	Länge Length (cm)	Spitze Tip (mm)
80-100-16	16,0	0,5 x 8,0
80-100-19	19,5	0,5 x 8,0
80-101-16	16,0	1,0 x 8,0
80-101-19	19,5	1,0 x 8,0
80-101-22	22,0	1,0 x 8,0
80-103-16	16,0	2,0 x 8,0
80-103-19	19,5	2,0 x 8,0

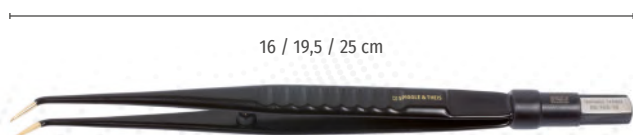

#### gerade, Spitze gewinkelt / straight, tip angled

Art.-Nr. Art.-No.	Länge Length (cm)	Spitze Tip (mm)
80-105-16	16,0	0,5 x 8,0
80-105-19	19,5	0,5 x 8,0
80-106-16	16,0	1,0 x 8,0
80-106-19	19,5	1,0 x 8,0
80-106-25	25,0	1,0 x 8,0
80-107-16	16,0	2,0 x 8,0
80-107-19	19,5	2,0 x 8,0



#### bajonett / bayonet

Art.-Nr. Art.-No.	Länge Length (cm)	Spitze Tip (mm)
80-110-16	16,0	0,5 x 8,0
80-110-19	19,5	0,5 x 8,0
80-111-16	16,0	1,0 x 8,0
80-111-19	19,5	1,0 x 8,0
80-112-16	16,0	2,0 x 8,0
80-112-19	19,5	2,0 x 8,0



#### bajonett / bayonet

Art.-Nr. Art.-No.	Länge Length (cm)	Spitze Tip (mm)
80-109-16	16,0	0,2 x 5,0
80-113-19	19,5	0,2 x 5,0
80-113-23	23,0	0,2 x 5,0
80-114-19	19,5	0,5 x 6,0
80-115-19	19,5	1,0 x 6,0
80-116-19	19,5	1,5 x 6,0



## 06 Bipolare Pinzetten, NON-STICK, Führungsstift

### Bipolar Forceps, NON-STICK, guide pin



**Bajonett, Spitze nach oben gewinkelt, 19,5 cm**  
 bayonet, tip angled upwards, 19.5 cm

Art.-Nr./No.	Spitze / Tip (mm)
80-117-19	0,2 x 8,0
80-118-19	1,0 x 8,0
80-119-19	2,0 x 8,0



**Bajonett, Spitze nach oben gewinkelt, 14 mm, 4 mm unisoliert, 1,5 mm, 19,5 cm**  
 bayonet, tip upwards angled, 14 mm, 4 mm unisolated, 1.5 mm, 19.5 cm

80-120-19

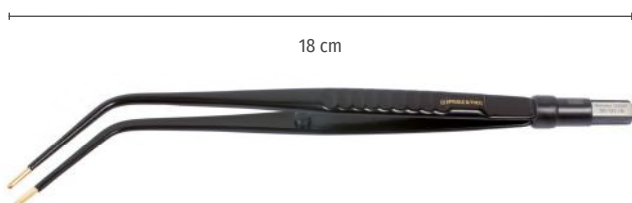

**Meuser, 60° gebogen , 2 mm, 18 cm**  
 Meuser, 60° curved , 2 mm, 18 cm

80-121-18



**Kniegebogen, extra fein, 0,2 x 8,0 mm, 16,5 cm**  
 angled, very fine, 0.2 x 8.0 mm, 16.5 cm

80-123-16



**Bajonett, Spitze nach oben gewinkelt, 25 cm**  
 bayonet, tip upwards angled, 25 cm

Art.-Nr. Art.-No.	Spitze Tip (mm)	
80-127-03	0,3 x 8,0	
80-127-07	0,7 x 8,0	
80-127-12	1,2 x 8,0	
80-127-20	2,0 x 8,0	
80-129-12	1,2 x 14,0	8 mm unisoliert 8 mm unisolated

## 06 Bipolare Pinzetten, NON-STICK, bajonett, Führungstift

### Bipolar Forceps, NON-STICK, bayonet, guide pin



**Spitze nach unten gewinkelt, 25 cm**  
tip downwards angled, 25 cm

Art.-Nr./No.	Spitze / Tip (mm)
80-128-03	0,3 x 8,0
80-128-07	0,7 x 8,0
80-128-12	1,2 x 8,0
80-128-20	2,0 x 8,0



**Spitze gerade, 25 cm / tip straight 25 cm**

Art.-Nr./No.	Spitze / Tip (mm)
80-125-03	0,3 x 8,0
80-125-07	0,7 x 8,0
80-125-12	1,2 x 8,0
80-125-20	2,0 x 8,0

## 07 Bipolare Saugpinzetten

### Bipolar Suction Forceps



**Nach Meuser mit Absaugung, 60° gebogen, 3,2 mm, 21 cm**  
Meuser with suction, 60° upcurved, 3.2 mm, 21 cm

**80-122-18**



**Saugunterbrecher, bajonett, 20 cm**  
suction control, bayonet, 20 cm

Art.-Nr./No.	Spitze / Tip (mm)
80-183-14	1,4 x 8,0
80-183-20	2,2 x 8,0



## 06 Koagulation

### Coagulation

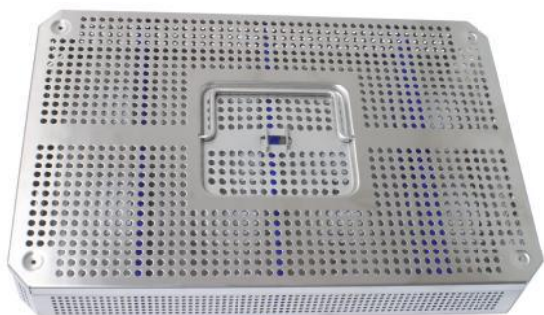

Siebkorb mit Deckel, 3/4, Edelstahl, gelocht, 405 x 255 x 75 mm  
Storage- and cleaning tray with lid, 3/4, stainless steel,  
perforated, 405 x 255 x 75 mm

80-260-34

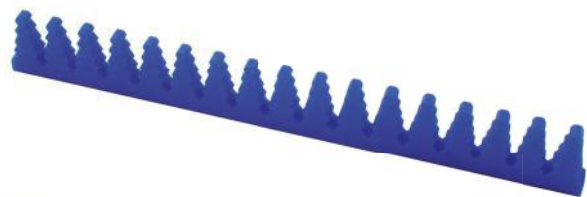

Silikonhalterung, Typ 1, Bäumchen, T-Profil, blau, 24 cm  
Silicone holder, type 1, tree shaped, t-profile, blue, 24 cm

80-270-24



Silikonhalterung, Typ 2, Universal, T-Profil, blau, 24 cm  
Silicone holder, type 2, universal, t-profile, blue, 24 cm

80-272-24

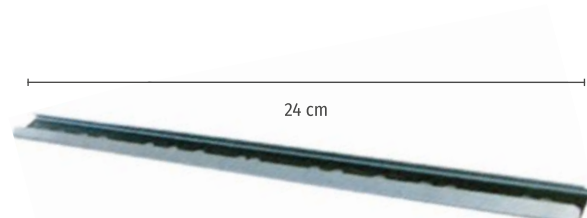

Leiste für Silikonhalterungen, Edelstahl, T-Profil, 24 cm  
Bar for silicone holders, stainless steel, t-profile, 24 cm

80-275-24



Schraube, Edelstahl, M2, 9 x 16 mm  
Screw, stainless steel, M2, 9 x 16 mm

80-280-00

### SET - 80-250-00

#### Bestehend aus / consisting of:

- 1 x 80-260-34
- 1 x 80-270-24
- 1 x 80-272-24
- 2 x 80-275-24
- 24 x 80-280-00

## 07 Tracheotomie, Weichteile, Allgemeines

### Tracheotomy, Neck Dissection, Miscellaneous



**Sternberg Lippenhaken / Sternberg lip retractor**

Art.-Nr./No.	Länge / Length (cm)
80-302-12	12,0
80-302-14	13,5
80-302-16	15,5

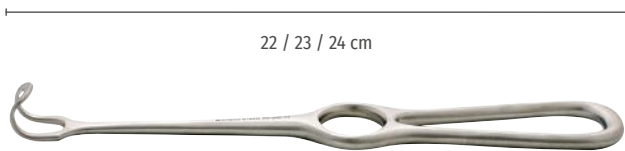

**Middeldorpf Wundhaken, Ringgriff**

**Middeldorpf antrum retractor, ring handle**

Art.-Nr. Art.-No.	Maße Dimensions (mm)	Länge Length (cm)
80-306-17	15,0 x 16,5	22
80-306-22	20,0 x 22,0	23
80-306-30	25,0 x 30,0	24

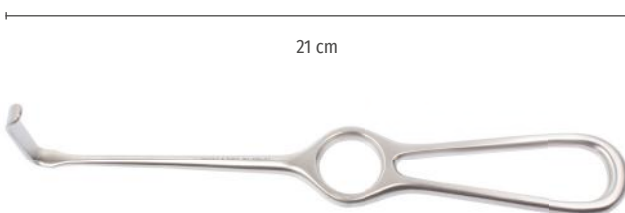

**Kocher-Langenbeck Wundhaken, Ringgriff, 21 cm**

**Kocher-Langenbeck retractor, ring handle, 21 cm**

Art.-Nr. Art.-No.	Maße Dimensions (mm)
80-308-06	25,0 x 6,0
80-308-07	35,0 x 8,0
80-308-10	35,0 x 11,0
80-308-15	35,0 x 15,0
80-308-20	60,0 x 20,0





## 07 Tracheotomie, Weichteile, Allgemeines

### Tracheotomy, Neck Dissection, Miscellaneous



**Langenbeck Wundhaken, Ringgriff**  
Langenbeck retractor, ring handle

Art.-Nr. Art.-No.	Maße Dimensions (mm)	Länge Length (cm)
80-309-11	31,0 x 11,0	23
80-309-14	31,0 x 14,0	23
80-309-16	31,0 x 16,0	23
80-309-41	41,0 x 11,0	22
80-309-51	51,0 x 11,0	21



**Volkman Wundhaken, Ringgriff, 23 cm**  
Volkman retractor, ring handle, 23 cm

Art.-Nr./No.	Beschreibung / Description
80-330-01	1-zinkig, scharf / 1 prong, sharp
80-330-02	2-zinkig, scharf / 2 prongs, sharp
80-330-03	3-zinkig, scharf / 3 prongs, sharp
80-330-04	4-zinkig, scharf / 4 prongs, sharp
80-330-06	6-zinkig, scharf / 6 prongs, sharp
80-332-01	1-zinkig, stumpf / 1 prong, blunt
80-332-02	2-zinkig, stumpf / 2 prongs, blunt
80-332-03	3-zinkig, stumpf / 3 prongs, blunt
80-332-04	4-zinkig, stumpf / 4 prongs, blunt
80-332-06	6-zinkig, stumpf / 6 prongs, blunt



**Schönborn Schilddrüsenhaken, 6,5 x 13 mm, 20,5 cm**  
Schönborn thyroid retractor, 6,5 x 13 mm, 20,5 cm

80-312-21



**Senn-Miller Wundhaken, doppelendig, 3 Zähne, 16,5 cm**  
Senn-Miller retractor, double ended, 3 teeth, 16,5 cm

Art.-Nr./No.	Beschreibung / Description
80-314-16	stumpf / blunt
80-315-16	scharf / sharp

## 07 Tracheotomie, Weichteile, Allgemeines

### Tracheotomy, Neck Dissection, Miscellaneous



**Roux Wundhaken, doppelendig / Roux retractor, double ended**

Art.-Nr. Art.-No.	Maße Dimensions (mm)	Länge Length (cm)
80-318-01	20,8 x 25,0 / 28,5 x 30,50	14,5
80-318-02	25,5 x 28,0 / 37,0 x 33,15	15,5
80-318-03	30,0 x 31,5 / 41,9 x 38,50	16,5



**Baby-Roux Haken, doppelendig, 16 x 16 und 21 x 19 mm, 13,5 cm**  
**Baby-Roux retractor, double ended, 16 x 16 and 21 x 19 mm, 13.5 cm**

**80-317-00**



**Trachealhäkchen, glatter Griff, 17 cm**  
**Trachea hook, flat handle, 17 cm**



Art.-Nr./No.	Beschreibung / Description
80-340-01	1-zinkig, scharf / 1 prong, sharp
80-340-02	2-zinkig, scharf / 2 prongs, sharp
80-340-03	3-zinkig, scharf / 3 prongs, sharp
80-340-04	4-zinkig, scharf / 4 prongs, sharp
80-342-01	1-zinkig, stumpf / 1 prong, blunt
80-342-02	2-zinkig, stumpf / 2 prongs, blunt
80-342-03	3-zinkig, stumpf / 3 prongs, blunt
80-342-04	4-zinkig, stumpf / 4 prongs, blunt



## 07 Tracheotomie, Weichteile, Allgemeines

### Tracheotomy, Neck Dissection, Miscellaneous

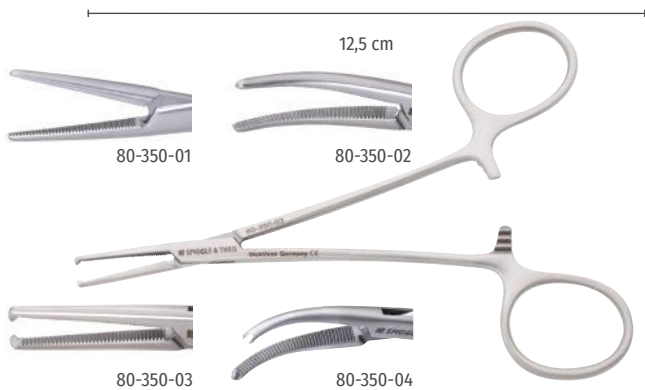

**Halsted-Mosquito-Klemme, 12,5 cm**  
Halsted-Mosquito artery forceps, 12.5 cm

Art.-Nr./No.	Beschreibung / Description
80-350-01	gerade, anat. / straight, anat.
80-350-02	gebogen, anat. / curved, anat.
80-350-03	gerade, chir. / straight, 1:2 teeth
80-350-04	gebogen, chir. / curved, 1:2 teeth



**Halsted-Mosquito-Klemme, mikro, 12,5 cm**  
Halsted-Mosquito artery forceps, micro, 12.5 cm

Art.-Nr./No.	Beschreibung / Description
80-352-01	gerade, anat. / straight, anat.
80-352-02	gebogen, anat. / curved, anat.
80-352-03	gerade, chir. / straight, 1:2 teeth
80-352-04	gebogen, chir. / curved, 1:2 teeth
80-353-01	gebogen, sehr fein, 12 cm / curved, very fine 12 cm

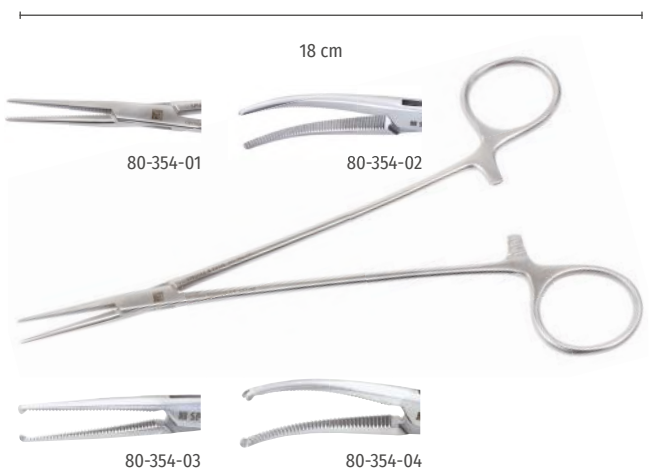

**Halsted-Mosquito-Klemme, 18 cm**  
Halsted-Mosquito artery forceps, 18 cm

Art.-Nr./No.	Beschreibung / Description
80-354-01	gerade, anat. / straight, anat.
80-354-02	gebogen, anat. / curved, anat.
80-354-03	gerade, chir. / straight, 1:2 teeth
80-354-04	gebogen, chir. / curved, 1:2 teeth

## 07 Tracheotomie, Weichteile, Allgemeines

### Tracheotomy, Neck Dissection, Miscellaneous

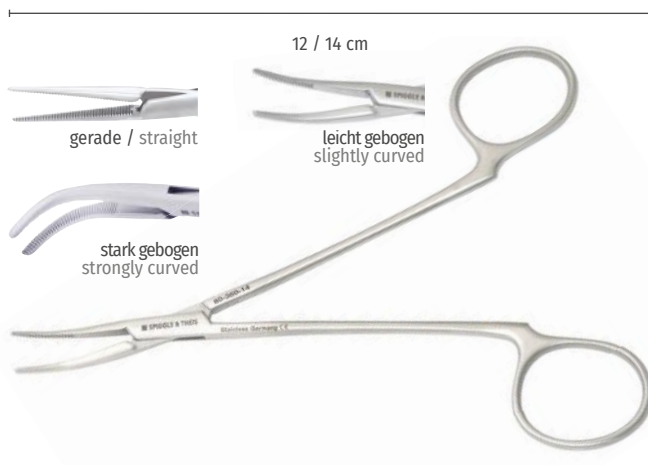

#### Präparierklemme ohne Sperre, anatomisch Artery forceps without ratchet, anatomical

Art.-Nr. Art.-No.	Länge Length (cm)	Beschreibung Description
80-356-12	12,0	gerade / straight
80-359-14	14,0	gerade / straight
80-357-12	12,0	leicht gebogen / slightly curved
80-360-14	14,0	leicht gebogen / slightly curved
80-361-14	14,0	stark gebogen / strongly curved

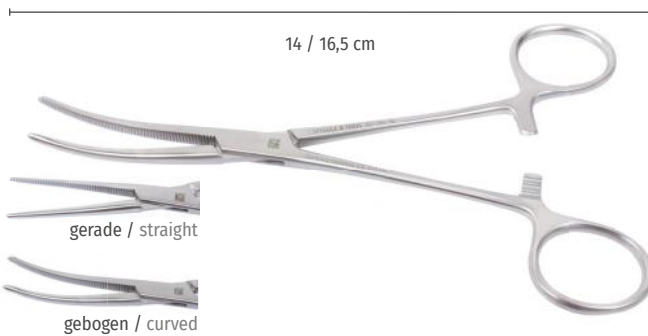

#### Pean Arterienklemme, anatomisch, fein Pean artery forceps, anatomical, fine

Art.-Nr. Art.-No.	Länge Length (cm)	Beschreibung Description
80-365-14	14,0	gerade / straight
80-365-16	16,5	gerade / straight
80-366-14	14,0	gebogen / curved
80-366-16	16,5	gebogen / curved

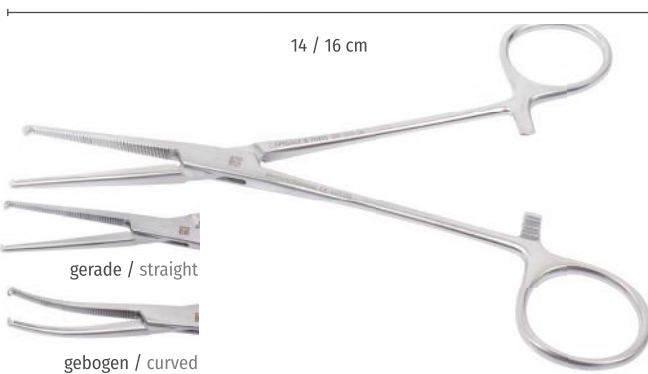

#### Kocher Arterienklemme, chirurgisch, fein Kocher artery forceps, 1:2 teeth, fine

Art.-Nr. Art.-No.	Länge Length (cm)	Beschreibung Description
80-370-14	14,0	gerade / straight
80-370-16	16,0	gerade / straight
80-372-14	14,0	gebogen / curved
80-372-16	16,0	gebogen / curved

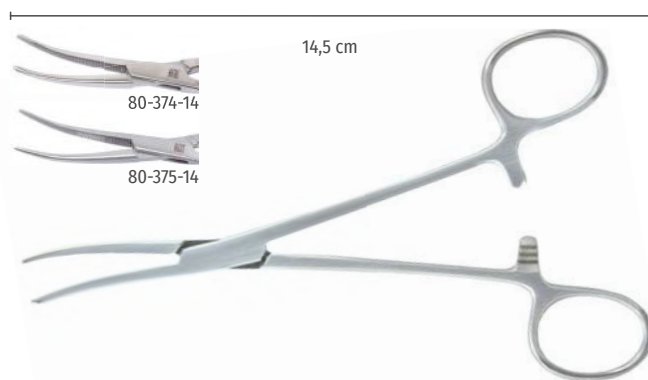

#### Crile Arterienklemme, anatomisch, gebogen, 14,5 cm Crile artery forceps, anatomical, curved, 14,5 cm

Art.-Nr./No.	Beschreibung / Description
80-374-14	normal / standard
80-375-14	mikro / micro



## 07 Tracheotomie, Weichteile, Allgemeines

### Tracheotomy, Neck Dissection, Miscellaneous

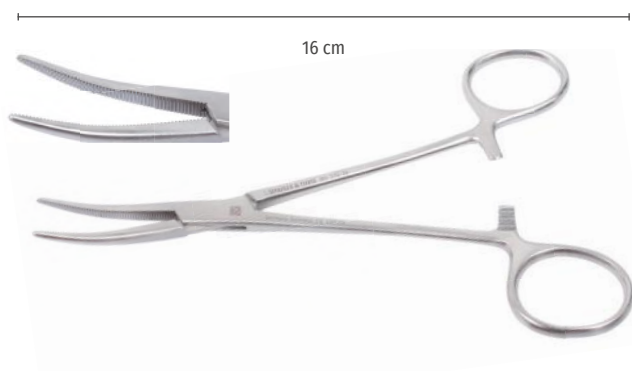

**Crile Arterienklemme, anatomisch, gebogen, 16 cm**  
Crile artery forceps, anatomical, curved, 16 cm

80-376-16



**Baby-Adson Präparierklemme, 90° gebogen, 18 cm**  
Baby-Adson artery forceps, 90° curved, 18 cm

80-380-18



**Rochester-Pean Arterienklemme, anatomisch, gerade**  
Rochester-Pean artery forceps, anatomical, straight

Art.-Nr./No.	Länge / Length (cm)
80-382-18	18,5
80-382-20	20,0



**Rochester-Pean Arterienklemme, anatomisch, gebogen**  
Rochester-Pean artery forceps, anatomical, curved

Art.-Nr./No.	Länge / Length (cm)
80-383-18	18,5
80-383-20	20,5
80-383-22	22,0

## 07 Tracheotomie, Weichteile, Allgemeines

### Tracheotomy, Neck Dissection, Miscellaneous

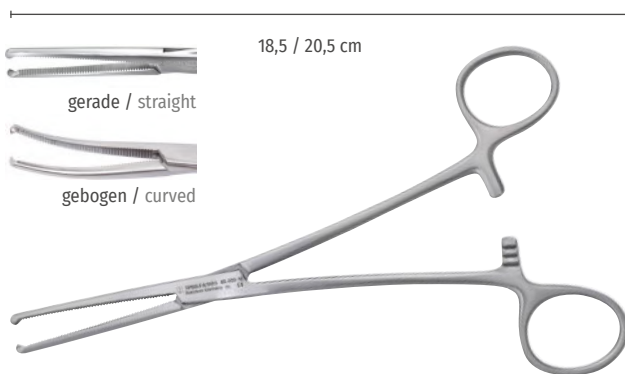

**Ochsner-Kocher Arterienklemme, chirurgisch, 1:2 Zähne**  
**Ochsner-Kocher artery forceps, 1:2 teeth**

Art.-Nr. Art.-No.	Länge Length (cm)	Beschreibung Description
80-385-18	18,5	recto / straight
80-385-20	20,5	recto / straight
80-387-18	18,5	curvo / curved
80-387-20	20,5	curvo / curved



**Backhaus Tuchklemme, scharf, gebogen**  
**Backhaus towel clamp, sharp, curved**

Art.-Nr./No.	Länge / Length (cm)
80-392-09	9
80-392-11	11
80-392-13	13



**Edna-Lorna Tuchklemme, stumpf, gerade, für Papiertücher**  
**Edna-Lorna towel clamp, blunt, straight, for paper towels**

Art.-Nr./No.	Länge / Length (cm)
80-394-09	10,0
80-394-13	13,5



## 07 Tracheotomie, Weichteile, Allgemeines

### Tracheotomy, Neck Dissection, Miscellaneous



**Tuchklemme zum schonenden Fassen von Papiertüchern, Kugel, gebogen**

Towel clamp for careful holding of paper towels, ball-end, curved

Art.-Nr./No.	Länge / Length (cm)
80-397-12	12
80-397-14	14



**Allis Gewebe-Fasszange, gerade, 4:5 Zähne, 15,5 cm**

Allis tissue holding forceps, straight, 4:5 teeth, 15.5 cm

**80-400-15**

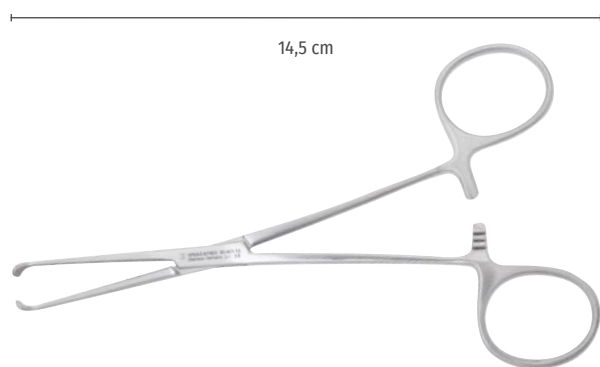

**Baby-Allis Gewebe-Fasszange, gerade, 4:5 Zähne, 14,5 cm**

Baby-Allis tissue holding forceps, straight, 4:5 teeth, 14.5 cm

**80-401-14**



**Braun Haken-Zange, 4:4 Zähne, scharf, gerade, 15,5 cm**

Braun hook forceps, 4:4 teeth, sharp, straight, 15.5 cm

**80-403-15**



## 07 Tracheotomie, Weichteile, Allgemeines

### Tracheotomy, Neck Dissection, Miscellaneous

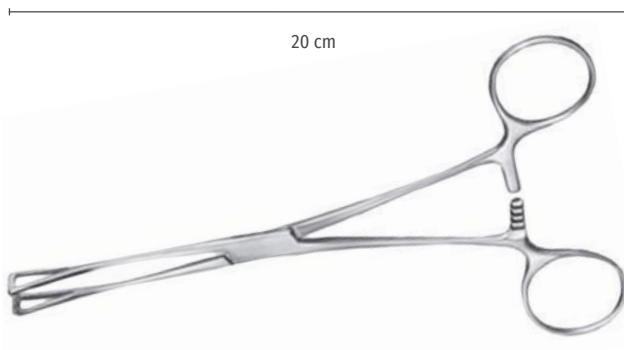

**Duval Gewebefasszange, gerade, 15 mm breit, 20 cm**  
**Duval tissue forceps, straight, 15 mm wide, 20 cm**

**80-405-20**



**Collin Zungenzange, gerade, 16 cm**  
**Collin tongue forceps, straight, 16 cm**

**80-407-16**

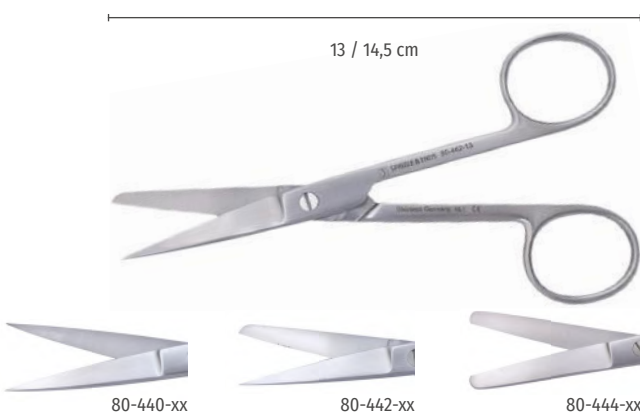

**Cooper Schere, gerade / Cooper scissors, straight**

Art.-Nr. Art.-No.	Länge Length (cm)	Beschreibung Description
80-440-13	13,0	spitz-spitz / sharp-sharp
80-440-15	14,5	spitz-spitz / sharp-sharp
80-442-13	13,0	spitz-stumpf / sharp-blunt
80-442-15	14,5	spitz-stumpf / sharp-blunt
80-444-13	13,0	stumpf-stumpf / blunt-blunt
80-444-15	14,5	stumpf-stumpf / blunt-blunt



## 07 Tracheotomie, Weichteile, Allgemeines

### Tracheotomy, Neck Dissection, Miscellaneous

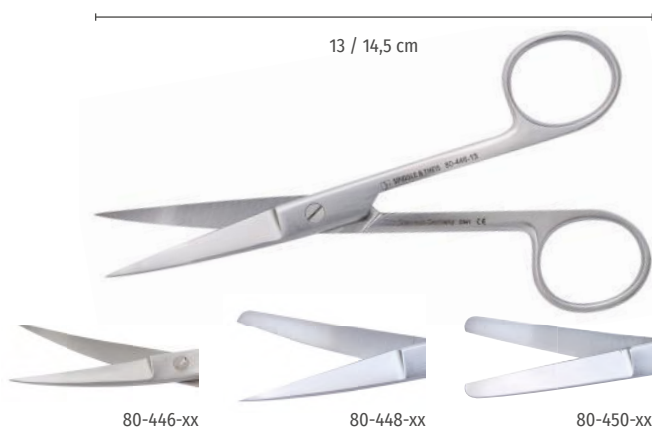

#### Cooper Schere, gebogen / Cooper scissors, curved

Art.-Nr. Art.-No.	Länge Length (cm)	Beschreibung Description
80-446-13	13,0	spitz-spitz / sharp-sharp
80-446-15	14,5	spitz-spitz / sharp-sharp
80-448-13	13,0	spitz-stumpf / sharp-blunt
80-450-13	13,0	stumpf-stumpf / blunt-blunt
80-450-15	14,5	stumpf-stumpf / blunt-blunt



#### Mayo-Style Schere, stumpf-stumpf Mayo-Style scissors, blunt-blunt

Art.-Nr. Art.-No.	Länge Length (cm)	Beschreibung Description
80-455-15	15,0	gerade / straight
80-455-17	17,0	gerade / straight
80-457-15	15,0	gebogen / curved



#### Mayo-Style Schere, Hartmetall, stumpf-stumpf, 15 cm Mayo-Style scissors, tungsten carbide, blunt-blunt, 15 cm

Art.-Nr./No.	Beschreibung / Description
80-459-15	gerade / straight
80-460-15	gebogen / curved



#### Lister Verbandsschere, gewinkelt Lister bandage scissors, angled

Art.-Nr./No.	Länge / Length (cm)
80-465-15	14,5
80-465-18	18,5
80-465-20	20,0

## 07 Tracheotomie, Weichteile, Allgemeines

### Tracheotomy, Neck Dissection, Miscellaneous

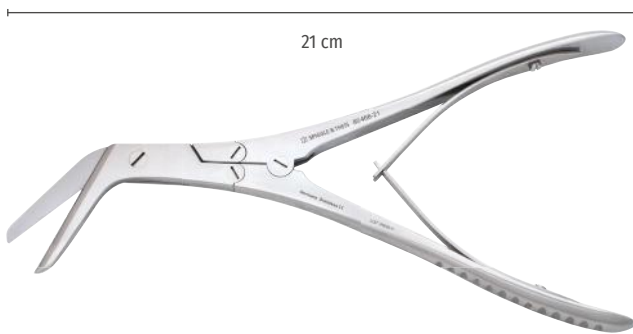

**Kilian Laryngofissur-Schere, gewinkelt, gezahnt, 21 cm**  
Kilian laryngectomy scissors, angled, serrated, 21 cm

**80-468-21**



**Kocher Führungssonde, mit Öffnung, 12,5 mm, 16,5 cm**  
Kocher director, with opening, 12,5 mm, 16.5 cm

**80-470-16**



**Hohlsonde, gerade, 14,5 cm / Hollow probe, straight, 14.5 cm**

**80-471-15**

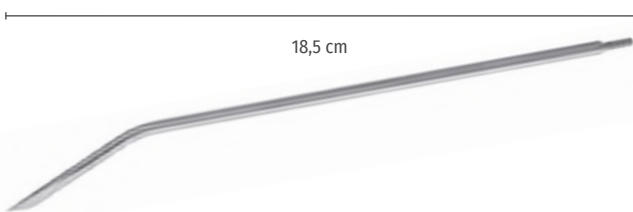

**Redon Führungsnadel, Lanzettspitze, leicht gebogen, 18,5 cm**  
Redon guide needle, lancet tip, slightly curved, 18.5 cm

Art.-Nr./No.	AD / OD (mm)
80-472-25	2,5
80-472-35	3,5
80-472-40	4,0



## 07 Tracheotomie, Weichteile, Allgemeines

### Tracheotomy, Neck Dissection, Miscellaneous

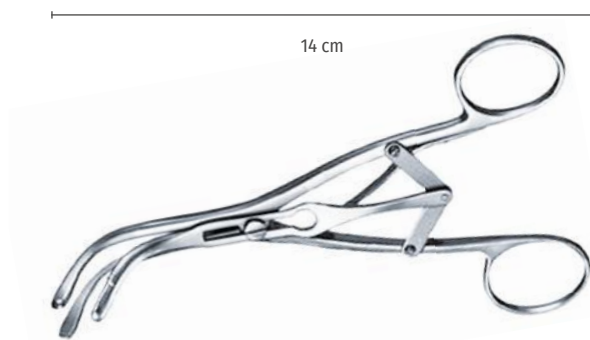

**Laborde Trachealdilatator, 3-armig, 14 cm**  
Laborde tracheal dilator, 3 prongs, 14 cm

**80-478-14**

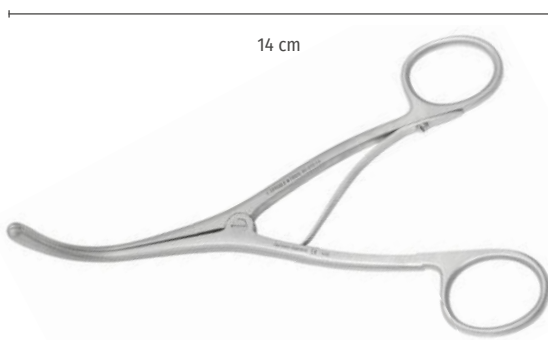

**Laborde Trachealdilatator, 2-armig, 14 cm**  
Laborde tracheal dilator, 2 prongs, 14 cm

**80-479-14**



**Weerda Trachealspekulum, 19 cm**  
Weerda tracheal speculum, 19 cm

**80-482-19**

## 07 Tracheotomie, Weichteile, Allgemeines

### Tracheotomy, Neck Dissection, Miscellaneous



#### Metallschale / Metal bowl

Art.-Nr. Art.-No.	Durchmesser Diameter (mm)	Höhe Height (mm)	Fassungs- vermögen Capacity (ml)
80-501-01 B1	Ø 40	H=19	20
80-501-02 B2	Ø 60	H=29	60
80-501-03 B3	Ø 85	H=40	160
80-501-04 B4	Ø 110	H=55	400



#### Medizinbecher, Edelstahl, graduiert

#### Medicine cup, stainless steel, graduated

Art.-Nr. Art.-No.	Durchmesser Diameter (mm)	Höhe Height (mm)	Fassungs- vermögen Capacity (ml)
80-503-03	Ø 50	H=25	30
80-504-05	Ø 53	H=45	50



#### Lösungsschale, Edelstahl / Solution bowl, stainless steel

Art.-Nr. Art.-No.	Durchmesser Diameter (mm)	Höhe Height (mm)	Fassungs- vermögen Capacity (ml)
80-505-10	Ø 72	H=33	100
80-505-20	Ø 87	H=50	200
80-506-30	Ø 95	H=60	300
80-507-40	Ø 120	H=70	500
80-509-75	Ø 150	H=75	750



#### Tablettenschale, Edelstahl, Ø 65 mm, H=19 mm

#### Tablet dish, stainless steel, Ø 65 mm, H=19 mm

80-512-00



#### Petrischale, Klarglas, mit Deckel / Petri dish, clear glass, with lid

Art.-Nr./No.	AD / OD (mm)	Höhe / Height (mm)
80-515-06	60	15
80-515-08	80	15
80-515-10	100	20



#### Medikamenten-Schälchen, Glas, schwarz, mit Deckel, 4 x 4 cm

#### Medication dish, glass, black, with lid, 4 x 4 cm

80-517-00



## 07 Tracheotomie, Weichteile, Allgemeines

### Tracheotomy, Neck Dissection, Miscellaneous

#### Medikamenten-Schälchen, Dappenglas, farbig, Ø 3,2 cm Medication dish, dappen-glass, colored, Ø 3.2 cm



80-519-00



80-519-01



80-519-02



80-519-03

Art.-Nr./No.	Farbe / Color
80-519-00	kristall / crystal
80-519-01	grün / green
80-519-02	rosa / pink
80-519-03	topas / topaz



#### Porzellan-Schälchen, rund, mit Ausguss China bowl, round, with spout

Art.-Nr./No.	Durchmesser / Diameter (cm)
80-520-06	Ø 8
80-520-08	Ø 10



#### Nierenschale, Edelstahl / Kidney bowl, stainless steel

Art.-Nr./No.	Größe / Size (cm)
80-525-17	17,5
80-525-25	25,0



#### Kornzangen-Behälter, Edelstahl / Forceps holder, stainless steel

Art.-Nr. Art.-No.	Durchmesser Diameter (cm)	Höhe Height (cm)
80-528-13	Ø 5,0	13,5
80-528-18	Ø 5,0	18,0
80-528-20	Ø 9,5	20,0



#### Kornzangen-Behälter, Glas, Edelstahldeckel mit Ausschnitt, Ø 8 cm, Höhe 20 cm

Forceps holder, glass, stainless steel lid with opening,  
Ø 8 cm, height 20 cm

80-530-20

## 07 Tracheotomie, Weichteile, Allgemeines

### Tracheotomy, Neck Dissection, Miscellaneous



**Norm-Sterilisations-Container, Boden geschlossen**  
Norm sterilization container, bottom closed

Art.-Nr. Art.-No.	Größe Size	Dimension (außen) Dimension (outside) (mm)
80-631-10	1/2	297 x 274 x 88
80-631-12	1/2	297 x 274 x 123
80-631-14	1/2	297 x 274 x 138
80-631-21	1/2	297 x 274 x 188
80-641-14	3/4	462 x 274 x 138
80-661-12	1	585 x 274 x 123
80-661-14	1	585 x 274 x 138
80-661-21	1	585 x 274 x 188



**Ventildeckel für Norm-Sterilisations-Container**  
Valve lid for norm sterilization container

Art.-Nr./No.	Art.-Nr./No.	Art.-Nr./No.
1/2	3/4	1
299 x 278 mm	462 x 278 mm	585 x 278 mm
80-632-00	80-642-00	80-662-00
80-632-01	80-642-01	80-662-01
80-632-02	80-642-02	80-662-02
80-632-03	80-642-03	80-662-03
80-632-04	80-642-04	80-662-04
80-632-05	80-642-05	80-662-05



**Edelstahl-Siebkorb, Geflecht, Fallgriffe**  
Stainless-steel wire basket, sliding handles

Art.-Nr./No.	Größe / Size (mm)
80-671-20	255 x 245 x 50
80-671-25	255 x 245 x 70
80-671-40	405 x 255 x 70
80-671-60	485 x 255 x 70



**Aluminium-Kennzeichnungsschild, 20 Zeichen, 56 x 17 mm**  
Coding label, 20 letters, 56 x 17 mm

Art.-Nr./No.	Farbe / Color
80-681-01	schwarz / black
80-681-02	rot / red
80-681-03	braun / brown
80-681-04	grün / green
80-681-05	gelb / yellow
80-681-06	lila / purple
80-681-07	blau / blue

**Einweg-Container-Siegel, blau, 100 Stück/Box**  
Container seal, disposable, blue, 100 pieces/box

80-683-10

**Indikator-Klebe-Etikett, Lasche rechts, 100 Stück/Box**  
Adhesive indicator label, latch right side, 100 pieces/box

80-684-10

**Klemmschild aus Edelstahl, hitzebeständig,**  
6 x 4 cm, 25 Stück/Box

Label holder with clip, stainless steel, heat resistant,  
6 x 4 cm, 25 pieces/box

80-688-00





## 08 Tonsillektomie/Adenotomie-Set

### Tonsillectomy/Adenotomy set

#### Bestehend aus / Consisting of:

- 20-254-03 Schmeden Conchotom, Größe 3, dreieckig, 10 mm, 12 cm  
Schmeden cutting forceps, size 3, triangular, 10 mm, 12 cm
- 20-615-18 Metzenbaum Schere, Hartmetall, gebogen, stumpf-stumpf, fein 18 cm  
Metzenbaum scissors, tungsten carbide, curved, blunt, fine, 18 cm
- 40-200-00 Beckmann Ringmesser, Größe 0, gerade, 10,5 mm, 22 cm  
Beckmann adenoid curette, size 0, straight, 10.5 mm, 22 cm
- 40-200-01 Beckmann Ringmesser, Größe 1, gerade, 13 mm, 22 cm  
Beckmann adenoid curette, size 1, straight, 13 mm, 22 cm
- 40-200-02 Beckmann Ringmesser, Größe 2, gerade, 14,5 mm, 22 cm  
Beckmann adenoid curette, size 2, straight, 14.5 mm, 22 cm
- 40-200-03 Beckmann Ringmesser, Größe 3, gerade, 16,5 mm, 22,5 cm  
Beckmann adenoid curette, size 3, straight, 16.5 mm, 22.5 cm
- 40-220-02 Jatho Nasenrachenzange, 70° aufgebogen, horizontal öffnend,  
Rohrschaft, Spülkanal, AL 15 cm / Jatho epipharyngeal forceps,  
70° curved upwards, horizontal opening, tubular model,  
irrig. channel, wl 15 cm
- 40-225-00 Jurasz Nasenrachenzange 19 cm / Jurasz adenoid forceps 19 cm
- 40-230-21 Nager Gaumensegelhaken 22 cm / Nager pillar retractor 22 cm
- 40-300-02 Davis-Meyer Mundsperrer, links offen, verschiebbare Zahnhaken  
Davis-Meyer mouth gag, left side open, movable teeth hooks
- 40-305-00 Mclvor Mundsperrer, geschlossen / Mclvor mouth gag, closed form
- 40-318-01 Russel-Davis Zungenspatel mit Rinne, Ausgang links,  
Größe 1, 30x70 mm / Russel-Davis tongue depressor with,  
central channel, outlet left side, size 1, 30x70 mm
- 40-318-02 Russel-Davis Zungenspatel mit Rinne, Ausgang links,  
Größe 2, 34x80 mm / Russel-Davis tongue depressor with,  
central channel, outlet left side, size 2, 34x80 mm
- 40-318-03 Russel-Davis Zungenspatel mit Rinne, Ausgang links,  
Größe 3, 39x85 mm / Russel-Davis tongue depressor with,  
central channel, outlet left side, size 3, 39x85 mm
- 40-318-04 Russel-Davis Zungenspatel mit Rinne, Ausgang links,  
Größe 4, 42x98 mm / Russel-Davis tongue depressor with,  
central channel, outlet left side, size 4, 42x98 mm
- 40-355-28 Brünings Tonsillenschnürer 29 cm / Brünings tonsil snare 29 cm
- 40-359-27 Roeder Ligatur-Instrument, Form E, für Vicryl-Faden 27 cm  
Roeder ligature instrument, form E, for vicryle wire 27 cm
- 40-381-15 Henke Raspatorium/Dissektor, breit, 15 mm, 24 cm  
Henke raspatory/dissector, large, 15 mm, 24 cm
- 40-390-21 Blohmke Fasszange, gebogen, 20 cm  
Blohmke tonsil forceps, curved, 20 cm
- 40-406-20 Tonsillen-Pinzette, 1:2 Zähne, breit, 2,5 mm, 20,5 cm  
Tonsil dissecting forceps, 1:2 teeth, large, 2.5 mm, 20.5 cm
- 40-420-29 Yankauer Saugrohr, für Erwachsene, 6 mm, abschraubbarer  
Ansatz, Öffnung 3 mm, 28,5 cm / Yankauer Suction tube,  
for adults, 6 mm, detachable tip, opening 3 mm, 28.5 cm
- 40-430-19 Good-Schweckendiek Tonsillenschere, gebogen, gezahnt, 19,5 cm  
Good-Schweckendiek tonsil scissors, curved, serrated, 19.5 cm
- 40-450-19 Schnidt Tonsillenklemme, einseitig offener Ring, schlank, leicht  
gebogen, 19 cm / Schnidt tonsil forceps, one ring open, slender,  
slightly curved, 19 cm
- 40-457-19 Negus Tonsillenklemme, schlank, stark gebogen, 20 cm  
Negus tonsil forceps, slender, wide curve, 20 cm
- 40-465-18 Crile-Wood Nadelhalter, schlank, Hartmetall, 18 cm  
Crile-Wood needle holder, slender, tungsten carbide, 18 cm
- 40-500-19 Brünings Zungenspatel, gefenestert, 19 cm  
Brünings tongue depressor, fenestrated, 19 cm
- 40-520-00 Griff für Kehlkopfspiegel, Zentralverschraubung, 11 cm  
Handle for laryngeal mirrors, central screw, 11 cm
- 40-524-02 Kehlkopfspiegel, Rhodium beschichtet, ohne Griff,  
ohne Gewinde, Gr. 2, 14,5 cm / Laryngeal mirror, rhodium  
coated, without handle, without screw, size 2, 14.5 cm
- 40-524-06 Kehlkopfspiegel, Rhodium beschichtet, ohne Griff,  
ohne Gewinde, Gr. 6, 22 cm / Laryngeal mirror, rhodium  
coated, without handle, without screw, size 6, 22 cm
- 40-553-02 Injektionskanüle, bajonett, Luer-Lock, 0,8 mm, AL 8,5 cm, GL 13 cm  
Injection needle bayonet, luer-lock, 0.8 mm, wl 8.5 cm, TL 13 cm
- 80-106-19 Bipolare Pinzette, NON-STICK, gerade, Spitze gewinkelt,  
Spitze 8mm lang, 1,0 mm breit, Führungsstift, 19,5 cm  
Bipolar forceps, NON-STICK, straight, angled tip,  
tip length 8 mm, 1.0 mm wide, guide pin, 19.5 cm
- 80-318-50 Bipolares Anschlusskabel passend für Erbe/Storz/Wolf 5 m  
Bipolar connecting cable compatible with Erbe/Storz/Wolf 5 m
- 80-392-09 6x Backhaus Tuchklemme, gebogen, scharf, 9 cm  
6x Backhaus towel clamp, curved, sharp, 9 cm
- 80-501-03 Metallschale, B4, Ø 85 mm, Höhe 40 mm, 160 ml  
Metal bowl, B4, Ø 85 mm, height 40 mm, 160 ml
- 80-504-05 Medizinbecher, graduiert, 50 ml / Medical cup, graduated, 50 ml

#### Ergänzung

#### Supplement

- 40-555-13 Kehlkopfkanüle, gebogen, Luer-Lock, 2,0 mm, 13 cm  
Laryngeal cannula, curved, Luer-lock, 2.0 mm, 13 cm
- 80-661-14 Norm-Sterilisations-Container Boden geschlossen, 585x274x138 mm  
Maße mit Deckel: 585x278x155 mm / Norm sterilization container  
bottom closed, 585x274x138 mm, dimensions with fitted  
lid: 585x278x155mm
- 80-662-00 Ventildeckel silber, für Container 80-661-14 585x278 mm  
Valve lid silver, for container 80-661-xx, 585x278 mm
- 80-671-60 Edelstahl-Siebkorb Geflecht, Fallgriffe 485x255x70 mm  
Stainless steel wire basket, sliding handles 485x255x70 mm
- 80-681-03 Aluminium-Kennzeichnungs-Schild braun, 20 Zeichen 56x17 mm  
Aluminium tag brown, 20 letters, 56x17 mm

Supplement for sales in EU (outside the EU only on request)

**Bestehend aus / Consisting of:**

- 20-254-03 Schmeden Conchotom, Größe 3, dreieckig, 10 mm, 12 cm  
Schmeden cutting forceps, size 3, triangular, 10 mm, 12 cm
- 20-615-18 Metzenbaum Schere, Hartmetall, gebogen, stumpf-stumpf, fein 18 cm  
Metzenbaum scissors, tungsten carbide, curved, blunt, fine, 18 cm
- 40-200-00 Beckmann Ringmesser, Größe 0, gerade, 10,5 mm, 22 cm  
Beckmann adenoid curette, size 0, straight, 10.5 mm, 22 cm
- 40-200-01 Beckmann Ringmesser, Größe 1, gerade, 13 mm, 22 cm  
Beckmann adenoid curette, size 1, straight, 13 mm, 22 cm
- 40-200-02 Beckmann Ringmesser, Größe 2, gerade, 14,5 mm, 22 cm  
Beckmann adenoid curette, size 2, straight, 14.5 mm, 22 cm
- 40-200-03 Beckmann Ringmesser, Größe 3, gerade, 16,5 mm, 22,5 cm  
Beckmann adenoid curette, size 3, straight, 16.5 mm, 22.5 cm
- 40-220-02 Jatho Nasenrachenzange, 70° aufgebogen, horizontal öffnend,  
Rohrschaft, Spülkanal, AL 15 cm / Jatho epipharyngeal forceps,  
70° curved upwards, horizontal opening, tubular model,  
irrig. channel, wl 15 cm
- 40-225-00 Jurasz Nasenrachenzange 19 cm / Jurasz adenoid forceps 19 cm
- 40-230-21 Nager Gaumensegelhaken 22 cm / Nager pillar retractor 22 cm
- 40-300-02 Davis-Meyer Mundsperrer, links offen, verschiebbare Zahnhaken  
Davis-Meyer mouth gag, left side open, movable teeth hooks
- 40-310-01 Mclvor Zungenspatel, glatt, Gr. 1, 23x75 mm  
Mclvor tongue depressor, smooth, size 1, 23x75 mm
- 40-310-02 Mclvor Zungenspatel, glatt, Gr. 2, 25x91 mm  
Mclvor tongue depressor, smooth, size 2, 25x91 mm
- 40-310-03 Mclvor Zungenspatel, glatt, Gr. 3, 26x103 mm  
Mclvor tongue depressor, smooth, size 3, 26x103 mm
- 40-420-29 Yankauer Saugrohr, für Erwachsene, 6 mm, abschraubbarer  
Ansatz, Öffnung 3 mm, 28,5 cm / Yankauer Suction tube,  
for adults, 6 mm, detachable tip, opening 3 mm, 28.5 cm
- 40-500-19 Brünings Zungenspatel, gefenstert, 19 cm  
Brünings tongue depressor, fenestrated, 19 cm
- 40-520-00 Griff für Kehlkopfspiegel, Zentralverschraubung, 11 cm  
Handle for laryngeal mirrors, central screw, 11 cm
- 40-524-02 Kehlkopfspiegel, Rhodium beschichtet, ohne Griff,  
ohne Gewinde, Gr. 2, 14,5 cm / Laryngeal mirror, rhodium  
coated, without handle, without screw, size 2, 14.5 cm
- 40-524-06 Kehlkopfspiegel, Rhodium beschichtet, ohne Griff,  
ohne Gewinde, Gr. 6, 22 cm / Laryngeal mirror, rhodium  
coated, without handle, without screw, size 6, 22 cm
- 80-121-18 Meuser bipolare Pinzette, NON-STICK, 60° gebogen,  
Spitze 8 mm lang, 2,0 mm, breit, Auflagestift, 18 cm  
Meuser Bipolar forceps NON-STICK, 60° curved, tip length  
8 mm, 2.0 mm wide, pin, 18 cm
- 80-318-50 Bipolares Anschlusskabel passend für Erbe/Storz/Wolf 5 m  
Bipolar connecting cable compatible with Erbe/Storz/Wolf 5 m
- 80-501-03 Metallschale, B4, Ø 85 mm, Höhe 40 mm, 160 ml  
Metal bowl, B4, Ø 85 mm, height 40 mm, 160 ml
- 80-504-05 2x Medizinbecher, graduert, 50 ml  
2x Medical cup, graduated, 50 ml

**Ergänzung****Supplement**

- 80-631-14 Norm-Sterilisations-Container Boden geschlossen,  
297x274x138 mm Maße mit Deckel: 585x278x155 mm  
Norm sterilization container, bottom closed, 297x274x138 mm,  
dimensions with fitted lid: 299x278x155mm
- 80-632-00 Ventildeckel silber, für Container 80-631-14, 299x278 mm  
Valve lid, silver, for container 80-631-xx, 299x278 mm
- 80-671-20 Edelstahl-Siebkorb, Geflecht, Fallgriffe, 255 x 245 x 50 mm  
Stainless steel wire basket, sliding handles, 255 x 245 x 50 mm
- 80-681-02 Aluminium-Kennzeichnungs-Schild, rot, 20 Zeichen, 56 x 17 mm  
Aluminium tag, red, 20 letter, 56 x 17 mm

[Supplement for sales in EU \(outside the EU only on request\)](#)



## 08 Tracheotomie-Set

### Tracheotomy set

#### Bestehend aus / Consisting of:

- 10-356-00 Wullstein Raspatorium, 4 mm breit, 16,5 cm  
Wullstein raspatory, 4 mm wide, 16.5 cm
- 10-360-03 Skalpellgriff, Nr. 3, 12,5 cm  
Scalpell handle, no. 3, 12.5 cm
- 10-360-04 Skalpellgriff, Nr. 4, 13,5 cm  
Scalpell handle, no. 4, 13.5 cm
- 10-438-17 2x Fisch Wundsperrer, mit Gelenken, 3:3 Zähne, halbscharf, zerlegbar, 16,5 cm  
2x Fisch retractor, with joints, 3:3 prongs, semi-sharp, dismountable, 16.5 cm
- 10-481-14 Pinzette, chirurgisch, anatomisch, gerade, 2 mm, 14,5 cm  
Dressing forceps, anatomical, straight, 2 mm, 14.5 cm
- 10-482-14 Pinzette, chirurgisch, anatomisch, gerade, 1,7 mm, 14,5 cm  
Dressing forceps, anatomical, straight, 1.7 mm, 14.5 cm
- 10-483-14 3x Pinzette, chirurgisch, 1:2 Zähne, gerade, 2,3 mm, 14,5 cm  
3x Dressing forceps, 1:2 teeth, straight, 2.3 mm, 14.5 cm
- 10-484-14 2x Pinzette, chirurgisch, 1:2 Zähne, gerade, 1,7 mm, 14,5 cm  
2x Dressing forceps, 1:2 teeth, straight, 1.7 mm, 14.5 cm
- 20-100-01 Hartmann Nasenspekulum, für Erwachsene, zerlegbar  
Hartmann nasal speculum, for adults, dismountable
- 20-305-18 Freer Doppelelevatorium, scharf/stumpf, 18,5 cm  
Freer elevator, double ended, sharp/blunt, 18.5 cm
- 20-610-15 Reynolds Schere, stumpf-stumpf, gebogen, verjüngte Spitzen, 16 cm  
Reynolds scissors, blunt, curved, tapered tips, 16 cm
- 20-615-15 Metzenbaum Schere, Hartmetall, gebogen, stumpf-stumpf, fein, 14,5 cm  
Metzenbaum scissors, tungsten carbide, curved, blunt, fine, 14.5 cm
- 20-615-18 Metzenbaum Schere, Hartmetall, gebogen, stumpf-stumpf, fein, 18 cm  
Metzenbaum scissors, tungsten carbide, curved, blunt, fine, 18 cm
- 20-740-15 Crile-Wood Nadelhalter, Hartmetall, 15 cm  
Crile-Wood needle holder, tungsten carbide, 15 cm
- 30-490-40 Hajek-Kofler Keilbeinstanze, aufeinander schneidend, 90° aufwärts, 4 mm, 14 cm, komplett zerlegbar  
Hajek-Kofler sphenoid punch, 90° curved upwards, 4 mm, 14 cm, totally detachable
- 40-465-18 Crile-Wood Nadelhalter, schlank, Hartmetall, 18 cm  
Crile-Wood needle holder, slender, tungsten carbide, 18 cm
- 40-475-26 Gross-Maier Kornzange, gebogen, 26 cm  
Gross-Maier sponge forceps, curved, 26 cm
- 40-508-18 Buchwald Zungenspatel, 19/23 mm, 18 cm  
Buchwald tongue depressor, 19/23 mm, 18 cm
- 80-105-16 Bipolare Pinzette, NON-STICK, gerade, Spitze gewinkelt, Spitze 8mm lang, 0,5 mm breit, Führungsstift, 16 cm  
Bipolar forceps, NON-STICK, straight, angled tip, tip length 8 mm, 0.5 mm wide, guide pin, 16 cm
- 80-107-19 Bipolare Pinzette, NON-STICK, gerade, Spitze gewinkelt, Spitze 8mm lang, 2,0 mm breit, Führungsstift, 19,5 cm  
Bipolar forceps, NON-STICK, straight, angled tip, tip length 8 mm, 2.0 mm wide, guide pin, 19.5 cm
- 80-308-10 2x Kocher-Langenbeck Wundhaken, Ringgriff, 36x10 mm, 22 cm  
2x Kocher-Langenbeck retractor, ring handle, 36x10 mm, 22 cm
- 80-308-15 2x Kocher-Langenbeck Wundhaken, Ringgriff, 35x15 mm, 22 cm  
2x Kocher-Langenbeck retractor, ring handle, 35x15 mm, 22 cm
- 80-308-20 2x Kocher-Langenbeck Wundhaken, Ringgriff, 61x20 mm, 23 cm  
2x Kocher-Langenbeck retractor, ring handle, 61x20 mm, 23 cm
- 80-312-21 Schönborn Schilddrüsenhaken, 6,5x13 mm, 20,5 cm  
Schönborn retractor, 6.5x13 mm, 20.5 cm
- 80-315-16 2x Senn-Miller Wundhaken, doppelendig, 3 Zähne, scharf, 16,5 cm  
2x Senn-Miller retractor, double ended, 3 teeth, sharp, 16.5 cm
- 80-318-50 Bipolares Anschlusskabel passend für Erbe/Storz/Wolf 5 m  
Bipolar connecting cable compatible with Erbe/Storz/Wolf 5 m
- 80-330-04 2x Volkmann Wundhaken, scharf, 4-zinkig, Ringgriff, 23 cm  
2x Volkmann retractor, sharp, 4 prongs, ring handle, 23 cm
- 80-350-02 6x Halsted-Mosquito-Klemme, gebogen, anatomisch, 12,5 cm  
6x Halsted-Mosquito artery forceps, curved, anatomical, 12.5 cm
- 80-354-02 6x Halsted-Mosquito-Klemme, gebogen, anatomisch, 18,5 cm  
6x Halsted-Mosquito artery forceps, curved, anatomical, 18.5 cm
- 80-365-16 2x Pean Arterienklemme, gerade, anatomisch, fein, 16,5 cm  
2x Pean artery forceps, straight, anatomical, fine, 16.5 cm
- 80-370-16 4x Kocher Arterienklemme, gerade, chirurgisch, fein, 16 cm  
4x Kocher artery forceps, straight, 1:2 teeth, fine, 16 cm
- 80-383-22 2x Rochester-Pean Arterienklemme, gebogen, anatomisch, 22 cm  
2x Rochester-Pean artery forceps, curved, anatomical, 22 cm
- 80-394-13 2x Edna-Lorna Tuchklemme, gerade, stumpf, für Papier-Tücher, 13,5 cm  
2x Edna-Lorna towel clamp, straight, blunt, for paper towels, 13.5 cm
- 80-448-15 2x Cooper Schere, gebogen, spitz-stumpf, 14,5 cm  
2x Cooper scissors, curved, sharp-blunt, 14.5 cm
- 80-478-14 Laborde Trachealdilatator, 3-armig, 15 cm  
Laborde tracheal dilator, 3 prongs, 15 cm
- 80-482-19 Weerda Trachealspekulum, 19 cm  
Weerda tracheal speculum, 19 cm
- 80-501-02 Metallschale, B2, Ø 60 mm, Höhe 29 mm, 60 ml  
Metal bowl, B2, Ø 60 mm, height 29 mm, 60 ml
- 80-501-04 Metallschale, B6, Ø 110 mm, Höhe 55 mm, 400 ml  
Metal bowl, B6, Ø 110 mm, height 55 mm, 400 ml
- 80-525-25 2x Nierenschale, Edelstahl, 250 mm  
2x Kidney bowl, stainless steel, 250 mm

#### Ergänzung

#### Supplement

- 80-631-14 Norm-Sterilisations-Container Boden geschlossen, 297x274x138 mm Maße mit Deckel: 585x278x155 mm  
Norm sterilization container, bottom closed, 297x274x138 mm, dimensions with fitted lid: 299x278x155mm
- 80-632-00 Ventildeckel silber, für Container 80-631-14, 299x278 mm  
Valve lid, silver, for container 80-631-xx, 299x278 mm
- 80-671-20 Edelstahl-Siebkorb, Geflecht, Fallgriffe, 255 x 245 x 50 mm  
Stainless steel wire basket, sliding handles, 255 x 245 x 50 mm
- 80-681-07 Aluminium-Kennzeichnungs-Schild, blau, 20 Zeichen, 56 x 17 mm  
Aluminium tag, blau, 20 letter, 56 x 17 mm

Supplement for sales in EU (outside the EU only on request)

**Bestehend aus / Consisting of:**

- 06-0741 AV 2x Overholt-Geissendoerfer Ligaturklemme, gebogen, 19,5 cm  
2x Overholt-Geissendoerfer ligature forceps, curved, 19.5 cm
- 10-356-00 Wullstein Raspatorium, 4 mm breit, 16,5 cm  
Wullstein raspatory, 4 mm wide, 16.5 cm
- 10-360-03 Skalpellgriff, Nr. 3, 12,5 cm / Scalpell handle, no. 3, 12.5 cm
- 10-360-04 Skalpellgriff, Nr. 4, 13,5 cm / Scalpell handle, no. 4, 13.5 cm
- 10-438-17 Fisch Wundsperrer, mit Gelenken, 3:3 Zähne, halbscharf, zerlegbar, 16,5 cm / Fisch retractor, with joints, 3:3 prongs, semi-sharp, dismountable, 16.5 cm
- 10-446-11 Preyer Wundsperrer, schmales Blatt, beidseits mit Noppen, Griff vergoldet, zerlegbar, 11 cm / Preyer retractor, slim blade, studded on both sides, gold plated grip, dismountable, 11 cm
- 10-481-14 2x Pinzette, chirurgisch, anatomisch, gerade, 2 mm, 14,5 cm  
2x Dressing forceps, anatomical, straight, 2 mm, 14.5 cm
- 10-484-14 2x Pinzette, chirurgisch, 1:2 Zähne, gerade, 1,7 mm, 14,5 cm  
2x Dressing forceps, 1:2 teeth, straight, 1.7 mm, 14.5 cm
- 10-487-16 2x DeBakey Pinzette, atraumatisch, gerade, 1,5 mm, 15,5 cm  
2x DeBakey dressing forceps, atraumatic, straight, 1.5 mm, 15.5 cm
- 20-150-55 Killian-Struycken Septumspekulum, 55 mm, 14 cm  
Killian-Struycken septum speculum, 55 mm, 14 cm
- 20-153-75 Cottle Septumspekulum, extra dünne Blätter, schwarz, mit Stellschraube, 75 mm, 13 cm / Cottle septum speculum, extra thin blades, black, with screw, 75 mm, 13 cm
- 20-305-18 Freer Doppellevatorium, scharf/stumpf, 18,5 cm  
Freer elevator, double ended, sharp/blunt, 18.5 cm
- 20-614-18 Metzenbaum Schere, gebogen, stumpf-stumpf, fein, 18 cm  
Metzenbaum scissors, curved, blunt, fine, 18 cm
- 20-615-15 Metzenbaum Schere, Hartmetall, gebogen, stumpf-stumpf, fein, 14,5 cm  
Metzenbaum scissors, tungsten carbide, curved, blunt, fine, 14.5 cm
- 20-730-16 2x Jansen Nasenpinzette, anatomisch, bajonett, 2,0 mm, 16 cm  
2x Jansen dressing forceps, anatomical, bayonet, 2.0 mm, 16 cm
- 20-740-15 Crile-Wood Nadelhalter, Hartmetall, 15 cm  
Crile-Wood needle holder, tungsten carbide, 15 cm
- 30-080-10 Frazier Saugrohr, mit Griffplatte und Unterbrecher, 10 CH, 9 cm  
Frazier suction tube, with suction control, 10 FR, 9 cm
- 30-080-12 Frazier Saugrohr, mit Griffplatte und Unterbrecher, 12 CH, 9 cm  
Frazier suction tube, with suction control, 12 FR, 9 cm
- 40-405-20 2x Tonsillen-Pinzette, 1:2 Zähne, fein, 2 mm, 20,5 cm  
2x Tonsil dissecting forceps, 1:2 teeth, fine, 2 mm, 20.5 cm
- 40-450-19 2x Schnidt Tonsillenklemme, einseitig offener Ring, schlank, leicht gebogen, 19 cm / 2x Schnidt tonsil forceps, one ring open, slender, slightly curved, 19 cm
- 40-465-18 Crile-Wood Nadelhalter, schlank, Hartmetall, 18 cm  
Crile-Wood needle holder, slender, tungsten carbide, 18 cm
- 80-107-19 Bipolare Pinzette, NON-STICK, gerade, Spitze gewinkelt, Spitze 8mm lang, 2,0 mm breit, Führungsstift, 19,5 cm  
Bipolar forceps, NON-STICK, straight, angled tip, tip length 8 mm, 2.0 mm wide, guide pin, 19.5 cm
- 80-309-51 2x Langenbeck Wundhaken, Ringgriff, 51x11 mm, 21 cm  
2x Langenbeck retractor, ring handle, 51x11 mm, 21 cm
- 80-317-00 2x Baby-Roux Haken, doppelendig, 16x16 und 21x19 mm, 13,5 cm  
2x Baby-Roux retractor, double ended, 16x16 and 21x19 mm, 13.5 cm
- 80-318-50 Bipolares Anschlusskabel passend für Erbe/Storz/Wolf 5 m  
Bipolar connecting cable compatible with Erbe/Storz/Wolf 5 m
- 80-330-03 2x Volkmann Wundhaken, scharf, 3-zinkig, Ringgriff, 23 cm  
2x Volkmann retractor, sharp, 3 prongs, ring handle, 23 cm
- 80-340-01 2x Trachealhäkchen, scharf, 1-zinkig, glatter Griff, 17 cm  
2x Trachea hook, sharp, 1 prong, flat handle, 17 cm
- 80-350-01 8x Halsted-Mosquito-Klemme, gerade, anatomisch, 12,5 cm  
8x Halsted-Mosquito artery forceps, straight, anatomical, 12.5 cm
- 80-350-02 8x Halsted-Mosquito-Klemme, gebogen, anatomisch, 12,5 cm  
8x Halsted-Mosquito artery forceps, curved, anatomical, 12.5 cm
- 80-360-14 2x Präparierklemme, leicht gebogen, anatomisch, ohne Sperre, 14,5 cm  
2x Artery Forceps, slightly curved, anatomical, without, ratchet, 14.5 cm
- 80-365-14 4x Pean Arterienklemme, gerade, anatomisch, fein, 14 cm  
4x Pean artery forceps, straight, anatomical, fine, 14 cm
- 80-370-14 4x Kocher Arterienklemme, gerade, chirurgisch, fein, 14 cm  
4x Kocher artery forceps, straight, 1:2 teeth, fine, 14 cm
- 80-442-15 Cooper Schere, gerade, spitz-stumpf, 14,5 cm  
Cooper scissors, straight, sharp-blunt, 14.5 cm
- 80-478-14 Laborde Trachealdilatator, 3-armig, 15 cm  
Laborde tracheal dilator, 3 prongs, 15 cm
- 80-482-19 Weerda Trachealspekulum, 19 cm  
Weerda tracheal speculum, 19 cm
- 80-501-03 Metallschale, B4, Ø 85 mm, Höhe 40 mm, 160 ml  
Metal bowl, B4, Ø 85 mm, height 40 mm, 160 ml
- 80-501-04 Metallschale, B6, Ø 110 mm, Höhe 55 mm, 400 ml  
Metal bowl, B6, Ø 110 mm, height 55 mm, 400 ml
- 80-525-25 Nierenschale, Edelstahl, 250 mm  
Kidney bowl, stainless steel, 250 mm

**Ergänzung****Supplement**

- 80-631-14 Norm-Sterilisations-Container Boden geschlossen, 297x274x138 mm Maße mit Deckel: 585x278x155 mm  
Norm sterilization container, bottom closed, 297x274x138 mm, dimensions with fitted lid: 299x278x155mm
- 80-632-00 Ventildeckel silber, für Container 80-631-14, 299x278 mm  
Valve lid, silver, for container 80-631-xx, 299x278 mm
- 80-671-20 Edelstahl-Siebkorb, Geflecht, Fallgriffe, 255 x 245 x 50 mm  
Stainless steel wire basket, sliding handles, 255 x 245 x 50 mm
- 80-681-07 Aluminium-Kennzeichnungs-Schild, blau, 20 Zeichen, 56 x 17 mm  
Aluminium tag, blau, 20 letter, 56 x 17 mm

Supplement for sales in EU (outside the EU only on request)





### Neck dissection basic set

#### Bestehend aus / Consisting of:

- 10-534-12 Schere, supercut, gebogen, spitz-spitz, 11,5 cm  
Scissors, supercut, curved, pointed, 11.5 cm
- 10-352-14 Cottle Raspatorium, gebogen, 14 mm, 19,5 cm  
Cottle raspatory, curved, 14 mm, 19.5 cm
- 10-360-03 Skalpellgriff, Nr. 3, 12,5 cm / Scalpell handle, no. 3, 12.5 cm
- 10-360-07 Skalpellgriff, Nr. 7, 16 cm / Scalpell handle, no. 7, 16 cm
- 10-435-15 Mollison Wundsperrer, 4:4 Zähne, scharf, zerlegbar, 15,5 cm  
Mollison retractor, 4:4 prongs, sharp, dismountable, 15.5 cm
- 10-438-17 Fisch Wundsperrer, mit Gelenken, 3:3 Zähne, halbscharf, zerlegbar, 16,5 cm / Fisch retractor, with joints, 3:3 prongs, semi-sharp, dismountable, 16.5 cm
- 10-481-14 Pinzette, chirurgisch, anatomisch, gerade, 2 mm, 14,5 cm  
Dressing forceps, anatomical, straight, 2 mm, 14.5 cm
- 10-482-14 Pinzette, chirurgisch, anatomisch, gerade, 1,7 mm, 14,5 cm  
Dressing forceps, anatomical, straight, 1.7 mm, 14.5 cm
- 10-484-14 2x Pinzette, chirurgisch, 1:2 Zähne, gerade, 1,7 mm, 14,5 cm  
2x Dressing forceps, 1:2 teeth, straight, 1.7 mm, 14.5 cm
- 10-485-14 2x Pinzette, chirurgisch, 1:2 Zähne, gerade, 1,4 mm, 14,5 cm  
2x Dressing forceps, 1:2 teeth, straight, 1.4 mm, 14.5 cm
- 10-486-14 DeBaKey Pinzette, atraumatisch, gerade, 2,0 mm, 15 cm  
DeBaKey dressing forceps, atraumatic, straight, 2.0 mm, 15 cm
- 10-496-12 Adson Pinzette, Hartmetall, anatomisch, 12,5 cm  
Adson dressing forceps, tungsten carbide, anatomical, 12.5 cm
- 20-150-75 Killian-Struycken Septumspekulum, 75 mm, 14 cm  
Killian-Struycken septum speculum, 75 mm, 14 cm
- 20-252-03 Hartmann Conchotom, Größe 3, rund, 9 mm, 12 cm  
Hartmann cutting forceps, size 3, round, 9 mm, 12 cm
- 20-306-20 Freer Doppellevatorium, scharf/stumpf, 20 cm  
Freer double ended elevator, sharp/blunt, 20 cm
- 20-309-20 Killian Raspatorium, doppelseitig, scharf/stumpf, 23,5 cm  
Killian raspatory, double ended, sharp/blunt, 23.5 cm
- 20-582-10 2x Joseph Doppel-Häkchen, 2-zinkig, scharf, 10 mm, 16 cm  
2x Joseph double hook, 2 prongs, sharp, 10 mm, 16 cm
- 20-601-14 2x Joseph Schere, gebogen, spitz-spitz, 14,5 cm  
2x Joseph scissors, curved, pointed, 14.5 cm
- 20-610-15 Reynolds Schere, stumpf-stumpf, gebogen, verjüngte Spitzen, 16 cm / Reynolds scissors, blunt, curved, tapered tips, 16 cm
- 20-615-15 2x Metzenbaum Schere, Hartmetall, gebogen, stumpf-stumpf, fein, 14,5 cm / 2x Metzenbaum scissors, tungsten carbide, curved, blunt, fine, 14.5 cm
- 20-615-18 2x Metzenbaum Schere, Hartmetall, gebogen, stumpf-stumpf, fein, 18 cm / 2x Metzenbaum scissors, tungsten carbide, curved, blunt, fine, 18 cm
- 20-624-11 Stevens Gefäßschere, verjüngte Spitzen, gebogen, 11,5 cm  
Stevens vascular scissors, small tips, blunt, curved, 11.5 cm
- 20-710-12 Adson-Brown Pinzette, 7:8 Zähne, 12,5 cm  
Adson-Brown forceps, 7:8 teeth, 12.5 cm
- 20-712-12 Adson Pinzette, chirurgisch, 1:2 Zähne, 12 cm  
Adson dressing forceps, 1:2 teeth, 12 cm
- 20-730-16 2x Jansen Nasenpinzette / 2x Jansen nasal forceps
- 20-740-15 Crile-Wood Nadelhalter, Hartmetall, 15 cm  
Crile-Wood needle holder, tungsten carbide, 15 cm
- 20-744-17 Senning Nadelhalter, Hartmetall, extra schlank, 17 cm  
Senning needle holder, tungsten carbide, slender shape, 17 cm
- 25-589-01 2x Einzinker, groß / 2x Hook, one prong, large
- 30-080-09 Frazier Saugrohr, mit Griffplatte und Unterbrecher, 9 CH, 9 cm  
Frazier suction tube, with suction control, 9 FR, 9 cm
- 30-080-12 Frazier Saugrohr, mit Griffplatte und Unterbrecher, 12 CH, 9 cm  
Frazier suction tube, with suction control, 12 FR, 9 cm
- 30-080-15 Frazier Saugrohr, mit Griffplatte und Unterbrecher, 15 CH, 9 cm  
Frazier suction tube, with suction control, 15 FR, 9 cm
- 40-381-12 Henke Raspatorium/Dissektor, schmal, 12 mm, 23,5 cm  
Henke raspatory/dissector, small, 12 mm, 23.5 cm
- 40-400-20 Tonsillen-Pinzette, gerieft, fein, 2,2 mm, 20 cm  
Tonsil dressing forceps, serrated, small, 2.2 mm, 20 cm
- 40-405-20 Tonsillen-Pinzette, 1:2 Zähne, fein, 2 mm, 20,5 cm  
Tonsil dissecting forceps, 1:2 teeth, fine, 2 mm, 20.5 cm
- 40-420-29 Yankauer Saugrohr, für Erwachsene, 6 mm, abschraubbarer Ansatz, Öffnung 3 mm, 28,5 cm / Yankauer Suction tube, for adults, 6 mm, detachable tip, opening 3 mm, 28.5 cm
- 40-441-18 Toennis-Adson Tonsillenschere, supercut, gebogen, stumpf, extra fein, 17,5 cm / Toennis-Adson tonsil scissors, supercut, curved, blunt, very fine, 17.5 cm
- 40-450-19 6x Schnidt Tonsillenklemme, einseitig offener Ring, schlank, leicht gebogen, 19 cm / 6x Schnidt tonsil forceps, one ring open, slender, slightly curved, 19 cm
- 40-455-20 2x Birkett Tonsillenklemme, schlank, gebogen, 20 cm  
2x Birkett tonsil forceps, slender, curved, 20 cm
- 40-457-19 2x Negus Tonsillenklemme, schlank, stark gebogen, 20 cm  
2x Negus tonsil forceps, slender, wide curve, 20 cm
- 40-462-18 2x Mikulicz Tonsillenklemme, gebogen, 1:2 Zähne, 18,5 cm  
2x Mikulicz tonsil forceps, curved, 1:2 teeth, 18.5 cm
- 40-465-18 Crile-Wood Nadelhalter, schlank, Hartmetall, 18 cm  
Crile-Wood needle holder, slender, tungsten carbide, 18 cm
- 40-474-20 Gross Kornzange, gebogen, 20 cm  
Gross sponge forceps, curved, 20 cm
- 40-500-19 Brünings Zungenspatel, gefenstert, 19 cm  
Brünings tongue depressor, fenestrated, 19 cm
- 80-112-19 Bipolare Pinzette, NON-STICK, bajonett, Spitze 8 mm lang, 2,0 mm breit, Führungsstift, 19,5 cm  
Bipolar forceps, NON-STICK, bayonet, tip length 8 mm, 2.0 mm wide, guide pin, 19.5 cm
- 80-308-07 2x Kocher-Langenbeck Wundhaken, Ringgriff, 35x7 mm, 21 cm  
2x Kocher-Langenbeck retractor, ring handle, 35x7 mm, 21 cm
- 80-308-15 2x Kocher-Langenbeck Wundhaken, Ringgriff, 35x15 mm, 22 cm  
2x Kocher-Langenbeck retractor, ring handle, 35x15 mm, 22 cm
- 80-308-20 2x Kocher-Langenbeck Wundhaken, Ringgriff, 61x20 mm, 23 cm  
2x Kocher-Langenbeck retractor, ring handle, 61x20 mm, 23 cm
- 80-312-21 2x Schönborn Schilddrüsenhaken, 6,5x13 mm, 20,5 cm  
2x Schönborn retractor, 6.5x13 mm, 20.5 cm
- 80-318-50 Bipolares Anschlusskabel passend für Erbe/Storz/Wolf 5 m  
Bipolar connecting cable compatible with Erbe/Storz/Wolf 5 m
- 80-332-04 2x Volkmann Wundhaken, stumpf, 4-zinkig, Ringgriff, 23 cm  
2x Volkmann retractor, blunt, 4 prongs, ring handle, 23 cm
- 80-330-04 2x Volkmann Wundhaken, scharf, 4-zinkig, Ringgriff, 23 cm  
2x Volkmann retractor, sharp, 4 prongs, ring handle, 23 cm
- 80-330-06 2x Volkmann Wundhaken, scharf, 6-zinkig, Ringgriff, 23 cm  
2x Volkmann retractor, sharp, 6 prongs, ring handle, 23 cm
- 80-350-01 10x Halsted-Mosquito-Klemme, gerade, anatomisch, 12,5 cm  
10x Halsted-Mosquito artery forceps, straight, anatomical, 12.5 cm
- 80-350-02 10x Halsted-Mosquito-Klemme, gebogen, anatomisch, 12,5 cm  
10x Halsted-Mosquito artery forceps, curved, anatomical, 12.5 cm
- 80-366-14 10x Pean Arterienklemme, gebogen, anatomisch, fein, 14 cm  
10x Pean artery forceps, curved, anatomical, fine, 14 cm

- 80-366-16 6x Pean Arterienklemme, gebogen, anatomisch, fein, 16,5 cm  
6x Pean artery forceps, curved, anatomical, fine, 16.5 cm
- 80-374-14 6x Crile Arterienklemme, gebogen, anatomisch, 14,5 cm  
6x Crile artery forceps, curved, anatomical, 14.5 cm
- 80-370-14 6x Kocher Arterienklemme, gerade, chirurgisch, fein, 14 cm  
6x Kocher artery forceps, straight, 1:2 teeth, fine, 14 cm
- 80-357-12 3x Präparierklemme, leicht gebogen, anatomisch, ohne Sperre, 12,5 cm / 3x Artery Forceps, slightly curved, anatomical, without, ratchet, 12.5 cm
- 80-392-09 12x Backhaus Tuchklemme, gebogen, scharf, 9 cm  
12x Backhaus towel clamp, curved, sharp, 9 cm
- 80-400-15 2x Allis Gewebefasszange, gerade, 4:5 Zähne, 15,5 cm  
2x Allis tissue holding forceps, straight, 4:5 teeth, 15.5 cm
- 80-403-15 2x Braun Hakenzange, gerade, 4:4 Zähne, scharf, 15,5 cm  
2x Braun hook forceps, straight, 4:4 teeth, sharp, 15.5 cm
- 80-440-15 Cooper Schere, gerade, spitz-spitz, 14,5 cm  
Cooper scissors, straight, sharp-sharp, 14.5 cm
- 80-448-15 Cooper Schere, gebogen, spitz-stumpf, 14,5 cm  
Cooper scissors, curved, sharp-blunt, 14.5 cm
- 80-468-21 Killian Laryngofissur-Schere, gewinkelt, gezahnt, 20 cm  
Killian laryngectomy scissors, angled, serrated, 20 cm
- 80-470-16 Kocher Führungs-sonde, mit Öffnung, 12,5 mm, 16,5 cm  
Kocher director, with opening, 12.5 mm, 16.5 cm
- 80-471-15 Hohlsonde, gerade, 14,5 cm  
Hollow probe, straight, 14.5 cm
- 80-501-03 Metallschale, B4, Ø 85 mm, Höhe 40 mm, 160 ml  
Metal bowl, B4, Ø 85 mm, height 40 mm, 160 ml
- 80-504-05 Medizinbecher, graduiert, 50 ml  
Medical cup, graduated, 50 ml
- 80-528-18 Kornzangen-Behälter, Edelstahl, Ø 50 mm, Höhe 180 mm  
Forceps holder, stainless steel, Ø 50 mm, height 180 mm

## Ergänzung

### Supplement

- 10-360-11 Skalpell-Klingen, Nr. 11, einzeln steril verpackt, 100 Stück  
Scalpel blades, no. 11, single sterile packed, 100 pieces
- 10-360-15 Skalpell-Klingen, Nr. 15, einzeln steril verpackt, 100 Stück  
Scalpel blades, no. 15, single sterile packed, 100 pieces
- 80-661-14 Norm-Sterilisations-Container Boden geschlossen, 585x274x138 mm  
Maße mit Deckel: 585x278x155 mm / Norm sterilization container  
bottom closed, 585x274x138 mm, dimensions with fitted  
lid: 585x278x155mm
- 80-662-00 Ventildeckel silber, für Container 80-661-14 585x278 mm  
Valve lid silver, for container 80-661-xx, 585x278 mm
- 80-671-60 Edelstahl-Siebkorb Geflecht, Fallgriffe 485x255x70 mm  
Stainless steel wire basket, sliding handles 485x255x70 mm
- 80-681-06 Aluminium-Kennzeichnungs-Schild lila, 20 Zeichen 56x17 mm  
Aluminium tag purple, 20 letters, 56x17 mm

[Supplement for sales in EU \(outside the EU only on request\)](#)



## 08 Weichteilchirurgie-Set II

### Neck dissection set II

#### Bestehend aus / Consisting of:

- 06-0741 AV 2x Overholt-Geissendoerfer Ligaturklemme, gebogen, 19,5 cm  
2x Overholt-Geissendoerfer ligature forceps, curved, 19.5 cm
- 10-352-08 Cottle Raspatorium, gebogen, 8 mm, 20 cm  
Cottle raspatory, curved, 8 mm, 20 cm
- 10-360-03 Skalpellgriff, Nr. 3, 12,5 cm / Scalpell handle, no. 3, 12.5 cm
- 10-360-04 Skalpellgriff, Nr. 4, 13,5 cm / Scalpell handle, no. 4, 13.5 cm
- 10-438-17 Fisch Wundsperrer, mit Gelenken, 3:3 Zähne, halbscharf, zerlegbar, 16,5 cm / Fisch retractor, with joints, 3:3 prongs, semi-sharp, dismountable, 16.5 cm
- 10-481-14 2x Pinzette, chirurgisch, anatomisch, gerade, 2 mm, 14,5 cm  
2x Dressing forceps, anatomical, straight, 2 mm, 14.5 cm
- 10-484-14 2x Pinzette, chirurgisch, 1:2 Zähne, gerade, 1,7 mm, 14,5 cm  
2x Dressing forceps, 1:2 teeth, straight, 1.7 mm, 14.5 cm
- 10-487-16 DeBakey Pinzette, atraumatisch, gerade, 1,5 mm, 15,5 cm  
DeBakey dressing forceps, atraumatic, straight, 1.5 mm, 15.5 cm
- 10-496-12 2x Adson Pinzette, Hartmetall, anatomisch, 12,5 cm  
2x Adson dressing forceps, tungsten carbide, anatomical, 12.5 cm
- 10-555-13 Halsey Nadelhalter, Hartmetall, fein, 13 cm  
Halsey needle holder, tungsten carbide, delicate, 13 cm
- 20-150-75 Killian-Struycken Septumspekulum, 75 mm, 14 cm  
Killian-Struycken septum speculum, 75 mm, 14 cm
- 20-252-02 Hartmann Conchotom, Größe 2, rund, 8 mm, 12 cm  
Hartmann cutting forceps, size 2, round, 8 mm, 12 cm
- 20-305-18 Freer Doppellevatorium, scharf/stumpf, 18,5 cm  
Freer double ended elevator, sharp/blunt, 18.5 cm
- 20-311-20 Freer-Joseph Doppel-Raspatorium, 20 cm  
Freer-Joseph raspatory double-ended, 20 cm
- 20-605-14 2x Joseph Schere, supercut, gebogen, spitz-spitz, 14,5 cm  
2x Joseph scissors, supercut, curved, pointed, 14.5 cm
- 20-610-15 Reynolds Schere, stumpf-stumpf, gebogen, verjüngte Spitzen, 16 cm / Reynolds scissors, blunt, curved, tapered tips, 16 cm
- 20-614-18 2x Metzenbaum Schere, gebogen, stumpf-stumpf, fein, 18 cm  
2x Metzenbaum scissors, curved, blunt, fine, 18 cm
- 20-615-15 2x Metzenbaum Schere, Hartmetall, gebogen, stumpf-stumpf, fein, 14,5 cm / 2x Metzenbaum scissors, tungsten carbide, curved, blunt, fine, 14.5 cm
- 20-625-11 2x Stevens Gefäßschere, verjüngte Spitzen, supercut, gebogen, 11,5 cm / 2x Stevens vascular scissors, tapered tips, supercut, curved, 11.5 cm
- 20-713-12 2x Adson-Brown Pinzette, Hartmetall, 7:8 Zähne, 12,5 cm  
2x Adson-Brown forceps, tungsten carbide, 7:8 teeth, 12.5 cm
- 20-730-16 2x Jansen Nasenpinzette, anatomisch, bajonett, 2,0 mm, 16 cm  
2x Jansen nasal forceps, anatomical, bayonet, 2.0 mm, 16 cm
- 20-740-15 Crile-Wood Nadelhalter, Hartmetall, 15 cm  
Crile-Wood needle holder, tungsten carbide, 15 cm
- 30-080-10 Frazier Saugrohr, mit Griffplatte und Unterbrecher, 10 CH, 9 cm  
Frazier suction tube, with suction control, 10 FR, 9 cm
- 30-080-12 Frazier Saugrohr, mit Griffplatte und Unterbrecher, 12 CH, 9 cm  
Frazier suction tube, with suction control, 12 FR, 9 cm
- 30-080-15 Frazier Saugrohr, mit Griffplatte und Unterbrecher, 15 CH, 9 cm  
Frazier suction tube, with suction control, 15 FR, 9 cm
- 40-365-01 Hurd Unterbindungsnadel, rechts, 22 cm  
Hurd tonsil suture needle, right, 22 cm
- 40-390-21 Blohmke Fasszange, gebogen, 20 cm  
Blohmke tonsil forceps, curved, 20 cm
- 40-402-20 2x Tonsillen-Pinzette, 1:2 Zähne, fein, 2 mm, 20 cm  
2x Tonsil dissecting forceps, 1:2 teeth, fine, 2 mm, 20 cm
- 40-405-20 2x Tonsillen-Pinzette, 1:2 Zähne, fein, 2 mm, 20,5 cm  
2x Tonsil dissecting forceps, 1:2 teeth, fine, 2 mm, 20.5 cm
- 40-420-29 Yankauer Saugrohr, für Erwachsene, 6 mm, abschraubbarer Ansatz, Öffnung 3 mm, 28,5 cm / Yankauer Suction tube, for adults, 6 mm, detachable tip, opening 3 mm, 28.5 cm
- 40-450-19 2x Schnid Tonsillenklemme, einseitig offener Ring, schlank, leicht gebogen, 19 cm / 2x Schnid tonsil forceps, one ring open, slender, slightly curved, 19 cm
- 40-457-19 2x Negus Tonsillenklemme, schlank, stark gebogen, 20 cm  
2x Negus tonsil forceps, slender, wide curve, 20 cm
- 40-465-18 Crile-Wood Nadelhalter, schlank, Hartmetall, 18 cm  
Crile-Wood needle holder, slender, tungsten carbide, 18 cm
- 40-474-20 Gross Kornzange, gebogen, 20 cm  
Gross sponge forceps, curved, 20 cm
- 80-053-01 Monopolare Messerelektrode, seitliche Spitze m. Schaft 4 mm, schwarz, 5 Stück/Box / Monopolar knife electrode, cutting edge sideways w. 4mm shaft, black, 5 pieces/box
- 80-112-19 Bipolare Pinzette, NON-STICK, bajonett, Spitze 8 mm lang, 2,0 mm breit, Führungsstift, 19,5 cm  
Bipolar forceps, NON-STICK, bayonet, tip length 8 mm, 2.0 mm wide, guide pin, 19.5 cm
- 80-309-51 2x Langenbeck Wundhaken, Ringgriff, 51x11 mm, 21 cm  
2x Langenbeck retractor, ring handle, 51x11 mm, 21 cm
- 80-312-21 Schönborn Schilddrüsenhaken, 6,5 x 13 mm, 20,5 cm  
Schönborn retractor, 6.5 x 13 mm, 20.5 cm
- 80-317-00 2x Baby-Roux Haken, doppelendig, 16x16 und 21x19 mm, 13,5 cm  
2x Baby-Roux retractor, double ended, 16x16 and 21x19 mm, 13.5 cm
- 80-318-50 Bipolares Anschlusskabel passend für Erbe/Storz/Wolf 5 m  
Bipolar connecting cable compatible with Erbe/Storz/Wolf 5 m
- 80-330-02 2x Volkmann Wundhaken, scharf, 2-zinkig, Ringgriff, 23 cm  
2x Volkmann retractor, sharp, 2 prongs, ring handle, 23 cm
- 80-330-03 2x Volkmann Wundhaken, scharf, 3-zinkig, Ringgriff, 23 cm  
2x Volkmann retractor, sharp, 3 prongs, ring handle, 23 cm
- 80-330-04 2x Volkmann Wundhaken, scharf, 4-zinkig, Ringgriff, 23 cm  
2x Volkmann retractor, sharp, 4 prongs, ring handle, 23 cm
- 80-330-06 2x Volkmann Wundhaken, scharf, 6-zinkig, Ringgriff, 23 cm  
2x Volkmann retractor, sharp, 6 prongs, ring handle, 23 cm
- 80-340-01 Trachealhäkchen, scharf, 1-zinkig, glatter Griff, 17 cm  
Trachea hook, sharp, 1 prong, flat handle, 17 cm
- 80-340-02 Trachealhäkchen, scharf, 2-zinkig, glatter Griff, 17 cm  
Trachea hook, sharp, 2 prong, flat handle, 17 cm
- 80-350-01 10x Halsted-Mosquito-Klemme, gerade, anatomisch, 12,5 cm  
10x Halsted-Mosquito artery forceps, straight, anatomical, 12.5 cm
- 80-350-02 10x Halsted-Mosquito-Klemme, gebogen, anatomisch, 12,5 cm  
10x Halsted-Mosquito artery forceps, curved, anatomical, 12.5 cm
- 80-360-14 2x Präparierklemme, leicht gebogen, anatomisch, ohne Sperre, 14,5 cm / 2x Artery Forceps, slightly curved, anatomical, without ratchet, 14.5 cm
- 80-365-14 10x Pean Arterienklemme, gerade, anatomisch, fein, 14 cm  
10x Pean artery forceps, straight, anatomical, fine, 14 cm
- 80-366-16 2x Pean Arterienklemme, gebogen, anatomisch, fein, 16,5 cm  
2x Pean artery forceps, curved, anatomical, fine, 16.5 cm
- 80-370-14 4x Kocher Arterienklemme, gerade, chirurgisch, fein, 14 cm  
4x Kocher artery forceps, straight, 1:2 teeth, fine, 14 cm
- 80-392-11 10x Backhaus Tuchklemme, gebogen, scharf, 11 cm  
10x Backhaus towel clamp, curved, sharp, 11 cm
- 80-401-14 2x Baby-Allis Gewebefasszange, gerade, 4:5 Zähne, 14,5 cm  
2x Baby-Allis tissue holding forceps, straight, 4:5 teeth, 14.5 cm
- 80-403-15 2x Braun Hakenzange, gerade, 4:4 Zähne, scharf, 15,5 cm  
2x Braun hook forceps, straight, 4:4 teeth, sharp, 15.5 cm
- 80-406-01 Elektroden-Handgriff, mit 2 Schaltern, schneiden & koagulieren, 4 mm Ansatz, für abnehmbare Anschlusskabel  
Electrode handle, with 2 switches, cutting and coagulating, 4 mm plug, for removable connecting cable



- 80-408-40 Monopolares Anschlusskabel, für SPIGGLE & THEIS Elektrodenhandgriffe, passend für Erbe ICC/ACC, Wolf/Storz, 4m, geräteseitig / Monopolar connecting cable, for SPIGGLE & THEIS electrode handles, compatible w. Erbe ICC/ACC,Wolf/Storz, 4m, unit-side
- 80-442-15 Cooper Schere, gerade, spitz-stumpf, 14,5 cm  
Cooper scissors, straight, sharp-blunt, 14.5 cm
- 80-468-21 Killian Laryngofissur-Schere, gewinkelt, gezahnt, 20 cm  
Killian laryngectomy scissors, angled, serrated, 20 cm
- 80-470-16 Kocher Führungssonde, mit Öffnung, 12,5 mm, 16,5 cm  
Kocher director, with opening, 12.5 mm, 16.5 cm
- 80-472-35 Redon Führungsnadel, Lanzettspitze, leicht gebogen, 3,5 mm, 18,5 cm / Redon guide needle, lancet tip, slight curve, 3.5 mm, 18.5 cm
- 80-472-40 Redon Führungsnadel, Lanzettspitze, leicht gebogen, 4 mm, 18,5 cm / Redon guide needle, lancet tip, slight curve, 4 mm, 18.5 cm
- 80-501-02 Metallschale, B2, Ø 60 mm, Höhe 29 mm, 60 ml  
Metal bowl, B2, Ø 60 mm, height 29 mm, 60 ml
- 80-501-03 Metallschale, B4, Ø 85 mm, Höhe 40 mm, 160 ml  
Metal bowl, B4, Ø 85 mm, height 40 mm, 160 ml
- 80-501-04 Metallschale, B6, Ø 110 mm, Höhe 55 mm, 400 ml  
Metal bowl, B6, Ø 110 mm, height 55 mm, 400 ml
- 80-525-25 Nierenschale, Edelstahl, 250 mm  
Kidney bowl, stainless steel, 250 mm

## Ergänzung

### Supplement

- 80-661-14 Norm-Sterilisations-Container Boden geschlossen, 585x274x138 mm  
Maße mit Deckel: 585x278x155 mm / Norm sterilization container bottom closed, 585x274x138 mm, dimensions with fitted lid: 585x278x155mm
- 80-662-00 Ventildeckel silber, für Container 80-661-14 585x278 mm  
Valve lid silver, for container 80-661-xx, 585x278 mm
- 80-671-60 Edelstahl-Siebkorb Geflecht, Fallgriffe 485x255x70 mm  
Stainless steel wire basket, sliding handles 485x255x70 mm
- 80-681-05 Aluminium-Kennzeichnungs-Schild gelb, 20 Zeichen 56x17 mm  
Aluminium tag yellow, 20 letters, 56x17 mm

Supplement for sales in EU (outside the EU only on request)

## 09 Mikro-Gefäß-Instrumentarium-Set

### Micro vascular set

#### Bestehend aus / Consisting of:

- 10-487-16 DeBakey Pinzette, atraumatisch, gerade, 1,5 mm, 15,5 cm  
DeBakey dressing forceps, atraumatic, straight, 1.5 mm, 15.5 cm
- 10-490-16 DeBakey Pinzette, atraumatisch, gewinkelt, 2 mm, 15,5 cm  
DeBakey dressing forceps, atraumatic, angled, 2mm, 15.5 cm
- 10-498-15 Wullstein Pinzette, anatomisch, gerade, 1,0 mm, 15,5 cm  
Wullstein dressing forceps, anatomical, straight, 1.0 mm, 15.5 cm
- 10-499-15 Wullstein Pinzette, chirurgisch, 1:2 Zähne, gerade, 1,0 mm, 15,5 cm  
Wullstein dressing forceps, 1:2 teeth, straight, 1.0 mm, 15.5 cm
- 10-534-12 Schere, supercut, gebogen, spitz-spitz, 11,5 cm  
Scissors, supercut, curved, pointed, 11.5 cm
- 20-611-15 Reynolds Schere, supercut, gebogen, stumpf-stumpf, 16 cm  
Reynolds scissors, supercut, curved, blunt, 16 cm
- 20-695-11 Mikro-Gefäßschere, gerade, spitz-spitz, 11 cm  
Micro vascular scissors, straight, pointed, 11 cm
- 20-696-11 Mikro-Gefäßschere, gebogen, spitz-spitz, 11 cm  
Micro vascular scissors, curved, pointed, 11 cm
- 20-697-11 Mikro-Gefäßschere, gewinkelt, spitz-spitz, 10 cm  
Micro vascular scissors, angled, pointed, 10 cm
- 20-760-14 Castroviejo Mikro-Gefäß-Nadelhalter, mit Sperre, gerade, 14,5 cm / Castroviejo micro vascular needle holder, with ratchet, straight, 14.5 cm
- 20-761-14 Castroviejo Mikro-Gefäß-Nadelhalter, mit Sperre, gebogen, 14,5 cm / Castroviejo micro vascular needle holder, with ratchet, curved, 14.5 cm
- 80-123-16 Bipolare Pinzette, NON-STICK, kniegebogen, extra fein, Spitze 8mm lang, 0,2 mm breit, Führungsstift, 16,5 cm  
Bipolar forceps, NON-STICK, angled, extra fine, tip length 8 mm, 0.2 mm wide, guide pin, 16.5 cm
- 80-318-50 Bipolares Anschlusskabel passend für Erbe/Storz/Wolf 5 m  
Bipolar connecting cable compatible with Erbe/Storz/Wolf 5 m

## Ergänzung

### Supplement

- 80-631-14 Norm-Sterilisations-Container Boden geschlossen, 297x274x138 mm Maße mit Deckel: 585x278x155 mm  
Norm sterilization container, bottom closed, 297x274x138 mm, dimensions with fitted lid: 299x278x155mm
- 80-632-00 Ventildeckel silber, für Container 80-631-14, 299x278 mm  
Valve lid, silver, for container 80-631-xx, 299x278 mm
- 80-671-20 Edelstahl-Siebkorb, Geflecht, Fallgriffe, 255 x 245 x 50 mm  
Stainless steel wire basket, sliding handles, 255 x 245 x 50 mm
- 80-681-02 Aluminium-Kennzeichnungs-Schild, grün, 20 Zeichen, 56 x 17 mm  
Aluminium tag, green, 20 letter, 56 x 17 mm

Supplement for sales in EU (outside the EU only on request)



## 08 Tränenweg-Chirurgie-Set

### Lacrimal duct surgery set

#### Bestehend aus / Consisting of:

- 10-300-30 Saugrohr, kniegebogen, zylindrisch, 3 mm, 11 cm  
Suction tube, angled, cylindrical, 3 mm, 11 cm
- 10-300-40 Saugrohr, kniegebogen, zylindrisch, 4 mm, 11 cm  
Suction tube, angled, cylindrical, 4 mm, 11 cm
- 10-481-14 Pinzette, chirurgisch, anatomisch, gerade, 2 mm, 14,5 cm  
Dressing forceps, anatomical, straight, 2 mm, 14.5 cm
- 10-484-14 Pinzette, chirurgisch, 1:2 Zähne, gerade, 1,7 mm, 14,5 cm  
Dressing forceps, 1:2 teeth, straight, 1.7 mm, 14.5 cm
- 20-100-01 Hartmann Nasenspekulum, für Erwachsene, zerlegbar  
Hartmann nasal speculum, for adults, dismountable
- 20-150-55 Killian-Struycken Septumspekulum, 55 mm, 14 cm  
Killian-Struycken septum speculum, 55 mm, 14 cm
- 20-150-90 Killian-Struycken Septumspekulum, 90 mm, 14 cm  
Killian-Struycken septum speculum, 90 mm, 14 cm
- 20-151-75 Cottle Septumspekulum, mit Stellschraube, 75 mm, 13 cm  
Cottle septum speculum, with screw, 75 mm, 13 cm
- 20-215-02 Blakesley Nasenzange, gerade, Griff vergoldet, 4 mm, 11,5 cm  
Blakesley nasal forceps, straight, gold plated grip, 4 mm, 11.5 cm
- 20-225-02 Blakesley Nasenzange, 45° aufgebogen, Griff vergoldet, 4 mm, 11,5 cm / Blakesley nasal forceps, 45° curved upwards, gold plated grip, 4 mm, 11.5 cm
- 20-307-18 Weber Doppellevatorium, scharf/stumpf, 18,5 cm  
Weber elevator, double ended, sharp/blunt, 18.5 cm
- 20-680-16 Heymann Nasenschere, gezahnt, gerade, fein, 16 cm  
Heymann nasal scissors, serrated, straight, fine, 16 cm
- 20-690-01 Conchotomie Schere, gezahnt, gerade, Spülkanal, 13 cm  
Nasal concha scissors, serrated, straight, irrigation channel, 13 cm
- 20-730-16 Jansen Nasenpinzette / Jansen nasal forceps
- 20-740-15 Crile-Wood Nadelhalter, Hartmetall, 15 cm  
Crile-Wood needle holder, tungsten carbide, 15 cm
- 30-101-25 Eicken Spülröhrchen, lange Biegung, Ø 2,5 mm  
Eicken antrum cannula, long curve, Ø 2.5 mm
- 30-101-30 Eicken Spülröhrchen, lange Biegung, Ø 3 mm  
Eicken antrum cannula, long curve, Ø 3 mm
- 30-102-25 Eicken Spülröhrchen, kurze Biegung, Ø 2,5 mm  
Eicken antrum cannula, short curve, Ø 2.5 mm
- 30-102-30 Eicken Spülröhrchen, kurze Biegung, Ø 3 mm  
Eicken antrum cannula, short curve, Ø 3 mm
- 30-200-01 Sichelmesser, spitz, 19,5 cm / Sickle knife, pointed, 19.5 cm
- 30-304-25 Antrumstanze, rückwärts schneidend, drehbar, Spülkanal, 2,5 mm, 10 cm / Antrum punch, backw. cutting, rotatable, irrig. chan., 2.5 mm, 10 cm
- 30-320-01 Durchschneidende Nasenzange, gerade, 5,0x1,5 mm, 14 cm  
Throughcutting nasal forceps, straight, 5.0x1.5 mm, 14 cm
- 30-469-20 Kerrison Keilbeinstanze, 40° aufw., Schuh vergold., kpl. zerlegb., 2 mm, 18 cm / Kerrison sphenoid punch, 40° upw., golden tip, totally detachable, 2 mm, 18 cm
- 30-720-16 Draf Siebbeinzängchen, gerade, 7x2,4 mm, 16 cm  
Draf ethmoid forceps, straight, 7x2.4 mm, 16 cm
- 30-722-16 Draf Siebbeinzängchen, 60° aufgebogen, 6,5x2,4 mm, 16 cm  
Draf ethmoid forceps, 60° angled, 6.5x2.4 mm, 16 cm
- 40-600-12 Speichelgangschere, gewinkelt, mit Knopf, 11,5 cm  
Salivary duct scissors, angled, with ball end, 11.5 cm
- 40-606-06 Bangerter Tränenwegkanüle, stumpf, seitliche Öffnung, gerade, Luer-Lock, 0,6x60 mm / Bangerter lacrimal duct cannula, blunt, lateral opening, straight, Luer-lock, 0.6x60 mm
- 40-606-08 Bangerter Tränenwegkanüle, stumpf, seitliche Öffnung, gerade, Luer-Lock, 0,8x60 mm / Bangerter lacrimal duct cannula, blunt, lateral opening, straight, Luer-lock, 0.8x60 mm
- 40-610-12 Bowman Speichelgangsonde, Neusilber, Gr. 1/2, 1,0 u. 1,2 mm, gerade, zylindrisch, 13 cm / Bowman salivary duct probe, alpaca, size 1/2, 1.0 a. 1.2 mm, straight, cylindrical, 13 cm
- 40-609-40 Bowman Speichelgangsonde, Silber, Gr. 0000/000, 0,4 u. 0,6 mm, 12,5 cm / Bowman salivary duct probe, silver, size 0000/000, 0.4 and 0.6 mm, 12.5 cm
- 40-609-34 Bowman Speichelgangsonde, Silber, Gr. 3/4, 1,3 u. 1,4 mm, 12,5 cm / Bowman salivary duct probe, silver, size 3/4, 1.3 a. 1.4 mm, 12.5 cm
- 40-615-01 Wilder Dilator, Gr. 1 (Länge der Spitze 23 mm), Griff-Ø 3 mm, Gesamtlänge 11 cm / Wilder dilator, size 1, (tip length 23 mm), handle Ø 3 mm, total length 11 cm
- 40-615-02 Wilder Dilator, Gr. 2 (Länge der Spitze 18 mm), Griff-Ø 3 mm, Gesamtlänge 11 cm / Wilder dilator, size 2, (tip length 18 mm), handle Ø 3 mm, total length 11 cm
- 40-615-03 Wilder Dilator, Gr. 3 (Länge der Spitze 12 mm), Griff-Ø 3 mm, Gesamtlänge 11 cm / Wilder dilator, size 3, (tip length 12 mm), handle Ø 3 mm, total length 11 cm
- 40-617-00 Speichelgang-Sonden-Set, doppelseitig, biegsam, Nitinol, 6 Größen / Salivary duct probe set, double ended, bendable, nitinol, 6 sizes
- 80-106-19 Bipolare Pinzette, NON-STICK, gerade, Spitze gewinkelt, Spitze 8mm lang, 1 mm breit, Führungstift, 19,5 cm  
Bipolar forceps, NON-STICK, straight, angled tip, tip length 8 mm, 1 mm wide, guide pin, 19.5 cm
- 80-318-50 Bipolares Anschlusskabel passend für Erbe/Storz/Wolf 5 m  
Bipolar connecting cable compatible with Erbe/Storz/Wolf 5 m
- 80-392-09 6x Backhaus Tuchklemme, gebogen, scharf, 9 cm  
6x Backhaus towel clamp, curved, sharp, 9 cm
- 80-501-03 Metallschale, B4, Ø 85 mm, Höhe 40 mm, 160 ml  
Metal bowl, B4, Ø 85 mm, height 40 mm, 160 ml
- 80-504-05 Medizinbecher, graduert, 50 ml / Medical cup, graduated, 50 ml

#### Ergänzung

#### Supplement

- 80-631-14 Norm-Sterilisations-Container Boden geschlossen, 297x274x138 mm Maße mit Deckel: 585x278x155 mm  
Norm sterilization container, bottom closed, 297x274x138 mm, dimensions with fitted lid: 299x278x155mm
- 80-632-00 Ventildeckel silber, für Container 80-631-14, 299x278 mm  
Valve lid, silver, for container 80-631-xx, 299x278 mm
- 80-671-20 Edelstahl-Siebkorb, Geflecht, Fallgriffe, 255 x 245 x 50 mm  
Stainless steel wire basket, sliding handles, 255 x 245 x 50 mm
- 80-681-01 Aluminium-Kennzeichnungs-Schild, schwarz, 20 Zeichen, 56 x 17 mm  
Aluminium tag, black, 20 letter, 56 x 17 mm

Supplement for sales in EU (outside the EU only on request)



## Alphabetisches Inhaltsverzeichnis

Abraham Tosillmesser .....	29	Hartmann Zungenspatel .....	31	Pelteson Kehlkopfwatteträger .....	34
Allis Gewebe-Fasszange .....	56	Henke Raspatorium .....	20	Petrischale mit Deckel .....	61
Ansatzrohr .....	35	Henke Raspatorium/Dissektor .....	21	Porzellanschälchen .....	62
Antibesclagmittel .....	8	Herberhold Zungenspatel .....	16	Präparierklemme oh. Sperre .....	53
Baby-Adson Präparierklemme .....	54	High Grade flex. Nasopharyngoskop .....	5	Raspatorium Würzburger Modell .....	21
Baby-Allis Gewebe-Fasszange .....	56	Hofer Gaumenbogenhaken .....	12	Redon Führungsnadel .....	59
Baby-Roux Haken .....	51	Hohlsonde .....	59	Reichert Epiglottis Halter .....	34
Backhaus Tuchklemme .....	55	Huber Universal Handgriff .....	35	Ring Zungenspatel .....	16
Ballenger Fasszange .....	22	Hurd Elevatorium/Retraktor .....	21	Rochester-Pean Arterienklemme .....	54
Bangerter Tränenwegkanüle .....	36	Hurd Unterbindungsnadel .....	20	Roeder Ligatur-Instrument .....	19
Beckmann Ringmesser .....	10	Hurd Raspatorium/Retraktor .....	21	Roux Wundhaken .....	51
Bipolare Pinzette, NON-STICK .....	43 - 47	Indikator-Klebe-Etikett .....	63	Ruedemann Dilatator .....	37
Bipolare Präparierschere .....	42	Injektionskanüle .....	33	Russel-Davis Zungenspatel .....	15
Bipolare Saugpinzette .....	47	Jatho Nasenrachenzange .....	11	Saugrohr .....	24
Bipolares Anschlusskabel .....	41	Jennings Mundsperrer .....	17	Seemann-Seiffert Mundsperrer .....	18
Birkett Tonsillenklemme .....	27	Jurasz Nasenrachenzange .....	11	Seiffert Hechtmaulansatz .....	35
Blohmke Fasszange .....	22	Kabel für Neutral-Elektrode .....	39	Schmeden Conchotom .....	12
Boettcher Tonsillenschere .....	25	Kabierske Pulverbläser .....	12	Schmidt Tonsillenklemme .....	27
Bowman Speichelgangsonde .....	36	Kehlkopf-Kanüle .....	33	Schönborn Schilddrüsenhaken .....	50
Bozemann Nadelhalter .....	29	Kehlkopfspiegel .....	32 - 33	Senn-Miller Wundhaken .....	50
Braun Hakenzange .....	56	Kehlkopfszange .....	34, 35	Siebkorb .....	7, 48, 63
Brünings Löffelansatz .....	35	Kette für Mundsperrer .....	17	Silikonhalterung .....	48
Brünings Tonsillmesser .....	29	Kilian Kehlkopfwatteträger .....	34	Silikon-Schützer für Mundsperrer .....	13
Brünings Tonsillenschnürer .....	19	Kilian Laryngofissur-Schere .....	59	Silikonformschlauch für Mundsperrer .....	13
Brünings Zungenspatel .....	31	Klemme .....	29	Skalpell-Griff .....	30
Buchwald Zungenspatel .....	31	Knopfkanüle .....	38	Skalpell-Klingen .....	30
Kennzeichnungs-Schild .....	63	Knotenführer .....	20	Sluder-Ballenger Tonsillotom .....	18
Collin Zungenzange .....	57	Koagulations-Saugrohr .....	46	Speichelgang-Schere .....	36
Colver Fasszange .....	22	Kocher Arterienklemme .....	58	Speichelgang-Sonden-Set .....	37
Colver-Fischer Tonsillmesser .....	29	Kocher Führungssonde .....	59	St. Clair-Thomson Nasenrachenzange .....	11
Container-Siegel .....	63	Kocher-Langenbeck Wundhaken .....	49	Sternberg Lippenhaken .....	49
Cooper Schere .....	57	Kornzangenbehälter .....	62	Stubbs Ringmesser .....	10
Crile Arterienklemme .....	53	Kugelektrode .....	44	Tablettenschale .....	61
Crile-Wood Nadelhalter .....	28	Laborde Trachealdilatator .....	60	Tapia Adenoid Spatel .....	31
Davis-Boyle Mundsperrer .....	13	Langenbeck Wundhaken .....	49	Toennis-Adson Tonsillenschere .....	25 - 26
Davis-Boyle Zungenspatel .....	14	Laryngoskop .....	7, 9	Tonsillektomie/Adenotomie-Set .....	64
Davis-Meyer Mundsperrer .....	13	LED-Leuchtgriff .....	8	Tonsillen-Pinzette .....	23
Dean Tonsillenschere .....	25	Leiste für Silikonhalterungen .....	48	Tonsillen-Schlingen .....	19
DeBakey Pinzette .....	24	Lister Verbandschere .....	58	Trachealhäkchen .....	51
DeBakey Nadelhalter .....	29	Lösungsschale .....	61	Tracheotomie-Set .....	66
Dehnhardt-Mundsperrer .....	18	Mayo-Hegar Nadelhalter .....	29	Tracheotomie-Set II .....	67
Dingmann Mundsperrer .....	16	Mayo-Stille-Schere .....	58	Tränenweg-Chirurgie-Set .....	72
Dingmann Wangenhaken .....	16	Mclvor Mundsperrer .....	13	Tuchklemme .....	55, 56
Dingmann Zahnhaken .....	16	Mclvor Zungenspatel .....	14	Tyding Fasszange .....	22
Dingmann Zungenspatel .....	16	Medikamentenschälchen .....	61	Ultra-Stop Antibesclagmittel .....	6
Draffin Mundsperrer-Aufhängung .....	17	Medizinbecher .....	61	Universal Drahtschneideschere .....	19
Duval Gewebefasszange .....	57	Metallschale .....	61	Vogel Ringmesser .....	10
Edna-Lorna Tuchklemme .....	55	Metzenbaum Schere .....	26 - 27	Volkman Wundhaken .....	50
Einpedal-Fußschalter .....	38	Meuser bipolare Elektrode .....	48	Weerda Tracheal-Spekulum .....	60
Elektroden-Handgriff .....	39	Middeldorf Wundhaken .....	49	Weichteilchirurgie-Basis-Set .....	68-69
Endoskope .....	7	Mikro-Gefäß-Instrumentarium .....	71	Weichteilchirurgie-Set II .....	71-72
Endoskop-Schutzhülse .....	6	Mikulicz Tonsillenklemme .....	28	White Fasszange .....	22
Endoskopie-Siebkorb .....	7	Molt Mundsperrer .....	18	Wilder Dilatator .....	37
Eves Tonsillenschnürer .....	19	Moritz-Schmidt Zungenspatel .....	31	Yankauer Saugrohr .....	24
Fadenhäkchen .....	20	Monopolare Elektroden .....	42	Zoom Laryngoskop .....	9
Fass-Zängchen .....	23	Monopolares Anschlusskabel .....	39	Zungenspatel Mod. Würzburg .....	15
Fein Kehlkopfwatteträger .....	34	Muck Tonsillenschere .....	25		
Flexible Alligatorzange .....	6	Nadelelektrode .....	42		
Flexible Löffelzange .....	6	Nager Gaumensegelhaken .....	12		
Flexible Reinigungsbürste .....	6	Nager Unterbindungsnadel .....	20		
Flexibles Endoskop .....	5	Nasopharynx-Set .....	65		
Fraenkel Löffelansatz .....	35	Narkosebügel .....	17		
Gelenkkloben .....	17	Negus Bruststütze .....	17		
Good Tonsillenschere .....	24	Negus Ringmesser .....	10		
Good-Schweckendiek Tonsillenschere .....	24	Negus Tonsillenklemme .....	27		
Griff für Kehlkopfspiegel .....	33	Neutral-Elektrode .....	41		
Gross Kornzange .....	28	Nierenschale .....	66		
Gross-Maier Kornzange .....	29	Norm-Sterilisations-Container .....	67		
Halsted Mosquito Klemme .....	52	Ochsner-Kocher Arterienklemme .....	55		
Halteband für Neutral-Elektrode .....	39	Overholt-Geissdoerfer Tonsillenklemme .....	28		
Hartmann Conchotom .....	11	Pean Arterienklemme .....	53		

Abraham tonsil knife.....	29	Good-Schweckendiek tonsil scissors.....	24	Pelteson laryngeal cotton carrier.....	34
Adhesive indicator label.....	63	Grasper.....	43	Petri Bowl.....	66
Anesthesia frame L-form.....	17	Gross sponge forceps.....	28	Raspatory Würzburg type.....	21
Allis tissue holding forceps.....	56	Gross-Maier sponge forceps.....	29	Redon guide needle.....	64
Anti-fog.....	8	Halsted mosquito artery forceps.....	57	Reichert epiglottis holder.....	34
Artery forceps w/o ratchet.....	29,58	Handle for laryngeal mirrors.....	33	Ring tongue depressor.....	16
Baby-Adson artery forceps.....	54	Hartmann cutting forceps.....	11	Rotation clamp.....	17
Baby-Allis tissue holding forceps.....	56	Hartmann tongue depressor.....	31	Rochester-Pean artery forceps.....	59
Baby-Roux retractor.....	51	Henke raspatory.....	20	Roeder ligature instrument.....	19
Backhaus towel clamp.....	55	Henke raspatory / dissector.....	21	Roux retractor.....	56
Ballenger tonsil forceps.....	22	Herberhold tongue depressor.....	16	Ruedemann dilator for infants.....	39
Bangerter lacrimal duct cannula.....	36	HF surgical unit.....	40	Russel-Davis tongue depressor.....	15
Basket.....	63	High Grade flexible endoscope.....	5	Salivary duct probe set.....	39
Bar for silicone holders.....	48	Hofer palate retractor.....	12	Salivary duct scissors.....	38
Beckmann adenoid curette.....	10	Holding band for neutral electrode.....	41	Scalpel blades.....	30
Bipolar connecting cable.....	41	Hollow probe.....	64	Scalpel handle.....	30
Bipolar dissecting scissors.....	42	Huber Universal handle.....	35	Solution bowl.....	66
Bipolar electrode.....	53	Hurd dissector/retractor.....	21	Schmeden cutting forceps.....	12
Bipolar forceps.....	43 - 46	Hurd elevator/retractor.....	21	Schmidt tonsil forceps.....	27
Bipolar needle electrode.....	53	Hurd tonsil suture needle.....	20	Schönborn thyroid retractor.....	55
Bipolar suction forceps.....	47	Injection needle.....	33	Seemann-Seiffert mouth gag.....	18
Birkett tonsil forceps.....	27	Instrument tray.....	44	Seiffert alligator tip.....	35
Blohmke tonsil forceps.....	22	Jatho epipharyngeal forceps.....	17	Senn-Miller retractor.....	55
Boettcher tonsil scissors.....	25	Jennings mouth gag.....	17	Silicone holder.....	52
Bowman salivary duct probe.....	36	Jurasz adenoid forceps.....	11	Silicone insert for mouth gags.....	13
Bozemann needle holder.....	29	Kabierske powder blower.....	12	Silicone neutral electrode.....	41
Braun hook forceps.....	56	Kidney bowl.....	67	Sluder-Ballenger tonsillotome + blade.....	18
Brünings tip.....	35	Kilian laryngeal cotton carrier.....	34	St. Clair-Thomson adenoid forceps.....	11
Brünings tongue depressor.....	31	Kilian laryngectomy scissors.....	64	Sternberg lip retractor.....	54
Brünings tonsil knife.....	29	Knot tier.....	20	Stubbs adenoid curette.....	10
Brünings tonsil snare.....	19	Kocher artery forceps.....	58	Suction tube.....	24
Buchwald tongue depressor.....	31	Kocher director.....	64	Suture hook.....	20
Chain for mouth gags.....	17	Kocher-Langenbeck retractor.....	54	Tablet dish.....	66
China bowl.....	62	Laborde tracheal dilatator.....	65	Tapia adenoid spatula.....	31
Coding label.....	63	Lacrimal duct surgery set.....	74	Toennis-Adson tonsil scissor.....	25 - 26
Collin tongue forceps.....	57	Langenbeck retractor.....	54	Tongue depressor, Würzburg model.....	15
Colver tonsil forceps.....	22	Laryngeal cannula.....	33	Tonsil dissecting forceps.....	23
Colver-Fischer tonsil knife.....	29	Laryngeal forceps.....	34 - 35	Tonsil dressing forceps.....	23
Connecting tube.....	35	Laryngeal mirror.....	32 - 33	Tonsil wire loops.....	19
Container seal.....	63	Laryngoscope.....	7, 9	Tonsillectomy/Adenotomy set.....	66
Cooper scissors.....	57	LED light handle.....	8	Towel clamp.....	61
Crile artery forceps.....	53	Lister bandage scissors.....	63	Trachea hook.....	56
Crile-Coller artery forceps.....	59	Mayo-Hegar needle holder.....	29	Tracheotomy set.....	68
Crile-Wood needle holder.....	28	Mayo-Stille scissors.....	63	Tracheotomy set II.....	69
Davis-Boyle mouth gag.....	13	Mclvor mouth gag.....	13	Tyding tonsil forceps.....	22
Davis-Boyle tongue depressor.....	14	Mclvor tongue depressor.....	14	Ultra-Stop antifog solution.....	6
Davis-Meyer mouth gag.....	13	Medication cup.....	66	Universal wire cutting scissors.....	20
Dean tonsil scissors.....	25	Metal Bowl.....	66	Valve lid for norm sterilization container.....	68
DeBaKey dressing forceps.....	24	Metzenbaum scissors.....	26 - 27	Vogel adenoid curette.....	10
DeBaKey needle holder.....	29	Meuser bipolar electrode.....	53	Volkman retractor.....	55
Dehnhardt mouth gag.....	18	Micro vascular set.....	73	Weerda tracheal speculum.....	65
Dingmann cheek retractors.....	16	Middeldorp antrum retractor.....	54	White tonsil forceps.....	22
Dingmann mouth gag.....	16	Mikulicz tonsil forceps.....	28	Wilder dilatator.....	39
Dingmann tooth hooks.....	16	Molt mouth gag.....	18	Yankauer suction tube.....	24
Dingmann tongue depressor.....	16	Moritz-Schmidt tongue depressor.....	31	Zoom laryngoscope.....	9
Draffin bipod suspension for mouth gags.....	17	Monopolar connecting cable.....	42		
Duval tissue forceps.....	57	Monopolar electrodes.....	44		
Edna-Lorna towel clamp.....	55	Muck tonsil scissors.....	25		
Electrode handle.....	39	Nager pillar retractor.....	12		
Endoscope.....	7	Nager tonsil suture needle.....	20		
Endoscope protective sleeve.....	6	Nasopharyngeal set.....	67		
Endoscopy container.....	7	Neck dissection basic set.....	70-71		
Eves tonsil snare.....	19	Neck Dissektion-Set II.....	72-73		
Fein laryngeal cotton carrier.....	34	Needle electrode.....	44		
Forceps holder.....	62	Negus adenoid curette.....	10		
Flexible alligator forceps.....	6	Negus chest support.....	17		
Flexible cleaning brush.....	6	Negus tonsil forceps.....	27		
Flexible cup forceps.....	6	Norm sterilization container.....	68		
Flexible endoscope.....	5	Ochsner-Kocher artery forceps.....	60		
Fraenkel tip.....	35	One pedal foot-switch.....	40		
Good tonsil scissors.....	24	Overholt-Geissdoerfer tonsil forceps.....	28		



## Numerisches Inhaltsverzeichnis

### Numeric Content

10-155-00.....12	40-200-03.....10	40-320-03.....15	40-394-23.....22	40-524-10.....32	80-407-40.....42
10-155-01.....12	40-200-04.....10	40-320-04.....15	40-395-22.....22	40-524-20.....32	80-408-40.....42
10-155-02.....12	40-203-00.....10	40-320-05.....15	40-400-20.....23	40-524-30.....32	80-409-30.....42
10-303-18.....24	40-203-01.....10	40-322-02.....16	40-401-20.....23	40-525-00.....33	80-010-40.....38
10-360-03.....30	40-203-02.....10	40-322-03.....16	40-402-20.....23	40-525-01.....33	80-011-40.....38
10-360-04.....30	40-203-03.....10	40-322-04.....16	40-405-20.....23	40-525-02.....33	80-012-75.....38
10-360-07.....30	40-203-04.....10	40-322-05.....16	40-406-20.....23	40-525-03.....33	80-053-01.....42
10-360-10.....30	40-206-00.....10	40-323-02.....16	40-407-20.....23	40-525-04.....33	80-053-02.....42
10-360-11.....30	40-206-01.....10	40-323-03.....16	40-408-20.....23	40-525-05.....33	80-053-03.....42
10-360-15.....30	40-206-02.....10	40-323-04.....16	40-410-20.....24	40-525-06.....33	80-053-04.....42
10-360-33.....30	40-206-03.....10	40-323-05.....16	40-412-20.....24	40-525-07.....33	80-053-05.....42
10-745-12.....19	40-211-07.....10	40-325-01.....16	40-420-29.....24	40-525-08.....33	80-100-16.....45
20-252-01.....11	40-220-01.....11	40-325-02.....16	40-420-99.....24	40-525-09.....33	80-100-19.....45
20-252-02.....11	40-220-02.....11	40-325-03.....16	40-421-21.....24	40-525-10.....33	80-101-16.....45
20-252-03.....11	40-225-00.....11	40-325-04.....16	40-430-19.....24	40-525-20.....33	80-101-19.....45
20-252-04.....11	40-230-21.....12	40-327-00.....16	40-431-19.....24	40-525-30.....33	80-101-22.....45
20-254-00.....12	40-232-23.....12	40-327-01.....16	40-433-18.....25	40-553-01.....33	80-103-16.....45
20-254-01.....12	40-300-01.....13	40-327-02.....16	40-434-18.....25	40-553-02.....33	80-103-19.....45
20-254-02.....12	40-300-02.....13	40-327-03.....16	40-436-17.....25	40-555-13.....33	80-105-16.....45
20-254-03.....12	40-302-01.....13	40-327-98.....16	40-438-18.....25	40-558-24.....34	80-105-19.....45
20-612-18.....26	40-302-02.....13	40-327-99.....16	40-440-18.....25	40-560-22.....34	80-106-16.....45
20-612-20.....26	40-302-03.....13	40-330-09.....17	40-441-18.....26	40-561-28.....34	80-106-19.....45
20-613-18.....26	40-302-04.....13	40-330-14.....17	40-442-18.....26	40-570-01.....34	80-106-25.....45
20-613-20.....26	40-303-00.....13	40-335-00.....17	40-450-19.....27	40-570-02.....34	80-107-16.....45
20-614-18.....26	40-305-00.....13	40-335-01.....17	40-451-19.....27	40-572-01.....35	80-107-19.....45
20-614-20.....26	40-305-01.....13	40-335-99.....17	40-454-20.....27	40-572-02.....35	80-109-16.....45
20-615-18.....26	40-305-10.....13	40-337-00.....17	40-455-20.....27	40-575-00.....35	80-110-16.....45
20-615-20.....26	40-305-99.....13	40-340-09.....17	40-457-19.....27	40-576-20.....35	80-110-19.....45
20-616-18.....27	40-310-01.....14	40-340-11.....17	40-458-19.....27	40-578-00.....35	80-111-16.....45
20-784-18.....28	40-310-02.....14	40-340-13.....17	40-460-19.....28	40-579-00.....35	80-111-19.....45
20-785-18.....28	40-310-03.....14	40-340-15.....17	40-462-18.....28	40-580-00.....35	80-112-16.....45
30-160-01.....6	40-311-01.....14	40-341-11.....18	40-465-18.....28	40-581-00.....35	80-112-19.....45
30-160-02.....6	40-311-02.....14	40-341-13.....18	40-465-20.....28	40-600-12.....36	80-113-19.....45
30-160-03.....6	40-311-03.....14	40-342-09.....18	40-465-23.....28	40-601-12.....36	80-113-23.....45
30-160-04.....8	40-311-04.....14	40-342-11.....18	40-474-20.....28	40-604-08.....36	80-114-19.....45
30-160-05.....8	40-311-15.....14	40-342-13.....18	40-475-26.....29	40-604-10.....36	80-115-19.....45
30-170-28.....5	40-311-25.....14	40-343-00.....18	40-480-22.....29	40-604-12.....36	80-116-19.....45
30-170-36.....5	40-311-35.....14	40-343-01.....18	40-481-18.....29	40-606-06.....36	80-117-19.....46
30-171-40.....5	40-312-01.....14	40-350-01.....18	40-482-23.....29	40-606-08.....36	80-118-19.....46
30-172-40.....6	40-312-02.....14	40-350-02.....18	40-484-22.....29	40-607-06.....36	80-119-19.....46
30-172-41.....6	40-312-03.....14	40-350-03.....18	40-490-16.....29	40-609-00.....36	80-120-19.....46
30-173-40.....6	40-312-04.....14	40-350-10.....18	40-490-18.....29	40-609-01.....36	80-121-18.....46
30-173-41.....6	40-312-05.....14	40-355-28.....19	40-491-20.....29	40-609-12.....36	80-122-18.....47
30-175-40.....6	40-313-01.....14	40-357-28.....19	40-500-19.....31	40-609-23.....36	80-123-16.....46
30-182-21.....6	40-313-02.....14	40-359-27.....19	40-502-17.....31	40-609-34.....36	80-125-03.....47
30-700-01.....17	40-313-03.....14	40-360-40.....19	40-504-15.....31	40-609-40.....36	80-125-07.....47
40-100-70.....9	40-313-04.....14	40-360-50.....19	40-506-19.....31	40-609-45.....36	80-125-12.....47
40-100-90.....9	40-313-05.....14	40-361-45.....19	40-508-18.....31	40-609-56.....36	80-125-20.....47
40-103-70.....9	40-315-01.....15	40-365-01.....20	40-509-17.....31	40-609-67.....36	80-127-03.....46
40-103-90.....9	40-315-02.....15	40-365-02.....20	40-510-01.....31	40-609-78.....36	80-127-07.....46
40-105-70.....9	40-315-03.....15	40-367-24.....20	40-510-02.....31	40-613-08.....37	80-127-12.....46
40-105-90.....9	40-315-04.....15	40-368-21.....20	40-510-03.....31	40-615-01.....37	80-127-20.....46
40-107-70.....9	40-315-05.....15	40-369-21.....20	40-520-00.....33	40-615-02.....37	80-128-03.....47
40-110-00.....7	40-316-01.....15	40-370-21.....20	40-524-00.....32	40-615-03.....37	80-128-07.....47
40-110-30.....7	40-316-02.....15	40-381-12.....21	40-524-01.....32	40-617-00.....37	80-128-12.....47
40-110-70.....7	40-316-03.....15	40-381-15.....21	40-524-02.....32	70-211-00.....8	80-128-20.....47
40-111-70.....7	40-318-01.....15	40-382-24.....20	40-524-03.....32	70-211-01.....8	80-129-12.....46
40-112-00.....7	40-318-02.....15	40-385-23.....21	40-524-04.....32	70-211-10.....8	80-150-17.....44
40-112-30.....7	40-318-03.....15	40-386-23.....21	40-524-05.....32	70-211-20.....8	80-150-20.....44
40-112-70.....7	40-318-04.....15	40-388-21.....21	40-524-06.....32	70-211-30.....8	80-150-23.....44
40-200-00.....10	40-318-05.....15	40-390-21.....22	40-524-07.....32	70-211-40.....8	80-152-17.....44
40-200-01.....10	40-320-01.....15	40-392-19.....22	40-524-08.....32	70-211-50.....8	80-152-20.....44
40-200-02.....10	40-320-02.....15	40-394-18.....22	40-524-09.....32	80-002-80.....38	80-152-23.....44



80-156-20.....	44	80-342-02.....	51	80-415-50.....	40	80-641-14.....	63
80-156-23.....	44	80-342-03.....	51	80-440-13.....	57	80-661-12.....	63
80-158-20.....	44	80-342-04.....	51	80-440-15.....	57	80-661-14.....	63
80-158-23.....	44	80-350-01.....	52	80-442-13.....	57	80-661-21.....	63
80-180-13.....	42	80-350-02.....	52	80-442-15.....	57	80-632-00.....	63
80-181-14.....	42	80-350-03.....	52	80-444-13.....	57	80-632-01.....	63
80-182-17.....	42	80-350-04.....	52	80-444-15.....	57	80-632-02.....	63
80-183-14.....	47	80-352-01.....	52	80-445-15.....	40	80-632-03.....	63
80-183-18.....	42	80-352-02.....	52	80-446-13.....	58	80-632-04.....	63
80-183-20.....	47	80-352-03.....	52	80-446-15.....	58	80-632-05.....	63
80-250-00.....	48	80-352-04.....	52	80-448-13.....	58	80-642-00.....	63
80-260-34.....	48	80-354-01.....	52	80-450-13.....	58	80-642-01.....	63
80-270-24.....	48	80-354-02.....	52	80-450-15.....	58	80-642-02.....	63
80-272-24.....	48	80-354-03.....	52	80-455-15.....	58	80-642-03.....	63
80-275-24.....	48	80-354-04.....	52	80-455-17.....	58	80-642-04.....	63
80-280-00.....	48	80-356-12.....	53	80-457-15.....	58	80-642-05.....	63
80-302-12.....	49	80-357-12.....	53	80-459-15.....	58	80-662-00.....	63
80-302-14.....	49	80-359-14.....	53	80-460-15.....	58	80-662-01.....	63
80-302-16.....	49	80-360-14.....	53	80-465-15.....	58	80-662-02.....	63
80-306-17.....	49	80-361-14.....	53	80-465-18.....	58	80-662-03.....	63
80-306-22.....	49	80-365-14.....	53	80-465-20.....	58	80-662-04.....	63
80-306-30.....	49	80-365-16.....	53	80-468-21.....	59	80-662-05.....	63
80-308-06.....	49	80-366-14.....	53	80-470-16.....	59	80-671-20.....	63
80-308-07.....	49	80-366-16.....	53	80-471-15.....	59	80-671-25.....	63
80-308-10.....	49	80-370-14.....	53	80-472-25.....	59	80-671-40.....	63
80-308-15.....	49	80-370-16.....	53	80-472-35.....	59	80-671-60.....	63
80-308-20.....	49	80-372-14.....	53	80-472-40.....	59	80-681-01.....	63
80-309-11.....	50	80-372-16.....	53	80-478-14.....	60	80-681-02.....	63
80-309-14.....	50	80-374-14.....	53	80-479-14.....	60	80-681-03.....	63
80-309-16.....	50	80-375-14.....	53	80-482-19.....	60	80-681-04.....	63
80-309-41.....	50	80-376-16.....	54	80-501-01.....	61	80-681-05.....	63
80-309-51.....	50	80-380-18.....	54	80-501-02.....	61	80-681-06.....	63
80-312-21.....	50	80-382-18.....	54	80-501-03.....	61	80-681-07.....	63
80-314-16.....	50	80-382-20.....	54	80-501-04.....	61	80-683-10.....	63
80-315-16.....	50	80-383-18.....	54	80-503-03.....	61	80-684-10.....	63
80-316-50.....	41	80-383-20.....	54	80-504-05.....	61	80-688-00.....	63
80-317-00.....	51	80-383-22.....	54	80-506-30.....	61	80-691-01.....	7
80-317-30.....	41	80-385-18.....	55	80-507-40.....	61	80-692-01.....	7
80-317-50.....	41	80-385-20.....	55	80-509-75.....	61		
80-318-01.....	51	80-387-18.....	55	80-512-00.....	61		
80-318-02.....	51	80-387-20.....	55	80-515-06.....	61		
80-318-03.....	51	80-392-09.....	55	80-515-08.....	61		
80-318-30.....	41	80-392-11.....	55	80-515-10.....	61		
80-318-50.....	41	80-392-13.....	55	80-517-00.....	61		
80-319-30.....	41	80-394-09.....	55	80-519-00.....	62		
80-319-50.....	41	80-394-13.....	55	80-519-01.....	62		
80-320-30.....	41	80-397-12.....	56	80-519-02.....	62		
80-320-50.....	41	80-397-14.....	56	80-519-03.....	62		
80-330-01.....	50	80-400-15.....	56	80-520-06.....	62		
80-330-02.....	50	80-401-14.....	56	80-520-08.....	62		
80-330-03.....	50	80-403-15.....	56	80-525-17.....	62		
80-330-04.....	50	80-405-20.....	57	80-525-25.....	62		
80-330-06.....	50	80-406-01.....	39	80-528-13.....	62		
80-332-01.....	50	80-406-02.....	39	80-528-18.....	62		
80-332-02.....	50	80-407-16.....	57	80-528-20.....	62		
80-332-03.....	50	80-410-04.....	39	80-530-20.....	62		
80-332-04.....	50	80-410-24.....	39	80-621-05.....	7		
80-332-06.....	50	80-411-04.....	39	80-622-56.....	7		
80-340-01.....	51	80-411-24.....	39	80-623-22.....	7		
80-340-02.....	51	80-412-04.....	39	80-631-10.....	63		
80-340-03.....	51	80-412-24.....	39	80-631-12.....	63		
80-340-04.....	51	80-413-00.....	39	80-631-14.....	63		
80-342-01.....	51	80-414-50.....	40	80-631-21.....	63		





## Umrechnungstabelle - Ch/Fr - mm - inch

### Conversion table - Ch/Fr - mm - inch

Charrière (CH) French (F)	mm	Inch
1	0,33	0,013
2	0,67	0,025
3	1,00	0,039
4	1,33	0,051
5	1,67	0,065
6	2,00	0,079
7	2,33	0,092
8	2,67	0,105
9	3,00	0,118
10	3,33	0,131
11	3,67	0,144
12	4,00	0,156
13	4,33	0,170
14	4,67	0,184
15	5,00	0,197
16	5,33	0,210
17	5,67	0,223
18	6,00	0,237
19	6,33	0,249
20	6,67	0,263
21	7,00	0,276
22	7,33	0,288
23	7,67	0,302
24	8,00	0,315
25	8,33	0,328
26	8,67	0,341
27	9,00	0,354
28	9,33	0,367
29	9,67	0,380
31	10,23	0,407
32	10,67	0,420
34	11,33	0,446
36	12,00	0,472
38	12,67	0,494
40	13,33	0,520
45	15,00	0,591





**SPIGGLE & THEIS**  
Medizintechnik

Burghof 14 · 51491 Overath · Germany

Phone: +49 2206 90 81 - 0

Fax: +49 2206 90 81 - 13

[info@spiggle-theis.com](mailto:info@spiggle-theis.com)

[www.spiggle-theis.com](http://www.spiggle-theis.com)

© 2022 by SPIGGLE & THEIS Medizintechnik GmbH

Änderungen und Irrtümer – einschließlich Bilder - vorbehalten.

Produktsortiment kann pro Land abweichen.

Modifications and errors – including pictures – reserved.

Product range might vary per country.



PO Box 3403, Erina, NSW, 2250, Australia

**P: +61 2 9810 6947**

[admin@coremed.com.au](mailto:admin@coremed.com.au)

[www.coremed.com.au](http://www.coremed.com.au)

# Endoskopie

## Endoscopy

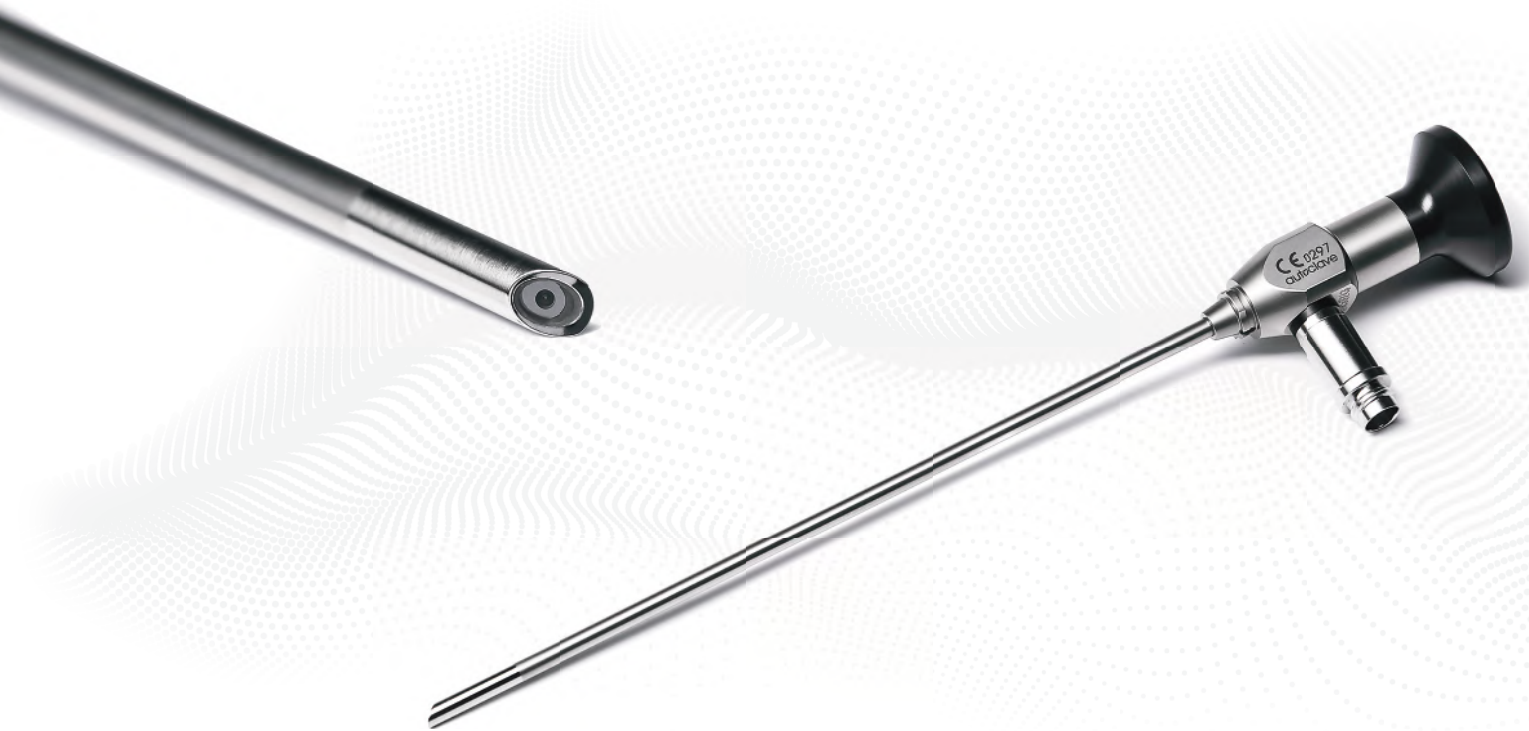

Quality you can rely on





# Über uns

---

# About Us

## Geschichte

**SPIGGLE & THEIS Medizintechnik GmbH** wurde 1994 von den Geschäftsführern **David Spiggle** und **Detlef Theis** gegründet. Bis heute haben wir uns vom reinen Vertriebsunternehmen zu einem renommierten Hersteller von Medizinprodukten im Bereich der HNO-Chirurgie weiterentwickelt. Weltweit exportieren wir in über 75 Länder und in Deutschland zählen mehr als 700 Kliniken zu unseren Kunden.

## Das Maß der Dinge

Im chirurgischen Instrumentenbau gilt das Siegel **“Made in Germany“** auch heute noch als Inbegriff von Qualität. Unsere chirurgischen Instrumente werden in allen Produktionsstufen unter strengsten Qualitätsanforderungen nahezu komplett in Deutschland produziert und sind somit noch größtenteils echt **“Made in Germany“**. Zur Verarbeitung wird ausschließlich Instrumentenstahl bester Güte verwendet, welcher den hohen Anforderungen moderner Chirurgie auch dauerhaft gerecht wird.

## Sicherheit

Die Gesundheit der Patienten und somit die Sicherheit und Qualität unserer Produkte stehen im Mittelpunkt unseres Handelns. In diesem Sinne ist **SPIGGLE & THEIS Medizintechnik GmbH** bereits seit 1997 **ISO-zertifiziert** und sind unsere Produkte nach der strengen europäischen Richtlinie für Medizinprodukte CE-gekennzeichnet. Alle unsere Produkte unterliegen einer permanenten Qualitätskontrolle - von der Auswahl des Rohmaterials über die einzelnen Fertigungsschritte bis zum Versand.

## Erfahrung

Unsere Mitarbeiter haben zum Teil mehr als 30 Jahre Berufserfahrung im Umgang mit chirurgischen Instrumenten. Durch dieses umfassende Know-How sowie den langjährigen und individuellen Kontakt mit den Anwendern, besitzen wir nicht nur theoretisches Wissen, sondern kennen auch deren Bedürfnisse und Ansprüche. Dies hilft uns bei der steten, praxisorientierten Weiterentwicklung unserer Produkte. Somit garantieren wir hohe Kompetenz und individuellen Service bei der Betreuung unserer Kunden.

## History

**SPIGGLE & THEIS Medizintechnik GmbH** was founded in 1994 by the managing directors **David Spiggle** and **Detlef Theis**. The company has evolved from being purely a distributor to the established manufacturer of medical products in the area of ENT that it is today. We can count over 700 clinics amongst our German customers and export to over 75 countries world-wide.

## The Seal Of Highest Quality

The stamp **“Made in Germany“** is still the epitome of quality standards in the production of surgical instruments in the world today. The majority of our surgical instruments is subjected to the strictest quality requirements at every step of their production, in the truest sense of the words, **“Made in Germany“**. Only the highest standard of instrument steel, capable of consistently meeting the demands of modern surgery, is used in the production.

## Safety First

The health of our patients and therefore the safety and quality of our products plays the central role in our decisions. **SPIGGLE & THEIS Medizintechnik GmbH** has been **ISO certified**. Our products are CE-marked in accordance with the strict European guideline for medical products since 1997. All our products undergo continual quality checks, from the selection of raw materials, to the individual stages of production and finally their dispatch.

## Experience

Our colleagues in instrument development can look back on over 30 years of professional practical experience with ENT surgical instruments. We offer more than theoretical knowledge – we understand our customer needs. We enjoy close, personal contact to many of the best surgeons world-wide. This enables us to continually develop innovative products. We guarantee the highest level of competence and individual service in meeting our customer requirements.



## Inhaltsverzeichnis

### Table of contents

01	Endoskopische / Mikroskopische Instrumente nach Prof. Panetti Endoscopic / Microscopic Instruments by Prof. Panetti .....	5 - 8
02	Ohr-Endoskope / Ear Endoscopes .....	9 - 10
03	NNH-Endoskope / Sinus Endoscopes .....	11 - 12
04	Laryngoskopie-Endoskope / Laryngoscopy Endoscopes .....	13 - 14
05	Bronchoskopie / Oesophagoskopie-Endoskope Bronchoscopy / Oesophagoscopy Endoscopes .....	15
06	Flexible Nasopharyngoskope / Flexible Nasopharyngoscopes .....	16 - 17
07	Endoskopie-Zubehör / Endoscopy Accessory .....	18 - 20
08	Kamera-Systeme / Camera Systems .....	21
09	Lichtquellen und Lichtkabel / Lightsources and Cables .....	22 - 25
	Index .....	26 - 27

#### Attention:

Not every instrument is available in all markets. Availability depends on local regulations. Please contact your SPIGGLE & THEIS representative or distributor, if you have any questions about the availability of our products in your region.



## 01 Endoskopische/Mikroskopische Instrumente nach Prof. Panetti

### Endoscopic/Microscopic Instruments by Prof. Panetti



Prof. Giuseppe Panetti, Direktor des San Paolo Krankenhaus, Neapel / Italien  
Prof. Giuseppe Panetti, Director of the ENT Department, San Paolo Hospital, Naples / Italy

Jedes Instrument besitzt einen Saugkanal mit Sogsteuerung im Handstück. Die Arbeitsteile der Instrumente entsprechen in Form und Funktion denen klassischer Schneidinstrumente für die Mittelohrchirurgie. Die Saugfunktion ermöglicht gleichzeitiges Schneiden und Absaugen mit nur einem Instrument. Durch die Saugfunktion des Instruments wird die Effizienz spürbar erhöht. Das Beschlagen der Optik wird deutlich verringert, Gewebeablagerungen an der Endoskopspitze können leicht mit Kochsalzlösung entfernt werden.

Each instrument has a suction duct with control hole on the hand piece; Despite being newly developed the tips of the instruments are the tried and tested forms classically used in middle ear dissection. The suction function enables simultaneous suction and dissection. Dissection is more effective when supported by the suction facility. Any otoendoscopic fogging or blood stains around the tip of the endoscope can be easily removed by rinsing with a hydro-saline solution. This presents a clear operating field, without interrupting the surgical procedure.

#### Vorteile der Endoskopischen/Mikroskopischen Instrumente nach Prof. Panetti:

- Vereinfacht das Entfernen versteckter Cholesteatome
- Spart Zeit
- Weniger traumatisch für den Patienten
- Präparieren und Schneiden bei gleichzeitiger, integrierter Absaugung
- Effektive Sogsteuerung

#### Advantages of the Endoscopic/Microscopic Instruments by Prof. Panetti:

- Enables easier removal of residual cholesteatoma
- Saves time
- Less traumatic for the patient
- Dissection and preparation with concurrent suction
- Effective suction control











#### Mikro-Ohrzängchen, ovale Löffel, fein, 0,8 x 1,3 mm, 8 cm Micro ear forceps, oval cups, fine, 0.8 x 1.3 mm, 8 cm

Art.-Nr./No.	Beschreibung / Description
10-703-03	aufwärts gebogen / curved upwards
10-703-07	abwärts gebogen / curved downwards



## 01 Endoskopische/Mikroskopische Instrumente nach Prof. Panetti

### Endoscopic/Microscopic Instruments by Prof. Panetti

		<p><b>Saug-Dissektor für Trommelfell, einfach gebogen, 3 mm, 13 cm, Luer-Lock</b> Suction dissector for ear drum, single curved, 3 mm, 13 cm, Luer-Lock</p>								
10-800-12										
10-801-12										
		<table border="0"> <thead> <tr> <th>Art.-Nr./No.</th> <th>Richtung / Direction</th> </tr> </thead> <tbody> <tr> <td>10-800-12</td> <td>links / left</td> </tr> <tr> <td>10-801-12</td> <td>rechts / right</td> </tr> </tbody> </table>	Art.-Nr./No.	Richtung / Direction	10-800-12	links / left	10-801-12	rechts / right		
Art.-Nr./No.	Richtung / Direction									
10-800-12	links / left									
10-801-12	rechts / right									
		<p><b>Saug-Dissektor für Sinus Tympani, doppelt gebogen, 6 mm, 13 cm, Luer-Lock</b> Suction dissector for sinus tympani, double curved, 6 mm, 13 cm, Luer-Lock</p>								
10-802-12										
10-803-12										
		<table border="0"> <thead> <tr> <th>Art.-Nr./No.</th> <th>Richtung / Direction</th> </tr> </thead> <tbody> <tr> <td>10-802-12</td> <td>rückwärts links / backward left</td> </tr> <tr> <td>10-803-12</td> <td>rückwärts rechts / backward right</td> </tr> </tbody> </table>	Art.-Nr./No.	Richtung / Direction	10-802-12	rückwärts links / backward left	10-803-12	rückwärts rechts / backward right		
Art.-Nr./No.	Richtung / Direction									
10-802-12	rückwärts links / backward left									
10-803-12	rückwärts rechts / backward right									
		<p><b>Saug-Dissektor für Attik, doppelt gebogen, 6 mm, 13 cm, Luer-Lock</b> Suction dissector for atticus, double curved, 6 mm, 13 cm, Luer-Lock</p>								
10-804-12										
10-805-12										
		<table border="0"> <thead> <tr> <th>Art.-Nr./No.</th> <th>Richtung / Direction</th> </tr> </thead> <tbody> <tr> <td>10-804-12</td> <td>vorwärts links / forward left</td> </tr> <tr> <td>10-805-12</td> <td>vorwärts rechts / forward right</td> </tr> </tbody> </table>	Art.-Nr./No.	Richtung / Direction	10-804-12	vorwärts links / forward left	10-805-12	vorwärts rechts / forward right		
Art.-Nr./No.	Richtung / Direction									
10-804-12	vorwärts links / forward left									
10-805-12	vorwärts rechts / forward right									
		<p><b>Saug-Mikrohäkchen, 45°, 13 cm, Luer-Lock</b> Suction micro hook, 45°, 13 cm, Luer-Lock</p>								
10-806-12										
10-867-12										
10-807-12										
		<table border="0"> <thead> <tr> <th>Art.-Nr./No.</th> <th>Haken / Hook (mm)</th> </tr> </thead> <tbody> <tr> <td>10-806-12</td> <td>1,0</td> </tr> <tr> <td>10-867-12</td> <td>1,5</td> </tr> <tr> <td>10-807-12</td> <td>2,0</td> </tr> </tbody> </table>	Art.-Nr./No.	Haken / Hook (mm)	10-806-12	1,0	10-867-12	1,5	10-807-12	2,0
Art.-Nr./No.	Haken / Hook (mm)									
10-806-12	1,0									
10-867-12	1,5									
10-807-12	2,0									



Maßstab / scale 1:1 (13 cm Länge)

## 01 Endoskopische/Mikroskopische Instrumente nach Prof. Panetti

### Endoscopic/Microscopic Instruments by Prof. Panetti

#### Saug-Rundschnittmesser, 45°, 13 cm, Luer-Lock

#### Suction separator, 45°, 13 cm, Luer-Lock



Art.-No. Art.-Nr.	Größe Size (mm)	Beschreibung Description
10-808-12	2,5	Saugöffnung innen suction inner side
10-809-12	2,0	Saugöffnung außen suction outer side
10-811-12	2,5	Saugöffnung außen suction outer side

#### Saug-Messer, oval, 13 cm, Luer-Lock

#### Suction knife, oval, 13 cm, Luer-Lock



Art.-Nr./No.	Beschreibung / Description
10-810-12	seitliche Öffnung links / lateral opening left
10-812-12	seitliche Öffnung rechts / lateral opening right

#### Saug-Dissektor für Trommelfell,

#### einfach gebogen, sehr fein, 13 cm, Luer-Lock

#### Suction dissector for ear drum,

#### single curved, very delicate, 13 cm, Luer-Lock



Art.-Nr./No.	Beschreibung / Description
10-813-12	seitliche Öffnung links / lateral opening left side
10-814-12	seitliche Öffnung rechts / lateral opening right side

#### Saug-Sichelmesser, gebogen, 13 cm, Luer-Lock

#### Suction sickle knife, curved, 13 cm, Luer-Lock

10-815-12



#### Saug-Kürette, gebogen, 13 cm, Luer-Lock

#### Suction curette, curved, 13 cm, Luer-Lock

10-816-12



## 01 Endoskopische/Mikroskopische Instrumente nach Prof. Panetti

### Endoscopic/Microscopic Instruments by Prof. Panetti

**Saug-Dissektor, stumpf, 13 cm, Luer-Lock**  
**Suction dissector, blunt, 13 cm, Luer-Lock**



Art.-Nr./No.	Beschreibung / Description
10-817-12	links aufgebogen / upcurved left
10-818-12	rechts aufgebogen / upcurved right

**Preyer Saug-Finder, stumpf, 13 cm, Luer-Lock**  
**Preyer Suction finder, blunt, 13 cm, Luer-Lock**



**10-819-12**

**Saugadapter, drehbar, 55° gebogen,**  
**Luer-Lock männlich, Schlauchansatz**  
**Suction adapter, rotatable, 55° curved,**  
**luer-lock male, hose connector**

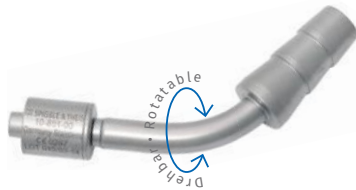

**10-851-00**

**Hochleistungs-Fiberglas-Lichtleitkabel,**  
**Ø 3,5 mm, 90° abgewinkelt, autoklavierbar**  
**High definition fibre light cable,**  
**Ø 3.5 mm, 90° angled, autoclavable**



Art.-Nr./No.	Länge / Length (mm)
70-266-02	1800
70-267-03	3000

**System-Siebkorb für Panetti-Instrumentarium**  
**System Screen Basket for Panetti Instruments**



Art.-Nr./No.	Beschreibung / Description
10-840-01	
10-841-01	klein / small

**Spülkomponente für System-Siebkorb Panetti-Instrumentarium**  
**Irrigation component for System Screen Basket**  
**for Panetti Instruments**



**10-845-01**

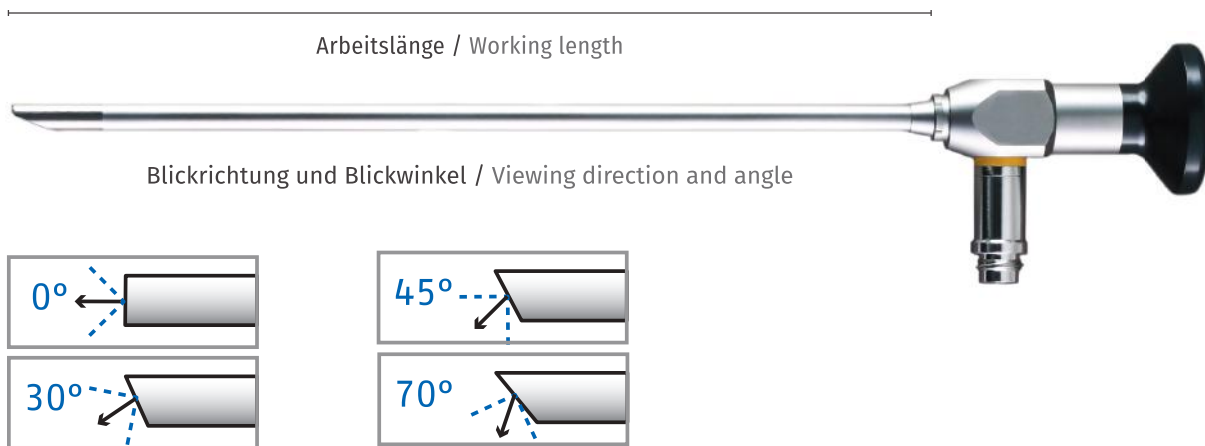

**Vorteile unserer Endoskope:**

- Kompatibel mit allen Lichtquellen auf dem Markt (universalkompatibel)
- Extrem robuste Rohrkonstruktion mit verstärktem 2-Rohr-Edelstahl-System
- Hochwertig vergütetes, hochauflösendes Linsen-System
- Optische Saphirglas-Frontlinse, kratzfest und hitzebeständig fixiert mit Epoxidharz
- Hitzebeständiges Polymer-Okular (PEEK)
- Hohe Dichtigkeit durch gelaserte Schnittstellen
- Mehr Bildinformation durch großen Öffnungswinkel
- Hohe Bildschärfe im gesamten Bildbereich
- Gleichmäßige Helligkeit bis zum Rand durch Lichtkonus
- Autoklavierbar
- 24 Monate Garantie

**Advantages of our endoscopes:**

- Compatible to all light sources available (universal camera compatible)
- Extremely robust stainless steel tube construction with reinforced outer tube
- High precision quality lens system
- Optical sapphire glass front lens, scratch resistant and fixed with heat-resistant epoxide
- Heat-resistant polymer ocular (PEEK)
- Tight sealing due to laser welded joints
- More image information due to wide viewing angle
- High focus quality in entire viewing area
- Constant brightness up to the edge of viewing area
- Autoclavable
- 24 months guarantee



**All unsere Endoskope sind aus Phynoxstahl**  
für verbesserten Schutz gegen Verbiegen und Bruch

**All our endoscopes are made of phynox steel**  
for improved protection against bending or breaking



## 02 Ohr-Endoskope

### Ear Endoscopes



**Otoskop, HD, autoklavierbar / Otoscope, HD, autoclavable**

Art.-Nr. Art.-No.	Größe Size (mm)	Länge Length (cm)	Winkel Angle
10-102-00	2,7	5,0	0°
10-102-30	2,7	5,0	30°
10-104-00	2,4	9,8	0°
10-104-30	2,4	9,8	30°



**Gehörgangs-Endoskop, HD, autoklavierbar, AD 4 mm, 5 cm**  
Ear canal endoscope, HD, autoclavable, OD 4 mm, 5 cm

Art.-Nr./No.	Winkel / Angle
10-106-00	0°
10-107-30	30°

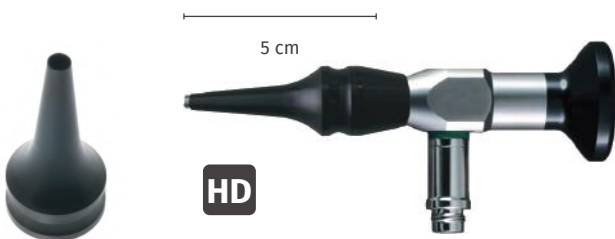

**Gehörgangs-Endoskop mit Ohrspekulum, HD, autoklavierbar, AD 4 mm, 5 cm**  
Ear canal endoscope with ear speculum, HD, autoclavable, OD 4 mm, 5 cm

Art.-Nr./No.	Winkel / Angle
10-108-00	0°
10-108-99	Ersatzspekulum für 10-108-00 spare speculum for 10-108-00

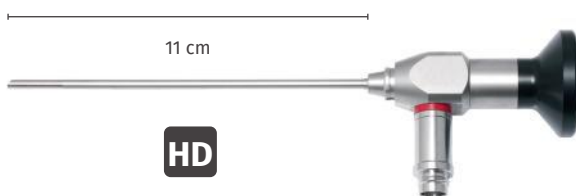

**Otoskop, HD, Großbild, autoklavierbar, AD 3 mm, 11 cm**  
Otoscope, HD, large picture, autoclavable, OD 3 mm, 11 cm

Art.-Nr./No.	Winkel / Angle
10-109-00	0°
10-109-30	30°
10-109-45	45°
10-109-70	70°

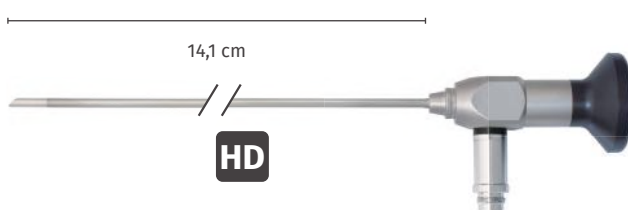

**Otoskop, HD, Großbild, autoklavierbar, AD 3 mm, 14,1 cm**  
Otoscope, HD, large picture, autoclavable, OD 3 mm, 14.1 cm

Art.-Nr./No.	Winkel / Angle
10-090-00	0°
10-090-30	30°
10-090-45	45°

## 03 NNH-Endoskope

### Sinus Endoscopes

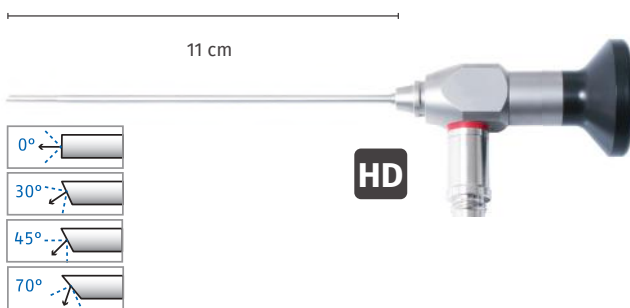

Otoskop, HD, Großbild, autoklavierbar, AD 2,4 mm, 11 cm

Otoscope, HD, large picture, autoclavable, OD 2.4 mm, 11 cm

Art.-Nr./No.	Winkel / Angle
10-111-00	0°
10-111-30	30°
10-111-45	45°
10-111-70	70°

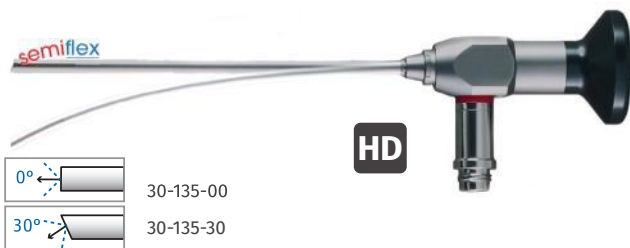

Sinuskop, HD, semiflex, autoklavierbar, AD 2,7 mm, 11 cm

Sinuscope, HD, semiflex, autoclavable, OD 2.7 mm, 11 cm

Art.-Nr./No.	Winkel / Angle
30-135-00	0°
30-135-30	30°

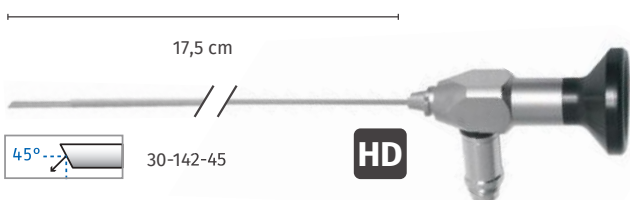

Sinuskop, HD, starr, autoklavierbar, AD 4,0 mm, 17,5 cm

Sinuscope, HD, rigid, autoclavable, OD 4.0 mm, 17.5 cm

Art.-Nr./No.	Winkel / Angle
30-142-45	45°
30-142-90	90°



Sinuskop, HD 4K, autoklavierbar, AD 4,0 mm, 17,5 cm

Sinuscope, HD 4K, autoclavable, OD 4.0 mm, 17.5 cm

Art.-Nr./No.	Winkel / Angle
30-143-00	0°
30-143-30	30°
30-143-70	70°





## 03 NNH-Endoskope

### Sinus Endoscopes

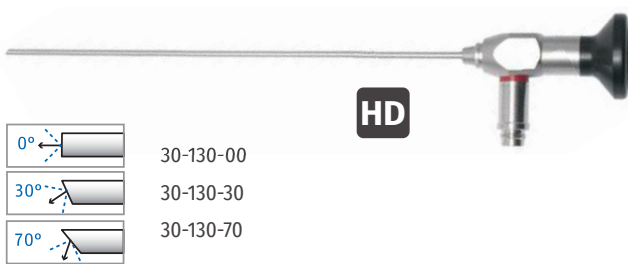

**Sinuskop, HD, starr, autoklavierbar, AD 2,7 mm, 18,75 cm**

**Sinuscope, HD, rigid, autoclavable, OD 2.7 mm, 18.75 cm**

Art.-Nr./No.	Winkel / Angle
30-130-00	0°
30-130-30	30°
30-130-70	70°

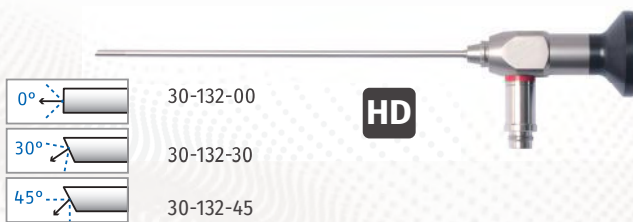

**Sinuskop, HD, starr, autoklavierbar, AD 2,7 mm, 14,1 cm**

**Sinuscope, HD, rigid, autoclavable, OD 2.7 mm, 14.1 cm**

Art.-Nr./No.	Winkel / Angle
30-132-00	0°
30-132-30	30°
30-132-45	45°

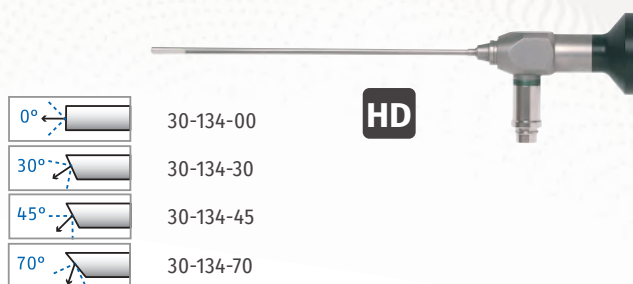

**Sinuskop universal, HD, starr, autoklavierbar, AD 2,7 mm, 11 cm**

**Universal sinuscope, HD, rigid, autoclavable, OD 2.7 mm, 11 cm**

Art.-Nr./No.	Winkel / Angle
30-134-00	0°
30-134-30	30°
30-134-45	45°
30-134-70	70°

## 04 Laryngoskopie-Endoskope

### Laryngoscopy Endoscopes

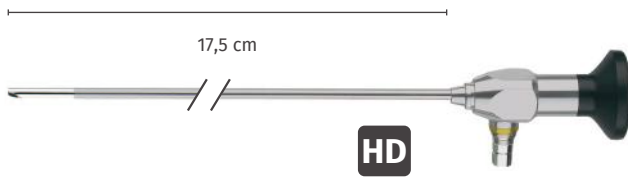

**Laryngoskop, HD, autoklavierbar, AD 4,0 mm, 17,5 cm**

**Laryngoscope, HD, autoclavable, OD 4.0 mm, 17.5 cm**

Art.-Nr./No.	Winkel / Angle
40-100-70	70°
40-100-90	90°

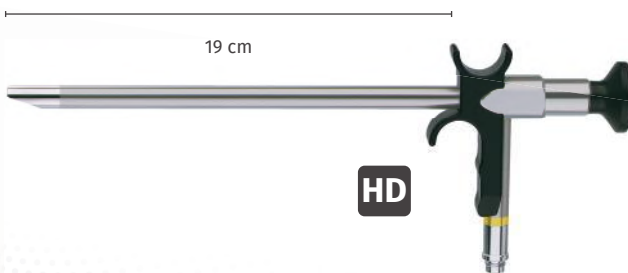

**Laryngoskop, HD, autoklavierbar, AD 10 mm, 19 cm, Handgriff**

**Laryngoscope, HD, autoclavable, OD 10 mm, 19 cm, handle**

Art.-Nr./No.	Winkel / Angle
40-103-70	70°
40-103-90	90°



## 04 Laryngoskopie-Endoskope

### Laryngoscopy Endoscopes



**Zoom Laryngoskop, HD, einlegbar, AD 10 mm, 20 cm, Handgriff**  
**Zoom Laryngoscope, HD, soakable, OD 10 mm, 20 cm, handle**

Art.-Nr./No.	Winkel / Angle
40-105-70	70°
40-105-90	90°



**Laryngoskop, HD, autoklavierbar, AD 8,0 mm, 19,8 cm, 70°**  
**Laryngoscope, HD, autoclavable, OD 8.0 mm, 19.8 cm, 70°**

**40-107-70**

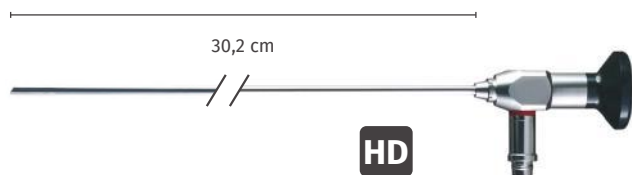

**Laryngoskop, HD, autoklavierbar, AD 2,7 mm, 30,2 cm**  
**Laryngoscope, HD, autoclavable, OD 2.7 mm, 30.2 cm**

Art.-Nr./No.	Winkel / Angle
40-110-00	0°
40-110-30	30°
40-110-70	70°

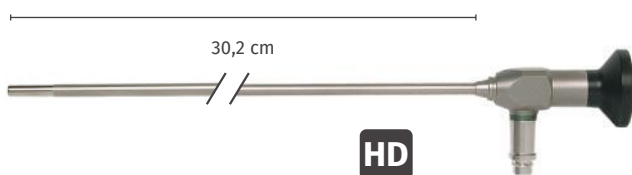

**Laryngoskop, HD, autoklavierbar, AD 4,0 mm, 30,2 cm**  
**Laryngoscope, HD, autoclavable, OD 4.0 mm, 30.2 cm**

Art.-Nr./No.	Winkel / Angle
40-112-00	0°
40-112-30	30°
40-112-70	70°

## 05 Bronchoskopie / Oesophagoskopie-Endoskope

### Bronchoscopy / Oesophagoscopy Endoscopes

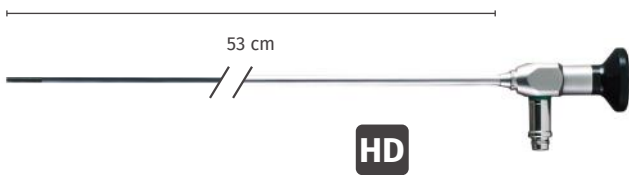

**Oesophagoskop, HD, autoklavierbar, AD 5,5 mm, 53 cm, 0°**  
**Oesophoscope, HD, autoclavable, OD 5.5 mm, 53 cm, 0°**

60-200-00

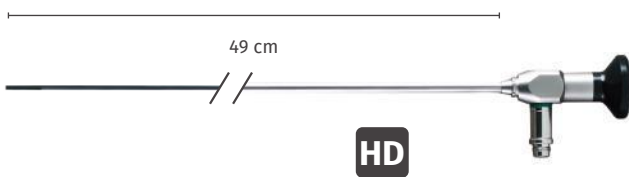

**Bronchoskop, HD, autoklavierbar, AD 5,5 mm, 49 cm**  
**Bronchoscope, HD, autoclavable, OD 5.5 mm, 49 cm**

Art.-Nr./No.	Winkel / Angle
60-202-00	0°
60-202-30	30°

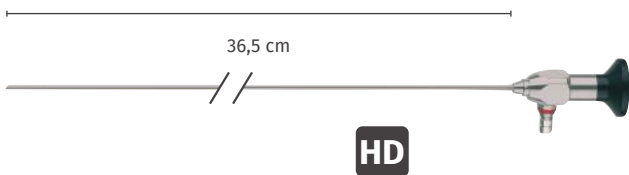

**Bronchoskop, HD, autoklavierbar, AD 2,9 mm, 36,5 cm**  
**Bronchoscope, HD, autoclavable, OD 2.9 mm, 36.5 cm**

Art.-Nr./No.	Winkel / Angle
60-204-00	0°
60-204-30	30°

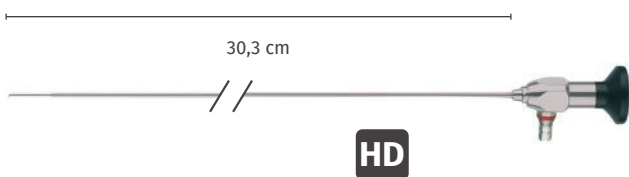

**Bronchoskop, HD, autoklavierbar, AD 2,9 mm, 30,3 cm**  
**Bronchoscope, HD, autoclavable, OD 2.9 mm, 30.3 cm**

Art.-Nr./No.	Winkel / Angle
60-206-00	0°
60-206-30	30°



## 06 Flexible Nasopharyngoskope

### Flexible Nasopharyngoscopes

Arbeitslänge	32 cm
Working length	32 cm
Abwinkelung (auf / ab)	130°
Angle (up / down)	130°
Biegeradius	8 mm
Bending radius	8 mm
Blickfeld	80°
Field of vision	80°
Tiefenschärfe	1-50 mm
Depth of focus	1-50 mm
Gewicht	230 g
Weight	230 g



Art.-Nr./No.

30-170-28	2,8 mm
30-170-36	3,4 mm
30-171-40	4,0 mm mit Arbeitskanal 4.0 mm with working channel

Die SPIGGLE & THEIS Nasopharyngoskope der neuen Generation sind intuitiv bedienbar und ergonomisch geformt. Sie wurden für die notwendige Feinfühligkeit im täglichen Routineeinsatz und für eine ermüdungsfreie Handhabung entwickelt.

Hochwertige Bildleiter und ein leistungsfähiges optisches System liefern große und helle Bilder bester Auflösung - die Voraussetzung für eine sichere Diagnose und Therapie. Dank solider Verarbeitung und konsequenter Verwendung moderner Hochleistungswerkstoffe sind SPIGGLE & THEIS Nasopharyngoskope robuster und langlebiger - trotz steigender Belastung durch moderne Aufbereitungsverfahren.

The new generation of SPIGGLE & THEIS nasopharyngoscopes impresses with intuitive operability and optimal ergonomics, designed for tactile sensation and non-tiring handling as required in daily routine operations.

High-end fibre-optic bundles and a high-capacity system produce large and bright images of the best quality - necessary for safe diagnosis and treatment. Due to the consistent use and reliable processing of high-class materials, the SPIGGLE & THEIS nasopharyngoscopes are robust and durable, in spite of the increasing stress of modern cleaning and sterilizing facilities.

#### Vorteile unserer Endoskope:

- Funktionelles Design für eine einfache und komfortable Handhabung
- Feinfühlig, aber robuste Steuerung
- Optimale Flexibilität und Torsionssteifigkeit des Einführungsschafts
- Leistungsfähiges optisches System: größere, hellere und schärfere Bilder

#### Geeignete Wiederaufbereitungsverfahren:

- Einlegbar in Reinigungs- und Desinfektionslösung
- STERIS
- NTDF-Sterilisation = Niedertemperatur-Dampf-Formaldehyd-Sterilisation
- Maschinelle Aufbereitung (RDG-E)

#### Advantages of our endoscopes:

- Functional design for easy and comfortable handling
- Sensitive yet robust control
- Optimal flexibility and torsional rigidity of the insertion channel
- High-performance optical system for larger, brighter and sharper images

#### Suitable reprocessing procedures:

- Fully immersible in cleaning and disinfectant solutions
- STERIS
- LTSF-sterilization = Low-Temperature Steam and Formaldehydesterilization
- Machine reprocessing (RDG-E)

## 06 Flexible Nasopharyngoskope

### Flexible Nasopharyngoscopes



**Flexible Biopsiezange, Ø 1 mm, ovaler Löffel, für flexibles Endoskop 30-171-40**

**Flexible biopsy forceps, Ø 1 mm, oval cups, for flexible endoscope 30-171-40**

Art.-Nr./No.	Länge / Length (cm)
30-172-40	120
30-172-41	40

**Flexible Alligator-Fasszange, Ø 1 mm, 120 cm, gezahntes Maul, für flexibles Endoskop 30-171-40**

**Flexible alligator forceps, Ø 1 mm, 120 cm, serrated jaws, for flexible endoscope 30-171-40**

Art.-Nr./No.	Länge / Length (cm)
30-173-40	120
30-173-41	40



**Reinigungsbürste mit Grifföse, AL 40 cm, Bürste Ø 2,0 mm, Besatzlänge 10 mm, für Arbeitskanal bis 1,5 mm, 10 Stück / Box, Einweg**

**Cleaning brush with loop, WL 40 cm, brush Ø 2.0 mm, length of edging 10 mm, for working channels up to 1.5 mm, 10 pieces / box, single use**

**30-175-40**



**Desinfektionssystem für starre und flexible Endoskope, 720 x 120 x 60-120 mm**

**Disinfection system for rigid and flexible endoscopes, 720 x 120 x 60-120 mm**

**70-470-00**



**Desinfektions-Wandhalterung für flexible Endoskope, 4 Glasköcher, Aufhängung höhenverstellbar, Timer, 233 x 750 x 60 mm (Lieferung ohne Endoskop)**

**Disinfection wall holder, for flexible endoscopes, 4 glass tubes, hanging height adjustable, timer, 233 x 750 x 60 mm (Delivery without endoscope)**

**70-472-00**



## 07 Endoskopie-Zubehör

### Endoscopy Accessory



**Endoskop-Handgriff, rund, Edelstahl, Griffmulde, 11 cm**  
Endoscope handle, round, stainless steel, moulded grip, 11 cm

Art.-Nr./No.	Beschreibung / Description
30-151-27	für 2,7 mm Endoskop / for 2.7 mm endoscopes
30-151-40	für 4,0 mm Endoskope / for 4.0 mm endoscopes

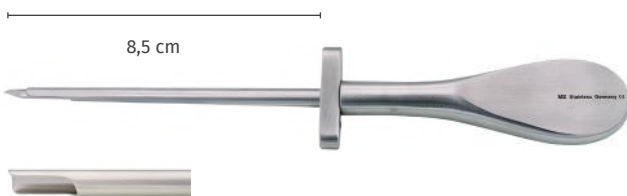

**Antrum-Trokar, schnabelförmig, 5,0 x 4,0 mm, AL 8,5 cm, für 4 mm Endoskope**  
Antrum trocar, beaked, 5.0 x 4.0 mm, WL 8.5 cm, for 4 mm endoscopes

**30-155-50**

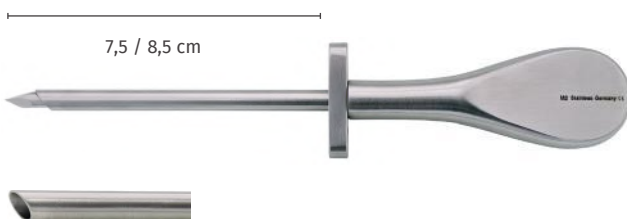

**Antrum-Trokar, schräges Ende, für Endoskope**  
Antrum trocar, oblique tip, for endoscopes

Art.-Nr./No.	Beschreibung / Description
30-156-33	3,3 x 2,8 mm, AL 7,5 cm, für 2,7 mm Endoskope 3.3 x 2.8 mm, WL 7.5 cm, for 2.7 mm endoscopes
30-156-40	4,0 x 3,0 mm, AL 8,5 cm, für 3,0 mm Endoskope 4.0 x 3.0 mm, WL 8.5 cm, for 3.0 mm endoscopes
30-156-50	5,0 x 4,0 mm, AL 8,5 cm, für 4,0 mm Endoskope 5.0 x 4.0 mm, WL 8.5 cm, for 4.0 mm endoscopes



**Ultra-Stop Antibeschlagmittel / Ultra-Stop Anti-Fog solution**

Art.-Nr./No.	Beschreibung / Description
30-160-01	25 ml Pipettenflasche, unsteril 25 ml pipette bottle, non-sterile
30-160-02	30 ml Durchstichflasche, steril 30 ml pierce bottle, sterile
30-160-03	15 ml Sprayflasche, unsteril 15 ml spray bottle, non-sterile





**Dr. Fog original Antibeschlagmittel mit Schwamm, steril**  
**Dr. Fog original anti-fog with sponge, sterile**

**30-160-04**



**Antifog Antibeschlag-Satz, steril, 48 Stück/Box**  
**Antifog-Solution Kit, sterile, 48 pieces/box**

**30-160-05**



**Saug- und Spülhandgriff für Endoskope**  
**Suction and irrigation handle for endoscopes**

**30-161-00**



16 / 17,5 cm



**Saug- und Spülschaft für Endoskop**  
**Suction and irrigation sheath for endoscopes**

Art.-Nr. Art.-No.	Größe Size (mm)	Länge Length (cm)	Winkel Angle
30-164-00	4,0	16,0	0°
30-164-30	4,0	16,0	30°
30-164-45	4,0	16,0	45°
30-164-70	4,0	16,0	70°
30-167-00	2,7	17,5	0°
30-167-30	2,7	17,5	30°

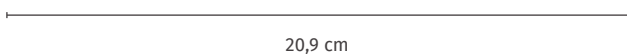

20,9 cm



**Endoskop-Schutzhülse, 20,9 cm, verlängerbar,**  
**autoklavierbar, für ein Endoskop 40-110-xx oder 40-112-xx.**  
**(Für 40-112-xx werden 2 Schutzhülsen benötigt)**

**Endoscope protective sleeve, 20.9 cm, extendable, autoclavable,**  
**for endoscope 40-110-xx or 40-112-xx.**  
**(Two protective sleeves are needed for 40-112-xx)**

**(Two protective sleeves are needed for 40-112-xx)**

**30-182-21**



## 07 Endoskopie-Zubehör

### Endoscopy Accessory



**Endoskopie-Siebkorb mit Deckel, Edelstahl, elektropliert**  
Endoscope container with lid, stainless steel, e-polished

Art.-Nr./No.	Größe / Size (cm)
80-690-01	29 x 8 x 5,2 für 1 Endoskop 29 x 8 x 5.2 for 1 endoscope
80-690-02	29 x 8 x 5,2 für 2 Endoskope 29 x 8 x 5.2 for 2 endoscopes



**Endoskopie-Siebkorb mit Deckel, Edelstahl, elektropliert**  
Endoscope container with lid, stainless steel, e-polished

Art.-Nr./No.	Größe / Size (cm)
80-691-01	46 x 8 x 5,2 für 1 Endoskop 46 x 8 x 5.2 for 1 endoscope
80-692-01	67 x 8 x 5,2 für 1 Endoskop 67 x 8 x 5.2 for 1 endoscope



**Endoskopie Sterilisations Container für 2 Endoskope,**  
Ø 2,5 - 5,0 mm, bis 19,5 cm Länge  
Endoscope sterilizing tray for 2 endoscopes,  
Ø 2.5 - 5.0 mm, up to 19.5 cm length

**80-621-05**



**Endoskopie Sterilisations-Container für 6 Endoskope,**  
Ø 2,5 - 5,0 mm, bis 19,5 cm Länge, 1 Lichtkabel  
Endoscope sterilizing & protecting tray for 6 endoscopes,  
Ø 2.5 - 5.0 mm, up to 19.5 cm length, 1 light-cable

**80-622-56**



**Endoskopie Sterilisations-Container für 2 Endoskope**  
Ø 2,5 - 5,0 mm, bis 19,5 cm Länge, 1 Lichtkabel, 1 Kamerakopf  
Endoscope sterilizing & protecting tray for 2 endoscopes  
Ø 2.5 - 5.0 mm, up to 19.5 cm length, 1 light-cable, 1 camera head

**80-623-22**



**Fußschalter für USB-Kamera 3 Tasten**  
3 button footswitch for USB camera

**70-102-00**



**Steckernetzteil, 115/240 V, 5 V, 6 W, für 30-169-01**  
Plug-in power supply, 115/240 V, 5 V, 6 W, for 30-169-01

**30-169-03**

**Belüftungskappe**  
Ventilation cap

**30-169-04**

**Adapter für Dichtigkeitstester, Typ Olympus/Xion**  
Adapter for air-pressure tester, type Olympus/XION

**30-169-05**

**Adapter Flexible Endoskope auf RDG-E**  
Connector flexible endoscopes to RDG-E

**30-169-06**

**Dichtigkeitstester für flexible Endoskope**  
Air-pressure tester for flexible endoscopes

**30-169-07**



## 09 Lichtquellen und Lichtkabel

### Lightsources and Cables



**MATRIX LED duo 2,**  
**LED Hochleistungslichtquelle, 2 Lichtauslässe, 100-240 V**  
**MATRIX LED duo 2,**  
**LED high-performance light source, 2 light outputs, 100-240 V**  
**70-203-00**

**Ersatzlampe Halogen, 150 Watt,**  
**für Halogen-Lichtquelle 150 Duo (70-203-15)**  
**Halogen sparelight, 150 Watt,**  
**for light source R 150 Duo (70-203-15)**  
**70-294-15**

**Ersatzlampe Halogen, 250 Watt,**  
**für Halogen-Lichtquelle 250 Duo (70-204-25)**  
**Halogen sparelight, 150 Watt,**  
**for light source R 250 Duo (70-204-25)**  
**70-294-25**



**Hochleistungs-Fiberglas-Lichtleitkabel, 3,5 mm, 1800 mm,**  
**Y-Form, 1x Geräteseite, 2x Instrumentenseite,**  
**Storz/Storz-Adapter, autoklavierbar**  
**High definition fibre light cable, 3.5 mm, 1800 mm, Y-shape,**  
**1x device side, 2x instrument side, Storz/Storz adapter,**  
**autoclavable**  
**70-270-35**

#### LED-Leuchtgriffe / LED light handles

Art-Nr./No.

70-211-00 LED-Hochleistungs-Leuchtgriff, 230 V, bestehend aus:  
(70-211-10, 70-211-20, 70-211-30, 70-211-40)  
LED high performance light-handle, 230 V, consisting of:  
(70-211-10, 70-211-20, 70-211-30, 70-211-40)

70-211-01 LED-Hochleistungs-Leuchtgriff, 120 V, bestehend aus:  
(70-211-10, 70-211-20, 70-211-30, 70-211-50)  
LED high performance light-handle, 120 V, consisting of:  
(70-211-10, 70-211-20, 70-211-30, 70-211-50)

70-211-10 LED-Handgriff, schwarz, mit Helligkeitsdimmer, Ausschaltautomatik, 3 W, 5500° K, 17500 Lux, zur Verwendung mit Li-Ionen-Akku 3,5 V und Endoskop-Adapter, 50 Std. Brenndauer  
LED light handle, black, with brightness dimmer, automatic switch-off, 3 W, 5500° K, 17500 lux, to use with Li-ion chargeable battery 3.5 V and endoscope adapter, 50 hours run-time

70-211-20 Li-Ionen-Akku, 3,5 V, für LED-Handgriff  
Li-ion rechargeable battery, 3.5 V, for LED light-handle

70-211-30 Endoskopie-Adapter für LED-Handgriff, passend für Standardgewinde an Endoskopen (AcMI-Gewinde)  
Endoscope adapter for LED light-handle, fits standard endoscope threads (AcMi-thread)

70-211-40 Ladegerät für bis zu 2 LED-Handgriffe, 3,5 V, 230 V, Standgerät, Wandhalterung  
Charging base for up to 2 LED light-handles, 3.5 V, 230 V, table model, with wall holder

70-211-50 Ladegerät für bis zu 2 LED-Handgriffe, 3,5 V, 120 V, Standgerät, Wandhalterung  
Charging base for up to 2 LED light-handles, 3.5 V, 120 V, table model, with wall holder





## 09 Lichtquellen und Lichtkabel

### Lightsources and Cables



**Hochleistungs-Fiberglas-Lichtleitkabel,  
ohne Anschlüsse, autoklavierbar**  
High definition fibre light cable,  
without connections, autoclavable

Art.-Nr./No.	AD / OD (mm)	Länge / Length (cm)
70-255-35	3,5	180
70-255-48	4,8	180
70-256-35	3,5	230
70-256-48	4,8	230
70-257-35	3,5	300
70-257-48	4,8	300



**Hochleistungs-Fiberglas-Lichtleitkabel,  
SPIGGLE & THEIS-Anschlüsse, autoklavierbar**  
High definition fibre light cable,  
SPIGGLE & THEIS connection, autoclavable

Art.-Nr./No.	AD / OD (mm)	Länge / Length (cm)
70-258-35	3,5	180
70-258-48	4,8	180
70-259-35	3,5	230
70-259-48	4,8	230
70-260-35	3,5	300
70-260-48	4,8	300



**Hochleistungs-Fiberglas-Lichtleitkabel,  
Ø 3,5 mm, 1800 mm, 90° abgewinkelt, autoklavierbar**  
High definition fibre light cable,  
Ø 3.5 mm, 1800 mm, 90° angled, autoclavable

Art.-Nr./No.	Beschreibung / Description
70-265-01	Wolf/Wolf-Adapter / connector Geräteseitig abgewinkelt / lightsource side angled
70-265-02	Storz/Storz-Adapter / connector Geräteseitig abgewinkelt / lightsource side angled



**Hochleistungs-Fiberglas-Lichtleitkabel,  
Ø 3,5 mm, 90° abgewinkelt, autoklavierbar**  
High definition fibre light cable,  
Ø 3.5 mm, 90° angled, autoclavable

Art.-Nr./No.	Länge / Length (mm)
70-266-02	1800
70-267-03	3000

## 09 Lichtquellen und Lichtkabel

### Lightsources and Cables



Lichtleitkabel-Tester für Olympus  
Fibre light cable tester for Olympus

70-277-00



SPIGGLE & THEIS/Storz-Adapter  
für Lichtleitkabel, endoskopseitig  
SPIGGLE & THEIS/Storz connection  
for light cable, endoscope side

70-270-01



SPIGGLE & THEIS/Storz-Adapter  
für Lichtleitkabel, geräteseitig  
SPIGGLE & THEIS/Storz connection  
for light cable, lightsource side

70-271-01



Wolf-Adapter für Lichtleitkabel,  
endoskopseitig  
Wolf connection  
for light cable, endoscope side

70-270-02



Wolf-Adapter für Lichtleitkabel,  
geräteseitig  
Wolf connection for light cable,  
lightsource side

70-271-02



Acmi-Adapter  
für Lichtleitkabel, endoskopseitig  
Acmi connection  
for light cable, endoscope side

70-270-03



Acmi-Adapter  
für Lichtleitkabel, geräteseitig  
Acmi connection  
for light cable, lightsource side

70-271-03



Olympus-Adapter für Lichtleitkabel  
Olympus connector for fibre light cable

70-271-04





## Alphabetisches Inhaltsverzeichnis

### Alphabetical Index

Acmi-Adapter .....	25	Acmi connection.....	25
Adapter .....	25	Adapter .....	25
Antifog.....	19	Antifog.....	19
Antrum Trokar .....	18	Antrum trocar.....	18
Belüftungskappe.....	21	Air-pressure tester.....	21
Bronchoskop .....	15	Bronchoscope .....	15
Desinfektions-Wandhalterung.....	17	Cleaning brush.....	19
Dichtigkeitstester.....	21	Cleaning set.....	19
Endoskop-Handgriff.....	18	Disinfection system.....	17
Endoskop-Schutzhülse.....	19	Ear-endoscope.....	10
Endoskopie-Siebkorb.....	20	Endoscope container .....	21
Endoskopie Sterilisations Container.....	20	Endoscope handle.....	20
Ersatzlampe .....	22	Endoscope sterilizing tray.....	22
Flexible Alligatorzange .....	17	Endoscope protection sleeve .....	21
Flexibles Nasopharyngoskope .....	16	Flexible alligator forceps .....	17
Flexible Löffelzange.....	17	Flexible nasopharyngoscopes.....	16
Flexible Reinigungsbürste .....	17	Flexible cup forceps .....	17
Fußschalter .....	21	Footswitch.....	21
Gehörgangs-Endoskop .....	10	Fibre light cable tester.....	31
Hochleistungs Fiberglas Licht-Leitkabel .....	22, 24	High definition fibre light cable.....	22, 24
Laryngoskop .....	13, 14	Irrigation and sterilization basket .....	19
LED-Leuchtgriffe.....	23	Laryngoscope.....	13 - 14
Lichtleitkabel-Tester .....	25	LED light handles .....	23
Oesophagoskop.....	15	Lightsource .....	22
Otoskop .....	10, 11	Oesophagoscope.....	15
Prof. Panetti .....	5 - 8	Otoscope .....	10 - 11
Reinigungsbürste .....	17	Prof. Panetti .....	5 - 8
Reinigungs-Set.....	19	Plug-in power supply.....	21
Saug- und Spülschaft .....	19	Sinuscope.....	11 - 12
Saug- und Spülhandgriff.....	19	Soundbar activebox set .....	25
Sinuskop.....	11, 12	Spiggle&Theis/Storz connection.....	25
Steckernetzteil.....	21	Suction and irrigation handle .....	20
Spiggle&Theis/Storz-Adapter .....	25	Suction and irrigation sheath .....	21
Spül-und Sterilisierkorb .....	20	Ultra-Stop-anti fog solution .....	20
Ultra-Stop Antibeschlagmittel.....	18	Ventilation cap.....	21
Wolf-Adapter.....	25	Wolf connection .....	25
Zoom Laryngoskop .....	14	Zoom laryngoscope.....	14

10-090-00.....	10	30-142-45.....	11	70-203-00.....	22
10-090-30.....	10	30-142-90.....	11	70-211-00.....	23
10-090-45.....	10	30-143-00.....	11	70-211-01.....	23
10-102-00.....	10	30-143-30.....	11	70-211-10.....	23
10-102-30.....	10	30-143-70.....	11	70-211-20.....	23
10-104-00.....	10	30-151-27.....	18	70-211-30.....	23
10-104-30.....	10	30-151-40.....	18	70-211-40.....	23
10-106-00.....	10	30-155-50.....	18	70-211-50.....	23
10-107-30.....	10	30-156-33.....	18	70-255-35.....	24
10-108-00.....	10	30-156-40.....	18	70-255-48.....	24
10-108-99.....	10	30-156-50.....	18	70-256-35.....	24
10-109-00.....	10	30-160-01.....	18	70-256-48.....	24
10-109-30.....	10	30-160-02.....	18	70-257-35.....	24
10-109-45.....	10	30-160-03.....	18	70-257-48.....	24
10-109-70.....	10	30-160-04.....	19	70-258-35.....	24
10-111-00.....	11	30-160-05.....	19	70-258-48.....	24
10-111-30.....	11	30-161-00.....	19	70-259-35.....	24
10-111-45.....	11	30-164-00.....	19	70-259-48.....	24
10-111-70.....	11	30-164-30.....	19	70-260-35.....	24
10-703-03.....	5	30-164-45.....	19	70-260-48.....	24
10-703-07.....	5	30-164-70.....	19	70-265-01.....	24
10-800-12.....	6	30-167-00.....	19	70-265-02.....	24
10-801-12.....	6	30-167-30.....	19	70-266-02.....	24
10-802-12.....	6	30-169-03.....	21	70-267-03.....	24
10-803-12.....	6	30-169-04.....	21	70-270-01.....	25
10-804-12.....	6	30-169-05.....	21	70-270-02.....	25
10-805-12.....	6	30-169-06.....	21	70-270-03.....	25
10-806-12.....	6	30-169-07.....	21	70-270-35.....	22
10-807-12.....	6	30-170-28.....	16	70-271-01.....	25
10-808-12.....	7	30-170-36.....	16	70-271-02.....	25
10-809-12.....	7	30-171-40.....	16	70-271-03.....	25
10-810-12.....	7	30-172-40.....	17	70-277-00.....	25
10-811-12.....	7	30-172-41.....	17	70-278-00.....	25
10-812-12.....	7	30-173-40.....	17	70-279-00.....	25
10-813-12.....	7	30-173-41.....	17	70-294-15.....	22
10-814-12.....	7	30-174-40.....	17	70-294-25.....	22
10-815-12.....	7	30-182-21.....	19	70-470-00.....	17
10-816-12.....	7	40-100-70.....	13	70-472-00.....	17
10-817-12.....	8	40-100-90.....	13	70-266-02.....	8, 24
10-818-12.....	8	40-103-70.....	13	70-267-03.....	8, 24
10-819-12.....	8	40-103-90.....	13	80-621-05.....	20
10-851-00.....	8	40-105-70.....	14	80-622-56.....	20
10-840-01.....	8	40-105-90.....	14	80-623-22.....	20
10-841-01.....	8	40-107-70.....	14	80-690-01.....	20
10-845-01.....	8	40-110-00.....	14	80-690-02.....	20
10-867-12.....	6	40-110-30.....	14	80-691-01.....	20
30-130-00.....	12	40-110-70.....	14	80-692-01.....	20
30-130-30.....	12	40-112-00.....	14		
30-130-70.....	12	40-112-30.....	14		
30-132-00.....	12	40-112-70.....	14		
30-132-30.....	12	60-200-00.....	15		
30-132-45.....	12	60-202-00.....	15		
30-134-00.....	12	60-202-30.....	15		
30-134-30.....	12	60-204-00.....	15		
30-134-45.....	12	60-204-30.....	15		
30-134-70.....	12	60-206-00.....	15		
30-135-00.....	11	60-206-30.....	15		
30-135-30.....	11	70-102-00.....	21		







## Umrechnungstabelle - Ch/Fr - mm - inch

### Conversion table - Ch/Fr - mm - inch

Charrière (CH) French (F)	mm	Inch
1	0,33	0,013
2	0,67	0,025
3	1,00	0,039
4	1,33	0,051
5	1,67	0,065
6	2,00	0,079
7	2,33	0,092
8	2,67	0,105
9	3,00	0,118
10	3,33	0,131
11	3,67	0,144
12	4,00	0,156
13	4,33	0,170
14	4,67	0,184
15	5,00	0,197
16	5,33	0,210
17	5,67	0,223
18	6,00	0,237
19	6,33	0,249
20	6,67	0,263
21	7,00	0,276
22	7,33	0,288
23	7,67	0,302
24	8,00	0,315
25	8,33	0,328
26	8,67	0,341
27	9,00	0,354
28	9,33	0,367
29	9,67	0,380
31	10,23	0,407
32	10,67	0,420
34	11,33	0,446
36	12,00	0,472
38	12,67	0,494
40	13,33	0,520
45	15,00	0,591





Burghof 14 · 51491 Overath · Germany  
Phone: +49 2206 90 81 - 0  
Fax: +49 2206 90 81 - 13  
info@spiggle-theis.com  
www.spiggle-theis.com

© 2022 by SPIGGLE & THEIS Medizintechnik GmbH

Änderungen und Irrtümer – einschließlich Bilder - vorbehalten.  
Produktsortiment kann pro Land abweichen.

Modifications and errors - including pictures - reserved.  
Product range might vary per country.



PO Box 3403, Erina, NSW, 2250, Australia

**P: +61 2 9810 6947**

admin@coremed.com.au

**www.coremed.com.au**



# Koagulation Coagulation

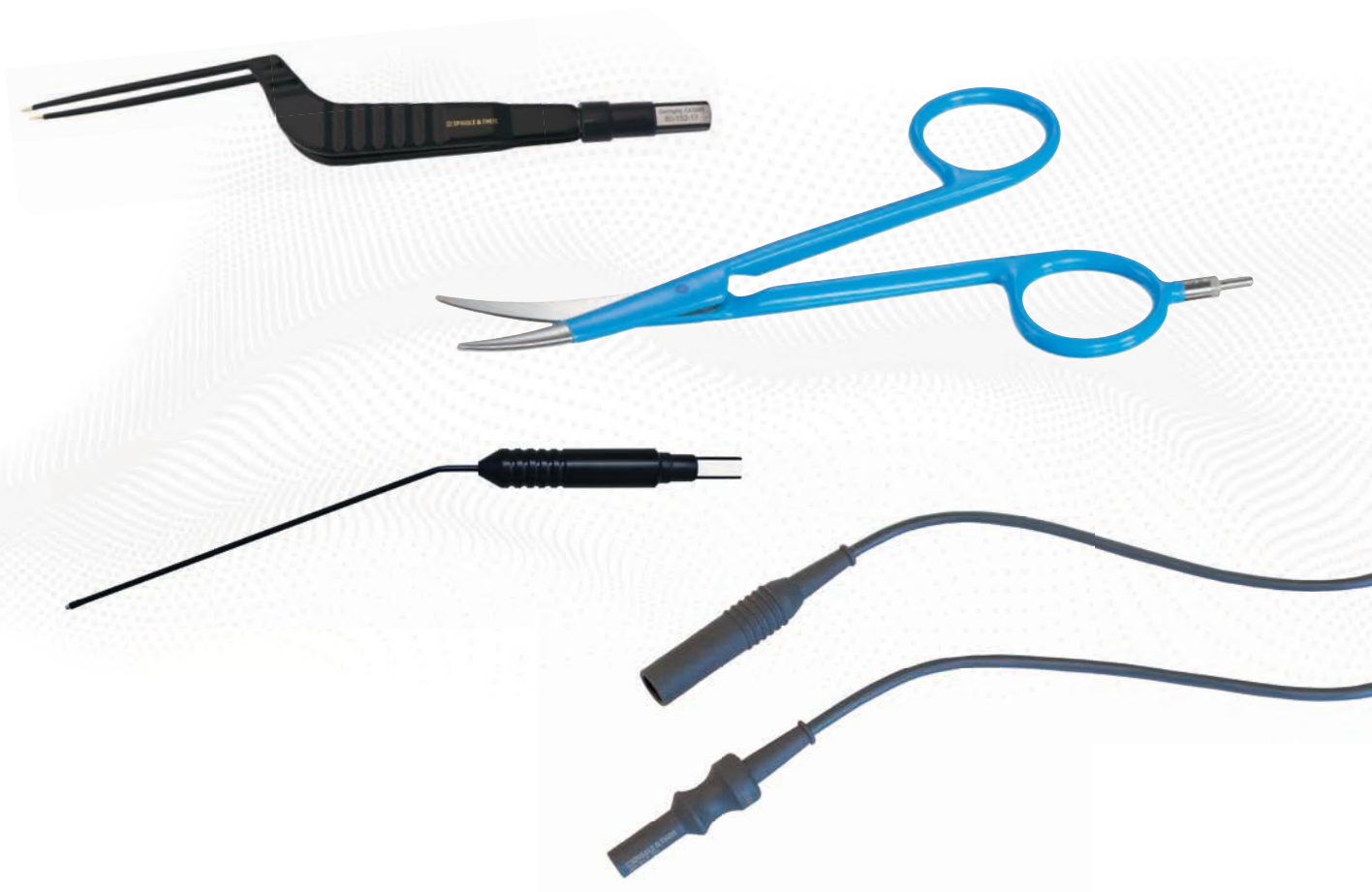





# Über uns

---

## About Us

### Geschichte

**SPIGGLE & THEIS Medizintechnik GmbH** wurde 1994 von den Geschäftsführern **David Spiggle** und **Detlef Theis** gegründet. Bis heute haben wir uns vom reinen Vertriebsunternehmen zu einem renommierten Hersteller von Medizinprodukten im Bereich der HNO-Chirurgie weiterentwickelt. Weltweit exportieren wir in über 75 Länder und in Deutschland zählen mehr als 700 Kliniken zu unseren Kunden.

### Das Maß der Dinge

Im chirurgischen Instrumentenbau gilt das Siegel **“Made in Germany“** auch heute noch als Inbegriff von Qualität. Unsere chirurgischen Instrumente werden in allen Produktionsstufen unter strengsten Qualitätsanforderungen nahezu komplett in Deutschland produziert und sind somit noch größtenteils echt **“Made in Germany“**. Zur Verarbeitung wird ausschließlich Instrumentenstahl bester Güte verwendet, welcher den hohen Anforderungen moderner Chirurgie auch dauerhaft gerecht wird.

### Sicherheit

Die Gesundheit der Patienten und somit die Sicherheit und Qualität unserer Produkte stehen im Mittelpunkt unseres Handelns. In diesem Sinne ist **SPIGGLE & THEIS Medizintechnik GmbH** bereits seit 1997 **ISO-zertifiziert** und sind unsere Produkte nach der strengen europäischen Richtlinie für Medizinprodukte CE-gekennzeichnet. Alle unsere Produkte unterliegen einer permanenten Qualitätskontrolle - von der Auswahl des Rohmaterials über die einzelnen Fertigungsschritte bis zum Versand.

### Erfahrung

Unsere Mitarbeiter haben zum Teil mehr als 30 Jahre Berufserfahrung im Umgang mit chirurgischen Instrumenten. Durch dieses umfassende Know-How sowie den langjährigen und individuellen Kontakt mit den Anwendern, besitzen wir nicht nur theoretisches Wissen, sondern kennen auch deren Bedürfnisse und Ansprüche. Dies hilft uns bei der steten, praxisorientierten Weiterentwicklung unserer Produkte. Somit garantieren wir hohe Kompetenz und individuellen Service bei der Betreuung unserer Kunden.

### History

**SPIGGLE & THEIS Medizintechnik GmbH** was founded in 1994 by the managing directors **David Spiggle** and **Detlef Theis**. The company has evolved from being purely a distributor to the established manufacturer of medical products in the area of ENT that it is today. We can count over 700 clinics amongst our German customers and export to over 75 countries world-wide.

### The Seal Of Highest Quality

The stamp **“Made in Germany“** is still the epitome of quality standards in the production of surgical instruments in the world today. The majority of our surgical instruments is subjected to the strictest quality requirements at every step of their production, in the truest sense of the words, **“Made in Germany“**. Only the highest standard of instrument steel, capable of consistently meeting the demands of modern surgery, is used in the production.

### Safety First

The health of our patients and therefore the safety and quality of our products plays the central role in our decisions. **SPIGGLE & THEIS Medizintechnik GmbH** has been **ISO certified**. Our products are CE-marked in accordance with the strict European guideline for medical products since 1997. All our products undergo continual quality checks, from the selection of raw materials, to the individual stages of production and finally their dispatch.

### Experience

Our colleagues in instrument development can look back on over 30 years of professional practical experience with ENT surgical instruments. We offer more than theoretical knowledge – we understand our customer needs. We enjoy close, personal contact to many of the best surgeons world-wide. This enables us to continually develop innovative products. We guarantee the highest level of competence and individual service in meeting our customer requirements.



## Inhaltsverzeichnis

### Table of contents

01	Bipolare Pinzetten / Bipolar Forceps .....	5 - 13
02	Bipolare Ringpinzetten / Bipolar Ring-Forceps .....	14
03	Bipolare Elektroden / Bipolar Electrodes .....	15
04	MICRODOME Bipolare Koagulations Elektroden / MICRODOME Bipolar Coagulation Electrodes .....	16
05	Bipolare Scheren / Bipolar Scissors .....	16
06	Dieler Bipolare Koagulationszangen / Dieler Bipolar Coagulation Forceps .....	17
07	HF-Chirurgie-Gerät / HF-Surgical-Unit .....	20
08	Bipolares Zubehör / Bipolare Accessory .....	21 - 22
09	Monopolares Zubehör / Monopolar Accessory .....	23 - 26
10	Zubehör / Accessory .....	27
	Index.....	28 - 29

#### Attention:

Not every instrument is available in all markets. Availability depends on local regulations. Please contact your SPIGGLE & THEIS representative or distributor, if you have any questions about the availability of our products in your region.

# NON-STICK Bipolare Pinzette

## NON-STICK Bipolar Forceps

Bis heute stellt das Verkleben beim Koagulieren mit bipolaren Pinzetten ein verbreitetes Problem für den Operateur dar. **NON-STICK Bipolare Pinzetten** lösen dieses Problem.

Punktuelle Überhitzungen werden vermieden.  
Das Gewebe löst sich leicht von der Pinzette.

Diese Eigenschaften bleiben bei ordnungsgemäßer Anwendung über die gesamte Lebensdauer des Instruments erhalten.

An adhesion when coagulating with bipolar forceps is a common problem for the surgeon. Our **NON-STICK bipolar forceps** solve this problem.

No punctual overheating.  
Tissue detaches easily from forceps.

With correct usage these characteristics remain over the entire life time of the instrument.



### Vorteile:

- Kein Verkleben durch Arbeitsteile aus massivem Silber
- Präzises Arbeiten ohne Unterbrechungen
- Perfekte Parallelführung durch Stopp-Führungsstift
- Flächiges Koagulieren durch "Perfect-Grip"-Arbeitsteil
- Autoklavierbar
- Passend für alle gängigen HF-Systeme durch Standard-Anschluss

### Advantages:

- No adhesion due to solid silver tips
- Precise working without interruptions
- Perfect parallel motion through guide pin
- Areal coagulation with "Perfect Grip" working part
- Autoclavable
- Standard adapter grants compatibility to all current HF-systems





## 01 Bipolare Pinzetten, X-FINE, NON-STICK, bajonett, Führungsstift

### Bipolar Forceps, X-FINE, NON-STICK, bayonet, guide pin



#### Spitze gerade / tip straight

Art.-Nr. Art.-No.	Länge Length (cm)	Spitze Tip (mm)
80-150-17	17	0,4 x 4,0
80-150-20	20	0,4 x 4,0
80-150-23	23	0,4 x 4,0
80-150-25	25	0,4 x 4,0
80-152-17	17	0,7 x 4,0
80-152-20	20	0,7 x 4,0
80-152-23	23	0,7 x 4,0



#### Spitze gerade 0,4 x 4,0 mm, Schaft leicht gebogen, für Ohrtrichter Tip straight 0.4 x 4.0 mm, shaft slightly curved, for ear specula

80-151-17



#### Spitze aufwärts gewinkelt / tip upwards angled

Art.-Nr. Art.-No.	Länge Length (cm)	Spitze Tip (mm)
80-156-20	20	0,4 x 4,0
80-156-23	23	0,4 x 4,0



#### Spitze abwärts gewinkelt / tip downwards angled

Art.-Nr. Art.-No.	Länge Length (cm)	Spitze Tip (mm)
80-158-20	20	0,4 x 4,0
80-158-23	23	0,4 x 4,0

## 01 Bipolare Pinzetten, NON-STICK, Führungsstift

### Bipolar Forceps, NON-STICK, guide pin

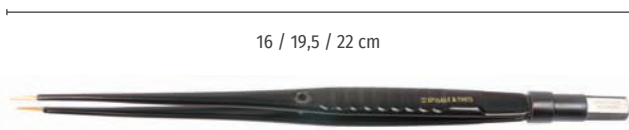

16 / 19,5 / 22 cm

#### gerade / straight

Art.-Nr. Art.-No.	Länge Length (cm)	Spitze Tip (mm)
80-100-16	16,0	0,5 x 8,0
80-100-19	19,5	0,5 x 8,0
80-101-16	16,0	1,0 x 8,0
80-101-19	19,5	1,0 x 8,0
80-101-22	22,0	1,0 x 8,0
80-103-16	16,0	2,0 x 8,0
80-103-19	19,5	2,0 x 8,0



16 / 19,5 / 25 cm

#### gerade, Spitze gewinkelt / straight, tip angled

Art.-Nr. Art.-No.	Länge Length (cm)	Spitze Tip (mm)
80-105-16	16,0	0,5 x 8,0
80-105-19	19,5	0,5 x 8,0
80-106-16	16,0	1,0 x 8,0
80-106-19	19,5	1,0 x 8,0
80-106-25	25,0	1,0 x 8,0
80-107-16	16,0	2,0 x 8,0
80-107-19	19,5	2,0 x 8,0



16 / 19,5 cm

#### bajonett / bayonet

Art.-Nr. Art.-No.	Länge Length (cm)	Spitze Tip (mm)
80-109-16	16,0	0,2 x 5,0
80-110-16	16,0	0,5 x 8,0
80-110-19	19,5	0,5 x 8,0
80-111-16	16,0	1,0 x 8,0
80-111-19	19,5	1,0 x 8,0
80-112-16	16,0	2,0 x 8,0
80-112-19	19,5	2,0 x 8,0



19,5 / 23 cm

#### bajonett / bayonet

Art.-Nr. Art.-No.	Länge Length (cm)	Spitze Tip (mm)
80-113-19	19,5	0,2 x 5,0
80-113-23	23,0	0,2 x 5,0
80-114-19	19,5	0,5 x 6,0
80-115-19	19,5	1,0 x 6,0
80-116-19	19,5	1,5 x 6,0





## 01 Bipolare Pinzetten, NON-STICK, Führungsstift

### Bipolar Forceps, NON-STICK, guide pin



**bajonett, Spitze nach oben gewinkelt, 19,5 cm**  
**bayonet, tip angled upwards, 19.5 cm**

Art.-Nr./No.	Spitze / Tip (mm)
80-117-19	0,2 x 8,0
80-118-19	1,0 x 8,0
80-119-19	2,0 x 8,0



**bajonett, Spitze nach oben gewinkelt, 14 mm, 4 mm unisoliert, 1,5 mm, 19,5 cm**  
**bayonet, tip upwards angled, 14 mm, 4 mm uninsulated, 1.5 mm, 19.5 cm**

**80-120-19**



**Meuser, 60° gebogen, 2 mm, 18 cm**  
**Meuser, 60° curved, 2 mm, 18 cm**

**80-121-18**



**kniegebogen, extra fein, 0,2 x 8,0 mm, 16,5 cm**  
**angled, extra fine, 0.2 x 8.0 mm, 16.5 cm**

**80-123-16**



**bajonett, Spitze nach oben gewinkelt, 25 cm**  
**bayonet, tip upwards angled, 25 cm**

Art.-Nr. Art.-No.	Spitze Tip (mm)	
80-127-03	0,3 x 8,0	
80-127-07	0,7 x 8,0	
80-127-12	1,2 x 8,0	
80-127-20	2,0 x 8,0	
80-129-12	1,2 x 14,0	8 mm unisoliert uninsulated

## 01 Bipolare Pinzetten, NON-STICK, bajonett, Führungsstift

### Bipolar Forceps, NON-STICK, bayonet, guide pin



**Spitze nach unten gewinkelt, 25 cm**

**Tip downwards angled, 25 cm**

Art.-Nr./No.	Spitze / Tip (mm)
80-128-03	0,3 x 8,0
80-128-07	0,7 x 8,0
80-128-12	1,2 x 8,0
80-128-20	2,0 x 8,0



**Spitze gerade / tip straight**

Art.-Nr./No.	Spitze / Tip (mm)
80-125-03	0,3 x 8,0
80-125-07	0,7 x 8,0
80-125-12	1,2 x 8,0
80-125-20	2,0 x 8,0

## 01 Bipolare Saugpinzetten

### Bipolar Suction Forceps



**Meuser mit Absaugung, 45° gebogen, 3,2 mm, 21 cm**

**Meuser with suction, 45° upcurved, 3.2 mm, 21 cm**

**80-122-18**

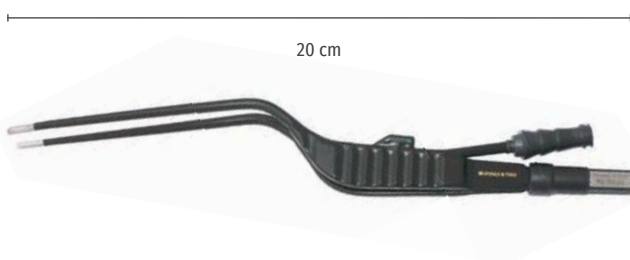

**Saugunterbrecher, bajonett, 20 cm**

**Suction control, bayonet, 20 cm**

Art.-Nr./No.	Spitze / Tip (mm)
80-183-14	1,4 x 8,0
80-183-20	2,2 x 8,0



# Bipolare Pinzette **Rotation+**

## Bipolar Forceps **Rotation+**

Integrierte Führung für präzises und  
paralleles Schließen der Spitzen  
Integrated guide ensures precise  
and parallel closing of the tips

Schlanke Pinzettenschenkel  
ermöglichen das Arbeiten in  
schwer zugänglichen Bereichen  
Slim forceps shanks allow work  
in narrow areas

Hochwertige Rilsanbeschichtung  
High-quality Rilsan coating

Non-Stick Pinzettenspitzen ver-  
meiden das Anhaften von Gewebe  
Non-Stick forceps tips prevent  
the adherence of tissue

## 01 Rotation+ Bipolare Pinzetten, NON-STICK, integrierte Führung

### Rotation+ Bipolar Forceps, NON-STICK, integrated guidance



gerade, Spitze gerade / straight, straight tip

Art.-Nr. Art.-No.	Länge Length (cm)	Spitze Tip (mm)
80-280-16	15,5	0,3
80-280-18	18,0	0,3
80-280-20	20,0	0,3
80-280-23	22,5	0,3



gerade, Spitze gerade / straight, straight tip

Art.-Nr. Art.-No.	Länge Length (cm)	Spitze Tip (mm)
80-281-16	15,5	0,6
80-281-18	18,0	0,6
80-281-20	20,0	0,6
80-281-23	22,5	0,6



gerade, Spitze gerade / straight, straight tip

Art.-Nr. Art.-No.	Länge Length (cm)	Spitze Tip (mm)
80-282-16	15,5	1,0
80-282-18	18,0	1,0
80-282-20	20,0	1,0
80-282-23	22,5	1,0



gerade, Spitze gerade / straight, straight tip

Art.-Nr. Art.-No.	Länge Length (cm)	Spitze Tip (mm)
80-283-16	15,5	2,0
80-283-18	18,0	2,0
80-283-20	20,0	2,0
80-283-23	22,5	2,0



## 01 Rotation+ Bipolare Pinzetten, NON-STICK, integrierte Führung

### Rotation+ Bipolar Forceps, NON-STICK, integrated guidance



gerade, Spitze gewinkelt / straight, angled tip

Art.-Nr. Art.-No.	Länge Length (cm)	Spitze Tip (mm)
80-285-16	15,5	0,3
80-285-18	18,0	0,3
80-285-20	20,0	0,3
80-285-23	22,5	0,3



gerade, Spitze gewinkelt / straight, angled tip

Art.-Nr. Art.-No.	Länge Length (cm)	Spitze Tip (mm)
80-286-16	15,5	0,6
80-286-18	18,0	0,6
80-286-20	20,0	0,6
80-286-23	22,5	0,6



gerade, Spitze gewinkelt / straight, angled tip

Art.-Nr. Art.-No.	Länge Length (cm)	Spitze Tip (mm)
80-287-16	15,5	1,0
80-287-18	18,0	1,0
80-287-20	20,0	1,0
80-287-23	22,5	1,0



gerade, Spitze gewinkelt / straight, angled tip

Art.-Nr. Art.-No.	Länge Length (cm)	Spitze Tip (mm)
80-288-16	15,5	2,0
80-288-18	18,0	2,0
80-288-20	20,0	2,0
80-288-23	22,5	2,0

## 01 Rotation+ Bipolare Pinzetten, NON-STICK, integrierte Führung

### Rotation+ Bipolar Forceps, NON-STICK, integrated guidance



#### bajonett, Spitze gerade / bayonet, straight tip

Art.-Nr. Art.-No.	Länge Length (cm)	Spitze Tip (mm)
80-300-25	25,0	0,3
80-301-25	25,0	0,6
80-302-25	25,0	1,0
80-303-25	25,0	1,5
80-304-25	25,0	2,0



#### bajonett, Spitze gerade / bayonet, straight tip

Art.-Nr. Art.-No.	Länge Length (cm)	Spitze Tip (mm)
80-310-18	18,0	0,3
80-311-18	18,0	0,6
80-312-18	18,0	1,0
80-313-18	18,0	1,5
80-314-18	18,0	2,0



#### bajonett, Spitze gerade / bayonet, straight tip

Art.-Nr. Art.-No.	Länge Length (cm)	Spitze Tip (mm)
80-315-20	20,0	0,3
80-316-20	20,0	0,6
80-317-20	20,0	1,0
80-318-20	20,0	1,5
80-319-20	20,0	2,0



#### bajonett, Spitze gerade / bayonet, straight tip

Art.-Nr. Art.-No.	Länge Length (cm)	Spitze Tip (mm)
80-320-23	22,5	0,3
80-321-23	22,5	0,6
80-322-23	22,5	1,0
80-323-23	22,5	1,5
80-324-23	22,5	2,0





## 02 Bipolare Ringpinzetten, kniegebogen, Führungsstift

### Bipolar Ring-Forceps, angled, guide pin



Dr. med. Rainer Zimmermann  
Leitender Oberarzt der Universitäts-  
HNO-Klinik Tübingen

Dr. Rainer Zimmermann M.D.,  
Senior consultant at the ENT clinic,  
University of Tübingen, Germany

Operative Zugänge zum inneren Gehörgang, insbesondere auch zur Akustikusneurinom-Chirurgie, sind meist sehr klein. Häufig vermisst der HNO-Chirurg ein geeignetes Instrument um zum Beispiel beim Fundus des inneren Gehörganges um die "Ecke" greifen zu können. Hierzu eignen sich Ringpinzetten mit verschiedenen Winkeln und verschiedenen Größen, sowohl mit als auch ohne Koagulationsmöglichkeit. In der Praxis haben sich die neu konstruierten Pinzetten hervorragend bewährt.

Operative access to the inner ear, particularly during acoustic neurinoma surgery, is often very small. It would be helpful for the surgeon if, when working in the inner ear canal, he had an instrument with which he can reach around corners. Ring forceps meet this need. They are available in various angles and sizes, as well as with and without coagulation facilities. In practice, the newly constructed ring forceps have proved themselves to be an excellent solution.

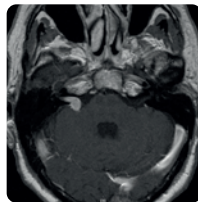

Intra-extrameatales AN links  
(Grad II)  
Intra-extrameatal AN left  
(2nd degree)

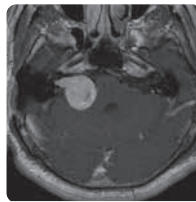

Intra-extrameatales AN rechts  
(Grad IV-V)  
Intra-extrameatal AN right  
(4th - 5th degree)

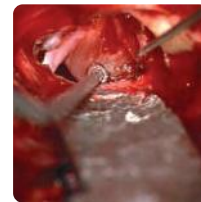

Transtemporale AN-  
Operation links  
Transtemporal AN surgery  
left



Translabrynthäre AN-  
Operation rechts  
Translabrynthine AN surgery  
right



**sehr fein, 16 cm / very fine, 16 cm**

Art.-Nr./No.	AD / OD (mm)
80-201-01	1,0
80-201-02	2,0
80-201-03	3,0



**Zimmermann Akustikusneurinom, sehr fein, 16 cm**  
**Zimmermann Acoustic neurinoma, very fine, 16 cm**

Art.-Nr.		AD
Art.-No.		OD (mm)
80-202-01	70°-80° aufwärts 70°-80° upwards	1,0
80-202-02	45° aufwärts 45° upwards	2,0



## 03 Bipolare Elektroden

### Bipolar Electrodes



#### Meuser

Art.-Nr./No.	Winkel / Angle	AL / WL (cm)
80-284-10	90°	10
80-285-10	45°	10



**gewinkelt, für Nase und Tonsillen, AL 10 cm**  
**angled, for nose and tonsils, WL 10 cm**

**80-286-10**



**für Larynx, 45° gewinkelt, AL 27 cm**  
**for larynx, 45° angled, for larynx, WL 27 cm**

**50-366-27**



**Nadel-Elektrode, gewinkelt, für Nasenmuschel, AL 10,5 cm**  
**Needle-electrode, angled, for turbinates, WL 10,5 cm**

**80-287-10**



## 04 MICRODOME Bipolare Koagulations Elektrode

### MICRODOME Bipolar Coagulation Electrode



80-390-13



80-390-14



80-391-13

**Flachstecker, AL 2 mm**

**Flat plug, WL 2 mm**

Art.-Nr. Art.-No.	Winkel Angle	Länge Length (cm)
80-390-13	bajonett / bayonet	13
80-390-14	biegbar / bendable	14
80-390-26	bajonett, biegbare bayonet, bendable	26
80-391-13	20° gewinkelt / 20° angled	13

## 05 Bipolare Präparierscheren

### Bipolar Dissecting Scissors

13 / 14 / 17,5 / 18 cm



**Bipolare Präparierschere**

**Bipolar dissecting scissors**

Art.-Nr. Art.-No.	Beschreibung Description	Länge Length (cm)
80-180-13	feines Blatt delicate blade	13,0
80-181-14	feines Blatt delicate blade	14,0
80-182-17	feines Blatt delicate blade	17,5
80-183-18	standard Blatt standard blade	18,0

## 06 Dieler Bipolare Koagulationszangen

### Dieler Bipolar Coagulation Forceps



Prof. Dr. med. Ralf Dieler  
Leitender Arzt, HNO-Abteilung,  
Rotkreuzklinik Würzburg

Prof. Dr. med. Ralf Dieler  
ENT-specialist  
Rotkreuzklinik Würzburg, Germany

Um den Gewebeschaden durch Koagulation arterieller Blutungen bei chirurgischen Eingriffen in der Nasennebenhöhle (A. ethmoidalis post. oder der A. sphenopalatina) möglichst gering zu halten, sind bipolare Zangen zu bevorzugen. Gegenüber der monopolaren Technik wird hierbei bis zu 30% weniger Leistung benötigt. Darüber hinaus entstehen keine relevanten elektrischen Interferenzen mit elektronischen Implantaten (z.B. Herzschrittmacher, Cochlear Implant) oder mit Geräten, die am Patienten angeschlossen sind (z.B. EKG, EEG).

Die Dieler Koagulations-Fasszange ist 30° gewinkelt, gefenestert und 360° drehbar, so dass ein gezieltes Fassen der genannten Gefäße möglich ist. Für eine bessere Sicht im Situs können mit Hilfe eines Einmal-Schlauchsets Blut und Schmauch gleichzeitig abgesaugt werden.

Bipolar forceps should be used in order to minimize tissue damage caused by coagulation in arterial bleeding (post ethmoid artery or the sphenopalatine artery) during paranasal sinus surgery. Up to 30% less power is required in comparison with monopolar technology. A further advantage is that there will be no relevant electrical interference with electrical implants (e.g. cardiac pacemaker, cochlear implant) or bodily function supporting devices (e.g. ECG, EEG).

The Dieler bipolar coagulation forceps is 30° angled, fenestrated and 360° rotatable. This allows a controlled grasping of the mentioned vessels. For better viewing conditions in situs, the disposable attachable suction tube effectively evacuates blood and smoke.



## 06 Dieler Bipolare Koagulationszangen

### Dieler bipolar coagulation forceps

Basis-Komponenten / Basic components



**Ringgriff für Dieler Koagulationszange**  
Ring handle for Dieler coagulation forceps

80-090-00



**Schaft für Dieler Koagulationszange, 3 mm, 15 cm**  
Shaft for Dieler coagulation forceps, 3 mm, 15 cm

80-090-01



**Saugschlauch, steril, 10 Stück/Box**  
Suction tube, sterile, 10 pieces/box

80-090-02

## 06 Dieler Bipolare Koagulationszangen

### Dieler Bipolar Coagulation Forceps

#### Aufsätze / Add-ons



**Fasszange, gefensterert, 15 cm / Grasping forceps, 15 cm**

Art.-Nr./No.	Winkel / Angle
80-090-03	gerade / straight
80-090-04	30° gewinkelt / 30° curved

**Löffelzange für Dieler Koagulationszange, aufgebogen, 15 cm  
Spoon forceps for Dieler coagulation forceps, upcurved, 15 cm**



Art.-Nr./No.	Größe / Size (mm)
80-090-05	2,0
80-090-06	2,7

**Zange für Dieler Koagulationszange, gerieft, 15 cm  
Forceps for Dieler coagulation forceps, serrated, 15 cm**



Art.-Nr.	Beschreibung / Description
80-090-07	aufgebogen/upcurved
80-090-08	aufgewinkelt/upangled

**Flamingo-Zange für Dieler Koagulationszange, vertikal, 15 cm  
Flamingo forceps for Dieler coagulation forceps, vertical, 15 cm**



Art.-Nr./No.	Winkel / Angle	Länge / Length (mm)
80-090-09	15°	0,7
80-090-10	15°	1,2
80-090-11	15°	2,0
80-090-12	30°	0,7
80-090-13	30°	1,2
80-090-14	30°	2,0
80-090-15	45°	0,7
80-090-16	45°	1,2
80-090-17	45°	2,0



## 07 HF-Chirurgie-Gerät

### HF-Surgical-Unit



HF-Generator 1E, 100 Watt, 460 khz, bipolar, monopolar, komplett mit Fußschalter, bipolarem Kabel 3 m, 2x Handgriff monopolar mit Kabel 3 m, 4 mm und 2,4 mm, Neutralelektrode mit Kabel 3 m

HF-generator 1E, 100 Watt, 460 khz bipolar, monopolar, complete with footswitch, bipolar cable 3 m, 2x handle monopolar with cable 3 m, 4.0 mm and 2.4 mm neutral electrode with cable 3 m

80-002-80



## 08 Bipolares Zubehör, Bipolare Anschlusskabel, autoklavierbar

### Bipolar Accessory, Bipolar Connecting Cable, autoclavable



passend für / compatible to  
Erbe/EMC/Dolly Stecker

Art.-Nr./No.	Länge / Length (m)
80-316-50	5



passend für / compatible to  
Sutter/Martin/Berchtold/Aesculap/Integra/SPIGGLE&THEIS

Art.-Nr./No.	Länge / Length (m)
80-317-30	3
80-317-50	5



passend für / compatible to  
Erbe/Storz/Wolf

Art.-Nr./No.	Länge / Length (m)
80-318-30	3
80-318-50	5



passend für / compatible to  
Valleylab/Lamidey/EMC/Bowa/Olympus

Art.-Nr./No.	Länge / Length (m)
80-319-30	3
80-319-50	5



für bipolare Scheren/Zangen, passend für  
for bipolar scissors/forceps, compatible to  
Sutter/Martin/Berchtold/Aesculap/Integra

Art.-Nr./No.	Länge / Length (m)
80-320-30	3
80-320-50	5



für bipolare Scheren/Zangen, passend für  
for bipolar scissors/forceps, compatible to  
Valleylab

Art.-Nr./No.	Länge / Length (m)
80-321-30	3
80-321-50	5





## 08 Bipolares Zubehör, Bipolare Anschlusskabel, autoklavierbar

### Bipolar Accessory, Bipolar Connecting Cable, autoclavable



**für bipolare Scheren/Zangen, passend für  
for bipolar scissors/forceps, compatible to  
Erbe/Storz/Wolf**

Art.-Nr./No.	Länge / Length (m)
80-322-30	3
80-322-50	5



**für bipolare Scheren/Zangen, passend für U20  
for bipolar scissors/forceps, compatible to U20**

Art.-Nr./No.	Länge / Length (m)
80-324-40	4

## 09 Monopolares Zubehör, Monopolare Anschlusskabel, autoklavierbar

### Monopolar Accessory, Monopolar Connecting Cable, autoclavable



für SPIGGLE & THEIS Elektroden-Handgriffe, 4 m, passend für  
for SPIGGLE & THEIS electrode handles, 4 m, compatible to  
Sutter/Martin/Berchtold/Aesculap/Integra/SPIGGLE & THEIS

80-407-40



für SPIGGLE & THEIS Elektroden-Handgriffe, 4 m, passend für  
for SPIGGLE & THEIS electrode handles, 4 m, compatible to  
Erbe ICC/ACC, Wolf/Storz

80-408-40



für Erbe Elektroden-Handgriffe, 3 m, passend für  
for Erbe electrode handles, 3 m, compatible to  
Erbe ICC/ACC, Wolf/Storz

80-409-30



für Instrumente, 4 mm, 5 m, passend für  
for instruments, 4 mm, 5 m compatible to  
Martin/Sutter/Berchtold/Aesculap/Integra/SPIGGLE & THEIS

80-414-50



für Instrumente, 4 mm, 5 m, passend für  
for instruments, 4 mm, 5 m, compatible to  
Erbe ICC/ACC/Wolf/Storz

80-415-50



für Instrumente, 5 m, passend für  
for instruments, 5 m, compatible to  
Valleylab/Conmed/Bovie

80-445-15



## 09 Monopolares Zubehör, Elektroden-Handgriffe, autoklavierbar

### Monopolar Accessory, Electrode Handle, autoclavable



mit zwei Schaltern, schneiden und koagulieren,  
für abnehmbare Anschlusskabel  
with 2 switches, cutting and coagulating,  
for removable connecting cable

Art.-Nr./No.	Ansatz / plug (mm)
80-406-01	4,0
80-406-02	2,4



mit fest verbundenem Anschlusskabel, 4 m, passend für Erbe  
with fixed connecting cable, 4 m, compatible to Erbe

Art.-Nr./No.	Ansatz / plug (mm)
80-410-04	4,0
80-410-24	2,4



mit fest verbundenem Anschlusskabel, 4 m, passend für International  
with fixed connecting cable, 4 m, compatible to International

Art.-Nr./No.	Ansatz / plug (mm)
80-411-04	4,0
80-411-24	2,4



mit fest verbundenem Anschlusskabel, 4 m, passend für Martin  
with fixed connecting cable, 4 m, compatible to Martin

Art.-Nr./No.	Ansatz / plug (mm)
80-412-04	4,0
80-412-24	2,4

## 09 Monopolares Zubehör, Elektroden

### Monopolar Accessory, Electrodes



**Silikon Neutral-Elektrode, 8 x 15 cm, 4 m Kabel, passend für  
Silicone neutral electrode, 8 x 15 cm, 4 m cable, compatible to  
Micromed/Martin/Berchtold/Aesculap**

**80-010-40**



**Silikon Neutral-Elektrode, 17 x 30 cm, 4 m Kabel, passend für  
Silicone neutral electrode, 17 x 30 cm, 4 m cable, compatible to  
Micromed/Martin/Berchtold/Aesculap**

**80-011-40**



**für Einmal Neutral-Elektrode, 4,5 m, passend für  
for single-use patient plates, 4,5 m, compatible to  
Micromed/Martin/Integra/Berchtold/Aesculap/  
Erbe/ICC/ACC/T-Serie**

**80-413-00**



**Halteband für Neutralelektrode, Gummi, 75 cm  
Holding band for neutral electrode, rubber, 75 cm**

**80-012-75**



## 09 Monopolares Zubehör, Elektroden

### Monopolar Accessory, Electrodes



**Nadelelektrode, spitz, gewinkelt, 4 mm Ansatz, AL 10 cm**  
Needle electrode, pointed, angled, 4 mm plug, WL 10 cm

**80-040-10**



**Kugelelektrode, gewinkelt, 4 mm Ansatz, AL 10 cm**  
Ball electrode, angled, 4 mm plug, WL 10 cm

**80-041-10**



**Monopolare Messerelektrode, seitliche Spitze mit Schaft 4 mm, schwarz, 5 Stück/Box**

Monopolar knife electrode, cutting edge sideways with 4mm shaft, black, 5 pieces/box

**80-053-01**



**Monopolare Nadelelektrode, Ø 0,5 mm m. Schaft 4 mm, schwarz, 5 Stück/Box**

Monopolar needle electrode, Ø 0.5 mm with 4 mm shaft, black, 5 pieces/box

**80-053-02**



**Monopolare Drahtschlingen-Elektrode, Ø 5 mm mit Schaft 4 mm, schwarz, 5 Stück/Box**

Monopolar wire loop electrode, Ø 5 mm with 4 mm shaft, black, 5 pieces/box

**80-053-03**



**Monopolare Kugelelektrode, gerade Ø 4 mm mit Schaft 4 mm, schwarz, 5 Stück/Box**

Monopolar ball electrode, straight Ø 4 mm with 4 mm shaft, black, 5 pieces/box

**80-053-04**



**Monopolare Kugelelektrode, gerade Ø 2 mm mit Schaft 4 mm, schwarz, 5 Stück/Box**

Monopolar ball electrode, straight Ø 2 mm with 4 mm shaft, black, 5 pieces/box

**80-053-05**





**Siebkorb mit Deckel, 3/4, Edelstahl, gelocht, 405 x 255 x 75 mm**  
Storage- and cleaning tray with lid, 3/4, stainless steel, perforated, 405 x 255 x 75 mm

**80-260-34**

**Not available outside Europe**

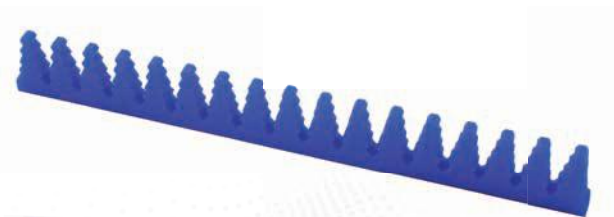

**Silikonhalterung, Typ 1, Bäumchen, T-Profil, blau, 24 cm**  
Silicone holder, type 1, tree shaped, t-profile, blue, 24 cm

**80-270-24**



**Silikonhalterung, Typ 2, Universal, T-Profil, blau, 24 cm**  
Silicone holder, type 2, universal, t-profile, blue, 24 cm

**80-272-24**



**Leiste für Silikonhalterungen, Edelstahl, T-Profil, 24 cm**  
Bar for silicone holders, stainless steel, t-profile, 24 cm

**80-275-24**



**Schraube, Edelstahl, M2, 9 x 16 mm**  
Screw, stainless steel, M2, 9 x 16 mm

**80-280-00**

### SET - 80-250-00

#### Bestehend aus / consisting of:

- 1 x 80-260-34
- 1 x 80-270-24
- 1 x 80-272-24
- 2 x 80-275-24
- 24 x 80-280-00

## Alphabetisches Inhaltsverzeichnis

### Alphabetical Index

Bipolare Ektrode .....	15	Ball electrode.....	26
Bipolare Pinzette.....	5 - 9	Bipolar electrode .....	15
Bipolare Präparierschere.....	16	Bipolar forceps .....	5 - 9
Bipolares Anschlusskabel.....	21	Bipolar connecting cable.....	21
Dieler Bipolare Koagulationszange.....	17	Bipolar dissection scissors .....	16
Einpedal-Fußschalter für HF-Gerät.....	20	Cable for single-use patient plates .....	23
Elektroden-Handgriff.....	24	Dieler bipolar Coagulation Forceps .....	17
HF-Gerät.....	20	Electrode handle .....	24
Kabel für Neutral-Elektrode.....	23	HF surgery unit .....	20
Kugelelektrode .....	26	Holding band.....	25
MICRODOME .....	16	MICRODOME .....	16
Monopolare Elektrode .....	26	Monopolar electrode .....	26
Monopolares Anschlusskabel.....	23	Monopolar connecting cable.....	23
Nadelelektrode .....	26	Needle electrode.....	26
Neutral-Elektrode .....	25	Neutral electrode .....	25
Rotation+ Bipolare Pinzette, NON-STICK.....	10 - 13	Rotation + bipolar forceps, NON-STICK.....	10 - 13
Textilbinde für Neutral-Elektrode .....	25	Single pedal footswitch for HF-unit .....	20
Zimmermann Akustikusneurinom Ringpinzette .....	14	Zimmermann acoustic neurinoma ring-forceps .....	14



50-366-27 ..... 15	80-106-16 ..... 7	80-151-17 ..... 6	80-284-10 ..... 15	80-319-50 ..... 21
80-000-80 ..... 20	80-106-19 ..... 7	80-152-17 ..... 6	80-285-10 ..... 15	80-320-23 ..... 13
80-003-01 ..... 20	80-106-25 ..... 7	80-152-20 ..... 6	80-285-16 ..... 12	80-320-30 ..... 21
80-003-02 ..... 20	80-107-16 ..... 7	80-152-23 ..... 6	80-285-18 ..... 12	80-320-50 ..... 21
80-010-40 ..... 25	80-107-19 ..... 7	80-156-20 ..... 6	80-285-20 ..... 12	80-321-23 ..... 13
80-011-40 ..... 25	80-109-16 ..... 7	80-156-23 ..... 6	80-285-23 ..... 12	80-321-30 ..... 21
80-012-75 ..... 25	80-110-16 ..... 7	80-158-20 ..... 6	80-286-10 ..... 15	80-321-50 ..... 21
80-040-10 ..... 26	80-110-19 ..... 7	80-158-23 ..... 6	80-286-16 ..... 12	80-322-23 ..... 13
80-041-10 ..... 26	80-111-16 ..... 7	80-180-13 ..... 16	80-286-18 ..... 12	80-322-30 ..... 22
80-053-01 ..... 26	80-111-19 ..... 7	80-181-14 ..... 16	80-286-20 ..... 12	80-322-50 ..... 22
80-053-02 ..... 26	80-112-16 ..... 7	80-182-17 ..... 16	80-286-23 ..... 12	80-323-23 ..... 13
80-053-03 ..... 26	80-112-19 ..... 7	80-183-18 ..... 16	80-287-10 ..... 15	80-324-23 ..... 13
80-053-04 ..... 26	80-113-19 ..... 7	80-183-14 ..... 9	80-287-16 ..... 12	80-324-40 ..... 22
80-053-05 ..... 26	80-113-23 ..... 7	80-183-20 ..... 9	80-287-18 ..... 12	80-390-13 ..... 16
80-090-00 ..... 18	80-114-19 ..... 7	80-201-01 ..... 14	80-287-20 ..... 12	80-390-14 ..... 16
80-090-01 ..... 18	80-115-19 ..... 7	80-201-02 ..... 14	80-287-23 ..... 12	80-390-26 ..... 16
80-090-02 ..... 18	80-116-19 ..... 7	80-201-03 ..... 14	80-288-16 ..... 12	80-391-13 ..... 16
80-090-03 ..... 19	80-117-19 ..... 8	80-202-01 ..... 14	80-288-18 ..... 12	80-406-01 ..... 24
80-090-04 ..... 19	80-118-19 ..... 8	80-202-02 ..... 14	80-288-20 ..... 12	80-406-02 ..... 24
80-090-05 ..... 19	80-119-19 ..... 8	80-250-00 ..... 27	80-288-23 ..... 12	80-407-40 ..... 23
80-090-06 ..... 19	80-120-19 ..... 8	80-260-34 ..... 27	80-300-25 ..... 13	80-408-40 ..... 23
80-090-07 ..... 19	80-121-18 ..... 8	80-270-24 ..... 27	80-301-25 ..... 13	80-409-30 ..... 23
80-090-08 ..... 19	80-122-18 ..... 9	80-272-24 ..... 27	80-302-25 ..... 13	80-410-04 ..... 24
80-090-09 ..... 19	80-123-16 ..... 8	80-275-24 ..... 27	80-303-25 ..... 13	80-410-24 ..... 24
80-090-10 ..... 19	80-125-03 ..... 9	80-280-00 ..... 27	80-304-25 ..... 13	80-411-04 ..... 24
80-090-11 ..... 19	80-125-07 ..... 9	80-280-16 ..... 11	80-310-18 ..... 13	80-411-24 ..... 24
80-090-12 ..... 19	80-125-12 ..... 9	80-280-18 ..... 11	80-311-18 ..... 13	80-412-04 ..... 24
80-090-13 ..... 19	80-125-20 ..... 9	80-280-20 ..... 11	80-312-18 ..... 13	80-412-24 ..... 24
80-090-14 ..... 19	80-127-03 ..... 8	80-280-23 ..... 11	80-313-18 ..... 13	80-413-00 ..... 23
80-090-15 ..... 19	80-127-07 ..... 8	80-281-16 ..... 11	80-314-18 ..... 13	80-414-50 ..... 23
80-090-16 ..... 19	80-127-12 ..... 8	80-281-18 ..... 11	80-315-20 ..... 13	80-415-50 ..... 23
80-090-17 ..... 19	80-127-20 ..... 8	80-281-20 ..... 11	80-316-20 ..... 13	80-445-15 ..... 23
80-100-16 ..... 7	80-128-03 ..... 9	80-281-23 ..... 11	80-316-50 ..... 21	
80-100-19 ..... 7	80-128-07 ..... 9	80-282-16 ..... 11	80-317-20 ..... 13	
80-101-16 ..... 7	80-128-12 ..... 9	80-282-18 ..... 11	80-317-30 ..... 21	
80-101-19 ..... 7	80-128-20 ..... 9	80-282-20 ..... 11	80-317-50 ..... 21	
80-101-22 ..... 7	80-129-12 ..... 8	80-282-23 ..... 11	80-318-20 ..... 13	
80-103-16 ..... 7	80-150-17 ..... 6	80-283-16 ..... 11	80-318-30 ..... 21	
80-103-19 ..... 7	80-150-20 ..... 6	80-283-18 ..... 11	80-318-50 ..... 21	
80-105-16 ..... 7	80-150-23 ..... 6	80-283-20 ..... 11	80-319-20 ..... 13	
80-105-19 ..... 7	80-150-25 ..... 6	80-283-23 ..... 11	80-319-30 ..... 21	



## Umrechnungstabelle - Ch/Fr - mm - inch

### Conversion table - Ch/Fr - mm - inch

Charriere (CH) French (F)	mm	Inch
1	0,33	0,013
2	0,67	0,025
3	1,00	0,039
4	1,33	0,051
5	1,67	0,065
6	2,00	0,079
7	2,33	0,092
8	2,67	0,105
9	3,00	0,118
10	3,33	0,131
11	3,67	0,144
12	4,00	0,156
13	4,33	0,170
14	4,67	0,184
15	5,00	0,197
16	5,33	0,210
17	5,67	0,223
18	6,00	0,237
19	6,33	0,249
20	6,67	0,263
21	7,00	0,276
22	7,33	0,288
23	7,67	0,302
24	8,00	0,315
25	8,33	0,328
26	8,67	0,341
27	9,00	0,354
28	9,33	0,367
29	9,67	0,380
31	10,23	0,407
32	10,67	0,420
34	11,33	0,446
36	12,00	0,472
38	12,67	0,494
40	13,33	0,520
45	15,00	0,591





Burghof 14 · 51491 Overath · Germany

Phone: +49 2206 90 81 - 0

Fax: +49 2206 90 81 - 13

info@spiggle-theis.com

www.spiggle-theis.com

© 2022 by SPIGGLE & THEIS Medizintechnik GmbH

Änderungen und Irrtümer – einschließlich Bilder - vorbehalten.

Produktsortiment kann pro Land abweichen

Modifications and errors - including pictures - reserved.

Product range might vary per country.



PO Box 3403, Erina, NSW, 2250, Australia

**P: +61 2 9810 6947**

admin@coremed.com.au

**www.coremed.com.au**

# Larynx Instrumentarium

## Larynx Instruments







# Über uns

---

# About Us

## Geschichte

**SPIGGLE & THEIS Medizintechnik GmbH** wurde 1994 von den Geschäftsführern **David Spiggle** und **Detlef Theis** gegründet. Bis heute haben wir uns vom reinen Vertriebsunternehmen zu einem renommierten Hersteller von Medizinprodukten im Bereich der HNO-Chirurgie weiterentwickelt. Weltweit exportieren wir in über 75 Länder und in Deutschland zählen mehr als 700 Kliniken zu unseren Kunden.

## Das Maß der Dinge

Im chirurgischen Instrumentenbau gilt das Siegel **“Made in Germany“** auch heute noch als Inbegriff von Qualität. Unsere chirurgischen Instrumente werden in allen Produktionsstufen unter strengsten Qualitätsanforderungen nahezu komplett in Deutschland produziert und sind somit noch größtenteils echt **“Made in Germany“**. Zur Verarbeitung wird ausschließlich Instrumentenstahl bester Güte verwendet, welcher den hohen Anforderungen moderner Chirurgie auch dauerhaft gerecht wird.

## Sicherheit

Die Gesundheit der Patienten und somit die Sicherheit und Qualität unserer Produkte stehen im Mittelpunkt unseres Handelns. In diesem Sinne ist **SPIGGLE & THEIS Medizintechnik GmbH** bereits seit 1997 **ISO-zertifiziert** und sind unsere Produkte nach der strengen europäischen Richtlinie für Medizinprodukte CE-gekennzeichnet. Alle unsere Produkte unterliegen einer permanenten Qualitätskontrolle - von der Auswahl des Rohmaterials über die einzelnen Fertigungsschritte bis zum Versand.

## Erfahrung

Unsere Mitarbeiter haben zum Teil mehr als 30 Jahre Berufserfahrung im Umgang mit chirurgischen Instrumenten. Durch dieses umfassende Know-How sowie den langjährigen und individuellen Kontakt mit den Anwendern, besitzen wir nicht nur theoretisches Wissen, sondern kennen auch deren Bedürfnisse und Ansprüche. Dies hilft uns bei der steten, praxisorientierten Weiterentwicklung unserer Produkte. Somit garantieren wir hohe Kompetenz und individuellen Service bei der Betreuung unserer Kunden.

## History

**SPIGGLE & THEIS Medizintechnik GmbH** was founded in 1994 by the managing directors **David Spiggle** and **Detlef Theis**. The company has evolved from being purely a distributor to the established manufacturer of medical products in the area of ENT that it is today. We can count over 700 clinics amongst our German customers and export to over 75 countries world-wide.

## The Seal Of Highest Quality

The stamp **“Made in Germany“** is still the epitome of quality standards in the production of surgical instruments in the world today. The majority of our surgical instruments is subjected to the strictest quality requirements at every step of their production, in the truest sense of the words, **“Made in Germany“**. Only the highest standard of instrument steel, capable of consistently meeting the demands of modern surgery, is used in the production.

## Safety First

The health of our patients and therefore the safety and quality of our products plays the central role in our decisions. **SPIGGLE & THEIS Medizintechnik GmbH** has been **ISO certified**. Our products are CE-marked in accordance with the strict European guideline for medical products since 1997. All our products undergo continual quality checks, from the selection of raw materials, to the individual stages of production and finally their dispatch.

## Experience

Our colleagues in instrument development can look back on over 30 years of professional practical experience with ENT surgical instruments. We offer more than theoretical knowledge – we understand our customer needs. We enjoy close, personal contact to many of the best surgeons world-wide. This enables us to continually develop innovative products. We guarantee the highest level of competence and individual service in meeting our customer requirements.





## Inhaltsverzeichnis

### Table of contents

01	Bruststütze / Chest Support .....	5
02	Laryngoskope / Laryngoscopes .....	6 - 11
03	Zahnschutz / Teeth Protection .....	12
04	Mikroinstrumente / Micro Instruments .....	13 - 14
05	Saugrohre und Watteträger / Suction Tubes and Cotton Carriers .....	15
06	Hochfrequenz-Instrumente / High Frequency Instruments.....	16 - 17
07	Drehbare Zangen / Rotatable Forceps .....	18
08	Laryngoskopiezangen / Laryngoscopy Forceps .....	19 - 22
09	Spezialinstrumente / Special Instruments.....	23
10	Allgemeines / Miscellaneous .....	24 - 25
11	Sterilisationssysteme / Sterilization Systems .....	26 - 27
12	Sets .....	28 - 30
	Index .....	31 - 32

#### Attention:

Not every instrument is available in all markets. Availability depends on local regulations. Please contact your SPIGGLE & THEIS representative or distributor, if you have any questions about the availability of our products in your region.

## 01 Bruststütze

### Chest Support



**Bruststütze für Erwachsene, Gummiring 9,5 cm, Stützstange 35 cm**  
Chest support for adults, rubber ring 9.5 cm, rod 35 cm

**50-101-00**

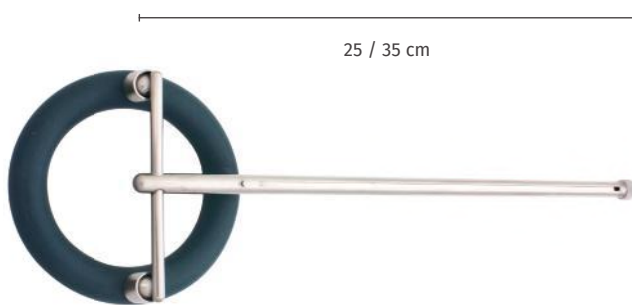

**Stützstange für Bruststütze, Gummiring 9,5 cm**  
Rod for chest support, rubber ring 9.5 cm

Art.-Nr./No.	Länge / Length (cm)
50-101-10	25 cm, für Kinder / for children
50-101-20	35 cm, für Erwachsene / for adults



**Gummiring für Bruststütze, 9,5 cm**  
Rubber ring for chest support, 9.5 cm

**50-101-40**



**Bruststütze alleine, ohne Stange**  
Chest support only, without rod

**50-101-30**



## 02 Laryngoskope

### Laryngoscopes

Geschützte Oberfläche für alle SPIGGLE & THEIS Instrumente macht das Instrument weitgehend resistent gegen mechanische und chemische Einflüsse. Reduziert Licht- und Laser-Reflexe. Einfach bei Ihrer Bestellung "TAN" hinter die jeweilige Artikel-Nummer setzen.

A protective surface for all SPIGGLE & THIS instruments makes the instruments resistant to mechanical and chemical influences whilst reducing light and laser reflections. Order by simply adding "TAN" behind the respective article number.



**Videolaryngoskop, Endoskopführung, zur Verwendung mit Endoskop 50-155-00, distal innen 18 x 13 mm, proximal innen 26 x 17 mm, 18,2 cm**

**Video laryngoscope, endoscope-guide, for use with endoscope 50-155-00, distal interior 18 x 13 mm, proximal interior 26 x 17 mm, 18.2 cm**

**50-150-00**



**Winkeloptik HD, zur Verwendung mit Videolaryngoskop 50-150-00, 4,0 mm, 15°, 17,7 cm, autoklavierbar**

**Angled HD scope, for use with video laryngoscope 50-150-00, 4.0 mm, 15°, 17.7 cm, autoclavable**

**50-155-00**

13,5 / 15,2 / 17 / 17,2 / 18,1 cm



**Operations-Laryngoskop / Surgical laryngoscope**

Art.-Nr. Art.-No.	Größe Size	Länge Length (cm)	ID (mm)	AD OD (mm)
50-200-01 für Kleinkinder / for small children	1	13,5	11,0	19,5 x 12,0
50-200-02 für Kinder / for children	2	15,2	11,0	20,5 x 13,0
50-200-03 für Jugendliche / for juveniles	3	18,1	12,0	21,0 x 13,0
50-200-04 für Frauen / for women	4	17,2	14,5	26,5 x 15,0
50-200-05 für Männer / for men	5	17,2	16,0	29,0 x 18,5



50-200-01



50-200-02



50-200-03

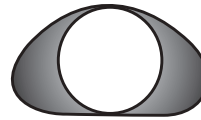

50-200-04

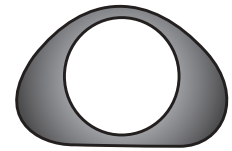

50-200-05

13,5 / 15,2 / 17,2 / 18,2 cm



**Operations-Laryngoskop, spreizbar / Surgical laryngoscope, spreadable**

Art.-Nr. Art.-No.	Größe Size	Länge Length (cm)	ID (mm)	AD OD (mm)
50-202-01 für Kleinkinder / for small children	1	13,5	11,0	20,0 x 12,0
50-202-02 für Kinder / for children	2	15,2	11,0	21,0 x 13,0
50-202-03 für Jugendliche / for juveniles	3	18,2	12,0	21,0 x 13,0
50-202-04 für Frauen / for women	4	17,2	14,5	27,0 x 15,0
50-202-05 für Männer / for men	5	17,2	16,0	29,0 x 19,0



50-202-01



50-202-02



50-202-03



50-202-04



50-202-05



## 02 Laryngoskope

### Laryngoscopes

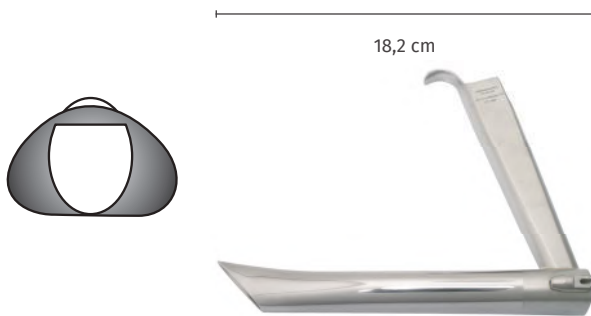

**Operations-Laryngoskop, Größe 6, für vordere Kommissur, ID 18 x 13 mm, AD 26 x 17 mm, 18,2 cm**

**Surgical laryngoscope, size 6, for anterior commissure, ID 18 x 13 mm, OD 26 x 17 mm, 18.2 cm**

**50-200-06**

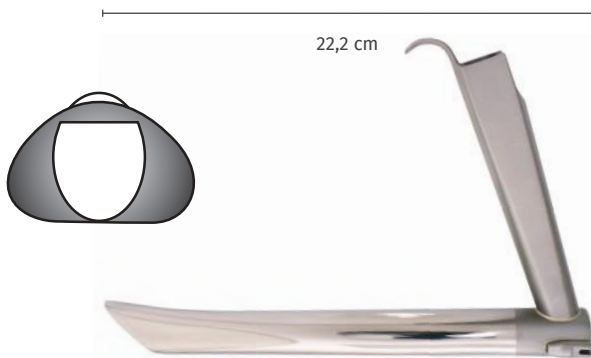

**Operations-Laryngoskop, Größe 7, für lange Häuse, 22,2 cm, ID 18 x 13 mm, AD 26 x 17,5 mm, 22,2 cm**

**Surgical laryngoscope, size 7, for long necks, ID 18 x 13 mm, OD 26 x 17.5 mm, 22.2 cm**

**50-200-07**

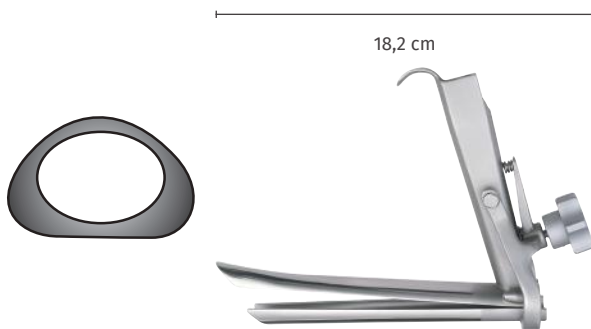

**Operations-Laryngoskop, Größe 6, spreizbar, für vordere Kommissur, ID 18 x 13 mm, AD 26 x 17 mm, 18,2 cm,**

**Surgical laryngoscope, size 6, spreadable, for anterior commissure, ID 18 x 13 mm, OD 26 x 17 mm, 18.2 cm**

**50-202-06**

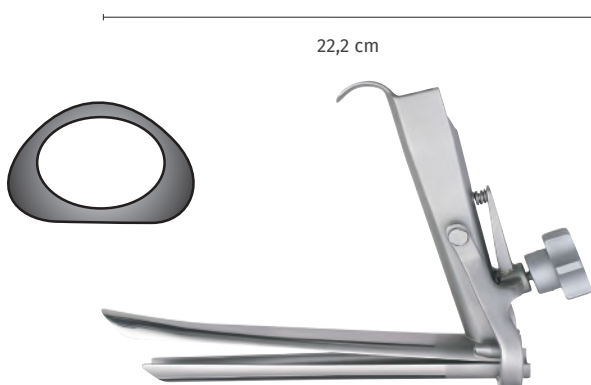

**Operations-Laryngoskop, Größe 7, spreizbar, für lange Häuse, ID 18 x 13 mm, AD 26 x 17 mm, 22,2 cm**

**Surgical laryngoscope, size 7, spreadable, for long necks, ID 18 x 13 mm, OD 26 x 17 mm, 22.2 cm**

**50-202-07**

## 02 Laryngoskope

### Laryngoscopes

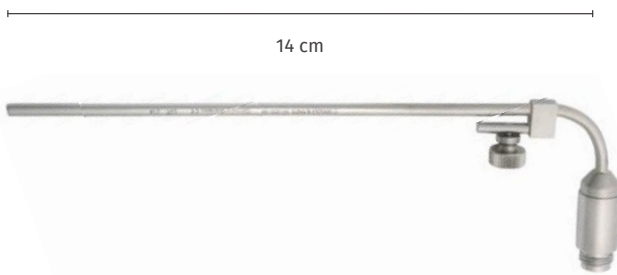

**Fiberglas-Lichtträger für starre und spreizbare Laryngoskope, 14 cm**  
**Fiberglass lightcarrier for rigid and spreadable laryngoscopes, 14 cm**

Art.-Nr./No.	Für Größen / For Sizes
50-205-12	1 / 2
50-205-36	3 / 4 / 5 / 6
50-205-70	7

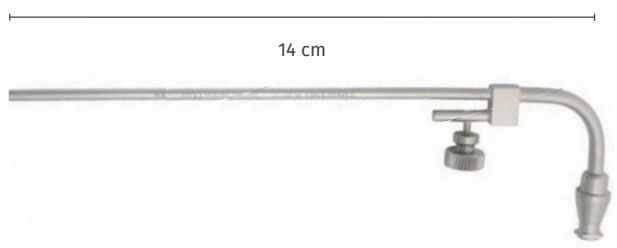

**Rauchabsaugrohr für starre und spreizbare Laryngoskope**  
**Größe 3 bis 7, 14 cm Länge**  
**Smoke evacuation tube for rigid and spreadable laryngoscopes**  
**size 3 to 7, 14 cm length**

**50-207-17**



**Inject-Timer-Kanüle für starre und spreizbare Laryngoskope**  
**Größe 1 bis 7, 11 cm Länge**  
**Inject timer cannula for rigid and spreadable laryngoscopes**  
**size 1 to 7, 11 cm length**

**50-209-17**

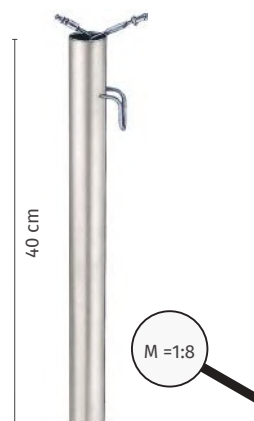

**Köcher für Saugrohre, 40 cm, Ø 40 mm,**  
**zum Einhängen an OP-Schiene**  
**Quiver for suction tubes, 40 cm, Ø 40 mm,**  
**for hook on op-table bar**

**50-330-40**





## 02 Laryngoskope

### Laryngoscopes



#### Laser-Laryngoskop / Laser laryngoscope

Art.-Nr. Art.-No.	Größe Size	Länge Length (cm)	ID (mm)	AD OD (mm)
50-215-01	1 für Kleinkinder / for small children	13,5	11,0	19,5 x 12,0
50-215-02	2 für Kinder / for children	15,2	11,0	20,5 x 13,0
50-215-03	3 für Jugendliche / for juveniles	18,1	12,0	21,0 x 13,0
50-215-04	4 für Frauen / for women	17,2	14,5	26,5 x 15,0
50-215-05	5 für Männer / for men	17,2	16,0	29,0 x 18,5

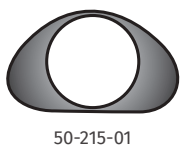

50-215-01

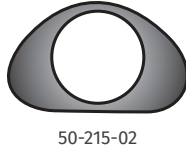

50-215-02

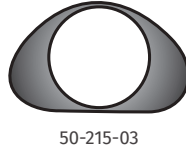

50-215-03

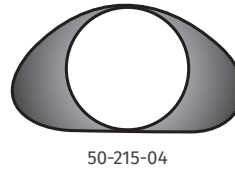

50-215-04

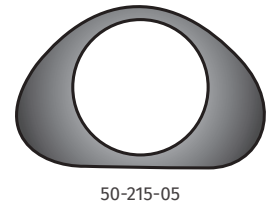

50-215-05



#### Laser-Laryngoskop, Größe 6, für vordere Kommissur, ID 18 x 13 mm, AD 26 x 17 mm, 18,2 cm

Laser laryngoscope, size 6, for anterior commissure,  
ID 18 x 13 mm, OD 26 x 17 mm, 18.2 cm

50-215-06



#### Laser-Laryngoskop, Größe 7, für lange Hälse, ID 18 x 13 mm, AD 26 x 17,5 mm, 22,2 cm

Laser laryngoscope, size 7, for long necks,  
ID 18 x 13 mm, OD 26 x 17.5 mm, 22.2 cm

50-215-07



## 02 Laryngoskope

### Laryngoscopes

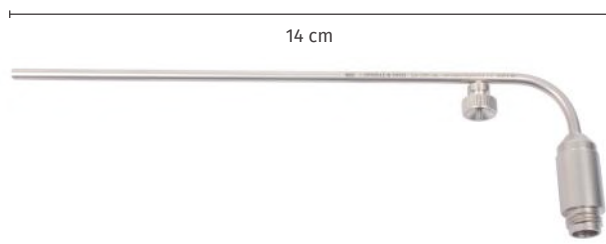

**Fiberglas-Lichtträger für Laserlaryngoskope, 14 cm**  
**Fiberglass lightcarrier for laser laryngoscopes, 14 cm**

Art.-Nr./No.	Für Größen / For Sizes
50-217-12	1 / 2
50-217-36	3 / 4 / 5 / 6
50-217-70	7

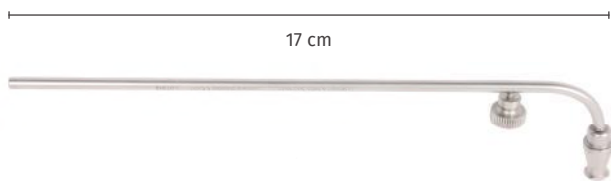

**Rauchabsaugrohr für Laserlaryngoskope Größen 3 bis 7, 17 cm**  
**Smoke evacuation tube for laser laryngoscopes size 3 to 7, 17 cm**

Art.-Nr./No.	Für Größen / For Sizes
50-218-12	1 / 2
50-218-17	3 / 4 / 5 / 6 / 7



**Inject-Timer-Kanüle für Laserlaryngoskope Größen 1 bis 7, 12 cm**  
**Inject timer cannula for laser laryngoscopes size 1 to 7, 12 cm**

**50-219-17**



**Holinger Laryngoskop, Handgriff abnehmbar,  
 Lichtträger innen mattiert**  
**Holinger laryngoscope, handle removable,  
 light carrier satin finished inside**

Art.-Nr./No.	Größen / Sizes
50-229-01	1 (12,0 cm)
50-229-02	2 (17,1 cm)
50-229-03	3 (18,0 cm)



**Jackson Laryngoskop, Handgriff abnehmbar, Lichtträger innen mattiert**  
**Jackson laryngoscope, handle removable, light carrier satin finished inside**

Art.-Nr./No.	Größen / Sizes
50-232-01	1 (12,0 cm)
50-232-02	2 (17,1 cm)
50-232-03	3 (18,0 cm)



**Laryngoskop-Handgriff, abnehmbar, einzeln**  
**Laryngoscope handle, removable, separate**

**50-235-00**



## 03 Zahnschutz

### Teeth Protectors



**Endoragard Zahnschutz, doppelseitig, Kunststoff, unsteril**  
**Endoragard teeth protector, double side, plastic, non-sterile**

**50-240-00**



**Zahnschutz aus Metall, gelocht**  
**Teeth protector, metal, with holes**

Art.-Nr./No.	Größen / Sizes
50-245-00	0, sehr klein / very small
50-245-01	1, klein / small
50-245-02	2, mittel / medium
50-245-03	3, groß / large



**Medasil Zahnschutz, Silikon, steril, lasergeeignet, 20 Stück**  
**Medasil teeth protector, silicone, sterile, laser resistant, 20 pieces**

**50-250-00**

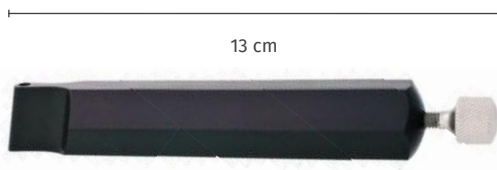

**Heermann Handgriff, groß, schwarz, 13 cm**  
Heermann handle, large, black, 13 cm

10-722-13

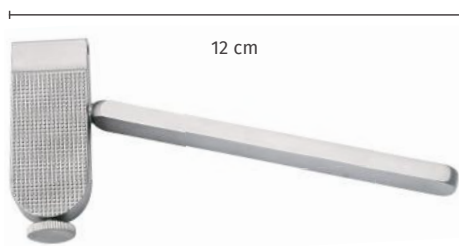

**Kleinsasser Handgriff, gewinkelt, 12 cm**  
Kleinsasser handle, angled, 12 cm

50-300-00

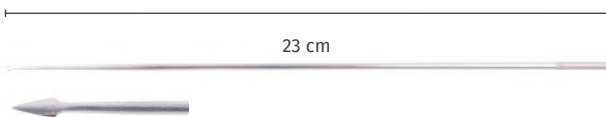

**Messer, gerade, lanzettförmig, 23 cm**  
Knife, straight, lanceolate, 23 cm

50-301-23

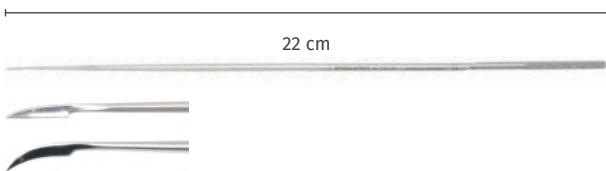

**Sichelmesser, AL 22 cm / Sickle knife, WL 22 cm**

Art.-Nr./No.	Winkel / Angle
50-310-23	gerade Schneide / straight edge
50-311-23	gebogene Schneide / curved edge

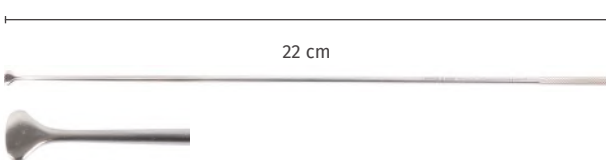

**Messer, oval, AL 22 cm / Knife, oval, WL 22 cm**

50-312-23

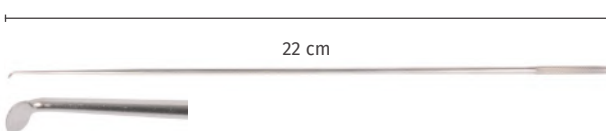

**Messer, rund, 2,5 mm, 45° gewinkelt, AL 22 cm**  
Knife, round, 2.5 mm, 45° angled, WL 22 cm

50-313-23

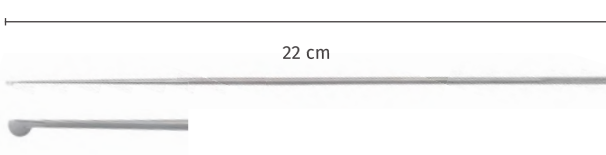

**Messer, oval, seitlich, AL 22 cm / Knife, oval, vertical, WL 22 cm**

50-314-23



## 04 Mikroinstrumente

### Micro Instruments

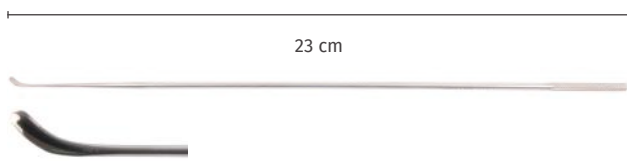

Messer, golfstockförmig, AL 23 cm  
 Knife, golf club shaped, WL 23 cm

50-315-23

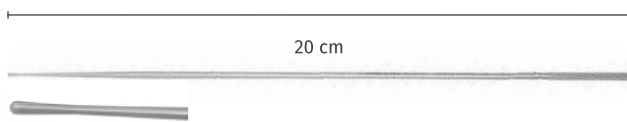

Sonde, stumpf, gerade, AL 20 cm / Probe, blunt, straight, WL 20 cm

50-232-23

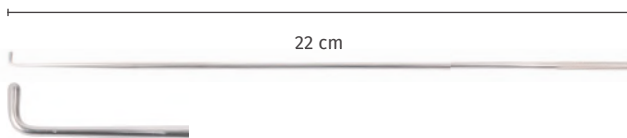

Häkchen, stumpf, 90°, AL 22 cm / Hook, blunt, 90°, WL 22 cm

50-317-23

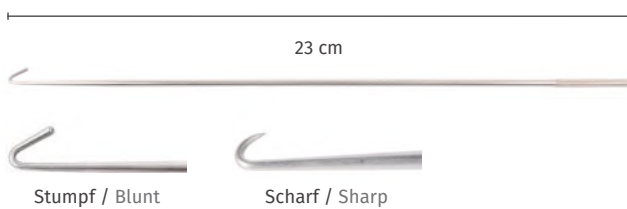

Häkchen, retrograd, AL 23 cm / Hook, backwards, WL 23 cm

Art.-Nr./No.	Beschreibung / Description
50-316-23	stumpf / blunt
50-318-23	scharf / sharp

Stumpf / Blunt

Scharf / Sharp

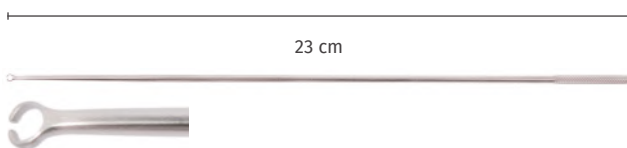

Knotenführer, gerade, AL 23 cm / Knot tier, straight, WL 23 cm

50-319-23

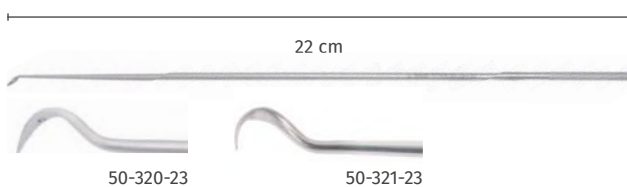

Umstechungsnadel, AL 22 cm / Suture needle, WL 22 cm

Art.-Nr./No.	Beschreibung / Description
50-320-23	rechts gebogen / right curved
50-321-23	links gebogen / left curved

50-320-23

50-321-23

## 05 Saugrohre und Watteträger

### Suction Tubes and Cotton Carriers

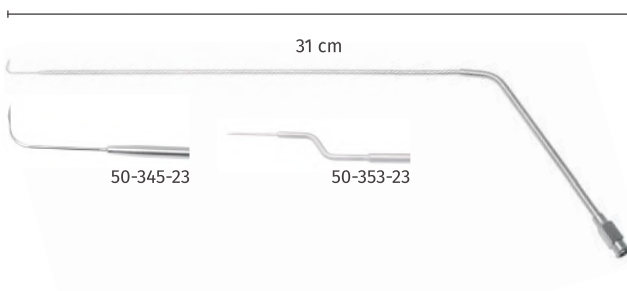

**Injektionsnadel, 31 cm, AL 24 cm**  
**Injection needle, 31 cm, WL 24 cm**

Art.-Nr./No.	Beschreibung / Description
50-345-23	gebogen / curved
50-353-23	bajonett / bayonet

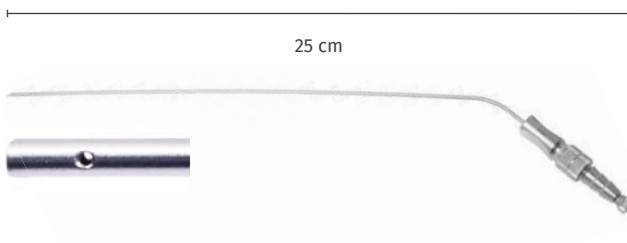

**Saugrohr mit Unterbrecher, kniegebogen, seitlich distale Öffnung, 25 cm**  
**Suction tube with interruptor, angled, distal side opening, 25 cm**

Art.-Nr./No.	ID / ID (mm)
50-347-20	2,0
50-347-25	2,5
50-347-30	3,0

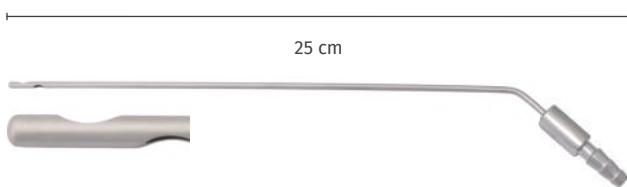

**Saugrohr mit Unterbrecher, Spitze geschlossen, zwei seitliche Öffnungen 3,0 mm, 25 cm**  
**Suction tube with interruptor, tip closed, two side openings 3.0 mm, 25 cm**

**50-349-30**

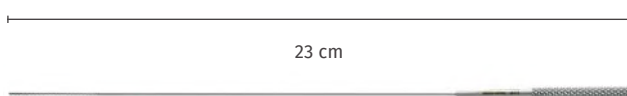

**Watteträger, gerieft, 2 mm, 23 cm**  
**Cotton carrier, serrated, 2 mm, 23 cm**

**50-351-23**



## 06 Hochfrequenz-Instrumente

### High Frequency Instruments

**Monopolare Koagulationszange, drehbar, Rauchabsaugung, Schaft 3,0 mm, 23,5 cm**  
**Monopolar coagulation forceps, rotatable, smoke evacuation, shaft 3.0 mm, 23.5 cm**

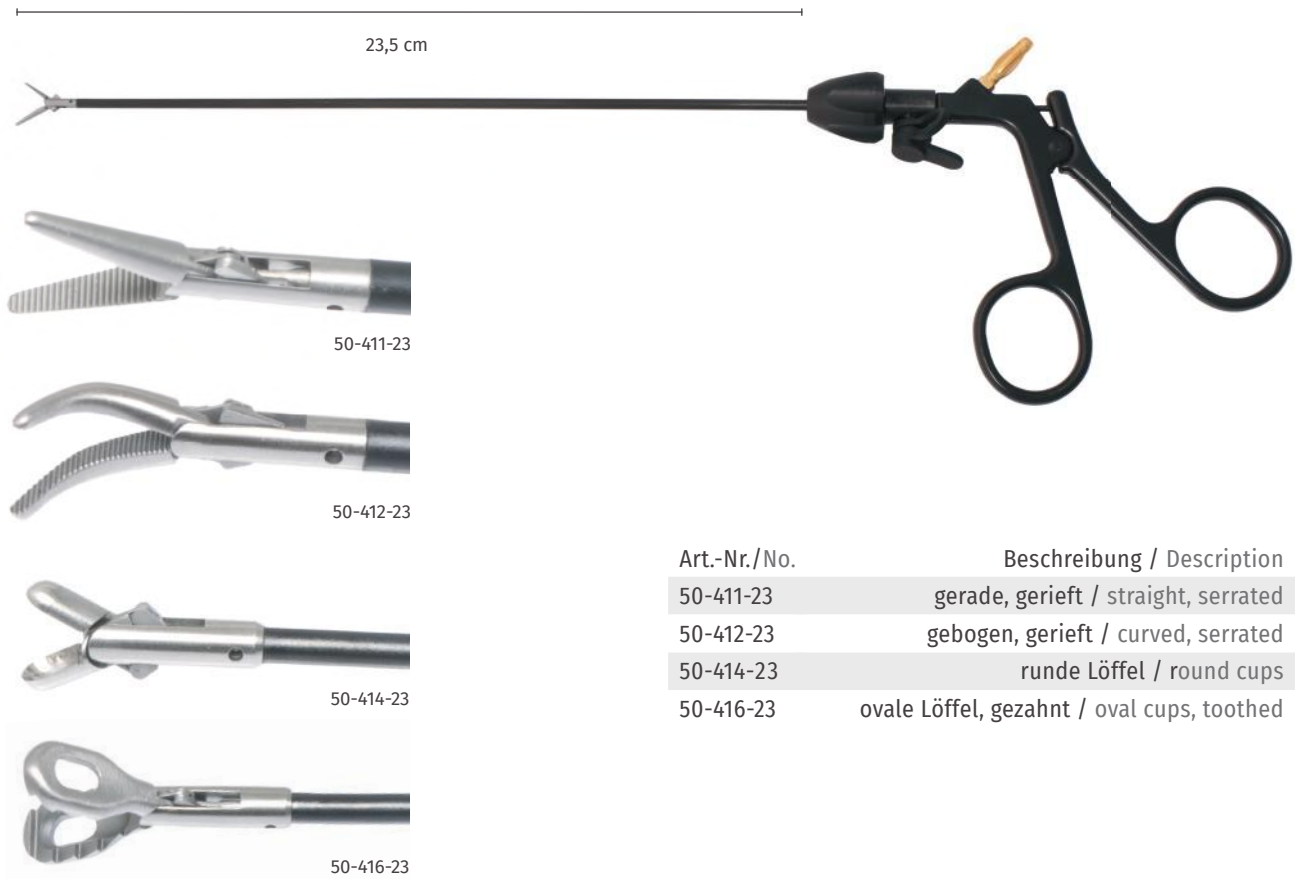

Art.-Nr./No.	Beschreibung / Description
50-411-23	gerade, gerieft / straight, serrated
50-412-23	gebogen, gerieft / curved, serrated
50-414-23	runde Löffel / round cups
50-416-23	ovale Löffel, gezahnt / oval cups, toothed

#### Vorteile:

- Monopolare Koagulation
- 360° drehbar
- Rauchabsaugung beim Lasern
- Reflexionsarme schwarze Oberfläche

#### Advantages:

- Monopolar coagulation
- 360° rotatable
- Laser smoke evacuation
- Non-reflecting black finish



**Bipolare Koagulationselektrode, innen isoliert, 27 cm Arbeitslänge**  
**Bipolar coagulation electrode, inside isolated, 27 cm working length**

**50-365-27**

## 06 Monopolares Zubehör, Monopolare Anschlusskabel, autoklavierbar\*

### Monopolar Accessory, monopolar connecting cable, autoclavable\*



**für Instrumente, 5 m, passend für**  
**for instruments, 5 m compatible to**  
**Martin/Sutter/Berchthold/Aesculap/Integra/SPIGGLE & THEIS**

**80-414-50**



**für Instrumente, 4 mm, 5 m passend für**  
**for instruments, 4 mm, 5 m, compatible to**  
**Erbe ICC/ACC, Wolf/Storz**

**80-415-50**

## 06 Bipolares Zubehör, Bipolare Anschlusskabel, autoklavierbar\*

### Bipolar Accessory, bipolar connecting cable, autoclavable\*



**passend für / compatible to**  
**Erbe/EMC/Dolly Stecker**

Art.-Nr./No.	Länge / Length (m)
80-316-50	5,0



**passend für / compatible to**  
**Sutter/Martin/Berchthold/Aesculap/Integra/SPIGGLE & THEIS**

Art.-Nr./No.	Länge / Length (m)
80-317-3,0	3,0
80-317-5,0	5,0



**passend für / compatible to Erbe/Storz/Wolf**

Art.-Nr./No.	Länge / Length (m)
80-318-3,0	3,0
80-318-5,0	5,0



**passend für / compatible to Valleylab/Lamidey/EMC/Bowa/Olympus**

Art.-Nr./No.	Länge / Length (m)
80-319-3,0	3,0
80-319-5,0	5,0

\* Abbildungen der Kabel sind ähnlich / images similar to product





## 07 Drehbare Zangen

### Rotatable Forceps

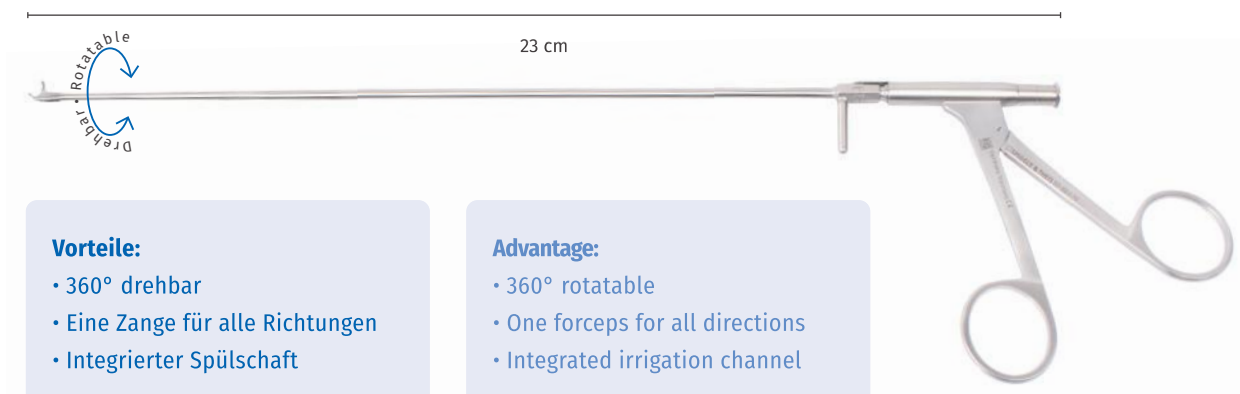

#### Vorteile:

- 360° drehbar
- Eine Zange für alle Richtungen
- Integrierter Spülkanal

#### Advantage:

- 360° rotatable
- One forceps for all directions
- Integrated irrigation channel



**Mikrolaryngoskopiezange, drehbar, runde Löffel 2,0 mm, Spülkanal, konischer Schaft (2,0 - 3,0 mm), gebogen, 23 cm**  
Micro laryngeal forceps, rotatable, round cups, 2.0 mm, irrigation channel, conical shaft, (2.0 - 3.0 mm), curved, 23 cm

**50-501-10**



**Mikrolaryngoskopiezange, drehbar, gerieft, Spülkanal, konischer Schaft (2,0 - 3,0 mm), gebogen, 23,5 cm**  
Micro laryngeal forceps, rotatable, serrated, irrigation channel, conical shaft (2.0 - 3.0 mm), curved, 23.5 cm

**50-502-10**



**Mikrolaryngoskopiezange, drehbar, dreieckiges Maul, gefenestert, Spülkanal, konischer Schaft (2,0 - 3,0 mm), gebogen, 23 cm**  
Micro laryngeal forceps, rotatable, triangular jaws, fenestrated, irrigation channel, conical shaft (2.0 - 3.0 mm), curved, 23 cm

**50-503-10**



**Mikrolaryngoskopieschere, drehbar, aufgebogen, Spülkanal, 23,5 cm**  
Micro laryngeal scissors, rotatable, curved upwards, irrigation channel, 23.5 cm

**50-504-10**

#### Vorteile / Advantages:

- Integrierter Spülkanal für optimierte Reinigung / Integrated irrigation channel for optimal cleaning
- Konischer Schaft für hohe Stabilität und optimale Sicht / Conical shaft for high stability and optimal view

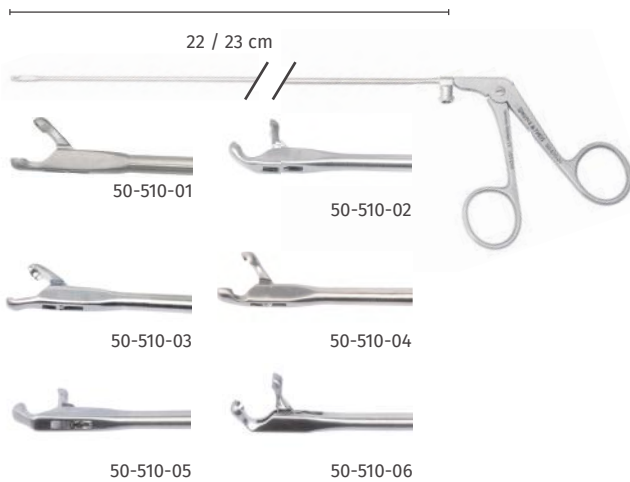

**Mikrolaryngoskopiezange mit Spülkanal,  
runde Löffel, 2,0 mm, konischer Schaft (2,0 - 3,0 mm),  
Micro laryngeal forceps with irrigation channel,  
round cups, 2.0 mm, conical shaft (2.0 - 3.0 mm)**

Art.-Nr./No.	Winkel / Angle
50-510-01	22 cm, gerade / 22 cm, straight
50-510-02	22 cm, aufgebogen / 22 cm, upcurved
50-510-03	22 cm, rechts gebogen / 22 cm, right curved
50-510-04	22 cm, links gebogen / 22 cm, left curved
50-510-05	22 cm, rechts aufgebogen / 22 cm, right upcurved
50-510-06	23 cm, (2,5 - 3,0 mm) links aufgebogen 23 cm, (2,5 - 3,0 mm) left upcurved

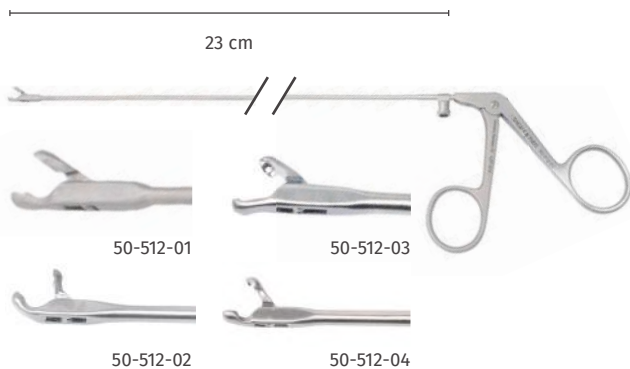

**Mikrolaryngoskopiezange mit Spülkanal,  
konischer Schaft (2,5 - 3,0 mm), runde Löffel, 4,0 mm, 23 cm  
Micro laryngeal forceps with irrigation channel,  
conical shaft (2.5 - 3.0 mm), round cups, 4.0 mm, 23 cm**

Art.-Nr./No.	Winkel / Angle
50-512-01	gerade / straight
50-512-02	aufgebogen / upcurved
50-512-03	rechts gebogen / right curved
50-512-04	links gebogen / left curved

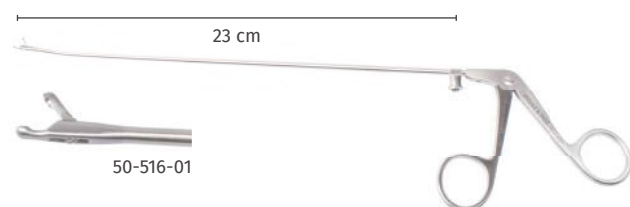

**Mikrolaryngoskopiezange Löffelmaul mit Spülkanal, 2 mm  
konischer Schaft, distales Ende 10° aufgebogen, 23 cm  
Micro laryngeal forceps with round cups, 2 mm conical shaft,  
distal 10° curved upwards, irrigation channel, 23 cm**

Art.-Nr./No.	Winkel / Angle
50-516-01	gerade / straight
50-516-02	45° aufgebogen / 45° upcurved
50-516-03	rechts gebogen / right curved
50-516-04	links gebogen / left curved

## 08 Laryngoskopiezangen

### Laryngoscopy Forceps

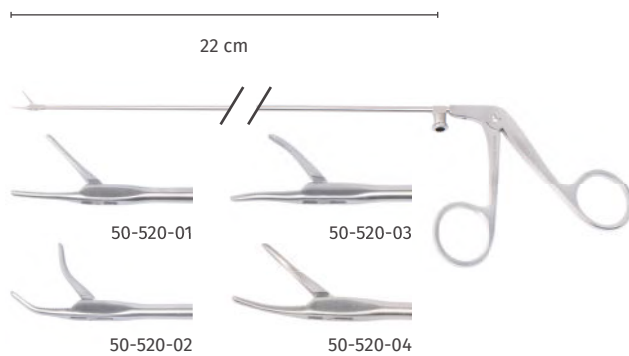

**Mikrolaryngoskopiezange mit Spülkanal, Hechtmaul, gerieft, konischer Schaft (2,0 - 3,0 mm), 22 cm**

**Micro laryngeal forceps with irrigation channel, alligator jaw, serrated, conical shaft (2.0 - 3.0 mm), 22 cm**

Art.-Nr./No.	Winkel / Angle
50-520-01	gerade / straight
50-520-02	aufgebogen / upcurved
50-520-03	rechts gebogen / right curved
50-520-04	links gebogen / left curved

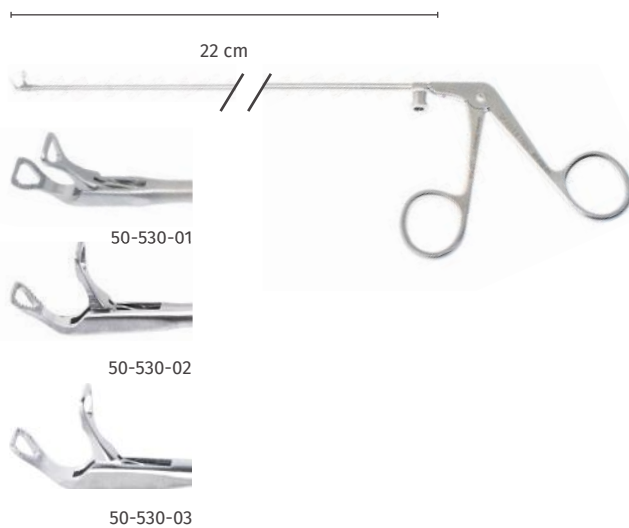

**Mikrolaryngoskopiezange mit Spülkanal,**

**Herzform, aufgebogen, konischer Schaft (2,0 - 3,0 mm), 22 cm**

**Micro laryngeal forceps with irrigation channel, heart shaped jaws, upcurved, conical shaft (2.0 - 3.0 mm), 22 cm**

Art.-Nr./No.	Winkel / Angle
50-530-01	gerade / straight
50-530-02	45° rechts / 45° right
50-530-03	45° links / 45° left

## 08 Laryngoskopiezangen

### Laryngoscopy Forceps

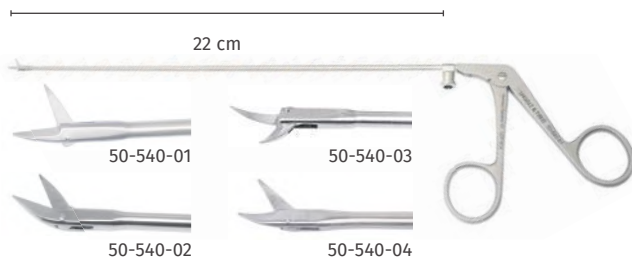

**Mikrolaryngoskopieschere mit Spülkanal,  
konischer Schaft (2,0 - 3,0 mm), 22 cm**  
**Micro laryngeal scissors with irrigation channel,  
conical shaft (2.0 - 3.0 mm), 22 cm**

Art.-Nr./No.	Winkel / Angle
50-540-01	gerade / straight
50-540-02	aufgebogen / upcurved
50-540-03	rechts gebogen / right curved
50-540-04	links gebogen / left curved

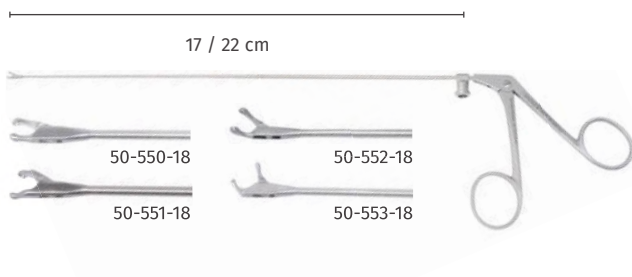

**Mikrolaryngoskopiezange mit Spülkanal,  
extra fein, runde Löffel, 1,0 mm, konischer Schaft (1,0 - 2,0 mm)**  
**Micro laryngeal forceps with irrigation channel,  
very fine, round cups, 1.0 mm, conical shaft (1.0 - 2.0 mm)**

Art.-Nr. Art.-No.	Länge Length (cm)	Winkel Angle
50-550-18	17	gerade / straight
50-550-23	22	gerade / straight
50-551-18	17	rechts gebogen / right curved
50-551-23	22	rechts gebogen / right curved
50-552-18	17	links gebogen / left curved
50-552-23	22	links gebogen / left curved
50-553-18	17	aufgebogen / upcurved
50-553-23	22	aufgebogen / upcurved

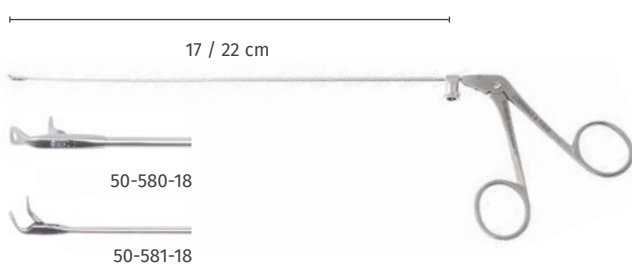

**Mikrolaryngoskopiezange mit Spülkanal,  
extra fein, Herzform, 1,0 mm, konischer Schaft (1,0 - 2,0 mm)**  
**Micro laryngeal forceps with irrigation channel,  
very fine, heartshaped jaw, 1.0 mm, conical shaft (1.0 - 2.0 mm)**

Art.-Nr. Art.-No.	Länge Length (cm)	Winkel Angle
50-580-18	17	rechts gebogen / right curved
50-580-23	22	rechts gebogen / right curved
50-581-18	17	links gebogen / left curved
50-581-23	22	links gebogen / left curved



## 08 Laryngoskopiezangen

### Laryngoscopy Forceps

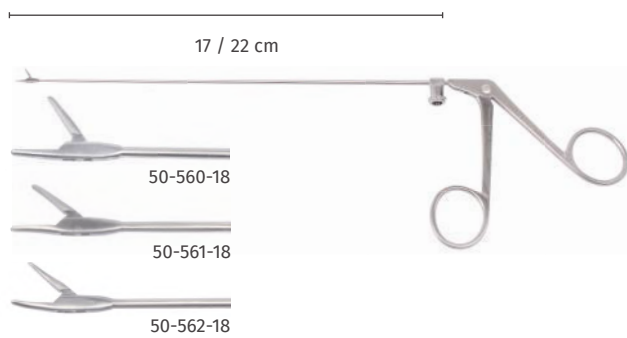

**Mikrolaryngoskopiezange mit Spülkanal,  
extra fein, Hechtmaul, 1,0 mm, konischer Schaft (1,0 - 2,0 mm)**  
Micro laryngeal forceps with irrigation channel,  
very fine, alligator jaws, 1.0 mm, conical shaft (1.0 - 2.0 mm)

Art.-Nr. Art.-No.	Länge Length (cm)	Winkel Angle
50-560-18	17	gerade / straight
50-560-23	22	gerade / straight
50-561-18	17	rechts gebogen / right curved
50-561-23	22	rechts gebogen / right curved
50-562-18	17	links gebogen / left curved
50-562-23	22	links gebogen / left curved

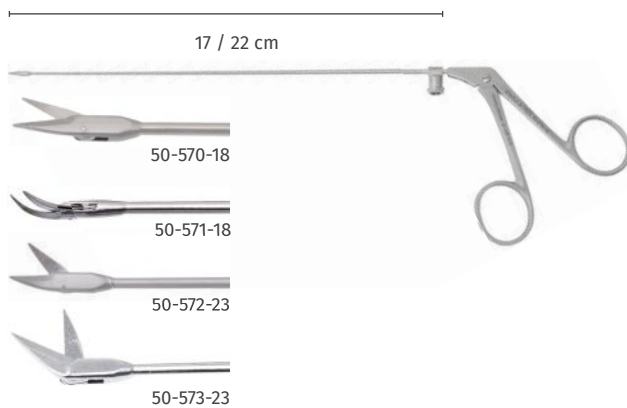

**Mikrolaryngoskopieschere mit Spülkanal,  
extra fein, 1,0 mm, konischer Schaft (1,0 - 2,0 mm)**  
Micro laryngeal scissors with irrigation channel,  
very fine, 1.0 mm, conical shaft (1.0 - 2.0 mm)

Art.-Nr. Art.-No.	Länge Length (cm)	Winkel Angle
50-570-18	17	gerade / straight
50-570-23	22	gerade / straight
50-571-18	17	rechts gebogen / right curved
50-571-23	22	rechts gebogen / right curved
50-572-18	17	links gebogen / left curved
50-572-23	22	links gebogen / left curved
50-573-18	18	aufgebogen / upcurved
50-573-23	22	aufgebogen / upcurved

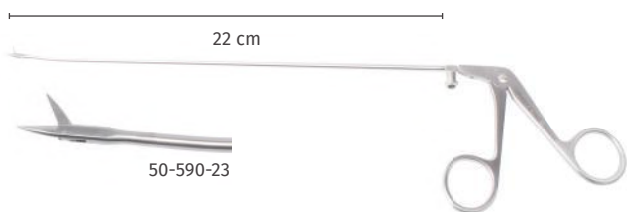

**Mikrolaryngoskopiescherchen mit konischem Schaftrohr,  
Schaft distal 10° aufgebogen, Spülung, NL 22 cm**  
Micro laryngeal scissors with conical shaft, distal 10° curved  
upwards, 22 cm, irrigation channel

Art.-Nr. Art.-No.	Winkel Angle
50-590-23	gerade / straight
50-591-23	rechts gebogen / right curved
50-592-23	links gebogen / left curved
50-593-23	45° aufgebogen / 45° upcurved

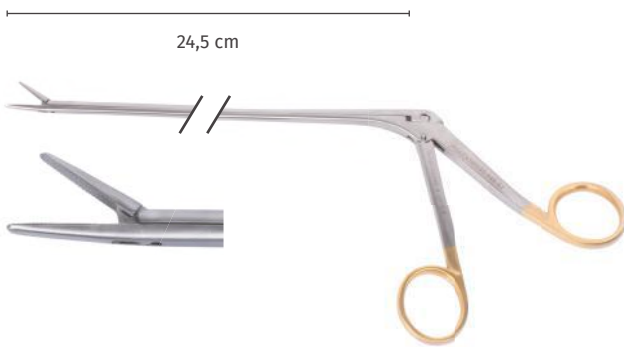

**Laryngoskopie-Nadelhalter**  
**Ring 20° aufgebogen, Hartmetall, 24,5 cm**  
 Laryngeal needle-holder  
 ring curved 20° upwards, tungsten carbide, 24.5 cm  
**50-649-23**



**Mikrolaryngoskopieschere, drehbar, 80° aufgebogen,**  
**Spülkanal, festes Schneideblatt rechts, 23,5 cm**  
 Microlaryngoscopy scissors, rotatable, 80° curved upwards,  
 irrigation channel, 23.5 cm

Art.-Nr./No.	Beschreibung / Description
50-580-01	festes Schneideblatt rechts / fixed blade right
50-580-02	festes Schneideblatt links / fixed blade left

**Vorteile / Advantages:**

- Integrierter Spülkanal für optimierte Reinigung / Integrated irrigation channel for optimal cleaning
- Konischer Schaft für hohe Stabilität und optimale Sicht / Conical shaft for high stability and optimal view

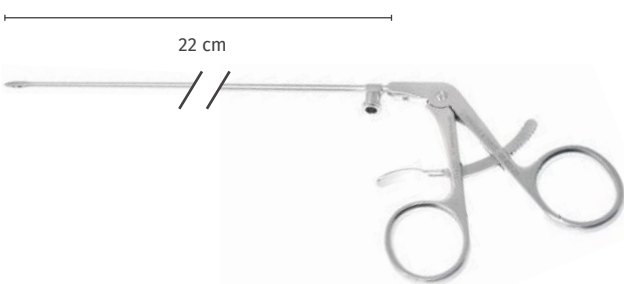

**Laryngoskopie-Nadelhalter mit Spülkanal, mit Sperre,**  
**konischer Schaft (2,0 - 3,0 mm), 22 cm**  
 Laryngeal needle-holder with irrigation channel, with ratchet,  
 conical shaft (2.0 - 3.0 mm), 22 cm  
**50-650-23**

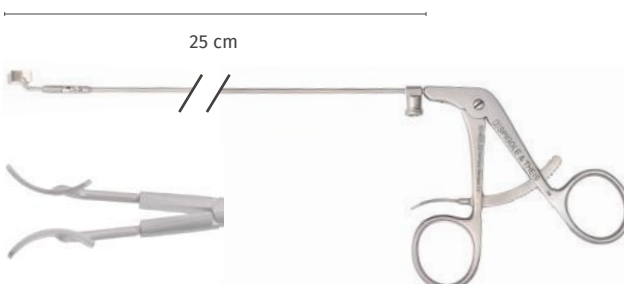

**Stimmband-Spreizer mit Spülkanal,**  
**zylindrischer Schaft, 2,0 mm, 25 cm**  
 Vocal cord spreader with irrigation channel,  
 cylindrical shaft, 2.0 mm, 25 cm  
**50-652-23**





**Metallschale / Metal bowl**

Art.-Nr. Art.-No.		Durchmesser Diameter (mm)	Höhe Height (mm)	Fassungs- vermögen Capacity (ml)
80-501-01	B1	Ø 40	H=19	20
80-501-02	B2	Ø 60	H=39	60
80-501-03	B3	Ø 85	H=40	160
80-501-04	B4	Ø 110	H=55	400



**Medizinbecher, Edelstahl, graduiert**

**Medicine cup, stainless steel, graduated**

Art.-Nr. Art.-No.		Durchmesser Diameter (mm)	Höhe Height (mm)	Fassungs- vermögen Capacity (ml)
80-503-03		Ø 50	H=25	30
80-504-05		Ø 53	H=45	50



**Lösungsschale, Edelstahl / Solution bowl, stainless steel**

Art.-Nr. Art.-No.		Durchmesser Diameter (mm)	Höhe Height (mm)	Fassungs- vermögen Capacity (ml)
80-506-30	B1	Ø 95	H=60	300
80-507-40	B2	Ø 120	H=70	500
80-509-75	B3	Ø 150	H=75	750



**Tablettenschale, Edelstahl, Ø 65 mm, H=20 mm**

**Tablet dish, stainless steel, Ø 65 mm, H=20 mm**

**80-512-00**



**Petrischale, Klarglas, mit Deckel / Petri dish, clear glass, with lid**

Art.-Nr./No.	AD / OD (mm)	Höhe / Height (mm)
80-515-06	60	15
80-515-08	80	15
80-515-10	150	20



**Medikamenten-Schälchen, Glas, schwarz, mit Deckel, 4 x 4 cm**

**Medication dish, glass, black, with lid, 4 x 4 cm**

**80-517-00**



**Medikamenten-Schälchen, Dappenglas, farbig, Ø 3,2 cm**  
**Medication dish, dappen-glass, colored, Ø 3.2 cm**



Art.-Nr./No.	Farbe / Color
80-519-00	kristall / crystal
80-519-01	grün / green
80-519-02	rosa / pink
80-519-03	topas / topaz

**Porzellan-Schälchen, rund, mit Ausguss**  
**China bowl, round, with spout**



Art.-Nr./No.	Durchmesser / Diameter (cm)
80-520-06	Ø 8
80-520-08	Ø 10

**Nierenschale, Edelstahl / Kidney bowl, stainless steel**



Art.-Nr./No.	Größe / Size (cm)
80-525-17	17,5
80-525-25	25,0

**Kornzangen-Behälter, Edelstahl / Forceps holder, stainless steel**



Art.-Nr. Art.-No.	Durchmesser Diameter (cm)	Höhe Height (cm)
80-528-13	Ø 5,0	13,5
80-528-18	Ø 5,0	18,0
80-528-20	Ø 9,5	20,0

**Kornzangen-Behälter, Glas, Edelstahldeckel mit Ausschnitt,  
 Ø 8 cm, Höhe 20 cm**

**Forceps holder, glass, stainless steel lid with opening,  
 Ø 8 cm, height 20 cm**



**80-530-20**



## 11 Sterilisationssysteme

### Sterilization Systems



#### Norm-Sterilisations-Container, Boden geschlossen Norm sterilization container, bottom closed

Art.-Nr. Art.-No.	Größe Size	Dimension (außen) Dimension (outside) (mm)
80-631-10	1/2	297 x 274 x 88
80-631-12	1/2	297 x 274 x 123
80-631-14	1/2	297 x 274 x 138
80-631-21	1/2	297 x 274 x 188
80-641-14	3/4	462 x 274 x 138
80-661-12	1	585 x 274 x 123
80-661-14	1	585 x 274 x 138
80-661-21	1	585 x 274 x 188



#### Ventildeckel für Norm-Sterilisations-Container Valve lid for norm sterilization container



Art.-Nr./No. 1/2 299 x 278 mm	Art.-Nr./No. 3/4 462 x 278 mm	Art.-Nr./No. 1 585 x 278 mm
80-632-00 ●	80-642-00 ●	80-662-00 ●
80-632-01 ●	80-642-01 ●	80-662-01 ●
80-632-02 ●	80-642-02 ●	80-662-02 ●
80-632-03 ●	80-642-03 ●	80-662-03 ●
80-632-04 ●	80-642-04 ●	80-662-04 ●
80-632-05 ●	80-642-05 ●	80-662-05 ●

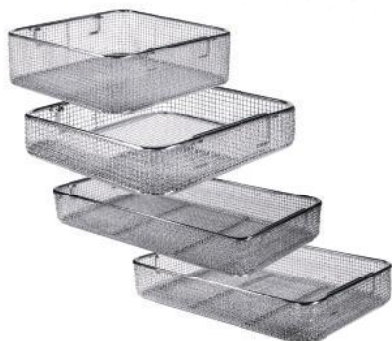

#### Edelstahl-Siebkorb, Geflecht, Fallgriffe Stainless-steel wire basket, sliding handles

Art.-Nr./No.	Größe / Size (mm)
80-671-20	255 x 245 x 50
80-671-25	255 x 245 x 70
80-671-40	405 x 255 x 70
80-671-60	485 x 255 x 70



#### Aluminium-Kennzeichnungs-Schild, 20 Zeichen, 56 x 17 mm

Coding label, 20 letters, 56 x 17 mm

Art.-Nr./No.	Farbe / Color
80-681-01	schwarz / black
80-681-02	rot / red
80-681-03	braun / brown
80-681-04	grün / green
80-681-05	gelb / yellow
80-681-06	lila / purple
80-681-07	blau / blue

#### Einweg-Container-Siegel, blau, 100 Stück/Box

Container seal, disposable, blue, 100 pieces/box

**80-683-10**

#### Indikator-Klebe-Etikett, Lasche rechts, 100 Stück/Box

Adhesive indicator label, latch right side, 100 pieces/box

**80-684-10**

#### Silikonmatte, blau, perforiert, 440 x 230 mm

Silicon mat, blue, perforated, 440 x 230 mm

**80-675-00**

#### Klemmschild aus Edelstahl, hitzebeständig,

6 x 4 cm, 25 Stück/Box

Label holder with clip, stainless steel, heat resistant,

6 x 4 cm, 25 pieces/box

**80-688-00**

## 12 Laryngoskopie-Basisset 50-950-00

### Laryngoscopy basic set 50-950-00

#### Bestehend aus / Consisting of:

- 50-101-00 1x Bruststütze für Erwachsene, Ring 9 cm, Stützstange 34,5 cm  
1x Chest support for adults, ring 9 cm, rod length 34.5 cm
- 50-200-05 1x Operations-Laryngoskop, Gr. 5, für Männer, 17,2 cm, ID 16 mm, OD 29 x 19 mm  
1x Surgical laryngoscope, size 5, for men, length 17.2 cm, ID 16 mm, OD 29 x 19 mm
- 50-200-03 1x Operations-Laryngoskop, Gr. 3, für Jugendliche, 17,2 cm, ID 12 mm, AD 21 x 13 mm  
1x Surgical laryngoscope, size 3, for juveniles, length 17.2 cm, ID 12 mm, OD 21 x 13 mm
- 50-202-04 1x Operations-Laryngoskop, spreizbar, Gr.4, für Frauen, 17,2 cm, ID 14,5 mm, AD 27 x 15 mm  
1x Surgical laryngoscope, spreadable, size 4, for women, 17.2 cm, ID 14.5 mm, OD 27 x 15 mm
- 50-205-36 1x Fiberglas-Lichtträger für starre und spreizbare Laryngoskope Gr. 3-6  
1x Fiberglass lightcarrier for rigid and spreadable laryngoscopes size 3-6
- 50-300-00 1x Kleinsasser Handgriff, gewinkelt  
1x Kleinsasser handle, angled
- 50-311-23 1x Sichelmesser, gebogene Schneide, Arbeitslänge 22 cm  
1x Sickle knife, curved edge, working length 22 cm
- 50-312-23 1x Messer, oval, gerade, Arbeitslänge 22 cm  
1x Knife, oval, straight, working length 22 cm
- 50-315-23 1x Messer, golfstockförmig, Arbeitslänge 23 cm  
1x Knife, golfstick shaped, working length 23 cm
- 50-317-23 1x Häkchen, stumpf, 90°, Arbeitslänge 22 cm  
1x Hook, blunt, 90°, working length 22 cm
- 50-319-23 1x Knotenführer, gerade, Arbeitslänge 23 cm  
1x Knot tier, straight, working length 23 cm
- 50-347-20 1x Saugrohr mit Unterbrecher, kniegebogen, seitl. distale Öffnung, 2,0 mm, 25 cm  
1x Suction tube with interruptor, distal side opening, angled, 2.0 mm, 25 cm
- 50-353-23 1x Injektionsnadel, bajonett, Arbeitslänge 23 cm  
1x Injection needle, bayonet, working length 23 cm
- 80-415-50 1x Monopolares Anschlusskabel für Instrumente, 5 m, passend für Erbe ICC/ACC/Wolf/Storz  
1x Monopolar connecting cable for instruments, 5 m, compatible with Erbe ICC/ACC/Wolf/Storz
- 50-501-10 1x Mikrolaryngoskopiezange, drehbar, runde Löffel, 2,0 mm, aufgebogen, mit Spülkanal, 23 cm  
1x Microlaryngoscopy forceps, rotatable, round cups, upcurved, 2.0 mm, with irrigation channel, 23 cm
- 50-502-10 1x Mikrolaryngoskopiezange, drehbar, Alligator, aufgebogen, mit Spülkanal, 23,5 cm  
1x Microlaryngoscopy forceps, rotatable, alligator, upcurved, with irrigation channel, 23.5 cm
- 50-503-10 1x Mikrolaryngoskopiezange, drehbar, dreieckiges Maul, aufgebogen, mit Spülkanal, 23 cm  
1x Microlaryngoscopy forceps, rotatable, triangular tip, upcurved, with irrigation channel, 23 cm
- 50-504-10 1x Mikrolaryngoskopieschere, drehbar, aufgebogen, mit Spülkanal, 23 cm  
1x Microlaryngoscopy scissors, rotatable, upcurved, with irrigation channel, 23 cm
- 50-512-01 1x Mikrolaryngoskopiezange mit Spülkanal, runde Löffel, 4,0 mm, gerade, 23 cm  
1x Micro laryngeal forceps with irrigation channel, round cups, 4.0 mm, straight, 23 cm
- 50-650-23 1x Laryngoskopie-Nadelhalter mit Spülkanal, mit Sperre, 22 cm  
1x Laryngeal needle-holder with irrigation channel, with ratchet, 22 cm
- 50-550-23 1x Mikrolaryngoskopiezange mit Spülkanal, extra fein, runde Löffel, 1,0 mm, gerade, konischer Schaft, 22 cm  
1x Micro laryngeal forceps with irrigation channel, very delicate, round cups, 1.0 mm, traight, conical shaft, 22 cm
- 50-560-23 1x Mikrolaryngoskopiezange mit Spülkanal, extra fein, Hechtmaul, 1,0 mm, gerade, konischer Schaft, 22 cm  
1x Micro laryngeal forceps with irrigation channel, very delicate, alligator jaw, 1.0 mm, straight, conical shaft, 22 cm
- 50-570-23 1x Mikrolaryngoskopieschere mit Spülkanal, extra fein, 1,0 mm, gerade, konischer Schaft, 22 cm  
1x Micro laryngeal scissors with irrigation channel, very delicate, 1.0 mm, straight, conical shaft, 22 cm

#### Ergänzung 50-950-99

#### Supplement 50-950-99

- 50-416-23 1x Monopolare Koagulationszange, drehbar, gefenstert, oval, gerade, Rauchabsaugung, Schaft 3,0 mm, 23,5 cm  
1x Monopolar coagulation forceps, rotatable, fenestrated, oval, straight, smoke evacuation, shaft 3.0 mm, 23.5 cm
- 50-240-00 5x Endoragard Zahnschutz, doppelseitig  
5x Endoragard teeth protector, double sided
- 80-661-14 1x Norm-Sterilisations-Container, Boden geschlossen, 585 x 274 x 138 mm  
1x Norm sterilization container, bottom closed, 585 x 274 x 138 mm
- 80-662-00 1x Ventildeckel, silber, für Container 80-661-14, 585 x 278 mm  
1x Valve lid, silver, for container 80-661-14, 585 x 278 mm
- 80-671-60 1x Edelstahl-Siebkorb, Geflecht, Fallgriffe, 485 x 255 x 70 mm  
1x Stainless steel wire basket, sliding handles, 485 x 255 x 70 mm
- 80-681-03 1x Aluminium-Kennzeichnungs-Schild, braun, 20 Zeichen  
1x Aluminium tag, brown, 20 letter

Supplement for sales in EU (outside the EU only on request)

## 12 Laser-Set für Erwachsene 50-960-00

### Laser set for adults 50-960-00

#### Bestehend aus / Consisting of:

- 50-215-05 1x Laser-Laryngoskop Größe 5 für Männer  
1x Laser laryngoscope size 5 for men
- 50-215-03 1x Laser-Laryngoskop Größe 3 für Jugendliche  
1x Laser laryngoscope size 3 for juveniles
- 50-217-36 1x Fiberglas-Lichtträger für Laserlaryngoskope Größen 3-6  
1x Fiberglass lightcarrier for laser laryngoscopes sizes 3-6
- 50-218-17 1x Rauchabsaugrohr für Laserlaryngoskope Größen 3-7  
1x Smoke evacuation tube for laser laryngoscopes sizes 3-7
- 50-347-20 1x Saugrohr mit Unterbrecher, kniegebogen, seitlich distale Öffnung 2,0 mm, 25 cm  
1x Suction tube with interruptor, angled, distal side opening 2.0 mm, 25 cm
- 50-349-30 1x Saugrohr mit Unterbrecher, Spitze geschlossen, zwei seitliche Öffnungen 3,0 mm, 25 cm  
1x Suction tube with interruptor, tip closed, two side openings 3.0 mm, 25 cm
- 80-415-50 1x Monopolares Anschlusskabel für Instrumente, 5 m, passend für Erbe ICC/ACC/Wolf/Storz  
1x Monopolar connecting cable for instruments, 5 m, compatible with Erbe ICC/ACC/Wolf/Storz
- 80-501-01 1x Metallschale B1, Ø 4,0 cm, Höhe 1,9 cm, 20 ml  
1x Metal bowl B1, Ø 4.0 cm, height 1.9 cm, 20 ml

#### Bestehend aus / Consisting of:

- 50-215-02 1x Laser-Laryngoskop, Gr. 2, schwarz, für Kinder, 15,2 cm, ID 11 mm, AD 20,5 x 13 mm  
1x Laser laryngoscope, size 2, black, for children, 15.2 cm, ID 11 mm, OD 20.5 x 13 mm
- 50-217-12 1x Fiberglas-Lichtträger für Laser-Laryngoskope Gr. 1 und 2  
1x Fiberglass lightcarrier for laser laryngoscopes size 1 and 2
- 50-218-17 1x Rauchabsaugrohr für Laserlaryngoskope Größen 3-7  
1x Smoke evacuation tube for laser laryngoscopes sizes 3-7
- 50-347-20 1x Saugrohr mit Unterbrecher, kniegebogen, seitlich distale Öffnung 2,0 mm, 25 cm  
1x Suction tube with interruptor, angled, distal side opening 2.0 mm, 25 cm
- 50-580-18 1x Mikrolaryngoskopiezange mit Spülkanal, extra fein, Herzform, 1,0 mm, rechts gebogen, konischer Schaft, 17 cm  
1x Micro laryngeal forceps with irrigation channel, very delicate, heartshaped jaw, 1.0 mm, right curved, conical shaft, 17 cm
- 50-581-18 1x Mikrolaryngoskopiezange mit Spülkanal, extra fein, Herzform, 1,0 mm, links gebogen, konischer Schaft, 17 cm  
1x Micro laryngeal forceps with irrigation channel, very delicate, heartshaped jaw, 1.0 mm, left curved, conical shaft, 17 cm
- 80-501-01 1x Metallschale B1, Ø 4,0 cm, Höhe 1,9 cm, 20 ml  
1x Metal bowl B1, Ø 4.0 cm, height 1.9 cm, 20 ml

#### Ergänzung 50-960-99

#### Supplement 50-960-99

- 50-412-23 1x Monopolare Koagulationszange, drehbar, gerieft, gebogen, Rauchabsaugung, Schaft 3,0 mm, 23,5 cm  
1x Monopolar coagulation forceps, serrated, curved, smoke evacuation, shaft 3.0 mm, 23.5 cm
- 50-240-00 1x Endoragard Zahnschutz, doppelseitig  
1x Endoragard teeth protector, double sided
- 50-416-23 1x Monopolare Koagulationszange, drehbar, gefenestert, oval, gerade, Rauchabsaugung, Schaft 3,0 mm, 23,5 cm  
1x Monopolar coagulation forceps, rotatable, fenestrated, oval, straight, smoke evacuation, shaft 3.0 mm, 23.5 cm
- 80-661-14 1x Norm-Sterilisations-Container, Boden geschlossen, 585 x 274 x 138 mm  
1x Norm sterilization container, bottom closed, 585 x 274 x 138 mm
- 80-662-00 1x Ventildeckel, silber, für Container 80-661-14, 585 x 278 mm  
1x Valve lid, silver, for container 80-661-14, 585 x 278 mm
- 80-671-60 1x Edelstahl-Siebkorb, Geflecht, Fallgriffe, 485 x 255 x 70 mm  
1x Stainless steel wire basket, sliding handles, 485 x 255 x 70 mm
- 80-681-02 1x Aluminium-Kennzeichnungs-Schild, rot, 20 Zeichen  
1x Aluminium tag, red, 20 letter

Supplement for sales in EU (outside the EU only on request)

## 12 Laser-Set für Kinder 50-970-00

### Laser set for children 50-970-00

- 80-415-50 1x Monopolares Anschlusskabel für Instrumente, 5 m, passend für Erbe ICC/ACC/Wolf/Storz  
1x Monopolar connecting cable for instruments, 5 m, compatible with Erbe ICC/ACC/Wolf/Storz

#### Ergänzung 50-970-99

#### Supplement 50-970-99

- 50-412-23 1x Monopolare Koagulationszange, drehbar, gerieft, gebogen, Rauchabsaugung, Schaft 3,0 mm, 23,5 cm  
1x Monopolar coagulation forceps, serrated, curved, smoke evacuation, shaft 3.0 mm, 23.5 cm
- 50-240-00 1x Endoragard Zahnschutz, doppelseitig  
1x Endoragard teeth protector, double sided
- 80-631-14 1x Norm-Sterilisations-Container, Boden geschlossen, 297 x 274 x 138 mm  
1x Norm sterilization container, bottom closed, 297 x 274 x 138 mm
- 80-632-00 1x Ventildeckel, silber, für Container 80-631-xx, 297 x 274 mm  
1x Valve lid, silver, for container 80-631-xx, 297 x 274 mm
- 80-671-20 1x Edelstahl-Siebkorb, Geflecht, Fallgriffe, 255 x 245 x 50 mm  
1x Stainless steel wire basket, sliding handles, 255 x 245 x 50 mm
- 80-681-01 1x Aluminium-Kennzeichnungs-Schild, schwarz, 20 Zeichen  
1x Aluminium tag, black, 20 letter





## 12 Pädiatrisches Laryngoskopie-Basisset 50-980-00

### Basic set for paediatric laryngoscopy 50-980-00

#### Bestehend aus / Consisting of:

- 50-101-00 1x Bruststütze für Erwachsene, Ring 9 cm, Stützstange 34,5 cm  
1x Chest support for adults, ring 9 cm, rod length 34.5 cm
- 50-101-10 1x Stützstange für Bruststütze, Ring 9 cm, 25 cm, für Kinder  
1x Rod for chest support, ring 9 cm, 25 cm, for children
- 50-215-01 1x Laser-Laryngoskop, Gr. 1, schwarz, für Kleinkinder, 13,5 cm, ID 11 mm, AD 20 x 12 mm  
1x Laser laryngoscope, size 1, black, for small children, 13.5 cm, ID 11 mm, OD 20 x 12 mm
- 50-215-02 1x Laser-Laryngoskop, Gr. 2, schwarz, für Kinder, 15,2 cm, ID 11 mm, AD 20,5 x 13 mm  
1x Laser laryngoscope, size 2, black, for children, 15.2 cm, ID 11 mm, OD 20.5 x 13 mm
- 50-217-12 1x Fiberglas-Lichtträger für Laser-Laryngoskope Gr. 1 und 2  
1x Fiberglass lightcarrier for laser laryngoscopes size 1 and 2
- 50-300-00 1x Kleinsasser Handgriff, gewinkelt  
1x Kleinsasser handle, angled
- 50-311-23 1x Sichelmesser, gebogene Schneide, Arbeitslänge 22 cm  
1x Sickle knife, curved edge, working length 22 cm
- 50-318-23 1x Häkchen, scharf, retrograd, Arbeitslänge 23 cm, Gesamtlänge 25 cm  
1x Hook, sharp, backwards, working length 23 cm, total length 25 cm
- 50-347-20 1x Saugrohr mit Unterbrecher, kniegebogen, seith. distale Öffnung, 2,0 mm, 25 cm  
1x Suction tube with interruptor, distal side opening, angled, 2.0 mm, 25 cm
- 50-551-23 1x Mikrolaryngoskopiezange mit Spülkanal, extra fein, runde Löffel, 1,0 mm, rechts gebogen, konischer Schaft, 22 cm  
1x Micro laryngeal forceps with irrigation channel, very delicate, round cups, 1.0 mm, right curved, conical shaft, 22 cm
- 50-552-23 1x Mikrolaryngoskopiezange mit Spülkanal, extra fein, runde Löffel, 1,0 mm, links gebogen, konischer Schaft, 22 cm  
1x Micro laryngeal forceps with irrigation channel, very delicate, round cups, 1.0 mm, left curved, conical shaft, 22 cm
- 50-571-23 1x Mikrolaryngoskopieschere mit Spülkanal, extra fein, 1,0 mm, rechts gebogen, konischer Schaft, 22 cm  
1x Micro laryngeal scissors with irrigation channel, very delicate, 1.0 mm, right curved, conical shaft, 22 cm
- 50-572-23 1x Mikrolaryngoskopieschere mit Spülkanal, extra fein, 1,0 mm, links gebogen, konischer Schaft, 22 cm  
1x Micro laryngeal scissors with irrigation channel, very delicate, 1.0 mm, left curved, conical shaft, 22 cm
- 50-580-23 1x Mikrolaryngoskopiezange mit Spülkanal, extra fein, Herzform, 1,0 mm, rechts gebogen, konischer Schaft, 22 cm  
1x Micro laryngeal forceps with irrigation channel, very delicate, heartshaped jaw, 1.0 mm, right curved, conical shaft, 23 cm
- 50-581-23 1x Mikrolaryngoskopiezange mit Spülkanal, extra fein, Herzform, 1,0 mm, links gebogen, konischer Schaft, 22 cm  
1x Micro laryngeal forceps with irrigation channel, very delicate, heartshaped jaw, 1.0 mm, left curved, conical shaft, 23 cm
- 50-550-18 1x Mikrolaryngoskopiezange mit Spülkanal, extra fein, runde Löffel, 1,0 mm, gerade, konischer Schaft, 17 cm  
1x Micro laryngeal forceps with irrigation channel, very delicate, round cups, 1.0 mm, straight, conical shaft, 17 cm
- 50-580-18 1x Mikrolaryngoskopiezange mit Spülkanal, extra fein, Herzform, 1,0 mm, rechts gebogen, konischer Schaft, 17 cm  
1x Micro laryngeal forceps with irrigation channel, very delicate, heartshaped jaw, 1.0 mm, right curved, conical shaft, 17 cm
- 50-581-18 1x Mikrolaryngoskopiezange mit Spülkanal, extra fein, Herzform, 1,0 mm, links gebogen, konischer Schaft, 17 cm  
1x Micro laryngeal forceps with irrigation channel, very delicate, heartshaped jaw, 1.0 mm, left curved, conical shaft, 17 cm
- 80-415-50 1x Monopolares Anschlusskabel für Instrumente, 5 m, passend für Erbe ICC/ACC/Wolf/Storz  
1x Monopolar connecting cable for instruments, 5 m, compatible with Erbe ICC/ACC/Wolf/Storz

#### Ergänzung 50-980-99

#### Supplement 50-980-99

- 50-240-00 1x Endoragard Zahnschutz, doppelseitig  
1x Endoragard teeth protector, double sided
- 50-412-23 1x Monopolare Koagulationszange, drehbar, gerieft, gebogen, Rauchabsaugung, Schaft 3,0 mm, 23,5 cm  
1x Monopolar coagulation forceps, serrated, curved, smoke evacuation, shaft 3.0 mm, 23.5 cm
- 80-631-14 1x Norm-Sterilisations-Container, Boden geschlossen, 297 x 274 x 138 mm  
1x Norm sterilization container, bottom closed, 297 x 274 x 138 mm
- 80-632-00 1x Ventildeckel, silber, für Container 80-631-xx, 297 x 274 mm  
1x Valve lid, silver, for container 80-631-xx, 297 x 274 mm
- 80-671-20 1x Edelstahl-Siebkorb, Geflecht, Fallgriffe, 255 x 245 x 50 mm  
1x Stainless steel wire basket, sliding handles, 255 x 245 x 50 mm
- 80-681-07 1x Aluminium-Kennzeichnungs-Schild, blau, 20 Zeichen  
1x Aluminium tag, blue, 20 letter

Supplement for sales in EU (outside the EU only on request)

Bipolare Koagulationselektrode.....	16	Angled endoscope HD .....	6
Bipolares Anschlusskabel.....	17	Basic set for paediatric laryngoscopy.....	30
Bruststütze.....	5	Basket .....	26
Codier-Schild.....	27	Bipolar coagulation electrode.....	16
Container-Siegel.....	27	Bipolar coagulation cable.....	17
Endoragard Zahnschutz.....	12	Chest support.....	5
Fiberglas-Lichtträger.....	9, 11	China bowl .....	25
Handgriff .....	11	Clip on coding clamp .....	25
Heermann Handgriff.....	13	Coding label.....	27
Holinger Laryngoskop.....	11	Container seal.....	27
Häkchen.....	14	Cotton carrier .....	15
Indikator-Klebe-Etikett .....	27	Endoragard teeth protector .....	12
Inject-Timer-Kanüle.....	9, 11	Fiberglass lightcarrier.....	9, 11
Injektionsnadel.....	15	Forceps holder.....	25
Jackson Laryngoskop .....	11	Handle .....	11
Kleinsasser Handgriff .....	13	Heermann handle .....	13
Klemmschild.....	26	Holinger Laryngoscope.....	11
Knotenführer.....	14	Hook .....	14
Kornzangen-Behälter.....	25	Inject-Timer cannula.....	9, 11
Laryngoskopie-Basisset.....	28	Injection needle .....	15
Laryngoskopie-Nadelhalter .....	23	Jackson Laryngoscope .....	11
Laser-Laryngoskop .....	10	Kidney bowl.....	25
Laser-Sets.....	29	Kleinsasser handle.....	13
Lösungsschale.....	24	Knives .....	13, 14
Medasil Zahnschutz.....	12	Knot tier.....	14
Medikamenten-Schälchen.....	24 - 25	Laryngeal needle-holder .....	23
Medizinbecher .....	24	Laryngoscopy Basic Set.....	28
Messer .....	13, 14	Laser laryngoscope .....	10
Metallschale.....	24	Laser Sets.....	29
Mikrolaryngoskopieschere mit Spülkanal .....	21 - 22	Medasil teeth protector .....	12
Mikrolaryngoskopiezange, drehbar .....	18	Medicine cup.....	24 - 25
Mikrolaryngoskopiezange mit Spülkanal .....	18 - 22	Metal bowl .....	24
Monopolare Koagulationszange .....	16	Micro laryngeal forceps, rotatable.....	18
Monopolares Anschlusskabel.....	17	Micro laryngeal forceps w. irrigation channel .....	18 - 22
Nierenschale.....	25	Micro laryngeal scissors w. irrigation channel .....	21 - 22
Norm-Sterilisations-Container.....	26	Monopolar coagulation forceps.....	16
Operations-Laryngoskop .....	7 - 8	Monopolar connecting cable.....	16
Pädiatrisches Laryngoskopie-Basisset.....	30	Norm sterilisation container .....	26
Petrischale.....	24	Petri dish.....	24
Porzellan-Schälchen.....	25	Probe .....	14
Rauchabsaugrohr.....	9, 11	Sickle knife.....	13
Saugrohr.....	15	Smoke evacuation tube .....	9, 11
Siebkorb .....	26	Solution bowl.....	24
Sichelmesser.....	13	Stainless steel label.....	27
Stimmband-Spreizer .....	23	Surgical laryngoscope.....	7 - 8
Sonde .....	14	Suction tube.....	15
Tablettenschale .....	24	Suture needle.....	14
Umstechungsnadel.....	14	Tablet dish .....	24
Videolaryngoskop.....	6	Teeth protector, metal .....	12
Watteträger.....	15	Valve lid for norm sterilization container.....	26
Winkeloptik HD.....	6	Vocal cord spreader.....	23
Zahnschutz aus Metall.....	12	Video laryngoscope.....	6





## Numerisches Inhaltsverzeichnis

### Numeric Index

10-722-13	13	50-318-23	14	50-571-23	22	80-632-02	26
50-101-00	5	50-319-23	14	50-572-18	22	80-632-03	26
50-101-10	5	50-320-23	14	50-572-23	22	80-632-04	26
50-101-20	5	50-321-23	14	50-573-18	22	80-632-05	26
50-101-30	5	50-330-40	9	50-573-23	22	80-641-14	26
50-101-40	5	50-345-23	15	50-580-01	23	80-642-00	26
50-150-00	6	50-347-20	15	50-580-02	23	80-642-01	26
50-155-00	6	50-347-25	15	50-580-18	21	80-642-02	26
50-200-01	7	50-347-30	15	50-580-23	21	80-642-03	26
50-200-02	7	50-349-30	15	50-581-18	21	80-642-04	26
50-200-03	7	50-351-23	15	50-581-23	21	80-642-05	26
50-200-04	7	50-353-23	15	50-590-23	22	80-661-12	26
50-200-05	7	50-365-27	16	50-591-23	22	80-661-14	26
50-200-06	7	50-411-23	16	50-592-23	22	80-661-21	26
50-200-07	8	50-412-23	16	50-593-23	22	80-662-00	26
50-202-01	7	50-414-23	16	50-649-23	22	80-662-01	26
50-202-02	7	50-416-23	16	50-650-23	23	80-662-02	26
50-202-03	7	50-501-10	18	50-652-23	23	80-662-03	26
50-202-04	7	50-502-10	18	50-950-00	28	80-662-04	26
50-202-05	7	50-503-10	18	50-960-00	29	80-662-05	26
50-202-06	8	50-504-10	18	50-970-00	29	80-671-20	26
50-202-07	8	50-510-01	19	50-980-00	30	80-671-25	26
50-205-12	9	50-510-02	19	80-414-50	17	80-671-40	26
50-205-36	9	50-510-03	19	80-415-50	17	80-671-60	26
50-205-70	9	50-510-04	19	80-316-50	17	80-675-00	27
50-207-17	9	50-510-05	19	80-317-30	17	80-681-01	27
50-209-17	9	50-510-06	19	80-317-50	17	80-681-02	27
50-215-01	10	50-512-01	19	80-318-30	17	80-681-03	27
50-215-02	10	50-512-02	19	80-318-50	17	80-681-04	27
50-215-03	10	50-512-03	19	80-319-30	17	80-681-05	27
50-215-04	10	50-512-04	19	80-319-50	17	80-681-06	27
50-215-05	10	50-516-01	19	80-501-01	24	80-681-07	27
50-215-06	10	50-516-02	19	80-501-02	24	80-683-10	27
50-215-07	10	50-516-03	19	80-501-03	24	80-684-10	27
50-217-12	11	50-516-04	19	80-501-04	24	80-688-00	27
50-217-36	11	50-520-01	20	80-503-03	24		
50-217-70	11	50-520-02	20	80-504-05	24		
50-218-17	11	50-520-03	20	80-506-30	24		
50-219-17	11	50-520-04	20	80-507-40	24		
50-229-01	11	50-530-01	20	80-509-75	24		
50-229-02	11	50-530-02	20	80-512-00	24		
50-229-03	11	50-530-03	20	80-515-06	24		
50-232-23	14	50-540-01	21	80-515-08	24		
50-232-01	11	50-540-02	21	80-515-10	24		
50-232-02	11	50-540-03	21	80-517-00	24		
50-232-03	11	50-540-04	21	80-519-00	25		
50-235-00	11	50-550-18	21	80-519-01	25		
50-240-00	12	50-550-23	21	80-519-02	25		
50-245-00	12	50-551-18	21	80-519-03	25		
50-245-01	12	50-551-23	21	80-520-06	25		
50-245-02	12	50-552-18	21	80-520-08	25		
50-245-03	12	50-552-23	21	80-525-17	25		
50-250-00	12	50-553-18	21	80-525-25	25		
50-300-00	13	50-553-23	21	80-528-13	25		
50-301-23	13	50-560-18	22	80-528-18	25		
50-310-23	13	50-560-23	22	80-528-20	25		
50-311-23	13	50-561-18	22	80-530-20	25		
50-312-23	13	50-561-23	22	80-631-10	26		
50-313-23	13	50-562-18	22	80-631-12	26		
50-314-23	13	50-562-23	22	80-631-14	26		
50-315-23	14	50-570-18	22	80-631-21	26		
50-316-23	14	50-570-23	22	80-632-00	26		
50-317-23	14	50-571-18	22	80-632-01	26		



## Umrechnungstabelle - Ch/Fr - mm - inch

### Conversion table - Ch/Fr - mm - inch

Charrière (CH) French (F)	mm	Inch
1	0,33	0,013
2	0,67	0,025
3	1,00	0,039
4	1,33	0,051
5	1,67	0,065
6	2,00	0,079
7	2,33	0,092
8	2,67	0,105
9	3,00	0,118
10	3,33	0,131
11	3,67	0,144
12	4,00	0,156
13	4,33	0,170
14	4,67	0,184
15	5,00	0,197
16	5,33	0,210
17	5,67	0,223
18	6,00	0,237
19	6,33	0,249
20	6,67	0,263
21	7,00	0,276
22	7,33	0,288
23	7,67	0,302
24	8,00	0,315
25	8,33	0,328
26	8,67	0,341
27	9,00	0,354
28	9,33	0,367
29	9,67	0,380
31	10,23	0,407
32	10,67	0,420
34	11,33	0,446
36	12,00	0,472
38	12,67	0,494
40	13,33	0,520
45	15,00	0,591





**SPIGGLE & THEIS**  
Medizintechnik

Burghof 14 · 51491 Overath · Germany  
Phone: +49 2206 90 81 - 0  
Fax: +49 2206 90 81 - 13  
info@spiggle-theis.com  
www.spiggle-theis.com

© 2021 by SPIGGLE & THEIS Medizintechnik GmbH

Änderungen und Irrtümer – einschließlich Bilder - vorbehalten.  
Produktsortiment kann pro Land abweichen.

Modifications and errors - including pictures - reserved.  
Product range might vary per country.



PO Box 3403, Erina, NSW, 2250, Australia

**P: +61 2 9810 6947**

[admin@coremed.com.au](mailto:admin@coremed.com.au)

[www.coremed.com.au](http://www.coremed.com.au)