

Bolero

Next Generation Wireless

User Manual

A20



This device complies with Part 15 of the FCC Rules and with Industry Canada licence-exempt RSS standard(s). Operation is subject to the following two conditions: (1) this device may not cause harmful interference, and (2) this device must accept any interference received, including interference that may cause undesired operation.

Le présent appareil est conforme aux CNR d'Industrie Canada applicables aux appareils radio exempts de licence. L'exploitation est autorisée aux deux conditions suivantes: (1) l'appareil ne doit pas produire de brouillage, et (2) l'utilisateur de l'appareil doit accepter tout brouillage radioélectrique subi, même si le brouillage est susceptible d'en compromettre le fonctionnement.

This equipment has been tested and found to comply with the limits for a Class A digital device, pursuant to Part 15 of the FCC Rules. These limits are designed to provide reasonable protection against harmful interference when the equipment is operated in a commercial environment. This equipment generates, uses, and can radiate radio frequency energy and, if not installed and used in accordance with the instruction manual, may cause harmful interference to radio communications. Operation of this equipment in a residential area is likely to cause harmful interference in which case the user will be required to correct the interference at his own expense.

Changes or modifications made to this equipment not expressly approved by Riedel may void the FCC authorization to operate this equipment.

Radiofrequency radiation exposure Information (for the Beltpack):

For body worn operation, this equipment has been tested and meets the FCC RF exposure guidelines when used with the Riedel accessories supplied or designated for this product. Use of other accessories may not ensure compliance with FCC RF exposure guidelines.

Radiofrequency radiation exposure Information (for the Antenna):

This equipment complies with FCC radiation exposure limits set forth for an uncontrolled environment. This equipment should be installed and operated with minimum distance of 20 cm between the radiator and your body. This transmitter must not be co-located or operating in conjunction with any other antenna or transmitter.

Beltpack: Este produto está homologado pela Anatel, de acordo com os procedimentos regulamentados pela Resolução nº. 242/2000 e atende aos requisitos técnicos aplicados, incluindo os limites de exposição da Taxa de Absorção Específica referente a campos elétricos, magnéticos e eletromagnéticos de radiofrequência de acordo com as Resoluções nº. 303/2002 e 533/2009.

This device is granted pursuant to the Japanese Radio Law (電波法) and the Japanese Telecommunications Business Law (電気通信事業法). This device should not be modified (otherwise the granted designation number will become invalid).



The devices conform to the following EU guidelines as attested by the CE mark.

- EMV (EMC) 2014/30/EU
- NSR (LVD) 2014/35/EU
- RTTE (RED) 2014/53/EU



- YFJANT101019 (Bolero DECT Antenna / BL-ANT-1010-19)
- YFJBPK100619 (Bolero Wireless Beltpack / BL-BPK-1006-19)

Industry Canada

- 8706A-ANT101019 (Bolero DECT Antenna / BL-ANT-1010-19)
- 8706A-BPK100619 (Bolero Wireless Beltpack / BL-BPK-1006-19)

Standards

- EN 300 328 V1.9.1 / ETSI EN 300 328 V2.0.20
- EN 300 330 V1.8.1 / ETSI EN 300 330 V2.1.0
- EN 301 406 V2.2.1
- EN 301 489-1/-3/-6/-17, EN 55022, EN 55024
- IEC/EN 60950-1
- ARIB STD-T66
- ARIB STD-T101

Singapore

Complies with
IMDA Standards
DB105184

Australia

Any device that connects to the data ports must comply with the clause 4.7 of AS/NZS 60950.1



Management System
ISO 9001:2015



www.tuv.com
ID 9105041375

**03-000HB01EG-A20
Bolero User Manual**

© November 2017 Riedel Communications GmbH & Co. KG. ALL RIGHTS RESERVED.

UNDER THE COPYRIGHT LAWS, THIS MANUAL MAY NOT BE COPIED, IN WHOLE OR IN PART, WITHOUT THE WRITTEN CONSENT OF RIEDEL. EVERY EFFORT HAS BEEN MADE TO ENSURE THAT THE INFORMATION IN THIS MANUAL IS ACCURATE. RIEDEL IS NOT RESPONSIBLE FOR PRINTING OR CLERICAL ERRORS. ALL TRADEMARKS ARE THE PROPERTY OF THEIR RESPECTIVE OWNERS.

CONTENT

| | | |
|----------|---|-----------|
| 1 | Preface | 5 |
| 1.1 | Information | 6 |
| 1.2 | About Bolero | 9 |
| 2 | Bolero Beltpack | 10 |
| 2.1 | Operating Elements | 11 |
| 2.2 | Status LEDs | 13 |
| 2.3 | Basic Operation | 14 |
| 2.3.1 | <i>StartUp</i> | 14 |
| 2.3.2 | <i>Key Functions</i> | 15 |
| 2.3.3 | <i>Headset Type</i> | 15 |
| 2.3.4 | <i>Volume Adjustment</i> | 16 |
| 2.3.5 | <i>Quick Menu</i> | 17 |
| 2.3.6 | <i>Main Menu</i> | 18 |
| 2.4 | Features in Detail | 22 |
| 2.4.1 | <i>Speaker</i> | 22 |
| 2.4.2 | <i>Brightness Mode</i> | 22 |
| 2.4.3 | <i>Profiles</i> | 23 |
| 2.4.4 | <i>Signalization</i> | 23 |
| 2.4.5 | <i>Silent Mode</i> | 24 |
| 2.4.6 | <i>Display Mode</i> | 24 |
| 2.4.7 | <i>Lock Keys</i> | 24 |
| 2.4.8 | <i>Bluetooth</i> | 25 |
| 2.4.8.1 | <i>Bluetooth State</i> | 26 |
| 2.4.8.2 | <i>Pair</i> | 27 |
| 2.4.8.3 | <i>Share To Net</i> | 28 |
| 2.4.9 | <i>Registration</i> | 28 |
| 2.4.9.1 | <i>Antenna OTA</i> | 29 |
| 2.4.9.2 | <i>Antenna NFC</i> | 30 |
| 2.4.9.3 | <i>Beltpack NFC</i> | 30 |
| 2.4.10 | <i>De-Registration</i> | 31 |
| 2.4.11 | <i>Walk-Test</i> | 31 |
| 2.4.12 | <i>Reset</i> | 32 |
| 2.4.13 | <i>Opening the Rubber Cover</i> | 32 |
| 2.4.14 | <i>Battery</i> | 33 |
| 2.4.14.1 | <i>Charging via USB in the Beltpack</i> | 33 |
| 2.4.14.2 | <i>Charging in the Charger</i> | 34 |
| 2.4.14.3 | <i>Replacing the Battery</i> | 35 |
| 2.4.14.4 | <i>Removing the Belt Clip</i> | 35 |
| 2.4.15 | <i>Firmware Update</i> | 36 |
| 2.5 | Technical Specifications | 38 |
| 3 | Bolero Antenna | 39 |
| 3.1 | Operating Elements | 39 |
| 3.2 | Status LEDs | 41 |
| 3.3 | Basic Operation | 42 |
| 3.3.1 | <i>StartUp</i> | 42 |
| 3.3.2 | <i>Key Functions</i> | 42 |
| 3.3.3 | <i>Main Menu</i> | 43 |
| 3.4 | Web Interface | 44 |
| 3.4.1 | <i>Net / Antenna</i> | 45 |
| 3.4.1.1 | <i>Edit</i> | 46 |
| 3.4.1.2 | <i>Menu</i> | 47 |
| 3.4.2 | <i>Beltpack Profiles</i> | 48 |
| 3.4.2.1 | <i>Edit</i> | 49 |
| 3.4.2.2 | <i>Menu</i> | 50 |
| 3.4.3 | <i>Registered Beltpacks</i> | 51 |
| 3.4.3.1 | <i>Edit</i> | 52 |
| 3.4.3.2 | <i>Menu</i> | 53 |

| | | |
|----------|-----------------------------------|-----------|
| 3.4.4 | System Logs | 54 |
| 3.4.5 | Settings | 55 |
| 3.4.5.1 | Firmware Manager | 55 |
| 3.4.5.2 | Network Service | 55 |
| 3.4.5.3 | Save Net Config | 55 |
| 3.4.5.4 | Upload Net Config | 56 |
| 3.4.5.5 | Login/Logout | 56 |
| 3.5 | Features in Detail | 57 |
| 3.5.1 | Bolero-Artist Setup | 57 |
| 3.5.2 | Switch Recommendations | 60 |
| 3.5.3 | Registration | 63 |
| 3.5.4 | De-Registration | 65 |
| 3.5.4.1 | Antennas | 65 |
| 3.5.4.2 | Beltpacks | 66 |
| 3.5.5 | Firmware Update | 67 |
| 3.6 | Mechanical Drawings | 70 |
| 3.7 | Technical Specifications | 71 |
| 4 | Bolero Charger | 72 |
| 4.1 | Operating Elements | 72 |
| 4.2 | Status LEDs | 74 |
| 4.3 | Charging Batteries | 75 |
| 4.4 | Technical Specifications | 76 |
| 5 | Appendix | 77 |
| 5.1 | Glossary | 77 |
| 5.2 | Maintenance Recommendations | 78 |
| 5.3 | Service | 79 |
| 5.4 | Notes | 80 |
| | Index | 82 |

1 Preface

Thank you for choosing a Riedel product.

This PDF document provides detailed information about the Bolero system, pin outs, mechanical and electrical data.

This manual is available in additional formats:

CHM "Compiled HTML Help" is the standard format for Windows online help and .Net applications
EPUB "Electronic Publishing format" is a cross-platform e-book standard

For further information, please refer to the [Riedel Website](#) or contact your local distributor or the Riedel headquarters in Wuppertal.

NOTICE

This manual, as well as the software and any examples contained herein are provided "as is" and are subject to change without notice. The content of this manual is for informational purpose only and should not be construed as a commitment by Riedel Communications GmbH & Co. KG or its suppliers. Riedel Communications GmbH & Co. KG gives no warranty of any kind with regard to this manual or the software including, but not limited to the implied warranties of merchantability and fitness for a particular purpose. Riedel Communications GmbH & Co. KG shall not be liable for any errors, inaccuracies or for incidental or consequential damages in connection with the furnishing, performance or use of this manual, the software or the examples herein. Riedel Communications GmbH & Co. KG reserves all patent, proprietary design, title and intellectual property rights contained herein, including, but not limited to, any images, text, photographs incorporated into the manual or software.

All title and intellectual property rights in and to the content that is accessed through use of the products is the property of the respective owner and may be protected by applicable copyright or other intellectual property laws and treaties.

1.1 Information

Symbols

The following tables are used to indicate hazards and provide cautionary information in relation to the handling and use of the equipment.

| Danger | |
|---|--|
|  | Indicates an imminently hazardous situation which, if not avoided, will result in death or serious injury. |
| | The highlighted line indicates the activity to prevent the danger. |

| Warning | |
|---|---|
|  | Indicates a potentially hazardous situation which, if not avoided, could result in death or serious injury. |
| | The highlighted line indicates the activity to prevent the danger. |

| Caution | |
|---|---|
|  | Indicates a potentially hazardous situation which, if not avoided, may result in minor or moderate injury. It may also be used to alert against unsafe practices. |
| | The highlighted line indicates the activity to prevent the danger. |

| | |
|---|---|
|  | This text is for generally information. It indicates the activity for ease of work or for better understanding. |
|---|---|

Service

- All service has to be undertaken **ONLY** by qualified service personnel.
- Do not plug in, turn on or attempt to operate an obviously damaged device.
- Never attempt to modify the equipment components for any reason.

| Caution | |
|---|--|
|  | All adjustments have been done at the factory before the shipment of the devices. No maintenance is required and no user serviceable parts are inside the module. |

Voltage

- The power cable should only be connected to a properly grounded source.
- Do not use any adapters.
- Never bypass a ground contact.

| Danger | |
|---|--|
|  | <p>To reduce the risk of electric shock do not remove cover or expose the products to rain or moisture.</p> |

| Warning | |
|---|---|
|  | <p>Laitte on liitettävä suojakoskettimilla varustettuun pistorasiaan.</p> |
| | <p>Apparatet må tilkoples jordet stikkontakt.</p> |
| | <p>Apparaten skall anslutas till jordat uttag.</p> |

Battery Safety

The Bolero-Beltpacks are operated with the following battery type: Lithium-Ion, 3.6V, 4.8Ah, 17.3Wh, 1ICP7/39/65-2, with integrated electronics. For best performance charge the battery fully before initial use or reusing it after being stored for a long period.

In order to ensure air transport safety, the Bolero Battery Pack is tested according to UN 38.3 – Transport of dangerous goods.

| Warning | |
|---|--|
|  | <p>There is a risk of fire and burns if the battery pack is handled improperly.</p> |
| | <ul style="list-style-type: none"> • Do not short-circuit. • Do not dismantle, open, crush, heat above 60°C (140°F) or incinerate. • Recycle or Dispose of property. • Charge before initial use. • Use the specified Riedel Bolero Charger only or charge the battery via the Beltpack. • Do not charge using any other equipment from either side. • Do not connect the contacts to any other equipment. <p>Further recommendations:</p> <ul style="list-style-type: none"> • Avoid storage in direct sunlight. • Do not subject batteries to mechanical shock. • In the event of a cell leaking, do not allow the liquid to come into contact with the skin or eyes. If contact has been made, wash the affected area with copious amounts of water and seek medical advice. • Do not use batteries which are not designed for use with the Beltpack. • Keep batteries out of the reach of children. • Keep batteries clean and dry. • Wipe the battery terminals with a clean dry cloth if they become dirty. • Use the battery only in the application for which it was intended. • When possible, remove the battery from the Beltpack when not in use. |

Environment

- Never place the devices in an area of high dust particles or humidity.
- Never expose the device to any liquids.
- If the devices have been exposed to a cold environment and transferred to a warm environment, condensation may form inside the housing. Wait at least 2 hours before applying any power to the devices.

Disposal

Disposal of old Electrical & Electric Equipment (Applicable throughout the European Union and other European countries with separate collection programs)

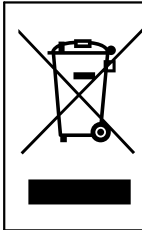

This symbol, found on your product or on its packaging, indicates that this product should not be treated as household waste when you wish to dispose of it. Instead, it should be handed over to an applicable collection point for the recycling of electrical and electronic equipment. By ensuring this product is disposed of correctly, you will help prevent potential negative consequences to the environment and human health, which could otherwise be caused by inappropriate disposal of this product. The recycling of materials will help to conserve natural resources. For more detailed information about the recycling of this product please contact your local city office.

1.2 About Bolero

Bolero Wireless Intercom

The Riedel Bolero Wireless Intercom system is a digital, easy to use full-duplex communications solution for broadcast, security, industrial and theater applications as well as for sports and cultural events. It is an all-new wireless intercom system capable of supporting 10 Beltpacks per antenna and up to 100 antennas in a single deployment. Bolero redefines the wireless intercom category with features such as ADR (Advanced DECT Receiver) with multiple-diversity and RF anti-reflection technology for greater RF robustness.

Bolero utilizes the benefits of the Digital Enhanced Cordless Telecommunications (DECT) standard's base layer. This provides a license-free, cellular architecture with seamless hand-over between cells, allowing each Bolero Wireless Beltpack to continuously monitor and automatically select the best connection to the Antenna.

Bolero is fully integrated in Riedel's Artist Matrix. Features like "Touch&Go" Beltpack registration, versatile operation as a wireless Beltpack, a wireless keypanel, and – in an industry first – a walkie-talkie pushing it beyond the limits of existing wireless intercom solutions.

Bolero runs over a standards-based AES67 IP network with decentralized antennas connected to AES67 switches and to Artist frames equipped with AES67 client cards, providing a fully integrated point-to-point roaming intercom ecosystem. The more decentralized antennas added, the more robust the network becomes. The Bolero high-clarity voice codec provides both higher speech intelligibility and more efficient use of RF spectrum supporting a higher number of Beltpacks per antenna in the same audio bandwidth.

The Riedel-exclusive ADR technology, combines a unique receiver design with multiple diversity elements specifically designed to reduce sensitivity to multipath RF reflections, making Bolero useable in challenging RF environments where other systems have great difficulty.

The Beltpack features 6 buttons for 6 intercom channels or point to point communications, plus a separate "Reply" button that easily facilitates a reply to the last person that called. Bolero's sunlight readable and dimmable display can be inverted so that it is readable in any orientation. The Beltpack can be used without a headset like a walkie-talkie radio utilizing an integrated mic and speaker. Bolero Beltpacks support Bluetooth 4.1, allowing a Smartphone to be connected.

The Beltpack design with a combination of premium materials, including high-impact plastics and rubber overmolds make it both tough and comfortable to use in any situation.

Light and powerful high performance lithium rechargeable battery packs are used for the Beltpack. Battery packs are able to charge inside the Beltpack as well as separately in the 5-bay charger.

What is Bolero?

- A next generation high performance digital wireless intercom system
- License-free, cellular architecture with seamless hand-over
- Riedel exclusive advanced next generation DECT receiver with multiple-diversity and RF anti-reflection technology for greater RF robustness
- Efficient use of RF spectrum for a hassle-free operation even with high channel count

Riedel Bolero – Key Features

- 10 Beltpacks per Antenna
- 100 Antennas per system
- 100 Beltpack capacity per system
- Cellular architecture with seamless hand-over
- Standards-based, decentralized, AES67 IP-networked Antennas
- Fully integrated with Artist for point-to-point comms
- License free
- No registration headaches! Touch the Beltpack to the antenna and GO!
- Riedel-exclusive ADR receiver technology
- Up to six full-duplex keys plus convenient REPLY button
- Modern, high-clarity voice codec
- Integrated mic and speaker for headset-free operation
- Can be used as a Beltpack, a portable desktop keypanel, or Walkie-Talkie
- Tough & ergonomic – Beltpack built to survive
- Bluetooth 4.1
- Weatherproof
- Bottle opener – just in case!

2 Bolero Beltpack

The Bolero Wireless Beltpack is a light and compact, digital station with six individually configurable keys for intercom, IFB or GPO triggering use. Two rotary level controls on the front of the Beltpack allow volume-control for each key and menu navigation. Pushing the Talk key toggles talk on/off with momentary or latching operation as well as an Auto mode that combines both functions in one. Activation is indicated in the display and a button backlit LED. Optional super bright call LEDs and a vibration motor are able to indicate an incoming call or warnings. The Beltpack features a sunlight readable color display which by default shows the labels for the six function keys. In addition, the display gives the user access to the Quick menu and the intuitive configuration menu.

With the new "Touch&Go" beltpack registration a quick and user friendly registration is implemented. Just touch the Beltpack to the antenna and GO.

The Bolero Wireless Beltpack has a user replaceable XLR connector for headset, a 3.5mm jack for a line-in signal and a USB port for firmware updates. Bolero Beltpacks support Bluetooth 4.1, allowing a Smartphone to be connected. When a Smartphone is connected, the Beltpack can act like a car's "hands free" setup so the user can receive calls on their phone and talk and listen via their Beltpack headset. Users can also inject phone calls directly into the intercom channels, providing new levels of workflow flexibility. A fully charged Bolero rechargeable Battery allows more than 17 hours of operation. The rugged housing with rubber protectors houses the internal antennas.

2.1 Operating Elements



Figure 1: Beltpack – Operating Elements (front/top, rear/bottom)

| | |
|----------|--|
| A | Full color sunlight readable display |
| B | Lanyard or safety cord mounting holes |
| C | Walkie-Talkie keys 5+6 (side) |
| D | Rotary encoder (2) |
| E | Speaker |
| F | Microphones |
| G | Keys 1...4 (top) |
| H | Rotary encoder (1) |
| I | Menu key |
| J | Reply key |
| K | NFC contact point |
| L | Belt clip |
| M | Charging contacts |
| N | Battery release button |
| O | Power button |
| P | Headset connector (XLR-4) |
| Q | Line-In and charging sockets (3.5mm jack / USB Type-C) underneath a rubber cover |
| R | Screw head mount and bottle opener |
| S | Removable battery pack |

XLR-4 (male)

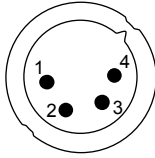

Figure 2: XLR 4 male

| Pin | Description |
|-----|-----------------------|
| 1 | Microphone - |
| 2 | Microphone + (+5 VDC) |
| 3 | Earphones - |
| 4 | Earphones + |

The headset connector is a 4-pole male XLR connector and supports mono headsets with electret or dynamic microphones, depending on the menu setting.

The microphone power (+5 VDC) will be switched on if the menu setting 'Audio > Headset Type' is set to **Electret** or **Auto** and an electret microphone is attached.

3.5mm jack (female)

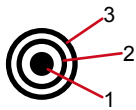

Figure 3: 3.5mm jack female

| Pin | Description |
|------------|-------------|
| 1 (Tip) | Left |
| 2 (Ring) | Right |
| 3 (Sleeve) | GND |

The 3.5 mm jack is a line input connector. The maximum input level is +12 dBu.

USB Type-C

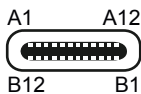

Figure 4: USB Type-C

| Pin | Description | Pin | Description |
|-----|-------------|-----|-------------|
| 1 | GND | 7 | Dn1 |
| 2 | SSTXp1 | 8 | SBU1 |
| 3 | SSTXn1 | 9 | VBUS |
| 4 | VBUS | 10 | SSRXn2 |
| 5 | CC1 | 11 | SSRXp2 |
| 6 | Dp1 | 12 | GND |

The USB connector is used to charge the Beltpack. Furthermore the connector is used for firmware updates. By default the Beltpack is updated in the Bolero Charger.

Charging is only possible with >500 mA USB ports. 100 mA are not supported. The charge current is limited to 500 mA by the Beltpack.

2.2 Status LEDs



Figure 5: Beltpack – Status LEDs (top)

| | | | |
|------|--------|--------------------------|--|
| 1 | Status | off | Beltpack is turned off |
| | | green | <ul style="list-style-type: none"> • Beltpack ready (System ok) • USB charging, battery full |
| | | green blinking | USB charging, battery level 90–99% |
| | | red | <ul style="list-style-type: none"> • booting • Beltpack not registered/not connected • low battery level • outside the Antenna coverage area |
| | | red blinking | critical battery level (<30 minutes of operation) |
| | | red fast blinking | critical error (no function) |
| | | orange blinking | USB charging, battery level 0–89% |
| 2, 3 | Call | off | no active call |
| | | green | incoming call |
| | | orange blinking | incoming notification/beep call |

2.3 Basic Operation

2.3.1 StartUp

Press the 'Power' key firmly to power-up the device.

If the Beltpack is already registered to a Net, the Beltpack will try to establish a connection to it.

An unregistered Beltpack shows "Not registered!" on the splash screen. Pushing the 'Reply' key for a second opens the **Registration** menu to register the Beltpack in a Bolero-Net.

The Main-View appears after successful registration and establishing a connection to a Net:

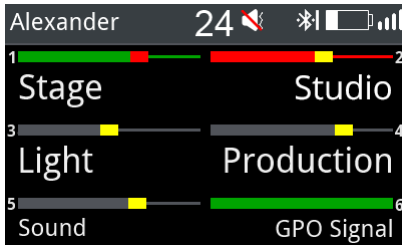
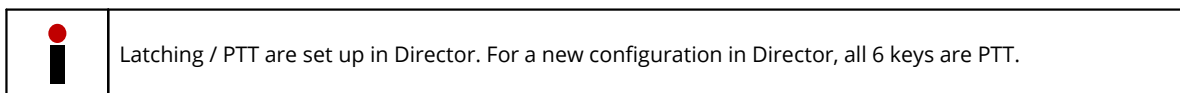

Figure 6: Main-View

| | | | |
|------------|----------------------|--------------|--|
| Status bar | Beltpack name | | Alexander |
| | Beltpack ID | | 24 |
| | Speaker switched off | optional | [Speaker off icon] [Headset off icon] [Bluetooth icon] |
| | Headset switched off | | |
| | Bluetooth icon | | |
| | Battery icon | | [Battery icon] |
| | Radio icon | | [Radio icon] |
| Main area | 6 keys | key number | 1 ... 6 |
| | | Level meter | [Level meter bar] |
| | | Channel name | Stage |

2.3.2 Key Functions

While the display is showing the Main View, users may talk individually or at the same time to all channels. Pushing one of the six keys allows talking in the respective channel. The Call LED is indicating if one channel is active at least. Each active channel has a colored indication in the display. The keys 5 and 6 are none latching by default. That means releasing this key will stop talking to this channel (Walkie-Talkie mode, PTT – push to talk). The keys 1 to 4 are latching. Push again the key to deactivate the respective channel. The inactive channel is displayed in inactive color and the Call LED is off. Both rotary encoders allow adjusting the master volume of the channels.



Menu Key

Three different functions can be triggered by pressing and holding the Menu key for a certain time.

| Hold time of the Menu key | Function | Description |
|---|--|---|
| short key press (<0.5 sec.) | Channel Volume adjustment | Menu to adjust the individual volume level of the channels. |
| middle key press (>0.5 sec. / <3 sec.) | Quick-Menu | The Quick-Menu offers shortcuts to frequently used menu commands. |
| long key press (>3 sec.) | Main-Menu | More in-depth information is displayed and settings can be modified in the Main-Menu. |

Navigation

Following keys can be used to navigate in the menu:

| | |
|-------------------------|--|
| Rotary Encoder 1 | <ul style="list-style-type: none"> • Select the next/previous menu item • Change values/settings |
| Rotary Encoder 2 | |
| Key 4 | Enter selected menu item |
| Menu Key | |
| Key 3 | Back to parent menu item |
| Reply Key | |

2.3.3 Headset Type

Open the Beltpack Menu by pressing and holding (>2.5 sec.) the Menu key. Select the microphone type of the headset:

Audio > Headset Type: Auto Detect, Dynamic, Electret

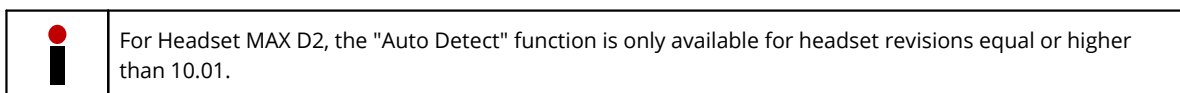

2.3.4 Volume Adjustment

The signal level is normalized and limited in the matrix. In the Beltpack the signal level can be manually leveled and limited.

Rotating either rotary encoder adjusts the master volume of the speaker or headset if the display shows the Main-View. The header shows a level meter of the current master volume.

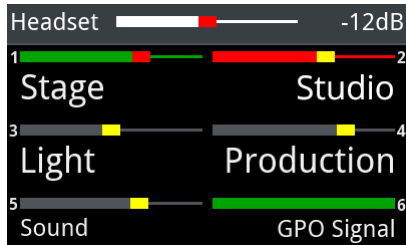

Figure 7: Master Volume

Press briefly the Menu key (<0.5 sec.) to change the volume level of a single channel.

Now the volume level of the channels (1+2) can be adjusted by the rotary encoders (A+B). The bars above the key labels indicate the individual adjusted volume level of the respective channel.

A second brief key press on the Menu key switches to the next channels 3+4, and a third short key press switches to 5+6 and finally to the Reply key. An additional key press switches back to the first channels.

After 3 seconds (factory default setting) with no rotary encoder change, the Beltpack switches back to the Main-View.



Figure 8: Channel Volume

2.3.5 Quick Menu

The Quick-Menu is opened by pressing and holding (>0.5 sec. / <3 sec.) the Menu key.
 The Quick-Menu allows using user defined shortcuts to frequently used menu commands.

Navigate with one of the rotary encoders to the desired menu item and press the menu key to open the respective menu.

The selected menu item can be deleted in the Quick Menu by pressing the Key-1.

A user defined menu item can be assigned to the Quick-Menu by pressing the Key-2 and selecting the desired menu item.



Figure 9: Quick-Menu

| | | |
|----------------------------------|--|--------------------------|
| Header | Time | 14:43 |
| | Speaker switched off | optional |
| | Headset switched off | |
| | Bluetooth icon | |
| | Microphone type (dynamic, electret, error) | D-Mic E-Mic Mic-Err |
| | Battery icon with remaining operation time, error icon | 12h30m ERR |
| Radio icon with level indication | -58 dBm | |
| Main area | User definable rows with menu shortcuts: | Brightness Mode Medium |
| | • Brightness Mode | Lock Keys |
| | • Lock Keys | Headset Type Auto Detect |
| | • Headset Type | Side Tone -12 dB |
| | • Side Tone | Silent Mode Off |
| • Silent Mode | | |
| Footer | Reply key – one layer back | Back |
| | Key 1 – delete the selected entry | Del |
| | Key 2 – add an entry | Add |
| | Menu key – trigger selection | Select |

2.3.6 Main Menu

The Main-Menu is opened by pressing and holding (>3 sec.) the Menu key.
 Basic information is displayed and settings can be modified in the Main-Menu.
 The Main-Menu contains following entries:

| | | | |
|--------------|----------------------|---|---|
| Audio | Gain Settings | Headset Volume | Volume level of the headset: Mute, -60 ... +12 dB [-12] |
| | | Speaker Volume | Volume level of the speaker: Mute, -60 ... +12 dB [-18] |
| | | Side Tone | Volume level of the Sidetone: Mute, -60 ... +12 dB [-12] |
| | | Headset Mic Gain | Gain level of the headsets microphone: 0 ... +30 dB [+6] |
| | | Internal Mic Gain | Gain level of the internal microphone: 0 ... +30 dB [+6] |
| | | Aux Input Gain | Gain level of the Aux input: Mute, -60 ... +12 dB [-12] |
| | | Beep Signalization | Volume level of the beep tones: -24 ... +12 dB [-12] |
| | | Voice Signalization | Volume level of the voice signalizations (relative to Headset/Speaker volume): -24 ... +12 dB [-6] |
| | | Limiter Threshold | Threshold level of the limiter: Off, -24 ... +12 dB [+8] |
| | | Vox Threshold | Threshold level of the Vox: Off, -24 ... +12 dB [-18] |
| | | Bluetooth Volume | Volume level of the Bluetooth audio signals: Mute, -60 ... +12 dB [0] |
| | | Headset Lower Limit | Lower volume level of the headset: <u>Mute</u> , -60 ... +12 dB |
| | | Speaker Lower Limit | Lower volume level of the speaker: <u>Mute</u> , -60 ... +12 dB |
| | | Headset Type | Selection of the microphone type in the headset: <u>Auto detect</u> , Dynamic, Electret |
| | | Enhancements | Headset Echo Cancellation Prevents/reduces acoustic echo distortions to improve voice quality: On, <u>Off</u> |
| | Speaker | Enables the internal speaker and microphone (walkie-talkie mode): On, <u>Off</u> | |

| | | | | |
|-------------------------|---|--|---|--|
| Brightness | Brightness Mode | Selection between one user defined and three pre-defined brightness definitions: Custom, Low, <u>Medium</u> , High | | |
| | Custom Settings | Display | Normal brightness level of the display: 10 ... 100% [50] | |
| | | Display Dim | Dimmed brightness level of the display: 10 ... 100% [10] | |
| | | Display Dim Timer | After this time of inactivity, the display illumination is dimmed: Off, 1 ... 300 sec. [10] | |
| | | Display Off Timer | After this time of inactivity, the display illumination is switched off: <u>Off</u> , 1 ... 60 min. | |
| | | Keys | Normal brightness level of the keys: 10 ... 100% [50] | |
| | | Keys Dim | Dimmed brightness level of the keys: 10 ... 100% [10] | |
| | | Keys Dim Timer | After this time of inactivity, the key illumination is dimmed: Off, 1 ... 300 sec. [10] | |
| | | Keys Off Timer | After this time of inactivity, the key illumination is switched off: <u>Off</u> , 1 ... 60 min. | |
| | | Call LED | Brightness level of the Call LED: 10 ... 100% [40] | |
| Status LED | Brightness level of the Status LED: 10 ... 100% [70] | | | |
| General Settings | Profile | Profile = User rights + parameter settings Profile Change only via PC (Director SW or Webserver) | | |
| | Change Profile | Changes the profile of the Beltpack. A list of available profiles is displayed. | | |
| | Signalization | Call | Defines the signalization mode of a call: <u>Light</u> , Vibrate, Beep | |
| | | Notification/Beep | Defines the signalization mode of a beep-call: <u>Light</u> , <u>Vibrate</u> , Beep | |
| | | Info/Low Battery | Defines the signalization mode if the battery power is low: <u>Light</u> , <u>Vibrate</u> , Beep, <u>Voice</u> | |
| | | Out of Range | Defines the signalization mode if the Beltpack loses the connection to the antenna: <u>Light</u> , <u>Vibrate</u> , Beep, <u>Voice</u> | |
| | Silent Mode | Disables the speaker and acoustic signalizations: On, <u>Off</u> | | |
| | Display Mode | Selection between three pre-defined display modes: <u>Standard</u> , Big Text, Flip Screen (upside down) | | |
| | Timeout | Menu | After this time of inactivity, the menu will be closed and the display shows the Main-View: Off, 1 ... 240 sec. [120] | |
| | | Volume Change | After this time of inactivity, the volume adjustment is terminated: Off, 1 ... 240 sec. [3] | |
| Lock Keys | Lock the keys to prevent accidental key actions: locked, <u>unlocked</u> | | | |
| Bluetooth | Bluetooth State | Enable the Bluetooth functionality: Connect to Mobile/PC, <u>Off</u> | | |
| | Connect / Disconnect | <ul style="list-style-type: none"> • Disconnect: If connected to a device • Connect: if paired but not connect to a device | | |
| | Pair | The Beltpack will be visible for Mobiles/PCs. | | |
| | Share to net | Shares a connected audio signal via intercom: <u>Local</u> , Public | | |
| | Dim Level | Dimmed Bluetooth audio level if Beltpack has an active intercom conference: <u>Mute</u> , -24 ... +12 dB | | |

| | | | |
|---------------------|--------------------------------------|---|---|
| Registration | Register to net *1 | Registers the Beltpack to an existing net. A list of available nets are displayed: <ul style="list-style-type: none"> Over The Air (OTA) | |
| | Connect to pre-registered net | Registers the Beltpack to previous registered nets. A list of available pre-registered nets are displayed: <ul style="list-style-type: none"> Select one to connect Currently connected net is shown with radio select icon | |
| | Delete pre-registered net | Deletes previous registered nets in the Beltpack. A list of pre-registered nets are displayed: <ul style="list-style-type: none"> Select one to delete | |
| Admin *2 | Registration Mode | Local Beltpack NFC | Registers a Beltpack at an already registered Beltpack via NFC: <ul style="list-style-type: none"> NFC (local BP) active as long as you exit |
| | | Over The Air (OTA) | Registers a Beltpack at an already registered Antenna via DECT: <ul style="list-style-type: none"> On, Off (all Antennas) |
| | | Antenna NFC | Allows registering a Beltpack at an already registered Antenna via NFC: <ul style="list-style-type: none"> On, Off (all Antennas NFC) |
| | | Timeout | After elapsing this time, the registration mode is disabled: Off , 1 ... 60 min. [2] (for OTA, System wide NFC, Charger) |
| | OTA Pin | Defines the legitimation during OTA registration | |
| | | Disable PIN | No PIN entry is required for OTA registration. |
| | | Set new Pin | Insert a new 4 digit PIN that is required for the OTA registration. |
| | | Set to Admin Pin | Defines to use the Admin PIN for OTA registration. |
| | Admin Pin | Defines the legitimation to open the Admin menu in the Beltpack or to log into the web interface of the Antenna. | |
| | | Disable PIN | No PIN entry is required for administration. |
| | | Set new PIN | Insert a new 4 digit PIN that is required for administration purposes. |
| | Time Source | Selects the synchronization source of the Beltpacks time setting: PTP, NTP, Internal | |
| | System Time | Allows entering the system time if the time source is set to Internal . | |
| | System Date | Allows entering the system date if the time source is set to Internal . | |
| | Time Format | Define the time format: 12h, 24h | |
| | Date Format | Defines the date format: (dd/mm/yyyy, mm/dd/yyyy, yyyy/mm/dd) | |

| | | | |
|----------------|---------------------------|--|--|
| Service | Test | Walk Test | Analyzes the signal quality to the visible antennas. Following values are shown: <ul style="list-style-type: none"> • Antenna ID • Antenna RPN • current Signal Strength • current Signal Quality |
| | | Walk Test Pro | Lists all Antennas that are visible at the current position. Following values are displayed: <ul style="list-style-type: none"> • Antenna ID • Antenna RPN • Signal strength • Busy: available Antenna capacity (ok, full) • CRC Errors downlink/uplink |
| | Reset | Profile Defaults | Resets the profile to default values. All individual changes will be reset. All registration data stays in memory. |
| | | Factory Reset | Resets the Beltpack to factory default settings. All data (Net lists, Profiles, Registrations) will be lost! A new registration is required. |
| | Information | Radio | Displays a table with radio information. Following values are displayed: <ul style="list-style-type: none"> • Visible Antennas • Actual Radio Level • Radio Quality • Antenna Name • Antenna Number |
| | | Beltpack | Displays a table with Beltpack information. Following values are displayed: <ul style="list-style-type: none"> • Firmware Version: Vxx.xx • Hardware-Revision: xx.xx • Main Version: xxx • Display Version: xxx • Serial number: (13 digits) |
| | | Battery | Displays a table with Battery information. Following values are displayed: <ul style="list-style-type: none"> • Charge Status: xx %, xxxx mAh • Charge Mode:(not charging, xxxx mA) • Temperature: (too cold!, cold, normal, warm, too hot!) • Battery Health: xxx % of max. capacity • Capacity Max.: xxxx mAh • Hardware: xx.xx • Serial Number: (13 digits) |
| | Area ^{*3} | Protected menu – for Riedel service purpose only | |

default values are underlined or displayed in [square brackets]

*1 OTA registration PIN necessary (Admin PIN by default)

*2 Admin PIN necessary

*3 Service PIN necessary

2.4 Features in Detail

2.4.1 Speaker

In the menu '**Audio > Speaker**' is defined, if the audio signal is routed to the internal speaker or to an attached headset. Connecting a headset will switch the speaker off. Removing a headset won't change the current setting.

The following table shows the usage of the internal and headset microphone:

| | Speaker Mode: On | Speaker Mode: Off |
|-----------------------------|-------------------------|--------------------------|
| Headset connected | Beltpack microphone | Headset microphone |
| no Headset connected | Beltpack microphone | no microphone active |



In the speaker mode the echo cancellation is always active.

2.4.2 Brightness Mode

The menu '**Brightness > Brightness-Mode**' allows switching between different predefined and one user specified display settings. Under **Brightness > Custom Settings** the single parameters can be modified.

The predefined modes have following values:

| Element | Description | High | Medium | Low |
|--------------------------|--|-------------|---------------|------------|
| Display | normal display brightness | 100% | 60% | 20% |
| Display Dim | dimmed display brightness | 50% | 20% | 10% |
| Display Dim Timer | inactivity timer to dim the display | Off | 20 sec. | 5 sec. |
| Display Off Timer | inactivity timer to turn off the display | Off | Off | 1 min. |
| Keys | normal key brightness | 100% | 60% | 20% |
| Keys Dim | dimmed key brightness | 50% | 20% | 10% |
| Keys Dim Timer | inactivity timer to dim the keys | Off | 20 sec. | 20 sec. |
| Keys Off Timer | inactivity timer to turn off the keys | Off | Off | 5 min. |
| Call LED Dim | dimmed Call LED brightness | 100% | 40% | 10% |
| Status LED Dim | dimmed Status LED brightness | 100% | 60% | 10% |

2.4.3 Profiles

A Profile is assigned to every Beltpack when it is registered. The profile contains default settings for the whole Beltpack-Config and user rights indicating which settings of the Beltpack-Config the Beltpacks user is allowed to see and/or to change.

Using the Admin or Registration Pin, a Profile to be assigned to all newly registered Beltpacks can be chosen in the Antennas Web Interface or in the Beltpack-Menu.

The Beltpack stays associated to its Profile as long as it is registered. Changes to the Profile will result in changes of the Beltpack-Config of every Beltpack using this Profile. There are some rules regarding these changes:

- Changes to the "user rights" are immediately applied to all Beltpacks using this Profile.
- Changes to settings the "Beltpack user is not allowed to change" are immediately applied to all Beltpacks using this Profile.
- Changes to settings the "Beltpack user is allowed to change" are only applied where the old Beltpack setting matches the setting in the Profile before the change (e.g. if the user already changed it, the new value is not applied; if it was still on default it is applied).

The Profile of a Beltpack can be changed by the Beltpack-User in the Beltpack-Menu ("Load Profile"; if he has the right), by the Admin using the Web Interface or by (re-)registering the Beltpack while a different Profile is selected to be used on all newly registered Beltpacks. A Profile change means that a complete reset to the new Profile defaults regarding the whole Beltpack-Config.

When a user chooses to load the same Profile that the Beltpack already has, the Beltpack-Config is reset back to Profile defaults. Should a Beltpack be (re-)registered using the same Profile that it already has, nothing is changed (e.g. no changes in the Beltpack-Config).

2.4.4 Signalization

In the menu 'General Settings > Signalization' is defined, how different events are signalized. It is possible to combine multiple signalization types.

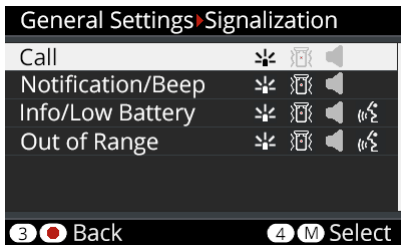





Figure 10: Signalization

| Events | Signalizations | |
|-------------------|---|--------------------------|
| Call |  Light | orange flashing Call LED |
| Notification/Beep |  Vibrate | Vibration |
| Info/Low Battery |  Beep | Signal sound |
| Out of Range |  Voice | Voice announcement |

2.4.5 Silent Mode

If the Silent Mode is activated, the speaker and vibration are disabled.

2.4.6 Display Mode

The menu 'General Settings > Display-Mode' allows selecting between the standard view, a view with bigger text and a Flip Screen mode.

The Flip Screen Mode flips the single rows in the display horizontally:



Figure 11: Flip Screen

2.4.7 Lock Keys

The menu 'General Settings > Lock-Keys' allows locking the keys to prevent accidental key actions.

To unlock the keys:

1. If any key is pressed, the display shows "keys/rotaries locked. To start the unlock sequence, press the Menu key".
2. Once the menu key is pressed, the display shows "press key4 to unlock". This screen stays until volume change timeout or key 4 is pressed.
3. If key 4 is pressed during that time, keys are unlocked. Otherwise keys remain locked.

2.4.8 Bluetooth

The Beltpack provides a Bluetooth 4.1 wireless connection, which is available even when no antenna connection is available or the Beltpack is not registered.

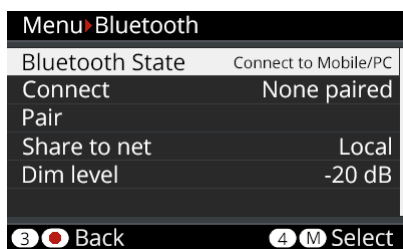

Figure 12: Bluetooth

The menu [Bluetooth State](#) allows defining the device to be paired as the source of an audio signal. The menu [Pair / Discoverable](#) allows pairing the desired device.

If the Beltpack is not connected to any device, the command **Connect** is displayed and allows establishing the connection to the paired device. If a connection is established, the command **Disconnect** is displayed.

After loosing the Bluetooth connection...

| | Bluetooth State: Mobile/PC |
|---------------------------------------|---|
| Connection loss (out of range) | The connection is <i>not</i> reestablished. |
| Reboot of the Bluetooth device | The connection is <i>not</i> reestablished. |
| Reboot of the Beltpack | The last connection is reestablished. |

The Mobile/PC is able to force re-establishment via button press.

During Music or Telephone call, the title or Name or number is visible in Status line.

2.4.8.1 Bluetooth State

In the menu 'Bluetooth > Bluetooth State' is selected, if the Beltpack should be connected to a Mobile/PC.

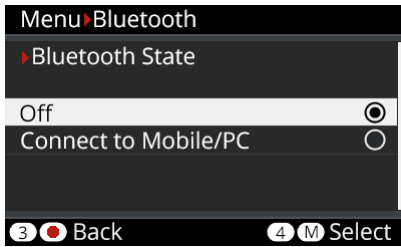



Figure 13: Bluetooth - Bluetooth State

| | |
|------------------|---|
| Mobile/PC | A mobile device (mobile phone, tablet) or PC is able to connect to the Beltpack. In this mode the Beltpack (including the wired headset) acts like a Bluetooth headset. The user is able to pick up a telephone call or skip forward to the next music track via the Beltpack user interface. A telephone call or music of the connected mobile phone is able to add to one or more channels of the Beltpack (Public) or is only hearable on the connected Beltpack (Local). <ul style="list-style-type: none"> • The pairing is triggered in the Beltpack menu or optionally by NFC. • Telephone call audio quality (bidirectional): Standard (20 Hz ... 4 kHz) • Music audio quality (unidirectional): HQ (20 Hz ... 20 kHz) |
| Off | The Bluetooth functionality of the Beltpack is switched off. This setting enables the Line input |

| | |
|---|---|
|  | If a Bluetooth connection is activated, the Line-Input is disabled. |
|---|---|

2.4.8.2 Pair

In the menu '**Bluetooth > Pair**' the pairing process between the Beltpack and a Bluetooth device can be started. After selecting this menu the Beltpack is visible as an audio device called "Bolero" for other Bluetooth devices.

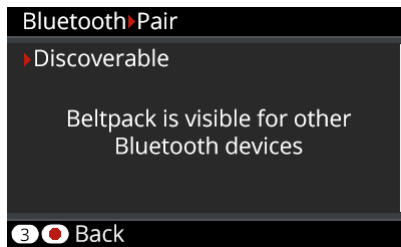

Figure 14: Bluetooth - Pair

Start the pairing process and confirm the generated PIN on the Mobile/PC. Confirm the PIN also on the Beltpack by pressing Key-4.

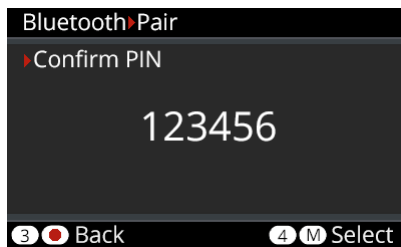

Figure 15: Bluetooth - Pair - Confirm



A new pairing will overwrite the old settings.

2.4.8.3 Share To Net

The signal from the mobile phone can be either heard/talked-to locally or be relayed to a public/intercom channel. Therefore the user is able to share the audio signal from the Beltpack connected mobile device via an activated intercom conference (**Public**) or listen to the audio signal at the Beltpack (**Local**) only. The audio signal is mixed to all active keys (channels).

The **Public** mode is indicated by a yellow status bar.

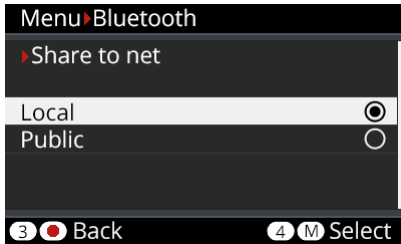

Figure 16: Share to net

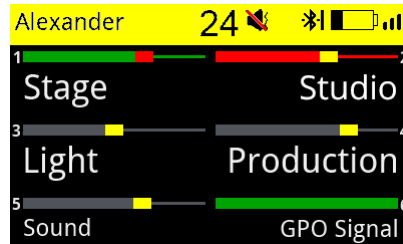

Figure 17: Public Mode enabled

| | |
|--|---|
| | <p>In Public mode the Dim-Level function for the Beltpack device is disabled because the audio signal is part of the conference.</p> <p>If the Bluetooth functionality is disabled, the Line input adopts the Share To Net Mode.</p> |
|--|---|

2.4.9 Registration

Before a Beltpack can connect to a Bolero-Net, it has to be registered to it. Registration means, that the Bolero-Net knows the Beltpack, the Beltpack knows the Bolero-Net and an encryption key is generated to be used by both sides.

There are different ways to register a Beltpack to a Bolero Net:

| | |
|---------------------|---|
| Antenna OTA | Allows registering a Beltpack O ver T he A ir at an already registered Antenna via DECT (D igital E nhanced C ordless T elecommunications). |
| Antenna NFC | Allows registering a Beltpack at an already registered Antenna via NFC (N ear F ield C ommunication). |
| Beltpack NFC | Allows registering a Beltpack at an already registered Beltpack via NFC. |

| | |
|--|--|
| | <p>Up to 10 Nets can be registered in a Beltpack. If the Beltpack needs to be registered in another Net, a pre-registered Net must be deleted.</p> |
|--|--|

2.4.9.1 Antenna OTA

This registration mode allows registering a Beltpack at an already registered Antenna over the air (DECT). Following steps are necessary to register a Beltpack via Antenna-OTA to a Bolero Net:

- At first the **'Registration Method (OTA)'** must be activated. This can be done in two ways:
 - a) Via the Antennas Web-Interface
(see chapter '[Bolero Antenna > Features in Detail > Registration](#)').
 - b) Via another Beltpack that is already registered in the Net:
Menu '**Admin > Registration Mode > Over The Air > On**'.
- Then start the registration process in the Beltpack that should be connected to the Net:
 - a) If the Beltpack is not registered to any Net, press and hold the **'Reply'** key for one second. The Beltpack starts automatically searching for available Nets.
 - b) If the Beltpack is already connected to another Net, push the Beltpack's Menu key for >3 seconds (long key press), navigate to the menu **'Registration'** and select **'Register to net'**.

The Beltpack begins to search for available Nets and displays them one at a time.

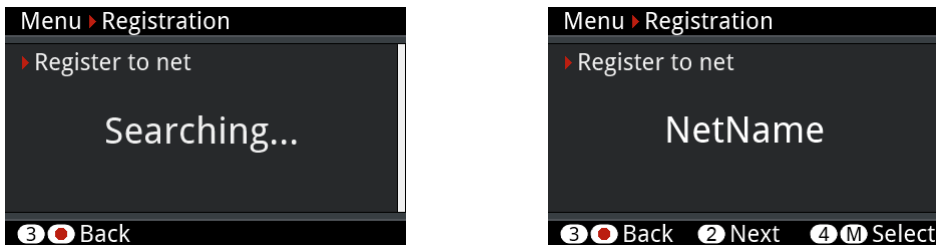



Figure 18: Net searching

- The Beltpack will continue to search until a Net is found or **'Back'** is pressed.
- If **'Back'** is pressed, the Beltpack will stop searching and return to the **Registration** menu.
- If **'Next'** is pressed, the current Net is blocked and the Beltpack will continue searching for other Nets. The blocking list is cleared by reentering the **Registration** menu.
- If **'Select'** is pressed, the user will be asked for the **OTA Registration PIN** that was defined via the Antennas Web-Interface or via the Beltpack where the registration mode was enabled (by default the **Admin PIN** is used).
- After registration, the Beltpacks are immediately connect to the Bolero net.

| | |
|---|--|
|  | <ul style="list-style-type: none"> • This setting is system wide and stays active until disabled or the registration timeout runs out. • The registration timeout is restarted each time a Beltpack is registered. |
|---|--|

2.4.9.2 Antenna NFC

This registration mode allows registering a Beltpack at an already registered Antenna via NFC. Following steps are necessary to register a Beltpack via Antenna-NFC contact point (📶) to a Bolero Net:

- At first the **'Registration Method (NFC)'** must be activated. This can be done in two ways:
 - a) Via the Antennas Web-Interface
(see chapter '[Bolero Antenna > Features in Detail > Registration](#)').
 - b) Via another Beltpack that is already registered in the Net:
Menu '**Admin > Registration Mode > Antenna NFC > On**'.
- The Beltpacks to be registered have to be turned on, no other special setting or user intervention is required.
- Just hold the NFC contact point of the Beltpacks close to the NFC contact point of any Antenna. The Beltpacks will be registered to the same net that the antenna belongs to.
- After registration, the Beltpacks will immediately connect to the Bolero net.

| | |
|---|---|
|  | <ul style="list-style-type: none"> • This setting is system wide and stays active until disabled or the registration timeout runs out (timeout is the same as for OTA registration). • All Antenna-NFCs are switched to registration mode. • The Beltpack-NFCs of connected Beltpacks are NOT switched to registration mode. |
|---|---|

2.4.9.3 Beltpack NFC

This registration mode allows registering a Beltpack at an already registered Beltpack via NFC. Following steps are necessary to register a Beltpack via Beltpack-NFC contact point (📶) to a Bolero Net:

At first the Registration Method '**Local Beltpack NFC**' must be activated at the already registered Beltpack ('Master'-Beltpack):

- Push the 'Master'-Beltpack's Menu key for >3 seconds (long key press).
- Navigate to the '**Admin**' menu.
- Enter the '**Admin PIN**' of the net.
- Select '**Registration Mode**' > '**Local Beltpack NFC**'.

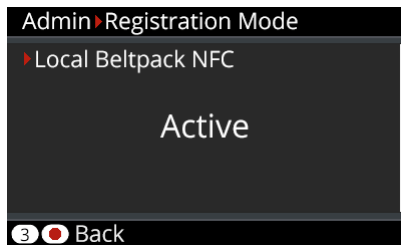



Figure 19: Registration Mode 'Local Beltpack NFC'

- The Beltpacks to be registered have to be turned on, no other special setting or user intervention is required.
- Just hold the NFC contact point of other Beltpacks close to the NFC contact point of the 'Master'-Beltpack. These Beltpacks will be registered to the same net that the 'Master'-Beltpack belongs to.
- After registration, the Beltpacks will immediately connect to the Bolero net.

| | |
|---|---|
|  | <ul style="list-style-type: none"> • The 'Master'-Beltpack stays in the registration mode until the user leaves the menu or the 'Master'-Beltpack is disconnected (there is no timeout). |
|---|---|

2.4.10 De-Registration

To de-register a Beltpack from a Net, choose the Menu 'Registration > Delete pre-registered Net'.

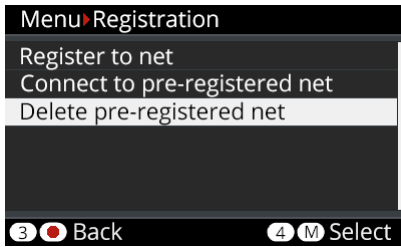

Figure 20: De-Registration

Select the Net to be removed from the list and confirm the de-registration by pressing Key-4. If the Beltpack is connected to this Net, it will be immediately disconnected.

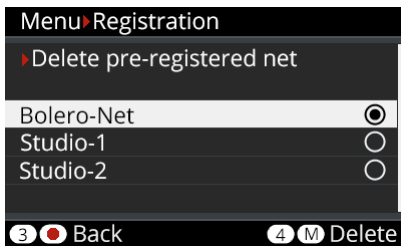

Figure 21: Delete pre-registered net

The De-Registration is also possible via the Antennas Web Interface (see chapter 'Bolero Antenna > Features in Detail > De-Registration > [Beltpacks](#)').

2.4.11 Walk-Test

The Walk-Tests (Pro) lets the user analyze the signal quality to the visible antennas.

This function is started in the **Beltpack Menu (Setup) > Test > Walk Test (Pro)**.

While walking through the Beltpacks' operation area, the display shows the current and the min/max radio levels of all visible antennas. The active Antenna is highlighted.

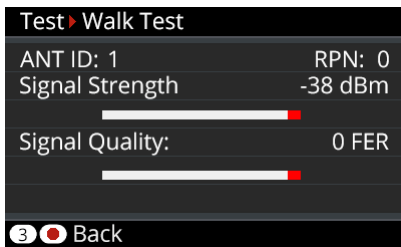

Figure 22: Walk Test

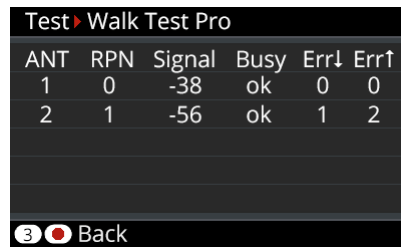

Figure 23: Walk Test Pro

2.4.12 Reset

The Beltpack-Menu 'Service > Reset' offers two different ways to reset the Beltpack to factory default settings.

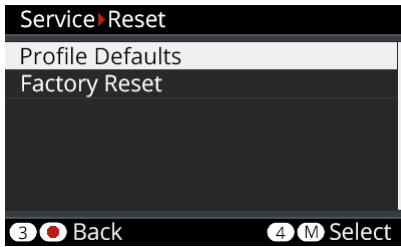

Figure 24: Beltpack – Reset Menu

Profile Defaults

This resets the Beltpacks' Profile data the current default settings of the net. All registration data stays in memory.

Factory Reset

This resets all data and settings to factory default. All Net lists and registrations data will be deleted.

2.4.13 Opening the Rubber Cover

The rubber cover yields protection against ingressing dirt and water inside the Beltpack. The rubber cover can be removed as follows:

- Turn the Beltpack's rear side upwards.
- Push your fingernail gently in the slit on the top of the rubber cover...
- and pull the rubber cover out of the Beltpack's connectors.
- Take care to seal the Beltpack when the connectors are not in use.



Figure 25: Insert fingernail



Figure 26: Pull rubber cover

2.4.14 Battery

Light and powerful custom lithium rechargeable battery packs are used to operate the Beltpacks. Batteries can be charged in following ways:

- Beltpack (with battery) in the Charger
- single Battery in the Charger
- Beltpack (with battery) via any USB device (USB charger, PC, etc.)

The charging speed depends on the ambient temperature and the charger:

| Temperature | | Display | Charger | USB charger | USB device |
|-------------|--------------|-----------|-----------------------------------|---------------------------------|-----------------------------------|
| <0°C | <32°F | too cold! | no charging | | |
| 0°...10°C | 32°...50°F | cold | slow charging (1.00A, 4.06V) | slow charging (0.90A, 4.06V) | slow charging (0.50A, 4.06V) |
| 10°...45°C | 50°...113°F | normal | normal charging (1.50A, 4.20V) | | normal charging (0.50A, 4.20V) |
| 45°...60°C | 113°...140°F | warm | slow charging (1.50A, 4.06V) | | slow charging (0.50A, 4.06V) |
| >60°C | >140°F | too hot! | no charging | | |

2.4.14.1 Charging via USB in the Beltpack

- Connect the Beltpack with an USB power supply or an USB connector that has a minimum current supply of 500mA.

During charging the Beltpack is still operable. The main screen shows in the top right the charge icon:

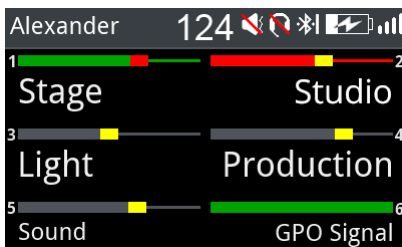

Figure 27: USB Charging view

More information is displayed in the Beltpack Menu 'Service > Information > Battery':

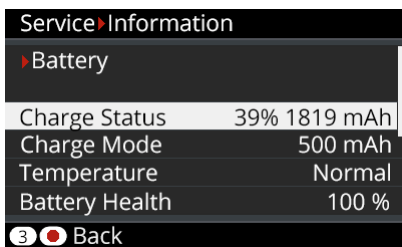



Figure 28: Charging information in the Beltpack menu

2.4.14.2 Charging in the Charger

- Plug the Beltpack or just the battery itself in an empty position in the charger.



| | |
|---|---|
|  | <p>The radio is switched off when the Beltpack is plugged into the Charger.</p> |
|---|---|

- The charging procedure will start automatically.



- The Beltpack's display and the corresponding Slot LED indicate the current charging state.

| | | | |
|----------------|--|------------|---|
| Bolero-Bpk | | 1 |  |
| Charge Status | | 23 % | |
| Time to Full | | 2 h 19 min | |
| Temperature | | Normal | |
| Battery Health | | 100 % | |

For further information refer chapter [Bolero Charger](#).

2.4.14.3 Replacing the Battery

The Beltpack battery can be replaced by following these steps:

- Pull the battery release button upwards...
- and push the battery at the belt clip to the bottom side of the Beltpack.
- Lift the battery upwards.
- Insert the battery in the opposite order.



Figure 29: Pull release button



Figure 30: Push battery



Figure 31: Lift battery

2.4.14.4 Removing the Belt Clip

The belt clip can be removed by following these steps:

- Pull the lock clip upwards...
- and push the belt clip to the top side of the battery.
- Insert the belt clip in the opposite order.



Figure 32: Pull lock clip



Figure 33: Push belt clip

2.4.15 Firmware Update

This chapter describes the update procedure of Bolero Beltpacks. The following devices are required:

- ✓ Bolero-Charger
- ✓ USB pen drive (Type A or Type C)
- ✓ Beltpack firmware package (for example "bolero_v1.23.package")
- ✓ Bolero-Beltpacks to be updated

It is possible to update the firmware of up to five Beltpacks simultaneously in one Bolero-Charger.

- Connect the Charger with mains.

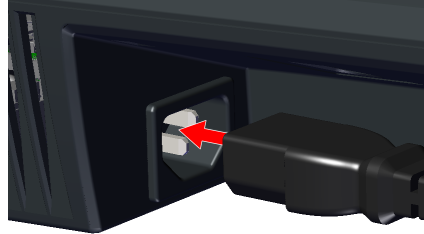

- Copy the new firmware package in the root directory of an USB pen drive.
- Only one package is allowed to be stored in the root directory.

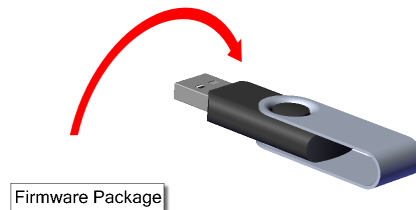

- Plug the Beltpack(s) in the charging slots.
- Take care that the rubber cover is not pulled out.
- The charging process is independent of the update procedure.



- Plug the pen drive into the respective USB slot (type A or type C) on the front side of the Charger.



- At first, the **Charger's** firmware will be updated.
- During this process the Charger's Status-LED will blink green and the Charger will be restarted.
- The current process will be also displayed on the Beltpacks' display.

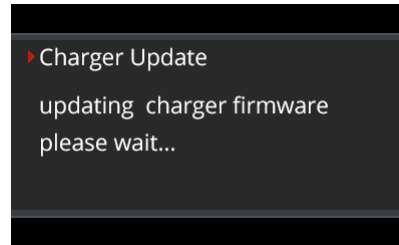

- Then, the **Beltpacks'** firmware will be updated.
- During this process the Beltpack will show the current '(Vxx.xx)' and the new '(Vzz.zz)' firmware version.
- Furthermore the current process (pending, starting, erasing, writing and verifying) and a progress bar will be displayed.

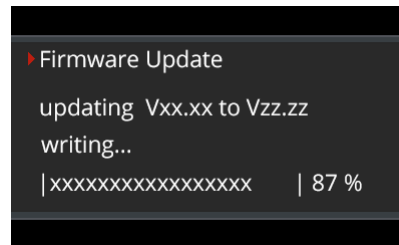

- Finally the Beltpack will be initialized, restarted and finalized.

Caution: Do not remove the Beltpacks during this process out of the charging slots.

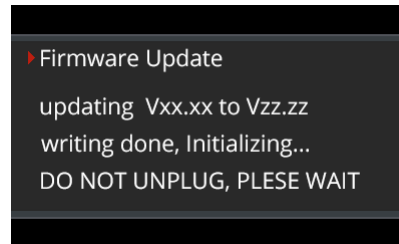

- After terminating the update process, the Beltpack will show 'done' and the new firmware version '(Vxx.xx)'.

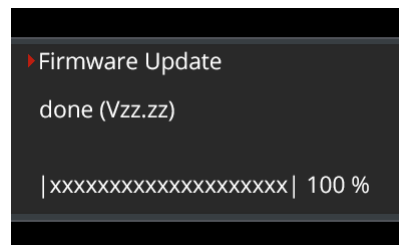

| | |
|--|---|
| | The order of plugging the Beltpacks and the USB stick doesn't matter. |
|--|---|

2.5 Technical Specifications

| | | |
|---|---|---|
| Beltpack Product Code | BL-BPK-1006-19 | |
| Multi-path delay spread protection | Yes, ADR (Advanced DECT Receiver) | |
| Audio Bandwidth | 200 Hz ... 7 KHz (-3dB) | |
| Mode of Operation | Full-duplex on all routes | |
| Encryption | AES256 Bit encryption | |
| Line in | 3.5 mm jack, 40 Hz ... 20 kHz, max. +12 dBu input level (local audio mix only) | |
| Talk Controls | 4x push buttons + 2x handheld keys (PTT, Latching & Auto mode) 1x reply key (PTT only) | |
| Volume / Level Controls | 2x Master or slave + menu navigation | |
| Display | High contrast sunlight readable full colour LCD | |
| Audio prompts | Out of range, Battery low, Belt pack registered | |
| No. of Full-Duplex Audio Paths | 6 with individual level control | |
| Handheld Operation | Walkie-talkie mode | |
| Vibrate Module | Vibrate indicates incoming Call | |
| Internal Loudspeaker | Freq. <500Hz ... >7kHz 80dB/SPL/0.5W/1m, @ <5% THD | |
| Remote Health Monitoring | Battery charge status, remaining time | |
| Battery | Lithium Ion external removeable battery pack with user removeable clip | |
| USB Type-C Connection | USB 2.0 | |
| Operation Time | ~17 hours typical | |
| Headset Connector | 4-pin male XLR, user replaceable | |
| Microphone Type | Electret (~5V bias voltage) or dynamic, user selectable or automatic | |
| Side-tone and microphone gain | Individually adjustable for each Beltpack & via remote control | |
| Bluetooth | V4.1 (HSF - hands free profile) | |
| Bluetooth phone call mix into intercom | Yes | |
| Lanyard anchor points | Yes | |
| Dimensions | Width | 86 mm / 3.4" |
| | Height | 130 mm / 5.1" |
| | Depth | 48 mm / 1.9" |
| Weight | 420 g (incl. battery and clip) | |
| Environmental | IP65 sealing: dust tight + water jet from all angles | |
| Operating Environment | Temperature | -10° ... +55°C |
| | Humidity | 0 % ... 90 % rel. (non-condensing), Ta=40°C |
| Storage Temperature | -20° ... +70°C | |

3 Bolero Antenna

Bolero active Antennas run over a standard AES67 IP network. Up to 100 antennas and 100 Beltpacks are able to connect to a system. The intelligent and highly efficient use of bandwidth results in 10 Beltpacks per Antenna. The decentralized Antennas allow the use of existing standard structured cabling and provide a wide area between the Antennas connected to AES67 switches and the Artist frames equipped with AES67 client cards. This provides a fully integrated point-to-point roaming intercom ecosystem. The more decentralized Antennas added, the more robust the network becomes. The Antenna is powered via Power-over-Ethernet (PoE+), simplifying installations by eliminating local power supplies or alternatively via a separate DC supply.



To prevent transmitting in a prohibited frequency range, the radio is switched off in Antennas that are configured to destinations outside Europe. The radio must be only switched on in the destination country.

3.1 Operating Elements

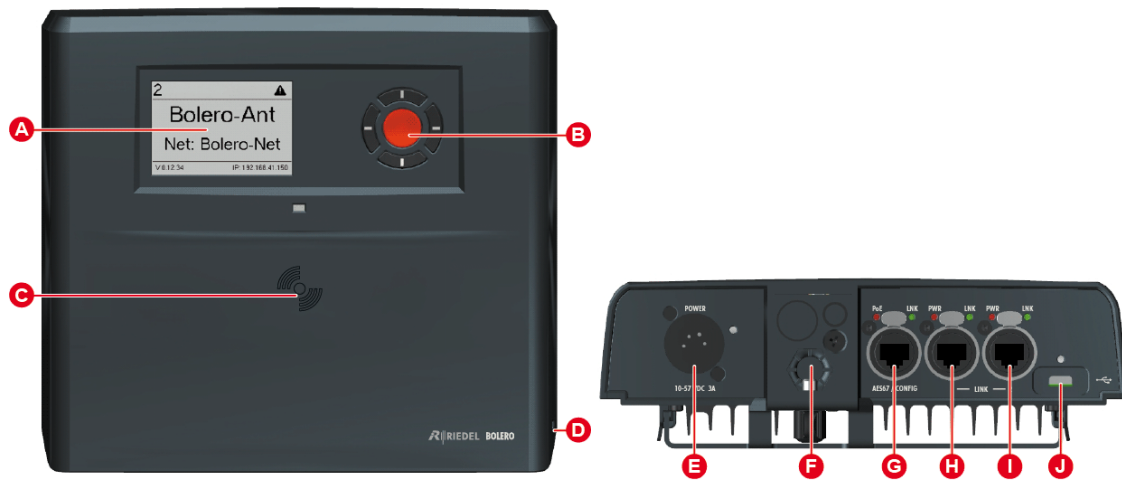

Figure 34: Antenna Operating Elements (front, bottom)

| | |
|----------|--|
| A | E-ink display |
| B | Navigation buttons (cursor and menu button) |
| C | NFC contact point |
| D | Kensington Security Slot |
| E | DC power supply connector (XLR-4) |
| F | Mounting element (spigot, 3/8" & 5/8" microphone stand mounting) |
| G | AES67/Config connector (RJ45 , 1Gbit) |
| H | LINK connector 1 (RJ45) |
| I | LINK connector 2 (RJ45) |
| J | USB connector (USB Type-C) |

XLR-4 (male)

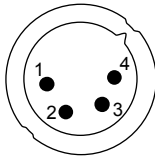

Figure 35: XLR-4 male

| Pin | Description |
|-----|--------------------------|
| 1 | -PWR |
| 2 | Chassis |
| 3 | Data |
| 4 | +PWR (10...57 VDC / 3 A) |

The length of the DC power cable should not exceed 1.5 meters.

RJ45

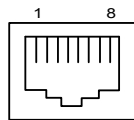

Figure 36: RJ45

| Pin | AES67/Config | LINK 1+2 |
|-----|----------------|----------|
| 1 | D1+ / PoE+ (p) | D1+ |
| 2 | D1- / PoE+ (p) | D1- |
| 3 | D2+ / PoE+ (n) | D2+ |
| 4 | D3+ / PoE+ (p) | D3+ |
| 5 | D3- / PoE+ (p) | D3- |
| 6 | D2- / PoE+ (n) | D2- |
| 7 | D4+ / PoE+ (n) | D4+ |
| 8 | D4- / PoE+ (n) | D4- |

1Gbit Ethernet connection is necessary to operate the Bolero net.

USB Type-C

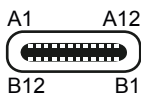

Figure 37: USB Type-C

| Pin | Description | Pin | Description |
|-----|-------------|-----|-------------|
| 1 | GND | 7 | Dn1 |
| 2 | SSTXp1 | 8 | SBU1 |
| 3 | SSTXn1 | 9 | VBUS |
| 4 | VBUS | 10 | SSRXn2 |
| 5 | CC1 | 11 | SSRXp2 |
| 6 | Dp1 | 12 | GND |

3.2 Status LEDs



Figure 38: Antenna - Status LEDs (front, bottom)

| | | | |
|------|-----------|------------------------|--------------------------------|
| 1 | Status | <i>off</i> | not powered |
| | | <i>green</i> | Antenna ready (System ok) |
| | | <i>red blinking</i> | Antenna power error |
| | | <i>orange</i> | Antenna powered up (Radio OFF) |
| | | <i>orange blinking</i> | booting |
| 2 | Power | <i>off</i> | no XLR input power |
| | | <i>green</i> | XLR input power ok |
| 3 | AES67-PoE | <i>off</i> | no PoE+ input power |
| | | <i>green</i> | PoE+ input power ok |
| 4 | AES67-LNK | <i>off</i> | no Ethernet connection present |
| | | <i>green</i> | Ethernet link ok |
| 5, 7 | LINK-PWR | <i>off</i> | no LINK input power |
| | | <i>green</i> | LINK input power ok |
| | | <i>red</i> | LINK input power out of range |
| 6, 8 | LINK-LNK | <i>off</i> | no LINK connection present |
| | | <i>green</i> | LINK connection ok |
| | | <i>red</i> | LINK connection failure |
| 9 | USB | <i>off</i> | no USB input power |
| | | <i>green</i> | USB input power ok |
| | | <i>red</i> | USB input power out of range |

3.3 Basic Operation

3.3.1 StartUp

The Antenna starts automatically after it is attached to power. Either with a separate power supply or via a switch including PoE+ functionality.

The Main-View appears after booting and is showing following information:

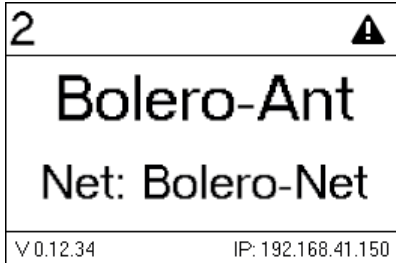

Figure 39: Main-View

| | | |
|-----------|---------------------------------|------------------------|
| Header | unique ID of the Antenna | 2 |
| | Warning symbol (optional) | ⚠ |
| Main area | Name of the Antenna | Bolero-Ant |
| | Name of the Net | Net: Bolero-Net |
| Footer | Firmware version of the Antenna | V 0.12.34 |
| | IP address of the Antenna | IP: 192.168.41.150 |

3.3.2 Key Functions

The five buttons right beside the display allows displaying system information or editing basic settings. Press any key to enter the Main Menu. The general key functions are as follows:

| | |
|--|--|
| | <ul style="list-style-type: none"> Select the previous menu item Increase values |
| | <ul style="list-style-type: none"> Select the next menu item Decrease values |
| | <ul style="list-style-type: none"> Back to parent menu item Move selection to the left |
| | <ul style="list-style-type: none"> Move selection to the right |
| | <ul style="list-style-type: none"> Enter selected menu item |

3.3.3 Main Menu

The Main-Menu is opened by pressing any key.

In the Main-Menu information are displayed and basic settings can be modified.
The Main-Menu contains following entries:

| | | |
|------------------------------------|---------------------------|---|
| Node Settings | Name | Antenna Name (12 characters) |
| | User ID | Unique device number (3 digits) |
| IP Settings | Mode ^{*1} | Allows setting the mode of IP address: Static, DHCP, Auto IP |
| | IP | Allows setting the IP4.0 address. |
| | Netmask | Allows setting the IP4.0 netmask. |
| | Gateway | Allows setting the IP4.0 gateway. |
| | | If the Mode is set to Static . |
| Information | Status/Warning | Displays states and warnings: -> Step trough all system errors & warnings |
| | System | Displays a table with System information. Following values are displayed: <ul style="list-style-type: none"> • Firmware Version: V x.x.x • AAFP (Antenna) Serial number: (13 digits) • Main Version: Vx.x.x • Radio Version: Vx.x.x • Display Version: Vx.x.x • Power Version: Vx.x.x |
| | Radio | Displays a table with radio information. Following values are displayed: <ul style="list-style-type: none"> • DECT enabled: YES/NO • DECT active: YES/NO • Local connected Beltpacks: xx • System wide connected Beltpacks: xx • Registered Beltpacks: xx • Area: Europe, US/Canada, South America, Brazil, Japan |
| Factory Reset ^{*1} | | <ul style="list-style-type: none"> • Resets the Antenna to factory default settings. • All Data will be deleted! |

^{*1} Admin PIN necessary

3.4 Web Interface

The Web Interface is opened by entering the IP address of the respective Antenna (e.g. 192.168.41.150).

Basic information is displayed and settings can be modified in the Web Interface.

The user must be logged in the Net to be able to change settings (see chapter [Login/Logout](#)).

- The entries in the table can be sorted by clicking on the desired column header.
- Clicking on an entry will select the respective item or deselects it. A selected entry is highlighted.

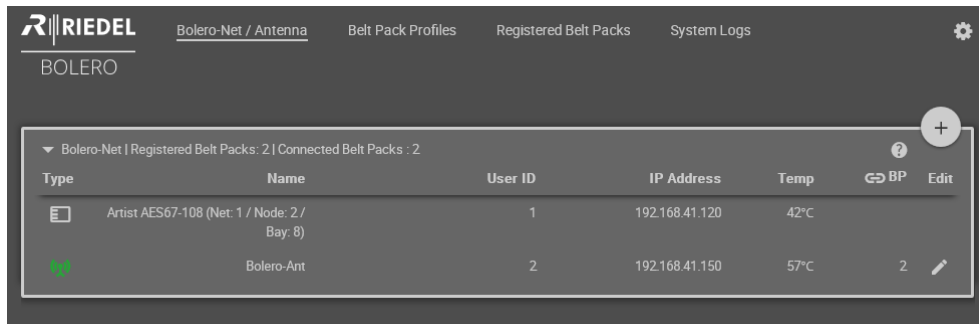

Figure 40: Antenna – Web-Interface

| | |
|-----------------------------|--|
| [Net-Name] / Antenna | General settings of the Bolero Net The name of the Net is displayed between the brackets (e.g. "Bolero-Net"). |
| Beltpack Profiles | Create and Edit Beltpack profiles. |
| Registered Beltpacks | Table of all registered Beltpacks. The Beltpack settings can be modified here. |
| System Logs | Table of logging (Events and Errors) |
| Settings | <ul style="list-style-type: none"> • Firmware Manager • Network Service • Save Net Config • Upload Net Config • Logout (if a user is logged in) |

3.4.1 Net / Antenna

The **Net / Antenna** window features following functions:

- Creating Nets
- Assigning Nodes (Antennas, Artist AES67 cards) to Nets
- General settings of Nets
- Defining the registration method of Beltpacks

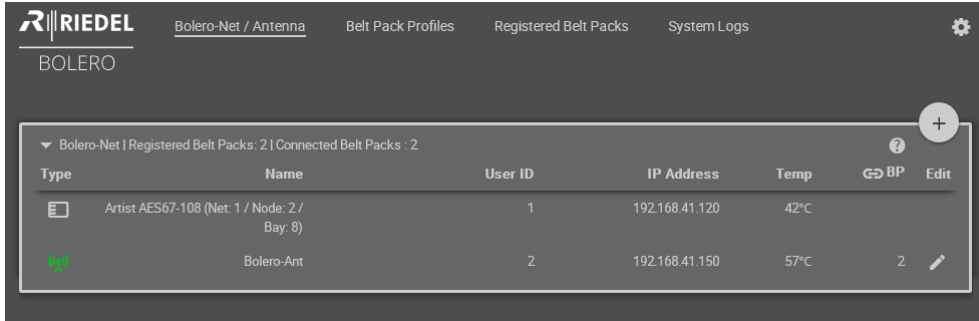



Figure 41: Web-Interface – Net / Antenna

| Name of the Net. Number of registered Beltpacks Number of connected Beltpacks | | | | | |
|---|---|---------|--|------------|--|
| Type | Symbols of the Node type (the green icon indicates the web-interfaces device) <table border="1" style="margin-left: 20px;"> <tr> <td>Antenna</td> <td></td> </tr> <tr> <td>AES67 card</td> <td></td> </tr> </table> | Antenna | | AES67 card | |
| Antenna | | | | | |
| AES67 card | | | | | |
| Name | Name of the Nodes. | | | | |
| User ID | Unique ID of the Nodes. | | | | |
| IP Address | IP Address of the Nodes. | | | | |
| Temp | Display of the inside temperature of the Nodes. | | | | |
| BP | Amount of registered Beltpacks at the Antenna. | | | | |
| Edit | Button to edit the Node settings. | | | | |
| | Opens a brief information about the selected page. | | | | |
| | Shows the Net/Antenna Menu . | | | | |

3.4.1.1 Edit

Clicking the  Edit symbol opens a dialog with the following setting. The dialog can be closed by pressing the ESC key without saving any changes.

| | |
|---------------|-----------------------|
| Apply | Stores all changes. |
| Cancel | Discards all changes. |

Edit Antenna Settings

| | |
|-----------------------------|---|
| Name | Name of the Antenna. |
| User ID | Unique ID of the Antenna. |
| Antenna RF | Enabling/Disabling the radio of the Antenna. |
| IP Address Mode | Selection of the IP address mode (Auto , DHCP , Static). |
| Static IP Address *1 | Fixed IP address of the Antenna. |
| Subnet Mask *1 | Fixed subnet mask of the Antenna. |
| Static Gateway *1 | Fixed Gateway of the Antenna. |
| PTP Master Priority | Selection of the PTP priority (default: 124). |

*1 if **IP Address Mode** = **Static**

3.4.1.2 Menu

Clicking the  symbol shows a menu with the following options. The dialog can be closed by pressing the ESC key or by clicking on another region in the window.

Edit Network Space

Editing of Net settings.

| | | |
|-------------------------|--------------------------------|--|
| General Settings | Name | Name of the Bolero Net. |
| | Multicast IP | IP address for the communication between the Bolero Net and the Artist system. |
| | Admin PIN | Defines the admin PIN (is required to log into the system, see chapter Login/Logout). |
| | System Mode | Defines if the Net is operated in stand-alone mode (AES67) or if the Net is connected to an Artist system (Artist). |
| | RF Strength Level | Selection of the radio power (High, Medium, Low, Ultralow). |
| | Enable Network Space RF | Enabling/Disabling the radio of the Antenna. |
| | PTP Domain | Selection of the PTP domain (default: 0). |
| Time Settings | Date Format | Selection of the date format (ddmmyyyy, mmdyyy, yyyyymmdd). |
| | Time Format | Selection of the time format (12h, 24h). |
| | Time Source | Selection of the system time source (Internal, PTP, NTP). |
| | Internal Time/Date *1 | Field to enter time and date manually. |
| | NTP Server *2 | Field to enter the IP address of the NTP server. |
| | Offset *2 | Field to change the time zone. |

*1 if **Time-Source** = Internal

*2 if **Time-Source** = NTP

Remove Selected Antennas

Removes all selected Nodes from the respective Net after confirmation.

Reboot Selected Antennas

Reboots all selected Nodes after confirmation.

Factory Reset Selected Antennas

Set all selected Nodes to factory default settings after confirmation.

Registration Mode

Enabling the Registration Mode of the Net.

| | | |
|---|---|--|
| Registration Method | OTA | If enabled, Beltpacks are allowed to register via DECT radio to this Net. |
| | NFC | If enabled, Beltpacks are allowed to register via Antenna NFC to this Net. |
| Use Admin PIN for OTA Registration | If enabled, the <i>Admin PIN</i> must be entered in the Beltpack during the registration procedure. If disabled, another field is visible to define an 'OTA Registration PIN' that must be entered in the Beltpack during the registration procedure. | |
| Profil | Selection of the profile, that will be assigned to a new registered Beltpack. | |
| Enable Timeout | If enabled, the registration to this Net will be disabled after a defined timeout. | |
| Timeout | Timeout in minutes to disable the registration to this Net. | |

3.4.2 Beltpack Profiles

The **Beltpack Profiles** window features the following functions:

- List of all available Profiles
- Creation of Profiles
- Changing of Profile settings

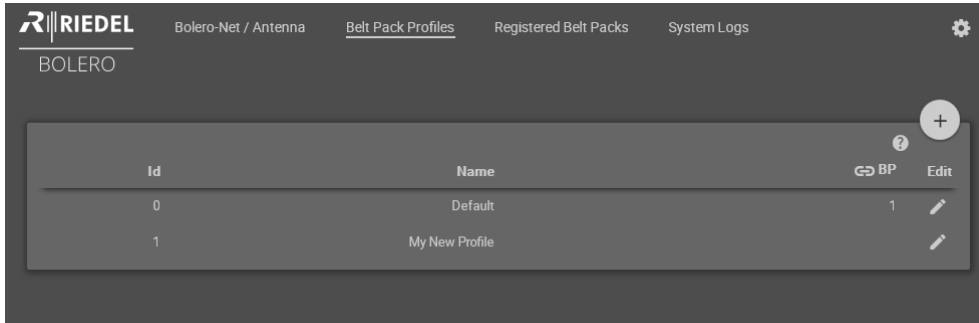





Figure 42: Web-Interface – Beltpack Profiles

| | |
|-------------|---|
| Id | Unique ID of the Profile. |
| Name | Name of the Profile. |
| BP | Amount of Beltpacks using this Profile. |
| Edit | Button to edit the Profile. |
| | Opens a brief information about the selected page. |
| | Shows the Beltpack Profiles Menu . |

3.4.2.1 Edit

Clicking the  Edit symbol opens a dialog with the following settings. The dialog can be closed by pressing the ESC key without saving any changes.

| | |
|---|---|
|  | The user of the Beltpack has the rights to edit the respective functions on the Belt Pack itself. |
|  | The user of the Beltpack has <i>no</i> rights to edit the respective functions on the Belt Pack itself. |
| Apply | Stores all changes. |
| Cancel | Discards all changes. |

Beltpack Properties

General

| | |
|---------------------|---|
| Profile Name | Name of the Profile. |
| Profile Id | Unique ID of the Profile. |
| Headset Type | <u>Auto</u> , Dynamic, Electret |
| Display Mode | <u>Standard</u> , Big Text, Flip Screen |
| Silent Mode | Switch to enable the silent mode. |

Name

| | |
|---------------------|---|
| Default Name | Default name of the Beltpack. |
| Append Id | Switch to use the User Id as Name suffix. |

Levels

| | |
|--------------------------|---|
| Headset | Slider to adjust the headset volume. |
| Sidetone | Slider to adjust the sidetone volume. |
| Headset Mic Gain | Slider to adjust the gain of the headset microphone. |
| Internal Mic Gain | Slider to adjust the gain of the internal microphone. |
| Aux Input Gain | Slider to adjust the gain of the line input. |
| Limiter Threshold | Slider to adjust the Limiter threshold. |
| VOX Threshold | Slider to adjust the Vox threshold. |

Speaker/Mic

| | |
|---------------|--|
| Enable | Switch to enable the internal Beltpack speaker and microphone. |
| Volume | Slider to adjust the speaker volume. |

Signalization

| | |
|----------------------------|--|
| Call | Switch to enable the respective signalization: |
| Indication/Beep | <ul style="list-style-type: none"> • Light • Vibrate |
| Info/Low Battery | <ul style="list-style-type: none"> • Beep |
| Out Of Range | <ul style="list-style-type: none"> • Voice (only for: Info/Low Battery, Out of Range) |
| Beep Signalization | Slider to adjust the tone signalization volume. |
| Voice Signalization | Slider to adjust the voice signalization volume. |

Timeout

| | |
|-----------------------|--|
| Timeout volume | Slider to adjust the volume timeout (how long the volume adjustment is opened without activity). |
| Timeout menu | Slider to adjust the menu timeout (how long a menu is opened without activity). |

Brightness (Display, Keys)

| | |
|------------------------|--|
| Brightness mode | High, <u>Medium</u> , Low, Custom (see Beltpack Brightness Mode) |
| Brightness | Slider to adjust the normal display/key brightness. |
| Dimmed | Slider to adjust the dimmed display/key brightness. |
| Dimm Timer | Slider to adjust the timeout, how fast the display/key illumination is dimmed. |
| Off Timer | Slider to adjust the timeout, how fast the display/key illumination is turned off. |

Bluetooth

| | |
|----------------|--|
| State | <u>Off</u> , Connect to Mobile/PC |
| Mode | <u>Local</u> , Public |
| Volume | Slider to adjust the bluetooth volume. |
| Dimming | Slider to adjust the Dim level. |

Audio Settings

| | |
|----------------------------------|---|
| Headset Echo Cancellation | Switch to enable the echo cancellation. |
|----------------------------------|---|

Limits

| | |
|----------------------------|--|
| Headset Lower Limit | Slider to adjust the minimum headset volume. |
| Speaker Lower Limit | Slider to adjust the minimum speaker volume. |

Operator Rights

Beltpack

| | |
|-----------------------|--------------------------------------|
| Change Profile | Switch to allow editing Profiles. |
| Reset | Switch to allow resetting. |
| Info | Switch to allow showing information. |

System

| | |
|------------------------|--|
| Registration | Switch to allow editing and enabling registration. |
| System Settings | Switch to allow editing system settings. |
| Test | Switch to allow testing. |

3.4.2.2 Menu

Clicking the  symbol shows a menu with following options. The dialog can be closed by pressing the ESC key or by clicking on another region in the window.

Create Beltpack Profile

Creating a new Beltpack Profile.

Copy Beltpack Profile

Creating a new Beltpack Profile by using the selected Beltpack Profile as template.

Remove Selected Profiles

Deleting the selected Profile after confirmation.

3.4.3 Registered Beltpacks

The **Registered Beltpacks** window features the following functions:

- Listing of all registered Beltpacks in the Net.
- Changing of Beltpack settings
- Changing of assigned Profiles
- Removing Beltpacks from Nets
- Enable registration
- Locating Beltpacks

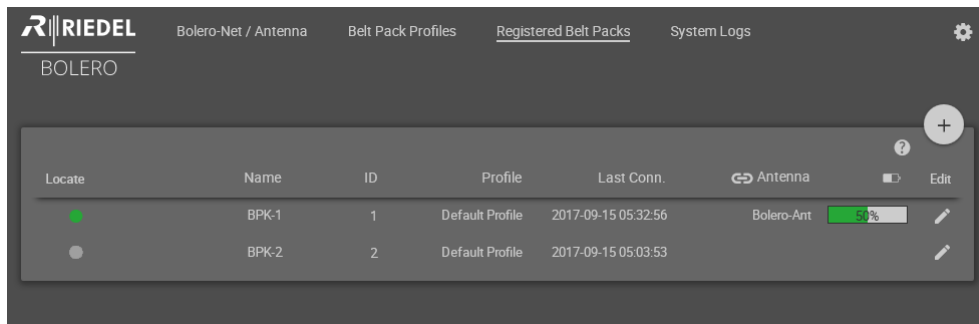





Figure 43: Web-Interface – Registered Beltpacks

| | |
|---|--|
| Locate | This feature is useful to identify a specific Beltpack visually. After clicking this icon, the Status-LED and the Status-Bar of the respective Beltpack will start flashing yellow until any key is pressed on the Beltpack. |
| Name | Name of the Beltpack. |
| ID | Unique ID of the Beltpack. |
| Profile | Name of the assigned Profile. |
| Last Conn. | Date and time of last connection. |
| Antenna | Name of the Antenna, the Beltpack is connected to. |
| Battery | State of battery of the Beltpack. |
| Edit | Button to edit the Beltpack settings.  |
|  | Opens a brief information about the selected page. |
|  | Shows the Registered Beltpacks Menu . |

3.4.3.1 Edit

Clicking the  Edit symbol opens a dialog with the following settings. The dialog can be closed by pressing the ESC key without saving any changes.

| | |
|---------------|-----------------------|
| Apply | Stores all changes. |
| Cancel | Discards all changes. |

Beltpack Properties

Name

| | |
|----------------|----------------------------|
| Name | Name of the Beltpack. |
| User ID | Unique ID of the Beltpack. |

General

| | |
|---------------------|---|
| Headset Type | <u>Auto</u> , Dynamic, Electret |
| Display Mode | <u>Standard</u> , Big Text, Flip Screen |
| Silent Mode | Switch to enable the silent mode. |

Levels

| | |
|--------------------------|---|
| Headset | Slider to adjust the headset volume. |
| Sidetone | Slider to adjust the sidetone volume. |
| Headset Mic Gain | Slider to adjust the gain of the headset microphone. |
| Internal Mic Gain | Slider to adjust the gain of the internal microphone. |
| Aux Input Gain | Slider to adjust the gain of the line input. |
| Limiter Threshold | Slider to adjust the Limiter threshold. |
| VOX Threshold | Slider to adjust the Vox threshold. |

Speaker/Mic

| | |
|---------------|--|
| Enable | Switch to enable the internal Beltpack speaker and microphone. |
| Volume | Slider to adjust the speaker volume. |

Signalization

| | |
|----------------------------|--|
| Call | Switch to enable the respective signalization: |
| Indication/Beep | <ul style="list-style-type: none"> • Light • Vibrate |
| Info/Low Battery | <ul style="list-style-type: none"> • Beep |
| Out Of Range | <ul style="list-style-type: none"> • Voice (only for: Info/Low Battery, Out of Range) |
| Beep Signalization | Slider to adjust the tone signalization volume. |
| Voice Signalization | Slider to adjust the voice signalization volume. |

Timeout

| | |
|-----------------------|--|
| Timeout volume | Slider to adjust the volume timeout (how long the volume adjustment is opened without activity). |
| Timeout menu | Slider to adjust the menu timeout (how long a menu is opened without activity). |

Brightness (Display, Keys)

| | |
|------------------------|--|
| Brightness mode | High, <u>Medium</u> , Low, Custom (see Beltpack Brightness Mode) |
| Brightness | Slider to adjust the normal display/key brightness. |
| Dimmed | Slider to adjust the dimmed display/key brightness. |
| Dimm Timer | Slider to adjust the timeout, how fast the display/key illumination is dimmed. |
| Off Timer | Slider to adjust the timeout, how fast the display/key illumination is turned off. |

Bluetooth

| | |
|----------------|--|
| State | <u>Off</u> , Connect to Mobile/PC |
| Mode | <u>Local</u> , Public |
| Volume | Slider to adjust the bluetooth volume. |
| Dimming | Slider to adjust the Dim level. |

Audio Settings

| | |
|----------------------------------|---|
| Headset Echo Cancellation | Switch to enable the echo cancellation. |
|----------------------------------|---|

Limits

| | |
|----------------------------|--|
| Headset Lower Limit | Slider to adjust the minimum headset volume. |
| Speaker Lower Limit | Slider to adjust the minimum speaker volume. |

3.4.3.2 Menu

Clicking the  symbol shows a menu with the following options. The dialog can be closed by pressing the ESC key or by clicking on another region in the window.

Change Profile

Allows changing the assigned Profile of the selected Beltpack.

Swap Configs

Allows swapping the Beltpack configuration of two selected Beltpacks.

Deregister

Allows removing a Beltpack from a Net.

Locate

Allows identifying the selected Beltpack visually. The Status-LED and the Status-Bar of the respective Beltpacks will start flashing yellow until any key is pressed on the Beltpack.

Clear Selected User IDs

Removes the User IDs of the selected Beltpacks. The User ID is set to zero ("0").

Auto-assign User IDs

Assigns the User IDs of the selected Beltpacks automatically. The initial value is one ("1").

Registration Mode

Enabling the Registration Mode of the Net (see chapter 'Bolero Antenna > Web Interface > Net/Antenna > [Menu – Registration Mode](#)').

3.4.4 System Logs

Status messages and errors are displayed in this tab.

Errors in the **Fault List** can be confirmed and hidden by clicking on **Acknowledge**.

The events in the Event Log can be cleared by clicking the plus symbol and choosing **Clear Logs**.

The screenshot shows the RIEDEL web interface for the 'System Logs' section. At the top, there is a navigation bar with 'System Logs' highlighted. Below the navigation bar, the system name 'BOLERO' is displayed. The main content area contains two log tables. The first table, titled 'Faults List: Current Faults: 5', has columns for Timestamp, Severity, Type, Audio Port, Device, and Fault Status. It lists three fault entries, each with an 'Acknowledge' button. The second table, titled 'Event Log: Start: 1970-01-01 00:00:38', has columns for Timestamp, Severity, Type, Audio Port, and Device. It lists three event entries, and a plus sign button is visible to its right, indicating the 'Clear Logs' function.

Figure 44: Web-Interface – System Logs

| Fault List Number of current entries | |
|--|---|
| Timestamp | Date and time of the failure. |
| Severity | Severity of the failure. |
| Type | Description of the failure. |
| Audio Port | Affected audio port. |
| Device | Affected device. |
| Fault Status | The respective message will be removed from the fault list by clicking the 'Acknowledge' button |

| Event Log Start date and time of logging | |
|---|--|
| Timestamp | Date and time of the event. |
| Severity | Severity of the event. |
| Type | Description of the event. |
| Audio Port | Affected audio port. |
| Device | Affected device. |
|  | Shows the 'Clear Logs' function. All messages in the Event Log will be removed without confirmation. |

3.4.5 Settings

3.4.5.1 Firmware Manager

The Firmware of Nodes can be updated in this tab.

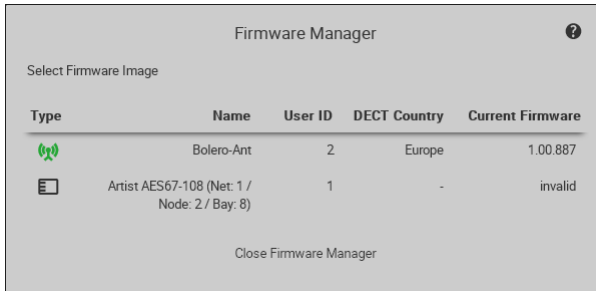

Figure 45: Web-Interface – Firmware

Proceed following steps to update one or multiple Nodes:

1. Click 'Select Firmware Image' and select the desired firmware file (*.package*).
2. Select the desired Nodes by clicking them.
3. Click 'Upload to Network Space' to upload the firmware to the devices.
4. Click 'Update All Devices' to start the update procedure.

3.4.5.2 Network Service

In the Network-Service the DECT country can be selected, where the system is in operation.

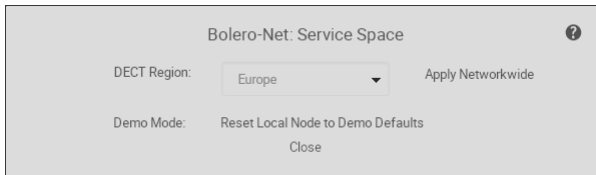

Figure 46: Web-Interface – Network Service

3.4.5.3 Save Net Config

This function allows storing the current Net configuration into a file.

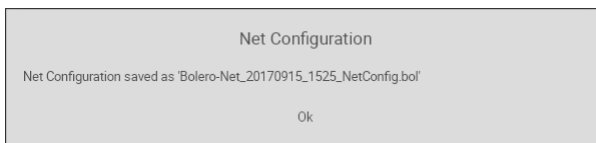

Figure 47: Web-Interface – Save Net Config

After executing this function the configuration is saved in the default download folder of the used browser. The filename is generated out of the Net name, the current date and time and the suffix "NetConfig.bol".

3.4.5.4 Upload Net Config

This function allows loading a previous stored Net configuration into the system.

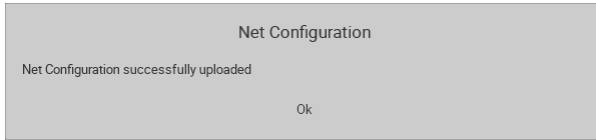

Figure 48: Web-Interface – Upload Net Config

After executing this function a dialog is opened to select the desired ".bol" file. The configuration is applied to the Net without confirmation.

3.4.5.5 Login/Logout

To be able to modify Net settings, the user must be logged into the respective Net. A big plus symbol is displayed in the top right of a Net if the user is logged in. If no user is logged in, a lock symbol is displayed instead.

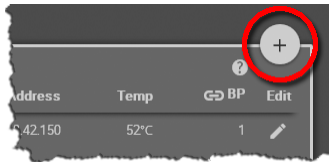

Figure 49: User logged in

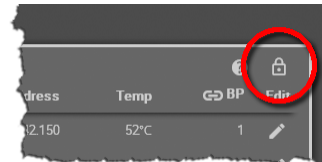



Figure 50: User logged out

Login

Click on the  symbol to log into the Net. A dialog is opened to enter the Net's Admin PIN.

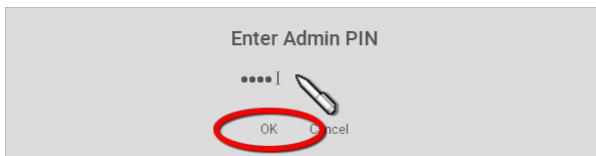



Figure 51: Dialog – Enter Admin PIN

Logout

Click on the  symbol to open a window on the right side. Click on **Logout** to open the dialog for confirmation. Click on **OK** to log out of the system.

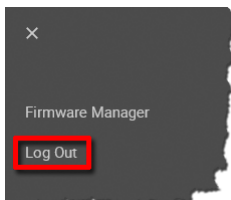

Figure 52: Logout function

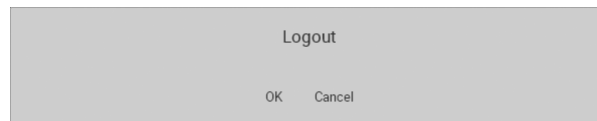

Figure 53: Logout confirmation

3.5 Features in Detail

3.5.1 Bolero-Artist Setup

This chapter describes the required steps to integrate a Bolero-System with an Artist-System. The following devices are required:

- ✓ Artist frame with AES67 client card
- ✓ Bolero Antenna
- ✓ Bolero Beltpack
- ✓ Gbps Network Switch (optionally with PoE+ functionality)

- Connect the 'AES67-1' port of the AES67 client card in the Artist frame to the network switch.
- Power up the Artist frame.

- Connect the Antenna's 'AES67/Config' port to the network switch. If a PoE+ switch is used, the Antenna is also supplied with power.
- Alternatively, attach a separate DC power supply to the Antenna's power connector. Riedel recommends to use the Bolero-Power-Supply 'BL-EPS-1005-00'.

After boot up, the IP address of the Antenna is shown in the bottom right of the display (e.g. 192.168.41.150). The e-ink display shows the current IP also when the Antenna is not powered!

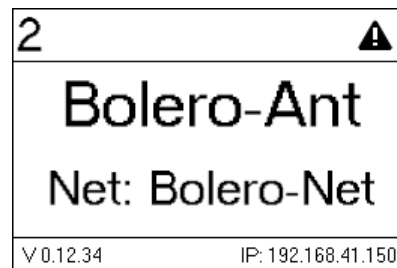

Figure 54: Antenna Display

- Start the Artist configuration software (**Director**) on your PC. For detailed information about Artist configuration and setup please refer to the Artist and Director manual.

Verify that the IP address of the AES67 card in the Artist frame is within the subnet of the Bolero Antenna:

- Open the AES67 properties by right clicking on the respective card and choosing "Properties".
- If necessary, edit the IP address and transfer the changes to the Artist frame.

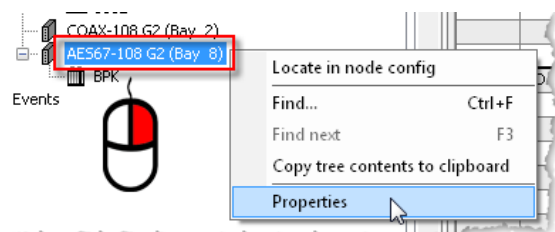

Figure 55: Open the AES67 card properties

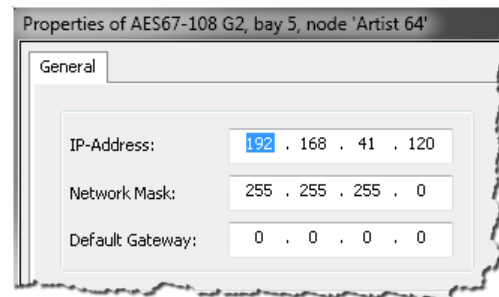

Figure 56: Properties of the AES67 card

Open the web interface of the Antenna to access the configuration:

- Enter the IP address of a Bolero Antenna in the Web-Browser (e.g. 192.168.41.150).

The PC needs to be in the same subnet.

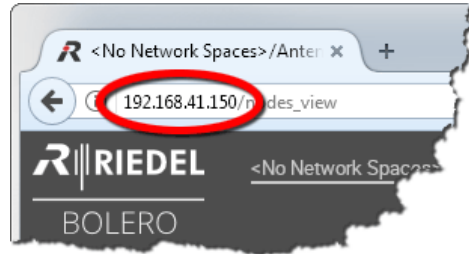

Figure 57: Web interface of the Antenna

- Select the Antenna(s) and AES67 card by left clicking.

Selected elements will be highlighted.

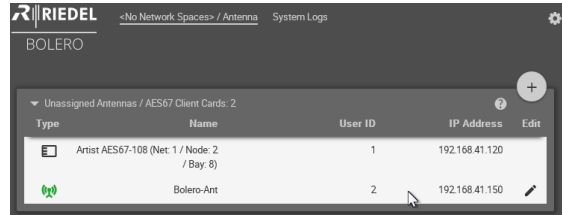

Figure 58: Selected Antennas and AES67 cards

- Click on the plus symbol and select the entry **Create Network Space**.

A dialog is opened to enter the Net name and the Admin PIN.

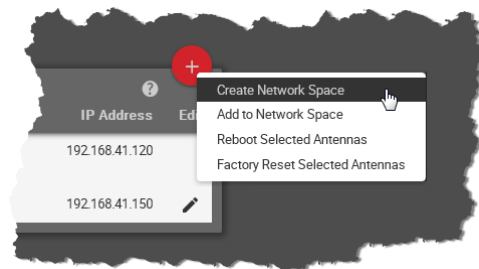

Figure 59: Create Network Space

- Enter a name for the Bolero net in the field **Name** (e.g. Bolero-Net).
- Define an **Admin PIN** (4 digits, 0–9).
- **Apply** the entries.

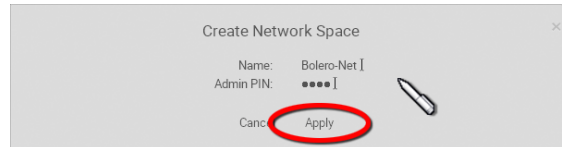

Figure 60: Dialog – Create Network Space

- Enter the **Admin PIN** again for confirmation.
- Click the **OK** button.

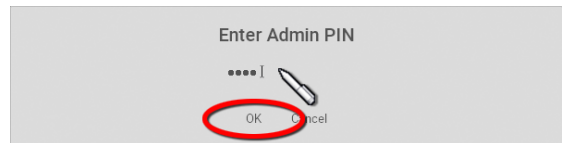

Figure 61: Dialog – Admin PIN

This example shows the new created Network Space called **Bolero-Net**. In this example, the net consists of one Antenna and one AES67 card.

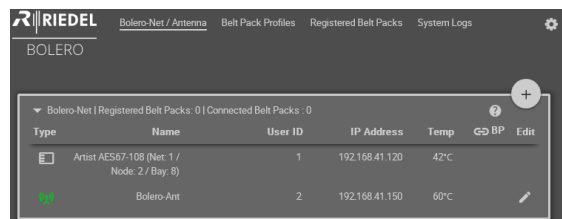

Figure 62: Assigned Antenna and AES67 card

- Click on the plus symbol and select the entry **Registration Mode**.

A dialog is opened to enter the registration options.

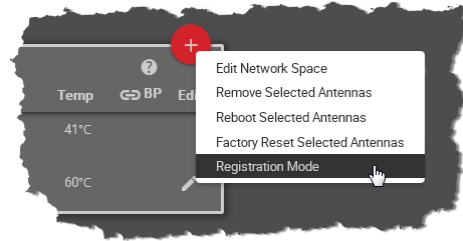

Figure 63: Registration Mode

- Enable the **OTA** and/or **NFC** registration method.
- **Apply** the changes.

Beltpacks require a PIN for the OTA registration. By default the **Admin PIN** is used. If the function 'Use Admin PIN for OTA Registration' is *disabled*, a different **OTA Registration PIN** can be defined for the OTA registration.

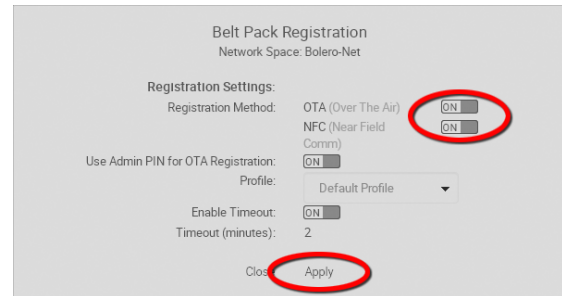

Figure 64: Dialog – Beltpack Registration

Beltpacks are able to register to this net as long as the registration mode is active (see chapter [Bolero Beltpack > Features in Detail > Net Registration](#)).



Figure 65: Beltpack Registration active

Registered Beltpacks are listed on the page **Registered Beltpacks**.

- Click on the Beltpack's ID and enter an unique Beltpack ID (0-999).

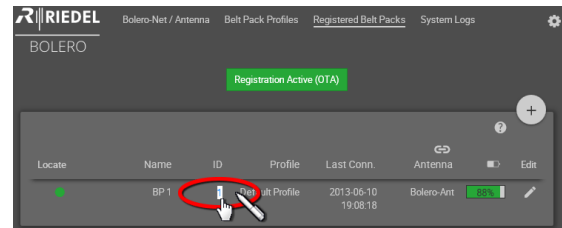

Figure 66: Registered Beltpacks

Now from the Artist configuration software (**Director**):

- Open the Beltpack properties by right clicking on the respective Beltpack and choosing "**Properties**".

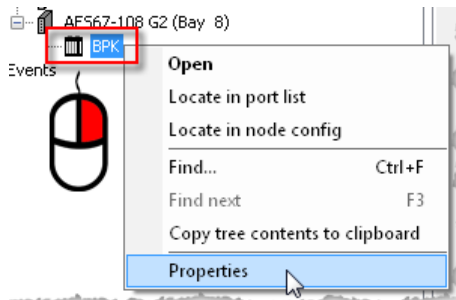

Figure 67: Open the Beltpack properties

- Select the 'Bolero' tab.
- Enter the same Bolero User ID that you entered in the Antenna's web interface.
- Edit the Multicast address.
A unique Multicast address must be used for each Beltpack in the Director config.
Riedel recommends to use the start address '239.255.0.1' for the Beltpacks Multicast addresses.

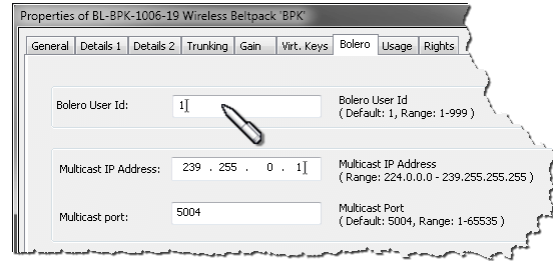

Figure 68: Properties of the Beltpack

The Beltpack's key functions can be defined now via Director.
The Beltpack is now able to talk to the Artist system and vice versa.

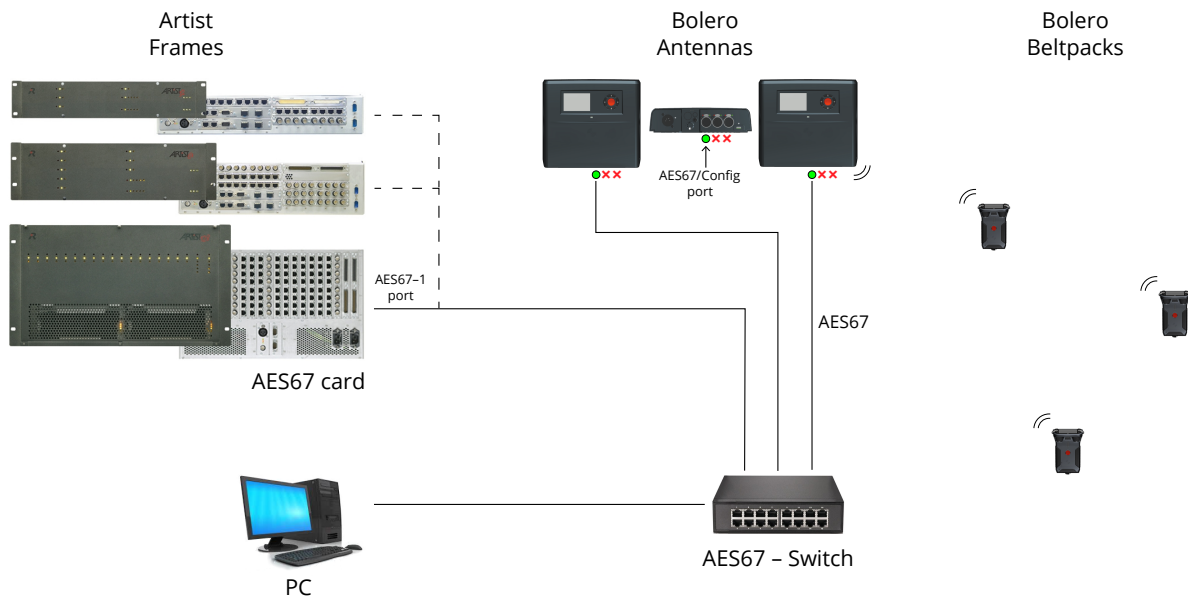

Figure 69: Bolero-Artist – Setup Diagram

i Cable requirements: Cat 5e / Cat 6 or better (according to ISO/IEC 11801), S/FTP or better, up to 100 m. Make sure ISO/IEC specification applies for the used length of the cable (in particular attenuation).

3.5.2 Switch Recommendations

This page describes all technologies that are needed for Bolero traffic and describes a simple network classification that can be used to specify the switch that you need to choose.

i After reading these pages, you should be able to determine, if a switch is suitable for Bolero by looking at the spec sheet. If you classify the network you are building, choosing a switch can be done without excessive testing.

The Bolero System needs the following key technologies supported by the switch fabric:

PoE+ (IEEE 802.3at)

Required to power the device without external PSU.

- Provides up to 30 W of power per port
- Antenna can be powered from the switch

Please note that the most switches do not power all ports simultaneously. The power supply limits the total power.

When using Power over Ethernet use PoE+ switches only.

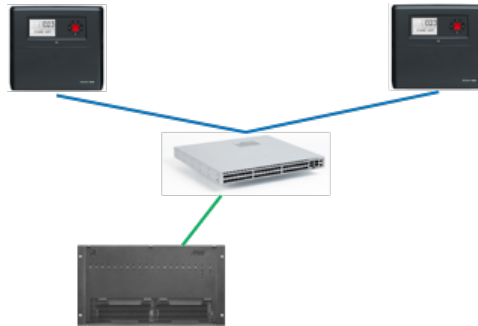

IGMP snooping (v2)

Required on every switch.

- Multicast traffic only reaches ports that explicitly ask for it
- Also prevents Artist CPU card from being flooded with Bolero traffic

Please note the limit of Multicast groups of a switch. Bolero needs 6+[amount of Beltpacks] Multicast groups (example: 42 Beltpacks require 48 Multicast groups). Cascading of switches does not raise the system limit. The lowest supported number in the complete system is the limit.

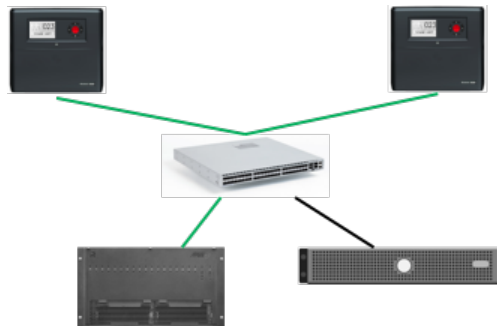

QoS (IEEE 802.1p), based on DiffServ (RFC 2474)

- Traffic from the Bolero Antennas can be prioritized when transmitted through a larger network.
- Extremely important when the network contains more than one switch.
- Prioritization on:
 - a. PTP [E, F]
 - b. AES67 [AFU1]

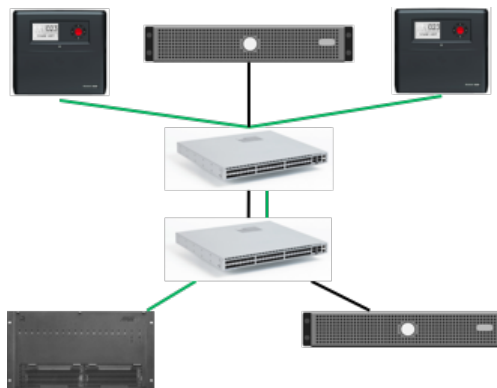

PTPv2 (IEEE 1588) boundary clock or transparent clock

Required to build networks with more than three switches and other traffic.

- Provides better synchronization of Bolero Antennas. The synchronization offset must not exceed 1 microsecond.
- Critical, if the network contains a lot of other devices (Video over IP, Servers, ...).
- Supported PTP mode:
 - AES67 profile
 - End-to-End delay measurement
 - Multicast traffic mode

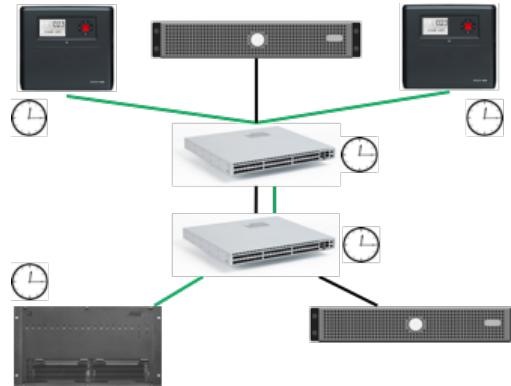

i When using Power over Ethernet use PoE+ (PoE **plus**) switches only!
The power of switches that are supporting PoE only is not sufficient!

i A 1Gbit Ethernet connection is necessary to operate the Bolero net.

| Network Size | Classifications | Requirements |
|---------------|--|---|
| Small | <ul style="list-style-type: none"> • Up to 20 Beltpacks and 5 Antennas • Only Riedel audio traffic • Central switch or stacked switches | <ul style="list-style-type: none"> • IGMP snooping • QoS |
| Medium | <ul style="list-style-type: none"> • Up to 50 Beltpacks and 20 Antennas • Only Riedel audio traffic • Up to three switch hops | <ul style="list-style-type: none"> • IGMP snooping • QoS |
| Large | <ul style="list-style-type: none"> • Up to 100 Beltpacks and 100 Antennas • Mixed traffic • More than three hops | <ul style="list-style-type: none"> • IGMP snooping • QoS • PTP boundary clock or PTP transparent clock |

3.5.3 Registration

To add more Antennas to a working **Network Space**, the new Antennas mustn't be assigned to any other Net. If a new Antenna is already assigned to a Net, see chapter '**De-Registration** > [Antennas](#)' to remove it from the current Net before proceeding the registration.

i
|

New Antennas have disabled radio, if the Antenna is not known by the matrix.

- Connect the Antenna's 'AES67/Config' port to the network switch. If a PoE+ switch is used, the Antenna is also supplied with power.
- Alternatively, attach a separate DC power supply to the Antenna's power connector.

After booting the display shows in the bottom right the IP address of the Antenna (e.g. 192.168.41.151).



Figure 70: Antenna Display

Open the web interface of the Antenna to access the configuration:

- Enter the IP address of a Bolero Antenna in the Web-Browser (e.g. 192.168.41.151).

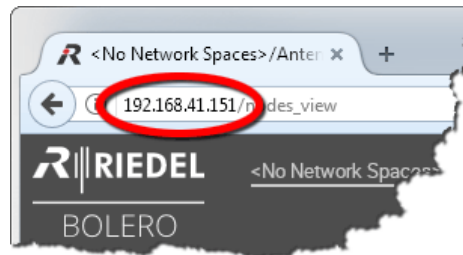

Figure 71: Web interface of the Antenna

i
|

Take care that the Antennas IP address is in the same IP range like the existing Net. The IP settings can be modified in the web interface (🔧) as well as in the Antennas' menu (**IP Settings**).

- Select the Antenna(s) to be added to an existing **Network Space**.

Selected elements will be highlighted.

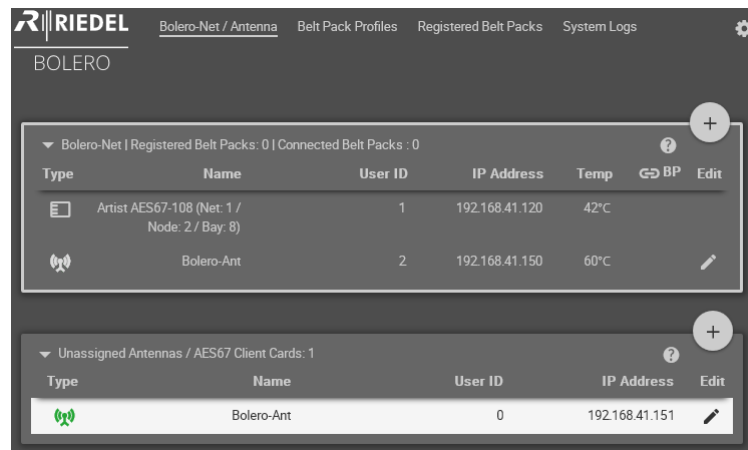

Figure 72: Selected new Antennas

- Click on the plus symbol off the unassigned Antenna(s) and select the entry 'Add to Network Space'.

A dialog is opened to select the Net.

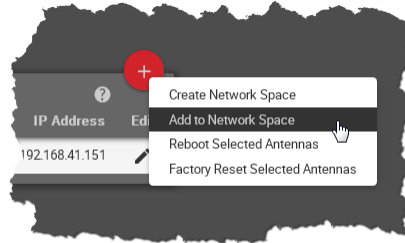

Figure 73: Add to Network Space

- Select in the drop-down menu an existing Network Space.
- Click the Apply button.

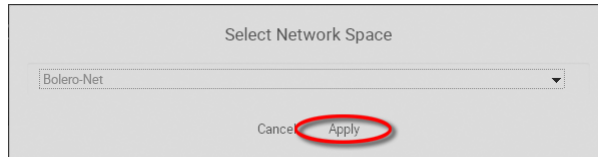

Figure 74: Dialog – Select Network Space

This example shows the new added Antenna in the existing Network Space **Bolero-Net**.

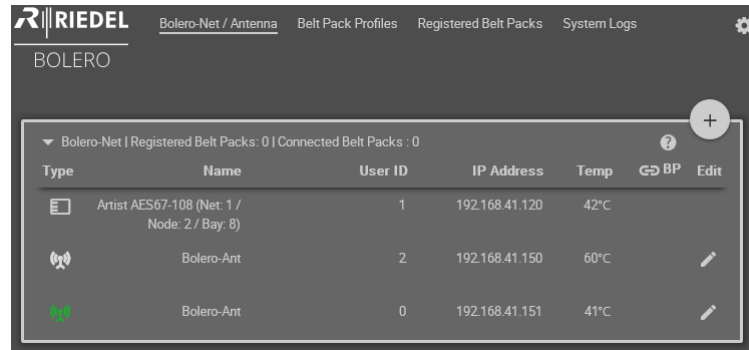

Figure 75: Added new Antenna in the Bolero-Net

Do not forget to assign a unique User ID to the new Antenna.

- Click the Edit icon of the new Antenna.
- Click the Apply button.

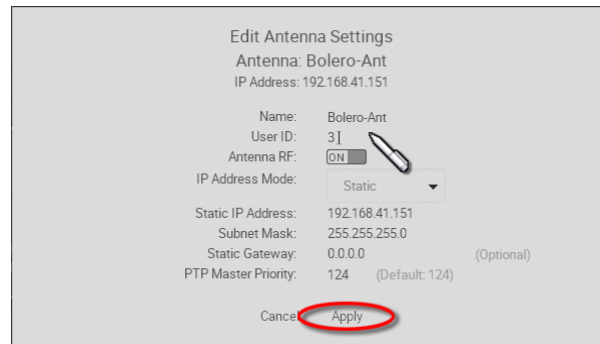

Figure 76: Apply unique User ID

Now the Network Space consists of two Antennas and one AES67 card.



Figure 77: Nodes in the Bolero-Net

3.5.4 De-Registration

In the Antennas Webinterface it is possible to remove registered Antennas as well as registered Beltpacks from a Net.

3.5.4.1 Antennas

To de-register Antennas from a Net, choose the register 'Net/Antenna'.
Then select the desired Antennas.

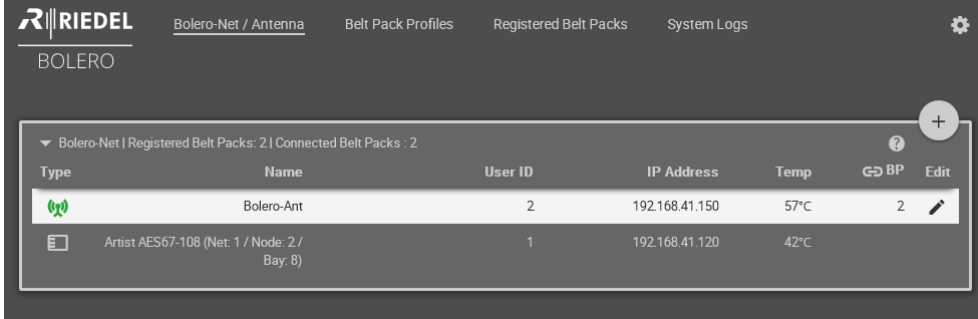



| Type | Name | User ID | IP Address | Temp | BP | Edit |
|---|--|---------|----------------|------|----|---|
|  | Bolero-Ant | 2 | 192.168.41.150 | 57°C | 2 |  |
|  | Artist AES67-108 (Net: 1 / Node: 2 / Bay: 8) | 1 | 192.168.41.120 | 42°C | | |

Figure 78: Web Interface – Net/Antenna

Click on the plus symbol and select the item 'Remove Selected Antennas'.

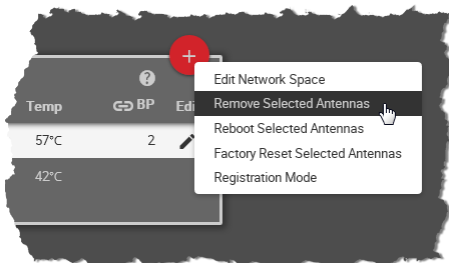

Figure 79: Remove Selected Antennas

Confirm the opened dialog by clicking 'Ok'.

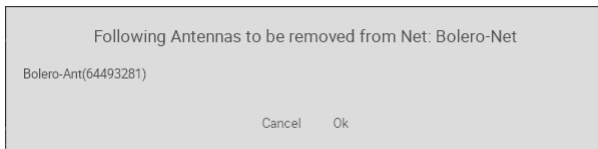

Figure 80: Confirmation dialog

The Antennas will be removed immediately from the Net.

3.5.4.2 Beltpacks

To de-register Beltpacks from a Net, choose the register 'Registered Beltpacks'. Then select the desired Beltpacks.

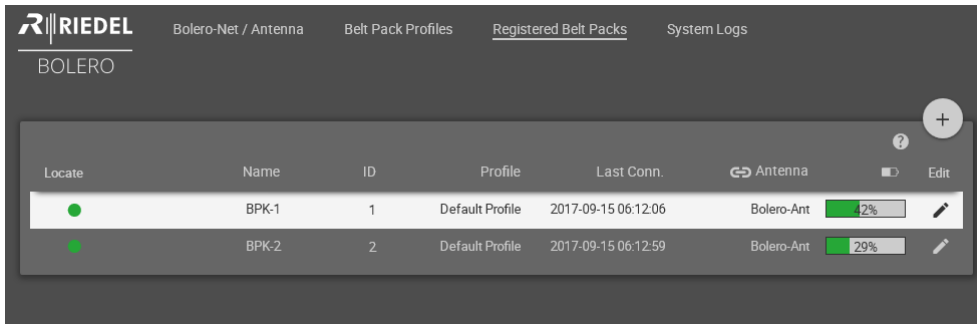

Figure 81: Web Interface – Registered Beltpacks

Click on the plus symbol and select the menu item 'Deregister'.

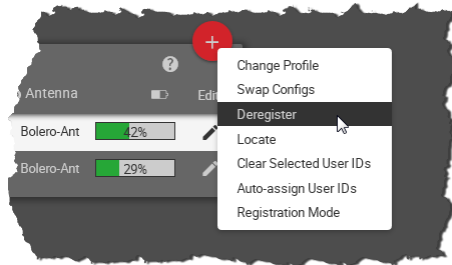

Figure 82: Deregister

Confirm the opened dialog by clicking 'Ok'.

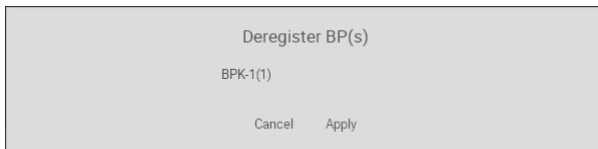

Figure 83: Confirmation dialog

The Beltpacks will be removed immediately from the Net.

3.5.5 Firmware Update

This chapter describes the update procedure of Bolero Nodes (Bolero-Antennas and Artist-AES67 client cards). The following devices are required:

- ✓ PC
- ✓ Bolero firmware package (for example "bolero_v1.23-456.package")
- ✓ Network Switch (optionally with PoE+ functionality)
- ✓ Bolero Nodes (Antennas and AES67 client cards to be updated)

- Attach the 'AES56/Config' connector of the Bolero-Antennas to the network switch(es). If the Antennas are connected to a 'PoE+' switch, they are also powered via the switch.
- Otherwise power the Antennas via external DC power supplies.

After the Antennas' bootup is finished, the respective IP address is displayed in the bottom right in the Antennas display (for example 192.168.41.150).

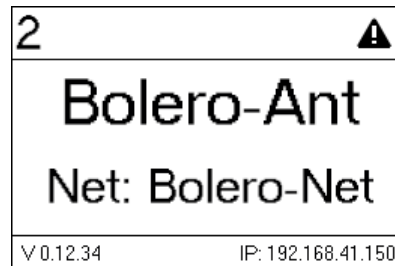

Figure 84: Antenna display

Open the web interface of an Antenna:

- Enter the IP address in the Web-Browser (e.g. 192.168.41.150).

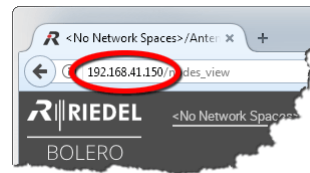

Figure 85: Web interface of the Antenna

In this example the Bolero Net consists of one Antenna and one AES67 client card.

- Log into the Net by clicking on the lock symbol.

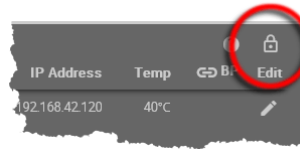

Figure 86: Login

A dialog is opened to enter the **Admin-PIN** of the Net.

- Enter the **Admin PIN**, that was defined when the Net was created.

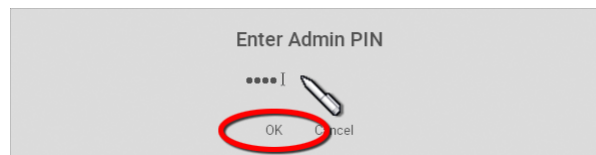



Figure 87: Dialog - Admin PIN

- Click on the  gear icon and select the entry **Firmware Manager**.
- A dialog is opened to reenter the **Admin PIN**.

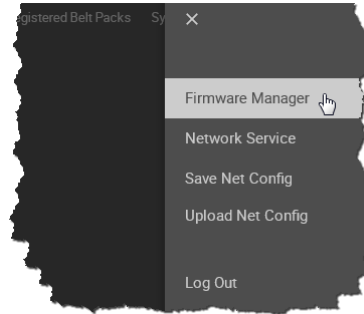

Figure 88: Firmware Manager

The Firmware Manager is opened.

- Click on the 'Select Firmware Image' button.
- Navigate to the location of the firmware package and select the desired one by clicking the **Open** button.



Figure 89: Firmware-Manager – Select Firmware Image

- Click on the 'Upload to Network Space' button.

The firmware package is transferred to the Bolero Net.

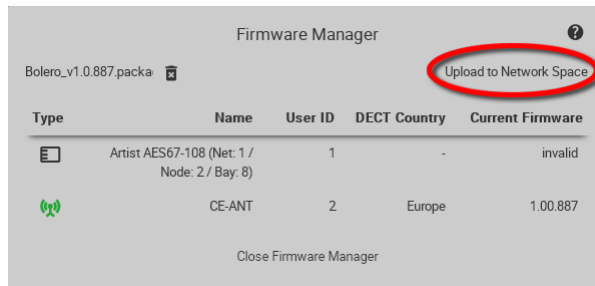

Figure 90: Firmware-Manager – Upload to Network Space

After uploading the package an information is displayed if the uploaded firmware package is compatible with the existing Nodes. **Incompatible** means, that the respective Node won't be updated.

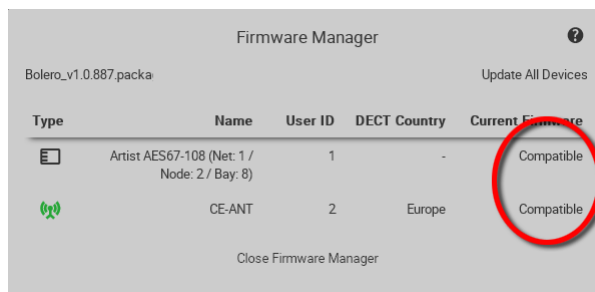

Figure 91: Firmware-Manager – Compatible Firmware-Package

- All **compatible** Nodes will be updated by clicking the **'Update All Devices'** button.

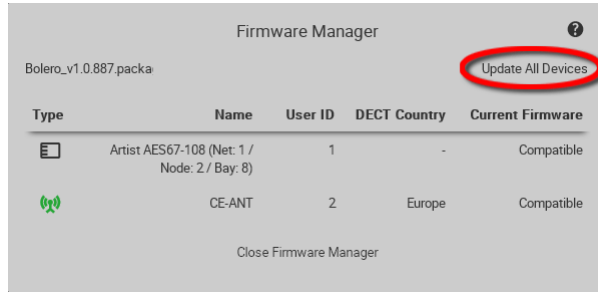

Figure 92: Firmware-Manager – Update all Devices

A dialog is opened to confirm the update of all compatible nodes.

- Click the **Apply** button to proceed.

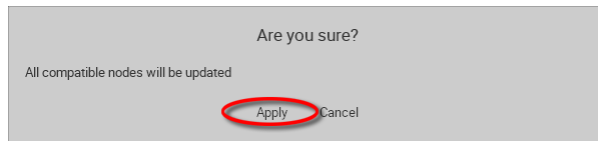

Figure 93: Firmware-Manager – Confirmation

Bar graphs visualize the update progress.

Caution: Do not remove the power from any devices.

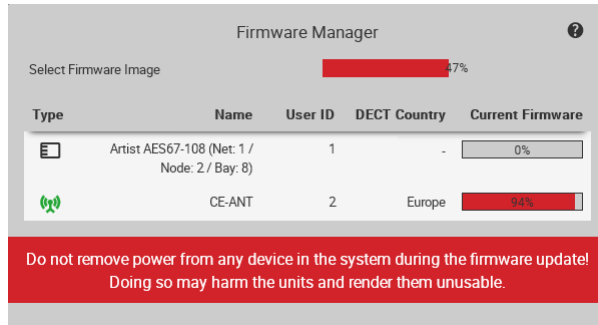

Figure 94: Firmware-Manager – progress

All Nodes must be rebooted to finish the update process.

- Click the **'Reboot Bolero System & Exit Manager'** button.

The firmware update is finished now.

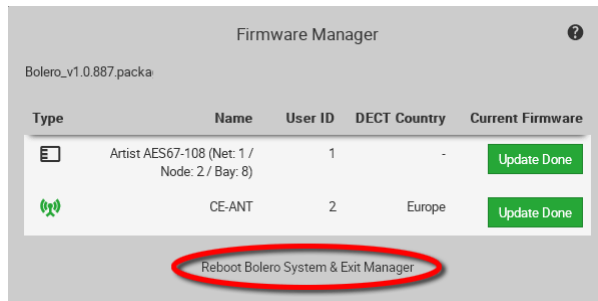

Figure 95: Firmware-Manager – Reboot devices

3.6 Mechanical Drawings

Below are the Antenna's dimensions illustrated (in mm).

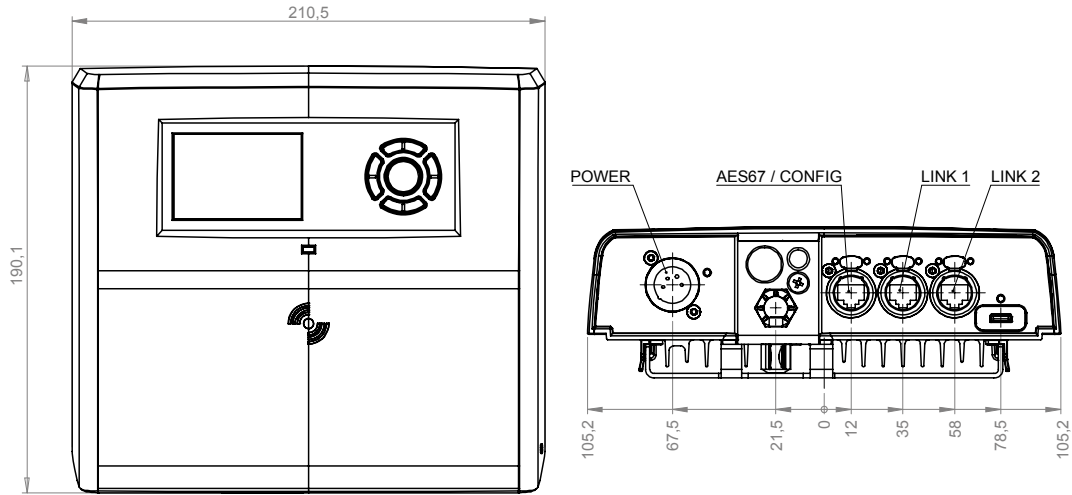

Figure 96: Antenna - Mechanical Drawing (front, bottom)

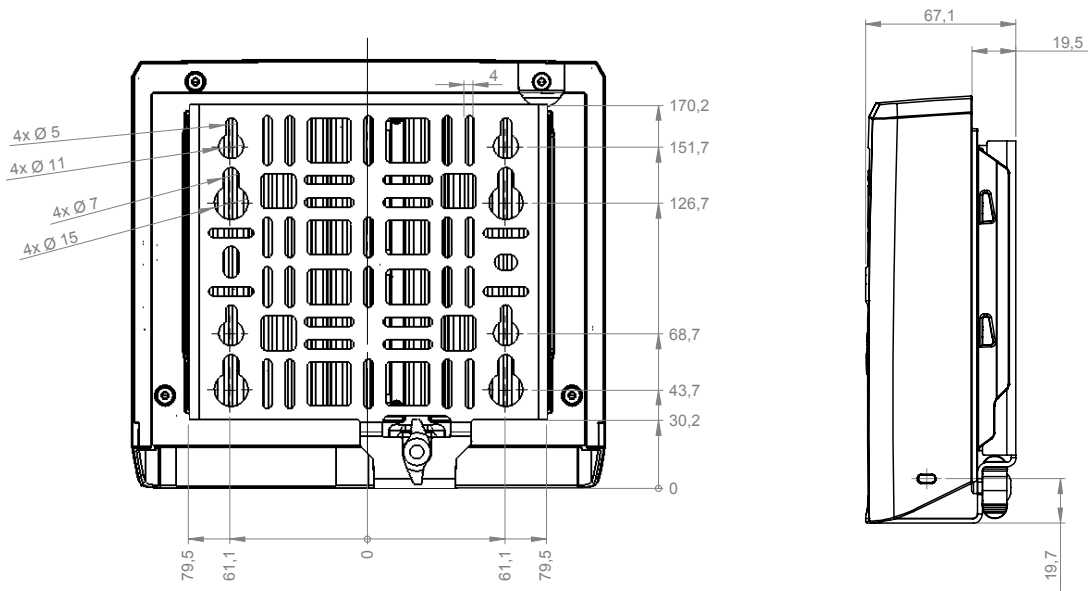

Figure 97: Antenna - Mechanical Drawing (rear, right)

3.7 Technical Specifications

| | | |
|---|--|--|
| Antenna Product Code | BL-ANT-1010-19 | |
| No of Beltpacks per Antenna | 10 | |
| RF Frequency Range | 1.880 ... 1.930GHz (region dependent, not changeable by the user) | |
| RF | Antenna Coverage | Indoor (structure dependent): ~200 ... 400m Outdoor (free line of sight): ~300 ... 500m |
| | Beltpack to Antenna range | Indoor (structure dependent): ~100 ... 200m Outdoor (free line of sight): ~150 ... 250m |
| Programmable RF Transmission power | Yes | |
| Beltpack Registration | 1 touch NFC & over the air | |
| Network Connection | AES67 IP | |
| USB Type-C Connection | USB 2.0 | |
| Display Type | High contrast E-ink display | |
| Power Supply | PoE+ (802.3at, type 2, class 4, 15 ... 30 W) or 10 ... 57 VDC, 3 A (Bolero-Power-Supply 'BL-EPS-1005-00') | |
| Power Consumption | 15 W | |
| Mounting points | Mic stand threaded socket 5/8" & 3/8" inside, spigot adapter with wing screw lock, Kensington lock hole, screw hole for a safety wire mounting | |
| Dimensions | Width | 210 mm / 8.3" |
| | Height | 190 mm / 7.5" |
| | Depth | 66 mm / 2.6" |
| Weight | 1320 g | |
| Environmental | IP54 sealing; dust protected + splashing of water | |
| Operating Environment | Temperature | -10° ... +55°C |
| | Humidity | 0 % ... 90 % rel. (non-condensing), Ta=40°C |
| Storage Temperature | -20° ... +70°C | |

4 Bolero Charger

The Bolero 5-bay battery charger has the ability to quickly and safely charge up to 5 Bolero batteries simultaneously. Light and powerful high performance lithium rechargeable battery packs are used for the Beltpack. Battery packs are able to charge inside the Beltpack as well as separately in the 5-bay charger.

Via the additional USB Type A and USB Type C connectors on the front side, two additional Bolero Beltpacks or any other USB devices can be charged.

Charging starts automatically after inserting the battery into a charging slot. An empty battery is charged in about 180 minutes. If a Beltpack is in the charging station, the Beltpack automatically shuts down the radio. If a Beltpack is charged via USB connector, the radio is not shut down.

4.1 Operating Elements

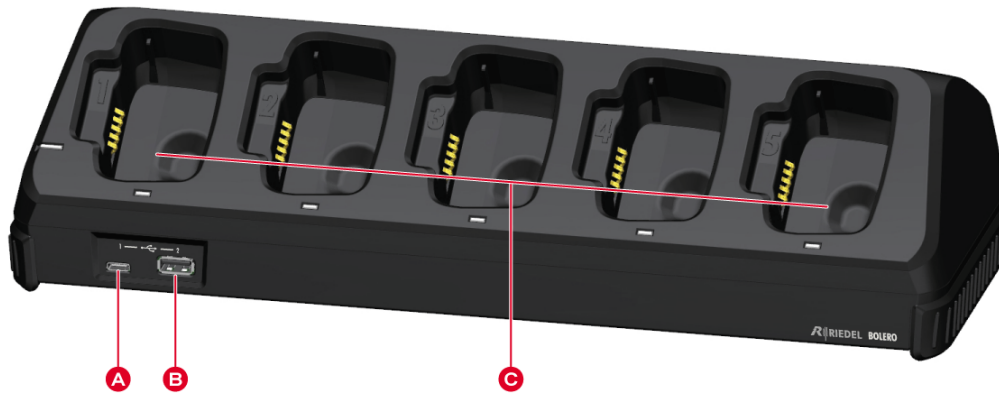

Figure 98: Charger – Operating Elements (top)

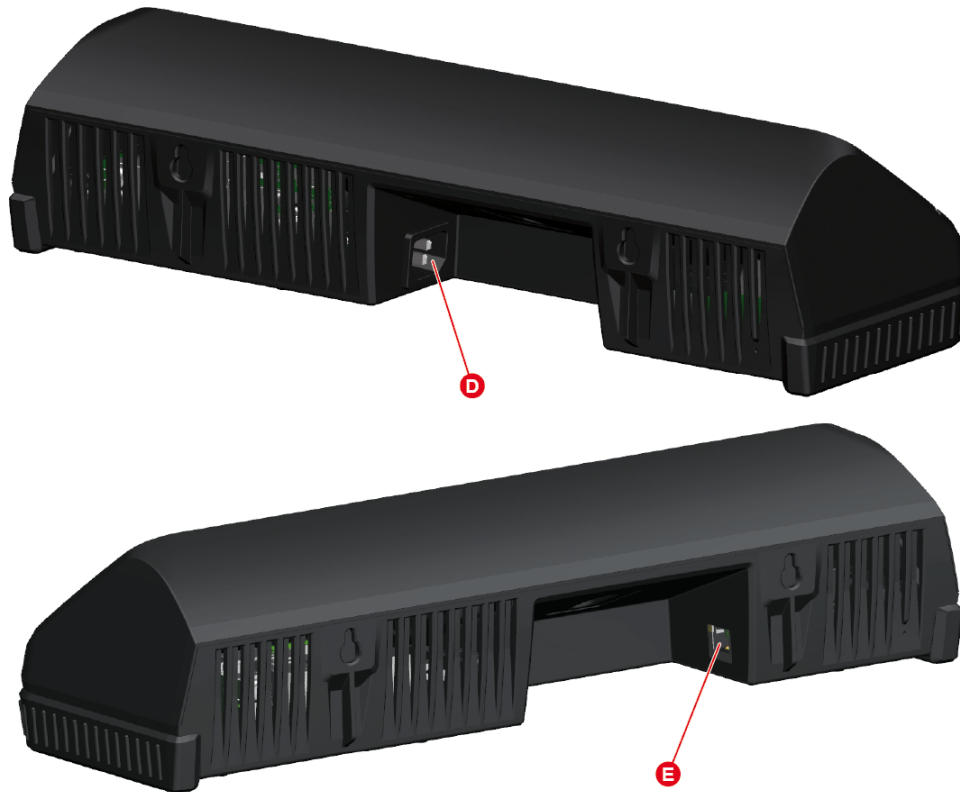

Figure 99: Charger – Operating Elements (rear)

| | |
|----------|--|
| A | USB connector (USB Type-C) |
| B | USB connector (USB Type-A) |
| C | 5× charging slots for Batteries or Beltpacks |
| D | IEC mains connector |
| E | Network connector (RJ45) |

USB Type-C

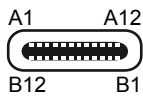

Figure 100: USB Type-C

| Pin | Description | Pin | Description |
|-----|-------------|-----|-------------|
| 1 | GND | 7 | Dn1 |
| 2 | SSTXp1 | 8 | SBU1 |
| 3 | SSTXn1 | 9 | VBUS |
| 4 | VBUS | 10 | SSRXn2 |
| 5 | CC1 | 11 | SSRXp2 |
| 6 | Dp1 | 12 | GND |

The USB connector is used to update the firmware and to charge an additional Bolero Beltpack or any other USB device. The maximum output current is 1.5 A.

USB Type-A

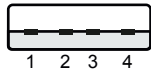

Figure 101: USB Type-A

| Pin | Description |
|-----|-------------|
| 1 | VBUS |
| 2 | D- |
| 3 | D+ |
| 4 | GND |

The USB connector is used to update the firmware and to charge an additional Bolero Beltpack or any other USB device. The maximum output current is 1.5 A.

RJ45

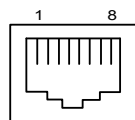

Figure 102: RJ45

| Pin | Description |
|-----|-------------|
| 1 | D1+ |
| 2 | D1- |
| 3 | D2+ |
| 4 | D3+ |
| 5 | D3- |
| 6 | D2- |
| 7 | D4+ |
| 8 | D4- |

The RJ45 port supports links up to 100 Mbps.

4.2 Status LEDs

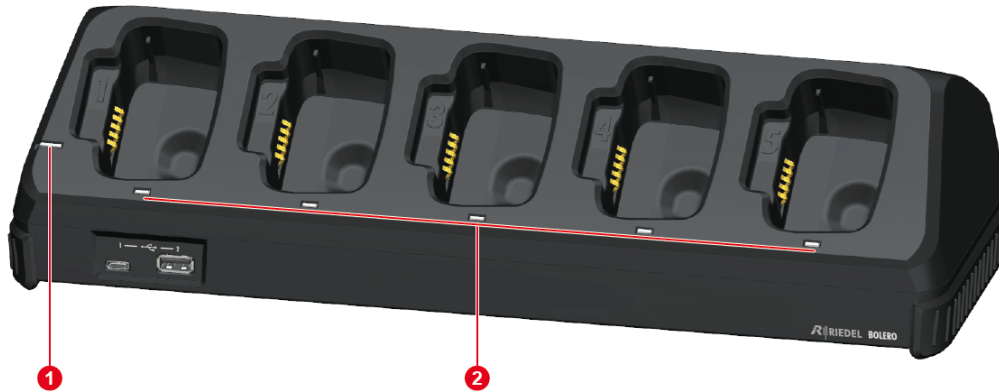

Figure 103: Charger – Status LEDs (top)

| | | | |
|----------|-----------------------|--------------------------|--|
| 1 | System | off | no input power |
| | | orange | booting |
| | | green | Charger ready |
| 2 | Slot (1 ... 5) | off | slot empty, not charging |
| | | orange blinking | charging, battery level 0–89% charged |
| | | green blinking | charging, battery level 90–99% charged |
| | | green | battery 100% charged |
| | | red fast blinking | battery failure (not chargeable) |

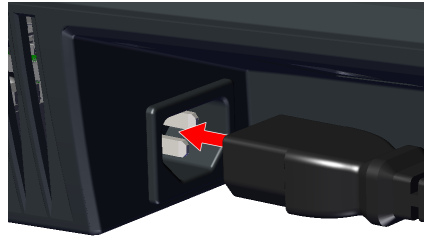

Figure 104: Charger – Status LED (rear)

| | | | |
|----------|-----------------|-----------------------|-----------------------------|
| 3 | Ethernet | off | no data connection |
| | | green | data connection ok |
| | | green blinking | data connection ok, traffic |

4.3 Charging Batteries

- Connect the charger to mains.
The System-LED indicates the overall status.



- Push the Beltpack or the battery in one charging slot.



The Beltpack's radio is switched off when the Beltpack is plugged into the Charger.

- The charging procedure will start automatically.
- The corresponding Slot-LED shows the charging state.



- The Beltpack's display shows the charging state.

| | | |
|----------------|------------|---|
| Bolero-Bpk | 1 |  |
| Charge Status | 23 % | |
| Time to Full | 2 h 19 min | |
| Temperature | Normal | |
| Battery Health | 100 % | |

- When the Beltpack is fully charged, the display shows the following content.
- Remove the Beltpack or battery out of the charger.

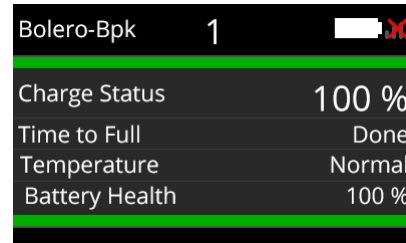

4.4 Technical Specifications

| | | |
|---|---|-------------------------------------|
| Charger Product Code | BL-CHG-1005-R | |
| No of Beltpack slots | 5 | |
| Beltpack Charge Time | up to 180 minutes | |
| Charge status LEDs | 1 per charge slot | |
| Beltpack Display | % charged, time to full, temperature, battery health | |
| USB Type-A / USB Type-C Connection | <ul style="list-style-type: none"> • For firmware update • For charging a Beltpack, a phone, etc. via cable • Max. 1.8 A (each port) | |
| Power Socket | 1x IEC | |
| Power Supply | 100 ... 230 VAC / 50 ... 60 Hz | |
| Mounting | Stand-alone table mount, 2x wall mounts or 19" rack via optional accessory kit "BL-RMK-1002-01" (1430045) | |
| Dimensions | Width | 380 mm / 15" |
| | Height | 95 mm / 3.8" |
| | Depth | 135 mm / 5.3" |
| Weight | 1140 g | |
| Operating Environment | Ambient Temperature | 0° ... +45°C |
| | Humidity | 20 % ... 90 % rel. (non-condensing) |
| Storage Temperature | -20° ... +70°C | |

5 Appendix

5.1 Glossary

| | |
|-------------|--|
| ANT | Antenna |
| ARI | A ccess R ight I ntity allows identifying a system or service provider. |
| BPK | Beltpack |
| CHG | Charger |
| DECT | DECT (D igital E nhanced C ordless T elecommunications) is an international standard for cordless radio communications. |
| NFC | N ear- F ield C ommunication is a transmission standard that enables wireless data transfer. |
| NTP | N etwork T ime P rotocol is a networking protocol for clock synchronization between computer systems over packet-switched networks. |
| OTA | O ver T he A ir |
| PTP | P recision T ime P rotocol is a network protocol for synchronization of clock settings of multiple devices in a network. |
| RPN | R adio fixed P art N umber |
| Vox | V oice O perated eX change, is a switch that operates when sound over a certain threshold is detected. |

5.2 Maintenance Recommendations

Following points are strongly recommended to prevent malfunction of the system.

General

None

Daily

None

Weekly

None

Monthly

None

Yearly

Check the capacity of the battery and replace it if necessary.

Other

None

5.3 Service

If you have any further questions, we offer comprehensive customer service options for this product including:

- Telephone Service
- Email Service
- Fax Service
- Configuration Support
- Trainings
- Repair

Your primary point of contact for any service issues is your local dealer.
In addition, Riedel Customer Service in Wuppertal, Germany is also available to assist you.

Telephone: +49 (0) 202 292 9400
(Monday - Friday, 8am – 5pm, Central European Time)

Fax: +49 (0) 202 292 9419

Or use the contact form on our website:
www.riedel.net > [Company](#) > [Contact](#) > [Wuppertal \(Headquarters\)](#)

For repairs, please contact your local dealer. Your dealer will be able to help process your repair as fast as possible and/or arrange for the delivery of spare parts.

The address for repairs sent directly to Riedel Communications GmbH is:

Riedel Communications GmbH & Co. KG
- Repairs -
Uellendahler Str. 353
D-42109 Wuppertal
Germany

Please add a completed repair form to all your repairs.
The form can be found at the Riedel website:
www.riedel.net > [Services](#) > [Repairs](#)

5.4 Notes

Notes

Index

- 3 -

3.5mm Jack female 12

- A -

About Bolero 9
Admin PIN 45
Antenna NFC 30
Antenna OTA 29
Audio Settings 46, 49, 52
Auto-assign User IDs 53

- B -

Basic Operation (Antenna) 42
Battery 33
Battery Charging in the Charger 34
Beltpack NFC 30
Beltpack Profiles 44
Beltpack Profiles (Web Interface Antenna) 48
Beltpack Properties 48
Bluetooth 46, 49, 52
Bluetooth (Beltpack) 25
Bluetooth State (Beltpack) 26
Bluetooth-Pairing (Beltpack) 27
Bolero Antenna 39
Bolero Beltpack 10
Bolero Charger 72
Bolero-Artist Setup 57
Brightness (Display, Keys) 46, 49, 52
Brightness Mode 22

- C -

Change Profile 53
Charging Batteries (Charger) 75
Charging Batteries (via USB) 33
Charging sockets Pinout 12, 73
Classifications 60
Clear Selected User IDs 53
Configuration Support 79
contact 79
Copy Beltpack Profile 50
Create Beltpack Profile 50

- D -

Daily Maintenance Recommendations 78
Date Format 45
DC power supply 40
Deregister 53
De-Registration 31, 65

De-Registration (Antennas) 65
De-Registration (Beltpacks) 66
Display Mode (Beltpack) 24
Disposal 6

- E -

Edit Network Space 47
Email 79
Enable Network Space RF 45
Environment 6

- F -

Factory Reset (Beltpack) 32
Factory Reset Selected Antennas 47
Fan / dust Filters Maintenance Recommendations 78
Fax 79
Features in Detail (Antenna) 57
Firmware Manager 44
Firmware Manager (Web Interface Antenna) 55
Firmware Update 12, 73
Firmware Update (Antenna) 67
Firmware Update (Beltpack) 36

- G -

General 46, 49, 52
General Maintenance Recommendations 78
Glossary 77

- H -

Headset connector Pinout 12
Headset Type (Beltpack) 15

- I -

IGMP snooping (v2 or v3) 60

- K -

Key Functions (Antenna) 42
Key Functions (Beltpack) 15

- L -

Levels 46, 49, 52
Limits 46, 49, 52
Locate 53
Lock Keys 24
Login/Logout 44
Login/Logout (Web Interface Antenna) 56

- M -

Main Menu (Beltpack) 18
Main-Menu (Antenna) 43
Maintenance Recommendations 78
Matrix Mode 46, 49, 52

Mechanical Drawings (Antenna) 70

Monthly Maintenance Recommendations 78

Multicast IP 45

- N -

Net / Antenna (Web Interface Antenna) 45

Net-Name/Antenna 44

Network Service (Web Interface Antenna) 55

Network Size 60

Notes 80

NTP Server 45

- O -

Opening the Rubber Cover 32

Operating Elements (Antenna) 39

Operating Elements (Beltpack) 11

Operating Elements (Charger) 72

Operator Rights 48

- P -

Pair (Beltpack) 27

PoE+ (IEEE 802.3at) 60

Power Supply Maintenance Recommendations 78

Preface 5

Profile Defaults (Beltpack) 32

Profiles (Beltpack) 23

PTP Domain 45

PTPv2 (IEEE 1588) boundary/transparent clock 60

- Q -

QoS (IEEE 802.1p), based on DiffServ (RFC 2474) 60

Quick Menu (Beltpack) 17

- R -

Reboot Selected Antennas 47

Registered Beltpacks 44

Registered Beltpacks (Web Interface Antenna) 51

Registration 28

Registration (Antenna) 63

Registration Method 45

Registration Mode 47, 53

Remove Selected Antennas 47

Remove Selected Profiles 50

Removing the Belt Clip 35

Repair 79

Replacing the Battery 35

Replay 46, 49, 52

Requirements 60

Reset (Beltpack) 32

RF Strength Level 45

RJ45 40, 73

- S -

Save Net Config (Web Interface Antenna) 55

Service 6, 79

Signalization 23, 46, 49, 52

Silent Mode 24

Skype 79

Speaker 22, 46, 49, 52

StartUp (Antenna) 42

StartUp (Beltpack) 14

Status LEDs (Antenna) 41

Status LEDs (Beltpack) 13

Status-LEDs (Charger) 74

Swap Configs 53

Switch Recommendations 60

Symbols 6

System Logs 44

System Logs (Web Interface Antenna) 54

System Mode 45

- T -

Technical Specifications (Antenna) 71

Technical Specifications (Beltpack) 38

Technical Specifications (Charger) 76

Telephone 79

Time Format 45

Time Source 45

Timeout 46, 49, 52

Trainings 79

- U -

Upload Net Config (Web Interface Antenna) 56

USB Type-A 73

USB Type-C 12, 40, 73

- V -

Ventilation 6

Voltage 6

Volume Adjustment (Beltpack) 16

- W -

Walk Test (Beltpack) 31

Web Interface (Antenna) 44

Weekly Maintenance Recommendations 78

- X -

XLR-4 male 12, 40

- Y -

Yearly Maintenance Recommendations 78

