

eLLK 92 LED 400/800

Linear LED Light Fitting
for Zone 1 and 21

 **COOPER** Crouse-Hinds



LINEAR LED LIGHT FITTING

NEW - linear LED Module for eLLK 92 Series

Cooper Crouse-Hinds designed a revolutionary module with LED light source to fit into existing eLLK 92018/18 and eLLK 92036/36. This converts a traditional fluorescent light fitting into an LED light. This module allows also a retrofit of already installed eLLK 92 with the latest generation electronic ballast (EVG 09).

A special designed reflector system prevents disability glare at low mounting heights. This also directs the light output of the high power LED chips to the working area respective measuring plane avoiding multi shadowing and light pollution.

The LED system design and certification allows the use in the well proven Ex e technology of eLLK 92. With the use of our electronic ballast EVG 09 as the driver we can refer to 20 years successful operation in harsh and hazardous environments.

The advantages of the LED-module:

- Environmental friendly, no mercury
- Shock and vibration resistant, no filament or glass to break
- Immediate start, instant full illumination
- No life time reduction due to switching cycles
- Reduced disposal costs

Energy and cost savings

- 20% energy savings compared to fluorescent lamps
- Reduced maintenance costs compared to standard fluorescent lamps
- Lower overall cost of ownership

Operating life

- Expected operating life of a Cooper Crouse-Hinds LED luminaire is 60,000 hours. This is a significant upgrade over traditional light sources.
- Heat sinks are specifically engineered to remove heat from the LEDs to ensure longer life, better lumen output and accurate colour temperature.
- Fully operational with CG-S modules for connection to CEAG central battery emergency lighting systems type ZB-S.

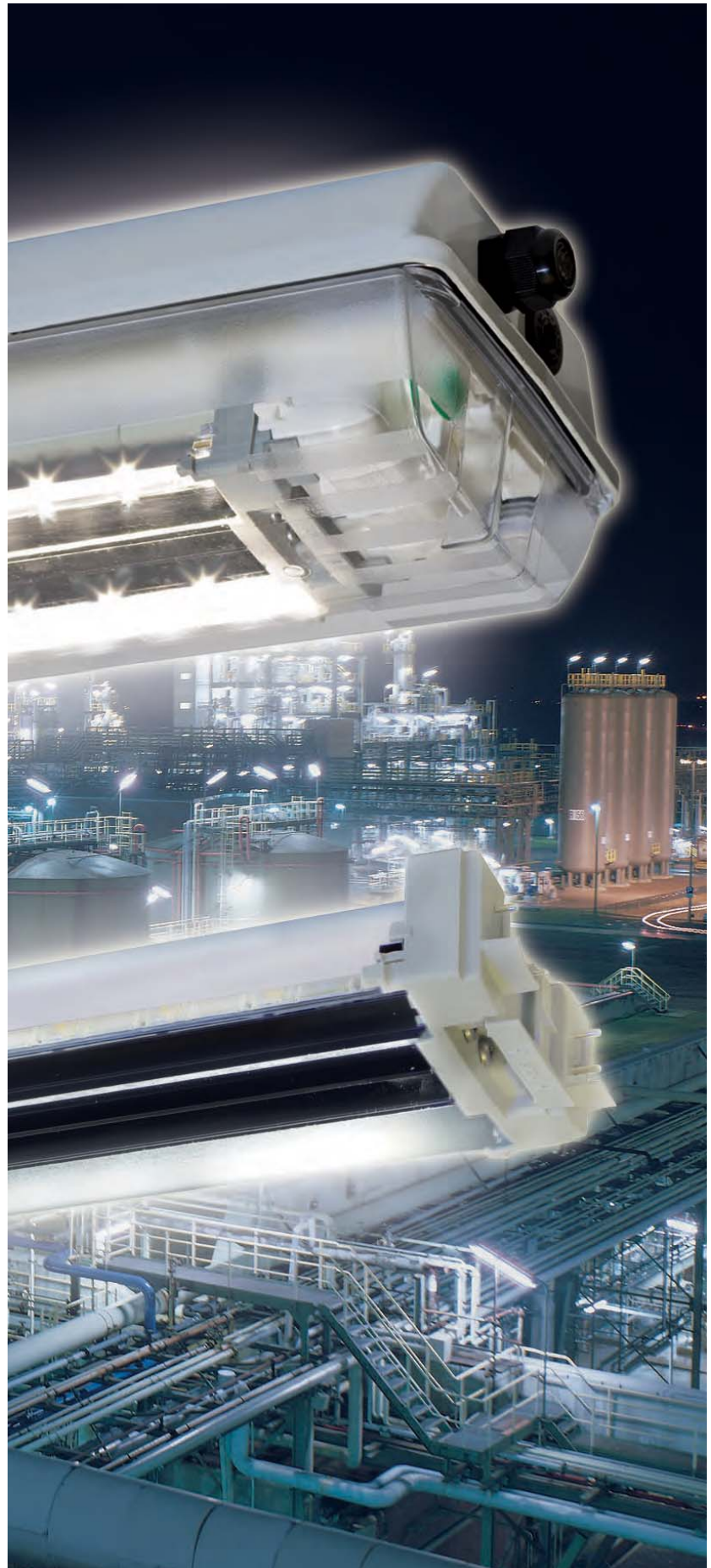

Can be retrofit into existing light fitting type eLLK 92 018/18 or eLLK 92036/36 (latest version)

Energy savings 20 % compared to fluorescent versions

Special reflector design with indirect light output to avoid disability glare and multi shadowing

Well-proven technology of used EVG 09 for more than 20 years

Selected LED chips with perfect binning, low power dissipation and long life span

Ex-e technology for easy maintenance

For environmental temperatures from -25 °C up to +50 °C

ELLK 92 LED 400/800

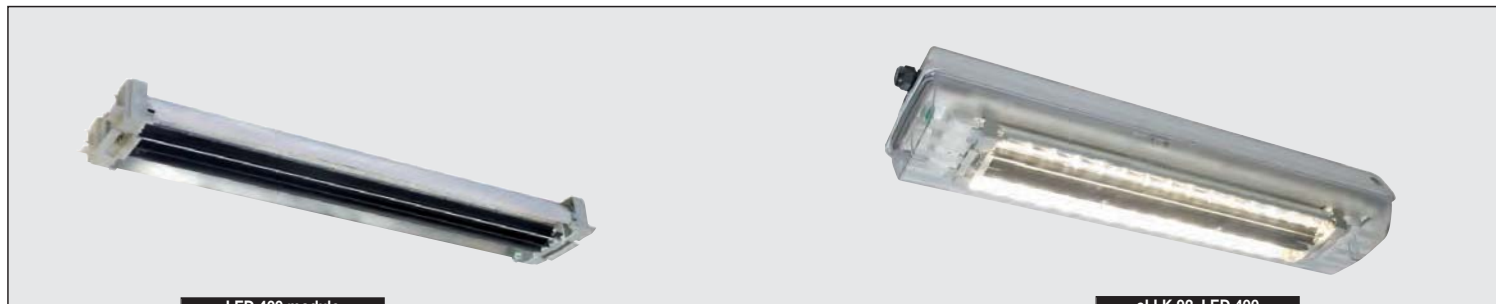

LED 400 module

eLLK 92 LED 400

Technical Data

eLLK 92 LED 400 / eLLK 92 LED 800

Marking to 94/9/EC	⊕ II 2 G Ex d e mb IIC T4 Gb ⊕ II 2 D Ex tb IIIC T80 °C Db IP66
EC-Type Examination Certificate	BVS 09 ATEX E 034
Marking to IECEx	Ex d e mb IIC T4 Gb/ Ex tb IIIC T80 °C Db
IECEX-Certification of conformity	IECEX BVS 09.0033
Rated voltage	110 - 254 V AC, 110 - 250 V DC
Frequency	50/60 Hz
Permissible ambient temperature	-25 °C up to +50 °C
Lumen maintenance	L70 = 60,000 h at ta = 25 °C
Power factor cos φ	>0.95
Driver	EVG 09
Connecting terminals	L1, L2, L3, N, PE; max. 2 x 6 mm ² per terminal
Insulation class	I
Light colour	4000 K
CRI	>75
Illuminance at measurement plane	equivalent to related fluorescent tubes
Degree of protection accd. EN 60529	IP 66
Cable glands/Gland plates/Enclosure drilling	Ex-e cable glands M25 x 1.5 (plastic) for cables Ø 8 - 17 mm Option: M20 x 1.5 metal thread
Enclosure material	Glass fibre reinforced polyester
Protective cover/protective bowl	Polycarbonate

	eLLK 92 LED 400	eLLK 92 LED 800
Rated current	0.14 A	0.27 A
Lamp/Illuminant	LED module 2 x 13 W	LED module 2 x 26 W
Dimensions (L x W x H)	760 x 188 x 130 mm	1360 x 188 x 130 mm
Weight	6.9 kg	10.7 kg

LED Module	LED 400	LED 800
Marking to 94/9/EC	⊕ II 2 G Ex e mb IIC Gb	⊕ II 2 G Ex e mb IIC Gb
EC-Type Examination Certificate	BVS 13 ATEX E 018 U	BVS 13 ATEX E 018 U
Marking to IECEx	Ex e mb IIC Gb	Ex e mb IIC Gb
IECEX-Certification of conformity	IECEX BVS 13.0030 U	IECEX BVS 13.0030 U
Dimensions	to fit into eLLK 92 018/18	to fit into eLLK 92 036/36
Weight	1.7 kg	3.3 kg

LINEAR LED LIGHT FITTING



Ordering details

LED Module

LED-Module 400 for eLLK/M 92 018/18, packed
 LED-Module 800 for eLLK/M 92 036/36, packed

1 2255 213 501
1 2256 226 501

Type	Terminals	Through-wiring		Cable glands ²⁾	Plugs	Order No
		single-ended	double-ended			
eLLK 92 LED 400						
1/6-1	1 x 6	x	-	2 x M25 x 1.5	1 x blanking	1 2265 500 101
2/6-2	2 x 6	-	x	2 x M25 x 1.5	2 x threaded	1 2265 500 103
1/6-1 M ¹⁾	1 x 6	x	-	2 x M20 x 1.5	1 x threaded	1 2265 500 109
2/6-2 M ¹⁾	2 x 6	-	x	4 x M20 x 1.5	2 x threaded	1 2265 500 111
eLLM 92 LED 400						
1/6-1	1 x 3	-	-	1 x M25 x 1.5		1 2268 500 101
eLLK 92 LED 800						
1/6-1	1 x 6	x	-	2 x M25 x 1.5	1 x blanking	1 2266 500 101
2/6-2	2 x 6	-	x	2 x M25 x 1.5	2 x threaded	1 2266 500 103
1/6-1 M ¹⁾	1 x 6	x	-	2 x M20 x 1.5	1 x threaded	1 2266 500 109
2/6-2 M ¹⁾	2 x 6	-	x	4 x M20 x 1.5	2 x threaded	1 2266 500 111
eLLM 92 LED 800						
1/6-1	1 x 3	-	-	1 x M25 x 1.5		1 2269 500 101

- 1) M: with metal thread, without cable gland
 2) With dustcover if entry/thread is not closed

Scope of delivery without lamp and fixing accessories.

Dimension drawing

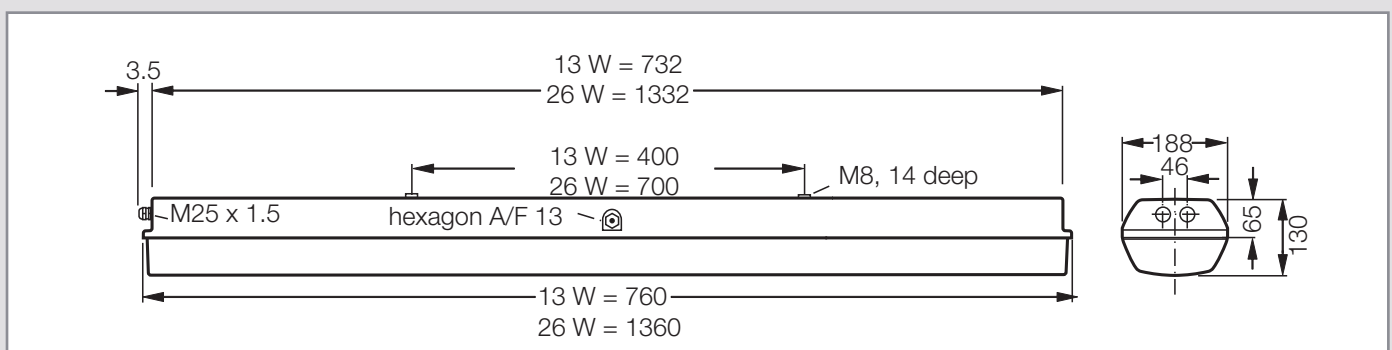

ELLK 92 LED 400/800



Polar curve

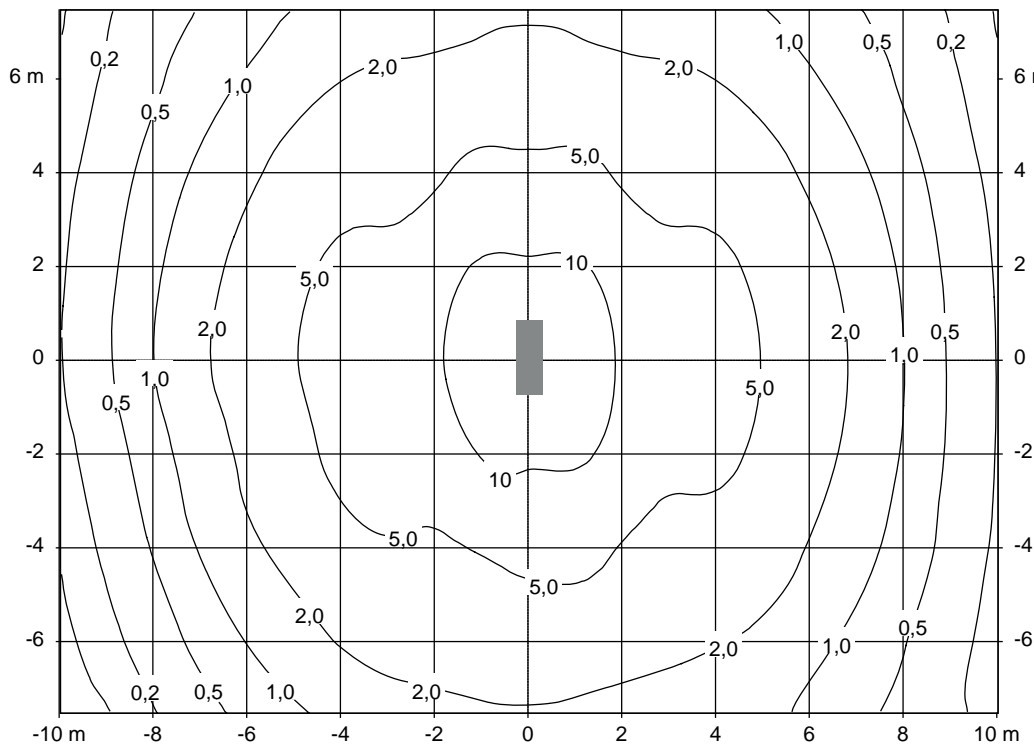
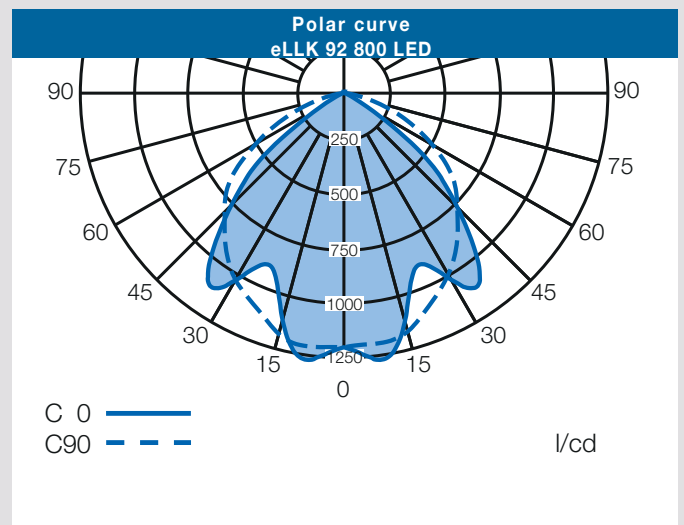
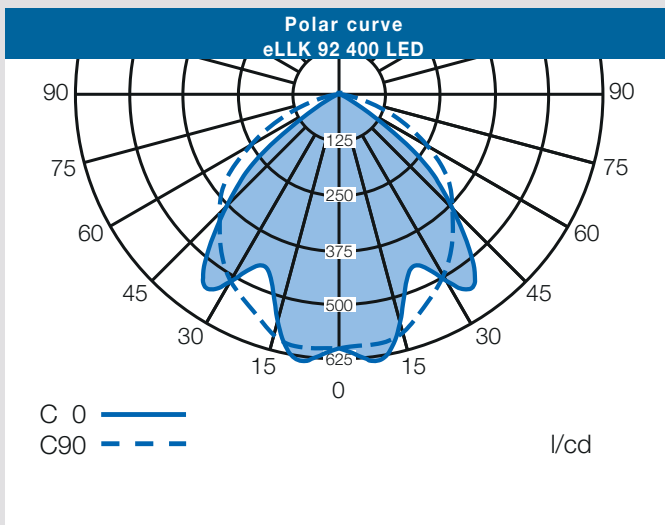

OVERVIEW LED LIGHT FITTINGS



High power LED technology from Cooper Crouse-Hinds

- ❑ Leading the way in LED technology for hazardous area lighting
- ❑ Cooper Crouse-Hinds offers a broad portfolio of LED luminaires for any hazardous or industrial applications
- ❑ Robust construction ensures highest safety and reliability suitable for application indoors/outdoors for the harshest environments
- ❑ Perfectly combining safety, reliability and energy efficiency

Refinery



Chemical plants



Heavy Industry



Offshore



Designed
for
hazardous
applications

Optimal LED quality

- ❑ Shock- and vibration- resistant solid-state devices have no filaments or glass components that could break, greatly reducing the risk of premature failure
- ❑ No UV or IR radiation: Immediate start, provides instant and full illumination
- ❑ Variance of colour temperature to meet the various applications of our customers
- ❑ No negative influence on lifetime from switching cycles
- ❑ Disposal – LEDs contain no mercury or other hazardous substances, thereby reducing disposal costs and limiting future liability.

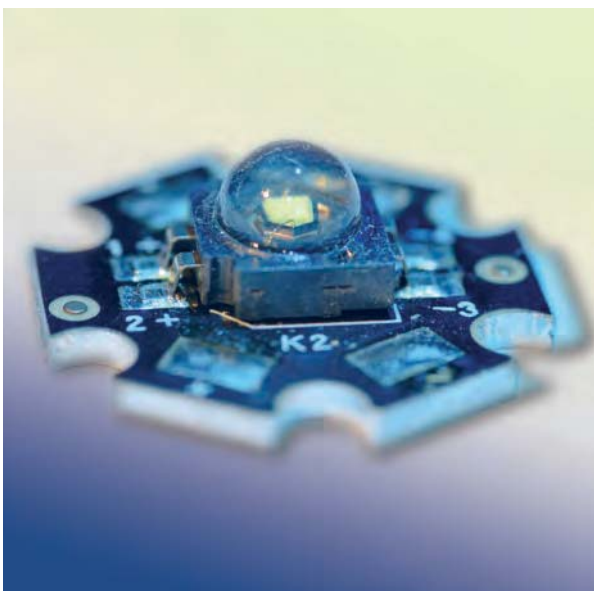



Environmentally friendly

- LEDs do not contain mercury or other hazardous substances, thereby reducing disposal costs and being environmental friendly
- Meets rising environmental standards
- Helps to save energy costs and to reduce CO₂ footprint
- Low weight

Energy and cost savings

- LED luminaires on average consume 50% less energy than HID luminaires and 85% less energy than incandescent luminaires.
- LED luminaires provide higher lumens per watt compared to many traditional lighting technologies (incandescent, compact fluorescent, HID).
- LED reduces the high maintenance costs associated with traditional lamps and frequent lamp changes
- Cut overall cost of ownership

Comparison Conventional Lamps vers. LED-Light Sources
Energy Consumption and Savings

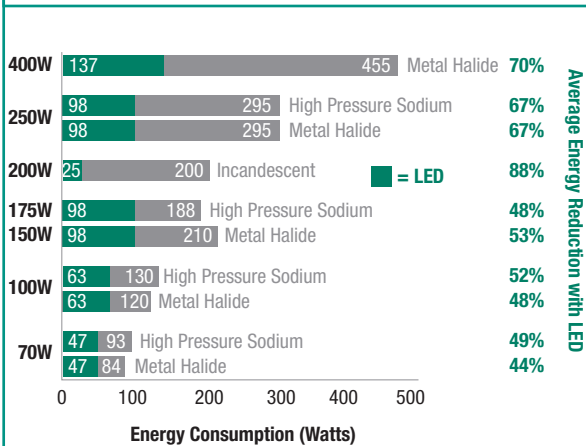

- Cooper Crouse-Hinds' LED luminaires provide the same or better light output at a fraction of the energy.

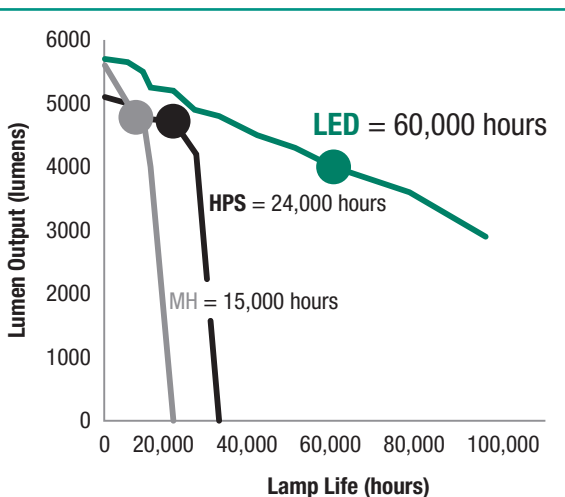

- LED maintains 70% of initial lumen output at end of rated life
- HID has ~50% failure rate at end of rated life

Operating life

- Expected operating life of a Cooper Crouse-Hinds LED luminaire is 60,000 hours. This is a significant upgrade over traditional light sources, such as incandescent and HID.
- Heat sinks are specifically engineered to remove heat from the LEDs and driver to ensure longer life, better lumen output and accurate colour temperature.
- Shock and vibration resistant light source
- Minimal early failures

Cooper Crouse-Hinds GmbH

Neuer Weg – Nord 49
D-69412 Eberbach
Telefon +49 (0) 6271/806-500
Telefax +49 (0) 6271/806-476
E-Mail sales.CCH.de@cooperindustries.com
Internet www.coopercrouse-hinds.eu

Cooper Crouse-Hinds S.A.

Avda. Santa Eulalia, 290
E-08223 Terrassa
Barcelona
Telefon +34 (0) 9-37362710
Telefax +34 (0) 9-37835055
E-Mail sales.CCH.es@cooperindustries.com

Cooper Crouse-Hinds LLC

Suite 302, Building 49
Dubai Healthcare City
Dubai
United Arab Emirates
Telefon 971-4-427-2522 / 2500
Telefax 971-4-429-8521
E-Mail sales.CCH.me@cooperindustries.com

Cooper Crouse-Hinds (UK) Ltd.

Building 2, Argosy Court, Whitley
Business Park, Simitar Way
GB-Coventry CV 3 4GA
Telefon +44 247-630-89 30
Telefax +44 247-630-10 27
E-Mail sales.CCH.gb@cooperindustries.com

Cooper Crouse-Hinds B. V.

Sydneystraat 74
NL-3047 BP Rotterdam
Telefon +31 (0) 10-2452145
Telefax +31 (0) 10-2452121
E-Mail sales.CCH.nl@cooperindustries.com

Cooper Crouse-Hinds Norge A/S

Husebysletta 9
N-3412-Lier
Telefon +47 32-244600
Telefax +47 32-244646
E-Mail sales.CCH.no@cooperindustries.com

COOPER Industries Crouse-Hinds Division

Wolf 7th North Streets
P. O. Box 4999
USA - Syracuse, NY 13221
Telefon +1 (0) 3-154777000
Telefax +1 (0) 3-154775717
E-Mail crouse.customerctr@cooperindustries.com
Internet www.crouse-hinds.com

COOPER Industries Turkey

Polat Is Merkezi, Selahattin Pinar Caddesi
Cemal Sahir Sokak No. 29 K: 4 Ofis:
41 Mecidiyekoy / Sisli
T - Istanbul
Telefon +90 212 266 31 10
Telefax +90 212 266 31 08
E-Mail Turkey@cooperindustries.com

COOPER Industries Russia

2\1 Paveletskaya nab.
Moscow. 115114
Russia
Telefon +7 495 510-24-27
Telefax +7 495 510-24-27
E-Mail info@cooper.ru.com
Internet www.cooper-russia.ru

©2013 Cooper Crouse-Hinds GmbH

Some of the information might lack topicality, correctness and completeness. Liability claims in regards to the presented information cannot be accepted.

Cooper Industries, Ltd.
600 Travis, Ste. 5800
Houston, TX 77002-1001
P: 713-209-8400
Internet www.cooperindustries.com