

# **PowerScan™ M8500**

Industrial Handheld Area Imager Bar Code Reader  
with Datalogic's STAR Cordless System™



**Product Reference Guide**

**Datalogic Scanning, Inc.**

959 Terry Street  
Eugene, Oregon 97402  
USA  
Telephone: (541) 683-5700  
Fax: (541) 345-7140

An Unpublished Work - All rights reserved. No part of the contents of this documentation or the procedures described therein may be reproduced or transmitted in any form or by any means without prior written permission of Datalogic Scanning, Inc. or its subsidiaries or affiliates ("Datalogic" or "Datalogic Scanning"). Owners of Datalogic products are hereby granted a non-exclusive, revocable license to reproduce and transmit this documentation for the purchaser's own internal business purposes. Purchaser shall not remove or alter any proprietary notices, including copyright notices, contained in this documentation and shall ensure that all notices appear on any reproductions of the documentation. Should future revisions of this manual be published, you can acquire printed versions by contacting your Datalogic representative. Electronic versions may either be downloadable from the Datalogic website ([www.scanning.datalogic.com](http://www.scanning.datalogic.com)) or provided on appropriate media. If you visit our website and would like to make comments or suggestions about this or other Datalogic publications, please let us know via the "Contact Datalogic" page.

**Disclaimer**

Datalogic has taken reasonable measures to provide information in this manual that is complete and accurate, however, Datalogic reserves the right to change any specification at any time without prior notice. Datalogic and the Datalogic logo are registered trademarks of Datalogic S.p.A. in many countries, including the U.S.A and the E.U. All other brand and product names referred to herein may be trademarks of their respective owners.

Microsoft Windows®, Windows® 2000, Windows®CE, Windows® NT, Windows® XP and the Windows logo are registered trademarks of Microsoft Corporation.

**Patents**

This product is covered by one or more of the following patents:

Design Pat. AU 310201; AU 310202; CN 693980; CN 735959; HK 0602013.5M001; HK 0602013.5M002; JP 1305693; KR 30-0460940; US D570,843 S.

US Pat. 6,478,226 B2; 6,512,218 B1; 6,808,114 B1; 6,877,664 B1; 6,997,385 B2; 7,053,954 B1; 7,102,116 B2; 7,282,688 B2; 7,387,246.

European Pat. 996,284 B1; 999,514 B1; 1,128,315 B1; 1,396,811 B1.

Additional patents pending.

# Table of Contents

<b>Preface .....</b>	<b>7</b>
About this Guide .....	7
Manual Overview .....	7
Manual Conventions .....	8
References .....	8
Service and Support .....	8
PRODUCTS .....	8
SERVICE & SUPPORT .....	8
CONTACT US .....	8
Compliance .....	9
Aiming System.....	9
Power Supply .....	12
WEEE Compliance .....	13
<b>Introduction.....</b>	<b>15</b>
Overview .....	15
General View .....	16
Powerscan® M8500 Readers .....	16
BC-80X0 / C-8000 CRADLES .....	17
Using the Reader .....	18
Aiming System.....	18
Normal Operation.....	19
Configuration Methods .....	19
Reading Configuration Codes .....	19
Using Datalogic Aladdin™ .....	19
Sending Configuration Strings from Host .....	19
Autoscanning .....	20
Normal Mode.....	20
Pattern Mode.....	20
Camera Control .....	20
Defining Data Formatting .....	21
Concatenation .....	22
<b>PowerScan M8500 Setup .....</b>	<b>23</b>
Package Contents .....	23
Installation .....	23
BC-80X0 Interface Cable Connections .....	23
RS-232 Connection .....	24
USB .....	24
IBM USB POS .....	24
WEDGE Connection .....	25
PEN Emulation Connection .....	25
Network Connections .....	26
BC-8060 Network Connectors.....	26
Network Cabling .....	26
Network Termination .....	27
PowerScan® M8500 Battery Maintenance .....	28
Battery Charging .....	28
Replacing PowerScan® M8500 Batteries .....	28
Mounting The BC-80X0 / C-8000 Cradle.....	30
Desktop Mounting .....	31
Portable Desktop Use .....	31
Fixed Desktop Use .....	32
Wall Mounting .....	33
System and Network Layouts .....	35
Stand-Alone Layouts .....	35

.....

Multiple Stand-Alone Layouts.....	36
Multidrop STAR-System™ Network Layouts.....	37
Host Master Layout .....	37
BC-8060 Master Layout .....	38
Master BC-8060 Network Troubleshooting .....	38
Setup Procedures .....	39
PowerScan® M8500/BC-80X0 Point-to-Point Setup.....	39
PowerScan® M8500/BC-80X0 Stand-Alone Setup .....	40
Using Multiple M-Series Readers with Same Cradle .....	42
PowerScan® M8500/STAR-Modem™ in Stand-Alone Mode .....	42
PowerScan® M8500/STAR-System™ Setup .....	43
BC-8060 STAR-System™ Network Setup.....	45
Interface Selection .....	47
RS-232.....	47
POS Terminals .....	47
PEN.....	47
WEDGE.....	48
IBM Terminals 31xx, 32xx, 34xx, 37xx: .....	48
KEY TRANSMISSION MODE.....	48
ALT MODE.....	49
WYSE TERMINALS .....	49
KEYBOARD TYPE.....	49
DIGITAL TERMINALS .....	50
USB Configuration.....	50
USB Start-up .....	50
<b>Configuration Using Code Symbols.....</b>	<b>53</b>
Configuration Parameters .....	53
Reading Configuration Barcodes .....	54
RS-232 PARAMETERS .....	55
Baud Rate.....	56
Parity.....	56
Data Bits .....	57
Stop Bits .....	57
Handshaking.....	57
ACK/NACK Protocol.....	58
FIFO .....	58
Inter-character Delay .....	58
RX Timeout.....	59
Serial Trigger Lock .....	59
USB PARAMETERS .....	60
USB-COM .....	61
Handshaking.....	61
ACK/NACK Protocol.....	61
FIFO .....	61
Inter-character Delay .....	62
RX Timeout.....	62
Serial Trigger Lock .....	63
USB-KBD .....	64
Keyboard Nationality.....	64
FIFO .....	65
Inter-character Delay .....	66
Inter-code Delay.....	66
USB Keyboard Speed .....	66
WEDGE PARAMETERS .....	67
Keyboard Nationality.....	68
Caps Lock .....	69
Caps Lock Auto-Recognition (IBM AT compatible only).....	70
Num Lock.....	70
Inter-character Delay .....	70
Inter-code Delay.....	71
Keyboard Setting .....	71

.....

Control Character Emulation .....	73
PEN EMULATION .....	74
Operating Mode .....	75
Minimum Output Pulse .....	76
Conversion to Code 39 .....	76
Conversion to Code 128 .....	77
Overflow .....	77
Output Level .....	77
Idle Level .....	78
Inter-Block Delay .....	78
NETWORK PARAMETERS .....	79
RS-485 Network .....	80
Network Baud Rate .....	80
Slave Address Range .....	81
Network Warning Message .....	81
Reception Warning Message .....	81
Master Cradle Header .....	82
Master Cradle Terminator .....	83
DATA FORMAT .....	84
Code Identifier .....	85
Custom Code Identifier .....	86
Header .....	89
Terminator .....	90
Code Length Tx .....	91
Address Stamping .....	91
Address Delimiter .....	92
Time Stamping .....	92
Time Stamping Delimiter .....	93
Symbology Dependent Parameters .....	94
Symbology Specific Format .....	95
Symbology Headers .....	95
Headers .....	96
Symbology Terminators .....	96
Terminators .....	96
Symbology Character Substitution .....	97
Character Substitution .....	97
Symbology Character Deletion .....	97
Character Deletion .....	98
Symbology Specific Format Default .....	98
Concatenation .....	99
Define Concatenation .....	99
Concatenation Enable/Disable .....	99
Concatenation Length .....	99
First Concatenated Code Length .....	99
Second Concatenated Code Length .....	99
Third Concatenated Code Length .....	100
Fourth Concatenated Code Length .....	100
Concatenation with Intercode Delay .....	100
Concatenation Failure Transmission .....	100
Concatenation Timeout .....	100
Transmission After Timeout .....	101
Concatenation Result Code ID .....	101
CAMERA CONTROL .....	102
Exposure Mode .....	102
AIMING SYSTEM .....	103
Good Read Spot .....	103
CODE SELECTION .....	104
Issue Identical Codes .....	104
Linear Symbologies .....	105
UPC/EAN/JAN Family .....	105
Code 39 Family .....	106

.....

Code 32 Family .....	107
Interleaved 2 of 5 Family .....	107
Codabar Family .....	108
Code 128 Family .....	109
Code 93 Family .....	110
GS1 Databar™ Family .....	111
2D Symbologies .....	112
PDF417 .....	112
Micro PDF417 .....	113
DataMatrix Family .....	113
QR Family .....	113
Micro QR .....	114
Postal Codes Family .....	114
Australian Table Selection .....	115
Intelligent Mail Barcode .....	115
Maxicode Family .....	115
Aztec .....	116
Composite Codes .....	116
READING PARAMETERS .....	117
Trigger Mode .....	118
Trigger Type .....	118
Flash Mode .....	118
Beeper Tone .....	118
Beeper Volume .....	119
Beeper Duration .....	119
Reads per Cycle .....	119
Scan Timeout .....	119
User Defined Beeper .....	120
User Defined Beeper Tone .....	120
User Defined Beeper Volume .....	120
User Defined Beeper Duration .....	120
Test User Defined Beeper .....	120
Code Ordering and Selection .....	121
Codes per Scan .....	121
Central Code Transmission .....	121
Order By Code Length .....	121
Order By Code Symbology .....	121
Autoscan .....	122
Autoscan Mode .....	122
Autoscan Aiming System .....	122
Autoscan Hardware Trigger .....	122
Autoscan Illumination System .....	122
Safety Time .....	123
Safety Time Duration .....	123
RADIO PARAMETERS .....	124
Radio Protocol Timeout .....	125
Radio RX Timeout .....	125
Power-Off Timeout .....	126
Reader Shut-Down .....	126
Transmission Mode .....	126
Beeper Control for Radio Response .....	127
Single Store .....	128
Batch Mode .....	129
Find Me .....	129
DISPLAY and KEYPAD PARAMETERS .....	130
DISPLAY PARAMETERS .....	131
Date and Time .....	131
Contrast .....	131
Font Size .....	131
Backlight .....	132
Display-Off Timeout .....	132

.....

Display Mode.....	132
KEYPAD PARAMETERS .....	133
Keypad .....	133
<b>Advanced Data Formatting .....</b>	<b>135</b>
Format Definition .....	136
Method 1 - Extracting Information from Barcode .....	137
Method 2 - Manipulating the Barcode Data .....	142
Match Conditions .....	151
Format Enable/Disable .....	152
Mismatch Result .....	153
<b>References .....</b>	<b>155</b>
RS-232 Parameters .....	155
Handshaking.....	155
ACK/NACK Protocol.....	156
PowerScan® M8500 Readers .....	156
FIFO .....	156
PowerScan® M8500 Readers .....	156
RX Timeout.....	157
Pen Parameters .....	157
Minimum Output Pulse .....	157
Conversion to Code 39 and Code 128.....	157
PowerScan® M8500 Series Readers .....	157
Overflow.....	157
Output and Idle Levels.....	158
Inter-Block Delay.....	158
Network Parameters .....	158
Slave Address Range First/Last .....	158
Network Warning Message .....	159
Reception Warning Message.....	159
Master Header/Terminator Selection .....	159
Data Format .....	160
Header/Terminator Selection .....	160
Define Special Key Sequence .....	161
Address Stamping .....	168
Address Delimiter .....	168
Time Stamping Format.....	168
Time Stamping Delimiter .....	168
Reading Parameters .....	168
Trigger Signal .....	168
Reads per Cycle.....	168
Safety Time.....	169
Configuration Editing Commands.....	169
Radio Parameters .....	170
Radio Protocol Timeout.....	170
Radio RX Timeout .....	170
Power-Off Timeout.....	170
Transmission Mode .....	171
Beeper Control for Radio Response .....	171
Single Store.....	171
Batch Mode.....	172
Find Me .....	172
Display Parameters .....	173
Display Mode.....	173
Default Parameters for POS Terminals .....	174
<b>Message Formatting .....</b>	<b>175</b>
Standard Message Formatting .....	175
Messages from Host to Reader .....	175
Cursor Control .....	176
Font Selection .....	177
Clearing Display.....	177

.....

LED and Beeper Control .....	177
Setting RTC .....	177
Messages from SCANNER Command Keys .....	178
PowerScan M8500 Keypad .....	178
<b>Technical Features .....</b>	<b>179</b>
Technical Features .....	179
BC-80X0 / C-8000 .....	184
System and Radio Features .....	185
Indicators .....	186
PowerScan® M8500 LED Indicators .....	186
Beeper .....	186
Good Read Spot .....	187
Default Settings .....	189
<b>Host Configuration Strings.....</b>	<b>193</b>
Serial Configuration Strings .....	194
<b>Programming for Expert Users.....</b>	<b>209</b>
Function Description .....	209
FindStringByStarting&EndingChar (FSTR) .....	210
FindStringByStartingChar&Len (FLSTR) .....	210
SelectString (SSTR) .....	210
FindPosition (FPOS) .....	211
StringLength (LSTR) .....	211
StringConcatenation .....	211
StringDiscard .....	211
InsertString (ISTR) .....	211
ReplaceString (RSTR) .....	211
Using Format Output in Format Definition .....	212
<b>Code Identifier Table .....</b>	<b>213</b>
<b>Sample Barcodes .....</b>	<b>215</b>
Test Code Symbols .....	215
<b>Hex &amp; Numeric Table.....</b>	<b>217</b>
Hex Numeric Table .....	219
Autoscan Pattern Code .....	222



## About this Guide

This Product Reference Guide (PRG) is provided for users seeking advanced technical information, including connection, programming, maintenance and specifications. The Quick Reference Guide (QRG) and other publications associated with this product are downloadable free of charge from the website listed on the back cover of this manual.

Typically, units are factory-programmed for the most common terminal and communications settings. If you need to modify any programmable settings, custom configuration can be accomplished by scanning the programming barcodes within this guide.

Programming can alternatively be performed using the Datalogic Aladdin™ Configuration application which is downloadable from the Datalogic website listed on the back cover of this manual. This multi-platform utility program allows device configuration using a PC. It communicates to the device using a serial or USB cable and can also create configuration barcodes to print.

## Manual Overview

[Chapter 1, Introduction](#) gives an general description of the product.

[Chapter 2, PowerScan M8500 Setup](#) provides information needed to get the device up and running.

[Chapter 3, Configuration Using Code Symbols](#) defines options for all symbologies and provides programming barcodes necessary for configuring these features.

[Chapter 4, Advanced Data Formatting](#), provides information about advanced formatting parameters.

[Chapter 5, References](#) gives additional, more detailed information for some complex parameters.

[Chapter 6, Message Formatting](#) explains the communication format between the reader and the host.

[Appendix A, Technical Features](#) lists physical and performance characteristics, as well as environmental and regulatory specifications and functions and behaviors of the reader's LED and Beeper indicators.

[Appendix B, Host Configuration Strings](#) provides a description of how to modify the device configuration using serial strings sent from the host.

[Appendix C, Programming for Expert Users](#) describes programming language for expert users who want to define a personalized code formatting.

[Appendix D, Code Identifier Table](#) lists Code IDs for various symbologies.

[Appendix E, Sample Barcodes](#) provides test code symbols allowing you to check the reader's functioning.

[Appendix F, Hex & Numeric Table](#) includes numeric barcodes to be scanned for certain parameter settings.

## Manual Conventions

The following conventions are used in this document:

The symbols listed below are used in this manual to notify the reader of key issues or procedures that must be observed when using the reader:



**Notes contain information necessary for properly diagnosing, repairing and operating the reader.**



**CAUTION**

**The CAUTION symbol advises you of actions that could damage equipment or property.**



**WARNING**

**A WARNING symbol calls attention to actions that could result in personal injury.**

## References

Current versions of the Product Reference Guide (PRG), Quick Reference Guide (QRG), Datalogic Aladdin™ Configuration application, and any other manuals, instruction sheets and utilities for this product can be downloaded from the website listed on the back cover of this manual. Alternatively, printed copies or product support CDs can be purchased through your Datalogic reseller.

## Service and Support

Datalogic provides several services as well as technical support through its website. Log on to [www.scanning.datalogic.com](http://www.scanning.datalogic.com) and click on the links indicated for further information including:

### PRODUCTS

Search through the links to arrive at your product page where you can download specific Manuals and Software & Utilities including:

- Datalogic Aladdin™ a multi-platform utility program that allows device configuration using a PC. It provides RS-232 interface configuration as well as configuration barcode printing.

### SERVICE & SUPPORT

- Technical Support - Product documentation and programming guides and Technical Support Department in the world
- Service Programs - Warranty Extensions and Maintenance Agreements
- Repair Services - Flat Rate Repairs and Return Material Authorization (RMA) Repairs.
- Downloads – Manuals & Documentation, Data Sheets, Product Catalogues, etc.

### CONTACT US

Information Request Form and Sales & Service Network

# Compliance

Figure 1. POWERSCAN® PM8500 Reader Product Label

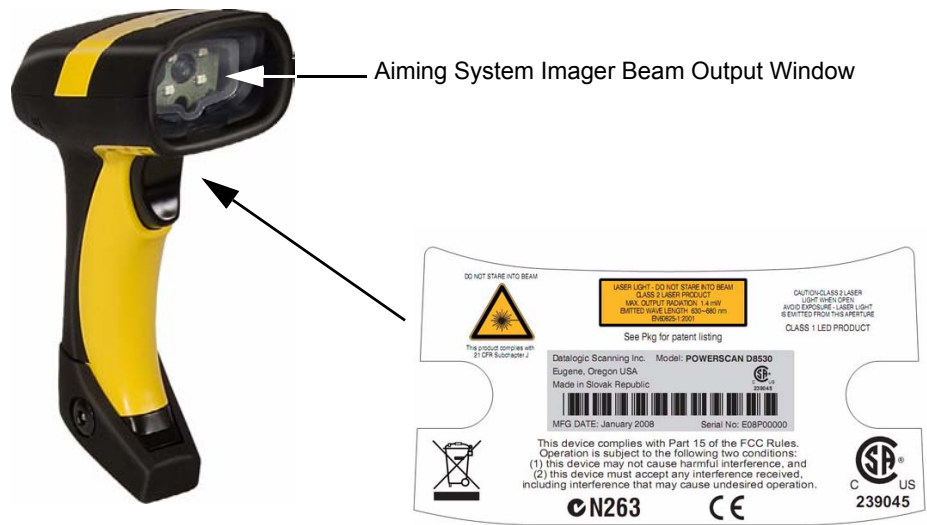

## Aiming System

The PowerScan® PM8500 aiming system meets the requirements for laser safety.

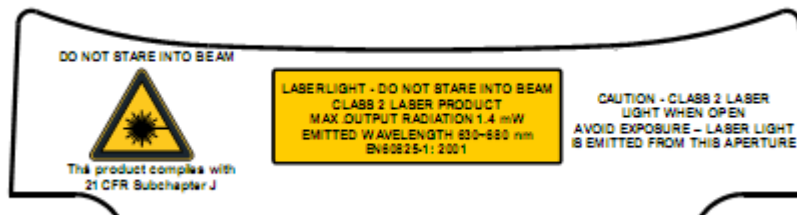

I	D	F	E
LA LUCE LASER È VISIBILE ALL'OCCHIO UMANO E VIENE EMESSA DALLA FINESTRA INDICATA NELLA FIGURA.	DIE LASER-STRAHLUNG IST FÜR DAS MENSCHLICHE AUGE SICHTBAR UND WIRD AM STRAHLAUS-TRITTSFENSTER AUSGESENDET (SIEHE BILD)	LE RAYON LASER EST VISIBILE À L'OEUIL NU ET IL EST ÉMIS PAR LA FENÊTRE DÉSIGNÉE SUR L'ILLUSTRATION DANS LA FIGURE	LA LUZ LÁSER ES VISIBILE AL OJO HUMANO Y ES EMITIDA POR LA VENTANA INDICADA EN LA FIGURA.
LUCE LASER NON FISSARE IL FASCIO APPARECCHIO LASER DI CLASSE 2 MASSIMA POTENZA D'USCITA: LUNGHEZZA D'ONDA EMESSA: CONFORME A EN 60825-1 (2001)	LASERSTRAHLUNG NICHT IN DEN STRAHL BLICKEN PRODUKT DER LASERKLASSE 2 MAXIMALE AUSGANGSLEISTUNG: WELLENLÄGE: ENTSPR. EN 60825-1 (2001)	RAYON LASER EVITER DE REGARDER LE RAYON APPAREIL LASER DE CLASSE 2 PUIS- SANCE DE SORTIE: LONGUEUR D'ONDE EMISE: CONFORME A EN 60825-1 (2001)	RAYO LÁSER NO MIRAR FIJO EL RAYO APARATO LÁSER DE CLASE 2 MÁXIMA POTENCIA DE SALIDA: LONGITUD DE ONDA EMITIDA: CONFORME A EN 60825-1 (2001)

## ENGLISH

The following information is provided to comply with the rules imposed by international authorities and refers to the correct use of your terminal.

### STANDARD LASER SAFETY REGULATIONS

This product conforms to the applicable requirements of both CDRH 21 CFR 1040 and EN 60825-1 at the date of manufacture.

For installation, use and maintenance, it is not necessary to open the device.



**Use of controls or adjustments or performance of procedures other than those specified herein may result in exposure to hazardous visible laser light.**

### WARNING

The product utilizes a low-power laser diode. Although staring directly at the laser beam momentarily causes no known biological damage, avoid staring at the beam as one would with any very strong light source, such as the sun. Avoid allowing the laser beam to hit the eye of an observer, even through reflective surfaces such as mirrors, etc.

## ITALIANO

Le seguenti informazioni vengono fornite dietro direttive delle autorità internazionali e si riferiscono all'uso corretto del terminale.

### NORMATIVE STANDARD PER LA SICUREZZA LASER

Questo prodotto risulta conforme alle normative vigenti sulla sicurezza laser alla data di produzione: CDRH 21 CFR 1040 e EN 60825-1.

Non si rende mai necessario aprire l'appa-recchio per motivi di installazione, utilizzo o manutenzione.



**L'utilizzo di procedure o regolazioni differenti da quelle descritte nella documentazione può provocare un'esposizione pericolosa a luce laser visibile.**

### ATTENZIONE

Il prodotto utilizza un diodo laser a bassa potenza. Sebbene non siano noti danni riportati dall'occhio umano in seguito ad una esposizione di breve durata, evitare di fissare il raggio laser così come si eviterebbe qualsiasi altra sorgente di luminosità intensa, ad esempio il sole. Evitare inoltre di dirigere il raggio laser negli occhi di un osservatore, anche attraverso superfici riflettenti come gli specchi.

## DEUTSCH

Die folgenden Informationen stimmen mit den Sicherheitshinweisen überein, die von internationalen Behörden auferlegt wurden, und sie beziehen sich auf den korrekten Gebrauch vom Terminal.

### NORM FÜR DIE LASERSICHERHEIT

Dies Produkt entspricht am Tag der Herstellung den gültigen EN 60825-1 und CDRH 21 CFR 1040 Normen für die Lasersicherheit.

Es ist nicht notwendig, das Gerät wegen Betrieb oder Installations-, und Wartungsarbeiten zu öffnen.



**Jegliche Änderungen am Gerät sowie Vorgehensweisen, die nicht in dieser Betriebsanleitung beschreiben werden, können ein gefährliches Laserlicht verursachen.**

### **ACHTUNG**

Der Produkt benutzt eine Laserdiode. Obwohl zur Zeit keine Augenschäden von kurzen Einstrahlungen bekannt sind, sollten Sie es vermeiden für längere Zeit in den Laserstrahl zu schauen, genauso wenig wie in starke Lichtquellen (z.B. die Sonne). Vermeiden Sie es, den Laserstrahl weder gegen die Augen eines Beobachters, noch gegen reflektierende Oberflächen zu richten.

## **FRANÇAIS**

Les informations suivantes sont fournies selon les règles fixées par les autorités internationales et se réfèrent à une correcte utilisation du terminal.

### **NORMES DE SECURITE LASER**

Ce produit est conforme aux normes de sécurité laser en vigueur à sa date de fabrication: CDRH 21 CFR 1040 et EN 60825-1.

Il n'est pas nécessaire d'ouvrir l'appareil pour l'installation, l'utilisation ou l'entretien.



**L'utilisation de procédures ou réglages différents de ceux donnés ici peut entraîner une dangereuse exposition à lumière laser visible.**

### **ATTENTION**

Le produit utilise une diode laser. Aucun dommage aux yeux humains n'a été constaté à la suite d'une exposition au rayon laser. Eviter de regarder fixement le rayon, comme toute autre source lumineuse intense telle que le soleil. Eviter aussi de diriger le rayon vers les yeux d'un observateur, même à travers des surfaces réfléchissantes (miroirs, par exemple).

## **ESPAÑOL**

Las informaciones siguientes son presentadas en conformidad con las disposiciones de las autoridades internacionales y se refieren al uso correcto del terminal.

### **NORMATIVAS ESTÁNDAR PARA LA SEGURIDAD LÁSER**

Este aparato resulta conforme a las normativas vigentes de seguridad láser a la fecha de producción: CDRH 21 CFR 1040 y EN 60825-1.

No es necesario abrir el aparato para la instalación, la utilización o la manutención.



***La utilización de procedimientos o regulaciones diferentes de aquellas descritas en la documentación puede causar una exposición peligrosa a la luz láser visible.***

**ATENCIÓN**

El aparato utiliza un diodo láser a baja potencia. No son notorios daños a los ojos humanos a consecuencia de una exposición de corta duración. Eviten de mirar fijo el rayo láser así como evitarían cualquiera otra fuente de luminosidad intensa, por ejemplo el sol. Además, eviten de dirigir el rayo láser hacia los ojos de un observador, también a través de superficies reflectantes como los espejos.



**The POWERSCAN® PM8500 Hand-Held Reader is not user-serviceable. Opening the case of the unit can cause internal damage and will void the warranty.**

**CAUTION**

## **Power Supply**

This device is intended to be supplied by a UL Listed or CSA Certified Power Unit marked "Class 2" or "LPS" output rated 5-30 V, minimum 0.75 A which supplies power directly to the scanner via the jack connector on the cable.

---

## WEEE Compliance



### English

For information about the disposal of Waste Electrical and Electronic Equipment (WEEE), please refer to the website at [www.scanning.datalogic.com](http://www.scanning.datalogic.com).

### Italian

Per informazioni sullo smaltimento delle apparecchiature elettriche ed elettroniche consultare il sito Web [www.scanning.datalogic.com](http://www.scanning.datalogic.com).

### French

Pour toute information relative à l'élimination des déchets électroniques (WEEE), veuillez consulter le site Internet [www.scanning.datalogic.com](http://www.scanning.datalogic.com).

### German

Informationen zur Entsorgung von Elektro- und Elektronik- Altgeräten (WEEE) erhalten Sie auf der Webseite [www.scanning.datalogic.com](http://www.scanning.datalogic.com).

### Spanish

Si desea información acerca de los procedimientos para el desecho de los residuos del equipo eléctrico y electrónico (WEEE), visite la página Web [www.scanning.datalogic.com](http://www.scanning.datalogic.com).

### Portuguese

Para informações sobre a disposição de Sucatagem de Equipamentos Elétricos e Eletrônicos (WEEE - Waste Electrical and Electronic Equipment), consultar o site web [www.scanning.datalogic.com](http://www.scanning.datalogic.com).

### Chinese

有关处理废弃电气电子设备 (WEEE) 的信息, 请参考 Datalogic 公司的网站: <http://www.scanning.datalogic.com/>。

### Japanese

廃電気電子機器 (W E E E) の処理についての関連事項は Datalogic のサイト [www.scanning.datalogic.com](http://www.scanning.datalogic.com), をご参照下さい。

# NOTES



# Chapter 1

## Introduction

### Overview

The PowerScan® PM8500 cordless handheld Reader Family packs a lot of performance into an attractive, rugged, handheld device. It operates in commercial and industrial environments as well as the front office.

In all applications where mobility is a value, the PowerScan® PM8500 represents the key to increase productivity and flexibility in the working area. PowerScan® PM8500 communicates through a low power, license free radio in the 433 MHz band (910 MHz for USA version) and allows bi-directional communication between the base station and the host. PowerScan® PM8500 also includes a display and a 3-key keypad. Thanks to these features, the operator can receive information from the host, interact with the central system and visualize the code read. The cordless system offers scalable solutions to solve simple applications and complex projects:

- Point to point: each reader is associated with its own base station;
- Multipoint: up to 32 readers transmit data to one base station;
- Network: to cover a wide area, connecting up to 16 bases and 512 readers simultaneously working in automatic roaming.

PowerScan® PM8500 is 100% compatible with STAR-System™, the Datalogic RF narrow band solution for mobile applications that provides the widest family of narrow band devices on the market. In addition, the main feature of PowerScan PM8500 are:

<b>Omni-directional Operating</b>	To read a symbol, simply aim at the code and pull the trigger. Since PowerScan® PM8500 is a powerful omni-directional reader, the orientation of the symbol is not important.
<b>Decoding and Imaging</b>	Thanks to powerful algorithms, PowerScan® PM8500 reliably decodes all major 1D (linear) barcodes, 2D stacked codes (such as PDF417), 2D matrix symbols (such as DataMatrix), postal codes (such as POSTNET, PLANET). The data stream — acquired from decoding a symbol — is rapidly sent to the host. The reader is immediately available to read another symbol.
<b>Flash Memory</b>	Flash technology allows upgrade of the PowerScan® PM8500 reader as new symbologies are supported or as improved decoding algorithms become available.
<b>USA Driver License Parsing</b>	The PowerScan® PM8500 reader can be set up to select and output a subset of data elements from USA Driver License PDF417 barcodes. This feature can be enabled using either Datalogic Aladdin™ or the barcodes in the USA Driver License Parsing Quick Reference Guide (QRG), available on the Datalogic website.

Your PowerScan® reader is supplied with its own Quick Reference Guide, which provides connection, diagrams, reading diagrams, basic application parameter settings, default values, and specific technical features. You can use either the Quick Reference Guide or this Manual for initial configuration in order to set the default values and select the interface for your application. This manual provides all the necessary information for complete mechanical installation and system software configuration.

## General View

### Powerscan® M8500 Readers

Figure 2. PowerScan® M8500 Readers



Figure 3. PowerScan® M8500 Reader with Display



---

## BC-80X0 / C-8000 CRADLES

Figure 4. BC-8000



The label on the cradle contains LED indicators and a scan finder button. When the button is pressed, the cradle transmits a “broadcast” message. All properly configured scanners (Radio RX Timeout set to keep the radio “awake”) linked to that base (through a bind or a join sequence) and within radio range coverage will emit a beep sequence once every 2 seconds for 30 seconds. A scanner is considered to be linked when the last transmission ends properly.

The scan finder works only in stand-alone layout (point to point or multiple readers).

Figure 5. Figure D – C-8000



## Using the Reader

### Aiming System

The PowerScan® M8500 reader uses an intelligent aiming system similar to those on cameras. By partially pulling the trigger, the aiming system indicates a field of view to be positioned over the code:

**Figure 6. Aiming System**

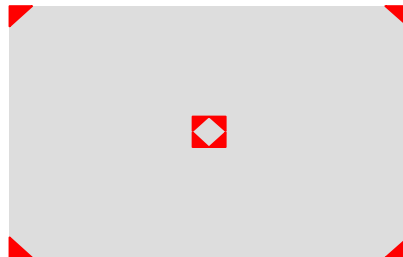

When you pull the trigger completely a red beam illuminates the code. If the aiming system is centered and the entire symbology is within the aiming system, you will get a good read. The field of view changes size as you move the reader closer or farther away from the code.

**Figure 7. Relative Size and Location of Aiming System Pattern**

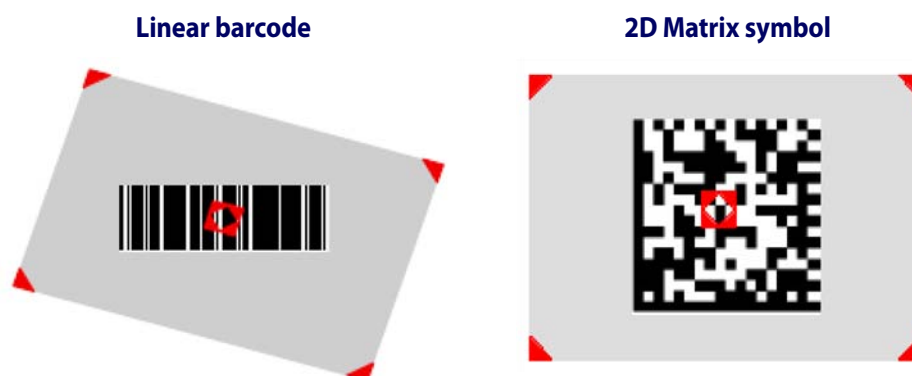

The field of view indicated by the aiming system will be smaller when the PowerScan® PM8500 is closer to the code and larger when it is farther from the code. Symbologies with smaller bars or elements (mil size) should be read closer to the unit. Symbologies with larger bars or elements (mil size) should be read farther from the unit. (See "[Technical Features](#)" starting on page 179 for further details).

## Normal Operation

PowerScan® M8500 normally functions by capturing and decoding codes.

Point the reader at the target and pull the trigger partially to enable the aiming system. Then, pull it completely to capture and decode the image. The reader will repeatedly flash until the symbol is decoded or timeout is reached. In between the flashes of the reader, the aiming system keeps on showing the field of view on the target (see [Figure 7 on page 18](#)).

As you are reading code symbols, adjust the distance at which you are holding the reader.



**The PowerScan® M8500 hand-held reader aiming system is designed for general reading and decoding of 1D and 2D symbols. Some variation in reading distance will occur due to narrow bar width and other factors.**



**If reading codes positioned on reflective surfaces, it may be necessary to tilt the reader with respect to the barcode and/or set the Camera Control parameters (see [page 102](#)).**

## Configuration Methods

### Reading Configuration Codes

This manual can be used for complete setup and configuration. If you wish to change the default settings, you can configure the PowerScan® PM8500 reader by reading the programming code symbols in this manual. Configuration commands and their relative arguments are read individually using the symbols in this manual. See "[Configuration Using Code Symbols](#)" starting on [page 53](#).

### Using Datalogic Aladdin™

Datalogic Aladdin™ is a multi-platform utility program providing a quick and user-friendly configuration method via the RS-232/USB-COM interface. Aladdin, available on the CD-ROM provided, allows you to program the reader by selecting configuration commands through a user-friendly graphical interface running on a PC. These commands are sent to the reader over the current communication interface, or they can be printed as barcodes to be scanned.

It also provides the ability to perform a software upgrade for the connected device (see the Datalogic Aladdin™ Help On-Line for more details).

### Sending Configuration Strings from Host

An alternative configuration method is provided in [Appendix B, Host Configuration Strings](#) using the RS-232 or USB COM interface. This method is particularly useful when many devices need to be configured with the same settings. Batch files containing the desired parameter settings can be prepared to configure devices quickly and easily.

The PowerScan® M8500 reader incorporates a multi-standard interface, which can be connected to a Host by plugging the correct interface cable into the connector and closing the cable cover.

# Autoscanning

## Normal Mode

PowerScan® M8500 provides an autoscan command (see [page 205](#)), which when enabled, causes the reader to scan continuously and to monitor the central zone of its reading area. In this way, PowerScan® M8500 is ready to capture any image (containing a potential code) positioned on a uniform background.

The aiming system can be enabled to indicate the reading area of the potential code to be captured. The illumination system can also be enabled when the ambient light conditions are not sufficient to autodetect the potential code to be captured; furthermore, the illumination system increases in intensity for an instant when capturing and decoding an image. A safety time may be defined to prevent PowerScan® M8500 from reading the same code repeatedly.

If the decoding is completed successfully, the reader starts monitoring the reading area again. In case of decoding failure, PowerScan® M8500 keeps on decoding until a potential code is present in the central zone of the reading area.

## Pattern Mode

The Autoscan pattern mode is particularly advised when reading barcodes positioned on a non-uniform background. In these cases PowerScan® M8500 may perceive some elements of the background as barcodes and start the decoding. To avoid this undesired effect, the Autoscan Pattern Code is placed in the PowerScan® M8500 reading area which prevents decoding. Using this code as the background, code reading takes place normally by presenting desired codes to be read over the Pattern Code. Between each code read, the Pattern Code must be presented to the reader.

The Pattern Code can be printed from this manual (see [Autoscan Pattern Code in Appendix F](#)).

In case of low ambient light conditions, PowerScan® M8500 automatically activates the illumination system. If desired, the illumination system can be enabled so that it is always active.

# Camera Control

## Exposure and Calibration

Three automatic control modes are available to optimize the reading performance:

- **Automatic based on entire image:** camera control mode based on the analysis of the whole image. This mode works well in most standard applications. It is the default setting.
- **Automatic based on central image:** camera control mode based on the analysis of a restricted area positioned in the central zone of the image. This mode is suggested when reading small codes positioned in a dark and extensive background.
- **Automatic for highly reflective surfaces:** camera control mode allowing reading of codes on highly reflective surfaces. This mode is suggested, for example, when reading codes positioned on plastic or metal surfaces.

Refer to [CAMERA CONTROL on page 102](#) for configuration codes.

---

## Defining Data Formatting

The string of a decoded code to be sent to the host may be formatted as follows:

- defining simple data formatting (see [page 84](#))
- defining advanced data formatting giving complete flexibility in changing the format of data (see [Advanced Data Formatting on page 135](#)).

When both simple and advanced data formatting are selected the info is processed in the following order:

1. the string of the decoded code is processed according to the advanced formatting rules;
2. the resulting string is processed according to the selection type rules of the simple data formatting;
3. character substitution is performed on the resulting string;
4. character deletion is performed on the resulting string;
5. code concatenation is performed;
6. code ID is attached to the resulting string;
7. global headers and terminators are attached to the resulting string;

The codes to be sent to the host may also be selected or ordered depending on the following two conditions:

### One Code Per Scan

- PowerScan® M8500 sends the code being closest to the image center. If the "Central Code Transmission" command is enabled, only the code containing the image center will be transmitted (see [page 205](#));

### All Codes Per Scan

- The codes to be sent to the host may be ordered either by length or by symbology starting from the code being closest to the image center (see [page 205](#)). When enabling both these criteria, codes belonging to the same symbology are sent to the host depending on their length.

## Concatenation

It is possible to concatenate up to 4 different codes, set their length and enable the Intercode Delay between them (the intercode delay is set in the specific interface parameters, see ["Configuration Using Code Symbols" starting on page 53](#) ). When enabling the delay one or more global headers and terminators are added to the decoded data. The concatenation procedure may occur in different ways depending on the number of codes to be decoded per image:

### One Code Per Scan

- If the code resulting from the single decoding of an image belongs to one of the code families to be concatenated, it is saved to the PowerScan® M8500 memory waiting for other codes to complete the concatenation.
- If the code belongs to the same family of a code previously saved, it overwrites the old one.
- If the code resulting from the decoding does not belong to one of the code families to be concatenated, it causes the concatenation failure and clears the temporary memory. If the "Concatenation Failure Transmission" command is set to "Tx codes causing failure" (see [page 100](#)), this code will be sent in the output message.

### All Codes Per Scan

- All codes resulting from the decoding of an image and belonging to one of the families to be concatenated are saved to the PowerScan® M8500 memory waiting for other codes to complete the concatenation.
- If one or more codes resulting from the decoding belong to the same family of codes previously saved, they overwrite the old ones.
- When the image contains no code to be concatenated, the concatenation fails and the reader temporary memory is cleared. If the "Concatenation Failure Transmission" command is set to "Tx codes causing failure" (see [page 100](#)), the codes causing the concatenation failure will be sent in the output message.



# Chapter 2

## PowerScan M8500 Setup

### Package Contents

The following parts are included in the PowerScan® PM8500 package contents:

- PowerScan® PM8500 Hand-Held Reader
- CD-ROM containing the PowerScan® PM8500 Configuration Tools software and PowerScan® PM8500 Reference Manual
- PowerScan® PM8500 Quick Reference Manual

You may want to save your packing material in case you need to ship the reader at some later time.

### Installation

#### BC-80X0 Interface Cable Connections

The BC-80X0 incorporates a multi-standard interface, which can be connected to a Host by simply plugging the correct interface cable into the Host connector, placed on the base of the cradle. In addition the cradle must be connected to an external power supply.

**Figure 8. BC-80X0 Connectors**



**Figure 9. Disconnecting the BC-80X0 Cable**

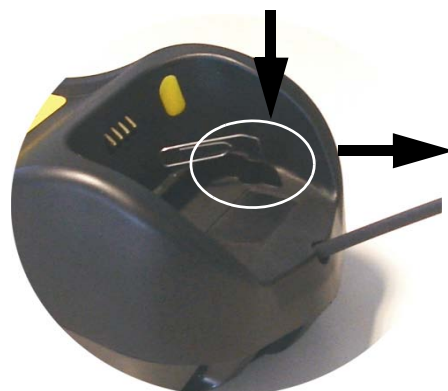

To disconnect the cable, insert a paper clip or other similar object into the hole corresponding to the Host connector on the body of the cradle.

Push down on the clip while unplugging the cable.

### RS-232 Connection

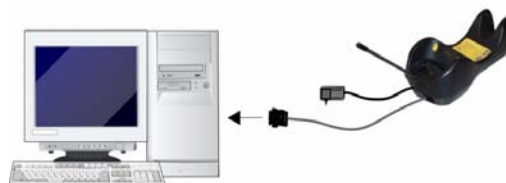

### USB

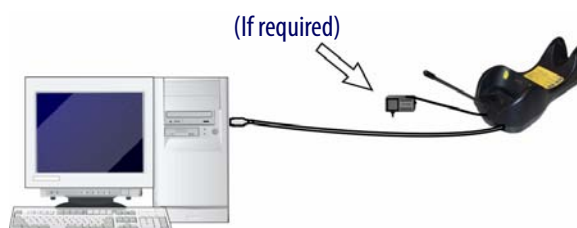

### IBM USB POS

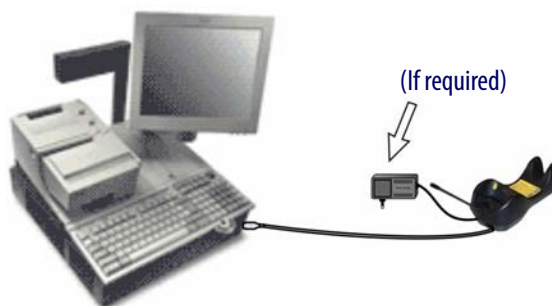

## WEDGE Connection

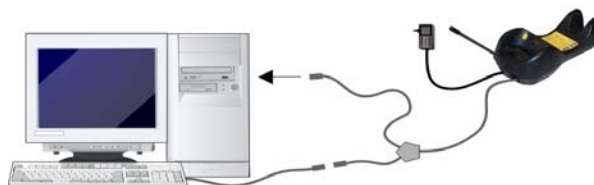
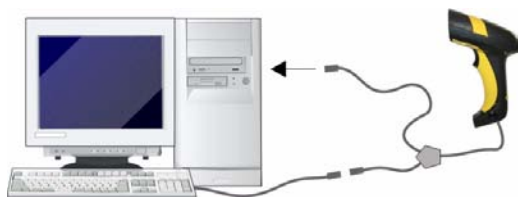

## PEN Emulation Connection

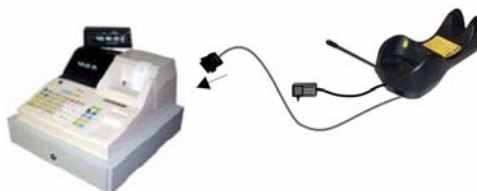
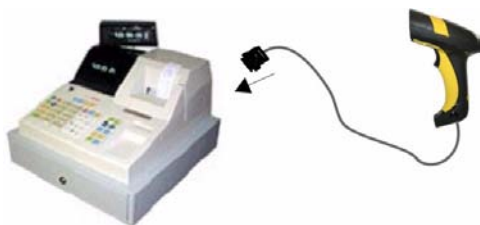

# Network Connections

## BC-8060 Network Connectors

The multidrop network is a bus system which is propagated from one BC-8060 cradle to another using individual cables. This is possible thanks to the RS-485 connector on the front panel of the cradle.

**Figure 10. Network Connectors**

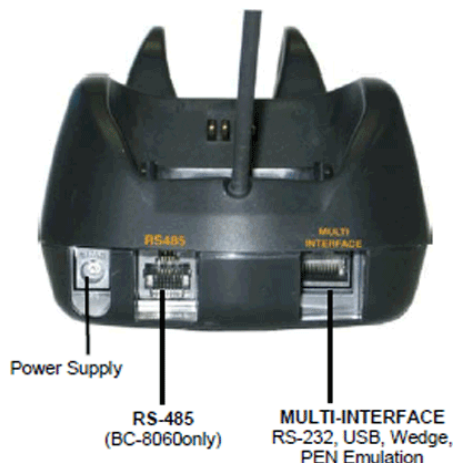

All cradles are connected together within the bus system through the Datalogic RS-485 splitter cable (CAB-428, part number 90A051950), which must be inserted in the RS-485 cradle connector.

Cable length should be kept to a minimum, as with all bus systems.

## Network Cabling

The Multidrop line is made using RJ45 connectors and a cable having the following specifications:

- twisted pair AWG 24 wires
- 120 Ω impedance
- maximum network cable length 1200 meters

Pin	Function
1	RS-485 +
2	RS-485 -
3	N.C.
4	VDC -
5	VDC -
6	N.C.
7	VDC +
8	VDC +

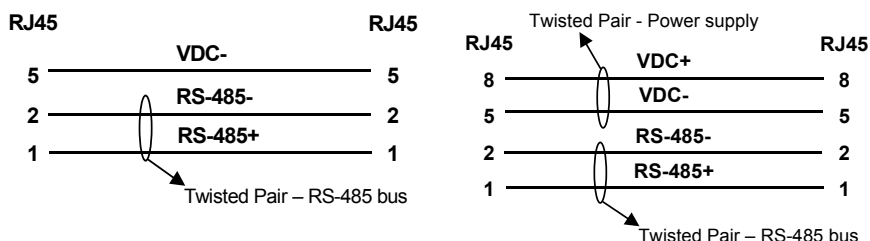
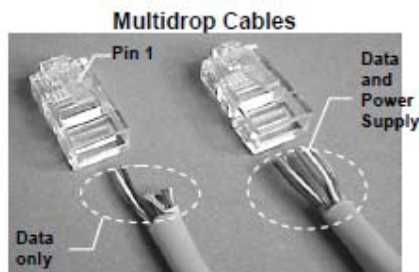

When wiring the multidrop cables, note the following:

- Pin 8 (or 7) can be connected only if the power has to be propagated from a cradle to a STARGATE™ base station or STAR-Box™ converter via the cable.
- Pins 5 (or 4) should always be connected as reference ground.
- To avoid excessive voltage drop, it is recommended not to propagate power between BC-8060 cradles when used as battery chargers but to supply each cradle individually. The total number of devices, which can be connected to a single power supply, depends on the power supply voltage, the wire length and resistance and therefore the voltage drop. **Do NOT connect VDC+ between network devices that are individually powered.**

## Network Termination

The first and last cradles of the chain (the two ends of the bus) must be properly terminated. The cradle has an internal terminator that can be selected via jumper. For this selection you must open the device.

**Figure 11. Terminator for Multidrop Network**

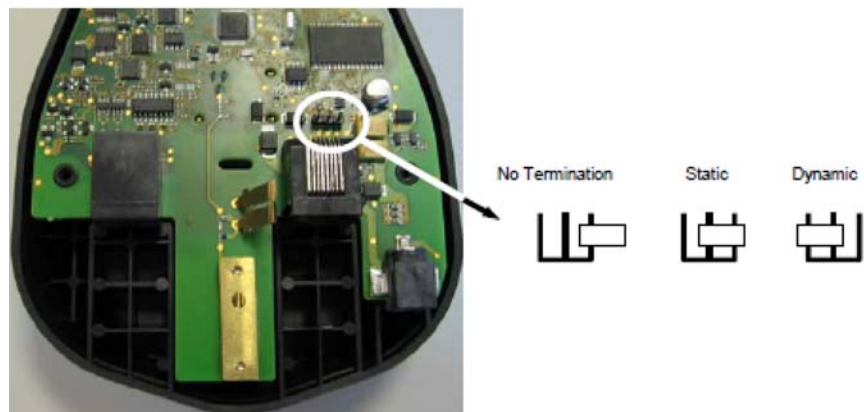

Static termination works for all network configurations. However, the network is always under load even when no data transmission takes place.

Dynamic termination can be used for baud rates at or above 38400 and provides less load on the network when idle.

# PowerScan® M8500 Battery Maintenance

## Battery Charging

Once the system is connected and powered, you can place the PowerScan® M8500 into the cradle to charge the battery.

When the reader is correctly inserted in the cradle, the "Reader" red LED on the cradle goes on to indicate that the battery is charging. The "Reader" green LED on the cradle goes on when the battery is completely charged.



## Replacing PowerScan® M8500 Batteries

1. To change the battery pack in your PowerScan® M8500 scanner, push the Release Button as indicated by Arrow 1 and extract the battery pack from the reader handle.



**When the batteries are extracted from the scanner, the timer maintains the current hour and date for about 1 minute.**

2. Then, insert the new battery pack into the reader handle until a 'click' is heard and the Release Button moves back to its neutral position.

**WARNING**

**Do not discharge the battery using any device except for the scanner. When the battery is used in devices other than the designated product, it may damage the battery or reduce its life expectancy. If the device causes an abnormal current to flow, it may cause the battery to become hot, explode or ignite and cause serious injury.**

**Lithium-ion battery packs may get hot, explode or ignite and cause serious injury if exposed to abusive conditions. Be sure to follow the safety warnings listed below:**

- **Do not place the battery pack in fire or heat.**
- **Do not connect the positive terminal and negative terminal of the battery pack to each other with any metal object (such as wire).**
- **Do not carry or store the battery pack together with metal objects.**
- **Do not pierce the battery pack with nails, strike it with a hammer, step on it or otherwise subject it to strong impacts or shocks.**
- **Do not solder directly onto the battery pack.**
- **Do not expose the battery pack to liquids, or allow the battery to get wet.**
- **Do not apply voltages to the battery pack contacts.**

**In the event the battery pack leaks and the fluid gets into your eye, do not rub the eye. Rinse well with water and immediately seek medical care. If left untreated, the battery fluid could cause damage to the eye.**

**CAUTION**

**Always charge the battery at 32° – 104°F (0° - 40°C) temperature range.**

**Use only the authorized power supplies, battery pack, chargers, and docks supplied by your Datalogic reseller. The use of any other power supplies can damage the device and void your warranty.**

**Do not disassemble or modify the battery. The battery contains safety and protection devices, which, if damaged, may cause the battery to generate heat, explode or ignite.**

**Do not place the battery in or near fire, on stoves or other high temperature locations.**

**Do not place the battery in direct sunlight, or use or store the battery inside cars in hot weather. Doing so may cause the battery to generate heat, explode or ignite. Using the battery in this manner may also result in a loss of performance and a shortened life expectancy.**

**Do not place the battery in microwave ovens, high-pressure containers or on induction cookware.**

**Immediately discontinue use of the battery if, while using, charging or storing the battery, the battery emits an unusual smell, feels hot, changes color or shape, or appears abnormal in any other way.**

**Do not replace the battery pack when the device is turned on.**

**Do not remove or damage the battery pack's label.**

**Do not use the battery pack if it is damaged in any part.**

**Battery pack usage by children should be supervised.**

As with other types of batteries, Lithium-Ion (LI) batteries will lose capacity over time. Capacity deterioration is noticeable after one year of service whether the battery is in use or not. It is difficult to precisely predict the finite life of a LI battery, but cell manufacturers rate them at 500 charge cycles. In other words, the batteries should be expected to take 500 full discharge/charge cycles before needing replacement. This number is higher if partial discharging / recharging is adhered to rather than full / deep discharging,

The typical manufacturer advertised useful life of LI batteries is one to three years, depending on usage and number of charges, etc., after which they should be removed from service, especially in mission critical applications. Do not continue to use a battery that is showing excessive loss of capacity, it should be properly recycled / disposed of and replaced. For most applications, batteries should be replaced after one year of service to maintain customer satisfaction and minimize safety concerns.

Collect and recycle waste batteries separately from the device in compliance with European Directive 2006/66/EC, 2002/95/EC, 2002/96/EC and subsequent modifications, US and China regulatory and others laws and regulations about the environment.

## Mounting The BC-80X0 / C-8000 Cradle

The cradle package contains the following items:

- BC-80X0 / C-8000 Cradle
- BC-80X0 Quick Reference / C-8000 Quick Reference
- BC-8000 Antenna
- 2 wall-mounting lock hinges
- 2 adhesive strips
- 4 rubber feet
- 1 horizontal base
- 1 inclined base

The cradle (either BC-80X0 or C-8000) can be mounted for portable or fixed desktop usage, or it can be fixed to a wall. The horizontal base allows portable and fixed desktop usage, while the inclined base provides desktop and wall mounting guaranteeing a comfortable handling of the PowerScan® M8500 reader.

**Figure 12. BC-80X0/C-8000 Cradle mounted on the Horizontal Base**



**Figure 13. BC-80X0/C-8000 Cradle mounted on the Inclined Base**





## Desktop Mounting

For desktop usage, you can mount the cradle either on the horizontal base, for reduced overall dimensions, or on the inclined base for a more ergonomic removal and insertion of the reader onto the cradle.

**Figure 14. Horizontal base**

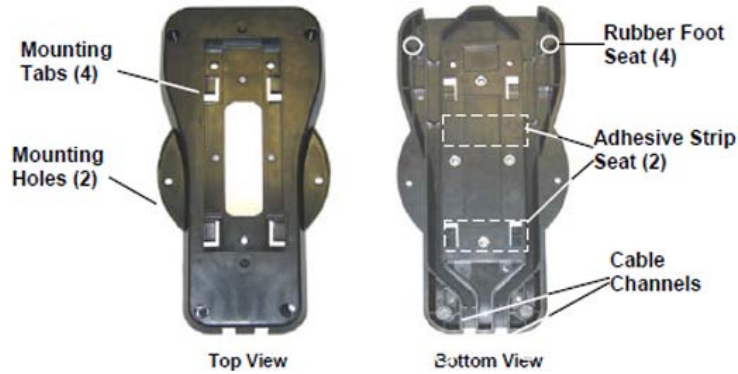

**Figure 15. Inclined base**

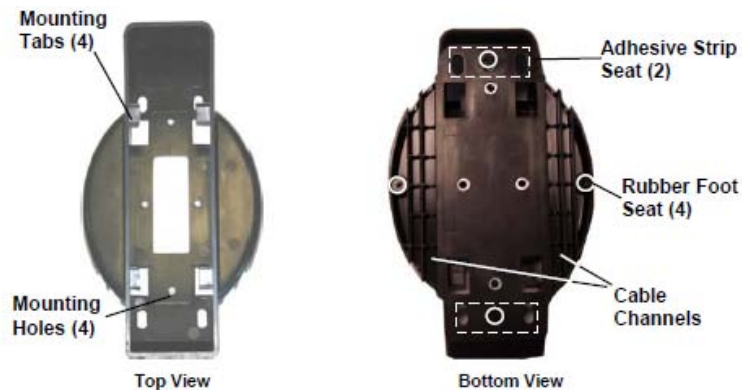

## Portable Desktop Use

1. Correctly position the BC-80X0/C-8000 onto the base by sliding it along the mounting tabs until aligned.



2. Carefully clean the rubber foot seats of the base to remove any impurities that could reduce adhesion.
3. Remove the protective plastic from the rubber feet and stick them onto the bottom surface of the base.
4. If mounting the BC-80X0 cradle, insert the antenna in the appropriate hole on the body of the cradle and screw it clockwise until tight.

## Fixed Desktop Use

For fixed desktop installation, use the adhesive strips or fixing screws (not provided) according to your needs.

### For mounting with adhesive strips:

1. Position the cradle onto the base by sliding it along the mounting tabs until aligned.
2. Carefully clean the adhesive strip seats of the base to remove any impurities that could reduce adhesion.
3. Remove the protective plastic from one side of the adhesive strips and stick them onto the base surface.
4. Position the cables to be connected to the BC-80X0/C-8000 cradle along the dedicated channels, as shown in the figures below:

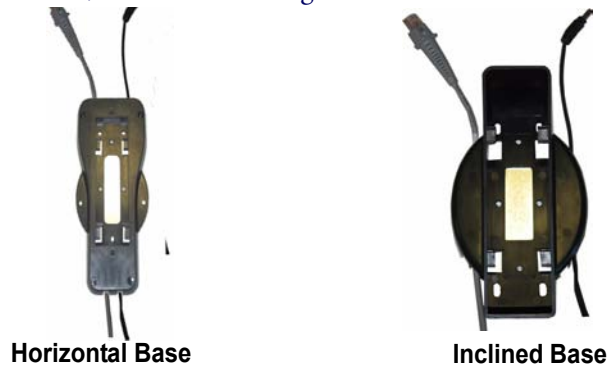

5. Remove the plastic from the other side of the strips and affix the base to the table.
6. If mounting the BC-80X0 cradle, insert the antenna in the appropriate hole on the body of the cradle and screw it clockwise until tight.

### For mounting with screws:

1. Position the cables to be connected to the BC-80X0/C-8000 cradle along the dedicated channels, as shown in the figures below:
2. Position the base on the table and affix it by means of the screws (not provided).
3. Position the cradle on the base by sliding it along the mounting tabs until aligned.
4. If mounting the BC-80X0 cradle, insert the antenna in the appropriate hole on the body of the cradle and screw it clockwise until tight.

## Wall Mounting



1. Remove the yellow caps and insert the two wall mounting lock hinges provided with your cradle.



2. Position the cables to be connected to the BC-80X0/C-8000 cradle along the dedicated channels (see figures on [page 32](#).)
3. Complete the procedure using one of the following two methods:

### **If using the adhesive strips:**

- Carefully clean the adhesive strip seats of the base to remove any impurities that could reduce adhesion.
- Remove the protective plastic from one side of the adhesive strips and stick them onto the base surface.
- Remove the plastic from the other side of the strips and affix the base to the wall as indicated in the figure below.

### **If using the mounting screws:**

- Using the mounting holes on the base as a pattern, mark the wall where you desire to mount the BC-80X0/C-8000.
- Drill the appropriate size holes and insert the threaded dowels (not provided) into the holes.
- Position the base on the wall as indicated in the figure below and affix it by means of the screws (not provided).

**Figure 16. Inclined Base Wall-Mounting**



4. Attach the cradle on the base by sliding it along the mounting tabs until aligned.
5. If mounting the BC-80X0 cradle, insert the antenna in the appropriate hole on the body of the cradle and screw it clockwise until tight.

There are two basic system layouts that can be employed: Stand-alone systems (including Point-to-Point layouts) and Multidrop STAR-System™ Networks.

# System and Network Layouts

## Stand-Alone Layouts

Figure 17. Point-to-Point Reader Layout

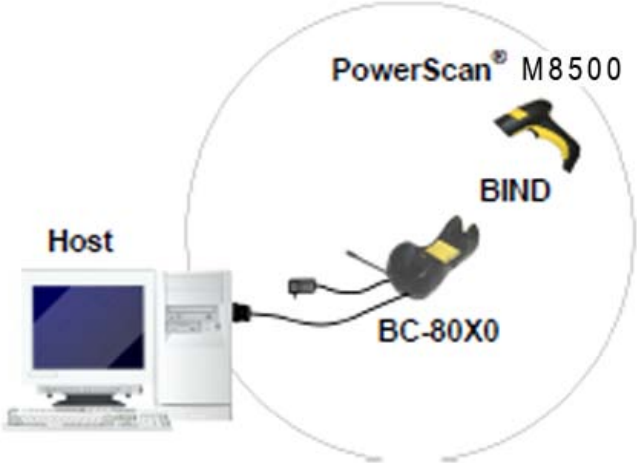

Figure 18. Stand-Alone Layout with Multiple Readers



In stand-alone systems, each cradle is connected to a single Host.

## Multiple Stand-Alone Layouts

Many stand-alone connections can operate in the same physical area without interference, provided all readers and cradles in the system have different addresses.

**Figure 19. Multiple Stand-alone Systems in the Same Area**



Since the cradles can communicate to multiple PowerScan® M8500 readers, you might find it useful to employ one or more C-8000 battery chargers in addition to the BC-80X0 cradle, so that the battery re-charging operation can be performed for several scanners at the same time.

**Figure 20. C-BOX Layout**

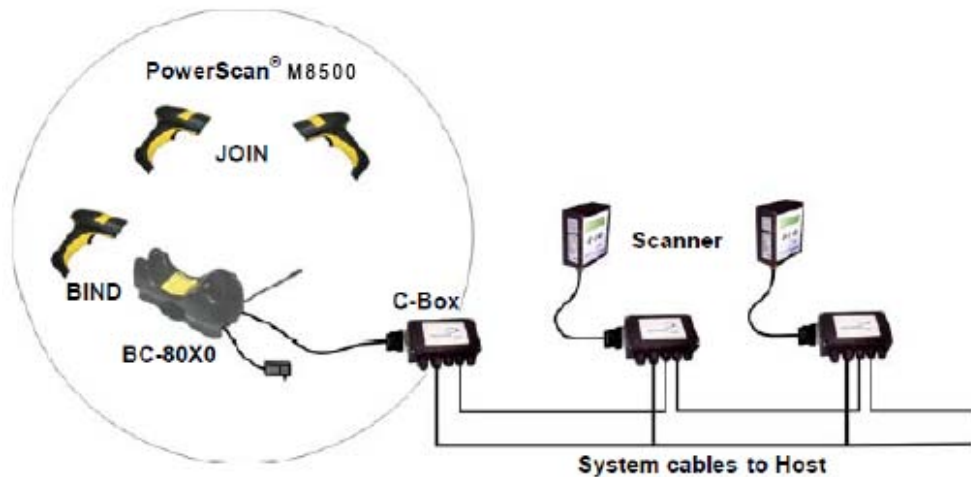

In this layout the BC-80X0 cradle is connected by a dedicated cable using the RS-232 interface to a C-BOX connection box as part of a fixed scanner network. This allows the flexibility of a hand-held reading station integrated into a variety of fixed scanning applications so that all readers (both fixed and hand-held), in the system provide communications to the Host.

The various C-BOX models provide many interface types for the Host system such as RS-232, RS-485, and Profibus.

## Multidrop STAR-System™ Network Layouts

Even though many stand-alone systems can operate in the same physical area without interfering with each other, it may be desirable to bridge data from multiple base stations in a network to a single Host. PowerScan® M8500 readers are compatible with STAR-System™ networks. These networks provide seamless active roaming for any RF reading device in the system.

### Host Master Layout

Figure 21. Example of Multidrop STAR-System™ Network with Host as Master

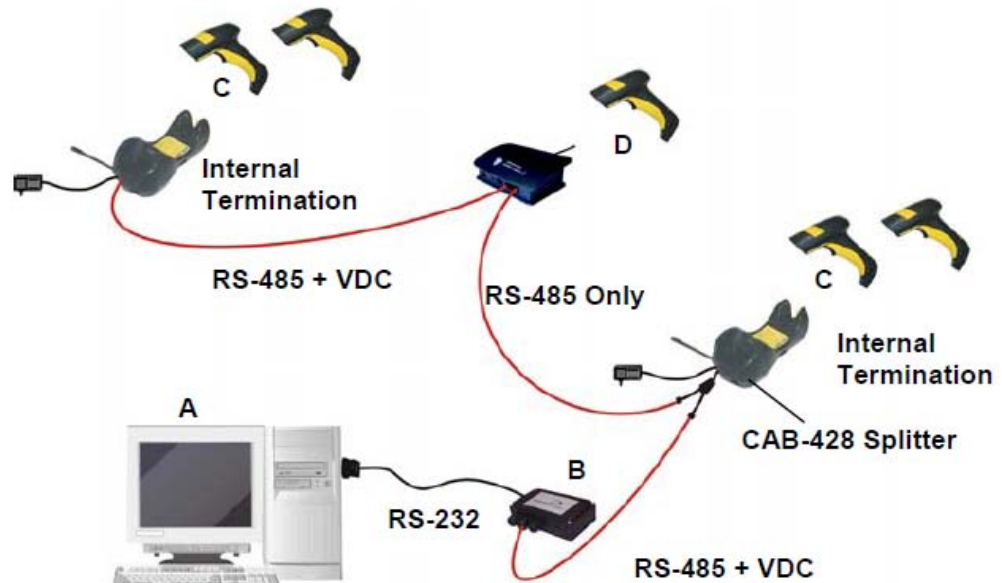

- A. Host Master with STAR-Link™
- B. STAR-Box™ converter
- C. BC-8060 slave cradles
- D. STARGATE™ base stations

In this layout the Host acts as the Master using STAR-Link™ software. The Host is connected in RS-232 to a STAR-Box™ converter, which is connected to the first slave in the RS-485 network. In this way the base stations provide communications between a single Host and all readers in the system. STARGATE™ base stations are used as slaves in this network. The Slaves at the ends of the network must be terminated (reference the STARGATE™ and STAR-Box™ Installation Manuals and "Network Termination" on page 27).

See "PowerScan® M8500/STAR-System™ Setup" on page 43 and "BC-8060 STAR-System™ Network Setup" on page 45, or the Datalogic Aladdin™ Help On-Line, for system configuration specifications.

## BC-8060 Master Layout

Figure 22. Example of Multidrop STAR-System™ Network with BC-8060 as Master

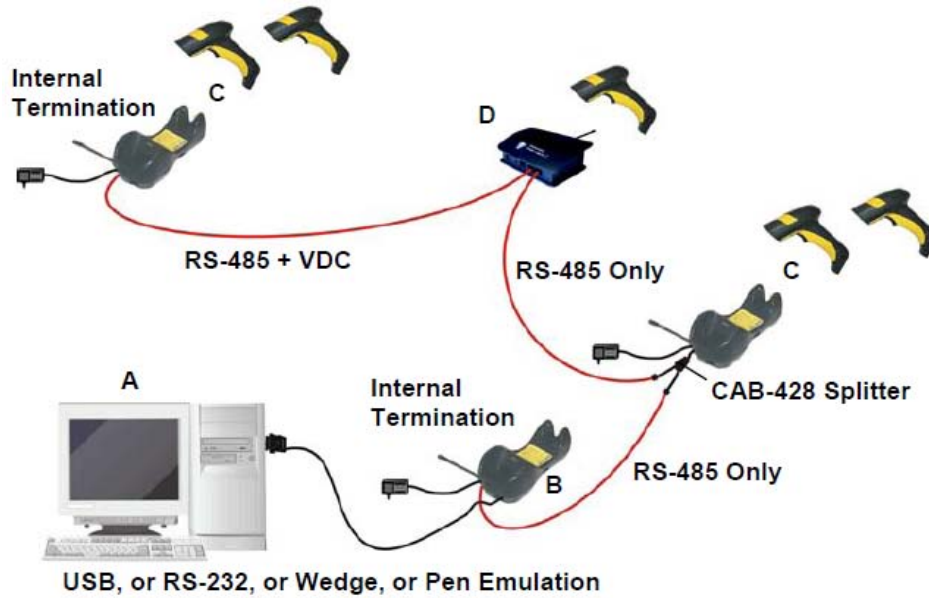

- A. Host
- B. BC-8060 Master cradle
- C. BC-8060 Slave cradles
- D. STARGATE™ base station

In this layout a BC-8060 cradle acts as the Master. The Host is connected to the BC-8060 Master using any one of the multi-standard interfaces (RS-232, USB, WEDGE, or PEN Emulation). The Master is then connected to the slaves in the RS-485 network. In this way the slave cradles provide communications between a single Host and all readers in the system. STARGATE™ base stations can also be used as slaves in this network. The devices at the ends of the network must be terminated (see "Network Termination" on page 27).

See "PowerScan® M8500/STAR-System™ Setup" on page 43 and "BC-8060 STAR-System™ Network Setup" on page 45, or the Datalogic Aladdin™ Help On-Line, for system configuration specifications.

## Master BC-8060 Network Troubleshooting

Two diagnostic strings can be sent via RS-232 from the Host to the Master cradle in order to have feedback about the network itself.

### #+LSlave

Returns a list of all the Slaves recognized at boot up.

**Example:** In a network where the Master cradle has address 0188 and one Slave cradle with address 0001, the response is:

```
188
1
```

### #+Alive<xxxx>

Executes a continuous Alive request to the slave xxxx in order to monitor the performance of the connection. A diagnostic message is displayed on the Host.

**Example:** If this command is sent for slave cradle with address 0032, the response is:

```
/*32: BC-80X0 SOFTWARE RELEASE 1.00 20/10/2006*/
if there are no communication errors
```

```
/*32: FAIL*/
if there are communication errors.
```

To exit from this command, reset the system by cycling power to the Master cradle.



## Setup Procedures

For PowerScan<sup>®</sup> M8500 Series readers, the setup procedures depend on two basic applications, Stand-alone or STAR-System<sup>™</sup>.

Stand-alone applications allow communication with the Host by either the BC-80X0 cradle (page 40), or by the STAR-Modem<sup>™</sup> radio modem (page 42).

STAR-System<sup>™</sup> applications allow communication with the Host through an RS-485 network by the STARGATE<sup>™</sup> RF base station or by the BC-8000 cradle (page 43 and 45).

Proceed as shown in the following diagram:

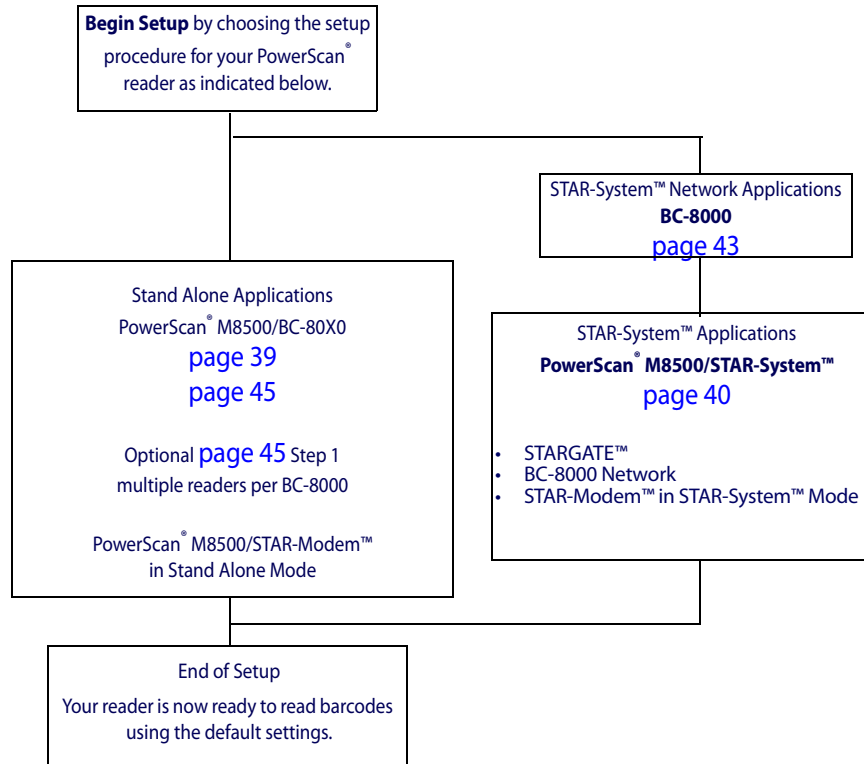

## PowerScan<sup>®</sup> M8500/BC-80X0 Point-to-Point Setup

A rapid configuration procedure has been devised for point-to-point applications where a single reader is associated exclusively with its own BC-80x0 base station and where it is not necessary to set the Date and Time parameters.

A special pre-printed bind-address label provided in the BC-80x0 base station package can be used to bind the PowerScan<sup>®</sup> M8500 reader to the base station with the address coded on the label. The address is also written numerically on the label to be easily recognized. Valid addresses are in the range from 0000 to 1999. Make sure that all cradles used in the same area have different addresses.

To rapidly configure your point-to-point application:

1. Apply the bind-address label onto the BC-80x0 base station as indicated in the BC-80x0 Quick Reference Guide.
2. When the BC-80X0 cradle is connected and powered, read the **Bind-Address** label to pair the PowerScan<sup>®</sup> M8500 to the BC-80X0 cradle.

The green LED on the PowerScan<sup>®</sup> M8500 will blink: the reader is ready to be positioned onto the cradle.

3. Firmly position the reader onto the cradle within 10 seconds, a beep will be emitted, signaling that the BC-80X0 cradle has been paired to the PowerScan® M8500, and the green LED on the reader will go off.



If it ever becomes necessary to change the reader, just read the bind-address label applied to the cradle and position the new reader onto the cradle.

Do not use multiple readers with this configuration method.

4. Configure the BC-80X0 cradle; refer to the "BC-80X0 Quick Reference Guide".

**END of procedure. YOUR READER IS NOW READY TO READ CODES.**

## PowerScan® M8500/BC-80X0 Stand-Alone Setup

Read the restore default parameters code below.

1. Restore PowerScan® M8500 Default



Follow the procedure below to set the radio address and bind PowerScan® M8500 to the BC-80X0 cradle.

2. Enter Configuration

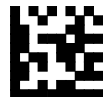

3. Set Date



+

six digits for Day, Month and Year (DDMMYY)

4. Set Time



+

four digits for Hour and Minutes (HHMM)

5. Set Radio Address

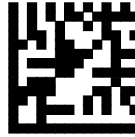

+

four digits for the PowerScan® M8500 Address (from **0000** to **1999**).

**All readers used in the same area must have different addresses.**

6. Exit and Save Configuration



7. Read the **Bind** code to pair the PowerScan® M8500 to the BC-80X0 cradle. The reader is dedicated to the cradle. Any previously **bound** reader will be excluded.

To connect several readers to the same cradle see  
["Using Multiple M-Series Readers with Same Cradle"](#) on page 42

Bind



The green LED on the PowerScan® M8500 will blink; the reader is ready to be inserted into the cradle.

8. Firmly insert the reader into the BC-80X0 cradle within 10 seconds, a beep will be emitted, signaling that the BC-80X0 cradle has been paired to the PowerScan® M8500, and the green LED on the reader will go off.



9. Read the BC-80X0 restore default code:

Restore BC-80X0 Default



Go to ["Interface Selection"](#) on page 47.

## Using Multiple M-Series Readers with Same Cradle

If you want to use several M-Series readers with the same BC-80X0 cradle, you must first Bind the cradle with one of the readers (see previously described configuration procedure).

**Successive readers** can be associated with the same cradle by following the configuration procedure substituting the **Bind** command with **Join** (see [step 7. on page 41](#)).

7. Join



The green LED on the PowerScan® M8500 will blink: the reader is ready to be positioned onto the cradle. **Complete step 8. on page 41.**

**END of procedure.**



**All readers associated with the same cradle must have different addresses.**

**CAUTION**

**YOUR READER IS NOW READY TO READ BARCODES.**

To change the defaults see "[Configuration Parameters](#)" on page 53.

## PowerScan® M8500/STAR-Modem™ in Stand-Alone Mode

To configure a PowerScan® M8500 reader to communicate with STAR-Modem™ in Stand-alone Mode, follow the procedure in "[PowerScan® M8500/BC-80X0 Stand-Alone Setup](#)" on page 40, substituting steps 6 and 7 with those below:

6. STAR-Modem™ Address



Read the code above and the four-digit address of the STAR-Modem™.

7. Exit and Save configuration



**END of procedure.**

**YOUR READER IS NOW READY TO READ BARCODES.**

To change the defaults see "[Configuration Parameters](#)" on page 53.

## PowerScan® M8500/STAR-System™ Setup

The following procedure allows configuring a PowerScan® M8500 reader to communicate with various STAR-System™ devices such as STARGATE™ RF base stations.

1. Restore PowerScan® M8500 Default



2. Enter Configuration

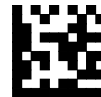

3. Set Date

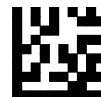

+

six digits for Day, Month and Year (DDMMYY)

4. Set Time



+

four digits for Hour and Minutes (HHMM)

5. Set the connection according to the length of the codes to be read:

Code Length  $\leq$ 240 Characters

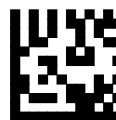

Code Length >240 Characters  
(not for systems with BC-8000 as Master)



6.

Set Radio Address

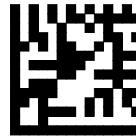

+

four digits from the Numeric Table in the range 0000-1999.

**All readers must have different addresses.**

7.

First STAR-System™ Address



Read the code above and the four-digit address of the First STAR-System™ device in the system.

8.

Set Last STAR-System™ Address



Read the code above and the four-digit address of the Last STAR-System™ device in the system.



**Whenever the system is composed of a single base station, the first and last base station addresses (steps 7 and 8) must have the same value.**

9.

Exit and Save Configuration



**END of procedure.**

**YOUR READER IS NOW READY TO READ BARCODES.**

To change the defaults see "[Configuration Parameters](#)" on page 53.

## BC-8060 STAR-System™ Network Setup

When the BC-8060 cradle model is used in an RS-485 network, it must be initially configured. To do this using configuration barcodes, follow the procedure below using any PowerScan® M8500 reader.

1. Set BC-8060 Address



+

four digits for the BC-8060 Address (from **0000** to **1999**).

All cradles used in the network must have different addresses.

2. Exit and Save configuration

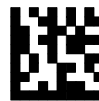

3. Read the **Bind** code to pair the PowerScan® M8500 to the BC-8060 cradle for configuration.

Bind



The green LED on the PowerScan® M8500 will blink; the reader is ready to be inserted into the cradle.

4. Firmly insert the reader into the BC-8060 cradle within 10 seconds, a beep will be emitted, signaling that the BC-8060 cradle has been paired to the PowerScan® M8500, and the green LED on the reader will go off.



5. Read the BC-8060 restore default code:

Restore BC-8060 Default

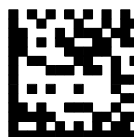

6. Read the desired Enable Network code.

Enable RS-485 Master

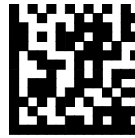

Enable RS-485 Slave



**END of procedure.**

For Host Master Network Layouts (see page 37), the network configuration parameters can be changed through STAR-Link™ software running on the PC. Star-Link™ software can be downloaded free from the web site: [www.scanning.datalogic.com](http://www.scanning.datalogic.com).

For BC-8060 Master Network Layouts (see page 38), the network configuration parameters can be changed either through the Datalogic Aladdin™ configuration software running on the PC or by reading the barcode selections in the Network section of this manual starting on page 79. If using configuration barcodes, it is advised to completely configure the cradles before reconfiguring the PowerScan® M8500 reader (see below).



**After completing the BC-8060 cradle configuration and connections in the network, you must reconfigure the PowerScan® M8500 reader using the STAR-System™ procedure on page 43.**



---

# Interface Selection

Read the interface selection code for your application.

## RS-232

Standard

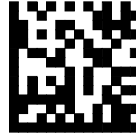

## POS TERMINALS

Nixdorf Mode A



Fujitsu

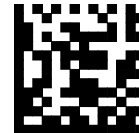

ICL Mode



For POS terminal default settings refer to [page 174](#).

## PEN



## WEDGE

IBM AT or PS/2 PCs



IBM XT



PC Notebook



IBM SURE1

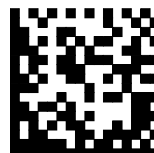

IBM Terminal 3153



### **IBM TERMINALS 31XX, 32XX, 34XX, 37XX:**

To select the interface for these IBM Terminals, read the correct KEY TRANSMISSION code. Select the KEYBOARD TYPE if necessary (default = advanced keyboard).

## KEY TRANSMISSION MODE

make-only keyboard

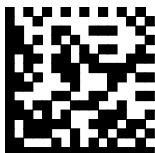

make-break keyboard

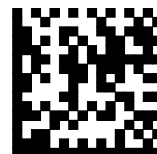

## WEDGE (continued)

### KEYBOARD TYPE

◆ advanced keyboard



typewriter keyboard

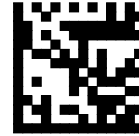

### ALT MODE

The ALT-mode selection allows barcodes sent to the PC to be interpreted correctly independently from the Keyboard Nationality used. You do not need to make a Keyboard Nationality selection. (Default=NumLock Unchanged).

**Make sure the NumLock key on your keyboard is ON.**

IBM AT - ALT mode



PC Notebook - ALT mode

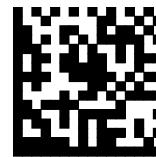

### WYSE TERMINALS

ANSI Keyboard

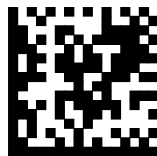

PC Keyboard



ASCII Keyboard



VT220 style Keyboard



## DIGITAL TERMINALS

VT2xx/VT3xx/VT4xx



### USB Configuration

The USB interface is available for BC-80x0 and C-8000 devices and is compatible with the following Operating Systems:

Windows 98 (and later)  
Mac OS 8.0 (and later)

IBM POS for Windows  
4690 Operating System

### USB Start-up

As with all USB devices, upon connection, the Host performs several checks by communicating with the device. During this phase normal operations are suspended. Two basic conditions must be met before the device is ready, **the correct USB driver must be loaded** and **sufficient power must be supplied to the reader**.

1. For all systems, the correct USB driver for the default USB-KBD interface is included in the Host Operating System and will either be loaded automatically or will be suggested by the O.S. and should therefore be selected from the dialog box (the first time only).

Normally the Host supplies sufficient power to the device and the start-up phase ends correctly. (The reader's LED stops blinking and the reader emits the beep OK signal).

In rare cases, if the Host does not supply sufficient power to the device, a dialog box will appear on the Host and the device will be blocked (the reader's LED continues blinking). In this case, disconnect the USB device cable at the Host (the reader's LED stops blinking), and then try a different USB port as indicated by the Operating System message. (The device emits the beep OK signal. You can now read codes).

2. At this point you can read the USB interface configuration code according to your application. Load drivers from the O.S. (if requested). When configuring the USB-COM interface, the relevant files and drivers must be installed from the USB Device Installation software, which can be downloaded from the web page <http://www.scanning.datalogic.com>.

The device is ready. Successive start-ups will automatically recognize the previously loaded drivers.

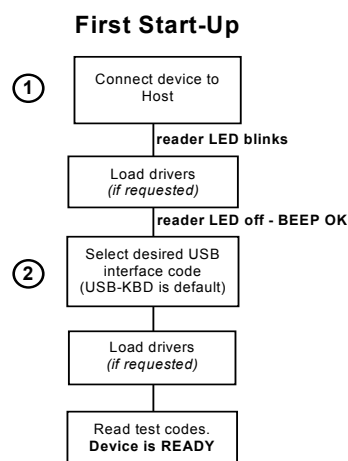

---

## USB Parameters

USB-KBD

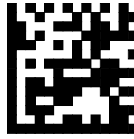

USB-KBD-ALT-MODE

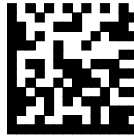

USB-KBD-APPLE

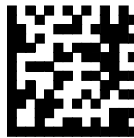

USB-COM\*

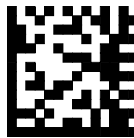

USB-IBM-Table Top



USB-IBM-Hand Held

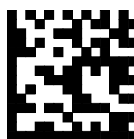

\* When configuring USB-COM, the relevant files and drivers must be installed from the USB Device Installation software, which can be downloaded from the web site <http://www.scanning.datalogic.com>.

# NOTES

# Chapter 3

## Configuration Using Code Symbols

This section provides programming barcodes to configure your reader by changing the default settings. For details about additional methods of programming, see ["Configuration Methods" on page 19](#).



**You must first enable your reader to read barcodes in order to use this section. If you have not done this, go to [Setup Procedures](#), starting on [page 39](#) and complete the appropriate procedure.**

### Configuration Parameters

Once the reader is set up, you can change the default parameters to meet your application needs. Refer to ["Default Settings" on page 189](#) for initial configuration in order to set the default values and select the interface for your application.

The configuration parameters are divided into logical groups, making it easy to find the desired function based on its reference group.

The first four groups are for Standard Interface parameter configuration for all PowerScan M8500/BC-80X0 Stand-alone configurations only.

- ["RS-232 PARAMETERS" on page 55](#)
- ["USB PARAMETERS" on page 60](#)
- ["WEDGE PARAMETERS" on page 67](#)
- ["PEN EMULATION" on page 74](#)

This group of parameters is applicable only to BC-8060 Network configurations:

- ["NETWORK PARAMETERS" on page 79](#)

The following parameter groups are common to all interface applications:

- ["DATA FORMAT" on page 84](#) parameters control the messages sent to the Host system.
- ["CAMERA CONTROL" on page 102](#) covers the control mode managing the camera.
- ["AIMING SYSTEM" on page 103](#) allows you to enable or disable the Aiming System.
- ["CODE SELECTION" on page 104](#) parameters allow configuration of a personalized mix of codes, code families and their options.
- ["READING PARAMETERS" on page 117](#) control various operating modes and indicators status functioning.
- ["RADIO PARAMETERS" on page 124](#) allow configuration of radio control parameters.
- ["DISPLAY and KEYPAD PARAMETERS" on page 130](#) (some M8500 series models only) allow configuration of reader display parameters.

## Reading Configuration Barcodes



You must first enable your reader to read barcodes in order to use this section. If you have not done this, go to [Setup Procedures](#), starting on page 39 and complete the appropriate procedure.

### To configure your reader:

1. Read the instructions for the setting that you want to configure.
1. If needed, go to [Appendix F](#) with the hex-numeric table and bookmark it or print it so you can use it during the device configuration.
2. Read the **Enter Configuration** code **ONCE**, available at the top of each page of configuration.
3. Modify the desired parameters in one or more sections, following the procedures given for each group.
4. Read the **Exit and Save Configuration** code **ONCE**, available at the top of each page of configuration.

Reference notes providing detailed information for the more complex parameters are given in "[References](#)" beginning on page 155.



## RS-232 PARAMETERS

PowerScan<sup>®</sup> M8500/BC-80X0 configurations only

Baud Rate <i>on page 56</i>
Parity <i>on page 56</i>
Data Bits <i>on page 57</i>
Stop Bits <i>on page 57</i>
Handshaking <i>on page 57</i>
ACK/NACK Protocol <i>on page 58</i>
FIFO <i>on page 58</i>
Inter-character Delay <i>on page 58</i>

1. Read the **Enter Configuration** code **ONCE**, available at the top of each page.
2. Read configuration codes from the desired groups.



= Read the code and follow the procedure given



= Default value

3. Read the **Exit and Save Configuration** code **ONCE**, available at the top of each programming page.

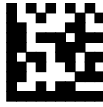

# RS-232 PARAMETERS



## Baud Rate

300 baud



1200 baud



4800 baud



19200 baud



600 baud

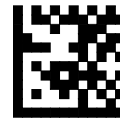

2400 baud

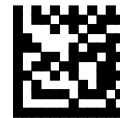

◆ 9600 baud

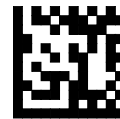

38400 baud



## Parity

◆ none



odd parity

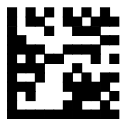

even parity





# RS-232 PARAMETERS

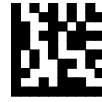

## Data Bits

7 bits



◆ 8 bits



9 bits



## Stop Bits

◆ 1 stop bit

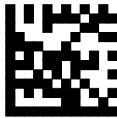

2 stop bits



## Handshaking

◆ disable



hardware (RTS/CTS)

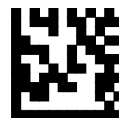

software (XON/XOFF)



RTS always ON



See "Handshaking" on page 155 for details.

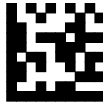

## RS-232 PARAMETERS



### ACK/NACK Protocol

◆ disable

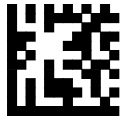

enable



See "ACK/NACK Protocol" on page 156 for details on implementing this parameter with PowerScan® M8500.

### FIFO

disable

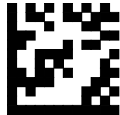

◆ enable

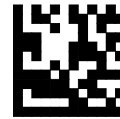

See "FIFO" on page 156 for more information.

### Inter-character Delay

delay between characters transmitted to Host



**Read 2 numbers from the Hex & Numeric Table where:**

00 = DELAY disabled

01-99 = DELAY from 1 to 99 milliseconds

◆ delay disabled

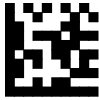

## RS-232 PARAMETERS

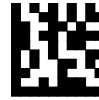

### RX Timeout

timeout control in reception from Host



**Read 2 numbers from the Hex & Numeric Table where:**

00 = TIMEOUT disabled

01-99 = TIMEOUT from **.1** to **9.9** seconds

◆ rx timeout 5 seconds

See "RX Timeout" on page 157 for details.

### Serial Trigger Lock

◆ disabled



enable and select characters



**Read 2 characters from the Hex & Numeric Table in the range 00-FE where:**

- First Character enables device trigger
- Second Character inhibits device trigger until the first character is received again.

## USB PARAMETERS

<b>USB-COM</b>
Handshaking <i>on page 61</i>
ACK/NACK Protocol <i>on page 61</i>
FIFO <i>on page 61</i>
Inter-character Delay <i>on page 62</i>
RX Timeout <i>on page 62</i>
Serial Trigger Lock <i>on page 63</i>
<b>USB-KBD</b>
Keyboard Nationality <i>on page 64</i>
FIFO <i>on page 65</i>
Inter-character Delay <i>on page 66</i>
Inter-code Delay <i>on page 66</i>
USB Keyboard Speed <i>on page 66</i>
<b>USB-IBM</b>
No parameter selection required.

1. Read the **Enter Configuration** code **ONCE**, available at the top of each page.
2. Read configuration codes from the desired groups.



= Read the code and follow the procedure given



= Default value

3. Read the **Exit and Save Configuration** code **ONCE**, available at the top of each programming page.

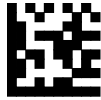

## USB PARAMETERS

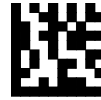

### USB-COM

#### Handshaking

◆ disable



hardware (RTS/CTS)



software (XON/XOFF)

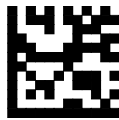

RTS always ON



See "Handshaking" on page 155 for details.

#### ACK/NACK Protocol

◆ disable



enable



See "ACK/NACK Protocol" on page 156 for details on implementing this parameter with PowerScan® M8500.

#### FIFO

disable



◆ enable



See "FIFO" on page 156 for more information.

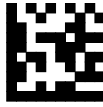

## USB PARAMETERS



### USB-COM (cont)

#### Inter-character Delay

delay between characters transmitted to Host



**Read 2 numbers from the Hex & Numeric Table where:**

00 = DELAY disabled

01-99 = DELAY from 1 to 99 milliseconds

◆ delay disabled

#### RX Timeout

timeout control in reception from Host



**Read 2 numbers from the Hex & Numeric Table where:**

00 = TIMEOUT disabled

01-99 = TIMEOUT from .1 to 9.9 seconds

◆ rx timeout 5 seconds

See "RX Timeout" on page 157 for details.



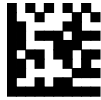

## USB PARAMETERS



---

### USB-COM (cont)

### Serial Trigger Lock

◆ disabled



enable and select characters



**Read 2 characters from the Hex & Numeric Table in the range 00-FE where:**

- First Character enables device trigger
- Second Character inhibits device trigger until the first character is received again.

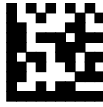

# USB PARAMETERS



## USB-KBD

### Keyboard Nationality

Not Available for USB-KBD-ALT-MODE Interface.

This parameter default value is restored through the Interface Selection code and not Restore Default.

Belgian

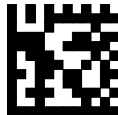

English (UK)

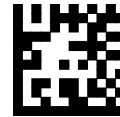

French



German

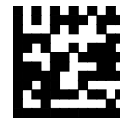

Italian

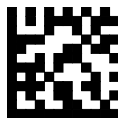

Spanish

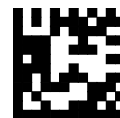

Swedish

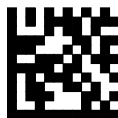

◆ USA





# USB PARAMETERS



## USB-KBD (cont)

The Japanese and Eastern Block Keyboard Nationality selections are valid only for IBM AT compatible PCs.

Japanese

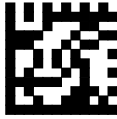

Russian (Latin)

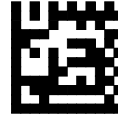

Russian (Cyrillic)



Hungarian



Slovenian, Croatian, Serbian (Latin)



Romanian



Czech Republic



## FIFO

disable



◆ enable



See "FIFO" on page 156 for details.

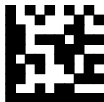

# USB PARAMETERS



## USB-KBD (cont)

### Inter-character Delay

delay between characters transmitted to Host



**Read 2 numbers from the Hex & Numeric Table where:**

00 = DELAY disabled

01-99 = DELAY from 1 to 99 milliseconds

◆ delay disabled

### Inter-code Delay

delay between codes transmitted to Host



**Read 2 numbers from the Hex & Numeric Table where:**

00 = DELAY disabled

01-99 = DELAY from 1 to 99 milliseconds

◆ delay disabled

### USB Keyboard Speed

◆ Normal



Fast



# WEDGE PARAMETERS

PowerScan<sup>®</sup> M8500/BC-80X0 configurations only

Keyboard Nationality <i>on page 68</i>
Caps Lock <i>on page 69</i>
Caps Lock Auto-Recognition (IBM AT compatible only) <i>on page 70</i>
Num Lock <i>on page 70</i>
Inter-character Delay <i>on page 70</i>
Inter-code Delay <i>on page 71</i>
Keyboard Setting <i>on page 71</i>
Control Character Emulation <i>on page 73</i>

1. Read the **Enter Configuration** code **ONCE**, available at the top of each page.
2. Read configuration codes from the desired groups.



= Read the code and follow the procedure given



= Default value

3. Read the **Exit and Save Configuration** code **ONCE**, available at the top of each programming page.

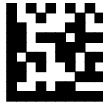

## WEDGE PARAMETERS



---

### Keyboard Nationality

Belgian

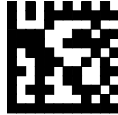

French

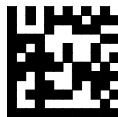

Italian

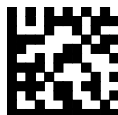

Swedish

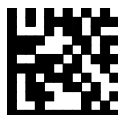

English (UK)

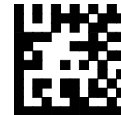

German

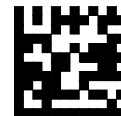

Spanish



◆ USA

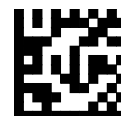

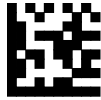

## WEDGE PARAMETERS



The Japanese and Eastern Block Keyboard Nationality selections are valid only for IBM AT compatible PCs.

Japanese

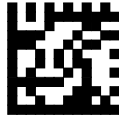

Russian (Latin)

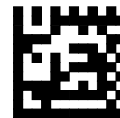

Russian (Cyrillic)



Hungarian

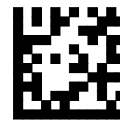

Slovenian, Croatian, Serbian  
(Latin)



Romanian

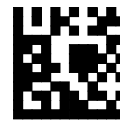

Czech Republic



## Caps Lock

◆ caps lock OFF



caps lock ON



Select the appropriate code to match your keyboard caps lock status.



**Caps lock manual configuration is ignored when Caps Lock Auto-Recognition is enabled.**

**For PC Notebook interface selections, the caps lock status is automatically recognized; therefore this command is not necessary.**

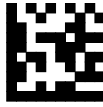

## WEDGE PARAMETERS



### Caps Lock Auto-Recognition (IBM AT compatible only)

disable



◆ enable



### Num Lock

toggle num lock



◆ num lock unchanged



This selection is used together with the Alt Mode interface selection for AT or Notebook PCs.

It changes the way the Alt Mode procedure is executed; therefore it should be set as follows:

- if your keyboard Num Lock is **normally on** use num lock unchanged
- if your keyboard Num Lock is **normally off** use toggle num lock

In this way the device will execute the Alt Mode procedure correctly for your application.

### Inter-character Delay

delay between characters transmitted to Host



**Read 2 numbers from the Hex & Numeric Table where:**

00 = DELAY disabled

01-99 = DELAY from 1 to 99 milliseconds

◆ delay disabled



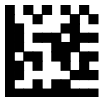

## WEDGE PARAMETERS



### Inter-code Delay

delay between codes transmitted to Host



**Read 2 numbers from the Hex & Numeric Table where:**

00 = DELAY disabled

01-99 = DELAY from 1 to 99 milliseconds

◆ delay disabled

### Keyboard Setting

#### Alphanumeric Keyboard Setting

The device (reader or cradle) can be used with terminals or PCs with various keyboard types and nationalities through a simple keyboard setting procedure.

The type of computer or terminal must be selected before activating the keyboard setting command.

Keyboard setting consists of communicating to the device how to send data corresponding to the keyboard used in the application. The keys must be set in a specific order.

Press and release a key to set it.

Some characters may require more than one key pressed simultaneously during normal use (refer to the manual of your PC or terminal for keyboard use). The exact sequence must be indicated to the reader in this case pressing and releasing the different keys.

#### Example:

If one has to press the "Shift" and "4" keys simultaneously on the keyboard to transmit the character "\$" to the video, to set the "\$", press and release "Shift" then press and release "4".

**Each pressed and released key must generate an acoustic signal on the device; otherwise repress the key. Never press more than one key at the same time, even if this corresponds to the normal use of your keyboard.**

**Press "Backspace" to correct a wrong key entry. In this case the device emits 2 beeps.**



**"CAPS LOCK" and "NUM LOCK" must be off before starting the keyboard setting procedure. "SHIFT" must be pressed for each character and cannot be substituted by "CAPS LOCK".**

setting the alphanumeric keyboard



Read the code above.

Press the keys shown in the following table according to their numerical order.

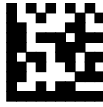

## WEDGE PARAMETERS



Some ASCII characters may be missing as this depends on the type of keyboard: these are generally particular characters relative to the various national symbologies. In this case:

- **The first 4 characters (Shift, Alt, Ctrl, and Backspace) can only be substituted with keys not used, or substituted with each other.**
- Characters can be substituted with other single symbols (e.g. "SPACE") even if not included in the barcode set used.
- Characters can be substituted with others corresponding to your keyboard.

**The device signals the end of the procedure with 2 beeps indicating the keys have been registered.**

01 : Shift		
02 : Alt		
03 : Ctrl		
04 : Backspace		
05 : SPACE	28 : 7	51 : N
06 : !	29 : 8	52 : O
07 : "	30 : 9	53 : P
08 : #	31 : :	54 : Q
09 : \$	32 : ;	55 : R
10 : %	33 : <	56 : S
11 : &	34 : =	57 : T
12 : '	35 : >	58 : U
13 : (	36 : ?	59 : V
14 : )	37 : @	60 : W
15 : *	38 : A	61 : X
16 : +	39 : B	62 : Y
17 : ,	40 : C	63 : Z
18 : -	41 : D	64 : [
19 : .	42 : E	65 : \
20 : /	43 : F	66 : ]
21 : 0	44 : G	67 : ^
22 : 1	45 : H	68 : _ (underscore)
23 : 2	46 : I	69 : `
24 : 3	47 : J	70 : {
25 : 4	48 : K	71 :
26 : 5	49 : L	72 : }
27 : 6	50 : M	73 : ~
		74 : DEL



### CAUTION

**Do not place the reader onto the BC-80X0 cradle during this procedure. Otherwise, the battery charging will occur, modifying the LED's functioning.**

Enter Reader Configuration



## WEDGE PARAMETERS

Exit and Save Reader Configuration

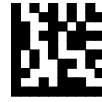

---

### Control Character Emulation

◆ Ctrl + Shift + Key



Ctrl + Key

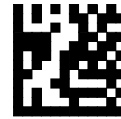

# PEN EMULATION

PowerScan® M8500/BC-80X0 configurations only

Operating Mode <i>on page 75</i>
Minimum Output Pulse <i>on page 76</i>
Conversion to Code 39 <i>on page 76</i>
Overflow <i>on page 77</i>
Output Level <i>on page 77</i>
Idle Level <i>on page 78</i>
Inter-Block Delay <i>on page 78</i>

1. Read the **Enter Configuration** code **ONCE**, available at the top of each page.
2. Read configuration codes from the desired groups.



= Read the code and follow the procedure given



= Default value

3. Read the **Exit and Save Configuration** code **ONCE**, available at the top of each programming page.

---

## Operating Mode



The operating mode parameters are complete commands and do not require reading the Enter and Exit configuration codes.

◆ interpret mode



Interprets commands without sending them to the decoder.

transparent mode



Sends commands to the decoder without interpreting them.

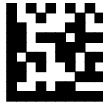

# PEN EMULATION



## Minimum Output Pulse

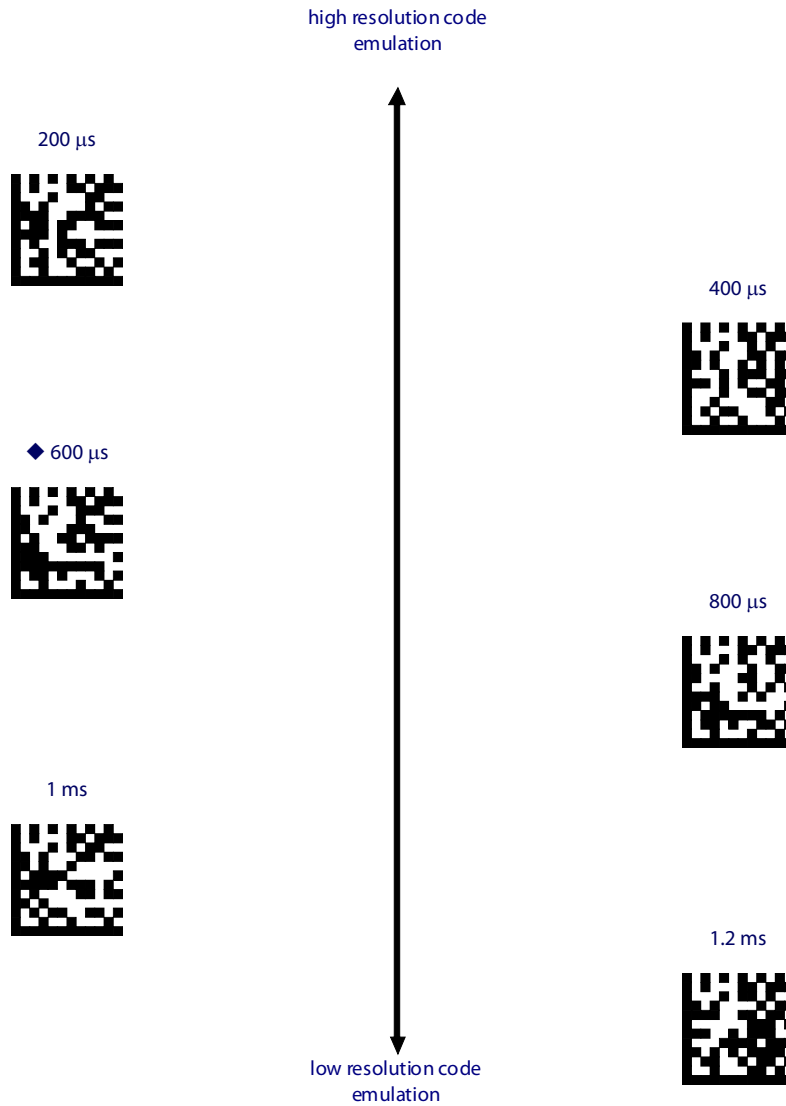

See "Minimum Output Pulse" on page 157 for details.

## Conversion to Code 39

◆ disable conversion to Code 39



Transmits codes in their original format.

◆ enable conversion to Code 39



Converts codes read into Code 39 format.

See "Conversion to Code 39 and Code 128" on page 157 for details.

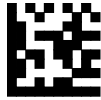

## PEN EMULATION

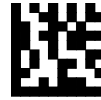

### Conversion to Code 128

enable conversion to Code 128

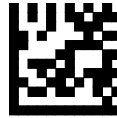

Converts codes read into Code 128 format.

See ["Conversion to Code 39 and Code 128" on page 157](#) for details.

### Overflow

narrow



◆ medium

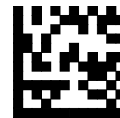

wide



See ["Overflow" on page 157](#) for details.

### Output Level

◆ normal



(white = logic level 0)

inverted



(white = logic level 1)

See ["Output and Idle Levels" on page 158](#) for details.



# PEN EMULATION



## Idle Level

◆ normal

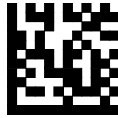

(black level)

inverted



(white level)

See ["Output and Idle Levels"](#) on page 158 for details.

## Inter-Block Delay

delay between character blocks transmitted to Host



**Read 2 numbers from the Hex & Numeric Table where:**

00 = DELAY disabled

01-99 = DELAY from .1 to 9.9 seconds

◆ delay disabled

See ["Inter-Block Delay"](#) on page 158 for details.



# NETWORK PARAMETERS

BC-8060 model configurations only

RS-485 Network <i>on page 80</i>
Network Baud Rate <i>on page 80</i>
Slave Address Range <i>on page 81</i>
Network Warning Message <i>on page 81</i>
Reception Warning Message <i>on page 81</i>
Master Cradle Header <i>on page 82</i>
Master Cradle Terminator <i>on page 83</i>

1. Read the **Enter Configuration** code **ONCE**, available at the top of each page.
2. Read configuration codes from the desired groups.



= Read the code and follow the procedure given



= Default value

3. Read the **Exit and Save Configuration** code **ONCE**, available at the top of each programming page.

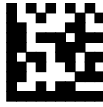

## NETWORK PARAMETERS



### RS-485 Network

◆ disable RS-485 network

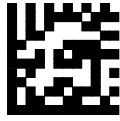

enable RS-485 slave



enable RS-485 master

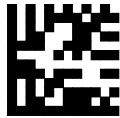

See "[Multidrop STAR-System™ Network Layouts](#)" on page 37 for details.



**If a BC-8060 cradle is errantly configured as a Slave but not connected to a network, it may not be able to receive further commands from the reader. In this case it can be reconfigured by executing the BIND procedure, which returns the cradle to Stand-alone configuration.**

### Network Baud Rate

9600



19200



◆ 38400



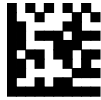

## NETWORK PARAMETERS



### Slave Address Range

First Address

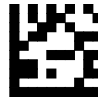

Read the code above and the four-digit address of the First Slave device in the system.

Last Address

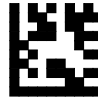

Read the code above and the four-digit address of the Last Slave device in the system.

See "[Slave Address Range First/Last](#)" on page 158 for details.

### Network Warning Message

◆ network warning message  
not transmitted

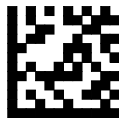

network warning message  
transmitted



See "[Network Warning Message](#)" on page 159 for details.

### Reception Warning Message

reception warning message not  
transmitted



◆ reception warning  
message transmitted



See "[Reception Warning Message](#)" on page 159 for details.

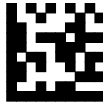

## NETWORK PARAMETERS



### Master Cradle Header

◆ no header

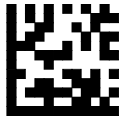

one character header

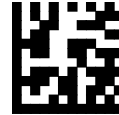

two character header

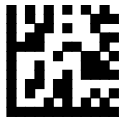

three character header

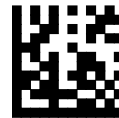

four character header



five character header



six character header



seven character header



eight character header



After selecting **one** of the desired Header codes, read the character(s) from the HEX table.

Valid characters are in the range: **00-FE**

Example:

four character header

Read



+ 41 + 42 + 43 + 44 = Header **ABCD**

For more details about default and WEDGE Interface Extended Keyboard values, see "Master Header/Terminator Selection" and "Header/Terminator Selection" on page 160, and "Define Special Key Sequence" on page 161.

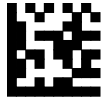

## NETWORK PARAMETERS

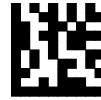

### Master Cradle Terminator

◆ no terminator

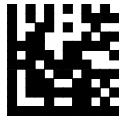

one character terminator



two character terminator



three character terminator



four character terminator



five character terminator



six character terminator



seven character terminator



eight character terminator



After selecting **one** of the desired Terminator codes, read the character(s) from the HEX table.

Valid characters are in the range: **00-FE**

Example:

Read  + **0D + 0A** = Terminator **CR LF**

For more details about default and WEDGE Interface Extended Keyboard values, see "[Master Header/Terminator Selection](#)" and "[Header/Terminator Selection](#)" on page 160, and "[Define Special Key Sequence](#)" on page 161.

# DATA FORMAT

NOT FOR PEN INTERFACES

<b>Symbology Independent Parameters</b>
Code Identifier <i>on page 85</i>
Custom Code Identifier <i>on page 86</i>
Header <i>on page 89</i>
Terminator <i>on page 90</i>
Code Length Tx <i>on page 91</i>
Address Stamping <i>on page 91</i>
Address Delimiter <i>on page 92</i>
Time Stamping <i>on page 92</i>
Time Stamping Delimiter <i>on page 93</i>

1. Read the **Enter Configuration** code **ONCE**, available at the top of each page.
2. Read configuration codes from the desired groups.



= Read the code and follow the procedure given



= Default value

3. Read the **Exit and Save Configuration** code **ONCE**, available at the top of each programming page.

Enter Reader Configuration



Exit and Save Reader Configuration



## DATA FORMAT

---

### Code Identifier

◆ disable



Datalogic standard



AIM standard

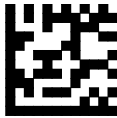

custom



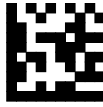

# DATA FORMAT



## Custom Code Identifier

The following procedure sets a new Code Identifier for a specific barcode symbology:

1. Read the Enter Reader Configuration code at the top of the page.
2. Read one of the following codes that corresponds to the required barcode symbology.
3. Define 1 or 2 identifying characters for each code type. If only 1 identifying character is required, the second character must be selected as FF (disabled). Read the hexadecimal value corresponding to the character(s) you want to define as identifiers for the symbology selected in step 2: valid characters are in the range 00-FD.



**Example:** To define Code 39 Code Identifier = @

	Valid characters are in the range:	<b>00-FD</b>
	Code 39	
<b>Read</b>		+ 40 + FF = @



EAN/UPC

CODABAR



CODE 128



CODE EAN 128

CODE 93

CODE 39

2/5 INTERLEAVED





# DATA FORMAT

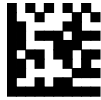

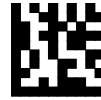
## Custom Code Identifier — continued

CODE 32

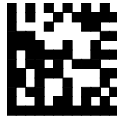

PDF 417

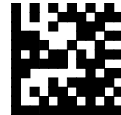

MICRO PDF 417

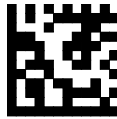

MAXICODE



DATAMATRIX

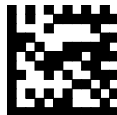

QR CODE



MICRO QR

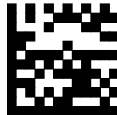

AZTEC



AUSTRALIAN POSTAL



INTELLIGENT MAIL  
BARCODE

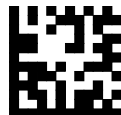

JAPAN POSTAL

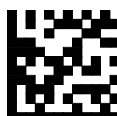

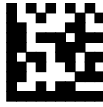

## DATA FORMAT



---

### Custom Code Identifier — continued



POSTNET POSTAL



RM4SCC POSTAL

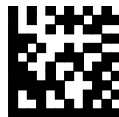

PLANET POSTAL



KIX POSTAL



GS1 DATABAR





# DATA FORMAT



## Header

no header



one character header



two character header



three character header



four character header

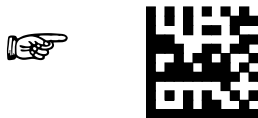

five character header



six character header



seven character header



eight character header



After selecting **one** of the desired Header codes, read the character(s) from the HEX table. Valid characters are in the range 00-FE. For Wedge and USB-KBD interfaces, it is also possible to read the Special Key(s) described on page "[Define Special Key Sequence](#)" on page 161.

Example:

Valid characters are in the range:

**00-FE**

four character header

**Read**



**+ 41 + 42 + 43 + 44 = Header ABCD**

For more details see "[Header/Terminator Selection](#)" on page 160 and "[Define Special Key Sequence](#)" on page 161.

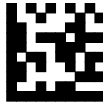

## DATA FORMAT



### Terminator

no terminator

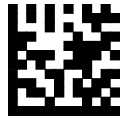

one character terminator



two character terminator



three character terminator



four character terminator



five character terminator



six character terminator



seven character terminator



eight character terminator



After selecting one of the desired Terminator codes, read the character(s) from the HEX table. Valid characters are in the range 00-FE. For Wedge and USB-KBD interfaces, it is also possible to read the Special Key(s). See ["Define Special Key Sequence" on page 161](#) for more information.

Example:

Valid characters are in the range:

**00-FE**

two character terminator

**Read**



+ **0D + 0A**

= Terminator **CRLF**

For more details see ["Header/Terminator Selection" on page 160](#) and ["Define Special Key Sequence" on page 161](#)



## DATA FORMAT

### Code Length Tx

- ◆ code length not transmitted



- code length transmitted in variable-digit format



- code length transmitted in fixed 4-digit format

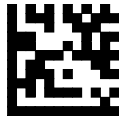

The code length is transmitted in the message after the Headers and Code Identifier characters. The code length is calculated after performing any field adjustment operations.

### Address Stamping

- ◆ disable reader address stamping

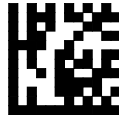

- ◆ disable cradle address stamping



- enable reader address stamping



- enable cradle address stamping



See ["Address Stamping" on page 168](#) for details.

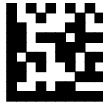

# DATA FORMAT



## Address Delimiter

◆ disable reader address delimiter

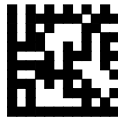

◆ disable cradle address delimiter



enable reader address delimiter and select characters

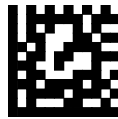

enable cradle address delimiter and select characters



Read 2 HEX characters in the range **00-FE**



Read 2 HEX characters in the range **00-FE**

See "Address Delimiter" on page 168 for details.

## Time Stamping

◆ disable



hour/minutes/seconds  
month/day/year



hour/minutes/seconds  
day/month/year



hour/minutes/seconds



month/day/year

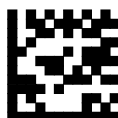

day/month/year



See "Time Stamping Format" on page 168 for details.

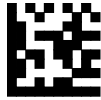

## DATA FORMAT



---

### Time Stamping Delimiter

◆ disable

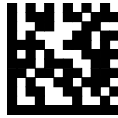

select delimiter



Read 2 HEX characters in the range **00-FE**.

See ["Time Stamping Delimiter" on page 168](#) for details.

## Symbology Dependent Parameters

<b>Symbology Dependent Parameters</b>
Symbology Specific Format <i>on page 95</i>
Symbology Headers <i>on page 95</i>
Headers <i>on page 96</i>
Symbology Terminators <i>on page 96</i>
Terminators <i>on page 96</i>
Symbology Character Substitution <i>on page 97</i>
Character Substitution <i>on page 97</i>
Symbology Character Deletion <i>on page 97</i>
Character Deletion <i>on page 98</i>
Symbology Specific Format Default <i>on page 98</i>
Define Concatenation <i>on page 99</i>
Concatenation Enable/Disable <i>on page 99</i>
Concatenation Length <i>on page 99</i>
Concatenation with Intercode Delay <i>on page 100</i>
Concatenation Failure Transmission <i>on page 100</i>
Concatenation Timeout <i>on page 100</i>
Transmission After Timeout <i>on page 101</i>
Concatenation Result Code ID <i>on page 101</i>

The “Symbology Specific Format Default” code on [page 98](#) allows you to restore the default values for symbology dependent parameters related to a specific code family.



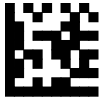

## DATA FORMAT



### Symbology Specific Format

Symbology Specific Format



1. Select a Datalogic Standard Code Identifier from the Code Identifier Table in [Appendix D](#).
2. Formatting:
  - 0 = select all - Stop
  - 1 = select right - followed by Step 3
  - 2 = select left - followed by Step 3
  - 3 = select middle - followed by a number in the range 000-999 for the starting character and then, by [Step 3](#)
  - 4 = discard right - followed by [Step 3](#)
  - 5 = discard left - followed by [Step 3](#)
  - 6 = discard middle - followed by a number in the range 000-999 for the starting character and then, by [Step 3](#)
3. Set the number of characters to select/discard in the range 000-999.

### Symbology Headers

Symbology Headers



1. Select a Datalogic Standard Code Identifier from the Code Identifier Table in [Appendix D](#).
2. Set the number of characters in the range 0-5.
3. Read the corresponding characters as Hex values from the Hex/Numeric table. Valid values are in the range:
  - 00-7F for RS-232, USB BULK, USB COM, USB Generic HID
  - 00-9B for Wedge and USB Keyboard
4. Read the following code to enable the configuration you have set.

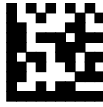

## DATA FORMAT



### Headers

Headers



1. Select a Datalogic Standard Code Identifier from the Code Identifier Table in [Appendix D](#).
2. 0 = disabled  
1 = enabled

### Symbology Terminators

Symbology Terminators



1. Select a Datalogic Standard Code Identifier from the Code Identifier Table in [Appendix D](#).
2. Set the number of characters in the range 0-5.
3. Read the corresponding characters as Hex values from the Hex/Numeric table. Valid values are in the range:
  - 00-7F for RS-232, USB BULK, USB COM, USB Generic HID
  - 00-9B for Wedge and USB Keyboard
4. Read the following code to enable the configuration you have set.

### Terminators

Terminators



1. Select a Datalogic Standard Code Identifier from the Code Identifier Table in [Appendix D](#).
2. 0 = disabled  
1 = enabled

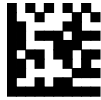

## DATA FORMAT



### Symbology Character Substitution

Symbology Character Substitution



1. Select a Datalogic Standard Code Identifier from the Code Identifier Table in [Appendix D](#).
2. Read the corresponding character as Hex value from the Hex/Numeric table which identifies the character to be substituted. Valid value is in the range 00-7F.
3. Read the corresponding character as Hex value from the Hex/Numeric table which identifies the new substituting character. Valid value is in the range 00-7F.
4. Read the following code to enable the configuration you have set.

### Character Substitution

Character Substitution



1. Select a Datalogic Standard Code Identifier from the Code Identifier Table in [Appendix D](#).
2. 0 = disabled  
1 = enabled

### Symbology Character Deletion

Symbology Character Deletion



1. Select a Datalogic Standard Code Identifier from the Code Identifier Table in [Appendix D](#).
2. Read the corresponding character as Hex value from the Hex/Numeric table which identifies the character to be deleted. Valid value is in the range **00-7F**.
3. Read the following code to enable the configuration you have set.

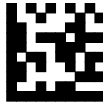

## DATA FORMAT



---

### Character Deletion

Character Deletion



1. Select a Datalogic Standard Code Identifier from the Code Identifier Table in [Appendix D](#).
2. 0 = disabled  
1 = enabled

### Symbology Specific Format Default

Symbology Specific Format Default



Select a Datalogic Standard Code Identifier from the Code Identifier Table in [Appendix D](#).

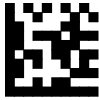

## DATA FORMAT

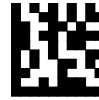

### Concatenation

#### Define Concatenation

Define Concatenation



1. Select the number of codes to concatenate in the range 2-4.
2. Select the Datalogic Standard Code Identifier for each code to concatenate (repeat for same code types) from the table in [Appendix D](#).
3. Read the following code to enable the configuration you have set.

#### Concatenation Enable/Disable

Disabled



Enabled



### Concatenation Length

#### First Concatenated Code Length

Set First Concatenated Code Length



Read the number in the range 000-255.  
000 = any code length

#### Second Concatenated Code Length

Set Second Concatenated Code Length



Read the number in the range 000-255.  
000 = any code length

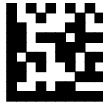

## DATA FORMAT



### Third Concatenated Code Length

Set Third Concatenated Code Length



Read the number in the range **000-255**.  
**000** = any code length

### Fourth Concatenated Code Length

Set Fourth Concatenated Code Length



Read the number in the range **000-255**.  
**000** = any code length

### Concatenation with Intercode Delay

Disabled



Enabled



This parameter is enabled with concatenation activated (see "[Concatenation](#)" on page 22 for details).

### Concatenation Failure Transmission

TX Codes Causing Failure



No Code TX



See "[Concatenation](#)" on page 22 for details.

### Concatenation Timeout

Concatenation Timeout



05-99 = timeout from 5 to 99 seconds.

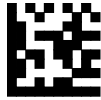

## DATA FORMAT



---

### Transmission After Timeout

No Code Transmission



First Code Transmission



Second Code Transmission



Third Code Transmission



### Concatenation Result Code ID

No Code Identifier



Use First Code Identifier



Use Second Code Identifier



Use Third Code Identifier



Use Fourth Code Identifier



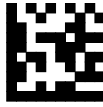

## CAMERA CONTROL



---

# CAMERA CONTROL

## Exposure Mode

Automatic  
(Entire Image)



Automatic (Central Part of Image)



Automatic for Highly  
Reflective Surfaces



See "[Camera Control](#)" on page 20 for details.



Enter Reader Configuration

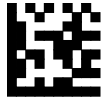

## AIMING SYSTEM

Exit and Save Reader Configuration

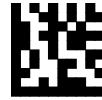

## AIMING SYSTEM

See "Aiming System" on page 18 for more information.

disable Aiming System

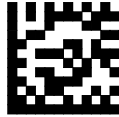

enable Aiming System



## Good Read Spot

A green Good-Read Spot will be projected in the field of view when the reading is successful.

disabled

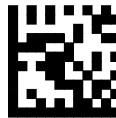

enable short

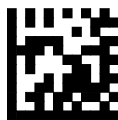

enable medium



enable long



enable continuous



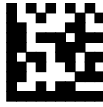

## CODE SELECTION



---

## CODE SELECTION

Disable All Symbologies



Disable All Linear Symbologies



Disable All 2D Symbologies



## Issue Identical Codes

This parameter manages the code transmission when more than one code containing the same information is detected in a single scan.

All identical codes are transmitted to the Host when the parameter is enabled; if disabled, only one of the identical codes is sent.

Disabled



Enabled



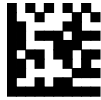

# CODE SELECTION

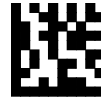

## Linear Symbologies

Linear Symbologies
UPC/EAN/JAN Family <i>on page 105</i>
Code 39 Family <i>on page 106</i>
Code 32 Family <i>on page 107</i>
Interleaved 2 of 5 Family <i>on page 107</i>
Codabar Family <i>on page 108</i>
Code 128 Family <i>on page 109</i>
Code 93 Family <i>on page 110</i>
GS1 Databar™ Family <i>on page 111</i>

## UPC/EAN/JAN Family

EAN/UPC/JAN Disabled



EAN/UPC/JAN Enabled



Add-On Disabled



Add-On Enabled



UPCE Expansion Disabled



UPCE Expansion Enabled





# CODE SELECTION



## Code 39 Family

Code 39 Std - Disabled



Code 39 Std - No Check Digit Control



Code 39 Std - Check Digit Control  
without Transmission



Code 39 Std - Check Digit Control  
and Transmission



Code 39 Full ASCII - Disabled



Code 39 Full ASCII - Enabled



Code Length Check - Disabled



Code Length Check - Enabled



Minimum Code Length



Read the number in the range  
**001-255.**

Maximum Code Length



Read the number in the range  
**001-255.**

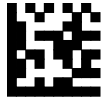

# CODE SELECTION

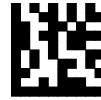

## Code 39 Family (continued)

Start-Stop Character Transmission - Disabled



Start-Stop Character Transmission - Enabled



## Code 32 Family

Disabled



Enabled



## Interleaved 2 of 5 Family

Disabled



Enabled - No Check Digit Control



Enabled - Check Digit Control and without Transmission



Enabled - Check Digit Control and Transmission



Code Length Check - Disabled



Code Length Check - Enabled



Minimum Code Length



Read the number in the range **001-255**.

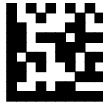

# CODE SELECTION



## Interleaved 2 of 5 Family (continued)

Maximum Code Length



Read the number in the range  
**001-255.**

## Codabar Family

Disabled



Enabled - No Check Digit Control



Enabled - Check Digit Control  
without Transmission



Enabled - Check Digit Control and  
Transmission



Code Length Check - Disabled



Code Length Check - Enabled



Minimum Code Length



Read the number in the range  
**001-255.**

Maximum Code Length



Read the number in the range  
**001-255.**

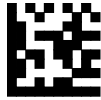

# CODE SELECTION

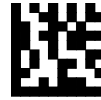

## Code 128 Family

Code 128 - Disabled



Code 128 - Enabled



Code Length Check - Disabled



Code Length Check - Enabled



Code 128 - Min. Code Length



Read the number in the range  
**001-255.**

Code 128 - Max. Code Length



Read the number in the range  
**001-255.**

EAN 128 - Disabled



EAN 128 - Enabled



EAN 128 - Code Length Check Disabled



EAN 128 - Code Length Check Enabled



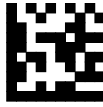

# CODE SELECTION



## Code 128 Family (continued)

EAN 128 - Min. Code Length



Read the number in the range  
**001-255.**

Maximum Code Length



Read the number in the range  
**001-255.**

## Code 93 Family

Disabled



Enabled



Code Length Check - Disabled



Code Length Check - Enabled



Minimum Code Length



Read the number in the range  
**001-255.**

Maximum Code Length



Read the number in the range  
**001-255.**



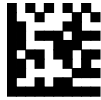

## CODE SELECTION

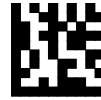

---

### GS1 Databar™ Family

Disable GS1 DataBar Expanded



Enable GS1 DataBar Expanded



Disable GS1 DataBar Limited



Enable GS1 DataBar Limited



Disable GS1 DataBar  
Omnidirectional



Enable GS1 DataBar Omnidirectional



Disable GS1 DataBar Expanded  
Stacked



Enable GS1 DataBar Expanded  
Stacked



Disable GS1 DataBar Stacked



Enable GS1 DataBar Stacked

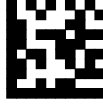

**CODE SELECTION****2D Symbologies**

<b>2D Symbologies</b>
PDF417 <i>on page 112</i>
Micro PDF417 <i>on page 113</i>
DataMatrix Family <i>on page 113</i>
QR Family <i>on page 113</i>
Postal Codes Family <i>on page 114</i>
Australian Table Selection <i>on page 115</i>
Maxicode Family <i>on page 115</i>
Aztec <i>on page 116</i>
Composite Codes <i>on page 116</i>

**PDF417**

Disabled



Enabled



Macro PDF417 Unbuffered Mode



Macro PDF417 Buffered Mode



The following command carries out its specific function and does not require reading the Enter or Exit and Save Configuration codes.

Abort Macro PDF417 Buffered Mode



It stops buffering the read codes at any time. All the buffered codes will not be saved.

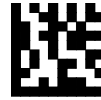
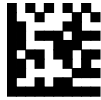

## CODE SELECTION

### Micro PDF417

Disabled



Enabled



### DataMatrix Family

Disabled



Enabled



Minimum Code Length



Read the number in the range  
**0001-3600.**

Maximum Code Length



Read the number in the range  
**0001-3600.**

Rectangular Style – Disabled



Rectangular Style - Enabled



### QR Family

Disabled



Enabled



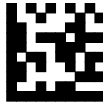

# CODE SELECTION



## Micro QR

Disabled

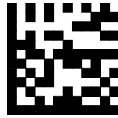

Enabled



## Postal Codes Family

All Disabled



Australian Post - Enabled



Japan Post - Enabled



PLANET - Enabled



POSTNET - Enabled



POSTNET with B and B' - Enabled



POSTNET and PLANET - Enabled



POSTNET with B and B' and PLANET - Enabled



KIX Code - Enabled



Royal Mail Code (RM4SCC) - Enabled



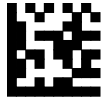

# CODE SELECTION

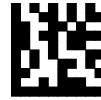

## Australian Table Selection

N Table



C Table



## Intelligent Mail Barcode

Disabled



Enabled

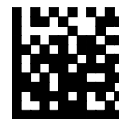

## Maxicode Family

Maxicode Mode 0 - Disabled



Maxicode Mode 0 Enabled



Maxicode Mode 1 - Disabled



Maxicode Mode 1 - Enabled



Maxicode Mode 2 - Disabled



Maxicode Mode 2 - Enabled



Maxicode Mode 3 - Disabled



Maxicode Mode 3 - Enabled



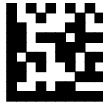

# CODE SELECTION



## Maxicode Family (continued)

Maxicode Mode 4 - Disabled



Maxicode Mode 4 - Enabled



Maxicode Mode 5 - Disabled



Maxicode Mode 5 - Enabled



Maxicode Mode 6 - Disabled



Maxicode Mode 6 - Enabled



## Aztec

Disabled



Enabled



## Composite Codes



**Before enabling this symbology, it is necessary to enable the linear barcode family (among GS1 DATABAR, EAN128 or UPC/EAN) contained in the composite code to be read.**

Disabled



Enabled



Keep Linear Part



Discard Linear Part



## READING PARAMETERS

Trigger Mode <i>on page 118</i>
Trigger Type <i>on page 118</i>
Flash Mode <i>on page 118</i>
Beeper Tone <i>on page 118</i>
Beeper Volume <i>on page 119</i>
Beeper Duration <i>on page 119</i>
Reads per Cycle <i>on page 119</i>
Scan Timeout <i>on page 119</i>
<b>User Defined Beeper</b>
User Defined Beeper Tone <i>on page 120</i>
User Defined Beeper Volume <i>on page 120</i>
User Defined Beeper Duration <i>on page 120</i>
Test User Defined Beeper <i>on page 120</i>
<b>Code Ordering and Selection</b>
Codes per Scan <i>on page 121</i>
Central Code Transmission <i>on page 121</i>
Order By Code Length <i>on page 121</i>
Order By Code Symbology <i>on page 121</i>
<b>AutoScan</b>
Autoscan Mode <i>on page 122</i>
Autoscan Aiming System <i>on page 122</i>
Autoscan Hardware Trigger <i>on page 122</i>
Autoscan Illumination System <i>on page 122</i>
Safety Time <i>on page 123</i>
Safety Time Duration <i>on page 123</i>

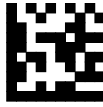

# READING PARAMETERS



## Trigger Mode

Trigger Level



Trigger Pulse



## Trigger Type

Normal Trigger



Software Trigger



## Flash Mode

Flash ON Duration



Read a number in the range **01-99**, which corresponds to a max 9.9 seconds duration.

Flash OFF Duration

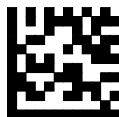

Read a number in the range **01-99**, which corresponds to a max 9.9 seconds duration.

## Beeper Tone

Tone 1



Tone 2



Tone 3



Tone 4





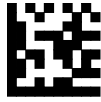

## READING PARAMETERS

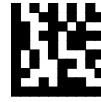

### Beeper Volume

Beeper OFF



Low Volume



Medium Volume



High Volume



### Beeper Duration

Beeper Duration



Read a number in the range **01-99**, which corresponds to a max 99 ms duration.

### Reads per Cycle

One Read per Cycle



Multiple Reads per Cycle



### Scan Timeout

Define Timeout



Read a number in the range **01-99**, which corresponds to a max 99 seconds duration. The timeout is activated when the decoding fails.

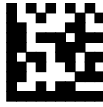

## READING PARAMETERS



### User Defined Beeper

In addition to the standard configuration settings for good/wrong reading and indicating errors, the PowerScan® M8500 basic software program can also manage the beeper (User Defined Beeper) when the reader is controlled by a Host PC. The beeper can be activated by a command from the Host to the reader via the current communication interface.

#### User Defined Beeper Tone

Tone 1



Tone 2



Tone 3



Tone 4



#### User Defined Beeper Volume

Beeper OFF



Low Volume



Medium Volume



High Volume



#### User Defined Beeper Duration

Set Duration



Read a number in the range  
**01-99**, which corresponds to a  
max 990 ms duration.

#### Test User Defined Beeper

The following command carries out its specific function and does not require reading the Enter or Exit and Save Configuration codes.

Test User Defined Beeper



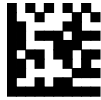

## READING PARAMETERS



### Code Ordering and Selection

#### Codes per Scan

One Code per Scan



All Codes per Scan



#### Central Code Transmission

The following command is available when working in "one code per scan".

Disabled



Enabled



See ["Defining Data Formatting" on page 21](#) for details.

#### Order By Code Length

The following command is available when working in "all codes per scan".

Disabled



Enabled - Increasing Order



Enabled - Decreasing Order



#### Order By Code Symbology

The following command is available when working in "all codes per scan".

Set Order



1. Select the number of codes in the range **0-9**.
2. Select the Datalogic Standard Code Identifier for each above defined code from the table in [Appendix D](#).

See ["Defining Data Formatting" on page 21](#) for details.

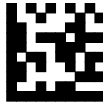

## READING PARAMETERS



### Autoscan

#### Autoscan Mode

Disabled



Enabled in Normal Mode



Enabled in Pattern Mode



See "Autoscanning" on page 20 for details.

#### Autoscan Aiming System

Disabled



Enabled



#### Autoscan Hardware Trigger

Disabled



Enabled



#### Autoscan Illumination System

Disabled



Enabled



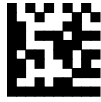

## READING PARAMETERS



The following commands can be activated only when One Code per Scan is enabled.

### Safety Time

Disabled



Enabled



Valid only with software trigger or autoscan enabled.

See "Safety Time" on page 169 for details.

### Safety Time Duration

Set Duration



Read a number in the range **01-99**, where 01 corresponds to 100 ms and 99 to 9.9 seconds.

# RADIO PARAMETERS

PowerScan® M8500 Series readers only

Radio Protocol Timeout <i>on page 125</i>
Radio RX Timeout <i>on page 125</i>
Power-Off Timeout <i>on page 126</i>
Transmission Mode <i>on page 126</i>
Beeper Control for Radio Response <i>on page 127</i>
Single Store <i>on page 128</i>
Batch Mode <i>on page 129</i>
Find Me <i>on page 129</i>

1. Read the **Enter Configuration** code **ONCE**, available at the top of each page.
2. Read configuration codes from the desired groups.



= Read the code and follow the procedure given



= Default value

3. Read the **Exit and Save Configuration** code **ONCE**, available at the top of each programming page.

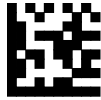

## RADIO PARAMETERS



### Radio Protocol Timeout

radio protocol timeout



Read a number from the table where:  
02-19 =timeout from 2 to 19 seconds  
◆ 2 seconds

See "Radio Protocol Timeout" on page 170 for details.

### Radio RX Timeout

radio RX timeout

◆ disable

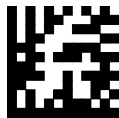

always on



specify timeout

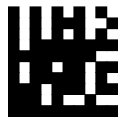

Read 2 numbers in the range 05-99:  
05-99 = Radio RX timeout range from 05 to 99 seconds.



**This functionality is available only for stand-alone layout.**

See "Radio RX Timeout" on page 170 for details.

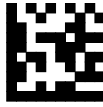

## RADIO PARAMETERS



### Power-Off Timeout

Power-off timeout



Read 2 numbers in the range 00-99:  
00 = Power-off disabled; reader always ready  
01-99 = corresponds to a max. 99 hour delay before power-off.

◆ power-off after 4 hours.

See "[Power-Off Timeout](#)" on page 170 for details.

### Reader Shut-Down



The following label is a complete command and does not require reading of the Enter and Exit configuration codes.



### Transmission Mode

◆ One Way



Two-ways



See "[Transmission Mode](#)" on page 171 for details.





## RADIO PARAMETERS



---

### Beeper Control for Radio Response

◆ normal

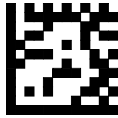

only good decode



only good reception

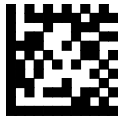

off

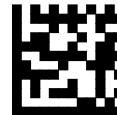

See "[Beeper Control for Radio Response](#)" on page 171 for details.

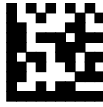

# RADIO PARAMETERS



## Single Store

◆ disable

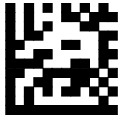

one attempt



two attempts

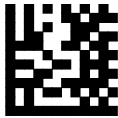

three attempts



four attempts



five attempts



six attempts



seven attempts



eight attempts

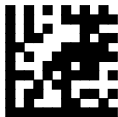

nine attempts



See "Single Store" on page 171 for details.

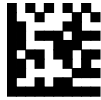

## RADIO PARAMETERS

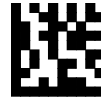

### Batch Mode

◆ disable batch

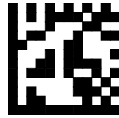

enable normal batch



enable automatic batch

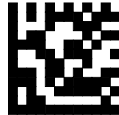

See "Batch Mode" on page 172 for details.



The following batch management parameters are complete commands and do not require reading the Enter and Exit configuration codes.

start normal batch transmission



delete batch data



### Find Me

disable



◆ enable



See "Find Me" on page 172 for details.

## DISPLAY AND KEYPAD PARAMETERS

<b>Display Parameters</b>
Date and Time <i>on page 131</i>
Contrast <i>on page 131</i>
Font Size <i>on page 131</i>
Backlight <i>on page 132</i>
Display-Off Timeout <i>on page 132</i>
Display Mode <i>on page 132</i>
<b>Keypad Parameters</b>
Keypad <i>on page 133</i>

1. Read the **Enter Configuration** code **ONCE**, available at the top of each page.
2. Read configuration codes from the desired groups.



= Read the code and follow the procedure given



= Default value

3. Read the **Exit and Save Configuration** code **ONCE**, available at the top of each programming page.

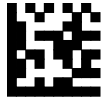

# DISPLAY and KEYPAD PARAMETERS

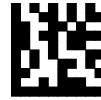

## DISPLAY PARAMETERS

### Date and Time

set date



set time

Read 6 numbers for DDMMYY



Read 4 numbers for HHMM

### Contrast

lighter

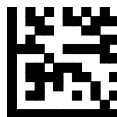

darker



Read the code until the desired contrast is reached.

### Font Size

◆ small

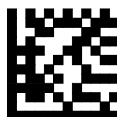

medium

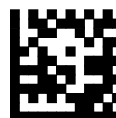

large



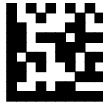

## DISPLAY and KEYPAD PARAMETERS



### Backlight

◆ backlight off

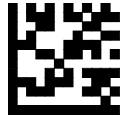

backlight on



### Display-Off Timeout

timeout



Read 2 numbers in the range 00-99:  
00 = disables display timeout (always on)  
01 to 99 = timeout from 1 to 99 seconds.

◆ display-off after 8 seconds.

◆ delay disabled

### Display Mode

normal



◆ local echo



clear display after decode



See "Display Mode" on page 173 for details.



## DISPLAY and KEYPAD PARAMETERS

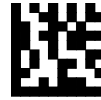

---

### KEYPAD PARAMETERS

#### Keypad

disable 3-key keypad

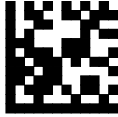

◆ enable 3-key keypad and select characters



Read 3 HEX characters in the range **00-FE**, corresponding to the left, center and right keys respectively.

**FF** = KeyID disabled

◆ left = '<'  
center = '='  
right = '>'

See "[PowerScan M8500 Keypad](#)" on page 178 for details.

# NOTES



# Chapter 4

## Advanced Data Formatting

Advanced data format has been designed to offer you complete flexibility in changing the format of barcode data before transmitting it to the host system. Advanced Formatting Parameters allow code concatenation and advanced formatting of messages towards the Host. It cannot be used with Pen Emulation connections.

Up to 5 advanced code management formats can be defined by completing the four given procedures following the desired order:

- "Format Definition"
- "Mismatch Result"
- "Format Enable/Disable"
- "Match Conditions"

The formats defined will be restored to default values when reading the general "Restore Default" code given in "PowerScan® M8500/BC-80X0 Stand-Alone Setup" on page 40.

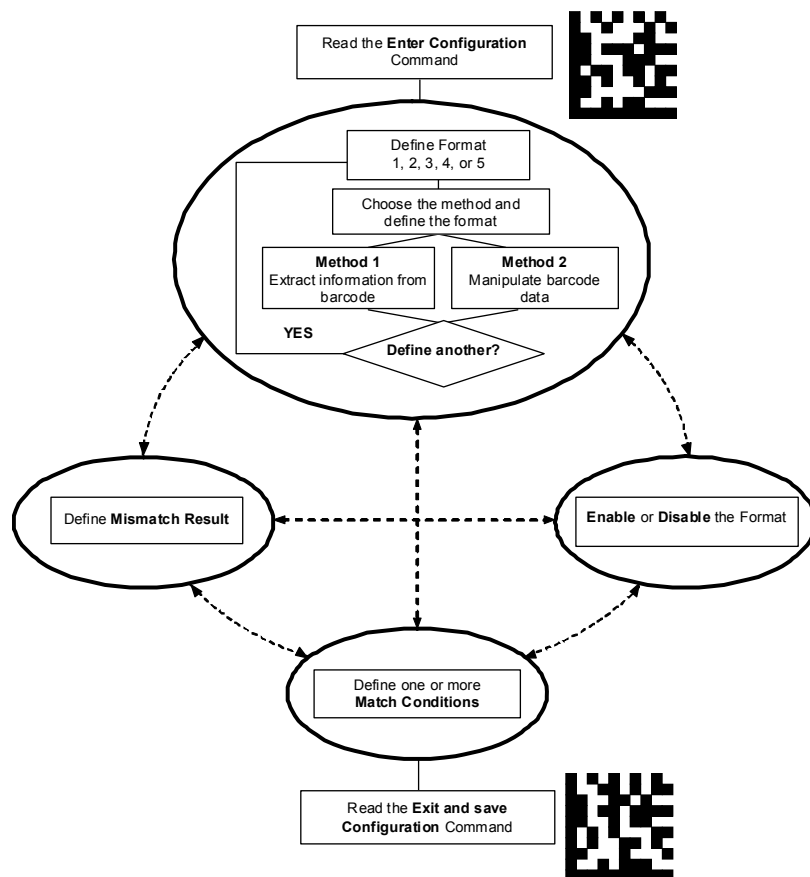

# Format Definition

<b>STEP 1</b>	<b>FORMAT DEFINITION</b>
---------------	--------------------------

Define Format 1



Define Format 2



Define Format 3



Define Format 4



Define Format 5



**STEP 2****FORMAT DEFINITION****Method 1 - Extracting Information from Barcode**

Method 1 allows extracting one or more fields by position or by characters from the decoded barcode. These fields are sent to the host computer as data of the output message, while the characters not included in the formatting procedure will be deleted and not inserted in the output message.

These two kinds of extraction (by position / by character) can be used together within the same format definition; furthermore, it is possible to complete the new format by adding a new string of characters. Since there is no fixed rule, the procedures can be freely put in order and repeated according to your requirement.

The only limit is determined by the size of the internal reserved memory used to define the format.

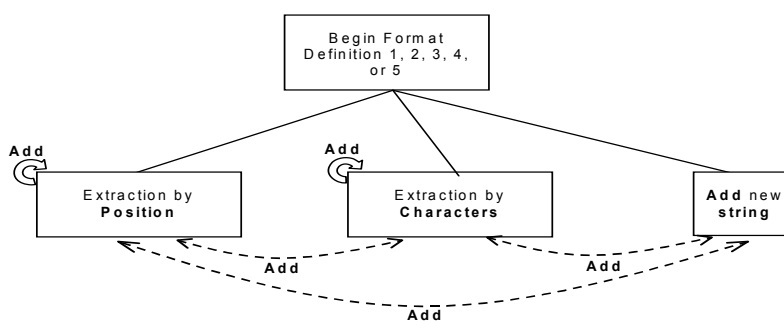

**Example Method 1 Extracting Information from Barcode**

**Decoded code:** <DATALOGICproduct>

**Formatting procedure:** Add new string + Extract field by position + Add new string + Extract field by character + Add new string

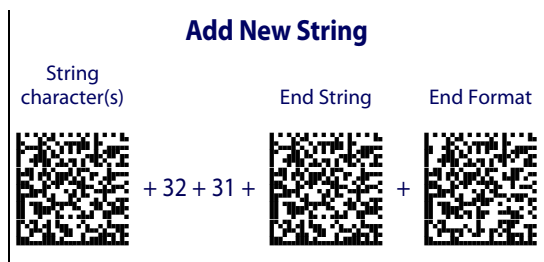
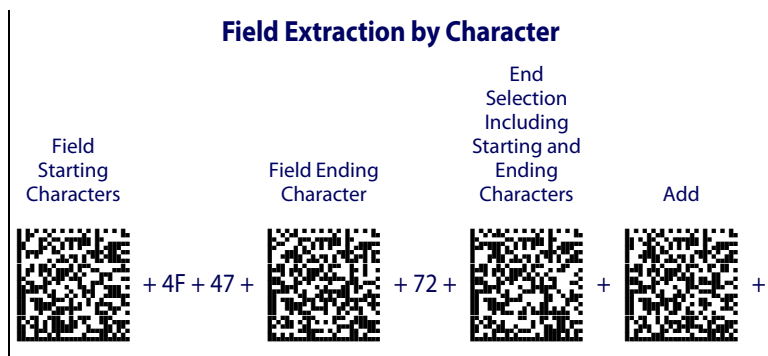
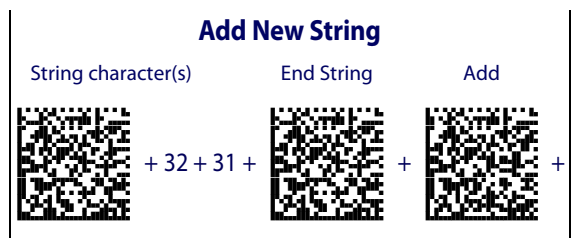
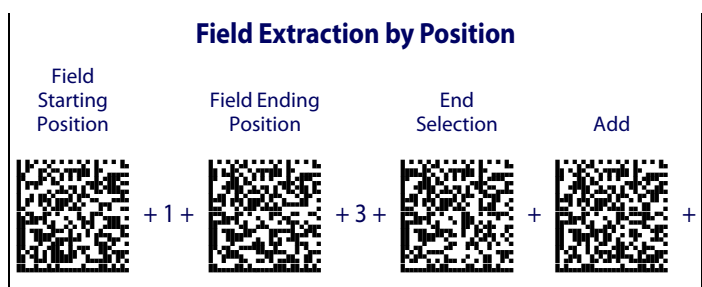

**Output message:** <21DAT21OGICpr21>

**FIELD EXTRACTION BY CHARACTER**

**a) Define Field Starting Character(s)**

Field Starting Character(s)



Read the Hex value from the Hex/Numeric table identifying the starting character(s) of the field to be extracted. Valid values are in the range **00-7F**.

**b) Define Field Ending Character(s)**

Field Ending Character(s)



Read the Hex value from the Hex/Numeric table identifying the ending character(s) of the field to be extracted. Valid values are in the range **00-7F**.

**c) Field Delimiter Selection**

Include Start/End Characters



OR

Discard Start/End Characters



**d) EITHER Add Field or String**

Add



- To add other fields selected by characters read the code and repeat this procedure from step **a** for each field to be selected;
- To add a new string of characters read the code and follow the procedure described on [page 141](#).
- To add the procedure selecting new fields by position read the code and follow the description given on [page 140](#).

OR

**End Format Definition**

End Format Definition



Read the code to end the format definition.

## FIELD EXTRACTION BY POSITION

a)

### Define Field Starting Position

Field Starting Position



Read a number corresponding to the field starting position.

b)

### Define Field Ending Position

Field Ending Position



Read a number corresponding to the field ending position.

Last Position



Read this code to set the field ending position to the last position of the code:

OR

c)

### End Field Selection

End Selection



Read the code to end the field selection.

d)

**EITHER**

### Add Field or String

Add



- To add other fields selected by position read the code and repeat this procedure from step **a** for each field to be selected;
- To add a new string of characters read the code and follow the procedure described on [page 141](#).
- To add the procedure selecting new fields by characters read the code and follow the description given on [page 139](#).

**OR**

### End Format Definition

End Format Definition



Read the code to end the format definition.

**ADD NEW STRING**

a)

**Define New String**

String Character(s)



Read the Hex value from the Hex/Numeric table identifying the character(s). Valid values are in the range **00-7F**.

b)

**End String**

End String



Read the code to end the string defined in step **a**.

c)

**EITHER**

**Add Procedure**

Add



- To add the procedure extracting fields by characters, follow the steps given on [page 139](#);
- To add the procedure extracting fields by position follow the steps given on [page 140](#).

**OR**

**End Format Definition**

End Format Definition



Read the code to end the format definition.

## Method 2 - Manipulating the Barcode Data

Method 2 allows modifying the barcode data by means of one of the following procedures:

- String insertion;
- String deletion;
- String substitution;
- Field deletion.

Once the data has been modified, it is sent to the host computer as data of the output message.

Unlike Method 1 this method does not allow associating different procedures together. This means that each format definition corresponds to a single procedure. Despite this, it possible to add a new string of characters to the beginning or ending part of the formatted barcode.

The only limit is determined by the size of the internal reserved memory used to define the format.

### STRING INSERTION

To complete this procedure proceed as follows:

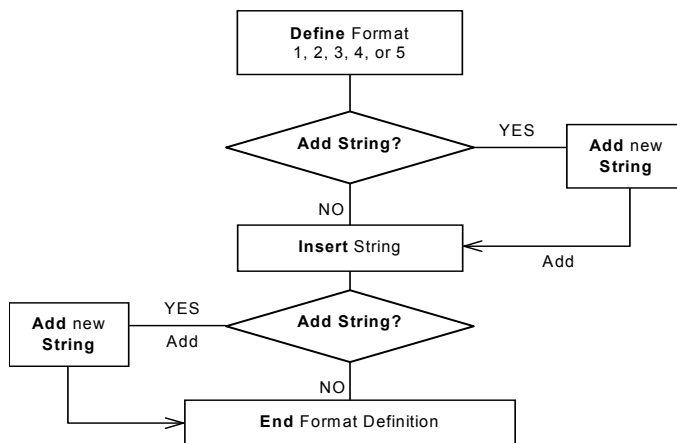

### Example:

**Decoded code:** <DATALOGICproduct>

**Formatting procedure:** Add new string + Insert String

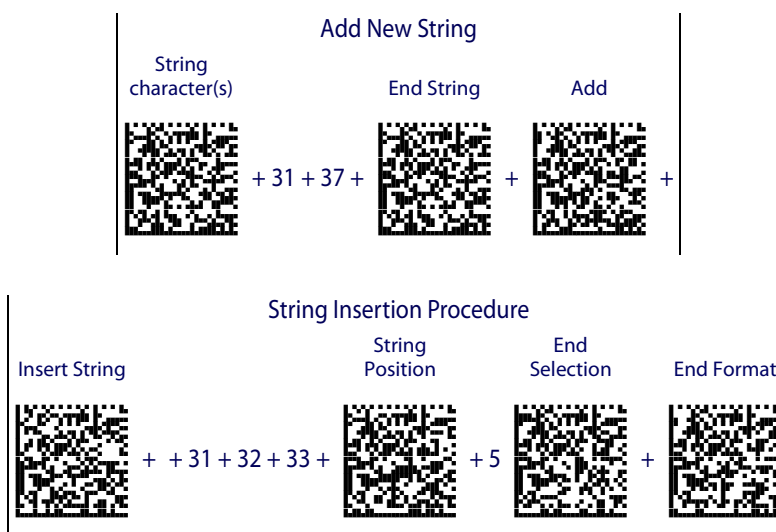

**Output message:** <17DATA123LOGICproduct>



**String Insertion Procedure**

a)

**Insert String**

Insert String



Read the Hex value from the Hex/Numeric table identifying the characters to be inserted. Valid values are in the range **00-7F**.

b)

**Define String Position**

String Position



Read a number corresponding to the string position within the barcode.

c)

**End Selection**

End Selection



Read the code to end the field selection.

d)

**EITHER**

**Add String**

Add



To add a new string of characters read the code and follow the procedure described on [page 150](#).

**OR**

**End Format Definition**

End Format Definition



Read the code to end the format definition.

**STRING DELETION**

To complete this procedure proceed as follows:

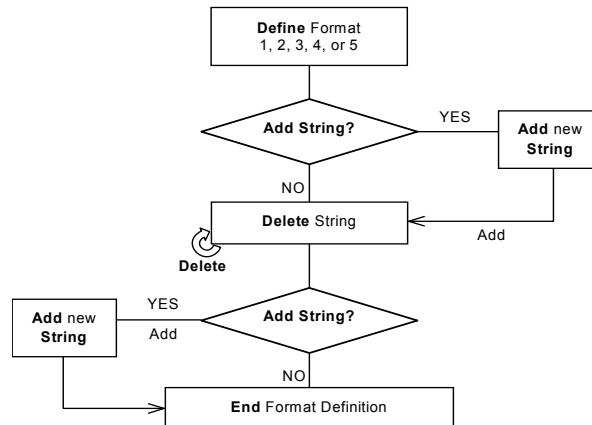

**Example:**

**Decoded code:** <DATALOGICproduct>

**Formatting procedure:** Delete First String + Delete Second String + Add New String.

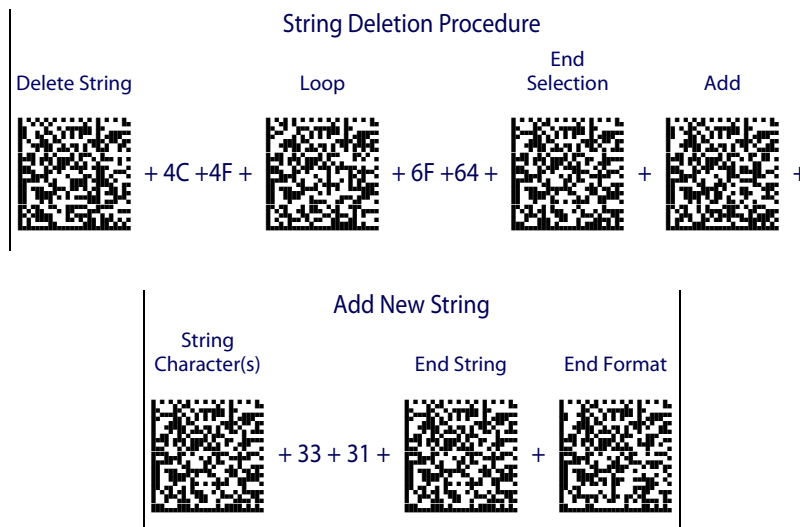

**Output message:** <DATAGICpruct31>

**String Deletion Procedure**

a)

Delete



**Delete String**

Read the Hex value from the Hex/Numeric table identifying the string character(s) to be deleted. Valid values are in the range **00-7F**.

b)

**(optional)**

Loop



**Select Other Strings to be Deleted**

Read the code above and repeat the procedure from step **a**.

c)

End Selection



**End Selection**

Read the code to end the selection.

d)

**EITHER**

Add



**Add String**

To add a new string of characters read the code and follow the procedure described on [page 150](#).

**OR**

**End Format Definition**

End Format Definition



Read the code to end the format definition.

### STRING SUBSTITUTION

To complete this procedure proceed as follows:

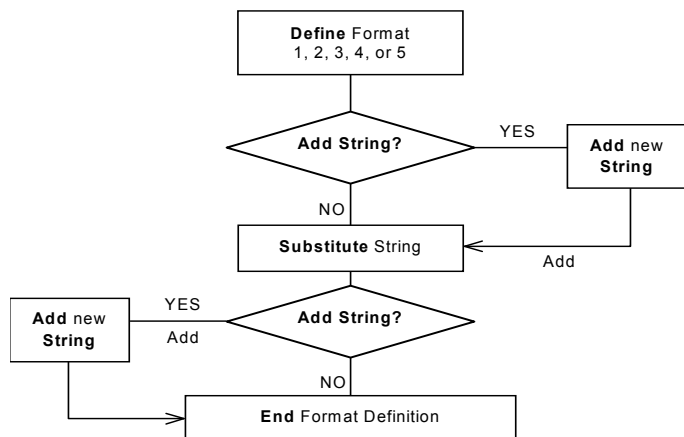

### Example

**Decoded code:** <DATALOGICproduct>

**Formatting procedure:** Add new string + String substitution + Add new string.

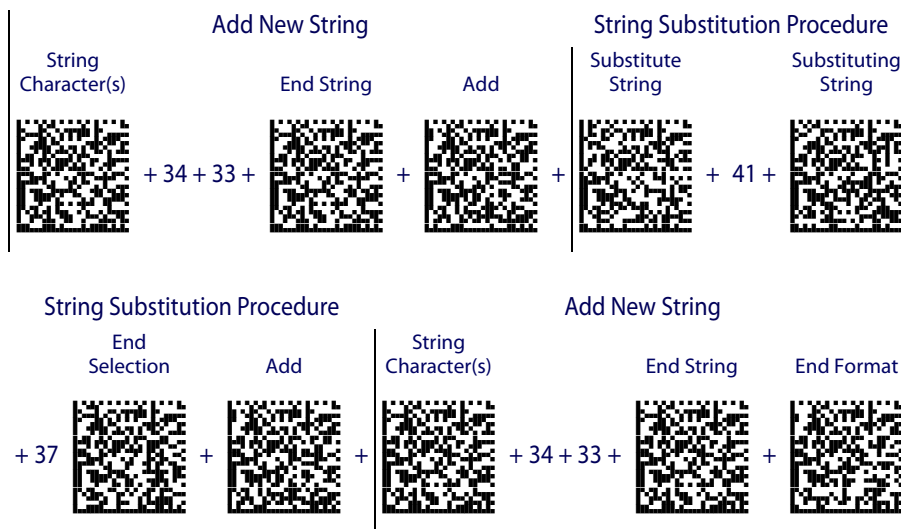

**Output message:** <43D7T7LOGICproduct43>

**String Substitution Procedure**

a)

**Define String to be Substituted**

Substitute String



Read the Hex value from the Hex/Numeric table identifying the characters of the string to be substituted. Valid values are in the range **00-7F**.

b)

**Define Substituting String**

Substituting String



Read the Hex value from the Hex/Numeric table identifying the characters of the substituting string. Valid values are in the range **00-7F**.

c)

**End Selection**

End Selection



Read the code to end the selection.

d)

**EITHER**

**Add String**

Add



To add a new string of characters read the code and follow the procedure described on [page 150](#).

**OR**

**End Format Definition**

End Format Definition



Read the code to end the format definition.

**FIELD DELETION**

To complete this procedure proceed as follows:

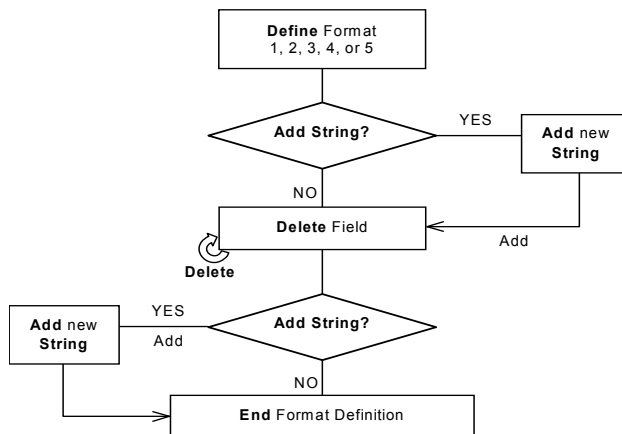

**Example**

**Decoded code:** <DATALOGICproduct>

**Formatting procedure:** Delete First Field + Delete Second Field + Add New String.

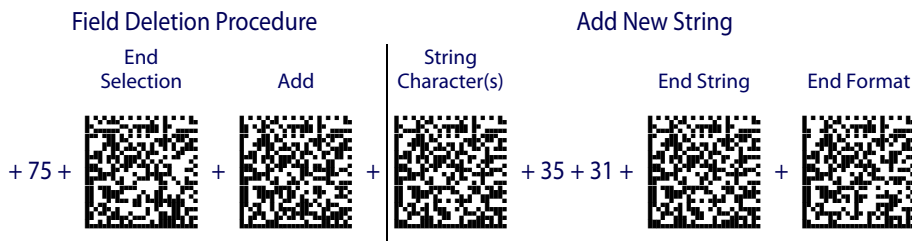
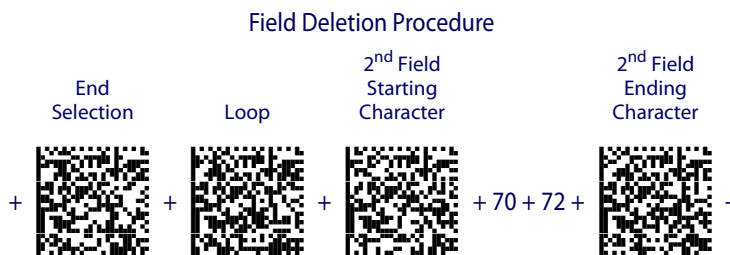
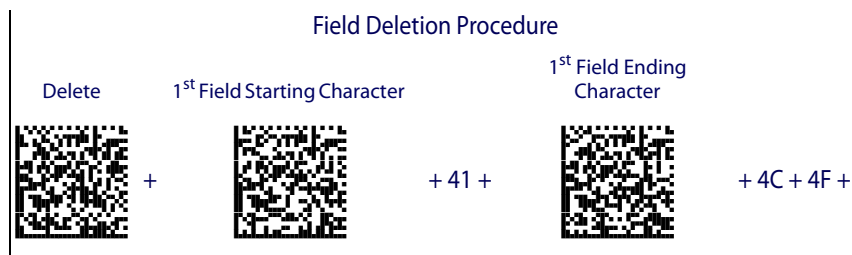

**Output message:** <DGICct51>

**Field Deletion Procedure**

a)

Delete



**Delete Field**

Read the code to enable the command deleting the field.

b)

Field Starting Character



**Define Field Starting Character**

Read the Hex value from the Hex/Numeric table identifying the starting characters. Valid values are in the range **00-7F**.

c)

Field Ending Character



**Define Field Ending Character**

Read the Hex value from the Hex/Numeric table identifying the ending character/s. Valid values are in the range **00-7F**.

d)

End Selection



**End Field Selection**

Read the code to end the field selection.

e)

**(optional)**

Loop



**Select Other Fields to be Deleted**

Read the following code and repeat the procedure from step **b** for each field to be deleted.

f)

**EITHER**

**Add String**

Add



To add a new string of characters read the code and follow the procedure described on [page 150](#).

**OR**

**End Format Definition**

End Format Definition



Read the code to end the format definition.

**ADD NEW STRING**

a)

**Define New String**

String Character



Read the Hex value from the Hex/Numeric table identifying the starting characters. Valid values are in the range **00-7F**.

b)

**End String and Define Procedure**

End String Plus Procedure



Read the code to end the string selection and continue defining a new procedure belonging to Method 1.

**OR**

**End String and Format**

End String & Format



Read the code to end the string and the format definition.



## Match Conditions

By setting one or more of the following conditions it is possible to select the codes to be formatted. Follow the given steps to define the desired condition.

### MATCH WITH PREDEFINED SUBSTRING

#### Define Matching Substring

Match with Substring



Read the above code and:

1. read a number in the range 1-5 corresponding to the desired format number;
2. set the number of characters defining the matching string in the range 00-10;
3. read the corresponding character as Hex value from the Hex/Numeric table identifying the substring character/s. Valid values are in the range 00-7F.

(optional)

#### Define Substring Position

Matching Substring Position



Read the above code and:

1. read a number in the range 1-5 corresponding to the desired format number;
2. read the number corresponding to the substring position in the range **0-255**;

AND/OR

### MATCH CODE LENGTH

#### Define Code Length

Match Code Length



Read the above code and:

1. read a number in the range **1-5** corresponding to the desired format number;
2. read the number in the range **0-255**;

AND/OR

### MATCH SYMBOLOGY

#### Define Code Symboology

Match Symboology



Read the above code and:

1. read a number in the range **1-5** corresponding to the desired format number;
2. set the number of the matching code symbologies in the range **0-4**;
3. select the Datalogic Standard Code Identifier from the Code Identifier Table in Appendix [D](#).

# Format Enable/Disable

Format 1



0 = disabled  
1 = enabled

Format 2



0 = disabled  
1 = enabled

Format 3



0 = disabled  
1 = enabled

Format 4



0 = disabled  
1 = enabled

Format 5



0 = disabled  
1 = enabled

Disable All Formats



## Mismatch Result

The result of each format may be set in case the match conditions previously selected are not satisfied.

Once the desired formats have been enabled and a code has been read, the results corresponding to each format will be concatenated together and transmitted in the output message. For this reason, it is strongly advised to set the mismatch result for each format.

### Example

**Decoded Code:** <DATALOGICproduct>

**Format definition:**

Format	Enable/Disable	Match Condition	Function	Mismatch Result
Format 1	Enabled	Code having a length of 16 characters	Select field from position1 to position3	No string
Format 2	Disabled	/	/	/
Format 3	Enabled	Code having a length of 25 characters	Substitute string "ab" with string "12"	Unformatted read code
Format 4	Enabled	Code having the sub-string "AT" in position 2	Insert string "789" in position 7	Unformatted read code
Format 5	Enabled	Code belonging to the PDF417 symbology	Delete string "DA" and "pr"	Unformatted read code

**Output message:** <DATALOGICproductDATALOGICproductDATALOGICproductDATALOGICproduct>  
 Format 1    Format 3                      Format 4                      Format 5

### Define Mismatch Result

Mismatch Result



Read the code at left and:

1. read a number in the range 1-5 corresponding to the desired format number;
2. 0 = empty string as output  
1 = unformatted read code as output.

# NOTES

## RS-232 Parameters

### Handshaking

#### Hardware handshaking: (RTS/CTS)

The RTS line is activated by the decoder before transmitting a character. Transmission is possible only if the CTS line (controlled by the Host) is active.

**Figure 23. RTS/CTS handshaking**

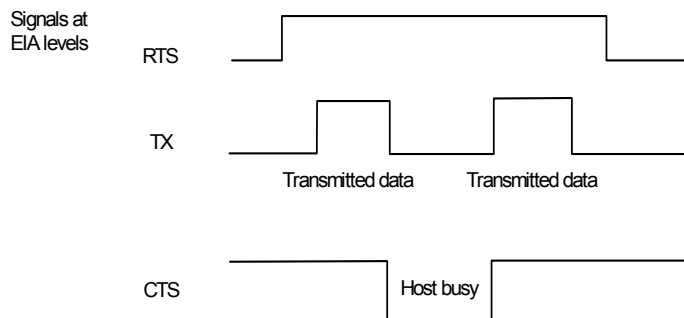

#### Software handshaking: (XON/XOFF)

During transmission, if the Host sends the XOFF character (13 Hex), the decoder interrupts the transmission with a maximum delay of one character and only resumes when the XON character (11 Hex) is received.

**Figure 24. XON/XOFF handshaking**

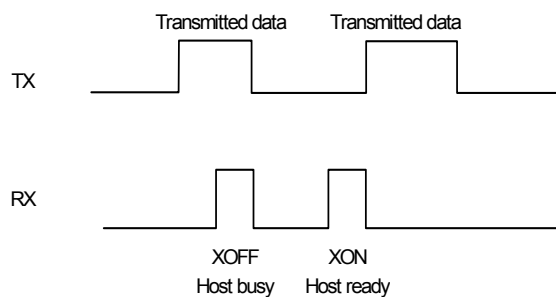

## ACK/NACK Protocol

### PowerScan® M8500 Readers

The transmission protocol takes place between reader, cradle and Host. The reader passes its data (code read) to the cradle, which sends it to the Host. The management of responses (from Host or cradle) depends on the Transmission Mode parameter, see [page 171](#).

In the following descriptions the completed transmission is indicated by the Beeper Control for Radio Response parameter with its default setting to Normal, see [page 171](#).

When ACK/NACK is disabled (in One-Way tx mode), there is no control from cradle to Host transmission, the reader responds with the good reception tone.

**Figure 25. ACK/NACK disabled**

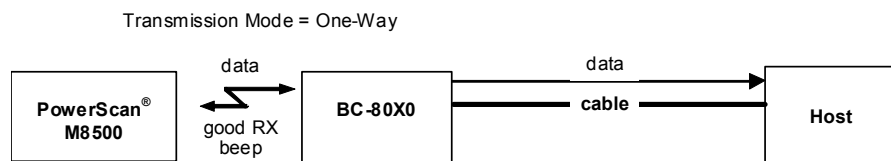

**Figure 26. ACK/NACK enabled**

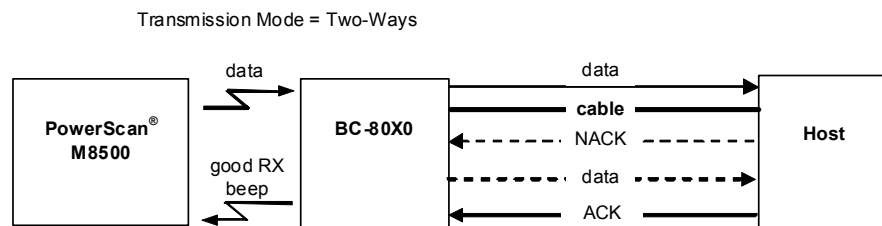

When ACK/NACK is enabled (in Two-Way tx mode), the Host sends an ACK character (06 HEX) in the case of good reception or the NACK character (15 HEX) requesting re-transmission, in the case of bad reception. **Only after the ACK character is received by the BC-80X0 does the reader respond with the good reception tone.**

If the BC-80X0 does not receive an ACK or NACK, transmission is ended after the RX Timeout, see [page 157](#). See also Radio Protocol Timeout, [page 170](#).

When ACK/NACK protocol is enabled, FIFO must be disabled manually, see below.

## FIFO

### PowerScan® M8500 Readers

If enabled, the BC-80X0 collects all messages sent by PowerScan® M8500 and sends them in order of acquisition to the connected Host.

If disabled, PowerScan® M8500 blocks message transmission until the BC-80X0 has completed transmission towards the Host.

---

## RX Timeout

When the RS-232 interface is selected, the Host can be used to configure the device by sending it command strings (see [Appendix B, Host Configuration Strings](#)).

This parameter can be used to automatically end data reception from the Host after the specified period of time.

If no character is received from the Host, after the timeout expires, any incomplete string (any string not terminated by <CR>) is flushed from the device buffer.

## Pen Parameters

### Minimum Output Pulse

This parameter sets the duration of the output pulse corresponding to the narrowest element in the barcode. In this way the code resolution is controlled by the signal sent to the decoder, independently of the physical resolution of the code read.

The shortest pulse (200  $\mu$ s) corresponds to a high-resolution code emulation and therefore a shorter transfer speed to the decoder (for decoders able to work on high resolution codes). Likewise, longer pulses correspond to low-resolution code emulation and therefore a longer transfer time to the decoder.

## Conversion to Code 39 and Code 128

### PowerScan<sup>®</sup> M8500 Series Readers

When using these readers it is possible to choose between converting the decoded codes into either Code 39 format or Code 128 format. It is not possible to disable conversion.

## Overflow

This parameter generates a white space before the first bar and after the last bar of the code. The selections are as follows:

narrow=space 10 times the minimum output pulse.

medium=space 20 times the minimum output pulse.

wide =space 30 times the minimum output pulse.

## Output and Idle Levels

The following state diagrams describe the different output and idle level combinations for Pen emulation:

**Figure 27. Output and Idle Levels**

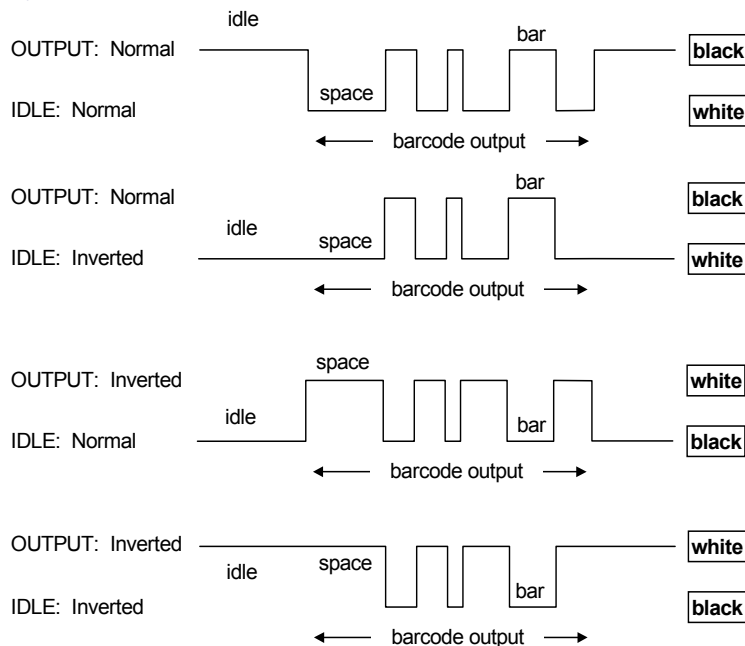

## Inter-Block Delay

For the PEN Emulation interface, data are sent to the Host in fixed size blocks of 20 characters each. The inter-block delay parameter allows setting a delay between each block sent to the Host.

## Network Parameters

### Slave Address Range First/Last

These parameters define the valid addresses for the Slave cradles on the network. Valid values are in the range 0 to 1999. However, the maximum number of cradles in a single network is 16, (including the Master if present). All cradles in the system must have different addresses.

To reduce system boot time, it is recommended to number the Slaves consecutively, while it is not necessary that the Master cradle address is contained in the range. The network addresses correspond to the radio addresses, see "[BC-8060 STAR-System™ Network Setup](#)" on page 45.

At system power-up, the Master searches for and initializes all the Slaves found in the valid address range. During this phase the yellow LED on the Master cradle blinks. The time to complete the start up procedure varies depending on the complexity of the network but is typically between a few seconds to a few minutes. Start up cannot be interrupted. At the end of this procedure the system will be operative and can collect data from all devices.



**CAUTION**

**All Slaves must be powered up either before or together with the Master. Slaves successively powered will not be recognized by the system even if their address is in the specified range.**



## Network Warning Message

The Master cradle can transmit warning messages to the Host regarding some network errors.

**/\*Slave xxxx not responding\*/**: when the Master can no longer communicate with the specified Slave previously identified at start up.

**/\*Frame out of sequence for terminal xxxx\*/**: if a reader is sending data packets out of sequence. This can happen if there are transmission problems on the network (either connection or communication), or if the reader has correctly transmitted data to a device not on the network (reader configuration error).

The message is sent in the following format:

**"Message" CR LF**

## Reception Warning Message

The Master cradle can transmit warning messages to the Host regarding wrong reception of data. Example:

**/\*Two-Ways Out of Sequence! (.....)\*/**

This message is transmitted to the Host by the Master cradle when the Master cradle receives a closing string from the Host for a Two-way tx communication, but this was either not open or already closed, therefore the data will be lost. See [page 171](#).

## Master Header/Terminator Selection

In addition to the standard header/terminator selection, the Master cradle can add its own header/terminator to the entire message sent to the Host.

In the STAR-System™ network headers and terminators for all RF Devices are disabled by default.

The Master header and terminator default values are as follows depending on the interface selection towards the Host:

- RS-232: no header, terminator CR-LF
- WEDGE: no header, terminator ENTER

See ["Header/Terminator Selection" on page 160](#) and ["Define Special Key Sequence" on page 161](#).

## Data Format

For an overview of Message Formatting see Chapter 6.

### Header/Terminator Selection

The header/terminator selection is not effected by the reading of the restore default code. In fact, header and terminator default values depend on the interface selection:

- RS-232: no header, terminator CR-LF
- WEDGE: no header, terminator ENTER

These default values are always restored through the reading of RS-232 or WEDGE interface selection code, see "[Interface Selection](#)" on page 47.

For the WEDGE interface, the following extended keyboard values can also be configured:

EXTENDED KEYBOARD TO HEX CONVERSION TABLE				
	IBM AT IBM 3153 APPLE ADB	IBM XT	IBM 31xx, 32xx, 34xx, 37xx	Wyse Digital
HEX	KEY	KEY	KEY	KEY
83	ENTER	ENTER	FIELD EXIT	RETURN
84	TAB	TAB	TAB	TAB
85	F1	F1	F1	F1
86	F2	F2	F2	F2
87	F3	F3	F3	F3
88	F4	F4	F4	F4
89	F5	F5	F5	F5
8A	F6	F6	F6	F6
8B	F7	F7	F7	F7
8C	F8	F8	F8	F8
8D	F9	F9	F9	F9
8E	F10	F10	F10	F10
8F	F11	ESC	F11	F11
90	F12	BACKSPACE	F12	F12
91	HOME	HOME	ENTER	F13
92	END	END	RESET	F14
93	PG UP	PG UP	INSERT	F15
94	PG DOWN	PG DOWN	DELETE	F16
95		-	FIELD -	UP
96		-	FIELD +	DOWN
97	↵	↵	ENTER (Paddle)	LEFT
98		*	PRINT	RIGHT
99	ESC	ESC		ESC
9A	CTRL (Right)	CTRL (Right)		CTRL (Right)
9B	Euro	Space	Space	Space

For all devices using [IBM AT \(compatible\) Wedge](#) or [USB-KBD](#) interfaces, all values from 9C to FE send the relative simulated keypress when available or else the relative ALT-Mode sequence. See the Hex to Character Conversion Table in [Appendix F](#).

For all devices using other Wedge interfaces, all values from 9C to FE send the Space character.

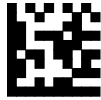

## Define Special Key Sequence

The Special Key(s) for Wedge IBM AT-PS/2 and USB-KBD interface users can be associated with a sequence of keyboard keys that otherwise could not be selected, i.e. ALT + F6, SHIFT + F1. These Special Keys can be used for:

- Headers/Terminators
- Character Replacement
- Field Adjustment
- Custom Code ID
- Advanced Formatting – Define Field
- Advanced Formatting – Additional Fixed Field

Follow the procedure to define the desired Special Key sequence:

1. Read the Enter Configuration code above and select the Special Key to define (one at a time):

Define Special Key 1

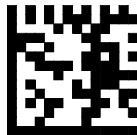

Define Special Key 2

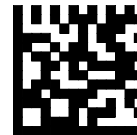

Define Special Key 3

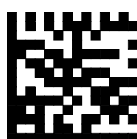

Define Special Key 4

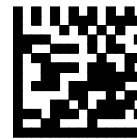

Define Special Key 5



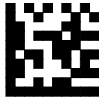

2. Read only one code to be associated with the special key sequence:

SHIFT



OR

CTRL



OR

ALT



OR

CTRL + SHIFT



OR

ALT + SHIFT



OR

CTRL + ALT



3. Select the character to be associated with the Special Key sequence by reading the codes corresponding to the 3 character values from [Appendix F](#).

Then, read the Exit and Save Configuration code above to complete the Special Key sequence.

The character values having the <sup>S</sup> and <sup>A</sup> symbols **require** SHIFT or ALT keys or key combinations in **step 2**, in particular:

<sup>S</sup> = the character is obtained in combination with SHIFT

<sup>A</sup> = the character is obtained in combination with ALT

The following character values change according to the keyboard nationality.

KEYB CHAR	ITA	USA	FR	BE	DE	UK	ES	SW	JP
!	016 <sup>S</sup>	016 <sup>S</sup>	04A	03E	016 <sup>S</sup>	016 <sup>S</sup>	016 <sup>S</sup>	016 <sup>S</sup>	016 <sup>S</sup>
"	01E <sup>S</sup>	052 <sup>S</sup>	026	026	01E <sup>S</sup>	01E <sup>S</sup>	01E <sup>S</sup>	01E <sup>S</sup>	01E <sup>S</sup>
#	052 <sup>A</sup>	026 <sup>S</sup>	026 <sup>A</sup>	026 <sup>A</sup>	05D	05D	026 <sup>A</sup>	026 <sup>S</sup>	026 <sup>S</sup>
\$	025 <sup>S</sup>	025 <sup>S</sup>	05B	05B	025 <sup>S</sup>	025 <sup>S</sup>	025 <sup>S</sup>	025 <sup>A</sup>	025 <sup>S</sup>
%	02E <sup>S</sup>	02E <sup>S</sup>	052 <sup>S</sup>	052 <sup>S</sup>	02E <sup>S</sup>	02E <sup>S</sup>	02E <sup>S</sup>	02E <sup>S</sup>	02E <sup>S</sup>
&	036 <sup>S</sup>	03D <sup>S</sup>	016	016	036 <sup>S</sup>	03D <sup>S</sup>	036 <sup>S</sup>	036 <sup>S</sup>	036 <sup>S</sup>
'	04E	052	025	025	05D <sup>S</sup>	052	04E	05D	03D <sup>S</sup>
(	03E <sup>S</sup>	046 <sup>S</sup>	02E	02E	03E <sup>S</sup>	046 <sup>S</sup>	03E <sup>S</sup>	03E <sup>S</sup>	03E <sup>S</sup>
)	046 <sup>S</sup>	045 <sup>S</sup>	04E	04E	046 <sup>S</sup>	045 <sup>S</sup>	046 <sup>S</sup>	046 <sup>S</sup>	046 <sup>S</sup>
*	05B <sup>S</sup>	03E <sup>S</sup>	05D	05B <sup>S</sup>	05B	03E <sup>S</sup>	05B <sup>S</sup>	05D <sup>S</sup>	052 <sup>S</sup>
+	05B	055 <sup>S</sup>	055 <sup>S</sup>	04A <sup>S</sup>	05B	055 <sup>S</sup>	05B	04E	04C <sup>S</sup>
,	041	041	03A	03A	041	041	041	041	041
-	04A	04E	036	055	04A	04E	04A	04A	04E
.	049	049	041 <sup>S</sup>	041 <sup>S</sup>	049	049	049	049	049
/	03D <sup>S</sup>	04A	049 <sup>S</sup>	049 <sup>S</sup>	03D <sup>S</sup>	04A	03D <sup>S</sup>	03D <sup>S</sup>	04A
0	045	045	045 <sup>S</sup>	045 <sup>S</sup>	045	045	045	045	045
1	016	016	016 <sup>S</sup>	016 <sup>S</sup>	016	016	016	016	016
2	01E	01E	01E <sup>S</sup>	01E <sup>S</sup>	01E	01E	01E	01E	01E
3	026	026	026 <sup>S</sup>	026 <sup>S</sup>	026	026	026	026	026
4	025	025	025 <sup>S</sup>	025 <sup>S</sup>	025	025	025	025	025
5	02E	02E	02E <sup>S</sup>	02E <sup>S</sup>	02E	02E	02E	02E	02E
6	036	036	036 <sup>S</sup>	036 <sup>S</sup>	036	036	036	036	036
7	03D	03D	03D <sup>S</sup>	03D <sup>S</sup>	03D	03D	03D	03D	03D
8	03E	03E	03E <sup>S</sup>	03E <sup>S</sup>	03E	03E	03E	03E	03E
9	046	046	046 <sup>S</sup>	046 <sup>S</sup>	046	046	046	046	046
:	049 <sup>S</sup>	04C <sup>S</sup>	049	049	049 <sup>S</sup>	04C <sup>S</sup>	049 <sup>S</sup>	049 <sup>S</sup>	052
;	041 <sup>S</sup>	04C	041	041	041 <sup>S</sup>	04C	041 <sup>S</sup>	041 <sup>S</sup>	04C
<	061	041 <sup>S</sup>	061	061	061	041 <sup>S</sup>	061	061	041 <sup>S</sup>
=	045 <sup>S</sup>	055	055	04A	045 <sup>S</sup>	055	045 <sup>S</sup>	045 <sup>S</sup>	04E <sup>S</sup>
>	061 <sup>S</sup>	049 <sup>S</sup>	061 <sup>S</sup>	061 <sup>S</sup>	061 <sup>S</sup>	049 <sup>S</sup>	061 <sup>S</sup>	061 <sup>S</sup>	049 <sup>S</sup>
?	04E	04A <sup>S</sup>	03A <sup>S</sup>	03A <sup>S</sup>	04E <sup>S</sup>	04A <sup>S</sup>	04E <sup>S</sup>	04E <sup>S</sup>	04A <sup>S</sup>
@	04C <sup>A</sup>	01E <sup>S</sup>	045 <sup>A</sup>	01E <sup>A</sup>	015 <sup>A</sup>	052 <sup>S</sup>	01E <sup>A</sup>	01E <sup>A</sup>	054
[	054 <sup>A</sup>	054	02E <sup>A</sup>	054 <sup>A</sup>	052 <sup>S</sup>	054	054 <sup>A</sup>	03E <sup>A</sup>	05B
\	00E	05D	03E <sup>A</sup>	061 <sup>A</sup>	04C <sup>S</sup>	061	00E <sup>A</sup>	04E <sup>A</sup>	051
]	05B <sup>A</sup>	05B	04E <sup>A</sup>	05B <sup>A</sup>	054 <sup>S</sup>	05B	05B <sup>A</sup>	046 <sup>A</sup>	05D
^	055 <sup>S</sup>	036 <sup>S</sup>	046 <sup>A</sup>	054	00E	036 <sup>S</sup>	054 <sup>S</sup>	05B <sup>S</sup>	055
_	04A <sup>S</sup>	04E <sup>S</sup>	03E	055	04A <sup>S</sup>	04E <sup>S</sup>	04A <sup>S</sup>	04A <sup>S</sup>	051 <sup>S</sup>
' (accent)	-	00E	03D <sup>A</sup>	05D <sup>A</sup>	055 <sup>S</sup>	00E	054	055 <sup>S</sup>	054 <sup>S</sup>
a	01C	01C	015	015	01C	01C	01C	01C	01C
b	032	032	032	032	032	032	032	032	032
c	021	021	021	021	021	021	021	021	021
d	023	023	023	023	023	023	023	023	023
e	024	024	024	024	024	024	024	024	024
f	02B	02B	02B	02B	02B	02B	02B	02B	02B
g	034	034	034	034	034	034	034	034	034
h	033	033	033	033	033	033	033	033	033
i	043	043	043	043	043	043	043	043	043
j	03B	03B	03B	03B	03B	03B	03B	03B	03B
k	042	042	042	042	042	042	042	042	042
l	04B	04B	04B	04B	04B	04B	04B	04B	04B
m	03A	03A	04C	04C	03A	03A	03A	03A	03A
n	031	031	031	031	031	031	031	031	031
o	044	044	044	044	044	044	044	044	044
p	04D	04D	04D	04D	04D	04D	04D	04D	04D
q	015	015	01C	01C	015	015	015	015	015

KEYB CHAR	ITA	USA	FR	BE	DE	UK	ES	SW	JP
r	02D	02D	02D	02D	02D	02D	02D	02D	02D
s	01B	01B	01B	01B	01B	01B	01B	01B	01B
t	02C	02C	02C	02C	02C	02C	02C	02C	02C
u	03C	03C	03C	03C	03C	03C	03C	03C	03C
v	02A	02A	02A	02A	02A	02A	02A	02A	02A
w	01D	01D	01A	01A	01D	01D	01D	01D	01D
x	022	022	022	022	022	022	022	022	022
y	035	035	035	035	01A	035	035	035	035
z	01A	01A	01D	01D	035	01A	01A	01A	01A
{	-	054 <sup>S</sup>	025 <sup>A</sup>	046 <sup>A</sup>	052	054 <sup>S</sup>	052 <sup>A</sup>	03D <sup>A</sup>	05B <sup>S</sup>
	00E <sup>S</sup>	05D <sup>S</sup>	036 <sup>A</sup>	016 <sup>A</sup>	04C	061 <sup>S</sup>	016 <sup>A</sup>	061 <sup>A</sup>	06A <sup>S</sup>
}	-	05B <sup>S</sup>	055 <sup>A</sup>	045 <sup>A</sup>	054	05B <sup>S</sup>	05D <sup>A</sup>	045 <sup>A</sup>	05D <sup>S</sup>
~	-	00E <sup>S</sup>	01E <sup>A</sup>	04A <sup>A</sup>	04E	05D <sup>S</sup>	-	05B <sup>A</sup>	055 <sup>S</sup>



**To use upper case letters, it is necessary to read one of the SHIFT commands from step 2 before the value corresponding to the lower case letters.**

The following key values are common to all the keyboard nationalities.

KEYB KEY	ITA	USA	FR	BE	DE	UK	ES	SW	JP
ENTER	05A	05A	05A	05A	05A	05A	05A	05A	05A
TAB	00D	00D	00D	00D	00D	00D	00D	00D	00D
F1	005	005	005	005	005	005	005	005	005
F2	006	006	006	006	006	006	006	006	006
F3	004	004	004	004	004	004	004	004	004
F4	00C	00C	00C	00C	00C	00C	00C	00C	00C
F5	003	003	003	003	003	003	003	003	003
F6	00B	00B	00B	00B	00B	00B	00B	00B	00B
F7	083	083	083	083	083	083	083	083	083
F8	00A	00A	00A	00A	00A	00A	00A	00A	00A
F9	001	001	001	001	001	001	001	001	001
F10	009	009	009	009	009	009	009	009	009
F11	078	078	078	078	078	078	078	078	078
F12	007	007	007	007	007	007	007	007	007
Home	26C	26C	26C	26C	26C	26C	26C	26C	26C
End	269	269	269	269	269	269	269	269	269
PG UP	27D	27D	27D	27D	27D	27D	27D	27D	27D
PG down	27A	27A	27A	27A	27A	27A	27A	27A	27A
Up arrow	275	275	275	275	275	275	275	275	275
Down arrow	272	272	272	272	272	272	272	272	272
Left arrow	26B	26B	26B	26B	26B	26B	26B	26B	26B
Right arrow	274	274	274	274	274	274	274	274	274
Esc	076	076	076	076	076	076	076	076	076
Ctrl right	214	214	214	214	214	214	214	214	214
€	02E <sup>A</sup>	02E <sup>A</sup>	024 <sup>A</sup>	024 <sup>A</sup>	024 <sup>A</sup>	025 <sup>A</sup>	02E <sup>A</sup>	02E <sup>A</sup>	-
SPACE	029	029	029	029			029		029



**If Caps Lock Auto-Recognition is disabled, it is necessary to verify that the keyboard caps lock status matches the reader one.**

**EXAMPLES**

**- Defining Special Key Sequences -**

1. The following example allows defining Special Key 1 as SHIFT + F5:

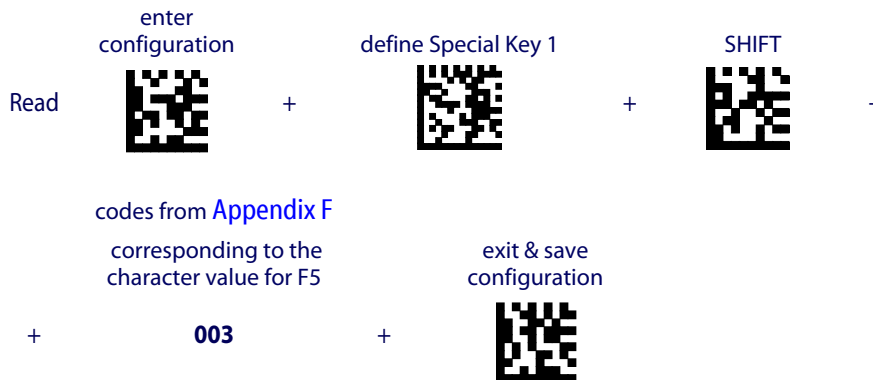

2. The following example allows defining Special Key 2 as CTRL + S (upper case):



3. The following example allows defining Special Key 3 as Alt + F6:

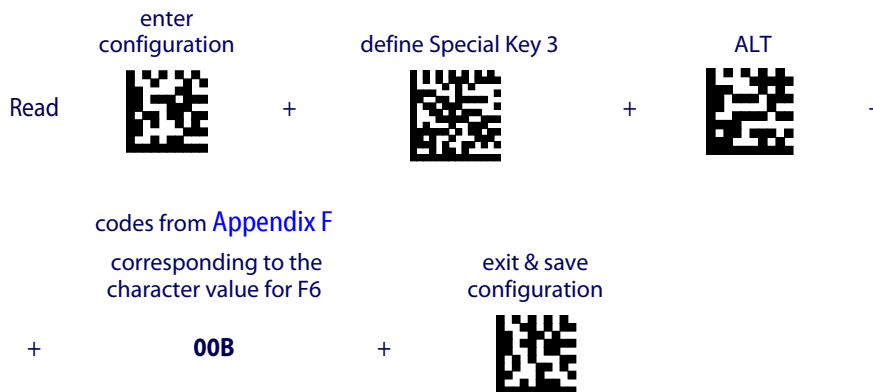

4. The following example allows defining Special Key 4 as Alt + Shift + F1:

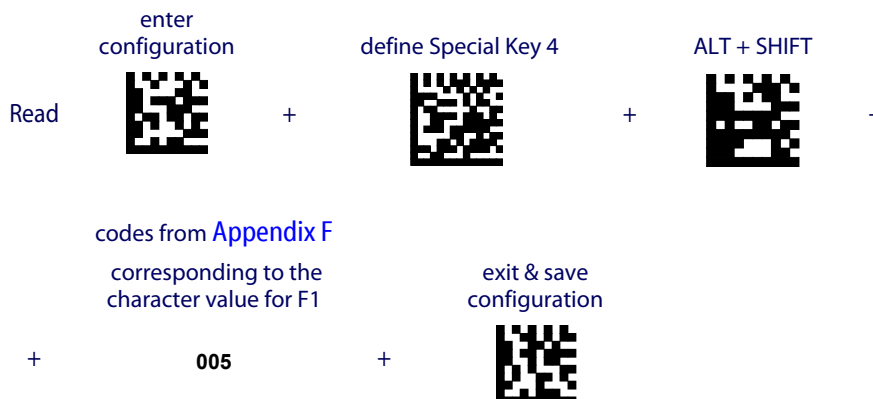



**- Integrating Special Keys in Headers/Terminators -**

1. The following example allows setting Special Key 1 (defined in example 1 above) as terminator:



2. The following example allows setting Special Key 2 (defined in example 2 above) as header:



3. The following example allows setting Special Key 3 (defined in example 3 above) as header:



4. The following example allows setting Special Key 4 (defined in example 4 above) and ENTER character as terminators:

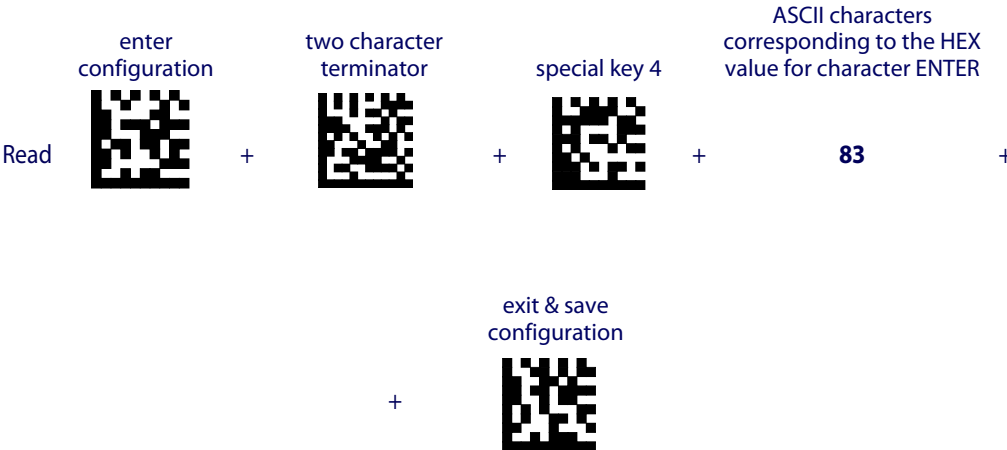

---

## Address Stamping

It is possible to include the reader address in the message sent to the host. The Reader Address Stamping and the Cradle Address Stamping parameters consist of a 4-digit number in the range 0000 to 1999.

For message output format, refer to ["Message Formatting" starting on page 175](#)

## Address Delimiter

The Address Delimiter allows a character to be included to separate the reader Address stamping field from the next field in the message. Any character can be included in the hexadecimal range from 00 to FE.

For message output format, refer to ["Message Formatting" starting on page 175](#).

## Time Stamping Format

The Time Stamping parameter sets the format for hour and date information. It consists of 1 or 2 groups of numbers, each one made up of 6 decimal digits.

For example, setting the Hour/Minutes/Seconds/Month/Day/Year format, the information *17:03:16 on June 12, 2009* will be formatted as 170316061209.

## Time Stamping Delimiter

The Time Stamping Delimiter allows a character to be included to separate the Time Stamping field from the next field in the message. Any character can be included in the hexadecimal range from 00 to FE.

## Reading Parameters

### Trigger Signal

This mode determines how the reading phase is controlled when the hardware trigger operating mode is selected:

- trigger active level: the reader goes ON when the trigger is pressed and goes OFF when it is released
- trigger active pulse: the reader goes ON at the first trigger press and goes OFF only at a second press

### Reads per Cycle

In general, a **reading cycle** corresponds to the ON + OFF times of a device.

The resulting effects of this parameter on code reading depend on other related configuration conditions. Here are the definitions of ON and OFF times.

- For readers using the software trigger parameter (FLASH MODE), a reading cycle corresponds to the *flash on* + *flash off* times. Code reading takes place during the *flash on* time.
- For readers using the *hardware trigger* parameter, a reading cycle corresponds to a trigger press (ON) + one of the following OFF events:
  - trigger release (for *trigger active level*)
  - a second trigger press (for *trigger active pulse*)

When one read per cycle is selected, the device decodes only one code during the ON period and immediately turns the reader OFF. It is only possible to read another code when the next ON time occurs.

In multiple reads per cycle, the ON period is extended so that the device can continue decoding codes until an OFF event occurs. For software trigger mode, the *flash on* period is immediately reset after each read and therefore extended. If another code is decoded before the reset *flash on* period expires, it is again reset and the effect is that the device remains ON, decoding codes until the *flash on* or *timeout* period expires.

The Safety Time parameter should be used in this case to avoid unwanted multiple reading of the same code, see below.

## Safety Time

Safety time prevents the device from immediately decoding the same code more than once. Same code consecutive reading can be disabled requiring the reader to be removed from the code (no decoding) for at least 400 ms, or a timeout can be set up to 9.9 seconds before the decoder will accept the same code. Reading is immediate if the code changes.

The safety time parameter is not applicable when reading stacked codes or when setting one read per cycle in hardware trigger operating mode, since these settings require voluntary action by the user.

## Configuration Editing Commands

The following commands carry out their specific function and do not require reading the Enter or Exit and Save Configuration codes.

### Command

### Description



Restore PowerScan® M8500 reader default configuration.



Transmit the PowerScan® M8500 reader Software release.



Transmit the PowerScan® M8500 current configuration in ASCII format to Host.



Transmit the PowerScan® M8500 current data format configuration in ASCII format to Host.

## Radio Parameters

### Radio Protocol Timeout

This parameter sets the valid time to wait before transmission between the M8500 series reader and BC-80X0 cradle is considered failed.

This parameter should be set taking into consideration the radio traffic (number of readers in the same area).

If the RS-232 interface is used with ACK/NACK enabled, this parameter should be at least equal to the RX Timeout parameter for low traffic environments. It should be increased if there are many readers in the same area.

It can be set between 2 and 19 seconds.

### Radio RX Timeout

When the scanner is used in a standalone layout (point-to-point or with multiple readers) it can be configured to receive “asynchronous” messages from the host at any time.

There are two modes which can enable the scanner to receive messages from the host:

1. **Enable “2 way” Communication Protocol** – After the transmission of each barcode, the scanner waits for an acknowledgement from the host.<sup>1</sup>

A message can be sent by the host accompanying this acknowledgement, or in place of it, to display something on the screen or execute a command (such as sound a beep sequence, turn an LED on or off, etc.). If no acknowledgement or message is received from the host within a programmable timeout duration, the radio will be switched off and an “error transmission” beep will be sounded.

2. **Independent of the Selected Protocol** – The scanner can be configured to keep the radio receiver “awake” for a defined period of time following each transmission. Any message coming from the host before expiration of the timeout is accepted. The parameter “Radio RX Timeout” is used for specifying how long the scanner have to wait for a message after receiving each code transmission.

In this mode, the radio can also be “awakened” by pressing the trigger.

The scanner can receive a message only if it is linked to the Base (i.e. the scanner has been joined to the Base and has had at least one “valid” transmission after the last power-on). Setting the “Radio RX timeout” value to “00” specifies that the radio never goes into sleep mode (always awake → the scanner can receive a message at any time). Choosing this setting will, of course, consume battery life more quickly.

### Power-Off Timeout

If this command is enabled, after the desired timeout in hours, the PowerScan<sup>®</sup> batteries are disconnected and all power consumption ceases. To restore power, press the trigger once. The reader will now be ready to read codes.

Power-off does not affect configuration parameters.

---

1. See ["Messages from Host to Reader" starting on page 175](#) for Host to Scanner message formatting.

## Transmission Mode

This parameter determines whether the reader receives responses or messages from the Host or not. In One-Way tx mode, neither Host nor cradle responds to the reader. In Two-Way tx mode, the reader must receive a response from either the cradle or the Host.

The cradle responds (empty message) to the reader, only after good transmission to the Host, for the following conditions: ACK/NACK enabled ([page 156](#)); WEDGE or PEN interface. For these conditions, it is suggested to prolong the Radio Protocol Timeout ([page 170](#)).

Enabling Two-Way tx mode temporarily disables FIFO buffering (see [page 156](#)).

With ACK/NACK disabled, the Host responds to the reader (through the cradle) with an answer message (message to reader display or command to reader), see "[Messages from Host to Reader](#)" on [page 175](#), and the following figure.

**Figure 28. Transmission Mode = Two Ways**

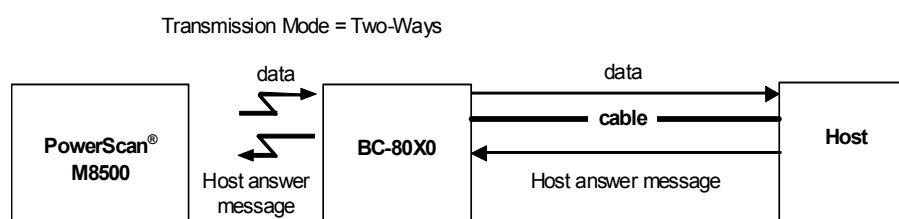

## Beeper Control for Radio Response

For M8500 series readers, the data entry good read tone normally results in two beeps; the first indicates that the reader has decoded the code; the second indicates whether BC-80X0 has received the data.

This can be changed according to the following selections:

- Normal: both good decode and good receptions are signaled (two beeps).
- Only Good Decode: only the first beep indicating a good read is signaled.
- Only Good Reception: only the second beep indicating a good reception is signaled.
- Off: Neither good read nor good reception beeps are signaled.

**For all configurations, any transmission errors will always be signaled.**

## Single Store

When single store mode is enabled, if the PowerScan<sup>®</sup> M8500 fails to transmit a code to the cradle, it enters a special operating mode that prevents the user from reading barcodes.

When such operating mode is entered, the trigger no longer enables barcode reading but is used to retry transmission itself for the number of attempts selected in configuration. Once the transmission is successful the reader returns to the standard mode. If transmission is not successful after the number of configured attempts, the code is discarded.

Single store may be useful if you often read codes at the limit of the coverage area and there is a chance that code transmission can fail. In such case single store allows you to move to a more favorable position or location (i.e. closer to the cradle) and retry transmission without the necessity of re-reading the code since it is already stored in the reader.

Conversely, if single store is disabled, and the user wants to retry transmission, the code must be read again, and therefore the attempt must be made from basically the same location. If the user gives up, he does not know if the transaction was successful. (Actually the transmission could have been successful but the cradle may have been unable to acknowledge the message). There are applications in which there is no risk of transmission failure. In such cases it may be better to disable single store so that the user perceives a more consistent behavior of the trigger in that it always corresponds to code reading.

## Batch Mode

This Operating Mode allows storing read codes in the internal reader memory. The stored codes are transmitted to the base station at a later time according to the type of batch mode selected.

Batch mode can be enabled either manually (normal batch mode) or automatically.

Normal batch mode temporarily suspends radio communication between reader and base station allowing codes to be stored in the reader on a FIFO (first in, first out) basis. This can be useful, for example, if codes must be read from a location where there is no radio network. Upon returning to the system working area, this mode requires reading the Start Normal Batch Transmission barcode to successively transmit the list of stored codes to the base station. The FIFO management assures that the first code read will be the first code to be transmitted to the base station.

The **Delete Batch Data** barcode allows canceling all barcode data stored in the reader.

Automatic batch mode allows codes to be stored in the reader on a FIFO basis whenever the reader is out of radio range. In this case radio communication is not suspended and transmission is attempted after each code read. If transmission cannot be successfully completed, then the code is added to the list. When the reader returns in range, transmission of the codes to the base station resumes automatically, according to the selected communication protocol, upon simply pressing and releasing the trigger or by successfully reading a new code.

In batch mode, the selected Transmission Mode determines the behavior of the reader at the time the list of codes is transmitted. If One-way mode is enabled, the codes are transmitted one after the other without interruption. In Two-way mode, after transmitting each code, the reader waits for the Host answer message to be shown on the display. Therefore, in Two-way transmission mode and normal batch mode, the Start Normal Batch Transmission barcode must be read after each code to continue; whereas with automatic batch mode, just pull and release the trigger after each code.

### 3-KEY MODEL

Each code is listed on the reader display together with its identifying position number and its total number of characters. The three keys under the display have the following function in batch mode:

	Key	Function
	▲ (left) Key	Scroll up in list
	ENTER (center) Key	Delete highlighted code
	▼ (right) Key	Scroll down in list

The code which has a transmission pending is shown on the display in reverse video, indicating that it cannot be deleted.

## Find Me

If enabled, after a timeout of a few minutes in which PowerScan<sup>®</sup> M8500 is not used, it enters stand-by mode and its green LED starts blinking in order to signal its location.

---

# Display Parameters

## Display Mode

The user can control the reader display behavior according to the following selections:

**Normal mode:** When a barcode is read with the reader:

- The code is sent to the Host.
- The reader display is NOT CLEARED. Therefore if any previous data was displayed on the reader screen it remains.
- There is no Local Echo to the reader display.

**Clear Display After Decode mode:** When a barcode is read with the reader:

- The code is sent to the Host.
- The reader display IS CLEARED. Therefore if any previous data was displayed on the reader screen it is cancelled and the screen remains blank.
- There is no Local Echo of the code to the reader display.

**Local Echo mode:** When a barcode is read with the reader:

- The code is sent to the Host.
- The reader display IS CLEARED.
- The code is also sent to the reader display (Local Echo).
- The cursor is positioned after the last printed character on the reader display.

HOST MESSAGES SENT TO THE READER are always written to the reader display.

## Default Parameters for POS Terminals

The default values of the RS-232 and Data Format parameters for POS terminals are listed in the following table:

	NIXDORF Mode A	FUJITSU	ICL Mode
RS-232 Group			
Baud Rate	9600	9600	9600
Parity	Odd	None	Even
Data Bits	8	8	8
Stop Bits	1	1	1
Handshaking	Hardware (RTS/CTS)	None	RTS always ON
ACK/NACK Protocol	Disabled	Disabled	Disabled
FIFO	Disabled	Enabled	Enabled
Inter-Character Delay	Disabled	Disabled	Disabled
RX Timeout	9.9 sec	2 sec	9.9 sec
Serial Trigger Lock	Disabled	Disabled	Disabled
Data Format Group			
Code Identifier	Custom	Custom	Custom
Header	No Header	No Header	No Header
Terminator	CR	CR	CR
Field Adjustment	Disabled	Disabled	Disabled
Code Length TX	Not Transmitted	Not Transmitted	Not Transmitted
Character Replacement	Disabled	Disabled	Disabled
Address Stamping	Disabled	Disabled	Disabled
Address Delimiter	Disabled	Disabled	Disabled
Time Stamping	Disabled	Disabled	Disabled
Time Delimiter	Disabled	Disabled	Disabled

The table below lists all the Code Identifiers available for the POS terminals:

CODE	NIXDORF Mode A	FUJITSU	ICL Mode
UPC-A	A0	A	A
UPC-E	C0	E	E
EAN-8	B	FF	FF
EAN-13	A	F	F
Code 39	M	None	C [code length]
Codabar	N	None	N [code length]
Code 128	K	None	L [code length]
Interleaved 2 of 5	I	None	I [code length]
Code 93	L	None	None
Industrial 2 of 5	H	None	H [code length]
UCC/EAN 128	P	None	L [code length]
MSI	O	None	None
GS1 DATABAR™	E	None	None
Other	None	None	None



# Chapter 6

## Message Formatting

### Standard Message Formatting

The system always provides scanner to host data communication using the following message formatting:

Output Message from PowerScan<sup>®</sup> M8500 or standard PowerScan<sup>®</sup> M8500 Stand-alone Towards Host

[Header] [Scanner\_Addr] [Scanner\_Addr\_delimiter] [Cradle\_Addr] [Cradle\_Addr\_delimiter]  
[Time stamp] [Ts\_delimiter] [Code ID] [Code Length] CODE [Terminator]

[Items in square brackets are optional.]

Output Message from PowerScan<sup>®</sup> M8500 STAR-System<sup>™</sup> Towards Host

[Time stamp] [Ts\_delimiter] [Header] [Code ID] [Code Length] CODE [Terminator]

[Items in square brackets are optional.]

For PowerScan<sup>®</sup> M8500 models with display, if the RS-232 interface is selected for communication between the Host and the BC-80X0 cradle, then the following additional communications between Host and Scanner can occur:

- The Host can send messages to any scanner associated with that cradle to control the Scanner's display, LEDs and beeper.
- The Scanner can send up to 3 user-defined characters to the Host using the 3 command keys on the Scanner.

### Messages from Host to Reader

The general format to enable the Scanner for a two-way communication is:

[Scanner\_Addr] [Scanner\_Addr\_delimiter] MESSAGE [CR]



If you have enabled the Scanner Address Stamping or the Scanner Address Delimiter, you **must** specify them in every message.

The format for other asynchronous messages is:

[Scanner\_Addr] [Scanner\_Addr\_delimiter] [DC2] MESSAGE [CR]

where DC2 is ASCII 0x12 (^R) character.

- If you have **not** enabled the Scanner Address Stamping or the Scanner Address Delimiter, you **must not** specify them. In this case all messages will be implicitly addressed to the 'binded' Scanner of the cradle directly connected to the serial line.
- The Scanner can only receive messages if two-way mode is enabled. (See "[Transmission Mode](#)" on page 171).
- Messages cannot start with '\$+' because they would be interpreted as a configuration command.
- You can send a message to the Scanner only while it is on. This happens when it has sent a message to the host and the radio timeout has not yet expired. (See "[Radio Protocol Timeout](#)" on page 170).
- If you want to control the Scanner's beeper from the host, you will also probably want to disable the good transmission beep that is emitted when the code is received from the cradle. (See "[Beeper Volume](#)" on page 119).

The message field can store plain text and escape sequences.

- Escape sequences are interpreted as commands.
- Plain text is directly printed on the display. If writing beyond the end of line, the display does not wrap automatically. Extra characters are ignored. Control characters are not interpreted (i.e. LF, FF, etc.).

## Cursor Control

<b>ESC [ n A</b>	Up <i>n</i> rows, no scroll
<b>ESC [ n B</b>	Down <i>n</i> rows, no scroll
<b>ESC [ n C</b>	Right <i>n</i> columns
<b>ESC [ n D</b>	Left <i>n</i> columns
<b>ESC [ G</b>	CR
<b>ESC [ r ; c H</b>	Move to row <i>r</i> , column <i>c</i> (ESC[1;1H is the upper left character position of the display)
<b>ESC D</b>	Down 1 row, with scroll
<b>ESC E</b>	CR and cursor down 1 row with scroll
<b>ESC M</b>	Up 1 row and scroll



- **Since CR is used as the message terminator, you must use ESC [ G or ESC E to print a CR.**
- **The cursor row position is not affected by the currently selected font. The display always has 4 rows, so when writing with the large font, actually two rows are written to: the current one and the one below it. You will need two ESC E commands to step from one row to the next when using the large font.**
- **The cursor column position is affected by the currently selected font. Therefore, column 6 is 36 pixels from the left border only if you last selected the 6x8 font; otherwise it could be 48 or 72 pixels from the left border.**

## Font Selection

<b>ESC [ 0 m</b>	Normal mode
<b>ESC [ 7 m</b>	Reverse mode
<b>ESC # 4</b>	Large font: subsequent characters are written on the current row and the row below it using the 12x16 font which allows for two rows of eight characters on the display.
<b>ESC # 5</b>	Normal font: subsequent characters are written using the 6x8 font, which allows for four rows of sixteen characters on the display.
<b>ESC # 7</b>	Medium font: subsequent characters are written using the 8x8 font, which allows for four rows of twelve characters on the display.

## Clearing Display

<b>ESC [ 0 K</b>	From cursor position to end of line inclusive
<b>ESC [ 1 K</b>	From beginning of line to cursor position (not inclusive)
<b>ESC [ 2 K</b>	Entire line
<b>ESC [ 0 J</b>	From cursor position to end of display inclusive
<b>ESC [ 1 J</b>	From beginning of display to cursor position (not inclusive)
<b>ESC [ 2 J</b>	Entire display; moves cursor to upper left corner on display

## LED and Beeper Control

<b>ESC [ 0 q</b>	Emit short High tone + short delay
<b>ESC [ 1 q</b>	Emit short Low tone + short delay
<b>ESC [ 2 q</b>	Emit long Low tone + short delay
<b>ESC [ 3 q</b>	Emit good read tone
<b>ESC [ 4 q</b>	Emit bad tx tone
<b>ESC [ 5 q</b>	Wait 100 ms
<b>ESC [ 6 q</b>	Turn on the green LED
<b>ESC [ 7 q</b>	Turn off the green LED
<b>ESC [ 8 q</b>	Turn on the red LED
<b>ESC [ 9 q</b>	Turn off the red LED

The LED control escape sequences are intended to activate the LEDs for short periods of time and can be used in combination with the Beeper. The LED and Beeper will be controlled by the system after the entire command sequence is interpreted.

### Example:

<b>ESC [ 6 q ESC [ 3 q ESC [ 7 q</b>	Turns on the green LED, emits a good read tone, and turns off the green LED.
<b>ESC [ 6 q ESC [ 5 q ESC [ 7 q</b>	Turns on the green LED for 100 ms and then turns off the green LED.

## Setting RTC

<b>ESC [ 0 p d d m m y y</b>	Set date to day, month, year
<b>ESC [ 1 p h h m m</b>	Set time to hours, minutes; seconds are automatically set to 00.

## Messages from SCANNER Command Keys

### PowerScan M8500 Keypad

The PowerScan® M8500 series scanners with display have 3 command keys that can each be associated with a character to send to the host.

By pressing the keys on the scanner, the associated character with its relative message formatting is sent to the Host. For example, keys can be used to select items from a menu sent to the scanner display by the application program.

The general format is:

[Header] [Scanner\_Addr] [Scanner\_Addr\_delimiter] ] [Cradle\_Addr] [Cradle\_Addr\_delimiter]  
 [Time stamp] [Ts\_delimiter] [Code ID] [Code Length] KeyID [Terminator]

[Items in square brackets are optional.]

The messages are handled by the system as if they were barcodes, that's why KeyID can have so many fields appended to it. If in your application there is some chance of reading a 1-char barcode identical to KeyID, the way you can distinguish between the two is to enable the Code ID: The KeyID is the only 1-character long EAN 8 code.

Refer to "Network Parameters" on page 158 for a complete description of the optional message fields in square brackets.

The default characters associated with each key (KeyID) are shown in the following table:

Default Key Identifiers		
	Key	KeyID
▲	(left) Key	'<'
ENTER	(center) Key	'='
▼	(right) Key	'>'

# Appendix A

## Technical Features

### Technical Features

#### PowerScan® M8500 Family Common Features

<b>Electrical Features</b>		
Battery Type	2150 Li-Ion battery pack	
Time of recharge	max. 4 hours with external power supply max. 10 hours with Host power	
Operating autonomy (continuous reading)	30,000 reads (typical)	
Display (Only available with some models)	LCD 4 lines x 16 chars Programmable font and backlight	
Indicators	Good Read LED green Good Read Spot green Beeper	
Radio Features	European Models	USA Models
Radio Frequency	433.92 MHz	910 MHz
Bit rate	19200 baud	36800 baud
Range (in open air)	exceed 50 m	exceed 30 m
System Configuration	BC-80X0 STARGATE™	
Max. number of devices per base station	32	
Max. number of devices in the same reading area	2000	
<b>Environmental Features</b>		
Operating Temperature	-10° to +50° C (+14° to +122° F)	
Storage Temperature	-20° to +70° C (-4° to +158° F)	
Humidity	0 to 95% NC	
Drop Resistance	2 m / 6.6 ft (over 50 drops to concrete)	
IP Sealing	IP65 (IP64 for models with display)	
<b>Mechanical Features</b>		
Weight (with batteries)	about 360 g (12.70 oz)	
Dimensions	212 x 109 x 71 mm (8.34 x 4.29 x 2.79 in)	
Material	Polycarbonate molded with rubber	
<b>Decoding Capability</b>		
1D	Interleaved 2 of 5, Code 39, Code 32, Code 128, EAN 128, Code93, UPC/EAN/JAN, Codabar, GS1 DataBar™	
2D	Aztec, PDF417, Micro PDF417, Macro PDF417, Maxicode, DataMatrix (ECC200), QR, Micro QR, Composite Codes	
Postal Codes	PLANET, Japan Post, Australia Post, Intelligent Mail Barcode, KIX Code, Royal Mail Code (RM4SCC)	

**PowerScan® M8500 Family Common Features (continued)**

<b>Optical Features</b>	
Sensor	1280 x 1024 pixel element, 2D CMOS Array
Illuminator	LED array
Wavelength	In the range 630 ~ 670 nm
LED Safety Class	Class 1 to EN 60825-1
Aiming System	Visible Laser Diode
Wavelength	650 nm
Laser Safety Class	Class 2 - EN 60825-1; Class II CDRH
Ambient light	0 - 100000 lux

**PowerScan® M8500™**

<b>Optical Features</b>			
Focus distance	140 mm		
Field of view	28°(H) x 23°(V)		
Horizontal field of view at distance ( <b>d</b> ) in mm	0.52 <b>d</b> + 15		
Vertical field of view at distance ( <b>d</b> ) in mm	0.42 <b>d</b> + 12		
Max Resolution	<b>Linear codes - mm (mils)</b>	<b>PDF417 - mm (mils)</b>	<b>Datamatrix - mm (mils)</b>
	0.10 (4)	0.10 (4)	0.17 (6.6)
<b>Depth of field*</b>			
<b>1D (linear):</b>	<b>X-dimension mm (mils)</b>	<b>DOF cm (in)</b>	
Code39	0.13 (5)	7.5 to 15.5 (2.95 to 6.10)	
	0.5 (20)	5.5 to 36.5 (2.17 to 14.37)	
EAN13	0.33 (13)	5.0 to 27 (1.97 to 10.63)	
<b>2D:</b>	<b>X-dimension mm (mils)</b>	<b>DOF cm (in)</b>	
PDF417	0.13 (5)	8.0 to 18.5 (3.15 to 7.28)	
	0.25 (10)	4.0 to 25.5 (1.57 to 10.04)	
QR	0.19 (7.5)	8.0 to 16.5 (3.15 to 6.5)	
	0.25 (10)	7.0 to 19.5 (2.76 to 7.68)	
DataMatrix	0.19 (7.5)	8.0 to 16.5 (3.15 to 6.5)	
	0.25 (10)	7.0 to 19.5 (2.76 to 7.68)	
Skew	±40°		
Pitch	±35°		
Rotation	360°		
Print Contrast (Min.)	15%		

\* Reading distances are measured from the nose of the reader.  
 NOTE: Typical performance at 20°C / 68°F on high quality bar codes.

**PowerScan® M8500™ HD**

<b>Optical Features</b>			
Focus distance	65 mm		
Field of view	27° (H) x 22° (V)		
Horizontal field of view at distance ( <b>d</b> ) in mm	0.50 <b>d</b> + 13		
Vertical field of view at distance ( <b>d</b> ) in mm	0.40 <b>d</b> + 10		
Max Resolution	Linear codes - mm (mils)	PDF 417 – mm (mils)	Datamatrix – mm (mils)
	0.05 (2 mils)	0.08 (3 mils)	0.10 (4 mils)
<b>Depth of field*</b>			
<b>1D (linear):</b>	<b>X-dimension mm (mils)</b>	<b>DOF cm (in)</b>	
Code39	0.08 (3)	4.5 to 8.0 (1.77 to 3.15)	
	0.13 (5)	3.5 to 9.5 (1.38 to 3.74)	
	0.51 (20)	6.0 to 18.5 (2.36 to 7.28)	
EAN13	0.33 (13)	5.0 to 14 (1.97 to 5.51)	
<b>2D:</b>	<b>X-dimension mm (mils)</b>	<b>DOF cm (in)</b>	
PDF417	0.08 (3)	5.0 to 8.5 (1.97 to 3.35)	
	0.13 (5)	4.5 to 9.5 (1.77 to 3.74)	
	0.25 (10)	3.0 to 13.0 (1.18 to 5.12)	
QR	0.10 (4)	5.5 to 7.5 (2.17 to 2.95)	
	0.19 (7.5)	5.0 to 8.0 (1.97 to 3.15)	
	0.25 (10)	4.5 to 9.5 (1.77 to 3.74)	
DataMatrix	0.10 (4)	5.5 to 7.5 (2.17 to 2.95)	
	0.19 (7.5)	5.0 to 8.0 (1.97 to 3.15)	
	0.25 (10)	4.5 to 9.5 (1.77 to 3.74)	
Skew	±40°		
Pitch	±35°		
Rotation	360°		
Print Contrast (Min.)	23%		

Reading distances are measured from the nose of the reader.  
 NOTE: Typical performance at 20°C / 68°F on high quality bar codes.



**PowerScan® M8500™ WA**

<b>Optical Features</b>			
Focus distance	110 mm		
Field of view	57° x 46°		
Horizontal field of view at distance (d) in mm	1.09d + 38		
Vertical field of view at distance (d) in mm	0.85d + 30		
Max Resolution	Linear codes - mm (mils)	PDF 417 - mm (mils)	Datamatrix - mm (mils)
	0.13 (5 mils)	0.13 (5 mils)	0.19 (7.5 mils)
<b>Depth of field*</b>			
<b>1D (linear):</b>	<b>X-dimension mm (mils)</b>	<b>DOF cm (in)</b>	
Code39	0.13 (5)	2.5 to 10.0 (0.98 to 3.94)	
	0.51 (20)	1.5 to 32 (0.59 to 12.60)	
EAN 13	0.33 (13)	1.5 to 26.0 (0.59 to 10.24)	
<b>2D:</b>	<b>X-dimension mm (mils)</b>	<b>DOF cm (in)</b>	
PDF417	0.13 (5)	3.0 to 10.5 (1.18 to 4.13)	
	0.25 (10)	1.5 to 21.5 (0.59 to 8.46)	
QR	0.19 (7.5)	5.5 to 8.5 (2.17 to 3.35)	
	0.25 (10)	3.0 to 12.5 (1.18 to 4.92)	
DataMatrix	0.19 (7.5)	5.5 to 8.5 (2.17 to 3.35)	
	0.25 (10)	3.0 to 12.5 (1.18 to 4.92)	
Skew	±40°		
Pitch	±35°		
Rotation	360°		
Print Contrast (Min.)	15%		

Reading distances are measured from the nose of the reader.

NOTE: Typical performance at 20°C / 68°F on high quality bar codes.

## BC-80X0 / C-8000

Electrical and General Features		
Supply Voltage		
External Power	10 to 30 VDC	
Host Power	5 VDC ±10%	
Power Consumption		
External Power	max. 10 W (charging)*	
Host Power	max. 500 mA (charging)	
Indicators	Ext. Power /Data <b>yellow</b> LED Host Power/Data <b>yellow</b> LED Reader batt. state <b>green/red</b> LED Aux. batt. state <b>green/red</b> LED (BC-8000/C-8000 only) <b>beeper</b>	
Recharge Time		
External Power	max. 4 hours with 2150 mAh Li-Ion battery	
Host Power	max. 10 hours with 2150 mAh Li-Ion battery	
Host Interfaces	BC-80X0	C-8000
RS-232	300 to 38400 baud	9600 baud
WEDGE	IBM AT or PS/2, XT, PC Notebook, IBM SURE1, IBM 3153, 31xx, 32xx, 34xx, 37xx terminals, Wyse terminals, Digital VT terminals, Apple ADB Bus supported	Not supported
PEN Emulation	Selectable minimum pulse from 200 µS to 1.2 mS	Not supported
USB	USB-KBD, USB-KBD-ALT-MODE, USB-KBD APPLE, USB-COM, USB-IBM-Table Top, USB-IBM-Hand Held	USB-COM
Environmental Features		
Working Temperature	-20° to +50 °C / -4° to +122 °F**	
Storage Temperature	-20° to +70 C / -4° to +158° F	
Humidity	90% non condensing	
Protection	IP40	
Mechanical Features		
Weight without cable	about 380 g / 13.4 oz	
Dimensions (without antenna)	204 x 108 x 95 mm / 9.44 x 4.25 x 3.74 in	
Material	ABS	

\* Having a switching regulator inside, the BC-80X0 and C-8000 draw the same power, regardless of the supply voltage. i.e. as the input voltage increases the current drawn decreases.

\*\* Batteries must be charged at a temperature ranging from 0° to +40 °C / +32° to +104 °F.

## System and Radio Features

<b>Radio Features</b>	<b>European Models</b>	<b>USA Models</b>
Radio Frequency	433.92 MHz	910 MHz
Bit Rate	19200	36800
Range (in open air)	exceed 50 m	exceed 30 m
<b>System Configurations</b>	<b>BC-8000 model only</b>	<b>STARGATE™</b>
Maximum number of devices per base station	32	255
Maximum number of devices in the same reading area	2000	
Maximum number of base stations in network	16 (including cradle Master)	

## Indicators

### PowerScan® M8500 LED Indicators

The PowerScan® M8500 family uses green LED indicators to signal the following reader functions:

STATUS	BEHAVIOR
Power ON	At power-on, the LEDs blink briefly, then light up for 2 seconds to signal the power supply is present.
Normal Function	The LED lights up after a good decoding and will switch off only at the next trigger press.

### Beeper

The PowerScan® M8500 basic software provides beeper signals for good/wrong reading and for indicating errors. Its tone, volume and duration can be directly configured by using the codes given in the PowerScan® M8500 Reference Manual available on the website.

The application program can also manage the beeper (User Defined Beeper) when the reader is controlled by a Host PC. It is possible to activate the beeper by sending a command from the Host to the reader via the current communication interface.

Symbol	Meaning
L	low tone
M	medium tone
H	high tone

### POWERSCAN® M8500 READER START-UP

Beeper	Meaning
L L L L	Parameters loaded correctly
H H H H long tones	Parameter loading error, reading or writing error in the non volatile memory
H L H L	Hardware error in EEPROM
H M L	reader correctly initialized

**POWERSCAN® M8500 READER CONFIGURATION**

Beeper	Meaning
HHH H	Correct entry or exit from Configuration mode
L	Good read of a command
M L	Enter configuration
M L M L	Exit configuration
short H	Good read of a command
long L	Command read error

**POWERSCAN® M8500 POWER**

Beeper	LED	Meaning
10 short H	10 short blinks	Low Battery
H M LL		Power off
10 short H	10 short blinks	Low battery
H M L	off	Power off

**POWERSCAN® M8500 BIND & JOIN COMMANDS**

Beeper	LED	Meaning
	Blinking	Command accepted; reader ready to be inserted into the cradle
L		Success
H L long tones		Failure
H M L	off	Power off
no sound	blinking	Command accepted; reader ready to be inserted into the cradle
H	off	BIND command succeeded
M L H M L M L	off	JOIN command succeeded
L	off	BIND or JOIN command not succeeded

**Good Read Spot**

A green Good-Read Spot will be projected in the field of view when the reading is successful.

**BC-80X0/C-8000 POWER/COMMUNICATION**

<b>Aux LED</b>	<b>Host LED</b>	<b>Meaning</b>
<b>Yellow</b>	<b>Yellow</b>	
OFF	OFF	Device off
ON		Power applied through an external power supply
	ON	Power applied through the Host
Flashing	Flashing	Transmission over the Host port

**BC-80X0/C-8000 CHARGE STATUS**

<b>Reader LED</b>			<b>Meaning</b>
<b>Red</b>	<b>Green</b>	<b>Beeper</b>	
OFF	OFF		No reader battery inserted
ON			Reader battery in charge
	ON	single beep	Reader battery completely charged
Flashing orange			Reader battery fault
Alternating red/green		repetitive beep	Charging out of temperature range, over-current or over-voltage conditions
Alternating red/green every 30 seconds		beep every 30 seconds	Reader not correctly inserted onto cradle, no charging takes place

<b>Spare LED (not for BC-8010)</b>			<b>Meaning</b>
<b>Red</b>	<b>Green</b>	<b>Beeper</b>	
OFF	OFF		No Spare battery inserted in the SBS-3000 slot
ON			Spare battery in charge
	ON		Spare battery completely charged
Flashing orange			Spare battery fault
Alternating red/green		repetitive beep	Charging out of temperature range, over-current or over-voltage conditions
Alternating red/green every 30 seconds		beep every 30 seconds	Spare battery not correctly inserted into SBS-3000, no charging takes place

## Default Settings

Configuration Field	Default Setting
<b>RS-232 Communication</b>	
Baud Rate	115200
Parity, Data Bits, Stop Bits	No parity; 8 Data bits; 1 Stop bit
Handshake	None
ACK/NACK Protocol	None
FIFO	Enabled
Intercharacter Delay	0
Intercode Delay	0
RX Timeout	10 seconds
Serial Trigger Lock	Disabled
Serial Trigger Lock Disable Character	NUL
Serial Trigger Lock Enable Character	NUL
<b>USB COM Emulation</b>	
Handshake	None
ACK/NACK Protocol	None
FIFO	Enabled
Intercharacter Delay	0
Intercode Delay	0
RX Timeout	10 seconds
<b>USB Keyboard Emulation</b>	
FIFO	Enabled
Intercharacter Delay	0
Intercode Delay	0
*Keyboard Nationality	USA
*Keyboard Speed	Normal
<b>WEDGE-Communication</b>	
*Keyboard Nationality	USA
CapsLock	OFF
CapsLock Auto-Recognition	ON
NumLock	OFF
Intercharacter Delay	0
Intercode Delay	0
<b>IBM USB Interface DEFAULT SETTINGS</b>	
device usage	Handheld

\*The default values of these parameters are set when reading the interface selection.

<b>Data Format-Symbology Independent Parameters</b>	
Code Identifier	Disabled
Custom Code Identifier	Disabled
Code Length	Disabled
*Header	No headers
*Terminator	CR and LF terminators for RS-232, USB BULK, USB COM, USB Generic HID ENTER terminator for Wedge, USB Kbd
<b>Data Format-Symbology Dependent Parameters</b>	
Symbology Specific Format	Select All
Header Symbology	No headers
Terminator Symbology	No terminators
Symbology Character Substitution	No character to substitute
Symbology Character Deletion	No character to delete
<b>Data Format-Concatenation</b>	
Concatenation	Disabled
Define Concatenation	2 EAN/UPC codes concatenated
Set First Concatenated Code Length	000 = any length
Set Second Concatenated Code Length	000 = any length
Set Third Concatenated Code Length	000 = any length
Set Fourth Concatenated Code Length	000 = any length
Concatenation with Intercode Delay	Disabled
Concatenation Timeout	10 seconds
Concatenation Failure Transmission	Tx codes causing failure
Transmission after Timeout	No code transmission
Concatenation Result Code ID	No code Identifier
<b>Advanced Formatting</b>	
Format enable/disable	Disabled
<b>Camera Control</b>	
Exposure Mode	Automatic, based on entire image
<b>Code Selection</b>	
Issue Identical Codes	Enabled

\*The default values of these parameters are set when reading the interface selection.

<b>EAN/UPC</b>	
Selection	Enabled
Add-On	Disabled
UPCE Expansion	Disabled
<b>Code 39</b>	
Selection	Enabled - no check digit
Code39 Full ASCII	Disabled
Code Length Check	Disabled
Minimum Length	001
Maximum Length	255
Start/Stop Character	Disabled
<b>Code 32</b>	
Selection	Disabled



<b>Interleaved 2 of 5</b>	
Selection	Disabled
Code Length Check	Disabled
Minimum Length	014
Maximum Length	255
<b>Codabar</b>	
Selection	Disabled
Code Length Check	Disabled
Minimum Length	001
Maximum Length	255
<b>Code 128</b>	
Code128 Selection	Enabled
Code Length Check	Disabled
Minimum Length	001
Maximum Length	255
<b>EAN 128</b>	
Selection	Disabled
Code Length Check	Disabled
Minimum Length	001
Maximum Length	255
<b>Code 93</b>	
Selection	Disabled
Code Length Check	Disabled
Minimum Length	001
Maximum Length	255
<b>PDF417</b>	
Selection	Enabled
Option	Macro PDF417 Buffered Mode
Micro PDF417	Disabled
<b>GS1 DataBar™ Family</b>	
GS1 DataBar Expanded	Disabled
GS1 DataBar Limited	Disabled
GS1 DataBar Omnidirectional	Disabled
GS1 DataBar Expanded Stacked	Disabled
GS1 DataBar Stacked	Disabled
<b>Data Matrix</b>	
Selection	Enabled - normal & inverted
Rectangular Style	Enabled
Minimum Code Length	0001
Maximum Code Length	3600
<b>QR</b>	
Selection	Enabled
<b>microQR</b>	
Selection	Disabled
<b>Postal Codes</b>	
Selection	Disabled
<b>Australian Table</b>	
Selection	N Table

<b>IMB</b>	
Selection	Disabled
<b>Maxicode</b>	
Maxicode Mode 0	Disabled
Maxicode Mode 1	Disabled
Maxicode Mode 2	Disabled
Maxicode Mode 3	Disabled
Maxicode Mode 4	Disabled
Maxicode Mode 5	Disabled
Maxicode Mode 6	Disabled
<b>Aztec</b>	
Selection	Disabled
<b>Composite Codes</b>	
Selection	Disabled
Discard Linear Part	Enabled
<b>Reading Parameters</b>	
Trigger Mode	Trigger level
Trigger Type	Normal trigger
Flash ON	2 sec
Flash OFF	2 sec
Beeper Tone	Tone 1
Beeper Volume	High volume
Beeper Duration	50 ms
Reads per Cycle	One read per cycle
Scan Timeout	5 sec
User Defined Beeper Tone	Tone 1
User Defined Beeper Volume	High Volume
User Defined Beeper Duration	100 ms
Codes per Scan	One code per scan
Central Code Transmission	Disabled
Order by Code Length	Disabled
Order by Code Symbology	Disabled
Autoscan Mode	Disabled
Autoscan Aiming System	Enabled
Autoscan Hardware Trigger	Enabled
Autoscan Illumination System	Disabled
Safety Time	500 ms (if Autoscan mode or Software trigger type is selected and the Multiple Reads per Cycle option is enabled).
<b>Radio Communication</b>	
Radio Protocol Timeout	2s
Radio RX Timeout	disabled
Transmission Mode	one-way
Beeper Control for Radio Response	normal
Find Me	enabled
<b>Display and Keyboard</b>	
Display Mode	local echo
Backlight	on
Keypad	enabled with default keymap '<' '=' '>'

# Appendix B

## Host Configuration Strings

In this section we provide a description of how to modify the device configuration using serial strings sent from the Host.



**This method requires the RS-232 or USB-Com interface.**

The device configuration can be changed by receiving commands from the Host through the serial interface. When this method is used, the programming sequence format is the following:

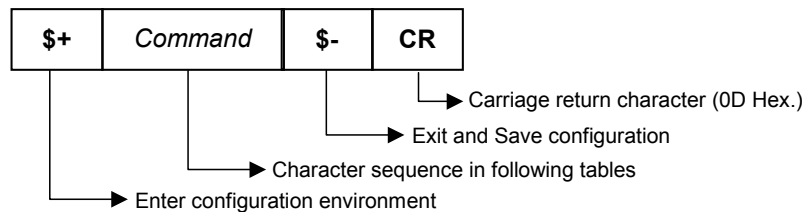

### Example:

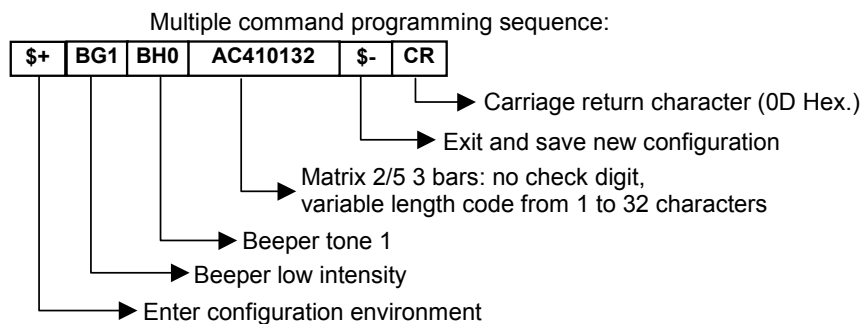

Each configuration parameter setting removes the condition previously active for that parameter.



**The device buffer can contain about 400 characters. If your programming string goes over this value, you must split it into separate groups and send each group after a delay of at least 3 seconds to give the reader time to empty the buffer and interpret the commands.**

## Serial Configuration Strings

SPECIAL CONFIGURATION COMMANDS	
DESCRIPTION	STRING
Enter Configuration	\$+
Exit and Save Configuration	\$-
Restore Default	\$\$*
Transmit Software Release (not for PEN emulation)	\$\$!
Transmit Device Configuration in ASCII (not for PEN emulation)	\$\$&
Set Custom Default	\$\$0
Restore Custom Default	\$\$1

These commands do not require \$-.

INTERFACE SELECTION			
DESCRIPTION		STRING	
RS-232	Standard	CP0	
	ICL Mode	CM0	
	Fujitsu	CM1	
	Nixdorf Mode A	CM2ECO	
WEDGE	for IBM AT	CP500	
	for IBM Terminals: 31xx, 32xx, 34xx, 37xx; make-break keyboard	CP501	
	for IBM Terminals: 31xx, 32xx, 34xx, 37xx; make-only keyboard	CP502	
	Keyboard Type for IBM Terminals 31xx, 32xx, 34xx, 37xx	typewriter	FK0
		advanced	FK1
	for IBM XT	CP503	
	for IBM Terminal 3153	CP504	
	for IBM PC Notebook	CP505	
	for IBM SURE1	CP506	
	for IBM AT - ALT mode	CP507	
	for IBM PC Notebook - ALT mode	CP508	
	for Wyse Terminal - ANSI Keyboard	CP509	
for Wyse Terminal - PC Keyboard	CP510		
for Wyse Terminal - ASCII Keyboard	CP511		
for Wyse Terminal - VT220 style Keyboard	CP514		
for Digital Terminals VT2xx/3xx/4xx	CP512		
PEN EMULATION		CP6	
USB	USB-KBD	UA03	
	USB-KBD-ALT-MODE	UA04	
	USB-KBD-APPLE	UA05	
	USB-COM	UA02	
	USB-IBM-Table Top	UA00	
	USB-IBM-Hand Held	UA01	

RS-232		
DESCRIPTION		STRING
Baud Rate	300	<b>CD1</b>
	600	<b>CD2</b>
	1200	<b>CD3</b>
	2400	<b>CD4</b>
	4800	<b>CD5</b>
	9600	<b>CD6</b>
	19200	<b>CD7</b>
	38400	<b>CD8</b>
Parity	none	<b>CC0</b>
	even	<b>CC1</b>
	odd	<b>CC2</b>
Data Bits	7	<b>CA0</b>
	8	<b>CA1</b>
	9	<b>CA2</b>
Stop Bits	1	<b>CB0</b>
	2	<b>CB1</b>
Handshaking	disable	<b>CE0</b>
	RTS/CTS	<b>CE1</b>
	XON/XOFF	<b>CE2</b>
	RTS always On	<b>CE3</b>
ACK/NACK Protocol	disable	<b>ER0</b>
	enable	<b>ER1</b>
FIFO	disable	<b>EC0</b>
	enable	<b>EC1</b>
Inter-character Delay ( <i>ms</i> )		<b>CK00 - CK99</b>
RX Timeout ( <i>100 ms</i> )		<b>CL00 - CL99</b>
Serial Trigger Lock	disable	<b>CR0</b>
	enable and select characters	<b>CR1ab</b>

**a** = Hex values representing an ASCII character from **00** to **FE** enabling the device trigger.

**b** = HEX values representing an ASCII character from **00** to **FE** inhibiting the device trigger.

<b>USB</b>		
<b>DESCRIPTION</b>		<b>STRING</b>
<b>USB-COM</b>		
Handshaking	disable	<b>CE0</b>
	RTS/CTS	<b>CE1</b>
	XON/XOFF	<b>CE2</b>
	RTS always ON	<b>CE3</b>
ACK/NACK Protocol	disable	<b>ER0</b>
	enable	<b>ER1</b>
FIFO	disable	<b>EC0</b>
	enable	<b>EC1</b>
Inter-character Delay ( <i>ms</i> )		<b>CK00 - CK99</b>
RX Timeout ( <i>100 ms</i> )		<b>CL00 - CL99</b>
Serial Trigger Lock	disable	<b>CR0</b>
	enable	<b>CR1<sup>a</sup>b</b>
<b>USB-KBD</b>		
Keyboard Nationality	Belgian	<b>FJ7</b>
(not for USB-KBD-ALT-MODE)	English (UK)	<b>FJ4</b>
	French	<b>FJ2</b>
	German	<b>FJ3</b>
	Italian	<b>FJ1</b>
	Spanish	<b>FJ6</b>
	Swedish	<b>FJ5</b>
	USA	<b>FJ0</b>
Keyboard Nationality	Japanese	<b>FJ8</b>
(IBM AT compatible only)	Russian (Latin)	<b>FJ9</b>
	Russian (Cyrillic)	<b>FJA</b>
	Hungarian	<b>FJB</b>
	Slovenian, Croatian, Serbian (Latin)	<b>FJC</b>
	Romanian	<b>FJD</b>
	Czech Republic	<b>FJE</b>
FIFO	disable	<b>EC0</b>
	enable	<b>EC1</b>
Delays	Inter-Character ( <i>ms</i> )	<b>CK00 - CK99</b>
	Inter-Code ( <i>s</i> )	<b>FG00 - FG99</b>
USB Keyboard Speed	normal	<b>UT10</b>
	fast	<b>UT01</b>

**a** = Hex values representing an ASCII character from **00** to **FE** enabling the device trigger.  
**b** = HEX values representing an ASCII character from **00** to **FE** inhibiting the device trigger.

<b>WEDGE</b>		
<b>DESCRIPTION</b>		<b>STRING</b>
Keyboard Nationality	Belgian	<b>FJ7</b>
	English (UK)	<b>FJ4</b>
	French	<b>FJ2</b>
	German	<b>FJ3</b>
	Italian	<b>FJ1</b>
	Spanish	<b>FJ6</b>
	Swedish	<b>FJ5</b>
	USA	<b>FJ0</b>
Keyboard Nationality	Japanese	<b>FJ8</b>
(IBM AT compatible only)	Russian (Latin)	<b>FJ9</b>
	Russian (Cyrillic)	<b>FJA</b>
	Hungarian	<b>FJB</b>
	Slovenian, Croatian, Serbian (Latin)	<b>FJC</b>
	Romanian	<b>FJD</b>
	Czech Republic	<b>FJE</b>
Caps Lock	caps Lock ON	<b>FE1</b>
	caps Lock OFF	<b>FE0</b>
Caps Lock Auto-Recognition	disable	<b>FP0</b>
(IBM AT compatible only)	enable	<b>FP1</b>
Num Lock	toggle num lock	<b>FL1</b>
	num lock unchanged	<b>FL0</b>
Delays	Inter-Character ( <i>ms</i> )	<b>CK00 - CK99</b>
	Inter-Code ( <i>s</i> )	<b>FG00 - FG99</b>
Control Character Emulation	Ctrl + Shift + Key	<b>FO0</b>
	Ctrl + Key	<b>FO1</b>

<b>PEN</b>		
<b>DESCRIPTION</b>		<b>STRING</b>
Operating Mode	interpret (does not require \$+ or \$-)	<b>\$]</b>
	transparent (does not require \$+ or \$-)	<b>\$\$[</b>
Minimum Output Pulse	200 $\mu$ s	<b>DG0</b>
	400 $\mu$ s	<b>DG1</b>
	600 $\mu$ s	<b>DG2</b>
	800 $\mu$ s	<b>DG3</b>
	1 ms	<b>DG4</b>
	1.2 ms	<b>DG5</b>
Conversion to Code 39 and Code 128	disable conversion to Code 39 (D series only)	<b>DA0</b>
	enable conversion to Code 39	<b>DA1</b>
	enable conversion to Code 128 (M series only)	<b>DA2</b>
Output Level	normal	<b>DD0</b>
	inverted	<b>DD1</b>
Idle Level	normal	<b>DE0</b>
	inverted	<b>DE1</b>
Overflow	narrow overflow	<b>DH0</b>
	medium overflow	<b>DH1</b>
	wide overflow	<b>DH2</b>
Inter-block Delay (100 ms)		<b>CK00-CK99</b>

<b>NETWORK</b>		
<b>DESCRIPTION</b>		<b>STRING</b>
RS-485 Network	Disable Network	<b>RZ0</b>
	Enable RS-485 Slave	<b>RZ1</b>
	Enable RS-485 Master	<b>RZ2</b>
Slave Address Range	Minimum Address	<b>JB0000-1999</b>
	Maximum Address	<b>JC0000-1999</b>
Network Baud Rate	9600	<b>JE0</b>
	19200	<b>JE1</b>
	38400	<b>JE2</b>
Network Warning Message	not transmitted	<b>JG0</b>
	transmitted	<b>JG1</b>
Transmission Warning Message	not transmitted	<b>JH0</b>
	transmitted	<b>JH1</b>
Master Header	no header	<b>JA00</b>
	one character	<b>JA01x</b>
	two characters	<b>JA02xx</b>
	three characters	<b>JA03xxx</b>
	four characters	<b>JA04xxxx</b>
	five characters	<b>JA05xxxxx</b>
	six characters	<b>JA06xxxxxx</b>
	seven characters	<b>JA07xxxxxxx</b>
	eight characters	<b>JA08xxxxxxxx</b>
Master Terminator	no terminator	<b>JA10</b>
	one character	<b>JA11x</b>
	two characters	<b>JA12xx</b>
	three characters	<b>JA13xxx</b>
	four characters	<b>JA14xxxx</b>
	Five characters	<b>JA15xxxxx</b>
	six characters	<b>JA16xxxxxx</b>
	seven characters	<b>JA17xxxxxxx</b>
	eight characters	<b>JA18xxxxxxxx</b>

**x** = Hex value from **00** to **FE** representing an ASCII character



DATA FORMAT		
NOT FOR PEN EMULATION INTERFACES		
DESCRIPTION		STRING
Code Identifier	disable	<b>EB0</b>
	Datalogic standard	<b>EB1</b>
	AIM standard	<b>EB2</b>
	custom	<b>EB3</b>
Custom Code Identifier		<b>EHabc</b>
Headers	no header	<b>EA00</b>
	one character	<b>EA01x</b>
	two characters	<b>EA02xx</b>
	three characters	<b>EA03xxx</b>
	four characters	<b>EA04xxxx</b>
	five characters	<b>EA05xxxxx</b>
	six characters	<b>EA06xxxxxx</b>
	seven characters	<b>EA07xxxxxxxx</b>
	eight characters	<b>EA08xxxxxxxxx</b>
Terminators	no terminator	<b>EA10</b>
	one character	<b>EA11x</b>
	two characters	<b>EA12xx</b>
	three characters	<b>EA13xxx</b>
	four characters	<b>EA14xxxx</b>
	five characters	<b>EA15xxxxx</b>
	six characters	<b>EA16xxxxxx</b>
	seven characters	<b>EA17xxxxxxxx</b>
	eight characters	<b>EA18xxxxxxxxx</b>

**a** = ASCII character.

**b, c, x** = HEX values representing an ASCII character.

**a** = ASCII character of the DATALOGIC STANDARD Code Identifier from the table in [Appendix D](#).

**b** = Hex value of the first Custom Code Identifier character from **00** to **FD**;

**FF** = disable Code Identifier

**c** = Hex value of the second Custom Code Identifier character from **00** to **FD**;

**FF** = disable second character of Custom Code Identifier

**x** = Hex value from **00** to **FE**

DATA FORMAT (continued)		
NOT FOR PEN EMULATION INTERFACES		
DESCRIPTION		STRING
Code Length Tx	not transmitted	<b>EE0</b>
	transmitted in variable-digit format	<b>EE1</b>
	transmitted in fixed 4-digit format	<b>EE2</b>
Field Adjustment	disable	<b>EF0</b>
	right addition	<b>EFa0d</b>
	left addition	<b>EFa1d</b>
	right deletion	<b>EFa2d</b>
	left deletion	<b>EFa3d</b>
Field Adjustment Character		<b>EGe</b>
Character Replacement	disable character replacement	<b>EO0</b>
	first character replacement	<b>EO1afg</b>
	second character replacement	<b>EO2afg</b>
	third character replacement	<b>EO3afg</b>
Address Stamping	disable reader address stamping	<b>RU0</b>
	enable reader address stamping	<b>RU1</b>
	disable cradle address stamping	<b>RW0</b>
	enable cradle address stamping	<b>RW1</b>
Address Delimiter	disable reader address delimiter	<b>RV0</b>
	enable reader address delimiter and select character	<b>RV1h</b>
	disable cradle address delimiter	<b>RY0</b>
	enable cradle address delimiter and select character	<b>RY1h</b>
Time Stamping	disable	<b>IL0</b>
	hour/minutes/seconds/month/day/year	<b>IL1</b>
	hour/minutes/seconds/day/month/year	<b>IL2</b>
	hour/minutes/seconds	<b>IL3</b>
	month/day/year	<b>IL4</b>
	day/month/year	<b>IL5</b>
Time Stamping Delimiter	disable time stamping delimiter	<b>IM0</b>
	enable time stamping delimiter and select character	<b>IM1h</b>

**a** = ASCII character.

**d** = a number from the Hex/Numeric Table

**e, f, g, h** = HEX values representing an ASCII character

**a** = ASCII character of the DATALOGIC STANDARD Code Identifier from the table in [Appendix D](#).

**d** = a number in the range **01-32** from the Hex/Numeric Table

**e** = Hex value from **00** to **FE**

**f** = Hex value of the character to be replaced from **00** to **FE**

**g** = Hex value of the new character to insert from **00** to **FE**

**FF** = replace with no new character (remove character)

**h** = a HEX value in the range from **00 - FE** representing the ASCII character.

<b>CODE SELECTION</b>		
<b>DESCRIPTION</b>		<b>STRING</b>
Disable All Symbologies		<b>AZA0</b>
Disable All Linear Symbologies		<b>AXA0</b>
Disable All 2D Symbologies		<b>AYA0</b>
Issue Identical Codes	disabled	<b>AWB0</b>
	enabled	<b>AWB1</b>
<b>LINEAR SYMBOLOGIES</b>		
UPC/EAN/JAN	disabled	<b>AEA0</b>
	enabled	<b>AEA1</b>
	Add-on	disabled
		enabled
	UPCE extension	disabled
		enabled
Code 39	Standard	disabled
		no check digit control
		check digit control without transmission
		check digit control and transmission
	Full ASCII	disabled
		enabled
	Code Len Check	disabled
		enabled
	Minimum Code Length	<b>ABD<i>d</i></b>
	Maximum Code Length	<b>ABE<i>d</i></b>
	Start/Stop Char TX	enabled
		disabled
Code 32	disabled	<b>ABL0</b>
	enabled	<b>ABL1</b>

***d*** = a number from the HEX/Numeric Table

***d*** = a number in the range 001-255

<b>CODE SELECTION - LINEAR SYMBOLOGIES</b>			
<b>DESCRIPTION</b>		<b>STRING</b>	
Interleaved 2/5	disabled	<b>ACA0</b>	
	enabled – no check digit control	<b>ACA1</b>	
	enabled – check digit control and without transmission	<b>ACA2</b>	
	enabled – check digit control and transmission	<b>ACA3</b>	
	Code Len Check	disabled	<b>ACB0</b>
	enabled	<b>ACB1</b>	
	Minimum Code Length	<b>ACCd</b>	
	Maximum Code Length	<b>ACDd</b>	
Codabar	disabled	<b>ADA0</b>	
	enabled – no check digit control	<b>ADA1</b>	
	enabled – check digit control and without transmission	<b>ADA2</b>	
	enabled – check digit control and transmission	<b>ADA3</b>	
	Code Len Check	disabled	<b>ADB0</b>
	enabled	<b>ADB1</b>	
	Minimum Code Length	<b>ADCd</b>	
	Maximum Code Length	<b>ADDd</b>	
Code 128	disabled	<b>AAA0</b>	
	enabled	<b>AAA1</b>	
	Code Len Check	disabled	<b>AAB0</b>
		enabled	<b>AAB1</b>
		Minimum Code Length	<b>AACd</b>
	Maximum Code Length	<b>AADd</b>	
EAN 128	disabled	<b>AOA0</b>	
	enabled	<b>AOA1</b>	
	Code Len Check	disabled	<b>AOB0</b>
		enabled	<b>AOB1</b>
		Minimum Code Length	<b>AOCd</b>
	Maximum Code Length	<b>AODd</b>	
Code 93	disabled	<b>AFA0</b>	
	enabled	<b>AFA1</b>	
	Code Len Check	disabled	<b>AFB0</b>
		enabled	<b>AFB1</b>
		Minimum Code Length	<b>AFCd</b>
	Maximum Code Length	<b>AFDd</b>	
GS1 DataBar™ Family	GS1 DataBar Expanded	disabled	<b>AMA0</b>
		enabled	<b>AMA1</b>
	GS1 DataBar Limited	disabled	<b>AMB0</b>
		enabled	<b>AMB1</b>
	GS1 DataBar Omnidirectional	disabled	<b>AMC0</b>
		enabled	<b>AMC1</b>
	GS1 DataBar Expanded	disabled	<b>AMD0</b>
	Stacked	enabled	<b>AMD1</b>
GS1 DataBar Stacked	disabled	<b>AME0</b>	
	enabled	<b>AME1</b>	

**d** = a number from the HEX/Numeric Table

**d** = a number in the range 001-255

<b>CODE SELECTION - 2D SYMBOLOGIES</b>		
<b>DESCRIPTION</b>		<b>STRING</b>
PDF417	disabled	<b>AGA0</b>
	enabled	<b>AGA1</b>
	Macro PDF417	unbuffered mode
		buffered mode
	Micro PDF417	disabled
		enabled
DataMatrix	disabled	<b>AHA0</b>
	enabled	<b>AHA1</b>
	Minimum Code Length	<b>AHCe</b>
	Maximum Code Length	<b>AHDe</b>
	Rectangular Style	disabled
		enabled
QR Family	disabled	<b>AIA0</b>
	enabled	<b>AIA1</b>
Micro QR	disabled	<b>AIB0</b>
	enabled	<b>AIB1</b>
Postal Codes	all disabled	<b>ALA0</b>
	Australian Post - enabled	<b>ALA1</b>
	Japan Post - enabled	<b>ALA2</b>
	PLANET - enabled	<b>ALA3</b>
	POSTNET - enabled	<b>ALA4</b>
	POSTNET with B and B' - enabled	<b>ALA5</b>
	POSTNET and PLANET - enabled	<b>ALA6</b>
	POSTNET with B and B' and PLANET - enabled	<b>ALA7</b>
	KIX Code - enabled	<b>ALA8</b>
	Royal Mail Code (RM4SCC) - enabled	<b>ALA9</b>
Australian Table	N Table	<b>ALB0</b>
	C Table	<b>ALB1</b>
IMB	disabled	<b>ALC0</b>
	enabled	<b>ALC1</b>
Maxicode	Mode 0	disabled
		enabled
	Mode 1	disabled
		enabled
	Mode 2	disabled
		enabled
	Mode 3	disabled
		enabled
	Mode 4	disabled
		enabled
	Mode 5	disabled
		enabled
	Mode 6	disabled
		enabled
Aztec	disabled	<b>AKA0</b>
	enabled	<b>AKA2</b>

CODE SELECTION - 2D SYMBOLOGIES (continued)		
DESCRIPTION		STRING
Composite Code	disabled	<b>ANA0</b>
	enabled	<b>ANA1</b>
	Discard Linear	disabled
	Part	enabled
		<b>ANB0</b>
		<b>ANB1</b>

e = a number from the HEX/Numeric Table

e = a number in the range 0001-3600

READING PARAMETERS		
DESCRIPTION		STRING
Trigger Mode	trigger level	<b>BAA0</b>
	trigger pulse	<b>BAA1</b>
Trigger Type	normal trigger	<b>BAB0</b>
	software trigger	<b>BAB1</b>
Flash On Duration		<b>BB0f</b>
Flash Off Duration		<b>BB1f</b>
Beeper Tone	tone 1	<b>GBA1</b>
	tone 2	<b>GBA2</b>
	tone 3	<b>GBA3</b>
	tone 4	<b>GBA4</b>
Beeper Volume	off	<b>GBB0</b>
	low	<b>GBB1</b>
	medium	<b>GBB2</b>
	high	<b>GBB3</b>
Beeper Duration		<b>GBCf</b>
Reads per Cycle	one read per cycle	<b>BCA0</b>
	multiple reads per cycle	<b>BCA1</b>
Scan Timeout		<b>BEAf</b>
User Defined Beeper Tone	tone 1	<b>GBD1</b>
	tone 2	<b>GBD2</b>
	tone 3	<b>GBD3</b>
	tone 4	<b>GBD4</b>
User Defined Beeper Volume	off	<b>GBE0</b>
	low	<b>GBE1</b>
	medium	<b>GBE2</b>
	high	<b>GBE3</b>
User Defined Beeper Duration		<b>GBFf</b>
Perform User Defined Beep**		<b>\$?GGG</b>

\*\*this command carries out its specific function and does not need \$+ and \$-.

<b>CODE ORDERING AND SELECTION</b>		
Code per Scan	one code per scan	<b>BCB0</b>
	all codes per scan	<b>BCB1</b>
Central Code Transmission	disabled	<b>OAA0</b>
	enabled	<b>OAA1</b>
Order by Code Length	disabled	<b>OAB0</b>
	enabled - increasing order	<b>OAB1</b>
	enabled - decreasing order	<b>OAB2</b>

**f** = a number from the HEX/Numeric Table

**f** = a number in the range 01-99

<b>READING PARAMETERS</b>		
<b>DESCRIPTION</b>		<b>STRING</b>
<b>AUTOSCAN</b>		
Autoscan Mode	disabled	<b>BBA0</b>
	enabled in normal mode	<b>BBA1</b>
	enabled in pattern mode	<b>BBA2</b>
Autoscan Aiming System	disabled	<b>BBB0</b>
	enabled	<b>BBB1</b>
Autoscan Hardware Trigger	disabled	<b>BBC0</b>
	enabled	<b>BBC1</b>
Autoscan Illumination System	disabled	<b>BBD0</b>
	enabled	<b>BBD1</b>
Safety Time	disabled	<b>BGA0</b>
	enabled	<b>BGA1</b>
Safety Time Duration		<b>BGBf</b>
Good Read Spot	disabled	<b>BIA0</b>
	enable short	<b>BIA1</b>
	enable medium	<b>BIA2</b>
	enable long	<b>BIA3</b>
	enable continuous	<b>BIA4</b>

**f** = a number from the HEX/Numeric Table

**f** = a number in the range 01-99

<b>RADIO PARAMETERS</b>		
<b>DESCRIPTION</b>		<b>STRING</b>
Radio Protocol Timeout	enable (seconds)	<b>RH02-RH19</b>
Radio RX Timeout		<b>RR00-RR99</b>
Power-Off Timeout		<b>RP00-RP99</b>
Reader Shut-Down <sup>a</sup>		<b>\$?XYZ</b>
Transmission Mode	one-way	<b>RI0</b>
	two-way	<b>RI1</b>
Beeper Control For Radio Response	normal	<b>BF0</b>
	only good decode	<b>BF1</b>
	only good reception	<b>BF2</b>
	off	<b>BF3</b>
Single Store	disable	<b>RO0</b>
	one attempt	<b>RO1</b>
	two attempts	<b>RO2</b>
	three attempts	<b>RO3</b>
	four attempts	<b>RO4</b>
	five attempts	<b>RO5</b>
	six attempts	<b>RO6</b>
	seven attempts	<b>RO7</b>
	eight attempts	<b>RO8</b>
nine attempts	<b>RO9</b>	
Find Me	disable	<b>Bk0</b>
	enable	<b>Bk1</b>

<sup>a</sup>. This command carries out its specific function and does not need \$+ and \$-.



DISPLAY PARAMETERS		
DESCRIPTION		STRING
Date		<b>IAddmmyy</b>
Time		<b>IBhhmm</b>
Contrast	lighter	<b>IC0</b>
	darker	<b>IC1</b>
Font Size	small	<b>ID0</b>
	medium	<b>ID1</b>
	large	<b>ID2</b>
Backlight	off	<b>IE0</b>
	on	<b>IE1</b>
Display-Off Timeout		<b>IFa</b>
Display Mode	normal	<b>IG0</b>
	local echo	<b>IG1</b>
	clear display after decode	<b>IG2</b>
Keypad	disabled keys	<b>IK0</b>
	enable and select KeyID characters	<b>IK1bbb</b>

**ddmmyy** = numbers from the Hex/Numeric Table representing day, month, year

**hhmm** = numbers from the Hex/Numeric Table representing hour, minutes

**a** = a number from the Hex/Numeric Table

**b** = HEX values representing an ASCII character

**a** = a number in the range **00-99** (sec.) from the Hex/Numeric Table

**00** = Timeout disabled (always on).

**b** = 3 Hex values from **00** to **FE** representing the left, center and right keys.

**FF** = KeyID disabled.

# NOTES

# Appendix C

## Programming for Expert Users

This document is addressed to expert users who are familiar with software programming languages and want to define a personalized code formatting. The provided programming language allows creating either simple or complex formatting expressions by means of the basic functions connected together through the following operators: (, ), -, +.

The syntax to be used to transmit the expressions to the PowerScan® M8500 is the following:

**`$+ELB<n>formatting expression<ETX>$-`**

where:

- **<n>** is a number in the range 1-5 corresponding to the format to be defined;
- **<ETX>** is the conventional character used as terminator of the command;
- the formatting expression uses ASCII characters when containing text strings. For this reason, the string must be inserted between two quotation marks. The following example shows the ASCII conversion of the "ABC" string:  
**`$+ELB1 } 414243+#DS^C$- .`**

### Function Description

All the functions and conventions to be used within the formatting expressions are listed below:

FUNCTION NAME	DESCRIPTION
FSTR	Searches for a defined substring by its starting and ending string.
FLSTR	Searches for a defined substring by its starting string and its length.
SSTR	Extracts a defined substring from the original string.
FPOS	Searches for a position of a defined substring within the original string.
LSTR	Returns a string length.
ISTR	Insert a substring in the original string.
RSTR	Substitutes a defined substring contained in the original string with a new one.

CONVENTIONS	DESCRIPTION
+	Concatenates two strings or fields.
-	Deletes a substring or a field from the original string.
#DS	Returns the string which has been decoded by the library.
#F<n>	Returns the result of a format which has been previously defined. The <n> value is in the range 1-4.

## FindStringByStarting&EndingChar (FSTR)

This function has the following syntax:

**FSTR<source\_string, string\_start, string\_stop, mode>⇒string**

This function searches for a substring having a defined starting character ("string\_start") and a defined ending character ("string\_stop") within the "source\_string". It returns the string you searched for, or an empty one in case of failure.

If searching for a substring having characters already known, the "string\_start" and "string\_stop" arguments must share the same value.

The "mode" argument allows managing the starting character ("string\_start") and the ending character ("string\_stop"):

0 = include both starting and ending character

1 = include only starting character

2 = include only ending character

3 = discard both starting and ending character

## FindStringByStartingChar&Len (FLSTR)

This function has the following syntax:

**FLSTR<source\_string, string\_start, len, mode>⇒string**

This function searches for a substring having a defined starting character ("string\_start") and a defined length ("len") within the "source\_string". It returns the string you searched for, or an empty one in case of failure.

If searching for a substring having a length already known, the "string\_start" and "string\_stop" arguments must share the same number.

The "mode" argument allows managing the starting character ("string\_start"):

0 = include starting character

1 = discard starting character

## SelectString (SSTR)

This function has the following syntax:

**SSTR<source\_string, pos\_start, pos\_end>⇒string**

It extracts a substring whose characters are between "pos\_start" and "pos\_end" from the "source\_string".

If "pos\_end" is longer than the "source\_string" length, no error will be generated since the exceeding characters are ignored.

The first character of every string is in position 1.

---

## FindPosition (FPOS)

This function has the following syntax:

**FPOS<source\_string, search\_string>⇒position**

This function searches for a defined substring within the "source\_string" and returns its position. If the substring is not found, the returned value is 1.

## StringLength (LSTR)

This function has the following syntax:

**LSTR<string>⇒length**

This function returns the length of the defined string.

## StringConcatenation

This function has the following syntax:

**string1 + string2⇒string**

This function allows concatenating two different strings in order to get a single string as result.

## StringDiscard

This function has the following syntax:

**string1 - string2⇒string**

This function discards all the strings having the same value as "string2" which can be found in "string1". If no "string2" is found within "string1", the result returns "string1".

## InsertString (ISTR)

This function has the following syntax:

**ISTR<source\_string, string1, position>⇒string**

This function inserts a new string ("string1") within the "source\_string" and places it in the defined "position".

If the value of the "position" argument is longer than "source\_string" length, "string1" will be placed after the last character of the source string.

## ReplaceString (RSTR)

This function has the following syntax:

**RSTR<source\_string, string1, string2>⇒string**

This function searches for "string1" within the "source\_string". All the strings having the same value as "string1" within the "source\_string" will be replaced by "string2".

If no "string1" is found in the "source\_string", the result returns the "source\_string".

## Examples

The string transmitted is **"12345abcdef3790"** and corresponds to the #DS function, as defined in the programming language.

1. expression ⇒ **SSTR<#DS,1,5> + SSTR<#DS,11,15> + SSTR<#DS,6,9>**  
result ⇒ **"12345f3790abcd"**

2. expression  $\Rightarrow$  `FSTR<#DS, }616263~, }616263~, 0> + SSTR<#DS,LSTR<#DS> -3, LSTR<#DS>`  
 result  $\Rightarrow$  `"abc3790"`
3. expression  $\Rightarrow$  `FSTR<#DS, }616272~, }616261~, 0>`  
 result  $\Rightarrow$  `"null string"`
4. expression  $\Rightarrow$  `#DS - FSTR<#DS, }616263~, }6566~, 0>`  
 result `"123453790"`

During the format definition the decoded string represented by #DS does not change.

## Using Format Output in Format Definition

The input used by the above functions to define the code formatting usually corresponds to the decoded code (#DS). Actually, the formatting expression of each function can also format the result (output) produced by a preceding code formatting.

The format output is represented as follows:

`#F<n>`, where:

`<n>` = format number in the range 1-4

`#F` = format output

Being Format 5 not included in other format expression, the format number is in the range 1-4. Furthermore, since a format expression operates upon the output of the preceding formats, the expression defining Format 1 will never contain the result of another format.

### Example

The following expression is used to define Format 3:

`#DS + FSTR<#F2, "6173", "6263", 0>`

The expression input consists of the decoded code and the result produced by Format 2 (#F2).

The FSTR function searches for a defined substring within the #F2 result; then, it concatenates this substring and the decoded code. The result corresponds to #F3 output.

# Appendix D

## Code Identifier Table

---

EAN/UPC



CODABAR



CODE 128



EAN 128



CODE 93



CODE 32



CODE 39



INTERLEAVED 2 OF 5



PDF417



MICRO PDF417



DATAMATRIX



MAXICODE



QR



MICRO QR



AUSTRALIA POST



IMB

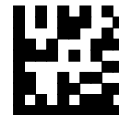

JAPAN POST



POSTNET



PLANET



GS1 DATABAR



KIX CODE



RM4SCC



AZTEC





# Appendix E

## Sample Barcodes

---

The sample barcodes in this appendix are typical representations for their symbology types.

### Test Code Symbols

Scan these 1D and 2D test symbols to check that the reader is imaging and decoding properly, according to your configuration.

UPC-A



EAN-13



Code 39 (Standard)



Code 128



QR



PDF417



DataMatrix (Normal)



DataMatrix (Inverse)



# Appendix F

## Hex & Numeric Table

CHARACTER TO HEX CONVERSION TABLE								
char	decimal	hex	char	decimal	hex	char	decimal	hex
NUL	000	00	*	042	2A	U	085	55
SOH	001	01	+	043	2B	V	086	56
STX	002	02	,	044	2C	W	087	57
ETX	003	03	-	045	2D	X	088	58
EOT	004	04	.	046	2E	Y	089	59
ENQ	005	05	/	047	2F	Z	090	5A
ACK	006	06	0	048	30	[	091	5B
BEL	007	07	1	049	31	\	092	5C
BS	008	08	2	050	32	]	093	5D
HT	009	09	3	051	33	^	094	5E
LF	010	0A	4	052	34	_	095	5F
VT	011	0B	5	053	35	`	096	60
FF	012	0C	6	054	36	a	097	61
CR	013	0D	7	055	37	b	098	62
SO	014	0E	8	056	38	c	099	63
SI	015	0F	9	057	39	d	100	64
DLE	016	10	:	058	3A	e	101	65
DC1	017	11	;	059	3B	f	102	66
DC2	018	12	<	060	3C	g	103	67
DC3	019	13	=	061	3D	h	104	68
DC4	020	14	>	062	3E	i	105	69
NAK	021	15	?	063	3F	j	106	6A
SYN	022	16	@	064	40	k	107	6B
ETB	023	17	A	065	41	l	108	6C
CAN	024	18	B	066	42	m	109	6D
EM	025	19	C	067	43	n	110	6E
SUB	026	1A	D	068	44	o	111	6F
ESC	027	1B	E	069	45	p	112	70
FS	028	1C	F	070	46	q	113	71
GS	029	1D	G	071	47	r	114	72
RS	030	1E	H	072	48	s	115	73
US	031	1F	I	073	49	t	116	74
SPACE	032	20	J	074	4A	u	117	75
!	033	21	K	075	4B	v	118	76
"	034	22	L	076	4C	w	119	77
#	035	23	M	077	4D	x	120	78
\$	036	24	N	078	4E	y	121	79
%	037	25	O	079	4F	z	122	7A
&	038	26	P	080	50	{	123	7B
'	039	27	Q	081	51		124	7C
(	040	28	R	082	52	}	125	7D
)	041	29	S	083	53	~	126	7E
			T	084	54	DEL	127	7F

CHARACTER TO HEX CONVERSION TABLE (continued)								
char	decimal	hex	char	decimal	hex	char	decimal	hex
€	128	80	ª	170	AA	Œ	213	D5
□	129	81	«	171	AB	Ö	214	D6
,	130	82	¬	172	AC	×	215	D7
ENTER	131	83	-	173	AD	Ø	216	D8
TAB	132	84	®	174	AE	Ù	217	D9
F1	133	85	-	175	AF	Ú	218	DA
F2	134	86	°	176	B0	Û	219	DB
F3	135	87	±	177	B1	Ü	220	DC
F4	136	88	²	178	B2	Ý	221	DD
F5	137	89	³	179	B3	Þ	222	DE
F6	138	8A	´	180	B4	ß	223	DF
F7	139	8B	µ	181	B5	à	224	E0
F8	140	8C	¶	182	B6	á	225	E1
F9	141	8D	·	183	B7	â	226	E2
F10	142	8E	,	184	B8	ã	227	E3
F11	143	8F	¹	185	B9	ä	228	E4
F12	144	90	º	186	BA	å	229	E5
HOME	145	91	»	187	BB	æ	230	E6
END	146	92	¼	188	BC	ç	231	E7
Pg UP	147	93	½	189	BD	è	232	E8
Pg Down	148	94	¾	190	BE	é	233	E9
↑	149	95	¿	191	BF	ê	234	EA
↑	150	96	À	192	C0	ë	235	EB
←	151	97	Á	193	C1	ì	236	EC
→	152	98	Â	194	C2	í	237	ED
ESC	153	99	Ã	195	C3	î	238	EE
CTRL(Right)	154	9A	Ä	196	C4	ï	239	EF
€	155	9B	Å	197	C5	ð	240	F0
œ	156	9C	Æ	198	C6	ñ	241	F1
□	157	9D	Ç	199	C7	ò	242	F2
ž	158	9E	È	200	C8	ó	243	F3
ÿ	159	9F	É	201	C9	ô	244	F4
NBSP	160	A0	Ê	202	CA	õ	245	F5
ı	161	A1	Ë	203	CB	ö	246	F6
ç	162	A2	Ì	204	CC	÷	247	F7
£	163	A3	Í	205	CD	ø	248	F8
¤	164	A4	Î	206	CE	ù	249	F9
¥	165	A5	Ï	207	CF	ú	250	FA
ı	166	A6	Ð	208	D0	û	251	FB
§	167	A7	Ñ	209	D1	ü	252	FC
¨	168	A8	Ò	210	D2	ý	253	FD
©	169	A9	Ó	211	D3	Reserved	254	FE
			Ô	212	D4	Reserved	255	FF

---

## HEX NUMERIC TABLE

0



1



2



3



4



5



6



7



8



9



---

A



B



C



D



E



F



## AUTOSCAN PATTERN CODE





---

# NOTES

# NOTES

# INDEX

## NUMERICS

2D Matrix symbol [18](#)

## A

About this Guide [7](#)

ACK/NACK Protocol [58, 61, 156](#)

Address Delimiter [92, 168](#)

Address Stamping [91, 168](#)

Aiming System [9, 18, 103](#)

Aladdin™ [19](#)

All Codes Per Scan [21, 22](#)

Alphanumeric Keyboard Setting [71](#)

Alt Mode [49](#)

Australian Table Selection [115](#)

Autoscan [122](#)

  Aiming System [122](#)

  Autoscan Aiming System [122](#)

  Autoscan Mode [122](#)

  Hardware Trigger [122](#)

  Illumination System [122](#)

Autoscanning [20](#)

  Normal Mode [20](#)

  Pattern Mode [20](#)

Aztec code [116](#)

## B

Backlight [132](#)

Batch Mode [129, 172](#)

battery

  WARNINGS [29](#)

Battery Charging [28](#)

Baud Rate [56](#)

  Network [80](#)

BC-8060

  Master Layout [38](#)

  Network Connectors [26](#)

  STAR-System™ Network Setup [45](#)

BC-80X0

  Interface Cable [23](#)

BC-80X0 / C-8000 [184](#)

  Cradles [17](#)

BC-80X0 / C-8000 CRADLES [17](#)

BC-80X0/C-8000

  Charge Status [188](#)

  Power/Communication [188](#)

Beeper [186](#)

  Duration [119](#)

  Tone [118](#)

  User Defined [120](#)

  Volume [119](#)

Beeper Control for Radio Response [127, 171](#)

## C

Camera Control

  Exposure and Calibration [20](#)

Caps Lock [69](#)

Central Code Transmission [121](#)

Character Deletion [98](#)

Character Substitution [97](#)

Clearing Display [177](#)

Codabar Family [108](#)

Code 128 Family [109](#)

Code 32 Family [107](#)

Code 39 Family [106](#)

Code 93 Family [110](#)

Code Identifier [85](#)

Code Length Tx [91](#)

Code Ordering and Selection [121](#)

Codes per Scan [121](#)

Composite Codes [116](#)

Concatenation [22](#)

  Define [99](#)

  Enable/Disable [99](#)

  Failure Transmission [100](#)

  Intercode Delay [100](#)

  Length [99](#)

  Result Code ID [101](#)

  Timeout [100](#)

  Transmission After Timeout [101](#)

Configuration Editing Commands [169](#)

Connections

  Network [26](#)

Contrast [131](#)

Control Character Emulation [73](#)

Conversion to Code 39 [76](#)

Conversion to Code 39 and Code 128 [77, 157](#)

Cursor Control [176](#)

Custom Code Identifier [86](#)

---

## D

Data Bits [57](#)  
Data Format [84, 160](#)  
Datalogic Aladdin™ [19](#)  
DataMatrix Family [113](#)  
Date and Time [131](#)  
Default Key Identifiers [178](#)  
Default Parameters for POS Terminals [174](#)  
Default Settings [189](#)  
Defining Special Key Sequences [166](#)  
Desktop Mounting [31](#)  
DIGITAL TERMINALS [50](#)  
Display Mode [132, 173](#)  
Display Parameters [173](#)  
Display-Off Timeout [132](#)  
Driver License Parsing [15](#)

## E

Exposure and Calibration [20](#)  
Exposure Mode [102](#)

## F

Field Deletion [148](#)  
Field Extraction by Character [139, 140](#)  
FIFO [58, 61, 65, 156](#)  
Find Me [129, 172](#)  
FindPosition (FPOS) [211](#)  
Fixed Desktop Use [32](#)  
Flash Mode [118](#)  
Font Selection [177](#)  
Font Size [131](#)  
Format Definition [136](#)  
Format Enable/Disable [152](#)

## G

General View [16](#)  
Good Read Spot [187](#)  
GS1 Databar™ [111](#)

## H

Handshaking [57, 61, 155](#)  
Header [89](#)  
Header/Terminator Selection [160](#)  
Hex & Numeric Table [217](#)  
Host Configuration Strings [193](#)  
Host Master Layout [37](#)

## I

IBM 31xx, 32xx, 34xx, 37xx [160](#)  
IBM Terminals 31xx, 32xx, 34xx, 37xx  
Interface [48](#)  
IBM USB POS [24](#)  
Idle Level [78](#)  
Indicators [186](#)  
Installation [23](#)  
Integrating Special Keys in Headers/  
Terminators [167](#)  
Inter-Block Delay [78, 158](#)  
Inter-character Delay [58, 62, 66, 70](#)  
Inter-code Delay [66, 71](#)  
Interface  
IBM Terminals 31xx, 32xx, 34xx, 37xx [48](#)  
PEN [47](#)  
POS Terminals [47](#)  
RS-232 [47](#)  
Wedge [48](#)  
Interface Selection [47](#)  
Interleaved 2 of 5 Family [107](#)  
Issue Identical Codes [104](#)

## K

Key Transmission Mode [48](#)  
Keyboard Nationality [64, 68](#)  
Keyboard Setting [71](#)  
Keyboard Type [49](#)  
KeyID [178](#)  
Keypad [133](#)

## L

LED and Beeper Control [177](#)  
Linear Symbologies [105](#)

## M

Master Cradle Header [82](#)  
Master Cradle Terminator [83](#)  
Master Header/Terminator Selection [159](#)  
Match Conditions [151](#)  
Maxicode Family [115, 116](#)  
Message Formatting [175](#)  
Messages from Host to Reader [175](#)  
Micro PDF417 [113](#)  
Minimum Output Pulse [76, 157](#)  
Mismatch Result [153](#)

## N

Network  
Baud Rate [80](#)  
Cabling [26](#)

Connections [26](#)  
Parameters [158](#)  
Termination [27](#)  
Troubleshooting [38](#)  
Warning Message [81, 159](#)  
**Normal Mode** [20](#)  
**Num Lock** [70](#)

## O

**Omni-directional Operating** [15](#)  
**One Code Per Scan** [21](#)  
**Operating Mode** [75](#)  
**Order By Code Length** [121](#)  
**Order By Code Symbology** [121](#)  
**Output and Idle Levels** [158](#)  
**Output Level** [77](#)  
**Overflow** [77](#)

## P

**Parity** [56](#)  
**Pattern Mode** [20](#)  
**PDF417** [112](#)  
**PEN** [74](#)  
**PEN Emulation Connection** [25](#)  
**Pen Interface** [47](#)  
**Portable Desktop Use** [31](#)  
**POS Terminals**  
Interface [47](#)  
**Postal Codes** [114](#)  
**Power Supply** [12](#)  
**Power-Off Timeout** [126, 170](#)  
**Product Specifications** [179](#)

## Q

**QR Family** [113, 114](#)

## R

**Radio Parameters** [124, 170, 206](#)  
**Radio Protocol Timeout** [125, 170](#)  
**Radio RX Timeout** [125, 170](#)  
**Reading Configuration Barcodes** [54](#)  
**Reading Parameters** [168](#)  
**Reads per Cycle** [119, 168](#)  
**Reception Warning Message** [81, 159](#)  
**RS-232**  
Baud Rate [56](#)  
Data Bits [57](#)  
Handshaking [57](#)  
Interface [47](#)  
PARAMETERS [55](#)  
Parity [56](#)  
Stop Bits [57](#)

**RS-232 Connection** [24](#)  
**RX Timeout** [59, 62, 157](#)

## S

**Safety Time** [123, 169](#)  
**Scan Timeout** [119](#)  
**Serial Configuration Strings** [194](#)  
**Serial Trigger Lock** [59, 63](#)  
**Service & Support** [8](#)  
**Setting RTC** [177](#)  
**Setup Procedures** [39](#)  
**Single Store** [128, 171](#)  
**Slave Address Range** [81, 158](#)  
**Software handshaking**  
(XON/XOFF) [155](#)  
**Stand-Alone Layouts** [35](#)  
**Standard Message Formatting** [175](#)  
**Stop Bits** [57](#)  
**String Deletion Procedure** [145](#)  
**String Insertion Procedure** [143](#)  
**Symbology Character Deletion** [97](#)  
**Symbology Character Substitution** [97](#)  
**Symbology Headers** [95](#)  
**Symbology Specific Format Default** [98](#)  
**Symbology types** [215](#)  
**System and Network Layouts** [35](#)

## T

**Terminator** [90, 96](#)  
**Test Code Symbols** [215](#)  
**Test User Defined Beeper** [120](#)  
**Time Stamping** [92](#)  
**Time Stamping Delimiter** [168](#)  
**Time Stamping Format** [168](#)  
**Transmission After Timeout** [101](#)  
**Transmission Mode** [126, 171](#)  
**Trigger**  
Mode [118](#)  
Signal [168](#)  
Type [118](#)

## U

**UPC/EAN/JAN Family** [105](#)  
**USB** [24](#)  
**USB Connection** [24](#)  
**USB Keyboard Speed** [66](#)  
**USB PARAMETERS** [60](#)  
**USB Parameters** [60](#)  
**USB Reader Configuration** [50](#)  
**USB Start-up** [50](#)  
**USB-COM** [61](#)  
ACK/NACK Protocol [61](#)  
Handshaking [61](#)  
**USB-KBD** [64](#)

---

**User Defined Beeper** [120](#)  
**Using Multiple M-Series Readers with Same  
Cradle** [42](#)  
**Using the Reader** [18](#)

## W

**Wall Mounting** [33](#)  
**Warning Message, Network** [81](#), [159](#)  
**Wedge** [48](#), [197](#)  
    Connection [25](#)  
    Interface [48](#)  
    Parameters [67](#)  
**WEEE Compliance** [13](#)  
**WYSE Terminals** [49](#)

## X

**XON/XOFF**  
    Software handshaking [155](#)



**Australia**

Datalogic Scanning Pty Ltd  
Telephone: [61] (2) 9870 3200  
australia.scanning@datalogic.com

**France and Benelux**

Datalogic Scanning SAS  
Telephone: [33].01.64.86.71.00  
france.scanning@datalogic.com

**Germany**

Datalogic Scanning GmbH  
Telephone: 49 (0) 61 51/93 58-0  
germany.scanning@datalogic.com

**India**

Datalogic Scanning India  
Telephone: 91- 22 - 64504739  
india.scanning@datalogic.com

**Italy**

Datalogic Scanning SpA  
Telephone: [39] (0) 39/62903.1  
italy.scanning@datalogic.com

**Japan**

Datalogic Scanning KK  
Telephone: 81 (0)3 3491 6761  
japan.scanning@datalogic.com

**Latin America**

Datalogic Scanning, Inc  
Telephone: (305) 591-3222  
latinamerica.scanning@datalogic.com

**Singapore**

Datalogic Scanning Singapore PTE LTD  
Telephone: (65) 6435-1311  
singapore.scanning@datalogic.com

**Iberia**

Datalogic Scanning SAS Sucursal en España  
Telephone: 34 91 746 28 60  
spain.scanning@datalogic.com

**United Kingdom**

Datalogic Scanning LTD  
Telephone: 44 (0) 1582 464900  
uk.scanning@datalogic.com



[www.scanning.datalogic.com](http://www.scanning.datalogic.com)

**Datalogic Scanning, Inc.**

959 Terry Street  
Eugene, OR 97402  
USA  
Telephone: (541) 683-5700  
Fax: (541) 345-7140

