

MEASUREMENT ORGANIZATION WEEKLY NOTES – 09/02/2020

WEEKLY NOTES TRANSITION As mentioned previously, the COVID-19 pandemic has exacerbated ongoing staffing shortfalls and Coast Guard IT infrastructure issues, which prompted us to explore less resource intensive alternatives for providing relevant and timely information to ACSs performing work on the Coast Guard's behalf. As a result, going forward we will issue updates less frequently in the form of Measurement Organization Informational Notes that we will continue to email to ACS representatives and post on our [U.S. Tonnage Publications](#) web page. We will reevaluate this practice once the U.S. has emerged from the pandemic.

Weekly Notes are issued by the Coast Guard Marine Safety Center's Tonnage Division (MSC-4) for use by organizations that perform measurement work on the Coast Guard's behalf. They are for informational purposes only, and are not intended as, nor should they be construed to represent, revisions of or substitutes for applicable statutes or regulations or established interpretations of either.

MEASUREMENT ORGANIZATION WEEKLY NOTES – 08/26/2020

DISCUSSIONS OF COMPLEX STERN ARRANGEMENTS We have received valuable information from ACS counterparts during our ongoing discussions on application of the 1969 Tonnage Convention rules for length and depth measurements to vessels with complex stern arrangements. We expect to conclude those conversations by week's end.

WEEKLY NOTES ALTERNATIVES As mentioned previously, we are exploring less resource intensive options for providing relevant and timely information to ACSs performing work on the Coast Guard's behalf. We received no comments or suggestions regarding the Weekly Notes and are in the process of making a decision on the frequency with which we issue them.

Weekly Notes are issued by the Coast Guard Marine Safety Center's Tonnage Division (MSC-4) for use by organizations that perform measurement work on the Coast Guard's behalf. They are for informational purposes only, and are not intended as, nor should they be construed to represent, revisions of or substitutes for applicable statutes or regulations or established interpretations of either.

MEASUREMENT ORGANIZATION WEEKLY NOTES – 08/19/2020

U.S. SURVEY FOOT (1866/1893/1959 – 2022) In 1866, Congress legalized the use of metric units across the country, specifying that 1 foot = 1200/3937 meter. Since 1893, the U.S. legal definition of the foot has been based on the meter, initially adopting the 1866 definition. In 1959, the U.S. redefined the foot to match the international standard: 1 foot = 0.3048 meter (known as an international foot), but temporarily allowed the earlier definition (which became known as a U.S. survey foot) to be used for geodetic surveying. This situation has led to confusion and errors that continue today. On December 31, 2022 the U.S. survey foot will be [deemed obsolete](#) and superseded by the international foot (to be known simply as a foot). Although mix-ups of these definitions of the foot are unlikely to affect certification of registered dimensions—a vessel would have to measure more than 25,000 feet before rounding to the nearest tenth of a foot could result in different values—it is a good time to highlight the need for care when converting units. When converting between feet and meters, always use 1 foot = 0.3048 meter.

Announcement. Effective July 1, 1959, all calibrations in the U.S. customary system of weights and measures carried out by the National Bureau of Standards will continue to be based upon metric measurement standards and, except those for the U.S. Coast and Geodetic Survey as noted below, will be made in terms of the following exact equivalents and appropriate multiples and sub-multiples:

1 yard = 0.914 4 meter
1 pound (avoirdupois) = 0.453 592 37 kilogram

Currently, the units defined by these same equivalents, which have been designated as the International Yard and the International Pound, respectively, will be used by the National Standards Laboratories of Australia, Canada, New Zealand, South Africa, and United Kingdom; thus there will be brought about international accord on the yard and pound

by the English-speaking nations of the world, in precise measurements involving these basic units.

Any data expressed in feet derived from and published as a result of geodetic surveys within the United States will continue to bear the following relationship as defined in 1893:

$$1 \text{ foot} = \frac{1200}{3937} \text{ meter}$$

The foot unit defined by this equation shall be referred to as the U.S. Survey Foot and it shall continue to be used, for the purpose given herein, until such a time as it becomes desirable and expedient to readjust the basic geodetic survey networks in the United States, after which the ratio of a yard, equal to 0.914 4 meter, shall apply.

Excerpt from [24 Federal Register \(FR\) 5348 \(July 1, 1959\)](#)

DISCUSSIONS OF COMPLEX STERN ARRANGEMENTS As mentioned in previous editions of the Weekly Notes, Mr. Marcus Akins is reaching out to ACS tonnage staff counterparts to schedule discussions on applying 1969 Tonnage Convention rules for length and depth measurements to vessels with complex stern arrangements.

Weekly Notes are issued by the Coast Guard Marine Safety Center's Tonnage Division (MSC-4) for use by organizations that perform measurement work on the Coast Guard's behalf. They are for informational purposes only, and are not intended as, nor should they be construed to represent, revisions of or substitutes for applicable statutes or regulations or established interpretations of either.

MEASUREMENT ORGANIZATION WEEKLY NOTES – 08/12/2020

WEEKLY NOTES ALTERNATIVES We are again exploring less resource intensive alternatives for providing relevant and timely information to measurement organizations that perform work on the Coast Guard's behalf. Possibilities include reducing the frequency of information dissemination to monthly, or posting similar information on our website only when the need arises. This is being driven - in part - by ongoing staffing shortfalls and Coast Guard IT infrastructure issues, which have been exacerbated by the COVID-19 pandemic. We welcome comments on the usefulness of the Weekly Notes editions in their current form, and suggestions or preferred alternatives that could reduce the resource burden.

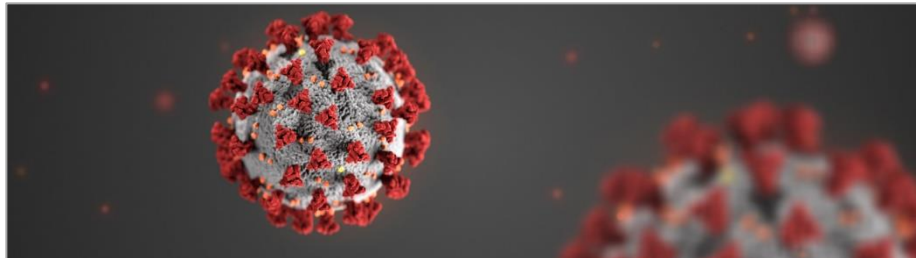

ENGINE ROOM LENGTH In applying the complex formal measurement rules for engine room deductions, it is helpful to keep in mind the long history of “rule beating” designs to minimize the “register” (now “net”) tonnage. The text which follows is from Professor Johnson's 1913 report “Measurement of Vessels for the Panama Canal.” The British “act of 1773” established a simplified tonnage formula - later adopted by the United States - that arrived at tonnage using a product of the vessel's principal dimensions.

“The only other important change made prior to 1835 in the act of 1773 was contained in the law of 1819, which provided that in measuring steam vessels the length of the engine room should be deducted from the vessel's length in calculating tonnage. This provision led to the abuse of constructing the engine room in two parts, one well forward and the other aft, with an intervening space between the two parts of the engine-room. The distance between the forward bulkhead and the after bulkhead of the engine room thus was made to include the greater part of the length of the vessel.”

Weekly Notes are issued by the Coast Guard Marine Safety Center's Tonnage Division (MSC-4) for use by organizations that perform measurement work on the Coast Guard's behalf. They are for informational purposes only, and are not intended as, nor should they be construed to represent, revisions of or substitutes for applicable statutes or regulations or established interpretations of either.

MEASUREMENT ORGANIZATION WEEKLY NOTES – 08/05/2020

MARPOL TIER III At its 74th session in May of 2019, the International Maritime Organization's Marine Environment Protection Committee (MEPC) discussed document MEPC 74/5/15 (Turkey and ICOMIA), regarding the implementation of the so-called Tier III emission requirements. This paper highlights challenges with this implementation for large yachts at least 24 m in length and under 500 GT, especially with regards to the size and weight of the pollution control equipment. Recognizing that the length definition used for these requirements is virtually identical to that which appears in the 1969 Tonnage Convention, measurement organizations should be aware of this industry driver, and refer questions on applicability of these requirements to Mr. David Karnes.

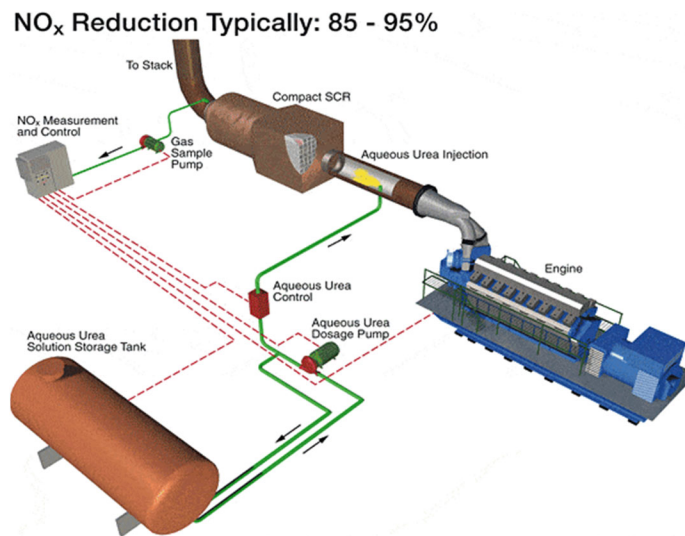

DISCUSSIONS OF COMPLEX STERN ARRANGEMENTS As mentioned in a previous edition of the Weekly Notes, Mr. Marcus Akins will be reaching out to ACS tonnage staff counterparts to schedule discussions - to occur within the next two weeks - on applying 1969 Tonnage Convention rules for length and depth measurements to vessels with complex stern arrangements. We intend to conduct the sessions using Microsoft Teams, which enables Coast Guard users to establish audio communications and share screens securely with outside entities on different kinds of devices, including personal cell phones and computers. We are finding that many of the MSC's industry customers regularly use the Microsoft Teams platform for such remote communications.



Weekly Notes are issued by the Coast Guard Marine Safety Center's Tonnage Division (MSC-4) for use by organizations that perform measurement work on the Coast Guard's behalf. They are for informational purposes only, and are not intended as, nor should they be construed to represent, revisions of or substitutes for applicable statutes or regulations or established interpretations of either.

MEASUREMENT ORGANIZATION WEEKLY NOTES – 07/29/2020

ENGINE ROOM DEDUCTION The engine room deduction under the Standard system is based on a percentage of a vessel's GRT or a percentage of its total propelling machinery space. However, if propelled by screw, only for those vessels with total propelling machinery space at least 20% of GRT, do owners have the opportunity to choose. The second set of propelling power options in TonCalc (excerpted below), only applies for vessels meeting this 20% of GRT criterion. In a future version of TonCalc, we are considering clarifying the associated labeling to better describe when the propelling machinery space volume is being used to calculate the propelling power allowance for the engine room deduction.

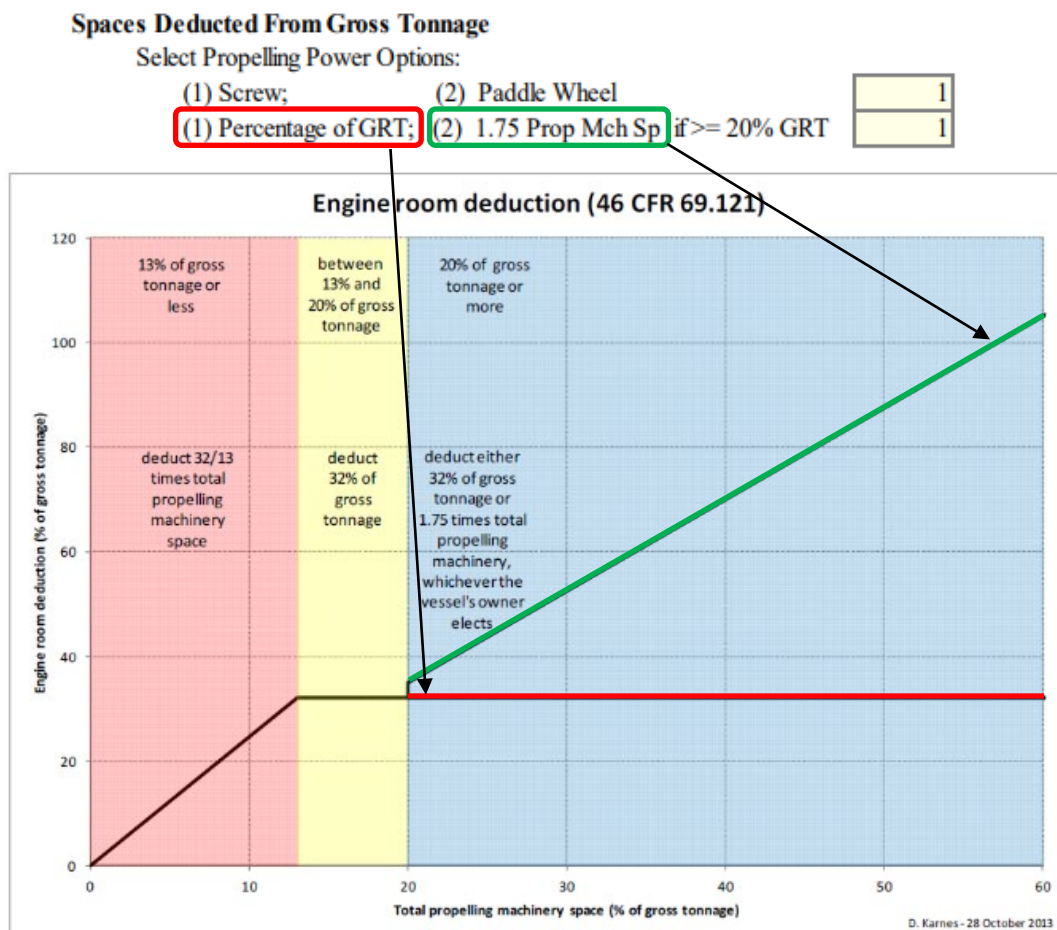

TONNAGE DIVISION VACANCY The Marine Safety Center has advertised a full-time naval architecture position in the Tonnage Division, with a salary range of \$102,663 to \$133,465 per year. Applications must be received no later than August 4, 2020. Details are available on the government's USAJobs website at <https://www.usajobs.gov/GetJob/ViewDetails/572646200> (open to the public) and <https://www.usajobs.gov/GetJob/ViewDetails/572647100> (open to current/former federal employees, etc.)

Weekly Notes are issued by the Coast Guard Marine Safety Center's Tonnage Division (MSC-4) for use by organizations that perform measurement work on the Coast Guard's behalf. They are for informational purposes only, and are not intended as, nor should they be construed to represent, revisions of or substitutes for applicable statutes or regulations or established interpretations of either.

MEASUREMENT ORGANIZATION WEEKLY NOTES – 07/22/2020

PROPULSOR WELLS We recently responded to an inquiry regarding the potential disruption of an alternating ordinary bottom framing pattern due to the fitting of large propulsor wells. Among many considerations in arriving at a decision was the well size (see the related item in the Weekly Notes edition of April 19, 2017), characteristics of the bottom plating, and the presence of internal welded brackets inside the well that served as continuations of the surrounding closely-spaced bottom framing. In view of the trends in ship design toward increasing use of non-traditional propulsion systems, careful consideration must be given to their impact on ordinary bottom and side frame systems when applying Regulatory measurement rules.



EMAIL ISSUES In recent weeks, we have received customer complaints of failure of email messages to reach MSC addressees, including the MSC's electronic commerce inbox msc@uscg.mil. In some cases, the email messages may make it through after delays of many hours, but in other cases they "disappear" completely with neither the sender nor recipient being notified. Large attachments seem to exacerbate the problems, but not in all cases. We are aware of the issues, but have no influence on affecting a solution and request your continued patience until the Coast Guard can develop a permanent fix.

CONVENTION MILESTONE ANNIVERSARY July 17, 2020 marked the 40th anniversary of Japan's acceptance of the 1969 Tonnage Convention. With its acceptance, a sufficient number of nations, representing not less than 65% of the gross tonnage of the world's merchant shipping, triggered the Convention's coming into force 24 months later on July 18, 1982.

Weekly Notes are issued by the Coast Guard Marine Safety Center's Tonnage Division (MSC-4) for use by organizations that perform measurement work on the Coast Guard's behalf. They are for informational purposes only, and are not intended as, nor should they be construed to represent, revisions of or substitutes for applicable statutes or regulations or established interpretations of either.

MEASUREMENT ORGANIZATION WEEKLY NOTES – 07/15/2020

GISIS COUNTRY FILE INFORMATION In preparing for the first U.S. audit under the IMO Member State Audit Scheme (IMSAS), the MSC is becoming more familiar with “Country File” information available through IMO’s [Global Integrated Shipping Information System \(GISIS\)](#). Member States are increasingly posting interpretive policy and other valuable material related to the 1969 Tonnage Convention and other IMO instruments to this website. Further, the fact that IMO will be repeating these audits on a recurring basis will help to ensure this information is kept current. The information is available to any member of the public, by registering with IMO for a free public account.

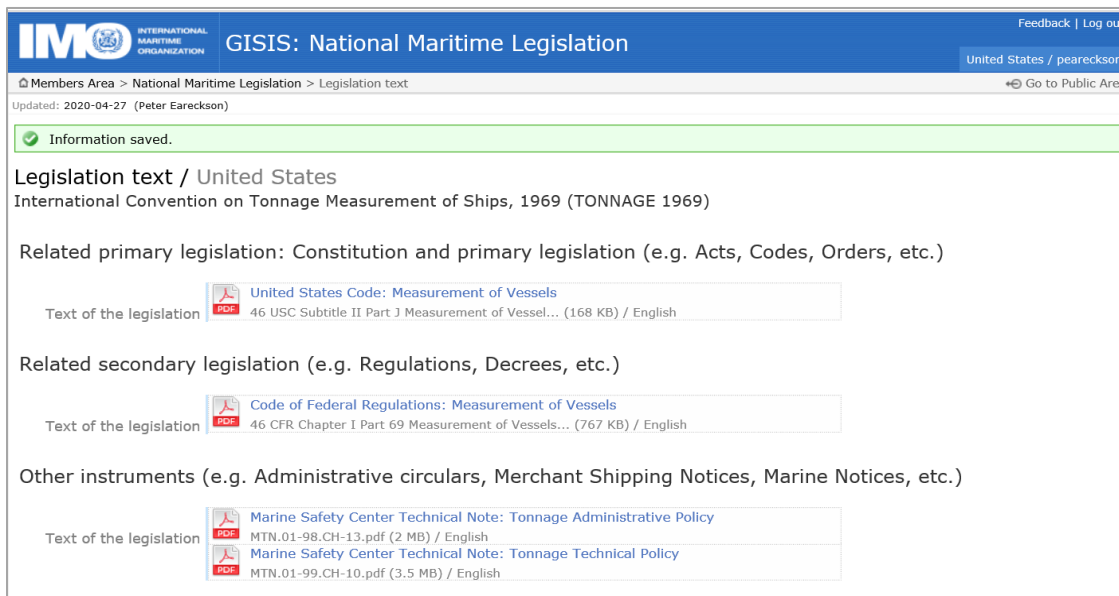

The screenshot shows the IMO GISIS National Maritime Legislation page for the United States. The page header includes the IMO logo and the title "GISIS: National Maritime Legislation". The breadcrumb trail is "Members Area > National Maritime Legislation > Legislation text". The page is updated as of 2020-04-27 by Peter Eareckson. A green notification bar at the top indicates "Information saved." The main content is titled "Legislation text / United States" and refers to the "International Convention on Tonnage Measurement of Ships, 1969 (TONNAGE 1969)". It lists three categories of related legislation:

- Related primary legislation:** Constitution and primary legislation (e.g. Acts, Codes, Orders, etc.)
 - United States Code: Measurement of Vessels (46 USC Subtitle II Part J Measurement of Vessel... (168 KB) / English)
- Related secondary legislation:** (e.g. Regulations, Decrees, etc.)
 - Code of Federal Regulations: Measurement of Vessels (46 CFR Chapter I Part 69 Measurement of Vessels... (767 KB) / English)
- Other instruments:** (e.g. Administrative circulars, Merchant Shipping Notices, Marine Notices, etc.)
 - Marine Safety Center Technical Note: Tonnage Administrative Policy (MTN.01-98.CH-13.pdf (2 MB) / English)
 - Marine Safety Center Technical Note: Tonnage Technical Policy (MTN.01-99.CH-10.pdf (3.5 MB) / English)

Weekly Notes are issued by the Coast Guard Marine Safety Center’s Tonnage Division (MSC-4) for use by organizations that perform measurement work on the Coast Guard’s behalf. They are for informational purposes only, and are not intended as, nor should they be construed to represent, revisions of or substitutes for applicable statutes or regulations or established interpretations of either.

MEASUREMENT ORGANIZATION WEEKLY NOTES – 07/08/2020

USCG DOMESTIC VESSEL INSPECTION ANNUAL REPORT Last month the Coast Guard announced publication of the [2019 Domestic Annual Report](#) on Flag State Control in the United States, containing statistics and information regarding inspections and enforcement of regulations on U.S. flag vessels. As required by the Save Our Seas Act of 2018, the report includes deficiency and detention rates for inspected vessels, as well as performance metrics for Recognized Organizations (ROs) that perform work on the Coast Guard's behalf. The report highlights the numbers – broken out by RO - of surveys and audits conducted, as well as inspections and detentions under the Paris and Tokyo MOUs.

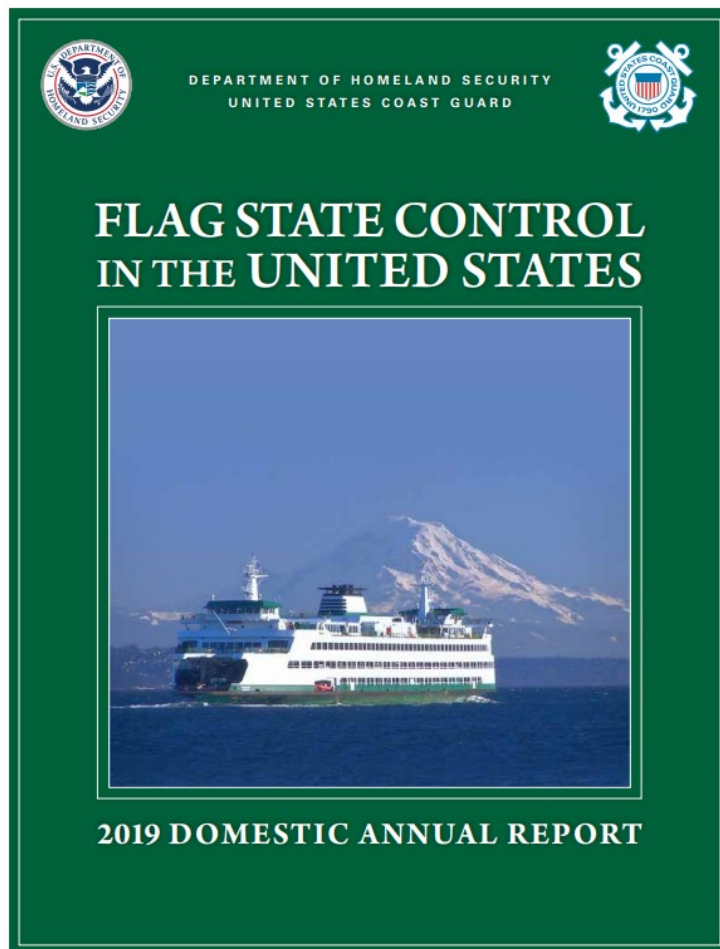

TONNAGE DIVISION VACANCY The Marine Safety Center has advertised a full-time naval architecture position in the Tonnage Division, with a salary range of \$102,663 to \$133,465 per year. Applications must be received no later than August 4, 2020. Details are available on the government's USAJobs website at <https://www.usajobs.gov/GetJob/ViewDetails/572646200> (open to the public) and <https://www.usajobs.gov/GetJob/ViewDetails/572647100> (open to current/former federal employees, etc.)

Weekly Notes are issued by the Coast Guard Marine Safety Center's Tonnage Division (MSC-4) for use by organizations that perform measurement work on the Coast Guard's behalf. They are for informational purposes only, and are not intended as, nor should they be construed to represent, revisions of or substitutes for applicable statutes or regulations or established interpretations of either.

MEASUREMENT ORGANIZATION WEEKLY NOTES – 07/01/2020

ACS AGREEMENTS Further to the item in the Weekly Notes edition of May 13, 2020, the Coast Guard posted its first updated ACS Agreement under this broader initiative. Of particular note is that the updated Agreements include explicit language for measurement organizations to maintain a tonnage measurement staff meeting certain requirements. The latest Agreements are available on a [website](#) now maintained by the Coast Guard's Flag State Control Division (CG-CVC-4).

The screenshot shows the United States Coast Guard website. The header includes the Coast Guard logo, the text "UNITED STATES COAST GUARD U.S. DEPARTMENT OF HOMELAND SECURITY", and a search bar. A navigation menu contains "OPERATIONS HOME", "ABOUT US", "OUR ORGANIZATION", "FEATURED CONTENT", "CONTACT", and "JOIN THE COAST GUARD". A left sidebar lists various categories, with "FLAG STATE CONTROL" expanded to show "CLASS SOCIETY AUTHORIZATION". The main content area is titled "Flag State Control Division (CG-CVC-4) Classification Society Authorizations". It includes a "Please Note" warning, a paragraph about the Coast Guard's authorization of classification societies, and sections for "Classification Society Approval", "Classification Society Recognition", "International Convention Certificate Authorization", "Classification Society Authorizations and Agreements" (with a bulleted list of agreements), "Alternate Compliance Program Authorization", and "U.S. Supplement Approval". A contact note is at the bottom, and the footer features the motto "SEMPER PARATUS ALWAYS READY" and social media icons.

INDEPENDENCE DAY HOLIDAY The MSC will be closed on Friday, July 3rd, in observance of Independence Day.

Weekly Notes are issued by the Coast Guard Marine Safety Center's Tonnage Division (MSC-4) for use by organizations that perform measurement work on the Coast Guard's behalf. They are for informational purposes only, and are not intended as, nor should they be construed to represent, revisions of or substitutes for applicable statutes or regulations or established interpretations of either.

MEASUREMENT ORGANIZATION WEEKLY NOTES – 06/24/2020

LONDON TONNAGE CONFERENCE ANNIVERSARY Yesterday marked the 51st anniversary of the conclusion of the diplomatic conference in London that created the 1969 Tonnage Convention. From historical records, it is clear that many of the issues we face today in applying measurement rules were known to those in attendance, notwithstanding the advances in ship design and construction since that time. These include how to characterize a vessel's enclosed volume and apply certain nautical terms that have eluded precise definition over the years, such as "stem", "stern", "complete deck", and "recess", especially when different languages are involved. The following excerpts from conference document TM/Conf/4, Basic Proposal A, highlight the different opinions at that time on the meaning of the seemingly straightforward term "step".

Netherlands

Step is a vertical shift of the deck whereby the parts of the deck are connected by a transverse bulkhead, and whereby none of the parts of the deck is continuous on the same level at that bulkhead."

In order to avoid that a construction as indicated in the sketch could be defined as a step.

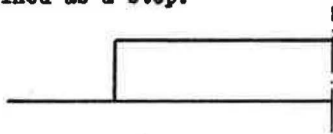

USSR

A step is a sharp difference in deck height as compared to the basic line formed by the vertical (in frame plan) or inclined section.

Where length of an inclined section is more than ten times the step's height, the inclined section is regarded as a sheer.

LINE OF THE UPPER DECK Further to the item in last week's edition of the Weekly Notes, we will be examining the following figure in our discussions with measurement organization representatives. It generated a lively discussion among attendees at the 1990 Expert Meeting on Tonnage of Ships in Tokyo, several of whom had also attended the 1969 Tonnage Conference in London.

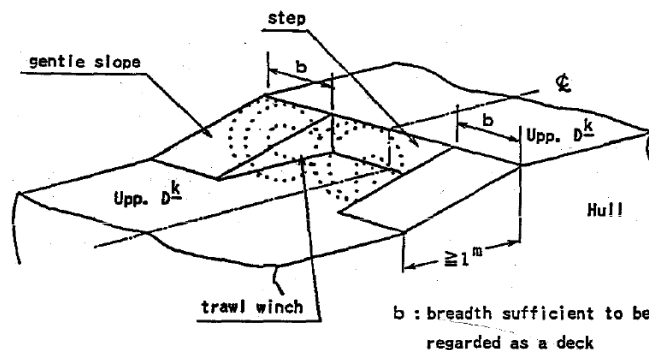

Weekly Notes are issued by the Coast Guard Marine Safety Center's Tonnage Division (MSC-4) for use by organizations that perform measurement work on the Coast Guard's behalf. They are for informational purposes only, and are not intended as, nor should they be construed to represent, revisions of or substitutes for applicable statutes or regulations or established interpretations of either.

MEASUREMENT ORGANIZATION WEEKLY NOTES – 06/17/2020

STERN STEPS AND RECESSES In the weeks ahead, the MSC will be reaching out to measurement organizations regarding application of the rules of the 1969 Tonnage Convention to complex stern arrangements, especially those involving steps, deck recesses, stern notches and similar discontinuities. Establishing the Convention length and molded depth measurements in such cases requires careful consideration of the operative definitions and interpretations, which can vary among international instruments and flag States.



Weekly Notes are issued by the Coast Guard Marine Safety Center's Tonnage Division (MSC-4) for use by organizations that perform measurement work on the Coast Guard's behalf. They are for informational purposes only, and are not intended as, nor should they be construed to represent, revisions of or substitutes for applicable statutes or regulations or established interpretations of either.

MEASUREMENT ORGANIZATION WEEKLY NOTES – 06/10/2020

DRAWING FORMATS As previously mentioned in the Weekly Notes, the MSC has a limited capability to view drawings, sketches, and similar files due to engineering software constraints. We encourage that supporting files accompanying requests for interpretations be submitted in .pdf format. If you are unable to send a drawing or sketch as a .pdf, AutoCAD .dwg files in a 2017 or earlier version are acceptable.

Weekly Notes are issued by the Coast Guard Marine Safety Center's Tonnage Division (MSC-4) for use by organizations that perform measurement work on the Coast Guard's behalf. They are for informational purposes only, and are not intended as, nor should they be construed to represent, revisions of or substitutes for applicable statutes or regulations or established interpretations of either.

MEASUREMENT ORGANIZATION WEEKLY NOTES – 06/03/2020

FRAME INTERSECTION TREATMENT The MSC recently responded to an inquiry regarding revised frame intersection criteria established by MTN 01-99 CH-10. A central issue was whether weld beads connecting ordinary and intersecting frames could be counted toward the 50% frame perimeter attachment criterion of § 69.109(p)(1)(i). The following figure shows an example of an intersecting frame with fitted collar plates and additional weld to fill small gaps that, taken together, render the final assembly as an integral unit. As we consider this configuration, including the weld, to have 100% frame perimeter attachment, we would also count weld beads toward the 50% attachment criterion in other cases.

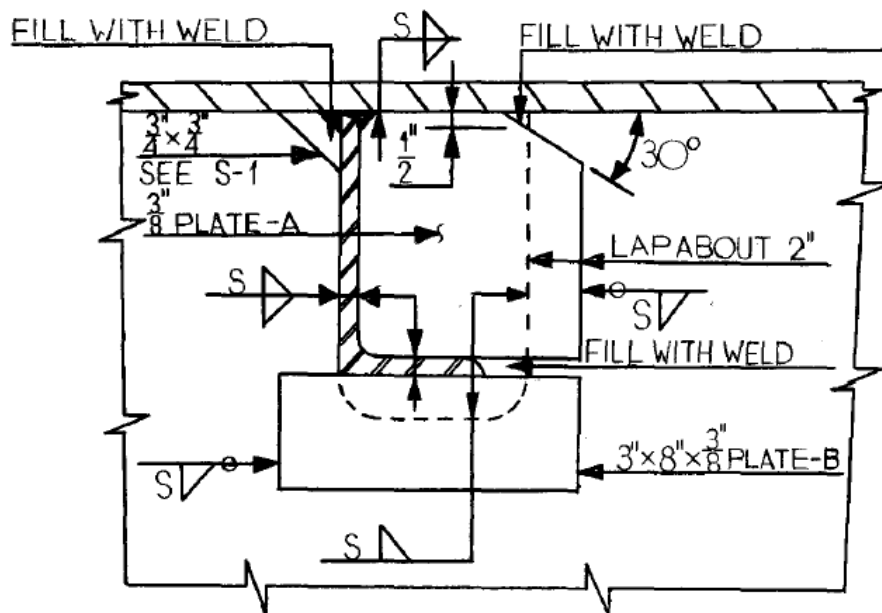

Image credit: Ship Structure Committee report [Review of Ship Structural Details](#) (1977)

WEEKLY NOTES MILESTONE The Weekly Notes - started in 2008 - now include over 600 pages in their consolidated form. While searching the entire document for information on a particular topic can be useful, we recognize that its file size (currently ~24 MB) may be unwieldy for some. As a compromise, we have resumed posting the latest edition along with the full consolidated version on our [U.S. Tonnage Publications web page](#). If you have any additional comments regarding the Weekly Notes format or future content, please feel free to share with Mr. David Karnes.

Weekly Notes are issued by the Coast Guard Marine Safety Center's Tonnage Division (MSC-4) for use by organizations that perform measurement work on the Coast Guard's behalf. They are for informational purposes only, and are not intended as, nor should they be construed to represent, revisions of or substitutes for applicable statutes or regulations or established interpretations of either.

MEASUREMENT ORGANIZATION WEEKLY NOTES – 05/27/2020

REMOTE SURVEY Since the onset of the COVID-19 pandemic, the MSC has approved requests for provisional remote tonnage surveys to facilitate social distancing, both on a case-by-case basis, and on a broader basis covering multiple surveys for the duration of the pandemic. We continue to entertain requests for such authorizations, noting the considerations described in the Weekly Notes edition of April 22, 2020. Of particular importance is obtaining photographic objective evidence during the survey of sufficient quality. See especially the discussion in the Weekly Notes edition of September 21, 2016 regarding the advantages of higher resolution photos.



HULL APPENDAGES The MSC recently issued a decision on hull appendages at the extreme ends of a vessel. Various provisions and interpretations of the 1969 Tonnage Convention and U.S. tonnage regulations provide for including such appendages in tonnage if they exceed one cubic meter. In evaluating whether an “appendage” is, in fact, an integral part of the hull, relevant governing text must be carefully considered. Note especially the interpretation regarding “buoyant hull envelope”, excerpted below, from MTN 01-99 CH-10, which applies to the overall length measurement.

(b) Attachments that are typically not part of the buoyant hull envelope, and are therefore not included in the overall length, include bowsprits, overhanging decks, swim platforms, stern-wheel supports and non-watertight bulwarks.

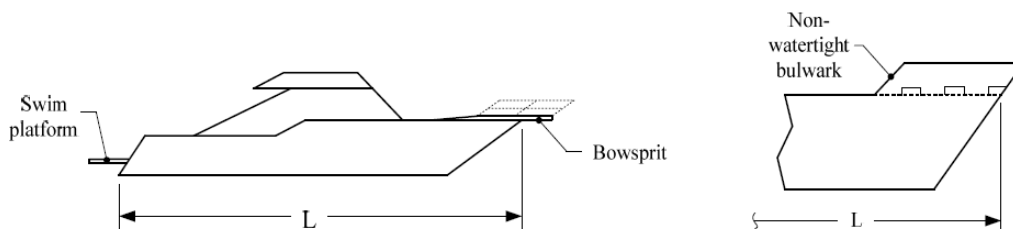

Weekly Notes are issued by the Coast Guard Marine Safety Center’s Tonnage Division (MSC-4) for use by organizations that perform measurement work on the Coast Guard’s behalf. They are for informational purposes only, and are not intended as, nor should they be construed to represent, revisions of or substitutes for applicable statutes or regulations or established interpretations of either.

MEASUREMENT ORGANIZATION WEEKLY NOTES – 05/20/2020

BULKHEAD OPENINGS We conclude our series on bulkhead openings, using the following figure to illustrate the distinction between open space progression from side and end openings under Standard system rules. For the side recess, there is no valid progression path that would permit exemption of interior compartments within the 1st tier deckhouse via the otherwise qualifying 4' x 5' opening, shown fitted with a temporary cover. This is because the tonnage regulations only permit open space to progress via qualifying openings in end bulkheads of a structure. Conversely, open space progresses from the end opening into both the wider and narrower spaces opposite the opening, and continues through the qualifying 4' x 5' opening (also shown fitted with a temporary cover) into other compartments within the 1st tier deckhouse. See especially § 69.117(d)(3)(i)(1)(a) of MSC Technical Note (MTN) 01-99 CH-10, and the related figure, for more details.

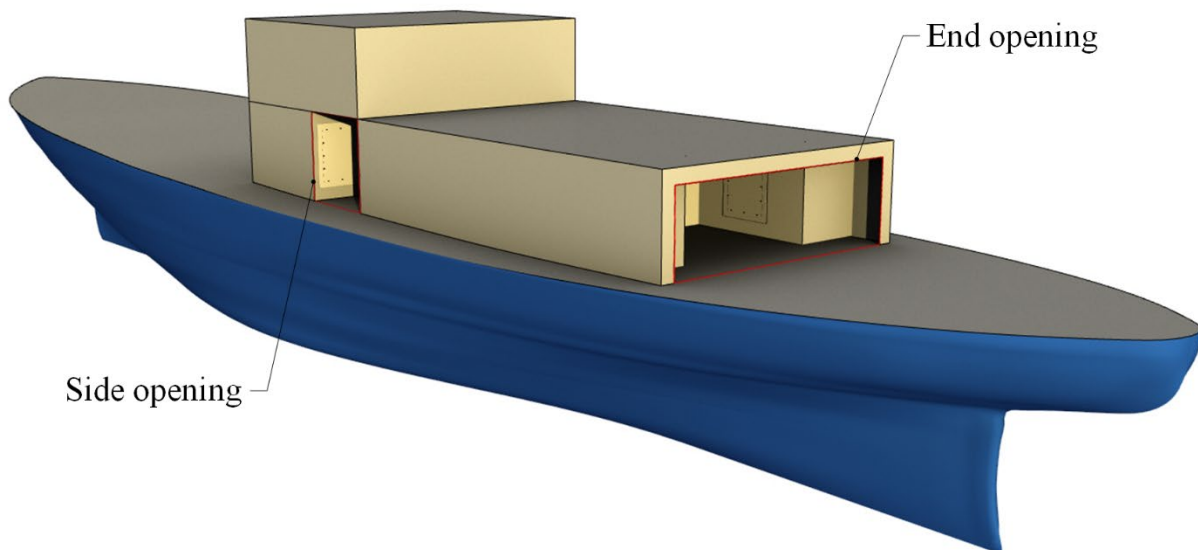

MEMORIAL DAY HOLIDAY The MSC will be closed on Monday, May 25, 2020 in observance of Memorial Day.

Weekly Notes are issued by the Coast Guard Marine Safety Center's Tonnage Division (MSC-4) for use by organizations that perform measurement work on the Coast Guard's behalf. They are for informational purposes only, and are not intended as, nor should they be construed to represent, revisions of or substitutes for applicable statutes or regulations or established interpretations of either.

MEASUREMENT ORGANIZATION WEEKLY NOTES – 05/13/2020

BULKHEAD OPENINGS The second area in our bulkhead openings discussion series is the nexus between Convention and Standard system rules regarding bulkhead opening treatment at the end of a deck structure, such as the 1st tier configuration depicted below. Under both rule sets, the larger opening is characterized as an end opening, and the end boundary bulkhead of the structure is the athwartships bulkhead fitted with the smaller opening and qualifying temporary cover plate. Under the Standard system rules, open space progresses from the excluded space opposite the end opening forward through the smaller opening into the 1st tier deckhouse structure, provided all the provisions of MSC Technical Note (MTN) 01-99 CH-10 are met.

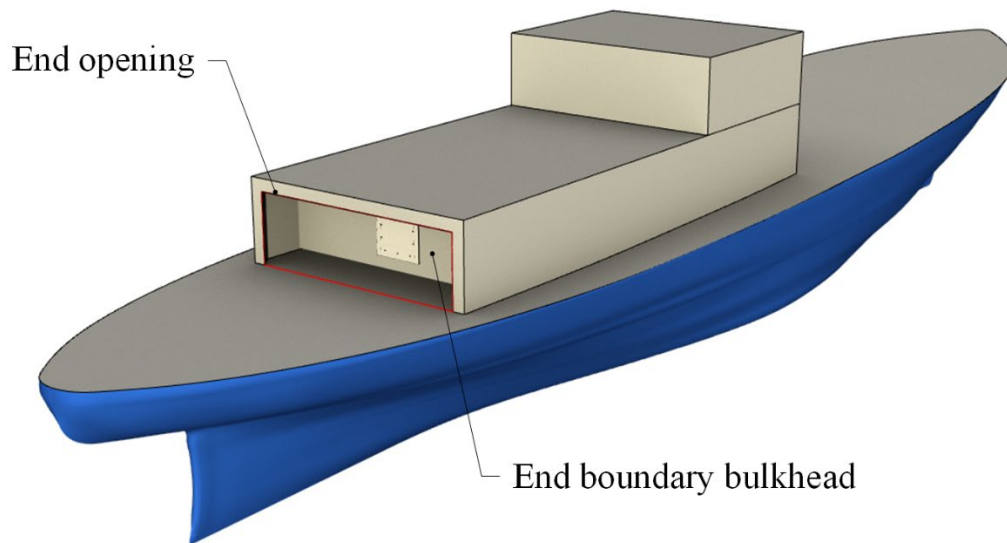

ACS AGREEMENTS Agreements under which ACSs perform tonnage measurement and other work on the Coast Guard's behalf are publicly available on a [CG-CVC-4 web page](#). In view of the ongoing work at the International Maritime Organization (IMO) on the Model Agreement and preparations for the first audit of the United States under the IMO Member State Audit Scheme (IMSAS), these documents are currently under review. If you have any input on this subject, please contact Mr. Peter Eareckson.

Weekly Notes are issued by the Coast Guard Marine Safety Center's Tonnage Division (MSC-4) for use by organizations that perform measurement work on the Coast Guard's behalf. They are for informational purposes only, and are not intended as, nor should they be construed to represent, revisions of or substitutes for applicable statutes or regulations or established interpretations of either.

MEASUREMENT ORGANIZATION WEEKLY NOTES – 05/06/2020

BULKHEAD OPENINGS The first area in our bulkhead openings discussion series is side recess treatment under Standard measurement. We note that there are no provisions of the tonnage regulations as interpreted by MSC Technical Note (MTN) 01-99 CH-10 that would allow progression of open space from a side recess (see especially § 69.117(d)(3)(ii)). As illustrated in the figure below, neither the longitudinal nor transverse bulkheads of the side recess are considered exterior end bulkheads in which qualifying openings may be used to progress open space into the structure under § 69.117(d)(2), nor are these bulkheads considered interior bulkheads through which open space may be progressed under § 69.117(d)(3)(i).

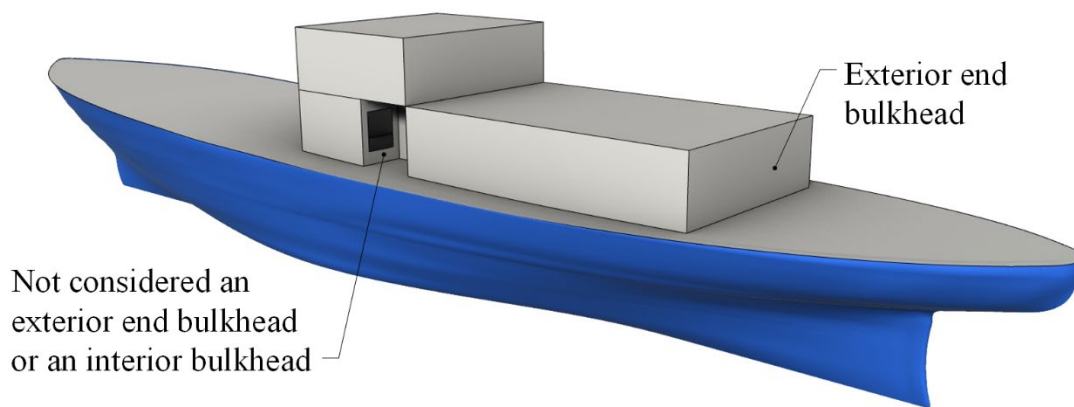

Weekly Notes are issued by the Coast Guard Marine Safety Center's Tonnage Division (MSC-4) for use by organizations that perform measurement work on the Coast Guard's behalf. They are for informational purposes only, and are not intended as, nor should they be construed to represent, revisions of or substitutes for applicable statutes or regulations or established interpretations of either.

MEASUREMENT ORGANIZATION WEEKLY NOTES – 04/29/2020

BULKHEAD OPENINGS Next week we will begin a multipart series on the subject of progression of open space from exterior bulkhead openings under the Standard system. In this series, we will discuss common areas of confusion in applying the measurement rules to “hybrid” situations involving semi-enclosed spaces, such as side recesses or spaces bounded by overhanging decks supported only by stanchions. We will focus on some of the foundational principles upon which the rules are based, including what constitutes a boundary bulkhead in this context, and the nexus with rules for excluded space treatment under the Convention system. We intend to use the following baseline image - created with the Rhino software application - to illustrate key points.

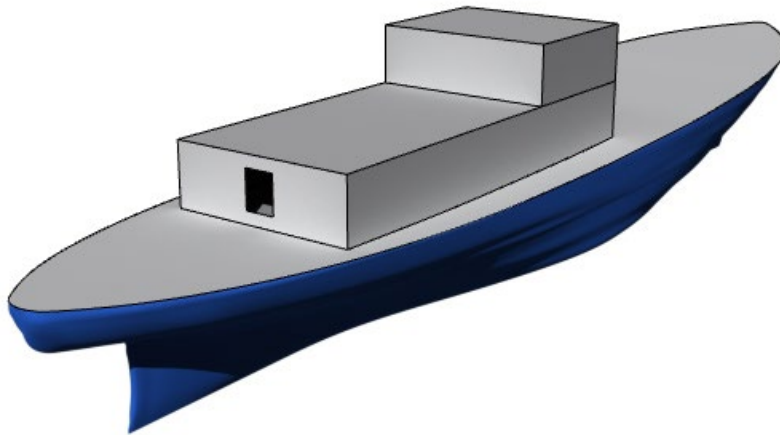

MSC DESIGN INVOLVEMENT As a reminder for ACS representatives and their clients, the MSC does not provide advice to vessel owners, operators, naval architects and others seeking to achieve particular tonnage objectives. However, we do assist customers in both the public and private sectors should questions arise on how tonnage measurement rules are to be applied to specific designs, and will provide formal rulings as necessary. To avoid costly modifications and/or construction delays stemming from a misunderstanding of the tonnage rules, we strongly encourage early MSC involvement in addressing such questions, either through the ACS that will be measuring the vessel, or by direct contact with the MSC.

MEASUREMENT ORGANIZATION WEEKLY NOTES – 04/22/2020

REMOTE SURVEY CONSIDERATIONS During recent discussions with ACS managers on provisional use of remote surveys to promote social distancing, a recurring theme was ensuring a satisfactory result when relying on an outside party as the “eyes and ears” of a remote ACS surveyor. Of particular concern were challenges in witnessing complex tasks (e.g., a hydrostatic test or obtaining measurements in the absence of adequate construction drawings), and assuring the accuracy and objectivity of the information being received remotely by the surveyor (e.g., the extent and quality of photographic evidence). In this regard, any requests for provisional remote tonnage survey approval in response to the COVID-19 pandemic should describe the extent of outside party involvement, and indicate how sufficient objective visual evidence will be obtained to confirm a vessel’s “as-measured” configuration at the time of the survey. For example, relying on owners to provide missing under-deck measurements would call into question the survey’s validity.

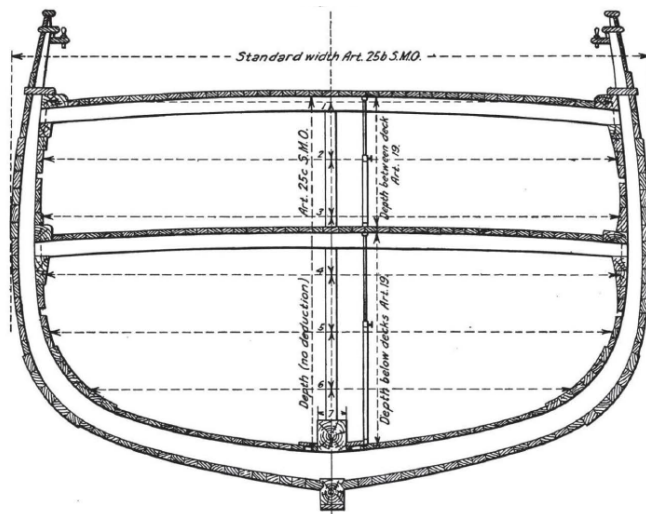

Figure from *Measurement of Vessels for the Panama Canal*, Government Printing Office, 1913, showing apparatus used in *Ship Measurement Instructions Issued by the German Government* to obtain accurate under-deck measurements of a two deck vessel.

USCG SOCIAL DISTANCING As previously mentioned in the Weekly Notes, the Coast Guard is making use of increased telework, with minimal in-office staffing, in order to facilitate social distancing during the COVID-19 pandemic. Both at the MSC and headquarters-wide, there are no immediate plans to discontinue this posture while we continue to support the Marine Transportation System. In a recent interview with Politico, the Commandant of the Coast Guard, Admiral Karl Schultz, touched on the service’s priorities during the pandemic:

We’ve been focused first and foremost on protecting our people and maintaining our service readiness. I think we’ve found that balance. We’re doing those missions America expects, but focus on a few. We all know the impacts to the economy. One of our key banner missions is economic prosperity, facilitating the marine transportation system. I think that’s as critical today as ever before. Ninety-five percent of the goods we all buy in America enter through seaports, so we are focused on the 355 seaports, the 25,000 miles of navigable water, keeping the maritime flow of commerce. The day-to-day rescue work of the Coast Guard continues.

Weekly Notes are issued by the Coast Guard Marine Safety Center’s Tonnage Division (MSC-4) for use by organizations that perform measurement work on the Coast Guard’s behalf. They are for informational purposes only, and are not intended as, nor should they be construed to represent, revisions of or substitutes for applicable statutes or regulations or established interpretations of either.

MEASUREMENT ORGANIZATION WEEKLY NOTES – 04/15/2020

NOTIFICATION PROCESS IMPROVEMENTS Further to the items appearing in the Weekly Notes editions of September 4, 2019 and January 22, 2020, the MSC is continuing work on improving the notification process for technical work completed on the Coast Guard's behalf. In consultation with ACS Information Technology (IT) and Technical Program managers, we are currently evaluating new ways of categorizing this work in a more generalized fashion that would capture essential information without burdensome detail (such as whether a tonnage certification action was for an initial measurement or a remeasurement). Examples using 2019 ACS notification data follow. If you have any input on this subject, please contact Mr. Marcus Akins.

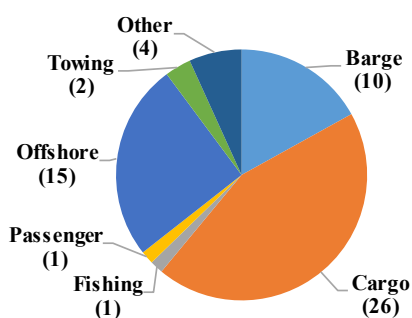

Vessel Type	Description (Subchapters)
Barge	Tank Barges (D), Freight/Industrial Barges (I), and Certain Bulk Dangerous Cargo Barges (O).
Cargo	Freight/Industrial Vessels (I), Tankships (D/O), and public vessels not covered by another category.
Passenger	Vessels carrying passengers (T/K/H) and passenger barges.
Fishing	Commercial fishing, fish processing or fish tenders.
Offshore	Offshore Supply Vessels (I/L), MODUS/Floating Production Systems (I-A), and Floating Offshore Installations (I-A/N).
Towing	Vessels with primary service of towing (M and I, C).
Other	Any vessel type not previously listed to include Recreational Vessels, Research (U), and School Ships (R).

Work Categories	Cross-Reference to Applicable MISLE System Codes
Structures, Stability, & Load Line	02 – Structural Conditions and 03 – Water/Weathertight Conditions (less Tonnage).
Tonnage	A subset of 02 – Structural Conditions and 03 – Water/Weathertight Conditions, pulled out due to separate delegated authority.
Cargo Operations	06 – Cargo Operations, including Equipment.
Fire Safety	07 – Fire Safety.
Propulsion & Machinery	13 – Propulsion and Auxiliary Machinery (less Electrical & Automation).
Electrical & Automation	A subset of 13 – Propulsion and Auxiliary Machinery, pulled out due to specialized skillset for review.
Personnel Safety	09 – Working and Living Conditions.
Other Safety	All other categories, including 08 – Alarms, 04 – Emergency Systems, 10 – Safety of Navigation, 11- Life Saving Appliances, 14 – Pollution Prevention, and 99 - Other

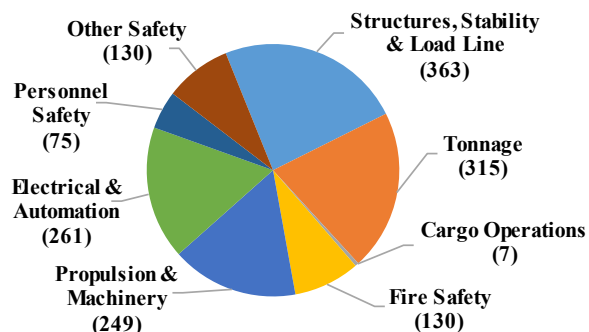

Weekly Notes are issued by the Coast Guard Marine Safety Center's Tonnage Division (MSC-4) for use by organizations that perform measurement work on the Coast Guard's behalf. They are for informational purposes only, and are not intended as, nor should they be construed to represent, revisions of or substitutes for applicable statutes or regulations or established interpretations of either.

MEASUREMENT ORGANIZATION WEEKLY NOTES – 04/08/2020

TONNAGE MEASUREMENT RECORDS In light of the ongoing COVID-19 pandemic, the National Archives and Records Administration (NARA), which maintains certain tonnage measurement records, has adjusted its normal operations to balance the need of completing its mission-critical work while also adhering to the recommended social distancing for the safety of its staff (one of whom tested positive for COVID-19 last month). NARA has suspended reproduction and digitization services until further notice due to COVID-19. ACSs should be aware that the MSC is practicing social distancing, and currently has limited staffing available to access the tonnage records maintained on site. The more advance notice we receive for ACS tonnage file requests, the better the chance of having someone available on site who could make the necessary electronic copies.



The screenshot shows the National Archives website. At the top left is the National Archives logo. To the right are links for "Blogs", "Bookmark/Share", and "Contact Us". Below these is a search bar with the text "Search Archives.gov" and a "Search" button. A navigation bar contains five categories: "RESEARCH OUR RECORDS", "VETERANS' SERVICE RECORDS", "EDUCATOR RESOURCES", "VISIT US", and "AMERICA'S FOUNDING DOCUMENTS". Below this is a dark banner with the word "Coronavirus" in white, and a small image of a coronavirus particle. Underneath the banner is a breadcrumb trail: "Home > Coronavirus". The main content area has the word "Coronavirus" in a large font. Below that is a large image of a coronavirus particle with a white box overlaid that says "COVID-19 Updates". At the bottom of the page, there is a caption: "(Image courtesy of the Public Health Image Library, Centers for Disease Control and Prevention)".

Weekly Notes are issued by the Coast Guard Marine Safety Center's Tonnage Division (MSC-4) for use by organizations that perform measurement work on the Coast Guard's behalf. They are for informational purposes only, and are not intended as, nor should they be construed to represent, revisions of or substitutes for applicable statutes or regulations or established interpretations of either.

MEASUREMENT ORGANIZATION WEEKLY NOTES – 04/01/2020

REMOTE INSPECTIONS AND SURVEYS The Coast Guard's Assistant Commandant for Prevention Policy issued [Marine Safety Information Bulletin \(MSIB\) 09-20](#), describing how the Coast Guard will use remote inspection techniques for commercial vessel compliance purposes in response to the COVID-19 outbreak. It also addresses certain ACS surveys conducted on the Coast Guard's behalf, subject to case-by-case approval. Because tonnage measurement surveys are performed under a different authority, the provisional ACS remote tonnage survey authorizations described in recent Weekly Notes editions need not be on a case basis. Last week, the MSC granted its first authorization for such remote tonnage surveys in response to the COVID-19 outbreak.



Marine Safety Information Bulletin

Commandant
U.S. Coast Guard
Inspections and Compliance Directorate
2703 Martin Luther King Jr Ave SE, STOP 7501
Washington, DC 20593-7501

MSIB Number: 09-20
Date: March 26, 2020
E-Mail: OutbreakQuestions@uscg.mil

Vessel Inspections, Exams, and Documentation

The uninterrupted flow of commerce on our Marine Transportation System (MTS) is critical to both National Security and National economic well-being. During this National emergency for COVID-19 it is paramount that the Coast Guard safeguards the continued operation of the MTS to ensure our domestic supply chain continues uninterrupted. Commercial vessel compliance activities should, to the extent possible, continue so as to safeguard the MTS and prevent an undue backlog from causing future delays. To facilitate the safe flow of commerce, the Coast Guard will liberally use remote inspection techniques to verify vessel compliance and, if needed, defer inspections. The following is the Coast Guard's current position on commercial vessel compliance activities:

Prior to boarding a vessel or immediately prior to conducting a pre-exam/inspection meeting, Marine Inspectors, Port State Control Officers (PSCOs), and Commercial Fishing Vessel Examiners will verify with the vessel representative that there are no ill persons onboard. Coast Guard personnel will practice the appropriate protective measures as outlined by the Centers for Disease Control and Prevention (CDC).

U.S. Flagged Vessel and Outer Continental Shelf (OCS) Inspections:

1. U.S. flagged vessels and OCS units due for Certificate of Inspection (COI) Renewals, Annual Inspections, Periodic Inspections, Dry Dock Exams, and Internal Structural Examinations (ISE) that are based on statutory or regulatory requirements should be addressed on a case-by-case basis by the local OCMI. Based on the OCMI's evaluation of the history of the vessel and in consultation with the vessel owner or operator, the OCMI may:
 - o Require Coast Guard attendance onboard the vessel to conduct a full or abbreviated inspection;
 - o Accept objective evidence such as recent classification surveys, pictures, video, vessel logs, machinery alarm reports, etc., in lieu of Coast Guard attendance onboard the vessel to credit a required inspection or exam. (A dry dock, pressure vessel, or other non-annual exam may only be credited for a maximum of one year.);
 - o Defer a required inspection or exam for up to 90 days; or
 - o Issue a CG Form CG-835V to restrict the vessel movement as a worklist item.
2. Recognized Organizations (ROs) and Third Party Organizations (TPOs) that are conducting surveys and audits on behalf of the Coast Guard may request extensions on a case-by-case basis on behalf of the vessel owner or operator. This includes both internal and external surveys for those companies/vessels subject to Subchapter M requirements. Surveys and audits that require travel to or through high-risk affected areas will generally constitute sufficient reason for the Coast Guard to grant an extension. When evaluating if an extension will be granted, the OCMI or the Office of Commercial Vessel Compliance (CG-CVC) will evaluate the vessel's history of compliance and may require objective evidence to verify if the vessel complies with the applicable laws and regulations. Any extension of a statutory or

This release has been issued for public information and notification purposes only.

regulatory required survey or audit will be documented in writing by the RO/TPO and should generally not be more than 90 days. ROs/TPOs that seek to use remote survey in lieu of attendance on vessels that are both classed and certificated should contact the Flag State Control Division (CG-CVC-4) or the Towing Vessel National Center of Expertise (TVNCOE) to propose the methods and administrative procedures that will be used. Extension requested for vessels subject to Subchapter M requirements should be relayed by the TPO to the OCMI.

Weekly Notes are issued by the Coast Guard Marine Safety Center's Tonnage Division (MSC-4) for use by organizations that perform measurement work on the Coast Guard's behalf. They are for informational purposes only, and are not intended as, nor should they be construed to represent, revisions of or substitutes for applicable statutes or regulations or established interpretations of either.

MEASUREMENT ORGANIZATION WEEKLY NOTES – 03/25/2020

REMOTE ONBOARD SURVEYS Further to the discussion in last week's Special Edition of the Weekly Notes, the Marine Safety Center (MSC) received its first request for approval of provisional remote tonnage measurement surveys. Action on this request is imminent. While the use of drones in performing certain inspection and testing functions has been the subject of ACS presentations to the MSC in recent years, we are unaware of this technology having been used for any ACS work performed on the Coast Guard's behalf. It appears such technology could be useful in the context of tonnage surveys, especially with respect to obtaining photographs of a vessel's outboard profile.



MSC COMMUNICATIONS Although the Coast Guard is taking aggressive action to implement IT infrastructure changes to support increased telework among Coast Guard employees, until such changes are fully implemented, communications with MSC staff will continue to be difficult. In general, for the short term, MSC staff may not be able to return phone calls or individual email inquiries on the same business day, and even longer in some cases. We appreciate your patience as we continue to pursue IT workarounds in the interim, with our highest priority being support of the Marine Transportation System.

Weekly Notes are issued by the Coast Guard Marine Safety Center's Tonnage Division (MSC-4) for use by organizations that perform measurement work on the Coast Guard's behalf. They are for informational purposes only, and are not intended as, nor should they be construed to represent, revisions of or substitutes for applicable statutes or regulations or established interpretations of either.

MEASUREMENT ORGANIZATION WEEKLY NOTES – 03/16/2020 - SPECIAL EDITION -

COVID-19 Based on telephone conversations with ACS representatives late last week, we understand that measures to contain the spread of coronavirus disease COVID-19 are already impacting tonnage measurement work performed on the Coast Guard's behalf. Such measures include travel restrictions, cancellation of face-to-face meetings, and other means of social distancing. Their impacts have not been limited to the private sector (e.g., see [ALCOAST 085/20 - MAR 2020](#)). We remain committed to supporting such measures to the maximum extent possible while facilitating maritime commerce, within constraints of federal law.

REMOTE ONBOARD SURVEYS Further to the item above, and in view of ongoing efforts across the federal government under the National Emergency declared by the President on March 13, 2020, the Marine Safety Center (MSC) is considering granting ACSs limited authorization to perform tonnage measurement onboard surveys using objective evidence obtained remotely. This could include photographic evidence provided by vessel owners or agents that meet certain conditions, subject to MSC verification on a case basis. ACSs interested in pursuing this flexibility in the short term should contact the MSC immediately.

MSC COMMUNICATIONS The Coast Guard is making use of increased telework in line with the ALCOAST guidance linked above, with minimal in-office staffing. In light of IT infrastructure constraints (discussed in last week's edition), this may result in communication challenges, including the possibility of irregular coverage and implementation of shift work. To facilitate communication, we encourage ACSs to copy all Tonnage Division members' individual email addresses when making submittals to the MSC's main inbox, msc@uscg.mil.

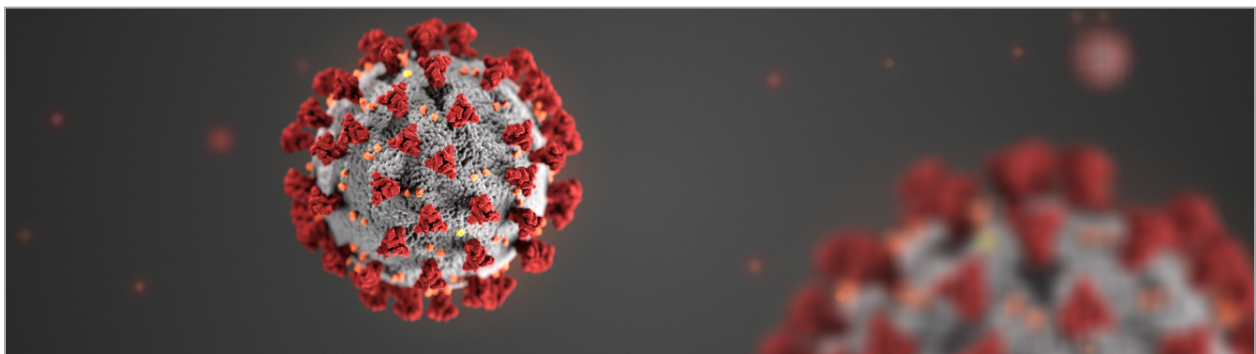

Weekly Notes are issued by the Coast Guard Marine Safety Center's Tonnage Division (MSC-4) for use by organizations that perform measurement work on the Coast Guard's behalf. They are for informational purposes only, and are not intended as, nor should they be construed to represent, revisions of or substitutes for applicable statutes or regulations or established interpretations of either.

MEASUREMENT ORGANIZATION WEEKLY NOTES – 03/11/2020

USCG IT INFRASTRUCTURE Multiple previous Weekly Notes editions have highlighted recurring IT issues (e.g., email, file transfer, PSIX, and network connectivity) that hamper our ability to communicate with external customers and execute our mission. The Commandant of the Coast Guard, Admiral Karl Schultz, called attention to these failures in a recent [article in Sea Technology](#) and his annual [State of the Coast Guard Address](#) last month: “Years of investment tradeoffs have brought our information technology to the brink of catastrophic failure. ... Our people will never fail our country, but our technology is failing our people.” ADM Schultz called for a “Tech Revolution” in the Coast Guard to address these fundamental issues, but in the meantime challenges the service to “make gains where we can.” More to follow, as the Tonnage Division considers workarounds - in addition to those already implemented - to improve information exchange with our customers.



Weekly Notes are issued by the Coast Guard Marine Safety Center’s Tonnage Division (MSC-4) for use by organizations that perform measurement work on the Coast Guard’s behalf. They are for informational purposes only, and are not intended as, nor should they be construed to represent, revisions of or substitutes for applicable statutes or regulations or established interpretations of either.

MEASUREMENT ORGANIZATION WEEKLY NOTES – 03/04/2020

MTN UPDATE Last week, the Marine Safety Center (MSC) issued an update to MSC Technical Note (MTN) 01-99, *Tonnage Technical Policy*. Change 10 to MTN 01-99 includes, but is not limited to, changes reflecting expansion and clarification of interpretive text on the treatment of smaller frame-edge openings; alignment of U.S. interpretations on the registered length of multihull vessels with international interpretations; and the addition of new regulations to Appendix B made mandatory in the Convention per IMO Assembly Resolution A.1084(28), Tonnage Convention Amendments.

DISCUSSION OF SPECIFIC MTN CHANGES In future Weekly Notes editions, we hope to highlight some specific changes made in this MTN update. As with any MTN update, we strongly urge all ACS tonnage staff members to review all changes by looking for the sidebars which identify the substantive changes, and then reading the associated entries in the “Discussion of Changes” appendix.

U.S. Department of
Homeland Security
United States
Coast Guard



**Marine Safety Center
Technical Note**

MTN 01-99 CH-10
16717/46CFR69/P009017
February 28, 2020

Subj: TONNAGE TECHNICAL POLICY

1. **Purpose:** This Technical Note promulgates policy for use by authorized measurement organizations in applying and interpreting provisions of the tonnage regulations (Title 46, Code of Federal Regulations, Part 69 (46 CFR 69), *Measurement of Vessels*.) It replaces MTN 01-99 Change 9.
2. **Discussion:** This Technical Note provides interpretations of the tonnage regulations through a reprint of the regulations in standard font, with interpretations inserted in italics font and interpretive figures added in appropriate locations. Appendices address grandfathering provisions for superseded interpretations, provide related interpretations of, and recommendations for, the International Convention on Tonnage Measurement of Ships, 1969 (the 1969 Tonnage Convention), and discuss changes from the previous version of this Technical Note. Side bars are used throughout this Technical Note to identify substantive changes. The pages are numbered sequentially from the beginning of the document to facilitate electronic use.
3. **Applicability:** Tonnage measurement under the tonnage regulations and the policy of this Technical Note is required for vessels for which the application of a law of the United States depends on the vessel's tonnage. Refer to MTN 01-98 as amended, *Tonnage Administrative Policy*, for additional information on administrative matters related to tonnage measurement.
4. **Action:** Authorized measurement organizations shall apply the interpretations of this Technical Note immediately. Any deviation from the interpretations of this Technical Note requires written approval from the Marine Safety Center (MSC). This Technical Note is available at <http://www.uscg.mil/hq/msc>.
5. **Disclaimer:** This guidance is not a substitute for applicable legal requirements, nor is it itself a rule. It is not intended to nor does it impose legally-binding requirements on any party. It represents the Coast Guard's current thinking on this topic and may assist industry, mariners, the general public, and the Coast Guard, as well as other federal and state regulators, in applying statutory and regulatory requirements. You can use an alternative approach for complying with these requirements if the approach satisfies the requirements of the applicable statutes and regulations. If you want to discuss an alternative approach (you are not required to do so), you may contact the Marine Safety Center (MSC-4), which is responsible for implementing this guidance.



S. J. KELLY

Weekly Notes are issued by the Coast Guard Marine Safety Center's Tonnage Division (MSC-4) for use by organizations that perform measurement work on the Coast Guard's behalf. They are for informational purposes only, and are not intended as, nor should they be construed to represent, revisions of or substitutes for applicable statutes or regulations or established interpretations of either.

MEASUREMENT ORGANIZATION WEEKLY NOTES – 02/26/2020

TONNAGE DIVISION VACANCY The Marine Safety Center has advertised a full-time naval architecture position in the Tonnage Division, with a salary range of \$102,663 to \$133,465 per year. Applications must be received no later than April 20, 2020. Details are available on the government's USAJobs website at <https://www.usajobs.gov/GetJob/ViewDetails/560333200> (open to the public) and <https://www.usajobs.gov/GetJob/ViewDetails/560332600> (open to current/former federal employees, etc.)

Weekly Notes are issued by the Coast Guard Marine Safety Center's Tonnage Division (MSC-4) for use by organizations that perform measurement work on the Coast Guard's behalf. They are for informational purposes only, and are not intended as, nor should they be construed to represent, revisions of or substitutes for applicable statutes or regulations or established interpretations of either.

MEASUREMENT ORGANIZATION WEEKLY NOTES – 02/19/2020

VESSEL DETERMINATION PROCESS Occasionally, the Marine Safety Center receives inquiries on whether non-traditional watercraft, such as theaters, hotels, gaming sites, restaurants, museums, and business offices either self-propelled or not, are eligible for measurement as vessels of the United States. Per § 8 of MTN 01-98 CH-13 and Volume II of the USCG Marine Safety Manual, if there is a question as to whether any specific craft is or will be a vessel, it is up to the cognizant USCG Officer in Charge, Marine Inspection (OCMI) to make such a determination. In a decision described in the Weekly Notes edition of January 22, 2013, the U.S. Supreme Court ruled that the floating house in the photograph below is not a vessel for purposes of admiralty jurisdiction.

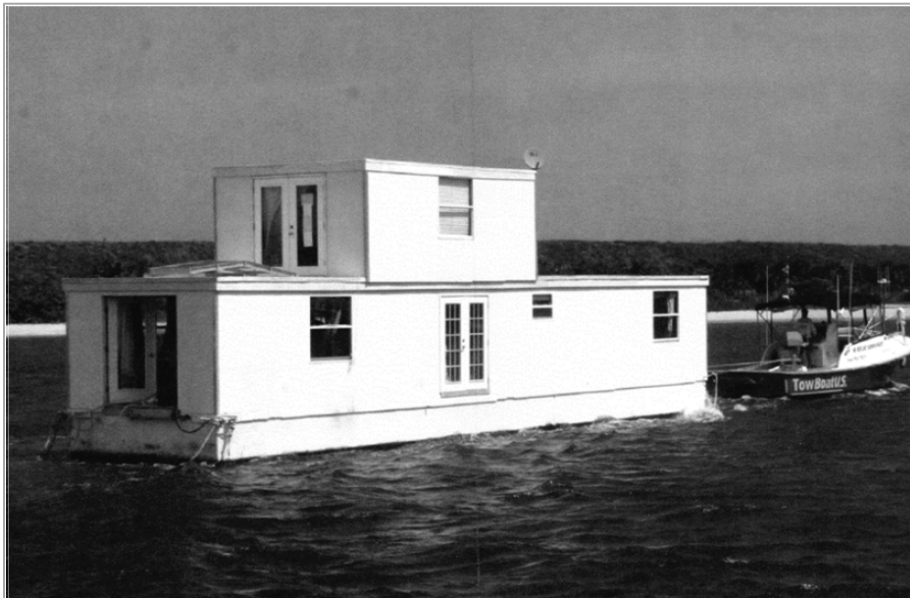

Weekly Notes are issued by the Coast Guard Marine Safety Center's Tonnage Division (MSC-4) for use by organizations that perform measurement work on the Coast Guard's behalf. They are for informational purposes only, and are not intended as, nor should they be construed to represent, revisions of or substitutes for applicable statutes or regulations or established interpretations of either.

MEASUREMENT ORGANIZATION WEEKLY NOTES – 02/12/2020

MEASUREMENT SERVICES 2019 Further to the item appearing in the 01/22/2020 edition, breakdowns by measurement service for the 2019 calendar year are presented in the charts below. These reflect total numbers of vessels as follows: Initial Measurement (221 vessels); Remeasurement (38 vessels); and Other (78 vessels). Note that while only 315 total unique vessels received ACS tonnage measurement services in 2019 – as reported previously – the numbers do not add up due to duplicate services reported for the same vessel (e.g., for a vessel initially measured in 2019 and subsequently reissued a certificate to reflect a name change). We also included an updated chart showing the overall tonnage measurement breakdown for 2019, which changed slightly due to updated vessel data in the Coast Guard’s MISLE system.

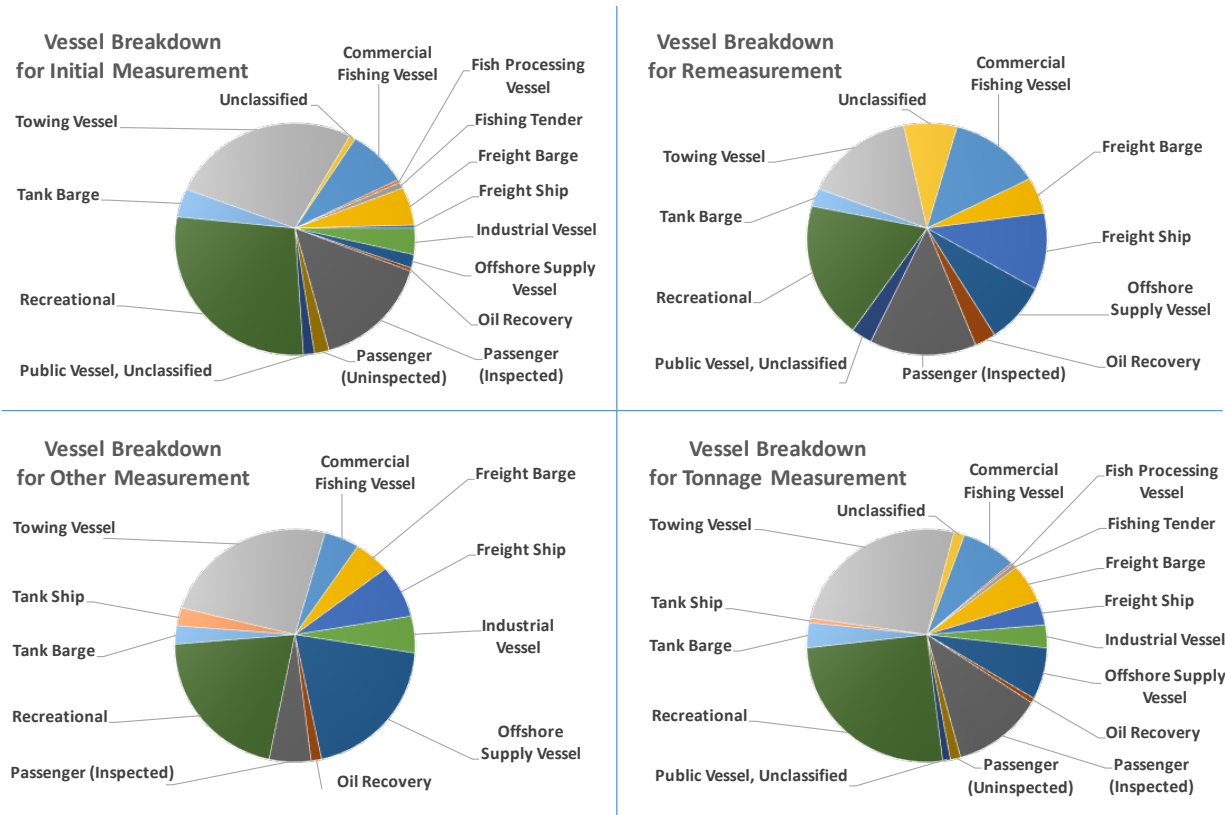

WASHINGTON’S BIRTHDAY HOLIDAY The Marine Safety Center will be closed on Monday, February 17, 2020 in observance of the birthday of George Washington.

Weekly Notes are issued by the Coast Guard Marine Safety Center’s Tonnage Division (MSC-4) for use by organizations that perform measurement work on the Coast Guard’s behalf. They are for informational purposes only, and are not intended as, nor should they be construed to represent, revisions of or substitutes for applicable statutes or regulations or established interpretations of either.

MEASUREMENT ORGANIZATION WEEKLY NOTES – 02/05/2020

SOLID MODELING Increasingly, industry is using 3-dimensional (or solid) modeling tools for ship design and construction in lieu of 2-dimensional drawings - an evolution that has left ACSs and regulatory bodies slow to catch up. While the Marine Safety Center currently lacks software and resources to transition from 2-D plan approval to approval of comparable information presented in digital 3-D models, we have encountered solid models used to compute volumes for Convention measurement. In 2009, the Tonnage Division provided guidelines to an ACS on using solid modeling methods to calculate Convention tonnages in cases where it is not possible to include offsets in the tonnage file. Some information from these guidelines was incorporated into MTN 01-98 CH-12 *Tonnage Administrative Policy*. We note that while we accept a wide range of solid modeling objective evidence (e.g., IGES or STEP files), this remains a work in progress.

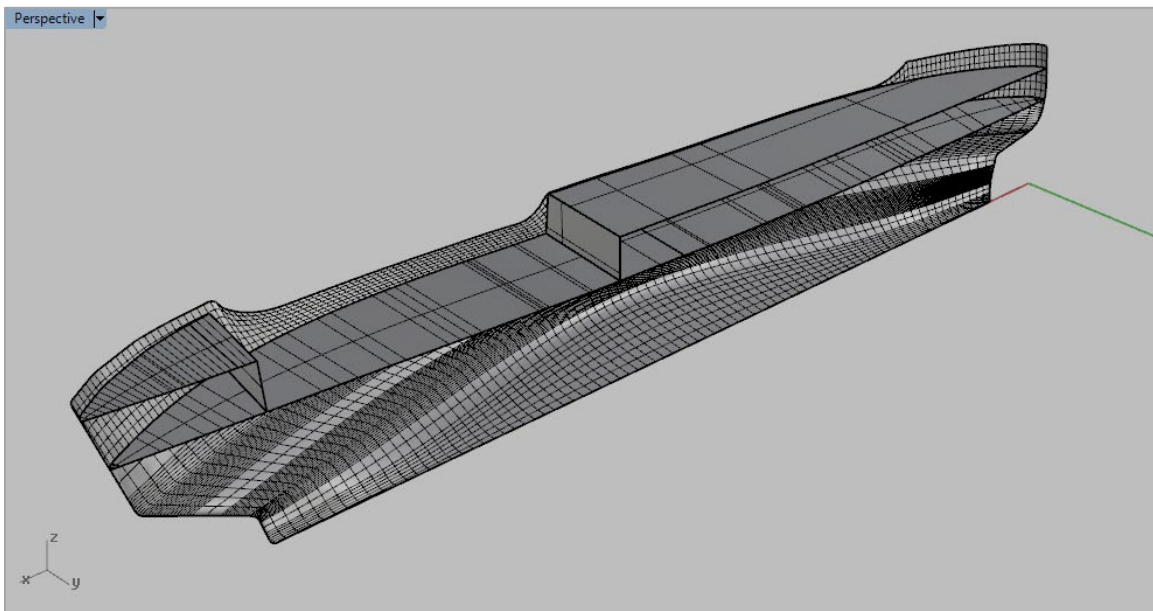

Weekly Notes are issued by the Coast Guard Marine Safety Center's Tonnage Division (MSC-4) for use by organizations that perform measurement work on the Coast Guard's behalf. They are for informational purposes only, and are not intended as, nor should they be construed to represent, revisions of or substitutes for applicable statutes or regulations or established interpretations of either.

MEASUREMENT ORGANIZATION WEEKLY NOTES – 01/29/2020

CERTIFICATE REISSUANCE The Marine Safety Center (MSC) recently responded to an inquiry from an ACS regarding a request to reissue a tonnage certificate to reflect a change in name for a vessel that had been previously measured by another ACS. Although neither ACS was able to locate associated tonnage calculations, the vessel's owner attested to build and other vessel information reflected on the existing certificates, including the date when the keel was laid or it was last substantially altered. The MSC noted that there are no provisions of U.S. law or associated Coast Guard policy that would preclude reissuance of a tonnage certificate in these circumstances, and authorized reissuance by the other ACS with an accompanying remark.

Weekly Notes are issued by the Coast Guard Marine Safety Center's Tonnage Division (MSC-4) for use by organizations that perform measurement work on the Coast Guard's behalf. They are for informational purposes only, and are not intended as, nor should they be construed to represent, revisions of or substitutes for applicable statutes or regulations or established interpretations of either.

MEASUREMENT ORGANIZATION WEEKLY NOTES – 01/22/2020

ACS NOTIFICATIONS 2019 The Marine Safety Center (MSC) is currently reviewing ACS notification data for the 2019 calendar year. The following charts illustrate the proportion of all 2019 ACS technical work as a function of the respective Coast Guard authorizations, along with a breakdown for the tonnage work by vessel service. The notification data include both initial certification work and other work performed on behalf of the Coast Guard. Note especially the relatively high volume of tonnage measurement work - in terms of the number of vessels affected - being reported.

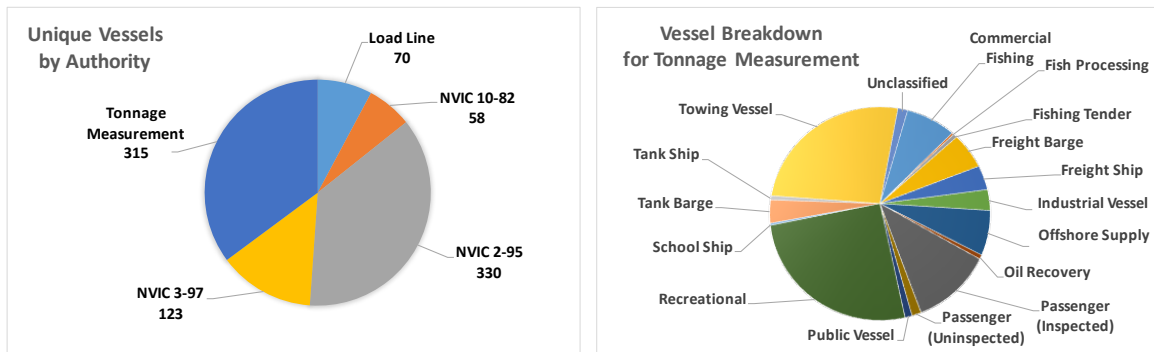

ACS ID Further to the item above, the MSC is reaching out to ACS tonnage points of contact on ACS ID data being reported through ACS notification worksheets. Per MSC Technical Note 04-03 CH-3, *Technical Support and Oversight of Authorized Classification Societies*, this parameter is defined as the “ACS’s unique vessel/structure identification number”. Ensuring the integrity of this reported data is part of a broader Coast Guard oversight initiative to better capture the third party work being conducted on its behalf, which includes relating this ACS ID information to MISLE database information.

	A	B	C	D	E	F	G	H	I	J
1	ACS	Authority	ACS ID No.	Submittal ID No.	Plan Name/Tonnage Assignment/Loadline Assignment	Plan or Certificate Number	Revision	Revision Date	Primary System	Secondary System
2	REQUIRED	REQUIRED	REQUIRED	Optional	REQUIRED	Plans/Certs only	Plans Only	Plans Only	REQUIRED	Optional
3	TONNAGE		12345		US				Tonnage Measurement (Initial)	
4										
5										

Weekly Notes are issued by the Coast Guard Marine Safety Center’s Tonnage Division (MSC-4) for use by organizations that perform measurement work on the Coast Guard’s behalf. They are for informational purposes only, and are not intended as, nor should they be construed to represent, revisions of or substitutes for applicable statutes or regulations or established interpretations of either.

MEASUREMENT ORGANIZATION WEEKLY NOTES – 01/15/2020

MOLDED VOLUME Although the 1969 Tonnage Convention does not use the term “molded volume”, the measurement system that it established is built around the concept of taking measurements to the molded lines of a ship (i.e., “to the inner side of the shell or structural boundary plating in ships constructed of metal, and to the outer surface of the shell or to the inner side of structural boundary surfaces in ships constructed of any other material”). In traditional shipbuilding, “lofting” of molded lines was used to produce full scale templates from smaller scale lines plans. When assigning Convention tonnages, ACSs should keep in mind that computer models for calculating displacement frequently account for the shell thickness of the hull, yielding slightly larger values than molded volumetric measurements.

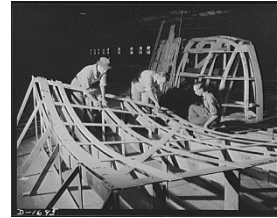
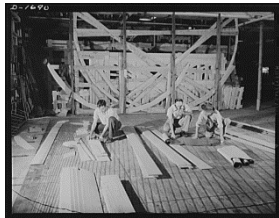

BIRTHDAY OF MARTIN LUTHER KING, JR. HOLIDAY The Marine Safety Center will be closed Monday, January 20 in observance of the Birthday of Martin Luther King, Jr.

Weekly Notes are issued by the Coast Guard Marine Safety Center's Tonnage Division (MSC-4) for use by organizations that perform measurement work on the Coast Guard's behalf. They are for informational purposes only, and are not intended as, nor should they be construed to represent, revisions of or substitutes for applicable statutes or regulations or established interpretations of either.

MEASUREMENT ORGANIZATION WEEKLY NOTES – 01/08/2020

MERCHANT VESSELS OF THE UNITED STATES One key resource the Marine Safety Center uses when searching for old tonnage measurement records is the now discontinued government publication “Merchant Vessels of the United States”, sometimes referred to as the “MVUS”. We recently learned that many of the MVUS editions have been scanned, and are now publicly available online. They contain register tonnage and other useful vessel information and, at least in some cases, are text searchable.



Official No.	Signal letters.	Rig.	Name of vessel.	Tonnage.	Horse-power.	Home port.
13670	Sl.	J. C. Caswell	7.25	Port Townsend, W. T.
13617	Sc.	J. C. Champion	21.49	Tillamook, Oregon.
13560	Sc.	J. C. Cousins	48.83	San Francisco, Cal.
13249	Sc.	J. Clark Curtan	23.46	Amityville, N. Y.
13161	H. L. G. F.	St.	J. C. Doughty	147.90	Poughkeepsie, N. Y.
12577	Sc.	J. C. Fremont	33.68	Brewer, Me.
12650	Sc.	J. C. Fremont	5.20	Stockton, Me.
13173	St. s.	J. C. Gibbs	38.05	New York, N. Y.
12852	Sc.	J. C. Harden	70.00	Gouldsboro, Me.
12718	Tug.	J. C. Harrison	37.95	Buffalo, N. Y.

Weekly Notes are issued by the Coast Guard Marine Safety Center’s Tonnage Division (MSC-4) for use by organizations that perform measurement work on the Coast Guard’s behalf. They are for informational purposes only, and are not intended as, nor should they be construed to represent, revisions of or substitutes for applicable statutes or regulations or established interpretations of either.

MEASUREMENT ORGANIZATION WEEKLY NOTES – 12/18/2019

FREE COMMUNICATION In a recent ruling, the Marine Safety Center (MSC) commented to the effect that there are no provisions of policy, the tonnage regulations, or the underlying tonnage statute that would permit the volume of a space that is only temporarily in free communication with the sea to be omitted from a vessel's Regulatory under-deck tonnage. The following figure, submitted during development of a related International Maritime Organization (IMO) Unified interpretation on this subject, illustrates a ship design for which compressed air is used to temporarily increase buoyancy under certain loading conditions.

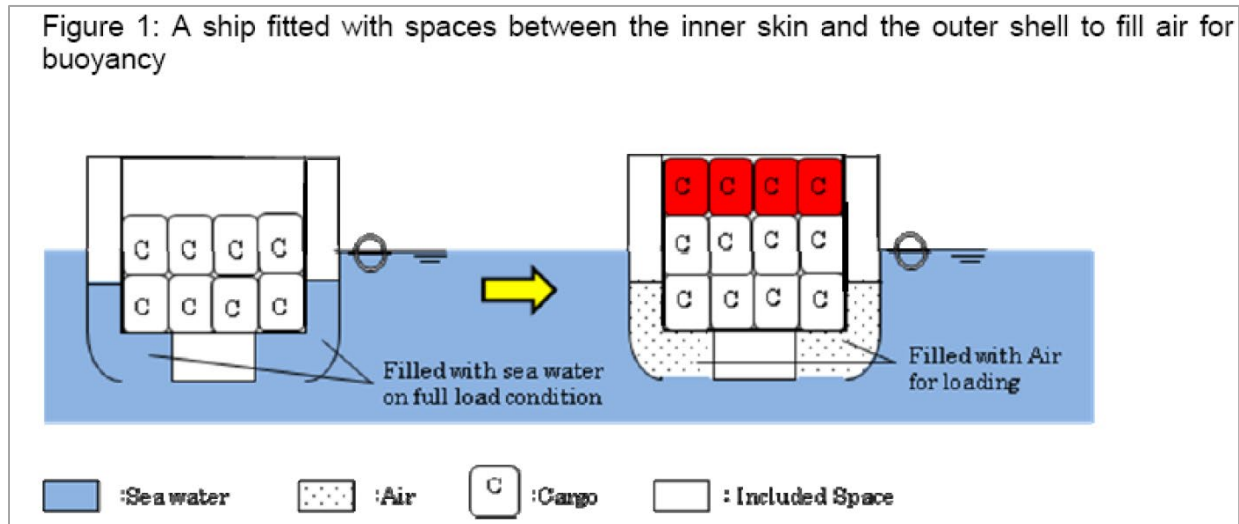

CHRISTMAS AND NEW YEAR'S HOLIDAYS The MSC will be closed on December 25, 2019 and January 1, 2020 in observance of the Christmas and New Year's Day holidays. In addition, the president issued an Executive Order closing all executive departments and agencies of the Federal Government on December 24, 2019. We will forego publishing Weekly Notes editions the next two weeks.

Weekly Notes are issued by the Coast Guard Marine Safety Center's Tonnage Division (MSC-4) for use by organizations that perform measurement work on the Coast Guard's behalf. They are for informational purposes only, and are not intended as, nor should they be construed to represent, revisions of or substitutes for applicable statutes or regulations or established interpretations of either.

MEASUREMENT ORGANIZATION WEEKLY NOTES – 12/11/2019

MEASURING MEMBER STATE PERFORMANCE As part of its strategic planning process, the International Maritime Organization (IMO) publishes a number of performance indicators related to implementing IMO Instruments, including the following table excerpted from IMO’s 2018-2023 Strategic Plan. The plan also cites the need for enforcement in order to create “a level playing field for its Members” (see IMO Assembly Resolution A.1110(30)). Note especially the references to ship type and world shipping tonnage, and the fact that the term “IMO Instruments” includes the 1969 Tonnage Convention.

TABLE 1 – PERFORMANCE INDICATORS

SD	PI Index	PI Name
SD 1 Improve implementation	PI 1.1	# of references in audit findings per instrument (article and regulation)
	PI 1.2	% of audit findings and observations with corrective actions implemented according to the target completion dates
	PI 1.3	% of deficiencies and detentions per ship type
	PI 1.4	# of deficiencies per category of deficiency
	PI 1.5	# of Member States that have ratified each IMO instrument, including those yet to enter into force
	PI 1.6	% of the world's merchant shipping (tonnage) covered by each IMO instrument, including those yet to enter into force
	PI 1.7	# of Member States requesting technical cooperation to implement corrective actions to address audit findings and observations
	PI 1.8	# of Member States receiving technical cooperation to implement corrective actions to address audit findings and observations
	PI 1.9	% of technical cooperation activities directed towards the implementation of IMO instruments with effective results for the receiving Member States

MEASURING ACS PERFORMANCE At this year’s annual ACS summit in Washington DC, the group discussed ACS performance measurement. Although the focus was principally on “survey” work as opposed to “technical” work under which tonnage measurement functions generally fall, many of the same principles apply to both areas. Pending the finalization of work on ACS performance measures stemming from the EL FARO marine casualty, the Marine Safety Center (MSC) continues to use a risk-based oversight selection approach that considers system complexity and criticality, along with random selections to ensure all types of work are subject to oversight

Weekly Notes are issued by the Coast Guard Marine Safety Center’s Tonnage Division (MSC-4) for use by organizations that perform measurement work on the Coast Guard’s behalf. They are for informational purposes only, and are not intended as, nor should they be construed to represent, revisions of or substitutes for applicable statutes or regulations or established interpretations of either.

MEASUREMENT ORGANIZATION WEEKLY NOTES – 12/04/2019

TONNAGE DIVISION VACANCY As previously mentioned, the Marine Safety Center has advertised a full-time naval architecture position in the Tonnage Division, with a salary range of \$99,172 to \$128,920 per year. Applications must be received no later than Monday, December 9, 2019. Details are available on the government's USAJobs website at <https://www.usajobs.gov/GetJob/ViewDetails/552002500> (open to the public) and <https://www.usajobs.gov/GetJob/ViewDetails/552003900> (open to current/former federal employees, etc.)

Weekly Notes are issued by the Coast Guard Marine Safety Center's Tonnage Division (MSC-4) for use by organizations that perform measurement work on the Coast Guard's behalf. They are for informational purposes only, and are not intended as, nor should they be construed to represent, revisions of or substitutes for applicable statutes or regulations or established interpretations of either.

MEASUREMENT ORGANIZATION WEEKLY NOTES – 11/20/2019

TONNAGE DIVISION VACANCY The Marine Safety Center (MSC) has advertised a full-time naval architecture position in the Tonnage Division, with a salary range of \$99,172 to \$128,920 per year. Applications must be received no later than Monday, December 9, 2019. Details are available on the government's USAJobs website at <https://www.usajobs.gov/GetJob/ViewDetails/552002500> (open to the public) and <https://www.usajobs.gov/GetJob/ViewDetails/552003900> (open to current/former federal employees, etc.)

FEDERAL GOVERNMENT FUNDING Funding for numerous government entities including the Department of Homeland Security, of which the Coast Guard is a part, is set to expire at midnight on Thursday, November 21, 2019. Lack of further funding could result in a government shutdown, disrupting services (including those provided by the MSC).

THANKSGIVING HOLIDAY The MSC will be closed on Thursday, November 28, 2019 in observance of the Thanksgiving holiday, and we will forego publishing a Weekly Notes edition next week.

MEASUREMENT ORGANIZATION WEEKLY NOTES – 11/13/2019

COMPLETENESS OF TONNAGE CALCULATIONS Further to last week’s discussion, Convention system calculations for a “sum of trapezoids” method must be complete and show dimensions involved per § 6.2(a) of MTN 01-98 CH-13. One way to satisfy the MTN requirements is to include scaled images of the relevant sections of the space, showing dimensions and calculated areas. These can be copied and pasted into additional TonCalc worksheets, as shown below.

GENERAL VOLUME CALCULATION						
Space category & frame location (or equivalent)	Volume (cubft)	Mult Fact	Volume (cubft)			
Underdeck, Fr 104-121	3921.2	2.00	7842.4			
	Distance	Sectional Area	Segment Volume			
	From fwd			See following worksheets for area calculations using Adobe Acrobat Reader.		
Frame	Perp. (ft)	(sqft)	(cubft)			
104	104.00	251.64				
110	110.00	238.64	1470.84			
121	121.00	206.88	2450.36			
			3921.20			

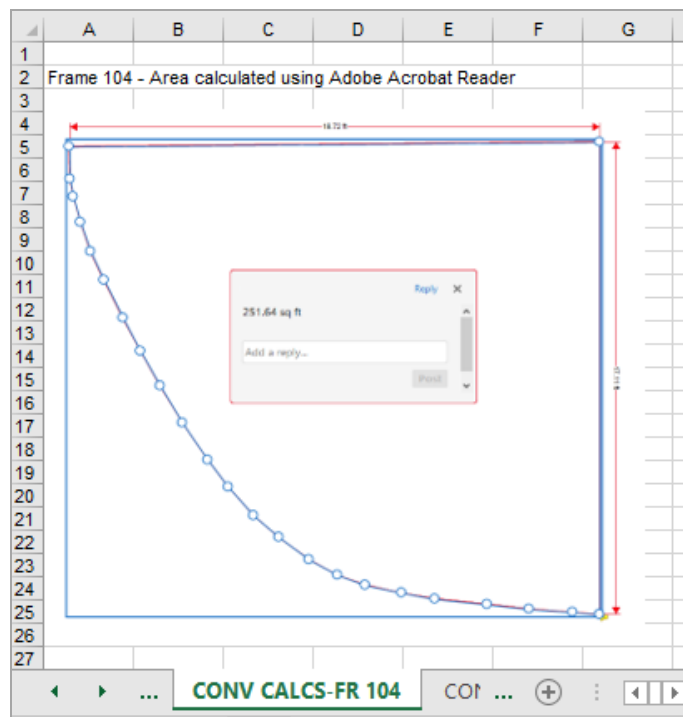

Weekly Notes are issued by the Coast Guard Marine Safety Center’s Tonnage Division (MSC-4) for use by organizations that perform measurement work on the Coast Guard’s behalf. They are for informational purposes only, and are not intended as, nor should they be construed to represent, revisions of or substitutes for applicable statutes or regulations or established interpretations of either.

MEASUREMENT ORGANIZATION WEEKLY NOTES – 11/06/2019

SUM OF TRAPEZOIDS METHOD Sophisticated solid modeling software, while extremely helpful in ensuring completeness and accuracy of Convention tonnage calculations, is not necessary when calculating volumes of complex shape. One acceptable alternative is to use TonCalc general volume calculation blocks to apply a “sum of trapezoids” method with input sectional areas obtained using free Adobe Acrobat Reader software, as shown below. If you have any questions about using this technique, please contact Mr. Marcus Akins.

GENERAL VOLUME CALCULATION			
Space category & frame location (or equivalent)	Volume (cubft)	Mult Fact	Volume (cubft)
Underdeck, Fr 104-121	3921.2	2.00	7842.4

Frame	Perp. (ft)	Sectional Area (sqft)	Segment Volume (cubft)
104	104.00	251.64	
110	110.00	238.64	1470.84
121	121.00	206.88	2450.36
			3921.20

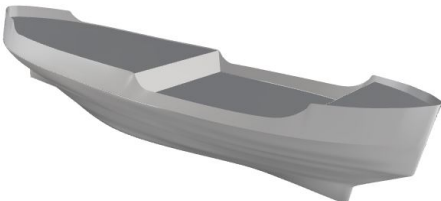

Solid model not necessary

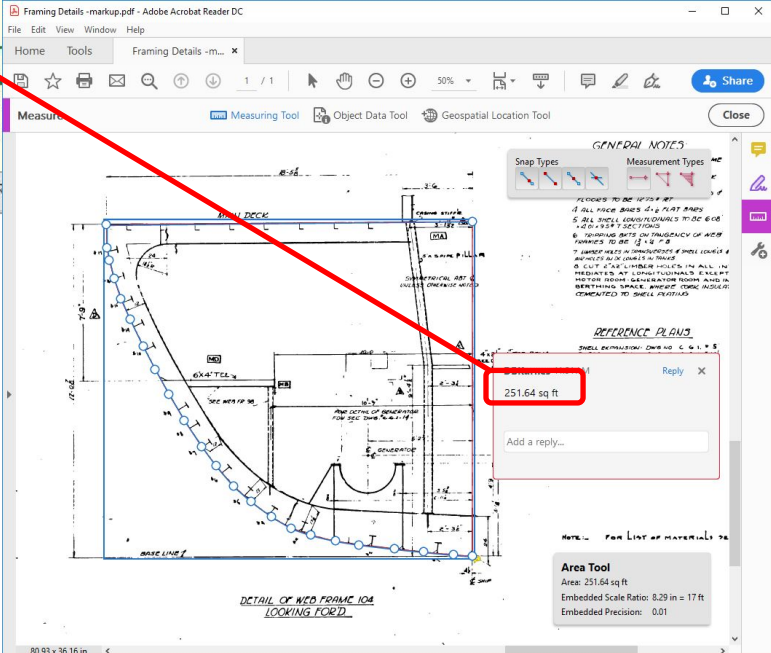

VETERANS DAY HOLIDAY The Marine Safety Center will be closed on Monday, November 11, 2019 in observance of the Veterans Day holiday.

Weekly Notes are issued by the Coast Guard Marine Safety Center's Tonnage Division (MSC-4) for use by organizations that perform measurement work on the Coast Guard's behalf. They are for informational purposes only, and are not intended as, nor should they be construed to represent, revisions of or substitutes for applicable statutes or regulations or established interpretations of either.

MEASUREMENT ORGANIZATION WEEKLY NOTES – 10/30/2019

OBJECTIVE EVIDENCE OF MARKINGS As a reminder, markings for deductible spaces under the Standard Regulatory Measurement System must be embossed, center-punched, carved, or permanently cut in a bulkhead or metal plate (like that shown below on the left, which is then appropriately fastened in place by welding, riveting, lock screws, etc.) Conversely, the use of stickers does not meet the marking requirements of MTN 01-99 CH-9 § 69.119(p). ACSs are encouraged to retain objective evidence in the form of survey photographs for all markings, especially for certified deductible spaces.



CG NUMBER REQUESTS Please copy Mr. David Karnes on any CG number requests through Monday, November 4, 2019. Afterward, please resume copying Mr. Marcus Akins.

Weekly Notes are issued by the Coast Guard Marine Safety Center's Tonnage Division (MSC-4) for use by organizations that perform measurement work on the Coast Guard's behalf. They are for informational purposes only, and are not intended as, nor should they be construed to represent, revisions of or substitutes for applicable statutes or regulations or established interpretations of either.

MEASUREMENT ORGANIZATION WEEKLY NOTES – 10/23/2019

TONNAGE PERSONNEL Mr. Tony Cao has accepted a new position with the Marine Safety Center's (MSC's) Major Vessel Branch of the Hull Division, where he will continue to coordinate load line oversight matters along with assuming many new responsibilities. We congratulate him and wish him well with his next endeavor. His last day in the Tonnage Division will be Friday, October 25, 2019.

MSC POINTS OF CONTACT Further to the entry above, please note the following updated MSC POCs for tonnage matters:

<u>Subject Type</u>	<u>Primary</u>	<u>Secondary</u>
Interpretations & Decisions	Akins	Karnes
File Requests	Akins	Karnes
CG Number Requests	Akins	Karnes
Navy Ships / USCG Cutters	Karnes	Akins
Tonnage Applicability	Karnes	Akins
TonCalc	Karnes	Akins
Simplified Measurement	Karnes	Akins
Tonnage Oversight	Akins	Karnes

Weekly Notes are issued by the Coast Guard Marine Safety Center's Tonnage Division (MSC-4) for use by organizations that perform measurement work on the Coast Guard's behalf. They are for informational purposes only, and are not intended as, nor should they be construed to represent, revisions of or substitutes for applicable statutes or regulations or established interpretations of either.

MEASUREMENT ORGANIZATION WEEKLY NOTES – 10/16/2019

LISTING ENCLOSED SPACES As discussed at the 2011 Tonnage Conference in Washington, DC, the practice of listing above-deck spaces on tonnage certificates by “tiers” has presented increasing challenges when measuring larger ships of complex geometries. ACSs continue to be given considerable latitude when listing such spaces, including their grouping by larger structural assemblies that may span multiple decks, as illustrated in the example below. In exercising this latitude, ACSs should keep in mind that the information should be sufficiently detailed to enable proper verification of the ship’s “main characteristics” during port State inspections (see Article 12 of the 1969 Tonnage Convention).



Name of Space	Location	Length (m)
Underdeck	---	---
Superstr 02-04 Lvl	Fr 35 - 68	37.22
Superstr 05-06 Lvl	Fr 40 - 52	16.31

EMAIL UPDATE Previously, when we have experienced delivery delays of incoming email to uscg.mil addresses, including the Marine Safety Center’s main inbox, msc@uscg.mil, we advised copying or sending messages to alternative uscg.dhs.gov addresses. These alternative uscg.dhs.gov addresses are no longer valid. If you encounter issues emailing us, please remember that for time-critical matters, the best way to reach us is by phone.

Weekly Notes are issued by the Coast Guard Marine Safety Center’s Tonnage Division (MSC-4) for use by organizations that perform measurement work on the Coast Guard’s behalf. They are for informational purposes only, and are not intended as, nor should they be construed to represent, revisions of or substitutes for applicable statutes or regulations or established interpretations of either.

MEASUREMENT ORGANIZATION WEEKLY NOTES – 10/09/2019

NET TONNAGE ITC (CONTINUED) Further to last week's discussion of the Convention Measurement System, the plot below shows how passenger count can result in net tonnage (NT ITC) values greater than gross tonnage (GT ITC) for a given vessel. The blue curve represents N_1 passenger counts that yield $NT\ ITC = GT\ ITC$ for vessels assumed to have no cargo volume and no passengers in cabins with more than eight berths ($N_2 = 0$). Points falling below the blue curve represent passenger vessels having $NT\ ITC < GT\ ITC$; the point above the curve represents a large cruise ship that, due to its high N_1 passenger count, has an $NT\ ITC > GT\ ITC$. With the trend toward cruise ships with greater passenger capacity, we may see more such vessels.

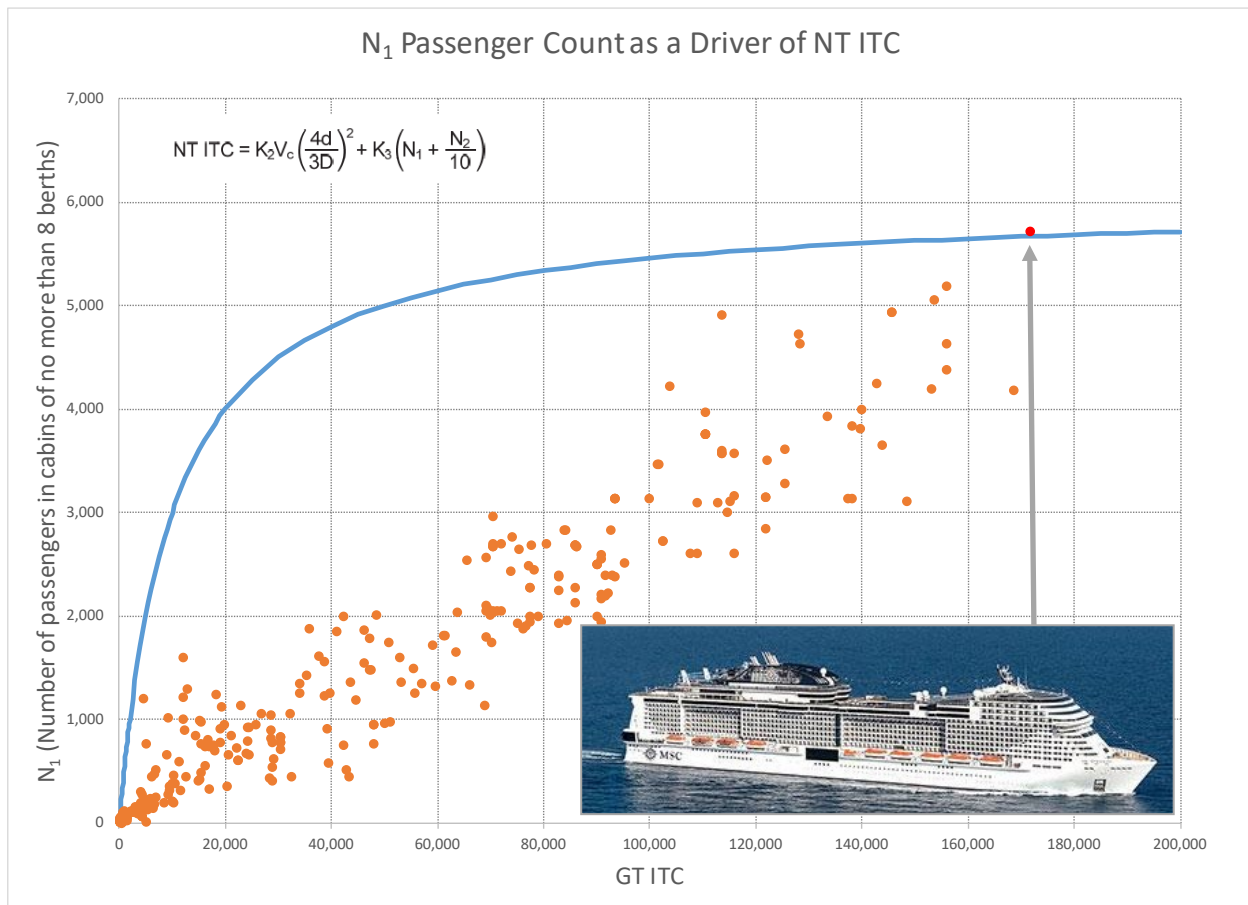

Weekly Notes are issued by the Coast Guard Marine Safety Center's Tonnage Division (MSC-4) for use by organizations that perform measurement work on the Coast Guard's behalf. They are for informational purposes only, and are not intended as, nor should they be construed to represent, revisions of or substitutes for applicable statutes or regulations or established interpretations of either.

MEASUREMENT ORGANIZATION WEEKLY NOTES – 10/02/2019

NET TONNAGE ITC The Convention Measurement System sets a lower limit on values for net tonnage (NT ITC) at 0.30 of gross tonnage (GT ITC), and many vessels have such assignments. Notably, there is no maximum for NT ITC, allowing the possibility for NT ITC to exceed GT ITC. Considering the formula for NT ITC (shown below), one can imagine possible drivers of net tonnages in the second term, which accounts for passengers. If you encounter vessels with NT ITC greater than GT ITC, please notify Mr. Marcus Akins.

$$\text{NT ITC} = K_2 V_c \left(\frac{4d}{3D} \right)^2 + K_3 \left(N_1 + \frac{N_2}{10} \right),$$

in which:

$$K_3 = 1.25 \left(\frac{\text{GT ITC} + 10,000}{10,000} \right)$$

N_1 = number of passengers in cabins with not more than eight berths, as "passenger" is defined in § 69.53.

N_2 = number of other passengers, as "passenger" is defined in § 69.53.

GT ITC = gross tonnage ITC as determined under § 69.57.

N_1 plus N_2 must equal the total number of passengers the vessel is permitted to carry as indicated on the ship's Passenger Certificate. If N_1 plus N_2 is less than 13, both N_1 and N_2 are zero.

MEASUREMENT ORGANIZATION WEEKLY NOTES – 09/25/2019

EMAIL ISSUES We have had recent reports of emails sent to uscg.mil addresses, including our primary Marine Safety Center (MSC) address, msc@uscg.mil, being returned as undeliverable due to senders' email lacking DomainKeys Identified Mail (DKIM) authentication. This seems to be a particular problem with smaller businesses that maintain their own email servers and domains. We have no timeline for a Coast Guard resolution. Multiple MSC submitters have resorted to using nationally-known email service providers as a workaround, as such larger companies have generally implemented the necessary DKIM protocols. If you encounter this problem, please notify the Tonnage Division.



Weekly Notes are issued by the Coast Guard Marine Safety Center's Tonnage Division (MSC-4) for use by organizations that perform measurement work on the Coast Guard's behalf. They are for informational purposes only, and are not intended as, nor should they be construed to represent, revisions of or substitutes for applicable statutes or regulations or established interpretations of either.

MEASUREMENT ORGANIZATION WEEKLY NOTES – 09/18/2019

ACCEPTANCE OF APPLICATIONS We occasionally encounter confusion as to whether the submission of a formal measurement application in some way obligates an ACS to accept the work. While tonnage regulations provide for ACSs to accept a measurement application “without discrimination,” MTN 01-98 CH-13 makes clear that an ACS must either accept an application subject to any specified conditions (e.g., issuance of certificates contingent on payment) and perform the requested services, or provide the applicant with written notification as to why the services will not be performed (e.g., incomplete information provided with the application). ACSs have considerable latitude in assessing whether submitted information - including plans and drawings - is adequate. We encourage ACSs to ensure that applications and their accompanying submitted drawings are complete prior to acceptance.

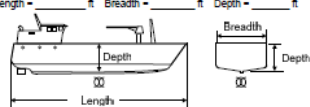
Reset Form	U.S. TONNAGE REGULATIONS APPLICATION FOR FORMAL MEASUREMENT SERVICES	MTN 01-98 as amended																																
I. APPLICABILITY																																		
A U.S. flag vessel is eligible to be measured under the Convention system (46 CFR 69 subpart B) if it is 79 feet or more in overall length. Also, any U.S. flag vessel, regardless of length, may be measured under the Standard system (46 CFR 69 subpart C) or Dual system (46 CFR 69 subpart D). Some vessels, including those that are less than 79 feet in overall length, are eligible to be measured under the Simplified system (46 CFR 69 subpart E), without the need for formal measurement. Refer to section 69.11 of 46 CFR 69 for complete measurement eligibility details.																																		
II. APPLICATION INFORMATION																																		
<p>*1. REQUESTED SERVICE (see instructions on reverse)</p> <p><input type="checkbox"/> INITIAL MEASUREMENT (Indicate measurement system(s))</p> <p style="padding-left: 20px;"><input type="checkbox"/> Subpart B - Convention system (GT/ITC/NT/ITC)</p> <p style="padding-left: 20px;"><input type="checkbox"/> Subpart C - Standard system (GRT/NRT)</p> <p style="padding-left: 20px;"><input type="checkbox"/> Subpart D - Dual system (GRT/NRT)</p> <p><input type="checkbox"/> REMEASUREMENT (Indicate reason(s))</p> <p style="padding-left: 20px;"><input type="checkbox"/> Configuration changes</p> <p style="padding-left: 20px;"><input type="checkbox"/> Change in passengers or draft</p> <p style="padding-left: 20px;"><input type="checkbox"/> Correction of measurement errors</p> <p style="padding-left: 20px;"><input type="checkbox"/> Other (describe in remarks)</p> <p><input type="checkbox"/> Other (describe in remarks)</p> <p>*2. REQUESTED TONNAGE CERTIFICATE(S): <input type="checkbox"/> US <input type="checkbox"/> ITC69</p> <p>*3. VESSEL NAME _____</p> <p>*4. VESSEL NUMBER _____</p> <p>5. HAULING PORT _____</p> <p>6. BUILDER'S NAME _____</p> <p>7. HIN OR HULL NUMBER _____</p> <p>8. PLACE BUILT _____</p> <p>9. KEEL LAID / ALTERATION DATE _____</p> <p>10. DELIVERY DATE _____</p> <p>11. VESSEL TYPE</p> <table style="width: 100%; border: none;"> <tr> <td><input type="checkbox"/> Barge</td> <td><input type="checkbox"/> Passenger</td> </tr> <tr> <td><input type="checkbox"/> Fishing</td> <td><input type="checkbox"/> Recreational</td> </tr> <tr> <td><input type="checkbox"/> Fish Processing</td> <td><input type="checkbox"/> Research</td> </tr> <tr> <td><input type="checkbox"/> Fish Tender</td> <td><input type="checkbox"/> Tanker</td> </tr> <tr> <td><input type="checkbox"/> Freight</td> <td><input type="checkbox"/> Towing</td> </tr> <tr> <td><input type="checkbox"/> Industrial</td> <td><input type="checkbox"/> Training</td> </tr> <tr> <td><input type="checkbox"/> Mobile Offshore Drilling Unit</td> <td><input type="checkbox"/> Unclassified</td> </tr> <tr> <td><input type="checkbox"/> Offshore Supply</td> <td><input type="checkbox"/> Warship</td> </tr> <tr> <td><input type="checkbox"/> Oil Spill Response</td> <td></td> </tr> </table>	<input type="checkbox"/> Barge	<input type="checkbox"/> Passenger	<input type="checkbox"/> Fishing	<input type="checkbox"/> Recreational	<input type="checkbox"/> Fish Processing	<input type="checkbox"/> Research	<input type="checkbox"/> Fish Tender	<input type="checkbox"/> Tanker	<input type="checkbox"/> Freight	<input type="checkbox"/> Towing	<input type="checkbox"/> Industrial	<input type="checkbox"/> Training	<input type="checkbox"/> Mobile Offshore Drilling Unit	<input type="checkbox"/> Unclassified	<input type="checkbox"/> Offshore Supply	<input type="checkbox"/> Warship	<input type="checkbox"/> Oil Spill Response		<p>12. OVERALL HULL DIMENSIONS</p> <p>Length = _____ ft Breadth = _____ ft Depth = _____ ft</p>  <p>13. ADDITIONAL VESSEL INFORMATION</p> <p>a. PROPULSION: <input type="checkbox"/> Self-Propelled <input type="checkbox"/> Non-Self-Propelled</p> <p>b. NUMBER OF PASSENGERS: _____ Total: _____ Accommodated in cabins for 8 or fewer: _____</p> <p>c. NUMBER OF CARGO SPACES: _____</p> <p>d. NUMBER OF PORTABLE ENCLOSED SPACES: _____</p> <p>e. DRAFT RESTRICTIONS: <input type="checkbox"/> Load Line <input type="checkbox"/> Other <input type="checkbox"/> Stability Letter</p> <p>f. INTENDED VOYAGES: <input type="checkbox"/> Domestic <input type="checkbox"/> Great Lakes <input type="checkbox"/> Foreign</p> <p>14. SUBMITTED DRAWINGS (check all submitted with application)</p> <table style="width: 100%; border: none;"> <thead> <tr> <th style="text-align: left; border-bottom: 1px solid black;">General Arrangements</th> <th style="text-align: left; border-bottom: 1px solid black;">Construction</th> <th style="text-align: left; border-bottom: 1px solid black;">Miscellaneous</th> </tr> </thead> <tbody> <tr> <td><input type="checkbox"/> Outboard Profile</td> <td><input type="checkbox"/> Midship Section</td> <td><input type="checkbox"/> Lines</td> </tr> <tr> <td><input type="checkbox"/> Inboard Profile</td> <td><input type="checkbox"/> Framing Plans</td> <td><input type="checkbox"/> Cargo</td> </tr> <tr> <td><input type="checkbox"/> Deck Arrangements</td> <td><input type="checkbox"/> Shell Expansion</td> <td><input type="checkbox"/> Tonnage</td> </tr> <tr> <td><input type="checkbox"/> Bow/Stem/Topside</td> <td><input type="checkbox"/> Other</td> <td><input type="checkbox"/> Other</td> </tr> </tbody> </table> <p>*15. POINT OF CONTACT</p> <p>16. REMARKS</p>	General Arrangements	Construction	Miscellaneous	<input type="checkbox"/> Outboard Profile	<input type="checkbox"/> Midship Section	<input type="checkbox"/> Lines	<input type="checkbox"/> Inboard Profile	<input type="checkbox"/> Framing Plans	<input type="checkbox"/> Cargo	<input type="checkbox"/> Deck Arrangements	<input type="checkbox"/> Shell Expansion	<input type="checkbox"/> Tonnage	<input type="checkbox"/> Bow/Stem/Topside	<input type="checkbox"/> Other	<input type="checkbox"/> Other
<input type="checkbox"/> Barge	<input type="checkbox"/> Passenger																																	
<input type="checkbox"/> Fishing	<input type="checkbox"/> Recreational																																	
<input type="checkbox"/> Fish Processing	<input type="checkbox"/> Research																																	
<input type="checkbox"/> Fish Tender	<input type="checkbox"/> Tanker																																	
<input type="checkbox"/> Freight	<input type="checkbox"/> Towing																																	
<input type="checkbox"/> Industrial	<input type="checkbox"/> Training																																	
<input type="checkbox"/> Mobile Offshore Drilling Unit	<input type="checkbox"/> Unclassified																																	
<input type="checkbox"/> Offshore Supply	<input type="checkbox"/> Warship																																	
<input type="checkbox"/> Oil Spill Response																																		
General Arrangements	Construction	Miscellaneous																																
<input type="checkbox"/> Outboard Profile	<input type="checkbox"/> Midship Section	<input type="checkbox"/> Lines																																
<input type="checkbox"/> Inboard Profile	<input type="checkbox"/> Framing Plans	<input type="checkbox"/> Cargo																																
<input type="checkbox"/> Deck Arrangements	<input type="checkbox"/> Shell Expansion	<input type="checkbox"/> Tonnage																																
<input type="checkbox"/> Bow/Stem/Topside	<input type="checkbox"/> Other	<input type="checkbox"/> Other																																
III. STATEMENT OF REPRESENTATION																																		
I understand that under the provisions of 46 CFR 69.25, a person making a false statement or representation in this application may be fined up to \$30,000 and that the vessel also is liable in rem for the penalty. I also acknowledge that I am required by 46 CFR 69.19 to report immediately to an authorized measurement organization any intent to structurally alter the vessel or to change its service or the use of its space. I certify that the information provided by me on this application, or in any attachments thereto, is correct.																																		
Owner's printed name _____	Owner's signature _____	Date _____																																
Formal Application (08/14)		Page 1 of 2																																

Weekly Notes are issued by the Coast Guard Marine Safety Center's Tonnage Division (MSC-4) for use by organizations that perform measurement work on the Coast Guard's behalf. They are for informational purposes only, and are not intended as, nor should they be construed to represent, revisions of or substitutes for applicable statutes or regulations or established interpretations of either.

MEASUREMENT ORGANIZATION WEEKLY NOTES – 09/11/2019

TRANSFERRING FILES - SITE ACCESS When accessing the [DoD SAFE](#) file transfer application described in last week's edition, "outside" users may receive a warning about the website's security certificate if their internet browsers are not configured to trust the certificate authorities (see below left). To proceed, users may either 1) try accessing the site using a different browser; 2) accept the risk and continue; or 3) import certificate authorities following [these instructions](#). Also, a pop-up may request an authentication certificate (below right); clicking Cancel should allow unauthenticated access to the site. If you encounter any issues with this, please contact Mr. Marcus Akins for assistance.

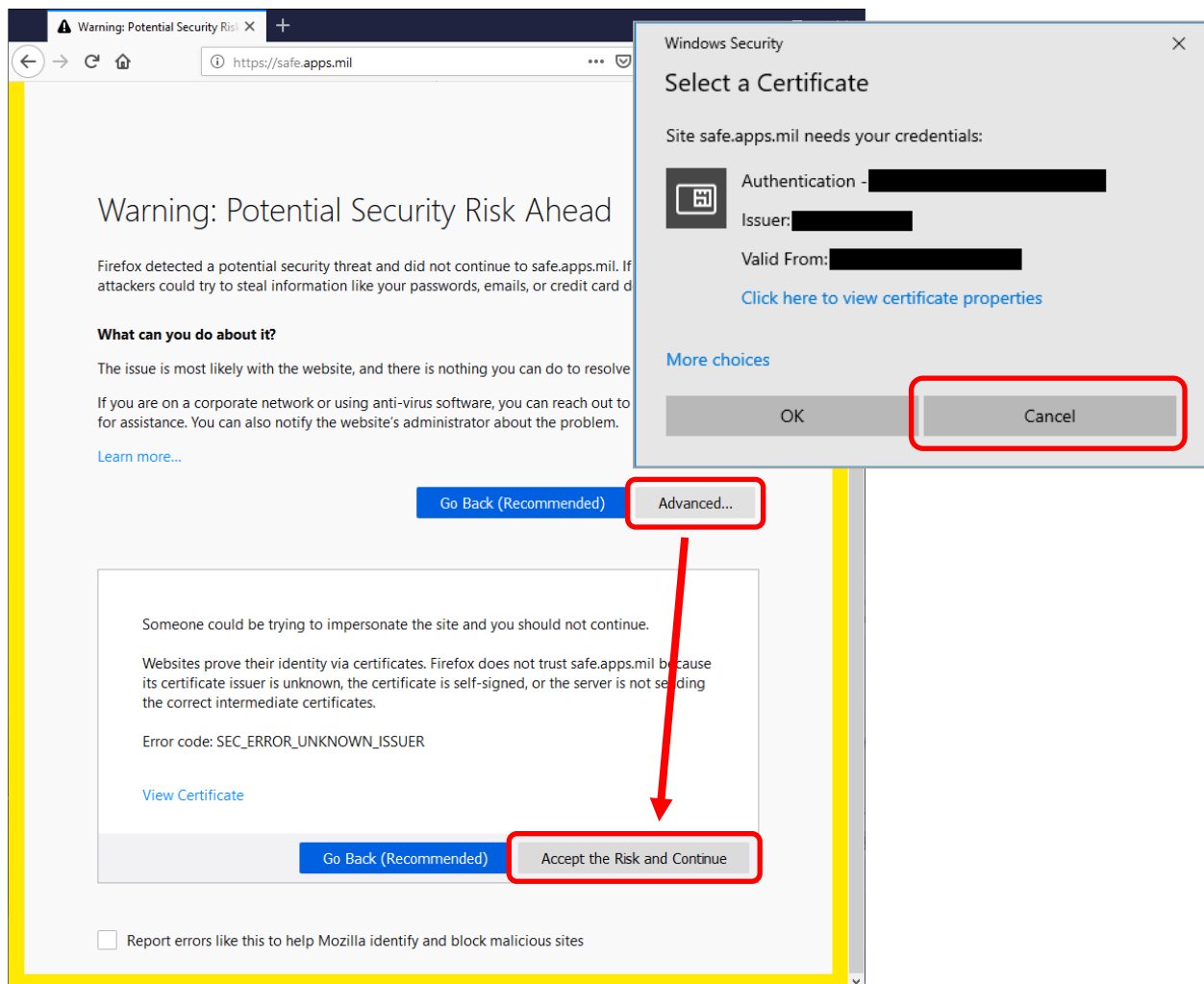

TRANSFERRING FILES - CAPACITY [DoD SAFE](#) is capable of handling transfers up to 8.0 GB in total file size when using a modern 64-bit internet browser. Older 32-bit browsers may limit drop-offs to 2 GB. For further details see the DoD SAFE [help page](#).

Weekly Notes are issued by the Coast Guard Marine Safety Center's Tonnage Division (MSC-4) for use by organizations that perform measurement work on the Coast Guard's behalf. They are for informational purposes only, and are not intended as, nor should they be construed to represent, revisions of or substitutes for applicable statutes or regulations or established interpretations of either.

MEASUREMENT ORGANIZATION WEEKLY NOTES – 09/04/2019

TRANSFERRING FILES [DoD SAFE](#) (Secure Access File Exchange) has replaced the [AMRDEC SAFE](#) and [ARL SAFE](#) file transfer applications frequently used to transmit tonnage files for oversight as well as informal submittals. To use the service as an “outside” user:

1. Notify Mr. Marcus Akins of your wish to send files using the system.
2. Mr. Akins will request a file “drop-off.”
3. You will receive an email with a link (valid for 14 days) to a website for “dropping-off” the requested files. Optionally, Mr. Akins may provide you with a request code to enter on the [SAFE](#) home page.
4. On the linked website, add or drag the files to “drop-off.” Note that the retention period for files awaiting pick-up is seven days.

Drop-off
Drop-off (*upload*) a file for a DoD user (must have request code from recipient).

Pick-Up
Pick-up (*download*) a file dropped-off for you.

Help
How to use DoD SAFE and information about this service.

NOTIFICATION PROCESS IMPROVEMENTS As part of broader Coast Guard oversight improvements stemming from the EL FARO marine casualty, the Marine Safety Center (MSC) is reassessing the current notification process for reporting completed ACS technical work done on the Coast Guard’s behalf. One possible option to improve data quality and reduce ACS administrative burdens is to require reporting of only those data fields circled in red below, provided the ACS reports a unique class number which is also recognizable by the MSC through an assigned IMO, CG, or official number. If you have any suggested improvements or comments, please contact Mr. Akins.

	A	B	C	D	E	F	G	H	I	J
1	ACS	Authority	ACS ID No.	Submittal ID No.	Plan Name/Tonnage Assignment/Loadline Assignment	Plan or Certificate Number	Revision	Revision Date	Primary System	Secondary System
2	REQUIRED	REQUIRED	REQUIRED	Optional	REQUIRED	Plans/Certs only	Plans Only	Plans Only	REQUIRED	Optional
3										
4										

	K	L	M	N	O	P	Q	R
1	ACS Approval Date	Vessel Name	Vessel Operating Subchapter	Builder Name	Hull No.	MSC Project No.	Unique Vessel ID Number	Unique Vessel ID Number Type
2	REQUIRED	see comment	see comment	REQUIRED	REQUIRED	see comment	see comment	see comment
3								
4								

Weekly Notes are issued by the Coast Guard Marine Safety Center’s Tonnage Division (MSC-4) for use by organizations that perform measurement work on the Coast Guard’s behalf. They are for informational purposes only, and are not intended as, nor should they be construed to represent, revisions of or substitutes for applicable statutes or regulations or established interpretations of either.

MEASUREMENT ORGANIZATION WEEKLY NOTES – 08/21/2019

FRAME INTERSECTION TREATMENT A previous Weekly Notes edition highlighted our ongoing review of how smaller frame-edge openings (i.e., “limber holes” and similar) are treated when applying ordinary framing provisions of the tonnage regulations. As part of this effort, we examined the Ship Structure Committee’s 1977 [Review of Ship Structural Details](#) report, which documented shipyard practices for making frame penetrations watertight through the use of collars.

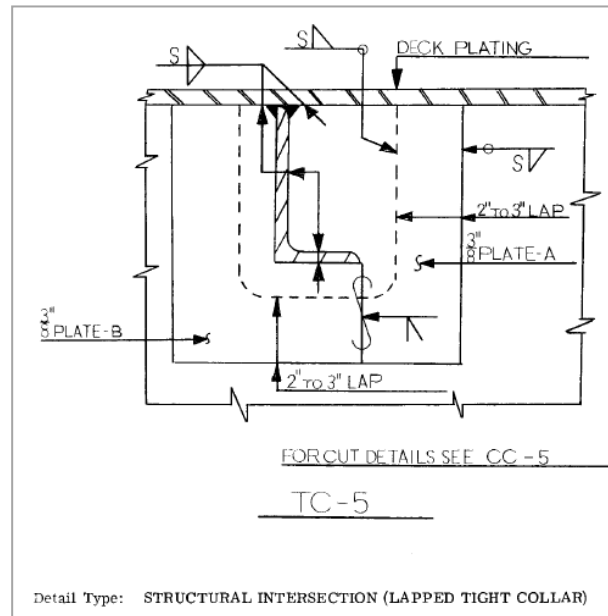
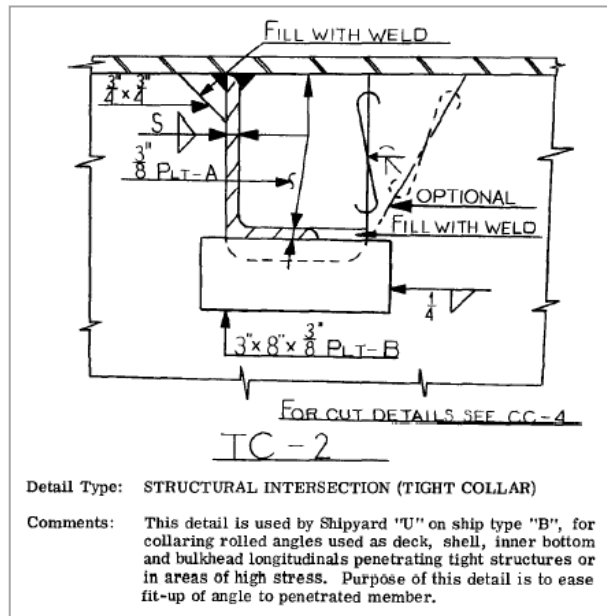

CG NUMBER REQUESTS Due to limited Tonnage Division staff availability, there may be a delay in response time for CG number requests next week. We anticipate processing all requests received prior to noon Tuesday, August 27, 2019 by the end of that day, with normal service resuming on Tuesday, September 3, 2019. We apologize for any inconvenience this interruption in service may cause. Please copy Mr. Marcus Akins on any CG number requests through August 30, 2019.

EDITOR'S NOTE Due to the aforementioned staffing shortfall, we will forego publishing a Weekly Notes edition next week.

LABOR DAY HOLIDAY The Marine Safety Center will be closed Monday, September 2, 2019 in observance of the Labor Day holiday.

Weekly Notes are issued by the Coast Guard Marine Safety Center's Tonnage Division (MSC-4) for use by organizations that perform measurement work on the Coast Guard's behalf. They are for informational purposes only, and are not intended as, nor should they be construed to represent, revisions of or substitutes for applicable statutes or regulations or established interpretations of either.

MEASUREMENT ORGANIZATION WEEKLY NOTES – 08/14/2019

EMAIL ISSUES Earlier this week, we experienced email connectivity issues within our Coast Guard network. These issues resulted in delays processing requests sent to the Marine Safety Center's (MSC's) electronic commerce inbox, msc@uscg.mil, and impacted our individual email accounts. As a reminder, for urgent matters, please call us to ensure we have received any email you have sent to the MSC. We apologize for any inconvenience these issues may have caused.

Weekly Notes are issued by the Coast Guard Marine Safety Center's Tonnage Division (MSC-4) for use by organizations that perform measurement work on the Coast Guard's behalf. They are for informational purposes only, and are not intended as, nor should they be construed to represent, revisions of or substitutes for applicable statutes or regulations or established interpretations of either.

MEASUREMENT ORGANIZATION WEEKLY NOTES – 08/07/2019

BUILD EVIDENCE Marine Safety Center (MSC) Technical Note (MTN) 01-98 CH-13, *Tonnage Administrative Policy*, requires certain build information to be specified on the U.S. Tonnage Certificate, including the town, and state or similar. When required information is not available, written authorization through formal MSC correspondence is required. In general, this authorization is predicated on a signed statement from the vessel's owner attesting to known details of the vessel's build, and circumstances under which the missing information is not available.

KETTLE-BOTTOM SHIPS Further to the historical item in the previous Weekly Notes edition, the First Congress of the United States drew on British measurement rules to establish a vessel's "register" tonnage using simplified formulas based on adjusted principal dimensions. For "double decked" vessels, these formulas took the depth as half the breadth measurement at the "broadest part above the main wales". By highly incentivizing vessel designs to minimize breadth measurements, this led to so-called "kettle-bottom" ships, having narrow weather decks and wide bottoms, with proportionally large depth measurements.

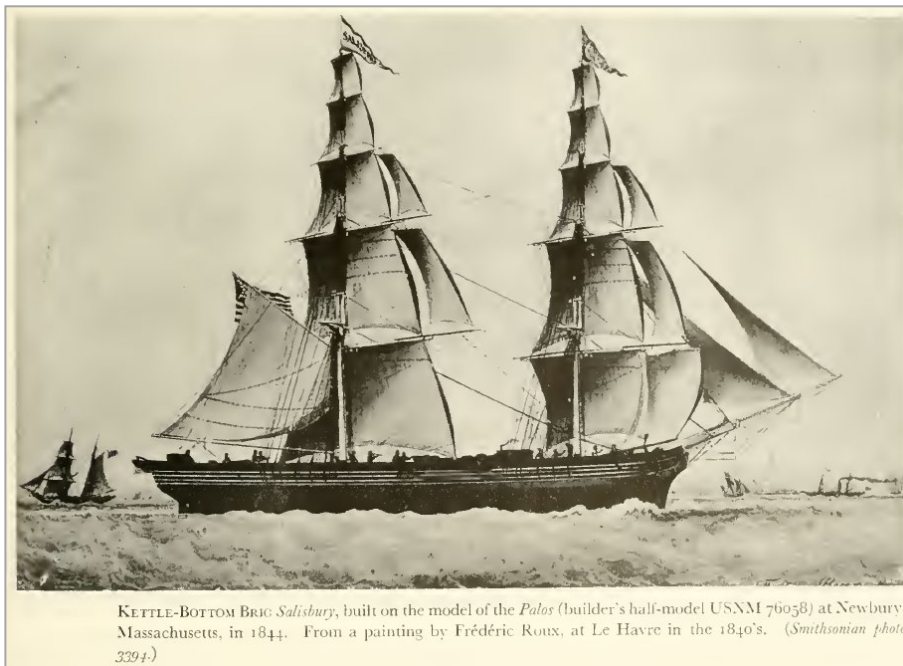

Weekly Notes are issued by the Coast Guard Marine Safety Center's Tonnage Division (MSC-4) for use by organizations that perform measurement work on the Coast Guard's behalf. They are for informational purposes only, and are not intended as, nor should they be construed to represent, revisions of or substitutes for applicable statutes or regulations or established interpretations of either.

MEASUREMENT ORGANIZATION WEEKLY NOTES – 07/31/2019

THIS DATE IN TONNAGE HISTORY On July 31, 1789 (230 years ago today), the First Congress and President Washington instituted a system to collect duties on tonnage. The fifth Act of its first session, “An Act to regulate the collection of the duties imposed by law on the tonnage of ships or vessels, and on goods, wares and merchandizes imported into the United States”, established specific districts and ports of entry and outlined responsibilities of officers (collectors, naval officers, and surveyors) assigned to them. Notably, the Act required that duties on a ship’s tonnage be paid to a collector within ten days of its entry and prior to its being permitted clearance.

CHAPTER V.

An ACT to regulate the COLLECTION of the DUTIES imposed by Law on the TONNAGE of SHIPS or VESSELS, and on GOODS, WARES and MERCHANDIZES imported into the United States.

Section 1. **B**E it enacted by the SENATE and HOUSE of REPRESENTATIVES of the United States of America in Congress assembled, That for the due collection of the duties imposed by law on the tonnage of ships and vessels, and on goods, wares and merchandizes imported into the United States, there shall be established and appointed, districts, ports, and officers, in manner following, to wit :

The state of NEW-HAMPSHIRE shall be one district, to include the town of Portsmouth as the sole port of entry ; and the towns of Newcastle, Dover and Exeter, as ports of delivery only ; but all ships or vessels bound to or from either of the said ports of delivery, shall first come to, enter and clear at Portsmouth ; and a naval-officer, collector and surveyor for the said district shall be appointed, to reside at Portsmouth.

Sec. 20. *And be it further enacted,* That all the duties imposed by law on the tonnage of any ship or vessel, shall be paid to the collector, within ten days after entry made, and before such ship or vessel shall be permitted to clear out ; the register of which ship or vessel at the time of entry, shall be lodged in the office of the collector, and there remain until such clearance.

FREDERICK AUGUSTUS MUHLENBERG,
Speaker of the House of Representatives.

JOHN ADAMS, *Vice-President of the United States,*
and President of the Senate.

APPROVED, July the 31st, 1789.

GEORGE WASHINGTON,
President of the United States.

Weekly Notes are issued by the Coast Guard Marine Safety Center’s Tonnage Division (MSC-4) for use by organizations that perform measurement work on the Coast Guard’s behalf. They are for informational purposes only, and are not intended as, nor should they be construed to represent, revisions of or substitutes for applicable statutes or regulations or established interpretations of either.

MEASUREMENT ORGANIZATION WEEKLY NOTES – 07/24/2019

APPLICATION FOR SIMPLIFIED MEASUREMENT Vessel owners use the [Application for Simplified Measurement](#) (form CG-5397) to certify information when a vessel is assigned tonnages and registered dimensions under the Simplified Regulatory Measurement System, if a Builder's Certificate was not used for this purpose. While the form is designed to calculate tonnages electronically, some web browsers may not support its full capability from within the browser. For example, some browsers display the form, but do not allow vessel data entry, or may allow data entry, but do not display calculated tonnages. Mobile devices may not support full capability, either. Users encountering these issues should download the form by saving the “.pdf” file to a computer, and open that file using the Adobe Acrobat software application, as explained on our [web page](#).

Reset Form **Print Form**

DEPARTMENT OF HOMELAND SECURITY
U.S. Coast Guard
APPLICATION FOR SIMPLIFIED MEASUREMENT OMB No: 1625-0022

Vessel Type: Monohull
Gross Tonnage: 97
Net Tonnage: 77

I. APPLICABILITY
A U.S. flag vessel is eligible to be measured under the Simplified system (46 CFR 69 subpart E) if it is either: 1) less than 79 feet in overall length, or 2) a non-self-propelled or recreational vessel. Some vessels that are 79 feet or more in overall length may also require measurement under the Convention system (46 CFR 69 subpart B). This includes vessels that engage on foreign voyages, as well as recreational vessels that engage on voyages outside the Great Lakes and have last sale dates after December 31, 1985. Refer to 46 CFR 69.11 for complete measurement eligibility details.

II. VESSEL DATA

1. VESSEL NAME: JOHNNY K
2. HULL ID No.: XYZ12345D989
3. HULL MATERIAL: Fibrous Reinforced Plastic (e.g., fiberglass)
4. PROPULSION MACHINERY: Located inside hull (e.g., inboard engine or stern drive)
5. SHAPE OF HULL(S): Powerboat, ship or cutter
6. OVERALL DIMENSIONS: Overall Length (L) = 65.0 ft, Overall Breadth (B) = 18.0 ft, Overall Depth (D) = 12.0 ft
7. ADDITIONAL DIMENSIONS FOR LARGE DECK STRUCTURES: Structure Length (L_s) = , Structure Breadth (B_s) = , Structure Depth (D_s) =
8. ADDITIONAL DIMENSION FOR TWIN HULL VESSELS: Individual Hull Breadth (B_i) =
9. ADDITIONAL DIMENSIONS FOR TRI-HULL VESSELS: Center Hull Length (L_c) = , Center Hull Breadth (B_c) = , Center Hull Depth (D_c) = , Outer Hull Length (L_o) = , Outer Hull Breadth (B_o) = , Outer Hull Depth (D_o) =

III. STATEMENT OF REPRESENTATION
I understand that, under the provisions of 46 CFR 69.25, a person making a false statement or representation in this application may be fined up to \$30,000 and that the vessel also is liable in rem for the penalty. I certify that the information provided by me above is correct.
Owner's printed name: _____ Owner's signature: _____ Date: _____
CG-5397 (10/17) Page 1 of 2

Example: full form capability in browser

Reset Form **Print Form**

DEPARTMENT OF HOMELAND SECURITY
U.S. Coast Guard
APPLICATION FOR SIMPLIFIED MEASUREMENT OMB No: 1625-0022

Vessel Type: Monohull
Gross Tonnage: 97
Net Tonnage: 77

I. APPLICABILITY
A U.S. flag vessel is eligible to be measured under the Simplified system (46 CFR 69 subpart E) if it is either: 1) less than 79 feet in overall length, or 2) a non-self-propelled or recreational vessel. Some vessels that are 79 feet or more in overall length may also require measurement under the Convention system (46 CFR 69 subpart B). This includes vessels that engage on foreign voyages, as well as recreational vessels that engage on voyages outside the Great Lakes and have last sale dates after December 31, 1985. Refer to 46 CFR 69.11 for complete measurement eligibility details.

II. VESSEL DATA

1. VESSEL NAME: _____
2. HULL ID No.: _____
3. HULL MATERIAL: Fibrous Reinforced Plastic (e.g., fiberglass)
4. PROPULSION MACHINERY: Located inside hull (e.g., inboard engine or stern drive) 0.75, Located entirely outside hull (e.g., outboard motor) 0.8, Non-self-propelled (not fitted with any propulsion machinery) 1
5. SHAPE OF HULL(S): Powerboat, ship or cutter, Sailboat distinct keel (or no keel), Box or barge, Sailboat integral keel (keel is faired to hull)
6. OVERALL DIMENSIONS: Overall Length (L) = 65.0 ft, Overall Breadth (B) = 18.0 ft, Overall Depth (D) = 12.0 ft
7. ADDITIONAL DIMENSIONS FOR LARGE DECK STRUCTURES: Structure Length (L_s) = , Structure Breadth (B_s) = , Structure Depth (D_s) =
8. ADDITIONAL DIMENSION FOR TWIN HULL VESSELS: Individual Hull Breadth (B_i) =
9. ADDITIONAL DIMENSIONS FOR TRI-HULL VESSELS: Center Hull Length (L_c) = , Center Hull Breadth (B_c) = , Center Hull Depth (D_c) = , Outer Hull Length (L_o) = , Outer Hull Breadth (B_o) = , Outer Hull Depth (D_o) =

III. STATEMENT OF REPRESENTATION
I understand that, under the provisions of 46 CFR 69.25, a person making a false statement or representation in this application may be fined up to \$30,000 and that the vessel also is liable in rem for the penalty. I certify that the information provided by me above is correct.
Owner's printed name: _____ Owner's signature: _____ Date: _____
CG-5397 (10/17) Page 1 of 2

Example: form not supported in browser

Weekly Notes are issued by the Coast Guard Marine Safety Center's Tonnage Division (MSC-4) for use by organizations that perform measurement work on the Coast Guard's behalf. They are for informational purposes only, and are not intended as, nor should they be construed to represent, revisions of or substitutes for applicable statutes or regulations or established interpretations of either.

MEASUREMENT ORGANIZATION WEEKLY NOTES – 07/17/2019

PSIX VESSEL INFORMATION During the tonnage certification process, ACSs may search the Coast Guard’s [Port State Information Exchange \(PSIX\)](#) website for vessel information, including evidence of previous measurement. However, PSIX data can be unclear and should not be used as the sole basis for completing tonnage certificate forms. For example, the “Length” field under Vessel Particulars does not specify the type (Convention, overall, or pre-1990) or whether it is a registered dimension. In the example below, PSIX lists the Convention length for a vessel that, having been measured prior to 1990, was assigned a different registered length. As a reminder, we include tonnage data sheets like that shown below in response to vessel file requests, which include additional information from the MISLE database.

Port State Information Exchange

Results for Vessel: TAMPA BAY

Vessel Information:	Vessel Particulars:
Vessel Name: TAMPA BAY Primary Vessel Number: 504982 (Official Number (U.S.)) Hull Identification Number: N/A Manufacturer Hull Number: 1055 IMO Number: 6610106 Vessel Flag: UNITED STATES Vessel Call Sign: KNJA	Service: Freight Ship Length: 516.90 ft Breadth: 76.00 ft Depth: 42.50 ft Build Year: 1966 Alternate VINs: N/A
Service Information:	Tonnage Information:
Service Status: Scrapped Out Of Service Date: 8/24/1997 Last Removed From Service By: N/A	Cargo Authority: N/A Tonnage: <ul style="list-style-type: none"> 6159 - Regulatory (Subpart C or D), Net Ton 3840 - Dual (D), Net Ton 6557 - Convention (Subpart B), Net Ton 10723 - Regulatory (Subpart C or D), Gross Ton 11524 - Convention (Subpart B), Gross Ton 7189 - Dual (D), Gross Ton 15295 - Dead Weight, Ton

7/17/2019 MSC AND MISLE DATABASE TONNAGE DATA SHEET FOR VESSEL (ON): 504982

The information contained on this data sheet was extracted from MSC and MISLE databases on the date indicated above. It is provided to authorized measurement organizations for informational purposes only. The information on this data sheet MUST NOT be used as the basis for tonnage certification actions unless the measurement organization independently verifies its accuracy. Refer questions to the MSC Tonnage Division (MSC-4).

MSC TONNAGE FILE DATA

Current File Location: Agency ABS, Xfer Date 6/29/1995, File type Paper, Calcs Certs US, Date unable to locate file: []

Location Filed by OIN, BowID # 3, Microfilm [], ITC [], Suez [], Panama [], Ballast Justification []

Electronic Copy Previously Available: []

* Xfer date is date transferred either to or from the MSC

MISLE TONNAGE DATA (Dimensions in Feet)

Registered Indicator	Length	Breadth	Depth
CONV	516.9	76.0	42.5
HULL			
PRE-1990	1	515.2	28.4
GT ITC	11524	NT ITC	6557
GRT (C/D)	10723	NRT (C/D)	6159
DUAL GRT LOW	7189		

Other Tonnage Data: Unspecified Length 515.2, Deadweight Tons 15295, Displacement Tons [], Total Passengers [], Overnight Passengers []

Additional Simplified Measurement Parameters: GRT [], NRT [], HULL_SHAPE [], PROPEL MACH LOC [], MULT-HULL [], DECKHOUSE LENGTH []

(0 = No, False or Null ; 1 = Yes or True)

OTHER MISLE VESSEL DATA

HAILING PORT [], STATE [], FLAG US, CALL SIGN KNJA, CG NUMBER [], IMO NUMBER 6610106, HULL NUMBER 1055, HIN [], SERVICE Freight Ship, CLASS General Dry Cargo Ship, TYPE General, SUB TYPE General 2

SELF PROPELLED True, INSP SUBCHAPTER I, IN DOCUMENTATION [], OUT OF SERVICE [], SHIPYARD [], COMPLETED BY [], COMPLETED CITY [], COMPLETED COUNTRY [], HULL BUILDER [], HULL BUILT CITY AVONDALE LA, STATE [], HULL BUILT COUNTRY UNITED STATES

CONTRACT DATE [], KEEL LAID DATE [], DELIVERY DATE 12/15/1966, CONVERSION DATE [], COMPLETED DATE 1966

(0 = No, False or Null ; 1 = Yes or True)

Weekly Notes are issued by the Coast Guard Marine Safety Center’s Tonnage Division (MSC-4) for use by organizations that perform measurement work on the Coast Guard’s behalf. They are for informational purposes only, and are not intended as, nor should they be construed to represent, revisions of or substitutes for applicable statutes or regulations or established interpretations of either.

MEASUREMENT ORGANIZATION WEEKLY NOTES – 07/10/2019

FRAME INTERSECTION TREATMENT In conjunction with a request for relief from a 2018 Marine Safety Center (MSC) decision described in the Weekly Notes edition of December 19, 2018, the MSC is conducting a comprehensive review of how smaller frame-edge openings (i.e., “limber holes” and similar) are treated when applying ordinary framing provisions of the tonnage regulations. We expect to publish a change to MSC Technical Note (MTN) 01-99 CH-9, *Tonnage Technical Policy*, in September 2019 to clarify this matter. In the interim, we will accept reasonable interpretations of MTN frame intersection provisions for situations involving such openings, notwithstanding this earlier decision. Please contact Mr. Marcus Akins at 202-795-6787 prior to submitting any formal requests in this regard.

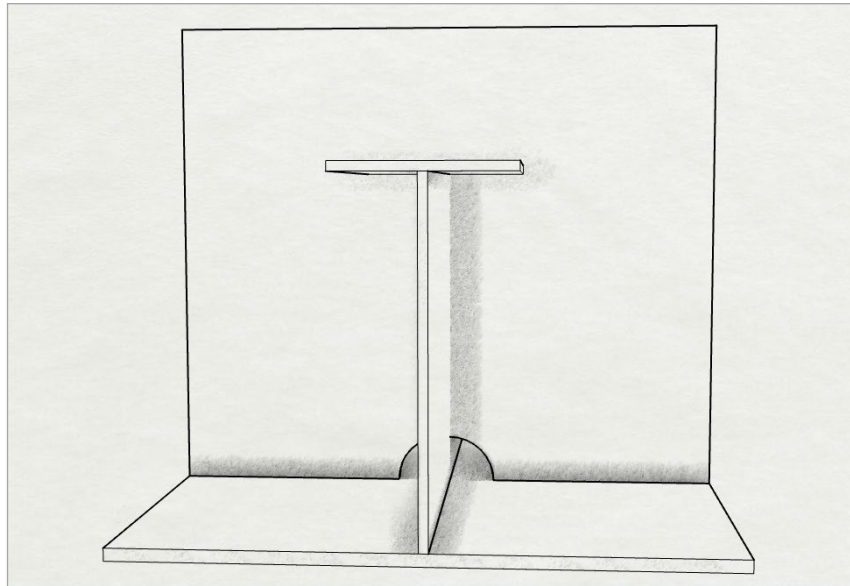

U.S. SUPPLEMENT As part of a Congressionally-mandated initiative to create a single U.S. Supplement, we are seeking ACS input on whether this new document should include a listing of U.S. interpretations of all International Conventions, including the 1969 Tonnage Convention, regardless of whether the related requirement is deemed “Critical”. We welcome any ACS input on the usefulness of such a listing, including how it could best be presented and maintained (e.g., should all interpretations listed in MTN 01-99 CH-9 be included in the U.S. Supplement, or would a simple reference to the MTN suffice?). If you would like to share input on this matter, please contact Mr. Peter Eareckson.

Weekly Notes are issued by the Coast Guard Marine Safety Center’s Tonnage Division (MSC-4) for use by organizations that perform measurement work on the Coast Guard’s behalf. They are for informational purposes only, and are not intended as, nor should they be construed to represent, revisions of or substitutes for applicable statutes or regulations or established interpretations of either.

MEASUREMENT ORGANIZATION WEEKLY NOTES – 07/03/2019

TONNAGE MEASUREMENT RECORDS When remeasuring a vessel, ACSs should obtain copies of the most recent tonnage certificate(s) and calculations, as part of their due diligence in a certification process with objective evidence. For some vessels this can involve requesting tonnage measurement records from the Marine Safety Center (MSC). Additionally, the National Vessel Documentation Center (NVDC) maintains copies of tonnage certificates and other documents used as the basis for tonnages and registered dimensions that appear on Certificates of Documentation. For more information see [Tonnage Guide 3 – Tonnage Measurement Records](#).

TONNAGE MEASUREMENT RECORDS		
DATE VESSEL MEASURED	ISSUING AUTHORITY	CURRENT RECORDS ENTITY
FORMAL SYSTEMS		
1789 - 1967	Bureau of Customs	MSC/NARA
1967 - 1982	USCG Field Units	MSC/NARA
1982 - 1989	USCG Field Units/ACSs	MSC/ACSs
1989 - Present	ACSs	ACSs
SIMPLIFIED SYSTEM		
1966 - 1984	Bureau of Customs/USCG Field Units	NVDC/MSC
1984 - 1988	USCG Headquarters	NVDC/MSC
1988 - 1995	USCG Field Units / NVDC	NVDC
1995 - Present	NVDC	NVDC

THE UNITED STATES OF AMERICA
DEPARTMENT OF COMMERCE
BUREAU OF NAVIGATION

Port of Milwaukee, Wisconsin

CERTIFICATE OF ADMEASUREMENT

I certify that an admeasurement has been made of the AMERICAN OIL SERVICE vessel called the WINDWARD of New York, N. Y. which was built in the year 1907, at Manitowish State of Wisconsin of Steel deck 1 mast 1 that her register length is 115.0 feet, her register breadth is 22.1 feet, her height under spar deck is 10.9 feet, and that her tonnage is as follows:

Capacity under tonnage deck	187.54
Capacity between decks, above tonnage deck	
Capacity of inclusions on the upper deck, viz:	
Forecastle	
Bridge	
Chart house	
Donkey engine and boiler	
Storage of sails	
Propelling power (actual space)	
Gross tonnage	211.41
Net tonnage	97

Edward J. Kelly
Surveyor

THE UNITED STATES OF AMERICA
TREASURY DEPARTMENT—BUREAU OF CUSTOMS

Port of New Orleans, Louisiana Certificate No. August 6, 1965

CERTIFICATE OF ADMEASUREMENT

I CERTIFY that an admeasurement has been made of the vessel described below:

Nationality	<u>American</u>	Builder's Hull No.	<u>61</u>
Rig	<u>Oil Screw</u>	Decks	<u>One</u>
Name	<u>Alan G.</u>	Masts	<u>One</u>
Port	<u>Houma, La.</u>	Stem	<u>Curved</u>
Official No.	<u>50234</u>	Stern	<u>Elliptical</u>
Built by	<u>Universal Iron Works, Inc.</u>	Register length	<u>93.1</u> feet
When built (year completed)	<u>1965</u>	Register breadth	<u>24.0</u> feet
Place of build	<u>Houma</u>	Register depth	<u>10.0</u> feet
State	<u>Louisiana</u>	Register height	<u></u> feet
Material	<u>Steel</u>		

Capacity under tonnage deck	12.98	Excess hatchways	
Forecastle		Light and air	
Bridge			
Chart house			
Donkey engine and boiler			
Storage of sails			
Propelling power (actual space)			
Gross tonnage	12.98		
Net tonnage	9.77		

Jerome V. Reel
Admeasurer

H.C. Friedrichs Jr.
Deputy Collector of Customs

INDEPENDENCE DAY HOLIDAY The MSC will be closed on Thursday, July 4, 2019 in observance of the Independence Day holiday.

Weekly Notes are issued by the Coast Guard Marine Safety Center's Tonnage Division (MSC-4) for use by organizations that perform measurement work on the Coast Guard's behalf. They are for informational purposes only, and are not intended as, nor should they be construed to represent, revisions of or substitutes for applicable statutes or regulations or established interpretations of either.

MEASUREMENT ORGANIZATION WEEKLY NOTES – 06/26/2019

IMO AUDIT REPORTS Earlier this month, the International Maritime Organization’s (IMO’s) Maritime Safety Committee reviewed an analysis of the first consolidated IMO Member State audit report, which presents detailed results in a number of different ways (e.g., by Port State, Flag State, Ill Code paragraph, etc.). Two figures that are relevant for Tonnage Measurement are excerpted below (see IMO document III 5/INF.3).

Figure 21: Number of references to LL 1966, PROT LL 1988, COLREG 1972 and Tonnage 1969

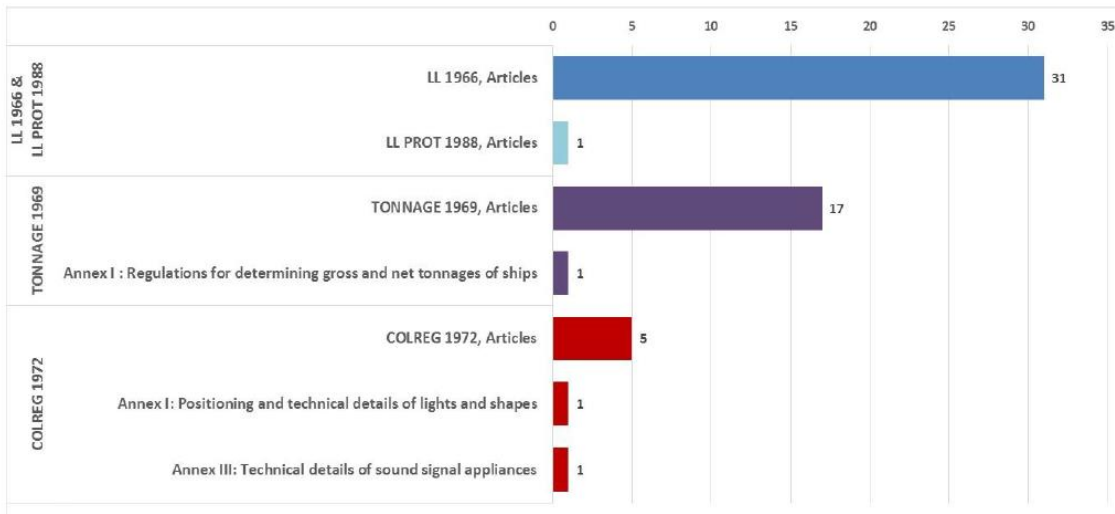
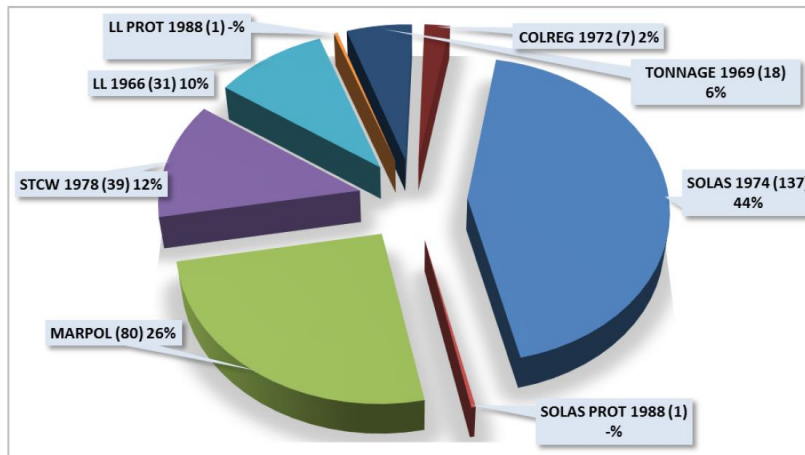

Figure 14: Findings by mandatory IMO instruments



MODEL AGREEMENT At this meeting, the Maritime Safety Committee also discussed a draft updated Model Agreement for use in conjunction with the Code for Recognized Organizations (RO Code). This draft Agreement is the subject of an International Association of Classification Societies (IACS) co-sponsored paper that generated a lively debate over whether ROs must inform the flag State of "any failures" as soon as possible, without regard to magnitude (see IMO document MSC 101/10/2).

Weekly Notes are issued by the Coast Guard Marine Safety Center’s Tonnage Division (MSC-4) for use by organizations that perform measurement work on the Coast Guard’s behalf. They are for informational purposes only, and are not intended as, nor should they be construed to represent, revisions of or substitutes for applicable statutes or regulations or established interpretations of either.

MEASUREMENT ORGANIZATION WEEKLY NOTES – 06/19/2019

LONDON TONNAGE CONFERENCE ANNIVERSARY This Sunday marks the 50th anniversary of the conclusion of the 1969 diplomatic conference that created the Tonnage Convention. Over the course of four weeks, delegations from 48 countries discussed three proposals for a universal system of tonnage measurement, each consisting of draft Convention text with annexed Regulations and a certificate. At its close, the Conference prepared and opened the Convention for signature and accession. To date, 157 Contracting States representing approximately 99.09% of the gross tonnage of the world's merchant fleet have consented to be bound by it.

FINAL ACT OF THE INTERNATIONAL CONFERENCE ON TONNAGE MEASUREMENT OF SHIPS, 1969

1. Recognizing that the establishment of a universal system of tonnage measurement for ships engaged on international voyages should constitute an important contribution to maritime transport, a Conference was held in London from 27 May to 23 June 1969, upon the invitation of the Inter-Governmental Maritime Consultative Organization, for the purpose of drawing up an International Convention on Tonnage Measurement of Ships.

2. The Governments of the following States were represented by delegations at the Conference:

Argentina	Liberia
Australia	Malagasy Republic
Belgium	Mexico
Brazil	Netherlands
Bulgaria	New Zealand
Cameroon	Nigeria
Canada	Norway
China, Republic of	Pakistan
Czechoslovakia	Peru
Denmark	Philippines
Federal Republic of Germany	Poland
Finland	Portugal
France	South Africa
Ghana	Spain
Greece	Sweden
Guatemala	Switzerland
Iceland	Union of Soviet
India	Socialist Republics
Indonesia	United Arab Republic
Ireland	United Kingdom
Israel	United States of
Italy	America
Japan	Venezuela
Korea, Republic of	Viet-Nam, Republic of
Kuwait	Yugoslavia

3. The Governments of the following States were represented at the Conference by observers:

Barbados	Iraq
Cambodia	Jordan
Holy See	Thailand
Hong Kong	

Weekly Notes are issued by the Coast Guard Marine Safety Center's Tonnage Division (MSC-4) for use by organizations that perform measurement work on the Coast Guard's behalf. They are for informational purposes only, and are not intended as, nor should they be construed to represent, revisions of or substitutes for applicable statutes or regulations or established interpretations of either.

MEASUREMENT ORGANIZATION WEEKLY NOTES – 06/12/2019

PSIX AVAILABILITY Recently, the Coast Guard's [Port State Information Exchange \(PSIX\)](#) website was temporarily unavailable. If you are unable to access PSIX (e.g., when searching for vessel official numbers prior to requesting a CG number from the Marine Safety Center), please notify Mr. Marcus Akins or Mr. David Karnes.

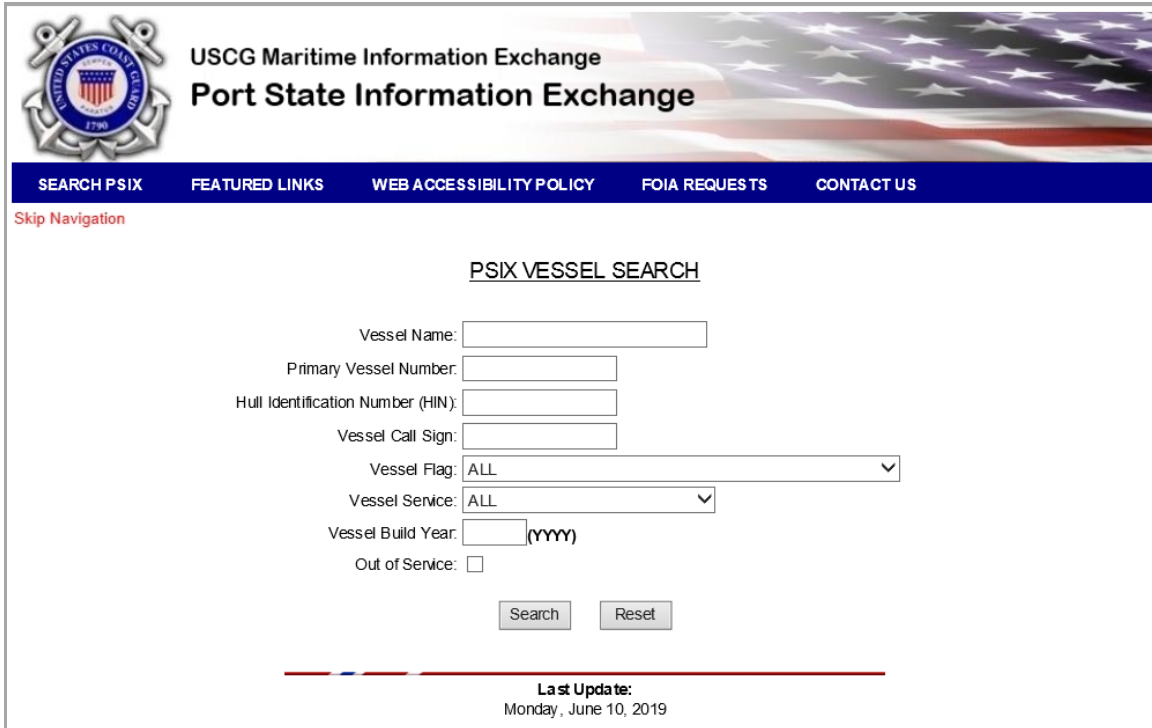

The screenshot shows the USCG Maritime Information Exchange Port State Information Exchange website. The header includes the USCG logo and the text "USCG Maritime Information Exchange Port State Information Exchange". Below the header is a navigation bar with links: "SEARCH PSIX", "FEATURED LINKS", "WEB ACCESSIBILITY POLICY", "FOIA REQUESTS", and "CONTACT US". A "Skip Navigation" link is also present. The main content area is titled "PSIX VESSEL SEARCH" and contains a search form with the following fields:

- Vessel Name:
- Primary Vessel Number:
- Hull Identification Number (HIN):
- Vessel Call Sign:
- Vessel Flag:
- Vessel Service:
- Vessel Build Year:
- Out of Service:

Below the form are "Search" and "Reset" buttons. At the bottom of the page, it says "Last Update: Monday, June 10, 2019".

CG NUMBER REQUESTS As a reminder, please copy Mr. Akins and Mr. Karnes on any CG number requests through June 14, 2019. Afterward, please resume copying Mr. Tony Cao.

Weekly Notes are issued by the Coast Guard Marine Safety Center's Tonnage Division (MSC-4) for use by organizations that perform measurement work on the Coast Guard's behalf. They are for informational purposes only, and are not intended as, nor should they be construed to represent, revisions of or substitutes for applicable statutes or regulations or established interpretations of either.

MEASUREMENT ORGANIZATION WEEKLY NOTES – 05/29/2019

CG NUMBER AND TONNAGE FILE REQUESTS Due to a temporary Tonnage Division staffing shortfall, there may be a delay in response time for CG number and file requests next week. We anticipate processing all requests received prior to noon Friday, May 31, 2019 before the weekend, with normal service resuming on Thursday, June 6. We apologize for any inconvenience this interruption in service may cause. Please copy both Mr. Marcus Akins and Mr. David Karnes on any CG number requests through June 14, 2019.

EDITOR'S NOTE Due to the aforementioned staffing shortfall, we will forego publishing a Weekly Notes edition next week.

Weekly Notes are issued by the Coast Guard Marine Safety Center's Tonnage Division (MSC-4) for use by organizations that perform measurement work on the Coast Guard's behalf. They are for informational purposes only, and are not intended as, nor should they be construed to represent, revisions of or substitutes for applicable statutes or regulations or established interpretations of either.

MEASUREMENT ORGANIZATION WEEKLY NOTES – 05/22/2019

96% LENGTH Change 9 to MTN-01-99, *Tonnage Technical Policy*, incorporated an international interpretation to use the 96% factor for Convention length measurement for ships that do not have a clearly defined stem or stern, such as column-stabilized units, submersibles, floating docks, and similar. However, while the matter remains under review, this interpretation does not extend to formally measured multi-hulls for which Simplified Measurement definitions for registered length must be used (see § 69.53 of the MTN).

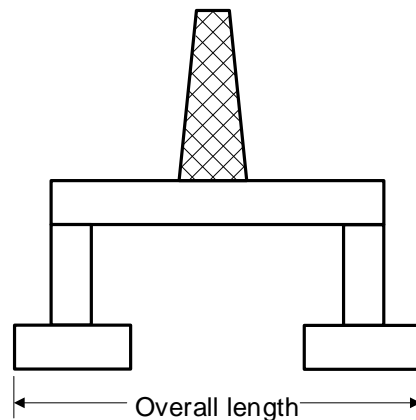

Column-stabilized units

MEMORIAL DAY HOLIDAY The Marine Safety Center will be closed on Monday, May 27, 2019 in observance of Memorial Day.

Weekly Notes are issued by the Coast Guard Marine Safety Center's Tonnage Division (MSC-4) for use by organizations that perform measurement work on the Coast Guard's behalf. They are for informational purposes only, and are not intended as, nor should they be construed to represent, revisions of or substitutes for applicable statutes or regulations or established interpretations of either.

MEASUREMENT ORGANIZATION WEEKLY NOTES – 05/15/2019

IN THE CLEAR REQUIREMENT The Marine Safety Center recently responded to an inquiry regarding a large PFD locker obstructing a proposed end opening. The questioned centered on whether this locker was of a temporary nature. Per § 69.117(d)(2')(i) of MTN 01-99 CH-9, only an obstruction which “can readily be removed underway, and whose removal does not adversely impact the safe operation of the vessel” is treated as temporary in nature. We noted that, in general, removal of lockers of this size and purpose could adversely impact safe operation, and may be considered to violate the in the clear requirement. See the figure below for an example of how a locker may violate the in the clear requirement due to its size and purpose.

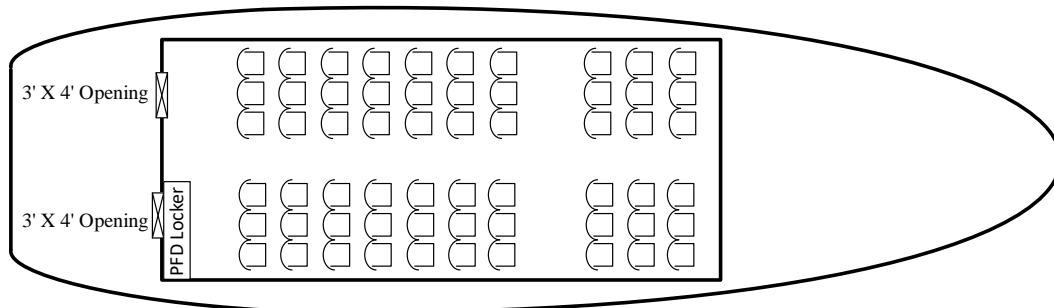

*PFD locker height nears ceiling/deck above
above

MEASUREMENT ORGANIZATION WEEKLY NOTES – 05/08/2019

OPEN SPACE PROGRESSION The Marine Safety Center recently responded to an inquiry regarding progression of open space to interior compartments. The inquiry referenced a side recess, similar to the one in the figure below, and contended that open space could progress from a side recess into an interior compartment via qualifying tonnage openings. We note that MTN 01-99 CH-9 (see especially § 69.117(d)(3)(ii)) contains no provisions to allow for progression of open space from such a side recess by way of openings in either the longitudinal or transverse boundary bulkheads. This subject was addressed in the September 14, 2010 edition of the Weekly Notes.

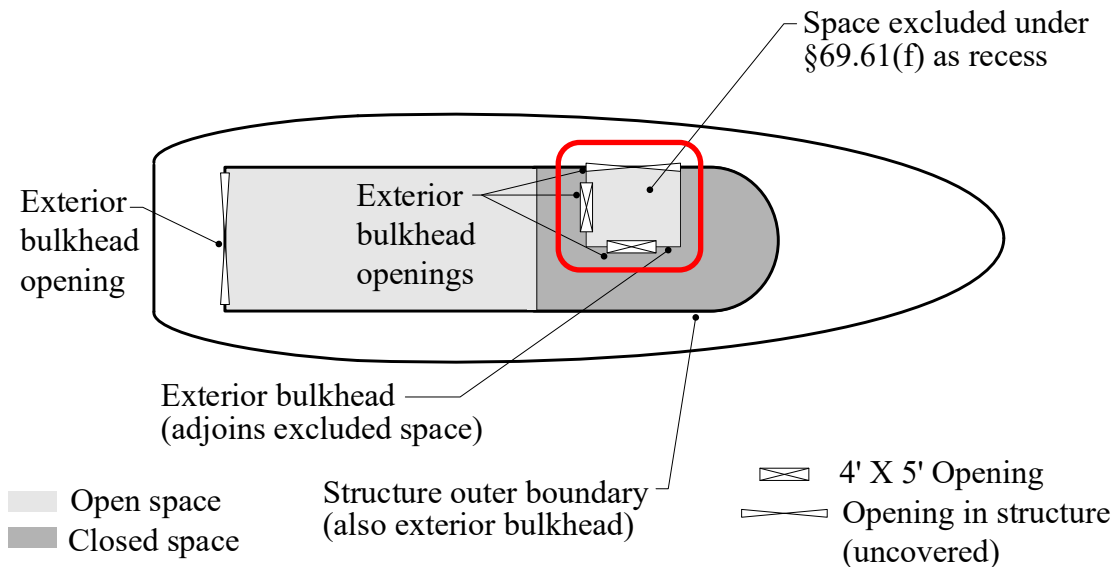

Weekly Notes are issued by the Coast Guard Marine Safety Center's Tonnage Division (MSC-4) for use by organizations that perform measurement work on the Coast Guard's behalf. They are for informational purposes only, and are not intended as, nor should they be construed to represent, revisions of or substitutes for applicable statutes or regulations or established interpretations of either.

MEASUREMENT ORGANIZATION WEEKLY NOTES – 05/01/2019

TONNAGE LENGTH During a recent oversight, the Tonnage Division identified a bulbous bow which was not reflected in the determination of the tonnage length. ACSs are reminded that, in accordance with § 69.109(f)(1)(i) of MTN 01-99 CH-9, for vessels with complex hull geometries at the extreme ends (e.g., SWATHs, mono-hulls with bulbous bows, etc.), the tonnage length is terminated on an imaginary plane that is perpendicular to the longitudinal axis of the vessel and tangent to the imaginary surface bounding the inboard faces of the ordinary frames at the extreme fore and aft location of this surface.

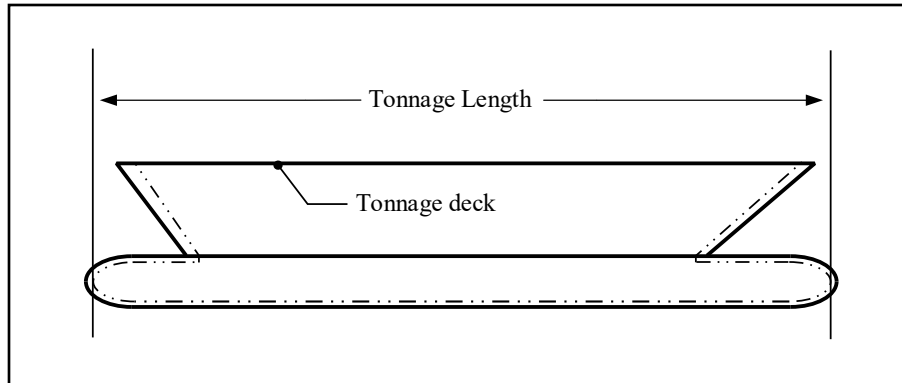

Weekly Notes are issued by the Coast Guard Marine Safety Center's Tonnage Division (MSC-4) for use by organizations that perform measurement work on the Coast Guard's behalf. They are for informational purposes only, and are not intended as, nor should they be construed to represent, revisions of or substitutes for applicable statutes or regulations or established interpretations of either.

MEASUREMENT ORGANIZATION WEEKLY NOTES – 04/24/2019

USCG DOMESTIC VESSEL INSPECTION ANNUAL REPORT The Coast Guard recently published the [2018 Domestic Annual Report](#) on Flag State Control in the United States, containing statistics and information regarding inspections and enforcement of regulations on U.S. flag vessels. As required by the Save Our Seas Act of 2018, the report includes deficiency and detention rates for inspected vessels, as well as performance metrics for Recognized Organizations that perform work on the Coast Guard's behalf.

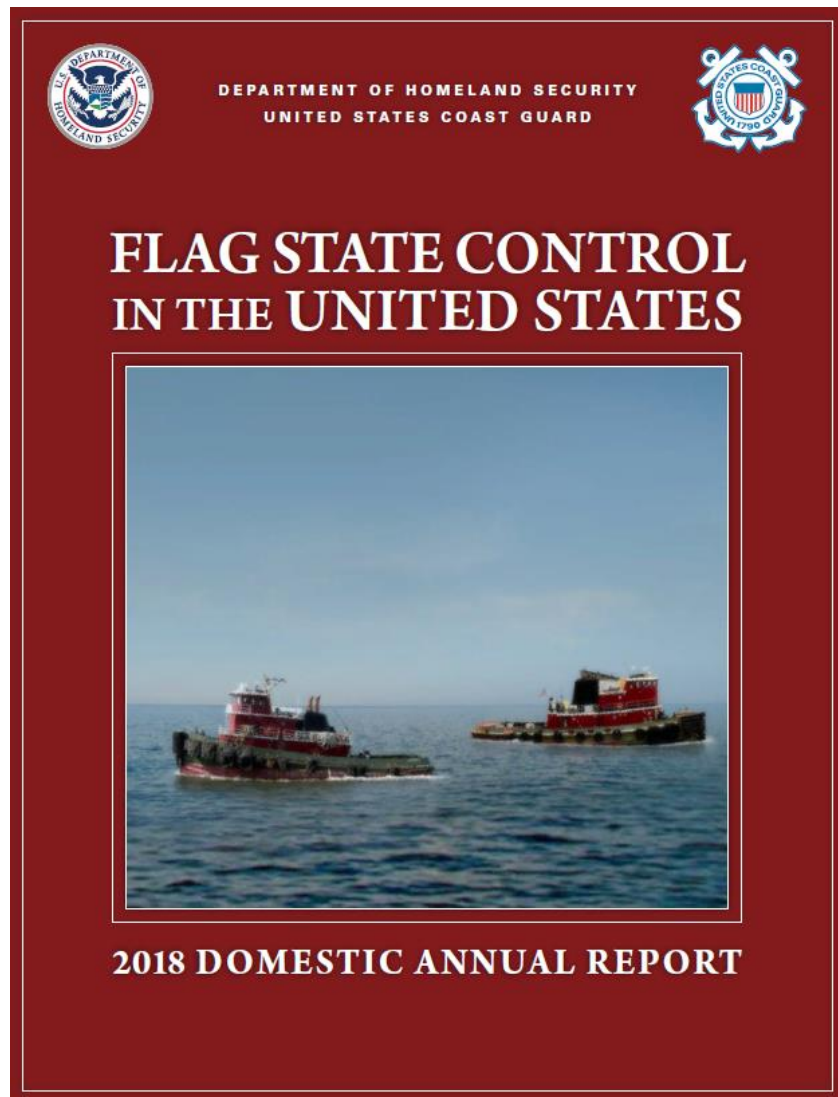

Weekly Notes are issued by the Coast Guard Marine Safety Center's Tonnage Division (MSC-4) for use by organizations that perform measurement work on the Coast Guard's behalf. They are for informational purposes only, and are not intended as, nor should they be construed to represent, revisions of or substitutes for applicable statutes or regulations or established interpretations of either.

MEASUREMENT ORGANIZATION WEEKLY NOTES – 04/17/2019

SUBSTANTIALLY ALTERED DATE The Marine Safety Center recently fielded a question regarding completion of the “Date” block on U.S. and International tonnage certificates. The question centered on what date should be entered into the block for vessels subject to “alterations or modifications of a major character.” We noted that while MTN 01-98 CH-13 refers to the MTN 01-99 CH-9 definition for “substantially altered,” this definition - unlike that for “keel laid date” - does not specify the stage of alteration corresponding to the date to be entered. Per NVIC 11-93 CH-3, “substantially altered” refers to the date a substantial alteration on a vessel was *commenced*.

SAMPLE U.S. TONNAGE CERTIFICATE - FRONT

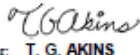
	UNITED STATES OF AMERICA CLASS SOCIETY NAME		Certificate Number: 111-US	
	TONNAGE CERTIFICATE			
GENERAL INFORMATION				
Vessel Name Sample	Vessel Number ON 123456	Vessel Type Fish Processing Vessel		
Builder Southeastern Steel and Iron Works	Hull Number 110	Propulsion <input checked="" type="checkbox"/> Self-Propelled <input type="checkbox"/> Not Self-Propelled		
Where Built Savannah, GA	Date Keel Laid/Altered 1944 / 2001			
MAIN DIMENSIONS				
Definition Used	Registered Dimensions	Length	Breadth	Depth
Convention	X	102.11 m 335.0 ft	21.31 m 69.9 ft	8.69 m 28.5 ft
Overall		105.10 m 344.8 ft	m ft	m ft
Pre-1990		m ft	m ft	m ft
TONNAGES				
Measurement System	46 CFR 69 Subpart	Gross Tonnage	Net Tonnage	
CONVENTION	B	9720 GT ITC	3477 NT ITC	
REGULATORY	C	4879 GRT	4313 NRT	
I CERTIFY that I am duly authorized by the United States Government to issue this certificate:				
Issued at: Washington, DC	(SEAL)	Issuing Officer:  T. G. AKINS		
Date: April 17, 2002				

Weekly Notes are issued by the Coast Guard Marine Safety Center's Tonnage Division (MSC-4) for use by organizations that perform measurement work on the Coast Guard's behalf. They are for informational purposes only, and are not intended as, nor should they be construed to represent, revisions of or substitutes for applicable statutes or regulations or established interpretations of either.

MEASUREMENT ORGANIZATION WEEKLY NOTES – 04/10/2019

TONCALC FIX Subsequent to the release of *TonCalc* 3.0.1, an ACS engineer found a bug in the Mean Breadth and Height calculation block for the Standard system. We have fixed this issue in the *TonCalc* 3.0.2 release, which we will distribute to ACS points of contact. If you encounter any other irregularities with *TonCalc* software, please bring them to the attention of Mr. Marcus Akins.

TonCalc 3.0.1 Bug

MEAN BREADTH AND HEIGHT CALCULATION						
Space category & frame location (or equivalent)	Lgth (ft)	Bdth (ft)	Dpth (ft)	Mult Fact	Tonnage	
*Deckhouse	50.00	0.00	0.00	1.00	0.00	
Station #	Breadth (ft)	Height (ft)				
1	24.00	7.80				
2	30.00	8.00				
3	34.00	8.00				

TonCalc 3.0.2 Fix

MEAN BREADTH AND HEIGHT CALCULATION						
Space category & frame location (or equivalent)	Lgth (ft)	Bdth (ft)	Dpth (ft)	Mult Fact	Tonnage	
*Deckhouse	50.00	29.33	7.93	1.00	116.29	
Station #	Breadth (ft)	Height (ft)				
1	24.00	7.80				
2	30.00	8.00				
3	34.00	8.00				

Weekly Notes are issued by the Coast Guard Marine Safety Center's Tonnage Division (MSC-4) for use by organizations that perform measurement work on the Coast Guard's behalf. They are for informational purposes only, and are not intended as, nor should they be construed to represent, revisions of or substitutes for applicable statutes or regulations or established interpretations of either.

MEASUREMENT ORGANIZATION WEEKLY NOTES – 04/03/2019

TONCALC 3.0.1 (CONCLUDED) Following the Marine Safety Center's (MSC's) release of *TonCalc* 3.0.1, we conclude our discussion of the principal differences from its previous version below.

TONCALC - ERROR CHECKING To help prevent data entry errors, *TonCalc* 3.0.1 incorporates additional automatic error-checking features on the Convention and Standard calculations worksheets. These new features provide warning messages alerting users to various issues, including a vessel's ineligibility for Convention measurement (shown below), the ineligibility of certain exempted spaces under the Standard/Dual system, and the inadvertent insertion of excluded space under a cargo space block.

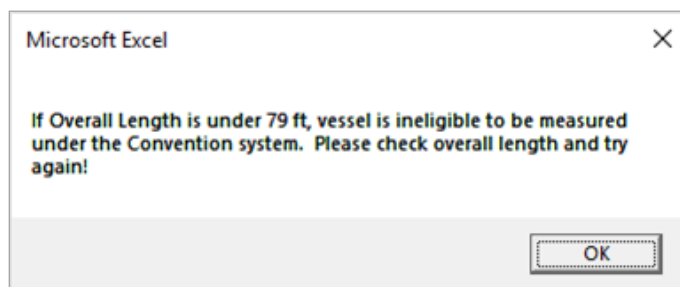

TONCALC – SUEZ CERTIFICATE With *TonCalc* 3.0.1, we converted vessel identifying information at the top of the Suez Canal Special Tonnage Certificate to a tabular layout for clarity and consistency with formats used by other issuance authorities. We also added a certificate number to the upper right corner, consistent with recent IMO electronic certificate guidance.

	SUEZ CANAL			Certificate Number:	
	SPECIAL TONNAGE CERTIFICATE				
UNITED STATES COAST GUARD					
Name of Vessel	Distinctive Number or Letters	Port of Registry	Tonnage on National Certificate		
			Gross	Net	
DETAILS OF TONNAGE					
FOR THE ABOVE NAMED VESSEL WHEN PASSING THROUGH THE SUEZ CANAL					

TONCALC AND TONNAGE FILE REQUIREMENTS Although the newer version is now available, ACSs do not need to transfer Standard/Dual system calculations completed in *TonCalc* 2.0.1 to *TonCalc* 3.0.1 in order to satisfy the tonnage file requirements of MTN 01-98 CH-13. As a reminder, § 6.2(a)(1)(ii) of the MTN requires only that ACSs use a calculation *format*, approved by the MSC, corresponding to that of the tonnage calculations sample in the MTN's Appendix A. For this purpose, both versions comply with the formatting requirement without the need for further MSC approval.

Weekly Notes are issued by the Coast Guard Marine Safety Center's Tonnage Division (MSC-4) for use by organizations that perform measurement work on the Coast Guard's behalf. They are for informational purposes only, and are not intended as, nor should they be construed to represent, revisions of or substitutes for applicable statutes or regulations or established interpretations of either.

MEASUREMENT ORGANIZATION WEEKLY NOTES – 03/27/2019

TONCALC 3.0.1 (CONTINUED) As previewed last week, the Marine Safety Center (MSC) has released *TonCalc* 3.0.1 and distributed it to ACS points of contact. Below, we continue our discussion of the principal differences from its previous version.

TONCALC - EXCLUDED SPACES In *TonCalc* 3.0.1, we have updated the Excluded Spaces block for the ITC69 (shown below) and U.S. certificates in accordance with §§ 2.4(b) and 3.4(b) of MTN 01-98 as amended.

Row	Column A	Column B	Column C	Column D	Column E	Column F	Column G	Column H	Column I	Column J	Column K	Column L	Column M	Column N	Column O
31															
32	EXCLUDED SPACES							MOULDED DRAUGHT							
33	(Regulation 2(5))							(Regulation 4(2))							
34	An asterisk (*) should be added to those spaces listed above which														
35	comprise both enclosed and excluded spaces. Listing of excluded														
36	spaces in this block is not required.														
38	Date and place of original measurement:							at							
39															
40	Date and place of last previous remeasurement:														
41															
43	REMARKS:														
45															
49	Overall length as defined under 46 CFR 69 Subpart E is VVVVVV m (WWWWW ft). Vessel built by XXXXX. Hull number is YYYYY. Official number is ZZZZZ. Certificate reassued to XXXXX. The ship is remeasured according to article 3(2)(d) of the 1969 Tonnage Convention. The GROSS TONNAGE according to the measurement system previously in force for the ship is additionally measured according to IMO Resolution YYYYY. The GROSS TONNAGE according to the measurement system previously in force for the measurement of this ship carries an IOPP Certificate in conformity with regulation 13A, Annex I, MARPOL 73/78. The following tanks are dedicated solely to the carriage of clean bulk cargo. Assigned tonnages include YYYYY cubic meters of enclosed space reserved for temporary deck equipment, located FR ZZZZZ. A U.S. Tonnage Certificate was not issued for this vessel. The dimensions on the front of this certificate are the registered dimensions.														

TONCALC - PICK LISTS *TonCalc* 3.0.1 incorporates changes to its pick lists to facilitate consistent data entry. For example, options for “Remarks” and “Vessel Types,” formerly accessed via the main menu, have been moved to the ITC/US BK (see above) and GEN DATA worksheets, respectively. We also added pick lists for shape, keel, and machinery factors on the Simplified system calculations worksheet and for Regulatory Measurement subpart (C, D, or E) on the GEN DATA worksheet.

TONCALC - FINE PRINT The MSC Tonnage Division developed the *TonCalc* software for use in calculating tonnages of vessels under the Convention, Standard, Dual, Suez, and Simplified measurement systems. The software is furnished on an “as is” basis. The MSC makes no warranties of any kind, either expressed or implied as to any matter including, but not limited to, warranty of fitness for a particular purpose or merchantability, exclusivity or results obtained from use of the software. The Tonnage Division maintains Work Instruction C3-02, *Generating Calculations and Certificates with TonCalc* giving information about how to use this product set on our [U.S. Tonnage Publications](#) web page.

Weekly Notes are issued by the Coast Guard Marine Safety Center’s Tonnage Division (MSC-4) for use by organizations that perform measurement work on the Coast Guard’s behalf. They are for informational purposes only, and are not intended as, nor should they be construed to represent, revisions of or substitutes for applicable statutes or regulations or established interpretations of either.

MEASUREMENT ORGANIZATION WEEKLY NOTES – 03/20/2019

TONCALC 3.0.1 The Marine Safety Center will soon release *TonCalc* 3.0.1, which we will use for tonnage certification of Navy and Coast Guard vessels. We will distribute a copy of the software to ACS points of contact and post a corresponding update to Work Instruction C3-02, *Generating Calculations and Certificates with TonCalc* to our [U.S. Tonnage Publications](#) web page. At their discretion, ACSs may use *TonCalc* to generate tonnage calculations and certificates. Below, and in the next Weekly Notes edition, we will highlight some of the principal differences from the previous version.

NEW TONCALC FEATURES *TonCalc* 3.0.1 includes two new utilities available via its main menu. One can be used to import Convention, Standard/Dual, and Suez Canal tonnage calculations from older versions of *TonCalc* (2.0.1 and later). The other, used in generating Suez Canal Special Tonnage Certificates, will automatically transpose calculations to pages three and four. The forthcoming work instruction mentioned above will provide further explanation.

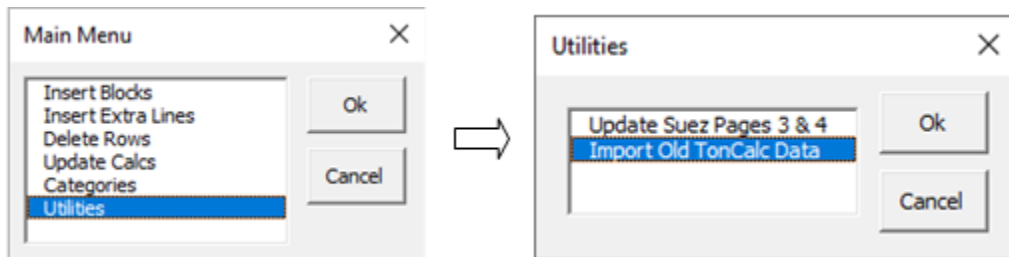

TONCALC - CERTIFICATE LOGOS With *TonCalc* 3.0.1, we have updated the process of inserting ACS logos that appear on tonnage certificates. After logos are inserted into the designated areas on the GEN DATA worksheet (as pictured below), they are automatically mapped to corresponding tonnage certificate worksheets. Logo size and placement within the designated areas may be adjusted as necessary.

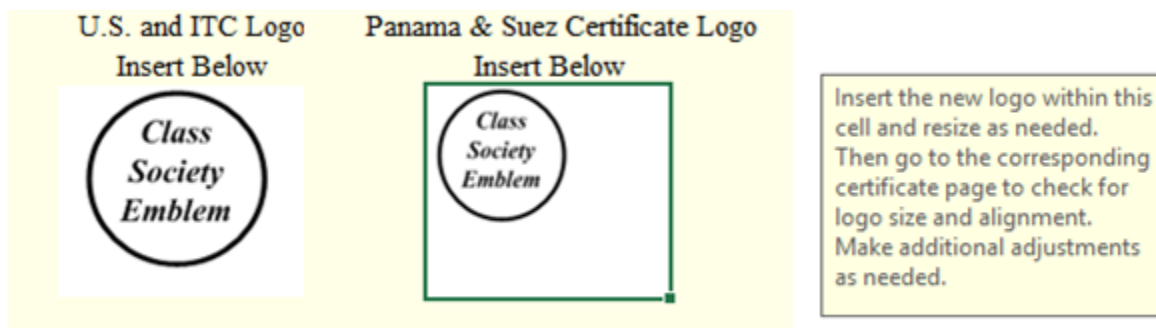

Weekly Notes are issued by the Coast Guard Marine Safety Center's Tonnage Division (MSC-4) for use by organizations that perform measurement work on the Coast Guard's behalf. They are for informational purposes only, and are not intended as, nor should they be construed to represent, revisions of or substitutes for applicable statutes or regulations or established interpretations of either.

MEASUREMENT ORGANIZATION WEEKLY NOTES – 03/13/2019

TONNAGE GUIDE 4 UPDATE We recently published Change 1 to Tonnage Guide 4, *Registered Dimensions Under Formal Systems*, which incorporates the MTN 01-99 CH-9 amendment to the registered length definition as well as other edits for clarity. We also updated multiple figures to better illustrate the treatment of steps and other discontinuities with respect to the registered depth dimension. Like our other tonnage guides and work instructions, it is available on the [U.S. Tonnage Publications](#) web page.

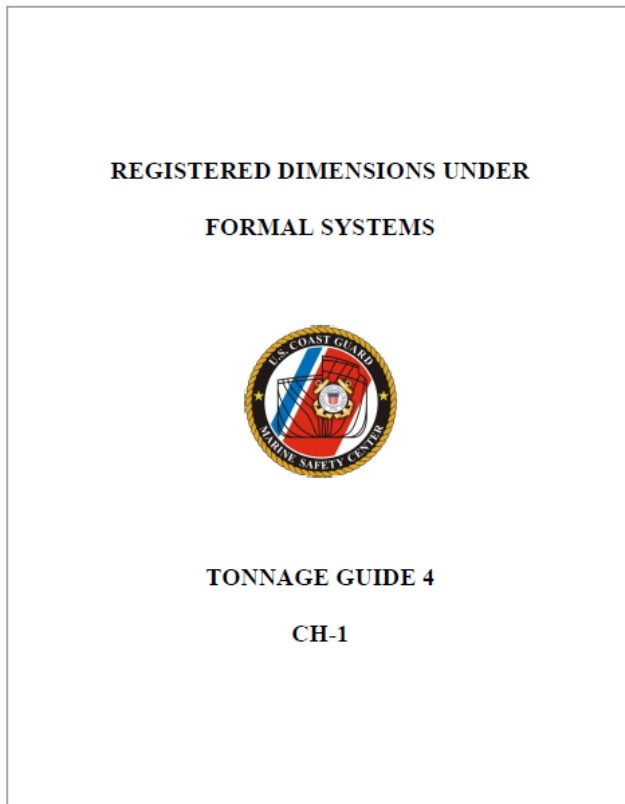

Registered Dimensions Under Formal Systems
5. Disclaimer

TG 4 CH-1
March 4, 2019

(8) Measure the distance between RS and RP. Record this distance as the registered breadth (B_{REG}).

(9) Measure the vertical distance between the line of the upper deck at the vessel's side and the top of the flat plate keel at Ω_{REG} . Record this distance as the registered depth (D_{REG}).

OUTBOARD PROFILE

TRANSVERSE SECTION AT Ω_{REG}

5. DISCLAIMER
This Guide is intended to provide information to assist industry, mariners, the general public, and the Coast Guard, as well as other Federal and state regulators, in understanding statutory and regulatory requirements. It is not intended as, nor should it be construed to represent, a revision of or substitute for applicable statutes or regulations or established interpretations of either.

6. FURTHER INFORMATION
General information on the U.S. Tonnage Measurement program, including related Coast Guard Marine Safety Center Tonnage publications, is available on the U.S. Tonnage Publications page of our website (<http://www.dco.uscg.mil/msc/>).

P. D. EARECKSON
Chief, Tonnage Division
U.S. Coast Guard
By direction

8

ACS CONTACT INFORMATION We have posted updated [ACS contact information](#) on our website. Thank you for your input.

Weekly Notes are issued by the Coast Guard Marine Safety Center's Tonnage Division (MSC-4) for use by organizations that perform measurement work on the Coast Guard's behalf. They are for informational purposes only, and are not intended as, nor should they be construed to represent, revisions of or substitutes for applicable statutes or regulations or established interpretations of either.

MEASUREMENT ORGANIZATION WEEKLY NOTES – 03/06/2019

TONNAGE DATA SHEETS As reported last week, IT infrastructure changes affected our ability to generate Tonnage Data Sheets. We have restored that capability and will once again include them in responses to vessel file requests.

ACS CONTACT INFORMATION We will update the [ACS contact information](#) posted on our website next week. If a correction or update is necessary for your respective tonnage office, please email Mr. Marcus Akins by Friday, March 8, 2019 with the current business or technical contact name, business address, email address, and phone number. Thank you for your assistance.

DOCUMENT UPDATES We are also in the process of revising several of our tonnage documents, including Tonnage Guide 4, *Registered Dimensions Under Formal Systems* and Work Instruction C3-02, *Generating Calculations and Certificates with TonCalc*. We will highlight changes in future Weekly Notes editions as we publish the revisions. Like other such documents, the new versions will be available on our [U.S. Tonnage Publications](#) web page.

Marine Safety Center Tonnage Guides

[Tonnage Guide 1 - Simplified Measurement](#)

[Tonnage Guide 2 - Measurement of Navy and Coast Guard Vessels](#)

[Tonnage Guide 3 - Tonnage Measurement Records](#)

[Tonnage Guide 4 - Registered Dimensions Under Formal Systems](#)

[Tonnage Guide 5 - Documentation and Tonnage of Smaller Commercial Vessels](#)

[Tonnage Guide 5 - Appendix \(8.5"x11" Brochure\)](#) [\(11"x17" Brochure\)](#)

Marine Safety Center Tonnage Work Instructions

[WI C3-01 - Processing Tonnage File Requests](#)

[WI C3-02 - Generating Calculations and Certificates With TonCalc](#)

[WI C3-03 - Tonnage Certification of Navy and Coast Guard Vessels](#)

[WI C3-04 - Tonnage Oversight Review](#)

[Attachment 1 to WI C3-04 - Administrative Review](#)

[Attachment 2 to WI C3-04 - Convention Tonnage Review](#)

[Attachment 3 to WI C3-04 - Principal Dimensions Review](#)

[Attachment 4 to WI C3-04 - Regulatory Tonnage Review](#)

Weekly Notes are issued by the Coast Guard Marine Safety Center's Tonnage Division (MSC-4) for use by organizations that perform measurement work on the Coast Guard's behalf. They are for informational purposes only, and are not intended as, nor should they be construed to represent, revisions of or substitutes for applicable statutes or regulations or established interpretations of either.

MEASUREMENT ORGANIZATION WEEKLY NOTES – 02/27/2019

TONNAGE DATA SHEETS Following recent changes to our IT infrastructure, we are currently unable to generate Tonnage Data Sheets in response to vessel file requests. We expect to restore this capability soon. As a reminder, vessel data is also available on [PSIX](#), although we have had recent reports of temporary service outages.

3/7/2018 **MSC AND MISLE DATABASE TONNAGE DATA SHEET FOR VESSEL (ON):** 528312

The information contained on this data sheet was extracted from MSC and MISLE databases on the date indicated above. It is provided to authorized measurement organizations for informational purposes only. The information on this data sheet MUST NOT be used as the basis for tonnage certification actions unless the measurement organization independently verifies its accuracy. Refer questions to the MSC Tonnage Division (MSC-4).

MSC TONNAGE FILE DATA

Current File Location		File Contents		File Missing Status Info
Agency	MSC	Xfer Date*		Date unable to locate file:
Location	Filled by CGDS#	Box/ID #	8277	Vessel formally measured:
Electronic Copy Previously Available:	<input type="checkbox"/>		File type	<input type="checkbox"/> MSC has no record of file
			Paper <input type="checkbox"/>	<input type="checkbox"/> File not in designated location
			Microfilm <input checked="" type="checkbox"/>	Vessel simplified measured <input type="checkbox"/>
			US <input checked="" type="checkbox"/>	
			ITC <input type="checkbox"/>	
			Suez <input type="checkbox"/>	
			Panama <input type="checkbox"/>	
			Ballast Justification: <input type="checkbox"/>	

* Xfer date is date transferred either to or from the MSC

MISLE TONNAGE DATA (Dimensions in Feet)

ORG	United States Coast Guard				MISLE VESSEL NAME DATA	
Registered Indicator	Length	Breadth	Depth	Date listed may represent the date when MISLE data was imported from another data system (e.g., 12/17/2001 from MSIS). Also, pre-1989 name data is incomplete.		
CONV 1	113.5	34.0	8.0	Unspecified Length	113.5	
HULL				Deadweight Tons		
PRE-1990	112.4	34.0	8.0	Displacement Tons		
GT ITC	172	NT ITC	61	Total Passengers	100	
GRT (C/D)	88	NRT (C/D)	60	Overnight Passengers		
DUAL GRT LOW						

current / former names	date entered
FT GAINES	5/18/2004
LINDSAY WARREN	12/17/2001

Additional Simplified Measurement Parameters

GRT NRT HULL_SHAPE

PROPEL MACH LOC MULTI-HULL DECKHOUSE LENGTH

(0 = No, False or Null ; 1 = Yes or True)

OTHER MISLE VESSEL DATA

HAILING PORT	STATE	FLAG	US	SELF PROPELLED	True	CONTRACT DATE	
CALL SIGN	WDB8419	IN DOCUMENTATION	1	INSP SUBCHAPTER	T	KEEL LAID DATE	
CG NUMBER	CG106258	OUT OF SERVICE		DELIVERY DATE	1/1/1970	CONVERSION DATE	
IMO NUMBER				COMPLETED DATE	1970		
HULL NUMBER	2021	SHIPYARD		COMPLETED BY		COMPLETED CITY	
HIN		COMPLETED CITY		COMPLETED CITY		STATE	
SERVICE	Passenger (Inspected)	COMPLETED COUNTRY		HULL BUILDER			
CLASS	Passenger Ship	HULL BUILT CITY	NEW BERN	HULL BUILT CITY	NEW BERN	STATE	North Carolina
TYPE	General	HULL BUILT COUNTRY	UNITED STATES	HULL BUILT COUNTRY	UNITED STATES		
SUB TYPE	General (More Than 6, Gross T						

(0 = No, False or Null ; 1 = Yes or True)

Weekly Notes are issued by the Coast Guard Marine Safety Center's Tonnage Division (MSC-4) for use by organizations that perform measurement work on the Coast Guard's behalf. They are for informational purposes only, and are not intended as, nor should they be construed to represent, revisions of or substitutes for applicable statutes or regulations or established interpretations of either.

MEASUREMENT ORGANIZATION WEEKLY NOTES – 02/20/2019

DEDUCTIBLE LIGHT OR AIR SPACES While the tonnage regulations provide for treating certain light or air spaces as deductible propelling machinery spaces, a one-half midship breadth restriction can significantly impact any benefit to the owner of such treatment (see § 69.121(d)(2) of Marine Safety Center Technical Note (MTN) 01-99 CH-9, *Tonnage Technical Policy*). The restriction stems from applicable provisions of the underlying U.S. statute, dating to 1895, which allow for propelling machinery spaces to be deducted from gross tonnage provided they are reasonable in extent. As illustrated in the figure below, the boilers and engines of steam propelled vessels of that era required substantial volumes of above-deck spaces for light and air, which could unduly influence the vessel's net tonnage in the absence of such restrictions.

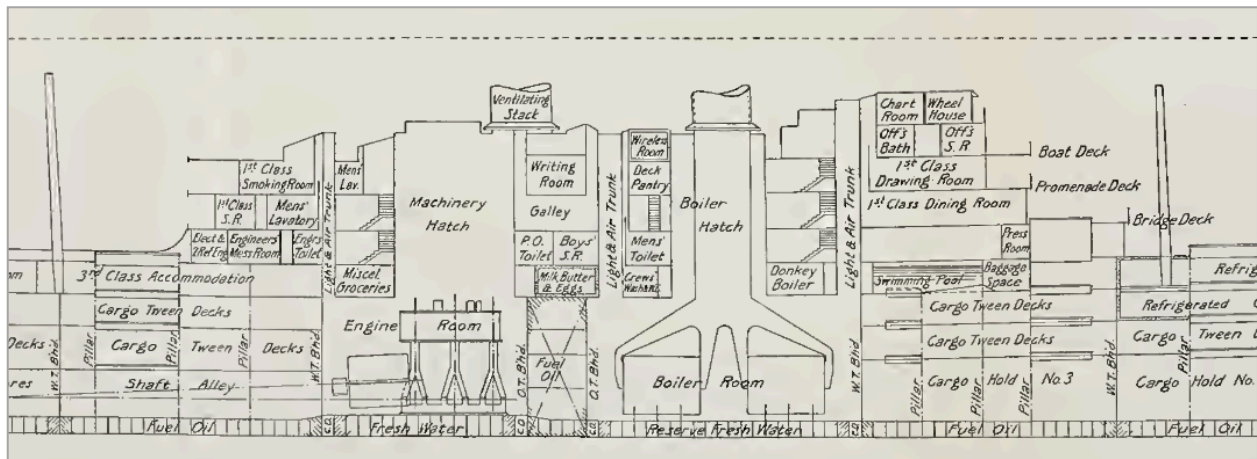

TRANSFERRING FILES - UPDATE Two weeks ago we detailed steps to transfer large files using ARL SAFE as an alternative to the disabled AMRDEC SAFE system on which we had previously relied. Recently, the [AMRDEC SAFE](#) service has been restored. To send us tonnage files for oversight or informal submittals using one of these systems, please coordinate with Mr. Marcus Akins.

OPERATING STATUS Federal offices in the Washington, DC area are closed today due to weather (snow). Teleworking employees continue to work, however communications may be slowed. Thank you for your patience.

Weekly Notes are issued by the Coast Guard Marine Safety Center's Tonnage Division (MSC-4) for use by organizations that perform measurement work on the Coast Guard's behalf. They are for informational purposes only, and are not intended as, nor should they be construed to represent, revisions of or substitutes for applicable statutes or regulations or established interpretations of either.

MEASUREMENT ORGANIZATION WEEKLY NOTES – 02/13/2019

WRAP-AROUND NOTCHES When evaluating wrap-around notches under §69.108(c)(4) of MTN 01-99 CH-9, ACSs must carefully consider the structures outboard or above the notch that could render the notch invalid when establishing the line of the uppermost complete deck. In a ruling prior to the latest shutdown, the Marine Safety Center (MSC) commented to the effect that bulwarks not exceeding five feet in height, open railings, and open gratings would not invalidate an otherwise qualifying notch. Conversely, the presence of enclosing overhead structures - including decks and deck beams - would render such a notch invalid. The figure below illustrates a stern notch modification that was subject to a Coast Guard ruling in the early 1970's, which established a number of precedents for qualifying wrap-around notches.

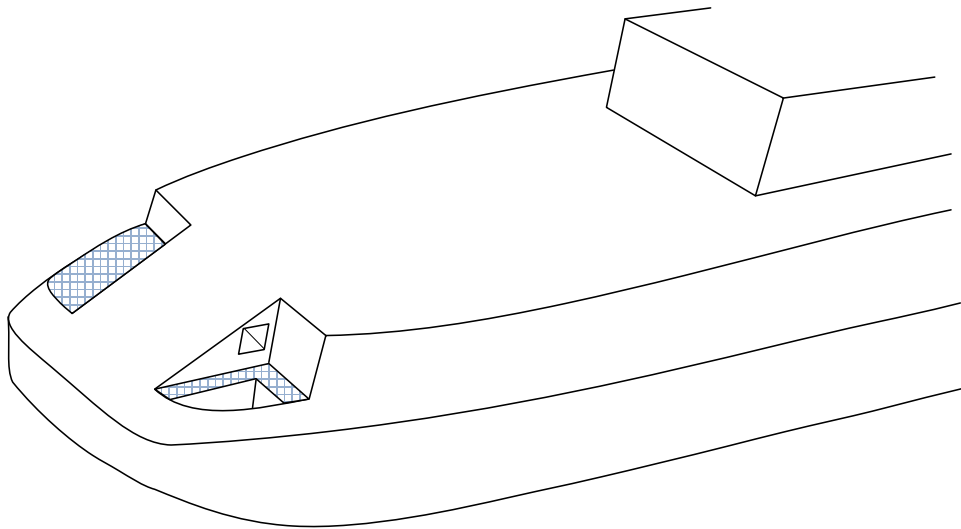

FEDERAL GOVERNMENT FUNDING Funding for numerous federal government entities including the Department of Homeland Security, of which the Coast Guard is a part, is set to expire at midnight on Friday, February 15, 2019. Lack of further funding could result in a partial government shutdown, disrupting services (including those provided by the MSC).

WASHINGTON'S BIRTHDAY HOLIDAY Even if funded, the MSC will be closed on Monday, February 18, 2019 in observance of the birthday of George Washington.

Weekly Notes are issued by the Coast Guard Marine Safety Center's Tonnage Division (MSC-4) for use by organizations that perform measurement work on the Coast Guard's behalf. They are for informational purposes only, and are not intended as, nor should they be construed to represent, revisions of or substitutes for applicable statutes or regulations or established interpretations of either.

MEASUREMENT ORGANIZATION WEEKLY NOTES – 02/06/2019

LARGE FILE TRANSFER PROCESS As mentioned in November, we have a workable alternative to the still-disabled, large file transfer application that had been frequently used to transmit tonnage files for oversight as well as informal submittals. To use the new system (called ARL SAFE):

1. Notify Mr. Marcus Akins of your wish to send files using the system.
2. Mr. Akins will request a file “drop-off”.
3. You will receive an email from safe-support@arl.army.mil with a link to a website for “dropping off” the requested files. The link is only valid for 14 days from the time of the email.
4. On the linked website (see image below), add or drag the files, and click “Drop-off Files.” Note that the retention period for files awaiting pick-up is four days.

The screenshot shows the ARL SAFE web interface. At the top right, the text 'ARL SAFE' is displayed in a large, light blue font. A 'Home' button is visible in the top left. A prominent red-bordered box contains a 'PLEASE NOTE' section with the following text: 'Any Sensitive/FOUO files **must** be encrypted prior to uploading using a tool such as Winzip, 7-Zip, Encryption Wizard, OpenSSL, etc.! PII/PHI data is not authorized. Click [here](#) for more information. Uploaded files are scanned for viruses.' Below this, a paragraph explains the drop-off process: 'This web page will allow you to drop-off (upload) one or more files for a DoD user. The recipient will receive an automated email containing the information you enter below and instructions for downloading the file.' The form includes a 'From:' field, a 'To:' field with a dropdown menu currently showing '@uscg.mil', and a 'Short note to the Recipients:' text area containing the text 'Please send the file as discussed.' There are four checkboxes: 'Calculate SHA-256 checksum of each file.', 'Send an email to me when each recipient picks up the file(s).', 'Send e-mail message to recipients', and 'which includes Passcode as well as Claim ID'. A blue button labeled 'Click to Add Files or Drag Them Here' is positioned above a table. The table has columns for 'Filename', 'Size', and 'Description'. It contains one entry: '1: Requested File.JPG' with a size of '112.1 KB' and an empty 'Description' field. Below the table, the text '112.1 KB / 8192 MB' is shown, followed by a blue 'Drop-off Files' button. At the bottom of the page, the text 'UNCLASSIFIED USE ONLY' is displayed in red.

EXPIRED “DROP-OFFS” Related to the item above, during our month-long shutdown absence, retention times lapsed for several files that ACS representatives had “dropped off” for us when requested for oversight. As a result, we have had to request them again. Thank you for your continued patience as we work through our shutdown-related backlog.

Weekly Notes are issued by the Coast Guard Marine Safety Center’s Tonnage Division (MSC-4) for use by organizations that perform measurement work on the Coast Guard’s behalf. They are for informational purposes only, and are not intended as, nor should they be construed to represent, revisions of or substitutes for applicable statutes or regulations or established interpretations of either.

MEASUREMENT ORGANIZATION WEEKLY NOTES – 01/30/2019

REOPEN FOR BUSINESS Following passage last Friday of a continuing resolution funding numerous federal government entities through February 15, 2019, the Tonnage Division returned to work Monday to resume normal operations. We request your patience as we work through our shutdown-related backlog toward a return to normal service standards for response times. In general, we are responding to requests in the order in which they were received.

H. J. Res. 28

One Hundred Sixteenth Congress of the United States of America

AT THE FIRST SESSION

*Begun and held at the City of Washington on Thursday,
the third day of January, two thousand and nineteen*

Joint Resolution

Making further continuing appropriations for fiscal year 2019, and for other purposes.

*Resolved by the Senate and House of Representatives of the
United States of America in Congress assembled,*

SECTION 1. SHORT TITLE. This joint resolution may be cited as the "Further Additional Continuing Appropriations Act, 2019".

SEC. 101. The Continuing Appropriations Act, 2019 (division C of Public Law 115-245) is further amended—

(1) by striking the date specified in section 105(3) and inserting "February 15, 2019"; and

(2) by adding after section 136 the following:

"SEC. 137. Amounts made available in this Act for personnel pay, allowances, and benefits in each department and agency shall be available for obligations incurred pursuant to subsection (c) of section 1341 of title 31, United States Code.

"SEC. 138. All obligations incurred and in anticipation of the appropriations made and authority granted by this Act for the purposes of maintaining the essential level of activity to protect life and property and bringing about orderly termination of Government function, and for purposes as otherwise authorized by law, are hereby ratified and approved if otherwise in accord with the provisions of this Act.

"SEC. 139. (a) If a State (or another Federal grantee) used State funds (or the grantee's non-Federal funds) to continue carrying out a Federal program or furloughed State employees (or the grantee's employees) whose compensation is advanced or reimbursed in whole or in part by the Federal Government—

(1) such furloughed employees shall be compensated at their standard rate of compensation for such period;

Weekly Notes are issued by the Coast Guard Marine Safety Center's Tonnage Division (MSC-4) for use by organizations that perform measurement work on the Coast Guard's behalf. They are for informational purposes only, and are not intended as, nor should they be construed to represent, revisions of or substitutes for applicable statutes or regulations or established interpretations of either.

MEASUREMENT ORGANIZATION WEEKLY NOTES – 12/19/2018

ORDINARY FRAME INTERSECTION We have responded to several recent inquiries seeking clarification on the treatment of limber holes, snipes, and similar small openings on the edges of under-deck framing. Placement of such openings adjacent to an intersecting frame (see the figure below) would violate frame intersection provisions of §69.109(p)(1)(i) of MTN 01-99 CH-9, which could affect sectional areas at the tonnage station of interest. In a future revision to the MTN, we intend to update the related figure in §69.109(p)(4)(ii) to clarify this matter.

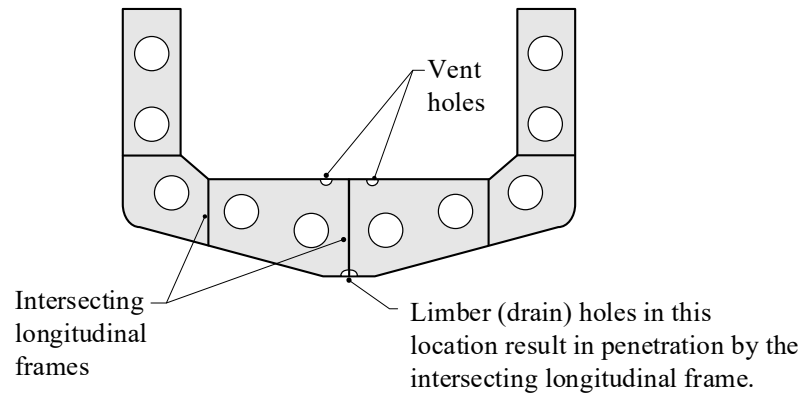

CHRISTMAS AND NEW YEAR'S DAY HOLIDAYS The Marine Safety Center (MSC) will be closed on December 25, 2018 and January 1, 2019 in observance of the Christmas and New Year's Day holidays. In addition, the president issued an Executive Order closing all executive departments and agencies of the Federal Government on December 24, 2018.

FEDERAL GOVERNMENT FUNDING Funding for numerous federal government entities including the Department of Homeland Security, of which the Coast Guard is a part, is set to expire at midnight on Friday, December 21, 2018. Lack of further funding could result in a partial government shutdown, disrupting services (including those provided by the MSC).

Weekly Notes are issued by the Coast Guard Marine Safety Center's Tonnage Division (MSC-4) for use by organizations that perform measurement work on the Coast Guard's behalf. They are for informational purposes only, and are not intended as, nor should they be construed to represent, revisions of or substitutes for applicable statutes or regulations or established interpretations of either.

MEASUREMENT ORGANIZATION WEEKLY NOTES – 12/12/2018

USCG DOMESTIC VESSEL INSPECTION ANNUAL REPORT The Coast Guard recently [published](#) the Domestic Vessel Inspection Annual Report on Flag State Control in the United States, which provides regulatory compliance statistics for U.S. flag vessels in 2017. As the first such report, its data will serve as the baseline to study trends, identify key performance indicators, and bring attention to issues in the fleet. In his introduction, Rear Admiral John Nadeau, USCG Assistant Commandant for Prevention Policy, highlights the Commandant's Final Action Memo on the sinking of the EL FARO, and that the Coast Guard will conduct more effective oversight of third parties.



Weekly Notes are issued by the Coast Guard Marine Safety Center's Tonnage Division (MSC-4) for use by organizations that perform measurement work on the Coast Guard's behalf. They are for informational purposes only, and are not intended as, nor should they be construed to represent, revisions of or substitutes for applicable statutes or regulations or established interpretations of either.

MEASUREMENT ORGANIZATION WEEKLY NOTES – 12/05/2018

OFFICE CLOSURE On December 1, 2018, the president issued an [Executive Order](#) to close federal offices, including the Marine Safety Center (MSC), on Wednesday, December 5, to observe a National Day of Mourning for President George H. W. Bush.

[Executive Order 13852](#) of December 1, 2018

Providing for the Closing of Executive Departments and Agencies of the Federal Government on December 5, 2018

By the authority vested in me as President by the Constitution and the laws of the United States of America, it is hereby ordered as follows:

Section 1. All executive departments and agencies of the Federal Government shall be closed on December 5, 2018, as a mark of respect for George Herbert Walker Bush, the forty-first President of the United States.

FEDERAL GOVERNMENT FUNDING Funding for numerous federal government entities including the Department of Homeland Security, of which the Coast Guard is a part, is set to expire at midnight on Friday, December 7, 2018. However, on Monday congressional leaders and White House officials agreed to extend the funding deadline by two weeks to December 21. The House and Senate are expected to approve the new deadline this week. Lack of further funding could result in a partial government shutdown, disrupting services (including those provided by the MSC).

Weekly Notes are issued by the Coast Guard Marine Safety Center's Tonnage Division (MSC-4) for use by organizations that perform measurement work on the Coast Guard's behalf. They are for informational purposes only, and are not intended as, nor should they be construed to represent, revisions of or substitutes for applicable statutes or regulations or established interpretations of either.

MEASUREMENT ORGANIZATION WEEKLY NOTES – 11/28/2018

FORMAL MEASUREMENT APPLICATION Among other important functions, a correctly completed and signed Application for Formal Measurement Services can serve as objective evidence for certain tonnage certificate information, and even for parameters used in tonnage calculations (e.g., the number of passengers and any draft restrictions). In this sense, the form effectively transfers the risk of certifying this information from the ACS to the vessel's owner, who by signing the form legally attests to the accuracy of this information. ACSs should keep this in mind when reviewing Formal Measurement Applications prior to acceptance.

U.S. TONNAGE REGULATIONS APPLICATION FOR FORMAL MEASUREMENT SERVICES		MTN 01-98 as amended
I. APPLICABILITY		
A U.S. flag vessel is eligible to be measured under the Convention system (46 CFR 69 subpart B) if it is 79 feet or more in overall length. Also, any U.S. flag vessel, regardless of length, may be measured under the Standard system (46 CFR 69 subpart C) or Dual system (46 CFR 69 subpart D). Some vessels, including those that are less than 79 feet in overall length, are eligible to be measured under the Simplified system (46 CFR 69 subpart E), without the need for formal measurement. Refer to section 69.11 of 46 CFR 69 for complete measurement eligibility details.		
<p>13. ADDITIONAL VESSEL INFORMATION</p> <p>a. PROPULSION: <input type="checkbox"/> Self-Propelled <input type="checkbox"/> Non-Self-Propelled</p> <p>b. NUMBER OF PASSENGERS: Total: <input style="width: 50px;" type="text"/> Accommodated in cabins for 8 or fewer: <input style="width: 50px;" type="text"/></p> <p>c. NUMBER OF CARGO SPACES: <input style="width: 50px;" type="text"/></p> <p>d. NUMBER OF PORTABLE ENCLOSED SPACES: <input style="width: 50px;" type="text"/></p> <p>e. DRAFT RESTRICTIONS: <input type="checkbox"/> Load Line <input type="checkbox"/> Other <input type="checkbox"/> Stability Letter</p>		
<p>e. <i>Draft restrictions</i> For vessels measured under the Convention system, indicate any draft restrictions by checking the applicable box(es). Describe the draft restrictions in Item 16, and enclose supporting documentation (e.g., copy of the stability letter).</p>		
III. STATEMENT OF REPRESENTATION		
I understand that under the provisions of 46 CFR 69.25, a person making a false statement or representation in this application may be fined up to \$30,000 and that the vessel also is liable in rem for the penalty. I also acknowledge that I am required by 46 CFR 69.19 to report immediately to an authorized measurement organization any intent to structurally alter the vessel or to change its service or the use of its space. I certify that the information provided by me on this application, or in any attachments thereto, is correct.		
Owner's printed name <input style="width: 150px;" type="text"/>	Owner's signature <input style="width: 150px;" type="text"/>	Date <input style="width: 50px;" type="text"/>
Formal Application (08/14)		Page 1 of 2

TRANSFERRING FILES - UPDATE As mentioned previously, the large file transfer application frequently used to transmit tonnage files for oversight as well as informal submittals has been disabled, perhaps permanently. It appears that we have a workable alternative for now. To use it, please contact Mr. Marcus Akins.

ACS CONTACT INFORMATION UPDATED Earlier this month, we updated [ACS contact information](#) posted on our website.

Weekly Notes are issued by the Coast Guard Marine Safety Center's Tonnage Division (MSC-4) for use by organizations that perform measurement work on the Coast Guard's behalf. They are for informational purposes only, and are not intended as, nor should they be construed to represent, revisions of or substitutes for applicable statutes or regulations or established interpretations of either.

MEASUREMENT ORGANIZATION WEEKLY NOTES – 11/14/2018

TRANSFERRING FILES - UPDATE As mentioned last week, [AMRDEC SAFE](#), the U.S. Army file transfer application frequently used to transmit tonnage files for oversight as well as informal submittals, has been disabled and may not be reinstated. We are currently seeking large file transfer alternatives. As a reminder, we can receive email with total file size of up to 9 MB. If you need to transmit larger files to us, please contact the Tonnage Division to coordinate. In some cases, ACSs have provided the Marine Safety Center (MSC) with accounts to access their own secure file transfer systems to facilitate transmission of large files.



SAFE is currently down.

The AMRDEC SAFE site was disabled as a preventative measure after agencies outside of AMRDEC identified potential security risks.

At this point, we are uncertain if the site will be reinstated.

In the interim, IT and mission-related questions should be directed to your specific organization to determine alternative methods for secure file exchange.

AMRDEC does not manage any other secure file transfer sites, nor are we aware of any other government-run sites.

AMRDEC SAFE was initially developed to facilitate the exchange of large data files between AMRDEC and its industry partners and customers. We recognize that the service provided by SAFE is now used by a variety of government agencies, and will continue to work with our higher headquarters to determine the appropriate way ahead.

AMRDEC Public Affairs Office

THANKSGIVING HOLIDAY The MSC will be closed on Thursday, November 22, 2018 in observance of the Thanksgiving holiday, and we will forego publishing a Weekly Notes edition next week.

Weekly Notes are issued by the Coast Guard Marine Safety Center's Tonnage Division (MSC-4) for use by organizations that perform measurement work on the Coast Guard's behalf. They are for informational purposes only, and are not intended as, nor should they be construed to represent, revisions of or substitutes for applicable statutes or regulations or established interpretations of either.

MEASUREMENT ORGANIZATION WEEKLY NOTES – 11/07/2018

WATER BALLAST SPACES The Marine Safety Center (MSC) recently confirmed that temporary hoses and pumps could be used to fill and dewater water ballast tanks via hatches without jeopardizing the water ballast exemption. The MSC commented that the surveyor need only ensure that there is some means at the time of survey for efficient handling of water ballast within a reasonable time frame. In this case, the operative statutory language has its origins in the evolution in ship construction from timber floored wooden vessels, to iron and steel vessels fitted with cellular double bottoms.

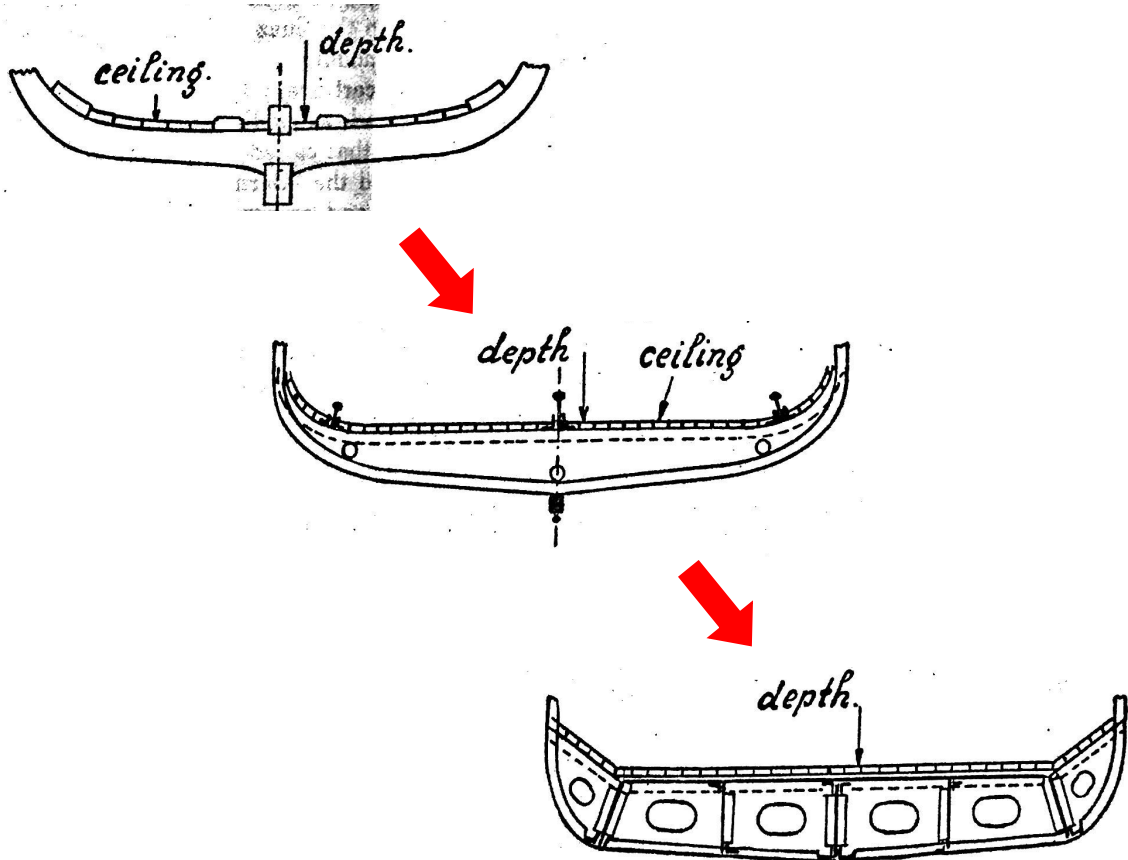

TRANSFERRING FILES [AMRDEC SAFE](#), the secure U.S. Army file transfer application we often use to receive material for oversight, is temporarily disabled. If you need to transmit large files to us, please contact the Tonnage Division to coordinate.

VETERANS DAY HOLIDAY The MSC will be closed on Monday, November 12, 2018 in observance of the Veterans Day holiday.

TONNAGE PERSONNEL Mr. Marcus Akins will be out of the office on Friday, November 9, 2018.

Weekly Notes are issued by the Coast Guard Marine Safety Center's Tonnage Division (MSC-4) for use by organizations that perform measurement work on the Coast Guard's behalf. They are for informational purposes only, and are not intended as, nor should they be construed to represent, revisions of or substitutes for applicable statutes or regulations or established interpretations of either.

MEASUREMENT ORGANIZATION WEEKLY NOTES – 10/31/2018

MARITIME COMMERCE STRATEGIC OUTLOOK As reported earlier this month in the [Maritime Commons blog](#), the Coast Guard released its [Maritime Commerce Strategic Outlook](#), which outlines the Commandant's long-term vision to support and grow maritime commerce in the United States. The document establishes three lines of effort that are critical to the Coast Guard's success, one of which involves the use and oversight of third-party organizations.



Transforming Workforce Capacity and Partnerships

The Coast Guard must have a highly adaptive mission-ready total workforce to advance, safeguard, and facilitate lawful trade and travel in an MTS made increasingly complex by the pace of innovation. The Service must have the capacity and be able to flex capabilities as commercial markets and demands are transformed by these innovations. The Coast Guard must build an adaptive force that is comfortable operating in volatility amid the rapid acceleration of technology. The Service will continuously review the human capital system that recruits, develops, and retains the best possible workforce to ensure it can adapt within a constantly changing environment. The Coast Guard will:

OBJECTIVE 1. Leverage and Ensure Effective Oversight of Third Parties:

Congressional, DHS, Coast Guard regulatory, and International Maritime Organization requirements have pushed the Coast Guard to increase the use and oversight of third-party organizations for regulatory functions and standards accrediting bodies. To achieve this, the Coast Guard will:

- Judiciously leverage the use of third-party organizations, while ensuring the Coast Guard Prevention workforce retains the necessary competencies, proficiency, and technical expertise and is provided the doctrine, strategies, training, and education needed to manage and conduct proper oversight.
- Strengthen third-party oversight, auditing, and integrated risk management. The Coast Guard must develop a system that measures performance by third-party organizations to ensure continual high performance standards are met, and improvements to the training platforms are made as needed.
- Adapt the organizational structure and related authorities, roles, and responsibilities to ensure the Service sustains the ability to monitor the global performance of the U.S. flag fleet and the third-party organizations that perform delegated functions on the Coast Guard's behalf.

Weekly Notes are issued by the Coast Guard Marine Safety Center's Tonnage Division (MSC-4) for use by organizations that perform measurement work on the Coast Guard's behalf. They are for informational purposes only, and are not intended as, nor should they be construed to represent, revisions of or substitutes for applicable statutes or regulations or established interpretations of either.

MEASUREMENT ORGANIZATION WEEKLY NOTES – 10/24/2018

WIRE MESH DOOR TREATMENT The Marine Safety Center recently commented on how a wire mesh door assembly is treated when applying open space requirements under the Standard system. In this particular case, the combination of the door framing and strapping was deemed to constitute cross braces which violated the “in the clear” requirement.

BATTENING Related to the item above is the term “battening”, for which restrictions apply in the context of tonnage opening temporary covers. Please note that - historically speaking - the term “battens” or “battening” referred to boards or similar used to secure tarps, and thereby temporarily effect a reasonably weathertight closure (hence the expression “batten down the hatches”).

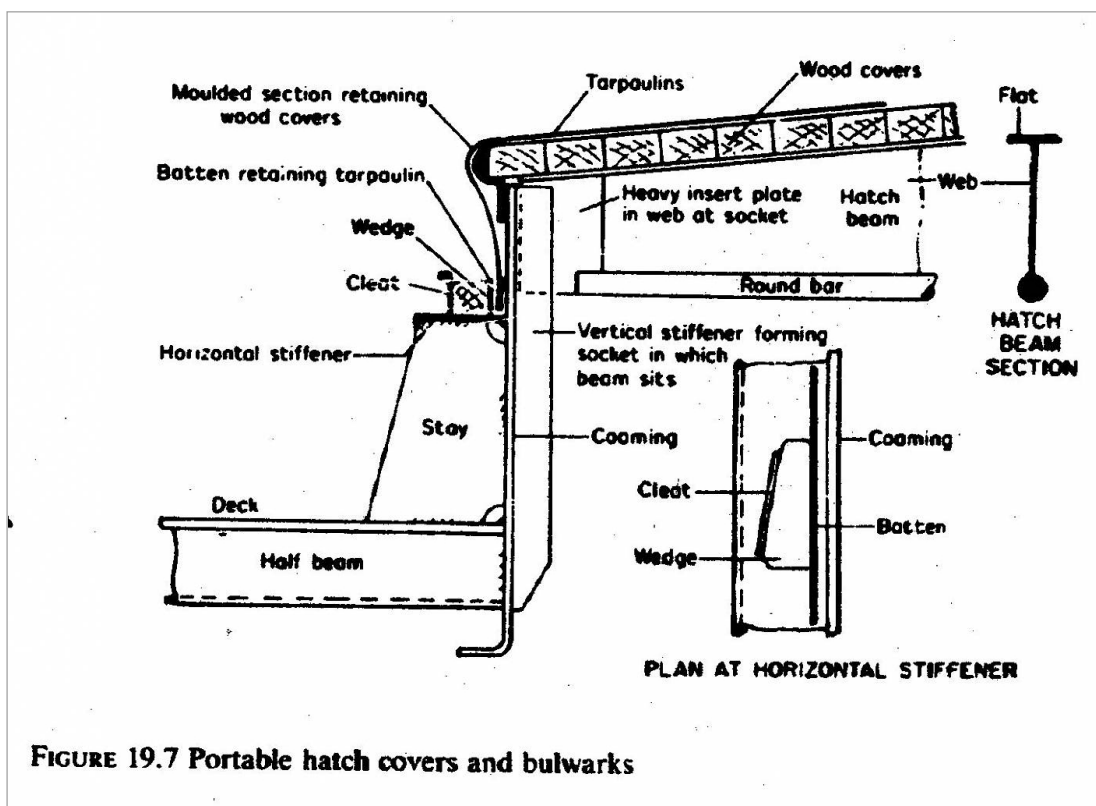

FIGURE 19.7 Portable hatch covers and bulwarks

ACS CONTACT INFORMATION We intend to update the [ACS contact information](#) posted on our website and request that you first take a moment to review it for your respective tonnage offices. Should a correction or update be necessary, please email Mr. Marcus Akins by Friday, November 2, 2018 with the current business or technical contact name, business address, email address, and phone number. Thank you for your assistance.

Weekly Notes are issued by the Coast Guard Marine Safety Center's Tonnage Division (MSC-4) for use by organizations that perform measurement work on the Coast Guard's behalf. They are for informational purposes only, and are not intended as, nor should they be construed to represent, revisions of or substitutes for applicable statutes or regulations or established interpretations of either.

MEASUREMENT ORGANIZATION WEEKLY NOTES – 10/17/2018

SPONSONS AND APPENDAGES In responding to a recent inquiry on treatment under the Standard system of sponsons being fitted to an existing vessel, the Marine Safety Center (MSC) commented that existing “deep” transverse ordinary frames which align with the transverse “deep” sponson frames may be considered to be a continuation of the sponson frames when establishing the under-deck breadth measurements, provided other ordinary frame requirements are met. Generally speaking, sponsons as treated no differently than other parts of a vessel’s hull under this system. However, the same may not be true for other hull attachments, such as bilge keels or similar appendages, whose presence typically does not affect the line of the ordinary frames, and hence the vessel’s tonnage. As always, please feel free to contact the MSC if in doubt on how the requirements are applied.

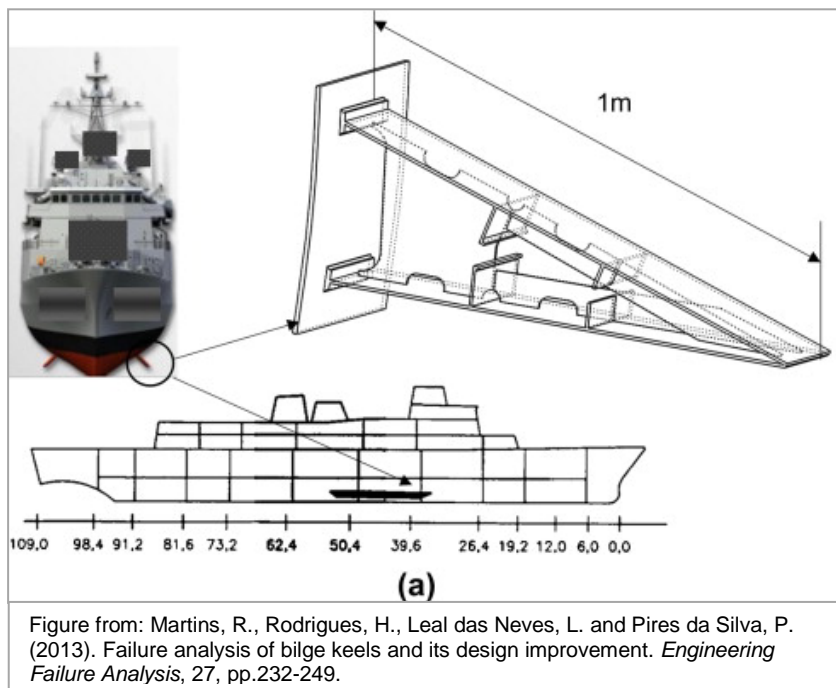
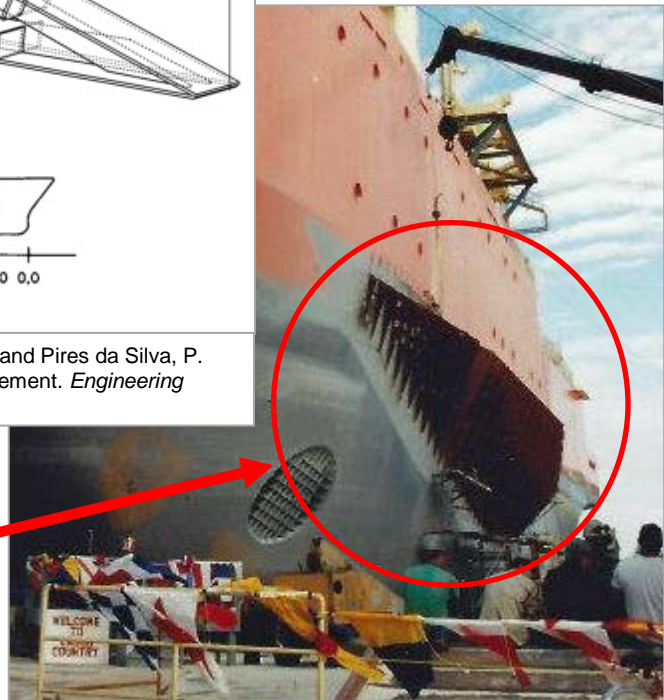

Figure from: Martins, R., Rodrigues, H., Leal das Neves, L. and Pires da Silva, P. (2013). Failure analysis of bilge keels and its design improvement. *Engineering Failure Analysis*, 27, pp.232-249.

Sponson frames
being fitted to hull



SAVE OUR SEAS ACT OF 2018 On October 11, the president signed into law the Save Our Seas Act of 2018. Among many provisions, this legislation directs: 1) the Coast Guard to report back to Congress on certain aspects of its ACS oversight program, and 2) the Comptroller General of the United States (the head of the Government Accountability Office (GAO)) to conduct of audit of the Coast Guard’s oversight and enforcement of Safety Management System plans.

Weekly Notes are issued by the Coast Guard Marine Safety Center’s Tonnage Division (MSC-4) for use by organizations that perform measurement work on the Coast Guard’s behalf. They are for informational purposes only, and are not intended as, nor should they be construed to represent, revisions of or substitutes for applicable statutes or regulations or established interpretations of either.

MEASUREMENT ORGANIZATION WEEKLY NOTES – 10/10/2018

POTENTIAL VIDEO CONTENT We recently presented at a conference of vessel documentation services, whose members wanted to learn how to determine whether a vessel requires formal tonnage measurement. We explained the steps to do so using characteristics of a notional vessel and NVIC 11-93 CH-3, *Applicability of Tonnage Measurement Systems to U.S. Flag Vessels*. We are considering incorporating this material in a new informational video to be made available on our website. If you would like to share any input on this matter, please contact Mr. Marcus Akins.

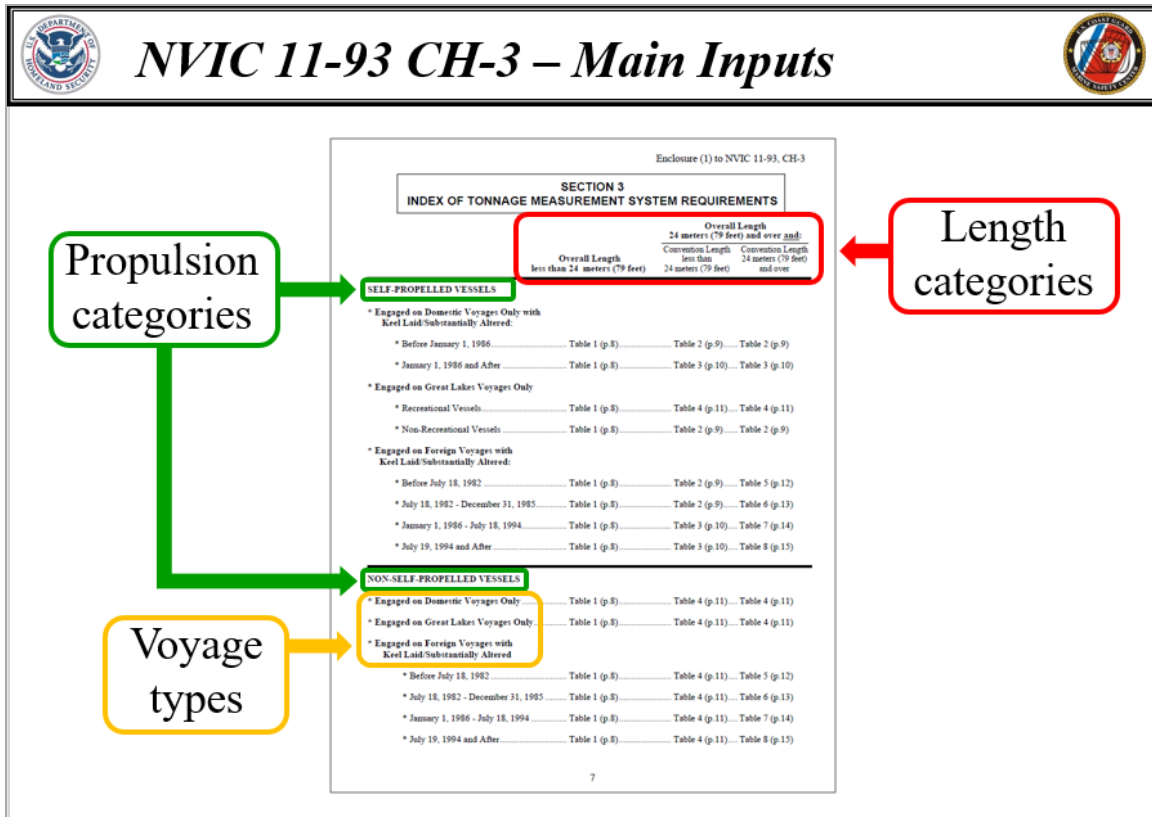

IT UPDATE – EMAIL We continue to experience occasional delivery issues with email sent to our primary Marine Safety Center (MSC) address, msc@uscg.mil. While troubleshooting, a Coast Guard IT specialist sent a test message to an ACS submitter last week. As a reminder, the MSC confirms receipt of emails to msc@uscg.mil with reply messages containing unique document numbers. If you do not receive such a response from the MSC and suspect that we have not received an email, please contact a Tonnage Division staff member.

Weekly Notes are issued by the Coast Guard Marine Safety Center's Tonnage Division (MSC-4) for use by organizations that perform measurement work on the Coast Guard's behalf. They are for informational purposes only, and are not intended as, nor should they be construed to represent, revisions of or substitutes for applicable statutes or regulations or established interpretations of either.

MEASUREMENT ORGANIZATION WEEKLY NOTES – 10/03/2018

IMO RO CODE AND OVERSIGHT At a meeting last week in London of the cognizant International Maritime Organization (IMO) Sub-Committee, there was substantial support for a draft updated Model Agreement for Recognized Organizations (ROs), that has been in the works for years. Although use of any such document pends IMO Committee and flag State action, it is significant that the document explicitly addresses, and brings clarity to, many of the interface issues between ACSs and flag Administrations related to oversight that have surfaced over the years. These include reporting requirements for completed work, access to records, treatment of nonconformities, and authorities for interpretations and equivalencies, as excerpted from document III 5/WP.4, below:

III 5/WP.4
Annex 1, page 4

5.2 Interpretations

While interpretations of the applicable instruments, as well as the determination of equivalents or the acceptance of substitutes to the requirements of the applicable instruments are the prerogative of the Administration, the RO will co-operate in their establishment as necessary.

5.3 Deviations and equivalent solutions

Exemptions and deviations from, and equivalents to, the requirements of the applicable instruments are the prerogative of the Administration and must be approved by the Administration prior to issuance.

In instances where, temporarily, the requirements of an applicable instrument cannot be met under particular circumstances, the RO ~~surveyor~~ will specify such measures or supplementary equipment as may be available to permit the vessel-ship to proceed to a suitable port where permanent repairs or rectifications can be effected or replacement equipment fitted.

6 Reporting to the flag State:

6.1 procedures for reporting in the case of general authorization ~~(refer to appendix 2)~~;

The RO shall establish relevant procedures for reporting to the Administration in the case of general authorization, in accordance with the requirements of RO Code and the additional requirements of the Administration.

COLUMBUS DAY HOLIDAY The Marine Safety Center will be closed on Monday, October 8, 2018 in observance of the Columbus Day holiday.

TONNAGE PERSONNEL Mr. Marcus Akins will be out of the office Tuesday, October 9, 2018.

Weekly Notes are issued by the Coast Guard Marine Safety Center's Tonnage Division (MSC-4) for use by organizations that perform measurement work on the Coast Guard's behalf. They are for informational purposes only, and are not intended as, nor should they be construed to represent, revisions of or substitutes for applicable statutes or regulations or established interpretations of either.

MEASUREMENT ORGANIZATION WEEKLY NOTES – 09/26/2018

FEDERAL GOVERNMENT FUNDING Funding for numerous federal government entities is set to expire on Sunday, September 30, 2018. Lack of further funding could result in a government shutdown, disrupting services (including those provided by the Marine Safety Center).

Weekly Notes are issued by the Coast Guard Marine Safety Center's Tonnage Division (MSC-4) for use by organizations that perform measurement work on the Coast Guard's behalf. They are for informational purposes only, and are not intended as, nor should they be construed to represent, revisions of or substitutes for applicable statutes or regulations or established interpretations of either.

MEASUREMENT ORGANIZATION WEEKLY NOTES – 09/19/2018

RADAR DOMES We recently responded to an inquiry on whether a radar dome space could be exempted from inclusion in tonnage. The space was sized to protect a large rotating antenna with adequate clearance. We commented that it could be exempted in its entirety as machinery space under § 69.117(b)(6) of MTN 01-99 CH-9 (categorized in TonCalc as “Other Machinery”). The photo below illustrates radar domes (circled) which, being greater than one cubic meter, must be included in tonnage, but which may be eligible for exemption as machinery space.



REFRIGERATOR TREATMENT We also recently responded to an inquiry on the eligibility for exempting space within a multi-use room. The room contains a power transformer, power and monitoring panels, air conditioners, dehumidifiers, an electronics rack, and two refrigerators used for refrigerated storage. We commented that the space within the multi-use room could be exempted as machinery space under § 69.117(b)(6) of the MTN, excepting space occupied by the refrigerators themselves and the entryway and other portions of the room used to access the refrigerators.

MEASUREMENT ORGANIZATION WEEKLY NOTES – 09/12/2018

IT UPDATES – WEBSITE We recently received reports of Coast Guard websites, including that of the Marine Safety Center, failing to load properly. In some cases, the list of menu items on the left-hand side is not expandable, which could lead to difficulty navigating to Tonnage Division pages as illustrated below. If you encounter such an issue, please try refreshing the web page or opening it in another browser. Thank you for your patience.



IT UPDATES – EMAIL We also continue to experience lapses in our email server connectivity, resulting in delivery delays. We apologize for any inconvenience this has caused. As a reminder, for time-critical matters, the best way to reach us is by phone.

Weekly Notes are issued by the Coast Guard Marine Safety Center's Tonnage Division (MSC-4) for use by organizations that perform measurement work on the Coast Guard's behalf. They are for informational purposes only, and are not intended as, nor should they be construed to represent, revisions of or substitutes for applicable statutes or regulations or established interpretations of either.

MEASUREMENT ORGANIZATION WEEKLY NOTES – 09/05/2018

PANAMA CANAL FEES We recently responded to an inquiry regarding Panama Canal transit fees (tolls) for a pair of decommissioned 1940s-era Coast Guard buoy tenders headed for scrapping. While these buoy tenders required formal tonnage measurement under Panama Canal rules, it was unclear how such vessels - while under tow - would be assessed transit fees. After consulting with the Panama Canal Authority (ACP), we confirmed that tolls for these former buoy tenders, which will be towed as dead ships, will be based on maximum displacement, as certified by official documents that also state main dimensions.



Buoy tender [USCGC PLANETREE \(WLB 307\)](#)



[NAUTILUS \(former SSN 571\)](#) under tow through the Panama Canal en route to Groton, Connecticut to become a museum ship, June 21, 1985

Weekly Notes are issued by the Coast Guard Marine Safety Center's Tonnage Division (MSC-4) for use by organizations that perform measurement work on the Coast Guard's behalf. They are for informational purposes only, and are not intended as, nor should they be construed to represent, revisions of or substitutes for applicable statutes or regulations or established interpretations of either.

MEASUREMENT ORGANIZATION WEEKLY NOTES – 08/29/2018

LARGE RECREATIONAL VESSEL LEGISLATION On August 13, 2018 the president signed into law the John S. McCain National Defense Authorization Act for Fiscal Year 2019. In addition to authorizing FY2019 appropriations and setting forth polices for Department of Defense programs and activities, the Act directs the Coast Guard to issue large recreational vessel regulations. Applicable to any recreational vessel over 300 GRT that does not carry any cargo or passengers for hire, these regulations would be comparable to United Kingdom's [Large Commercial Yacht Code \(LY3\)](#) or an equivalent standard. Prior to the effective date of these future regulations, such vessels shall not be subject to inspection if they comply with the LY3 or an acceptable equivalent.

<p style="text-align:center">One Hundred Fifteenth Congress of the United States of America</p> <p style="text-align:center">AT THE SECOND SESSION</p> <p style="text-align:center"><i>Began and held at the City of Washington on Wednesday, the third day of January, two thousand and eighteen</i></p> <p style="text-align:center">An Act</p> <p>To authorize appropriations for fiscal year 2019 for military activities of the Department of Defense, for military construction, and for defense activities of the Department of Energy, to prescribe military personnel strengths for such fiscal year, and for other purposes.</p> <p><i>Be it enacted by the Senate and House of Representatives of the United States of America in Congress assembled,</i></p> <p>SECTION 1. SHORT TITLE.</p> <p>(a) IN GENERAL.—This Act may be cited as the “John S. McCain National Defense Authorization Act for Fiscal Year 2019”.</p> <p>(b) REFERENCES.—Any reference in this or any other Act to the “National Defense Authorization Act for Fiscal Year 2019” shall be deemed to be a reference to the “John S. McCain National Defense Authorization Act for Fiscal Year 2019”.</p>	<p style="text-align:center"> Maritime and Coastguard Agency</p> <hr/> <p style="text-align:center">LY3 The Large Commercial Yacht Code</p> <hr/> <p style="text-align:center">Applicable to yachts which are 24 metres and over in load line length, are in commercial use for sport or pleasure, do not carry cargo and do not carry more than 12 passengers.</p>
--	---

LABOR DAY HOLIDAY The Marine Safety Center will be closed Monday, September 3, 2018 in observance of the Labor Day holiday.

Weekly Notes are issued by the Coast Guard Marine Safety Center's Tonnage Division (MSC-4) for use by organizations that perform measurement work on the Coast Guard's behalf. They are for informational purposes only, and are not intended as, nor should they be construed to represent, revisions of or substitutes for applicable statutes or regulations or established interpretations of either.

MEASUREMENT ORGANIZATION WEEKLY NOTES – 08/22/2018

3-D VISUALIZATION When reviewing a tonnage file, we first familiarize ourselves with a vessel's overall layout and structure. We find that a 3-dimensional model viewed from various angles can be much more helpful in this regard than two-dimensional drawings and photographs alone. Referencing such images during onboard surveys may also facilitate checking for configuration differences between a model used for tonnage measurement and the as-built vessel. We used the free [Deadweight](#) software to generate the examples below from a GHS model.

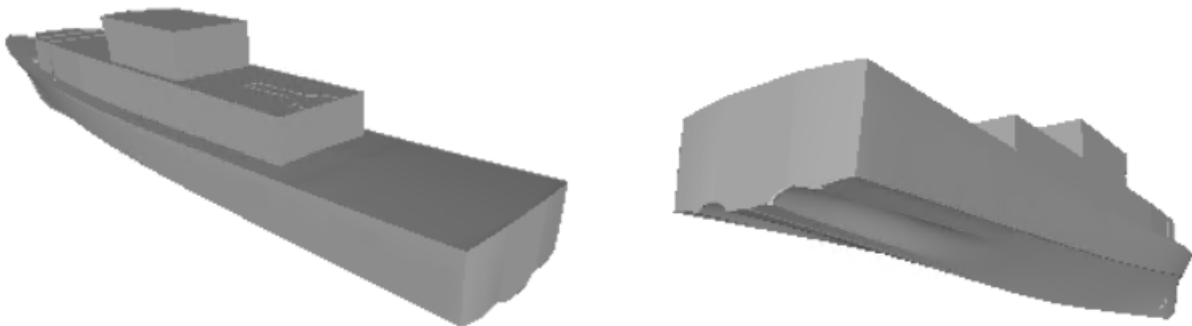
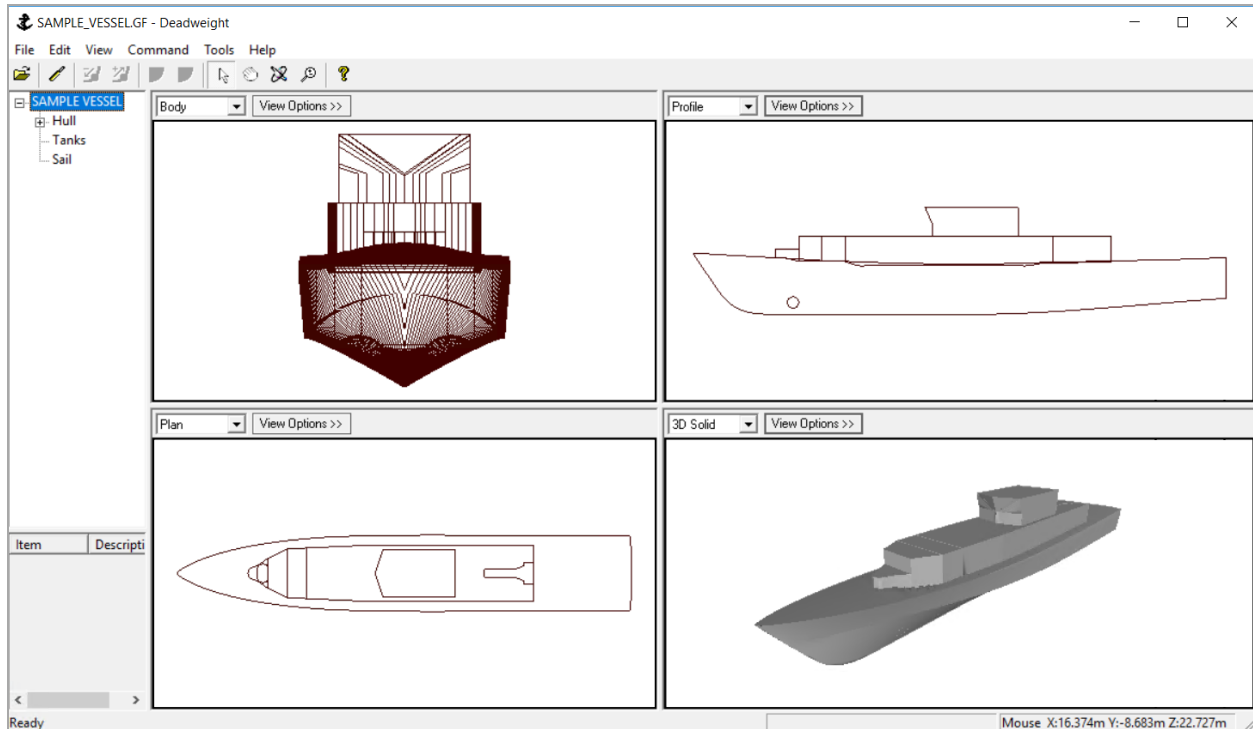

Weekly Notes are issued by the Coast Guard Marine Safety Center's Tonnage Division (MSC-4) for use by organizations that perform measurement work on the Coast Guard's behalf. They are for informational purposes only, and are not intended as, nor should they be construed to represent, revisions of or substitutes for applicable statutes or regulations or established interpretations of either.

MEASUREMENT ORGANIZATION WEEKLY NOTES – 08/15/2018

KPI INFORMATION We wish to thank all those who provided information to Mr. Marcus Akins of the Tonnage Division staff on ACS key performance indicators (KPIs) applicable to tonnage measurement work. The following table from the Coast Guard's [2017 Port State Control Annual Report](#) illustrates how performance data is tracked on the Survey/Inspection side. Note especially the large number of safety exams conducted annually, and the "Detention Ratio" used to quantify performance.

Calendar Year	Number of Safety Exams	Safety Related Detentions	Annual Detention Ratio	3-Year Average Detention Ratio	Major ISPS Control Actions	Annual ISPS Control Action Ratio	Rolling Average ISPS Control Action Ratio ⁽¹⁾
2008	11,578	176	2.03%	1.75%	27	0.31%	0.41%
2009	9,657	161	1.88%	1.92%	18	0.21%	0.34%
2010	9,907	156	1.67%	1.86%	17	0.18%	0.23%
2011	10,129	97	1.04%	1.53%	15	0.16%	0.18%
2012	9,469	105	1.17%	1.30%	8	0.09%	0.14%
2013	9,394	121	1.29%	1.11%	8	0.09%	0.12%
2014	9,232	143	1.55%	1.31%	10	0.12%	0.10%
2015	9,265	201	2.17%	1.67%	11	0.13%	0.11%
2016	9,390	98	1.04%	1.58%	8	0.09%	0.11%
2017	9,105	91	0.99%	1.40%	6	0.06%	0.10%

¹ Targeting thresholds for vessel security was fixed at 1.5% in 2005 and has remained fixed since that time.

TONNAGE PERSONNEL As a reminder, Mr. Tony Cao is currently out of the office and will return on Monday, August 20. During this time, please copy Mr. David Karnes on any CG number requests.

Weekly Notes are issued by the Coast Guard Marine Safety Center's Tonnage Division (MSC-4) for use by organizations that perform measurement work on the Coast Guard's behalf. They are for informational purposes only, and are not intended as, nor should they be construed to represent, revisions of or substitutes for applicable statutes or regulations or established interpretations of either.

MEASUREMENT ORGANIZATION WEEKLY NOTES – 08/08/2018

TONNAGE PERSONNEL Mr. Tony Cao is currently out of the office and will return on Monday, August 20. During this time, please copy Mr. David Karnes on any CG number requests.

MEASUREMENT ORGANIZATION WEEKLY NOTES – 08/01/2018

COMPLETENESS OF TONNAGE CALCULATIONS During oversight reviews, we have encountered situations where the ACS omitted volumes of certain qualifying exemptible spaces when calculating tonnage, but failed to reflect those exemptions in the tonnage calculations. Per MTN 01-98 CH-13 § 6.2(a)(1), tonnage files must include the complete calculations used to arrive at assigned tonnages. Please note that tonnage calculations are not complete unless they account for every space, including those exempted from gross tonnage in their entirety, as shown in the TonCalc example below.

Enclosure Category: ***2nd Tier**

RECTANGULAR CALCULATION					
Space category & frame location (or equivalent)	Lgth (ft)	Wdth (ft)	Hght (ft)	Mult Fact	Tonnage
*Deckhouse: CO's Stateroom Fr: 74-81	6.63	21.32	9.51	1.00	13.44
*Deckhouse: Life Jacket Locker Fr: 110-118	6.08	9.55	8.55	1.00	4.96
*Deckhouse: Stack/Vent-Blower Space Fr 92-106	14.48	9.55	13.86	1.00	19.17
*Deckhouse: Crane Control Room Fr: 70-74	3.54	9.67	9.51	1.00	3.26
*Deckhouse: Fan Space Fr: 74-92	17.14	18.84	4.28	1.00	13.82
*Deckhouse: Stack/Vent-Blower Space Fr 106-110	5.86	9.55	8.55	1.00	4.78
*Deckhouse: Companions Fr 95-100	4.52	4.77	13.86	2.00	5.98
*Deckhouse: CO's Stateroom Fr: 81-95	13.57	18.84	9.51	1.00	24.31

2nd Tier Tonnage As Measured: 89.72

RECTANGULAR CALCULATION					
Space category & frame location (or equivalent)	Lgth (ft)	Wdth (ft)	Hght (ft)	Mult Fact	Tonnage
*Light & Air: Stack/Vent-Blower Space Fr 92-106	14.48	9.55	13.86	1.00	19.17
*Light & Air: Fan Space Fr: 74-92	17.14	18.84	4.28	1.00	13.82
*Light & Air: Stack/Vent-Blower Space Fr 106-110	5.86	9.55	8.55	1.00	4.78

2nd Tier Exemptions: 37.77

Weekly Notes are issued by the Coast Guard Marine Safety Center's Tonnage Division (MSC-4) for use by organizations that perform measurement work on the Coast Guard's behalf. They are for informational purposes only, and are not intended as, nor should they be construed to represent, revisions of or substitutes for applicable statutes or regulations or established interpretations of either.

MEASUREMENT ORGANIZATION WEEKLY NOTES – 07/25/2018

ORDINARY TRANSOM FRAMES We recently fielded several questions on treatment of transom frames in association with the tonnage length measurement, where the transom frames are of different sizes to accommodate propelling machinery or auxiliary equipment. As a reminder, ordinary transom frames (cant frames) must conform to all ordinary frame requirements in §69.109(p) of MTN 01-99 CH-9. The figure below illustrates how the tonnage length would be determined in the case of different sized transom frames, where the deeper frames have been notched out.

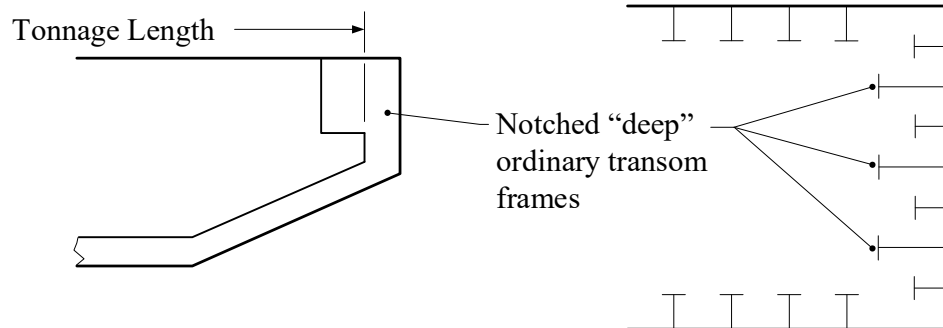

KEY PERFORMANCE INDICATORS As part of a broader Coast Guard initiative, the Marine Safety Center is gathering information on key performance indicators (KPIs) required under the Code for Recognized Organizations (RO Code). Over the next few weeks, Mr. Marcus Akins of the Tonnage Division staff will be reaching out to ACS counterparts to discuss KPIs applicable for tonnage measurement work. We note that the RO Code mandates use of the following information for planning continual improvement, corrective and preventive actions.

- customer complaints;
- non-conformance reports;
- outputs from management reviews;
- internal audit reports;
- outputs from data analysis;
- relevant records;
- outputs from customer feedback and satisfaction measurements;
- process measurements;
- results of self-assessment;
- in-service experience.

Weekly Notes are issued by the Coast Guard Marine Safety Center's Tonnage Division (MSC-4) for use by organizations that perform measurement work on the Coast Guard's behalf. They are for informational purposes only, and are not intended as, nor should they be construed to represent, revisions of or substitutes for applicable statutes or regulations or established interpretations of either.

MEASUREMENT ORGANIZATION WEEKLY NOTES – 07/18/2018

TONNAGE GUIDE 2 UPDATE We recently published Change 4 to Tonnage Guide 2 (TG 2 CH-4), *Measurement of Navy and Coast Guard Vessels*, to reflect implementation of electronic tonnage certificates at the Marine Safety Center, along with other changes of an administrative nature. Like our other tonnage guides and work instructions, it is available on our [U.S. Tonnage Publications page](#).

<p>MEASUREMENT OF NAVY AND COAST GUARD VESSELS</p>  <p>TONNAGE GUIDE 2 CH-4</p>	<p>Measurement of Navy and Coast Guard Vessels 6. Suez Canal Measurement</p> <p style="text-align: right;">TG 2 CH-4 July 17, 2018</p> <p>6. SUEZ CANAL MEASUREMENT The Coast Guard issues Suez Canal Special Tonnage Certificates to certify tonnage used by the Suez Canal Authority to assesses canal transit fees under its regulations (reference (c)). The Suez Canal Authority is the entity of the Government of Egypt charged with the administration and operation of the Suez Canal. Specific requirements on tonnage measurement that apply to vessels of war are summarized below:</p> <p>(a) MEASUREMENT SYSTEMS Two methods are used to measure vessels of war which transit the Suez Canal, both of which establish a net tonnage value upon which transit fees are based. This tonnage is a volumetric measure similar to the net tonnage under the U.S. Standard or Dual Regulatory Measurement system. A brief discussion of each method follows.</p> <p>(1) Rule 1 This method involves detailed measurements of a vessel's interior spaces, and certification of the resulting tonnage by the Coast Guard on a Suez Canal certificate. The Coast Guard transmits this certificate to the vessel.</p> <p>(2) Rule 2 This method uses an empirical formula to calculate net tonnage. The formula is applied by the Suez Canal Authority upon arrival of the vessel at the canal.</p> <p>(b) APPLICABILITY All vessels of war for which a transit of the Suez Canal is expected during the life of the vessel should be measured under Rule 1. Rule 2 is used only when a vessel of war arrives at the Suez Canal without a valid Suez Canal certificate. <i>NOTE: Use of Rule 2 may result in higher transit fees.</i></p> <p>(c) FUEL ASSESSMENTS Under certain circumstances, fuel tanks (or portions thereof) that are located in the vessel's inner bottom are listed on the Suez Canal certificate. For the fuel tanks so listed, the Suez Canal Authority may increase the transit fee, depending on whether or not the tanks contain fuel during the transit. If this is done, the Suez Canal Authority will add the tonnage of the fuel tanks that are not in ballast during the transit to the Suez Canal net tonnage that is specified on the front of the Suez Canal certificate. For newer vessels of war, the Coast Guard includes all double bottom tanks in the vessel's under-deck tonnage.</p> <p>7. TONNAGE CERTIFICATE MAINTENANCE The vessel's crew is responsible for maintaining any Panama or Suez Canal certificate issued to the vessel in a secure location on board the vessel along with other official vessel documents, regardless of whether the certificate is a paper or electronic document.¹ The Coast Guard maintains U.S. Tonnage Certificates in its files, and there is no requirement to maintain a copy of this certificate onboard.</p> <p>(a) REPLACEMENT CERTIFICATES The Coast Guard will provide an electronic or electronically signed² replacement Panama or Suez Canal certificate to the vessel in the event that the certificate is lost. If no such electronic document is available, the Coast Guard will provide a certified true paper copy of the certificate as a replacement upon authorization from NAVSEA. Such a replacement bears an embossed official seal of the Coast Guard, and is an acceptable legal document.</p> <p>(b) INACTIVATED VESSELS For an inactivated vessel which may be used as a "mobilization asset", the Panama and/or Suez Canal certificate should be maintained on board the vessel as</p> <p><small>¹ In January 2018, the Coast Guard began issuing electronic tonnage certificates in lieu of paper certificates, consistent with IMO FAL 5-Circ. 39 Rev. 2 dated 20 April 2016, <i>Guidelines for the Use of Electronic Certificates</i>, and CG-CVC Policy Letter 17-09 dated 27 November 2017, <i>Issuance and Acceptance of Electronic Certificates</i>. ² The term "electronically signed" refers to an electronic document formerly issued by the Marine Safety Center which bears a digitized (as opposed to digital) signature. See Marine Safety Center Business Procedure B-12 dated 27 July 2006, <i>Electronically Signed Marine Safety Center Documents</i>.</small></p> <p style="text-align: center;">5</p>
--	--

ORIGINAL TONNAGE CERTIFICATES The increasing trend toward “going paperless” has presented some unique challenges when referring to electronic documents used in certification processes. For example, one can no longer speak of a “copy” of an “original” tonnage certificate if it is an electronic certificate meeting current International Maritime Organization and Coast Guard requirements, as “true” electronic certificates can be replicated multiple times. Considerable care was taken in developing Change 4 to Tonnage Guide 2 to distinguish between various different kinds of replacement certificates (e.g., paper vs. electronically signed with a digitized (as opposed to digital) signature).

Weekly Notes are issued by the Coast Guard Marine Safety Center's Tonnage Division (MSC-4) for use by organizations that perform measurement work on the Coast Guard's behalf. They are for informational purposes only, and are not intended as, nor should they be construed to represent, revisions of or substitutes for applicable statutes or regulations or established interpretations of either.

MEASUREMENT ORGANIZATION WEEKLY NOTES – 07/11/2018

ELECTRONIC CERTIFICATES We recently responded to an inquiry regarding electronic ITC certificates. The issue involved whether these “E-Certificates” could be issued in lieu of paper certificates on behalf of the United States, consistent with International Maritime Organization (IMO) Circulation FAL.5/Circ.39/Rev.2 and Coast Guard (CG-CVC) Policy Letter 17-09 dated November 27, 2017. We had no objection to issuing “E-Certificates” that met all requirements set forth in these documents. We note however, that other flag States or agencies may not accept electronic certificates, and urge vessel owners to verify with cognizant flag States and agencies prior to requesting an “E-certificate”.

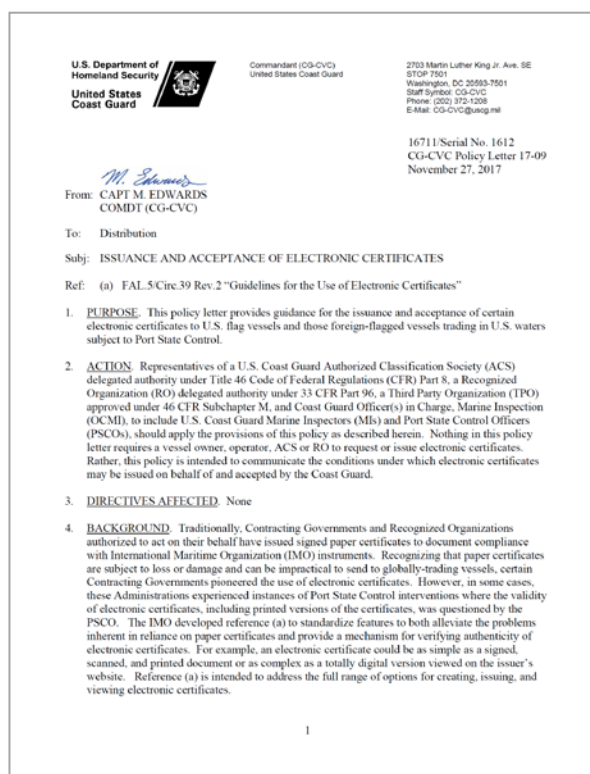
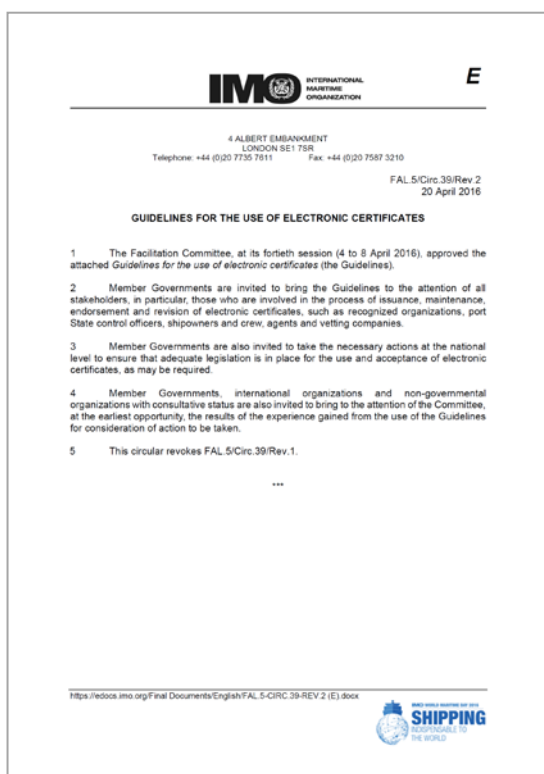

Weekly Notes are issued by the Coast Guard Marine Safety Center's Tonnage Division (MSC-4) for use by organizations that perform measurement work on the Coast Guard's behalf. They are for informational purposes only, and are not intended as, nor should they be construed to represent, revisions of or substitutes for applicable statutes or regulations or established interpretations of either.

MEASUREMENT ORGANIZATION WEEKLY NOTES – 06/27/2018

ROLES AND RESPONSIBILITIES At a recent conference in Athens, Greece, Rear Admiral John Nadeau, USCG Assistant Commandant for Prevention Policy (and past Marine Safety Center (MSC) Commanding Officer), spoke about the [Coast Guard's role as the regulator](#), who must “always be mindful of the need to facilitate commerce, and do our best not to impede it.” As the MSC engages with ACSs on broader efforts to improve the final safety net, we continue to focus on practical implementation and measured enforcement, and welcome your input.



INDEPENDENCE DAY HOLIDAY The MSC will be closed on July 4, 2018 in observance of the Independence Day holiday. As this holiday falls on a Wednesday, we will forego publishing a Weekly Notes edition next week.

TONNAGE PERSONNEL Mr. Tony Cao will be out of the office Friday (June 29th) and return on Thursday (July 5th). Mr. Marcus Akins will be out of the office Monday (July 2nd) and return on Monday (July 9th). As a result, there may be a delay in response time for CG number or file requests. If you need a CG number before next Thursday (July 5th), please send it to Mr. Akins by close of business this Thursday (June 28th), and copy Mr. Cao on file requests next week. As usual, send all requests to msc@uscg.mil to ensure a response.

Weekly Notes are issued by the Coast Guard Marine Safety Center's Tonnage Division (MSC-4) for use by organizations that perform measurement work on the Coast Guard's behalf. They are for informational purposes only, and are not intended as, nor should they be construed to represent, revisions of or substitutes for applicable statutes or regulations or established interpretations of either.

MEASUREMENT ORGANIZATION WEEKLY NOTES – 06/20/2018

TONNAGE PERSONNEL We welcome back Mr. Tony Cao, who has returned to the Marine Safety Center (MSC) from his reserve Coast Guard duty. He resumes his previous duties, as noted below.

MSC POINTS OF CONTACT Further to the entry above, please note the following updated MSC POCs for tonnage matters:

<u>Subject Type</u>	<u>Primary</u>	<u>Secondary</u>
Interpretations & Decisions	Akins	Karnes
File Requests	Akins	Karnes
CG Number Requests	Cao	Karnes
Navy Ships / USCG Cutters	Cao	Akins
Tonnage Applicability	Karnes	Akins
TonCalc	Cao	Akins
Simplified Measurement	Cao	Akins
Tonnage Oversight	Akins	Cao
Load Line Oversight	Cao	Akins

Weekly Notes are issued by the Coast Guard Marine Safety Center's Tonnage Division (MSC-4) for use by organizations that perform measurement work on the Coast Guard's behalf. They are for informational purposes only, and are not intended as, nor should they be construed to represent, revisions of or substitutes for applicable statutes or regulations or established interpretations of either.

MEASUREMENT ORGANIZATION WEEKLY NOTES – 06/13/2018

PUBLICATION FREQUENCY OF NOTES Due to recent and ongoing resource constraints, we are considering publishing these Measurement Organization Notes on a monthly, instead of weekly, basis. We recognize the value these notes have had over the years and wish to continue to provide you with the same level of technical content. We request your input on this matter. Please send your comments to Mr. David Karnes.

TM CONVENTION RATIFICATION HISTORY Although delegation members signed the 1969 International Convention on Tonnage Measurement of Ships at London for the United States - subject to acceptance - on June 23, 1969, the White House did not transmit it to the Senate for advice and consent until nearly three years later. President Richard Nixon transmitted a certified copy of the Convention with the letter shown below on June 15, 1972 (forty-six years ago this week). It would be another ten years before the Senate gave its advice and consent and President Ronald Reagan signed the treaty.

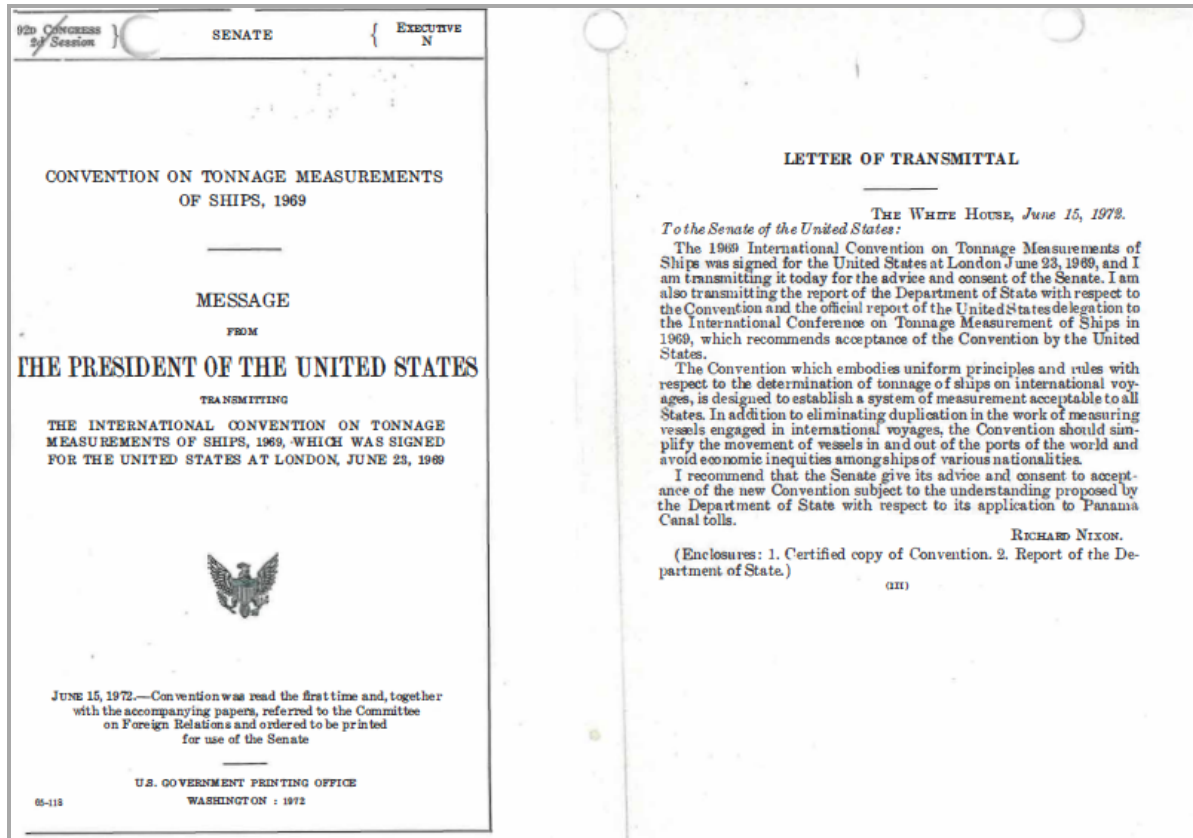

Weekly Notes are issued by the Coast Guard Marine Safety Center's Tonnage Division (MSC-4) for use by organizations that perform measurement work on the Coast Guard's behalf. They are for informational purposes only, and are not intended as, nor should they be construed to represent, revisions of or substitutes for applicable statutes or regulations or established interpretations of either.

MEASUREMENT ORGANIZATION WEEKLY NOTES – 06/06/2018

DELEGATION HISTORY In a 1987 rulemaking, the Coast Guard effectively turned over the measurement of all vessels to ACSs, except for vessels of war and those that are Simplified measured. On June 6, 1988 - thirty years ago today - the Coast Guard published a Final Rule ([53 FR 20619](#)) changing the tonnage regulations to remove the original limitation on the delegation of measurement authority to a single ACS.

OVERSIGHT CHANGES Since the beginning of this year, the Coast Guard has published a number of instructions and procedures related to its Alternate Compliance Program (ACP), under which ACSs perform certain delegated tasks on the Coast Guard's behalf, including tonnage measurement. The latest, featured in a Maritime Commons blog entry on May 23, 2018, addresses the use of Quality Cases to request internal ACS investigations or root cause analyses in certain instances of unsatisfactory execution of delegated functions. We continue to be involved in these broader efforts, stemming from the EL FARO marine casualty, to ensure that the Coast Guard provides the final safety net with sustainable policy, oversight, and accountability.

COAST GUARD MARITIME COMMONS
THE COAST GUARD BLOG FOR MARITIME PROFESSIONALS

5/23/2018: Release of Mission Management System Work Instruction 005 – Request for recognized organization internal Quality Management System review.

Posted by LT Amy Midgett, Wednesday, May 23, 2018

Submitted by Lt. Cmdr. Chris Nichols, Flag State Compliance Division
[Office of Commercial Vessel Compliance](#)

Recognized Organizations (ROs) and Third Party Organizations that perform delegated functions on behalf of the Coast Guard are required to implement and maintain a Quality Management System. Today, the Coast Guard Office of Commercial Vessel Compliance released [Mission Management System \(MMS\) Work Instruction 005 \(CVC-WI-005\)](#), [Request for Recognized Organization \(RO\) Internal Quality Management System \(QMS\) Review](#). This instruction formalizes a process, known as a Quality Case, for the Coast Guard to request an internal investigation or root cause analysis when objective evidence indicates that a potential failure or lack of effectiveness of the Recognized Organization's Quality Management System resulted in the unsatisfactory execution of delegated function(s).

The Quality Case process establishes additional accountability between the Coast Guard and ROs. The results will be used to inform Flag State Audits of the ROs' performance and to ensure that any necessary corrective actions have been effectively implemented. In addition, the data, records, and non-conformities derived from Quality Cases will be used to inform Key Performance Indicators for the ROs and may be used to employ additional verification and monitoring activities as described in the RO Code or similar domestic regulations.

This blog is not a replacement or substitute for the formal posting of regulations and updates or existing processes for receiving formal feedback of the same. Links provided on this blog will direct the reader to official source documents, such as the Federal Register, Homeport and the Code of Federal Regulations. These documents remain the official source for regulatory information published by the Coast Guard.

Comments
comments

Tags: [quality management review](#), [recognized organization](#), [work instruction](#)

Categories
Bridge Programs
Commercial Vessel Compliance
– Domestic Vessels
– Fishing Vessels
– Foreign Vessels
Offshore
Congressional Hearings
Cyber Awareness & Risk Management
Design & Engineering Standards
– Lifesaving & Fire Safety
Emerging Policy
Environmental Response Policy
Federal Register
Investigations & Casualty Analysis
Mariner Credentialing
Navigation Systems
Operating & Environmental Standards
Ports and Facilities
– Cargo & Facilities
– Domestic Ports
Safety
Standards Evaluation & Development
Uncategorized
Vessel Documentation
Waterways Policy

United States Coast Guard

Weekly Notes are issued by the Coast Guard Marine Safety Center's Tonnage Division (MSC-4) for use by organizations that perform measurement work on the Coast Guard's behalf. They are for informational purposes only, and are not intended as, nor should they be construed to represent, revisions of or substitutes for applicable statutes or regulations or established interpretations of either.

MEASUREMENT ORGANIZATION WEEKLY NOTES – 05/30/2018

TREATMENT OF SPACE BOUNDED BY AWNINGS When considering the Convention measurement treatment of awnings, ACSs should note that under Interpretation R.2(4) of MTN 01-99 CH-9, permanent or movable awnings are not considered to create enclosed space. However, under Interpretation R.2(4)-2, the presence of an awning may impact the treatment of a space that it covers. For example, awnings such as the ones shown in the image below may effectively render enclosed spaces within the awning boundaries “closed” or “covered”, precluding exclusion under Regulation 2(5).



COMMANDANT’S CHANGE OF COMMAND As mentioned last week, Admiral Karl L. Schultz will relieve Admiral Paul F. Zukunft as Commandant of the Coast Guard in a ceremony held at our headquarters building this Friday. Consequently, CG headquarters employees will rely on increased telework, which may slow communications. Thank you in advance for your patience.

Weekly Notes are issued by the Coast Guard Marine Safety Center’s Tonnage Division (MSC-4) for use by organizations that perform measurement work on the Coast Guard’s behalf. They are for informational purposes only, and are not intended as, nor should they be construed to represent, revisions of or substitutes for applicable statutes or regulations or established interpretations of either.

MEASUREMENT ORGANIZATION WEEKLY NOTES – 05/23/2018

COMMANDANT’S CHANGE OF COMMAND On Friday, June 1, 2018, Vice Admiral Karl L. Schultz will relieve Admiral Paul F. Zukunft as Commandant of the Coast Guard in a ceremony held at our headquarters building. With more than 2,000 attendees expected to cause logistical challenges during the day, employees will rely on increased telework, which may slow communications. Thank you in advance for your patience.

MEMORIAL DAY HOLIDAY The Marine Safety Center will be closed on Monday, May 28, 2018 in observance of Memorial Day, a holiday commemorating people who have died while serving in the United States armed forces. To honor one such service member, in 2013 Congress enacted [Public Law No: 113-31](#) naming the Douglas A. Munro Coast Guard Headquarters Building. Signalman First Class Munro was killed in action and posthumously awarded the Medal of Honor for his actions at Matanikau River, Guadalcanal in 1942. To date, he is the only member of the Coast Guard who has received the medal.

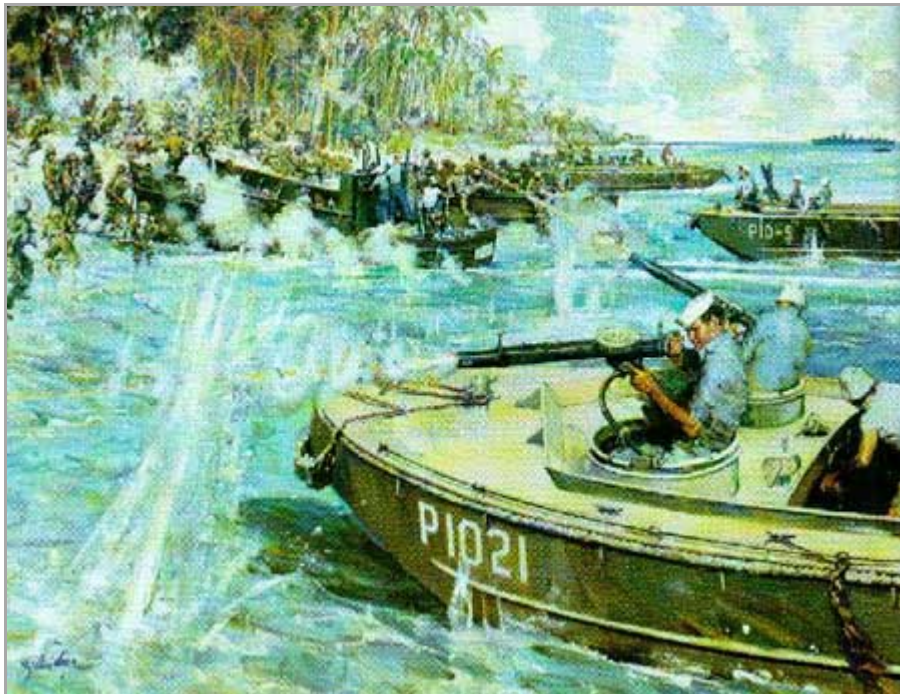

“Douglas A. Munro Covers the Withdrawal of the 7th Marines at Guadalcanal”
by artist Bernard D’Andrea for the Coast Guard Bicentennial Celebration

Weekly Notes are issued by the Coast Guard Marine Safety Center's Tonnage Division (MSC-4) for use by organizations that perform measurement work on the Coast Guard's behalf. They are for informational purposes only, and are not intended as, nor should they be construed to represent, revisions of or substitutes for applicable statutes or regulations or established interpretations of either.

MEASUREMENT ORGANIZATION WEEKLY NOTES – 05/16/2018

HULL MODELING In recently providing technical support to an ACS, we noted hull-modeling anomalies for a Convention measurement stemming from an incorrect assumption that the lines plan represented the hull below the upper deck. In fact, the lines plan may additionally reflect the presence of bulwarks and similar enclosed structures, as illustrated in the figure below for the forward and after “wells” (circled). Conversely, lines plans may omit large portions of the hull above the water line that are not required for hydrostatic calculations. When using lines plans or computer hull models developed by outside parties for Convention calculations or assignment of main dimensions, always ensure that the models are verified against other objective evidence (e.g., construction drawings or scaled photographs).

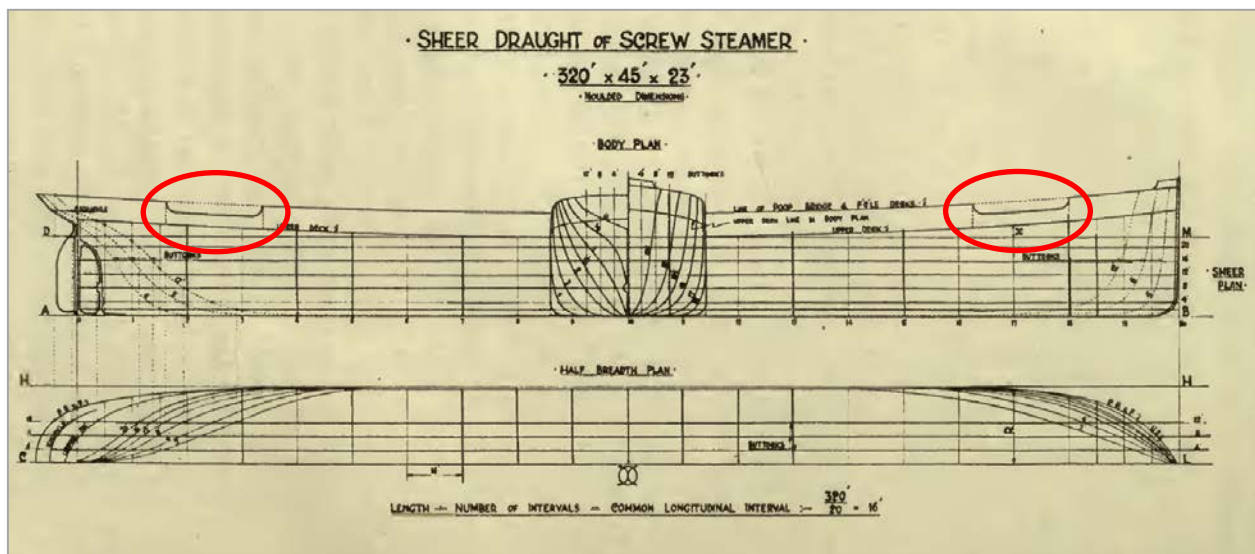

Figure from A.L. Ayre's *The theory and design of British shipbuilding* (1921)

Weekly Notes are issued by the Coast Guard Marine Safety Center's Tonnage Division (MSC-4) for use by organizations that perform measurement work on the Coast Guard's behalf. They are for informational purposes only, and are not intended as, nor should they be construed to represent, revisions of or substitutes for applicable statutes or regulations or established interpretations of either.

MEASUREMENT ORGANIZATION WEEKLY NOTES – 05/09/2018

REPLACING LOST ORIGINALS We recently encountered a situation involving the reissuance of a tonnage certificate not issued by the ACS, solely to replace a missing original certificate. We concluded that - absent written authorization from the Marine Safety Center - an ACS has no authority to issue a replacement certificate for a missing original document unless that same ACS was the issuing authority for the original document. For example, if an owner seeks a replacement for a valid U.S. Certificate of Admeasurement issued by the Coast Guard, the ACS has no authority to reissue the certificate unless the vessel will be remeasured at the same time under Marine Safety Center Technical Note (MTN) 01-99 CH-9, *Tonnage Technical Policy* (see especially § 69.9).

DEPARTMENT OF TRANSPORTATION U. S. COAST GUARD CG-1414 (Rev. 9-07)		THE UNITED STATES OF AMERICA DEPARTMENT OF TRANSPORTATION U. S. COAST GUARD		Form approved. Budget Bureau No. 04-R3047	
Port of	Mobile, AL	Certificate No.	4652	14 December 1978 (Date)	
CERTIFICATE OF ADMEASUREMENT					
I CERTIFY that an admeasurement has been made of the vessel described below:					
Nationality	American	Builder's Hull No.	88		
Rig	Oil Screw	Decks	one		
Name	VIRGINIA WAVE	Masts	one		
Port	Norfolk, VA	Stem	raked		
Official No.	600617	Stern	square		
Built by	Quality Marine, Inc.	Register length	81.6	feet	
When built (year completed)	1978	Register breadth	24.0	feet	
Place of build	Theodore	Register depth	12.7	feet	
State	Alabama	Register height		feet	
Material	Steel				
Capacity under tonnage deck (Forepeak Afterpeak)				TONS	100ms
Capacity between decks, above tonnage deck				126	14
Capacity of enclosures on the upper deck, viz:					
Forecastle	34.07	Deckhouses	7.92	Excess hatchways	
Bridge		Side houses		Light and air ²	
Poop		Mast houses			
Break		Trunks			
GROSS TONNAGE				41	99
Deductions under Section 4153, Revised Statutes, as amended (Section 77, title 46, United States Code):				168	13
Crew space		Anchor gear		Donkey engine and boiler	
Master's cabin		Boatswain's stores		Radio house	
Steering gear		Chart house		Storage of sails	
Propelling power (actual space)	22.86				
				32 % x GT	53.80
				TOTAL DEDUCTIONS	53.80
NET TONNAGE				114	X X X
The following-described spaces, and no others, have been omitted, viz:					
Forepeak		Companions	0.88		
Afterpeak		Galley	5.08		
Other spaces (except double bottoms) for water ballast		Styhtights and air shafts not over propelling machinery			
Open forecastle		Wheelhouse	6.30		
Open bridge		Water closets	4.89		
Open poop		Anchor gear			
Open shelter deck		Donkey engine and boiler			
Open houses		Steering gear	0.23		
Passenger cabins		Light and air over propelling machinery	0.46		
		Other machinery spaces			
Roy C. McMillan, Admeasurer.		R. K. SIMONDS, CAPT, USCG Officer in Charge, Marine Inspection.			
I agree to the above description and admeasurement.		(SEAL)			
Owner, Master, or Agent.					
<small> ¹ G/T or tonnage of each peak tank used other than for water ballast, which is included herein. ² These spaces are to be added to tonnage only by permission of the Officer in Charge, Marine Inspection. </small>					
GPO 932-430					

Weekly Notes are issued by the Coast Guard Marine Safety Center's Tonnage Division (MSC-4) for use by organizations that perform measurement work on the Coast Guard's behalf. They are for informational purposes only, and are not intended as, nor should they be construed to represent, revisions of or substitutes for applicable statutes or regulations or established interpretations of either.

MEASUREMENT ORGANIZATION WEEKLY NOTES – 05/02/2018

PHYSICAL MEASUREMENT The difficulties and limitations of so-called “physical measurement” of ships have long been understood in the naval architectural world, and continue to be a source of nonconformities identified through the Coast Guard’s oversight program. While researching another matter, we came across the following discussion from a Smithsonian publication from 1960, authored by noted naval architect and historian Howard I. Chapelle.¹

“In any case, the registered dimensions of a vessel can seldom be made to comply precisely with the true dimensions of the hull as built or as designed. Indeed, it is difficult to establish any fixed proportion in the variation between the two; even in New England coasting and fishing schooners built after 1865 this variation often amounts to as much as 12 inches in each 100 feet of length. . . . The variations in the real and register dimensions are, and were, due in part to the practical difficulties in taking the external registered length and beam when it is necessary to measure with [staffs] or foot rules over or around deck structures and where measurement points must be plumbed.”

PASSENGER SPACE EXEMPTION The publication cited above also provides a description, and the following photo, of a model of a side-wheel packet steamer. The design features are similar to those of earlier vessels in service at the time of the 1865 law establishing the passenger space exemption, which remains in effect. This model is instructive in helping understand why the passenger space exemption was limited to “cabins or staterooms . . . constructed entirely above the first deck which is not a deck to the hull”.

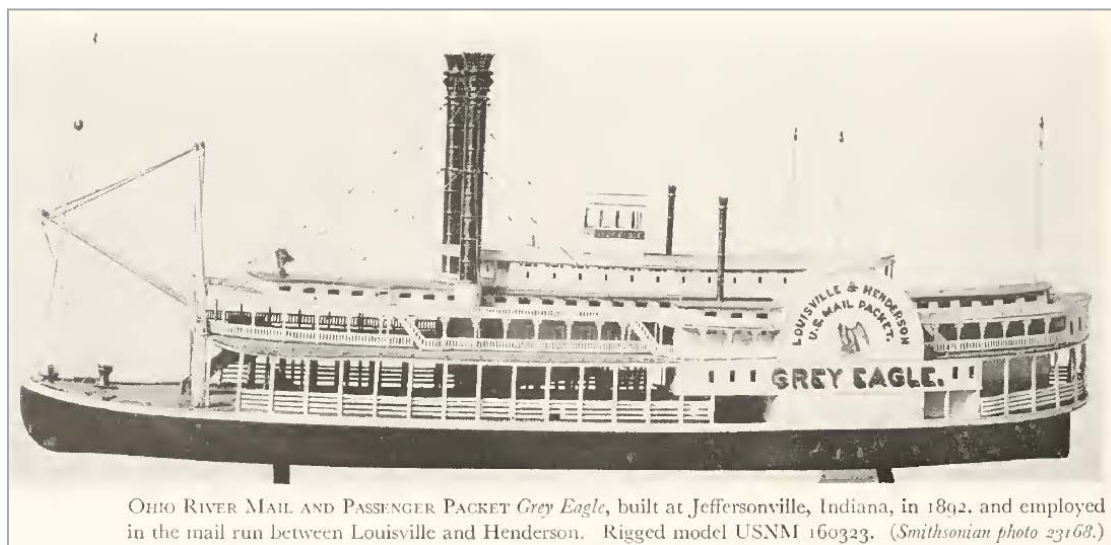

¹ Chapelle, Howard I. “The National Watercraft Collection.” *United States National Museum Bulletin*, no. 218, 1960.

Weekly Notes are issued by the Coast Guard Marine Safety Center’s Tonnage Division (MSC-4) for use by organizations that perform measurement work on the Coast Guard’s behalf. They are for informational purposes only, and are not intended as, nor should they be construed to represent, revisions of or substitutes for applicable statutes or regulations or established interpretations of either.

MEASUREMENT ORGANIZATION WEEKLY NOTES – 04/25/2018

SCUPPER TREATMENT (CONTINUED) Continuing last week's discussion, the orientation of the figure in the first edition of the Code of Federal Regulations undoubtedly caused some confusion, and was subsequently corrected. We have included (below on the left) what we believe to be the "original figure" - attached to Circular Letter No. 177 dated October 9, 1937 - next to the one initially codified, but later rotated for clarity. When providing decisions or conducting oversight, we regularly encounter situations in which the camera angle of photographic evidence can lead to misimpressions of how a vessel is actually configured. In our experience, there is no substitute for clear and accurate drawings or computer models, given current state-of-the-art ship design and construction visualization aids.

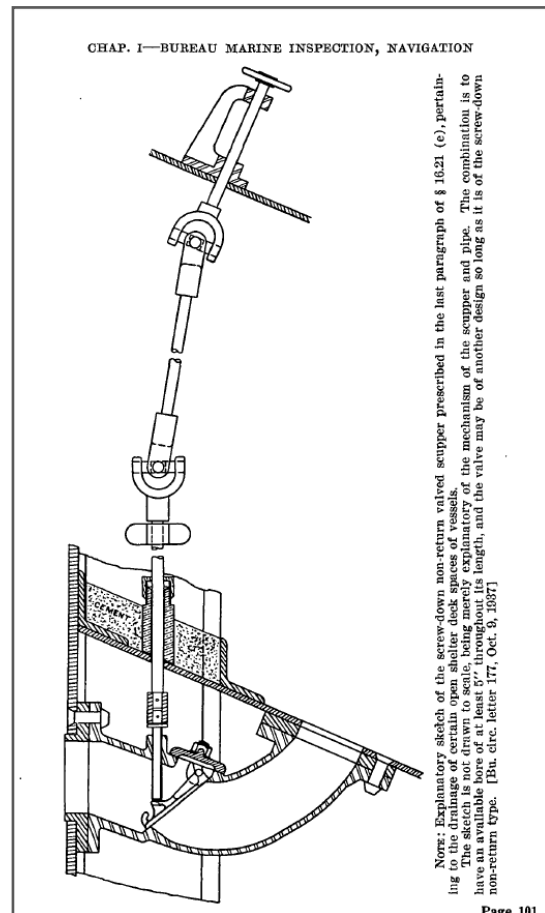
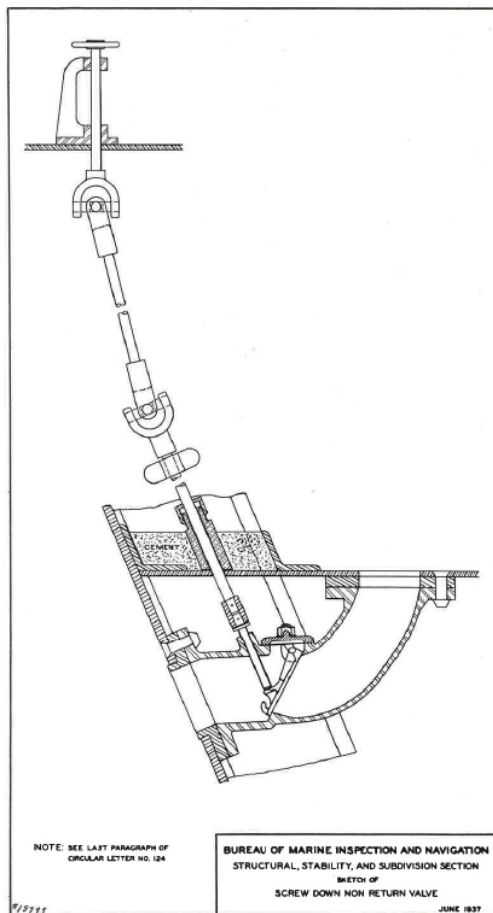

Weekly Notes are issued by the Coast Guard Marine Safety Center's Tonnage Division (MSC-4) for use by organizations that perform measurement work on the Coast Guard's behalf. They are for informational purposes only, and are not intended as, nor should they be construed to represent, revisions of or substitutes for applicable statutes or regulations or established interpretations of either.

MEASUREMENT ORGANIZATION WEEKLY NOTES – 04/18/2018

SCUPPER TREATMENT In responding to a recent inquiry on scupper treatment under middle line opening requirements of § 69.117(e) of MTN 01-99 CH-9, we commented that for the vessel in question, the term “in way of” means that the scupper openings in the deck must be outboard of the middle line opening, and that the discharge hull fittings must be located below the uppermost complete deck. The following illustration of a scupper with the required screw down non-return valve arrangement appeared in the first edition of the Code of Federal Regulations (1939), which codified the rules and regulations of various government entities that were in effect on June 1, 1938.

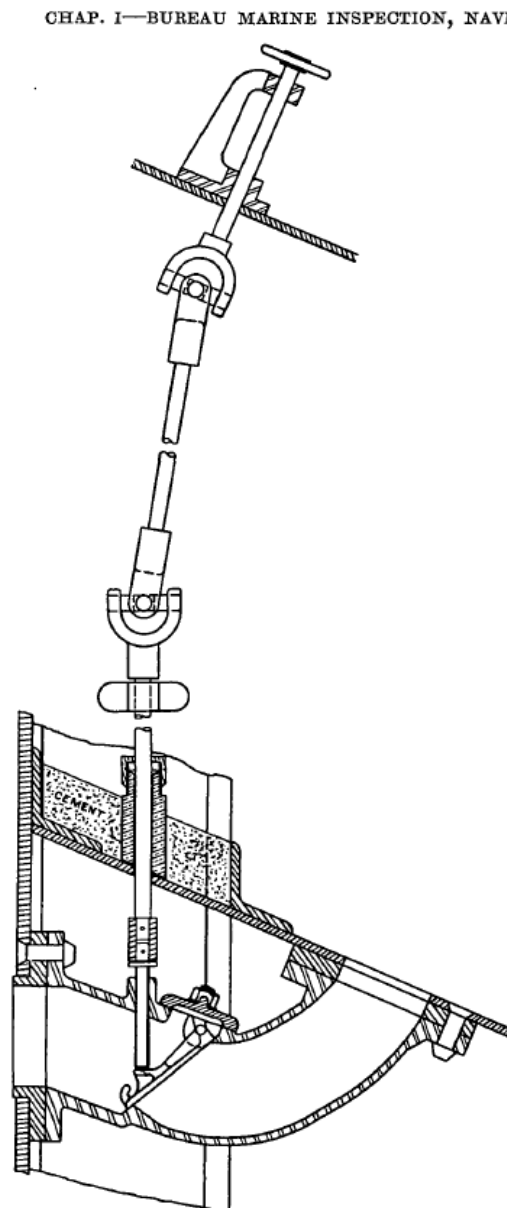

NOTE: Explanatory sketch of the screw-down non-return valved scupper prescribed in the last paragraph of § 16.21 (c), pertaining to the drainage of certain open shelter deck spaces of vessels. The sketch is not drawn to scale, being merely explanatory of the mechanism of the scupper and pipe. The combination is to have an available bore of at least 5' throughout its length, and the valve may be of another design so long as it is of the screw-down non-return type. [Bu. circ. letter 177, Oct. 3, 1937]

Page 101

Weekly Notes are issued by the Coast Guard Marine Safety Center's Tonnage Division (MSC-4) for use by organizations that perform measurement work on the Coast Guard's behalf. They are for informational purposes only, and are not intended as, nor should they be construed to represent, revisions of or substitutes for applicable statutes or regulations or established interpretations of either.

MEASUREMENT ORGANIZATION WEEKLY NOTES – 04/11/2018

CHANGE OF COMMAND On Friday, April 6, 2018, the Marine Safety Center (MSC) welcomed Captain Scott J. Kelly as its 13th Commanding Officer. He relieved Captain John W. Mauger during a ceremony at the Douglas A. Munro Coast Guard Headquarters Building attended by over two hundred people, including the Deputy Secretary of the Department of Homeland Security, Elaine C. Duke, and the Deputy Commandant for Operations, Vice Admiral Charles W. Ray, who served as the presiding official. Following the change of command, Captain Mauger was frocked to the rank of Rear Admiral. He assumes duties at United States Cyber Command as the Director of Training and Exercises (J7).



CAPT Scott J. Kelly (left) relieves CAPT John W. Mauger (right) as MSC Commanding Officer before the Deputy Commandant for Operations, VADM Charles W. Ray



CAPT Scott J. Kelly USCG



CAPT John W. Mauger USCG

Weekly Notes are issued by the Coast Guard Marine Safety Center's Tonnage Division (MSC-4) for use by organizations that perform measurement work on the Coast Guard's behalf. They are for informational purposes only, and are not intended as, nor should they be construed to represent, revisions of or substitutes for applicable statutes or regulations or established interpretations of either.

MEASUREMENT ORGANIZATION WEEKLY NOTES – 04/04/2018

DOCUMENT SHARING We recognize the adverse effects that necessary IT security enhancements can have on open communications with our ACS counterparts, which is particularly problematic for electronic document sharing (e.g., drawings, photographs, calculations, etc.) We continue to discourage exchanging such documents via individual email for situations that do not require formal correspondence, as once received, these documents become Federal Records subject to disclosure under the Freedom of Information Act (FOIA). One alternative is to share such documents through AMRDEC SAFE without formally transmitting them to the MSC. Please contact Mr. Marcus Akins before sharing any documents in this manner.

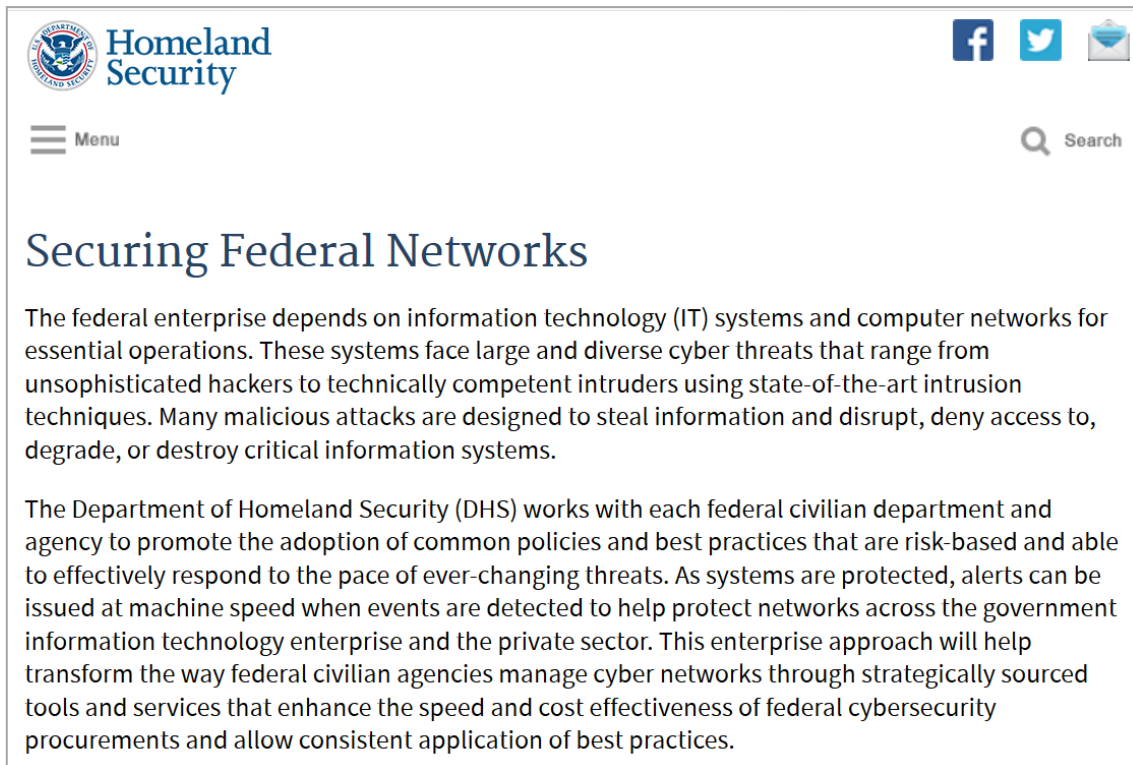

The screenshot shows the top portion of a website. On the left is the Department of Homeland Security logo. To its right is the text "Homeland Security". In the top right corner are icons for Facebook, Twitter, and an envelope. Below the logo is a "Menu" button with a hamburger icon. To the right of the menu is a search bar with a magnifying glass icon and the word "Search". The main heading is "Securing Federal Networks". Below the heading is a paragraph of text: "The federal enterprise depends on information technology (IT) systems and computer networks for essential operations. These systems face large and diverse cyber threats that range from unsophisticated hackers to technically competent intruders using state-of-the-art intrusion techniques. Many malicious attacks are designed to steal information and disrupt, deny access to, degrade, or destroy critical information systems." Below this is another paragraph: "The Department of Homeland Security (DHS) works with each federal civilian department and agency to promote the adoption of common policies and best practices that are risk-based and able to effectively respond to the pace of ever-changing threats. As systems are protected, alerts can be issued at machine speed when events are detected to help protect networks across the government information technology enterprise and the private sector. This enterprise approach will help transform the way federal civilian agencies manage cyber networks through strategically sourced tools and services that enhance the speed and cost effectiveness of federal cybersecurity procurements and allow consistent application of best practices."

ADDITIONAL WORK INSTRUCTIONS POSTED Further to the item appearing in the 02/21/2018 edition of the Weekly Notes, we recently posted three additional work instructions to the [U.S. Tonnage Publications](#) web page: [WI C3-01, Processing Tonnage File Requests](#), and [WI C3-03, Tonnage Certification of Navy and Coast Guard Vessels](#).

Weekly Notes are issued by the Coast Guard Marine Safety Center's Tonnage Division (MSC-4) for use by organizations that perform measurement work on the Coast Guard's behalf. They are for informational purposes only, and are not intended as, nor should they be construed to represent, revisions of or substitutes for applicable statutes or regulations or established interpretations of either.

MEASUREMENT ORGANIZATION WEEKLY NOTES – 03/28/2018

INTERIOR SPACE MEASUREMENT We recently responded to an inquiry regarding breadth measurements for a space within a superstructure measured under the Standard system, for which the interior bulkheads were comprised of parallel plates spaced several inches apart. The figure below demonstrates measurement of typical spaces for which interior framing is either completely exposed, or covered by plating or joiner work. Note that for interior bulkheads with coverings on both sides of the frames, the breadth measurements terminate on the imaginary vertical plane midway between the parallel plates.

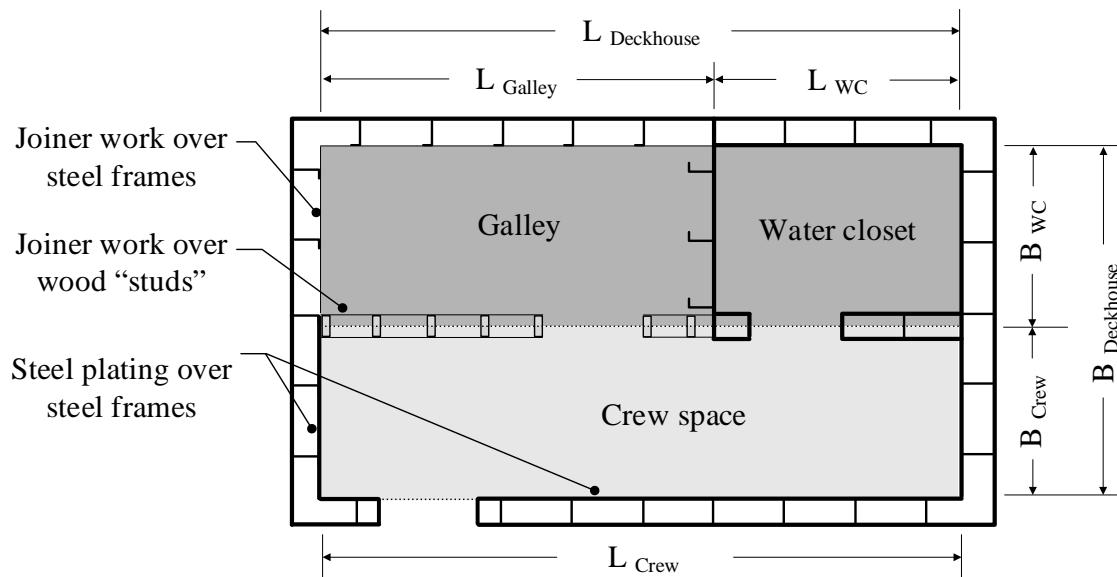

Weekly Notes are issued by the Coast Guard Marine Safety Center's Tonnage Division (MSC-4) for use by organizations that perform measurement work on the Coast Guard's behalf. They are for informational purposes only, and are not intended as, nor should they be construed to represent, revisions of or substitutes for applicable statutes or regulations or established interpretations of either.

MEASUREMENT ORGANIZATION WEEKLY NOTES – 03/21/2018

IT UPDATES As previously reported, our earlier email issues are largely resolved. Also, due to various internet browser settings, readers of the consolidated Weekly Notes document posted on the Marine Safety Center (MSC) website may find it necessary to refresh the web page after opening. Additionally, accessing it via the link (illustrated below) from the [U.S. Tonnage Publications](#) page may work better than a bookmark or saved link.

[Miscellaneous Tonnage Documents](#)
[Formal Measurement Application](#)
 [Measurement Organization Weekly Notes](#)
[CG Number Requests - How-to Video](#)

FEDERAL GOVERNMENT FUNDING Funding for numerous federal government entities is set to expire on Friday, March 23, 2018. Lack of further funding could result in a government shutdown, disrupting services (including those provided by the MSC).

Weekly Notes are issued by the Coast Guard Marine Safety Center's Tonnage Division (MSC-4) for use by organizations that perform measurement work on the Coast Guard's behalf. They are for informational purposes only, and are not intended as, nor should they be construed to represent, revisions of or substitutes for applicable statutes or regulations or established interpretations of either.

MEASUREMENT ORGANIZATION WEEKLY NOTES – 03/14/2018

TIP FOR TRANSFERRING FILES As a reminder, we recommend using the secure U.S. Army file transfer application [AMRDEC SAFE](#) to submit large (> 9MB) tonnage files for oversight. The application allows a user to send up to 25 individual files per package, so long as the total file size does not exceed 2GB. To send more than 25 files using AMRDEC, consolidating and uploading them as .zip format archives may conveniently avoid the need for multiple packages. Please contact the Tonnage Division to coordinate.



Weekly Notes are issued by the Coast Guard Marine Safety Center's Tonnage Division (MSC-4) for use by organizations that perform measurement work on the Coast Guard's behalf. They are for informational purposes only, and are not intended as, nor should they be construed to represent, revisions of or substitutes for applicable statutes or regulations or established interpretations of either.

MEASUREMENT ORGANIZATION WEEKLY NOTES – 03/07/2018

EMAIL ISSUES As indicated in a recent notice posted on our website, the email issues we reported in last week's edition have largely been resolved. For more details, the notice is available at: http://www.dco.uscg.mil/Portals/9/MSC/Website_Notice.pdf

TONNAGE DATA SHEETS The recent updates to our IT infrastructure temporarily affected our ability to generate Tonnage Data Sheets in response to vessel file requests. We ask for your continued patience as we work to fully restore this capability. A sample Data Sheet follows, with notes that explain its usefulness and limitations.

3/7/2018 This is the Data Sheet generation date. The MISLE data could be up to a week old.

MSC AND MISLE DATABASE TONNAGE DATA SHEET FOR VESSEL (ON): 528312

The information contained on this data sheet was extracted from MSC and MISLE databases on the date indicated above. It is provided to authorized measurement organizations for informational purposes only. The information on this data sheet **MUST NOT** be used as the basis for tonnage certification actions unless the measurement organization independently verifies its accuracy. Refer questions to the MSC Tonnage Division (MSC-4).

MSC TONNAGE FILE DATA

Current File Location: Agency **MSC** Note that this refers only to the location of Coast Guard tonnage records. The "ORG" field below should indicate whether an ACS subsequently remeasured the vessel, although in some cases this information may not be complete.

Location Filed by CGD5# _____

Electronic Copy Previously A _____

File Missing Status Info

Date unable to locate file: _____

Vessel formally measured:

MSC has no record of file

File not in designated location

Vessel simplified measured

* Xfer date is date transferred either to or from the MSC Ballast Justification:

MISLE TONNAGE DATA (Dimensions in Feet)

ORG: United States Coast Guard

Registered Indicator	Length	Breadth	Depth
CONV 1	113.5	34.0	8.0
HULL			
PRE-1990	112.4	34.0	8.0
GT ITC	172	NT ITC	61
GRT (CD)	88	NRT (CD)	60
DUAL GRT LOW			

For a vessel currently in documentation, this information matches the information that appears on the COD. The same is true for the vessel's current name, and certain other information that appears on this sheet, such as the completed date.

MISLE VESSEL NAME DATA

Date listed may represent the date when MISLE data was imported from another data system (e.g., 12/17/2001 from MSIS). Also, pre-1989 name data is incomplete.

current / former names	date entered
FT GAINES	5/18/2004
LINDSAY WARREN	12/17/2001

This list is extremely helpful, both for former names (although the list may not be complete), and the vessel's current name used by the NVDC when generating the COD.

Additional Simplified Measurement Parameters

GRT _____

PROPEL MACH LOC _____

(0 = No, False or Null)

OTHER MISLE VESSEL DATA

HAILING PORT	SELF PROPELLED	True	CONTRACT DATE	
STATE	FLAG	US	KEEL LAID DATE	
CALL SIGN	INSP SUBCHAPTER	T	DELIVERY DATE	1/1/1970
CG NUMBER	WDB8419	CG108258	CONVERSION DATE	
IMO NUMBER	OUT OF SERVICE		COMPLETED DATE	1970
HULL NUMBER		2021	SHIPYARD	
HIN			COMPLETED BY	
SERVICE		Passenger (Inspected)	COMPLETED CITY	
CLASS		Passenger Ship	STATE	
TYPE		General		
SUB TYPE		General (More Than 6, Gross T	HULL BUILT	
			HULL BUILT	

A "1" in this field means that the vessel was documented, or was in the process of being documented, at the time of the MISLE data extract from which this Data Sheet was generated.

(0 = No, False or Null ; 1 = Yes or True)

Weekly Notes are issued by the Coast Guard Marine Safety Center's Tonnage Division (MSC-4) for use by organizations that perform measurement work on the Coast Guard's behalf. They are for informational purposes only, and are not intended as, nor should they be construed to represent, revisions of or substitutes for applicable statutes or regulations or established interpretations of either.

MEASUREMENT ORGANIZATION WEEKLY NOTES – 02/28/2018

EMAIL ISSUES We are currently experiencing email connectivity issues within the Coast Guard network related to recent updates to our IT infrastructure. This may result in delays in processing requests sent to the Marine Safety Center's (MSC's) electronic commerce inbox, msc@uscg.mil, and also impacts our individual email accounts. For urgent matters, please call Mr. Marcus Akins or Mr. David Karnes to ensure we have received any email you have sent to the MSC. We apologize for any inconvenience these issues may be causing.

TONNAGE PERSONNEL Mr. Marcus Akins will be out of the office March 2-6, 2018. Mr. Tony Cao is expected to be out of the office for approximately three (3) months, beginning March 5, 2018, for reserve Coast Guard duty.

MSC POINTS OF CONTACT Until Mr. Cao's return, please note the following updated MSC POCs for tonnage matters:

<u>Subject Type</u>	<u>Primary</u>	<u>Secondary</u>
Interpretations & Decisions	Akins	Eareckson
File Requests	Akins	Karnes
CG Number Requests	Akins	Karnes
Navy Ships / USCG Cutters	Eareckson	Akins
Tonnage Applicability	Karnes	Akins
TonCalc	Akins	Eareckson

Weekly Notes are issued by the Coast Guard Marine Safety Center's Tonnage Division (MSC-4) for use by organizations that perform measurement work on the Coast Guard's behalf. They are for informational purposes only, and are not intended as, nor should they be construed to represent, revisions of or substitutes for applicable statutes or regulations or established interpretations of either.

MEASUREMENT ORGANIZATION WEEKLY NOTES – 02/21/2018

TONNAGE WORK INSTRUCTIONS In the interest of transparency, and to better assist ACSs in the performance of their work on the Coast Guard's behalf, the Marine Safety Center (MSC) has posted two work instruction documents to the [U.S. Tonnage Publications](#) web page. We distributed the first, *WI C3-02 Generating Calculations and Certificates with TonCalc*, along with MSC's TonCalc software, to ACSs in 2012. The second, *WI C3-04 Tonnage Oversight Review*, has not been previously distributed. It provides internal MSC procedures for conducting oversight reviews of ACS tonnage files, with checklists for 1. administrative review; 2. Convention tonnage review; 3. principal dimensions review; and 4. Regulatory tonnage review (shown below). ACSs are cautioned that this work instruction is not comprehensive.

Attachment 4 to WI C3-04 02/27/2017

**OVERSIGHT CHECK LIST
REGULATORY TONNAGE REVIEW (TTMR)**

Vessel Name: _____

Vessel Geometry	Verify Geometry (e.g., use photos, approved plans etc.) <input type="checkbox"/> Hull shape and configuration properly represented <input type="checkbox"/> Large superstructure spaces included <input type="checkbox"/> Small superstructure spaces included, as appropriate <input type="checkbox"/> Line of the uppermost complete deck properly established <input type="checkbox"/> Line of the tonnage deck properly established <input type="checkbox"/> Open vessel criteria properly applied, as appropriate
Tonnage Drawing	Verify Accuracy <input type="checkbox"/> Tonnage length correct <input type="checkbox"/> Ordinary frames used as basis for measurements correct, <u>at all stations</u> <input type="checkbox"/> Breadth and depth measurements correct, on sampling basis
Under-Deck Calculations	Check Calculation Inputs <input type="checkbox"/> Dimensions properly transcribed from tonnage drawing <input type="checkbox"/> Water ballast space exemption correct, if applicable (see WI C3-XX under development) <input type="checkbox"/> Eligibility of deducted spaces verified <input type="checkbox"/> Calculation methodology correct (e.g., Simpson's vs. rectangular?)
Above-Deck Calculations	Check Calculation Inputs <input type="checkbox"/> Dimensions verified against drawings, photos, etc <input type="checkbox"/> Eligibility of exempted spaces verified <input type="checkbox"/> Eligibility of deducted spaces verified <input type="checkbox"/> Calculation methodology correct
Tonnage Assignment	Verify Calculated Tonnages <input type="checkbox"/> GRT and NRT properly calculated and rounded down <input type="checkbox"/> GT comparable to estimate (e.g., evaluate exemptions on TonCalc summary) <input type="checkbox"/> NT comparable to estimate (e.g., evaluate deductions on TonCalc summary)
Certificate Information	Verify Tonnage Information <input type="checkbox"/> GRT and NRT properly transcribed
Comments:	

Page 1 of 1

Weekly Notes are issued by the Coast Guard Marine Safety Center's Tonnage Division (MSC-4) for use by organizations that perform measurement work on the Coast Guard's behalf. They are for informational purposes only, and are not intended as, nor should they be construed to represent, revisions of or substitutes for applicable statutes or regulations or established interpretations of either.

MEASUREMENT ORGANIZATION WEEKLY NOTES – 02/14/2018

ELECTRONIC CERTIFICATES The Marine Safety Center (MSC) is moving forward with electronic tonnage certificate implementation for Navy warships and Coast Guard cutters, consistent with International Maritime Organization (IMO) Circular FAL.5/Circ.39/Rev.2 dated April 20, 2016 and Coast Guard (CG-CVC) Policy Letter 17-09 dated November 27, 2017. We have faced some challenges regarding contractual requirements referring to delivery of “original” certificates to the shipyard, and with markups of electronically secured certificates. For example, we have previously left entry of call signs to the ship’s crew, although we have not allowed alterations to the ship’s name as shown in the graphic below obtained from the internet. We would appreciate hearing from you on your experiences with “E-Certificates”. Our point of contact for this matter is Mr. Marcus Akins.

Name of Ship	Official Number or Call Letters	Port of Registry	Tonnage on Certificate of Registry	
			Gross	Net
YANFZE TALENSON (NK) GRAND-BEE (NK)	HK-2079 IMO 9403227	Hong Kong	160218	103527

WASHINGTON’S BIRTHDAY HOLIDAY The MSC will be closed on Monday, February 19, 2018 in observance of the birthday of George Washington.



Wyeth, N. C. *George Washington at Yorktown*. 1938/1939.
Permanent Collection / University Museums, Iowa State U.

Weekly Notes are issued by the Coast Guard Marine Safety Center’s Tonnage Division (MSC-4) for use by organizations that perform measurement work on the Coast Guard’s behalf. They are for informational purposes only, and are not intended as, nor should they be construed to represent, revisions of or substitutes for applicable statutes or regulations or established interpretations of either.

MEASUREMENT ORGANIZATION WEEKLY NOTES – 02/07/2018

CONVENTION AND SIMPLIFIED MEASUREMENTS We recently fielded a question regarding a vessel whose owner may choose to have it measured under both the Convention Measurement System and the Simplified Regulatory Measurement System. Should an ACS encounter this rare circumstance, contact Mr. Marcus Akins for direction on completing the U.S. Tonnage Certificate. Per § 69.209(c) of MTN 01-99 CH-9, the vessel's Certificate of Documentation or a completed Application for Simplified Measurement (form CG-5397) serves as evidence of tonnage measurement under the Simplified system. Please ensure that this evidence is available prior to contacting Mr. Akins for direction on completing the tonnage certificate.

FEDERAL GOVERNMENT FUNDING Funding for the federal government is set to expire Thursday, February 8, 2018. Lack of further funding could result in a government shutdown, disrupting services (including those provided by the Marine Safety Center).

MEASUREMENT ORGANIZATION WEEKLY NOTES – 01/31/2018

THIRD PARTY PROGRAMS The Coast Guard's Assistant Commandant for Prevention Policy (and former Commanding Officer of the Marine Safety Center) RADM John Nadeau testified before the House Subcommittee on Coast Guard and Maritime Transportation in a recent hearing. "Today, like other flag states around the globe, the U.S. relies far more on third parties than ever before," he said, also citing a 2016 study that concluded third party (ACS/RO) programs provide additional technical expertise, promote innovation, and reduce cost for the U.S. fleet. "Third party programs have gone from an option to a necessity," he added. However, RADM Nadeau acknowledged the fallibility of third party programs, but said the Coast Guard has the authority and competency needed to establish more effective oversight and provide clear accountability.



TRANSFERRING FILES We recently encountered problems with the submittal of a large tonnage file for oversight that was broken down into 13 emails, three of which were not delivered to our msc@uscg.mil inbox for some reason. To facilitate transfer of multiple (up to 25) or large (> 9MB) attachments, we recommend using the secure U.S. Army file transfer application [AMRDEC SAFE](#). Please contact the Tonnage Division to coordinate. Also, if you receive messages from postmaster@uscg.mil indicating delayed delivery of an email to msc@uscg.mil, please notify Mr. David Karnes.



Weekly Notes are issued by the Coast Guard Marine Safety Center's Tonnage Division (MSC-4) for use by organizations that perform measurement work on the Coast Guard's behalf. They are for informational purposes only, and are not intended as, nor should they be construed to represent, revisions of or substitutes for applicable statutes or regulations or established interpretations of either.

MEASUREMENT ORGANIZATION WEEKLY NOTES – 01/24/2018

MEASUREMENT TRENDS The 01/03/2018 edition of the Weekly Notes includes a graph of tonnage measurement actions reported through ACS notification worksheets. Further to that, the Marine Safety Center generated the following graph, which shows a breakdown of initial vessel measurements according to vessel service, using information from the Coast Guard's MISLE database. We note that these yearly totals of initial measurements may not align with those previously reported due to discrepancies in data collection. As a result, this plot does not account for approximately 150 vessels, most of which were measured in 2016.

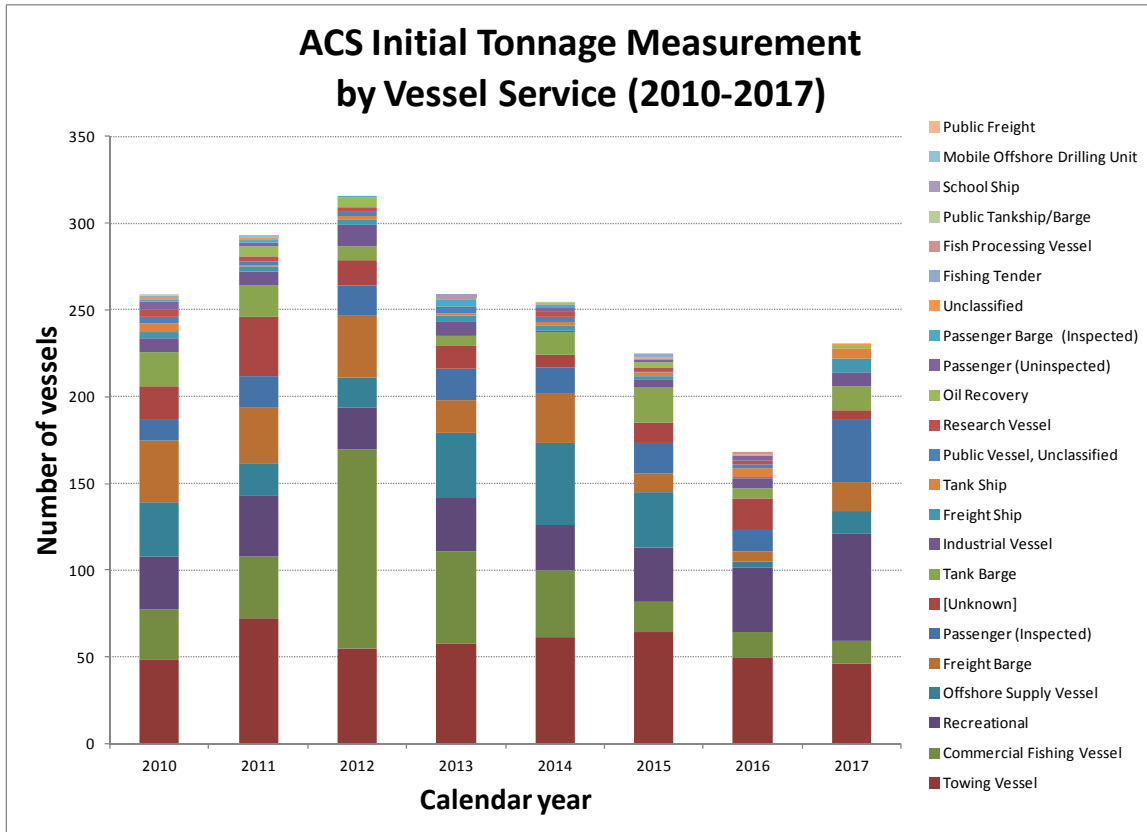

Weekly Notes are issued by the Coast Guard Marine Safety Center's Tonnage Division (MSC-4) for use by organizations that perform measurement work on the Coast Guard's behalf. They are for informational purposes only, and are not intended as, nor should they be construed to represent, revisions of or substitutes for applicable statutes or regulations or established interpretations of either.

MEASUREMENT ORGANIZATION WEEKLY NOTES – 01/17/2018

EL FARO MARINE CASUALTY Last month, the Coast Guard released the Commandant's [Final Action Memo](#) (FAM) on the tragic loss of the Steam Ship EL FARO and the 33 persons aboard. The following excerpts from this report are particularly relevant to third party (ACS/RO) tonnage measurement work.

- *“The Coast Guard failed to adequately oversee the third party in this case, and the investigation reveals that the Coast Guard has not sustained the proficiency and policy framework to do so in general. The Coast Guard is fully committed to rectifying the shortcomings that led to these failures.”*
- *“The Coast Guard must, and will, establish a risk-based and enduring policy framework that is simpler to execute and enables more robust oversight of delegated functions.”*
- *“The Coast Guard will issue an annual domestic vessel compliance report, as recommended. This report will include relevant vessel, ACS and RO performance statistics to ensure full transparency of Coast Guard oversight activities.”*
- *“The Coast Guard will establish a procedure to assess the effectiveness of ACS surveyor training programs, and will implement policy to ensure appropriate corrective actions are taken when the Coast Guard identifies inadequate ACS performance. This policy will include a provision to revoke an individual surveyor's authority to conduct surveys on U.S. Flag vessels.”*
- *“This is a call to action for the entire maritime community . . . Recognized Organizations (ROs) must fully and effectively perform their duties and responsibilities . . . Coast Guard must, and will, provide the final safety net with sustainable policy, oversight, and accountability.”*



Prepared by the Tonnage Division for the USCG Marine Board of Investigation's [report](#)

FEDERAL GOVERNMENT FUNDING Funding for the federal government is set to expire Friday, January 19, 2018. Lack of further funding could result in a government shutdown, disrupting services (including those provided by the Marine Safety Center).

Weekly Notes are issued by the Coast Guard Marine Safety Center's Tonnage Division (MSC-4) for use by organizations that perform measurement work on the Coast Guard's behalf. They are for informational purposes only, and are not intended as, nor should they be construed to represent, revisions of or substitutes for applicable statutes or regulations or established interpretations of either.

MEASUREMENT ORGANIZATION WEEKLY NOTES – 01/10/2018

UNDER-DECK GRAPHICAL REPRESENTATIONS As discussed in a recent Weekly Notes edition, graphical representations provide objective evidence of dimensions used in volume calculations. Note that computer modeling tools could be used to generate the required transverse sections at each tonnage station (e.g., by projecting the frame outline of the shallowest frame of an alternating “deep” frame set onto the transverse section at that station, as obtained from the lines plan). While time consuming, this method may be the most effective way to ensure accurate tonnage measurement and compliance with MTN 01-98 CH-13 graphical representation requirements.

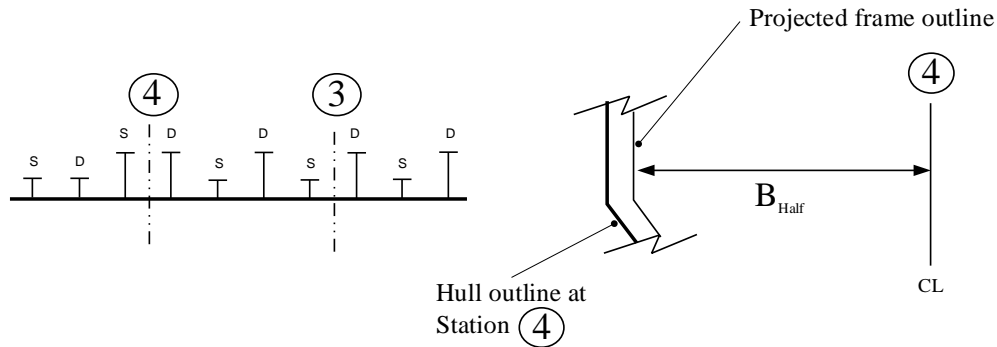

BIRTHDAY OF MARTIN LUTHER KING, JR. HOLIDAY The Marine Safety Center will be closed Monday, January 15 in observance of the Birthday of Martin Luther King, Jr.

Weekly Notes are issued by the Coast Guard Marine Safety Center's Tonnage Division (MSC-4) for use by organizations that perform measurement work on the Coast Guard's behalf. They are for informational purposes only, and are not intended as, nor should they be construed to represent, revisions of or substitutes for applicable statutes or regulations or established interpretations of either.

MEASUREMENT ORGANIZATION WEEKLY NOTES – 01/03/2018

MEASUREMENT TRENDS The Marine Safety Center generated the following graph using data reported since 2007 through ACS notification worksheets. As described in an earlier Weekly Notes edition, such trend data is used in various discussions with ACS representatives.

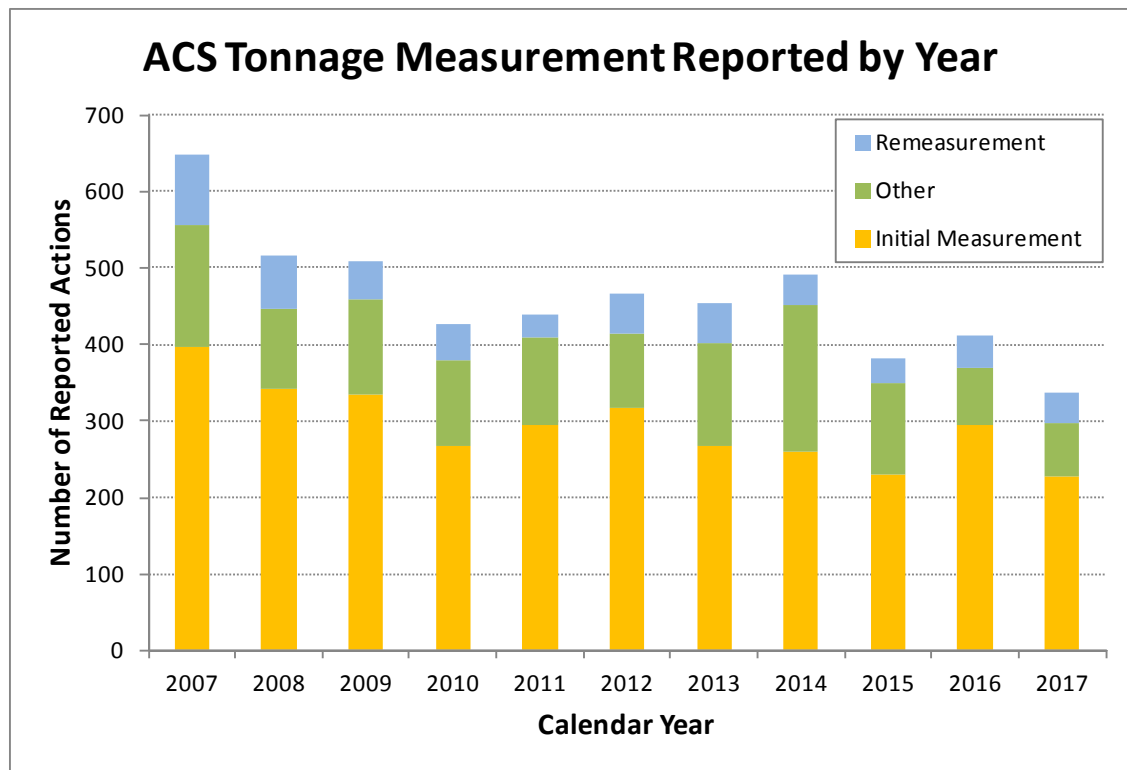

TONNAGE PERSONNEL Mr. Marcus Akins will be out of the office until Monday, January 8, 2018. During this time, please copy Mr. David Karnes on any file requests.

Weekly Notes are issued by the Coast Guard Marine Safety Center's Tonnage Division (MSC-4) for use by organizations that perform measurement work on the Coast Guard's behalf. They are for informational purposes only, and are not intended as, nor should they be construed to represent, revisions of or substitutes for applicable statutes or regulations or established interpretations of either.

MEASUREMENT ORGANIZATION WEEKLY NOTES – 12/27/2017

GRAPHICAL REPRESENTATION ISSUES A recent analysis of ACS oversight results revealed that over half (20 out of 37) of the tonnage files we reviewed since establishing comprehensive drawing requirements had at least one nonconformity related to graphical representations. As stated in a previous weekly note, these issues appear to be rooted in misconceptions on the need for objective evidence and thorough reviews. Below, we highlight some misconceptions on graphical representations, which we present in a “Myth” vs. “Reality” format.

- 1. Myth:** Graphical Representations Are Just for the Coast Guard.
Reality: The graphical representations required to be in a tonnage file by Tonnage Administrative Policy (MTN 01-98 CH-13) help to preclude certification errors. We note that graphical representation nonconformities contributed to inaccurate tonnages and main dimensions in 9 of the 37 tonnage files reviewed.
- 2. Myth:** Smaller Vessels Require Less Graphical Representations.
Reality: Although size can be a factor, the number of graphic representations required to support tonnage calculations is more a function of the complexity of the measurement than the vessel's overall size. For example, a small fishing vessel with extensive “deep” framing, multiple exemptions and “certified” deductions, and an engine room deduction that's a percentage of the total propelling machinery space, requires a much more extensive set of arrangement and framing drawings than is needed for a large freight vessel that lacks such features.
- 3. Myth:** Owners Don't Have to Provide Required Drawings.
Reality: Under the tonnage regulations, vessel owners are responsible for providing drawings and other information needed to complete the measurement process, although ACSs have discretion to provide missing information. For Standard measurement, the regulations require a lines plan, booklet of offsets, capacity plans for tanks, construction plans showing measurements and scantlings of hull and superstructure, a tonnage drawing showing tonnage length in profile and tonnage sections, and arrangement plans.

NEW YEAR'S DAY HOLIDAY As a reminder, the Marine Safety Center will be closed on January 1, 2018 in observance of the New Year's Day holiday. We wish you all a happy and safe holiday season.

TONNAGE PERSONNEL Mr. Tony Cao has been out of the office beginning Tuesday, December 26, 2017 and will return Monday, January 8, 2018. During this time, please copy Mr. David Karnes on any CG number requests.

Weekly Notes are issued by the Coast Guard Marine Safety Center's Tonnage Division (MSC-4) for use by organizations that perform measurement work on the Coast Guard's behalf. They are for informational purposes only, and are not intended as, nor should they be construed to represent, revisions of or substitutes for applicable statutes or regulations or established interpretations of either.

MEASUREMENT ORGANIZATION WEEKLY NOTES – 12/20/2017

IT ISSUES UPDATE As mentioned last week, we had noticed delivery delays of incoming email to uscg.mil addresses, as well as the inability to exchange email between uscg.mil and comcast.net addresses. Both of these issues have been resolved. We apologize for any inconvenience they caused.

CHRISTMAS AND NEW YEAR'S DAY HOLIDAYS The Marine Safety Center will be closed on December 25, 2017 and January 1, 2018 in observance of the Christmas and New Year's Day holidays. We wish you all a happy and safe holiday season.

MEASUREMENT ORGANIZATION WEEKLY NOTES – 12/13/2017

VESSEL DOCUMENTATION AND MEASUREMENT SYSTEM APPLICABILITY We are currently working with owners of several recently documented recreational vessels over 79 feet in overall length that had only been measured under the Simplified Regulatory Measurement System. Unless these vessels operate only on the Great Lakes, they require Convention measurement, as they are self-propelled and have recent keel laid dates. In this case, there was some confusion over tonnage measurement applicability language in the 2016 Tonnage Regulations Amendments Final Rule. To be clear, that rulemaking made no change to longstanding measurement requirements for recreational vessels, and we highly recommend consulting NVIC 11-93 CH-3 *Applicability of Tonnage Measurement Systems to U.S. Flag Vessels* for pertinent information.

IT ISSUES This morning we experienced connectivity issues with the Coast Guard network that appear to have been resolved. Also, we have noticed ongoing delivery delays of incoming email to uscg.mil addresses, including the Marine Safety Center's (MSC's) main inbox, msc@uscg.mil. As a faster alternative, please copy or send messages directly to HQS-PF-fldr-MS-EC@uscg.dhs.gov, for the time being. In addition, we learned that Comcast customers using comcast.net addresses are unable to send email to, or receive it from, uscg.mil addresses. We apologize for any inconvenience these issues have caused and will provide updates.

MEASUREMENT ORGANIZATION WEEKLY NOTES – 12/06/2017

POSTED WEEKLY NOTES As mentioned previously, we believe we have resolved the delays in viewing the updated compilation of current and previous editions of the Weekly Notes on the [U.S. Tonnage Publications](#) web page. We will discontinue posting the most recent edition separately.

BOOKMARKING MTNS We are seeking your input on whether adding bookmarks to the electronic versions of our MTNs and other documents would help users when looking for information, as illustrated below. Another idea is to embed linked documents within these .pdf files, so that the linked materials could be accessed without the need to be online, recognizing that the size of the .pdf files would increase accordingly. If you would like to provide input, please contact Mr. Marcus Akins.

The image shows a PDF viewer interface. On the left, a 'Bookmarks' pane is visible, listing various sections of a document. The selected bookmark is '(b) Propelling Machinery Spaces'. The main content area displays a technical diagram of a ship's engine room, labeled '(b) Propelling Machinery Spaces'. The diagram shows the layout of the Upper Motor Room (MR) and Upper Engine Room (ER), with various pieces of machinery and equipment labeled. A legend indicates that shaded areas represent 'Propelling machinery space'. Below the diagram, there are two main sections of text: (1) General Propelling machinery spaces and (2) Specific Spaces Propelling machinery spaces are -.

(b) Propelling Machinery Spaces

(1) *General* Propelling machinery spaces are the spaces occupied by the main propelling machinery and auxiliary machinery used in connection with propelling the vessel, and spaces reasonably necessary for the operation and maintenance of the machinery. Propelling machinery spaces do not include spaces for fuel tanks, spaces exempt from tonnage under § 69.117, and spaces not used or not available for use in connection with propelling machinery.

(2) *Specific Spaces* Propelling machinery spaces are -

(i) *Space Below the Crown.* The crown is the top of the main space of the engine room to which the heights of the main space are taken. The crown is either the underside of a deck or, if the side bulkheads are sloping, the uppermost point at which the slope terminates. (See §69.123, figures 13 and 14.)

(ii) *Space Between the Crown and Uppermost Complete Deck* Framed-in space located between the crown and the uppermost complete deck and used for propelling machinery or for the admission of light or air to propelling machinery spaces. (See §69.123, figures 13 and 14.)

(iii) *Shaft Tunnel and Thrust Block Recess* Shaft tunnel space and thrust block recess space.

(iv) *Escape Shafts and Trunks.* Space below the uppermost complete deck used for escape shafts

FEDERAL GOVERNMENT FUNDING Funding for the federal government is set to expire on December 8, 2017. Lack of further funding could result in a government shutdown, disrupting services (including those provided by the Marine Safety Center).

Weekly Notes are issued by the Coast Guard Marine Safety Center's Tonnage Division (MSC-4) for use by organizations that perform measurement work on the Coast Guard's behalf. They are for informational purposes only, and are not intended as, nor should they be construed to represent, revisions of or substitutes for applicable statutes or regulations or established interpretations of either.

MEASUREMENT ORGANIZATION WEEKLY NOTES – 11/29/2017

CG NUMBER REQUESTS VIDEO Making use of additional capabilities afforded by the Coast Guard's new web platform, we have posted an instructional video linked from the [U.S. Tonnage Publications](#) web page. The video explains the process by which ACSs should request a CG number from the Marine Safety Center. Please contact Mr. David Karnes if you wish to comment on whether this sort of video content is useful; to comment on this particular video; or to suggest topics for future videos.

Miscellaneous Tonnage Documents

[Formal Measurement Application](#) 

[Measurement Organization Weekly Notes for November 22, 2017](#) 

[Measurement Organization Weekly Notes](#) 

[CG Number Requests - How-to Video](#)

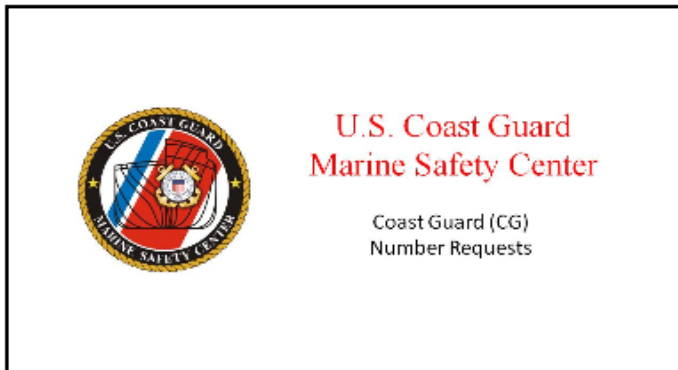

Historical Marine Safety Center Technical Notes (MTNs)

[MTN 01-99 CH-8](#) 

Weekly Notes are issued by the Coast Guard Marine Safety Center's Tonnage Division (MSC-4) for use by organizations that perform measurement work on the Coast Guard's behalf. They are for informational purposes only, and are not intended as, nor should they be construed to represent, revisions of or substitutes for applicable statutes or regulations or established interpretations of either.

MEASUREMENT ORGANIZATION WEEKLY NOTES – 11/22/2017

UPDATED APPLICATION FOR SIMPLIFIED MEASUREMENT Last week, the Coast Guard issued an updated Application for Simplified Measurement (form CG-5397). Vessel owners use the form to certify information when a vessel is assigned tonnages and registered dimensions under the Simplified Regulatory Measurement System, if a Builder's Certificate was not used for this purpose. The Marine Safety Center (MSC) has posted this updated form to the same [web page](#) that provided the previous version.

Vessel Type: Monohull Gross Tonnage: 97 Net Tonnage: 77	DEPARTMENT OF HOMELAND SECURITY U.S. Coast Guard APPLICATION FOR SIMPLIFIED MEASUREMENT	OMB No: 1625-0022
I. APPLICABILITY <small>A U.S. flag vessel is eligible to be measured under the Simplified system (46 CFR 69 subpart E) if it is either: 1) less than 79 feet in overall length; or 2) a non-self-propelled or recreational vessel. Some vessels that are 79 feet or more in overall length may also require measurement under the Convention system (46 CFR 69 subpart B). This includes vessels that engage on foreign voyages, as well as recreational vessels that engage on voyages outside the Great Lakes and have keel laid dates after December 31, 1985. Refer 46 CFR 69.11 for complete measurement eligibility details.</small>		
II. VESSEL DATA		
<p>1. VESSEL NAME <u>JOHNNY K</u></p> <p>2. HULL ID No. <u>XYZ12345D899</u> <small>(also provide official number, if available)</small></p> <p>3. HULL MATERIAL:</p> <p><input type="checkbox"/> Wood <input type="checkbox"/> Steel <input checked="" type="checkbox"/> Fibrous Reinforced Plastic (e.g., fiberglass)</p> <p><input type="checkbox"/> Aluminum <input type="checkbox"/> Concrete <input type="checkbox"/> Other _____</p> <p>4. PROPULSION MACHINERY:</p> <p><input checked="" type="checkbox"/> Located inside hull (e.g., inboard engine or stern drive)</p> <p><input type="checkbox"/> Located entirely outside hull (e.g., outboard motor)</p> <p><input type="checkbox"/> Non-self-propelled (not fitted with any propulsion machinery)</p> <p>5. SHAPE OF HULL(S): <small>(for tri-hull vessels, check the block best describing the center hull)</small></p> <p><input checked="" type="checkbox"/> Powerboat, ship or circular <input type="checkbox"/> Sailboat distinct keel (or no keel) </p> <p><input type="checkbox"/> Box or barge <input type="checkbox"/> Sailboat integral keel (keel is faired to hull) </p> <p>6. OVERALL DIMENSIONS:</p> <p>Overall Length (L) = <u>65.0</u> ft <u>10</u> in</p> <p>Overall Breadth (B) = <u>18.0</u> ft <u>2</u> in</p> <p>Overall Depth (D) = <u>12.0</u> ft <u>1</u> in</p>	<p>7. ADDITIONAL DIMENSIONS FOR LARGE DECK STRUCTURES: <small>(Complete only if the volume of the principal deckhouse, cabin or similar structure above the main deck exceeds the hull volume)</small></p> <p>Structure Length (L_s) = _____ ft _____ in</p> <p>Structure Breadth (B_s) = _____ ft _____ in</p> <p>Structure Depth (D_s) = _____ ft _____ in</p> <p>8. ADDITIONAL DIMENSION FOR TWIN HULL VESSELS: <small>(Applies only if there is no buoyant volume in the structure that connects the hulls together)</small></p> <p>Individual Hull Breadth (B_i) = _____ ft _____ in</p> <p>9. ADDITIONAL DIMENSIONS FOR TRI-HULL VESSELS: <small>(Applies only if there is no buoyant volume in the structure that connects the hulls together)</small></p> <p>Center Hull Length (L_c) = _____ ft _____ in</p> <p>Center Hull Breadth (B_c) = _____ ft _____ in</p> <p>Center Hull Depth (D) = _____ ft _____ in</p> <p>Outer Hull Length (L_o) = _____ ft _____ in</p> <p>Outer Hull Breadth (B_o) = _____ ft _____ in</p> <p>Outer Hull Depth (D_o) = _____ ft _____ in</p>	
III. STATEMENT OF REPRESENTATION <small>I understand that, under the provisions of 46 CFR 69.25, a person making a false statement or representation in this application may be fined up to \$30,000 and that the vessel also is liable in rem for the penalty. I certify that the information provided by me above is correct.</small>		
Owner's printed name <u>Bruce Robertson</u> Owner's signature <u>Bruce Robertson</u> Date <u>1/6/2015</u>		Page 1 of 2
<small>CG-5397 (01/15)</small>		

THANKSGIVING HOLIDAY The MSC will be closed on Thursday, November 23, 2017, in observance of the Thanksgiving holiday.

Weekly Notes are issued by the Coast Guard Marine Safety Center's Tonnage Division (MSC-4) for use by organizations that perform measurement work on the Coast Guard's behalf. They are for informational purposes only, and are not intended as, nor should they be construed to represent, revisions of or substitutes for applicable statutes or regulations or established interpretations of either.

MEASUREMENT ORGANIZATION WEEKLY NOTES – 11/15/2017

MEASUREMENT SYSTEM APPLICABILITY We caution against making “easy” generalizations on measurement system applicability, as the governing laws are quite complex, especially with regard to recreational vessels. To determine which system or systems apply, we highly recommend you consult NVIC 11-93 CH-3, *Applicability of Tonnage Measurement Systems to U.S. Flag Vessels*, available on the [U.S. Tonnage Publications](#) page. An index in the NVIC’s enclosure references the applicable table of measurement system requirements for any given vessel.

SECTION 3 INDEX OF TONNAGE MEASUREMENT SYSTEM REQUIREMENTS			
	Overall Length less than 24 meters (79 feet)	Overall Length 24 meters (79 feet) and over and:	
		Convention Length less than 24 meters (79 feet)	Convention Length 24 meters (79 feet) and over
SELF-PROPELLED VESSELS			
* Engaged on Domestic Voyages: Only with Keel Laid/Substantially Altered:			
* Before January 1, 1986.....	Table 1 (p.8)	Table 2 (p.9)	Table 2 (p.9)
* January 1, 1986 and After.....	Table 1 (p.8)	Table 3 (p.10)	Table 3 (p.10)
* Engaged on Great Lakes Voyages: Only			
* Recreational Vessels.....	T		
* Non-Recreational Vessels.....	T		
* Engaged on Foreign Voyages with Keel Laid/Substantially Altered:			
* Before July 18, 1982.....	T		
* July 18, 1982 - December 31, 1985.....	T		
* January 1, 1986 - July 18, 1994.....	T		
* July 19, 1994 and After.....	T		
NON-SELF-PROPELLED VESSELS			
* Engaged on Domestic Voyages: Only.....	T		
* Engaged on Great Lakes Voyages: Only.....	T		
* Engaged on Foreign Voyages with Keel Laid/Substantially Altered			
* Before July 18, 1982.....	T		
* July 18, 1982 - December 31, 1985.....	T		
* January 1, 1986 - July 18, 1994.....	T		
* July 19, 1994 and After.....	T		

TABLE 3	
Item	Requirement
Measurement Requirements	The vessel must be assigned tonnages under the convention measurement system. The vessel may additionally be assigned tonnages under the regulatory measurement system. <i>Note:</i> A vessel assigned tonnages only under the regulatory measurement system before October 12, 1989 is exempt from the requirement to be assigned tonnages under the convention measurement system until such time as the vessel is remeasured for any reason.
Available Regulatory Measurement Systems	<i>Recreational vessels:</i> 46 CFR 69 standard (Subpart C), dual (Subpart D), or simplified (Subpart E). <i>All other vessels:</i> 46 CFR 69 standard (Subpart C) or dual (Subpart D).
U.S. Laws	<i>Vessels assigned tonnages under both the regulatory measurement system and the convention measurement system:</i> Unless otherwise provided for by law, apply laws and regulations that were in effect before July 19, 1994 using regulatory measurement system tonnages, and all other laws and regulations using convention measurement system tonnages. Refer to 46 U.S.C. 14305(a) for details. <i>All other vessels:</i> Apply laws and regulations using the tonnages assigned to the vessel (either convention or regulatory).
International Conventions	<i>Vessels engaged on domestic voyages only:</i> Not applicable. <i>All other vessels:</i> Unless otherwise provided for by law or international convention, apply international conventions using convention measurement system tonnages (if assigned). Otherwise, apply international conventions using regulatory measurement system tonnages.

POSTED WEEKLY NOTES We believe we have resolved the delays - mentioned last week - in viewing the updated compilation of current and previous editions of the Weekly Notes. In the near term, we will continue to post the most recent edition separately while monitoring our mitigation efforts with the larger document.

Weekly Notes are issued by the Coast Guard Marine Safety Center's Tonnage Division (MSC-4) for use by organizations that perform measurement work on the Coast Guard's behalf. They are for informational purposes only, and are not intended as, nor should they be construed to represent, revisions of or substitutes for applicable statutes or regulations or established interpretations of either.

MEASUREMENT ORGANIZATION WEEKLY NOTES – 11/08/2017

POSTED WEEKLY NOTES We publish Weekly Notes and upload an updated compilation of current and previous editions to the U.S. Tonnage Publications page each week, usually on Wednesday afternoon. However, following the transition of uscg.mil web pages to a new platform, we have noticed increased delays before the updated documents become available for viewing, with variations among different web browsers. We are investigating whether this may be related to the file size, and in the interim, have posted a link to the latest Weekly Notes edition on the U.S. Tonnage Publications web page. We apologize for the inconvenience and appreciate your patience until we resolve this matter.

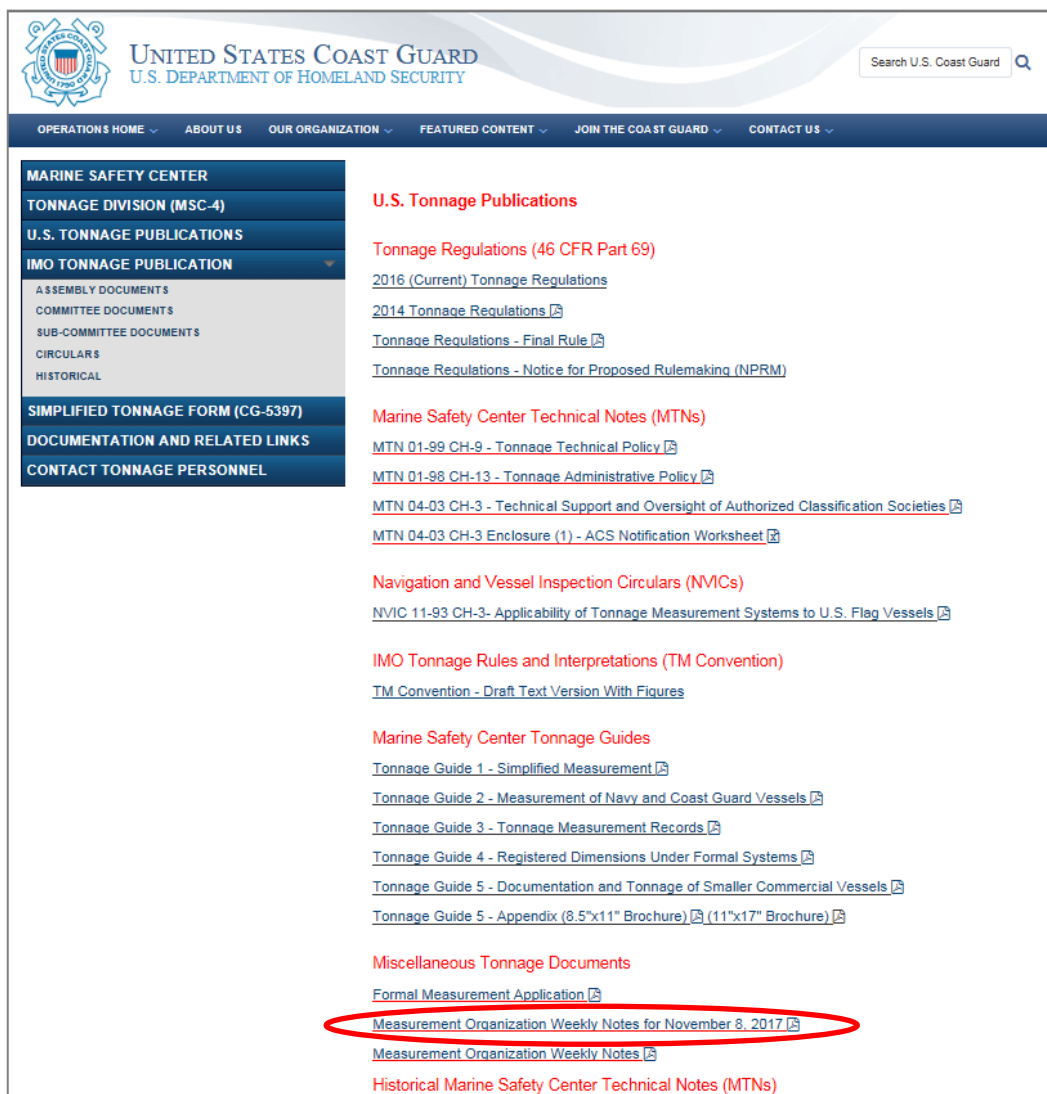

The screenshot shows the U.S. Coast Guard website with the following content:

- U.S. Tonnage Publications**
- Tonnage Regulations (46 CFR Part 69)**
 - [2016 \(Current\) Tonnage Regulations](#)
 - [2014 Tonnage Regulations](#)
 - [Tonnage Regulations - Final Rule](#)
 - [Tonnage Regulations - Notice for Proposed Rulemaking \(NPRM\)](#)
- Marine Safety Center Technical Notes (MTNs)**
 - [MTN 01-99 CH-9 - Tonnage Technical Policy](#)
 - [MTN 01-98 CH-13 - Tonnage Administrative Policy](#)
 - [MTN 04-03 CH-3 - Technical Support and Oversight of Authorized Classification Societies](#)
 - [MTN 04-03 CH-3 Enclosure \(1\) - ACS Notification Worksheet](#)
- Navigation and Vessel Inspection Circulars (NVICs)**
 - [NVIC 11-93 CH-3- Applicability of Tonnage Measurement Systems to U.S. Flag Vessels](#)
- IMO Tonnage Rules and Interpretations (TM Convention)**
 - [TM Convention - Draft Text Version With Figures](#)
- Marine Safety Center Tonnage Guides**
 - [Tonnage Guide 1 - Simplified Measurement](#)
 - [Tonnage Guide 2 - Measurement of Navy and Coast Guard Vessels](#)
 - [Tonnage Guide 3 - Tonnage Measurement Records](#)
 - [Tonnage Guide 4 - Registered Dimensions Under Formal Systems](#)
 - [Tonnage Guide 5 - Documentation and Tonnage of Smaller Commercial Vessels](#)
 - [Tonnage Guide 5 - Appendix \(8.5"x11" Brochure\)](#) [\(11"x17" Brochure\)](#)
- Miscellaneous Tonnage Documents**
 - [Formal Measurement Application](#)
 - [Measurement Organization Weekly Notes for November 8, 2017](#) (circled in red)
 - [Measurement Organization Weekly Notes](#)
- Historical Marine Safety Center Technical Notes (MTNs)**

VETERANS DAY HOLIDAY The Marine Safety Center will be closed on Friday, November 10, 2017 in observance of the Veterans Day holiday.

Weekly Notes are issued by the Coast Guard Marine Safety Center's Tonnage Division (MSC-4) for use by organizations that perform measurement work on the Coast Guard's behalf. They are for informational purposes only, and are not intended as, nor should they be construed to represent, revisions of or substitutes for applicable statutes or regulations or established interpretations of either.

MEASUREMENT ORGANIZATION WEEKLY NOTES – 11/01/2017

MARINE SAFETY CENTER INFORMATION BULLETIN This week the [Marine Safety Center \(MSC\)](#) issued an [Information Bulletin](#) addressing the ongoing transitions of its uscg.mil and Homeport websites. As part of the updates, all plan review guides, tonnage guides, and ballast water type approvals - some of which had only been available through Homeport - are now posted on the enhanced [uscg.mil](#) site. Thank you for your patience as we add more references and functionality in the coming weeks.

WEBSITE REFERENCES Further to the entry above, new links to MSC Technical Notes (MTNs) and tonnage guides are now available under the References section in the left hand column of the MSC website. The documents will continue to be available on the [U.S. Tonnage Publications](#) page.

The screenshot shows the official website of the U.S. Coast Guard Marine Safety Center. At the top, there is a search bar and a navigation menu with options like 'OPERATIONS HOME', 'ABOUT US', 'OUR ORGANIZATION', 'FEATURED CONTENT', 'JOIN THE COAST GUARD', and 'CONTACT US'. A message below the navigation states: 'We are in the process of building a better MSC website for you. Click to contact us with feedback on how we can improve it to fit your needs.'

The left sidebar contains several sections: 'MARINE SAFETY CENTER (MSC)', 'SERVICES' (listing HULL DIVISION, ENGINEERING DIVISION, TANK VESSEL/OFFSHORE DIVISION, TONNAGE DIVISION, VESSEL SECURITY DIVISION, SALVAGE ENGINEERING RESPONSE TEAM, and BALLAST WATER MANAGEMENT), 'REFERENCES' (with 'MSC TECHNICAL NOTES', 'PLAN REVIEW GUIDELINES', and 'TONNAGE GUIDES' circled in red), 'ABOUT US', 'MEDIA' (MSC FIELD ACTIVITY, MSC INFORMATION BULLETINS), and 'CONTACT MSC' (Meet the Commanding Officer, with a photo of a man).

The main content area features the U.S. Coast Guard Marine Safety Center logo and the text 'U.S. COAST GUARD MARINE SAFETY CENTER WASHINGTON, D.C.'. Below this is a 'Marine Safety Center Services' section with a photo of a staff engineer measuring a buoy and the text 'Tonnage Division A Tonnage Division staff engineer obtains dimensions for the initial tonnage assignment for a U.S. Coast Guard buoy tender. Photo by Mr. David Karnes'. At the bottom, there is an 'About the Marine Safety Center' section with the text: 'The Marine Safety Center (MSC) supports the people and objectives of the Marine Safety, Security, and Environmental Protection programs through the verification of compliance with technical standards for the design, construction, and operation of vessels and structures.'

Weekly Notes are issued by the Coast Guard Marine Safety Center's Tonnage Division (MSC-4) for use by organizations that perform measurement work on the Coast Guard's behalf. They are for informational purposes only, and are not intended as, nor should they be construed to represent, revisions of or substitutes for applicable statutes or regulations or established interpretations of either.

MEASUREMENT ORGANIZATION WEEKLY NOTES – 10/25/2017

PROXIMITY REQUIREMENTS We recently received an inquiry on how the presence of an intersecting boundary (like a longitudinal frame) affects the treatment of frame openings in a transverse ordinary bottom frame. In responding, the Marine Safety Center (MSC) commented that the circular openings shown in a figure accompanying § 69.109(p)(4)(ii) of MTN 01-99 CH-9 (below) are not within the longest linear dimension of either opening, and the presence of a separating boundary has no bearing on application of proximity requirements to adjacent openings.

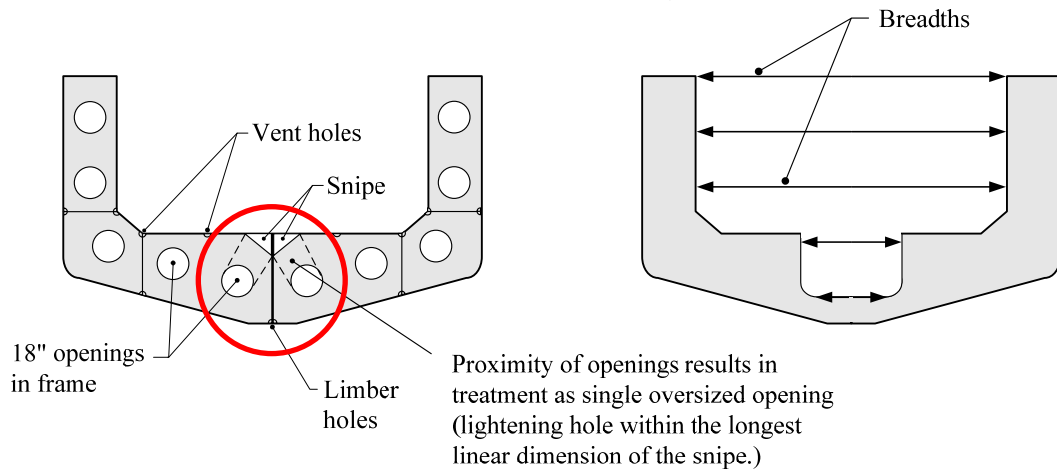

The MSC also noted that this treatment is consistent with application of similar requirements to openings divided by partitions in certain longitudinal framing applications of § 69.109(p)(7)(iv)(2), as illustrated in the accompanying figure (below).

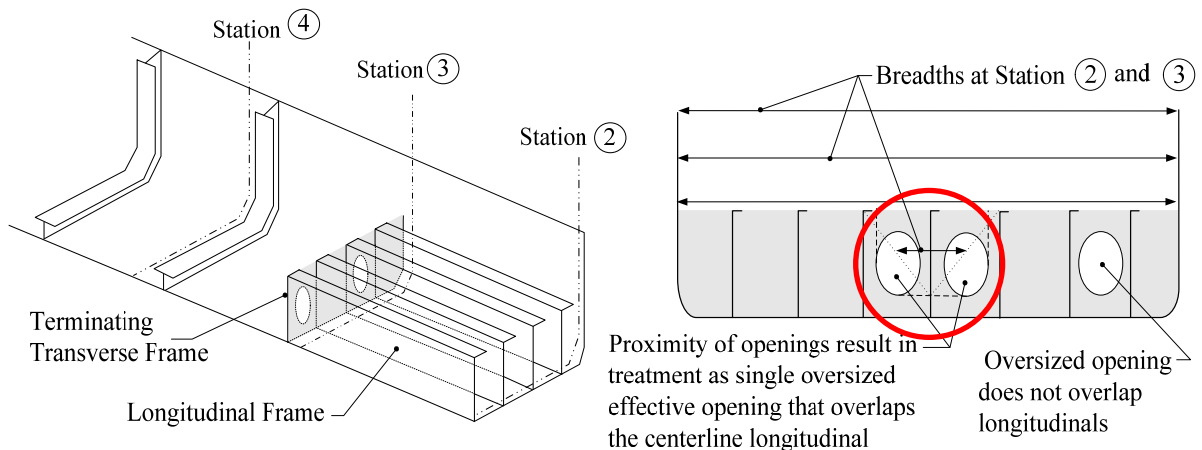

MSC WEBSITE AND HOMEPORT In part to address customer concerns about accessing information on our Homeport website, the MSC is moving forward with improvements to its new uscg.mil website. These include posting all Plan Review Guides (PRGs), along with other MSC documents that are currently available only through Homeport. We hope to deploy these improvements within the next several weeks.

Weekly Notes are issued by the Coast Guard Marine Safety Center's Tonnage Division (MSC-4) for use by organizations that perform measurement work on the Coast Guard's behalf. They are for informational purposes only, and are not intended as, nor should they be construed to represent, revisions of or substitutes for applicable statutes or regulations or established interpretations of either.

MEASUREMENT ORGANIZATION WEEKLY NOTES – 10/18/2017

HOMEPORT 2.0 In addition to its uscg.mil websites, the Coast Guard has also transitioned its Homeport Internet Portal website to a new platform to provide a better user experience and improve security of user information. Effective October 17, 2017, links to the old Marine Safety Center (MSC) main site on the Homeport Internet Portal were no longer operational. MSC customers, including naval architects, who seek tonnage and plan review documents on Homeport, can now find such references at: <https://homeport.uscg.mil/missions/vessel-standards/marine-safety-center/references>

Title	Summary	Modified
Plan Review Guidelines	These guidelines were developed by the Marine Safety Center staff as an aid in the preparation and review of vessel plans and submissions. They were developed to supplement existing guidance. They are not intended to substitute or replace laws, regulations, or other official Coast Guard policy documents. The responsibility to demonstrate compliance with all applicable laws and regulations still rests with the plan submitter. SOLAS Plan Review Guidance is for foreign passenger vessels involved in the Control Verification Program or for domestic passenger vessels engaged in international trade.	08/07/2017
MSC Technical Notes	Marine Safety Center Technical Notes (MTNs) are issued by the Coast Guard Marine Safety Center to inform the maritime public of policy determinations and interpretations of technical requirements in the regulations relating to commercial vessel plan review.	07/24/2017
Tonnage Guides	These Guides provide information related to the administration of the tonnage measurement program and are primarily directed to an audience composed of vessel builders, brokers and owners, mortgage companies and other interested members of the public. They are not to be used as the basis for Coast Guard tonnage decisions in response to questions and appeals from the public or government entities. Such decisions will be deferred to applicable law, regulations, and policy documents, such as Marine Safety Center Technical Notes (MTNS).	06/12/2017
Useful Links	Policy, Regulations, and Guidelines	06/14/2016
IMO Resolution A.673 Policy Interpretation for Offshore Supply Vessels	Attached is the official, signed policy interpreting and implementing IMO Resolution A.673 for U.S. flagged OSVs.	05/23/2012

Showing 1 to 5 of 5 entries

Previous 1 Next

Weekly Notes are issued by the Coast Guard Marine Safety Center's Tonnage Division (MSC-4) for use by organizations that perform measurement work on the Coast Guard's behalf. They are for informational purposes only, and are not intended as, nor should they be construed to represent, revisions of or substitutes for applicable statutes or regulations or established interpretations of either.

MEASUREMENT ORGANIZATION WEEKLY NOTES – 10/11/2017

3-D MODELING EXAMPLES The Marine Safety Center (MSC) is increasingly using 3-dimensional (solid) modeling tools in its work. Below are some examples of MSC computer graphics included in the recently released report of investigation on the loss of the EL FARO in 2015. They were created using Robert McNeel & Associates' Rhinoceros (Rhino) software version Rhino 5, and demonstrate the usefulness of 3-D modeling, both in conducting engineering assessments and in helping to better understand a ship's geometry. Please contact Mr. David Karnes if you have any questions on how such modeling might be used in the tonnage certification process, or if you wish to share your own 3-D modeling experiences.

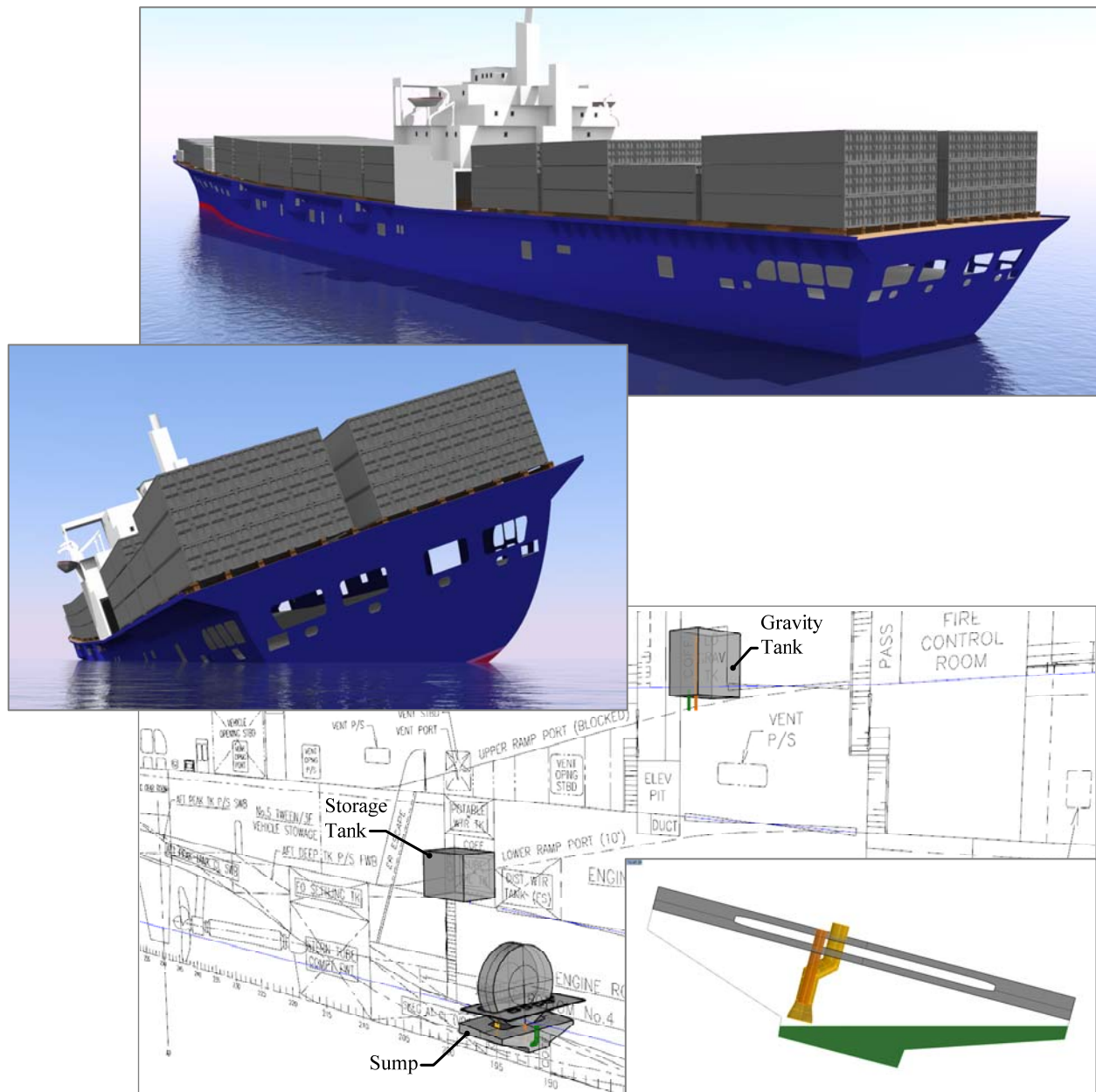

Weekly Notes are issued by the Coast Guard Marine Safety Center's Tonnage Division (MSC-4) for use by organizations that perform measurement work on the Coast Guard's behalf. They are for informational purposes only, and are not intended as, nor should they be construed to represent, revisions of or substitutes for applicable statutes or regulations or established interpretations of either.

MEASUREMENT ORGANIZATION WEEKLY NOTES – 10/04/2017

IMO CONSOLIDATED AUDIT FINDINGS Last month, IMO released its latest annual flag State Consolidated Audit Summary Report (CASR). The report was the subject of discussions at last week's Implementation Subcommittee meeting in London, which included comments by the Deputy Secretary General urging work to address "significant problems" with third party (ACS) agreements. The report included 13 separate findings related to lack of interpretations of various IMO instruments, including the 1969 Tonnage Convention.



IMO INTERNATIONAL
MARITIME
ORGANIZATION

E

4 ALBERT EMBANKMENT
LONDON SE1 7SR
Telephone: +44 (0)20 7735 7611 Fax: +44 (0)20 7587 3210

Circular Letter No.3772
4 September 2017

To: All IMO Member States

Subject: **IMO Member State Audit Scheme – Consolidated Audit Summary Report (CASR)**

1 The Secretary-General has the honour to transmit herewith the first consolidated audit summary report (CASR) prepared in accordance with paragraph 7.4.3 of the Procedures for the IMO Member State Audit (resolution A.1067(28)), containing lessons learned from eighteen mandatory audits that were completed in 2016.

2 The CASR, which is intended to facilitate the attainment of three of the objectives of the Scheme as contained in paragraphs 5.2.1, 5.2.3 and 5.2.4 of the Scheme's Framework, has been developed to reflect the findings and observations issued during audits, as well as corresponding summaries of root causes identified by the audited States and summaries of corrective actions taken or proposed by the Member State, which provide valuable lessons for Member States. The CASR also contains best practices revealed in audits, in order to share them with Member States, with a view to assisting them to enhance further their implementation and enforcement of mandatory IMO instruments.

3 In order to enable the Organization to further consider the effectiveness and appropriateness of its legislation and to facilitate provision of technical assistance to Member States in those areas identified in audits, future CASRs will continue to be issued as Circular Letters, as and when the reporting from a reasonable number of audits have been completed. A reference to each Circular Letter issued will be included in the document reporting to the Council and Assembly on progress made in the implementation of the Scheme.

COLUMBUS DAY HOLIDAY The Marine Safety Center will be closed on Monday, October 9, 2017 in observance of the Columbus Day holiday.

Weekly Notes are issued by the Coast Guard Marine Safety Center's Tonnage Division (MSC-4) for use by organizations that perform measurement work on the Coast Guard's behalf. They are for informational purposes only, and are not intended as, nor should they be construed to represent, revisions of or substitutes for applicable statutes or regulations or established interpretations of either.

MEASUREMENT ORGANIZATION WEEKLY NOTES – 09/27/2017

OVERSIGHT ALIGNMENT As part of several broader initiatives, the Marine Safety Center is reviewing its ACS oversight processes and procedures, and examining opportunities for better alignment with the RO Code and other International instruments. One area of discussion is how ACS technical work (including issuance of tonnage certificates) is being reported to various flag States. We are particularly interested in reporting methods that might offer advantages over our current Excel notification process. If you would like to share information on this subject, please contact Mr. Marcus Akins.

IMO FLAG STATE AUDITS Further to the entry above, we offer the following excerpt from a recent IMO Consolidated Audit Summary Report as an example of how IMO writes up findings against flag States. Under the new IMO mandatory audit scheme, flag States (including the United States) are audited for their compliance with International instruments, including the 1969 Tonnage Convention.

OB

421 The maritime administration and Port Authority had not established nor participated in an oversight programme for monitoring of ROs (III Code, part 2, paragraph 20).

Corrective action

422 Arrangements will be entered into with other Administrations or entities which have expertise to undertake oversight and monitoring of Recognized Organizations (ROs).

423 Procedures establishing periodicity of monitoring, review of reports and follow-up with ROs based on findings will be included in the maritime administration's QMS.

424 The maritime administration and the Port Authority will enter into an MOU for mutual recognition/acceptance and monitoring/oversight of ROs and of surveyors to whom flag State services are delegated.

425 The deadline for the implementation of this corrective action is 30 September 2019.

Root cause

426 There was insufficient personnel with the requisite expertise to carry out the oversight programme.

Weekly Notes are issued by the Coast Guard Marine Safety Center's Tonnage Division (MSC-4) for use by organizations that perform measurement work on the Coast Guard's behalf. They are for informational purposes only, and are not intended as, nor should they be construed to represent, revisions of or substitutes for applicable statutes or regulations or established interpretations of either.

MEASUREMENT ORGANIZATION WEEKLY NOTES – 09/20/2017

MSC WEB PAGES As previously mentioned, the Coast Guard has transitioned some of its uscg.mil web pages, including those for the [Marine Safety Center](#) (MSC), to a new platform. As part of a broader initiative to improve MSC communications with its external customers, we are exploring options to provide a better end-user experience on this new platform (e.g., audio, video, and other web elements commonly found on private sector websites). If you have any suggestions for how to make our web pages - including the [U.S. Tonnage Publications](#) page shown below - more useful, please contact Mr. Marcus Akins.

The screenshot shows the U.S. Coast Guard website's navigation and content. At the top left is the Coast Guard logo and the text "UNITED STATES COAST GUARD DEPARTMENT OF HOMELAND SECURITY". A search bar is located at the top right. Below the header is a dark blue navigation bar with links: OPERATIONS HOME, OUR ORGANIZATION, FEATURED CONTENT, ABOUT US, JOIN THE COAST GUARD, and CONTACT US. A left sidebar contains a menu for the Tonnage Division (MSC-4) with items: U.S. TONNAGE PUBLICATIONS, IMO TONNAGE PUBLICATION, SIMPLIFIED TONNAGE FORM (CG-53), DOCUMENTATION AND RELATED LI, MARINE SAFETY CENTER, and CONTACT TONNAGE PERSONNEL. Below the menu is a "Social Media" section with three Facebook posts and social media icons for Facebook (720,837 likes) and Twitter (5,584 followers). The main content area is titled "U.S. Tonnage Publications" and lists several links: Tonnage Regulations (46 CFR Part 69), 2016 (Current) Tonnage Regulations, 2014 Tonnage Regulations, Tonnage Regulations - Final Rule, Tonnage Regulations - Notice for Proposed Rulemaking (NPRM), Marine Safety Center Technical Notes (MTNs), MTN 01-99 CH-9 - Tonnage Technical Policy, MTN 01-98 CH-13 - Tonnage Administrative Policy, MTN 04-03 CH-3 - Technical Support and Oversight of Authorized Classification Societies, MTN 04-03 CH-3 Enclosure (1) - ACS Notification Worksheet, Navigation and Vessel Inspection Circulars (NVICs), NVIC 11-93 CH-3- Applicability of Tonnage Measurement Systems to U.S. Flag Vessels, IMO Tonnage Rules and Interpretations (TM Convention), TM Convention - Draft Text Version With Figures, Marine Safety Center Tonnage Guides, Tonnage Guide 1 - Simplified Measurement, and Tonnage Guide 2 - Measurement of Navy and Coast Guard Vessels.

HURRICANE HARVEY EFFECTS We are pleased to report that Lloyd's Register of Shipping's Houston offices are again open for normal business following a closure due to flooding from Hurricane Harvey.

Weekly Notes are issued by the Coast Guard Marine Safety Center's Tonnage Division (MSC-4) for use by organizations that perform measurement work on the Coast Guard's behalf. They are for informational purposes only, and are not intended as, nor should they be construed to represent, revisions of or substitutes for applicable statutes or regulations or established interpretations of either.

MEASUREMENT ORGANIZATION WEEKLY NOTES – 09/13/2017

GRAPHICAL REPRESENTATIONS Among other things, MTN 01-98 CH-13 requires the following graphical representations for a vessel being measured for the first time:

Vessel Profile An outboard or inboard profile, identifying the location of the rudder stock axis (if applicable), the waterline at 85 percent of the least molded depth, and the termination points of the vessel's overall length, registered length, and registered depth, with all dimensions labeled.

Transverse Section The transverse section at amidships (as defined in § 69.53 of MTN 01-99 as amended), identifying the termination points of the vessel's registered breadth and registered depth, with all dimensions labeled.

Further to the discussion in the 11/16/2016 edition of the Weekly Notes, we developed the following updated figure, which we hope better illustrates what is required. The figure eliminates unnecessary detail from the earlier version. It also reflects adjustments for clarity and simplicity, and to properly align the profile and section drawings with respect to the molded depth dimension, which remains a source of confusion. We are considering a figure along these lines for inclusion in either Tonnage Guide 4 (TG-4), *Registered Dimensions Under Formal Systems*, or the MTN.

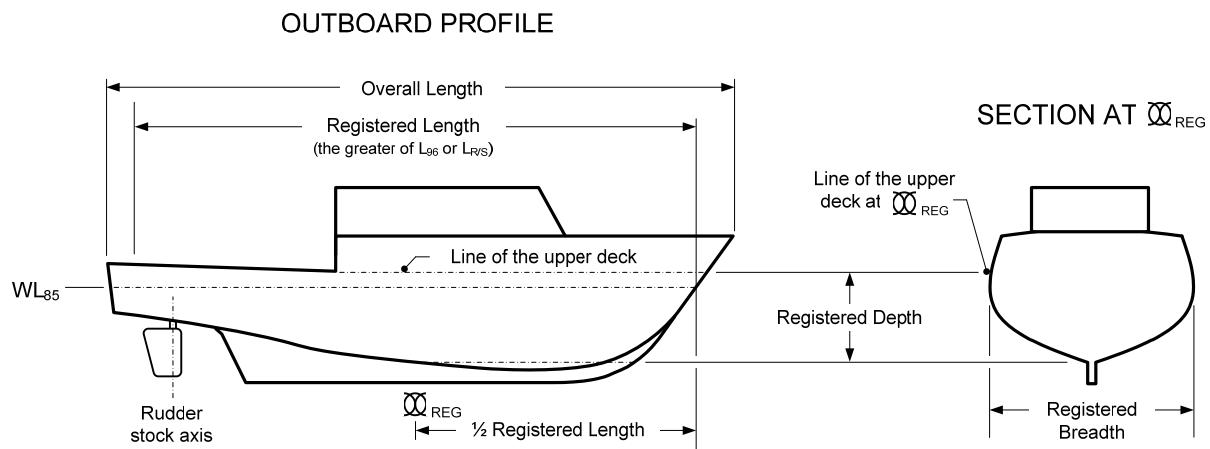

TONNAGE PERSONNEL As a reminder, Mr. Tony Cao will be out of the office until Monday, September 18, 2017. During this time, please copy Mr. David Karnes on any CG number requests.

Weekly Notes are issued by the Coast Guard Marine Safety Center's Tonnage Division (MSC-4) for use by organizations that perform measurement work on the Coast Guard's behalf. They are for informational purposes only, and are not intended as, nor should they be construed to represent, revisions of or substitutes for applicable statutes or regulations or established interpretations of either.

MEASUREMENT ORGANIZATION WEEKLY NOTES – 09/06/2017

FASTENERS FOR TEMPORARY COVERS The Tonnage Division recently responded to a question on the accessibility of cover plate fasteners (see configuration in question below). ACSs should note that anything used to “hide” the portions of the fasteners to which access is required must be of a temporary nature and attached only to the cover plate. We recognize that determining whether fasteners are considered “accessible” as required under § 69.117(d)(6')(iii) of MTN 01-99 CH-9 may be problematic when tonnage openings are fitted into structural fire protection or reefer/freezer boundaries. Should you come across a cover plate configuration where accessibility of the fasteners is in question, please contact Mr. Marcus Akins to discuss compliance with the MTN.



HURRICANE HARVEY IMPACTS Due to flooding from Hurricane Harvey, Lloyd's Register of Shipping's Houston offices remain closed until further notice. We are pleased to report that the ABS and DNV GL offices in the Houston area are again open for normal business.

TONNAGE PERSONNEL Mr. Tony Cao will be out of the office beginning Friday, September 8 and returning Monday, September 18, 2017. During that time, please copy Mr. David Karnes on any CG number requests.

Weekly Notes are issued by the Coast Guard Marine Safety Center's Tonnage Division (MSC-4) for use by organizations that perform measurement work on the Coast Guard's behalf. They are for informational purposes only, and are not intended as, nor should they be construed to represent, revisions of or substitutes for applicable statutes or regulations or established interpretations of either.

MEASUREMENT ORGANIZATION WEEKLY NOTES – 08/30/2017

PROPRIETARY DRAWINGS Recently, a U.S. tonnage certification action was delayed pending availability of hull descriptive information, which a shipyard considered “proprietary”. In hindsight, the vessel owner could probably have intervened to expedite the release of the needed information. ACSs are encouraged to remind owners of the requirement to submit copies of the lines plan and booklet of offsets when applying for measurement services (see 46 CFR 69.55 & 69.105), recognizing that ACSs may accept applications lacking such submissions provided that, in the end, the minimum requirements for tonnage file contents are met. (See § 6.2 of MTN 01-98 CH-13, an excerpt of which is below.)

(i) Convention Measurement System Measurement organizations may use any calculation format that meets the minimum requirements of this section. If tonnages are generated using computer modeling tools, include written or electronic output showing all dimensions involved in the calculations and their locations (e.g., hull and superstructure offsets, or an equivalent geometrical description as reflected in a *International Graphics Exchange Interface (IGES)* or *Standard for the Exchange of Product Model Data (STEP)* file, or any similar computer aided design format authorized by the National Records Administration for permanent electronic records).

Related instruction from the Application for Formal Measurement Services:

14. SUBMITTED DRAWINGS

Indicate all drawings submitted with the application by checking the applicable boxes. If other drawings are submitted, describe them in Item 16. Note that drawing submission for initial measurement and remeasurement following configuration changes is required by the tonnage regulations. Measurement organizations may assess additional fees to develop, or otherwise obtain, required drawings that are not included as part of the application package.

LABOR DAY HOLIDAY The Marine Safety Center will be closed on Monday, September 4, 2017 in observance of the Labor Day holiday.

HURRICANE HARVEY Our thoughts and prayers go out to all of those in the Gulf areas affected by Hurricane Harvey. We hope that all of our friends and associates, as well as their families, are safe. We understand that the ABS Americas and DNV GL offices in the Houston area are closed until further notice, but are hopeful that they can get back to normal operations before too long.

Weekly Notes are issued by the Coast Guard Marine Safety Center's Tonnage Division (MSC-4) for use by organizations that perform measurement work on the Coast Guard's behalf. They are for informational purposes only, and are not intended as, nor should they be construed to represent, revisions of or substitutes for applicable statutes or regulations or established interpretations of either.

MEASUREMENT ORGANIZATION WEEKLY NOTES – 08/23/2017

CONTAINERS AND EXCLUDED SPACE CLOSURE One condition for excluding any enclosed space from tonnage under the TM Convention is that “the construction provides any possibility of such openings being closed”. A question that remains unsettled is whether containers and other cargo could be considered to effectively close the opening, depending on proximity and other factors. An example is the mooring deck space on certain containership designs, which is completely open from above except when containers are loaded (see image below). We welcome your input, especially if you are aware of any related International, IACS, or other flag State interpretations on this subject.



TONNAGE PERSONNEL Mr. Marcus Akins will be out of the office on Friday, August 25 and Monday, August 28, 2017. During that time, please copy Mr. David Karnes on any urgent file requests. Also, Mr. Tony Cao will be out through Friday, August 25. In his absence, please copy Mr. Karnes on any CG number requests to ensure efficient service.

Weekly Notes are issued by the Coast Guard Marine Safety Center's Tonnage Division (MSC-4) for use by organizations that perform measurement work on the Coast Guard's behalf. They are for informational purposes only, and are not intended as, nor should they be construed to represent, revisions of or substitutes for applicable statutes or regulations or established interpretations of either.

MEASUREMENT ORGANIZATION WEEKLY NOTES – 08/16/2017

TONNAGE AND LOAD LINE The Marine Safety Center is implementing a new framework for load line oversight, which includes cross-checks of certain inputs for load line calculations, against information used in certifying tonnage. An example is the vessel's displacement at an 85% waterline, which is used in freeboard calculations, and which may also be obtained - with adjustments - from hull models created for tonnage measurement purposes. Mr. Tony Cao of the Tonnage Division has been heading this initiative, and would welcome any input on the load line / tonnage nexus.

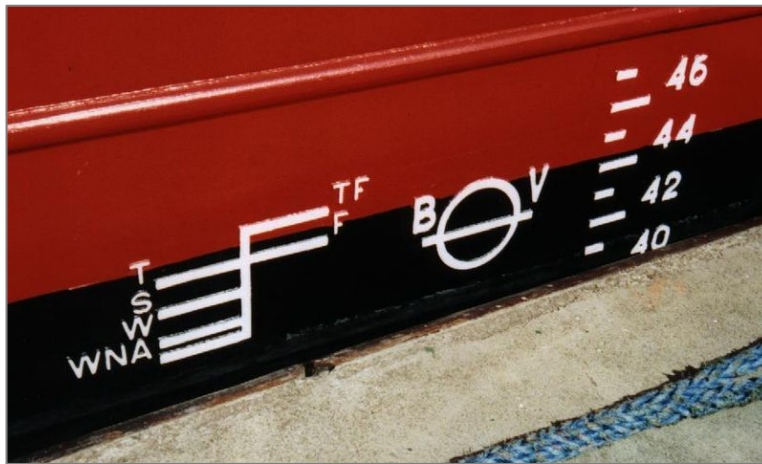

ACCEPTANCE BY MADAGASCAR Subsequent to the recent accession by Seychelles, IMO published TM.2/Circ.151, which states that the Tonnage Convention will enter into force for the Republic of Madagascar on October 27, 2017 following the deposit of an instrument of acceptance on July 27, 2017. This brings to 155 the number of Contracting States to the Convention.

Weekly Notes are issued by the Coast Guard Marine Safety Center's Tonnage Division (MSC-4) for use by organizations that perform measurement work on the Coast Guard's behalf. They are for informational purposes only, and are not intended as, nor should they be construed to represent, revisions of or substitutes for applicable statutes or regulations or established interpretations of either.

MEASUREMENT ORGANIZATION WEEKLY NOTES – 08/09/2017

ACCESSION BY SEYCHELLES IMO recently published TM.2/Circ.150, which states that the Tonnage Convention will enter into force for the Republic of Seychelles on October 17, 2017 following the deposit of an instrument of accession on July 17, 2017. At present, there are 154 Contracting States to the Convention, representing approximately 99.03% of the gross tonnage of the world's merchant shipping.

USCG & TONNAGE BIRTHDAYS Last Friday, the Coast Guard celebrated its 227th birthday, as counted from August 4, 1790, when Congress authorized the Secretary of the Treasury to create a maritime service to enforce customs laws. Not to be outdone, the tonnage program observed its own birthday marking 228 years from the passage of the fifth Act of the First Congress, which regulated the collection of the duties imposed by law on the tonnage of ships.

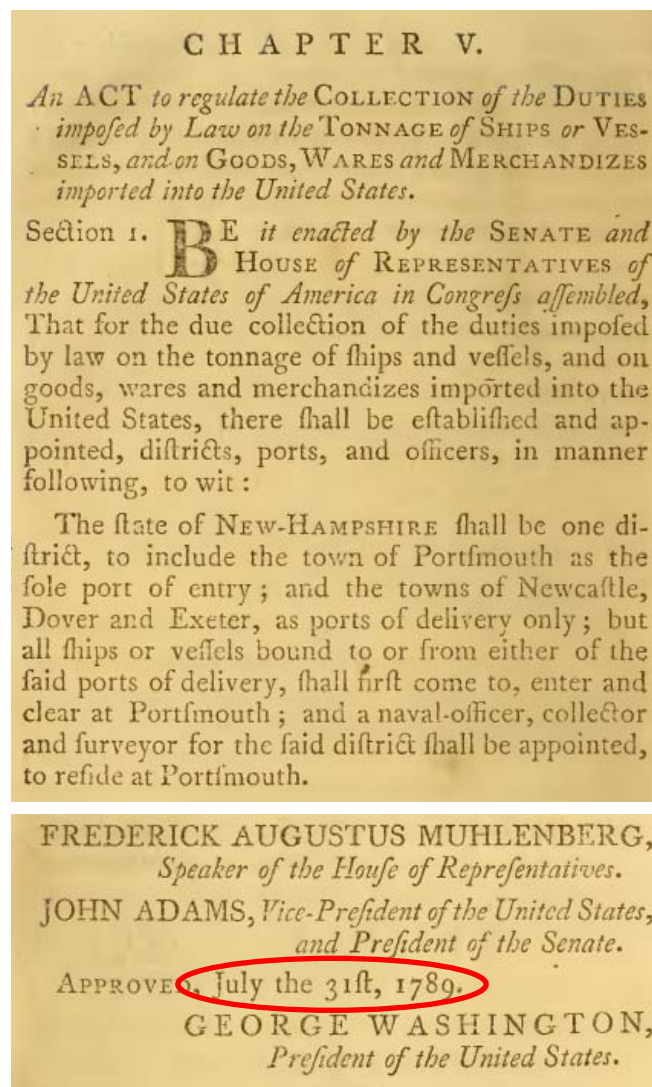

Weekly Notes are issued by the Coast Guard Marine Safety Center's Tonnage Division (MSC-4) for use by organizations that perform measurement work on the Coast Guard's behalf. They are for informational purposes only, and are not intended as, nor should they be construed to represent, revisions of or substitutes for applicable statutes or regulations or established interpretations of either.

MEASUREMENT ORGANIZATION WEEKLY NOTES – 08/02/2017

DRAWING REQUIREMENTS We recently responded to an inquiry regarding drawing submissions when applying for formal measurement. We noted that the minimum drawing requirements of § 6.2 of MTN 01-98 CH-13 for tonnage file purposes should not be confused with drawing requirements specified in the tonnage regulations for measurement application purposes, and that ACSs have considerable latitude in assessing whether submitted drawings are adequate. We encourage ACSs to ensure that Applications for Formal Measurement Services (shown below) and their accompanying submitted drawings are complete prior to acceptance.

U.S. TONNAGE REGULATIONS APPLICATION FOR FORMAL MEASUREMENT SERVICES		MTN 01-98 as amended																																
<p align="center">I. APPLICABILITY</p> <p>A U.S. flag vessel is eligible to be measured under the Convention system (46 CFR 69 subpart B) if it is 79 feet or more in overall length. Also, any U.S. flag vessel, regardless of length, may be measured under the Standard system (46 CFR 69 subpart C) or Dual system (46 CFR 69 subpart D). Some vessels, including those that are less than 79 feet in overall length, are eligible to be measured under the Simplified system (46 CFR 69 subpart E), without the need for formal measurement. Refer to section 69.11 of 46 CFR 69 for complete measurement eligibility details.</p>																																		
<p align="center">II. APPLICATION INFORMATION</p>																																		
<p>*1. REQUESTED SERVICE (see instructions on reverse)</p> <p><input type="checkbox"/> INITIAL MEASUREMENT (indicate measurement system(s))</p> <p><input type="checkbox"/> Subpart B - Convention system (GT/ITC/NT/ITC)</p> <p><input type="checkbox"/> Subpart C - Standard system (GRT/NRT)</p> <p><input type="checkbox"/> Subpart D - Dual system (GRT/NRT)</p> <p><input type="checkbox"/> REMEASUREMENT (indicate reason(s))</p> <p><input type="checkbox"/> Configuration changes</p> <p><input type="checkbox"/> Change in passengers or draft</p> <p><input type="checkbox"/> Correction of measurement errors</p> <p><input type="checkbox"/> Other (describe in remarks)</p> <p><input type="checkbox"/> OTHER (describe in remarks)</p> <p>*2. REQUESTED TONNAGE CERTIFICATE(S): <input type="checkbox"/> US <input type="checkbox"/> ITC69</p> <p>*3. VESSEL NAME _____</p> <p>*4. VESSEL NUMBER _____</p> <p>5. HAILING PORT _____</p> <p>6. BUILDER'S NAME _____</p> <p>7. HIN OR HULL NUMBER _____</p> <p>8. PLACE BUILT _____</p> <p>9. KEEL LAID / ALTERATION DATE _____</p> <p>10. DELIVERY DATE _____</p> <p>11. VESSEL TYPE</p> <table border="0"> <tr> <td><input type="checkbox"/> Barge</td> <td><input type="checkbox"/> Passenger</td> </tr> <tr> <td><input type="checkbox"/> Fishing</td> <td><input type="checkbox"/> Recreational</td> </tr> <tr> <td><input type="checkbox"/> Fish Processing</td> <td><input type="checkbox"/> Research</td> </tr> <tr> <td><input type="checkbox"/> Fish Tender</td> <td><input type="checkbox"/> Tanker</td> </tr> <tr> <td><input type="checkbox"/> Freight</td> <td><input type="checkbox"/> Towing</td> </tr> <tr> <td><input type="checkbox"/> Industrial</td> <td><input type="checkbox"/> Training</td> </tr> <tr> <td><input type="checkbox"/> Mobile Offshore Drilling Unit</td> <td><input type="checkbox"/> Unclassified</td> </tr> <tr> <td><input type="checkbox"/> Offshore Supply</td> <td><input type="checkbox"/> Warship</td> </tr> <tr> <td><input type="checkbox"/> Oil Spill Response</td> <td></td> </tr> </table>	<input type="checkbox"/> Barge	<input type="checkbox"/> Passenger	<input type="checkbox"/> Fishing	<input type="checkbox"/> Recreational	<input type="checkbox"/> Fish Processing	<input type="checkbox"/> Research	<input type="checkbox"/> Fish Tender	<input type="checkbox"/> Tanker	<input type="checkbox"/> Freight	<input type="checkbox"/> Towing	<input type="checkbox"/> Industrial	<input type="checkbox"/> Training	<input type="checkbox"/> Mobile Offshore Drilling Unit	<input type="checkbox"/> Unclassified	<input type="checkbox"/> Offshore Supply	<input type="checkbox"/> Warship	<input type="checkbox"/> Oil Spill Response		<p>12. OVERALL HULL DIMENSIONS</p> <p>13. DRAFT RESTRICTIONS: <input type="checkbox"/> Load Line <input type="checkbox"/> Other</p> <p><input type="checkbox"/> Stability Letter</p> <p>14. INTENDED VOYAGES: <input type="checkbox"/> Domestic <input type="checkbox"/> Great Lakes</p> <p><input type="checkbox"/> Foreign</p> <p>14. SUBMITTED DRAWINGS (check all submitted with application)</p> <table border="1"> <thead> <tr> <th>General Arrangements</th> <th>Construction</th> <th>Miscellaneous</th> </tr> </thead> <tbody> <tr> <td><input type="checkbox"/> Outboard Profile</td> <td><input type="checkbox"/> Midship Section</td> <td><input type="checkbox"/> Lines</td> </tr> <tr> <td><input type="checkbox"/> Inboard Profile</td> <td><input type="checkbox"/> Framing Plans</td> <td><input type="checkbox"/> Cargo</td> </tr> <tr> <td><input type="checkbox"/> Deck Arrangements</td> <td><input type="checkbox"/> Shell Expansion</td> <td><input type="checkbox"/> Tonnage</td> </tr> <tr> <td><input type="checkbox"/> Bow/Stern/Topside</td> <td><input type="checkbox"/> Other</td> <td><input type="checkbox"/> Other</td> </tr> </tbody> </table> <p>15. POINT OF CONTACT</p> <p>16. REMARKS</p>	General Arrangements	Construction	Miscellaneous	<input type="checkbox"/> Outboard Profile	<input type="checkbox"/> Midship Section	<input type="checkbox"/> Lines	<input type="checkbox"/> Inboard Profile	<input type="checkbox"/> Framing Plans	<input type="checkbox"/> Cargo	<input type="checkbox"/> Deck Arrangements	<input type="checkbox"/> Shell Expansion	<input type="checkbox"/> Tonnage	<input type="checkbox"/> Bow/Stern/Topside	<input type="checkbox"/> Other	<input type="checkbox"/> Other
<input type="checkbox"/> Barge	<input type="checkbox"/> Passenger																																	
<input type="checkbox"/> Fishing	<input type="checkbox"/> Recreational																																	
<input type="checkbox"/> Fish Processing	<input type="checkbox"/> Research																																	
<input type="checkbox"/> Fish Tender	<input type="checkbox"/> Tanker																																	
<input type="checkbox"/> Freight	<input type="checkbox"/> Towing																																	
<input type="checkbox"/> Industrial	<input type="checkbox"/> Training																																	
<input type="checkbox"/> Mobile Offshore Drilling Unit	<input type="checkbox"/> Unclassified																																	
<input type="checkbox"/> Offshore Supply	<input type="checkbox"/> Warship																																	
<input type="checkbox"/> Oil Spill Response																																		
General Arrangements	Construction	Miscellaneous																																
<input type="checkbox"/> Outboard Profile	<input type="checkbox"/> Midship Section	<input type="checkbox"/> Lines																																
<input type="checkbox"/> Inboard Profile	<input type="checkbox"/> Framing Plans	<input type="checkbox"/> Cargo																																
<input type="checkbox"/> Deck Arrangements	<input type="checkbox"/> Shell Expansion	<input type="checkbox"/> Tonnage																																
<input type="checkbox"/> Bow/Stern/Topside	<input type="checkbox"/> Other	<input type="checkbox"/> Other																																
<p align="center">III. STATEMENT OF REPRESENTATION</p> <p>I understand that under the provisions of 46 CFR 69.25, a person making a false statement or representation in this application may be fined up to \$30,000 and that the vessel also is liable in rem for the penalty. I also acknowledge that I am required by 46 CFR 69.19 to report immediately to an authorized measurement organization any intent to structurally alter the vessel or to change its service or the use of its space. I certify that the information provided by me on this application, or in any attachments thereto, is correct.</p> <p>Owner's printed name _____ Owner's signature _____ Date _____</p> <p>Formal Application (08/14) Page 1 of 2</p>																																		

14. SUBMITTED DRAWINGS
Indicate all drawings submitted with the application by checking the applicable boxes. If other drawings are submitted, describe them in Item 16. Note that drawing submission for initial measurement and remeasurement following configuration changes is required by the tonnage regulations. Measurement organizations may assess additional fees to develop, or otherwise obtain, required drawings that are not included as part of the application package.

Weekly Notes are issued by the Coast Guard Marine Safety Center's Tonnage Division (MSC-4) for use by organizations that perform measurement work on the Coast Guard's behalf. They are for informational purposes only, and are not intended as, nor should they be construed to represent, revisions of or substitutes for applicable statutes or regulations or established interpretations of either.

MEASUREMENT ORGANIZATION WEEKLY NOTES – 07/26/2017

ITC69 REISSUANCE FOLLOWING CHANGE OF FLAG During recent oversight reviews of vessels that had been issued new International Tonnage Certificates to reflect changes to U.S. flag, we noticed tonnage files that do not meet content requirements. Please note that for such vessels, ACS's must assign tonnages and certify dimensions as though they were initial measurements using current regulations, interpretations, and administrative requirements (e.g., for file content). As U.S. administrative requirements may differ from those of other flag States or IACS, ACS's should consider including them in country files, in addition to technical interpretations.

CG NUMBER REQUESTS Mr. Tony Cao has assumed responsibility for assignment of CG numbers, taking over for Mr. David Karnes. For efficient service, please be sure to send requests to msc@uscg.mil, copying Mr. Cao.

MEASUREMENT ORGANIZATION WEEKLY NOTES – 07/19/2017

HULL NUMBER DISCREPANCY We recently responded to an inquiry regarding a discrepancy in hull numbers, in which one submitted for documentation purposes did not match that on the vessel's U.S. Tonnage Certificate. In this case, the ACS had correctly certified the hull number assigned by the builder. However, if the ACS had certified an incorrect hull number, vessel documentation may have been delayed until a revised tonnage certificate was issued. This highlights the importance of ensuring the correctness of vessel information listed on an owner's Application for Formal Measurement Services.

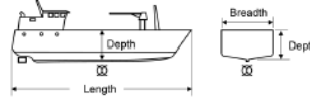
U.S. TONNAGE REGULATIONS APPLICATION FOR FORMAL MEASUREMENT SERVICES		MTN 01-68 as amended														
I. APPLICABILITY A U.S. flag vessel is eligible to be measured under the Convention system (46 CFR 69 subpart B) if it is 79 feet or more in overall length. Also, any U.S. flag vessel, regardless of length, may be measured under the Standard system (46 CFR 69 subpart C) or Dual system (46 CFR 69 subpart D). Some vessels, including those that are less than 79 feet in overall length, are eligible to be measured under the Simplified system (46 CFR 69 subpart E), without the need for formal measurement. Refer to section 69.11 of 46 CFR 69 for complete measurement eligibility details.																
II. APPLICATION INFORMATION																
*1. REQUESTED SERVICE (see instructions on reverse) <input type="checkbox"/> INITIAL MEASUREMENT (indicate measurement system(s)) <input type="checkbox"/> Subpart B - Convention system (GT ITC/NT ITC) <input type="checkbox"/> Subpart C - Standard system (GRT/NRT) <input type="checkbox"/> Subpart D - Dual system (GRT/NRT) <input type="checkbox"/> REMEASUREMENT (indicate reason(s)) <input type="checkbox"/> Configuration changes <input type="checkbox"/> Change in passengers or draft <input type="checkbox"/> Correction of measurement errors <input type="checkbox"/> Other (describe in remarks) <input type="checkbox"/> OTHER (describe in remarks)	12. OVERALL HULL DIMENSIONS Length = _____ ft Breadth = _____ ft Depth = _____ ft 															
*2. REQUESTED TONNAGE CERTIFICATE(S): <input type="checkbox"/> US <input type="checkbox"/> ITC69	13. ADDITIONAL VESSEL INFORMATION a. PROPULSION: <input type="checkbox"/> Self-Propelled <input type="checkbox"/> Non-Self-Propelled b. NUMBER OF PASSENGERS: Total: _____ Accommodated in cabins for 8 or fewer: _____ c. NUMBER OF CARGO SPACES: _____ d. NUMBER OF PORTABLE ENCLOSED SPACES: _____ e. DRAFT RESTRICTIONS: <input type="checkbox"/> Load Line <input type="checkbox"/> Other <input type="checkbox"/> Stability Letter f. INTENDED VOYAGES: <input type="checkbox"/> Domestic <input type="checkbox"/> Great Lakes <input type="checkbox"/> Foreign															
*3. VESSEL NAME _____	14. SUBMITTED DRAWINGS (check all submitted with application) <table border="1"><thead><tr><th>General Arrangements</th><th>Construction</th><th>Miscellaneous</th></tr></thead><tbody><tr><td><input type="checkbox"/> Outboard Profile</td><td><input type="checkbox"/> Midship Section</td><td><input type="checkbox"/> Lines</td></tr><tr><td><input type="checkbox"/> Inboard Profile</td><td><input type="checkbox"/> Framing Plans</td><td><input type="checkbox"/> Cargo</td></tr><tr><td><input type="checkbox"/> Deck Arrangements</td><td><input type="checkbox"/> Shell Expansion</td><td><input type="checkbox"/> Tonnage</td></tr><tr><td><input type="checkbox"/> Bow/Stern/Topside</td><td><input type="checkbox"/> Other</td><td><input type="checkbox"/> Other</td></tr></tbody></table>	General Arrangements	Construction	Miscellaneous	<input type="checkbox"/> Outboard Profile	<input type="checkbox"/> Midship Section	<input type="checkbox"/> Lines	<input type="checkbox"/> Inboard Profile	<input type="checkbox"/> Framing Plans	<input type="checkbox"/> Cargo	<input type="checkbox"/> Deck Arrangements	<input type="checkbox"/> Shell Expansion	<input type="checkbox"/> Tonnage	<input type="checkbox"/> Bow/Stern/Topside	<input type="checkbox"/> Other	<input type="checkbox"/> Other
General Arrangements	Construction	Miscellaneous														
<input type="checkbox"/> Outboard Profile	<input type="checkbox"/> Midship Section	<input type="checkbox"/> Lines														
<input type="checkbox"/> Inboard Profile	<input type="checkbox"/> Framing Plans	<input type="checkbox"/> Cargo														
<input type="checkbox"/> Deck Arrangements	<input type="checkbox"/> Shell Expansion	<input type="checkbox"/> Tonnage														
<input type="checkbox"/> Bow/Stern/Topside	<input type="checkbox"/> Other	<input type="checkbox"/> Other														
*4. VESSEL NUMBER _____	*15. POINT OF CONTACT															
*5. HAULING PORT _____	16. REMARKS															
*6. BUILDER'S NAME _____																
*7. HIN OR HULL NUMBER _____																
8. PLACE BUILT _____																
9. KEEL LAID / ALTERATION DATE _____																
10. DELIVERY DATE _____																
11. VESSEL TYPE <input type="checkbox"/> Barge <input type="checkbox"/> Passenger <input type="checkbox"/> Fishing <input type="checkbox"/> Recreational <input type="checkbox"/> Fish Processing <input type="checkbox"/> Research <input type="checkbox"/> Fish Tender <input type="checkbox"/> Tanker <input type="checkbox"/> Freight <input type="checkbox"/> Towing <input type="checkbox"/> Industrial <input type="checkbox"/> Training <input type="checkbox"/> Mobile Offshore Drilling Unit <input type="checkbox"/> Unclassified <input type="checkbox"/> Offshore Supply <input type="checkbox"/> Warship <input type="checkbox"/> Oil Spill Response																
III. STATEMENT OF REPRESENTATION I understand that under the provisions of 46 CFR 69.25, a person making a false statement or representation in this application may be fined up to \$30,000 and that the vessel also is liable in rem for the penalty. I also acknowledge that I am required by 46 CFR 69.19 to report immediately to an authorized measurement organization any intent to structurally alter the vessel or to change its service or the use of its space. I certify that the information provided by me on this application, or in any attachments thereto, is correct. Owner's printed name _____ Owner's signature _____ Date _____ Formal Application (08/14) Page 1 of 2																

CONVENTION MILESTONE ANNIVERSARY July 18, 2017 marks the 35th anniversary of the 1969 Tonnage Convention's coming into force (1982). A sufficient number of nations, representing not less than 65% of the gross tonnage of the world's merchant shipping, triggered the Convention's coming into force when Japan accepted it 24 months earlier on July 17, 1980.

Weekly Notes are issued by the Coast Guard Marine Safety Center's Tonnage Division (MSC-4) for use by organizations that perform measurement work on the Coast Guard's behalf. They are for informational purposes only, and are not intended as, nor should they be construed to represent, revisions of or substitutes for applicable statutes or regulations or established interpretations of either.

MEASUREMENT ORGANIZATION WEEKLY NOTES – 07/12/2017

CG WEBSITES UPDATE As mentioned previously, the Coast Guard’s website transition continues, with some web pages having changed addresses (e.g., that for the [Tonnage Division](#), subsequent to the last Weekly Notes edition). We apologize for any inconvenience changing URLs may cause and will provide further updates in the coming weeks. Please note the following new links:

Marine Safety Center (MSC): www.dco.uscg.mil/msc
 MSC Tonnage Division: www.dco.uscg.mil/msc/tonnage-division

EXCEL NOTIFICATION FILE As a reminder, this spring the MSC updated the Excel notification file for reporting completed work done on the Coast Guard’s behalf. This latest version (available on the [U.S. Tonnage Publications](#) page as Enclosure (1) to MTN 04-03 as amended) includes several features that facilitate more consistent data entry. For example, its error checking function highlights cells missing required data and provides relevant error messages. Please note that in order to see all columns (A through T), it may be necessary to scroll within the window.

	A	B	C	D	E	F	G	H	I	J
1	ACS	Authority	ACS ID No.	Submittal ID No.	Plan Name/Tonnage Assignment/Loadline Assignment	Plan or Certificate Number	Revision	Revision Date	Primary System	Secondary System
2	REQUIRED	REQUIRED	REQUIRED	Optional	REQUIRED	Plans/Certs only	Plans Only	Plans Only	REQUIRED	Optional
3	TONNAGE		12345		US					Tonnage Measurement (Initial)
4										
5										

K	L	M	N	O	P	Q	R	S	T
ACS Approval Date	Vessel Name	Vessel Operating Subchapter	Builder Name	Hull No.	MSC Project No.	Unique Vessel ID Number	Unique Vessel ID Number Type		Total error(s) found on this sheet:
REQUIRED	see comment	see comment	REQUIRED	REQUIRED	see comment	see comment	see comment		4
7/12/2017	MISTY		Chris-Craft, Inc.						Required cell contains no data

Weekly Notes are issued by the Coast Guard Marine Safety Center’s Tonnage Division (MSC-4) for use by organizations that perform measurement work on the Coast Guard’s behalf. They are for informational purposes only, and are not intended as, nor should they be construed to represent, revisions of or substitutes for applicable statutes or regulations or established interpretations of either.

MEASUREMENT ORGANIZATION WEEKLY NOTES – 07/05/2017

NEW CG WEBSITES As mentioned last week, the Coast Guard continues to shift all uscg.mil websites, including those for the Marine Safety Center (MSC) and its Tonnage Division, to a new platform with different web addresses. Although the older MSC uscg.mil site remains operational for now, its links do not redirect to the new sites (e.g., the [Tonnage Division's](#), shown below). We also note that some document links on the new U.S. Tonnage Publications page do not yet function. We will provide further updates in the coming weeks.

UNITED STATES COAST GUARD
DEPARTMENT OF HOMELAND SECURITY

Search U.S. Coast Guard

OPERATIONS HOME | ABOUT US | OUR ORGANIZATION | FEATURED CONTENT | JOIN THE COAST GUARD | CONTACT US

TONNAGE DIVISION (MSC-4)

U. S. TONNAGE PUBLICATIONS

IMO TONNAGE PUBLICATION

SIMPLIFIED TONNAGE FORM (CG-5397)

DOCUMENTATION AND RELATED LINKS

MARINE SAFETY CENTER

CONTACT TONNAGE PERSONNEL

Social Media

COAST GUARD We hope everyone enjoyed their Fourth of July celebrations! Crewmembers and th...

COAST GUARD Fourth of July is a day to celebrate our nation's independence. It's also a grea...

COAST GUARD The 2017 Warrior Games kicked off on June 30. Throughout

706,870 LIKE US → **5,519** FOLLOW US →

Marine Safety Center Tonnage Division

The Marine Safety Center's Tonnage Division has the overall responsibility for the U.S. tonnage measurement program, under which gross and net tonnages and registered dimensions are assigned to vessels. The following are specific responsibilities of the Division:

- Promulgate and interpret U.S. tonnage measurement rules through the issuance of regulations (e.g., 46 CFR 69) and interpretative guidance (e.g., MTN 01-99, as amended).
- Provide oversight of organizations that measure vessels on behalf of the U.S. Coast Guard.
- Administer the Simplified Regulatory Measurement system, under which qualifying U.S. flag vessels may be assigned tonnages based on dimensions submitted by the vessel's owner (or his/her representative).
- Coordinate with Federal Agencies, other Departments, State and local governments, the International Maritime Organization (IMO), and foreign governments.
- Assign gross/net tonnages and issue tonnage certificates to U.S. Navy warships and U.S. Coast Guard cutters.
- Maintain tonnage files for vessels that have been formally measured by the U.S. Coast Guard.

**Please use the links to the left to access U.S. tonnage measurement program information.

[Return to Marine Safety Center \(MSC\)](#)

TONNAGE PERSONNEL Mr. Marcus Akins will be out of the office on Friday, July 7, 2017. During that time, please copy Mr. David Karnes on any file requests.

Weekly Notes are issued by the Coast Guard Marine Safety Center's Tonnage Division (MSC-4) for use by organizations that perform measurement work on the Coast Guard's behalf. They are for informational purposes only, and are not intended as, nor should they be construed to represent, revisions of or substitutes for applicable statutes or regulations or established interpretations of either.

MEASUREMENT ORGANIZATION WEEKLY NOTES – 06/28/2017

UPCOMING CHANGES TO CG WEBSITES The Coast Guard has begun an effort to shift all uscg.mil websites, including those for the Marine Safety Center (MSC) and its Tonnage Division, to a new platform. As a result, addresses for the updated websites will change. We will provide further details in the weeks ahead.

United States Coast Guard
U.S. Department of Homeland Security

Contact Us | Frequently Asked Questions

Search Current Unit Search

USCG Home Overview Our Organization Our Missions Doing Business Join Us

Marine Safety Center (MSC)

Tonnage Division (MSC-4)

Contact Webmaster

Security Levels

MARSEC LEVEL 1 SIGNIFICANT RISK

National Terrorism Advisory System

NTAS
NATIONAL TERRORISM ADVISORY SYSTEM

U.S. COAST GUARD MARINE SAFETY CENTER
WASHINGTON, D.C.

WELCOME

The Marine Safety Center (MSC) supports the people and objectives of the Marine Safety, Security, and Environmental Protection programs through the verification of compliance with technical standards for the design, construction, alteration and repair of commercial vessels. The MSC is an independent Headquarters command that was established in 1986 by consolidating the Coast Guard Merchant Marine Technical offices located in New York, New Orleans, Cleveland and San Francisco. The MSC's primary mission is the review and approval of plans for the design, construction, alteration and repair of U.S. and foreign flag commercial vessels subject to the U.S. laws, regulations and international standards. The MSC has a current complement of 28 Officers, 23 Civilians, 2 Reservists, and 16 Contract Employees.

Additional information is available on our [main site](#).

INDEPENDENCE DAY HOLIDAY The MSC will be closed on Tuesday, July 4, 2017 in observance of the Independence Day holiday.

Weekly Notes are issued by the Coast Guard Marine Safety Center's Tonnage Division (MSC-4) for use by organizations that perform measurement work on the Coast Guard's behalf. They are for informational purposes only, and are not intended as, nor should they be construed to represent, revisions of or substitutes for applicable statutes or regulations or established interpretations of either.

MEASUREMENT ORGANIZATION WEEKLY NOTES – 06/21/2017

LONDON TONNAGE CONFERENCE ANNIVERSARY This Friday is the 48th anniversary of the conclusion of the 1969 diplomatic conference that created the Tonnage Convention. Over the course of four weeks, delegations from 48 countries discussed three proposals for a universal system of tonnage measurement, each consisting of draft Convention text with annexed Regulations and a certificate. At its close, the Conference prepared and opened the Convention for signature and accession. To date, 153 Contracting States representing 99.01% of world tonnage have consented to be bound by it.

FINAL ACT OF THE INTERNATIONAL CONFERENCE
ON TONNAGE MEASUREMENT OF SHIPS, 1969

1. Recognizing that the establishment of a universal system of tonnage measurement for ships engaged on international voyages should constitute an important contribution to maritime transport, a Conference was held in London from 27 May to 23 June 1969, upon the invitation of the Inter-Governmental Maritime Consultative Organization, for the purpose of drawing up an International Convention on Tonnage Measurement of Ships.

Weekly Notes are issued by the Coast Guard Marine Safety Center's Tonnage Division (MSC-4) for use by organizations that perform measurement work on the Coast Guard's behalf. They are for informational purposes only, and are not intended as, nor should they be construed to represent, revisions of or substitutes for applicable statutes or regulations or established interpretations of either.

MEASUREMENT ORGANIZATION WEEKLY NOTES – 06/14/2017

PROPELLING MACHINERY SPACE MEASUREMENT METHODS During a recent oversight review, we noted that an ACS measured a propelling machinery space using Simpson's first rule - reserved exclusively for locations in the extreme aft end of the hull - instead of the "average height and breadth" method, as was required for its location. Please note that MTN 01-99 CH-9 allows use of the "average height and breadth" method (depicted below), regardless of location. Use of this method not only saves time and effort, but also generally results in a higher propelling machinery space tonnage. This could benefit owners seeking to maximize the associated deduction.

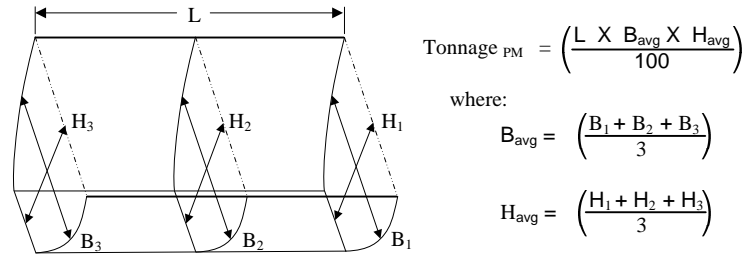

TONCALC UPDATE As mentioned previously, a new version of the TonCalc software application has been under development, which includes several improvements (e.g., the new formats for International and U.S. Tonnage Certificates that do not require listing excluded spaces in the corresponding blocks). While we are in the final phase of beta testing, there may still be time to incorporate further enhancements prior to its release in the weeks ahead. Please contact Mr. Marcus Akins if you would like to share any suggestions.

MEASUREMENT ORGANIZATION WEEKLY NOTES – 06/07/2017

TONNAGE DATA SHEETS The Marine Safety Center (MSC) has restored functionality for generating tonnage data sheets to include in file request responses. These data sheets provide a summary of vessel-specific information from MSC tonnage files and the Coast Guard's MISLE database (e.g., keel laid date, vessel service, and former names). ACS's should refer to them when measuring vessels to determine whether certificates or calculations reflect the latest tonnage data available from Coast Guard sources.

06/07/2017		MSC AND MISLE DATABASE TONNAGE DATA SHEET FOR VESSEL (ON): 123456					
The information contained on this data sheet was extracted from MSC and MISLE databases on the date indicated above. It is provided to authorized measurement organizations for informational purposes only. The information on this data sheet MUST NOT be used as the basis for tonnage certification actions unless the measurement organization independently verifies its accuracy. Refer questions to the MSC Tonnage Division (MSC-4).							
MSC TONNAGE FILE DATA							
Current File Location		File Contents		File Missing Status Info			
Agency	MSC	Xfer Date*		File type	Calcs Certs	Date unable to locate file:	
Location	Filed by CGD5#	Box/ID #	7958	Paper	<input type="checkbox"/>	US	<input type="checkbox"/>
Electronic Copy Previously Available:	<input type="checkbox"/>			Microfilm	<input checked="" type="checkbox"/>	ITC	<input type="checkbox"/>
						Suez	<input type="checkbox"/>
						Panama	<input type="checkbox"/>
						Ballast Justification	<input type="checkbox"/>
* Xfer date is date transferred either to or from the MSC						Vessel formally measured:	
						<input type="checkbox"/>	MSC has no record of file
						<input type="checkbox"/>	File not in designated location
						<input type="checkbox"/>	Vessel simplified measure
MISLE TONNAGE DATA (Dimensions in Feet)				MISLE VESSEL NAME DATA			

PROPOSED PANAMA CANAL TOLL MODIFICATIONS As reported in Dennis Bryant's Maritime Blog, the Panama Canal Authority (ACP) is proposing modifications to its current tolls structure. Among other changes, the proposal would reassign "container/breakbulk" vessels currently classified under the "others" segment by the ACP, into the "general cargo segment", in which tolls are based upon Panama Canal Universal measurement system (PC/UMS) tons.

Weekly Notes are issued by the Coast Guard Marine Safety Center's Tonnage Division (MSC-4) for use by organizations that perform measurement work on the Coast Guard's behalf. They are for informational purposes only, and are not intended as, nor should they be construed to represent, revisions of or substitutes for applicable statutes or regulations or established interpretations of either.

MEASUREMENT ORGANIZATION WEEKLY NOTES – 05/31/2017

RAISED WORKING DECK SPACES Further to the discussion in a recent Weekly Notes edition, we issued a formal decision on the measurement treatment of spaces below raised working decks. Our letter provided interpretations for future measurements, which are attached. Please note that under these interpretations, the wooden deck boards used in such arrangements are NOT treated as open deck gratings for Convention measurement.

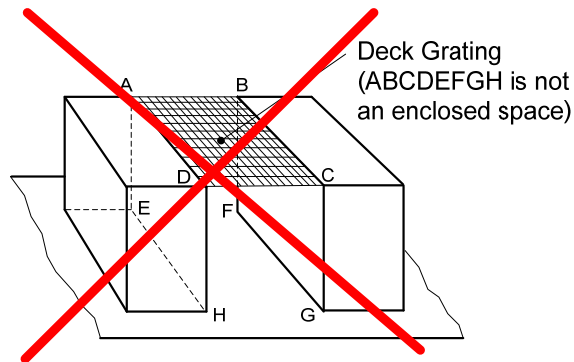

TONNAGE CERTIFICATE FORMATS To date, two ACS's have opted to use the new formats for International and U.S. Tonnage Certificates that do not require listing excluded spaces in the corresponding blocks, although the asterisks are still required. Additionally, the Tonnage Division has incorporated these new formats into the Marine Safety Center's updated TonCalc software application, which we hope to make available to ACS's soon. We note that use of the new formats may alleviate unnecessary administrative burden or confusion associated with certifying excluded spaces, especially for vessels of complex geometry.

Weekly Notes are issued by the Coast Guard Marine Safety Center's Tonnage Division (MSC-4) for use by organizations that perform measurement work on the Coast Guard's behalf. They are for informational purposes only, and are not intended as, nor should they be construed to represent, revisions of or substitutes for applicable statutes or regulations or established interpretations of either.

FORMAL MEASUREMENT TREATMENT OF RAISED WORKING DECK SPACES

The following Coast Guard interpretations apply when measuring a vessel fitted with a raised working deck and freeing port arrangement that permits the rapid clearing of water in the space both above and below the working deck, as depicted in the figure below. The Marine Safety Center (MSC) will provide written determinations on measurement treatment of raised working deck configurations that are not addressed by these interpretations, on a case basis.

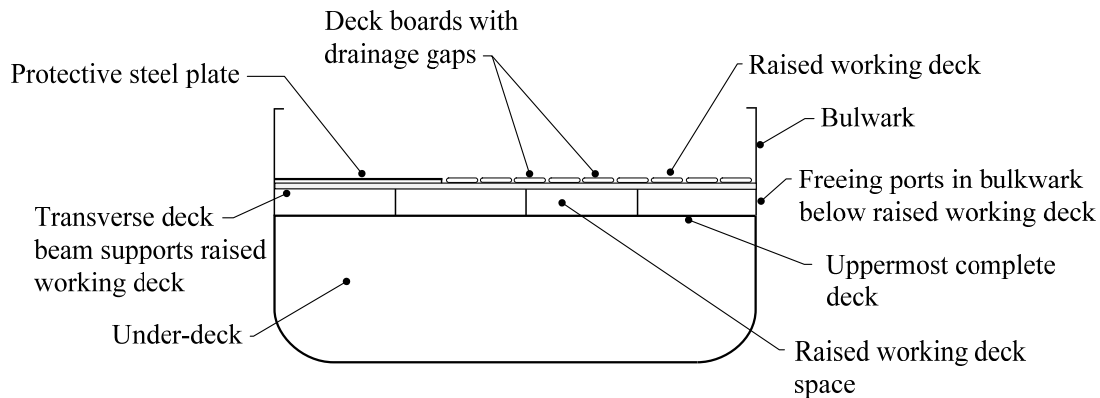

Convention Measurement System The entire raised working deck space is treated as an enclosed space per § 69.59 of Marine Safety Center Technical Note (MTN) 01-99 CH-9, *Tonnage Technical Policy*. The space, or a portion thereof, cannot be excluded from the total volume of all enclosed spaces (V) unless it otherwise qualifies for exclusion under § 69.61 of the MTN (e.g., is fitted with an end opening meeting the specified criteria). The deck boards do not constitute an open grating per Interpretation R.2(4)-8 of the MTN.

Standard and Dual Regulatory Measurement Systems Those portions of the raised working deck space not covered by the deck boards (e.g., the space directly below protective steel plates) are categorized as superstructure spaces per the definition of § 69.103 of MTN 01-99 CH-9.¹ The associated volume is included in superstructure tonnage per § 69.113 of the MTN, unless the space is eligible for exemption (e.g., as light or air space meeting the requirements of § 69.117(b)(4) of the MTN), or the volume does not exceed one cubic meter. The remaining raised working deck space volumes that are in free communication with the freeing ports are ignored.

¹ Hatchway spaces are measured under § 69.115 of the MTN, and their volumes included in the excess hatchway tonnage calculation.

MEASUREMENT ORGANIZATION WEEKLY NOTES – 05/24/2017

PORTABLE TOILETS The Marine Safety Center (MSC) recently responded to an inquiry as to whether the space surrounding a portable toilet qualifies for exemption as a water closet under the Standard system. The MSC response noted that the space lacks the bulkheads or partitions implicit in the term “closet” that serve both to delineate such a space and to preclude its use for other purposes. Further, the mere presence of a portable toilet in any space would not necessarily meet the condition that the space is “fitted with a toilet”, nor the condition that the space is “adapted and used” exclusively as a water closet space. Accordingly, the particular space in question does not qualify as an exemptible water closet space.

MEMORIAL DAY HOLIDAY The MSC will be closed on Monday, May 29, 2017 in observance of the Memorial Day holiday.

MEASUREMENT ORGANIZATION WEEKLY NOTES – 05/17/2017

TONNAGE GUIDE 3 The Marine Safety Center (MSC) published an updated version of Tonnage Guide (TG) 3, *Tonnage Measurement Records*, available on the MSC [Tonnage Publications](#) web page. Among other changes, this update includes revised nomenclature consistent with that used in the 2016 Tonnage Regulations Amendments rulemaking, a new National Vessel Documentation Center (NVDC) fax number, and a sample request for copies of tonnage records maintained by the MSC. Please note that this sample records request is intended for use by the general public, and is **NOT** to be confused with the sample for ACS records requests found in MTN 01-98 as amended.

MEASUREMENT SYSTEMS Further to the entry above, the updates to TG-3 include the following figure to help illustrate the difference between Convention and Regulatory measurement, and Formal and Simplified measurement. The figure uses the acronyms “GT ITC”, “NT ITC”, “GRT”, and “NRT” to distinguish between tonnages assigned under the Convention and Regulatory Measurement Systems.

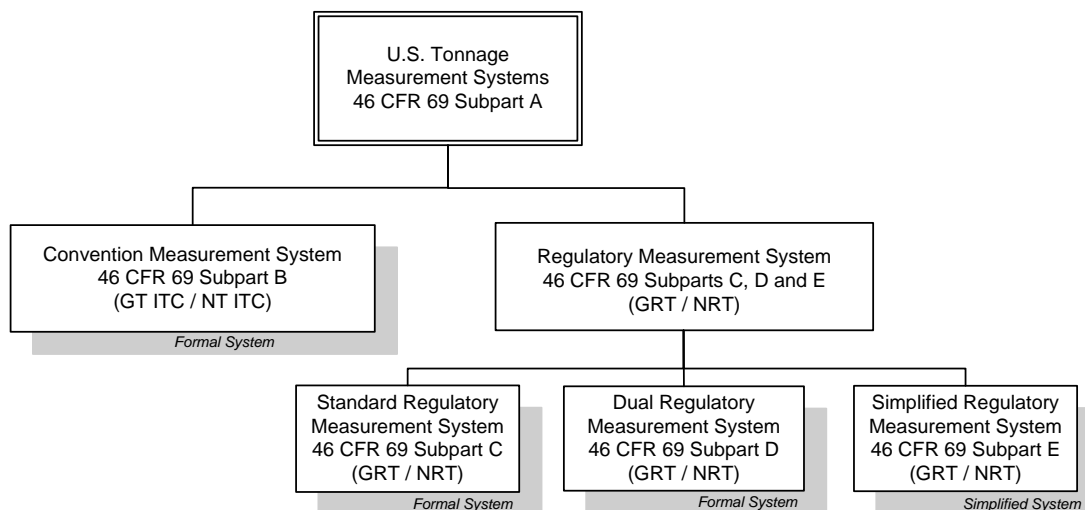

Weekly Notes are issued by the Coast Guard Marine Safety Center's Tonnage Division (MSC-4) for use by organizations that perform measurement work on the Coast Guard's behalf. They are for informational purposes only, and are not intended as, nor should they be construed to represent, revisions of or substitutes for applicable statutes or regulations or established interpretations of either.

MEASUREMENT ORGANIZATION WEEKLY NOTES – 05/10/2017

RAISED WORKING DECKS We are currently responding to an inquiry on the measurement treatment of raised working decks on fishing vessels. These decks are generally comprised of wood planks fitted to elevated transverse steel frames at a spacing that facilitates drainage, as depicted in the figure below. They have become increasingly common for certain Pacific Northwest fishing vessel designs since the 1960's. Pending our decision, please contact the Marine Safety Center (MSC) for direction on how to treat spaces bounded by such decks when certifying either Convention or Regulatory tonnage.

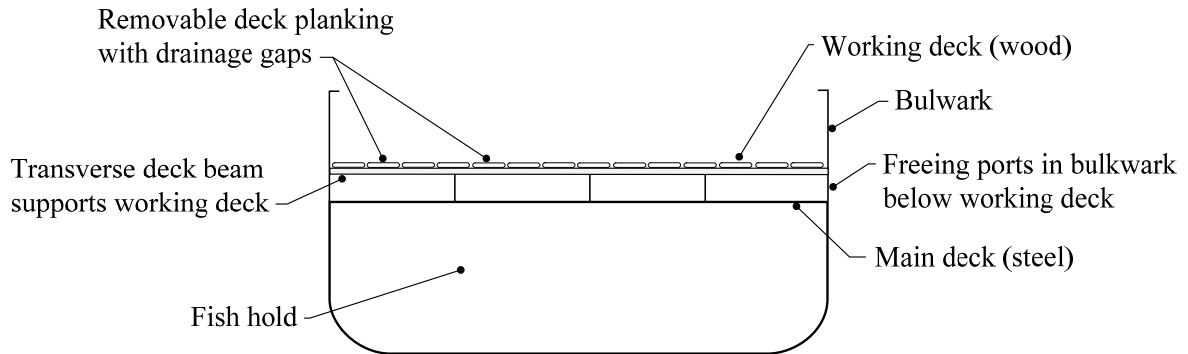

NOTIFICATION AUDITING As part of a broader Coast Guard initiative, the MSC is auditing the reporting of technical work completed by ACS's on the Coast Guard's behalf under provisions of MTN 04-03 CH-3, *Technical Support and Oversight of Authorized Classification Societies*. This includes tonnage measurement work. As a reminder, the MTN requires such notification be made upon work completion (typically within 5-10 business days). Failure to submit notification worksheets to the MSC (assessment-msc@uscg.mil) in a timely manner could result in adverse oversight findings.

Weekly Notes are issued by the Coast Guard Marine Safety Center's Tonnage Division (MSC-4) for use by organizations that perform measurement work on the Coast Guard's behalf. They are for informational purposes only, and are not intended as, nor should they be construed to represent, revisions of or substitutes for applicable statutes or regulations or established interpretations of either.

MEASUREMENT ORGANIZATION WEEKLY NOTES – 05/03/2017

UPDATED EXCEL NOTIFICATION FILE As mentioned previously in the Weekly Notes, the Marine Safety Center revisited the notification process for reporting completed work done on the Coast Guard's behalf, including tonnage measurement work. To facilitate more consistent data entry, we revised the Excel notification file (available on the [Tonnage Publications](#) web page as Enclosure (1) to MTN 04-03 as amended). Changes include error checking features which should help improve data quality, and updated pick lists for non-tonnage reporting.

Weekly Notes are issued by the Coast Guard Marine Safety Center's Tonnage Division (MSC-4) for use by organizations that perform measurement work on the Coast Guard's behalf. They are for informational purposes only, and are not intended as, nor should they be construed to represent, revisions of or substitutes for applicable statutes or regulations or established interpretations of either.

MEASUREMENT ORGANIZATION WEEKLY NOTES – 04/26/2017

SUBMISSIONS FOR DECISIONS As discussed in earlier Weekly Notes editions, the Marine Safety Center can provide faster service in providing formal decisions on interpretations of the tonnage regulations if the submittals are complete and have been discussed in advance with Tonnage Division staff. We encourage ACS staff to ensure such submittals conform to the informal guidelines offered earlier, and repeated below.

- 1) Application for Formal Measurement Services – If no Application for Formal Measurement has been submitted, the information that would be required in the application should be included in the request.
- 2) Vessel Alteration/Measurement History
- 3) Graphical Representation
 - a. Sketch of vessel/space configuration with pertinent dimensions
 - b. Photos
 - c. Current or proposed drawings (annotate scaling)
- 4) Description of Interpretation Requested
 - a. Applicable regulation or MTN section.
 - b. Include previous decisions which may be related to the request.

Weekly Notes are issued by the Coast Guard Marine Safety Center's Tonnage Division (MSC-4) for use by organizations that perform measurement work on the Coast Guard's behalf. They are for informational purposes only, and are not intended as, nor should they be construed to represent, revisions of or substitutes for applicable statutes or regulations or established interpretations of either.

MEASUREMENT ORGANIZATION WEEKLY NOTES – 04/19/2017

CIRCULAR FOUNDATIONS The Marine Safety Center (MSC) recently responded to an inquiry on treatment of a circular crane foundation that interrupted a transverse deep framing system within a vessel's under-deck. While not explicitly addressed in MTN 01-99 CH-9, the MSC interpreted the tonnage regulations as permitting such a foundation to have no effect on under-deck breadth and depth measurements provided there are no oversized openings in the foundation, the qualifying transverse ordinary frames are joined to the foundation to the same extent they are joined to the hull, and the foundation diameter does not exceed 8.0 ft in diameter.

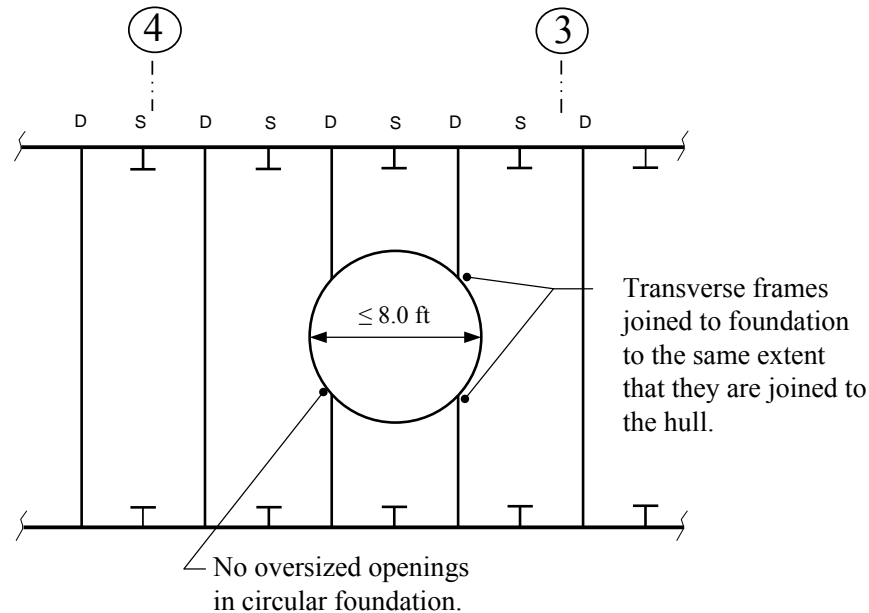

JONES ACT VIOLATION As reported in Dennis Bryant's Maritime Blog, the U.S. Department of Justice recently announced the agreement of a company to pay \$10 million in penalties for a Jones Act violation. In this case, a foreign flag vessel was used to transport a jack-up drill rig between points in the United States. Use of a foreign built vessel measuring over 5 net tons in the United States fisheries may similarly be subject to substantial penalties.

Weekly Notes are issued by the Coast Guard Marine Safety Center's Tonnage Division (MSC-4) for use by organizations that perform measurement work on the Coast Guard's behalf. They are for informational purposes only, and are not intended as, nor should they be construed to represent, revisions of or substitutes for applicable statutes or regulations or established interpretations of either.

MEASUREMENT ORGANIZATION WEEKLY NOTES – 04/12/2017

TOP NONCONFORMITY TYPES Examining the types of tonnage oversight nonconformities identified by the Marine Safety Center (MSC) since April 2014, we compiled the following summary of the five most frequently occurring nonconformity types. We conducted oversight on 52 vessels during this time period.

1. Graphical Representations. These include missing or incomplete drawings of vessel inboard or outboard profiles, framing details, and interior layouts.
2. Certification Data. These include incorrect or missing keel laid or alteration dates, and specification of the wrong measurement system on tonnage certificates.
3. Tonnage Rules. These include misapplication of provisions of the Convention, Standard, and Dual systems for treating various enclosed spaces.
4. Volume Determinations. These include incorrect modeling of hull and superstructure spaces, and improper treatment of smaller volumes such as appendages.
5. Measurement Errors. These include incorrect dimensions in calculations; measurements that do not match the actual vessel geometry; and failure to include certain enclosed spaces in tonnage.

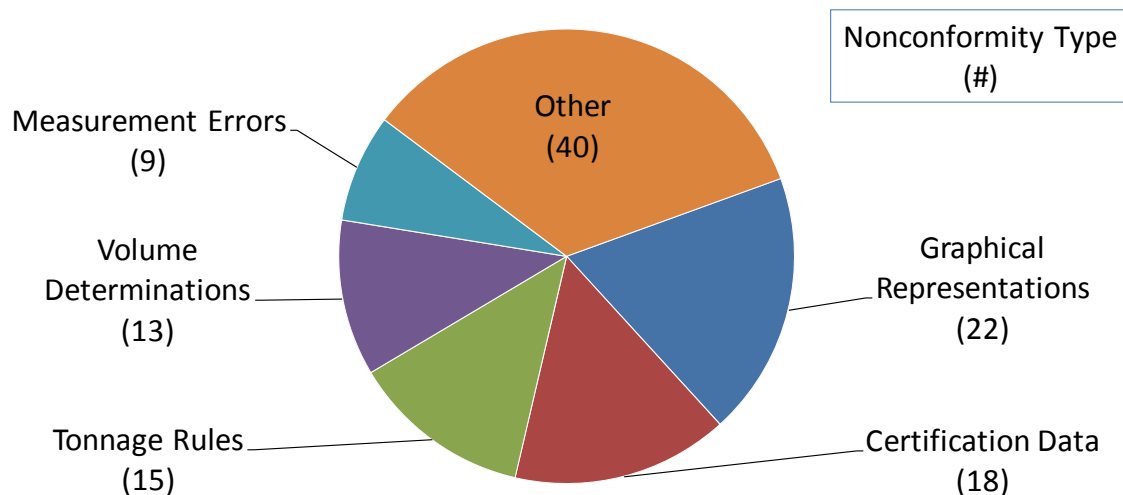

TM69 AMENDMENTS The Weekly Notes of December 30, 2015 mentioned that, per IMO's TM.7/Circ.1, amendments to the 1969 Tonnage Convention (TM69) were subject to Contracting Government acceptance or rejection by February 28, 2016. According to IMO's C 117/17, the conditions for entry into force were met, and amendments (IMO A.1084(28)) to TM69, requiring IMO Member State audits, entered into force on February 28, 2017.

TONNAGE PERSONNEL Mr. David Karnes will be out of the office beginning Monday, April 17 and returning on Tuesday, May 2, 2017. During that time, please copy Mr. Marcus Akins on any CG number requests.

Weekly Notes are issued by the Coast Guard Marine Safety Center's Tonnage Division (MSC-4) for use by organizations that perform measurement work on the Coast Guard's behalf. They are for informational purposes only, and are not intended as, nor should they be construed to represent, revisions of or substitutes for applicable statutes or regulations or established interpretations of either.

MEASUREMENT ORGANIZATION WEEKLY NOTES – 04/05/2017

PART 10 MTN UPDATES SERIES We conclude our ten-part series highlighting changes made through the recent updates to the Tonnage Administrative and Technical Policy MTN's, with the following items:

GRT GRANDFATHERING PROVISIONS MTN 01-99 CH-9 incorporated new definitions related to substantial alterations and so-called “GRT tonnage grandfathering” provisions under International Conventions (see the excerpted table from the IMO resolution, below). These definitions were adapted from NVIC 11-93 CH-3 and align with the new international interpretations of TM.5/Circ.6. However, please recognize that for a U.S. flag vessel, unless remeasurement is required, the 1% substantial alteration criterion does not come into play. Further, only the GT ITC tonnage change is now a factor in evaluating whether a vessel has been substantially altered (and NOT the GRT tonnage change). With these changes, U.S. flag “Interim Scheme” vessels are no longer treated any differently than “Art.3(2)(d)” vessels when making substantial alteration determinations.

Basis for Using National Tonnage to Apply International Conventions*			
Ship's Keel Laid Date / Substantial Alteration Date	Ship's National Gross Tonnage		
	GRT < 400	400 ≤ GRT < 1600	GRT ≥ 1600
Before 18 July 1982	TM69 Art.3(2)(d)	TM69 Art.3(2)(d)	TM69 Art.3(2)(d)
18 July 1982 - 31 December 1985	A.494(XII) / A.541(13)	A.494(XII)	A.494(XII)
1 January 1986 - 18 July 1994	A.494(XII) / A.541(13)	A.494(XII)	Not Eligible
After 18 July 1994	Not Eligible	Not Eligible	Not Eligible

* Unless otherwise provided for in an International Convention or other instrument.

REMEASUREMENT MTN 01-98 CH-3 incorporated the remeasurement criteria from NVIC 11-93 CH-3, without substantive change. As before, changes which result in an increase or decrease of more than 5% in the vessel's GT ITC or NT ITC tonnage will necessitate a remeasurement, as will changes affecting the main dimensions and certain changes related to GRT tonnage reduction.

Weekly Notes are issued by the Coast Guard Marine Safety Center's Tonnage Division (MSC-4) for use by organizations that perform measurement work on the Coast Guard's behalf. They are for informational purposes only, and are not intended as, nor should they be construed to represent, revisions of or substitutes for applicable statutes or regulations or established interpretations of either.

MEASUREMENT ORGANIZATION WEEKLY NOTES – 03/29/2017

PART 9 MTN UPDATES SERIES We continue our ten-part series highlighting changes made through the recent updates to the Tonnage Administrative and Technical Policy MTN's, with the following item:

IDENTIFYING ELIGIBLE PROPELLING MACHINERY SPACES MTN 01-99 CH-9 added the clarifying figure below to illustrate that auxiliary machinery must be used in connection with propelling the vessel in order to be deducted as part of a propelling machinery space. It also shows measurement to the line of the ordinary framing for the propelling machinery space deduction. This figure appeared in an earlier Weekly Notes edition, and was developed from a Coast Guard cutter machinery arrangement drawing.

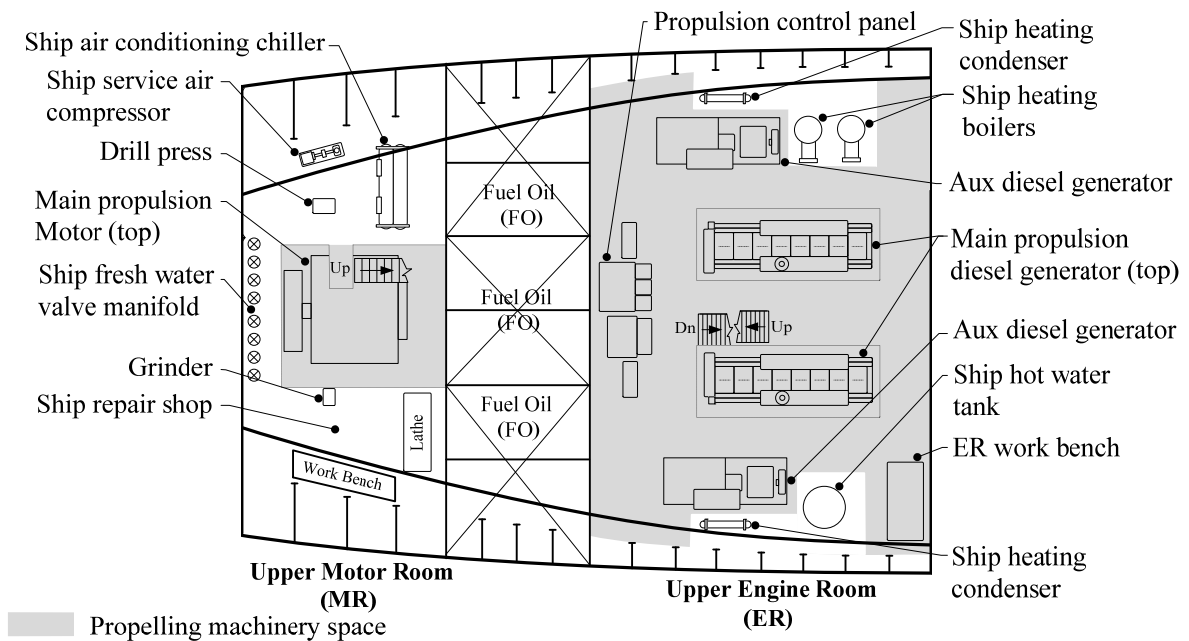

Weekly Notes are issued by the Coast Guard Marine Safety Center's Tonnage Division (MSC-4) for use by organizations that perform measurement work on the Coast Guard's behalf. They are for informational purposes only, and are not intended as, nor should they be construed to represent, revisions of or substitutes for applicable statutes or regulations or established interpretations of either.

MEASUREMENT ORGANIZATION WEEKLY NOTES – 03/22/2017

PART 8 MTN UPDATES SERIES We continue our ten-part series highlighting changes made through the recent updates to the Tonnage Administrative and Technical Policy MTN's, with the following items:

MEASUREMENT METHODS MTN 01-99 CH-9 added the two figures below to illustrate how to measure certain propelling machinery spaces. The first figure shows the “average height and breadth method”, reserved for spaces with continuous fair lines, or located at the hull’s extreme aft end (if requested by the owner). The second figure shows the more time consuming “three-dimensional Simpson’s first rule” method, reserved exclusively for locations at the extreme aft end of the hull. CH-9 also clarified that the tonnage interval for the Simpson’s method should be most nearly equal in length to the interval used in calculating the under-deck tonnage.

Average Height and Breadth

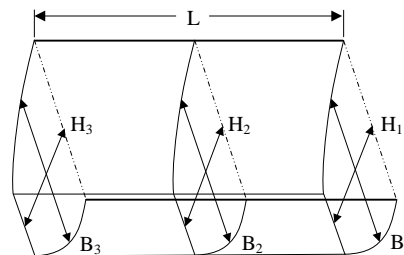

$$\text{Tonnage}_{PM} = \left(\frac{L \times B_{avg} \times H_{avg}}{100} \right)$$

where:

$$B_{avg} = \left(\frac{B_1 + B_2 + B_3}{3} \right)$$

$$H_{avg} = \left(\frac{H_1 + H_2 + H_3}{3} \right)$$

3-Dimensional Simpson’s First Rule

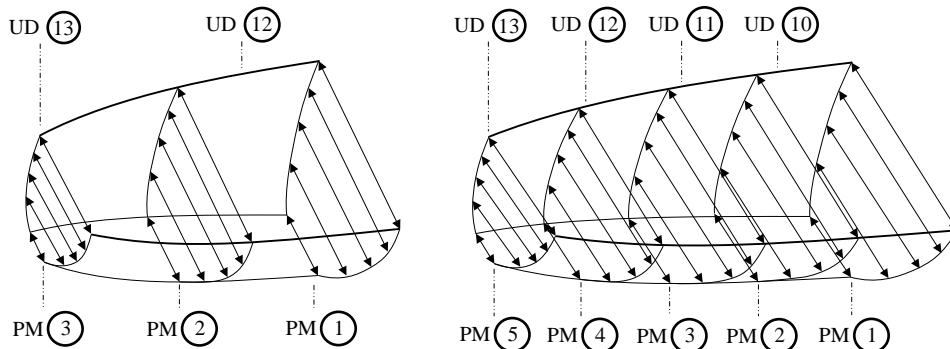

MEASUREMENT ADJUSTMENTS A new section in MTN 01-99 CH-9 addresses measurement adjustments to ensure that propelling machinery deductions reflect only those portions of spaces that are included in the gross tonnage. Like the adjustments for other deductible spaces mentioned in last week’s edition, this is done by applying the zone of influence method used for water ballast exemptions, or other authorized methods.

Weekly Notes are issued by the Coast Guard Marine Safety Center’s Tonnage Division (MSC-4) for use by organizations that perform measurement work on the Coast Guard’s behalf. They are for informational purposes only, and are not intended as, nor should they be construed to represent, revisions of or substitutes for applicable statutes or regulations or established interpretations of either.

MEASUREMENT ORGANIZATION WEEKLY NOTES – 03/15/2017

PART 7 MTN UPDATES SERIES We continue our ten-part series highlighting changes made through the recent updates to the Tonnage Administrative and Technical Policy MTN's, with the following items:

MASTS, AIR TRUNKS, AND SIMILAR MTN 01-99 CH-9 relocated and updated the interpretive figure on Convention measurement of miscellaneous topside spaces, which is included below. Note especially the treatment of radar domes in the figure.

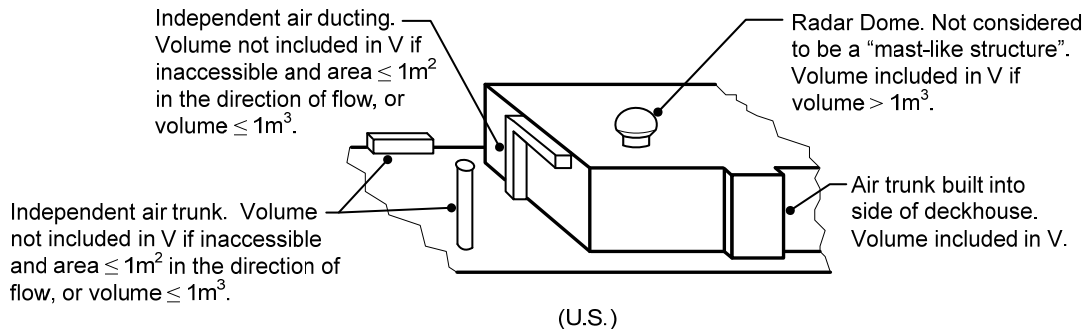

COMPANIONS Although exemption of the "uppermost tier" for "stairs over stairs" is implicit in the longstanding tonnage regulations text on companions, MTN 01-99 CH-9 added explicit interpretative text to clarify this exemption.

PASSAGEWAYS MTN 01-99 CH-9 added the following figure to clarify that deductible passageways must serve deductible and exempted spaces only, with limited exceptions (such as a ship's office).

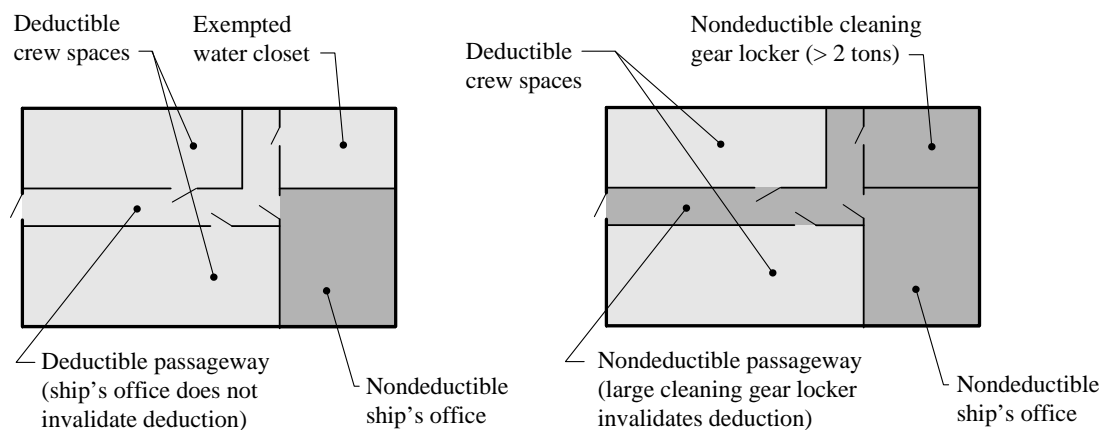

MEASUREMENT ADJUSTMENTS A new section in MTN 01-99 CH-9 provides for adjusting measurements to ensure that deductions (other than those for propelling machinery) reflect only those portions of spaces that are included in the gross tonnage. We will address propelling machinery adjustments in next week's edition.

Weekly Notes are issued by the Coast Guard Marine Safety Center's Tonnage Division (MSC-4) for use by organizations that perform measurement work on the Coast Guard's behalf. They are for informational purposes only, and are not intended as, nor should they be construed to represent, revisions of or substitutes for applicable statutes or regulations or established interpretations of either.

MEASUREMENT ORGANIZATION WEEKLY NOTES – 03/08/2017

PART 6 MTN UPDATES SERIES We continue our ten-part series highlighting changes made through the recent updates to the Tonnage Administrative and Technical Policy MTN's, with the following items:

SMALL FRAME EDGE OPENINGS MTN 01-99 CH-9 added interpretations to address the fitting of small openings on the edges of ordinary frames, along the lines discussed in the July 8, 2015 Weekly Notes edition. These interpretations provide for limber holes, snipes, and similar small openings on the edges of ordinary frames to be ignored when applying the opening proximity criterion, provided the separation distance between the opening within the web and the frame-edge opening exceeds the longest frame edge opening in question. The following illustrative figure was also added.

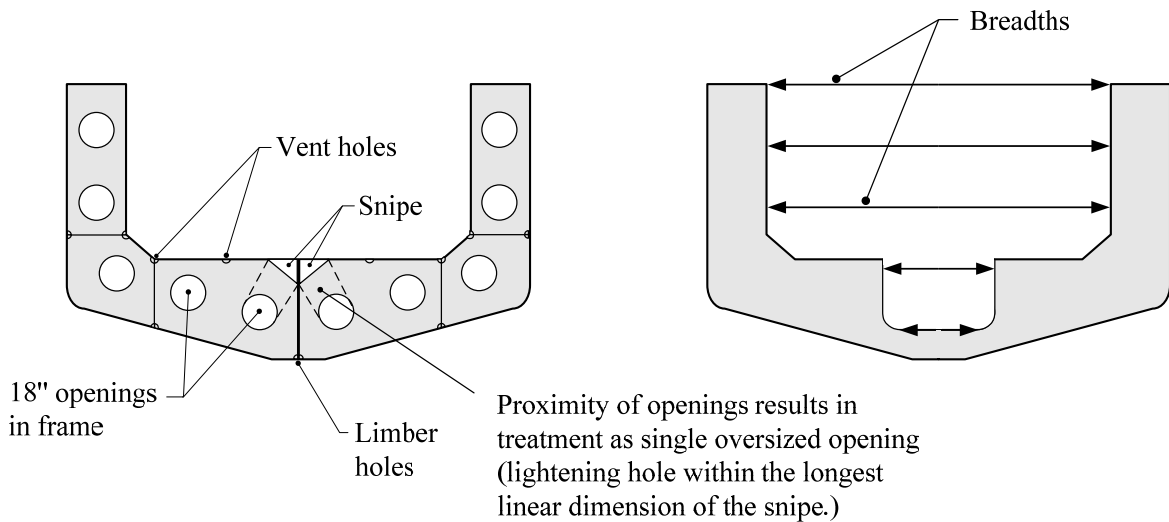

LONGITUDINAL SIDE FRAMES MTN 01-99 CH-9 included revisions clarifying that the web of an ordinary longitudinal side frame must not rest directly on bottom frames or floors ("ceiling on floors") or otherwise serve as a deck. These revisions explicitly preclude the use of two decks 8 feet apart with a single "shallow" longitudinal side frame placed in-between to create a "zero area" station. The following illustrative figure was also added.

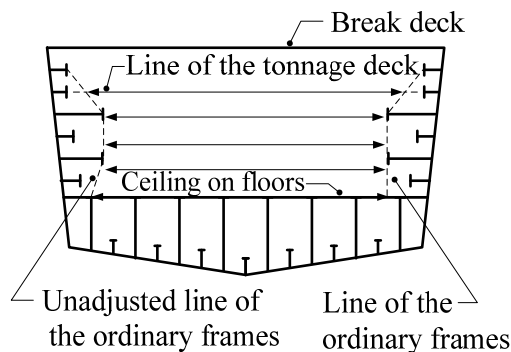

Weekly Notes are issued by the Coast Guard Marine Safety Center's Tonnage Division (MSC-4) for use by organizations that perform measurement work on the Coast Guard's behalf. They are for informational purposes only, and are not intended as, nor should they be construed to represent, revisions of or substitutes for applicable statutes or regulations or established interpretations of either.

MEASUREMENT ORGANIZATION WEEKLY NOTES – 03/01/2017

PART 5 MTN UPDATES SERIES We continue our ten-part series highlighting changes made through the recent updates to the Tonnage Administrative and Technical Policy MTN's, with the following items:

CEILING ON FLOORS The recent Tonnage Regulations Amendments rulemaking codified a longstanding interpretation that the uppermost complete deck must not rest directly on consecutive or alternating ordinary bottom frames or floors, for a distance of over one-half of the tonnage length. MTN 01-99 CH-9 clarified that this restriction refers to the cumulative distance that this "ceiling on floors" rests on ordinary bottom frames/floors in cases where such "decking" is not contiguous (in other words, where there are gaps or interruptions in the "ceiling on floors" as illustrated in the following figure).

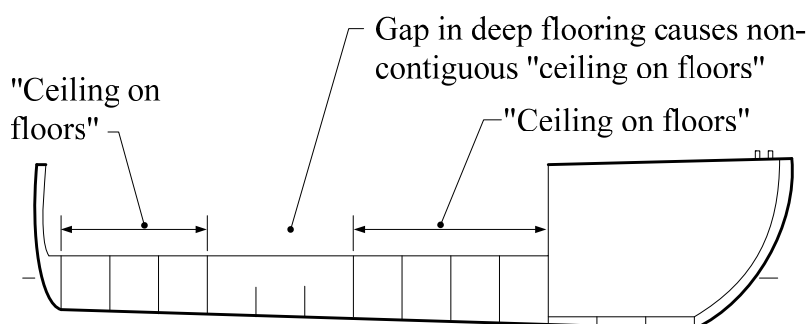

MIDSHIP DEPTH MTN 01-99 CH-9 added the following figure illustrating how bulwarks, the midship depth, and freeing ports are addressed when applying the one-sixth "midship depth" criterion for measuring smaller vessels as open vessels. This criterion first appeared in a 1935 Bureau of Navigation and Steamboat Inspection General Letter, and was apparently drawn from Swedish regulations. Multiple rulings from this timeframe focused on the question of "excessive" bulwarks. The restriction to smaller vessels (tonnage length of less than 50 feet) was established by a 1948 rulemaking.

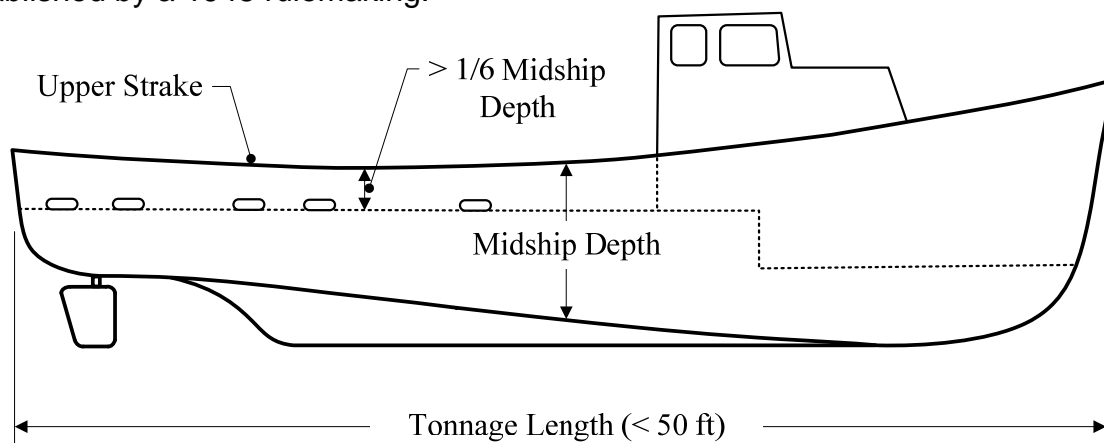

Weekly Notes are issued by the Coast Guard Marine Safety Center's Tonnage Division (MSC-4) for use by organizations that perform measurement work on the Coast Guard's behalf. They are for informational purposes only, and are not intended as, nor should they be construed to represent, revisions of or substitutes for applicable statutes or regulations or established interpretations of either.

MEASUREMENT ORGANIZATION WEEKLY NOTES – 02/22/2017

PART 4 MTN UPDATES SERIES We continue our ten-part series highlighting changes made through the recent updates to the Tonnage Administrative and Technical Policy MTN's, with the following items:

NAVAL ARCHITECTURAL PRACTICES MTN 01-99 CH-9 introduced a criterion for the accuracy of volume calculations, requiring Convention measurement volumes to be within approximately 1% of as-built volumes, unless otherwise specified or authorized. This was based on IMO work and validated at the workshop in Houston, TX in May of 2016. The 1969 Tonnage Convention requirement that “all measurement used in the calculation of volumes shall be taken to the nearest centimetre or one-twentieth of a foot” is unaffected, although this precision was extended to Standard measurement.

TREATMENT OF SPACES NOT EXCEEDING 1 m³ Under longstanding U.S. and IMO interpretations, enclosed spaces above the upper deck, appendages, and spaces open to the sea not exceeding 1 m³ in volume are not included in Convention tonnage. These provisions, coupled with provisions for treatment of linear appendages, masts, and similar (e.g., hollow skegs, bilge keels, deckhouse overhangs, and cockpit coamings), give some flexibility for properly accounting for volumes of miscellaneous smaller spaces. Note that MTN 01-99 CH-9 extended the Convention treatment of enclosed spaces not exceeding 1 m³ to Standard measurement, consistent with current practice.



Weekly Notes are issued by the Coast Guard Marine Safety Center's Tonnage Division (MSC-4) for use by organizations that perform measurement work on the Coast Guard's behalf. They are for informational purposes only, and are not intended as, nor should they be construed to represent, revisions of or substitutes for applicable statutes or regulations or established interpretations of either.

MEASUREMENT ORGANIZATION WEEKLY NOTES – 02/15/2017

PART 3 MTN UPDATES SERIES We continue our ten-part series highlighting changes made through the recent updates to the Tonnage Administrative and Technical Policy MTN's, with the following item:

TONNAGE CERTIFICATE FORMATS MTN 01-98 CH-13 introduced revised formats for International and U.S. Tonnage Certificates that do not require listing excluded spaces in the corresponding blocks. This change follows our conclusion that listing the excluded spaces was never intended, based on our review of reports from the 1969 Tonnage Conference, along with the authentic English and French versions of the 1969 Tonnage Convention. ACS's may opt to use the new formats - which require prior Marine Safety Center approval - or may continue to use the existing formats, provided the excluded spaces continue to be listed in the block, as before. Asterisk use is still required.

GROSS TONNAGE		
Name of Space	Location	Length (m)
Underdeck	----	----
1st Tier	Fr 15-16	8.71
2nd Tier*	Fr 16-60	8.71
3rd Tier	Fr 16-60	4.05
4th Tier	Fr 16-23	2.77
P/S Funnel	Fr 65-67	0.79
Crane Posts	Fr 56	0.40
Crane Cab	Fr 55-56	0.69
Seasonal Trailers	Fr 52-58	3.72
EXCLUDED SPACES (Regulation 2(5)) 2nd Tier Overhang An asterisk (*) should be added to those spaces listed above which comprise both enclosed and excluded spaces.		

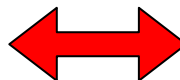

GROSS TONNAGE		
Name of Space	Location	Length (m)
Underdeck	----	----
1st Tier	Fr 15-16	8.71
2nd Tier*	Fr 16-60	8.71
3rd Tier	Fr 16-60	4.05
4th Tier	Fr 16-23	2.77
P/S Funnel	Fr 65-67	0.79
Crane Posts	Fr 56	0.40
Crane Cab	Fr 55-56	0.69
Seasonal Trailers	Fr 52-58	3.72
EXCLUDED SPACES (Regulation 2(5)) An asterisk (*) should be added to those spaces listed above which comprise both enclosed and excluded spaces. Listing of excluded spaces in this block is not required.		

WASHINGTON'S BIRTHDAY HOLIDAY The Marine Safety Center will be closed Monday, February 20, 2017 in observance of the birthday of George Washington.

Weekly Notes are issued by the Coast Guard Marine Safety Center's Tonnage Division (MSC-4) for use by organizations that perform measurement work on the Coast Guard's behalf. They are for informational purposes only, and are not intended as, nor should they be construed to represent, revisions of or substitutes for applicable statutes or regulations or established interpretations of either.

MEASUREMENT ORGANIZATION WEEKLY NOTES – 02/08/2017

PART 2 MTN UPDATES SERIES We continue our ten-part series highlighting changes made through the recent updates to the Tonnage Administrative and Technical Policy MTN's, with the following items:

REMEASUREMENT SERVICES MTN 01-98 CH-13 expanded § 1.3(b) for clarity, to align the requirements for remeasurement determinations with related language from the recently published tonnage regulations, and to incorporate the specific remeasurement criteria previously codified in NVIC 11-93 CH-3 and MTN 01-99 CH-8, without substantive change. We hope that the more comprehensive requirements, along with the consolidation of requirements into one document, will help facilitate future remeasurement determinations.

ROLES OF CONTRACTORS MTN 01-98 CH-13 also introduced a new § 1.3(e) which codified current practices for how contractors are used in the tonnage measurement process. This new section precludes non-ACS employees from performing certain tonnage measurement functions such as the signing and issuing of tonnage certificates, water ballast justification approval letters, and remeasurement determinations. The intent of this new section is to clarify how ACS's may use contractors through the consolidation of language found in the tonnage regulations, ACS agreements with the Coast Guard, and formal MSC correspondence.

Weekly Notes are issued by the Coast Guard Marine Safety Center's Tonnage Division (MSC-4) for use by organizations that perform measurement work on the Coast Guard's behalf. They are for informational purposes only, and are not intended as, nor should they be construed to represent, revisions of or substitutes for applicable statutes or regulations or established interpretations of either.

MEASUREMENT ORGANIZATION WEEKLY NOTES – 02/01/2017

PART 1 MTN UPDATES SERIES We begin our ten-part series - mentioned last week - highlighting changes made through the recent updates to the Tonnage Administrative and Technical Policy MTN's, with the following items:

REFERENCES TO NVIC 11-93 MTN 01-98 CH-13 deleted reference to Navigation and Vessel Inspection Circular (NVIC) 11-93, as amended, *Applicability of Tonnage Measurement Systems to U.S. Flag Vessels*, since related interpretations were incorporated in the amendments to the tonnage regulations published in March 2016 and the recent change to MTN 01-99.

REPRINT OF THE 1969 TONNAGE CONVENTION MTN 01-99 CH-9 introduced a new method of presenting Convention Measurement System interpretations through a reprint of the 1969 Tonnage Convention. This reprint appears in Appendix B, which also includes all U.S., IMO, and IACS interpretations and associated figures, along with clarifying footnotes. Interpretative material previously included in the "Subpart B" section of the MTN was relocated to this new appendix, where appropriate. We hope that this change will help facilitate understanding and application of U.S interpretations of the Convention, particularly for ACS's that regularly measure vessels for other flag States.

LENGTH OF SHIPS WITHOUT A RUDDER STOCK MTN 01-99 CH-9 adopted the Unified interpretation published in IMO Circular TM.5/Circ.6 (19 May 2014) that extended the treatment of the Convention length measurement for "barges" to all vessels without a rudder stock. This interpretation supersedes the U.S. interpretation of § 69.53 of MTN 01-99 CH-8, that previously provided for rudder stock location to be taken at the axis of rotation of alternate steering devices when determining the length of vessels without a rudder stock.



Weekly Notes are issued by the Coast Guard Marine Safety Center's Tonnage Division (MSC-4) for use by organizations that perform measurement work on the Coast Guard's behalf. They are for informational purposes only, and are not intended as, nor should they be construed to represent, revisions of or substitutes for applicable statutes or regulations or established interpretations of either.

MEASUREMENT ORGANIZATION WEEKLY NOTES – 01/25/2017

MARINE SAFETY CENTER INFORMATION BULLETIN Last week, the [Marine Safety Center \(MSC\)](#) issued an [Information Bulletin](#) announcing the updates to the Tonnage Administrative and Technical Policy MTN's, mentioned last week. Consistent with past practice, we circulated this bulletin via email to a list of approximately 1200 MSC customers - including naval architects - generated from the MSC's electronic commence inbox.



USCG MARINE SAFETY CENTER BULLETIN

BULLETIN 01-17
January 18, 2017

Tonnage Policy Updates

MTN 01-98 CH-13 Tonnage Administrative Policy
The Marine Safety Center has issued Change 13 to [MSC Technical Note \(MTN\) 01-98, Tonnage Administrative Policy](#). This Technical Note provides administrative requirements for certification of vessel tonnages and dimensions by authorized measurement organizations acting on the Coast Guard's behalf. It was last updated in 2014. Change 13 incorporates revisions for consistency with the recent amendments to the tonnage regulations (see [MSC Bulletin 01-16](#)) and related changes to MTN 01-99.

MTN 01-99 CH-9 Tonnage Technical Policy
The Marine Safety Center has issued Change 9 to [MSC Technical Note \(MTN\) 01-99, Tonnage Technical Policy](#). This Technical Note provides interpretations of the tonnage regulations (46CFR69) through a reprint of the regulations in standard font, with interpretations inserted in italics font, and interpretive figures added in appropriate locations. Change 9 was developed to address interpretative matters not reflected in MTN 01-99 CH-8 (see [MSC Bulletin 02-16](#)), that had arisen since the previous MTN version was issued in 2005, including interpretations stemming from the conclusion of the recent IMO work on tonnage measurement. A new appendix presents U.S. interpretations of the 1969 Tonnage Convention, along with interpretations of the International Maritime Organization (IMO) and the International Association of Classification Societies (IACS).

Additional Information
Refer to the appendices of the respective MTNs for a more comprehensive discussion of the revisions to each. Please contact Mr. Marcus Akins of the MSC's Tonnage Division staff at (202) 795-6787 or marcus.j.akers@uscg.mil if you have any questions on this bulletin.

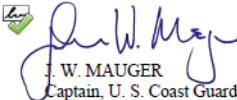

J. W. MAUGER
Captain, U. S. Coast Guard
Commanding Officer

SERIES ON SPECIFIC MTN CHANGES Next week we will begin a ten-part series highlighting some of the specific changes made through these MTN updates. This series is not comprehensive in nature, and as the changes are effective immediately, we strongly urge all ACS tonnage staff members to review all of the changes without delay, if you have not done so already. This can be done by looking for the sidebars which identify the substantive changes, and then reading the associated entries in the "Discussion of Changes" appendix of each document.

Weekly Notes are issued by the Coast Guard Marine Safety Center's Tonnage Division (MSC-4) for use by organizations that perform measurement work on the Coast Guard's behalf. They are for informational purposes only, and are not intended as, nor should they be construed to represent, revisions of or substitutes for applicable statutes or regulations or established interpretations of either.

MEASUREMENT ORGANIZATION WEEKLY NOTES – 01/18/2017

MTN UPDATES Yesterday, we issued updates to both MTN 01-98, *Tonnage Administrative Policy* and MTN 01-99, *Tonnage Technical Policy*. [Change 13 to MTN 01-98](#) incorporates revisions for consistency with the recent amendments to the tonnage regulations and related changes to the Technical Policy MTN. [Change 9 to MTN 01-99](#) addresses interpretative matters not reflected in MTN 01-99 CH-8 that had arisen since the previous MTN version was issued in 2005, including interpretations stemming from the conclusion of the recent IMO work on tonnage measurement. A new appendix presents U.S. interpretations of the 1969 Tonnage Convention, along with interpretations of the International Maritime Organization (IMO) and the International Association of Classification Societies (IACS). Both MTN changes take effect immediately.

U.S. Department of Homeland Security
United States Coast Guard



Marine Safety Center
Technical Note

MTN 01-98 CH-13
16717/46CFR69/P009016
January 17, 2017

Subj: TONNAGE ADMINISTRATIVE POLICY

1. **Purpose:** This Technical Note provides administrative requirements for certification of vessel tonnages and dimensions by authorized measurement organizations acting under the tonnage regulations (Title 46, Code of Federal Regulations, Part 69 (46 CFR 69), *Measurement of Vessels*). It replaces MTN 01-98 Change 12.

2. **Discussion:** This Technical Note is organized into sections addressing specific tonnage measurement requirements, including Coast Guard oversight and tonnage file maintenance. These are followed by appendices that provide forms and sample documents, list the authorized measurement organizations, and discuss changes from the previous version of this Technical Note. Sidebars are used throughout this Technical Note to identify substantive changes. The pages are numbered sequentially from the beginning of the document to facilitate electronic use.

3. **Applicability:** The requirements of this Technical Note are used by authorized measurement organizations in certifying tonnages and dimensions for vessels for which the application of a law of the United States depends on the vessel's tonnage. Refer to MTN 01-99 as amended, *Tonnage Technical Policy*, for technical interpretations of the tonnage regulations, and related information.

4. **Action:** Authorized measurement organizations shall implement this Technical Note immediately. Any deviation from this Technical Note requires written approval from the Marine Safety Center (MSC). This Technical Note is available at <http://www.uscg.mil/hq/msc>.

5. **Disclaimer:** While the policy contained in this Technical Note may assist the industry, the public, the Coast Guard, and other Federal and State agencies in applying statutory and regulatory requirements, this policy is not a substitute for the applicable legal requirements, nor is it in itself a regulation. It is not intended to, nor does it impose legally binding requirements on any party, including the Coast Guard, other Federal agencies, the States, or the regulated community.

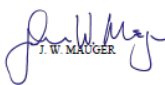

J. W. MAUGER

U.S. Department of Homeland Security
United States Coast Guard



Marine Safety Center
Technical Note

MTN 01-99 CH-9
16717/46CFR69/P009017
January 17, 2017

Subj: TONNAGE TECHNICAL POLICY

1. **Purpose:** This Technical Note promulgates policy for use by authorized measurement organizations in applying and interpreting provisions of the tonnage regulations (Title 46, Code of Federal Regulations, Part 69 (46 CFR 69), *Measurement of Vessels*). It replaces MTN 01-99 Change 8.

2. **Discussion:** This Technical Note provides interpretations of the tonnage regulations through a reprint of the regulations in standard font, with interpretations inserted in italics font and interpretive figures added in appropriate locations. Appendices address grandfathering provisions for superseded interpretations, provide related interpretations of, and recommendations for, the International Convention on Tonnage Measurement of Ships, 1969 (the 1969 Tonnage Convention), and discuss changes from the previous version of this Technical Note. Side bars are used throughout this Technical Note to identify substantive changes. The pages are numbered sequentially from the beginning of the document to facilitate electronic use.

3. **Applicability:** Tonnage measurement under the tonnage regulations and the policy of this Technical Note is required for vessels for which the application of a law of the United States depends on the vessel's tonnage. Refer to MTN 01-98 as amended, *Tonnage Administrative Policy*, for additional information on administrative matters related to tonnage measurement.

4. **Action:** Authorized measurement organizations shall apply the interpretations of this Technical Note immediately. Any deviation from the interpretations of this Technical Note requires written approval from the Marine Safety Center (MSC). This Technical Note is available at <http://www.uscg.mil/hq/msc>.

5. **Disclaimer:** While the policy contained in this Technical Note may assist the industry, the public, the Coast Guard, and other Federal and State agencies in applying statutory and regulatory requirements, this policy is not a substitute for the applicable legal requirements, nor is it in itself a regulation. It is not intended to, nor does it impose legally binding requirements on any party, including the Coast Guard, other Federal agencies, the States, or the regulated community.

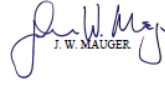

J. W. MAUGER

INAUGURATION DAY The Marine Safety Center will be closed Friday, January 20 for Inauguration Day.

Weekly Notes are issued by the Coast Guard Marine Safety Center's Tonnage Division (MSC-4) for use by organizations that perform measurement work on the Coast Guard's behalf. They are for informational purposes only, and are not intended as, nor should they be construed to represent, revisions of or substitutes for applicable statutes or regulations or established interpretations of either.

MEASUREMENT ORGANIZATION WEEKLY NOTES – 01/11/2017

BIRTHDAY OF MARTIN LUTHER KING, JR. HOLIDAY The Marine Safety Center will be closed Monday, January 16 in observance of the Birthday of Martin Luther King, Jr.

Weekly Notes are issued by the Coast Guard Marine Safety Center's Tonnage Division (MSC-4) for use by organizations that perform measurement work on the Coast Guard's behalf. They are for informational purposes only, and are not intended as, nor should they be construed to represent, revisions of or substitutes for applicable statutes or regulations or established interpretations of either.

MEASUREMENT ORGANIZATION WEEKLY NOTES – 01/04/2017

CONSOLIDATED REPORTING The Marine Safety Center (MSC) recently authorized an ACS to make the required notifications of technical work completed under the authority of NVIC 02-95 CH-2, in a consolidated format. This consolidated format utilizes the ACS's existing data system to produce a report of work completed during a specified timeframe, and avoids the need to manually complete the standardized notification spreadsheets that are required for other work. The authorization was made on a case basis after extensive testing for data integrity. ACS's interested in exploring such an alternate notification process may contact LCDR Frank Strom at 202-795-6731.

MTN 04-03, CH-3 The MSC recently issued [Change 3](#) to MTN 04-03 *Technical Support and Oversight of Authorized Classification Societies*. This change includes amendments to the "Follow-up" section that explicitly require an ACS formal response for a major nonconformity finding to detail the action taken to prevent recurrence. Additionally, regardless of whether follow-up action is required by the MSC, the ACS must evaluate all findings (observations, nonconformities, and major nonconformities) and determine what internal actions are needed to prevent recurrence. As a reminder, the MTN is available on the [U.S. Tonnage Publications](#) web page.

	Marine Safety Center Technical Note
MTN 04-03, CH-3 16703 December 30, 2016	
MARINE SAFETY CENTER TECHNICAL NOTE (MTN) NO. 04-03, CH-3	
Subj: TECHNICAL SUPPORT AND OVERSIGHT OF AUTHORIZED CLASSIFICATION SOCIETIES	
Ref: (a) Title 46, Code of Federal Regulations, Part 69 (b) Navigation and Vessel Inspection Circular (NVIC) 10-82, as amended, "Acceptance of Plan Review and Inspection Tasks Performed by the American Bureau of Shipping (ABS) for New Construction or Major Modification of U.S. Flag Vessels" (c) NVIC 10-85, "Oversight of Technical and Administrative Aspects of Load Line Assignment" (d) NVIC 2-95, as amended, "The Alternate Compliance Program (ACP)" (e) NVIC 3-97, "Stability Related Review Performed by the American Bureau of Shipping for U.S. Flag Vessels" (f) NVIC 03-05, "Guidance for Oversight of Post-Licensing Activities Associated with Development of Deepwater Ports (DWP _s)" (g) NVIC 01-13, as amended, "Inspection and Certification of Vessels under the Maritime Security Program (MSP)"	
1. Purpose: This Marine Safety Center Technical Note (MTN) updates the processes used by the Marine Safety Center (MSC) to support and oversee technical work performed on behalf of the U.S. Coast Guard by third parties duly recognized under applicable authorizations.	
2. Applicability: This MTN applies to plan review, tonnage measurement, load line assignment, and other technical work performed on behalf of the Coast Guard by classification societies, measurement organizations, assigning authorities, and other third parties recognized under the provisions of references (a) through (g) and similar authorizations. Additional policy applicable to tonnage measurement oversight is available in MTN 01-98, as amended, "Tonnage Administrative Policy." Throughout this MTN, the term "authorized classification society" (ACS) is used to refer to any organization duly recognized to perform technical work on behalf of the Coast Guard.	
3. Discussion: a. The MSC is responsible for ensuring technical work performed on behalf of the Coast Guard by third parties meets the objectives outlined under the applicable authorizations. We accomplish this by monitoring the accuracy and consistency of work performed by third party organizations on our behalf. Our oversight of technical work is part of a broader program of Coast Guard oversight that includes ACS rule review, U.S.	

Weekly Notes are issued by the Coast Guard Marine Safety Center's Tonnage Division (MSC-4) for use by organizations that perform measurement work on the Coast Guard's behalf. They are for informational purposes only, and are not intended as, nor should they be construed to represent, revisions of or substitutes for applicable statutes or regulations or established interpretations of either.

MEASUREMENT ORGANIZATION WEEKLY NOTES – 12/28/2016

NEW YEAR'S DAY HOLIDAY The Marine Safety Center will be closed on January 2, 2017 in observance of the New Year's Day holiday. We wish you all a happy and safe holiday season.

TONNAGE PERSONNEL As a reminder, Mr. Marcus Akins will be out of the office until Wednesday, January 4, 2017. During that time, please copy Mr. David Karnes on any file requests.

Weekly Notes are issued by the Coast Guard Marine Safety Center's Tonnage Division (MSC-4) for use by organizations that perform measurement work on the Coast Guard's behalf. They are for informational purposes only, and are not intended as, nor should they be construed to represent, revisions of or substitutes for applicable statutes or regulations or established interpretations of either.

MEASUREMENT ORGANIZATION WEEKLY NOTES – 12/21/2016

CHRISTMAS AND NEW YEAR'S DAY HOLIDAYS The Marine Safety Center will be closed on December 26, 2016 and January 2, 2017 in observance of the Christmas and New Year's Day holidays. We wish you all a happy and safe holiday season.

TONNAGE PERSONNEL Mr. Marcus Akins will be out of the office beginning Tuesday, December 27, 2016 and returning Wednesday, January 4, 2017. During that time, please copy Mr. David Karnes on any file requests.

MEASUREMENT ORGANIZATION WEEKLY NOTES – 12/14/2016

NOTIFICATION EXCEL FILE As mentioned in a previous edition of the Weekly Notes, the Marine Safety Center is revisiting the notification process for reporting completed work done on the Coast Guard's behalf, including tonnage measurement work. As part of this effort, we intend to revise the Excel notification file (available on the [Tonnage Publications](#) web page). Under consideration are ways to facilitate more consistent data entry as well as revision of the current pick lists. If you have any suggested improvements or comments on use of this spreadsheet, please contact Mr. Tony Cao.

U.S. Tonnage Publications

Tonnage Regulations (46 CFR Part 69)

[2016 \(Current\) Tonnage Regulations](#)

[2014 Tonnage Regulations](#)

[Tonnage Regulations - Final Rule](#)

[Tonnage Regulations - Notice for Proposed Rulemaking \(NPRM\)](#)

Marine Safety Center Technical Notes (MTNs)

[MTN 01-99 CH-8 - Tonnage Technical Policy](#)

[MTN 01-98 CH-12 - Tonnage Administrative Policy](#)

[MTN 04-03 CH-2 - Technical Support and Oversight of Authorized Classification Societies](#)

[MTN 04-03 CH-2 Enclosure \(1\) - Tonnage Notification Template](#)

Navigation and Vessel Inspection Circulars (NVICs)

[NVIC 11-93 CH-3- Applicability of Tonnage Measurement Systems to U.S. Flag Vessels](#)



Weekly Notes are issued by the Coast Guard Marine Safety Center's Tonnage Division (MSC-4) for use by organizations that perform measurement work on the Coast Guard's behalf. They are for informational purposes only, and are not intended as, nor should they be construed to represent, revisions of or substitutes for applicable statutes or regulations or established interpretations of either.

MEASUREMENT ORGANIZATION WEEKLY NOTES – 12/07/2016

GRANDFATHERING PROVISIONS The provisions of § 69.13(c) of MTN 01-99 CH-8 (excerpted below) afford some grandfathering relief to owners who had vessels designed or redesigned on the basis of rules and procedures that were superseded by the Tonnage Regulations Amendments rulemaking of earlier this year. Along similar lines, provisions of Appendix A of the MTN may afford some relief for interpretations of the tonnage regulations promulgated by a new MTN change. Note there are no longer any provisions for extending grandfathering to identical sister vessels.

(c) *Grandfathering of Rules and Procedures*

Unless otherwise provided for by law, the tonnage measurement rules and procedures that immediately predate the rules and procedures prescribed in this part may be applied, at the option of the vessel owner, to the following vessels:

- (1) A vessel which has not been measured and which was contracted for on or before May 2, 2016.
- (2) A vessel which has been measured, but which has undergone modifications contracted for on or before May 2, 2016.

TONNAGE FILE REQUESTS Per MTN 01-98 CH-12, our customer service standard for responding to tonnage file requests from an ACS is two business days from receipt. To ensure timely response, please submit such requests to msc@uscg.mil, copying Mr. Marcus Akins. For vessels measured by another ACS, contact the ACS directly for governing policy and procedures on release of copies of their tonnage measurement records. Also, although we have made some progress on restoring functionality for generating tonnage data sheets, they remain unavailable. Please contact Mr. David Karnes if you need vessel information typically provided on the sheets that cannot be obtained through [PSIX](#).

Weekly Notes are issued by the Coast Guard Marine Safety Center's Tonnage Division (MSC-4) for use by organizations that perform measurement work on the Coast Guard's behalf. They are for informational purposes only, and are not intended as, nor should they be construed to represent, revisions of or substitutes for applicable statutes or regulations or established interpretations of either.

MEASUREMENT ORGANIZATION WEEKLY NOTES – 11/30/2016

TONNAGE WEBSITE We have updated the Marine Safety Center's tonnage website to include relevant IMO documents, such as Assembly Resolutions, SDC/SLF Subcommittee reports and papers, and TM and MSC Circulars. Links can be found at <http://www.uscg.mil/hq/msc/tonnage/imotonnagepubs.asp>.



OVERALL LENGTH During a recent oversight review, we noted that an overall length dimension incorrectly included a vessel's non-watertight bulwark. As a reminder, in accordance with § 69.203 of MTN 01-99 CH-8, the overall length does not include bowsprits, rudders, outboard motor brackets, and swim platforms that do not contain buoyant volume, and other similar fittings and attachments, such as non-watertight bulwarks, that are not part of the buoyant hull envelope. If you have any questions as to whether a fitting or attachment is part of the buoyant hull envelope, please contact Mr. Marcus Akins.

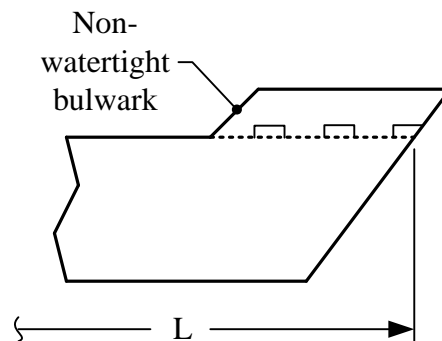

Weekly Notes are issued by the Coast Guard Marine Safety Center's Tonnage Division (MSC-4) for use by organizations that perform measurement work on the Coast Guard's behalf. They are for informational purposes only, and are not intended as, nor should they be construed to represent, revisions of or substitutes for applicable statutes or regulations or established interpretations of either.

MEASUREMENT ORGANIZATION WEEKLY NOTES – 11/23/2016

CG NUMBER REQUESTS AND FORMAL APPLICATIONS We have recently received a number of Coast Guard (CG) number requests that did not include a completed *Application for Formal Measurement Services*. As a reminder, MTN 01-98 CH-12 requires ACS acceptance of the application form of Appendix A (also available [online](#)). In order to avoid delays, please ensure inclusion of a completed copy of this form when submitting CG number requests.

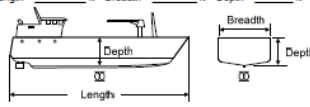
U.S. TONNAGE REGULATIONS APPLICATION FOR FORMAL MEASUREMENT SERVICES		MTN 01-98 as amended																																
I. APPLICABILITY																																		
A U.S. flag vessel is eligible to be measured under the Convention system (46 CFR 69 subpart B) if it is 79 feet or more in overall length. Also, any U.S. flag vessel, regardless of length, may be measured under the Standard system (46 CFR 69 subpart C) or Dual system (46 CFR 69 subpart D). Some vessels, including those that are less than 79 feet in overall length, are eligible to be measured under the Simplified system (46 CFR 69 subpart E), without the need for formal measurement. Refer to section 69.11 of 46 CFR 69 for complete measurement eligibility details.																																		
II. APPLICATION INFORMATION																																		
<p>*1. REQUESTED SERVICE (see instructions on reverse)</p> <p><input type="checkbox"/> INITIAL MEASUREMENT (indicate measurement system(s))</p> <p style="margin-left: 20px;"><input type="checkbox"/> Subpart B - Convention system (GT/ITC/NT/ITC)</p> <p style="margin-left: 20px;"><input type="checkbox"/> Subpart C - Standard system (GRT/NRT)</p> <p style="margin-left: 20px;"><input type="checkbox"/> Subpart D - Dual system (GRT/NRT)</p> <p><input type="checkbox"/> REMEASUREMENT (indicate reason(s))</p> <p style="margin-left: 20px;"><input type="checkbox"/> Configuration changes</p> <p style="margin-left: 20px;"><input type="checkbox"/> Change in passengers or draft</p> <p style="margin-left: 20px;"><input type="checkbox"/> Correction of measurement errors</p> <p style="margin-left: 20px;"><input type="checkbox"/> Other (describe in remarks)</p> <p><input type="checkbox"/> OTHER (describe in remarks)</p> <p>*2. REQUESTED TONNAGE CERTIFICATE(S): <input type="checkbox"/> US <input type="checkbox"/> ITC69</p> <p>*3. VESSEL NAME _____</p> <p>*4. VESSEL NUMBER _____</p> <p>5. HAULING PORT _____</p> <p>6. BUILDER'S NAME _____</p> <p>7. HIN OR HULL NUMBER _____</p> <p>8. PLACE BUILT _____</p> <p>9. KEEL LAID / ALTERATION DATE _____</p> <p>10. DELIVERY DATE _____</p> <p>11. VESSEL TYPE</p> <table style="width: 100%; border: none;"> <tr> <td><input type="checkbox"/> Barge</td> <td><input type="checkbox"/> Passenger</td> </tr> <tr> <td><input type="checkbox"/> Fishing</td> <td><input type="checkbox"/> Recreational</td> </tr> <tr> <td><input type="checkbox"/> Fish Processing</td> <td><input type="checkbox"/> Research</td> </tr> <tr> <td><input type="checkbox"/> Fish Tender</td> <td><input type="checkbox"/> Tanker</td> </tr> <tr> <td><input type="checkbox"/> Freight</td> <td><input type="checkbox"/> Towing</td> </tr> <tr> <td><input type="checkbox"/> Industrial</td> <td><input type="checkbox"/> Training</td> </tr> <tr> <td><input type="checkbox"/> Mobile Offshore Drilling Unit</td> <td><input type="checkbox"/> Unclassified</td> </tr> <tr> <td><input type="checkbox"/> Offshore Supply</td> <td><input type="checkbox"/> Warship</td> </tr> <tr> <td><input type="checkbox"/> Oil Spill Response</td> <td></td> </tr> </table>	<input type="checkbox"/> Barge	<input type="checkbox"/> Passenger	<input type="checkbox"/> Fishing	<input type="checkbox"/> Recreational	<input type="checkbox"/> Fish Processing	<input type="checkbox"/> Research	<input type="checkbox"/> Fish Tender	<input type="checkbox"/> Tanker	<input type="checkbox"/> Freight	<input type="checkbox"/> Towing	<input type="checkbox"/> Industrial	<input type="checkbox"/> Training	<input type="checkbox"/> Mobile Offshore Drilling Unit	<input type="checkbox"/> Unclassified	<input type="checkbox"/> Offshore Supply	<input type="checkbox"/> Warship	<input type="checkbox"/> Oil Spill Response		<p>12. OVERALL HULL DIMENSIONS</p> <p>Length = _____ ft Breadth = _____ ft Depth = _____ ft</p>  <p>13. ADDITIONAL VESSEL INFORMATION</p> <p>a. PROPULSION: <input type="checkbox"/> Self-Propelled <input type="checkbox"/> Non-Self-Propelled</p> <p>b. NUMBER OF PASSENGERS: _____</p> <p>Total: _____ Accommodated in cabins for 8 or fewer: _____</p> <p>c. NUMBER OF CARGO SPACES: _____</p> <p>d. NUMBER OF PORTABLE ENCLOSED SPACES: _____</p> <p>e. DRAFT RESTRICTIONS: <input type="checkbox"/> Load Line <input type="checkbox"/> Other</p> <p style="margin-left: 20px;"><input type="checkbox"/> Stability Letter</p> <p>f. INTENDED VOYAGES: <input type="checkbox"/> Domestic <input type="checkbox"/> Great Lakes</p> <p style="margin-left: 20px;"><input type="checkbox"/> Foreign</p> <p>14. SUBMITTED DRAWINGS (check all submitted with application)</p> <table style="width: 100%; border: none;"> <thead> <tr> <th style="text-decoration: underline;">General Arrangements</th> <th style="text-decoration: underline;">Construction</th> <th style="text-decoration: underline;">Miscellaneous</th> </tr> </thead> <tbody> <tr> <td><input type="checkbox"/> Outboard Profile</td> <td><input type="checkbox"/> Midship Section</td> <td><input type="checkbox"/> Lines</td> </tr> <tr> <td><input type="checkbox"/> Inboard Profile</td> <td><input type="checkbox"/> Framing Plans</td> <td><input type="checkbox"/> Cargo</td> </tr> <tr> <td><input type="checkbox"/> Deck Arrangements</td> <td><input type="checkbox"/> Shell Expansion</td> <td><input type="checkbox"/> Tonnage</td> </tr> <tr> <td><input type="checkbox"/> Bow/Stem/Topside</td> <td><input type="checkbox"/> Other</td> <td><input type="checkbox"/> Other</td> </tr> </tbody> </table> <p>*15. POINT OF CONTACT</p> <p>16. REMARKS</p>	General Arrangements	Construction	Miscellaneous	<input type="checkbox"/> Outboard Profile	<input type="checkbox"/> Midship Section	<input type="checkbox"/> Lines	<input type="checkbox"/> Inboard Profile	<input type="checkbox"/> Framing Plans	<input type="checkbox"/> Cargo	<input type="checkbox"/> Deck Arrangements	<input type="checkbox"/> Shell Expansion	<input type="checkbox"/> Tonnage	<input type="checkbox"/> Bow/Stem/Topside	<input type="checkbox"/> Other	<input type="checkbox"/> Other
<input type="checkbox"/> Barge	<input type="checkbox"/> Passenger																																	
<input type="checkbox"/> Fishing	<input type="checkbox"/> Recreational																																	
<input type="checkbox"/> Fish Processing	<input type="checkbox"/> Research																																	
<input type="checkbox"/> Fish Tender	<input type="checkbox"/> Tanker																																	
<input type="checkbox"/> Freight	<input type="checkbox"/> Towing																																	
<input type="checkbox"/> Industrial	<input type="checkbox"/> Training																																	
<input type="checkbox"/> Mobile Offshore Drilling Unit	<input type="checkbox"/> Unclassified																																	
<input type="checkbox"/> Offshore Supply	<input type="checkbox"/> Warship																																	
<input type="checkbox"/> Oil Spill Response																																		
General Arrangements	Construction	Miscellaneous																																
<input type="checkbox"/> Outboard Profile	<input type="checkbox"/> Midship Section	<input type="checkbox"/> Lines																																
<input type="checkbox"/> Inboard Profile	<input type="checkbox"/> Framing Plans	<input type="checkbox"/> Cargo																																
<input type="checkbox"/> Deck Arrangements	<input type="checkbox"/> Shell Expansion	<input type="checkbox"/> Tonnage																																
<input type="checkbox"/> Bow/Stem/Topside	<input type="checkbox"/> Other	<input type="checkbox"/> Other																																
III. STATEMENT OF REPRESENTATION																																		
I understand that under the provisions of 46 CFR 69.25, a person making a false statement or representation in this application may be fined up to \$30,000 and that the vessel also is liable in rem for the penalty. I also acknowledge that I am required by 46 CFR 69.19 to report immediately to an authorized measurement organization any intent to structurally alter the vessel or to change its service or the use of its space. I certify that the information provided by me on this application, or in any attachments thereto, is correct.																																		
Owner's printed name _____	Owner's signature _____	Date _____																																
Formal Application (08/14)		Page 1 of 2																																

THANKSGIVING HOLIDAY The Marine Safety Center will be closed on Thursday, November 24, 2016, in observance of the Thanksgiving holiday.

Weekly Notes are issued by the Coast Guard Marine Safety Center's Tonnage Division (MSC-4) for use by organizations that perform measurement work on the Coast Guard's behalf. They are for informational purposes only, and are not intended as, nor should they be construed to represent, revisions of or substitutes for applicable statutes or regulations or established interpretations of either.

MEASUREMENT ORGANIZATION WEEKLY NOTES – 11/16/2016

GRAPHICAL REPRESENTATIONS During recent oversight activities, we have encountered tonnage files that either do not include a profile drawing and transverse section - required by §6.2(a)(4)(i) and (ii) of MTN 01-98 CH-12 – or, if included, the drawings do not fully meet MTN requirements. We believe this lack of compliance may have contributed to main dimension nonconformities. Below, we offer examples of acceptable drawings.

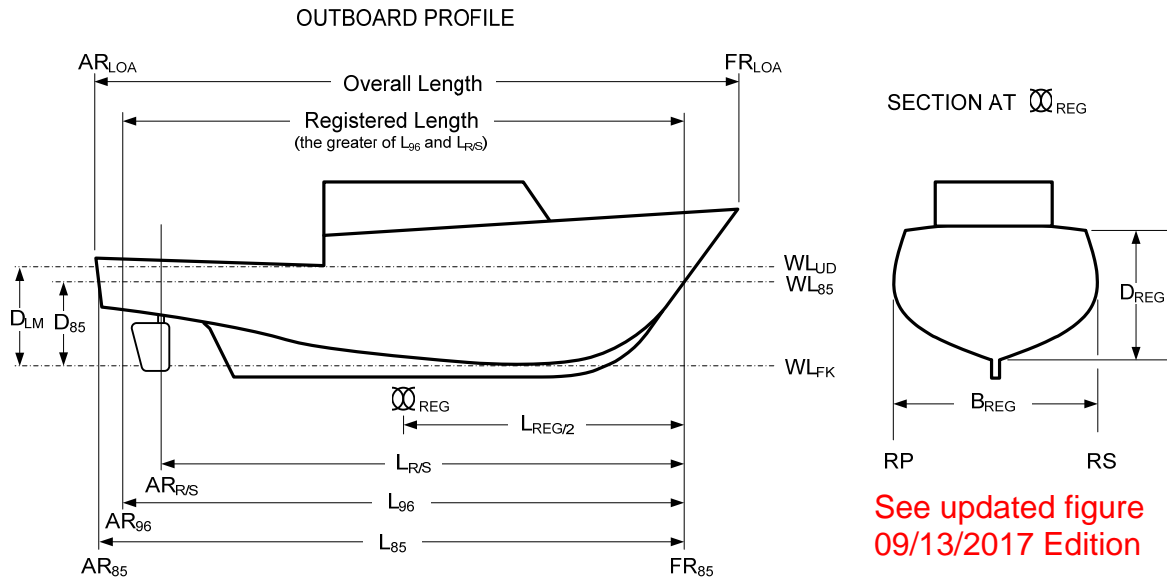

SUBMITTAL REQUIREMENTS Per paragraph 4(d) of MTN 04-03 CH-2, work items selected for oversight are submitted to the Marine Safety Center within 5 working days. This requirement covers the entire tonnage file. Tonnage files should be complete upon submittal, including all principal information used to assign tonnages and dimensions.

Weekly Notes are issued by the Coast Guard Marine Safety Center's Tonnage Division (MSC-4) for use by organizations that perform measurement work on the Coast Guard's behalf. They are for informational purposes only, and are not intended as, nor should they be construed to represent, revisions of or substitutes for applicable statutes or regulations or established interpretations of either.

MEASUREMENT ORGANIZATION WEEKLY NOTES – 11/09/2016

U.S. vs. FOREIGN BUILD We recently received an inquiry on whether regulations related to build requirements for vessels that engage in the U.S. fisheries have recently changed. We responded to the effect that no such changes have been made, and that that the information in [Tonnage Guide \(TG\) 5 CH-0](#) on this subject remains current. As discussed in TG 5, there are no U.S. build requirements for vessels that engage in the fisheries but are excluded from documentation by virtue of their tonnage being less than 5 net tons. Conversely, U.S. build requirements apply to vessels of at least 5 net tons that engage in the fisheries, and these vessels must be documented.

U.S. Build Requirement Summary		
Documentation Status	Coastwise Trade	Fisheries
Vessel Documented	U.S. Build Required*	U.S. Build Required*
Vessel Not Documented	U.S. Build Required	U.S. Build <u>NOT</u> Required

* unless waived or otherwise excepted

OVERSIGHT RESULTS DISCUSSIONS The Marine Safety Center (MSC) is renewing efforts to improve the way we communicate results of completed oversight reviews with our measurement organization (ACS) counterparts. Among other changes, we are implementing managerial level discussions to supplement the ACS written responses on oversight findings, along the lines of audit “close-out” meeting discussions that typically occur under various quality management systems.

VETERANS DAY HOLIDAY The MSC will be closed Friday, November 11, 2016 in observance of the Veterans Day holiday.

Weekly Notes are issued by the Coast Guard Marine Safety Center's Tonnage Division (MSC-4) for use by organizations that perform measurement work on the Coast Guard's behalf. They are for informational purposes only, and are not intended as, nor should they be construed to represent, revisions of or substitutes for applicable statutes or regulations or established interpretations of either.

MEASUREMENT ORGANIZATION WEEKLY NOTES – 11/02/2016

CONVENTION MEASUREMENT SYSTEM APPLICABILITY The Tonnage Division continues to field questions regarding applicability of the Convention Measurement System to vessels close to its 79-foot length threshold and to vessels with keel laid dates prior to July 19, 1994. We also noted during a recent oversight that a vessel with a registered length less than 79 feet had not been measured under the Convention even though its overall length exceeded the 79-foot threshold, and its voyage type and keel laid/substantial alteration date required Convention measurement. We are currently considering ways to help preclude this type of error, such as including a warning message in the Marine Safety Center's TonCalc software application if a vessel over 79 feet in overall length has not been measured under the Convention. If you have any "lessons learned", input, or comments on this matter, please contact Mr. Marcus Akins.

MEASURING SUPERSTRUCTURE SPACES Further to a July weekly note regarding computational methods for superstructure spaces, the Tonnage Division has encountered several recent cases where a three-dimensional Simpson's first rule integration method was used to calculate superstructure volumes under the Regulatory Measurement System. While this method is authorized for Convention measurement of certain structures, it is not authorized for calculation of volumes of superstructure spaces under the Standard or Dual systems. The images below illustrate the differences between two-dimensional and three-dimensional Simpson's first rule integration methods.

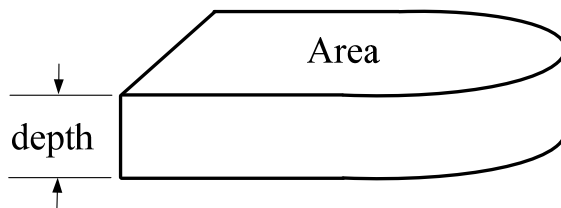

Two-dimensional Simpson's

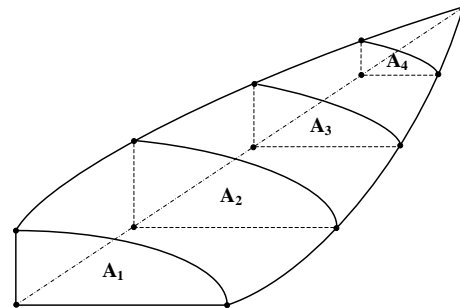

Three-dimensional Simpson's

Weekly Notes are issued by the Coast Guard Marine Safety Center's Tonnage Division (MSC-4) for use by organizations that perform measurement work on the Coast Guard's behalf. They are for informational purposes only, and are not intended as, nor should they be construed to represent, revisions of or substitutes for applicable statutes or regulations or established interpretations of either.

MEASUREMENT ORGANIZATION WEEKLY NOTES – 10/26/2016

MEASUREMENT PRECISION AND TOLERANCES Following discussion of precision and tolerances at the ABS Tonnage Workshop this past May, we have given further thought to how they factor into tonnage certification. In the figure below, “Physical” represents an actual vessel in its as-built configuration; “Theoretical” represents plans and computer models for the vessel; and “As-Certified” represents its assigned measurements. Between these broad categories are shown estimates of uncertainty (e.g., the uncertainty that arises from construction tolerances is shown between Theoretical and Physical). We note that a vessel (Physical) is constructed based on a design, usually represented on plans or through modeling (Theoretical). Assigned measurements (As-Certified) must reflect the as-built vessel (Physical); however, these assignments (As-Certified) are usually based on plans or models (Theoretical). This highlights the importance of onboard surveys to verify that previously available information (Theoretical) used in the measurement process is correct and of sufficient accuracy.

Measurement Precision and Tolerances

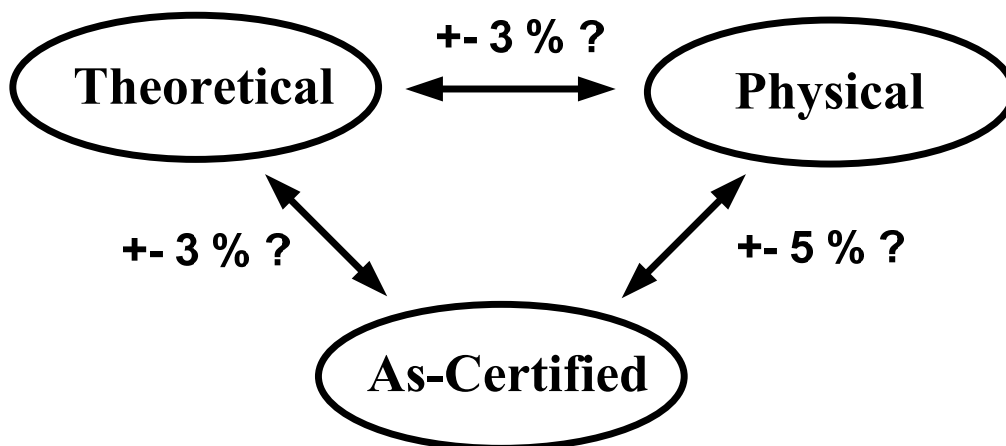

Weekly Notes are issued by the Coast Guard Marine Safety Center's Tonnage Division (MSC-4) for use by organizations that perform measurement work on the Coast Guard's behalf. They are for informational purposes only, and are not intended as, nor should they be construed to represent, revisions of or substitutes for applicable statutes or regulations or established interpretations of either.

MEASUREMENT ORGANIZATION WEEKLY NOTES – 10/19/2016

ADMINISTRATIVE POLICY UPDATE We are in the process of updating MTN 01-98 CH-12. Among other changes, we are considering allowing measurement organizations more flexibility in listing spaces on Tonnage Certificates, and clarifying roles and responsibilities of contractors in providing measurement services. If you have any input for this update, please feel free to contact Mr. Marcus Akins.

OVERSIGHT & REMEASUREMENT CRITERIA Further to the entry above, we recently conducted an internal review of criteria for categorizing oversight findings, and establishing which vessel changes require remeasurement. Our review included standards on stability instruments - which provide for tolerances ranging from 0.35% to 2% of displacement - and information exchanged both during the recent IMO work on the TM Convention and at the Tonnage Workshop in Houston this past May. A useful table on the use of graduated scales from IMO document SDC 1/INF.4 is excerpted below. Your input on this subject would be particularly helpful, especially if you are aware of any guidance from other flag States regarding tolerances or remeasurement criteria.

Table 1-6 Experience with graduated scales	
Flag Administration	Administration's experience
Canada	A tonnage change criterion of 5% is applied for ships under 24 m in length and a tonnage change criterion of 1% is applied for ships of 24 m and over.
Finland	Graduated scales are not used for tonnage changes.
Germany	None.
Italy	Graduated scales are not used.
Japan	Many graduated scales are used to apply maritime standards. An example is catching allowances in fisheries.
Republic of Korea	None.
Russian Federation	Graduated scales are not used.
Sweden	Graduated scales are not used for tonnage changes.
United States	A graduated scale is used to apply "foreign rebuilt" requirements, which are based on percentage of steel weight changes. Below 7.5% a ship is deemed as not rebuilt foreign, between 7.5% and 10% the changes are evaluated by the Administration on a case basis, and above 10% the ship is automatically deemed foreign rebuilt.
Vanuatu	None to date.

Weekly Notes are issued by the Coast Guard Marine Safety Center's Tonnage Division (MSC-4) for use by organizations that perform measurement work on the Coast Guard's behalf. They are for informational purposes only, and are not intended as, nor should they be construed to represent, revisions of or substitutes for applicable statutes or regulations or established interpretations of either.

MEASUREMENT ORGANIZATION WEEKLY NOTES – 10/12/2016

ONBOARD SURVEYS Per MTN 01-98 CH-12, onboard surveys serve a number of important functions, including verification of space utilization. For a Convention measured vessel, this survey information is often needed to supplement information from required drawings, which may lack necessary detail for fully assessing the eligibility of excluded spaces. In fact, the Tonnage Division often obtains additional material from plan review drawings and internet photos when conducting oversight to help fill in these gaps. The image below illustrates some specific features subject to verification during a vessel's onboard survey that influence excluded space eligibility.



Do curtain plate depths exceed the depth of deck beams by more than one inch?

Are recesses fitted with a means of closure?

Are spaces fitted with securing devices?

IMO CONSOLIDATED AUDIT FINDINGS In reviewing IMO consolidated audit reports, we noted a number of findings on the failure to establish interpretations for matters left "to the satisfaction of the Administration". One such finding refers to the text in the 1969 Tonnage Convention about "modifications deemed to be of a major character". While the Marine Safety Center has issued an interpretation of this term (see § 69.71(c)(2) of MTN 01-99 CH-8), we have not similarly defined what is meant by the text "volumes shall be calculated . . . with an accuracy acceptable to the Administration". We would be interested in hearing if other Administrations have issued interpretations on this text. If you would like to share information on this subject, please contact Mr. Marcus Akins.

TONNAGE PERSONNEL As a reminder, Mr. David Karnes will be out of the office until Monday, October 17. During this time, please copy Mr. Marcus Akins on any CG number requests.

Weekly Notes are issued by the Coast Guard Marine Safety Center's Tonnage Division (MSC-4) for use by organizations that perform measurement work on the Coast Guard's behalf. They are for informational purposes only, and are not intended as, nor should they be construed to represent, revisions of or substitutes for applicable statutes or regulations or established interpretations of either.

MEASUREMENT ORGANIZATION WEEKLY NOTES – 10/05/2016

SUEZ CERTIFICATE FORM When measuring warships, the Tonnage Division issues Suez Canal Special Tonnage Certificates using a certificate form that has not been updated in over 20 years. During recent work at IMO, we noted that other flag States issue Suez Certificates with different formats and contents that better lend themselves to inclusion of calculations on the form. The following are examples of the last page of two Suez Certificates, one issued by the Coast Guard and the other by Germany, which show significant differences. If you have any “lessons learned” or other information on this subject which you would be willing to share with the Coast Guard or other measurements organizations, please contact Mr. Tony Cao of the Tonnage Division staff at (202) 795-6788 or email Tony.J.Cao@uscg.mil.

DETAILED MEASUREMENTS OF PROPELLING MACHINERY SPACES																																			
UNITED STATES OF AMERICA																																			
SUEZ CANAL																																			
TONNAGE CERTIFICATE																																			
NAME OF VESSEL (PRINTED OR STAMPED)																																			
REGISTRATION NUMBER																																			
CLASSIFICATION																																			
<p>MEAN MEASURED ENGINE CALCULATION</p> <table border="1"> <thead> <tr> <th>Name (company & State location (or equivalent))</th> <th>Light (HP)</th> <th>Dark (HP)</th> <th>Mean (HP)</th> <th>Mean Tonnage</th> </tr> </thead> <tbody> <tr> <td>Propulsion Machinery</td> <td>21.87</td> <td>20.15</td> <td>21.01</td> <td>86.85</td> </tr> <tr> <td>None</td> <td></td> <td></td> <td></td> <td></td> </tr> <tr> <td>Staircase</td> <td>1.19</td> <td>0.61</td> <td>0.90</td> <td>3.58</td> </tr> <tr> <td>Passageway</td> <td>2</td> <td>20.9</td> <td>10.5</td> <td>41.2</td> </tr> <tr> <td>Total</td> <td></td> <td></td> <td></td> <td>132.73</td> </tr> </tbody> </table>						Name (company & State location (or equivalent))	Light (HP)	Dark (HP)	Mean (HP)	Mean Tonnage	Propulsion Machinery	21.87	20.15	21.01	86.85	None					Staircase	1.19	0.61	0.90	3.58	Passageway	2	20.9	10.5	41.2	Total				132.73
Name (company & State location (or equivalent))	Light (HP)	Dark (HP)	Mean (HP)	Mean Tonnage																															
Propulsion Machinery	21.87	20.15	21.01	86.85																															
None																																			
Staircase	1.19	0.61	0.90	3.58																															
Passageway	2	20.9	10.5	41.2																															
Total				132.73																															
<p>DOUBLE BOTTOM COMPARTMENTS AVAILABLE FOR THE CARRIAGE OF OIL</p> <table border="1"> <thead> <tr> <th>Name (company & State location (or equivalent))</th> <th>Mean (HP)</th> <th>Mean Tonnage</th> </tr> </thead> <tbody> <tr> <td>Propulsion Machinery</td> <td>21.01</td> <td>86.85</td> </tr> <tr> <td>None</td> <td></td> <td></td> </tr> <tr> <td>Staircase</td> <td>0.90</td> <td>3.58</td> </tr> <tr> <td>Passageway</td> <td>10.5</td> <td>41.2</td> </tr> <tr> <td>Total</td> <td>32.41</td> <td>132.73</td> </tr> </tbody> </table>						Name (company & State location (or equivalent))	Mean (HP)	Mean Tonnage	Propulsion Machinery	21.01	86.85	None			Staircase	0.90	3.58	Passageway	10.5	41.2	Total	32.41	132.73												
Name (company & State location (or equivalent))	Mean (HP)	Mean Tonnage																																	
Propulsion Machinery	21.01	86.85																																	
None																																			
Staircase	0.90	3.58																																	
Passageway	10.5	41.2																																	
Total	32.41	132.73																																	

PARTICULARS OF PROPELLING POWER SPACES						
NAME AND LOCATION	DIMENSIONS	VOLUME (CU FT)	NAME AND LOCATION	DIMENSIONS	VOLUME (CU FT)	
E.R. on floor	9.47 - 50	9.18 x 13.08 x 6.02	176.81	Deck on floor		
	9.22 - 47	29.70 x 13.08 x 9.09	2897.81	Small diesel gen. Cat B	4.25 x 4.00 x 5.20 x102	91.81
				Fire pit	1.80 x 3.80 x 3.80	25.19
				Large messroom	1.20 x 2.80 x 3.50	11.38
				Large & small gen	1.80 x 5.20 x 3.80	35.62
						137.89
Stair case	9.22 - 42	20.00 x 3.75 x 0.78	58.40			
M/E of pump T	9.23 - 42	See tank plan	113.40			
E.R. on 4th deck	9.26 - 51	19.86 x 10.09 x 5.16	1034.00			
Gen. S	9.26 - 51	19.86 x 10.09 x 5.16	1034.00			
E.R. on 3rd deck	9.47 - 50	9.18 x 13.08 x 7.77	975.78			
Deck	R. 21 1/2 - 46 1/2	24.00 x 13.88 x 7.77	2555.85			
Ballast	9.22 - 23 1/2	4.80 x 13.08 x 7.77	499.77			
Gen. room P	Cat B	9.26 - 51	19.86 x 14.42 x 7.77 x102	1112.89		
Gen. room S	Cat B	9.26 - 51	19.86 x 14.42 x 7.77 x102	1112.89		
E.R. on 2nd deck						
Bed S	Cat B	9.26 - 43	13.80 x 7.40 x 5.17 x102	286.15		
eng. room	Cat B	9.26 - 43	13.80 x 13.17 x 9.89	1729.84		
eng. control	Cat B	9.43 - 47	2.97 x 18.09 x 3.43 x102	92.14		
switchboard	Cat B	9.47 - 50	4.23 x 18.24 x 3.43 x102	109.85		
Cat B						
*No. 2 gen P	Cat B	3.19 x 3.11 x 3.43 x102	21.39			
*No. 1 gen P	Cat B	3.19 x 2.49 x 3.43 x102	13.89			
*No. 3 gen P	Cat B	3.19 x 19.80 x 3.43 x102	99.58			
E.R. on 1st deck, 1st tier						
eng. room	Cat B	9.26 - 43	13.80 x 13.17 x 4.22	735.85		
				17792.43		
Deck as space				137.89		
				17794.58		
Collected fuel oil tank						
H.F.O. SERV. T. (P)	see tank plan	224.40				
H.F.O. DETT. T. (P)	see tank plan	254.40				
LOW SULPHUR H.F.O. SERV. T. (P)	see tank plan	112.20				
LOW SULPHUR H.F.O. DETT. T. (P)	see tank plan	112.20				
Unlimited volume	1.2 x 1.36 x 98274 x 56.04		793.30			
			867.77			
Engines open as measured			17957.76			
DOUBLE BOTTOM COMPARTMENTS AVAILABLE FOR THE CARRIAGE OF OIL						
NAME AND LOCATION	DIMENSIONS	VOLUME (CU FT)	NAME OR NUMBER	VOLUME (CU FT)		
On Deck 2nd tier			None			
Passageway, P	1.36 x 1.45 x 3.75	7.46				
Passageway	1.36 x 13.53 x 3.75	68.86				
	1.76 x 1.70 x 3.75	11.82				
Staircase		89.22	On Deck 5th tier			
		10.85	Passageway	1.30 x 16.72 x 3.38	69.87	
				0.35 x 1.17 x 3.38	1.38	
				1.36 x 9.48 x 3.38	40.29	
					116.54	
On Deck 3rd tier						
Passageway, P	1.30 x 8.63 x 3.48	38.04	Staircase	1.20 x 2.00 x 3.38	8.11	
Passageway, S	1.30 x 20.40 x 3.48	92.29	On Deck 7th tier			
	1.76 x 1.70 x 3.48	16.67	Staircase	1.20 x 2.00 x 3.38	8.11	
		162.70				
Staircase	1.40 x 2.00 x 3.48	9.74	On Deck 8th tier			
			Passageway	1.30 x 20.65 x 3.38	90.74	
				1.76 x 1.70 x 3.38	10.63	
					101.37	
On Deck 6th tier						
Passageway P aft	2.00 x 1.11 x 3.38	7.88	Staircase	1.20 x 3.00 x 3.38	8.11	
P aft	0.40 x 2.94 x 3.38	3.43				
	1.20 x 10.42 x 3.38	84.21				
S aft	0.91 x 2.28 x 3.38	6.54				
S aft	2.00 x 1.08 x 3.38	13.98	On Deck 9th tier			
C aft	1.76 x 1.70 x 3.38	16.11	Passageway	1.30 x 16.14 x 3.38	79.71	
		124.35		1.76 x 1.70 x 3.38	16.11	
					95.82	
Staircase	1.20 x 2.00 x 3.38	8.11				
			Staircase up	1.20 x 2.00 x 3.37	8.76	
				1.00 x 0.95 x 4.20	4.41	
				1.00 x 2.00 x 1.66	3.30	
				1.50 x 0.96 x 0.84	1.20	
					14.32	
On Deck 7th tier						
Passageway	1.20 x 24.02 x 3.48	109.87				
	1.76 x 1.70 x 3.48	16.67				
		126.54				
Staircase	1.20 x 2.00 x 3.48	8.35				
			Staircase	1.20 x 2.00 x 3.37	8.09	
			E/C on Deck 2nd tier	3.10 x 1.10 x 4.06	13.34	
			Lobby			

COLUMBUS DAY HOLIDAY The Marine Safety Center will be closed on Monday, October 10, 2016 in observance of the Columbus Day holiday.

TONNAGE PERSONNEL Mr. David Karnes will be out of the office beginning Friday, October 7 and returning Monday, October 17. During that time, please copy Mr. Marcus Akins on any CG number requests.

Weekly Notes are issued by the Coast Guard Marine Safety Center's Tonnage Division (MSC-4) for use by organizations that perform measurement work on the Coast Guard's behalf. They are for informational purposes only, and are not intended as, nor should they be construed to represent, revisions of or substitutes for applicable statutes or regulations or established interpretations of either.

MEASUREMENT ORGANIZATION WEEKLY NOTES – 09/28/2016

OVERSIGHT PROCESS Within the past year, we established new subcategories for grouping oversight findings, which provide increased granularity in our results reporting, and permit reviews of only certain aspects of a vessel tonnage file. Also, we implemented new business procedures to require additional discussions between the Marine Safety Center (MSC) and measurement organization counterparts at a managerial level, and to elevate the signature levels for MSC oversight correspondence. These measures were taken to facilitate better communications between all concerned, which are critical to achieving our mutual marine safety goals, and to improve the effectiveness of our oversight program. The new subcategories are listed below. Please feel free to contact Mr. Marcus Akins if you have any questions on how we apply these subcategories.

Tonnage Calculations (Convention)

Tonnage Calculations (Regulatory)

Tonnage Measurement Main Dimensions

Tonnage Measurement Administrative

Weekly Notes are issued by the Coast Guard Marine Safety Center's Tonnage Division (MSC-4) for use by organizations that perform measurement work on the Coast Guard's behalf. They are for informational purposes only, and are not intended as, nor should they be construed to represent, revisions of or substitutes for applicable statutes or regulations or established interpretations of either.

MEASUREMENT ORGANIZATION WEEKLY NOTES – 09/21/2016

TONNAGE FILE SUBMITTAL When a tonnage file is selected for oversight, it is important that it be submitted to the Marine Safety Center (MSC) within 5 working days, without any alteration to the file. While missing information or other gaps noted during its preparation for submittal may be documented by the measurement organization (e.g., through a note to file), the file material should not be otherwise altered without written authorization from the MSC.

PHOTO RESOLUTION AND FILE SIZE In recent years, technological advances in digital photography have vastly improved the ability to visualize and confirm vessel configurations during the tonnage measurement process, even in cases where ample drawings are available. However, low resolution digital photos (from cameras of less than 2 megapixels and typically less than 1.5 MB) are of limited value for this purpose, as illustrated by the 90 KB photo below that we obtained from the internet. In our experience, digital photos of roughly 2 MB, taken with a 3 megapixel camera or higher, generally provide adequate resolution, and offer a good compromise when trading off between the convenience of storing and transmitting smaller file size images, and the obvious advantages of obtaining the highest resolutions possible. Along these lines, we note that Coast Guard Marine Investigators use 5 megapixel digital cameras to capture JPEG images of at least 2 MB when taking photos of important vessel details.



Weekly Notes are issued by the Coast Guard Marine Safety Center's Tonnage Division (MSC-4) for use by organizations that perform measurement work on the Coast Guard's behalf. They are for informational purposes only, and are not intended as, nor should they be construed to represent, revisions of or substitutes for applicable statutes or regulations or established interpretations of either.

MEASUREMENT ORGANIZATION WEEKLY NOTES – 09/14/2016

ORDINARY TRANSOM FRAMES The Tonnage Division recently responded to an inquiry as to whether a transom frame arrangement would qualify as ordinary frames per § 69.109(p) of MTN 01-99 CH-8. The arrangement consists of three vertical transom frames, fitted above a water jet flange, which transition into two frames that extend downward, effectively boxing in the flange on the top and sides, with a separation of approximately five feet between the two secondary frames on either side of the flange. The Marine Safety Center determined that the arrangement does not meet MTN requirements for ordinary frames used to establish the line of the ordinary frames as the arrangement's frame spacing below the flange exceeds four feet. Please direct any questions on this matter to Mr. Marcus Akins.

BOSTON LIGHT AND TONNAGE DUTY - 1716 As reported in Bryant's Maritime Consulting Newsletter, Boston Light on Brewster Island in Boston Harbor was lit for the first time three hundred years ago today on September 14, 1716. The Great and General Court of the Province of the Massachusetts Bay passed the Act of 23 July 1715 for building and maintaining the lighthouse. In addition to establishing a duty of one penny per ton assessed against ships and vessels transiting in or out of the harbor, the Act specified how vessel tonnage would be measured.

Acts and Laws

Passed by the Great and General Court or Assembly of His Majesties Province of the *Massachusetts-Bay in New-England*: Begun and Held at *Boston* upon Wednesday the Twenty-fifth of *May, 1715*. And continued by Prorogation unto Wednesday the Twentieth Day of *July* following, and then Met.

An Act for Building and Maintaining a Lighthouse upon the Great Brewster (called Beacon Island) at the Entrance of the Harbour of *Boston*.

Measure of Vessels.

And that all Vessels having Two Decks shall be measured upon the Main-deck, from the Stem to the Stern-post, then Subducting the breadth from Out-side to Out-side athwart the Main beam, the remainder to be accounted her Length by the Keel, which being Multiplied by the breadth aforesaid, and the product thereof Multiplied by one half of the said breadth as the depth of the Hold: And the whole product divided by One Hundred, the Quotient shall be accounted the Tunage of said Ship or Vessel; and all Ships or other Vessels having a single Deck or Deck and half to be Measured in the same manner (except the depth in Hold) which shall be from the under-side of the Main beam to the Cieling.

Weekly Notes are issued by the Coast Guard Marine Safety Center's Tonnage Division (MSC-4) for use by organizations that perform measurement work on the Coast Guard's behalf. They are for informational purposes only, and are not intended as, nor should they be construed to represent, revisions of or substitutes for applicable statutes or regulations or established interpretations of either.

MEASUREMENT ORGANIZATION WEEKLY NOTES – 09/07/2016

REQUESTS FOR DECISIONS ON INTERPRETATIONS The Tonnage Division formally responds to requests for decisions on interpretations of the tonnage regulations, with a 30 day customer service standard for such responses. Often, the timeliness of our response is related to the completeness of the request. To ensure the fastest possible service, we ask that such requests include the following information, although more information may be necessary depending on the complexity of the issue:

- 1) Description of issue requiring interpretation, including:
 - a. Regulation or MTN section in question
 - b. Reference to any related decisions
 - c. Measurement organization / owner / designer interpretation or preference

- 2) Vessel information, such as:
 - a. Unique VIN (e.g., ON, IMO Number, CG Number)
 - b. Builder and hull number
 - c. Vessel type and designer
 - d. Copy of the Formal Measurement application, containing the above

- 3) Vessel alteration/measurement history (if applicable)

- 4) Graphical representations, such as:
 - a. Sketches of vessel/space configuration with pertinent dimensions
 - b. Current or proposed drawings (annotate scaling)
 - c. Illustrative photos

Please remember that MSC decisions do not establish policy, and are generally provided on a case basis for the vessel or circumstance at issue. Further, because of the time required to process, record, and file formal decisions, we strongly encourage you to contact the Tonnage Division by phone with questions on applying the tonnage regulations to situations that are unfamiliar or not directly addressed by the MTN, to determine if a formal decision is necessary. In many cases, we can identify language in various guides, policy documents, rulemaking documents or similar that can resolve the issue without the need for a formal decision.

Weekly Notes are issued by the Coast Guard Marine Safety Center's Tonnage Division (MSC-4) for use by organizations that perform measurement work on the Coast Guard's behalf. They are for informational purposes only, and are not intended as, nor should they be construed to represent, revisions of or substitutes for applicable statutes or regulations or established interpretations of either.

MEASUREMENT ORGANIZATION WEEKLY NOTES – 08/31/2016

AN ACT FOR REGISTERING AND CLEARING VESSELS, REGULATING THE COASTING TRADE, AND FOR OTHER PURPOSES Following passage of the Act to regulate the collection of duties on tonnage (mentioned last month), on September 1, 1789, the First Congress and President Washington established a framework to register “vessels of the United States”, now known as vessel documentation. “An Act for registering and clearing vessels, regulating the coasting trade, and for other purposes” prescribed inclusion of a vessel’s tonnage on its certificate of registry, and the method for ascertaining tonnages for various vessel types. It also stipulated that a surveyor measure a vessel in the presence of the vessel master or other representative of the owner, who was required to sign the certificate attesting to its veracity.

CHAPTER XI.

An ACT for REGISTERING and CLEARING VESSELS, REGULATING the COASTING TRADE, and for other Purposes.

Section 1. **B**E it enacted by the SENATE and HOUSE of REPRESENTATIVES of the United States of America in Congress assembled, That any ship or vessel built within the United States, and belonging wholly to a citizen or citizens thereof, or not built within the said States, but on the sixteenth day of May, one thousand seven hundred and eighty-nine, belonging, and thereafter continuing to belong wholly to a citizen or citizens thereof, and of which the master is a citizen of the United States, and no other, may be registered in manner herein after provided, and being so registered, shall be deemed and taken to be, and denominated, a ship or vessel of the United States, and entitled to the benefits granted by any law of the United States, to ships or vessels of the descriptions aforesaid.

Surveyor to measure vessels in presence of master, or other person, on the part of the owners.

Sec. 8. *And be it further enacted*, That the surveyor or other person, to be appointed in pursuance of this act, shall, previous to the registering or granting of any certificate of registry, as aforesaid, examine and measure such ship or vessel, as to all and every particular contained in the form of the certificate aforesaid, in the presence of the master, or of any other person to be appointed for that purpose on the part of the owner or owners, and shall deliver a just and true account in writing of the built, description, and measurement of every such ship or vessel as are specified in the form of the certificate above recited, to the person authorized as aforesaid, to make such registry and grant such certificate thereof; and the said master or other person attending on the part of the owner or owners, is hereby required to sign his name also to the certificate of the surveying or examining officer, or other person duly appointed, in testimony of the truth thereof, provided such master or other person, shall agree to the several particulars therein set forth and described.

Sec. 3. *And be it further enacted*, That to ascertain the tonnage of all ships or vessels, the surveyor or other person appointed by the collector to measure the same, shall take the length of every vessel, if double decked, from the fore part of the main stem to the after part of the stern post above the upper deck, the breadth at the broadest part above the main wales, and half such breadth shall be accounted the depth of every double decked vessel; he shall then deduct from the length three fifths of the breadth, multiply the remainder by the breadth, and the product by the depth, dividing the product of the whole by ninety-five, the quotient shall be deemed the true contents or tonnage of such ship or vessel. To ascertain the tonnage of every single decked vessel, he shall take the length and breadth, as is directed to be taken for double decked vessels, and deduct three fifths in like manner, and the depth from the under side of the deck plank to the ceiling in the hold, and shall multiply and divide as aforesaid, and the quotient shall be deemed the true contents or tonnage of such single decked vessel.

Rule for ascertaining the tonnage of ships or vessels.

FREDERICK AUGUSTUS MUHLENBERG,
Speaker of the House of Representatives.

JOHN ADAMS, *Vice-President of the United States,*
and President of the Senate.

APPROVED, September the 1st, 1789.

GEORGE WASHINGTON,
President of the United States.

LABOR DAY HOLIDAY The Marine Safety Center will be closed beginning Friday, September 2 around noon through Monday, September 5, 2016 in observance of the Labor Day holiday.

Weekly Notes are issued by the Coast Guard Marine Safety Center’s Tonnage Division (MSC-4) for use by organizations that perform measurement work on the Coast Guard’s behalf. They are for informational purposes only, and are not intended as, nor should they be construed to represent, revisions of or substitutes for applicable statutes or regulations or established interpretations of either.

MEASUREMENT ORGANIZATION WEEKLY NOTES – 08/24/2016

NOTIFICATION TEMPLATE As a reminder, MTN 01-98 CH-12 requires authorized measurement organizations to notify the Marine Safety Center by email (assessment-msc@uscg.mil) as tonnage work is completed. This is done by attaching .pdf copies of issued tonnage certificates and a tonnage notification Excel file, the current version of which is available on the [Tonnage Publications](#) web page. Note that for vessels to be documented as vessels of the United States, there are additional MTN requirements for copies of tonnage certificates to be sent to the National Vessel Documentation Center (NVDC).

Weekly Notes are issued by the Coast Guard Marine Safety Center's Tonnage Division (MSC-4) for use by organizations that perform measurement work on the Coast Guard's behalf. They are for informational purposes only, and are not intended as, nor should they be construed to represent, revisions of or substitutes for applicable statutes or regulations or established interpretations of either.

MEASUREMENT ORGANIZATION WEEKLY NOTES – 08/17/2016

DEPTH MEASUREMENTS OF OPEN VESSELS The Marine Safety Center (MSC) recently engaged in a discussion on the measurement of open vessels, particularly, those with a tonnage length greater than 50 feet that contain "ceiling on floors" for a distance of over one-half of the tonnage length. We note that the tonnage regulations for open vessels do not explicitly address the treatment of "deep" frames with no measureable area; however, our tonnage predecessors have issued relevant correspondence dating back to 1944. In general, in establishing under-deck breadth and depth measurements for an open vessel, "ceiling on floors" are ignored. Please refer any questions on this subject to Mr. Marcus Akins.

MEASUREMENT OF DEDUCTIBLE SPACES < 15 FEET LONG During a recent oversight review, the Tonnage Division identified a non-rectangular deductible space, the volume of which had been calculated as a rectangular space. While § 69.119(q) of MTN 01-99 CH-8 allows for a deductible space less than 15 feet in length to be measured by any practical method, certain methods could calculate its volume to be greater than its actual volume included in gross tonnage. As a general rule, the calculation method used to measure the structure in which the space is located is considered practical for deductible spaces not of a standard geometric shape. Feel free to contact Mr. Akins for any questions regarding application of this requirement.

MEASUREMENT ORGANIZATION WEEKLY NOTES – 08/10/2016

CFVs AND LENGTH THRESHOLDS The Coast Guard Authorization Act of 2015 changed the applicability of classing requirements for certain commercial fishing vessels (CFVs). Earlier legislation extended the classing requirement to CFVs of 50 feet or more overall in length and built after July 1, 2013. The 2015 Act exempts from that requirement CFVs of at least 50 and not more than 79 feet overall in length, and built after February 8, 2016, provided their construction is overseen by a State-licensed naval architect or marine engineer, and their design “incorporates standards equivalent to those prescribed by a classification society . . . or another qualified organization. . . .” In a recent NPRM, the Coast Guard proposes to align its CFV regulations with the mandatory provisions of the earlier legislation, but does not incorporate any of the 2015 provisions, which must be reflected in Coast Guard regulations through future regulatory action. See 81 Federal Register (FR) 40437 (June 21, 2016).

OVERALL IN LENGTH The term “overall in length” as used in the above Weekly Notes item is not currently defined in Coast Guard regulations or interpretive policy. Pending completion of related rulemakings, or issuance of Coast Guard interpretations on this subject, the 50-foot threshold is applied as indicated in 81 FR 40437, and the 79-foot threshold is applied using the length appearing on a valid certificate of documentation or certificate of number as provided for by Coast Guard regulations (Title 46, Code of Federal Regulations (CFR) Part 67 or Title 33 CFR Part 174, respectively). You may direct any questions on regulatory actions or interpretations involving the application of these length thresholds to the Coast Guard Office of Commercial Vessel Compliance (CVC). Any questions on how a vessel's length is measured and certified should be addressed to the Marine Safety Center's Tonnage Division (MSC-4).

Weekly Notes are issued by the Coast Guard Marine Safety Center's Tonnage Division (MSC-4) for use by organizations that perform measurement work on the Coast Guard's behalf. They are for informational purposes only, and are not intended as, nor should they be construed to represent, revisions of or substitutes for applicable statutes or regulations or established interpretations of either.

MEASUREMENT ORGANIZATION WEEKLY NOTES – 07/27/2016

REGISTERED DIMENSIONS IN CATAMARANS The Marine Safety Center recently fielded a question regarding the registered length of a catamaran. The question centered on whether a catamaran may be considered a multi-hull vessel in applying the definition for registered length under § 69.53 of MTN 01-99 CH-8. As a reminder, per § 69.203, a multi-hull vessel is a vessel with more than one distinct hull; to be considered a distinct hull, the hull must connect to another hull only by structure that is not a part of the vessel's buoyant hull envelope.

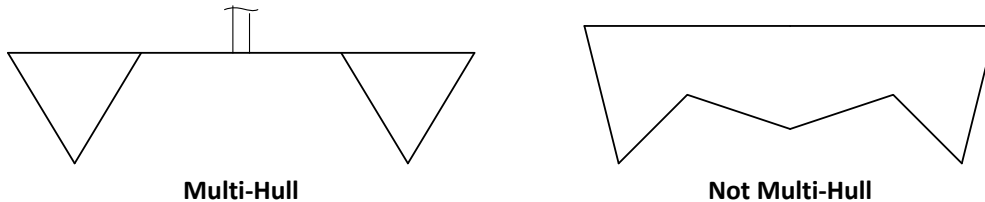

AN ACT TO REGULATE THE COLLECTION OF DUTIES ON TONNAGE Following passage of the Act imposing duties on tonnage (mentioned last week), the First Congress and President Washington instituted a system to collect such duties on July 31, 1789. The fifth Act of its first session, "An Act to regulate the collection of the duties imposed by law on the tonnage of ships or vessels, and on goods, wares and merchandizes imported into the United States", established specific districts and ports of entry and outlined responsibilities of officers (collectors, naval officers, and surveyors) assigned to them. Notably, the Act required that duties on a ship's tonnage be paid to a collector within ten days of its entry and prior to its being permitted clearance.

CHAPTER V.
An ACT to regulate the COLLECTION of the DUTIES imposed by Law on the TONNAGE of SHIPS or VESSELS, and on GOODS, WARES and MERCHANDIZES imported into the United States.

Section 1. **B**E it enacted by the SENATE and HOUSE of REPRESENTATIVES of the United States of America in Congress assembled, That for the due collection of the duties imposed by law on the tonnage of ships and vessels, and on goods, wares and merchandizes imported into the United States, there shall be established and appointed, districts, ports, and officers, in manner following, to wit:

The state of NEW-HAMPSHIRE shall be one district, to include the town of Portsmouth as the sole port of entry; and the towns of Newcastle, Dover and Exeter, as ports of delivery only; but all ships or vessels bound to or from either of the said ports of delivery, shall first come to, enter and clear at Portsmouth; and a naval-officer, collector and surveyor for the said district shall be appointed, to reside at Portsmouth.

Sec. 20. *And be it further enacted,* That all the duties imposed by law on the tonnage of any ship or vessel, shall be paid to the collector, within ten days after entry made, and before such ship or vessel shall be permitted to clear out; the register of which ship or vessel at the time of entry, shall be lodged in the office of the collector, and there remain until such clearance.

Duties on tonnage to be paid within ten days, & before clearance.

FREDERICK AUGUSTUS MUHLENBERG,
Speaker of the House of Representatives.
JOHN ADAMS, *Vice-President of the United States,*
and President of the Senate.
APPROVED, July the 31st, 1789.
GEORGE WASHINGTON,
President of the United States.

Weekly Notes are issued by the Coast Guard Marine Safety Center's Tonnage Division (MSC-4) for use by organizations that perform measurement work on the Coast Guard's behalf. They are for informational purposes only, and are not intended as, nor should they be construed to represent, revisions of or substitutes for applicable statutes or regulations or established interpretations of either.

MEASUREMENT ORGANIZATION WEEKLY NOTES – 07/20/2016

MEASURING SUPERSTRUCTURE SPACES During recent oversight reviews, the Tonnage Division has noticed calculations of volumes for superstructure spaces that have not met minimum MTN requirements. Section 69.113 of MTN 01-99, CH-8 requires the use of a two-dimensional Simpson's first rule computational method in which the length of the space is divided into an even number of equal parts "most nearly equal to those into which the tonnage length is divided" for structures not of standard geometric shape. For the purpose of applying the provision of this section, the term "those" shall be considered to represent "the intervals" into which the under-deck is divided.

AN ACT IMPOSING DUTIES ON TONNAGE The First United States Congress held its first session from March through September of 1789, meeting at Federal Hall on Wall Street in New York. On July 20, 1789 President George Washington signed into law its third Act, which imposed duties on tonnage. Exactly one year later, Washington approved the 30th Act of its second session, "An Act imposing duties on the tonnage of ships or vessels", which repealed and replaced the earlier Act on September 1, 1790.

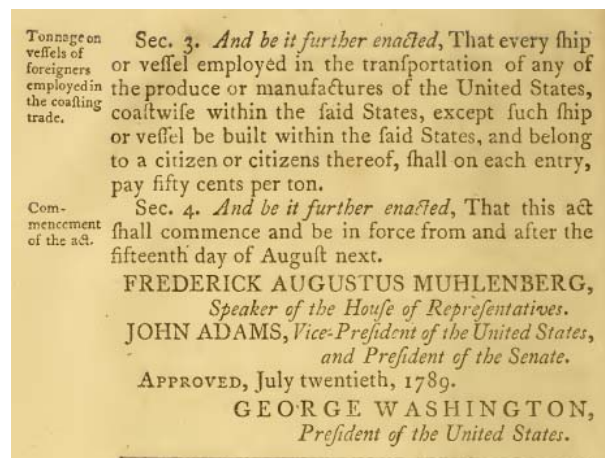
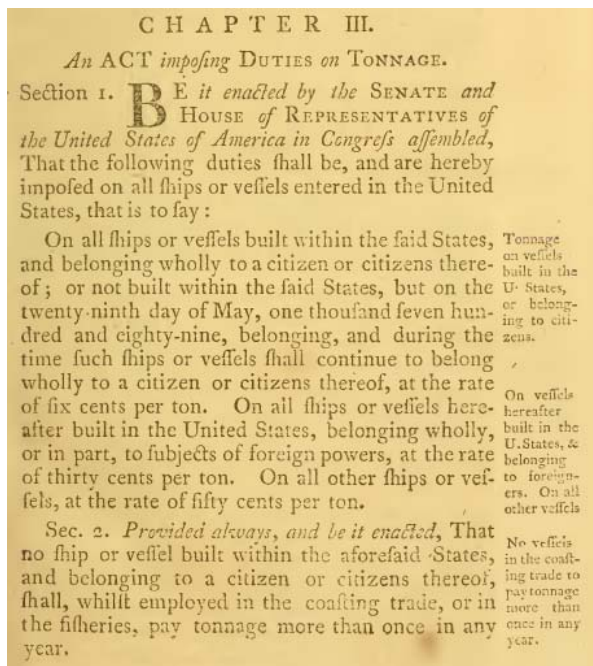

Weekly Notes are issued by the Coast Guard Marine Safety Center's Tonnage Division (MSC-4) for use by organizations that perform measurement work on the Coast Guard's behalf. They are for informational purposes only, and are not intended as, nor should they be construed to represent, revisions of or substitutes for applicable statutes or regulations or established interpretations of either.

MEASUREMENT ORGANIZATION WEEKLY NOTES – 07/13/2016

WATER BALLAST TANK MEASUREMENT In accordance with § 69.117(g)(3) of MTN 01-99 CH-8, when calculating the volume of a water ballast tank that consists of a series of contiguous but distinct spaces of varying shapes and sizes, the volume of each distinct space is calculated separately, rather than treating the distinct spaces within the tank as a single tank. The zone of influence method is then applied to each distinct space.

OVERSIGHT SUBMISSIONS Measurement organization should note that, in accordance with paragraph 4(d) of MTN 04-03 CH-2, work items selected for oversight shall be submitted to the MSC within five (5) working days of the date of the email providing notification of the selection. If this requirement cannot be met, please contact Mr. Marcus Akins prior to the fifth working day after the date of the selection email.

TONNAGE PERSONNEL As a reminder, Mr. David Karnes will be out of the office until Tuesday, July 19th. During this time, please copy Mr. Marcus Akins on any CG number requests.

MEASUREMENT ORGANIZATION WEEKLY NOTES – 07/06/2016

WEATHER STRIPPING AND TEMPORARY COVER PLATES The Marine Safety Center (MSC) recently responded to an inquiry on end opening modifications involving a temporary cover plate fitted with a door assembly. While noting there are no requirements to fit an end opening with a sill or coaming, the MSC commented to the effect that weather stripping at the bottom of a door assembly flush with the deck would render the opening closed, as would fastening any portion of the door frame to the deck. For such a configuration, this latter restriction would not preclude the use of a slide bolt or similar device to prevent a door from swinging open.

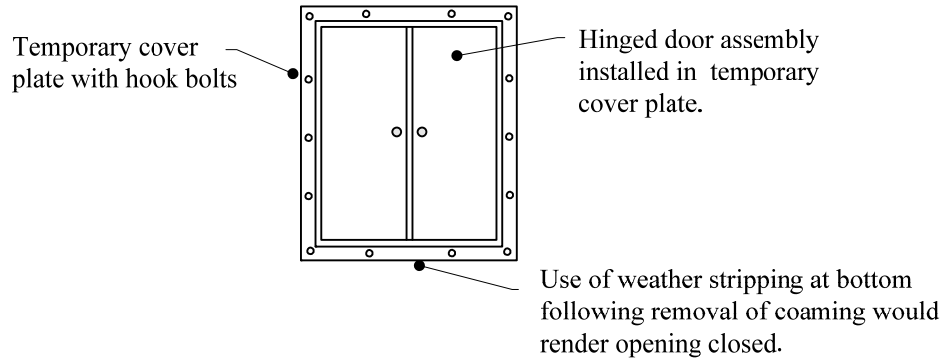

TONNAGE PERSONNEL Mr. David Karnes will be out of the office beginning Wednesday, July 13th and returning Tuesday, July 19th. During that time, please copy Mr. Marcus Akins on any CG number requests.

MEASUREMENT ORGANIZATION WEEKLY NOTES – 06/29/2016

HEAT EXCHANGERS (COOLERS) Earlier this month, the International Maritime Organization (IMO) approved a unified interpretation of the 1969 TM Convention, to treat heat exchangers (coolers) fitted in hull recesses or outside of the hull as machinery and not as appendages (MSC.1/Circ.1546). The distinction is important, because Regulation 6(2) of TM Convention states that “volumes of appendages shall be included in the total volume”. The interpretation was recommended by IACS, and is consistent with longstanding U.S. policy and practice.



MSC.1/Circ.1546
Annex, page 1

ANNEX

UNIFIED INTERPRETATION OF THE 1969 TM CONVENTION

Regulation 2(4) – Enclosed spaces

Regulation 6(2) – Calculation of volumes

Heat exchangers (coolers) fitted in hull recesses or outside of the hull should be treated as machinery under interpretation R.2(4)-9 set out in the annex to the *Unified interpretations relating to the International Convention on Tonnage Measurement of Ships, 1969 (TM.5/Circ.6)* and not as appendages.

INDEPENDENCE DAY HOLIDAY The Marine Safety Center will be closed on Monday, July 4th in observance of the Independence Day holiday.

TONNAGE PERSONNEL Mr. Marcus Akins will be out of the office beginning Friday, July 1st and returning Monday, July 11th. During that time, please copy Mr. David Karnes on any file requests.

Weekly Notes are issued by the Coast Guard Marine Safety Center's Tonnage Division (MSC-4) for use by organizations that perform measurement work on the Coast Guard's behalf. They are for informational purposes only, and are not intended as, nor should they be construed to represent, revisions of or substitutes for applicable statutes or regulations or established interpretations of either.

MEASUREMENT ORGANIZATION WEEKLY NOTES – 06/22/2016

REMEASUREMENT TO CORRECT ERRORS Under the tonnage regulations, owners of formally measured vessels who perceive certification errors should contact the responsible measurement organization. If an error is confirmed, remeasurement/recertification is performed “to the extent necessary”. In situations of disagreement, please contact the Marine Safety Center (MSC) for options on how to proceed (e.g., through the ACS appeals process in cases where both parties agree to the facts, or to the MSC in cases where the facts are in dispute).

LONDON TONNAGE CONFERENCE ANNIVERSARY On June 23rd, 1969 the tonnage Conference in London concluded with signing of the Convention on Tonnage Measurement of Ships. Former Coast Guard Commandant ADM Edwin Roland presided over the diplomatic conference, and the U.S. delegation included RADM Charles Murphy, USCG (Chief of the Office of Marine Safety), Mr. Robert Cunningham (consultant), and Mr. Phillips Stitt (Admeasurement Branch, USCG). The latter two co-authored the chapter on tonnage in SNAME’s *Ship Design and Construction*, 1980.

For the Government of the United States of America
Pour le Gouvernement des Etats-Unis d'Amérique
От имени Правительства Соединенных Штатов Америки
Por el Gobierno de los Estados Unidos de América

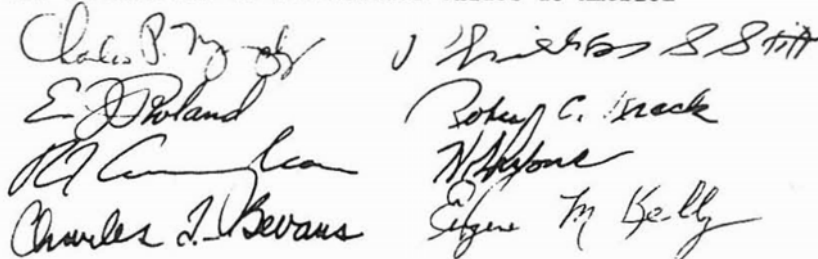

Charles B. Murphy J. Phillips Stitt
Edwin Roland Robert C. Mack
RADM Cunningham W. K. Malone
Charles J. Keenan Eugene M. Kelly

Weekly Notes are issued by the Coast Guard Marine Safety Center’s Tonnage Division (MSC-4) for use by organizations that perform measurement work on the Coast Guard’s behalf. They are for informational purposes only, and are not intended as, nor should they be construed to represent, revisions of or substitutes for applicable statutes or regulations or established interpretations of either.

MEASUREMENT ORGANIZATION WEEKLY NOTES – 06/15/2016

DIFFERENT SIZED FRAMING The tonnage regulations final rule that came into effect on May 2nd codifies the principal technical interpretation on the measurement treatment of different sized ordinary frames and restricts the conditions for which grandfathering may be extended. Per this codification, the line of the ordinary frames is established using the set of alternating frames that yields the smallest sectional area at the associated tonnage station. The rulemaking precludes grandfathering the practice of using two consecutive “deep” frames, one on each side of a tonnage station, as the basis for the line of the ordinary frames at that station. The use of two consecutive “deep” frames, one on each side of a tonnage station, is treated as shown in the figure below.

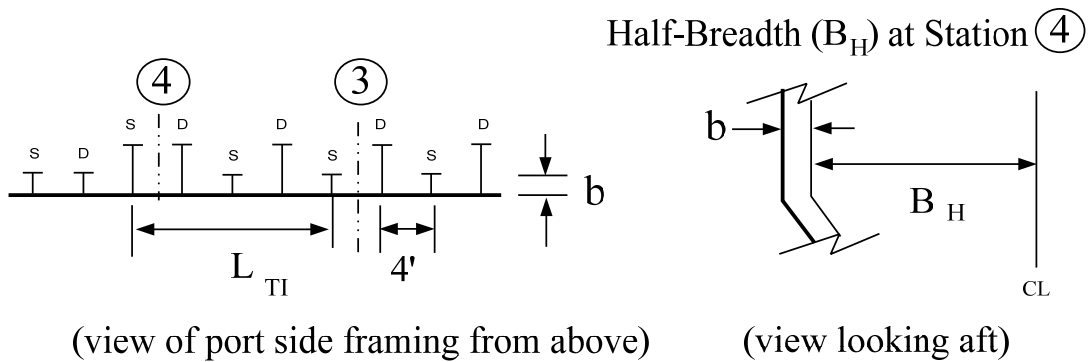

Weekly Notes are issued by the Coast Guard Marine Safety Center’s Tonnage Division (MSC-4) for use by organizations that perform measurement work on the Coast Guard’s behalf. They are for informational purposes only, and are not intended as, nor should they be construed to represent, revisions of or substitutes for applicable statutes or regulations or established interpretations of either.

MEASUREMENT ORGANIZATION WEEKLY NOTES – 06/08/2016

RADAR DOMES AND SIMILAR SPACES During a recent oversight, the Tonnage Division identified a radar dome such as the one shown in the figure below that had been ignored from inclusion in Convention Measurement System calculations. In discussing this with the Marine Safety Center (MSC), the measurement organization representative commented that even if it were over 1 cubic meter in volume, it would have been ignored on the basis that it was inaccessible. Please be advised that in almost all cases, a radar dome is designed to be removable, or is fitted with accesses, for servicing. Moreover, we do not consider such an enclosed space to be a “mast-like structure” as described in § 69.65 of MTN 01-99 CH-8. We intend to clarify this matter in a future revision to the MTN. Also, we will discuss methods for calculating these types of spaces in a future Weekly Notes edition.



2016 TONNAGE REGULATIONS We posted a copy of the 2016 (current) tonnage regulations to the MSC [Tonnage Publications](#) web page. As a reminder, the complete regulations text appears in MTN 01-99 CH-8 in standard font, with interpretations inserted in italics font and interpretive figures added in appropriate locations.

Weekly Notes are issued by the Coast Guard Marine Safety Center's Tonnage Division (MSC-4) for use by organizations that perform measurement work on the Coast Guard's behalf. They are for informational purposes only, and are not intended as, nor should they be construed to represent, revisions of or substitutes for applicable statutes or regulations or established interpretations of either.

MEASUREMENT ORGANIZATION WEEKLY NOTES – 06/01/2016

LINE OF THE UPPER DECK During oversight reviews, the Tonnage Division regularly sees vessels fitted with stern steps that effectively create deck discontinuities which could possibly impact the determination of the vessel's line of the upper deck. Measurement organizations should note that, in accordance with § 69.53 of MTN 01-99 CH-8, discontinuities in the upper deck that do not extend from side to side of the vessel, are one meter or less in length, or are outside the boundaries of "registered length," are ignored when establishing the line of the upper deck. While the longitudinal length of a stern step may extend from side to side and exceed one meter, upon determining the registered length dimension using the stern step as the basis for the line of the upper deck, the stern step must be found to be within the bounds of the registered length. In such a case where it is not within the bounds of the registered length, as shown in the top image, the registered length dimension must be determined while ignoring the stern step.

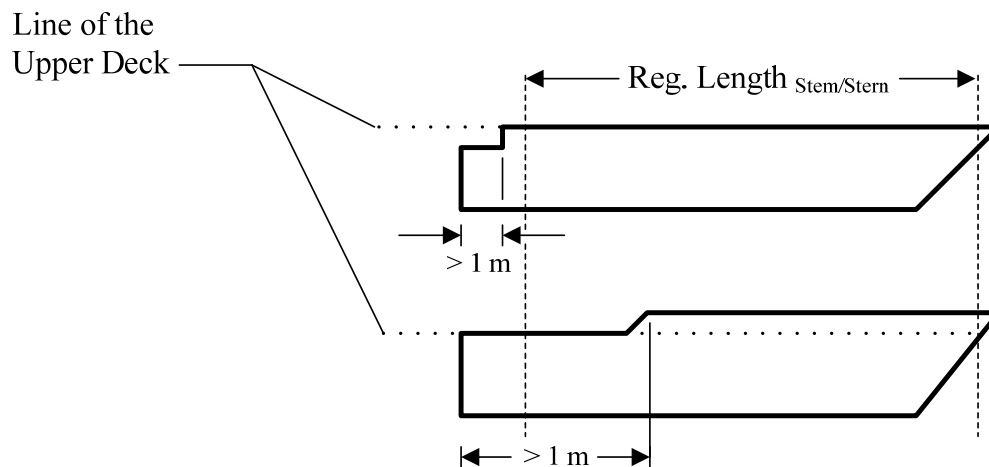

RETENTION OF TONNAGE RECORDS As a reminder, per MTN 01-98 CH-12, copies of tonnage calculations, tonnage certificates, remeasurement notifications, water ballast justification approval letters, and tonnage mark certification records are considered long-term records, and shall be retained until such time that the measurement organization's Memorandum of Agreement (MOA) (or equivalent) with the Coast Guard is terminated. Vessel file material other than that described above shall be retained, as a minimum, for one year following issuance of the associated tonnage certificate, or until the measurement organization's MOA (or equivalent) with the Coast Guard is cancelled, whichever comes first.

Weekly Notes are issued by the Coast Guard Marine Safety Center's Tonnage Division (MSC-4) for use by organizations that perform measurement work on the Coast Guard's behalf. They are for informational purposes only, and are not intended as, nor should they be construed to represent, revisions of or substitutes for applicable statutes or regulations or established interpretations of either.

MEASUREMENT ORGANIZATION WEEKLY NOTES – 05/25/2016

OPEN SPACE PROGRESSION The Tonnage Division recently responded to inquiries regarding the progression of open space through space below overhanging decks. In accordance with § 69.117(d)(1)(i) of MTN 01-99 CH-8, for situations where one boundary of a compartment is not clearly defined, the "projected" boundary that delineates the compartment is taken as the continuation of the bulkhead of the compartment from which open space is progressing. Particularly, in situations where an exterior bulkhead bounding the compartment is absent, such as in the case of space below an overhanging deck, the outermost edge of the deck overhead delineates the boundary of the compartment.

TONNAGE WORKSHOP We will schedule a Marine Safety Center (MSC) presentation for authorized measurement organization personnel who were unable to participate in the ABS Tonnage Workshop via web-conference last week due to technical difficulties. Mr. Marcus Akins will coordinate a date and time for this presentation.

MEMORIAL DAY HOLIDAY The MSC will be closed on Friday, May 27th beginning at noon and continuing through Monday, May 30th in observance of the Memorial Day holiday.

TONNAGE PERSONNEL Mr. Marcus Akins will be out of the office Friday, May 27th through Tuesday, May 31st. During that time, please copy Mr. David Karnes on any file requests.

MEASUREMENT ORGANIZATION WEEKLY NOTES – 05/18/2016

TONNAGE WORKSHOP We would like to thank ABS for hosting the ABS Tonnage Workshop for authorized measurement organizations this week. The Marine Safety Center Tonnage Division will be back in the office on Thursday, May 19th.

Weekly Notes are issued by the Coast Guard Marine Safety Center's Tonnage Division (MSC-4) for use by organizations that perform measurement work on the Coast Guard's behalf. They are for informational purposes only, and are not intended as, nor should they be construed to represent, revisions of or substitutes for applicable statutes or regulations or established interpretations of either.

MEASUREMENT ORGANIZATION WEEKLY NOTES – 05/11/2016

TONNAGE WORKSHOP The ABS Tonnage Workshop for authorized measurement organizations will commence at 0800 at ABS Americas in Houston, TX on May 17, 2016. Those members who have not confirmed attendance of the workshop in person or via web-conference should contact Mr. Henry Wong at (281) 877-6820 by COB May 12, 2016. Dress is business casual.

MARINE SAFETY CENTER INFORMATION BULLETIN Yesterday, the [Marine Safety Center \(MSC\) issued an Information Bulletin](#) announcing the change to MTN 01-99 mentioned in last week's weekly notes. Please be aware that we circulated this bulletin to a list of approximately 1200 Marine Safety Center customers who have made submittals through our electronic commence inbox in recent years. This includes many naval architects.

TONNAGE PERSONNEL Mr. Marcus Akins will be out of the office for the tonnage workshop May 16-18. During that time, please forward any file requests to Mr. David Karnes.

MEASUREMENT ORGANIZATION WEEKLY NOTES – 05/04/2016

ZIP FILES We recently learned that emails containing .zip format attachments sent to @uscg.mil addresses since April 1, 2016 are likely being blocked. Further, senders receive no indication that such messages are not delivered. If you have sent a .zip file to us during this timeframe, please contact the Tonnage Division as soon as possible to confirm receipt or coordinate another means of transmission. As a reminder, other "unzipped" file format attachments (e.g., .pdf, .doc, .xls) are generally acceptable, and we have large file transfer capability using a secure U.S. Army application.



MTN 01-99 CH-8 Earlier this week, we issued Change 8 to MTN 01-99, *Tonnage Technical Policy*, to coincide with the coming into effect of the Tonnage Regulations Amendments final rule on Monday, May 2nd. As explained in Change 8, this updated MTN version reflects changes for consistency with the amendments of the final rule, and also includes administrative updates, and formatting and other changes of an editorial nature. Additional MTN changes are under development, which will incorporate interpretive material addressing matters that have arisen since the MTN was updated in 2005. [MTN 01-99 CH-8](#) takes effect immediately, and is available on the [Tonnage Publications](#) web page.

TONNAGE WORKSHOP Authorized measurement organization members seeking to participate in the ABS Tonnage Workshop via webconference, must submit their email address and telephone number to Mr. Henry Wong by COB May 12, 2016. Those members attending the workshop at the ABS facility should report to the ABS front lobby at the Northchase Drive entrance for check in by 7:30 a.m. Dress is business casual. For any questions regarding attendance, please contact Mr. Wong at (281) 877-6820.

TONNAGE PERSONNEL Mr. David Karnes will be out of the office on May 10th, 11th, and 13th. During those days, please copy Mr. Marcus Akins on CG number requests sent to msc@uscg.mil to ensure efficient service.

Weekly Notes are issued by the Coast Guard Marine Safety Center's Tonnage Division (MSC-4) for use by organizations that perform measurement work on the Coast Guard's behalf. They are for informational purposes only, and are not intended as, nor should they be construed to represent, revisions of or substitutes for applicable statutes or regulations or established interpretations of either.

MEASUREMENT ORGANIZATION WEEKLY NOTES – 04/27/2016

TONNAGE WORKSHOP A number of authorized measurement organization representatives have already confirmed their attendance to the ABS Tonnage Workshop scheduled for May 17-18, 2016. As mentioned in a previous weekly note, please contact Mr. Henry Wong at (281) 877-6820 if you plan to attend. Also, please ensure that you have an official form of identification on hand upon arrival at the ABS facility.

FRAME OPENINGS In response to a comment from the public, the Tonnage Regulations Amendments final rule includes some changes affecting treatment of openings in ordinary frames. Specifically, this rulemaking will permit 15 x 23 inch oval frame openings to be fitted in locations other than fuel tanks without affecting the line of the ordinary frames, with certain restrictions. The restrictions constrain the minor and major axis dimensions in such locations to 15 inches and 23 inches, respectively, to maintain the principle of impeding personnel and cargo movement through the frame.

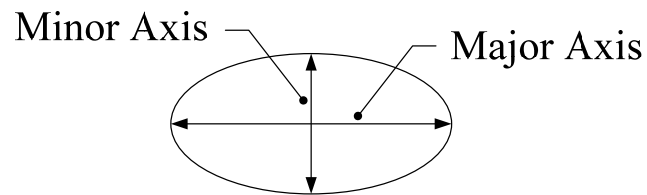

TECHNICAL POLICY UPDATE We have altered our plans to issue a comprehensive update to MTN 01-99 CH-7, in view of the May 2nd date (next Monday) established in the Tonnage Regulations Amendments rulemaking for the final rule to take effect. Instead, we are developing a scaled-back version of the update, which picks up the changes from the rulemaking, but leaves other updates for the future.

MEASUREMENT ORGANIZATION WEEKLY NOTES – 04/20/2016

TONNAGE PERSONNEL The Marine Safety Center (MSC) Tonnage Division welcomes a new staff member to its ranks. Mr. Tony Cao graduated from the University of Massachusetts, Amherst and served in the Coast Guard for 12 years as an active duty officer, including tours as: 1) Engineering Officer in Training aboard USCGC BOUTWELL (WHEC 719); 2) Contingency Planner at Sector Boston; 3) Staff Engineer at MSC; and 4) Marine Inspector and Investigator at Sector Los Angeles/Long Beach. He holds Master's Degrees in Mechanical Engineering and Naval Architecture and Marine Engineering from the University of Michigan.

MEASUREMENT TOLERANCES We have engaged in a number of discussions over the past few months with measurement organization representatives on the subject of measurement tolerances. Primarily, the focus has been on the need to recertify tonnages following identification of inaccuracies in volume calculations, during oversight. At one time, the U.S. tonnage regulations were quite prescriptive on measurement precision, which enters into overall measurement tolerances. For example, the 1874 regulations required use of a tape graduated in feet and tenths, and even recommended a specific brand (the "Chesterman's metallic tape"). If you would like to be part of the current discussions, please contact Mr. Marcus Akins.



Weekly Notes are issued by the Coast Guard Marine Safety Center's Tonnage Division (MSC-4) for use by organizations that perform measurement work on the Coast Guard's behalf. They are for informational purposes only, and are not intended as, nor should they be construed to represent, revisions of or substitutes for applicable statutes or regulations or established interpretations of either.

MEASUREMENT ORGANIZATION WEEKLY NOTES – 04/13/2016

TONNAGE WORKSHOP We have had some questions about attending next month's tonnage workshop, which is being hosted by ABS in Houston and is open to all authorized measurement organization representatives. If you plan to attend, please contact Mr. Henry Wong, to make sure that ABS has a complete list of attendees.

DOCKSHIP SPACE One of the changes of TM.5/Circ.6 strongly supported by the United States was the corrected dockship section, as shown below. The original figure did not align with the text of the circular, which defines the term "erection" as an enclosed space bounded by bulkheads and a deck above. Hence the space bounded by the coaming at the top of the original figure should not have been shown as cargo space. The corrected figure, which deletes the coaming, is consistent with longstanding United States interpretations, and we intend to include it in a future update to MTN 01-99 CH-7, *Tonnage Technical Policy*.

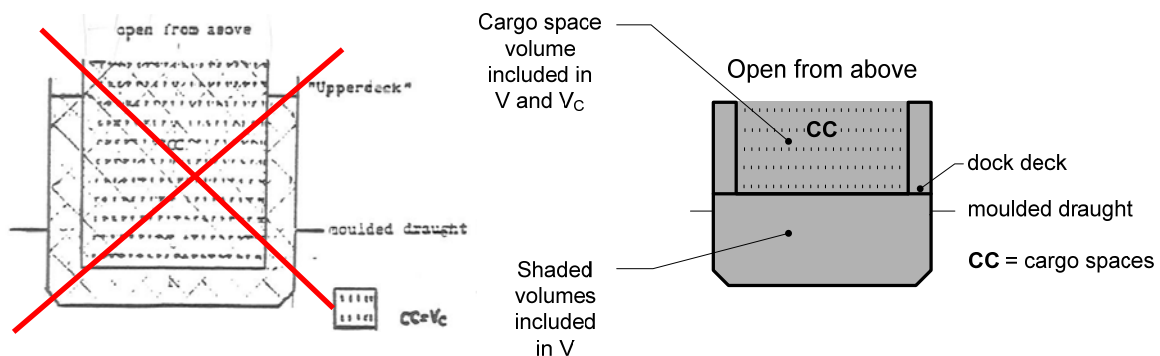

TONNAGE PERSONNEL Mr. Marcus Akins is currently out of the office, and will return on April 18, 2016. During this time, please forward any file requests to Mr. David Karnes.

Weekly Notes are issued by the Coast Guard Marine Safety Center's Tonnage Division (MSC-4) for use by organizations that perform measurement work on the Coast Guard's behalf. They are for informational purposes only, and are not intended as, nor should they be construed to represent, revisions of or substitutes for applicable statutes or regulations or established interpretations of either.

MEASUREMENT ORGANIZATION WEEKLY NOTES – 04/06/2016

TONNAGE FINAL RULE The Coast Guard issued its long-anticipated [final rule](#), which amends the tonnage regulations to implement statutory changes, codify principal technical interpretations, and incorporate administrative, non-substantive clarifications and updates. The rule becomes effective on May 2, 2016. We invite measurement organization representatives to familiarize themselves with the rule’s changes, which are summarized in Table 3 in its preamble. An [excerpt](#) from this multi-page table follows.

TABLE 3—ASSESSMENT OF THE COST IMPACTS OF THIS RULE—Continued		
Description of change	Type of change	Cost impact
Provides requirements on the measurement treatment of ordinary frames in the under-deck, including construction, frame spacing, different sized frames, frame openings, and asymmetrical framing.	Codification: Principal interpretations from policy document, with revised criteria on oval frame openings.	No cost. Interpretations on different sized framing in effect since 1950 (Treasury Decision 52578). Other interpretations in effect since 2002 (MTN 01–99 CH–4). Revised criteria to permit more flexibility for oval openings without tonnage impact.
§ 69.111 Between-deck tonnage		
Replaces the phrase “at different levels from stem to stern” with the more commonly used term “stepped”. Requires a minimum size for a longitudinal step being used as the basis for establishing the line of the uppermost complete deck. Replaces the phrase “face of the normal side frames” with the phrase “line of the normal frames”.	Codification: Principal interpretation from policy document. Codification: Principal interpretation from policy document. Administrative: Clarification	No cost. Interpretation in effect since 2005 (MTN 01–99 CH–7). No cost. Interpretation in effect since 2005 (MTN 01–99 CH–7). No cost.
§ 69.113 Superstructure tonnage		
Incorporates interpretations on treatment of portable spaces	Codification: Principal interpretations from policy document. Administrative: Clarification	No cost. Interpretations in effect since 1997 (NVIC 11–93 CH–2). No cost.
Clarifies that measurements are to be taken to the “line of the normal frames”. Defines superstructure tonnage as the tonnage of all superstructure spaces.	Administrative: Clarification	No cost.
§ 69.115 Excess hatchway tonnage		
Revises nomenclature consistent with revisions to § 69.9	Administrative: Clarification	No cost.
§ 69.117 Spaces exempt from inclusion in tonnage		
Revises nomenclature consistent with revisions to § 69.9	Administrative: Editorial change Codification: Principal interpretation from policy document.	No cost. No cost. Interpretation in effect since 2005 (MTN 01–99 CH–7).

MARINE SAFETY CENTER INFORMATION BULLETIN Late last week, the [Marine Safety Center \(MSC\) issued an Information Bulletin](#) announcing this final rule and highlighting some of the changes in general terms. Please be aware that we circulated this bulletin to a list of approximately 1200 Marine Safety Center customers who have made submittals through our electronic commence inbox in recent years. This includes many naval architects.

TONNAGE GUIDE 2 The MSC published an updated version of Tonnage Guide 2, Measurement of Navy and Coast Guard Vessels, available on the MSC [Tonnage Publications](#) web page. Among other changes, this update reflects revised points of contact and nomenclature changes consistent with the final rule.

Weekly Notes are issued by the Coast Guard Marine Safety Center’s Tonnage Division (MSC-4) for use by organizations that perform measurement work on the Coast Guard’s behalf. They are for informational purposes only, and are not intended as, nor should they be construed to represent, revisions of or substitutes for applicable statutes or regulations or established interpretations of either.

MEASUREMENT ORGANIZATION WEEKLY NOTES – 03/30/2016

SCALING FROM PDFS Further to the discussion last week on the accuracy of dimensions obtained using the measuring tool in Adobe Acrobat, the figure below illustrates establishment of a precise scale ratio taken to the nearest hundredth. In this example, the longest known dimension (18½ inches) measured 0.83 inches in the .pdf document. These values were used to set the measuring (distance) tool scale ratio for subsequent dimensions (e.g., 18.50 in).

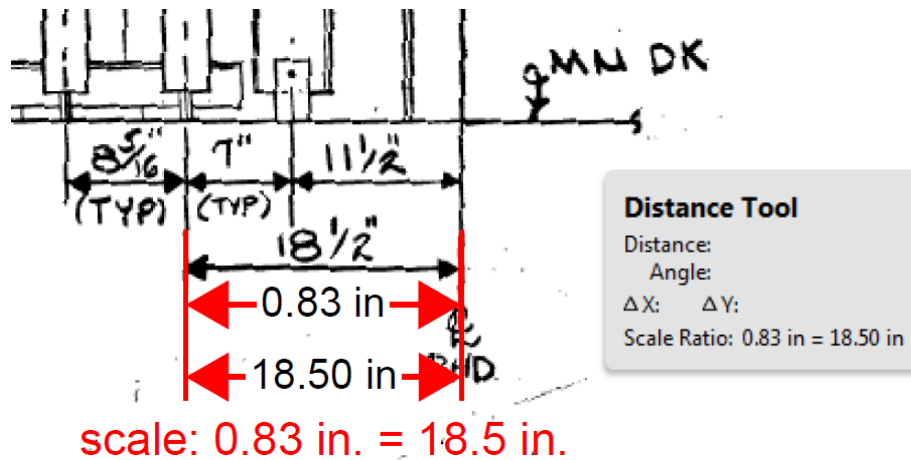

BUREAU OF CUSTOMS MARINE CIRCULAR No. 5 As mentioned earlier this month, Federal Register Doc. 42-1839 (March 4, 1942) invoked the authority granted by President Franklin D. Roosevelt in Executive Order 8976 to waive compliance with the navigation and vessel inspection laws for war purposes. On April 1, 1942, the Bureau of Customs issued Marine Circular No. 5, detailing application of Doc. 42-1839's provisions for making shelter deck bulkhead tonnage openings and middle line tonnage openings watertight. These provisions were later rescinded.

TREASURY DEPARTMENT
BUREAU OF CUSTOMS
WASHINGTON

April 1, 1942

BUREAU OF CUSTOMS
MARINE CIRCULAR NO. 5

TO COLLECTORS OF CUSTOMS, SHIP OWNERS AND OPERATORS
AND OTHERS CONCERNED:

Re: Shelter-deck vessels.

On February 28, 1942, the Acting Secretary of Commerce issued the following order (7 F.R. 1696):

(Order No. 224)

"Upon the request of the Secretary of the Navy and by virtue of the authority vested in me by the provisions of Executive Order No. 8976, dated December 12, 1941 (6 F.R. 6441), I hereby waive compliance with the provisions of section 4153 R.S., as amended (46 U.S.C. 77), to the extent and upon the terms hereinafter set forth.

Weekly Notes are issued by the Coast Guard Marine Safety Center's Tonnage Division (MSC-4) for use by organizations that perform measurement work on the Coast Guard's behalf. They are for informational purposes only, and are not intended as, nor should they be construed to represent, revisions of or substitutes for applicable statutes or regulations or established interpretations of either.

MEASUREMENT ORGANIZATION WEEKLY NOTES – 03/23/2016

SNAPPING DIMENSIONS IN PDFs Continuing the discussion on precision and accuracy from last week, multiple factors may influence the accuracy of a dimension obtained using the measuring tool in Adobe Acrobat from a .pdf drawing. In general, the better the scale, the more accurate the measurements will be. This places an emphasis on establishing a precise scale ratio for the measurement tool. It is recommended that measurements used to establish the scale ratio be taken to the nearest hundredth. Also, accuracy may also be increased by zooming into the image and establishing more clearly defined end points for the snapped dimensions.

SUPERSTRUCTURE CALCULATION METHODS For measurement of superstructure spaces under the Standard and Dual Measurement systems, the tonnage rules allow only two methods for calculating volumes: two-dimensional Simpson's First Rule integration or a simple geometric formula. Structure #1 below, forms a standard geometric shape, and its volume may be calculated by a simple geometric formula. Structure #2, however, is faired into a non-standard geometric form and must be measured by a Simpson's First Rule integration method. Measurement organizations should note that, in accordance with MTN 01-99 CH-7, 69.113(b)(3), when using the prescribed two-dimensional Simpson's First Rule integration, if the end of a structure is in the form of a continuous arc or curve (Structure #3 in Figure 1), the breadth at that end is one-half the nearest breadth. Also, if the end of a structure is in the form of an arc or curve having a decided flat (Structure #3 in Figure 2), the breadth at the end is two-thirds of the nearest breadth.

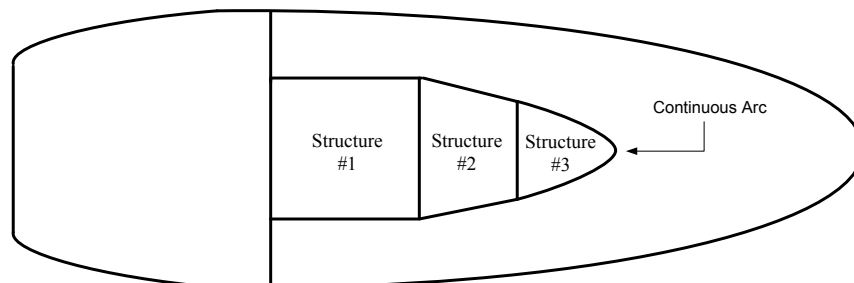

Figure 1

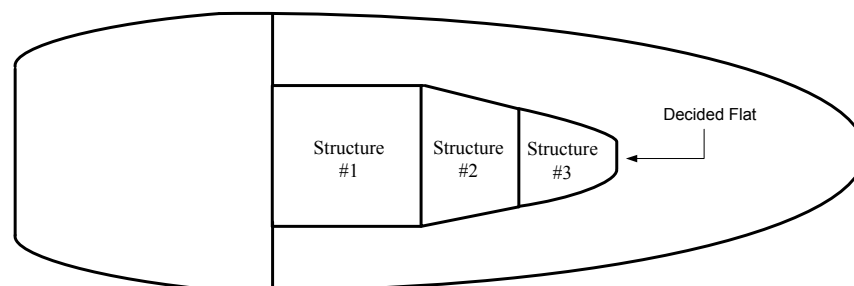

Figure 2

Weekly Notes are issued by the Coast Guard Marine Safety Center's Tonnage Division (MSC-4) for use by organizations that perform measurement work on the Coast Guard's behalf. They are for informational purposes only, and are not intended as, nor should they be construed to represent, revisions of or substitutes for applicable statutes or regulations or established interpretations of either.

MEASUREMENT ORGANIZATION WEEKLY NOTES – 03/16/2016

NOTIFICATION EXCEL FILE The MSC is revisiting the notification process for reporting completed work done on the Coast Guard's behalf, including tonnage measurement work. Among many suggested changes are improvements to the Excel notification workbooks, and possibly allowing alternative reporting methods, such as periodic electronic reports that provide the same data. In the interim, measurement organizations are reminded to use the current notification template (Excel file) when reporting measurement work, filling in the required fields for unique vessel ID number and type and attaching copies of associated tonnage certificates. The notification template - an enclosure to MTN 04-03 CH-2 - is available on the MSC [Tonnage Publications](#) web page. We invite you to provide input to Mr. Marcus Akins.

PRECISION VS. ACCURACY The 1969 Tonnage Convention and U.S. tonnage regulations provide for precision of certain measurements (e.g., to the nearest twentieth of a foot), but both of these important legal documents only indirectly address measurement accuracy. In our business, precision generally refers to the number of significant digits recorded when taking measurements, whereas accuracy generally refers to the proximity of those recorded measurements to their true values. We will provide further discussion on precision and accuracy in future Weekly Notes editions.

3-D MODELING FOR VOLUME CALCULATION To aid tonnage measurement volume calculation, it can be useful to create three-dimensional models from of a series of plan view drawings. For example, one can distribute individual two-dimensional deck plans at their specified heights and create appropriate vertical surfaces between them, from which the bounded volume can be computed. The image below shows this technique being used in Rhino to model an unusual deckhouse structure.

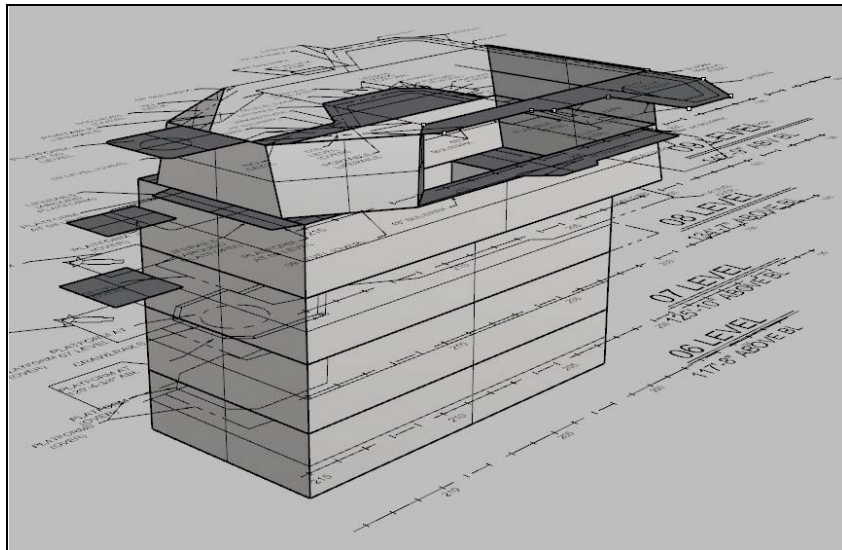

Weekly Notes are issued by the Coast Guard Marine Safety Center's Tonnage Division (MSC-4) for use by organizations that perform measurement work on the Coast Guard's behalf. They are for informational purposes only, and are not intended as, nor should they be construed to represent, revisions of or substitutes for applicable statutes or regulations or established interpretations of either.

MEASUREMENT ORGANIZATION WEEKLY NOTES – 03/09/2016

UPCOMING TONNAGE WORKSHOP Planning continues for the upcoming tonnage workshop at the American Bureau of Shipping in Houston. We anticipate participation from members of all six authorized measurement organizations, including some by telephone from outside the United States. We continue to encourage submission of discussion topics as well as workshop ideas (i.e., actual vessel measurement or mock vessel measurement modules) and would like to thank those who have already submitted topics for discussion.

MEASUREMENT INSTRUMENTS In researching the origins of precision requirements under various tonnage measurement rules, we came across photos of one of the tonnage measurement instruments described in early editions of the U.S. tonnage regulations. We have reproduced them below, courtesy of the Maine Maritime Museum website. Various referred to as “tonnage rods”, “sliding sticks”, “sliding rods”, etc., these instruments were oriented vertically when taking under-deck breadth measurements, with the heights of each measurement marked with white chalk. The instrument is calibrated in feet (red numbers) and tenths of a foot (black numbers), with intermediate markings representing each 20th of a foot.

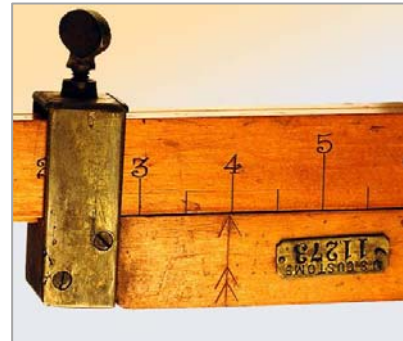
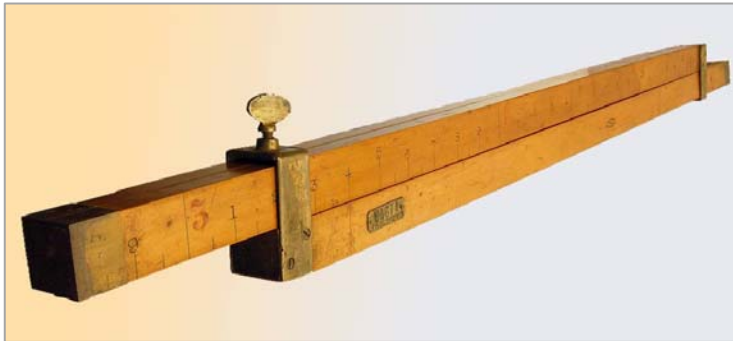

Weekly Notes are issued by the Coast Guard Marine Safety Center's Tonnage Division (MSC-4) for use by organizations that perform measurement work on the Coast Guard's behalf. They are for informational purposes only, and are not intended as, nor should they be construed to represent, revisions of or substitutes for applicable statutes or regulations or established interpretations of either.

MEASUREMENT ORGANIZATION WEEKLY NOTES – 03/02/2016

UPCOMING TONNAGE WORKSHOP The previously mentioned tonnage workshop for authorized measurement organization personnel is going forward, and is tentatively scheduled for May 17-18 at the American Bureau of Shipping in Houston. If you would like to submit ideas, or participate in the workshop by video or telephone conference, please contact Mr. Marcus Akins.

TONCALC UPDATE As reported last month, we have been beta testing a new version of TonCalc. A number of programming issues have delayed release of TonCalc 2.0.2. Thank you for your patience.

NOTIFICATIONS FILE FORMATS MTN 01-98 CH-12 requires measurement organizations to notify the Marine Safety Center by e-mail (assessment-msc@uscg.mil) as tonnage work is completed, in accordance with MTN 04-03 as amended. As a reminder, this is done by attaching the tonnage notification Excel file and .pdf copies of issued tonnage certificates. Please note that other file formats (e.g., .zip) are not acceptable.

F. R. Doc. 42-1839 As mentioned in December, President Franklin D. Roosevelt issued Executive Order 8976, authorizing the Secretary of Commerce to waive compliance with the navigation and vessel inspection laws for war purposes. On March 4, 1942, this authority was invoked for tonnage purposes in Federal Register Doc. 42-1839, which provided for making shelter deck bulkhead tonnage openings and middle line tonnage openings watertight.

TITLE 46—SHIPPING
CHAPTER I—BUREAU OF MARINE
INSPECTION AND NAVIGATION
SUBCHAPTER B—MEASUREMENT

[Order No. 224]

FEBRUARY 28, 1942.

Upon the request of the Secretary of the Navy and by virtue of the authority vested in me by the provisions of Executive Order No. 8976, dated December 12, 1941 (6 F.R. 6441), I hereby waive compliance with the provisions of section 4153 R.S., as amended (46 U.S.C. 77), to the extent and upon the terms hereinafter set forth.

(1) So much of section 4153 R.S., as amended, as requires the tonnage of the shelter deck space above the upper deck, which is under cover and permanently closed in, to be added to the gross tonnage is waived to the extent necessary to permit the tonnage of that space to be omitted from the gross tonnage: *Provided, That,*

(a) At the time of construction of the vessel the space above referred to was

open to the weather and not permanently closed in.

(b) After construction the space above referred to is closed in by making the weather tight hatch in the shelter deck water tight, and by closing the tonnage openings in the transverse bulkheads between the freeboard and shelter decks, making those bulkheads water tight.

(c) The load line of the vessel is not raised as a result of the closing in of the space above referred to.

[SEAL] WAYNE C. TAYLOR,
Acting Secretary of Commerce.

[F. R. Doc. 42-1839; Filed, March 2, 1942;
3:49 p. m.]

Weekly Notes are issued by the Coast Guard Marine Safety Center's Tonnage Division (MSC-4) for use by organizations that perform measurement work on the Coast Guard's behalf. They are for informational purposes only, and are not intended as, nor should they be construed to represent, revisions of or substitutes for applicable statutes or regulations or established interpretations of either.

MEASUREMENT ORGANIZATION WEEKLY NOTES – 02/24/2016

UNDER-DECK MEASUREMENT We recently encountered a circumstance in which depth and breadth measurements were taken at the inboard surface of the skin of the hull and not to the line of the ordinary frames in the under-deck. Measurement organizations should note that depth and breadth measurements of transverse sections are to be taken to the line of the ordinary frames at the station of interest, unless there are no qualifying ordinary frames or if the qualifying ordinary frames do not meet the pattern requirements of Section 69.109(p)(2) and (p)(3). Please refer any questions on this subject to Mr. Marcus Akins.

GLOBAL TONNAGE As previously mentioned, the International Maritime Organization (IMO) announced that signatories to the Ballast Water Management (BWM) Convention represented insufficient global tonnage to trigger the convention's entry into force. In its announcement, IMO did not specify a value for total global tonnage; however, the United Nations Conference on Trade and Development publishes related historical data, plotted below.

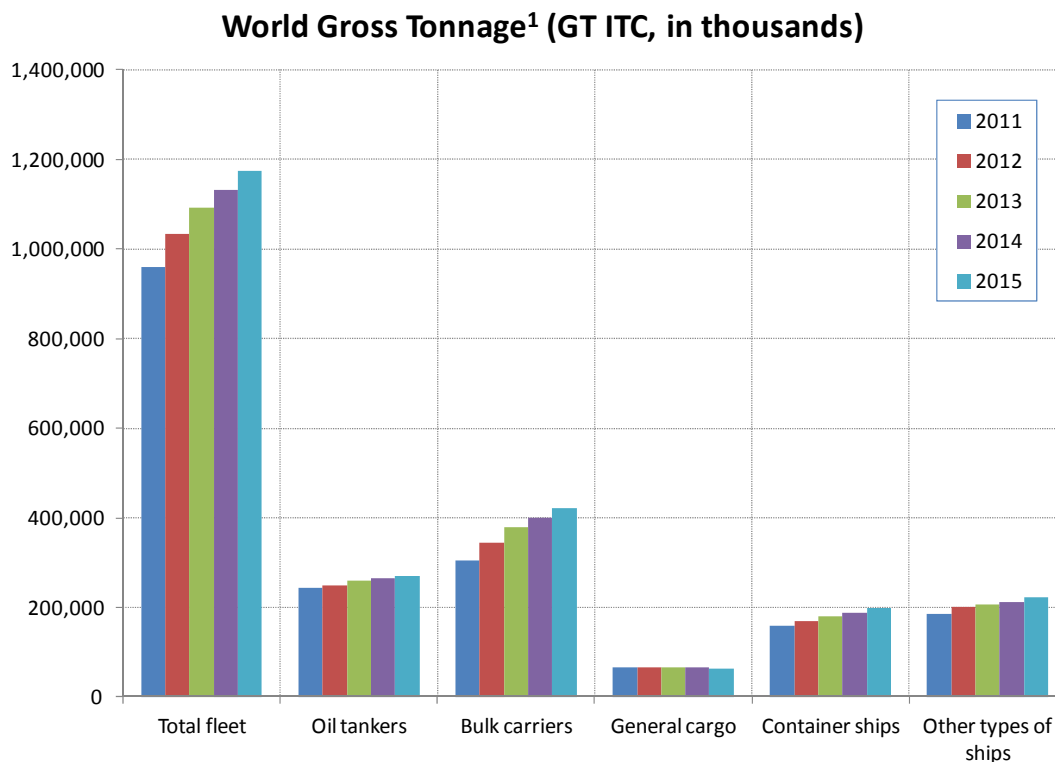

¹ Includes seagoing propelled merchant ships of 100 GT ITC and above, excluding inland waterway vessels, fishing vessels, military vessels, yachts, and offshore fixed and mobile platforms and barges (with the exception of FPSOs (floating production, storage, and offloading vessels) and drillships)

Weekly Notes are issued by the Coast Guard Marine Safety Center's Tonnage Division (MSC-4) for use by organizations that perform measurement work on the Coast Guard's behalf. They are for informational purposes only, and are not intended as, nor should they be construed to represent, revisions of or substitutes for applicable statutes or regulations or established interpretations of either.

MEASUREMENT ORGANIZATION WEEKLY NOTES – 02/17/2016

UCD IN DUAL MEASUREMENT SYSTEM When calculating tonnages under the Dual Measurement System, it is important to note that the method of identifying the uppermost complete deck (UCD) does not deviate from that used for the Standard Measurement System. For a vessel with two or more decks, proper identification of the UCD is critical to determining the extent of space above the tonnage deck that is eligible for exemption as miscellaneous exemptible, passenger, or dry cargo and stores space.

TONNAGE WORKSHOP In addition to the quarterly telephone conferences mentioned last week, the Marine Safety Center is considering conducting a tonnage workshop for authorized measurement organizations. This workshop would take place around May 2016 in Houston, TX. We are currently seeking both a host measurement organization and ideas for training sessions and topics for discussion. Please contact Mr. Marcus Akins regarding hosting the workshop or to submit ideas.

BWM CONVENTION UPDATE As mentioned last month, the International Maritime Organization (IMO) had announced that signatories to the Ballast Water Management (BWM) Convention represented insufficient global tonnage (35% minimum) to trigger the convention's entry into force. IMO has completed its tonnage figures verification and found that the combined fleets of the 47 countries that have ratified the BWM Convention comprise 34.35% of global tonnage (revised from 34.56% as estimated earlier). This further illustrates the importance of the tonnage measurement tolerances, as aggregate differences in tonnage assignments, however slight, could determine whether a broad-reaching international agreement takes effect.

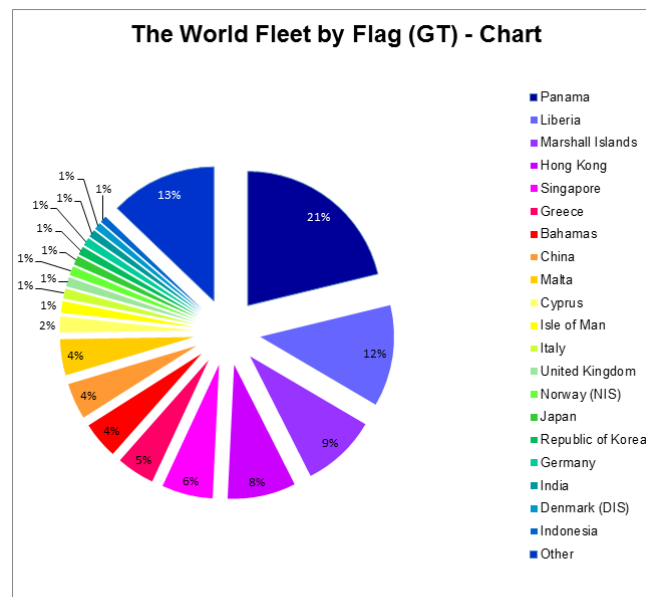

Source: UNCTAD Review of Maritime Transport, 2014

Weekly Notes are issued by the Coast Guard Marine Safety Center's Tonnage Division (MSC-4) for use by organizations that perform measurement work on the Coast Guard's behalf. They are for informational purposes only, and are not intended as, nor should they be construed to represent, revisions of or substitutes for applicable statutes or regulations or established interpretations of either.

MEASUREMENT ORGANIZATION WEEKLY NOTES – 02/10/2016

TONCALC ISSUE We recently learned that TonCalc 2.0.1 does not properly recognize "Between-Deck" spaces when executing the "Update" command. Instead, it aborts the operation and gives the error message below. If you encounter this issue before we release TonCalc 2.0.2, please email us the TonCalc workbook, and we will make the necessary coding fix. We are now beta testing TonCalc 2.0.2, with an anticipated release later this month. There is still time to incorporate other TonCalc corrections and improvements, if you have not already sent them in. Mr. Marcus Akins is our point of contact on this matter.

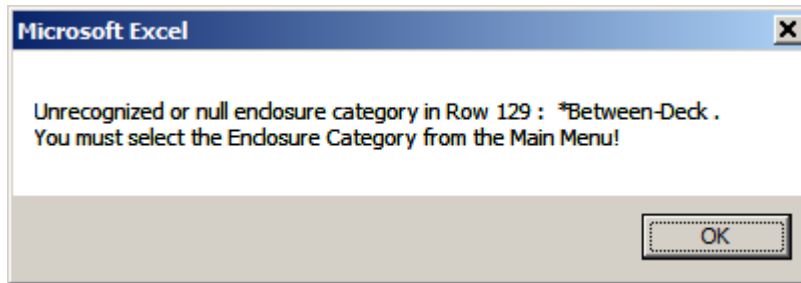

QUARTERLY TELEPHONE CONFERENCES We are preparing the first round of quarterly telephone conferences with authorized measurement organizations for 2016. Please contact Mr. Marcus Akins for scheduling or to request any specific topics you would like covered.

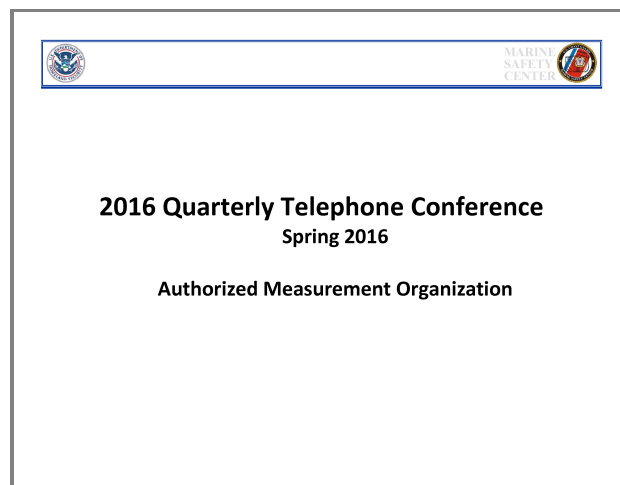

WASHINGTON'S BIRTHDAY HOLIDAY The Marine Safety Center will be closed Monday, February 15th in observance of the birthday of George Washington.

Weekly Notes are issued by the Coast Guard Marine Safety Center's Tonnage Division (MSC-4) for use by organizations that perform measurement work on the Coast Guard's behalf. They are for informational purposes only, and are not intended as, nor should they be construed to represent, revisions of or substitutes for applicable statutes or regulations or established interpretations of either.

MEASUREMENT ORGANIZATION WEEKLY NOTES – 02/03/2016

WALK-IN COOLERS In providing a recent ruling on the treatment of a modular walk-in cooler, the Marine Safety Center (MSC) commented that subspaces of inconsequential volume have historically been ignored when calculating exemptions, depending on individual circumstances which include how the subspace is used. For example, smaller refrigerators, cabinets, ventilation ducts, dumb-waiters, fire stations, switchboards, and lockers have been ignored, whereas subspaces over one ton have generally not been ignored. As a practical matter, any walk-in space will generally measure over one ton.

FISH AS DRY CARGO AND STORES The MSC also recently upheld past decisions treating well-drained (dry) fish bins as “dry cargo and stores” under the Dual Measurement System. Although the rulings may appear counterintuitive, the law was intended to treat liquid cargo tanks differently from dry cargo spaces according to the legislative history for the 1965 implementing statute.

CG NUMBER REQUESTS AND FORMAL APPLICATIONS When processing Coast Guard (CG) number requests, we occasionally encounter [Applications for Formal Measurement Services](#) which are missing key information, such as vessel numbers, that the owner was eventually able to provide. We encourage measurement organizations to review these applications for completeness before submitting them to the MSC, and to advise their clients that properly completed forms can help avoid costly delays. Please note that in the absence of a U.S. official number or IMO number, we are often able to find vessels in the MISLE data system by searching on a foreign official number, HIN, hull number, state number, or the like.

MEASUREMENT ORGANIZATION WEEKLY NOTES – 01/27/2016

IACS PAPERS AT SDC 3 Last week, the Ship Design and Construction (SDC) Sub-Committee discussed the IACS papers on cooler and open deck spaces. Delegations from multiple countries, including the United States, expressed support for the IACS cooler Unified interpretation (UI), with the only expressed objection being that it was "too soon" after issuance of TM.5/Circ.6. Conversely, the open deck space UI was the subject of four interventions expressing opposition, with none expressing support. Opposition (Japan, Australia, Netherlands, and Germany) centered around treating cargo deck spaces on Offshore Support Vessels differently from other vessels.

DEADWEIGHT TONNAGE Also at SDC 3, there was a lively discussion concerning the effect of trim on deadweight tonnage certification, which could put a vessel over one of the deadweight tonnage thresholds that appear in international instruments. The Sub-Committee generally agreed to certifying the deadweight tonnage with the vessel trimmed to an even keel, but favored including additional information on appropriate certificates for vessels for which a deadweight threshold would be exceeded. IACS agreed to develop a UI reflecting this discussion, for presentation at the next Sub-Committee meeting. Although the GT ITC measurement is not affected in this manner, the design trim of a vessel can substantively affect the vessel's length measurement under the 1969 Tonnage Convention.

PASSENGER SUPPORT SPACES In a recent decision, the Marine Safety Center (MSC) clarified that passenger support space accessibility requirements may not necessarily conflict with 1995 guidance on treating serving bar spaces. The MSC advised the measurement organization that it may continue to apply criteria of the 1995 guidance until otherwise directed by the MSC. We intend to address this matter in the next update to MSC Technical Note (MTN) 01-99 CH-7, Tonnage Technical Policy.

DIGGING OUT Due to last weekend's snow storm, Federal offices in the Washington, D.C. area were closed on Monday and Tuesday. Many employees, still dealing with unplowed roads and reduced public transit options, continue to work remotely. If you need to contact the Tonnage Division, please leave a voice message or email, as we have access to both from remote worksites.

Weekly Notes are issued by the Coast Guard Marine Safety Center's Tonnage Division (MSC-4) for use by organizations that perform measurement work on the Coast Guard's behalf. They are for informational purposes only, and are not intended as, nor should they be construed to represent, revisions of or substitutes for applicable statutes or regulations or established interpretations of either.

MEASUREMENT ORGANIZATION WEEKLY NOTES – 01/20/2016

BWM CONVENTION As reported in Bryant's Maritime Consulting Newsletter, the International Maritime Organization announced that, despite recent ratifications of the Ballast Water Management (BWM) Convention in November 2015, there is still insufficient global tonnage represented to trigger the convention's entry into force. Forty-seven countries have ratified the convention (30 are required), but their combined fleets comprise 34.56% of global tonnage, with 35% required for its entry into force. This illustrates the importance of the tolerances to which tonnages are measured, as aggregate differences in tonnage assignments, however slight, could determine whether a broad-reaching international agreement takes effect.

PASSAGEWAY DEDUCTIONS We recently were involved in a matter requiring clarification in applying Section 69.119(o)(2) of Marine Safety Center Technical Note (MTN) 01-99 CH-7, *Tonnage Technical Policy*, regarding passageway deductions. The MTN allows for an otherwise deductible passageway to serve as the sole means of access to the nondeductible spaces listed in this section (e.g., a ship's office) without invalidating the deduction. However, the deduction is invalidated if the passageway also serves a nondeductible space that is not so listed (e.g., a large cleaning gear locker), as illustrated below.

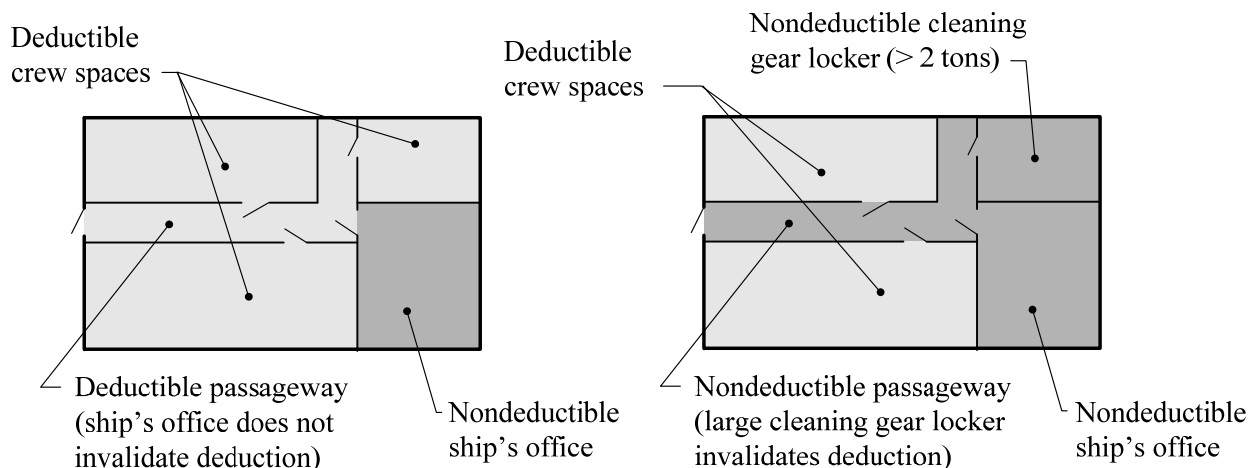

Weekly Notes are issued by the Coast Guard Marine Safety Center's Tonnage Division (MSC-4) for use by organizations that perform measurement work on the Coast Guard's behalf. They are for informational purposes only, and are not intended as, nor should they be construed to represent, revisions of or substitutes for applicable statutes or regulations or established interpretations of either.

MEASUREMENT ORGANIZATION WEEKLY NOTES – 01/13/2016

TONNAGE PUBLICATIONS WEB PAGE We recently learned that a user encountered a server error when accessing the Marine Safety Center Tonnage Publications [web page](#). If you experience any issues opening the site, please contact Mr. David Karnes.

The screenshot shows the United States Coast Guard website's Marine Safety Center Tonnage Publications page. The header includes the USCG logo, 'United States Coast Guard U.S. Department of Homeland Security', and navigation links like 'Contact Us' and 'Frequently Asked Questions'. A search bar is present. The main content area is divided into a left sidebar and a main right section. The sidebar contains links for 'Marine Safety Center', 'Tonnage Division (MSC-4)', 'Tonnage Publications', 'Simplified Tonnage Form (CG-5397)', 'Tonnage Personnel', 'Documentation and Tonnage Related Links', and 'Contact Webmaster'. The main section features several categories of publications: 'Marine Safety Center Tonnage Publications', 'Marine Safety Center Technical Notes (MTNs)' with links to MTN 01-99 CH-7, MTN 01-98 CH-12, MTN 04-03 CH-2, and MTN 04-03 CH-2 Enclosure (1); 'Navigation and Vessel Inspection Circulars (NVICs)' with a link to NVIC 11-93 CH-3; 'IMO Tonnage Rules and Interpretations (TM Convention)' with links to TM Convention - Draft Text Version and TM.5/Circ.6; 'Marine Safety Center Tonnage Guides' with links to guides 1 through 5; 'Miscellaneous Tonnage Documents' with links to Formal Measurement Application and Measurement Organization Weekly Notes; and 'Historical Marine Safety Center Technical Notes (MTNs)' with links to MTN 01-99 CH-6 and MTN 01-99 CH-5. Security level widgets for MARSEC and NTAS are also visible on the left.

IN MEMORIAM: DON FLETCHER Early this week, the sad news of Mr. Don Fletcher's passing reached us courtesy of Mr. Phil Essex of Moorsom Consulting. Don's remarkable career in our highly specialized field spanned nearly 5 decades, and included federal service both as a Panama Canal and Coast Guard admeasurer. He led an exceptionally full life, making the most of his 82 years despite some significant health challenges at the end, and will be long remembered by the Tonnage Division Staff for his technical competence, courtesy, and professionalism. Don will be sorely missed by all who had the pleasure of knowing him, and remains very much in our thoughts.

MARTIN LUTHER KING, JR. HOLIDAY The Marine Safety Center will be closed Monday, January 18th in observance of the Birthday of Martin Luther King, Jr.

Weekly Notes are issued by the Coast Guard Marine Safety Center's Tonnage Division (MSC-4) for use by organizations that perform measurement work on the Coast Guard's behalf. They are for informational purposes only, and are not intended as, nor should they be construed to represent, revisions of or substitutes for applicable statutes or regulations or established interpretations of either.

MEASUREMENT ORGANIZATION WEEKLY NOTES – 01/06/2016

UPDATE TO MTN 01-99 CH-7 The Marine Safety Center is developing a long-overdue update to MTN 01-99 CH-7, Tonnage Technical Policy, which - among other things - will address interpretations that stem from recent International Maritime Organization (IMO) tonnage work. One possible change would include a new appendix, based on a reprint of the 1969 Tonnage Measurement Convention (TM69), with various interpretations (i.e., IMO, IACS, and US) inserted in italics, so that all of this information would be in one convenient location. Any comments on the usefulness of such an appendix are welcome.

SPACE BOUNDED BY AWNINGS There has been some difficulty over the years in understanding the purpose of the IMO interpretation on space bounded by awnings (currently Interpretation R.2(4)-2 of TM.5/Circ.6). The interpretation reads: "Space located within the boundaries of 'permanent or movable awnings' should be subject to treatment under regulation 2(5)". On the surface, this interpretation seems to contradict language in the TM69 that provides for ignoring the volumes of spaces bounded by permanent or moveable awnings. Based on information exchanged during recent IMO tonnage work, we developed the following figure to illustrate an enclosed space within the boundaries of an awning. We are considering including a figure along these lines in the MTN update.

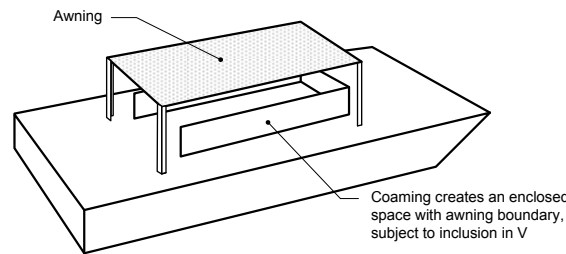

WATER BALLAST SPACE DETAILS Further to previous Weekly Notes addressing necessary graphical representations, we offer the following example from the MTN of how dimensions used in the volume calculation for water ballast space exemptions could be reflected, as well as the proper application of the zone of influence method.

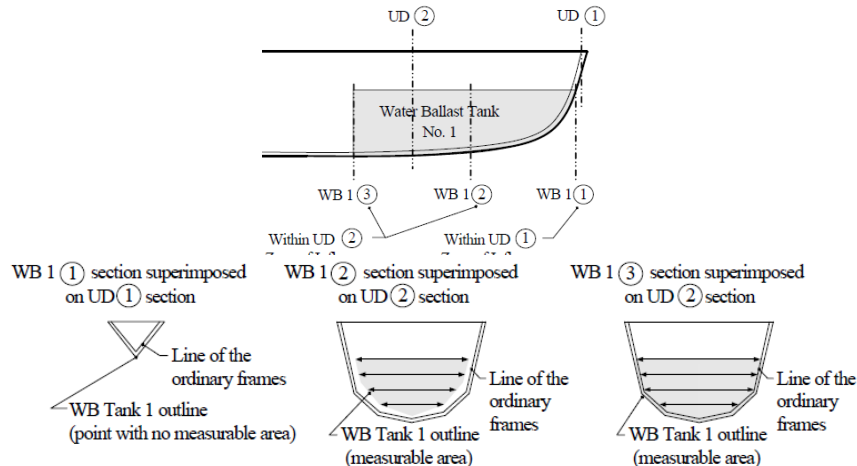

Weekly Notes are issued by the Coast Guard Marine Safety Center's Tonnage Division (MSC-4) for use by organizations that perform measurement work on the Coast Guard's behalf. They are for informational purposes only, and are not intended as, nor should they be construed to represent, revisions of or substitutes for applicable statutes or regulations or established interpretations of either.

MEASUREMENT ORGANIZATION WEEKLY NOTES – 12/30/2015

TM69 AMENDMENTS Last week, the International Maritime Organization (IMO) announced that certain treaty amendments will enter into force on January 1st, making IMO Member State audits mandatory. Per TM.7/Circ.1, the associated 1969 Tonnage Convention (TM69) amendments are to enter into force on February 28, 2017, predicated on unanimous Contracting Government acceptance by February 28, 2016. Note that a Contracting Government which does not communicate its acceptance or rejection of the amendments by February 28, 2016 will be deemed to have accepted the amendments.

IMO AUDIT FINDINGS Although audits have not been mandatory, IMO has conducted 74 voluntary audits since 2006. Based on the consolidated results IMO publishes, these audits yielded approximately 630 findings (nonconformities and observations), of which 21 were related to tonnage. Most of the tonnage findings were administrative in nature (e.g., failure to notify IMO of laws and regulations), with only two involving application of the rules themselves (one being the failure to notify Recognized Organizations (RO's) of how to interpret certain TM69 provisions, and the other related to the qualifications of Member State personnel who oversee tonnage work).

NEW YEAR'S DAY CLOSURE The Marine Safety Center will be closed on January 1st in observance of the New Year's Day holiday. We wish you a happy and safe New Year, and look forward to working with you all in 2016.

MEASUREMENT ORGANIZATION WEEKLY NOTES – 12/23/2015

ESTIMATING PROPELLING MACHINERY TONNAGE In cases where the engine room deduction under the U.S. Regulatory Measurement System is 32/13 or 1.75 times the measured propelling machinery tonnage, there is no question that detailed supporting calculations are required. Less clear are those situations where the deduction claimed for such spaces is 32% of the gross tonnage, which only applies if the tonnage of the total propelling machinery space is more than 13% of the vessel's gross tonnage. We currently allow measurement organizations considerable latitude in estimating the tonnage when applying this 13% criterion, but caution that the legal requirement is based on the precise tonnage value - were it to be calculated in detail. The following is an example from a recent oversight, where the measurement organization used engineering judgment (appropriately) to estimate the propelling machinery tonnage.

Spaces Deducted From Gross Tonnage	
Select Propelling Power Options:	
(1) Screw:	(2) Paddle Wheel
(1) Percentage of GRT:	(2) 1.75 Prop Mch Sp if >= 20% GRT
Boatswain's Stores (Measured)	44.16
Propelling Machinery Space (Measured)	44.16
% of Gross Register Tonnage	47.5%

SDC PUBLIC MEETING The Department of State published a Federal Register notice concerning the previously-mentioned public meeting to prepare for the International Maritime Organization's (IMO's) upcoming Sub-Committee on Ship Design and Construction's (SDC's) third Session. The [notice](#) includes a list of agenda items as well as RSVP contact details. Public in-person attendance is limited; however, a call-in number option will be available upon RSVP.

CHRISTMAS AND NEW YEAR HOLIDAY CLOSURES The Marine Safety Center will be closed on December 25th and January 1st in observance of the Christmas and New Year holidays and, as mentioned last week, on the afternoon of December 24th by Executive Order. We wish you all a happy and safe holiday season.

Weekly Notes are issued by the Coast Guard Marine Safety Center's Tonnage Division (MSC-4) for use by organizations that perform measurement work on the Coast Guard's behalf. They are for informational purposes only, and are not intended as, nor should they be construed to represent, revisions of or substitutes for applicable statutes or regulations or established interpretations of either.

MEASUREMENT ORGANIZATION WEEKLY NOTES – 12/16/2015

IACS UIs AND IMO In recent years, IACS has been submitting its Unified Interpretations (UIs) to the International Maritime Organization (IMO) for consideration at the appropriate Sub-Committee. When these IACS papers are introduced at IMO, adverse comments could trigger reviews by IACS, and subsequent adjustments to the UI. The message here is that if you participate in the UI development process on tonnage matters, you may be able to resolve United States concerns beforehand - and thereby avoid unnecessary adjustments to a UI - by soliciting input from the Marine Safety Center's (MSC's) Tonnage Division during the UI development process.

GUEST SPACES ON RECREATIONAL VESSELS Our records show that as early as 1915, a predecessor agency (Department of Commerce) ruled to the effect that any person carried on a vessel, who is not connected with her navigation, ownership, or business, is a passenger. Subsequent rulings have held that a stateroom on a yacht used exclusively for guests who do not engage in the operation of the vessel may be eligible for exemption as passenger space (e.g., depending on location relative to the uppermost complete deck). How a "guest" stateroom on a recreational vessel will be used is one of many items that should be discussed among owners and measurement organization representatives during the measurement process.

CHRISTMAS HOLIDAY CLOSURE The MSC will be closed on Friday, December 25th, in observance of the Christmas holiday. In addition, the president issued an Executive Order closing all executive branch departments and agencies of the Federal Government for the last half of the scheduled workday on Thursday, December 24th.

EXECUTIVE ORDER

HALF-DAY CLOSING OF EXECUTIVE DEPARTMENTS AND AGENCIES

OF THE FEDERAL GOVERNMENT ON THURSDAY, DECEMBER 24, 2015

By the authority vested in me as President of the United States of America, by the Constitution and the laws of the United States, it is hereby ordered as follows:

Section 1. All executive branch departments and agencies of the Federal Government shall be closed and their employees excused from duty for the last half of the scheduled workday on Thursday, December 24, 2015, the day before Christmas Day, except as provided in section 2 of this order.

Weekly Notes are issued by the Coast Guard Marine Safety Center's Tonnage Division (MSC-4) for use by organizations that perform measurement work on the Coast Guard's behalf. They are for informational purposes only, and are not intended as, nor should they be construed to represent, revisions of or substitutes for applicable statutes or regulations or established interpretations of either.

MEASUREMENT ORGANIZATION WEEKLY NOTES – 12/09/2015

SDC 3 PUBLIC MEETING The State Department will conduct a public meeting to prepare for the third Session of the International Maritime Organization's (IMO) Sub-Committee on Ship Design and Construction (SDC) at 9:00 am on Wednesday, January 6, 2016, in Conference Room 4 of the Department of Transportation Headquarters Conference Center, West Building, 1200 New Jersey Avenue SE, Washington, DC 20590. The SDC meeting will be held at the International Maritime Organization's headquarters in London, January 18-22, 2016. The two previously mentioned IACS tonnage papers are on the agenda.

PSIX TONNAGE INFORMATION Please be advised that following the update to the Coast Guard's MISLE database in September, PSIX had erroneously listed units for gross and net tonnages as long tons and short tons, respectively. While that is no longer the case, PSIX now lists "Gross Ton" and "Net Ton", respectively.

FEDERAL GOVERNMENT FUNDING Funding for the Department of Homeland Security and many other federal entities is set to expire on December 11, 2015. Lack of further funding could result in a government shutdown, disrupting services (including those provided by the Marine Safety Center).

EXECUTIVE ORDER 8976 On December 12, 1941, President Franklin D. Roosevelt issued Executive Order No. 8976, authorizing the Secretary of Commerce to waive compliance with the navigation and vessel inspection laws for war purposes. This authority was invoked several months later for vessel tonnage purposes. More details to follow.

EXECUTIVE ORDER

AUTHORIZING THE SECRETARY OF COMMERCE TO WAIVE COMPLIANCE WITH THE NAVIGATION AND VESSEL INSPECTION LAWS FOR WAR PURPOSES

By virtue of the authority vested in me by the Constitution and Statutes of the United States as President of the United States and Commander-in-Chief of the Army and Navy, and to further the successful prosecution of the war, it is hereby ordered as follows:

1. The Secretary of Commerce is directed to waive compliance with the navigation and vessel inspection laws upon the request of the Secretary of the Navy

or the Secretary of War to the extent deemed necessary in the conduct of the war by the officer making the request.

2. The Secretary of Commerce is authorized to waive compliance with the navigation and vessel inspection laws to such extent and in such manner and upon such terms as he may prescribe, either upon his own initiative or upon the written recommendation of the head of any other Government agency that such action is necessary in the conduct of the war.

FRANKLIN D ROOSEVELT

THE WHITE HOUSE,
December 12, 1941.

[No. 8976]

[F. R. Doc. 41-9470; Filed, December 10, 1941;
12:03 p. m.]

Weekly Notes are issued by the Coast Guard Marine Safety Center's Tonnage Division (MSC-4) for use by organizations that perform measurement work on the Coast Guard's behalf. They are for informational purposes only, and are not intended as, nor should they be construed to represent, revisions of or substitutes for applicable statutes or regulations or established interpretations of either.

MEASUREMENT ORGANIZATION WEEKLY NOTES – 12/02/2015

HTML/RICH TEXT EMAIL UPDATE On a trial basis, the Coast Guard is once again able to view and create email in HTML and Rich Text formats. This capability has been restored for the next 30 days.

PIPING PENETRATIONS In responding to a recent inquiry regarding treatment of piping penetrations through ordinary frames, the Marine Safety Center commented that the penetration opening size is taken as the inside pipe diameter where manufacturing steps render the final assembly to appear as an integral unit, such as by continuous welding.

SDC 3 PREPARATIONS As part of the preparations for the upcoming Ship Design and Construction Sub-Committee (SDC) meeting in London next month, the Coast Guard will hold a public meeting to solicit input on the various agenda items, including the two IACS papers on tonnage mentioned in last week's edition. Meeting details to follow.

MEASUREMENT ORGANIZATION WEEKLY NOTES – 11/25/2015

IACS TONNAGE PAPERS Two IACS papers on tonnage have posted to the International Maritime Organization's (IMO's) website. These papers inform IMO of the recent adoption of two new IACS Unified Interpretations (UI's). We welcome your input on either paper, as the United States develops its position for the Ship Design and Construction (SDC) meeting in London in January 2016. A brief description follows:

1. **Paper SDC 3/14/6 Heat Exchangers (Coolers) Treatment (IACS UI TM2)**
This UI provides for treating heat exchangers (coolers) fitted in hull recesses or outside of the hull as machinery under TM.5/Circ.6 Interpretation R.2(4)-9, and not as appendages.
2. **Paper SDC 3/14/8 Open Deck Spaces Bounded by Partitions or Bulkheads (IACS UI TM3)**
This UI provides for treating uncovered open deck spaces along similar lines to that provided for under Marine Safety Center Technical Note (MTN) 01-99 CH-7, *Tonnage Technical Policy*.

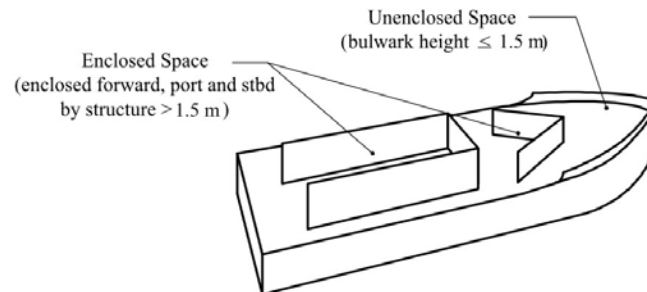

IACS INTERPRETATIONS We caution that IACS interpretations do not automatically supersede Coast Guard interpretations on tonnage matters, notwithstanding the statements in both the above-mentioned papers to apply the interpretations unless "provided with written instruction to apply a different instruction by the Administration." We have no such "tacit acceptance" provisions with IACS, nor are such provisions included in our written agreements with authorized measurement organizations.

MSC MOVE COMPLETE The MSC has resumed normal operations following last week's office move.

THANKSGIVING CLOSURE The Marine Safety Center will be closed Thursday, November 26th in observance of the Thanksgiving holiday.

Weekly Notes are issued by the Coast Guard Marine Safety Center's Tonnage Division (MSC-4) for use by organizations that perform measurement work on the Coast Guard's behalf. They are for informational purposes only, and are not intended as, nor should they be construed to represent, revisions of or substitutes for applicable statutes or regulations or established interpretations of either.

MEASUREMENT ORGANIZATION WEEKLY NOTES – 11/19/2015

ELEVATOR SHAFTS AND PASSENGER SPACES We recently responded to an inquiry regarding exemption of elevator shafts as passenger space. We commented that elevator shaft space reserved exclusively for passenger use (including passenger support) and located on or above the first deck above the uppermost complete deck is exempt as passenger space. In this context, passenger support includes services provided by the crew exclusively for passengers (e.g., hotel service).

MSC PHONE NUMBER Beginning next week following the previously mentioned relocation of the Marine Safety Center (MSC), the new main telephone number will be (202) 795-6729. Direct lines to MSC staff will be (202) 795-XXXX, where XXXX is the same last four digits of current phone numbers. This information will be updated on the MSC website in the near future.

SUEZ CANAL TOLLS The Suez Canal opened to shipping on 17 November 1869. In 2014, the Canal saw vessel transits of over 962.7 million Suez Canal Net Tons (SCNT). As canal tolls are a function of net tonnage, the +/-5% tolerance to which such tonnages are measured can make a significant difference. For example, a large containership like the Mærsk E-class (158,030 SCNT) could pay about \$374,000 in tolls per transit. If its SCNT were certified 5% more/less, its canal toll would increase/decrease by about \$14,000. If it made 10 canal transits annually, a 10% error would cost or save the operator \$280,000 (at the benefit or expense of the Egyptian government).

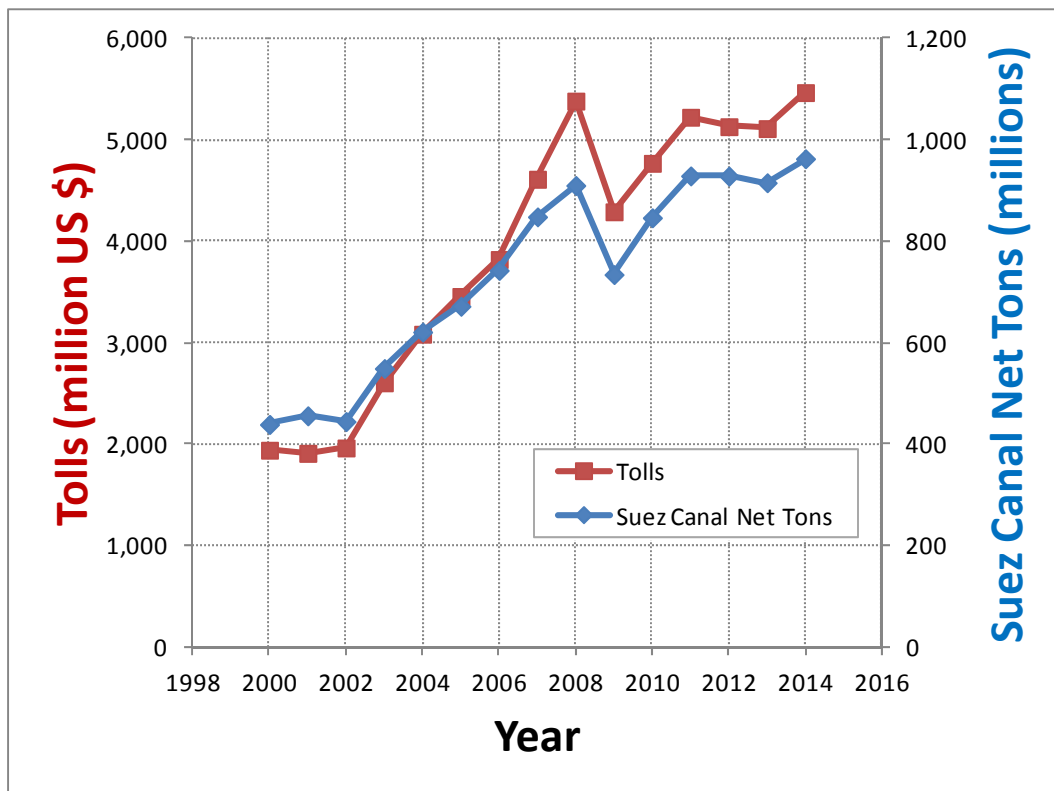

Weekly Notes are issued by the Coast Guard Marine Safety Center's Tonnage Division (MSC-4) for use by organizations that perform measurement work on the Coast Guard's behalf. They are for informational purposes only, and are not intended as, nor should they be construed to represent, revisions of or substitutes for applicable statutes or regulations or established interpretations of either.

MEASUREMENT ORGANIZATION WEEKLY NOTES – 11/10/2015

REVIEW REQUESTS From time to time, we receive requests from members of the public to review and comment on drawings to confirm that the tonnages calculated by an owner or designer are correct. Please be aware that the Marine Safety Center (MSC) does not provide this review service. Instead, we encourage the requestor to contact authorized measurement organizations to ascertain whether they could provide this kind of review service. Conversely, the MSC provides written responses to the public on matters of interpretation and application of the tonnage regulations or policy requiring clarification, or which involve unusual or otherwise novel designs.

VETERANS DAY CLOSURE As a reminder, the MSC will be closed Wednesday, November 11th in observance of the Veterans Day holiday.

MSC MOVE IMPACTS As mentioned previously, the MSC will move next week (November 19th – 20th). Please understand that, although we are making every effort to minimize disruptions, our office will be effectively shut down during certain phases of this move, with e-mail and telephone connections completely severed during the latter part of the week. We ask for your patience until service is fully restored during Thanksgiving week.

MEASUREMENT ORGANIZATION WEEKLY NOTES – 11/04/2015

PIPING PENETRATIONS We recently responded to an inquiry regarding treatment of piping penetrations in ordinary frames, commenting to the effect that restrictions on opening size and proximity are applied to the frame penetrations through which the piping passes. The opening size is taken as the inside pipe diameter where manufacturing steps render the final assembly to appear as an integral unit, such as by continuous welding.

MSC MOVE DETAILS The previously mentioned relocation of the Marine Safety Center (MSC) will occur on November 19, 2015. The MSC expects the office to go offline November 19th – 20th with reduced services prior to and after the move. Notably, tonnage file request services will be suspended on November 17th until further notice.

Effective November 23rd, the MSC's main telephone number will be (202) 795-6729. Its new mailing address for conventional mail will be:

Commanding Officer
Attn: when addressing a specific MSC staff member
Marine Safety Center
US Coast Guard Stop 7430
2703 Martin Luther King Jr Ave SE
Washington, DC 20593-7430

Further information is available on the Coast Guard's [Maritime Commons](#) blog. Please feel free to contact Mr. Marcus Akins if you have any questions regarding the move.

VETERANS DAY CLOSURE The MSC will be closed Wednesday, November 11th in observance of the Veterans Day holiday.

Weekly Notes are issued by the Coast Guard Marine Safety Center's Tonnage Division (MSC-4) for use by organizations that perform measurement work on the Coast Guard's behalf. They are for informational purposes only, and are not intended as, nor should they be construed to represent, revisions of or substitutes for applicable statutes or regulations or established interpretations of either.

MEASUREMENT ORGANIZATION WEEKLY NOTES – 10/28/2015

RELOCATION OF MSC The Coast Guard is finalizing its plans to relocate the Marine Safety Center (MSC) from Arlington, Virginia to the Douglas A. Munro [Coast Guard Headquarters](#) building on the St. Elizabeths campus in southeast DC. We expect the move to be completed within the next two months and will provide more detailed information as soon as it is available.



Weekly Notes are issued by the Coast Guard Marine Safety Center's Tonnage Division (MSC-4) for use by organizations that perform measurement work on the Coast Guard's behalf. They are for informational purposes only, and are not intended as, nor should they be construed to represent, revisions of or substitutes for applicable statutes or regulations or established interpretations of either.

MEASUREMENT ORGANIZATION WEEKLY NOTES – 10/21/2015

OVERSIGHT RESULTS REPORTING We are in the process of implementing several changes to the way we report oversight results to authorized measurement organizations, including the use of new subcategories listed below for grouping oversight findings. The changes are intended to provide another level of granularity in our results reporting, along similar lines to how results are reported for certain plan review oversight activities, and to facilitate reporting in cases when we review only certain aspects of a vessel tonnage file. Please feel free to contact Mr. Marcus Akins if you have any questions or comments on these changes.

Tonnage Measurement - Convention

Tonnage Measurement - Regulatory

Tonnage Measurement - Dimensions

Tonnage Measurement - Administrative

FRAMING AND DEDUCTIONS We recently issued a decision on deducting certain miscellaneous under-deck spaces (e.g., passageway and generator spaces) within "deep framed" portions of the hull, affirming the measurement organization's approach to ensure deduction of only those portions of the spaces that were included in the gross tonnage. The Marine Safety Center (MSC) is currently developing policy on this subject. Until this policy is published, measurement organizations are encouraged to contact the MSC for guidance on how to measure such spaces.

TEMPORARY CERTIFICATES OF DOCUMENTATION The Coast Guard's National Vessel Documentation Center will suspend issuance of Temporary Certificates of Documentation as of October 22, 2015. The intent of the program was to allow legal operation of vessels during the busy summer boating season. The Coast Guard will consider reinstating the program again next spring, depending on the recreational vessel documentation backlog. Please note that there is no similar provision for temporary tonnage certificates.

Weekly Notes are issued by the Coast Guard Marine Safety Center's Tonnage Division (MSC-4) for use by organizations that perform measurement work on the Coast Guard's behalf. They are for informational purposes only, and are not intended as, nor should they be construed to represent, revisions of or substitutes for applicable statutes or regulations or established interpretations of either.

MEASUREMENT ORGANIZATION WEEKLY NOTES – 10/14/2015

PC RECORD SET As reported in Bryant's Maritime Consulting Newsletter, the Panama Canal Authority issued a [news release](#) stating that, for the fiscal year ending on September 30, 2015, the Canal set a new tonnage record of 340.8 million Panama Canal tons (PC/UMS) through the canal. The previous record was set in FY2012.

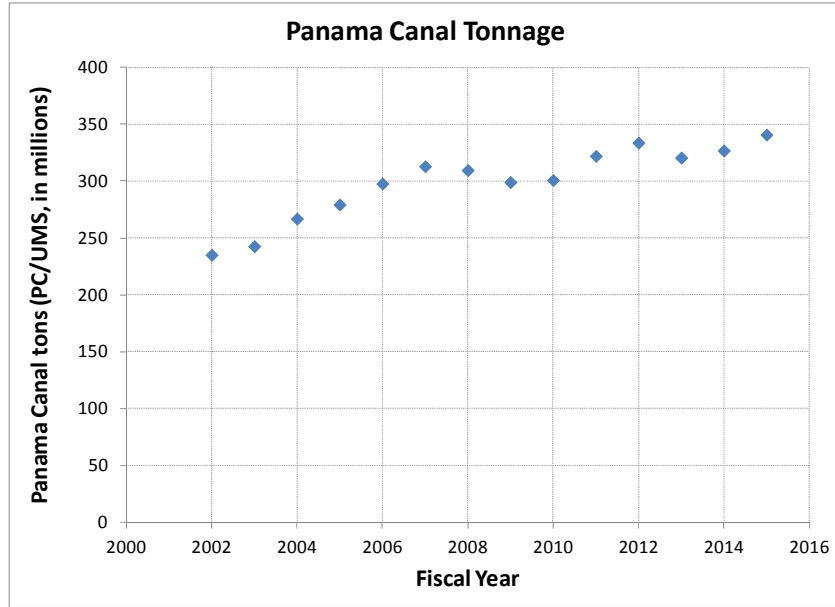

EQUAL PARTS When applying Simpson's First Rule in measuring certain propelling machinery spaces, the tonnage regulations provide for dividing the space into an even number of equal parts. The following figure illustrates how such divisions are to be made, which is consistent with the approach used in measuring water ballast spaces.

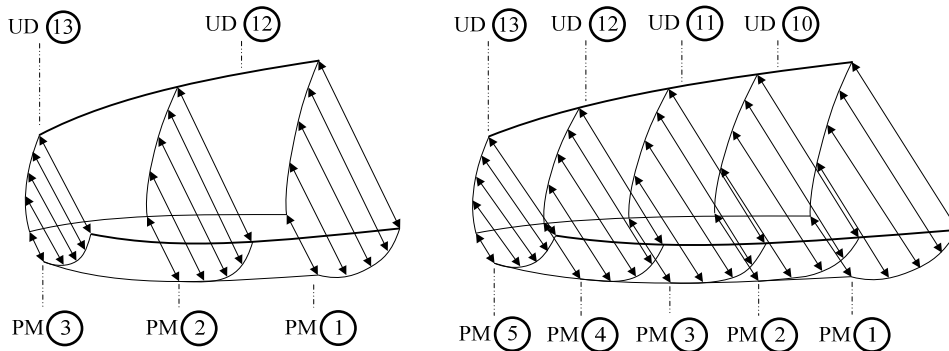

Weekly Notes are issued by the Coast Guard Marine Safety Center's Tonnage Division (MSC-4) for use by organizations that perform measurement work on the Coast Guard's behalf. They are for informational purposes only, and are not intended as, nor should they be construed to represent, revisions of or substitutes for applicable statutes or regulations or established interpretations of either.

MEASUREMENT ORGANIZATION WEEKLY NOTES – 10/07/2015

TONNAGE MEASUREMENT POCs To facilitate open communications, the Marine Safety Center (MSC) maintains appropriate points of contact at authorized measurement organizations. The attachment summarizes information on the subject that was recently provided to an authorized measurement organization. Please note that technical points of contact (POCs) must be exclusive employees familiar with the governing tonnage certification requirements, including administrative requirements applicable to the tonnage certification process.

MACHINERY ARRANGEMENT DRAWINGS Further to the entry in the September 9th Weekly Notes edition on necessary graphical representations, we offer the following example of how a machinery arrangement drawing could be marked up to reflect dimensions used in calculating the engine room deduction.

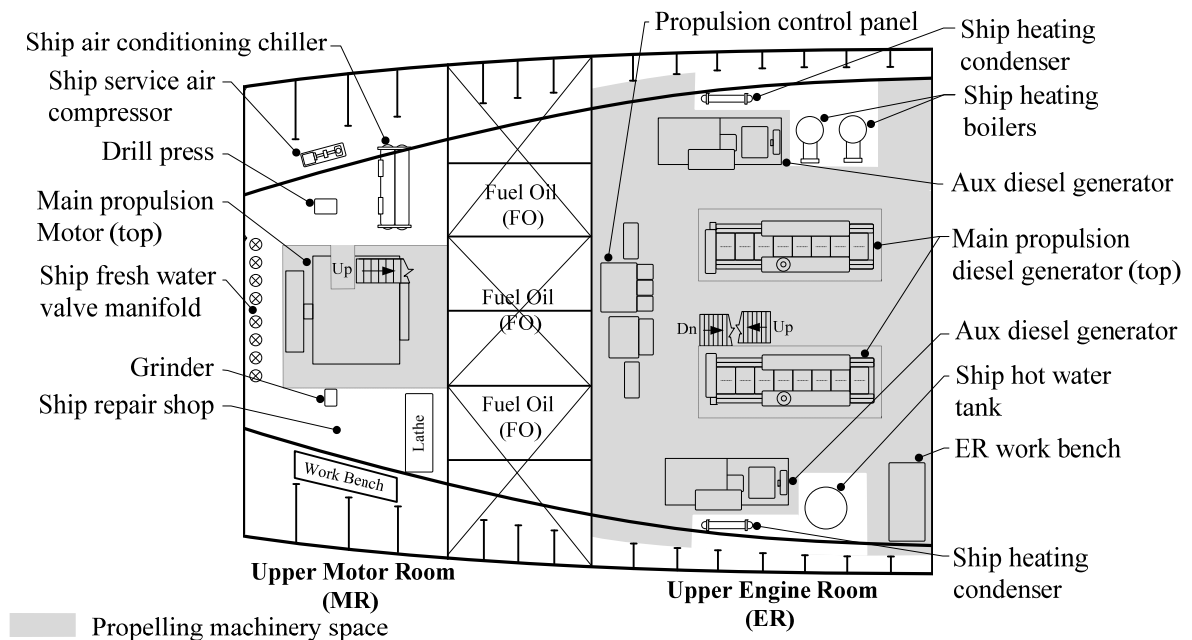

COLUMBUS DAY CLOSURE The MSC will be closed Monday, October 12th in observance of the Columbus Day holiday.

Weekly Notes are issued by the Coast Guard Marine Safety Center's Tonnage Division (MSC-4) for use by organizations that perform measurement work on the Coast Guard's behalf. They are for informational purposes only, and are not intended as, nor should they be construed to represent, revisions of or substitutes for applicable statutes or regulations or established interpretations of either.

INFORMATION ON TONNAGE MEASUREMENT POCs

1. **Purpose** To provide general information regarding points of contact (POCs) for tonnage measurement work performed by authorized classification societies (ACSs) on the Coast Guard's behalf. Open communications between the Marine Safety Center (MSC) and these ACSs are critical to achieving mutual marine safety goals (see paragraph 3 of MSC Technical Note (MTN) 04-03 CH-2, Technical Support and Oversight of Authorized Classification Societies).

2. **Technical POCs** Delegation of tonnage measurement authority is predicated on the agreement of the ACS to maintain a tonnage measurement staff that is experienced in measuring vessels under formal U.S. systems (see Title 46, Code of Federal Regulations (CFR), 69.27(b)(5)), and familiar with applicable U.S. laws and regulations, Coast Guard policies, interpretations, and instructions (see language in the Coast Guard/ACS authorization agreement, as applicable). Accordingly, as a minimum, the ACS must designate at least one tonnage technical POC, who is an exclusive employee of the ACS familiar with the governing tonnage certification requirements, including administrative requirements applicable to the certification process as described in MTN 01-98 CH-12, Tonnage Administrative Policy. Further, if a tonnage technical POC is unable to respond to MSC questions about work performed on a specific vessel, that individual must be able to readily obtain the required information from the qualified ACS employee who performed or reviewed the work, and be conversant with that information.

3. **Other POCs** The ACS may also designate POCs who provide managerial or administrative interface functions, such as addressing major nonconformities, forwarding notifications of technical work (see paragraph 4.b of MTN 04-03 CH-2), or requests for CG number assignments (see Sections 2.3(b)(2) and 3.3(b)(2) of MTN 01-98 CH-12). These POCs need only be familiar with requirements related to such interface matters.

4. **MSC Correspondence** It is the MSC's expectation that POCs discuss any issue involving interpretation or application of the tonnage regulations and related policy with the appropriate MSC tonnage POC, prior to submitting a written request for MSC action. Although MSC business procedures permit use of individual MSC employee email to respond to submittals of a routine, administrative nature, such as directing customers to appropriate requirements in regulations or policy documents, these procedures require signed formal MSC correspondence in responding to other submittals, including requests to provide tonnage interpretations or confirm that tonnage rules are being correctly applied to a given vessel. Experience has shown that, in most cases, delays inherent in the issuance of formal MSC correspondence can be avoided through a simple phone call, in which complex issues can often be quickly explained, discussed and resolved.

Weekly Notes are issued by the Coast Guard Marine Safety Center's Tonnage Division (MSC-4) for use by organizations that perform measurement work on the Coast Guard's behalf. They are for informational purposes only, and are not intended as, nor should they be construed to represent, revisions of or substitutes for applicable statutes or regulations or established interpretations of either.

MEASUREMENT ORGANIZATION WEEKLY NOTES – 09/30/2015

BOXED-IN VS. FRAMED-IN Marine Safety Center Technical Note (MTN) 01-99 CH-7 makes a distinction in certain contexts between propelling machinery spaces that are “framed-in” - as opposed to “boxed-in” - without providing a definition of either term. Pending our clarification of this matter in a future MTN 01-99 revision, you may assume that the term “boxed-in” generally refers to housings or similar non-stiffened protective coverings, typically fitted on engines in the open cockpit of motorboats or similar small craft, whereas the term “framed-in” generally refers to structures stiffened with framing or similar, as is the case with conventional superstructures. As always, if in doubt, contact the Marine Safety Center (Mr. Marcus Akins) for assistance in applying these provisions of the tonnage regulations.

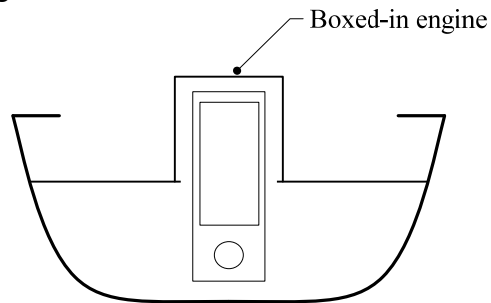

TONNAGE DATA SHEETS Following the upgrade of the Coast Guard’s MISLE database earlier this month, tonnage data sheets are currently unavailable for release. The timeline for resolution is unknown. We will resume releasing data sheets once this issue is resolved. We apologize for the inconvenience. In the interim, please contact Mr. David Karnes if you need vessel information typically provided on the sheets that is not available through [PSIX](#).

TONNAGE DIVISION VACANCY As mentioned earlier, the Marine Safety Center has advertised a full-time naval architecture position in the Tonnage Division, with a close date of Wednesday, October 7, 2015. Details are available on the government’s USAJobs website at <https://www.usajobs.gov/GetJob/ViewDetails/415406300> (Open-Competitive) and <https://www.usajobs.gov/GetJob/ViewDetails/415406400> (Merit Promotion/Status).

Weekly Notes are issued by the Coast Guard Marine Safety Center’s Tonnage Division (MSC-4) for use by organizations that perform measurement work on the Coast Guard’s behalf. They are for informational purposes only, and are not intended as, nor should they be construed to represent, revisions of or substitutes for applicable statutes or regulations or established interpretations of either.

MEASUREMENT ORGANIZATION WEEKLY NOTES – 09/22/2015

PROPELLING MACHINERY SPACE In developing information for a future revision to MTN 01-99 CH-7, *Tonnage Technical Policy*, we created the following figure to illustrate how a propelling machinery space is measured if the boundaries are continuous fair lines. This method is most frequently used to measure a machinery space extending the full breadth of the hull and located in a vessel's mid-body. Note that breadth is measured at half-height of each height.

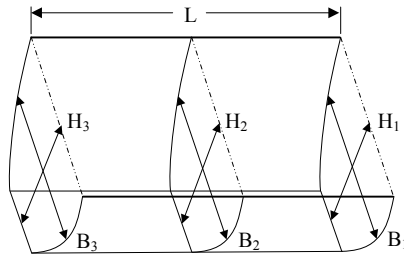

$$\text{Tonnage}_{PM} = \left(\frac{L \times B_{avg} \times H_{avg}}{100} \right)$$

where:

$$B_{avg} = \left(\frac{B_1 + B_2 + B_3}{3} \right)$$

$$H_{avg} = \left(\frac{H_1 + H_2 + H_3}{3} \right)$$

CFSAC Last week, the Commercial Fishing Safety Advisory Committee met in Seattle, Washington to discuss various issues relating to safety in the commercial fishing industry. The Tonnage Division's Mr. Marcus Akins attended, presented information, and received feedback on a number of tonnage matters.

PAPAL VISIT Please be advised that Pope Francis will visit Washington, D.C. this week (Tuesday through Thursday). The Coast Guard is encouraging employees to telecommute due to expected commuting disruptions throughout the area. For time critical matters, please follow up by email if you leave any phone messages during this time, as sometimes there are unavoidable delays in retrieving voice mail when we are telecommuting.

Weekly Notes are issued by the Coast Guard Marine Safety Center's Tonnage Division (MSC-4) for use by organizations that perform measurement work on the Coast Guard's behalf. They are for informational purposes only, and are not intended as, nor should they be construed to represent, revisions of or substitutes for applicable statutes or regulations or established interpretations of either.

MEASUREMENT ORGANIZATION WEEKLY NOTES – 09/16/2015

PROCESS ELEMENTS We recently reviewed business metrics for tonnage measurement work conducted by the Coast Guard and predecessor agencies over the past 75 years. One common theme was the time required to conduct independent reviews of tonnage calculations; such reviews generally constituted 10% of time expended on any measurement job. The following listing reflects our view of appropriate time allotment for a “typical” vessel measurement. This is based on the Navy and USCG measurement work that we conduct and our oversight of authorized measurement organizations. We welcome any comments on your experience in this regard. If you care to share, please contact Mr. Marcus Akins.

PROCESS ELEMENTS (~% Total Time)

- Ensure submittal completeness (10%)
- Establish principal dimensions (10%)
- Develop model / calculations (50%)
- Review model / calculations (10%)
- Conduct onboard survey (10%)
- Develop Tonnage Certificate(s) (5%)
- Transmit / file / admin (5%)

CG NUMBER REQUESTS We are once again able to process CG number requests, following an upgrade to the Coast Guard’s MISLE database. As a reminder, for efficient service, requests should be sent to msc@uscg.mil with Mr. David Karnes copied.

TONNAGE DIVISION VACANCY The Marine Safety Center has advertised a full-time naval architecture position in the Tonnage Division, with a salary range of \$63,722 to \$118,069 per year. Applications must be received by no later than Wednesday, October 7, 2015. Details are available on the government’s USAJobs website at <https://www.usajobs.gov/GetJob/ViewDetails/415406300> (Open-Competitive) and <https://www.usajobs.gov/GetJob/ViewDetails/415406400> (Merit Promotion/Status).

Weekly Notes are issued by the Coast Guard Marine Safety Center’s Tonnage Division (MSC-4) for use by organizations that perform measurement work on the Coast Guard’s behalf. They are for informational purposes only, and are not intended as, nor should they be construed to represent, revisions of or substitutes for applicable statutes or regulations or established interpretations of either.

MEASUREMENT ORGANIZATION WEEKLY NOTES – 09/09/2015

ARRANGEMENT DRAWINGS We continue to develop the new Tonnage Guide to address requirements for drawings or other graphical representations. One concept we intend to address is the level of arrangement detail needed when measuring propelling machinery spaces and similar, to account for working areas, non-deductible portions of such spaces, and the like. The following is an example of an arrangement drawing from our files from which many of the dimensions used in propelling machinery volume calculations could be ascertained, if properly marked-up.

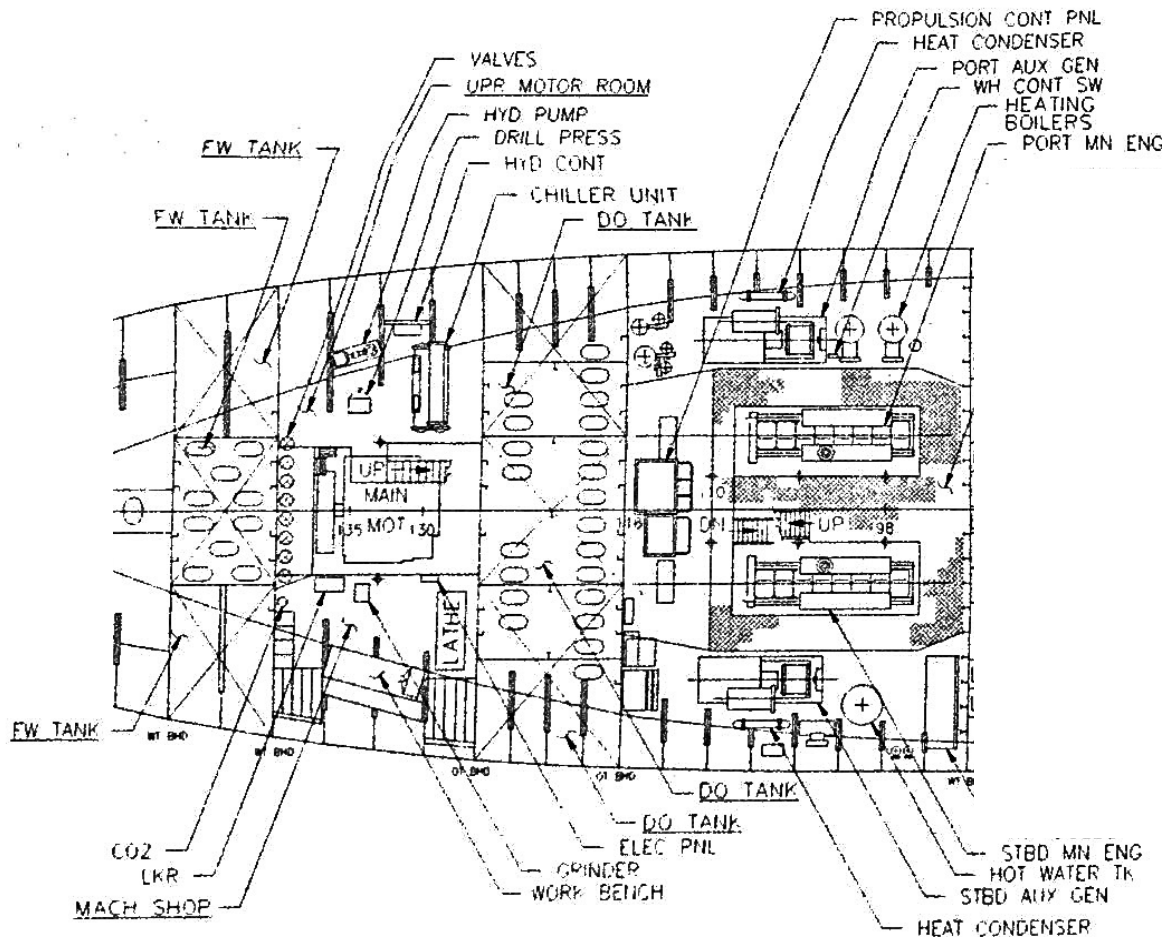

CG NUMBER REQUESTS Please be advised that we will be unable to process CG number requests until Monday, September 14th (at the earliest), following an upgrade to the Coast Guard's MISLE database. We apologize for the inconvenience.

Weekly Notes are issued by the Coast Guard Marine Safety Center's Tonnage Division (MSC-4) for use by organizations that perform measurement work on the Coast Guard's behalf. They are for informational purposes only, and are not intended as, nor should they be construed to represent, revisions of or substitutes for applicable statutes or regulations or established interpretations of either.

MEASUREMENT ORGANIZATION WEEKLY NOTES – 09/02/2015

PLAIN TEXT EMAIL ONLY The Coast Guard is no longer able to view or create email in HTML or Rich Text formats. As a result, we are unable to see images, tables, graphs, or text enhancements (e.g., italics, underline, and bolded characters) embedded in email messages. Incoming email containing such features is converted to plain text. If you need to convey any such information, we request that you attach a separate document. We apologize for this inconvenience.

KEY SUCCESS FACTORS During a recent joint Marine Safety Center (MSC) / measurement organization management meeting, the MSC identified a number of factors critical to ensuring the quality of the tonnage measurement work that it performs. These “key success factors” are:

- Adequate 3D models / drawings
- Familiarity with standards
- Sufficient staffing for workload
- Two party checks (independent reviews)
- Clear standards (MSC)

LABOR DAY CLOSURE The MSC will be closed Monday, September 7th in observance of the Labor Day holiday.

Weekly Notes are issued by the Coast Guard Marine Safety Center's Tonnage Division (MSC-4) for use by organizations that perform measurement work on the Coast Guard's behalf. They are for informational purposes only, and are not intended as, nor should they be construed to represent, revisions of or substitutes for applicable statutes or regulations or established interpretations of either.

MEASUREMENT ORGANIZATION WEEKLY NOTES – 08/26/2015

SMALL SPACES Per MTN 01-99 CH-12, spaces of less than one cubic meter in volume are ignored from calculations (or, to use the TM.5/Circ.6 term, are “not measured”). This interpretation applies equally to hull and superstructure spaces. In our experience, naval architects are increasingly including modeling details such as appendages, thrusters, and recesses, which in some cases are less than one cubic meter and therefore require adjustment (along with the adjustments that are sometimes required to omit the hull plating thickness). Note that there are no Coast Guard requirements to demonstrate - through the calculations - that a small volume which you have ignored from tonnage does - in fact - measure less than one cubic meter.

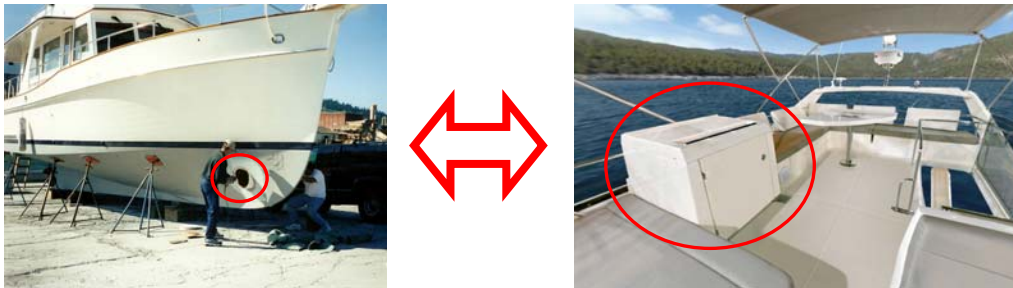

AUDITS BY FLAG STATES During recent management meetings, we have been advised that flag States have recently conducted oversight activities under the RO Code, which took effect at the beginning of this year for 1974 SOLAS, the 1988 Load Lines Protocol, and MARPOL. We would be interested in hearing about your experiences with tonnage measurement oversight by other flag States, as the MSC is currently reviewing its oversight processes and procedures. Please contact Mr. Marcus Akins if you have any information in this regard that you would like to share.

Weekly Notes are issued by the Coast Guard Marine Safety Center's Tonnage Division (MSC-4) for use by organizations that perform measurement work on the Coast Guard's behalf. They are for informational purposes only, and are not intended as, nor should they be construed to represent, revisions of or substitutes for applicable statutes or regulations or established interpretations of either.

MEASUREMENT ORGANIZATION WEEKLY NOTES – 08/19/2015

USE OF PUBLICLY AVAILABLE INFORMATION In addition to Marine Safety Center plan review records - as mentioned previously – the Tonnage Division makes use of publicly available information from a variety of internet sources (e.g., company websites, vessel sales listings, [PSIX](#), and the [Transport Canada Vessel Registration Query System](#)). These sources may provide U.S. Regulatory Measurement System and Convention tonnages as well as build and other information.

PROGRESSION OF OPEN SPACE We recently responded to an inquiry regarding progression of open space within structures. As a reminder, open space cannot progress from a sunken forecastle to a break aft of the forecastle. The illustrative figure below is taken from MTN 01-99 CH-7.

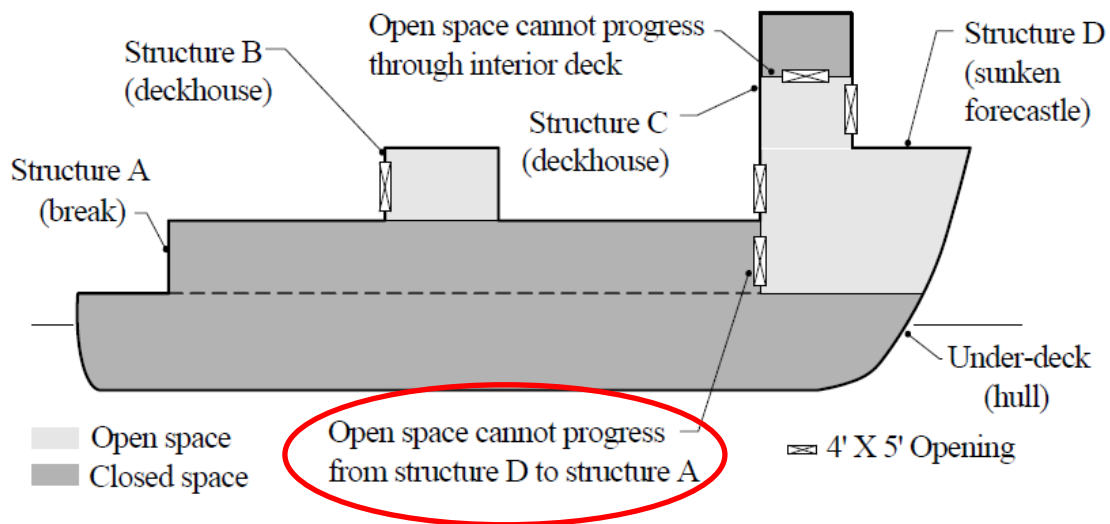

Weekly Notes are issued by the Coast Guard Marine Safety Center's Tonnage Division (MSC-4) for use by organizations that perform measurement work on the Coast Guard's behalf. They are for informational purposes only, and are not intended as, nor should they be construed to represent, revisions of or substitutes for applicable statutes or regulations or established interpretations of either.

MEASUREMENT ORGANIZATION WEEKLY NOTES – 08/12/2015

ITC69 REISSUANCE FOR CHANGE OF FLAG We recently encountered a situation where a field surveyor had inappropriately crossed out the original foreign flag State on an International Tonnage Certificate (ITC69) and hand written the new State upon a vessel's change to U.S. flag. Please note that under the Convention, an ITC69 remains valid for a period not exceeding three months following the change of flag State, or until the Administration of the new flag State issues an ITC69 to replace it, whichever comes first. Handwritten edits to certificates are not acceptable.

TONNAGE CERTIFICATE FORMS Note that tonnage certificate forms for certificates issued on behalf of the United States must be approved by the Marine Safety Center (MSC). Samples of the front sides of ITC69 and U.S. Tonnage Certificates, excerpted from MTN 01-98 CH-12, are shown below. Form changes also require MSC approval.

SAMPLE INTERNATIONAL TONNAGE CERTIFICATE (1969) - FRONT

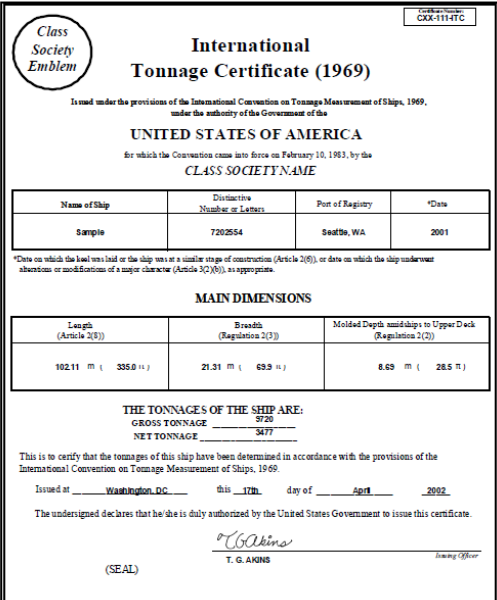

The image shows a sample International Tonnage Certificate (1969) for the United States of America. It includes a Class Society Emblem, the text 'International Tonnage Certificate (1969)', and 'UNITED STATES OF AMERICA'. The certificate is for a vessel named 'Sample' with a distinctive number of '7202554' and a port of registry of 'Seattle, WA'. It lists main dimensions: Length 102.11 m (335.0 ft), Breadth 21.31 m (69.9 ft), and Molded Depth 8.69 m (28.5 ft). The tonnages are Gross Tonnage 9720 and Net Tonnage 3477. It is issued at Washington, DC on April 17, 2002, by T. G. ARKINS.

SAMPLE U.S. TONNAGE CERTIFICATE - FRONT

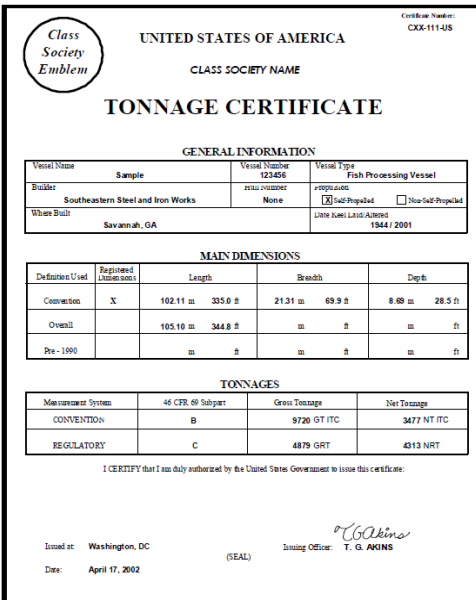

The image shows a sample U.S. Tonnage Certificate for the United States of America. It includes a Class Society Emblem, the text 'UNITED STATES OF AMERICA', and 'TONNAGE CERTIFICATE'. The certificate is for a vessel named 'Sample' with a vessel number of '122456' and a builder of 'Southeastern Steel and Iron Works'. It lists main dimensions: Length 102.11 m (335.0 ft), Breadth 21.31 m (69.9 ft), and Depth 8.69 m (28.5 ft). The tonnages are Gross Tonnage 9720 GT ITC and Net Tonnage 3477 NT ITC. It is issued at Washington, DC on April 17, 2002, by T. G. ARKINS.

U.S. TONNAGE CERTIFICATE HULL NUMBERS MTN 01-98 CH-12 addresses cases when a hull number or hull identification number (HIN) was unassigned or is unavailable. If neither number was assigned for the vessel (as in the sample above right), enter "NONE" in the Hull Number field on the U.S. Tonnage Certificate. If neither is available, enter a dash "-".

Weekly Notes are issued by the Coast Guard Marine Safety Center's Tonnage Division (MSC-4) for use by organizations that perform measurement work on the Coast Guard's behalf. They are for informational purposes only, and are not intended as, nor should they be construed to represent, revisions of or substitutes for applicable statutes or regulations or established interpretations of either.

MEASUREMENT ORGANIZATION WEEKLY NOTES – 08/07/2015

WATER BALLAST ACCOUNTING IN TONCALC There is some understandable confusion about how water ballast spaces can be labeled in TonCalc 2.0.1. Please be aware that when TonCalc populates the water ballast information in the Calculation Results Section, it looks only at the text to the left of the colon, as shown in the example below. This gives considerable flexibility in naming and grouping the spaces, and is especially useful in accommodating the 12 line restriction for vessels with large numbers of ballast tanks.

Exempted Water Ballast

Forepeak Water Ballast	7.35
Afterpeak Water Ballast	
Other Water Ballast Spaces	
Water Ballast Tank 1	0.09
Total Exempted Water Ballast	7.44

*Water Ballast Tank 1: Fr 45-49 S	1.00	1.00	1.00	4.00	0.04
*Water Ballast Tank 1: Fr 45-49 P	1.00	1.00	1.00	5.00	0.05

TONNAGE PERSONNEL Mr. David Karnes is out of the office beginning August 6th, and returning August 12th. During that time, please forward any CG number requests to Mr. Marcus Akins. Also, please note that Mr. Karnes has been selected to fill Mr. Ellis’s position (leaving a new unfilled vacancy). Mr. Karnes is now “officially” our new Tonnage Applicability Manager, while still handling most of his previous responsibilities (at least for the time being).

EDITOR’S NOTE We generally try to issue the Weekly Notes on Wednesday, but ran into unexpected delays this week. We intend to issue next week’s edition “on schedule”.

Weekly Notes are issued by the Coast Guard Marine Safety Center’s Tonnage Division (MSC-4) for use by organizations that perform measurement work on the Coast Guard’s behalf. They are for informational purposes only, and are not intended as, nor should they be construed to represent, revisions of or substitutes for applicable statutes or regulations or established interpretations of either.

MEASUREMENT ORGANIZATION WEEKLY NOTES – 07/29/2015

MEASUREMENT APPLICATION PHASE-IN DEADLINE As a reminder, Tonnage Administrative Policy requires that — effective August 1st, 2015 — measurement organizations shall accept only the application form of MTN 01-98, CH-12, Appendix A, *Application for Formal Measurement Services*. The form is available [online](#). Note that the electronic version has “built in” error checking and “hover help” features to assist the owner in completing the form.

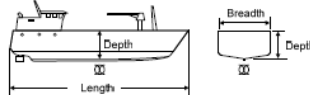
U.S. TONNAGE REGULATIONS APPLICATION FOR FORMAL MEASUREMENT SERVICES		MTN 01-98 as amended																																
I. APPLICABILITY																																		
<p>A U.S. flag vessel is eligible to be measured under the Convention system (46 CFR 69 subpart B) if it is 79 feet or more in overall length. Also, any U.S. flag vessel, regardless of length, may be measured under the Standard system (46 CFR 69 subpart C) or Dual system (46 CFR 69 subpart D). Some vessels, including those that are less than 79 feet in overall length, are eligible to be measured under the Simplified system (46 CFR 69 subpart E), without the need for formal measurement. Refer to section 69.11 of 46 CFR 69 for complete measurement eligibility details.</p>																																		
II. APPLICATION INFORMATION																																		
<p>*1. REQUESTED SERVICE (see instructions on reverse)</p> <p><input type="checkbox"/> INITIAL MEASUREMENT (indicate measurement system(s))</p> <p style="margin-left: 20px;"><input type="checkbox"/> Subpart B - Convention system (GT ITC/NT ITC)</p> <p style="margin-left: 20px;"><input type="checkbox"/> Subpart C - Standard system (GRT/NRT)</p> <p style="margin-left: 20px;"><input type="checkbox"/> Subpart D - Dual system (GRT/NRT)</p> <p><input type="checkbox"/> REMEASUREMENT (indicate reason(s))</p> <p style="margin-left: 20px;"><input type="checkbox"/> Configuration changes</p> <p style="margin-left: 20px;"><input type="checkbox"/> Change in passengers or draft</p> <p style="margin-left: 20px;"><input type="checkbox"/> Correction of measurement errors</p> <p style="margin-left: 20px;"><input type="checkbox"/> Other (describe in remarks)</p> <p><input type="checkbox"/> OTHER (describe in remarks)</p> <p>*2. REQUESTED TONNAGE CERTIFICATE(S): <input type="checkbox"/> US <input type="checkbox"/> ITC59</p> <p>*3. VESSEL NAME _____</p> <p>*4. VESSEL NUMBER _____</p> <p>5. HAULING PORT _____</p> <p>6. BUILDER'S NAME _____</p> <p>7. HIN OR HULL NUMBER _____</p> <p>8. PLACE BUILT _____</p> <p>9. KEEL LAID / ALTERATION DATE _____</p> <p>10. DELIVERY DATE _____</p> <p>11. VESSEL TYPE</p> <table style="width: 100%; border: none;"> <tr> <td><input type="checkbox"/> Barge</td> <td><input type="checkbox"/> Passenger</td> </tr> <tr> <td><input type="checkbox"/> Fishing</td> <td><input type="checkbox"/> Recreational</td> </tr> <tr> <td><input type="checkbox"/> Fish Processing</td> <td><input type="checkbox"/> Research</td> </tr> <tr> <td><input type="checkbox"/> Fish Tender</td> <td><input type="checkbox"/> Tanker</td> </tr> <tr> <td><input type="checkbox"/> Freight</td> <td><input type="checkbox"/> Towing</td> </tr> <tr> <td><input type="checkbox"/> Industrial</td> <td><input type="checkbox"/> Training</td> </tr> <tr> <td><input type="checkbox"/> Mobile Offshore Drilling Unit</td> <td><input type="checkbox"/> Unclassified</td> </tr> <tr> <td><input type="checkbox"/> Offshore Supply</td> <td><input type="checkbox"/> Warship</td> </tr> <tr> <td><input type="checkbox"/> Oil Spill Response</td> <td></td> </tr> </table>	<input type="checkbox"/> Barge	<input type="checkbox"/> Passenger	<input type="checkbox"/> Fishing	<input type="checkbox"/> Recreational	<input type="checkbox"/> Fish Processing	<input type="checkbox"/> Research	<input type="checkbox"/> Fish Tender	<input type="checkbox"/> Tanker	<input type="checkbox"/> Freight	<input type="checkbox"/> Towing	<input type="checkbox"/> Industrial	<input type="checkbox"/> Training	<input type="checkbox"/> Mobile Offshore Drilling Unit	<input type="checkbox"/> Unclassified	<input type="checkbox"/> Offshore Supply	<input type="checkbox"/> Warship	<input type="checkbox"/> Oil Spill Response		<p>12. OVERALL HULL DIMENSIONS</p> <p>Length - _____ ft Breadth - _____ ft Depth - _____ ft</p>  <p>13. ADDITIONAL VESSEL INFORMATION</p> <p>a. PROPULSION: <input type="checkbox"/> Self-Propelled <input type="checkbox"/> Non-Self-Propelled</p> <p>b. NUMBER OF PASSENGERS: _____</p> <p>Total: _____ Accommodated in cabins for 8 or fewer: _____</p> <p>c. NUMBER OF CARGO SPACES: _____</p> <p>d. NUMBER OF PORTABLE ENCLOSED SPACES: _____</p> <p>e. DRAFT RESTRICTIONS: <input type="checkbox"/> Load Line <input type="checkbox"/> Other</p> <p style="margin-left: 20px;"><input type="checkbox"/> Stability Letter</p> <p>f. INTENDED VOYAGES: <input type="checkbox"/> Domestic <input type="checkbox"/> Great Lakes</p> <p style="margin-left: 20px;"><input type="checkbox"/> Foreign</p> <p>14. SUBMITTED DRAWINGS (check all submitted with application)</p> <table style="width: 100%; border: none;"> <thead> <tr> <th style="text-align: left;">General Arrangements</th> <th style="text-align: left;">Construction</th> <th style="text-align: left;">Miscellaneous</th> </tr> </thead> <tbody> <tr> <td><input type="checkbox"/> Outboard Profile</td> <td><input type="checkbox"/> Midship Section</td> <td><input type="checkbox"/> Lines</td> </tr> <tr> <td><input type="checkbox"/> Inboard Profile</td> <td><input type="checkbox"/> Framing Plans</td> <td><input type="checkbox"/> Cargo</td> </tr> <tr> <td><input type="checkbox"/> Deck Arrangements</td> <td><input type="checkbox"/> Shell Expansion</td> <td><input type="checkbox"/> Tonnage</td> </tr> <tr> <td><input type="checkbox"/> Bow/Stem/Topside</td> <td><input type="checkbox"/> Other</td> <td><input type="checkbox"/> Other</td> </tr> </tbody> </table> <p>*15. POINT OF CONTACT</p> <p>16. REMARKS</p>	General Arrangements	Construction	Miscellaneous	<input type="checkbox"/> Outboard Profile	<input type="checkbox"/> Midship Section	<input type="checkbox"/> Lines	<input type="checkbox"/> Inboard Profile	<input type="checkbox"/> Framing Plans	<input type="checkbox"/> Cargo	<input type="checkbox"/> Deck Arrangements	<input type="checkbox"/> Shell Expansion	<input type="checkbox"/> Tonnage	<input type="checkbox"/> Bow/Stem/Topside	<input type="checkbox"/> Other	<input type="checkbox"/> Other
<input type="checkbox"/> Barge	<input type="checkbox"/> Passenger																																	
<input type="checkbox"/> Fishing	<input type="checkbox"/> Recreational																																	
<input type="checkbox"/> Fish Processing	<input type="checkbox"/> Research																																	
<input type="checkbox"/> Fish Tender	<input type="checkbox"/> Tanker																																	
<input type="checkbox"/> Freight	<input type="checkbox"/> Towing																																	
<input type="checkbox"/> Industrial	<input type="checkbox"/> Training																																	
<input type="checkbox"/> Mobile Offshore Drilling Unit	<input type="checkbox"/> Unclassified																																	
<input type="checkbox"/> Offshore Supply	<input type="checkbox"/> Warship																																	
<input type="checkbox"/> Oil Spill Response																																		
General Arrangements	Construction	Miscellaneous																																
<input type="checkbox"/> Outboard Profile	<input type="checkbox"/> Midship Section	<input type="checkbox"/> Lines																																
<input type="checkbox"/> Inboard Profile	<input type="checkbox"/> Framing Plans	<input type="checkbox"/> Cargo																																
<input type="checkbox"/> Deck Arrangements	<input type="checkbox"/> Shell Expansion	<input type="checkbox"/> Tonnage																																
<input type="checkbox"/> Bow/Stem/Topside	<input type="checkbox"/> Other	<input type="checkbox"/> Other																																
III. STATEMENT OF REPRESENTATION																																		
<p>I understand that under the provisions of 46 CFR 69.25, a person making a false statement or representation in this application may be fined up to \$30,000 and that the vessel also is liable in rem for the penalty. I also acknowledge that I am required by 46 CFR 69.19 to report immediately to an authorized measurement organization any intent to structurally alter the vessel or to change its service or the use of its space. I certify that the information provided by me on this application, or in any attachments thereto, is correct.</p>																																		
Owner's printed name _____	Owner's signature _____	Date _____																																
Formal Application (08/14)		Page 1 of 2																																

TELEPHONE CONFERENCE SCHEDULING The latest round of quarterly telephone conferences with authorized measurement organizations is underway. Please contact Mr. Marcus Akins to schedule a session.

TONNAGE PERSONNEL Mr. Marcus Akins will be out of the office July 30th, returning August 4th. During that time, please forward any file requests to Mr. David Karnes.



Weekly Notes are issued by the Coast Guard Marine Safety Center's Tonnage Division (MSC-4) for use by organizations that perform measurement work on the Coast Guard's behalf. They are for informational purposes only, and are not intended as, nor should they be construed to represent, revisions of or substitutes for applicable statutes or regulations or established interpretations of either.

MEASUREMENT ORGANIZATION WEEKLY NOTES – 07/22/2015

POLICY DEVELOPMENT We are developing a new change to our Tonnage Administrative Policy MTN to reflect outcomes of recent tonnage work at IMO, especially regarding information appearing on the International Tonnage Certificate (1969), and to address several other matters. If you have any input on areas that require clarification or updating, please contact Mr. Marcus Akins.

TONNAGE OPENING ORIGIN In researching a matter on the evolution of tonnage measurement law using internet search tools, we came across several important British court documents from the S.S. BEAR proceedings that shed light on why we treat deck and bulkhead openings the way we do under the Regulatory Measurement System. One such document was a report by the court-appointed Lloyd's surveyor in Glasgow, who spent three days aboard the vessel. His report was the basis for the decision in favor of the vessel's owner. Most histories of this pivotal case omit important details of the vessel's geometry, including the presence of scuppers with non-return valves, removable cattle stalls and pens, non-watertight gangway doors in the sides, and portable planks for covering the deck openings. A drawing from the report follows.

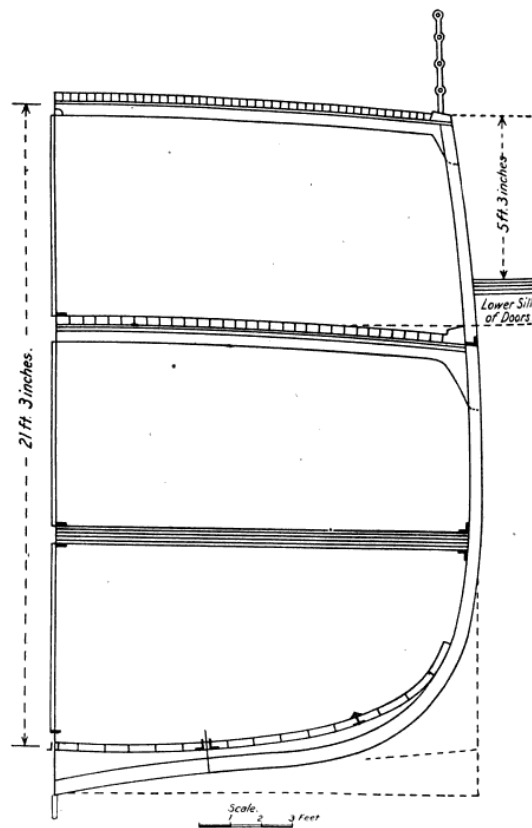

Weekly Notes are issued by the Coast Guard Marine Safety Center's Tonnage Division (MSC-4) for use by organizations that perform measurement work on the Coast Guard's behalf. They are for informational purposes only, and are not intended as, nor should they be construed to represent, revisions of or substitutes for applicable statutes or regulations or established interpretations of either.

MEASUREMENT ORGANIZATION WEEKLY NOTES – 07/15/2015

ENCLOSED SPACE CHARACTERISTICS Based on the outcome of recent work at IMO, we will continue to give latitude to measurement organizations in how they characterize and list enclosed spaces on the reverse side of International Tonnage Certificates (1969), provided it is done consistently on any given vessel and that excluded spaces are properly identified. For example, any listed enclosed space must have an asterisk if a portion of it is excluded, and all excluded spaces must be reflected in the length measurements. Also, if the length of a 1st tier space is measured to the foremost extent of the boundary bulkhead and the aftermost part of a roof extension covering an excluded space at the aft end of the structure, the same approach needs to be used on the other tiers.

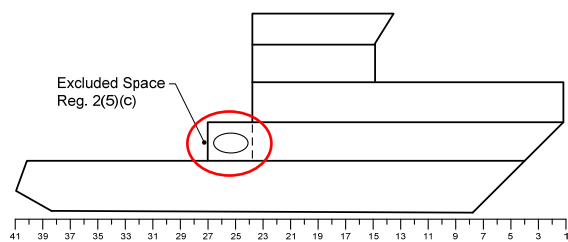

SPACES INCLUDED		
GROSS TONNAGE		
Name of Space	Location	Length (m)
Underdeck	-----	-----
1st Tier*	Fr 1-27	35.48
2nd Tier	Fr 1-24	31.09
3rd Tier	Fr 15-24	10.67
4th Tier	Fr 13-24	11.89

EXCLUDED SPACES (Regulation 2(5))
1st Tier Pump Space 2(5)(c)

An asterisk (*) should be added to those **spaces** listed above which comprise both enclosed and excluded spaces.

CONVENTION MILESTONE ANNIVERSARY July 17, 2015 marks the 35th anniversary of the day Japan accepted the 1969 Tonnage Convention. As a result, a sufficient number of nations, representing not less than 65% of the gross tonnage of the world's merchant shipping, triggered the Convention's coming into force 24 months later on July 18, 1982.

Weekly Notes are issued by the Coast Guard Marine Safety Center's Tonnage Division (MSC-4) for use by organizations that perform measurement work on the Coast Guard's behalf. They are for informational purposes only, and are not intended as, nor should they be construed to represent, revisions of or substitutes for applicable statutes or regulations or established interpretations of either.

MEASUREMENT ORGANIZATION WEEKLY NOTES – 07/08/2015

TREATMENT OF LIMBER HOLES AND SIMILAR FRAME OPENINGS The Marine Safety Center recently responded to an inquiry concerning the application of ordinary frame opening proximity requirements for limber holes, snipes, and similar small openings on the edges of ordinary frames. While the subject is currently under review, we responded to the effect that - in general - the presence of such openings does not violate proximity requirements, provided the separation distance between the opening within the web and the frame-edge opening exceeds the longest linear dimension of the frame-edge opening in question. We intend to clarify this matter in the next revision to MTN 01-99 CH-7, *Tonnage Technical Policy*.

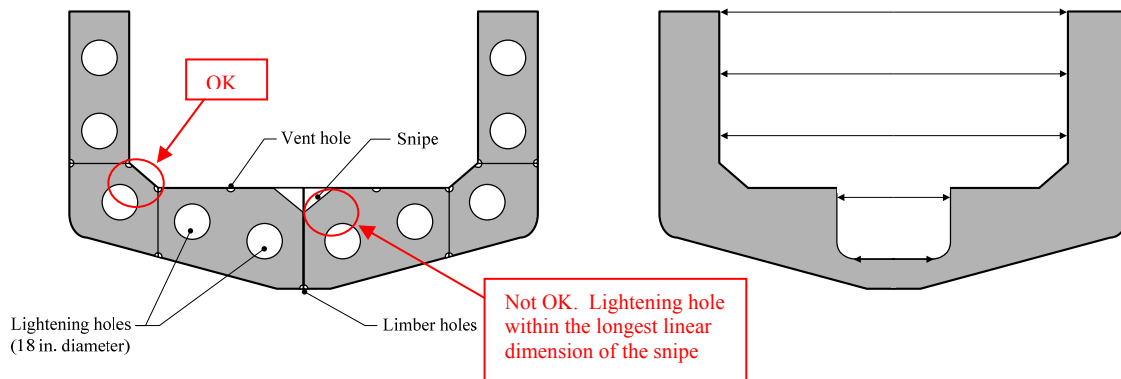

Weekly Notes are issued by the Coast Guard Marine Safety Center's Tonnage Division (MSC-4) for use by organizations that perform measurement work on the Coast Guard's behalf. They are for informational purposes only, and are not intended as, nor should they be construed to represent, revisions of or substitutes for applicable statutes or regulations or established interpretations of either.

MEASUREMENT ORGANIZATION WEEKLY NOTES – 07/01/2015

TOP NONCONFORMITY TYPES Examining the types of tonnage oversight nonconformities identified by the Marine Safety Center (MSC) since July 2011, we compiled the following summary of the five most frequently occurring nonconformity types. We conducted oversight on 42 vessels during this time period.

1. Graphical Representations. These include missing or incomplete drawings of vessel inboard or outboard profiles, framing details, and interior layouts.
2. Measurement Errors. These include incorrect dimensions in calculations; measurements that do not match the actual vessel geometry; and failure to include certain enclosed spaces in tonnage.
3. Certification Data. These include incorrect or missing keel laid or alteration dates, and specification of the wrong measurement system on tonnage certificates.
4. Volume Determinations. These include incorrect modeling of hull and superstructure spaces, and improper treatment of smaller volumes such as appendages.
5. Tonnage Rules. These include misapplication of provisions of the Convention, Standard, and Dual systems for treating various enclosed spaces.

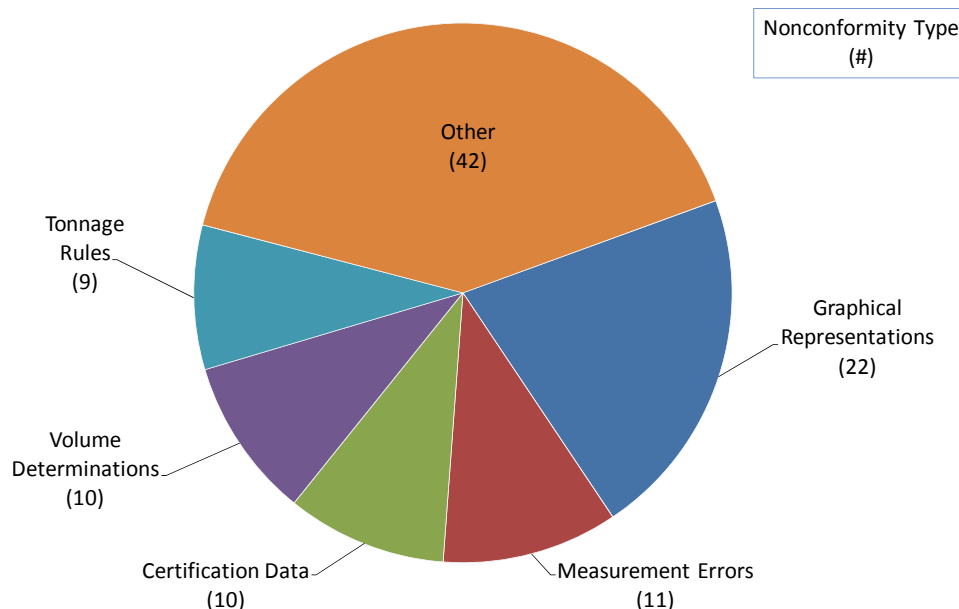

INDEPENDENCE DAY HOLIDAY CLOSURE The MSC will be closed beginning on Thursday, July 2nd at noon and continuing through Friday, July 3rd in observance of the Independence Day holiday.

Weekly Notes are issued by the Coast Guard Marine Safety Center's Tonnage Division (MSC-4) for use by organizations that perform measurement work on the Coast Guard's behalf. They are for informational purposes only, and are not intended as, nor should they be construed to represent, revisions of or substitutes for applicable statutes or regulations or established interpretations of either.

MEASUREMENT ORGANIZATION WEEKLY NOTES – 06/24/2015

CERTIFICATION ISSUES Concluding the discussion we began in last week's edition, we present several additional misconceptions we have heard recently from members of the public, which we present in a "Myth" vs. "Reality" format.

5. **Myth:** The Coast Guard Certifies Tonnage "Surveyors".

Reality: The Coast Guard does not certify individuals to perform onboard tonnage surveys – or any other tonnage measurement services - on its behalf. Under the tonnage regulations, the Coast Guard authorizes classification societies meeting certain requirements, referred to as "[measurement organizations](#)", to perform tonnage work on its behalf. Qualification and/or certification of measurement organization tonnage staff members is the responsibility of these organizations, for which International Association of Classification Societies (IACS) standards apply.

6. **Myth:** A Tonnage Consultant Plays a Role in the Certification Process.

Reality: While vessel owners are welcome to obtain advice from naval architects, self-styled "tonnage consultants", or other outside parties in implementing design features to meet tonnage objectives, only employees of authorized measurement organizations and their contractors may provide tonnage measurement services on the Coast Guard's behalf. Further, tonnage consulting by such employees and contractors for the same vessel for which they provide these measurement services is strictly prohibited. The Coast Guard does not regulate the aforementioned "tonnage consultants", nor do we provide information on their general performance to the public. However, we encourage owners to contact measurement organizations for any recommendations on the performance of such "tonnage consultants".

7. **Myth:** A Measurement Organization Cannot Refuse a Measurement Job.

Reality: We have encountered some confusion on whether the mere submission of a formal measurement application in some way obligates the measurement organization to accept the work. It is true that the tonnage regulations provide for measurement organizations to accept a measurement application "without discrimination". However, MTN 01-98 CH-12 makes clear that a measurement organization must either accept an application subject to any specified conditions (e.g., issuance of certificates contingent on payment) and perform the requested services, or provide the applicant with written notification as to why the services will not be performed (e.g., incomplete information provided with the application).

Weekly Notes are issued by the Coast Guard Marine Safety Center's Tonnage Division (MSC-4) for use by organizations that perform measurement work on the Coast Guard's behalf. They are for informational purposes only, and are not intended as, nor should they be construed to represent, revisions of or substitutes for applicable statutes or regulations or established interpretations of either.

MEASUREMENT ORGANIZATION WEEKLY NOTES – 06/17/2015

CERTIFICATION ISSUES We recently encountered a number of tonnage certification issues across multiple classification societies through enhanced oversight and technical assistance. These issues have affected vessel deliveries, in some cases substantially delaying vessel departures and requiring costly modifications to meet owner tonnage objectives. While circumstances differ according to the individual cases, in general the issues appear to be rooted in misconceptions on the need for objective evidence and thorough reviews in order to ensure the integrity of the measurement process. Below, we highlight some misconceptions that we have heard from owners of affected vessels, and other members of the public, which we present in a “Myth” vs. “Reality” format.

- 1. Myth:** Graphical Representations Are Not Required.
Reality: Tonnage Administrative Policy (MTN 01-98 CH-12) requires that a tonnage file contain graphical representations reflecting the vessel’s as-measured configuration, from which all dimensions used in volume calculations may be ascertained (e.g., details of relevant under-deck framing such as ordinary side and bottom frames or floor timbers, where applicable).
- 2. Myth:** Retrofitting Tonnage Reduction Features Is Easy.
Reality: For vessels not initially designed and constructed to incorporate them, retrofitting such features can involve considerable planning and structural reconfiguration, often at significant expense. It should involve the services of a naval architect, who can carefully evaluate the impact of the changes and develop necessary drawings.
- 3. Myth:** No One Ever Checks My Work.
Reality: Following issuance of a tonnage certificate, the Marine Safety Center may select the file for oversight, subjecting it to close scrutiny per published policy standards and other governing requirements. In addition, Coast Guard field offices have shown increased interest in vessel tonnage assignments.
- 4. Myth:** I Don’t Need to Check the Standard.
Reality: Regardless of one’s past experience with - or memory of - vessel tonnage measurement process and rules, calculations and related certification work must be done strictly in accordance with Tonnage Technical Policy (MTN 01-99 CH-7) and Tonnage Administrative Policy (MTN 01-98 CH-12). In our office, we usually have electronic versions of these documents open, and we refer to them constantly.

Weekly Notes are issued by the Coast Guard Marine Safety Center’s Tonnage Division (MSC-4) for use by organizations that perform measurement work on the Coast Guard’s behalf. They are for informational purposes only, and are not intended as, nor should they be construed to represent, revisions of or substitutes for applicable statutes or regulations or established interpretations of either.

MEASUREMENT ORGANIZATION WEEKLY NOTES – 06/10/2015

COMPUTER MODELING While there are no restrictions on different modeling tools used to generate Convention calculations, MTN 01-98 CH-12 - in effect - requires that vessel files include written or electronic outputs showing the hull and superstructure offsets, or the equivalent. If you are using NAPA or SOLIDWORKS for this purpose, this means you must generate output in a design format authorized by the National Archives and Records Administration (e.g., IGES) as part of the vessel's tonnage file. The Marine Safety Center will use these files when conducting oversight (we open them in Rhino3D).



RHINO MODEL



National Science Foundation: New Polar Research Vessel

TONNAGE PERSONNEL As reported last week, Mr. Brian Ellis's last day in the Tonnage Division is Thursday, June 11th. Mr. David Karnes has assumed his responsibilities for assignment of CG numbers and all other questions on MISLE and PSIX data.

Weekly Notes are issued by the Coast Guard Marine Safety Center's Tonnage Division (MSC-4) for use by organizations that perform measurement work on the Coast Guard's behalf. They are for informational purposes only, and are not intended as, nor should they be construed to represent, revisions of or substitutes for applicable statutes or regulations or established interpretations of either.

MEASUREMENT ORGANIZATION WEEKLY NOTES – 06/03/2015

MSC PLAN REVIEW RECORDS When conducting tonnage oversight reviews, the Tonnage Division increasingly makes use of drawings and other information submitted to other Marine Safety Center (MSC) Divisions under the MSC's plan review and approval authority. This trend is a consequence of both improved data tracking systems at the MSC, and the fact that the vast majority of plan review submittals are now electronic and readily accessible. Because the information may be proprietary in nature, MSC plan review records can be released to measurement organizations only through requests under the Freedom of Information Act (FOIA), and such release may be restricted or prohibited altogether.

MEASUREMENT TRENDS In meetings and other discussions with measurement organization (Authorized Classification Society or "ACS") representatives, we have presented measurement trend data as reported through the PRAS (and earlier) processes. The following graph presents this information for all ACS's through the year 2000, when we started to capture the data.

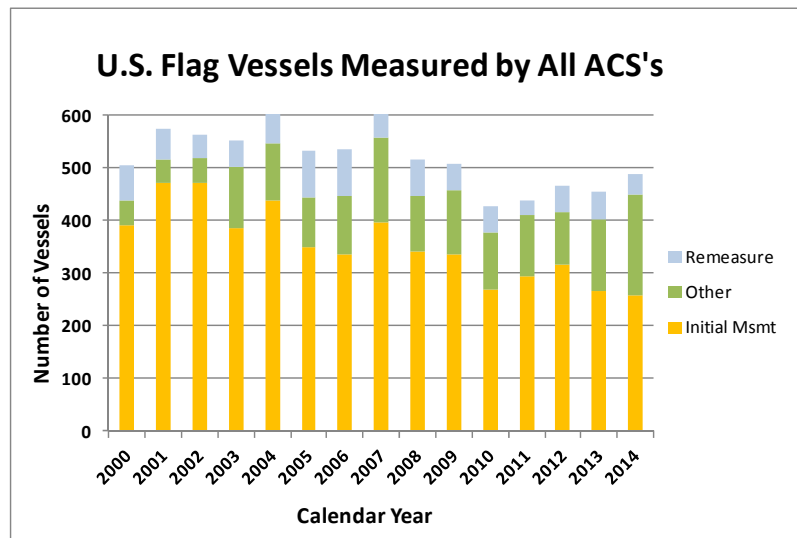

TONNAGE PERSONNEL Mr. Brian Ellis has accepted a new position as the Deputy to the Chief of the Office of Naval Engineering at Coast Guard Headquarters. We congratulate him on this promotion. His last day in the Tonnage Division will be Thursday, June 11th. Mr. David Karnes has assumed his responsibilities for measurement organization interface, including assignment of CG numbers and all other questions on MISLE and PSIX data. In addition, Mr. Marcus Akins will be out of the office June 4th and 5th.

Weekly Notes are issued by the Coast Guard Marine Safety Center's Tonnage Division (MSC-4) for use by organizations that perform measurement work on the Coast Guard's behalf. They are for informational purposes only, and are not intended as, nor should they be construed to represent, revisions of or substitutes for applicable statutes or regulations or established interpretations of either.

MEASUREMENT ORGANIZATION WEEKLY NOTES – 05/27/2015

HULL IDENTIFICATION NUMBERS As a reminder, MTN 01-98 CH-12 requires a U.S. tonnage certificate to list a vessel builder's name; hull identification number (HIN) or hull number (if assigned); and place built. This information is also required on applications for initial measurement. If available, a HIN contains [Manufacturers ID Code \(MIC\)](#) and month and year of production. Additionally, a vessel's HIN can be used to search the [Port State Information eXchange \(PSIX\)](#) for an existing CG number.

August 1, 1984 to present

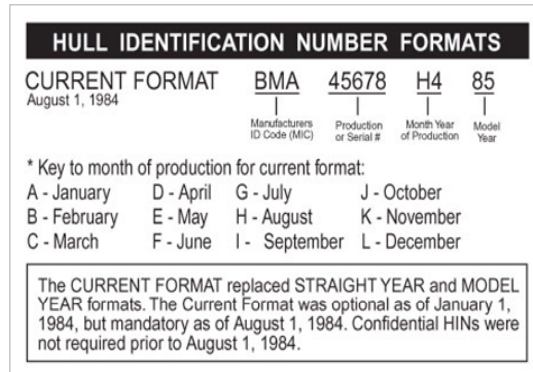

November 1, 1972 to July 31, 1984

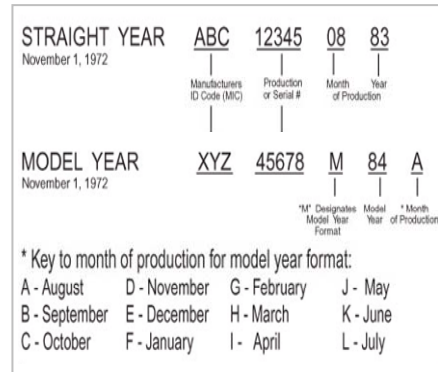

VENT STRUCTURES The MSC recently responded to an inquiry on Convention Measurement System treatment of upper deck side vent structures, through which the predominant air flow direction is vertical. Citing interpretations in MTN 01-99 CH-7 and TM.5/Circ.6, the MSC commented to the effect that structures similar to those in question could be ignored from volume calculations, provided they are inaccessible, separated on all their sides from other enclosed spaces, and have cross-sectional areas in the plane of the deck of less than one square meter.

TELEPHONE CONFERENCE PREPARATIONS We are preparing for the next round of quarterly telephone conferences with authorized measurement organizations. Please contact Mr. Marcus Akins with any suggestions on specific topics you would like covered.

Weekly Notes are issued by the Coast Guard Marine Safety Center's Tonnage Division (MSC-4) for use by organizations that perform measurement work on the Coast Guard's behalf. They are for informational purposes only, and are not intended as, nor should they be construed to represent, revisions of or substitutes for applicable statutes or regulations or established interpretations of either.

MEASUREMENT ORGANIZATION WEEKLY NOTES – 05/20/2015

FRAMING DETAILS In general, we have seen marked improvement in the completeness of drawings and other graphical representations in oversighted vessel tonnage files, but continue to see gaps with ordinary framing details. A reviewer must be able to verify that the line of the ordinary frames at each Tonnage Station is correctly established. In the case of ordinary “deep” frames, this requires more information than can be provided on a single profile and plan view (e.g., what do the frames look like between Stations 4 and 5 in the example below?).

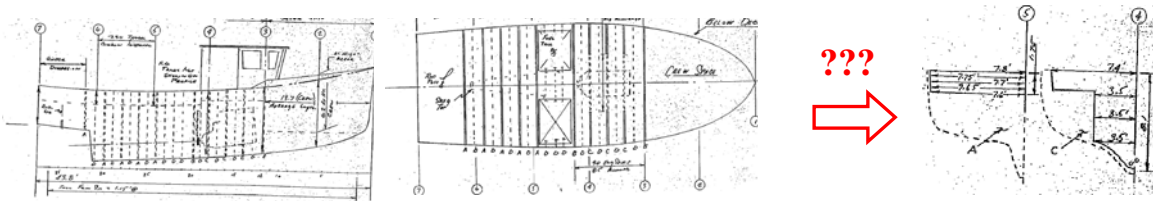

NEW TONNAGE GUIDE DEVELOPMENT Further to the entry above and mentioned previously in the Weekly Notes, the Marine Safety Center (MSC) is developing a new tonnage guide to address tonnage file requirements for drawings or other graphical representations reflecting a vessel's as-measured configuration. Using a notional fishing vessel as an example, the document will address the level of framing detail necessary for a reviewer's verification of registered dimensions and assigned tonnages.

MEMORIAL DAY CLOSURE The MSC will be closed Monday, May 25th in observance of the Memorial Day holiday.

TONNAGE PERSONNEL Mr. Marcus Akins will be out of the office on Thursday, May 21st and Tuesday, May 26th.

Weekly Notes are issued by the Coast Guard Marine Safety Center's Tonnage Division (MSC-4) for use by organizations that perform measurement work on the Coast Guard's behalf. They are for informational purposes only, and are not intended as, nor should they be construed to represent, revisions of or substitutes for applicable statutes or regulations or established interpretations of either.

MEASUREMENT ORGANIZATION WEEKLY NOTES – 05/13/2015

VESSEL DETERMINATIONS ON NON-TRADITIONAL WATERCRAFT We recently responded to an inquiry regarding measurement of non-traditional watercraft (i.e., those that either by design or intent do not usually get underway and/or do not possess the practical capability or equipment for being used as a means of transportation on water). As a reminder, before accepting an application for measurement of such a vessel, contact the Tonnage Division for instructions as to whether a vessel determination is required, and if so, the process for obtaining such a determination.

APPLICATION ACCEPTANCE NOTIFICATION After receiving a completed application for measurement services, a measurement organization must either accept the application subject to any specified conditions and perform the requested services, or provide the applicant with written notification as to why the services will not be performed. Ensure the application is signed before it is accepted. As a courtesy to vessel owners, measurement organizations are urged to provide notification in a timely manner.

U.S. TONNAGE REGULATIONS
APPLICATION FOR FORMAL MEASUREMENT SERVICES MTN 01-98
as amended

I. APPLICABILITY

A U.S. flag vessel is eligible to be measured under the Convention system (46 CFR 69 subpart B) if it is 75 feet or more in overall length. Also, any U.S. flag vessel, regardless of length, may be measured under the Standard system (46 CFR 69 subpart C) or Dual system (46 CFR 69 subpart D). Some vessels, including those that are less than 75 feet in overall length, are eligible to be measured under the Simplified system (46 CFR 69 subpart E), without the need for formal measurement. Refer to section 69.11 of 46 CFR 69 for complete measurement eligibility details.

II. APPLICATION INFORMATION

*1. REQUESTED SERVICE (see instructions on reverse)

INITIAL MEASUREMENT (Indicate measurement system(s))

Subpart B - Convention system (GT/ITC/NT/ITC)

Subpart C - Standard system (GRT/NRT)

Subpart D - Dual system (GRT/NRT)

REMEASUREMENT (Indicate reason(s))

Configuration changes

Change in passengers or draft

Correction of measurement errors

Other (describe in remarks)

OTHER (describe in remarks)

2. REQUESTED TONNAGE CERTIFICATE(S): US ITC69

*3. VESSEL NAME JOHNNY K

*4. VESSEL NUMBER None

5. HAULING PORT _____

6. BUILDER'S NAME _____

7. HIN or HULL NUMBER XYZ12345D899

8. PLACE BUILT _____

9. KEEL LAID / ALTERATION DATE _____

10. DELIVERY DATE _____

11. VESSEL TYPE

Barge Passenger

Fishing Recreational

Fish Processing Research

Fish Tender Tanker

Freight Towing

Industrial Training

Mobile Offshore Drilling Unit Unclassified

Offshore Supply Warship

Oil Spill Response

12. OVERALL HULL DIMENSIONS

Length - 95.8 ft Breadth - 18.2 ft Depth - 12.1 ft

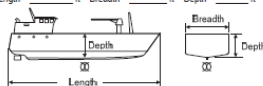

13. ADDITIONAL VESSEL INFORMATION

a. PROPULSION: Self-Propelled Non-Self-Propelled

b. NUMBER OF PASSENGERS: _____

TOTAL: _____ Accommodated in cabins for 8 or fewer: _____

c. NUMBER OF CARGO SPACES: _____

d. NUMBER OF PORTABLE ENCLOSED SPACES: _____

e. DRAFT RESTRICTIONS: Load Line Other

Stability Letter

f. INTENDED VOYAGES: Domestic Great Lakes

Foreign

14. SUBMITTED DRAWINGS (check all submitted with application)

General Arrangements	Construction	Miscellaneous
<input type="checkbox"/> Outboard Profile	<input type="checkbox"/> Midship Section	<input type="checkbox"/> Lines
<input type="checkbox"/> Inboard Profile	<input type="checkbox"/> Framing Plans	<input type="checkbox"/> Cargo
<input type="checkbox"/> Deck Arrangements	<input type="checkbox"/> Shell Expansion	<input type="checkbox"/> Tonnage
<input type="checkbox"/> Bow/Stern/Topside	<input type="checkbox"/> Other	<input type="checkbox"/> Other

*15. POINT OF CONTACT

Bruce Robertson, 1080 West Addison, Chicago, IL 60613
555-2368

16. REMARKS

III. STATEMENT OF REPRESENTATION

I understand that under the provisions of 46 CFR 69.25, a person making a false statement or representation in this application may be fined up to \$30,000 and that the vessel may be forfeited for the penalty. I also acknowledge that I am responsible for reporting immediately to an appropriate enforcement organization any intent to structurally alter the vessel or to change its service or the use of its space. I understand that the information provided by me on this application, or in any attachments thereto, is correct.

Owner's printed name Bruce Robertson Owner's signature Bruce Robertson date 5/13/2015

Form No. Application (08/14)

TONNAGE EXCHANGE PROGRAM In the past, Marine Safety Center (MSC) Tonnage Division personnel have visited authorized measurement organizations as part of an exchange program. As a reminder, personnel from measurement organizations may also arrange to come to the MSC for training and information exchange.

Weekly Notes are issued by the Coast Guard Marine Safety Center's Tonnage Division (MSC-4) for use by organizations that perform measurement work on the Coast Guard's behalf. They are for informational purposes only, and are not intended as, nor should they be construed to represent, revisions of or substitutes for applicable statutes or regulations or established interpretations of either.

MEASUREMENT ORGANIZATION WEEKLY NOTES – 05/06/2015

DRAFT RESTRICTIONS As the new standardized measurement application form is being phased-in, please pay particular attention to the blocks on draft restrictions. This is one of many vessel characteristics certified by owners that could have a bearing on the tonnage assignment. Failure to take into account this owner-furnished information could result in an incorrect NT ITC, and other nonconformities.

e. DRAFT RESTRICTIONS:	<input type="checkbox"/> Load Line	<input checked="" type="checkbox"/> Other
	<input type="checkbox"/> Stability Letter	

CREW SPACE DEDUCTION We recently responded to an inquiry questioning whether a portion of the open deck area of a fishing vessel being measured as an open vessel could be deducted as a crew space. The answer was no. An open deck, by its very nature, permits unrestricted access throughout, for a variety of purposes. The mere designation and marking of a portion of the exposed deck space as one of the crew spaces eligible for deduction - as listed in the tonnage regulations - is not sufficient to delineate the portion of the space as a separate space, nor would such action preclude its use for other purposes (e.g., deploying nets, sorting the catch, handling lines, etc.).

PANAMA CANAL TOLLS In an April 29th press release, the Panama Canal Authority announced a modified Canal tolls structure. According to this document, most segments will be priced based upon different units of measurement to meet and align with the diverse traffic transiting the locks. For instance, dry bulkers will be based on **deadweight** tonnage capacity and **metric tons** of cargo. Liquefied Natural Gas (LNG) and Liquefied Petroleum Gas (LPG) vessels, will be based on **cubic meters** and tankers will be measured and priced on Panama Canal Universal measurement system (**PC/UMS**) tons and **metric tons** of cargo. Container ships will continue to be measured and priced on **TEUs** and passenger vessels will continue to be based on **berths** or **PC/UMS**. In addition, a new Intra Maritime Cluster segment includes vessels that do not compete with international trade.

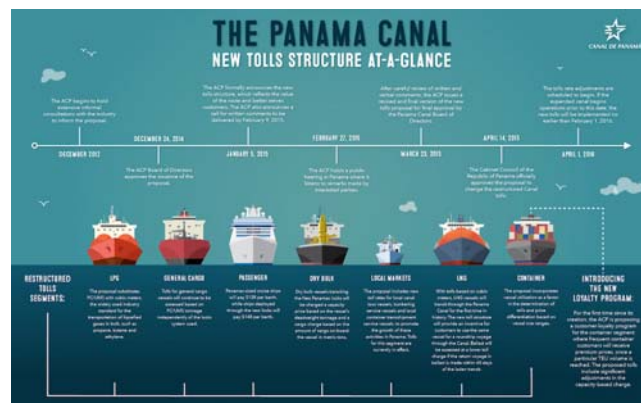

Weekly Notes are issued by the Coast Guard Marine Safety Center's Tonnage Division (MSC-4) for use by organizations that perform measurement work on the Coast Guard's behalf. They are for informational purposes only, and are not intended as, nor should they be construed to represent, revisions of or substitutes for applicable statutes or regulations or established interpretations of either.

MEASUREMENT ORGANIZATION WEEKLY NOTES – 04/29/2015

CHANGE OF COMMAND On Monday, April 27th, the Marine Safety Center (MSC) welcomed Captain John W. Mauger as its 12th commanding officer. He relieved Captain John P. Nadeau at a ceremony at the Douglas A. Munro Coast Guard Headquarters Building attended by over two hundred people, including the Deputy Commandant for Operations, Vice Admiral Charles D. Michel, who also spoke. Following the change of command, Captain Nadeau was frocked to the rank of Rear Admiral. He assumes duties as Assistant Commandant for Capability (CG-7).



CAPT John P. Nadeau USCG



CAPT John W. Mauger USCG

Weekly Notes are issued by the Coast Guard Marine Safety Center's Tonnage Division (MSC-4) for use by organizations that perform measurement work on the Coast Guard's behalf. They are for informational purposes only, and are not intended as, nor should they be construed to represent, revisions of or substitutes for applicable statutes or regulations or established interpretations of either.

MEASUREMENT ORGANIZATION WEEKLY NOTES – 04/22/2015

USE OF DEADWEIGHT Infrequently, the Tonnage Division responds to inquiries regarding deadweight tonnage, for which no Coast Guard office (including ours) is responsible. Deadweight tonnage is used for various regulatory purposes. For example, an oil recovery vessel must be inspected under 46 CFR Subchapter I (Cargo and Miscellaneous Vessels) if it has oil-holding capacity less than or equal to 20 percent of its deadweight tonnage, but must be inspected under Subchapter D (Tank Vessels) if the capacity is greater than 20 percent. Vessel deadweight tonnage is not certified under any comprehensive and universally accepted definitions, although it does appear on the International Oil Pollution Prevention (IOPP) certificate.

IMPACT OF ERRORS Please note that even minor errors in tonnage certification that affect documentation can have significant consequences for a vessel owner. For example, if resolving an oversight nonconformity involves correcting a documented vessel's registered dimensions, the Certificate of Documentation is invalidated. The owner must reapply for documentation (and pay application fees again) to the National Vessel Documentation Center. Further, if there is a preferred mortgage on the vessel, lender involvement is necessary before a new Certificate of Documentation may be issued. This could lead to a loss of revenue for a commercial vessel unable to operate during the documentation process.

LARGE FILE TRANSFER CAPABILITY As a reminder, the Coast Guard email server limits the total size of attachments to 10MB. To facilitate transfer of larger files that cannot be split into multiple emails conveniently, you can now use a secure U.S. Army file transfer application (for files up to 2GB) to which the Coast Guard has access. If you need to submit such files, please contact the Tonnage Division to coordinate.



Weekly Notes are issued by the Coast Guard Marine Safety Center's Tonnage Division (MSC-4) for use by organizations that perform measurement work on the Coast Guard's behalf. They are for informational purposes only, and are not intended as, nor should they be construed to represent, revisions of or substitutes for applicable statutes or regulations or established interpretations of either.

MEASUREMENT ORGANIZATION WEEKLY NOTES – 04/15/2015

USCG FIELD UNIT INTERFACE We recently responded to an inquiry regarding a “surveyor” who transmitted unsolicited vessel tonnage materials to a local Coast Guard field office, which we were able to resolve quickly. Please note that, in general, Coast Guard field units are under instruction to refer routine tonnage measurement matters to the Marine Safety Center (MSC), including those involving verifications of vessel tonnage assignments. We recommend that you contact Mr. Marcus Akins immediately, if you receive any such inquiries from Coast Guard field units.

QUARTERLY TELEPHONE CONFERENCES We are preparing the third round of quarterly telephone conferences with authorized measurement organizations. If there are any specific topics you would like covered, please contact Mr. Marcus Akins with suggestions.

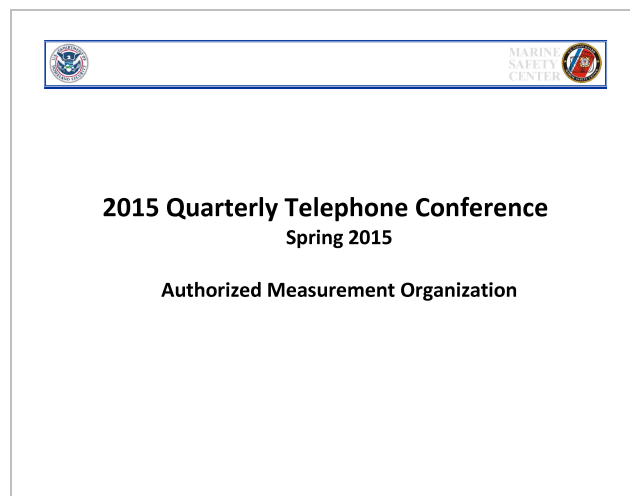

TONNAGE PERSONNEL Mr. Marcus Akins will be out of the office on April 16-17, 2014. During that time, please forward any questions on tonnage standards or file requests to Mr. Brian Ellis.

Weekly Notes are issued by the Coast Guard Marine Safety Center's Tonnage Division (MSC-4) for use by organizations that perform measurement work on the Coast Guard's behalf. They are for informational purposes only, and are not intended as, nor should they be construed to represent, revisions of or substitutes for applicable statutes or regulations or established interpretations of either.

MEASUREMENT ORGANIZATION WEEKLY NOTES – 04/08/2015

REQUIREMENT FOR ONBOARD SURVEY In accordance with MTN 01-98 CH-12, measurement organizations shall conduct an onboard survey (physical inspection) of a vessel once all work on the vessel that could affect the assigned tonnages or registered dimensions has been completed, but before the appropriate tonnage certificate is issued. The purpose of this survey is not only to obtain dimensions and other information required in the tonnage measurement process that is not readily available from other sources, but also to perform a variety of other critical certification functions (e.g., verify accuracy of drawings, space utilization accounting, and proper labeling).

CONFLICT OF INTEREST As an important reminder, consulting on a vessel for which the same individual provides measurement services pursuant to the tonnage regulations raises the appearance of impropriety, since it could compromise the objectivity of tonnage certification in the event that the advice was incorrectly given or applied. Accordingly, there are strict restrictions on consulting, as explicitly addressed in the tonnage regulations and MTN 01-98 CH-12. For example, if a “tonnage consultant” gives advice regarding the assignment of tonnages to a particular vessel for a fee or consideration (i.e., other compensation), that consultant is prohibited from conducting the vessel’s onboard survey.

NEW TONNAGE GUIDE DEVELOPMENT The Marine Safety Center is developing a new tonnage guide to address tonnage file requirements for drawings or other graphical representations reflecting a vessel’s as-measured configuration. Among other things, we are considering use of a notional fishing vessel along the lines of one featured in material developed by Coast Guard field admeasurement staff in the 1980’s - which was not officially sanctioned or widely distributed - to help illustrate key concepts. As an aside, we caution that while some of the illustrations in this earlier material remain useful, they are outdated, and should not be used as the basis for any tonnage certification actions.

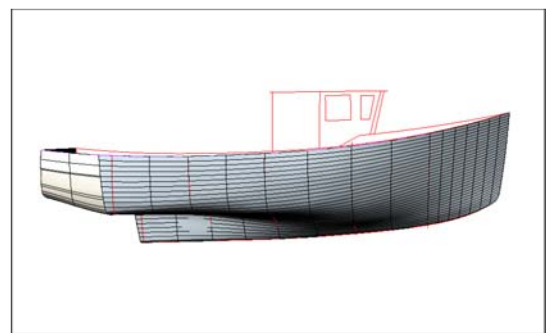
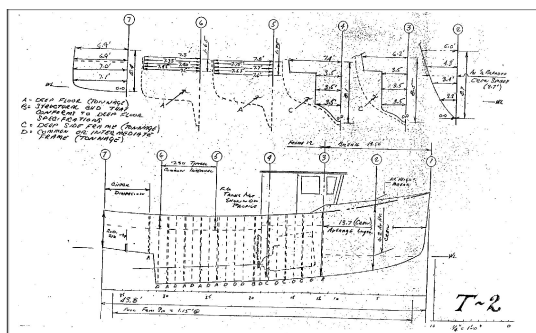

Weekly Notes are issued by the Coast Guard Marine Safety Center’s Tonnage Division (MSC-4) for use by organizations that perform measurement work on the Coast Guard’s behalf. They are for informational purposes only, and are not intended as, nor should they be construed to represent, revisions of or substitutes for applicable statutes or regulations or established interpretations of either.

MEASUREMENT ORGANIZATION WEEKLY NOTES – 04/01/2015

PASSENGER SPACE EXEMPTIONS The Tonnage Division recently responded to inquiries regarding Regulatory Measurement System treatment of passenger spaces eligible for exemption. Per MTN 01-99 CH-7 section 69.117(c)(2), spaces used by both passengers and crew members (e.g., first aid stations), or used for passenger support but not accessible to passengers at all times (e.g., vaults on a gaming vessel) cannot be exempted as passenger space.

REMEASUREMENT In accordance with 46 CFR 69.19(a), a vessel's owner is required to report immediately to an authorized measurement organization any intent to structurally alter the vessel or to change the use of a space within the vessel, with the organization advising the owner if remeasurement is necessary. Should the measurement organization deem that the intended change will require tonnage certificate reissuance, the measurement organization shall provide written notification to the vessel's owner, with instructions to submit an application for measurement services in accordance with 46 CFR 69.17(a). Although it is anticipated that measurement organizations will notify owners if tonnage certificate reissuance is not required, there is no provision for a written notification.

COAST GUARD HISTORY On April 1, 1967 the Department of Transportation Act ([Public Law 89-670](#)) transferred the Coast Guard from the Department of the Treasury to the newly-formed Department of Transportation (DOT). Under the provisions of this Act, the authority to measure and document vessels officially conveyed to the Secretary of DOT. In March of 2003, the Coast Guard was transferred to the newly established Department of Homeland Security where it remains today.

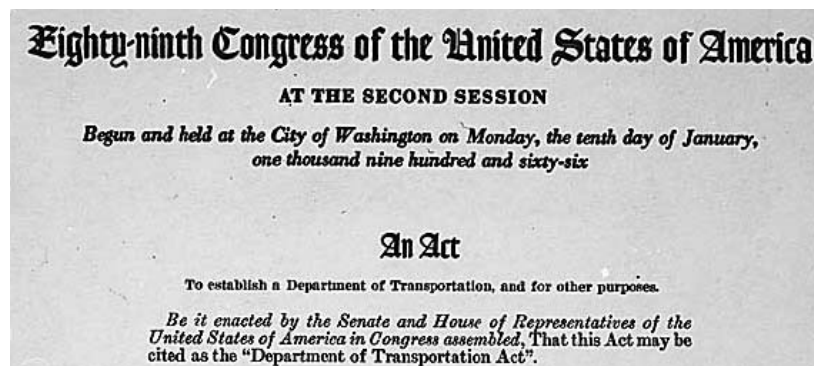

Source: <http://research.archives.gov/description/299943>

Weekly Notes are issued by the Coast Guard Marine Safety Center's Tonnage Division (MSC-4) for use by organizations that perform measurement work on the Coast Guard's behalf. They are for informational purposes only, and are not intended as, nor should they be construed to represent, revisions of or substitutes for applicable statutes or regulations or established interpretations of either.

MEASUREMENT ORGANIZATION WEEKLY NOTES – 03/25/2015

OPEN SPACE AND BULKHEADS In responding to a recent inquiry, we noted a need for clarification to MTN 01-99 CH-7 section 69.117(d)(3)(ii)(4) regarding obstructions for openings where the boundary is not clearly defined. Specifically, in the figure below not only does the obstructing bulkhead render compartment “C” as closed, but the passageway width itself of 28” precludes circulation of open space to compartment “C”. We intend to clarify this matter in a future update to the MTN.

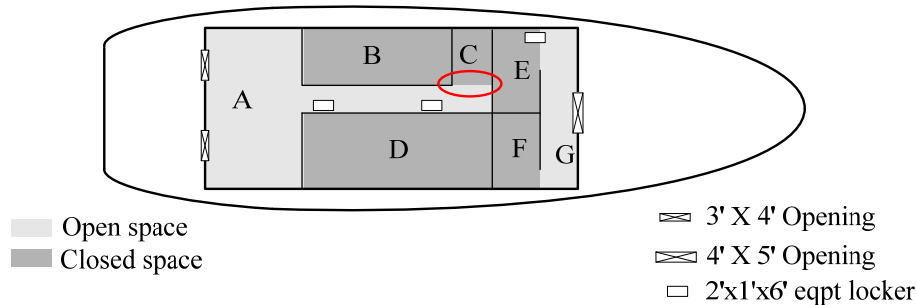

FRP CONSTRUCTION Further to the entry in the March 11th Weekly Notes edition on possible development of IMO interpretations of the TM Convention, we are interested in learning the origin of IACS’s paper (document [SDC 1/4/1](#)) on treatment of composite sandwich panels and related matters. For example, was any consideration given to measuring to the inside of the outer laminate surface when interpreting the language “inner side of structural boundary surfaces” in the Convention? If you have any information that could assist us in this regard, please contact Mr. Marcus Akins.

NATHANIEL HAWTHORNE’S “THE CUSTOM-HOUSE” The U.S. tonnage program long resided with the Custom Service. American novelist Nathaniel Hawthorne worked at custom houses in Boston as Measurer of Salt and Coal¹ (1839-40)² and in Salem as Surveyor (1846-49)¹. In “The Custom-House” introductory to his novel *The Scarlet Letter*, published in March of 1850, the narrator begins employment as a surveyor at the Salem office and describes the building and his coworkers³.



Salem Custom House

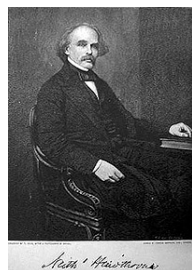

Nathaniel Hawthorne



Images from National Park Service collections

¹ <http://www.hawthorneinsalem.org/page/10179/>

² Nathaniel Hawthorne. (2015). In Encyclopædia Britannica. Retrieved from <http://www.britannica.com/EBchecked/topic/257594/Nathaniel-Hawthorne>

³ Hawthorne, N. (1850). The Custom-House [Introductory]. In N. Hawthorne, *The Scarlet Letter*. Retrieved from <http://www.gutenberg.org>

Weekly Notes are issued by the Coast Guard Marine Safety Center’s Tonnage Division (MSC-4) for use by organizations that perform measurement work on the Coast Guard’s behalf. They are for informational purposes only, and are not intended as, nor should they be construed to represent, revisions of or substitutes for applicable statutes or regulations or established interpretations of either.

MEASUREMENT ORGANIZATION WEEKLY NOTES – 03/18/2015

AIR TRUNK TREATMENT Section 69.65(h)(1) of MTN 01-99 CH-7 addresses treatment of air trunks under the Convention Measurement System, although neither the tonnage regulations nor this interpretative policy document define the term “air trunk” in this context. Recently, we learned that some designers and measurement organizations are inappropriately ignoring the volumes of multi-compartmented side structures that are fitted with ventilation intakes and exhausts. The MSC ruled that such structures are not “air trunks”.

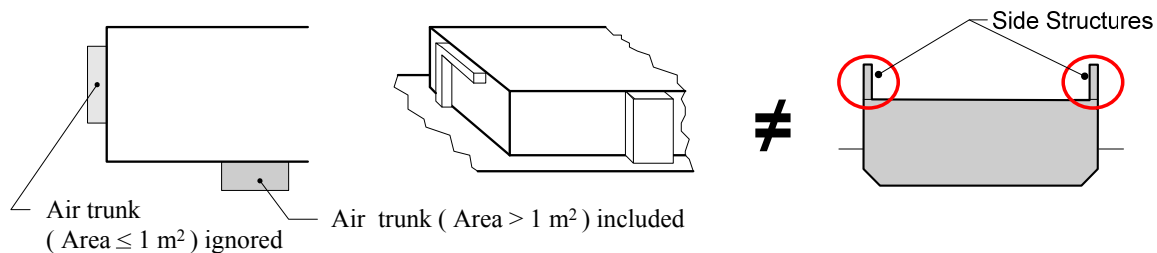

PHOTOS AND FRAMING For vessels being measured under Subparts C or D, the tonnage files must include graphical representations of relevant under-deck framing, such as ordinary side and bottom frames or floor timbers. The following photo shows sufficient details of the floor construction for the associated tonnage station, except for the lack of a scale. Placing a tape measure in the photo with the tape extended could suffice. Alternatively surveyor “grade rods” (many of which are conveniently marked in feet and tenths of feet, along the lines of the old tonnage “lift rods”) could be used for this purpose.

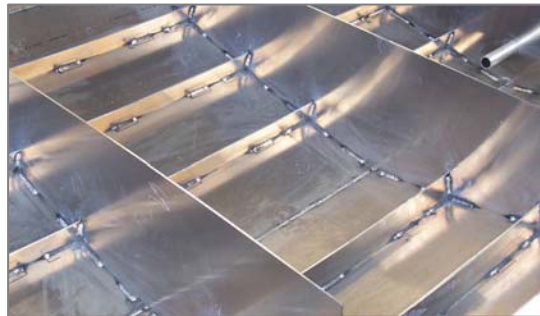

Collapsible Survey “Grade Rod”

TONNAGE PERSONNEL Mr. Marcus Akins will be out of the office March 19-20, 2015.

Weekly Notes are issued by the Coast Guard Marine Safety Center’s Tonnage Division (MSC-4) for use by organizations that perform measurement work on the Coast Guard’s behalf. They are for informational purposes only, and are not intended as, nor should they be construed to represent, revisions of or substitutes for applicable statutes or regulations or established interpretations of either.

MEASUREMENT ORGANIZATION WEEKLY NOTES – 03/11/2015

CUSTOMER SERVICE STANDARDS The Marine Safety Center (MSC) recently revised its customer service standards for response times to submittals requesting Tonnage Division (MSC-4) action. The changes bring MSC-4 response times into alignment with longstanding MSC customer service standards for plan review submissions. Our goal is to better these “cycle” time standards where practicable, especially in responding to requests for interpretations from measurement organizations where they apply to a vessel being initially measured or remeasured.

Revised Customer Service Standards Effective March 6, 2015	
Submitter	MSC-4 Response Time in Days from Submittal Receipt
Measurement Organizations	
VIN (CG Number) Assignments	2 Business Days
Tonnage File Requests	2 Business Days
All Other Submissions	30 Calendar Days
All Other Entities	30 Calendar Days

IMO WORK WITH IACS Now that the IMO Sub-Committee work on the “planned output” on tonnage has concluded, MSC-4 is pursuing the development of several Unified interpretations of the TM Convention which received broad support during the earlier work, but due to time constraints were ultimately not included in TM.5/Circ.6. If you are interested in working with the MSC on this effort, please contact Mr. Marcus Akins. As always, you are welcome to provide input through your representative on the IACS Statutory Panel. We plan to coordinate with other governments and the IACS representative to IMO on this matter.

PUMP ROOM DEDUCTIONS In accordance with Section 69.119(l) of MTN 01-99 CH-7, spaces below the line of the uppermost complete deck containing pumps that are not capable of handling cargo and that are not fuel oil transfer pumps considered part of the propelling machinery are deductible, provided that the spaces are used exclusively for pumps and are reasonable in size for such use. When a pump room is larger than necessary for the safe and efficient operation of deductible pumps, only the space occupied by the pumps plus a two foot maximum working space on each side of the pumps, if available, is deductible, per Section 69.119(b) of the MTN.

Weekly Notes are issued by the Coast Guard Marine Safety Center’s Tonnage Division (MSC-4) for use by organizations that perform measurement work on the Coast Guard’s behalf. They are for informational purposes only, and are not intended as, nor should they be construed to represent, revisions of or substitutes for applicable statutes or regulations or established interpretations of either.

MEASUREMENT ORGANIZATION WEEKLY NOTES – 03/04/2015

NEW PANAMA TOLL STRUCTURE Last Friday, the Panama Canal Authority held a hearing on adjustments to its toll structure. Upon final approval, the adjustments - for all market segments, except for the new Intra Maritime Cluster Segment - are scheduled to begin in April of 2016. According to the Authority's press release, "the proposed restructuring calls for each segment to be priced based upon different units of measurement, while aligning with customers' needs and requests, and modifying pricing for all Canal segments. For instance, containers will be measured and priced on TEUs, dry bulkers will be based on deadweight tonnage capacity and metric tons of cargo, passenger vessels will be based on berths, LNG will be based on cubic meters and tankers will be measured and priced on Panama Canal (PCUMS) tons and metric tons."

Source: <http://www.pancanal.com/eng/pr/press-releases/2015/02/27/pr542.html>

REDUCED GROSS TONNAGE Further to the entry in our last Weekly Notes edition while a number of the 21 delegates who spoke on this item supported - in principle - the German proposal to implement a reduced gross tonnage parameter for crew accommodations, others expressed reservations. These centered on the lack of clarity of terms and definitions, the cost of certifying the parameter, and whether the parameter would ultimately be used. Following the discussion, the SDC Sub-Committee decided to conclude the work on this parameter, without any further development.

DHS FUNDING SITUATION The Department of Homeland Security (DHS), of which the Coast Guard is a part, is currently operating on a one-week extension to a Continuing Resolution. Yesterday afternoon the House of Representatives passed a bill to fund DHS through September. The Senate had already passed such a bill and the president is expected to sign it into law soon, averting a DHS shutdown.

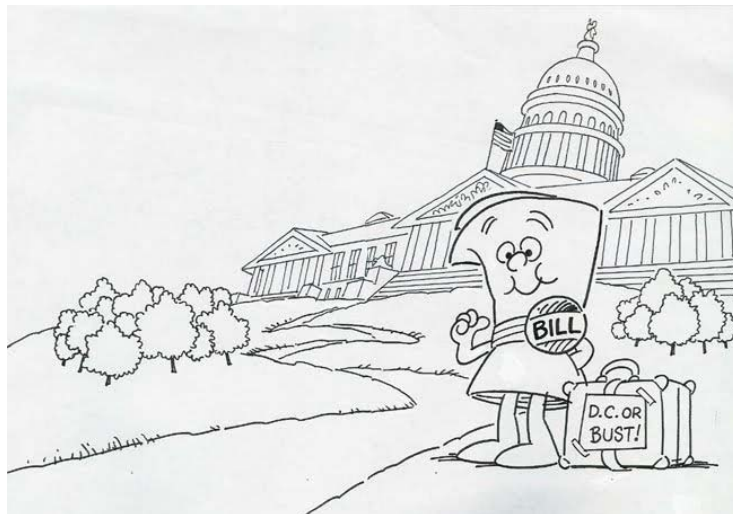

Frishberg, D. (1977). I'm Just a Bill [Television series episode]. In *Schoolhouse Rock!*. ABC.

Weekly Notes are issued by the Coast Guard Marine Safety Center's Tonnage Division (MSC-4) for use by organizations that perform measurement work on the Coast Guard's behalf. They are for informational purposes only, and are not intended as, nor should they be construed to represent, revisions of or substitutes for applicable statutes or regulations or established interpretations of either.

MEASUREMENT ORGANIZATION WEEKLY NOTES – 02/25/2015

TOWING VESSEL GRT DISTRIBUTION NEAR TONNAGE THRESHOLDS Concluding the examinations of vessel populations and the potential influence of tonnage thresholds upon them, the graph below shows the distribution of in-service U.S. flag towing vessels that measured less than 220 GRT. Similar to the OSVs examined last week, there are spikes just below 100 and 200 GRT, but less clustering. Of the towing vessels that measured less than 100 GRT, 9% fall in the 97-99 GRT range. These examinations indicate that vessels are being designed extremely close to tonnage thresholds, such that “worst case” stack-ups of dimensional and other differences between submitted drawings and as-built configurations could result in a failure to meet owner tonnage objectives.

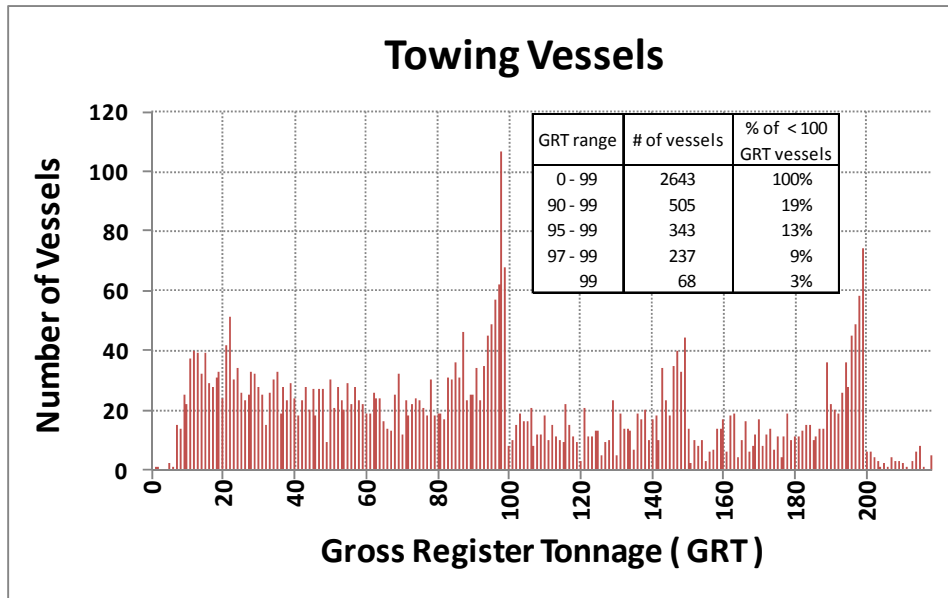

SDC 2 MEETING OUTCOME At last week’s meeting in London, the SDC 2 Sub-Committee decided to bring the work on the TM Convention to a close, without finalizing additional interpretations of the TM Convention or the draft resolution on reduced gross tonnage for crew accommodation spaces.

MOLDED DRAFT ON U.S. CERTIFICATES When completing the reverse side of the U.S. certificate, please remember that you *must* specify the molded draft as defined in 46 CFR 69.53 in terms of both meters (rounded to two decimal places, or the nearest centimeter) and feet (to one decimal place, or the nearest tenth of a foot).

MOLDED DRAFT	
6.52 m	21.4 ft

Weekly Notes are issued by the Coast Guard Marine Safety Center’s Tonnage Division (MSC-4) for use by organizations that perform measurement work on the Coast Guard’s behalf. They are for informational purposes only, and are not intended as, nor should they be construed to represent, revisions of or substitutes for applicable statutes or regulations or established interpretations of either.

MEASUREMENT ORGANIZATION WEEKLY NOTES – 02/18/2015

OSV GRT DISTRIBUTION NEAR TONNAGE THRESHOLDS Following examinations of vessel populations and the potential influence of tonnage thresholds upon them, the graph below shows the distribution of in-service U.S. flag offshore supply vessels (OSVs) that measured less than 220 GRT. In addition to spikes just below 100 and 200 GRT, there is significant clustering. Most (62%) of the OSVs that measured less than 100 GRT fall in the 90-99 GRT range. Further, of the OSVs less than 100 GRT, 13% measured 99 GRT, within one ton of the threshold.

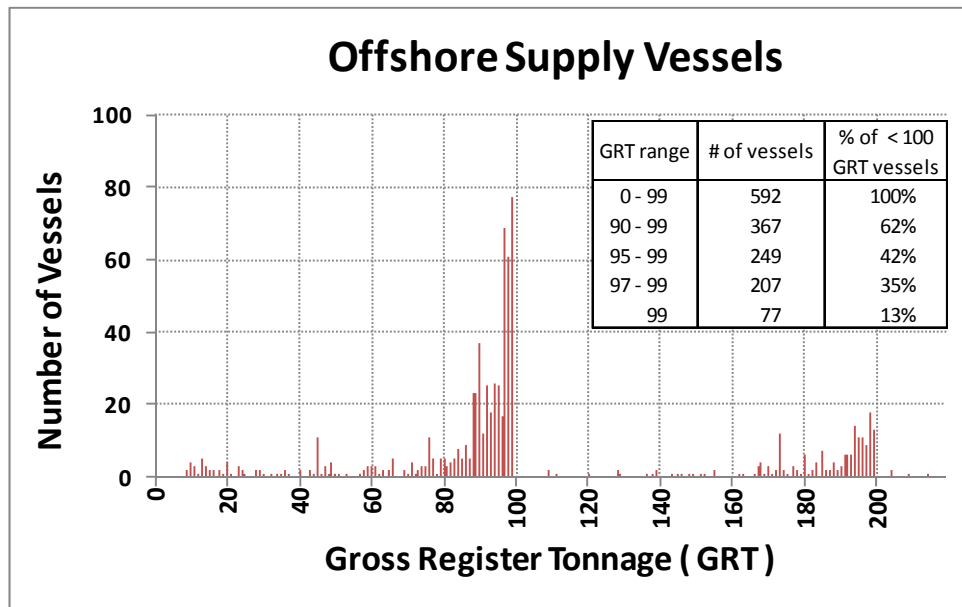

UNIFIED INTERPRETATIONS The SDC 2 meeting is in progress in London. It is running a bit behind schedule; as a result, we have not gotten a report on the discussions concerning the tonnage agenda item. We expect these discussions to occur today. Whatever the outcome of SDC 2, the United States is considering working with IACS and intergovernmentally to finalize those Unified interpretations of the TM Convention which received broad support during the earlier work, but due to time constraints were ultimately not included in TM.5/Circ.6. More on this to follow.

QUARTERLY TELEPHONE CONFERENCES We have commenced the second of our new series of quarterly telephone conferences with authorized measurement organizations. This time we are focusing on treatment of alternating "deep" frames when establishing the line of the ordinary frames, as well the zone of influence method for measuring water ballast spaces. Mr. Marcus Akins is the point of contact for organizing these conferences.

OPERATING STATUS The Marine Safety Center was closed Tuesday, 17 February due to inclement weather (snow). Normal business hours have resumed.

Weekly Notes are issued by the Coast Guard Marine Safety Center's Tonnage Division (MSC-4) for use by organizations that perform measurement work on the Coast Guard's behalf. They are for informational purposes only, and are not intended as, nor should they be construed to represent, revisions of or substitutes for applicable statutes or regulations or established interpretations of either.

MEASUREMENT ORGANIZATION WEEKLY NOTES – 02/11/2015

GT ITC DISTRIBUTION OF YACHTS (2012) Continuing the examination of vessel populations and the potential influence of tonnage thresholds upon them, the graph below shows the distribution of yachts operating worldwide in 2012 that measured in the 90 to 600 GT ITC range. Along the lines of our discussion of general cargo vessels (last week), the significant spike just below 500 GT ITC is likely driven by the 500 gross tonnage SOLAS thresholds (e.g., Ship Safety Certificates and ISM Code) that may apply to yachts under certain circumstances.

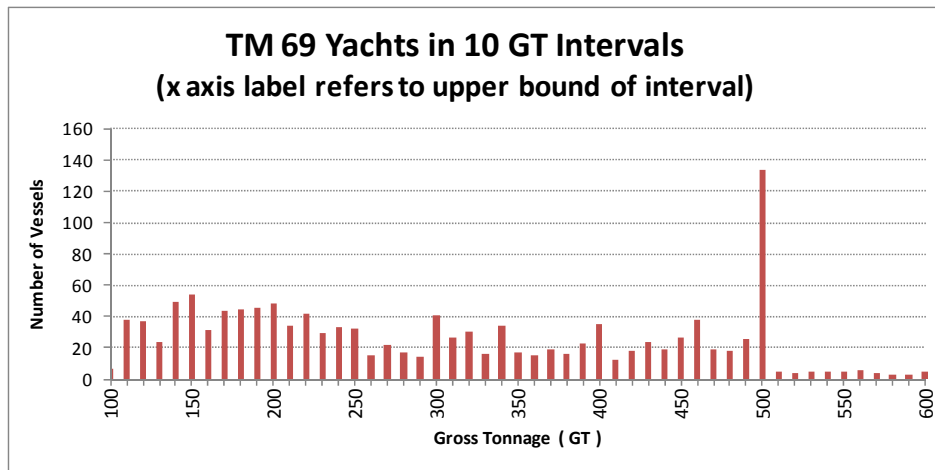

TONNAGE LENGTH TERMINUS The following figure is from the tonnage regulations amendments NPRM, but also appears in the current regulations and for editing reasons was omitted from MTN 01-99, as amended. Note that the forward termination point of the tonnage length does not necessarily coincide with the after extremity of a single stem frame (or “cant frame”).

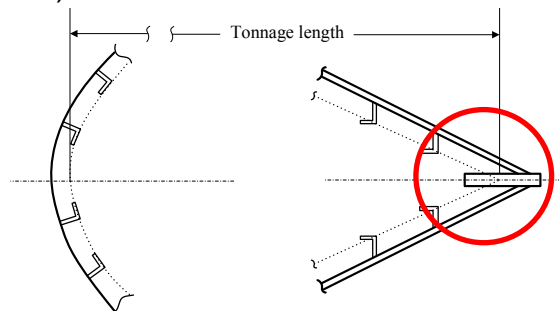

WASHINGTON’S BIRTHDAY HOLIDAY CLOSURE

The Marine Safety Center will be closed Monday, February 16th in observance of the birthday of George Washington. Officially “[Washington’s Birthday](#)”, this holiday is commonly called “President’s Day”.



Washington Crossing the Delaware
(or, *Artistic License and How to Overload an Open Boat*)
Emanuel Leutze (1816-1868)

Weekly Notes are issued by the Coast Guard Marine Safety Center’s Tonnage Division (MSC-4) for use by organizations that perform measurement work on the Coast Guard’s behalf. They are for informational purposes only, and are not intended as, nor should they be construed to represent, revisions of or substitutes for applicable statutes or regulations or established interpretations of either.

MEASUREMENT ORGANIZATION WEEKLY NOTES – 02/04/2015

GT ITC DISTRIBUTION OF GENERAL CARGO VESSELS (2010) This continues a series of Weekly Notes entries that examines various vessel populations and the potential influence of tonnage thresholds upon them. The graph below shows the distribution of general cargo vessels operating worldwide in 2010 that measured in the 90 to 600 GT ITC range. The pronounced spike in the number of vessels just below 500 GT ITC may be due to the 500 gross tonnage SOLAS and STCW thresholds (e.g., Ship Safety Certificates, ISM Code, and ISPS Code). The spike just below 200 GT ITC is less clear, but may be due to the 200 gross tonnage thresholds for seafaring credentialing under various national requirements.

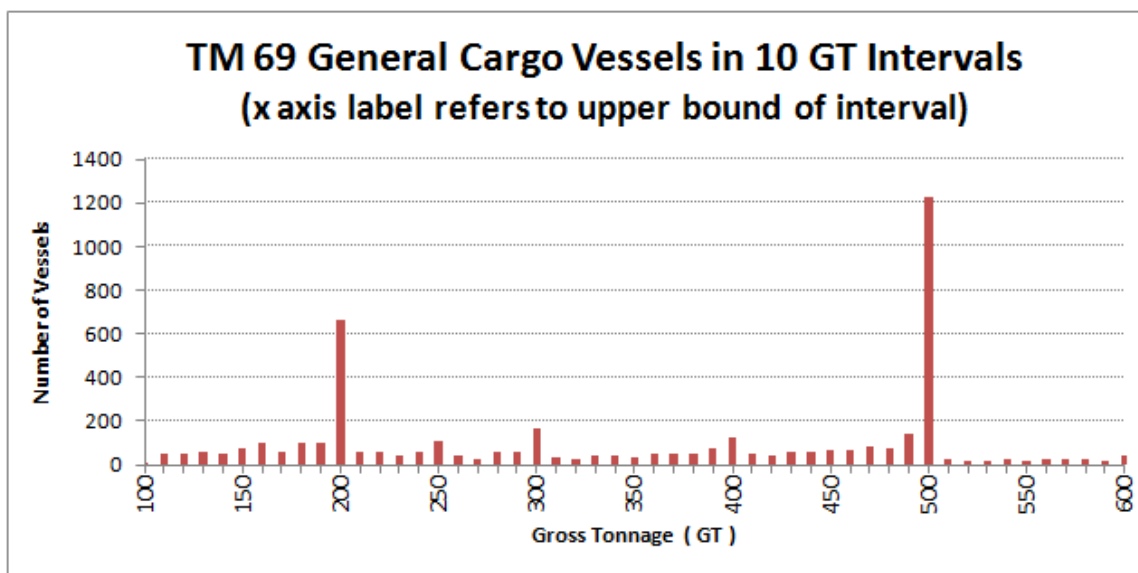

TONNAGE GUIDE 5 The Marine Safety Center (MSC) Tonnage Division recently released Tonnage Guide 5. It provides information concerning federal documentation and tonnage measurement requirements for commercial vessels of the United States that are less than 79 feet in overall length. The MSC posted this Guide and its appendix, an informational brochure, on the Tonnage Publications web page (<http://www.uscg.mil/hq/msc/tonnage/pubs.asp>). The Guide's direct link is: http://www.uscg.mil/hq/msc/tonnage/docs/TG-5_Current.pdf. The brochure attached to this Guide gives an overview of tonnage measurement systems that apply to such vessels.

NEW DISTRIBUTION OF WEEKLY NOTES Beginning with this edition, MSC circulates Weekly Notes via email to representatives of authorized measurement organizations only. Such representatives may forward these emails to contractors or other parties without restriction. As a reminder, the same information is available in an archive on the Tonnage Publications web page (<http://www.uscg.mil/hq/msc/tonnage/pubs.asp>). Its direct link is: http://www.uscg.mil/hq/msc/tonnage/docs/Weekly_Notes.pdf.

Weekly Notes are issued by the Coast Guard Marine Safety Center's Tonnage Division (MSC-4) for use by organizations that perform measurement work on the Coast Guard's behalf. They are for informational purposes only, and are not intended as, nor should they be construed to represent, revisions of or substitutes for applicable statutes or regulations or established interpretations of either.

MEASUREMENT ORGANIZATION WEEKLY NOTES – 01/28/2015

GT ITC DISTRIBUTION OF PASSENGER FERRIES (2010) This is the first in a series of Weekly Notes entries that will examine various vessel populations. The graph below shows the distribution of passenger ferries operating worldwide in 2010 that measured in the 90 to 600 GT ITC range. In general, when tonnage thresholds for various requirements exist that strongly influence a vessel population (e.g., STCW), this sort of plot would show significant “drop-offs” just above the associated tonnage threshold. The noticeable decline in the number of vessels just above 500 GT ITC may be due, at least in part, to the 500 gross tonnage seafarer credentialing threshold.

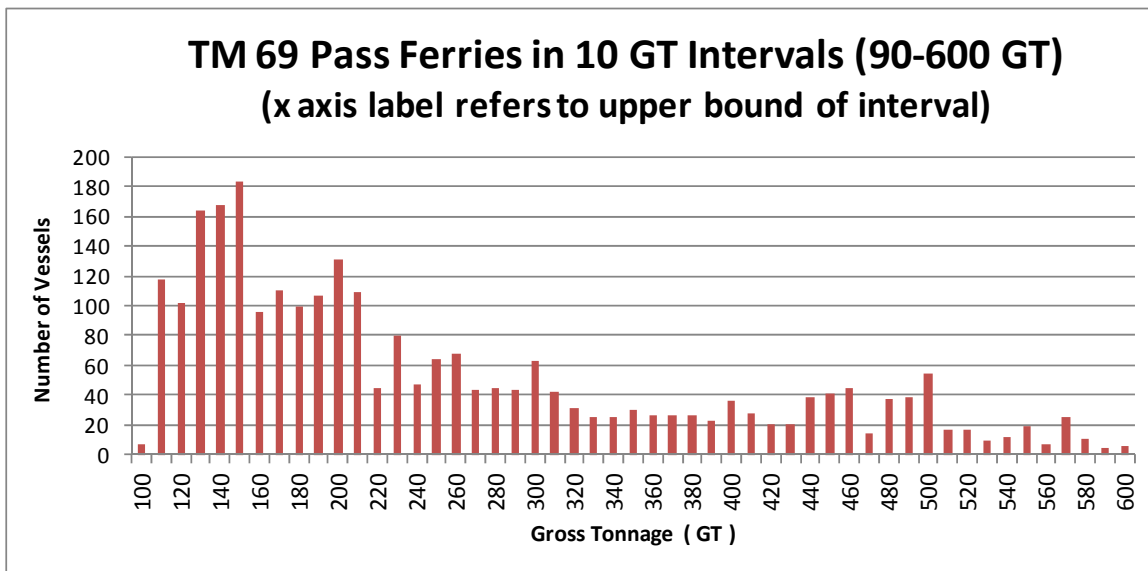

UPDATED APPLICATION FOR SIMPLIFIED MEASUREMENT The Coast Guard will soon issue an updated Application for Simplified Measurement (form CG-5397). Vessel owners complete the form to certify information which is used to assign an eligible vessel's tonnages and registered dimensions under the Simplified Regulatory Measurement System. The Marine Safety Center (MSC) will post this updated form to replace the current version at: http://www.uscg.mil/hq/msc/interactive_tonnage.asp.

NEW DISTRIBUTION OF WEEKLY NOTES Following this edition, MSC will circulate Weekly Notes via email to representatives of authorized measurement organizations only. Such representatives may forward these emails to contractors or other parties without restriction. As a reminder, the same information will be available in an archive on the Tonnage Publications web page (<http://www.uscg.mil/hq/msc/tonnage/pubs.asp>). Its direct link is: http://www.uscg.mil/hq/msc/tonnage/docs/Weekly_Notes.pdf

Weekly Notes are issued by the Coast Guard Marine Safety Center's Tonnage Division (MSC-4) for use by organizations that perform measurement work on the Coast Guard's behalf. They are for informational purposes only, and are not intended as, nor should they be construed to represent, revisions of or substitutes for applicable statutes or regulations or established interpretations of either.

MEASUREMENT ORGANIZATION WEEKLY NOTES – 01/21/2015

TONNAGE GUIDE 5 The Marine Safety Center (MSC) Tonnage Division will soon release Tonnage Guide 5. It provides information concerning federal documentation and tonnage measurement requirements for commercial vessels of the United States that are less than 79 feet in overall length. An informational brochure, attached to the Guide as an appendix, gives an overview of the information that could be helpful to vessel owners and other interested parties in both the public and private sectors.

TONCALC 2.0.1 The MSC is working on an update to TonCalc 2.0.1 to incorporate a number of enhancements and resolve several discrepancies that are unrelated to the STD_CALC_S worksheet. For example, an error message appears for the 2-Dimensional Simpson's calculation on the CONV_CALC_S worksheet, for which we have a workaround that will be incorporated in TonCalc 2.0.2. If you have any comments or suggestions on how to improve TonCalc functionality, please contact Mr. David Karnes.

DISTRIBUTING WEEKLY NOTES Further to last week's entry, a compilation of current and previous Weekly Notes editions has been posted to the Tonnage Publications web page (<http://www.uscg.mil/hq/msc/tonnage/pubs.asp>). The direct link to the archive is: http://www.uscg.mil/hq/msc/tonnage/docs/Weekly_Notes.pdf

MSC TO MOVE On Friday, it was announced that the MSC will move from our offices in northern Virginia to Coast Guard Headquarters in Washington, DC later this year. This consolidation of USCG National Capital Region employees will bring about the fourth building move for the Tonnage Division since 1994.

Weekly Notes are issued by the Coast Guard Marine Safety Center's Tonnage Division (MSC-4) for use by organizations that perform measurement work on the Coast Guard's behalf. They are for informational purposes only, and are not intended as, nor should they be construed to represent, revisions of or substitutes for applicable statutes or regulations or established interpretations of either.

MEASUREMENT ORGANIZATION WEEKLY NOTES – 01/14/2015

PC/UMS PROPOSAL The Panama Canal Authority recently announced its decision to use a wider range of measurement units in assessing Panama Canal tolls, including deadweight tons of capacity and metric tons of cargo. In this announcement, the Authority noted that it will introduce new structures for the following market segments: full containers, dry bulk, liquid bulk (tankers and gas carriers), vehicle carriers and Ro-Ro. The following table was excerpted from their January 2015 “Proposal to Modify the Regulations for the Admeasurement of Vessels and the Panama Canal Tolls System”. The Authority extended the industry consultation process for a minimum of 30 days.

Proposed Tariff and Structure for 2016													
DWT Bands 3/	Laden Transits By Commodity												Ballast Tariff (\$/DWT MT)
	Grains			Coal			Iron Ore			ODB			
	Panamax locks (\$/DWT MT) 1/	Neopanamax locks 2/		Panamax locks (\$/DWT MT)	Neopanamax locks		Panamax locks (\$/DWT MT)	Neopanamax locks		Panamax locks (\$/DWT MT)	Neopanamax locks		
		Fixed Tariff (\$/DWT MT)	Variable Tariff (\$/ Cargo MT) 4/		Fixed Tariff (\$/DWT MT)	Variable Tariff (\$/ Cargo MT)		Fixed Tariff (\$/DWT MT)	Variable Tariff (\$/ Cargo MT)		Fixed Tariff (\$/DWT MT)	Variable Tariff (\$/ Cargo MT)	
1st 5,000	\$4.09	\$5.74	\$0.35	\$3.42	\$5.15	\$0.30	\$3.40	\$4.85	\$0.28	\$4.09	\$5.74	\$0.35	\$2.75
Next 5,000	\$3.23	\$4.97	\$0.34	\$2.74	\$4.12	\$0.29	\$2.52	\$3.88	\$0.27	\$3.23	\$4.97	\$0.34	\$2.40
Next 10,000	\$2.57	\$4.21	\$0.33	\$2.45	\$3.61	\$0.28	\$2.13	\$2.91	\$0.26	\$2.57	\$4.21	\$0.33	\$2.00
Next 20,000	\$2.38	\$2.68	\$0.30	\$2.15	\$3.09	\$0.27	\$2.04	\$2.62	\$0.24	\$2.38	\$2.68	\$0.30	\$1.80
Next 20,000	\$2.09	\$1.91	\$0.25	\$2.05	\$2.06	\$0.26	\$1.94	\$1.84	\$0.20	\$2.09	\$1.91	\$0.25	\$1.75
Next 25,000	\$1.71	\$0.77	\$0.20	\$1.96	\$0.82	\$0.25	\$1.84	\$0.78	\$0.16	\$1.71	\$0.77	\$0.20	\$1.25
Next 35,000	\$1.28	\$0.38	\$0.15	\$1.47	\$0.26	\$0.20	\$0.97	\$0.24	\$0.10	\$1.28	\$0.38	\$0.15	\$0.45
Rest	\$0.86	\$0.38	\$0.10	\$0.78	\$0.10	\$0.15	\$0.49	\$0.10	\$0.05	\$0.86	\$0.38	\$0.10	\$0.25

SDC 2 PREPARATIONS Yesterday, IMO posted on its website the U.S. paper described in a previous Weekly Notes edition. Other than the German paper (Crew Accommodations) and the IACS paper (Hull Recesses for Cooler), also previously described, no other papers on tonnage have posted.

DISTRIBUTING WEEKLY NOTES Further to last week’s Weekly Notes entry, we are in the process of implementing the website changes for posting the compilation of current and previous Weekly Notes editions. We expect to have this compilation posted by close of business this week.

MARTIN LUTHER KING, JR. HOLIDAY The Marine Safety Center will be closed Monday, January 19th in observance of the Birthday of Martin Luther King, Jr.

Weekly Notes are issued by the Coast Guard Marine Safety Center’s Tonnage Division (MSC-4) for use by organizations that perform measurement work on the Coast Guard’s behalf. They are for informational purposes only, and are not intended as, nor should they be construed to represent, revisions of or substitutes for applicable statutes or regulations or established interpretations of either.

MEASUREMENT ORGANIZATION WEEKLY NOTES – 01/07/2015

DISTRIBUTING WEEKLY NOTES The Tonnage Division is changing its procedures for distributing Weekly Notes, in an effort to improve transparency and facilitate access to previous editions. Effective next week, we will post on the MSC's website a compilation of current and previous Weekly Notes editions, which will be available to all measurement organizations, contractors, and the public at large. In the future, we will continue to circulate, via email, the current edition of the Weekly Notes to representatives of authorized measurement organizations. These emails may be forwarded to contractors or other parties without restriction, although the same information will be available through the MSC's website. Please contact Mr. David Karnes if you have any questions about this procedural change.

PUBLIC MEETING SDC 2 A public meeting will be held at 09:00 on February 4th to obtain input on matters before the IMO's SDC 2 Sub-Committee at its upcoming meeting in London. This includes the tonnage work (technical interpretations offered by IACS, and reduced gross tonnage), which may finish up at this session. The meeting will be held in Arlington, VA. Please contact Mr. Brian Ellis if you have any questions on this public meeting.

IMO PAPER REDUCED GROSS TONNAGE Germany has submitted a paper for consideration by SDC 2 at its February meeting, proposing a simplified approach for implementing a reduced gross tonnage parameter for crew accommodation spaces. The German proposal uses the framework of an earlier proposal by Germany, India, the United States and ITF, but without linkage to minimum accommodation standards. Under Germany's simplified approach, certain stairways and passageways are counted as accommodation spaces.

 IMO INTERNATIONAL MARITIME ORGANIZATION	E
SUB-COMMITTEE ON SHIP DESIGN AND CONSTRUCTION 2nd session Agenda item 11	SDC 2/11/2 12 December 2014 Original: ENGLISH
PROVISIONS TO ENSURE THE INTEGRITY AND UNIFORM IMPLEMENTATION OF THE 1969 TM CONVENTION	
Reduced gross tonnage for crew accommodation spaces	
Submitted by Germany	

Weekly Notes are issued by the Coast Guard Marine Safety Center's Tonnage Division (MSC-4) for use by organizations that perform measurement work on the Coast Guard's behalf. They are for informational purposes only, and are not intended as, nor should they be construed to represent, revisions of or substitutes for applicable statutes or regulations or established interpretations of either.

Measurement Organization Weekly Notes – 12/31/2014

ITEMS: Substantial Alteration Criteria; Upper Strake; New Year's Day Closure; Tonnage Personnel

SUBSTANTIAL ALTERATION CRITERIA: The Tonnage Division recently responded to an inquiry regarding application of substantial alteration criteria in a case where the only change to a vessel was the certification and marking of additional deductible spaces. In the response, the Marine Safety Center (MSC) letter stated that such a change does not constitute "alterations or modifications" as described by NVIC 11-93 CH-3.

UPPER STRAKE: In a previous weekly note, we discussed the evolution of terminology related to the term "upper strake", which is of critical importance when establishing the line of the tonnage deck on an open vessel. Per MTN 01-99 CH-7, any vessel (other than one having a mechanically refrigerated hold) that has a tonnage length of less than 50 feet is measured as an open vessel if the distance between the line of its tonnage deck and the upper edge of the upper strake is more than one-sixth of the midship depth. The following example illustrates the location of the upper strake, and the application of the one-sixth depth criterion, in measuring a smaller fiberglass vessel without a mechanically refrigerated hold as an open vessel.

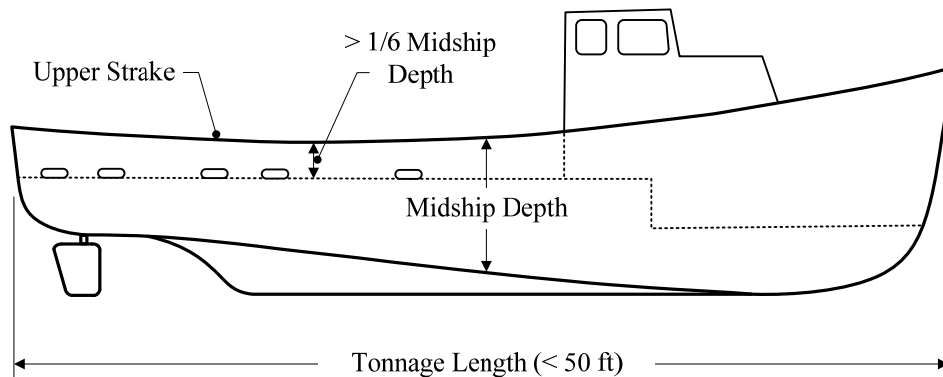

NEW YEAR'S DAY CLOSURE: The MSC will be closed along with other federal offices January 1st in observance of the New Year's Day holiday.

TONNAGE PERSONNEL: Mr. Marcus Akins will be out of the office January 1st through 5th. Mr. Brian Ellis will be out of the office January 1st and 2nd.

Weekly Notes are issued by the Coast Guard Marine Safety Center's Tonnage Division (MSC-4) for use by organizations that perform measurement work on the Coast Guard's behalf. They are for informational purposes only, and are not intended as, nor should they be construed to represent, revisions of or substitutes for applicable statutes or regulations or established interpretations of either.

Measurement Organization Weekly Notes – 12/24/2014

ITEMS: IACS IMO Paper; Christmas & New Year Holiday Closures; Tonnage Personnel

IACS IMO PAPER: Three weeks ago IACS submitted a paper to the IMO Sub-Committee on Ship Design and Construction (SDC), which will be introduced at the February meeting in London. The paper seeks clarification on the measurement of hull recesses and external closed system piping (coolers) associated with engine cooling. Note that per MTN 01-99 CH-7, enclosed spaces having a volume not exceeding one cubic meter are ignored from volume calculations.



CHRISTMAS & NEW YEAR HOLIDAY CLOSURES: The Marine Safety Center will be closed along with other federal offices on December 25th and 26th and January 1st in observance of the Christmas and New Year's Day holidays and by Executive Order (26th). We wish you all a happy and safe holiday season.

TONNAGE PERSONNEL: Mr. Marcus Akins will be out of the office December 29th and 30th. Mr. Brian Ellis will be out of the office December 24th through 29th.

Weekly Notes are issued by the Coast Guard Marine Safety Center's Tonnage Division (MSC-4) for use by organizations that perform measurement work on the Coast Guard's behalf. They are for informational purposes only, and are not intended as, nor should they be construed to represent, revisions of or substitutes for applicable statutes or regulations or established interpretations of either.

Measurement Organization Weekly Notes – 12/17/2014

ITEMS: U.S. IMO Paper; Quarterly Telephone Conferences; Christmas Holiday Closure

U.S. IMO PAPER: Last Thursday, the U.S. submitted a paper to the IMO Sub-Committee on Ship Design and Construction (SDC), which will be introduced at the February meeting in London. The paper identifies issues with the two matters of interpretation raised by IACS in papers submitted last year, and questions the benefit of continuing work on these matters. The U.S. paper has not yet posted on IMO's website.

SUB-COMMITTEE ON SHIP DESIGN AND CONSTRUCTION 2nd session Agenda item 11	SDC 2/11/X 11 December 2014 Original: ENGLISH
PROVISIONS TO ENSURE THE INTEGRITY AND UNIFORM IMPLEMENTATION OF THE 1969 TM CONVENTION	
Further Development of Draft Interpretations of the TM Convention	
Submitted by the United States	

QUARTERLY TELEPHONE CONFERENCES: The inaugural quarterly telephone conferences with each authorized measurement organization are underway. If you have feedback on these conferences, please provide it to Mr. Akins at marcus.j.akins@uscg.mil or 703-872-6787.

CHRISTMAS HOLIDAY CLOSURE: On Thursday, December 25th, the Marine Safety Center will be closed along with other federal offices in observance of the Christmas holiday. In addition, the president issued an Executive Order closing all executive branch departments on Friday, December 26th.

Weekly Notes are issued by the Coast Guard Marine Safety Center's Tonnage Division (MSC-4) for use by organizations that perform measurement work on the Coast Guard's behalf. They are for informational purposes only, and are not intended as, nor should they be construed to represent, revisions of or substitutes for applicable statutes or regulations or established interpretations of either.

Measurement Organization Weekly Notes – 12/10/2014

ITEMS: Spaces Open to the Sea, Collection of Information, Tonnage Personnel

SPACES OPEN TO THE SEA: Recent discussions at IMO led to agreement that spaces open to sea should not be excluded from the total volume of all enclosed spaces (V) if they are used for cargo and/or buoyancy purposes. Interpretation R.6(3)-3 was developed for [TM.5/Circ.6](#) as a result, which includes the following figure. This is consistent with longstanding Coast Guard policy.

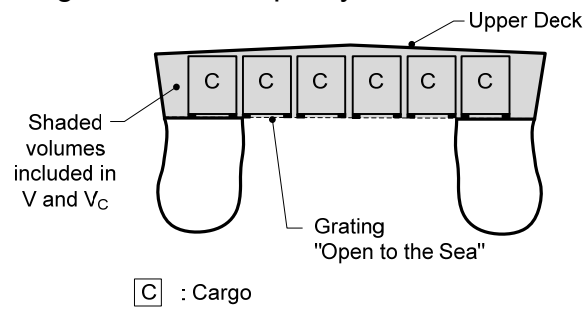

COLLECTION OF INFORMATION: The Coast Guard has forwarded an Information Collection Request (ICR) to the Office of Information and Regulatory Affairs (OIRA) for approval of a revision to the collection of information for tonnage measurement. As mentioned in a previous weekly note, this ICR pertains to the burden imposed by the Federal government on the public for collecting certain information.

TONNAGE PERSONNEL: Mr. David Karnes has been out of the office unexpectedly for the last three working days. Please direct any day to day vessel measurement questions to Mr. Marcus Akins at marcus.j.akers@uscg.mil or 703-872-6787 until further notice.

Measurement Organization Weekly Notes – 12/03/2014

ITEMS: Quarterly Conferences, Deck Gratings, Bars and Railing

QUARTERLY CONFERENCES We are finalizing the schedule for the inaugural quarterly telephone conferences with each authorized measurement organization. The first is scheduled for December 11th. If you have input on the format and/or scope of these conferences, please contact Mr. Akins at marcus.j.akers@uscg.mil or 703-872-6787 by COB Friday, December 5th. We look forward to this opportunity to exchange information and provide training on specific topics.

DECK GRATINGS One of the few matters on which there was relative consensus at IMO during the recent work on tonnage was whether a deck grating constitutes a “deck” that bounds enclosed space. The answer, as appears in [TM.5/Circ.6](#), Interpretation R.2(4)-8 is “No”, as shown in the following figure from the circular.

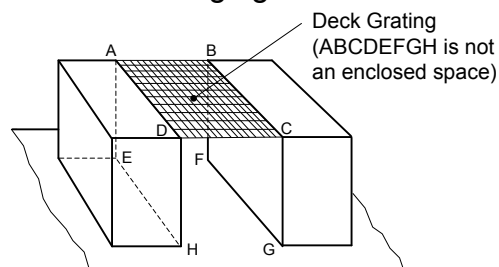

BARS AND RAILINGS Another matter discussed at IMO, and agreed to, was the treatment of bars and railings in evaluating the effect on excluded space eligibility for spaces associated with certain side openings. This was driven by considerations over rails being added to facilitate lifeboat deployment, and inhibit piracy attacks. Interpretation R.2(5)-5 was developed for [TM.5/Circ.6](#) as a result, which includes the following figure.

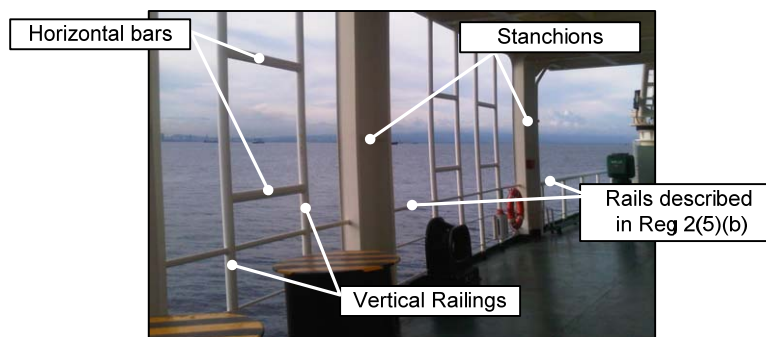

Weekly Notes are issued by the Coast Guard Marine Safety Center's Tonnage Division (MSC-4) for use by organizations that perform measurement work on the Coast Guard's behalf. They are for informational purposes only, and are not intended as, nor should they be construed to represent, revisions of or substitutes for applicable statutes or regulations or established interpretations of either.

Measurement Organization Weekly Notes – 11/26/2014

ITEMS: Listing Excluded Spaces, Excluded Spaces Block, Thanksgiving

LISTING EXCLUDED SPACES

Further to our discussion on asterisks in last week's edition, the U.S. is only one of many flag Administrations that requires all excluded spaces to be listed in the "Excluded Spaces" block on the reverse side of the ITC69. Unlike use of the asterisk, the TM Convention does not mandate listing spaces in the excluded spaces block. See next item.



EXCLUDED SPACES
(Regulation 2(5))
1st Tier Opposite Side Openings
4th Tier Overhang

An asterisk (*) should be added to those spaces listed above which comprise both enclosed and excluded spaces.

EXCLUDED SPACES BLOCK

From the recent IMO work on the TM Convention, we learned that there was never an intent to list the specific excluded spaces on the ITC69. The confusion stems from the typesetting used when IMCO (later IMO) published the booklet version of the TM Convention, leaving a large space that did not appear in the original English and French versions of the Convention. The Coast Guard is currently reviewing this matter.

Original English Version

EXCLUDED SPACES
(Regulation 2(5))

An asterisk (*) should be added to those spaces listed above which comprise both enclosed and excluded spaces.

Original French Version

ESPACES EXCLUS (Règle 2-5)

Marquer d'un astérisque (*) les espaces cités ci-dessus qui comprennent simultanément des espaces fermés et des espaces exclus

IMCO / IMO Publication

EXCLUDED SPACES
(Regulation 2(5))

An asterisk (*) should be added to those spaces listed above which comprise both enclosed and excluded spaces.

THANKSGIVING We will be closed tomorrow. Have a Happy Thanksgiving!

Weekly Notes are issued by the Coast Guard Marine Safety Center's Tonnage Division (MSC-4) for use by organizations that perform measurement work on the Coast Guard's behalf. They are for informational purposes only, and are not intended as, nor should they be construed to represent, revisions of or substitutes for applicable statutes or regulations or established interpretations of either.

Measurement Organization Weekly Notes – 11/19/2014

ITEMS: Asterisks on Certificates, Suez Canal Opening, Tonnage Personnel

ASTERISKS ON CERTIFICATES: When listing spaces in the Gross Tonnage block on the reverse side of the U.S. or ITC69 certificate, please remember that you *must* add an asterisk (*) after the name of each enclosed space that contains excluded space. See the following example.

SPACES INCLUDED IN TONNAGE					
GROSS TONNAGE			NET TONNAGE		
Name of Space	Location	Length (m)	Name of Space	Location	Length (m)
Underdeck	----	----			
1st Tier*	Fr 78-304	68.88			
2nd Tier	Fr 90-232	43.28			
3rd Tier	Fr 96-232	41.45			
4th Tier*	Fr 96-130	10.36			
5th Tier	Fr 106-128	6.71			



SUEZ CANAL OPENING: As reported Monday in Bryant’s Maritime newsletter, the Suez Canal first opened to shipping on November 17, 1869. From Professor Johnson’s 1913 report “Measurement of Vessels for the Panama Canal”, the franchise of the Suez Canal Company authorized collection of tolls based on “ton of capacity”, which was undefined. At first, tolls were assessed on the net tonnage appearing on the ships’ papers. However, due to insufficient toll receipts, a commission eventually developed a measurement system, similar to the British Moorsom system, which is still in use today.

TONNAGE PERSONNEL: Mr. David Karnes will be out of the office November 21 – December 3, 2014. Please direct any day to day vessel measurement questions to Mr. Marcus Akins at marcus.j.akers@uscg.mil or 703-872-6787. In addition, the MSC will be closed on November 27, 2014 in observance of the Thanksgiving holiday.

Weekly Notes are issued by the Coast Guard Marine Safety Center’s Tonnage Division (MSC-4) for use by organizations that perform measurement work on the Coast Guard’s behalf. They are for informational purposes only, and are not intended as, nor should they be construed to represent, revisions of or substitutes for applicable statutes or regulations or established interpretations of either.

Measurement Organization Weekly Notes – 11/12/2014

ITEMS: Least Molded Depth; Quarterly Conferences

LEAST MOLDED DEPTH: The least molded depth (D_{LM}) is of critical importance when establishing a vessel's Convention length. After much discussion, IMO agreed to the following TM.5/Circ.6 figure, which is consistent with longstanding Coast Guard policy. Note that this treatment is different from that used under Load Line Convention interpretations for certain vessels with a "reverse rake" keel.

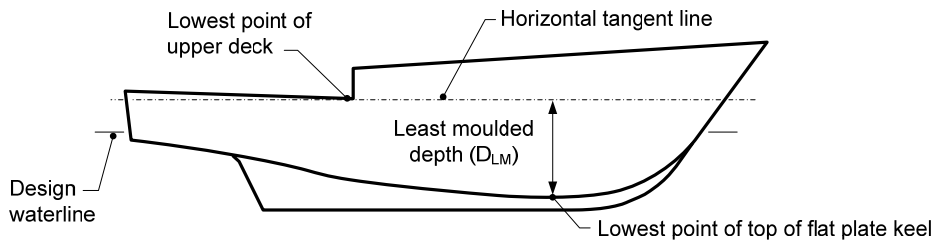

QUARTERLY CONFERENCES: The Tonnage Division is moving forward with a plan to hold - on a trial basis - quarterly telephone conferences with each authorized measurement organization to exchange information and provide training opportunities on relevant topics. Contractor participation will be at measurement organization discretion. Topics planned during these first sessions include, but are not limited to, determination of the uppermost complete deck, propelling machinery deductions, tonnage file requirements, space accountability (exemptions vs. deductions), and treatment of semi-enclosed spaces under the Convention Measurement System.

Weekly Notes are issued by the Coast Guard Marine Safety Center's Tonnage Division (MSC-4) for use by organizations that perform measurement work on the Coast Guard's behalf. They are for informational purposes only, and are not intended as, nor should they be construed to represent, revisions of or substitutes for applicable statutes or regulations or established interpretations of either.

Measurement Organization Weekly Notes – 11/04/2014

ITEMS: Exempted Spaces; Veterans Day Closure; Tonnage Personnel

EXEMPTED SPACES: In applying Regulatory Measurement System rules to a “pilot house,” measurement organizations must keep in mind the distinction between exemptible and deductible spaces. A space used exclusively for controlling the vessel is exempted as wheelhouse space, whereas certain spaces, including those used exclusively for navigating the vessel or accommodating the crew, may be deducted if properly marked. The following example illustrates how such spaces in the pilot house of a small vessel could be accounted for:

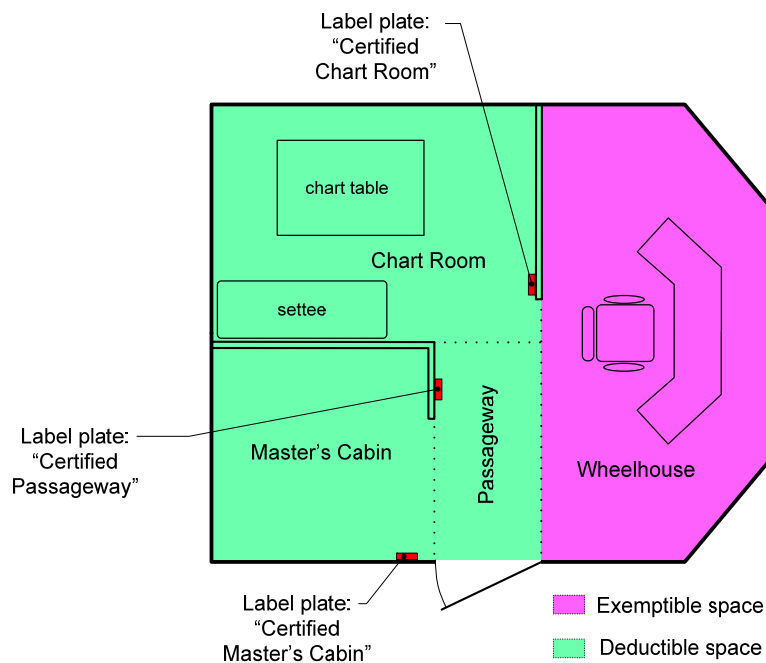

VETERANS DAY CLOSURE: On Tuesday, November 11th, the Marine Safety Center will be closed along with other federal offices in observance of the Veterans Day holiday.

TONNAGE PERSONNEL: Mr. Marcus Akins will be out of the office November 10-11, 2014. During that time, please forward any questions on tonnage standards or file requests to Mr. Brian Ellis at 703-872-6788

Weekly Notes are issued by the Coast Guard Marine Safety Center's Tonnage Division (MSC-4) for use by organizations that perform measurement work on the Coast Guard's behalf. They are for informational purposes only, and are not intended as, nor should they be construed to represent, revisions of or substitutes for applicable statutes or regulations or established interpretations of either.

Measurement Organization Weekly Notes – 10/28/2014

ITEMS: Open Vessels and Strakes; Dimension Labels; Marking of Spaces

OPEN VESSELS AND STRAKES: In applying requirements regarding open vessels, MTN 01-99 CH-7 uses the term “upper strake”. The following illustration identifies locations of the related term “sheerstrake” on a vessel c. 1900. Note that per a 1950 Treasury Decision, the “upper strake of a bulwark which consists of planking or plating not attached to hull frames which extend above the deck is the upper strake of the hull within the meaning” of the tonnage regulations “if it is substantially a continuation upward of the skin of the vessel.” We advise you contact the Tonnage Division should you have questions regarding measurement of open vessels fitted with bulwarks.

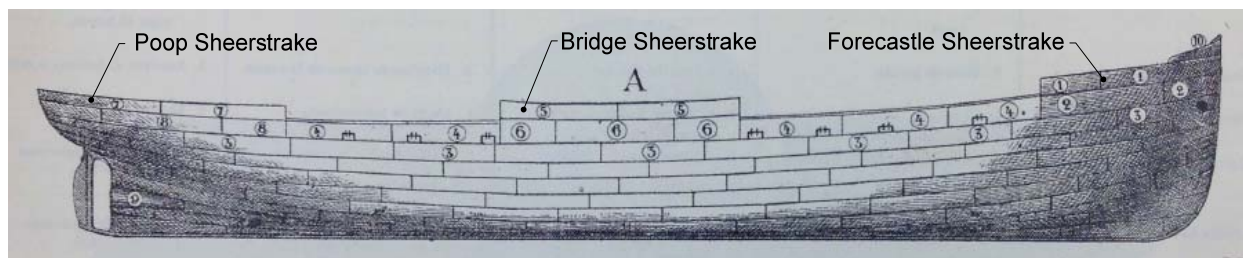

Source: Challamel, P. (1924) *From Keel to Truck*. Paris: Société d'Éditions Géographiques, Maritimes et Coloniales.

DIMENSION LABELS: New requirements for graphical representations - in effect since this summer - use the term “dimension lines”. The following example illustrates this term for an overall length measurement.

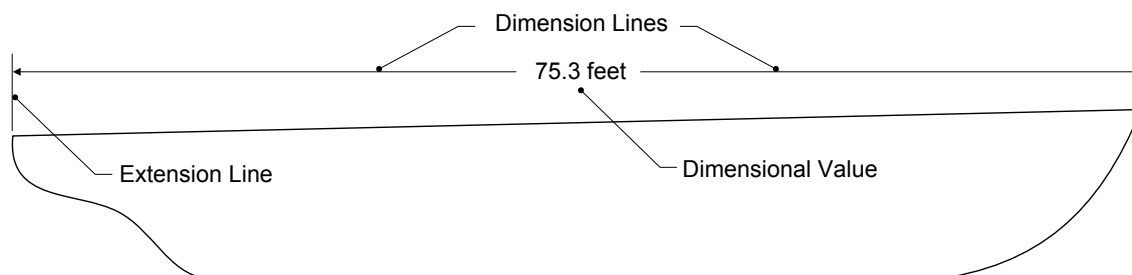

MARKING OF SPACES: We recently encountered some confusion on the subject of marking spaces under the Regulatory Measurement System. Please note there is no requirement to mark exempted spaces, nor is there a requirement to mark a deducted propelling machinery space. Marking requirements for other deducted spaces are found in MTN 01-99 CH-7, section 69.119.

Weekly Notes are issued by the Coast Guard Marine Safety Center's Tonnage Division (MSC-4) for use by organizations that perform measurement work on the Coast Guard's behalf. They are for informational purposes only, and are not intended as, nor should they be construed to represent, revisions of or substitutes for applicable statutes or regulations or established interpretations of either.

Measurement Organization Weekly Notes – 10/21/2014

ITEMS: MSC Tonnage Decisions; Uppermost Complete Deck; Tonnage Personnel

MSC TONNAGE DECISIONS: The Tonnage Division routinely responds to requests for decisions on interpretations of the tonnage regulations. These decisions are provided on a case basis and, unless otherwise directed, apply only to the vessel or circumstance for which the decision is requested. A decision letter does not establish policy. Accordingly, measurement organizations should continue to contact the Tonnage Division regarding vessel designs and configurations which are not directly addressed by the MTN.

UPPERMOST COMPLETE DECK: We strongly recommend that the first step in the formal measurement of any vessel under the Regulatory system is identifying the uppermost complete deck (UCD) in accordance with MTN 01-99 CH-7. See the example below, in which no tonnage opening is fitted in the vessel. The deck shown in red constitutes a stepped UCD, regardless of whether or not the “Main Deck” continues to the stem within the forecastle. Only after the UCD has been properly identified, should consideration be given to establishing the line of the UCD.

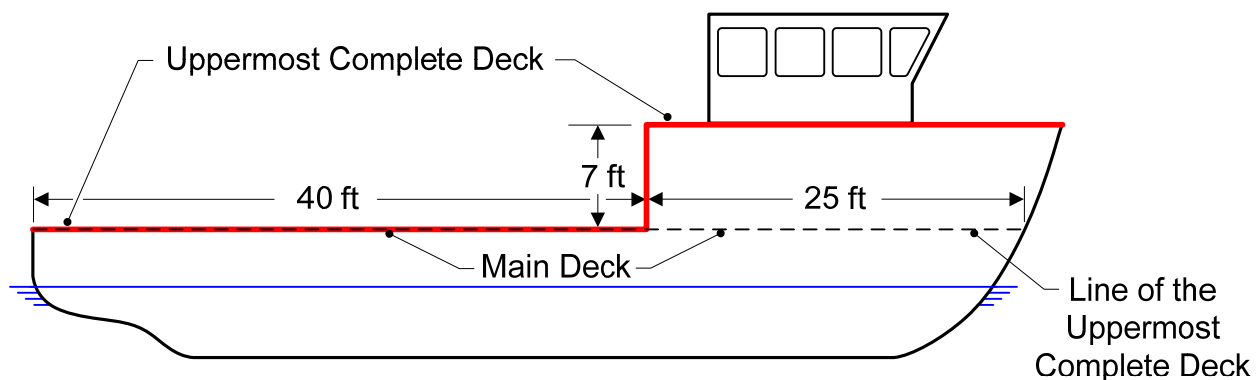

TONNAGE PERSONNEL: Mr. Marcus Akins will be out of the office October 23-27, 2014. During that time, please forward any questions on tonnage standards or file requests to Mr. Brian Ellis at 703-872-6788.

Weekly Notes are issued by the Coast Guard Marine Safety Center's Tonnage Division (MSC-4) for use by organizations that perform measurement work on the Coast Guard's behalf. They are for informational purposes only, and are not intended as, nor should they be construed to represent, revisions of or substitutes for applicable statutes or regulations or established interpretations of either.

Measurement Organization Weekly Notes – 10/14/2014

ITEMS: IACS Paper; Excluded Spaces Not Optional; Feedback on New Weekly Notes Format

IACS PAPER: The U.S. is preparing a paper commenting on an [IACS paper](#) submitted last year concerning Convention measurement of metal and non-metal structures. We would appreciate any input from our IACS members on this matter, as there was some debate at IMO and we are not clear what IACS was trying to say. (e.g., does IACS consider the term “other superstructures” to include deckhouses?) Please forward any comments to Mr. David Karnes at david.b.karnes@uscg.mil. The following figure illustrates the problem—we believe—that was behind the IACS paper.

Vessel made of GRP “sandwich” construction throughout

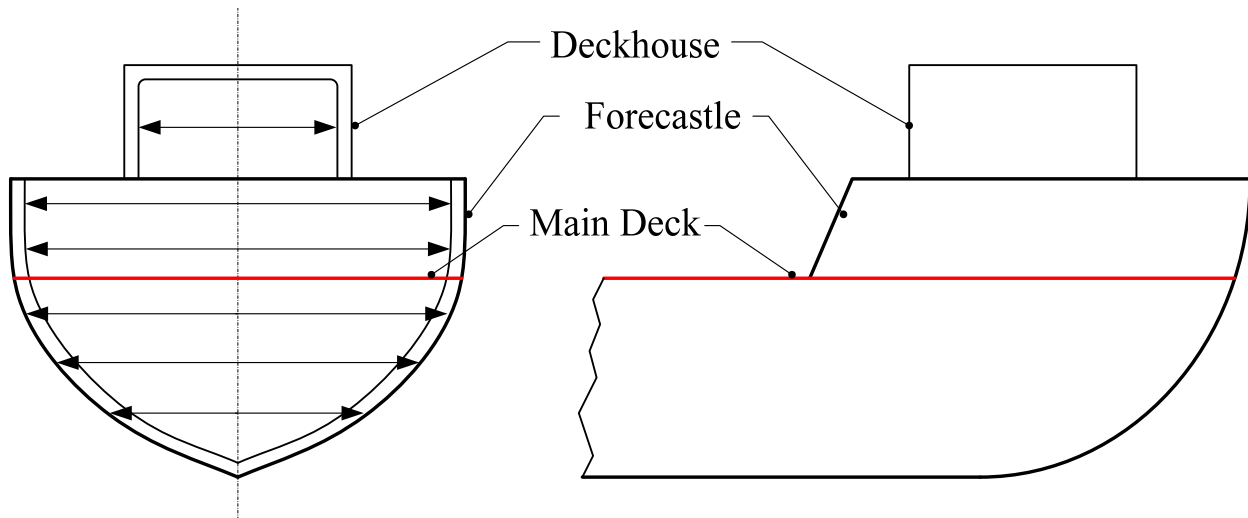

EXCLUDED SPACES NOT OPTIONAL: Please note that spaces which are eligible for exclusion under the Convention must be excluded if they meet the requirements of MTN 01-99 CH-7, 69.61. The TM Convention uses the word “shall” in this context.

FEEDBACK ON NEW WEEKLY NOTES FORMAT: We received a number of comments regarding the new .pdf format for the weekly notes. Thank you. We will continue to evaluate adjustments to the previous format.

Weekly Notes are issued by the Coast Guard Marine Safety Center's Tonnage Division (MSC-4) for use by organizations that perform measurement work on the Coast Guard's behalf. They are for informational purposes only, and are not intended as, nor should they be construed to represent, revisions of or substitutes for applicable statutes or regulations or established interpretations of either.

Measurement Organization Weekly Notes – 10/7/2014

Items:

NEW FORMAT FOR WEEKLY NOTES; COLUMBUS DAY CLOSURE

POSSIBLE NEW FORMAT FOR WEEKLY NOTES: Going forward, we are considering changes to the weekly notes that will include an increased use of graphics. In order to incorporate graphics in an accessible format across various email platforms, we have developed this Adobe .pdf format on a trial basis. Please feel free to provide any suggestions on this new format to Mr. David Karnes at david.b.karnes@uscg.mil (e.g., is this format convenient or do you prefer the old format without graphics?)

COLUMBUS DAY CLOSURE: On Monday, the Marine Safety Center will be closed along with other federal offices in observance of a holiday to recognize Columbus's discovery of America in 1492. Interestingly, all reconstructions of Columbus's ships are based on the tonnage of the *Niña*, with reconstructions of the *Pinta* and *Santa Maria* scaled up from this ship. According to Michele de Cuneo, who in 1494 sailed to Cuba and back aboard *Niña*, its burthen (tonnage) was "about 60 tons." On a voyage to Rome in 1497 she carried a cargo of 51 tons. During that era in Spain, the tonnage measure referred to a vessel's cubic capacity in terms of tuns (casks) of wine, roughly equivalent to 40 cubic feet each. Harvard historian Samuel Eliot Morison, himself a sailor who retraced Columbus's route across the Atlantic, estimated the dimensions of a 55- to 60-ton caravel of 1492 as:

Overall length (between perpendiculars): ~70 feet

Length of keel: ~50 feet

Beam: ~23 feet

Depth of hold amidships: ~9 feet

Source: Morison, S. E. (1942). *Niña, Pinta and Santa Maria*. In *Admiral of the Ocean Sea*. Boston: Little, Brown and Company



Weekly Notes are issued by the Coast Guard Marine Safety Center's Tonnage Division (MSC-4) for use by organizations that perform measurement work on the Coast Guard's behalf. They are for informational purposes only, and are not intended as, nor should they be construed to represent, revisions of or substitutes for applicable statutes or regulations or established interpretations of either.

Measurement Organization Weekly Notes – 9/30/2014

EDITOR'S NOTE: The weekly notes were not published last week. We apologize for the interruption of this service. As of this week, publication resumes with Mr. David Karnes serving as editor.

PROPELLING MACHINERY: According to Section 69.121(c)(7) of MTN 01-99 CH-7, if the boundaries of the propelling machinery space are continuous fair lines, heights are measured at the fore and aft ends and at the center of the space from the bottom frames, floors, or tank top of a double bottom (water ballast) up to the line of the crown. A breadth is measured at half-height of each height. The product of the length, mean breadth, and mean height, divided by 100, is the tonnage of the space.

APPLICATIONS FOR MEASUREMENT SERVICES: Section 6.2(a)(7) of MTN 01-98 CH-12 requires that the application for measurement services be included in a vessel's tonnage file. Measurement organizations should note that written notifications provided to the applicant, such as remeasurement determinations, are also required to be included in the vessel's tonnage file.

COLLECTION OF INFORMATION: The Coast Guard issued a federal register notice regarding the burden imposed by the Federal government on the public for collecting certain information, which includes submission of measurement applications, and invites comments on whether the information collection request should be granted based on the collections being necessary for the proper performance of Departmental functions. A link to this notice follows: [79FR56083](https://www.federalregister.gov/documents/2014/09/17/2014-18783). Comments must either be submitted to our online docket via <http://www.regulations.gov> on or before November 17, 2014 or reach the Docket Management Facility by that date.

Weekly Notes are issued by the Coast Guard Marine Safety Center's Tonnage Division (MSC-4) for use by organizations that perform measurement work on the Coast Guard's behalf. They are for informational purposes only, and are not intended as, nor should they be construed to represent, revisions of or substitutes for applicable statutes or regulations or established interpretations of either.

Measurement Organization Weekly Notes - 9/23/2014

Weekly notes not published.

Weekly Notes are issued by the Coast Guard Marine Safety Center's Tonnage Division (MSC-4) for use by organizations that perform measurement work on the Coast Guard's behalf. They are for informational purposes only, and are not intended as, nor should they be construed to represent, revisions of or substitutes for applicable statutes or regulations or established interpretations of either.

Measurement Organization Weekly Notes - 9/17/2014

TONNAGE CERTIFICATION HISTORY: Section 2.4(f) of MTN 01-98 CH-12 requires that the date and place of the last previous remeasurement be listed on the reverse side of the certificate as part of the vessel's tonnage certification history. Measurement organizations should note that the latest revision to MTN 01-98 clarifies that the term "last previous remeasurement" refers to the remeasurement previous to the vessel's current measurement, and therefore the associated block on the ITC69 need be completed only if the vessel has undergone multiple remeasurements.

NOTIFICATION SPREADSHEETS: As mentioned in previous weekly notes, it is important that measurement organizations correctly complete all required information in the notification worksheet. In completing these worksheets, measurement organizations should note that in the "ACS Approval" column, the date should be entered in a MM/DD/YY format; and in the "Tonnage Assignment" column, the type of certificate issued should be entered (US or ITC). Also, as described in Enclosure (1) of the MTN, when a vessel is issued both a U.S and ITC Tonnage certificate, please note that separate rows are to be used for each certificate issued.

OVERSIGHT SUBMISSIONS: According to paragraph 4(d) of MTN 04-03 CH-2, work items selected for oversight shall be submitted to the MSC within five (5) working days of the date of the email providing notification of the selection. Measurement organizations should ensure compliance with this standard without the need of Tonnage Division intervention. Also, all tonnage files must be complete at the time of issuance of the tonnage certificate(s). This facilitates timely submission of tonnage files upon request for oversight, and ensures that the principal information used to assign tonnages and dimensions is readily available to any interested party.

Weekly Notes are issued by the Coast Guard Marine Safety Center's Tonnage Division (MSC-4) for use by organizations that perform measurement work on the Coast Guard's behalf. They are for informational purposes only, and are not intended as, nor should they be construed to represent, revisions of or substitutes for applicable statutes or regulations or established interpretations of either.

Measurement Organization Weekly Notes - 9/9/2014

UNDER-DECK RECESSES: According to Section 69.109(n) of MTN 01-99 CH-7, the volume of any portion of an outside shaft tunnel or other recess in the hull that is included in tonnage through the process of measurement is subtracted from the under-deck or between-deck tonnage. This is achieved through the provisions of Section 69.109(q)(7) which allow for subtracting out portions of breadth measurements that are outside the hull. Measurement organizations should note that there are no provisions for similarly subtracting from tonnage the volume of those portions of deck recesses that are below the line of the uppermost complete deck.

SUPERSTRUCTURE CALCULATION METHODS: For measurement of superstructure spaces under the Standard and Dual Measurement systems, the tonnage regulations allow only two methods for calculating volumes: two-dimensional Simpson's first rule integration or a simple geometric formula. Measurement organizations should note that simple formulae may only be used to calculate volumes of structures or their components if their dimensions and form correspond to that of a simple geometric shape. In all cases, an accurate volume must be attained when a simple geometric formula is used.

MIDDLE LINE OPENINGS: The Tonnage Division recently responded to an inquiry regarding middle line openings. Measurement organizations should note that, the provisions of Section 69.117(e) of MTN 01-99 CH-7 restrict the location of middle line openings to shelter decks. Also, middle line openings are restricted from being within a structure of any type. As such, open space resulting from a qualifying middle line opening cannot be progressed vertically through a subsequent middle line opening.

Measurement Organization Weekly Notes - 9/5/2014

NEW DRAWING REQUIREMENTS: We wish to highlight that all vessel tonnage files must include a vessel profile, a transverse section at amidships, and a tonnage drawing (regulatory measurement system only) for vessels being initially measured that were certificated after August 1, 2014. See the updated drawing requirements of MTN 01-98 CH-12. Failure to comply with this new requirement will result in nonconformities during any oversight review, and the need to immediately provide the missing drawings to the MSC.

PROPELLING MACHINERY: In accordance with Section 69.121(c) of MTN 01-99 CH-7, the methods utilized for measuring propelling machinery spaces are limited by the configuration of the space. For example, if the propelling machinery space is not bulkheaded off or is larger than necessary for the safe operation and maintenance of the propelling machinery, only the space occupied by the propelling machinery itself plus a working space of two feet, if available, on each side of the propelling machinery is measured for the engine room deduction.

FRAME OPENINGS: The Tonnage Division recently responded to an inquiry regarding penetration of ordinary frames. In accordance with Section 69.109(p) of MTN 01-99 CH-7, an ordinary frame may be penetrated by an intersecting frame when initially assembled, provided subsequent manufacturing steps are taken to render the final assembly to appear as an integral unit (such as by continuous welding). Additionally, openings which are not oversized may be penetrated by piping, ventilation, cabling, shafting and similar items of a non-structural nature without affecting breadth measurements.

Measurement Organization Weekly Notes - 8/26/2014

LIFT LEG WELLS: Over the past few years, the convention measurement system treatment of spaces within a hull which are open to the sea has been the subject of much review at IMO. While the lift legs themselves are ignored from measurement per Section 69.65(h)(4) of the MTN, their presence may affect the treatment of the leg wells as spaces open to the sea. Recently, the Tonnage Division responded to an inquiry concerning the treatment of wells containing buoyant lift legs “spuds”, where effectively, the wells were included in the Convention tonnage. Pending completion of the Coast Guard’s review of the IMO work, measurement organizations should refer any questions to Mr. Marcus Akins at (703)872-6787.

TONNAGE LENGTH: The Tonnage Division recently responded to an inquiry regarding the tonnage length for a vessel fitted with ordinary frames in both the bow and the stern. Admeasurers should note that, the provisions of Section 69.109(f) do not restrict tonnage length termination at the inboard face of ordinary end framing from being taken at the bow and stern simultaneously, provided the frames conform to all MTN requirements for their use in establishing the line of the ordinary frames.

USCG VESSEL DOCUMENTATION RENEWAL FEES: The USCG National Vessel Documentation Center (NVDC) recently amended the documentation regulations to establish a \$26 fee for renewals of Certificates of Documentation. The cost of renewals had previously been included in the Coast Guard’s general overhead cost. This rule becomes effective on November 10, 2014. The rule can be viewed at: <https://www.federalregister.gov/articles/2014/08/12/2014-18999/vessel-documentation-renewal-fees>

LABOR DAY CLOSURE: The Marine Safety Center will be closed for the Labor Day holiday on Monday, September 1ST. Normal business hours will resume on Tuesday September 2nd, although Mr. Akins will be out of the office that day. For matters that cannot wait, please forward any questions on tonnage standards or file requests to Mr. Brian Ellis at 703-872-6788.

Measurement Organization Weekly Notes - 8/11/2014

MTN 01-98 CH-12: The Marine Safety Center has issued a change to MTN 01-98. Please note the August 1, 2015 deadline for fully implementing the new Application for Formal Measurement Services form. All other new requirements are effective immediately, including those on labeling the vessel's length, breadth, and depth dimensions, on the vessel profile and transverse sections. A copy of MTN 01-98 CH-12 has been distributed to each of the authorized measurement organizations. MTN 01-98 CH-12 may also be obtained on the Coast Guard's website: <http://www.uscg.mil/hq/msc/tonnage/pubs.asp>.

OTHER MACHINERY SPACES: The Tonnage Division recently responded to an inquiry as to whether an enclosed fish processing van space was restricted from being exempted from gross tonnage as other machinery spaces under the Regulatory Measurement System, depending on its measurement treatment under the Convention system. Measurement organizations should note that, there are no such restrictions that would preclude exemption of an enclosed fish processing van space from being exempted in this manner.

OPEN VESSELS: Section 69.109(o)(3) of MTN 01-99 CH-7 states that any vessel, other than one having a mechanically refrigerated hold, that is not an open vessel and that has a tonnage length of less than 50 feet is measured as an open vessel, if the distance between the line of its tonnage deck and the upper edge of the upper strake is more than one-sixth of the midship depth. Measurement organizations should note that, tonnage files should include sufficient drawings or other graphical representations showing the height of the upper edge of the upper stake above the line of the tonnage deck, which were used to assess whether the vessel should be measured as an open vessel.

Measurement Organization Weekly Notes - 7/31/2014

U.S COAST GUARD BIRTHDAY: On August 4, 1790, Congress authorized the Secretary of the Treasury, Alexander Hamilton, to create a maritime service to enforce customs laws (1 Stat. L. 145, 175). Alternately known as the system of cutters, Revenue Service, and Revenue-Marine, this service was placed under the control of the Treasury Department. This service, known as the Cutter Revenue Service, eventually became what is now the U.S. Coast Guard. In 1967, the Coast Guard welcomed the tonnage program following its transfer from Customs.

TONNAGE PERSONNEL: Mr. Marcus Akins will be out of the office August 4-6, 2014. During that time, please forward any questions on tonnage standards or file requests to Mr. Brian Ellis at 703-872-6788.

Measurement Organization Weekly Notes - 7/24/2014

REPORTING OF MEASUREMENT WORK: When reporting work in accordance with Section 4.2(a) of MTN 01-98 CH-11, it is important that measurement organizations correctly complete all required blocks in the notification worksheet. Notifications are processed through software tools which cannot correct errors. Errors in notification worksheets can lead to unprocessed notifications.

COMMENT PERIOD CLOSED: The comment period for the Tonnage Regulations Amendments NPRM closed on July 7, 2014. As of today's date, the docket shows input from six commenters. The Coast Guard is currently considering this public input.

FINAL SUMMARY OF NPRM CHANGES: With the closure of the comment period, our summaries of the NPRM changes in these weekly notes will also come to a close. We will do so by highlighting the proposed revisions to section 46 CFR 69.109 which incorporates interpretations from MTN 01-99, as amended, which provide detail on identifying the tonnage deck, enumerating the decks to identify the second deck from the keel, identifying the line of the tonnage deck, determining the tonnage length, division of vessel into transverse sections, depths of transverse sections, breadths of transverse sections, spaces open to the sea, general requirements on ordinary frames.

TONNAGE PERSONNEL: Mr. Marcus Akins will be out of the office July 29, 2014. During that time, please forward any questions on tonnage standards or file requests to Mr. Brian Ellis at 703-872-6788.

Measurement Organization Weekly Notes - 7/15/2014

TM5.CIRC.6: According to the IMO website, the consolidated set of interpretations of the provisions of the International Convention on Tonnage Measurement of Ships, 1969 (TM.5/Circ.6), agreed upon by the Maritime Safety Committee in May of this year, has been posted. This circular supersedes circular TM.5/Circ.5.

MTN 01-98 UPDATE: As discussed in a previous weekly note, the Tonnage Division has distributed a draft change to MTN 01-98 CH-11 to the measurement organizations for comment. As a reminder, comments and/or general feedback are due no later than July 18, 2014.

TONNAGE REGULATION AMENDMENTS: In the Tonnage Regulations Amendments NPRM, the Coast Guard proposes to add section 46 CFR 69.108 to incorporate comprehensive requirements related to the “uppermost complete deck” as interpreted by MTN 01-99, as amended. This amendment proposes to restrict the uppermost deck from extending above any space exempted as open space, extending below the waterline, or resting directly on consecutive or alternating ordinary bottom frames or floors for over half of the tonnage length. It also proposes to identify deck discontinuities whose presence would disqualify a deck as being the uppermost complete deck, such as certain through-deck openings, middle line openings, deck recesses, and notches.

Weekly Notes are issued by the Coast Guard Marine Safety Center’s Tonnage Division (MSC-4) for use by organizations that perform measurement work on the Coast Guard’s behalf. They are for informational purposes only, and are not intended as, nor should they be construed to represent, revisions of or substitutes for applicable statutes or regulations or established interpretations of either.

Measurement Organization Weekly Notes - 7/8/2014

MTN 01-98: As discussed in a previous weekly note, the Tonnage Division has developed a draft change to MTN 01-98 CH-11 and distributed it to the measurement organizations for comment. This draft change principally features, among others, a standardized application for measurement services, revised tonnage calculations requirements to address 3-D modeling tools, and expansion of the tonnage file drawings requirements. Should you have any questions regarding the tonnage measurement process or the draft change to the MTN, please contact Mr. Marcus Akins at marcus.j.akins@uscg.mil.

COMPARTMENT BOUNDARIES: The Tonnage Division recently responded to an inquiry regarding progression of open space through an opening created by a partial bulkhead. In accordance with Section 69.117(d)(3)(i) MTN 01-99 CH-7, for situations where one boundary of a compartment is not clearly defined, the "projected" boundary that delineates the compartment is taken as the continuation of the bulkhead of the compartment from which open space is progressing. Also, in those situations where an exterior bulkhead bounding the compartment is absent, the outermost edge of the deck overhead delineates the boundary of the compartment.

TONNAGE PERSONNEL: Mr. Marcus Akins will be out of the office July 9-11 2014. During that time, please forward any questions on tonnage standards or file requests to Mr. Brian Ellis at 703-872-6788.

Measurement Organization Weekly Notes - 7/1/2014

PRINCIPAL DIMENSIONS: As mentioned in a previous weekly note, during an oversight activity, the Tonnage Division will perform a complete verification of the assigned registered dimensions and overall length. Recent oversight activities resulting in nonconformities related to principal dimensions indicate that administrative mistakes are the most frequent type of error. As indicated in Section 4.2(d) of MTN 01-98 CH-11, errors exceeding 1% are considered major nonconformities and will require recertification of the vessel. Measurement organizations are highly encouraged to review their quality assurance processes and, if one is not already in place, institute a two-party check for principal dimension calculations.

TONNAGE REGULATION AMENDMENTS: As mentioned in previous weekly notes, a Notice of Proposed Rulemaking (NPRM) regarding proposed changes to the tonnage regulations was issued by the Coast Guard on April 7, 2014. Comments on this NPRM should be submitted by July 7, 2014. A link to this notice follows: [79FR19420](#).

INDEPENDENCE DAY HOLIDAY CLOSURE: The Marine Safety Center will close on Friday, July 4th for the Independence Day holiday. Normal business hours will resume on Monday, July 7th.

TONNAGE PERSONNEL: Mr. Marcus Akins will be out of the office July 2-7 2014. During that time, please forward any questions on tonnage standards or file requests to Mr. Brian Ellis at 703-872-6788.

Measurement Organization Weekly Notes - 6/24/2014

Weekly notes not published.

Weekly Notes are issued by the Coast Guard Marine Safety Center's Tonnage Division (MSC-4) for use by organizations that perform measurement work on the Coast Guard's behalf. They are for informational purposes only, and are not intended as, nor should they be construed to represent, revisions of or substitutes for applicable statutes or regulations or established interpretations of either.

Measurement Organization Weekly Notes - 6/19/2014

INTERIOR VS. EXTERIOR OPENINGS: The Tonnage Division recently responded to an inquiry regarding interior bulkheads. Please note, in accordance with Section 69.117(d)(3)(ii)(1)(a) of MTN 01-99 CH-7, interior bulkheads are bulkheads which are inside of the outer boundary of a structure which does not adjoin any portion of a space which is eligible for exclusion under Section 69.61 of the MTN. For structures with an open side or sides, the outer boundary is established by the outboardmost edge of the deck that covers the structure.

PRE-1990 VESSEL DIMENSIONS: Registered dimensions assigned prior to, and based on definitions prior to October 12, 1989 should be shown on the U.S. Tonnage Certificate if the vessel has not undergone changes which affect any of those dimensions or has not been remeasured at the request of the owner to reflect the new registered dimensions definitions. For vessels being assigned tonnages only for the purpose of issuance of an International Tonnage Certificate, retain the Pre-1990 dimensions in the appropriate blocks. If Pre-1990 dimensions are shown, place an "X" in the "Registered Dimensions" block.

TONNAGE REGULATION AMENDMENTS: In the Tonnage Regulations Amendments NPRM, the Coast Guard proposes to amend 46 CFR 69.61 by incorporating interpretations from MTN 01-99, as amended, which provide for treatment of space below the upper deck, which qualify as "open to the sea", as an excluded space.

Measurement Organization Weekly Notes - 6/10/2014

PUBLIC MEETING: As mentioned in the previous weekly note, on June 5, 2014, the Tonnage Division hosted a public meeting on the Tonnage Regulation Amendments NPRM. An audio recording of the public meeting as well as a written summary of the meeting and comments will be made available in the online docket in the near future.

TONNAGE REGULATION AMENDMENTS: In the Tonnage Regulations Amendments NPRM, the Coast Guard proposes to amend 46 CFR 69.59 to incorporate the concept of temporary deck equipment - now generalized to “portable enclosed space” - found in NVIC 11-93, as amended, which states that “any enclosed space of a semi-permanent nature located on the weather decks of a vessel and which cannot be considered as deck cargo” should be considered enclosed volume to be included in tonnage.

TONNAGE PERSONNEL: Mr. Brian Ellis will be out of the office June 10-13, 2014. During that time, please forward any questions on tonnage applicability and CG Number requests to Mr. Marcus Akins at (703)872-6787 or marcus.j.akers@uscg.mil.

Measurement Organization Weekly Notes - 6/4/2014

MTN 01-98 UPDATE: The MSC is in the process of finalizing a new change to our Tonnage Administrative Policy MTN, which we hope to circulate for comment to measurement organizations by the end of next week (COB Friday, June 13th). This draft MTN change provides for implementation of the long anticipated standardized formal measurement application and several other updates, including updated requirements for tonnage file drawings and other information. We are considering a telephone conference call with measurement organization principals to discuss this draft change, after they have had the opportunity to review it.

REGISTERED DEPTH: In accordance with Section 69.53 of MTN 01-99, CH-7, registered depth equals the vertical distance amidships between the lower and upper terminus of the vessel. The upper terminus is taken at the line of the upper deck at the vessel's side or, if the vessel has rounded gunwales, from the intersection of the line of the upper deck extended to the molded line of the shell plating as though the gunwales were of angular design. The lower terminus is taken at top of the flat plate keel, or equivalent. For vessels with a cambered upper deck, measurement organizations should note that the registered depth is not taken at the upper terminus of the camber, but at the line of the upper deck at the vessel's side.

MR. KARNES OUT ON TONNAGE EXCHANGE PROGRAM: Mr. David Karnes will be out of the office to participate in an MSC Exchange Program with ABS from Monday, June 9th until Friday, June 13th. Please direct any day to day vessel measurement questions on to Mr. Marcus Akins at marcus.j.akers@uscg.mil or 703-872-6787.

Measurement Organization Weekly Notes - 5/28/2014

PUBLIC MEETING: The public meeting on the Tonnage Regulation Amendments NPRM is scheduled for June 5, 2014 at the U.S. Coast Guard Recruiting Command (CGRC), 4200 Wilson Boulevard, in the Alexander Hamilton Room, 6th floor, Arlington, VA 20598-7200. Additional details can be found at <https://www.federalregister.gov/articles/2014/05/21/2014-11789/tonnage-regulations-amendments>. Please notify Mr. Marcus Akins at marcus.j.akers@uscg.mil or 703-872-6787 if you plan to attend.

TONNAGE REGULATION AMENDMENTS: In the Tonnage Regulations Amendments NPRM, the Coast Guard proposes to add section 46 CFR 69.20 to provide comprehensive requirements within the tonnage measurement regulations on how tonnage thresholds in international agreements and Federal statutes and regulations are to be applied, including alternate tonnage thresholds. These requirements are based on provisions of the tonnage measurement law and the Convention, and are consistent with the interpretations of NVIC 11-93, as amended.

OVERSIGHT FOLLOW UP: Measurement organizations should note that, per MTN 01-98 CH-11, not all corrective actions resulting from oversight require follow-up with the MSC. Each oversight letter will include a request for follow-up, if required. When follow-up is requested, as required by MTN 04-03 CH-2, measurement organizations shall respond within 30 days of receipt of the MSC letter, unless otherwise specified or authorized by the MSC.

TONNAGE STAFF AVAILABILITY: On Friday, May 30th, Mr. Akins will out of the office attending the Commandant's Change of Command ceremony. Please direct any questions on tonnage matters that cannot wait until the next business day to Mr. David Karnes at 703-872-6789.

Measurement Organization Weekly Notes - 5/20/2014

WATER BALLAST JUSTIFICATIONS: The Tonnage Division recently responded to an inquiry regarding water ballast justifications. Please note that if the water ballast space(s) or its use, purpose or piping is changed, the vessel owner or operator must report the change promptly to a measurement organization for a determination as to whether a tonnage remeasurement is required. Oftentimes, vessel modifications result in changes in loading conditions which affect stability, immersion or trim, preloading, or seakeeping.

TONNAGE REGULATION AMENDMENTS: In the Tonnage Regulations Amendments NPRM, the Coast Guard proposes to amend 46 CFR 69.19 to clarify that remeasurement may be optionally performed to reflect the latest measurement rules, or may be required as a result of a change in the use of spaces or vessel service, for example, as might occur if a water ballast justification approval was in effect under § 69.117(f)(4).

MEMORIAL DAY CLOSURE: The Marine Safety Center will be closed for the Memorial Day holiday, on Monday May 26th. Normal business hours will resume on Tuesday May 27th.

Measurement Organization Weekly Notes - 5/15/2014

ELECTRONIC RECORDS: The Tonnage Division recognizes that measurement organizations are increasing transitioning to electronic tonnage records. While MTN 01-98 CH-11 currently does not include specific requirements on electronic records, please note that long-term tonnage records kept in accordance with Section 6.3 MTN 01-98 CH-11 should be in a form that will be accessible in the future (e.g., Adobe Portable Document Format (pdf)). We recommend that hull and superstructure offsets that are part of a vessel's tonnage file be printed and saved as a hard copy or saved electronically in an easily printable format.

SUPERSTRUCTURE FRAMES: Section 69.113 of MTN 01-99, CH-7 provides the method of calculating the tonnage of all superstructures. Please note that, per Section 69.113(b)(1) of the MTN, all longitudinal and transverse measurements used to establish superstructure tonnage are terminated at the line of the normal framing. For example, the length of each structure is measured to the line of the normal framing at each end and to the skin of the superstructure if normal framing is not present.

TONNAGE REGULATION AMENDMENTS: In the Tonnage Regulations Amendments NPRM, the Coast Guard proposes to amend 46 CFR 69.13 to allow for grandfathering of superseded tonnage measurement rules under this part 69. These proposed amendments are based on similar grandfathering provisions in MTN 01-99, as amended, except that grandfathering is not extended to an identical sister vessel, consistent with grandfathering approaches used in applying other marine safety regulations. The proposed grandfathering provisions take into account the effective date of the regulation and the contract date for construction of, or modification to, the vessel and allow for grandfathering of previous interpretations only if the codified conditions for grandfathering are met.

Measurement Organization Weekly Notes - 5/6/2014

SIMPLIFIED TONNAGE FORM: The Tonnage Division was recently made aware that customers utilizing Windows Internet Explorer 9 may experience minor difficulty when attempting to fill in the “depth” block in Section 6 - Overall Dimensions of the Application for Simplified Measurement (form CG-5397). Anyone experiencing this issue should save the CG-5397 outside of the browser to attempt to resolve the issue or call Mr. David Karnes at 703-872-6789.

TONNAGE REGULATION AMENDMENTS: In the Tonnage Regulations Amendments NPRM, the Coast Guard proposes to amend 46 CFR 69.11 to align it with Sections 303(c) and (f) of the 2010 Coast Guard Authorization Act. This amendment would provide for identical tonnage measurement treatment of documented and undocumented U.S. flag vessels and preclude foreign flag vessels greater than 79 feet in length from being measured under the Regulatory Measurement System.

TONNAGE PERSONNEL: Mr. Marcus Akins will be out of the office May 8-11 2014. During that time, please forward any questions on tonnage standards or file requests to Mr. Brian Ellis at 703-872-6788.

Measurement Organization Weekly Notes - 4/29/2014

TONNAGE REGULATION AMENDMENTS: In the Tonnage Regulations Amendments NPRM, the Coast Guard proposes to amend 46 CFR 69.9 to create new terms and introduce new concepts. These include, among others, “deck cargo,” “gross register tonnage,” “gross tonnage ITC,” “net register tons,” “non-self-propelled vessel,” “Regulatory Measurement System,” “remeasurement,” “self-propelled vessel,” and “portable enclosed space,” based on definitions for similar terms in NVIC 11-93, as amended.

TONNAGE DIVISION WEBSITE: The Tonnage Division has updated the tonnage information on the Marine Safety Center’s tonnage webpage at <http://www.uscg.mil/hq/msc/tonnage.asp>. This update includes the addition of the MTN on “Technical Support and Oversight” and historical versions of MTN 01-98 and MTN 01-99. As a reminder, the information on this website is provided as an alternative to the tonnage information and publications located on the Coast Guard’s Homeport website.

TONNAGE PERSONNEL: Mr. Marcus Akins will be out of the office May 1-5 2014. During that time, please forward any questions on tonnage standards or file requests to Mr. Brian Ellis 703-872-6788.

Measurement Organization Weekly Notes - 4/22/2014

TONNAGE CALCULATIONS: According to Section 6.2(a)(1) of MTN 01-98, CH-11, authorized measurement organizations may use any calculation format that meets the minimum requirements for Convention System tonnage calculations. If these tonnages are generated using computer modeling tools, the tonnage file must include written or electronic output showing all dimensions involved in the calculations. For example, hull and superstructure offsets, which provide a location in the vessel to at least the nearest frame (or equivalent) for all dimensions used in the volume calculations, will meet this minimum requirement.

TONNAGE REGULATION AMENDMENTS: In the Tonnage Regulations Amendments NPRM, the Coast Guard proposes to amend 46 CFR 69.3 to align it with the tonnage measurement law, Title 46 U.S.C. 14104, which requires the measurement of all U.S. and foreign flag vessels, regardless of size, for which the application of an international agreement or other law of the United States depends on the vessel's tonnage. This proposed change expands the scope of the regulations to apply to foreign flag vessels, as well as U.S. flag vessels, and removes a 5 net ton minimum size restriction for measurement of U.S. flag vessels.

REPORTING OF MEASUREMENT WORK: Measurement organizations are reminded that, in accordance with Section 4.2(a) of MTN 01-98 CH-11, notification of completion of each tonnage work item shall be made in accordance with MTN 04-03, as amended. This notification must be made in the form of an email attachment delivered to assessment-msc@uscg.mil using the worksheet shown in enclosure (1) of MTN 04-03, as amended and available for download at <http://www.uscg.mil/hq/msc/tonnage/pubs.asp>. Tonnage work which has not been reported should be forwarded to the MSC using this notification process immediately.

Weekly Notes are issued by the Coast Guard Marine Safety Center's Tonnage Division (MSC-4) for use by organizations that perform measurement work on the Coast Guard's behalf. They are for informational purposes only, and are not intended as, nor should they be construed to represent, revisions of or substitutes for applicable statutes or regulations or established interpretations of either.

Measurement Organization Weekly Notes - 4/15/2014

TONNAGE REGULATION AMENDMENTS: In the Tonnage Regulations Amendments NPRM, the Coast Guard proposes to amend 46 CFR 69.1 to align it with Sections 303(c) and (f) of the 2010 Coast Guard Authorization Act, which eliminates disparate treatment of documented and undocumented U.S. flag vessels, and to reflect the use of tonnage for environmental and security purposes.

PUBLIC MEETING: The Coast Guard plans to hold one public meeting on the Tonnage Regulation Amendments NPRM. A notice with the specific date and location of the meeting will be published in the Federal Register as soon as these details have been determined. Individuals interested in receiving this notice personally should submit their contact information to "msc@uscg.mil" with "Tonnage Public Meeting" in the subject line.

TONNAGE PERSONNEL: Mr. Brian Ellis will be out of the office April 14-18 2014. During that time, please forward any questions on tonnage applicability to Mr. Marcus Akins at (703)872-6787 or marcus.j.akers@uscg.mil and forward CG Number requests to Mr. David Karnes at david.b.karnes@uscg.mil.

Measurement Organization Weekly Notes - 4/8/2014

TONNAGE REGULATION AMENDMENTS: The Coast Guard issued a Notice of Proposed Rulemaking (NPRM) regarding proposed changes to its tonnage regulations by implementing amendments to the tonnage measurement law made by the Coast Guard Authorization Act of 2010. This rulemaking would also codify principal technical interpretations issued by the Coast Guard, and incorporate administrative, nonsubstantive clarifications of and updates to the tonnage regulations. A link to this notice follows: [79FR19420](#). Comments should be submitted by July 7, 2014.

UPDATED TONNAGE GUIDE: The MSC has updated Tonnage Guide (TG) 3, Tonnage Measurement Records. The updated version, TG 3 CH-2, is available at <http://www.uscg.mil/hq/msc/tonnage/docs/TG.03.CH-2.pdf>.

SIMPLIFIED MEASUREMENT: The Tonnage Division recently responded to an inquiry regarding submission of simplified measurement system calculations in lieu of submitting an Application for Simplified Measurement (form CG-5397). In accordance with Section 69.205 of MTN 01-99 CH-7, an owner may apply for measurement under the simplified measurement system by completing an Application for Simplified Measurement (form CG-5397) or a Builder's Certification and First Transfer of Title (form CG-1261). The formulas included in Tonnage Guide 1 are only to assist vessel owners who are seeking to understand how the tonnage values are calculated from the data entered into the form.

Measurement Organization Weekly Notes - 4/1/2014

MSC INQUIRIES: MSC staff engineers have recently received several written inquiries for interpretations of the simplified and standard measurement system tonnage regulations. We wish to reiterate our advice that if you are at all in doubt as to whether an existing policy document covers the matter in question, please give us a call, and if necessary, submit your interpretation question via our electronic commerce procedures, outlined in our homeport website. If you have questions, please feel free to call Mr. Marcus Akins at 703-872-6787, or e-mail him at marcus.j.akers@uscg.mil.

APPLICATION FOR MEASUREMENT: Thank you to all who provided feedback on the draft standardized application for formal measurement services distributed to measurement organizations. The Tonnage Division appreciates and values your effort to support the U.S. tonnage measurement program.

COAST GUARD HISTORY: On April 1, 1967, the Department of Transportation Act, Public Law 89-670 became effective and transferred the Coast Guard from the Treasury Department to the newly-formed Department of Transportation (DOT). Under the provisions of this Act, the authority to measure and document vessels officially conveyed to the Secretary of DOT. In March of 2003, the Coast Guard was transferred to the newly established Department of Homeland Security where it remains today.

Weekly Notes are issued by the Coast Guard Marine Safety Center's Tonnage Division (MSC-4) for use by organizations that perform measurement work on the Coast Guard's behalf. They are for informational purposes only, and are not intended as, nor should they be construed to represent, revisions of or substitutes for applicable statutes or regulations or established interpretations of either.

Measurement Organization Weekly Notes - 3/25/2014

ORDINARY FRAMES: The Tonnage Division recently responded to an inquiry regarding the construction of ordinary frames. In accordance with Section 69.109(p)(2)(iii) of MTN 01-99 CH-7, a frame may be penetrated by piping, ventilation, cabling, shafting and similar items of a non-structural nature without affecting breadth measurements. Admeasurers should note that to “penetrate” a frame in the MTN means to intersect the frame via an opening in the frame. This does not, however, obviate the affect an oversized opening has on breadth measurements.

SPACES WITHIN A HULL OPEN TO THE SEA: At its meeting in London in January of this year, the SDC Sub-Committee considered an interpretation concerning whether spaces within a hull open to the sea should be included in the total volume of enclosed spaces. The Sub-committee agreed with the interpretation proposed by the Tonnage Correspondence Group which stated that spaces open to the sea should not be excluded from the total volume of enclosed spaces (V) if they are used for cargo and/or buoyancy purposes.

TONNAGE DATA SHEETS: The issue resulting from recent IT security system updates has been resolved and the Tonnage Division will resume inclusion of tonnage data sheets in file request responses.

Measurement Organization Weekly Notes - 3/18/2014

MARINE SAFETY MANUAL, VOLUME III: The US Coast Guard seeks comment on its draft revision to Volume III of the Marine Safety Manual (MSM, Vol. III, Marine Industry Personnel). The revisions include clarifications to the applicability of tonnage measurement systems for U.S. flag vessels as well as the incorporation of the 2010 amendments to the STCW Convention. Additionally, the draft revision addresses public comments received from the initial solicitation on August 9, 2013, as well as input from the Merchant Marine Personnel Advisory Committee (MERPAC). Comments should be submitted by May 16, 2014. 79 Fed. Reg. 14714 (March 17, 2014).

SDC 1 REPORT POSTED: The report of the SDC 1 Sub-Committee meeting in January has been issued and is available on the TM Convention Correspondence group's website: <http://www.uscg.mil/imo/slf/subcomdocs.asp>. Annex 4 of the report contains the updated draft interpretations, for approval by the Maritime Safety Committee. The intervention by the Bahamas on novel craft interpretation is summarized in the report along with India's intervention on the need to continue work on the TM Convention.

OPERATING STATUS: The Marine Safety Center was closed March 17, 2014 due to inclement weather (snow). Normal business hours have resumed as of Tuesday, March 18th.

Measurement Organization Weekly Notes - 3/13/2014

APPLICATION FOR FORMAL MEASUREMENT: As a result of our review of processes for tonnage measurement application submissions per our March 26, 2010 letter to measurement organizations, the Tonnage Division developed a draft standardized application for formal measurement services. We intend to incorporate this draft application in the upcoming MTN 01-98 revision mentioned in the weekly notes earlier this year. We have requested measurement organization feedback, and will consider their comments when we finalize this application.

TONNAGE DATA SHEETS: Due to recent IT security system updates, tonnage data sheets are currently unavailable for release. The timeline for resolution is unknown. We will resume releasing data sheets once this issue is resolved.

Measurement Organization Weekly Notes - 3/4/2014

TONNAGE LENGTH: The Tonnage Division recently responded to an inquiry regarding the tonnage length for a vessel fitted with a bulbous bow. Admeasurers should note that, in accordance with MTN 01-99, CH-7, for vessels with complex hull geometries at the extreme ends (e.g., SWATHs, mono-hulls with bulbous bows, etc.), the tonnage length is terminated on an imaginary plane that is perpendicular to the longitudinal axis of the vessel and tangent to the imaginary surface bounding the inboard faces of the ordinary frames at the extreme fore and aft location of this surface.

TONNAGE CERTIFICATE COPIES TO NVDC: Measurement organizations submitting tonnage certificates to the NVDC in accordance with MTN 01-98, CH-11 will now receive automated e-mail responses for documents filed through NVDC.PDF.FILING@uscg.mil. The NVDC requests that all emails submitted to this email address be sent formatted in plain text, without "html" formatting or pre-set features (such as decorative backgrounds or company logos). As a reminder, only ".pdf" attachments will be accepted (no .docs, .docx, .xls, etc.). Further details regarding this new process are available at <http://www.uscg.mil/hq/cg5/nvdc/nvdcnews.asp>.

OPERATING STATUS: The Marine Safety Center was closed March 3, 2014 due to inclement weather (snow). Normal business hours have resumed as of Tuesday, March 4th.

Measurement Organization Weekly Notes - 2/26/2014

ELECTRONIC COMMERCE: The Tonnage Division has recently upgraded its capability to view drawings, sketches, and similar files. We continue to encourage files submitted to support requests for interpretations to be submitted in “.pdf” format. If you are unable to send a drawing or sketch in “.pdf” format, AutoCAD files in a 2012 or earlier version are acceptable.

TONNAGE STAFF TO VISIT OSC: On Wednesday, February 26, 2014, Mr. Peter Eareckson and Mr. Brian Ellis will be out of the office visiting the Operations Systems Center (OSC) to discuss the development of a new version of the Coast Guard’s Marine Information for Safety and Law Enforcement (MISLE) database. The information provided in PSIX is derived from the MISLE database. Should you have any questions or concerns regarding the tonnage information produced by PSIX, please submit them to Mr. Brian Ellis at brian.t.ellis@uscg.mil.

Measurement Organization Weekly Notes - 2/19/2014

VESSEL NUMBER: In a previous weekly note, the Tonnage Division noted that measurement organizations seeking to determine if a vessel has a previously assigned unique identifier (Official Number or CG Number) could utilize any state registration numbers provided in the application for tonnage measurement to search for vessels in the Coast Guard sponsored PSIX website. Measurement organizations should also note that PSIX displays both CG Numbers and Official Numbers, and should use caution when transferring this unique identifier to the "Vessel Number" block of the tonnage certificate. For questions regarding the use of PSIX for vessel searches, contact Mr. Brian Ellis (703)872-6788.

CITIZENSHIP WAIVERS: On February 14, 2014, the U.S. Coast Guard promulgated a rule amending its regulations to include a description of the procedures for requesting and processing waivers of citizenship requirements on commercial fishing vessels. Included in the information required for these waivers is the vessel's tonnage, which will be used to verify the documentation status of the vessel. The rule comes into effect on 17 March. [79 Fed. Reg. 8864](#)

Measurement Organization Weekly Notes - 2/11/2014

1% SUBSTANTIAL ALTERATION CRITERIA: Despite efforts of the United States and others at SDC 1, the position of Canada and IACS as expressed in the correspondence group prevailed, and SDC 1 decided to retain the 1% criterion of TM.5/Circ.5, as modified to delete reference to national (GRT) tonnage and extend the criterion to Interim Scheme vessels. Although the U.S. position on this matter as reflected in NVIC 11-93 CH-3 remains unchanged, we are currently evaluating changes to the NVIC and other policy documents consistent with this international decision. It is almost certain that, barring any further developments, the U.S. will have to tighten its tolerances for oversight nonconformities provided for in MTN 01-98 CH-11, consistent with the SDC 1 action.

TONNAGE HISTORY: In 1789, the tonnage measurement function resided in the Department of Treasury, which was established by the First Congress along with the departments of State and War. It remained in Treasury until February 14, 1903 (note the date), when it was transferred to the newly created Department of Commerce and Labor. Tonnage measurement and its associated regulations resided under the direction of the Department of Commerce and Labor (later the Department of Commerce), until World War II, when the tonnage function was transferred back to Treasury. In 1967, the tonnage function was again transferred, this time to the newly created Department of Transportation. It remained at the Department of Transportation until moving to the newly created Department of Homeland Security, along with the rest of the Coast Guard, in 2003. As you can see, we are an extremely well-traveled governmental organization!

PRESIDENT'S DAY CLOSURE: The Marine Safety Center will be closed on Monday February 17, 2014 in observance of the President's Day holiday. We will resume normal business hours on February 18th.

Measurement Organization Weekly Notes - 2/5/2014

STRUCTURAL BOUNDARY SURFACES: At its recent meeting in London, the SDC Subcommittee considered an IACS proposed interpretation regarding the measurement of ships constructed of materials other than metal. The Sub-Committee agreed that this issue could be addressed by developing a draft Unified interpretation but further in-depth discussion was still required. Among the concerns raised by the tonnage drafting group was the need for additional clarity when applying the language “structural boundary surfaces” to composite sandwich constructions, and distinguishing what constitutes a hull structure, as opposed to a superstructure (i.e., spaces situated below the upper deck as opposed above the upper deck). The observer from IACS did not agree that there was a lack of understanding when making reference to the hull and superstructure.

FINALIZED IMO INTERPRETATIONS: The SDC Subcommittee also took note of ten “well-developed” draft interpretations and figures identified in table 3-2 of annex 1 to document SDC 1/INF.4 that received favorable support from the correspondence group but achieved only moderate consensus, and thus were not included in the draft TM.5 circular. These were further considered by the tonnage drafting group, and five of the interpretations and figures carried forward to the draft TM Circular, which was agreed to by the Sub-Committee.

TM69 CALCULATION FORMATS: During the SDC Subcommittee meeting, a number of the delegates knowledgeable on tonnage met informally for several hours, and exchanged information and ideas regarding the possible standardized of TM69 calculation formats. It became readily apparent that there are a variety of software tools in current usage (e.g., NAPA, GHS, Rhino, and Adobe Professional, not to mention a number of proprietary tools), many of which have incompatible data formats. It was eventually agreed that, as a practical matter, there is no easy way to place detailed geometry information in a standardized format that can be readily used on a worldwide basis, at least at the present time.

Measurement Organization Weekly Notes - 1/29/2014

SDC 1 MEETING: At its meeting in London last week, the SDC Subcommittee considered an IACS proposal for a 2% margin for remeasurement in instances where a ship has not been altered or modified, as contained in document SDC 1/4/4. The Subcommittee noted that the proposal had received support and should be taken forward. The SDC documents which have been published by IMO are available on the TM Convention Correspondence group's website:

<http://www.uscg.mil/imo/slf/subcomdocs.asp>.

SDC 1 MEETING: The SDC Subcommittee also agreed to continue work on the reduced gross tonnage parameter, which received quite some support. A future group is likely to be tasked to further develop a reduced gross tonnage parameter for accommodation spaces, taking into account document SDC 1/WP.7, the options in annex 3 to document SDC 1/4, and the proposal in document SDC 1/4/2.

REDUCED GROSS TONNAGE: Further to the weekly note above, the United States is currently preparing its position on this matter, and considering a related paper for submission to MSC 93. We note that during the Tonnage Correspondence Group's work, the United States supported the implementation of a reduced gross tonnage (GT_r) parameter. Comments and input regarding this matter should be submitted to Mr. Brian Ellis at brian.t.ellis@uscg.mil.

U.S COAST GUARD: On January 28, 1915, President Woodrow Wilson signed into law the "Act to Create the Coast Guard." This Act, which was passed by Congress on January 20, 1915, combined the Life-Saving Service with the Revenue-Cutter Service. As part of the military forces of the United States, the Coast Guard would begin operations under the Treasury Department in time of peace and as part of the Navy in time of war or when the President so directed.

Measurement Organization Weekly Notes - 1/22/2014

MTN 01-98: We are currently in the process of developing a revision to MTN 01-98. In addition to administrative edits, we intend to address applications for formal measurement. Questions or comments regarding potential changes to this MTN should be submitted to Mr. Marcus Akins at marcus.j.akers@uscg.mil.

OVERALL LENGTH: As mentioned in a previous weekly note, the 2010 Coast Guard Authorization Act requires the survey and classification of fishing vessels of at least 50 feet in overall length, built after July 1, 2012 and that operate beyond the three nautical mile limit. Admeasurers are reminded that the overall length does not include bowsprits, rudders, outboard motor brackets, swim platforms that do not contain buoyant volume, and other similar fittings and attachments that are not part of the buoyant hull envelope. If you have any questions as to whether a fitting or attachment is part of the buoyant hull envelope, please contact the MSC Tonnage Division.

OPERATING STATUS: The Marine Safety Center was closed January 21, 2014 due to inclement weather (snow). Normal business hours have resumed as of Wednesday January 22nd.

Measurement Organization Weekly Notes - 1/14/2014

TONNAGE FILES TRANSFER: Measurement organizations are reminded that, in accordance with Section 4.2(c) of MTN 01-98 CH-11, each tonnage file selected for oversight shall be transferred, or provided to the MSC as a complete electronic or paper copy. Should the electronic copy option be chosen, the electronic copy must include the tonnage records required under Section 6.2 of the MTN.

PUBLIC MEETING: As mentioned in the previous weekly note, a public meeting was held on January 9, 2014 to obtain input on matters before the SDC 1 Sub-Committee, including the tonnage work. During the meeting, one participant noted that compliance with a 1% substantial alteration criterion to determine vessel eligibility to use national tonnages when applying certain older tonnage-based provisions of international conventions would be problematic. A participant also noted concern regarding the ability of the Sub-Committee to establish agreement on a reduced gross tonnage parameter.

MARTIN LUTHER KING JR. (MLK) HOLIDAY: The Marine Safety Center will be closed on Monday, January 20th, in observance of the Birthday of Martin Luther King Jr. We will resume normal business hours on January 21st.

TONNAGE PERSONNEL: Mr. Marcus Akins will be out of the office Tuesday, January 21st. During that time, please forward any questions on tonnage standards or file requests to Mr. Brian Ellis 703-872-6788.

Measurement Organization Weekly Notes - 01/07/2014

VOLUME CALCULATIONS: According to the Section 69.65(g) of MTN 01-99, convention measurement system volume calculations must be made on a worksheet and be sufficiently detailed to permit easy review. If the calculations were performed using computer software, printed output showing a description of all dimensional information (e.g., hull and superstructure offsets) upon which volumes are based can be substituted for a worksheet.

PUBLIC MEETING: As mentioned in a previous weekly note, a public meeting will be held to obtain input on matters before the SDC 1 Sub-Committee, including the tonnage work. The official meeting date is Thursday, January 9, 2014, in Arlington VA. We expect discussions on the Tonnage Agenda Item will focus on the Correspondence Group's report, document SDC 1/4, which recommends the Sub-Committee agree to the Unified interpretations and associated draft TM.5 circular, and the 1% substantial alteration criterion to determine vessel eligibility to use national tonnages when applying certain older tonnage-based provisions of international conventions. Detailed information regarding the time and location is published in the Federal Register at <http://www.gpo.gov/fdsys/pkg/FR-2013-11-25/pdf/2013-28231.pdf>.

NOTICE OF ARRIVAL REQUIREMENTS: The USCG issued Marine Safety Information Bulletin (MSIB) 01-14 to address the Notice of Arrival requirements for privately owned yachts (i.e., foreign recreational vessels over 300 GT) arriving to the U.S. under Title 33 Code of Federal Regulations, part 160.202 and 160.203. The applicability of this regulation includes all foreign recreational vessels 300 GT ITC or more (300 GRT if GT ITC not assigned).

Measurement Organization Weekly Notes - 12/24/2013

HAPPY HOLIDAYS TO ALL OUR TONNAGE DIVISION FRIENDS, CUSTOMERS AND COLLEAGUES!

CHRISTMAS HOLIDAY: The Marine Safety Center will be closed for the Christmas holiday, on Wednesday, December 25th. Normal business hours will resume on Thursday, December 26th.

TONNAGE PERSONNEL: Mr. Brian Ellis will be out of the office December 26-27, 2013. Mr. Marcus Akins will be out of the office December 27, 2013 through January 3, 2014. During their absence, please contact 703-872-6731 for tonnage technical or applicability issues and CG Number or file requests which require responses outside of the Tonnage Division service standards in Section 2.3(b)(iii) and Section 5.4 of MTN 01-98 CH-11.

Measurement Organization Weekly Notes - 12/19/2013

PROPELLING MACHINERY: In accordance with Section 69.121(c) of MTN 01-99 CH-7, the methods utilized for measuring propelling machinery spaces are limited by the configuration of the space. For example, if the propelling machinery space is in the aft end of the hull, extends from side to side of the hull, and has a continuous bottom line, the length of the space is divided into the even number of equal parts most nearly equal to the number of parts that the tonnage length under §69.109(g) was divided. The tonnage is then calculated by the same method used for calculating the under-deck tonnage in §69.109(l).

TONNAGE CERTIFICATE COPIES: In accordance with the reporting requirements described in Sections 1 and 4 of MTN 01-98 CH-11, copies of tonnage certificates issued on the Coast Guard's behalf are to be distributed to the MSC, and to the NVDC for vessels to be documented as vessels of the United States. Measurement organizations are reminded that all emails and associated reporting worksheets must be accompanied by certificates corresponding to each tonnage work item listed.

VESSEL IDENTIFICATION: Measurement organizations seeking to determine if a vessel has a previously assigned unique identifier (Official Number or CG Number) are encouraged to utilize any state registration numbers provided in the application for tonnage measurement to search for the vessel in the Coast Guard sponsored Port State Information Exchange (PSIX) website (<http://cgmix.uscg.mil/PSIX/PSIXSearch.aspx>). Should a vessel search in PSIX result in a positive match using this technique, please reconcile any differences in the vessel's name in PSIX and on the application (i.e., spelling and/or spacing of initials in the vessel's name) prior to requesting a CG Number. For questions regarding the use of PSIX for vessel searches, contact Mr. Brian Ellis (703)872-6788.

Measurement Organization Weekly Notes - 12/12/2013

IMO RESOLUTION ON TONNAGE: According to a document (A 28/INF.7) on the IMO website, the Assembly has passed a resolution on tonnage grandfathering. This resolution replaces two current resolutions. The Tonnage Division will inform the measurement organizations when the resolution is available, and provide additional details.

MARINE SAFETY MANUAL, VOLUME II: The Coast Guard recently published a revision to Marine Safety Manual, Volume II which includes tonnage requirements. This revision reformats the entire document to a MS Word format that will facilitate future changes and revisions and amends the text regarding appeals. An electronic copy of this document is available at:

http://www.uscg.mil/directives/cim/16000-16999/CIM_16000_7B.pdf.

OPERATING STATUS: The Marine Safety Center was closed December 10, 2013 due to inclement weather (snow). Normal business hours have resumed as of Wednesday December 11th.

Weekly Notes are issued by the Coast Guard Marine Safety Center's Tonnage Division (MSC-4) for use by organizations that perform measurement work on the Coast Guard's behalf. They are for informational purposes only, and are not intended as, nor should they be construed to represent, revisions of or substitutes for applicable statutes or regulations or established interpretations of either.

Measurement Organization Weekly Notes - 12/4/2013

TONNAGE RECORDS: As per Section 6.2(a)(4) of MTN 01-98 CH-11, drawings used as the basis for obtaining dimensions or other information used in establishing tonnages or registered dimensions must be included in all tonnage files. If drawings or computer models are not used as this basis, sketches and/or scaled photographs providing equivalent information must be included. Measurement organizations are reminded that such sketches and/or scaled photographs must be sufficiently detailed to support the dimensions used in the tonnage measurement.

SLF TONNAGE WORK: Germany has submitted a paper commenting on the portion of the report of the correspondence group regarding a reduced GT parameter for accommodation spaces. Specifically, this paper proposes a reduced GT formula as a variation of the current gross tonnage formula, by reducing the volume parameter (V) by the total volume of crew space (V_{CREW}). This concept was initially introduced in the annex of document SLF 55/9/3, which also proposed a reduced gross tonnage parameter to encourage improved working and living conditions onboard ships. This paper, along with the paper mentioned below, is available on the TM Convention Correspondence group's website: <http://www.uscg.mil/imo/slf/subcomdocs.asp>.

SLF TONNAGE WORK: IACS has submitted a paper requesting clarification from the Sub-Committee on how to measure the tonnage of ships constructed of materials other than metal. Specifically, this paper proposes that dimensions used to establish volumes should be taken to the outer surface of the hull and hull continuations (e.g. poops, forecastles, and raised quarter decks) and to the inner surface of structural boundaries for other superstructures. According to the paper, IACS believes that the volume within composite sandwich panels can be significant and that difficulties in measuring such configurations currently exist.

Measurement Organization Weekly Notes - 11/26/2013

ONBOARD SURVEYS: Measurement organizations are reminded that, in addition to items listed under Section 1.4 (a)-(f) of MTN 01-98 CH-11, all information required in the tonnage measurement process (e.g., exempted spaces are adapted and used for their identified purpose; all openings in the sides of the vessel below the upper deck are fitted with permanent means of watertight closing) is to be verified during an onboard survey. Verification of administrative information utilized to identify the vessel is highly encouraged, but not explicitly required.

PUBLIC MEETING: As mentioned in a previous weekly note, a public meeting will be held to obtain input on matters before the SDC 1 Sub-Committee, including the tonnage work. The official meeting date is Thursday, January 9, 2014, in Arlington VA. We expect discussions on the Tonnage Agenda Item will focus on the Correspondence Group's report, document SDC 1/4, which recommends the Sub-Committee agree to the Unified interpretations and associated draft TM.5 circular, and the 1% substantial alteration criterion used for vessel eligibility to use national tonnages when applying certain older tonnage-based provisions of international conventions. Detailed information regarding the time and location is published in the Federal Register at <http://www.gpo.gov/fdsys/pkg/FR-2013-11-25/pdf/2013-28231.pdf>.

THANKSGIVING OFFICE CLOSURE: The Marine Safety Center will be closed on Thursday, November 28th for the Thanksgiving Day holiday. The normal business hours will resume on Friday, November 29th.

The Tonnage Division would like to wish you all a safe and Happy Thanksgiving holiday.

Measurement Organization Weekly Notes - 11/19/2013

FIVE NET TON DOCUMENTATION THRESHOLD: As mentioned in a previous weekly note, the MSC has received multiple calls and letters concerning vessels assigned tonnages of less than five net tons. We are considering addressing the potential for future inquiries of this nature by developing a brochure for public distribution. The proposed brochure would educate the public on issues such as documentation, simplified measurement versus formal measurement, crew space certifications, etc. As we continue to consider a brochure as well as other means of addressing this issue, the Tonnage Division welcomes any input regarding information which admeasurers consider pertinent for owners of vessels assigned tonnages of less than five net tons. Comments and input should be submitted to Mr. Marcus Akins at marcus.j.akins@uscg.mil.

SDC 1 TONNAGE WORK: The paper providing a report of the work of the TM Convention Correspondence Group and an associated information paper have been posted to the IMO website. These papers describe the results of the work completed by the Correspondence Group, as well as the information collected, respectively. Measurement organizations are encouraged to read both papers as they will serve as the basis for discussion at the Ship Design and Construction (SDC) subcommittee meeting in London in January. Copies of these papers are also available at <http://www.uscg.mil/imo/slf/subcomdocs.asp>.

SDC 1 TONNAGE WORK (cont.): Annex 2 to document SDC 1/4 indicates a majority of correspondence group participants supported retaining a 1% criterion for substantial (major) alterations. We wish to highlight the fact that IACS was one of those that strongly favored this option. The United States is currently preparing its position on this matter, and considering a related paper for submission to SDC 1. We note our earlier paper (SLF 55/9/4), which cited the problematic nature of the 1% criterion.

PUBLIC MEETING: A public meeting will be held to obtain input on matters before the SDC 1 Sub-Committee, including the tonnage work. The tentative meeting date is Thursday, January 9, 2014, with the tentative location Arlington VA. Details will be published in the Federal Register, once meeting plans are finalized.

Measurement Organization Weekly Notes - 11/14/2013

REMEASUREMENT: The Tonnage Division recently addressed multiple inquiries regarding issuance of tonnage certificates following remeasurement which was requested by a vessel's owner. Measurement organizations should note that, for self-propelled vessels over 79 feet in overall length that engage on domestic voyages only, and with keel laid dates before January 1, 1986, a convention system measurement is not required upon remeasurement which does not result in a substantial alteration determination. However, in such a case, a vessel may lose grandfathering provisions under Article 3(2)(d).

LINE OF THE UPPER DECK: In establishing the upper deck, discontinuities in the upper deck that do not extend from side to side of the vessel, are one meter or less in length, or are outside the boundaries of "registered length", are ignored. Additionally, for a vessel having openings in its side below the uppermost continuous deck, which are not closed, but limited inboard by weathertight versus watertight bulkheads and decks, the deck below such openings should be considered the upper deck. Admeasurers should note that the line of the upper deck is a critical factor in determining the molded depth and subsequently, the registered length.

Measurement Organization Weekly Notes - 11/05/2013

NON-TANK VESSEL RESPONSE PLAN FINAL RULE: On September 30, 2013, the Non-tank Vessel Response Plan final rule was published. This final rule requires owners and operators of covered nontank vessels to prepare and submit oil spill response plans. The rule requires vessel owners and operators to submit their Vessel Response Plan control number as part of the already-required advance notice of arrival (ANOA) information. This part of the rule is effective on October 30, 2013. The applicability of this rule includes all covered non-tank vessels 400 GT ITC or more (400 GRT if GT ITC not assigned).

TONNAGE RECONCILIATION LETTERS: In the past, Coast Guard field units and, in some cases, classification societies have issued so-called tonnage reconciliation letters. Typically, these documents have sought to explain or amplify GRT grandfathering privileges under international conventions that are being claimed for a qualifying vessel. The need for these documents was eliminated with the adoption of IMO resolutions, which provided for tonnage grandfathering remarks to be included, where applicable, on the ITC69. The Tonnage Division strongly recommends that measurement organizations not issue such letters, and is considering a change to NVIC 11-93 CH-3 that highlights the difficulties we have encountered with these documents. For additional questions or comments, contact Mr. Brian Ellis (703)872-6788.

VETERAN'S DAY CLOSURE: The Marine Safety Center will be closed on Monday, November 11th for the Veterans Day holiday. Normal business hours will resume on Tuesday November 12th.

Measurement Organization Weekly Notes - 10/30/2013

ENGINE ROOM DEDUCTION: According to 46 CFR 69.121(e)(2), the engine room deduction is calculated based on the tonnage of the propelling machinery space relative to the vessel's gross tonnage expressed as a percentage. The attached figure illustrates the allowable engine room deduction as a function of the total propelling machinery space expressed as a percentage of the gross tonnage. Admeasurers should note that if the total propelling machinery space is 20 percent or more of the vessel's gross tonnage (the blue-shaded region on the right of the figure), the vessel owner may elect to use a deduction of either 32 percent of the vessel's gross tonnage or 1.75 times the total propelling machinery space.

MSC MAIL SERVICE: All incoming regular and courier mail deliveries are sent to a facility in Maryland and processed prior to delivery at the MSC. Following our move to Arlington, VA we have received reports of mail service delays. This processing should take no more than four days for courier mail and one week for regular mail, but some deliveries have taken much longer. Please keep this in mind when sending items into the MSC, pending our follow-up actions to improve this service. If you have any questions regarding items mailed to the MSC, please contact Mr. David Karnes at david.b.karnes@uscg.mil or 703-872-6789.

Measurement Organization Weekly Notes - 10/23/2013

ELECTRONIC COMMERCE: The computer servers that receive and route all electronic commerce (including tonnage file requests and CG Number requests) sent to "msc@uscg.mil" unexpectedly malfunctioned and rejected all incoming emails for a period of four hours on Friday, October 18th. If a confirmation email of electronic commerce submitted during this time period was not received, please contact Mr. Brian Ellis (703)872-6788. We apologize for any inconvenience this may have caused.

SDC 1 TONNAGE WORK (Formerly SLF 56): The coordinators of the TM Convention Correspondence Group transmitted the group's Report, and the associated Information Paper, to IMO on Friday, October 18th. The transmitted documents are available on the group's website, under the heading "Documents Submitted to Secretariat": <http://www.uscg.mil/imo/slf/cgdocs.asp>. It remains unclear as to whether further development of interpretations will be possible at the SDC 1 meeting in January in London, due to IMO's adherence to restrictions on the number of working and drafting groups at such meetings.

MARINE PERSONNEL REGULATIONS: As mentioned in a previous weekly note, enforcement of Canadian Marine Personnel Regulations on the engineering watches of U.S. vessels with a propulsive power of at least 750 kW (1000 HP), that operate in Canadian waters will begin on October 26, 2013. These Canadian regulations will primarily impact U.S. uninspected vessels such as uninspected towing vessels, but may impact certain passenger vessels falling below the U.S. tonnage threshold for a chief engineer. Accordingly, all personnel (including additional engineering personnel employed to comply with the Canadian regulations) must hold a valid Merchant Mariner Credential issued by the U.S.

Measurement Organization Weekly Notes - 10/16/2013

NVDC STATUS: Due to the continued government shutdown, the National Vessel Documentation Center (NVDC) will remain operating under restricted conditions. All commercial vessel-related business is suspended until the government resumes operations. Recreational fee funding has not been affected; therefore, the limited number of onsite staff is focused on processing recreational vessel applications. Further information can be found on its website: <http://www.uscg.mil/nvdc>.

SDC 1 TONNAGE WORK (Formerly SLF 56): The coordinators of the TM Convention Correspondence Group are finalizing the group's report, which is due for submittal to IMO this Friday. It remains unclear as to whether further development of interpretations will be possible at the SDC 1 meeting in January in London, due to IMO's adherence to restrictions on the number of working and drafting groups at such meetings.

Measurement Organization Weekly Notes - 10/08/2013

TONNAGE DIVISION STATUS: Although the U.S. government shutdown continues, the Tonnage Division has been placed back in a work status via legislation signed by the President on September 30th. Normal business operations have resumed; however, access to voicemail in our new phone system has been limited. Email should be used as the primary means of leaving messages until further notice.

COLUMBUS DAY CLOSURE: The Marine Safety Center will be closed for the Columbus Day holiday, on Monday October 14th. Normal business hours will resume on Tuesday October 15th.

Measurement Organization Weekly Notes - 10/1/2013

Weekly notes foregone due to furlough.

Weekly Notes are issued by the Coast Guard Marine Safety Center's Tonnage Division (MSC-4) for use by organizations that perform measurement work on the Coast Guard's behalf. They are for informational purposes only, and are not intended as, nor should they be construed to represent, revisions of or substitutes for applicable statutes or regulations or established interpretations of either.

Measurement Organization Weekly Notes - 9/26/2013

RELOCATION OF MSC: As mentioned in a previous weekly note, the MSC will move to Arlington, VA on Friday, September 27, 2013. We anticipate an interruption of normal business operations as early as noon on Thursday, September 26th and plan to resume normal business operations on October 1st. Updated telephone numbers, effective September 30th, have been attached for your convenience. Please click the following link for the latest Marine Safety Center Information Bulletin describing the procedures for submitting tonnage related requests: <http://www.uscg.mil/hq/msc/docs/MSCIB%2001-13.pdf>. For further questions regarding our move, please contact Brian Ellis at brian.t.ellis@uscg.mil or call (202)475-5636.

Weekly Notes are issued by the Coast Guard Marine Safety Center's Tonnage Division (MSC-4) for use by organizations that perform measurement work on the Coast Guard's behalf. They are for informational purposes only, and are not intended as, nor should they be construed to represent, revisions of or substitutes for applicable statutes or regulations or established interpretations of either.

Measurement Organization Weekly Notes - 9/19/2013

FILE REQUEST SERVICE: Contrary to a previous weekly note, as a result of the MSC's impending relocation, file request service has been suspended until further notice. We anticipate that tonnage files will be available shortly after completion of the move and the reconstitution of MSC files.

FIVE NET TON DOCUMENTATION THRESHOLD: In recent months, the MSC has received multiple calls and letters concerning vessels assigned tonnages of less than five net tons. These inquiries have come from both the public (vessel owners and media outlets) and the government (Coast Guard personnel and Congress). Measurement organizations are reminded that, in accordance with Section 1.4 of MTN 01-98 CH-11, spaces which could have a bearing on the tonnage assignment according to their use are to be properly accounted for, and the marking of the vessel, particularly deductible spaces, is correct.

SDC 1 TONNAGE WORK (Formerly SLF 56): Participants from 12 countries and 2 non-governmental organizations (including IACS) submitted input during the now-completed Round 3 correspondence group work. Results are being incorporated into the correspondence group's draft report, which will be distributed to participants in the near future.

RELOCATION OF MSC NEARS: As mentioned in a previous weekly note, the MSC is scheduled to move to Arlington, VA on 27 September 2013. Please click the following link for the latest Marine Safety Center Information Bulletin describing the procedures for submitting tonnage related requests: <http://www.uscg.mil/hq/msc/docs/MSCIB%2001-13.pdf>. Updated contact information will be provided as it becomes available. For further questions regarding our move, please contact Brian Ellis at brian.t.ellis@uscg.mil or call (202)475-5636.

Measurement Organization Weekly Notes - 9/10/2013

BUILDER'S CERTIFICATE: A new version of the Builder's Certificate form (CG-1261) is now available on the NVDC website. The form, which is often utilized for simplified tonnage measurements, was revised to clarify dimensional and shape information. The new Builder's Certificate is available at:

<http://www.uscg.mil/hq/cg5/nvdc/forms/cg1261.pdf>

CONGRESSIONAL INTEREST IN TONNAGE: As part of an initiative to legislatively restore grandfathering privileges to a 191-foot dive support vessel, the Hon. Don Young (Alaska) made a floor statement during consideration by the House of Representatives of the Coast Guard Authorization Act of 2012. Mr. Young's speech highlighted the impact tonnage has on the maritime industry and underscored the importance of accurate tonnage measurement and assignment.

Measurement Organization Weekly Notes - 9/3/2013

SLF 56 TONNAGE WORK: As a reminder, Round 3 Questionnaires for the SLF 56 tonnage correspondence group are due on Friday, Sept 6th. So far, participants representing 8 countries have completed Round 3 Questionnaires. As mentioned in previous weekly notes, measurement organizations are encouraged to participate in this process via IACS. The questionnaires are available at:

<http://www.uscg.mil/imo/slf/cgdocs.asp>.

FILE REQUEST SERVICE: As mentioned in a previous weekly note, the MSC is scheduled to relocate to Arlington on September 27, 2013. The relocation process will include the MSC's hard copy tonnage files being boxed up and prepared for transfer to Arlington on September 13, 2013. Upon this date, MSC's capability to fulfill file requests within the two-day service standard may be hindered. If an urgent request for tonnage file information is to be made, it must be telephoned to Mr. Marcus Akins, giving an explanation for the immediate need. This request is to be followed by a submission of the request form.

Measurement Organization Weekly Notes - 8/27/2013

CANADIAN MARINE PERSONNEL REGULATIONS: As reported in Bryant's Newsletter, the U.S. Coast Guard issued guidance to its field units regarding Canadian Marine Personnel Regulations which require certain non-Canadian vessels of less than 200 GRT on voyages to Canada to have a Certificate of Inspection (COI) or safe manning documentation relating to engineering personnel and engineering watch requirements.

FUTURE RELOCATION OF MSC: As mentioned in a previous weekly note, the MSC is scheduled to move 8 miles west of its current location in Washington, DC, to Arlington, VA on 27 September 2013. Please click the following link for the latest Marine Safety Center Information Bulletin describing the procedures for submitting tonnage related requests: <http://www.uscg.mil/hq/msc/docs/MSCIB%2001-13.pdf>. For further questions regarding our move, please contact Brian Ellis at brian.t.ellis@uscg.mil or call (202)475-5636.

LABOR DAY CLOSURE: The Marine Safety Center will be closed for the Labor Day holiday on Monday, September 2nd. Normal business hours will resume on Tuesday September 3rd.

Measurement Organization Weekly Notes - 8/21/2013

Maritime Labour Convention 2006: As mentioned in a previous weekly note, August 20, 2013 marked the entry into force of the Maritime Labour Convention (MLC 2006), adopted by the International Labour Organization (ILO). The MLC 2006 is considered by IMO Secretariat to be the 'fourth pillar' of the most important maritime regulations covering international shipping, complementing three major conventions adopted by IMO: the International Convention for the Safety of Life at Sea (SOLAS); the International Convention for the Prevention of Pollution from Ships (MARPOL); and the International Convention on Standards of Training, Certification and Watchkeeping for Seafarers (STCW).

IN THE CLEAR REQUIREMENT: In accordance with Section 69.117(d)(2') the MTN, to be considered in the clear, an opening must be unobstructed for a distance of 30 inches both inside and outside of the opening. Obstructions of a temporary nature (i.e., that are not permanently attached to the vessel, can readily be removed underway, and whose removal does not adversely impact the safe operation of the vessel) are not considered to violate the in the clear requirement. For example, portable furniture and lockers are considered to be of a temporary nature, whereas bulkheads, stanchions, bunks that are part of joiner work, and handrails are not. In all cases, attachments to temporary covers authorized under §69.117(d)(6') and deck cargo are not considered to violate the in the clear requirement.

Weekly Notes are issued by the Coast Guard Marine Safety Center's Tonnage Division (MSC-4) for use by organizations that perform measurement work on the Coast Guard's behalf. They are for informational purposes only, and are not intended as, nor should they be construed to represent, revisions of or substitutes for applicable statutes or regulations or established interpretations of either.

Measurement Organization Weekly Notes - 8/13/2013

ONBOARD SURVEYS: Measurement organizations are reminded that, per Section 1.8(e) of MTN 01-98 CH-11, onboard surveys prior to tonnage certificate reissuance are required only if the certificate is being reissued to: 1) reflect measurement under an additional measurement system; 2) reflect tonnage and/or dimension changes resulting from remeasurement; or 3) correct errors for which the MSC has specified that an onboard survey is necessary. In the case of changes or error correction, the survey is limited to the portions of the vessel associated with the changes or errors requiring verification.

BUILDER INFORMATION: The Tonnage Division recently responded to an inquiry regarding an application for tonnage measurement which did not include builder information. As mentioned in a previous weekly note, builder information required under Sections 3.3(4) and (6) of MTN 01-98 CH-11 cannot be omitted from the tonnage certificate without prior approval from MSC (e.g., the name of the builder and location of build). Admeasurers should note that, the builder information may be derived from a Hull Identification Number (HIN) should the application include it. In accordance with 33 CFR 181.31, each person required to affix HINs must request a manufacturer identification code in writing from the Coast Guard Recreational Boating Product Assurance Branch. The code assigned to this person coincides with the first three characters of the HIN.

Weekly Notes are issued by the Coast Guard Marine Safety Center's Tonnage Division (MSC-4) for use by organizations that perform measurement work on the Coast Guard's behalf. They are for informational purposes only, and are not intended as, nor should they be construed to represent, revisions of or substitutes for applicable statutes or regulations or established interpretations of either.

Measurement Organization Weekly Notes - 8/7/2013

MR. DAVID KARNES JOINS TONNAGE STAFF: The MSC Tonnage Division welcomes a new staff member to its ranks. Mr. Karnes is a 2000 University of Michigan graduate (B.S. in Naval Architecture and Marine Engineering), who joins us from Science and Technology Corporation, where as a senior naval architect he was involved in a number of design and engineering support projects for the Coast Guard, MARAD and other organizations.

U.S COAST GUARD BIRTHDAY: On Sunday, August 4th, the U.S. Coast Guard celebrated its 223rd Birthday. This day represents the date when the first Congress authorized the construction of 10 vessels to enforce tariff and trade laws, prevent smuggling, and protect the collection of federal revenue. In 1946, approximately 157 years after the First Congress established the tonnage program, Congress permanently transferred the Commerce Department's Bureau of Marine Inspection and Navigation (where Tonnage had once resided), to the Coast Guard, thereby placing merchant marine licensing and merchant vessel safety under our purview. Tonnage measurement was eventually transferred to the Coast Guard from Customs in 1967, the same year the trademark racing stripe design was adopted at the recommendation of the presidentially assigned (Kennedy) industrial design firm of Raymond Loewy/William Snaith.

Measurement Organization Weekly Notes - 7/30/2013

BRAVERY AT SEA: As reported on the IMO website, two rescue swimmers from the USCG will be receiving the 2013 IMO Award for Exceptional Bravery at Sea for saving the lives of 14 crew members from the tall ship HMS Bounty. Aviation Survival Technicians (AST) Randy J. Haba and Daniel J. Todd were deployed by Coast Guard helicopters in the wind and rain of Hurricane Sandy in an effort to save lives. AST Haba demonstrated the utmost determination and perseverance, performing two rescues without the use of a mask. Whilst AST Todd was assisting a survivor into the rescue basket, a large wave toppled the life raft containing the four remaining survivors. Todd immediately secured a handhold on the sea anchor to stabilize his position, repositioned himself to a second life raft, and expedited the rescue of six survivors. In the end, both men overcame the effects of cold, fatigue and ingesting sea water to deliver 14 crew members of HMS Bounty to safety.

SLF TONNAGE WORK: The Round 3 Questionnaires for the correspondence group have been completed and distributed to the participants. The questionnaires are due Friday, Sept 6th. Measurement organizations are encouraged to participate in this process via IACS. Details on the work of the correspondence group, as well as the questionnaires are available at: <http://www.uscg.mil/imo/slf/tonnagecg.asp>.

Measurement Organization Weekly Notes - 7/23/2013

WATER BALLAST JUSTIFICATION: In accordance with MTN 01-99 CH-7, if the total of all water ballast spaces to be exempted from gross tonnage exceeds 30% of the vessel's gross tonnage (as calculated under this subpart without any allowance for water ballast), a justification of the operating conditions that require the water ballast must be submitted to the measuring organization for approval. Should the conditions of a water ballast justification, such as a change in the water ballast space or its use, purpose or piping be changed, the vessel may be subject to remeasurement.

SLF 56 TONNAGE WORK: After review of the Round 2 Remeasurement Questionnaire results, the Tonnage Division noted that IACS favors a 1% criterion for the loss of GRT grandfathering per Article 3(2)(b) of the Convention. This position differs from that of the United States as discussed in IMO paper SLF 55/9/4, which cites the problematic nature of the 1% criterion.

FUTURE RELOCATION OF MSC: As mentioned in a previous weekly note, the MSC is scheduled to move 8 miles west of its current location in Washington, DC, to Arlington, VA on 27 September 2013. Our new mailing address and phone numbers will be provided in the coming weeks. Our electronic commerce information is not expected to change. For questions regarding our move, please contact Brian Ellis at brian.t.ellis@uscg.mil or call (202)475-5636.

Measurement Organization Weekly Notes - 7/17/2013

SPACE OPEN TO THE SEA: In accordance with Section 69.61(f ') of MTN 01-99 CH-7, for a space to be considered open to the sea, the space must be located on the seaward side of the vessel's buoyant hull envelope and when the vessel is hypothetically immersed to the upper deck, the space must fill with water without any detrimental effect on the operation of the vessel. Please note that certain space configurations subject to open to the sea determinations may require advanced calculations to demonstrate that filling the space with water will not detrimentally affect the operation of the vessel.

SLF 56 TONNAGE WORK: Participants from 10 countries and 3 non-governmental organizations (including IACS) submitted input during the now-completed Round 2 correspondence group work. Results are being incorporated into the Round 3 Questionnaire, which will be distributed to participants in the near future.

Measurement Organization Weekly Notes - 7/9/2013

AWNINGS: In gathering information to support further interpretation of Regulation 2(4) within the draft Unified Interpretations, the Tonnage Division discovered multiple definitions of the term “awnings” dating back to 1924. These definitions considered an awning to be a covering which provided: Webster's Universal Unabridged 1940 - protection against "sun's rays, the rain and the wind"; Webster's Collegiate 1977 - "shelter"; American Heritage - "shelter from weather"; Dictionnaire De Marine: From Keel to Truck 1924 - protection against "against sun or rain".

EMAIL INQUIRIES: A gentle reminder to all concerned that emails to the MSC electronic commerce inbox and to personal email addresses at MSC become a federal record, subject to disclosure to the public under FOIA procedures (refer to Tonnage Bulletin 21). For this and other reasons, we continue to encourage you to discuss pertinent issues on the phone with the Tonnage Division staff before resorting to email. Of course, written inquiries are both appropriate and encouraged where interpretations of the tonnage regulations and associated requirements are needed. In such cases, please send the email to msc@uscg.mil, copying Mr. Marcus Akins or Mr. Brian Ellis.

Measurement Organization Weekly Notes - 7/2/2013

SLF 56 TONNAGE WORK: As a reminder, Round 2 Questionnaires for the SLF 56 tonnage correspondence group are due on Friday, July 12th. As stated in a previous weekly note, measurement organizations are encouraged to participate in this process via IACS. The questionnaires are available at: <http://www.uscg.mil/imo/slf/cgdocs.asp>. Comments and feedback on the tonnage information posted on this site should be submitted to Mr. Marcus Akins at marcus.j.akers@uscg.mil.

INDEPENDENCE DAY: The Marine Safety Center will be closed on Thursday, July 4th in observance of the Independence Day holiday. This day marks the anniversary of the publication of the Declaration of Independence from Great Britain in 1776. This is the 237th year of our independence. Normal business hours will resume on Friday, July 5th.

Measurement Organization Weekly Notes - 6/25/2013

ITC ISSUANCE: In accordance with Section 69.69 of MTN 01-99 CH-7, on request of the vessel owner, an International Tonnage Certificate (1969) is issued for a vessel, measured under subpart B of 46 CFR part 69, that is 79 feet or more in registered length and that will engage on a foreign voyage. The Certificate is issued to the vessel owner or master and must be maintained on board the vessel when it is engaged on a foreign voyage.

SLF 56 TONNAGE WORK: Three draft Round 3 Questionnaires for the SLF 56 tonnage correspondence group have been distributed to the participants. The comments on these questionnaires are due Friday, July 12th. As stated in a previous weekly note, measurement organizations are encouraged to participate in this process via IACS. The questionnaires are available at: <http://www.uscg.mil/imo/slf/cgdocs.asp>.

MR. AKINS OUT OF THE OFFICE: Mr. Marcus Akins will be out of the office July 1-5, 2013. Please direct any tonnage technical questions to Mr. Brian Ellis at 202-475-5636. For file request, please copy Mr. Ellis at brian.t.ellis@uscg.mil.

Measurement Organization Weekly Notes - 6/18/2013

END OPENINGS: The Tonnage Division recently responded to an inquiry regarding exclusion of space that is opposite an end opening. Measurement organizations should note that a restricted or obstructed opening may limit the amount of space that is excluded in a deck structure. For restrictions, in accordance with MTN 01-99 CH-7, only the space between the line of the opening and a parallel line drawn through the point where the breadth of the space is equal to 90 percent of the breadth of the deck structure is excluded. For obstructions within a distance of half the breadth of the deck in way of the opening, measurement organizations should contact the MSC for direction.

VESSEL DOCUMENTATION: As stated in the NVDC's FAQs, vessels of at least five net tons, engaged in fisheries on navigable waters of the U.S. or in the EEZ, or engaged in coastwise trade, must be documented unless the vessel is exempted from documentation. In addition, towboats operating between points in the U.S. or the EEZ or between the EEZ and points in the U.S. and dredges operating in the U.S. or the EEZ must be documented. Vessels that do not operate on the navigable waters of the U.S., or engage in fisheries in the EEZ, are exempt from the requirement to be documented. Also exempt are coastwise qualified, non-self-propelled vessels used in coastwise trade within a harbor, on the rivers or lakes (except the Great Lakes) of the U.S., or the internal waters or canal of any state.

Measurement Organization Weekly Notes - 6/11/2013

FUTURE RELOCATION OF MSC: The MSC is scheduled to move 8 miles west of its current location in Washington, DC, to Arlington, VA on 27 September 2013. Our new mailing address and phone numbers will be provided in the coming weeks. Our electronic commerce information is not expected to change. For questions regarding our move, please contact Brian Ellis at brian.t.ellis@uscg.mil or call (202)475-5636.

TONNAGE DIVISION WEBSITE: The Tonnage Division has updated the tonnage information on the Marine Safety Center's webpage at <http://www.uscg.mil/hq/msc>. This update includes the addition of searchable versions of international documents. Please note that this website is intended only to provide an alternative to the tonnage information and publications located on the Coast Guard's Homeport website.

Measurement Organization Weekly Notes - 6/4/2013

SLF TONNAGE WORK: The Round 2 Questionnaires for the correspondence group have been completed and distributed to the participants. The questionnaires are due Friday, July 12th. Measurement organizations are encouraged to participate in this process via IACS. Details on the work of the correspondence group, as well as the questionnaires are available at: <http://www.uscg.mil/imo/slf/tonnagecg.asp>.

TONNAGE CERTIFICATION: In accordance with Section 2.3(b)(4) of MTN 01-98 CH-11, when considering the date as defined by the asterisk (*) notation, the definition of “substantially altered” in NVIC 11-93 as amended is to be used as the definition of “alterations or modifications of a major character”. In the case of a vessel which has undergone such an alteration or modification, measurement organizations are to specify the year when the work on the alteration or modification was commenced in the date block on the front of the International Tonnage Certificate (1969).

Measurement Organization Weekly Notes - 5/30/2013

REQUEST FOR MSC TONNAGE DECISIONS: As mentioned in previous weekly notes, the inclusion of the vessel/space configuration in question and the specific question or questions regarding the configuration will greatly assist the Tonnage Division in responding to requests for decisions on interpretation of the tonnage regulations. If possible, and when applicable, it is highly recommended that a sketch of the vessel/space configuration be submitted. We also encourage measurement organizations to include the MTN 01-99 CH-7 interpretation, if any, which they feel most accurately reflects how the tonnage rules should be applied.

MARITIME LABOUR CONVENTION, 2006: As reported in Bryant's Maritime Consulting Newsletter on May 29th, The Paris Memorandum of Understanding on Port State Control (Paris MoU) issued a news release stating that it has amended the Memorandum to include the Maritime Labour Convention, 2006 (MLC 2006) as a relevant instrument and provide guidance for port state control officers to inspect ships for minimum requirements for seafarer working conditions. Inspections under MLC 2006 will begin on 20 August 2013 and feature tonnage thresholds of 200, 500, 3000, and 10000 GT ITC. It should be noted that provisions of MLC 2006, along with many other approaches, are under consideration by the Tonnage Correspondence Group for the development of an accommodation space reduced gross tonnage parameter for optional use in assessing fees.

Measurement Organization Weekly Notes - 5/21/2013

FILE REQUESTS: In accordance with Section 5.2 MTN 01-98 CH-11, MSC tonnage records consist of tonnage calculations, certificates and/or water ballast justification approval letters issued by the Coast Guard for which the Coast Guard remains responsible. Please note that the standard and procedures for requests for tonnage records in the MTN only applies to MSC tonnage measurement records. For information regarding obtaining copies of tonnage measurement records generated by other entities, please refer to Tonnage Guide 3, as amended. Tonnage Guide 3 can be found at <http://www.uscg.mil/hq/msc/tonnage/pubs.asp>.

IMO – REDUCTION OF ADMINISTRATIVE BURDENS: The IMO issued a news release stating that it is seeking widespread input on the administrative burdens that result from compliance with IMO instruments. It is hoping to identify administrative requirements that may have become unnecessary, disproportionate, or obsolete. Through 31 October, comments may be submitted via a dedicated website: <http://administrativeburdens.bimco.org/>

MEMORIAL DAY CLOSURE: The Marine Safety Center will be closed for the Memorial Day holiday, on Monday May 27th. Normal business hours will resume on Tuesday May 28th.

Measurement Organization Weekly Notes - 5/14/2013

ANTI-FOULING SYSTEM CONVENTION: The US Coast Guard issued a Marine Safety Information Bulletin (MSIB) reminding owners and operators of US vessels over 400 gross tonnage, engaged in an international voyage (including a voyage on the Great Lakes between the United States and Canada), that these vessels are required to be in compliance with the International Convention on the Control of Harmful Anti-Fouling Systems (AFS) on Ships, 2001 by carrying an International Antifouling System Certificate. This threshold is one of the newest tonnage thresholds in international conventions.

SLF TONNAGE WORK: As mentioned in a previous weekly note, the Round 1 Questionnaires for the correspondence group are due Friday, May 17th. Measurement organizations are encouraged to participate in this process via IACS. The questionnaires are available at: <http://www.uscg.mil/imo/slf/tonnagecg.asp>.

TONNAGE PERSONNEL: Mr. Akins was unexpectedly out of the office for two days last week and the weekly notes were not published. As of this week, we will resume our weekly publication.

SUBSTANTIAL ALTERATIONS AND REMEASUREMENT: Thank you to all who provided support for the Remeasurement Questionnaire distributed to measurement organization. The Tonnage Division appreciates and values your effort to support the U.S. tonnage measurement program.

Measurement Organization Weekly Notes - 5/7/2013

Akins out of office. Weekly notes foregone.

Weekly Notes are issued by the Coast Guard Marine Safety Center's Tonnage Division (MSC-4) for use by organizations that perform measurement work on the Coast Guard's behalf. They are for informational purposes only, and are not intended as, nor should they be construed to represent, revisions of or substitutes for applicable statutes or regulations or established interpretations of either.

Measurement Organization Weekly Notes - 4/30/2013

ELECTRONIC COMMERCE: Please be reminded that electronic correspondence requiring official Marine Safety Center action must be sent to msc@uscg.mil. You will receive an email from one of our office automation assistants confirming receipt, along with a unique tracking number. Action on a recent submittal was delayed because a customer sent their submittal to our oversight assessment mailbox and failed to follow-up on the submittal when a return receipt was not received.

REMEASUREMENT QUESTIONNAIRE: The Tonnage Division distributed to the measurement organizations a Remeasurement Questionnaire aimed at collecting information on U.S. vessel changes that are reported to, and evaluated by, authorized measurement organizations under the provisions of 46 CFR 69.19(a). The deadline to submit the questionnaire is May 10, 2013.

MR. AKINS OUT OF THE OFFICE: Mr. Marcus Akins will be out of the office May 1-2, 2013. Please forward any tonnage technical questions or file request to Mr. Brian Ellis at brian.t.ellis@uscg.mil.

Measurement Organization Weekly Notes - 4/24/2013

TONNAGE CERTIFICATES: When completing tonnage certificates, measurement organizations are reminded that required information cannot be omitted without prior approval from MSC (e.g., the name of the builder and location of build required in Sections 3.3(4) and (6) of MTN 01-98 CH-11). Accordingly, as stated in previous weekly notes, a dash ("-"), the word "none", or a remark, not specifically authorized by the MTN, cannot be used on a tonnage certificate without written approval from the MSC.

TONNAGE CALCULATIONS FORMAT: Effective September 1, 2012, measurement organizations were required to use a calculation format which was approved by the MSC. Measurement organizations are reminded that, in lieu of using the MSC's TonCalc software application, a calculation format which corresponds to the format in Appendix A of MTN 01-98 CH-11 may be submitted to the Tonnage Division for approval.

SUBSTANTIAL ALTERATIONS AND REMEASUREMENT: As mentioned in a previous weekly note, the Tonnage Division intends to seek input in support of the development of the U.S. response to the TM Convention Correspondence Group Round 1 Alterations Questionnaire. We anticipate distributing a survey to measurement organizations early next week in order to gather this input.

Measurement Organization Weekly Notes - 4/16/2013

DRAFT UNIFIED INTERPRETATIONS: The Round 1 Questionnaires discussed in last week's weekly notes also include a questionnaire for the correspondence group regarding the draft Unified Interpretations TM.5 Circular. This questionnaire focuses on gathering information to support further development of the draft Unified Interpretations developed by SLF 55. Measurement organizations are encouraged to participate in this process via IACS. Details on the work of the correspondence group, as well as the questionnaires are available at: <http://www.uscg.mil/imo/slf/tonnagecg.asp>.

REQUESTS FOR TONNAGE RECORDS: The scanners used to scan tonnage files are currently out of order. We apologize for any inconvenience that file request processing delays may have caused. As of today, April 16, 2013, we have developed a temporary solution. Currently outstanding requests will be processed in the order received. Please refer any questions on outstanding file requests to Mr. Marcus Akins (202 475-3349).

Measurement Organization Weekly Notes - 4/9/2013

SLF TONNAGE WORK: The Round 1 Questionnaires for the correspondence group have been completed and distributed to the participants. The questionnaires are due Friday, May 17th. Measurement organizations are encouraged to participate in this process via IACS. Details on the work of the correspondence group, as well as the questionnaires are available at: <http://www.uscg.mil/imo/slf/tonnagecg.asp>.

SUBSTANTIAL ALTERATIONS AND REMEASUREMENT: Round 1 includes a questionnaire for the correspondence group regarding the 1% substantial alteration criterion. The questionnaire focuses on gathering specific information on the application of "GRT Grandfathering" criteria to provide the basis for an informed recommendation on this subject. As stated in a previous weekly note, we intend to seek measurement organization input regarding the kinds of changes affecting tonnage that are typically being made to U.S. flag vessels, in order to assist us in developing the U.S. position.

CREW SPACE REDUCED GROSS TONNAGE: Round 1 also includes a questionnaire for the correspondence group regarding a reduced gross tonnage parameter that seeks to gather specific information to aid in the development of an accommodation space reduced gross tonnage parameter for optional use in assessing fees. Specifically, the questionnaire requests comment on various approaches to defining an accommodation space within the proposed reduce gross tonnage parameter.

Measurement Organization Weekly Notes - 4/2/2013

TONNAGE OPENINGS: We recently fielded a question on openings installed in end or side bulkheads per Sections 69.117(d) of Marine Safety Center Technical Note (MTN) 01-99 CH-7, Tonnage Technical Policy. Measurement organizations are reminded that, in accordance with Section 69.117(d)(6')(ii) and (iii), anything affixed to a temporary cover must not hinder the removal of the cover and removal of fasteners used to hold a cover in place must result in the cover "falling free". Tonnage opening cover plates are required to be verified during an onboard survey under Section 1.4(e) of MTN 01-98 CH-11.

REQUESTS FOR CG TONNAGE RECORDS: Measurement organizations are reminded that when vessel owners contact the measurement organization for copies of Coast Guard tonnage records, they shall not be released without prior authorization from the MSC. These records are designated as "Permanent" records and remain the property of the Coast Guard. Parties interested in obtaining information from these records are to be directed to the MSC.

Measurement Organization Weekly Notes - 3/26/2013

SUPERSTRUCTURE CALCULATION METHODS: For measurement of superstructure spaces under the Standard and Dual Measurement systems, the tonnage regulations allow only two methods for calculating volumes: two-dimensional Simpson's first rule integration or a simple geometric formula. Measurement organizations are reminded that an accurate volume must be attained when a simple geometric formula is used.

TONNAGE CONSULTING: MTN 01-98 CH-11 provides restrictions on tonnage consulting, which is defined as giving advice regarding the assignment of tonnages for a fee or consideration (i.e., other compensation). Admeasurers are reminded that, if in doubt, contact Mr. Marcus Akins before engaging in any activity that could be construed as "consulting" on a vessel for which you are also providing measurement services on behalf of a measurement organization.

SLF 56 TONNAGE WORK: As mentioned in a previous weekly note, comments on the three draft Round 1 questionnaires are due Friday, March 29th. Measurement organizations are encouraged to participate in this process via IACS. The questionnaires are available at: <http://www.uscg.mil/imo/slf/cgdocs.asp>.

Measurement Organization Weekly Notes - 3/19/2013

ORDINARY FRAMES: In accordance with Section 69.109(p) of MTN 01-99 CH-7, an ordinary frame which is to be used as the basis for establishing the line of the ordinary frames must be of the same material as the adjacent hull and must attach to the hull to at least the same extent as adjacent ordinary and normal framing. Admeasurerers should note that extensions to ordinary frames must be attached to the original ordinary frame in the same manner as the original ordinary frame is attached to the hull.

TONNAGE CERTIFICATION HISTORY: Section 2.4(e) of MTN 01-98 CH-11 requires that the date and place of the original measurement be listed on the reverse side of the certificate in order to reflect the tonnage certification history of the vessel. Measurement organizations are reminded that, should a vessel's tonnage file not be available, a vessel's tonnage certificate, if available, may be obtained from the NVDC via an official FOIA request. Procedures for obtaining tonnage records via FOIA request from the NVDC are detailed in Tonnage Guide 3 (TG 3) "Tonnage Measurement Records".

Measurement Organization Weekly Notes - 3/12/2013

MTN 01-98 CH-11: The Marine Safety Center has issued a change to MTN 01-98. A copy of MTN 01-98 CH-11 has been distributed to each of the authorized measurement organizations. MTN 01-98 CH-11 may also be obtained on the Coast Guard's Homeport website: Missions > Vessel Standards > Marine Safety Center > References > MSC Technical Notes.

SLF 56 TONNAGE WORK: Three draft Round 1 Questionnaires for the newly reestablished correspondence group have been distributed to the participants. The comments on these questionnaires are due Friday, March 29th. As stated in a previous weekly note, measurement organizations are encouraged to participate in this process via IACS. The questionnaires are available at: <http://www.uscg.mil/imo/slf/cgdocs.asp>.

SUBSTANTIAL ALTERATIONS AND REMEASUREMENT At SLF 55 there was much discussion, and considerable disagreement, over the 1% substantial alteration criterion, with a minority (principally Canada, IACS, Sweden) favoring retention of this criterion, and a majority favoring some relaxation, and/or possible replacement with a graduated (or "sliding") scale that provides for proportionally larger tonnage changes for smaller vessels. As the United States further develops its position on this subject, we intend to seek measurement organization input regarding the kinds of changes affecting tonnage that are typically being made to U.S. flag vessels, in order to assist us in making an informed decision. If you have any information to share on this subject in advance, please contact Mr. Marcus Akins.

Weekly Notes are issued by the Coast Guard Marine Safety Center's Tonnage Division (MSC-4) for use by organizations that perform measurement work on the Coast Guard's behalf. They are for informational purposes only, and are not intended as, nor should they be construed to represent, revisions of or substitutes for applicable statutes or regulations or established interpretations of either.

Measurement Organization Weekly Notes - 3/5/2013

ELECTRONIC COMMERCE: The MSC has a limited capability to view drawings, sketches, and similar files due to engineering software constraints. We encourage files submitted to support requests for interpretations to be submitted in “.pdf” format. If you are unable to send a drawing or sketch in “.pdf” format, AutoCAD files in a 2009 or earlier version are acceptable. The version of the AutoCAD file may be checked by opening it in Notepad/Wordpad, where a code will be given in the first line as follows:

AC1018- DWG from AutoCAD 2004/2005/2006

AC1021- DWG AutoCAD 2007/2008/2009

AC1024- DWG AutoCAD 2010/2011/2012

AC1027- DWG AutoCAD 2013

SUEZ CANAL BERTHING AND SETTING SAIL AREAS: The Suez Canal Authority issued a circular, Circ 3/2013, concerning berthing and setting sail at ship-to-ship (STS) transfer area south of the waiting area at the Gulf of Suez and northeast of Port Said. The service requirements and charges come into effect immediately. These charges are listed as flat rate fees for each vessel as opposed to a weighted toll based on net tonnage.

Measurement Organization Weekly Notes - 2/26/2013

SLF 55 MEETING: At its meeting in London last week, the SLF Subcommittee agreed to re-establish the Tonnage correspondence group under the coordination of the United States. The correspondence group is tasked to further develop the draft interpretations submitted to the Sub-Committee and the draft Recommendation on the use of national tonnage in applying international conventions. The correspondence group is also tasked to further consider a reduced gross tonnage for crew accommodation spaces.

TONNAGE RECORDS: Copies of drawings used as the basis for obtaining dimensions or other information used in establishing tonnages or registered dimensions must be included in all tonnage files per Section 6.2(a)(4) of MTN 01-98 CH-10. If drawings or computer models were not used as this basis, sketches and/or scaled photographs providing equivalent information must be included. Measurement organizations are reminded that, for vessels measured under 46 CFR 69 Subparts C or D, details showing relevant features such as the depth of side and bottom frames or floor timbers must be reflected in sketches and/or scaled photographs.

Measurement Organization Weekly Notes - 2/19/2013

TONNAGE CERTIFICATES: The Tonnage Division recently responded to an inquiry regarding the information required to be on the International and U.S. tonnage certificates. Admeasurers should note that, as stated in the cover letter of the administrative policy, deviations from MTN 01-98, CH-10 require written approval from the MSC. Specifically, a dash ("-"), the word "none", or a remark, not specifically authorized by the MTN, should not be used on a tonnage certificate without written approval from the MSC.

SLF 55 MEETING: The SLF Sub-Committee meets this week in London. At this meeting, the United States will participate in discussions regarding draft interpretations of the TM Convention. Mr. Peter Eareckson is attending the meeting and will return to the office on February 25, 2013.

MR. ELLIS OUT OF THE OFFICE: Mr. Brian Ellis will be out of the office February 25, 2013. Please forward any tonnage applicability questions or CG Number requests during his absence to Mr. Marcus Akins at marcus.j.akins@uscg.mil.

Measurement Organization Weekly Notes - 2/12/2013

MARITIME LABOUR CONVENTION (MLC) 2006: The Coast Guard published a Federal Register Notice (78 Fed. Reg. 9709) seeking comment on a draft Navigation and Vessel Inspection Circular (NVIC) which sets forth the Coast Guard's policies and procedures regarding inspection of U.S. vessels for voluntary compliance with the MLC 2006. There are a significant number of tonnage thresholds within this document, including a 500 GT ITC applicability threshold. Comments must either be submitted to our online docket via <http://www.regulations.gov> on or before March 13, 2013 or reach the Docket Management Facility by that date.

MR. AKINS OUT OF THE OFFICE: Mr. Marcus Akins will be out of the office Feb 14 - 15, 2013. Please forward any tonnage-related requests to Mr. Brian Ellis at brian.t.ellis@uscg.mil.

PRESIDENT'S DAY CLOSURE: The Marine Safety Center will be closed on Monday February 18, 2013 in observance of the President's Day holiday. We will resume normal business hours on February 19th.

Measurement Organization Weekly Notes - 2/5/2013

MEASURING BETWEEN-DECK AND SUPERSTRUCTURE SPACES: Sections 69.111 and 69.113 of MTN 01-99, CH-7 state that the measurement spacing of a between-deck/superstructure space is to be established by dividing the length of the space into an even number of equal parts “most nearly equal to those into which the tonnage length is divided”. Admeasurers should note that, for the purposes of applying the provisions of these sections, the term “those” shall be considered to represent the “common intervals” into which the under-deck is divided. We intend to clarify this matter in a future change to the MTN.

OPEN VESSELS: Section 69.109(o)(2) of MTN 01-99 CH-7 states that the line of the tonnage deck for an open vessel is the upper edge of the upper strake, with the depths of transverse sections taken from this line. Accordingly, a break, forecastle or poop, or any portion of a deckhouse below the upper strake on an open vessel is included in the under-deck measurement, with the upper strake located at the upper edge of the hull or qualifying bulwark. Please refer any questions on this subject to Mr. Marcus Akins (202 475-3349).

Measurement Organization Weekly Notes - 01/30/2013

MTN 01-98: As discussed in a previous weekly note, the Tonnage Division has developed a draft change to MTN 01-98 CH-10 and distributed it to the measurement organizations for comment. The deadline for submittal of comments is this Friday (February 1, 2013). In addition to situations involving the identification of discrepancies related to the vessel's measurement, this draft change requires issuance of tonnage certificates within 30 days of the onboard survey, a written response following remeasurement determinations, and formal acknowledgement of acceptance, rejection, or rescission of a measurement application. Questions or comments regarding this draft change should be submitted to Mr. Marcus Akins at marcus.j.akers@uscg.mil.

PANAMA CANAL AUTHORITY CONSIDERING PLANS TO CHANGE FEE STRUCTURE: The Panama Canal may change how it calculates tolls for ships carrying energy cargoes to boost traffic once the \$5.25 billion dollar canal expansion is complete in 2015. The canal is investigating charging fees based on the cargo capacity of commodity carriers and tankers hauling fuels including liquid gases. The canal is used by 14,000 vessels a year, carrying 5% of world trade, according to its website. The canal authority is expected to consult canal users about the proposed changes before making changes. The new fee structure is expected to be announced by February 2014, for potential implementation by 2015.

TONNAGE STAFF TO VISIT NVDC: On Thursday, January 31, 2013, Mr. Brian Ellis and Mr. Marcus Akins will be out of the office visiting the National Vessel Documentation Center (NVDC) to discuss the development of a new version of the Coast Guard's vessel information database and recent changes to the tonnage administration policy. Should you have any questions or concerns regarding NVDC processes or its staff, please submit them to Mr. Brian Ellis at brian.t.ellis@uscg.mil.

Measurement Organization Weekly Notes - 01/22/2013

VESSEL DETERMINATION BY SUPREME COURT: The Supreme Court of the United States ruled 7-2 that, in a case in Florida, a floating house is not a vessel for purposes of admiralty jurisdiction. Previously, the district court and the appellate court agreed that the floating home was a vessel because it was potentially capable of movement and transportation over the water (having been towed in the past to various locations). The Supreme Court reversed those decisions, including in their findings that "transportation" must be applied in a practical way. A structure does not fall within the scope of the statutory phrase unless a reasonable observer, looking at the house's physical characteristics and activities, would consider it designed to a practical degree for carrying people or things over water. Bearing this in mind, measurement organizations are reminded to refer to MTN 01-98 CH-10, Section 8 and contact the MSC prior to accepting applications for measurement on non-traditional watercraft.

OVERSIGHT FOLLOW UP: Measurement organizations should note that, per MTN 01-98 CH-10, not all corrective actions resulting from oversight require follow-up with the MSC. Each oversight letter will include a request for follow-up, if required. When follow-up is requested, as required by MTN 04-03 CH-2, measurement organizations shall respond within 30 days of receipt of the MSC letter, unless otherwise specified or authorized by the MSC.

DUAL MEASUREMENT: The Tonnage Division recently responded to an inquiry regarding the determination of the uppermost complete deck under the dual measurement system. As per Section 69.157 of MTN 01-99 CH-7, the definition of uppermost complete deck for the standard measurement system also applies to the dual measurement system. Admeasurers should note that the uppermost complete deck under these systems is considered to be the uppermost complete deck of a vessel exposed to sea and weather, which shall be deemed to be that deck which has permanent means of closing all openings in the weather portions thereof. Discontinuities which would invalidate such a deck, or a portion thereof, from qualifying as the uppermost complete deck, are detailed in the definition of "uppermost complete deck" in Section 69.103 of the MTN.

Measurement Organization Weekly Notes - 01/15/2013

TONNAGE DIVISION POC's: Please refer to the attached organizational chart for the appropriate Tonnage Division Points of Contact. We ask that you contact Mr. Marcus Akins for day to day questions or concerns regarding interpretation of the tonnage regulations or the administrative requirements for certification of tonnages and dimensions. For issues concerning the application of tonnage regulations, please contact Mr. Brian Ellis.

SLF SOLAS WORKING GROUP PUBLIC MEETING: A public meeting will be held at USCGHQ in Washington, DC in preparation for the SLF 55 meeting in London in February. For the tonnage item at SLF, we expect discussions will focus on the correspondence group's report, document SLF 55/9, recommending endorsement of its conclusions that no amendments to the 1969 Tonnage Convention are necessary at this time, but that updated interpretations should be further developed at SLF 55. As a reminder, the group offered two draft documents as annexes to progress this work. Along with Germany, India and ITF, the United States sponsored document SLF 55/9/3, proposing a draft Assembly resolution to implement an accommodation space reduced gross tonnage parameter for optional use in assessing fees. Finally, the United States submitted document SLF 55/9/XXX, recommending the removal, or relaxation, of the 1% substantial alteration criterion currently found in TM.5/Circ.5. This criterion addresses vessel eligibility for use of national tonnages when applying certain older tonnage-based provisions of international conventions.

MARTIN LUTHER KING JR. (MLK) HOLIDAY: The Marine Safety Center will be closed on Monday, January 21st, in observance of the Birthday of Martin Luther King Jr. We will resume normal business hours on January 22nd.

Measurement Organization Weekly Notes - 01/08/2013

SLF TONNAGE WORK: IACS has submitted a paper commenting on the correspondence groups work in preparation for SLF 55. Specifically, this paper provides diagrams aimed at supporting the Draft Unified Interpretations developed by the correspondence group. This paper is available on the TM Convention Correspondence group's website: <http://www.uscg.mil/imo/slf/subcomdocs.asp>.

MTN 01-98: As discussed in a previous weekly note, the Tonnage Division has developed a draft change to MTN 01-98 CH-10 and distributed it to the measurement organizations for comment. This draft change addresses specific processes and timelines for reissuance of tonnage certificates, including situations involving the identification of discrepancies related to the vessel's measurement. Should you have any questions regarding the tonnage measurement process or the draft change to the MTN, please contact Mr. Marcus Akins at marcus.j.akers@uscg.mil.

Measurement Organization Weekly Notes - 12/31/2012

SLF TONNAGE WORK: The U.S. has submitted a paper commenting on the correspondence groups work in preparation for SLF 55, specifically, criterion for what constitutes a substantial alteration that would cause a loss of grandfathering under the Convention. In addition, papers from IACS and Italy, along with the co-sponsored on accommodation space reduced gross tonnage, are being posted on the TM Convention Correspondence group's website: <http://www.uscg.mil/imo/slf/subcomdocs.asp>. A public meeting in preparation for SLF 55 will be held on January 23rd at USCGHQ in Washington, DC.

NEW YEAR HOLIDAY CLOSURE: The Marine Safety Center will close on Monday, December 31st at noon for the New Year holiday. Normal business hours will resume on Wednesday, January 2nd.

MR. AKINS OUT OF THE OFFICE: Mr. Marcus Akins will be out of the office Dec 31st 2012 thru Jan 4th 2013. Please forward any tonnage technical questions or file request to Mr. Brian Ellis at brian.t.ellis@uscg.mil.

Measurement Organization Weekly Notes - 12/26/2012

SPECIAL TONNAGE LEGISLATION: On December 20, 2012, the President signed the Coast Guard Authorization Act of 2012 into law. Along with appropriations for the Coast Guard in the next two fiscal years, this Act included special legislation which authorizes the Coast Guard to consider the tonnage measurements for the vessel AQUEOS ACADIAN (ON 553645) recorded on the certificate of inspection for the vessel issued on September 8, 2011, to be valid until May 2, 2014, if the vessel and the use of its space is not changed after November 16, 2012, in a way that substantially affects the tonnage of the vessel.

CHRISTMAS HOLIDAY: The Marine Safety Center has resumed normal business hours after being closed December 24-25, 2012 for the Christmas holiday. Happy Holidays to all our Tonnage friends, customers and colleagues.

MR. ELLIS OUT OF THE OFFICE: Mr. Brian Ellis will be out of the office Dec 26-28, 2012. Please forward any tonnage applicability questions or CG Number requests to Mr. Marcus Akins at marcus.j.akers@uscg.mil.

Measurement Organization Weekly Notes - 12/18/2012

CREW SPACE REDUCED GROSS TONNAGE: A paper, co-sponsored by the U.S., Germany, India, and the International Transport Worker's Federation (ITF) has been submitted to IMO for the 55th session of the Sub-Committee on Stability Load Line and on Fishing Vessels Safety (SLF). This paper proposes and supports an optional reduced gross tonnage parameter which excludes the volume of "crew" accommodation spaces from gross tonnage. The exclusion is limited to living spaces that meet the minimum requirements of the Maritime Labour Convention, 2006.

PORT OF REGISTRY: As reported in Bryant's Maritime Consulting Newsletter on December 14, the US Coast Guard issued a Marine Inspection Notice clarifying the use of the term "Port of Registry" on the Certificate of Inspection, Certificate of Documentation (COD), and certificates required by various international instruments. For commercial and recreational vessels of the United States, "Port of Registry" is the same as the "Hailing Port" indicated on the COD and so marked on the stern of the vessel. In light of the Marine Inspection Notice, measurement organizations are reminded that the "Port of Registry" block on international tonnage certificates are to meet the requirements in Section 2.3(b)(3) of MTN 01-98 CH-10, which specifies the use of the hailing port.

Measurement Organization Weekly Notes - 12/11/2012

SLF TONNAGE WORK: The paper providing a report of the work of the TM Convention Correspondence Group and an associated information paper have been posted to the IMO website. These papers describe the results of the work completed by the Correspondence Group, as well as the information collected, respectively. Of particular note, Annex 1 of the information paper, provides a description of each issue evaluated by the group during the course of its Round 1 work, along with a discussion of the associated solutions proposed by group participants, and a summary of comments offered by the group on each, as obtained from the Round 1 Questionnaires. Measurement organizations are encouraged to read both papers as they will serve as the basis for discussion at SLF 55. Copies of these papers are also available at <http://www.uscg.mil/imo/slf/subcomdocs.asp>.

EMAIL SIZE LIMITS: It has come to our attention that an oversight package, submitted via email to msc@uscg.mil, did not properly transmit to our Electronic Commerce (EC) email inbox. Please be aware that, while the official Coast Guard limit on email size is 10 MB, in the past, files ranging between 8-10 MB have failed to transmit to the EC inbox without notification to the sender that delivery has failed. In such a case, the email may be acknowledged, but not delivered to the EC inbox. If you do not receive a response detailing the assignment of a Document Number to your submission within two business days, please contact a member of the Tonnage Division immediately.

Weekly Notes are issued by the Coast Guard Marine Safety Center's Tonnage Division (MSC-4) for use by organizations that perform measurement work on the Coast Guard's behalf. They are for informational purposes only, and are not intended as, nor should they be construed to represent, revisions of or substitutes for applicable statutes or regulations or established interpretations of either.

Measurement Organization Weekly Notes - 12/4/2012

USES OF TONNAGE ASSIGNMENTS: Both international standards and the Code of Federal regulations contain a multitude of tonnage and registered length thresholds which govern the safety, environmental, and security standards for which vessels comply with. As a part of certifying compliance with these standards, a vessel's tonnage and registered length assignment are often listed on safety, environmental, and security documents. Measurement organizations should note that, because tonnage and registered length assignments are used in this manner, an error on tonnage certificates may also appear on such documents.

REMEASUREMENT TIMELINE: In conducting a recent oversight, the Tonnage Division noted that the Tonnage Administrative Policy (MTN 01-98 CH-10) does not detail a specific timeline for reissuance of tonnage certificates after identifying a discrepancy related to the vessel's measurement. We are currently developing a change to the MTN to incorporate new requirements on this matter. We anticipate completing a draft change to the MTN by end of December. At that time, we anticipate soliciting comment from the measurement organizations prior to its publication. In the interim, should you encounter such a situation, please contact Mr. Marcus Akins at marcus.j.akins@uscg.mil.

Measurement Organization Weekly Notes - 11/27/2012

TONNAGE CERTIFICATE REMARKS: In conducting a recent oversight, the Tonnage Division noted a remark on an International Tonnage Certificate (1969) that indicated that the certificate was reissued to reflect vessel modifications. These modifications did not affect the vessel's assigned tonnages under the Convention, but did result in a substantial alteration. In truth, the certificate was reissued to reflect a new substantial alteration date which resulted from the modifications. When utilizing remarks in accordance with Section 2.4(g)(2) of MTN 01-98 CH-10, measurement organizations should ensure that the reason for certificate reissuance is both brief and accurate.

TONNAGE CERTIFICATE COPIES: In accordance with the reporting requirements described in Sections 1 and 4 of MTN 01-98 CH-10, copies of tonnage certificates issued on the Coast Guard's behalf are to be distributed to the MSC, and to the NVDC for vessels to be documented as vessels of the United States. Measurement organizations are reminded that the signature on the tonnage certificate attests to the validity of the information provided thereon, including the correctness of any tonnages and dimensions assigned by the issuing measurement organization. As such, any certificates distributed under requirements of the MTN, should reflect the signature of an authorized official.

Measurement Organization Weekly Notes - 11/20/2012

SUPERSTRUCTURE CALCULATION METHODS: For measurement of superstructure spaces under the Standard and Dual Measurement systems, the tonnage regulations allow only two methods for calculating volumes: two-dimensional Simpson's first rule integration or a simple geometric formula. Three-dimensional Simpson's first rule integration is not authorized for this purpose. Measurement organizations are reminded that superstructure spaces are those spaces which are above the line of the uppermost complete deck, or shelter deck, if fitted.

SUEZ CANAL ANNIVERSARY: On November 17, 1869 the Suez Canal first opened to shipping. Excavation had taken ten years using forced labor and rudimentary mechanical equipment. Once the Canal opened and proved successful, British interests acquired a majority ownership. In 2008, over 21,000 ships transited the Canal, earning the Government of Egypt over \$5 billion in tolls. The measurement system used to obtain a Suez Canal Tonnage Certificate was derived from the Moorsom System created in Great Britain in 1854.

THANKSGIVING OFFICE CLOSURE: The Marine Safety Center will be closed on Thursday, November 22nd for the Thanksgiving Day holiday. The office will be open Friday the 23rd, however Mr. Marcus Akins and Mr. Brian Ellis will be out. If you have matters requiring attention on that Friday, please contact Mr. Peter Eareckson.

****The Tonnage Division would like to wish you all a safe and Happy Thanksgiving holiday.****

Measurement Organization Weekly Notes - 11/13/2012

SLF TONNAGE WORK: With last Friday's deadline for the submission of the group's report to Secretariat, the work of the TM Convention Correspondence Group is complete. We expect to see the report, and associated information paper, posted to IMO's website in the next few weeks. The U.S. is now turning its focus on developing the U.S. positions on the many tonnage issues that will be before SLF 55 in February, including the reduced gross tonnage parameter for crew space. A public meeting in preparation for SLF 55 will be held on January 23rd at USCGHQ in Washington, DC.

MOLDED DRAFT: Section 2.4(d) of MTN 01-98 CH-10 requires that the "Molded Draft" block on the reverse side of the ITC specify the draft as defined by 46 CFR 69.53. Prior to assigning a vessel a molded draft of 75% of the molded depth, measurement organizations are reminded of the requirements of the related section of MTN 01-99 CH-7 to establish if the vessel has an assigned load line or is restricted in draft under any Coast Guard requirement.

MARINE PERSONNEL REGULATIONS The US Coast Guard issued a Marine Safety Information Bulletin (MSIB 021-12) advising that Canada will commence enforcement of its Marine Personnel Regulations for an engineering watch on U.S. vessels having a propulsive power of at least 750 kW (1000 HP). The Canadian regulations will primarily impact U.S. uninspected vessels such as uninspected towing vessels, but may impact certain passenger vessels falling below the U.S. tonnage threshold for a chief engineer. MSIB 021-12 (10/26/12).

Measurement Organization Weekly Notes - 11/06/2012

TONNAGE CERTIFICATE REISSUANCE: As provided by 46 CFR 69.19(c) and MTN 01-98 CH-10, following notification or discovery that a vessel has been structurally altered or the use of a space or spaces changed within that vessel to a degree that requires remeasurement or that results in a substantial alteration, measurement organizations will issue new tonnage certificates to reflect the new as-configured tonnage or the latest substantial alteration date, when applicable. For questions this issue, please contact Mr. Marcus Akins at marcus.j.akers@uscg.mil.

SUBSTANTIAL ALTERATION DATES: Section 3.3(b)(8) of MTN 01-98 CH-10 requires that the keel laid date and, if applicable, the substantially altered date, separated from the keel laid date by a forward slash be entered on the front of the U.S. tonnage certificate. Measurement organizations should note that, if the vessel has undergone multiple substantial alterations, the Date Keel Laid/Vessel Altered block should only reflect the keel laid date and the date of when the last substantial alteration commenced.

VETERAN'S DAY CLOSURE: The Marine Safety Center will be closed for the Veterans Day holiday, on Monday November 12th. Normal business hours will resume on Tuesday November 13th.

Measurement Organization Weekly Notes - 10/31/2012

OPERATING STATUS: The Marine Safety Center was closed October 29-30, 2012 due to inclement weather resulting from Hurricane Sandy. Normal business hours have resumed as of Wednesday October 31st.

Weekly Notes are issued by the Coast Guard Marine Safety Center's Tonnage Division (MSC-4) for use by organizations that perform measurement work on the Coast Guard's behalf. They are for informational purposes only, and are not intended as, nor should they be construed to represent, revisions of or substitutes for applicable statutes or regulations or established interpretations of either.

Measurement Organization Weekly Notes - 10/23/2012

REDUCED GROSS TONNAGE FOR CREW SPACES: With the work of the TM Convention Correspondence Group drawing to a close (final deadline for comments on its draft report is this Friday), focus is shifting to evaluating the information collected and formulating governmental positions on the many issues raised. This includes implementing a possible crew accommodation space reduced gross tonnage parameter, as mentioned in previous weekly notes. For information and input, please contact Mr. Brian Ellis at brian.t.ellis@uscg.mil or (202)475-5636.

2011 TONNAGE DATA: In evaluating the influence of the TM Convention on ship design and safety under the ongoing IMO work, the Tonnage Division Staff prepared the attached material. It includes a graphical representation of a portion of the world's fleet extracted from 2011 Fairplay data. Of particular interest are the groupings of vessels below the 200, 300 and 500 GT ITC thresholds. If you have any observations about this data, or wish to share any thoughts with us on the influence of the TM Convention on ship design, please contact Mr. Brian Ellis.

Measurement Organization Weekly Notes - 10/16/2012

NEW TONNAGE RECORD: As reported in Bryant's Newsletter, the Panama Canal Authority issued a press release stating that, for the fiscal year ending on 30 September, the Canal set a new tonnage record of 333.7 million Panama Canal tons (PC/UMS). During the year, Canal Waters Time (CWT) averaged 25.66 hours.

TONNAGE DIVISION WEBSITE: The Tonnage Division has updated the tonnage information on the Marine Safety Center's webpage at <http://www.uscg.mil/hq/msc>. This update includes the addition of tonnage division publications and tonnage personnel contact information. The intent of this update is to provide an alternative to the tonnage information and publications located on the Coast Guard's Homeport website. Comments and feedback on the tonnage information posted on this site should be submitted to Mr. Marcus Akins at marcus.j.akers@uscg.mil.

Measurement Organization Weekly Notes - 10/09/2012

VESSEL NAMES: When completing the “Vessel Name” block on a tonnage certificate for a documented vessel and submitting any official correspondence, measurement organizations should note that 46 CFR 67.117 requires that all vessel names (1) Must be composed of letters of the Latin alphabet or Arabic or Roman numerals; (2) May not be identical, actually or phonetically, to any word or words used to solicit assistance at sea; and (3) May not contain nor be phonetically identical to obscene, indecent, or profane language, or to racial or ethnic epithets. Properly documenting a vessel’s name is especially critical to identifying or creating the vessel in the Coast Guard’s vessel database.

VESSEL IDENTIFICATION: Measurement organizations seeking to determine if a vessel has a previously assigned unique identifier (Official Number, IMO Number, CG Number) or are seeking a vessel’s name as documented by the Coast Guard are encouraged to use the Coast Guard sponsored Port State Information Exchange (PSIX) website (<http://cgmix.uscg.mil/PSIX/PSIXSearch.aspx>). This website may also be used to resolve minor spelling and syntax conflicts between previously issued tonnage certificates and applications for tonnage measurement.

TONNAGE PERSONNEL: Mr. Brian Ellis will be out of the office October 10-17 2012. During that time, please forward any questions on tonnage applicability or CG Number requests to Mr. Marcus Akins at (202) 475-3349 or marcus.j.akins@uscg.mil.

Measurement Organization Weekly Notes - 10/02/2012

HULL IDENTIFICATION NUMBERS: The Coast Guard published a Federal Register notice (77 Fed. Reg. 59575) seeking public comment regarding the existing regulatory requirement to indicate a boat's model year as part of the 12-character hull identification number (HIN). In accordance with MTN 01-98 CH-10, measurement organizations must specify the vessel's HIN, if assigned, in the "Hull Number" block on the front of the U.S. tonnage certificate. Comments must either be submitted to our online docket via <http://www.regulations.gov> on or before November 27, 2012 or reach the Docket Management Facility by that date.

SLF TONNAGE WORK: The latest version of the Round 3 Draft Report has been distributed. The deadline for IACS to submit comments on the draft report is close of business on Friday, October 26th, so that potential edits can be made prior to sending the final report to Secretariat on the following Friday. Details on the work of the Correspondence Group, as well as the Round 3 Draft Report are available at: <http://www.uscg.mil/imo/slf/tonnagecg.asp>.

COLUMBUS DAY CLOSURE: The Marine Safety Center will be closed for the Columbus Day holiday, on Monday October 8th. Columbus Day became a federal holiday in 1937, but was celebrated as far back as 1792, when U.S. cities celebrated the 300th anniversary of his landing in the "New World". The holiday has been centered on patriotic rituals such as support for war, citizenship boundaries, and the importance of loyalty to the nation, and celebrating social progress since the 19th century.

Weekly Notes are issued by the Coast Guard Marine Safety Center's Tonnage Division (MSC-4) for use by organizations that perform measurement work on the Coast Guard's behalf. They are for informational purposes only, and are not intended as, nor should they be construed to represent, revisions of or substitutes for applicable statutes or regulations or established interpretations of either.

Measurement Organization Weekly Notes - 9/25/2012

CUSTOMER SERVICE STANDARD: The Tonnage Division endeavors to respond to all tonnage related requests in a timely fashion. In accordance with Section 2.3(b)(iii) and Section 5.4 of MTN 01-98 CH-10, our service standard for response time to CG Number requests and file requests (records maintained on-site at the MSC only) is 2 business days from receipt of the request. Our service standard for response time to requests for formal decisions is 10 business days from receipt of the request. If you feel that these customer service standards do not meet your work flow demands, please feel free to call Mr. Marcus Akins at 202-475-3349, or e-mail him at marcus.j.akers@uscg.mil with any suggestions.

SISTER VESSEL TONNAGE CALCULATION FORMATTING: The Tonnage Division recently responded to an inquiry regarding the formatting of tonnage calculations for sister vessels that are “identical from the standpoint of tonnage measurement”. Measurement organizations may “grandfather” the formatting of the original calculations for these sisters vessels. However, these calculations must meet the minimum calculations standards in Section 6.2(a) of MTN 01-98 CH-10. We intend to clarify this matter in a future change to the MTN.

Measurement Organization Weekly Notes - 9/18/2012

SLF TONNAGE WORK: As a reminder, the deadline for IACS to submit comments on the preliminary Round 3 Draft Report is Friday, September 21, 2012. Details on the work of the Correspondence Group, as well as the Round 3 Draft Report are available at: <http://www.uscg.mil/imo/slf/tonnagecg.asp>.

AUTHORIZED SIGNATURE BLOCK: Sections 2.3(f) and 3.3(f) of MTN 01-98 CH-10 require that an authorized official of the measurement organization signs the tonnage certificate on the appropriate line. For this purpose, only an exclusive employee of the measurement organization may sign tonnage certificates as an authorized official. Furthermore, measurement organizations are to ensure that the "Authorization Signature and Seal" block only reflects one corresponding signature.

Measurement Organization Weekly Notes - 9/11/2012

SURVEYOR SENTENCED: As reported in Bryant's Maritime Consulting Newsletter on September 5th, the Department of Justice (DOJ) reported that a ship surveyor was sentenced to 21 months' incarceration and one year of supervised release after being convicted of lying to the U.S. Coast Guard and falsely certifying the safety of ships for sea. According to the associated press release, a federal jury found the surveyor guilty of lying to a Coast Guard inspector and a federal agent about the drydocking of the CALA GALDANA, a 68-meter cargo vessel, in San Juan, Puerto Rico in April of 2009 and December 2009. The surveyor repeatedly claimed the vessel was drydocked in Cartagena, Colombia in March of 2006, while evidence at the trial proved conclusively that the vessel was never in Colombia during 2006.

WORLD MERCHANT FLEET: Equasis has posted its World Merchant Fleet in 2011. While small ships (under 500 GT) represent 36% of the world fleet by number, they constitute only 1% by tonnage. In terms of tonnage, large and very large ships (25,000 GT and greater) constitute 78% of the world fleet.

SUEZ CANAL TONNAGE CERTIFICATES: Measurement organizations are reminded that Suez Canal tonnage certificates are not issued on behalf of the U.S. government. In accordance with 46 CFR 69.7, Suez Canal tonnage certificates are "provided by measurement organizations authorized by the respective canal authority", and should not include language stating that the signee is authorized by the U.S. government to issue the certificate.

Measurement Organization Weekly Notes - 9/4/2012

U.S. RATIFICATION OF THE ANTI-FOULING SYSTEM (AFS) CONVENTION: The IMO issued a circular stating that the United States submitted its instrument of ratification for the AFS convention. The AFS Convention will come into effect for the United States on 21 November 2012, AFS.1/Circ.49 (8/21/12). This convention applies to ships of 400 GT ITC and above.

REPORTING OF MEASUREMENT WORK: Measurement organizations are reminded that, in accordance with Section 4.2(a) of MTN 01-98 CH-10, notification of completion of each tonnage work item shall be made in accordance with MTN 04-03, as amended. This notification must be made in the form of an email attachment delivered to assessment-msc@uscg.mil, using the worksheet shown in enclosure (1) of MTN 04-03, as amended and available for download at homeport.uscg.mil/msc. Tonnage work which has not been reported should be forwarded to the MSC using this notification process immediately.

Weekly Notes are issued by the Coast Guard Marine Safety Center's Tonnage Division (MSC-4) for use by organizations that perform measurement work on the Coast Guard's behalf. They are for informational purposes only, and are not intended as, nor should they be construed to represent, revisions of or substitutes for applicable statutes or regulations or established interpretations of either.

Measurement Organization Weekly Notes - 8/31/2012

LABOR DAY CLOSURE: The Marine Safety Center will be closed for the Labor Day holiday, on Monday September 3rd. As we reported last year, this holiday is devoted to the recognition of working people's contribution to society. It was first celebrated in New York City on September 5th, 1882, under the sponsorship of the Knights of Labor, the largest American labor organization of the 19th century. It became a national holiday in 1894.

SLF TONNAGE WORK: The preliminary Round 3 Draft Report has been distributed. This draft report represents the culmination of the Correspondence Groups efforts over the past 6 months. The deadline for IACS to submit comments on the draft report is Friday, September 21, 2012. Details on the work of the Correspondence Group, as well as the Round 3 Draft Report are available at: <http://www.uscg.mil/imo/slf/tonnagecq.asp>.

Measurement Organization Weekly Notes - 8/21/2012

MARITIME LABOUR CONVENTION, 2006: The International Labour Organization (ILO) issued a news release stating that the Maritime Labour Convention, 2006 (MLC 2006), which establishes minimum requirements for seafarer working conditions, has now been ratified by thirty nations (The United States has not ratified this convention yet). Those nations represent more than 33% of the world's gross shipping tonnage. MLC 2006 will enter into force on 20 August 2013 and feature tonnage thresholds of 200, 500, 3000, and 10000 GT ITC.

SLF TONNAGE WORK: Participants from 14 countries and 4 non-governmental organizations (including IACS) submitted input during the now-completed second phase of the Round 2 correspondence group work. Results are being incorporated into the Round 3 Draft Report, which will be distributed to participants in the near future.

TONNAGE CALCULATIONS FORMAT: Further to last week's weekly note regarding standard measurement tonnage calculation formats, measurement organizations are reminded that tonnage calculations not generated by TonCalc 2.0.1 are unacceptable effective September 1st unless a corresponding format has received written approval from the MSC. Contractor developed standard measurement tonnage calculations not in an approved format will have to be redone by the measurement organizations.

Measurement Organization Weekly Notes - 8/14/2012

STANDARDIZED TONNAGE CALCULATIONS: Classification societies are reminded that in accordance with MTN 01-98 CH-10, effective on September 1, 2012, measurement organizations must use a standardized calculation format for vessels measured under the Standard or Dual Measurement System. This standardized format corresponds to that provided in the tonnage calculation sample included in Appendix A of the MTN.

SLF TONNAGE WORK: The Correspondence Group work continues. As a reminder, the deadline for IACS to submit its final input into Round 2 Questionnaires is this Friday, August 17, 2012.

MR. AKINS OUT OF THE OFFICE: Mr. Marcus Akins will be out of the office on temporary duty Aug 13 - 16, 2012. Please forward any tonnage requests to Mr. Brian Ellis at brian.t.ellis@uscg.mil.

Measurement Organization Weekly Notes - 8/7/2012

US COAST GUARD BIRTHDAY: On Saturday, August 4th, the U.S. Coast Guard celebrated its 222nd Birthday. This day represents the date when the first Congress authorized the construction of 10 vessels to enforce tariff and trade laws, prevent smuggling, and protect the collection of federal revenue. In 1946, approximately 157 years after the First Congress established the tonnage program, Congress permanently transferred the Commerce Department's Bureau of Marine Inspection and Navigation (where Tonnage had once resided), to the Coast Guard, thereby placing merchant marine licensing and merchant vessel safety under our purview. Tonnage measurement was eventually transferred to the Coast Guard from Customs in 1967, the same year the trademark racing stripe design was adopted at the recommendation of the presidentially assigned (Kennedy) industrial design firm of Raymond Loewy/William Snaith.

MTN 04-03 CH-2: In the recent update to MTN 04-03 the email address for notification worksheets was changed to the general E-Commerce inbox (msc@uscg.mil) in error. The correct address for automatic processing of notification worksheets is: Assessment-msc@uscg.mil. There is no need to resubmit notifications sent to the E-Commerce inbox as those notifications will be manually processed by the Marine Safety Center. We [anticipate] a correction to the MTN will be issued as soon as possible.

Weekly Notes are issued by the Coast Guard Marine Safety Center's Tonnage Division (MSC-4) for use by organizations that perform measurement work on the Coast Guard's behalf. They are for informational purposes only, and are not intended as, nor should they be construed to represent, revisions of or substitutes for applicable statutes or regulations or established interpretations of either.

Measurement Organization Weekly Notes - 7/31/2012

TONNAGE SURVEYORS: The Tonnage Division recently responded to an inquiry regarding “certified tonnage surveyors”. Please note that the Coast Guard does not certify individuals to perform tonnage measurement surveys on its behalf. Under the tonnage regulations, the Coast Guard authorizes measurement organizations to perform tonnages work on its behalf. Qualification and/or certification of tonnage surveyors is the responsibility of the authorized measurement organizations.

REQUEST FOR MSC TONNAGE DECISIONS: The Tonnage Division has responded to a number of requests for decisions on interpretation of the tonnage regulations. Please note that inclusion of the vessel/space configuration in question and the specific question or questions regarding the configuration will greatly assist us in providing a timely response. If possible, and when applicable, a sketch of the vessel/space configuration should be submitted. We also encourage measurement organizations to include the MTN 01-99 CH-7 interpretation, if any, which they feel most accurately reflects how the tonnage rules should be applied.

TERMINOLOGY: As part of the ongoing IMO work, the correspondence group is attempting to standardize terminology to the maximum extent practicable. For example, the expression “treated” is being used instead of “considered” per language in Regulation 2(5) of the Convention, the phrase “included in the total volume of all enclosed spaces (V)” replaces “included in the gross tonnage”, the term “1969 Tonnage Convention” replaces the term “TM Convention” and the acronym “ITC69” replaces “ITC” when referring to International Tonnage Certificates (1969). If you have any thoughts on this subject you would like to share with the U.S. participants, please contact Mr. Marcus Akins.

Measurement Organization Weekly Notes - 7/25/2012

MILESTONE DATE: July 18, 2012 marked the 30th anniversary of the coming into force of the 1969 Tonnage Convention; two years to the day after Japan acceded to the Convention in 1980. This provided a sufficient number of nations representing not less than 65% of the gross tonnage of the world's merchant shipping.

SLF TONNAGE WORK: The Correspondence Group is in the final phase of its work to make specific recommendations on changes to the Draft Unified Interpretations and the TM Convention itself. We are assuming that tonnage representatives from all authorized measurement organizations are actively engaged in this critical effort through IACS. The deadline for IACS to submit its final input is Friday, August 17, 2012.

ONBOARD SURVEY: The Tonnage Division recently responded to an inquiry regarding onboard survey requirements. Measurement organizations are reminded that, per Section 1.4 of MTN 01-98 CH-10, tonnage-related labeling and marking of cargo compartments, deducted spaces, and tonnage marks are to be verified during an onboard survey. Verification of administrative information utilized to identify the vessel is highly encouraged, but not explicitly required.

Measurement Organization Weekly Notes - 7/17/2012

MARINE SAFETY CENTER CHANGE OF COMMAND: Captain John Nadeau relieved Captain Patrick Little as Commanding Officer of the USCG Marine Safety Center in a ceremony presided over by Mr. Jeffery Lantz, Director of Commercial Regulations and Standards on Friday, 13 July. The Change of Command was followed by a retirement ceremony celebrating Captain Little's 26 years of honorable service. We wish Captain Little and his family fair winds and following seas. We welcome Captain Nadeau and his vast marine safety experience and proven leadership, as he enters his 3rd tour of duty with the Marine Safety Center.

ORDINARY FRAME CONSTRUCTION: The Tonnage Division recently responded to an inquiry regarding the construction of ordinary frames. In accordance with Section 69.109(p)(1)(i) of MTN 01-99 CH-7, a frame may be considered to be an ordinary frame if it is initially penetrated by an intersecting frame that is used to strengthen the vessel's hull, only if subsequent manufacturing steps are taken to render the final assembly to appear as an integral unit. Admeasurers should note that to "penetrate" a frame in the MTN means to intersect the frame via an opening in the frame.

Measurement Organization Weekly Notes - 7/10/2012

SLF TONNAGE WORK: Input from the correspondence group on tonnage has been incorporated into the Round 2 Questionnaire Form, which is posted on the IMO SLF Tonnage Correspondence Groups webpage under the 'Documents' tab. The Preliminary Annex of figures is also provided there as well. IACS has proposed establishing the interpretation that "a "substantial change" is one where the gross tonnage is changed by more than 1% of the original gross tonnage." Round 2 ends on August 18th.

ALTERNATE TONNAGE THRESHOLD FOR OSRV's: The interim rule establishing an alternate tonnage threshold for oil spill response vessels (OSRVs) based on the convention measurement system was finalized without change. The final rule comes into effect immediately. 77 Fed. Reg. 38729 (June 29, 2012).

TONNAGE PERSONNEL: Mr. Marcus Akins will be out of the office 09 JULY-15 JULY. During that time, please forward any questions on tonnage standards or file requests to Mr. Brian Ellis (202) 475-5636.

Measurement Organization Weekly Notes - 7/03/2012

ALTERNATE TONNAGE THRESHOLD FOR OSRV's: The interim rule establishing an alternate tonnage threshold for oil spill response vessels (OSRVs) based on the convention measurement system was finalized without change. The final rule comes into effect immediately. 77 Fed. Reg. 38729 (June 29, 2012).

SLF TONNAGE WORK: Participants from 10 countries and 2 non-governmental organizations (including IACS) submitted input during the now-completed first phase of the Round 2 correspondence group work. Results are being incorporated into the Round 2 Questionnaires, which will be distributed Monday, July 9.

Measurement Organization Weekly Notes - 6/26/2012

DISTRIBUTION OF TONNAGE CERTIFICATES COPIES: MTN 01-98 CH-10 includes a change to the previous requirements for reporting tonnage certificates to the NVDC. Section 1.7 was revised to permit electronic transmittal of tonnage certificate copies to the NVDC, consistent with changes to documentation regulations described in the Federal Register (72 FR 42310 dated August 2, 2007).

SLF TONNAGE WORK: On Friday, June 29th, the first phase of Round 2 of the Correspondence Group's work ends. The goal of the first phase of Round 2 is to gather specific proposed revisions to a Draft Unified Interpretations document, proposed IMO resolutions, and/or proposed revisions (amendments) to the TM Convention. As stated in a previous weekly note, measurement organizations are encouraged to participate in this process via IACS. Details on the work of the Correspondence Group, as well as this questionnaire are available at: <http://www.uscg.mil/imo/slf/tonnagecg.asp>.

Measurement Organization Weekly Notes - 6/19/2012

MTN 04-03 CH-2: The Marine Safety Center has issued a change to MTN 04-03, Technical Support and Oversight of Authorized Classification Societies. Changes to MTN 04-03 include but are not limited to a new framework for classifying nonconformities and the addition of notification worksheet instructions. A copy of MTN 04-03 CH-2 may be obtained on the Coast Guard's Homeport website: Missions > Vessel Standards > Marine Safety Center > References > MSC Technical Notes.

MTN 01-98 CH-10: The Marine Safety Center has also issued a change to MTN 01-98. A copy of MTN 01-98 CH-10 has been distributed to each of the authorized measurement organizations. MTN 01-98 CH-10 may also be obtained on the Coast Guard's Homeport website: Missions > Vessel Standards > Marine Safety Center > References > MSC Technical Notes.

TONNAGE DIVISION WEBSITE – The Tonnage Division is currently updating the tonnage information on the Marine Safety Center's webpage at <http://www.uscg.mil/hq/msc>. To date, we have added frequently used tonnage publications such as MTN 01-98, MTN 01-99, and NVIC 11-93. Comments and feedback on the tonnage information posted on this site should be submitted to Mr. Marcus Akins at marcus.j.akers@uscg.mil.

Weekly Notes are issued by the Coast Guard Marine Safety Center's Tonnage Division (MSC-4) for use by organizations that perform measurement work on the Coast Guard's behalf. They are for informational purposes only, and are not intended as, nor should they be construed to represent, revisions of or substitutes for applicable statutes or regulations or established interpretations of either.

Measurement Organization Weekly Notes - 6/12/2012

TONCALC 2.0.1: As indicated in last week's weekly notes, measurement organizations using TonCalc 2.0.1 will be in compliance with the standard calculations formatting requirements planned under MTN 01-98, CH-10. As a reminder, the use of this software to generate tonnage calculations remains discretionary and the responsibility for accurate tonnage assignment remains that of the measurement organization.

ENDORSEMENT OF OFFSHORE SUPPLY VESSELS AS OIL SPILL RESPONSE VESSELS: The Deputy Commandant for Commercial Vessel Compliance (CG-CVC) issued a policy letter informing Officers in Charge, Marine Inspection (OCMI) and their designated reps of how to properly endorse qualified vessels as Oil Spill Response Vessels on their Certificate of Inspection. This policy follows the alternate tonnage threshold established in the interim rule of Dec 12, 2011, which modified 46 CFR Subchapter L and is anticipated to become final shortly.

Measurement Organization Weekly Notes - 6/05/2012

REDUCED GROSS TONNAGE FOR CREW ACCOMODATION SPACES: The tonnage correspondence group is reviewing recommendations to create a crew accommodations-based reduced gross tonnage parameter aimed at encouraging improved design, size and function of crew accommodation spaces and minimizing tonnage fees for vessel owners and operators. Note that classification society representatives should be providing their input through their respective representatives on the IACS Statutory Panel. All others should forward their input to Mr. Brian Ellis; email brian.t.ellis@uscg.mil or phone (202)475-5636.

MTN 01-98: As discussed in a previous weekly note, the Tonnage Division is in the process of finalizing MTN 01-98, CH-10. MTN 01-98, CH-10 is planned to feature the use of the standard calculations format based on TonCalc 2.0, a new framework for classifying nonconformities established by the soon to be published MTN 04-03, CH-2, and a revised list of authorized measurement organizations. Please forward any questions regarding MTN 01-98, CH-10 to Mr. Marcus Akins at 202-475-3349, or e-mail him at marcus.j.akers@uscg.mil.

Measurement Organization Weekly Notes - 5/29/2012

NET TONNAGE: Section 69.119(a) of MTN 01-99, CH-7 provides the requirements for spaces, which, though included in calculating gross tonnage, are deducted from gross tonnage in deriving net tonnage. Measurement organizations are reminded that the volume of a space must be included in the gross tonnage calculation before it may be deducted for the purposes of calculating net tonnage.

TONNAGE TRAINING: With the release of TonCalc 2.0 and the impending release of MTN 01-98, CH-10, the Marine Safety Center plans to conduct on-site tonnage training for the authorized measurement organizations and their contractors. These training sessions will cover topics typically covered during our annual conferences, the use of TonCalc 2.0, and reporting requirements associated with MTN 01-98, CH-10. Authorized measurement organizations will be contacted individually to schedule training.

Measurement Organization Weekly Notes - 5/22/2012

SLF TONNAGE WORK: Yesterday, Round 2 of the correspondence group's work commenced. Unlike Round 1, which focused on gathering and evaluating ideas, Round 2 is focused on developing specific recommended revisions to the draft Unified Interpretations document (replacement to TM.5/Circ.5) and/or the TM Convention itself. Altogether, participants representing 13 countries and 3 non-governmental organizations (NGOs) completed Round 1 Questionnaires, the preliminary results from which are posted on the group's website: <http://www.uscg.mil/imo/slf/cgdocs.asp>.

LONGITUDINAL ORDINARY FRAMES: In establishing the line of the ordinary frames, horizontal plating that rests on ordinary bottom floors or framing cannot serve as an "ordinary" longitudinal side frame. While this is not explicitly prohibited by MTN 01-99, CH-7, we consider that any structure that serves the function of ceiling (as described in the MTN) or a deck or platform cannot also be construed as constituting part of the web of an ordinary longitudinal frame. We intend to clarify this matter in a future change to the MTN.

MEMORIAL DAY CLOSURE: The Marine Safety Center will be closed for the Memorial Day holiday, on Monday May 28th. Normal business hours will resume on Tuesday May 29th.

Measurement Organization Weekly Notes - 5/15/2012

TONNAGE CERTIFICATION HISTORY: Measurement organizations are reminded that an accurate tonnage certification history must be reflected on the reverse side of all tonnage certificates. For example, should a vessel be previously assigned an Official Number, yet undocumented following remeasurement, the U.S. Tonnage Certificate must reflect the most recent tonnage certification regardless of the measurement system used to determine the previously assigned tonnage.

VESSEL DETERMINATIONS: An important case that could affect vessel determinations, *Fane Lozman v. The City of Riviera Beach, Florida*, is expected to be heard by the Supreme Court this fall. The case involves a “houseboat” that was “permanently moored” at a marina. Please be aware that this pending case does not alter how vessel determinations on non-traditional watercraft are made. Vessel determinations on non-traditional watercraft shall continue to be made in accordance with Section 8 of MTN 01-98, CH-9.

Measurement Organization Weekly Notes - 5/8/2012

TONNAGE FILE REQUESTS AND CG NUMBERS REQUESTS: When submitting tonnage file request and CG number requests in accordance with MTN 11-98, CH-9, Appendix A and MSC Tonnage Guide 3, it is very important that the MSC electronic submission email address be included on all ACS email requests. Including msc@uscg.mil in each email request improves response times and allows for more efficient management of tonnage staff workload. Your cooperation is greatly appreciated.

MARITIME LABOUR CONVENTION 2006 (MLC 06): A recent review of the, not yet ratified, MLC 06 revealed 16 tonnage thresholds, the majority of which are directed at berthing space floor dimensions for officers and crew. This convention has been ratified by countries which represent the requisite percentage of the world's gross tonnage. However, it has not been ratified by the required number of countries, including the U.S.

Measurement Organization Weekly Notes - 5/1/2012

TONCALC 2.0.1: The MSC has released TonCalc 2.0.1, and will be using it for tonnage certification of Navy and Coast Guard vessels. A copy of this software, along with a copy of the MSC work instruction on TonCalc has been distributed to each of the authorized measurement organizations. Use of this software to generate tonnage calculations is at the discretion of authorized measurement organizations. We extend our thanks to those of you who provided feedback on this new TonCalc release.

AIR TRUNKS: The Tonnage Division recently discussed an inquiry regarding the convention measurement treatment of air trunks. In accordance with MTN 01-99, CH-7, air trunks having a cross-sectional area not exceeding one square meter are ignored from volume calculations. Admeasurers are to note that the figures associated with this interpretation reflect that the cross-sectional area of the two-dimensional section is taken perpendicular to a line which runs along the length of the air trunk.

TONNAGE PERSONNEL: Mr. Marcus Akins will be out of the office 03MAY-7MAY and will return Monday, 08MAY2012. During that time, please forward any questions on tonnage standards or file requests to Mr. Brian Ellis (202) 475-5636.

Measurement Organization Weekly Notes - 4/25/2012

TONNAGE MEASUREMENT OF WARSHIPS: A gentle reminder that per 46 CFR 69.15, all U.S. Coast Guard vessels and all U.S. Navy vessels of war to be measured or remeasured must be measured by the Coast Guard. There are no exceptions.

ONBOARD SURVEYS: Measurement organizations are reminded that surveyors must verify, among other things, that excluded spaces meet requirements of Section 69.61(g) of MTN 01-99 (e.g., spaces are not fitted with shelves or other means designed for securing cargo or stores, openings are not fitted with means of closure, etc.), that tonnage openings are fitted in accordance with Section 69.117(d)(2) of MTN 01-99, and that dimensional information used in the tonnage measurement process is correct and of sufficient accuracy (e.g., drawings, computer models). See MTN 01-98 CH-9 Section 1.4 for complete onboard survey requirements.

TONNAGE CALCULATIONS AND FRAME LOCATIONS: MTN 01-98 CH-9 Section 6.2(a)(1) requires that tonnage calculations under the regulatory system (GRT/NRT) list the frame locations (or equivalent) for dimensions used in volume calculations. This includes all dimensions associated with spaces included in or exempted or deducted from tonnage. Compliance with this requirement is imperative to the reconstruction of a tonnage measurement from the tonnage file. To provide clarity for and consistency in compliance with this standard, the attached examples from TonCalc tonnage calculations worksheets are provided.

Measurement Organization Weekly Notes - 4/17/2012

TONCALC 2.0 RELEASE: The Tonnage Division recently released the latest version of the TonCalc tonnage calculation worksheet. The deadline for feedback is April 30th. This represents the final opportunity to provide feedback on the calculation worksheet prior to its official release. Please note that, if the TonCalc tonnage calculation worksheet is opened in the Page Break Preview View, "Main Menu" will not display in the right click pick list. TonCalc must be viewed in either the Normal View or Page Layout View to access the "Main Menu" upon right clicking.

TONNAGE CONSULTING: Please be aware of the restrictions in MTN 01-98 CH-9 on tonnage consulting, defined as giving advice regarding the assignment of tonnages for a fee or consideration (i.e., other compensation). If in doubt, contact Mr. Marcus Akins before engaging in any activity that could be construed as "consulting" on a vessel for which you are also providing measurement services on behalf of a measurement organization.

MTN 04-03 CH-2 DRAFT: The Marine Safety Center is in the process of updating this MTN, principally to align language related to oversight with that increasingly being used by the International Maritime Organization. For example, we are intending to adopt the more general term "finding", and eliminate our current Category 1, 2 and 3 designations. If you desire more information about the intended changes, and/or wish to provide your input, please contact Mr. Marcus Akins.

Measurement Organization Weekly Notes - 4/10/2012

MTN 01-98: The Tonnage Division is developing a change to its Tonnage Administrative Policy to update the document and incorporate the use of a standard calculations format. Measurement organizations are encouraged to submit suggestions for changes to MTN 01-98, CH-9. All comments or suggested changes should be submitted to Mr. Marcus Akins at marcus.j.akers@uscg.mil.

SLF TONNAGE WORK: In reference to last week's item on this subject, the work has - arguably - entered its most important phase, where the group is evaluating the various proposals to resolve issues with the TM Convention. The Round 1 Questionnaire contains many interesting ideas, along with photos and other graphics, and is worth a look, even if you are not actively engaged in this effort: http://www.uscg.mil/imo/slf/docs/tonnage/TM_Conv_CG_Round_1_Questionnaire_Rev_0.pdf. Note that classification society representatives should be providing their input through their respective representatives on the IACS Statutory Panel, once IACS has circulated the questionnaire to this panel.

TONCALC 2.0 RELEASE: The Tonnage Division is putting the finishing touches on TonCalc 2.0 Beta, and intends to distribute it to measurement organizations for their comment later this week. The new version incorporates a number of improvements from the version distributed earlier this year, including additional error checking features, improved pick-list functionality, and the color coding of all data entry fields to help improve usability. It also uses an added "right click" menu item (or CTRL M) to access the Main Menu, rather than CTRL Z, as CTRL Z is the default "undo" combination shortcut key command in Excel, and has confused some users.

Weekly Notes are issued by the Coast Guard Marine Safety Center's Tonnage Division (MSC-4) for use by organizations that perform measurement work on the Coast Guard's behalf. They are for informational purposes only, and are not intended as, nor should they be construed to represent, revisions of or substitutes for applicable statutes or regulations or established interpretations of either.

Measurement Organization Weekly Notes - 4/3/2012

CERTIFICATE OF INSPECTION REMARKS: The tonnage division recently discussed tonnage related remarks appearing on a vessel's Certificate of Inspection. It was explained that remarks are not under the Marine Safety Center's authority and any comments or requests for interpretation should be directed to the cognizant Officer in Charge of Marine Inspection (OCMI).

SLF TONNAGE WORK: The Round 1 Questionnaire for the correspondence group has been completed and distributed to the participants. The questionnaire is due Friday, May 11th. As stated in a previous weekly note, measurement organizations are encouraged to participate in this process via IACS. Details on the work of the correspondence group, as well as this questionnaire are available at: <http://www.uscg.mil/imo/slf/tonnagecg.asp>.

MR. EARECKSON OUT OF THE OFFICE: Mr. Eareckson will be out of the office the week of April 02-06, 2012 and will return Monday, April 9, 2012. During that time, please forward any questions regarding the correspondence group to Mr. Marcus Akins at 202-475-3349, or e-mail him at marcus.j.akers@uscg.mil.

Measurement Organization Weekly Notes - 3/27/2012

FOREIGN REBUILDING DETERMINATION: The US Coast Guard issued a notice stating that it has denied a petition for rulemaking to amend its regulation concerning foreign rebuilt determinations for US vessels entitled to a coastwise trade endorsement. The current policy, published at 46 CFR § 67.177, will remain in effect. 77 Fed. Reg. 16172 (March 20, 2012). As reported earlier, criteria for a foreign rebuild determination is not the same as criteria for substantial alterations. For example, rebuild determinations involve an evaluation of the percentage change in steel weight or equivalent (e.g., 7.5% or 10%), as opposed to a percentage change in the gross tonnage for substantial alterations.

SLF TONNAGE WORK: Participants from 9 countries and 3 non-governmental organizations (including IACS) submitted input during the now-completed first phase of the Round 1 correspondence group work. Results are being incorporated into the Round 1 Questionnaires, which will be distributed by next Monday.

TONNAGE PERSONNEL: Mr. Marcus Akins will be out of the office 29MAR-30MAR and will return Monday, 02APR2012. During that time, please forward any questions on tonnage standards or CG Number/file requests to Mr. Brian Ellis (202) 475-5636.

Measurement Organization Weekly Notes - 3/20/2012

ELECTRONIC COMMERCE DELAYS: The computer servers that route all electronic commerce (including tonnage file requests and CG Number requests) sent to 'msc@uscg.mil' were unexpectedly reconfigured within the past several days, causing some delays and disruptions to MSC business processes. While no files were lost, we anticipate some minor delays in routing and completing any requests that came in on or after Friday, 16 March. We apologize for any inconvenience this may have caused. If a measurement organization has not received confirmation of an electronic commerce submittal by COB Wednesday 21 March, please contact Mr. Brian Ellis (202)475-5636.

VESSEL IDENTIFICATION: Measurement organizations seeking to determine if a vessel has a previously assigned unique identifier (Official Number, IMO Number, CG Number) are encouraged to use the Coast Guard sponsored Port State Information Exchange (PSIX) website (<http://cgmix.uscg.mil/PSIX/PSIXSearch.aspx>). The information contained in PSIX represents a daily snapshot of releasable (e.g., Freedom of Information Act (FOIA)) MISLE data on U.S. flag vessels and foreign vessels operating in U.S. waters.

SLF TONNAGE WORK: Friday (March 23rd) is the correspondence group's deadline for identification of new issues and submittal of proposed solutions for the 32 previously identified issues. So far, a number of new issues have been submitted, including four from the U.S. participants. U.S. proposed solutions for the previously identified issues is being finalized, and will be submitted later this week.

Measurement Organization Weekly Notes - 3/13/2012

VESSEL NAMES: Measurement organizations requesting CG Numbers for vessels should note that each character in a vessel's name is critical to identifying or creating the vessel in the Coast Guard's vessel database. For example, "J.H.B. LATROBE" is different from "J H B LATROBE" and "JHB LATROBE". Also, omit prefixes unless they are part of the vessel's name. Thus, the motor vessel "GLORIA" should never be cited as the "M/V GLORIA" unless the M/V is part of the vessel's official name. Please be aware that including any extra characters or using a number when the number should be spelled out may lead to delays or inaccuracies in CG Number assignment.

FILE REQUESTS: Please continue to send your file requests to the MSC's electronic commerce email address: msc@uscg.mil. Although not a requirement, we encourage you to include the name of a sister vessel in your request. If the tonnage file of the vessel requested is not available, the MSC can provide the tonnage file for a sister vessel to aid in remeasurement.

Measurement Organization Weekly Notes - 3/06/2012

COAST GUARD NUMBER REQUESTS: In accordance with Section 3.3(b)(iii) of MTN 01-98 CH-9, a Coast Guard (CG) number is specified in the "Vessel Number" block of the U.S. Tonnage Certificate when an IMO or official number is not applicable to the vessel. Please be aware that when a Coast Guard Number is requested and the vessel has been previously assigned an official number, only the official number will be provided.

ITC FORMAT: As part of the TM Convention Correspondence Group work, we are considering editorial changes to the form of the ITC, such as changing the note referring to alterations or modifications of a "major character" to better align this statement with the language in Article 3(2)(b) of the Convention. As part of this effort, we are reviewing general formatting issues, such as why the U.S. Coast Guard incorporated some formatting changes in the form that it adopted in 1982, including a much larger header on the front of the certificate than appears in Annex II of the Convention. If you have any information that could assist us in answering these questions, please contact Mr. Marcus Akins.

Measurement Organization Weekly Notes - 2/28/2012

SLF TONNAGE WORK: The tonnage Correspondence Group continues its work, and was recently joined by participants representing the Russian Federation, Brazil and Finland. So far, one new issue (treatment of legs and “rigs” on self-elevating drill structures) has been identified and circulated to the group. The deadline for identification of new issues is Friday, March 23rd.

RECESSES: Section 69.109(n) of MTN 01-99, CH-7 provides interpretations on measuring hull recesses and deck recesses under the standard measurement system. Admeasurers are reminded to use caution when evaluating a recess’s effect on under-deck and between-deck tonnage. Particularly, please note that while the portion of a through-hull deck recess which is below the line of the uppermost complete deck may be subtracted out of portions of the breadth measurements using the procedure of Section 69.109(q)(7), the same is not true for deck recesses below the uppermost complete deck.

TONNAGE HISTORY: On February 28, 1942, Executive Order 9083 “Redistribution of Maritime Functions” transferred the measurement of vessels from the Bureau of Marine Inspections and Navigation to the Bureau of Customs. Tonnage measurement remained a function of the Bureau of Customs until February 24, 1967, when Treasury Department Order No. 167-81 transferred it to the U.S. Coast Guard. The responsibility for the performance of tonnage measurement was transferred to the Coast Guard later that year on May 9, 1967.

Measurement Organization Weekly Notes - 2/21/2012

MISDIRECTED TONNAGE PLANS: On occasion, the MSC receives tonnage plan submittals for “approval”, which we return without action. These are usually from naval architects who may not be familiar with the differences between the plan approval process for inspected vessels (which involves the MSC or class societies under special plan approval authorizations), and the tonnage measurement process for formal measurement (which does not involve the MSC, under normal circumstances). In your dealings with your customers, please keep in mind that those who are new to the business may not be aware of this distinction. Any assistance you can give to ensure that tonnage plans are submitted to an authorized measurement organization would be much appreciated.

ALTERNATE TONNAGE THRESHOLD FOR OSRV’S: The public comment period for the alternate tonnage interim rule published December 12, 2011, ended 10 February. There were no comments received. The regulation team is preparing to publish the final rule for Offshore Supply Vessels that seek designation as an Oil Spill Response Vessel’s. It is anticipated that this rule will increase the nation’s oil spill response capability and capacity.

TONNAGE CALCULATIONS: At the 2011 Tonnage Conference, developing minimum standards for tonnage calculations was discussed. In the discussions, one participant noted that an administration requires computations and calculations in either printed or electronic form and that owners provide offsets as a minimum standard. GHS is specifically mentioned within this participant’s requirements as acceptable documentation and the administration is obliged to protect the information on behalf of the ship owner. There was some consensus that a flag should require offsets be submitted, which allows for “spot-checks”, however this is not a perfect system to recreate the calculations from. All administrations present noted that they do not audit or certify the software used in modeling in submissions for accuracy.

Measurement Organization Weekly Notes - 2/14/2012

TONNAGE REGULATIONS AMENDMENTS: On Monday February 13, 2012, DHS published its Unified Agenda of Federal Regulatory and Deregulatory Actions which provides a semiannual summary of all current and projected rulemakings, existing regulations, and completed actions of the Department of Homeland Security (DHS) and its components. Not published in the Federal Register, but included in Unified Agenda is the Coast Guard's projected publication of a Notice for Proposed Rulemaking for tonnage regulation amendments. A link to the Unified Agenda is listed below. Mr. Marcus Akins has the lead on this project.

<http://www.reginfo.gov/public/do/eAgendaViewRule?pubId=201110&RIN=1625-AB74>

SLF TONNAGE WORK COMMENCES: The correspondence group has commenced the work to review the TM Convention and its interpretations, and come up with solutions to any identified issues. In Round 1, participants are being asked to identify new issues, and offer proposed solutions for issues that have already been identified. These will then be compiled and distributed to participants on a Round 1 Questionnaire in April. Measurement organizations are encouraged to participate in this process via IACS. More details are available on the group's website:

<http://www.uscg.mil/imo/slf/tonnagecg.asp>.

PRESIDENT'S DAY CLOSURE: Until 1971, both February 12 and February 22 were observed as federal public holidays to honor the birthdays of Abraham Lincoln (February 12) and George Washington (February 22). In 1971 President Richard Nixon proclaimed one single federal public holiday, the Presidents' Day, to be observed on the 3rd Monday of February, honoring all past presidents of the United States of America. On Monday, February 20, the MSC and most federal offices will be closed in observance of this holiday.

Measurement Organization Weekly Notes - 2/7/2012

1969 TONNAGE CONFERENCE DOCUMENTS: We've recently updated the IMO Tonnage Information website, replacing the existing scanned versions of principal meeting documents from the 1969 Tonnage Conference with OCR converted versions. This means that there is now a word search capability for such documents. In addition, we've created "consolidated" versions of each set of principal meeting documents, so that users can quickly search the complete meeting reports for each of the major committees. This work was done in preparation for the launch of the Round 1 Correspondence Group work, which is to begin on Monday, February 13th. A link to the page listing these documents follows: <http://www.uscg.mil/imo/slf/historical.asp>.

CONTAINERS AND TONNAGE: In reference to the item above, by searching meeting documents on the word "container", one will find that the TM Convention was written with containers and containerships in mind. For example, see page 13 of document C.1/SR.15:

http://www.uscg.mil/imo/slf/docs/tonnage/ITC69_General_Committee_15th_meeting.pdf

. According to this document, the language mandating inclusion in Vc of only those cargo spaces that "have been included in the computation of gross tonnage" was placed there specifically to address shipping container treatment. This language now appears in Regulation 2(7) of the TM Convention.

CG NUMBER REQUESTS: As stated in a previous weekly note, submitting a complete tonnage application when requesting a CG number for any particular vessel is critical in creating vessel profiles in the MISLE database and avoiding vessel duplications. Information such as Vessel Type, Builder, Hull Number, HIN, and current and previous vessel names are among the most important details we use in our search and in vessel profile creation. Please ensure that all applications submitted when requesting a CG number contain the aforementioned details (if available).

Measurement Organization Weekly Notes - 2/1/2012

TONCALC DEADLINE: The deadline for feedback on the TonCalc tonnage calculation worksheet is tomorrow (February 1st). We are in the process of incorporating a new calculation block to address the measurement of propelling machinery spaces under MTN 01-99 CH-7, Section 69.121(c)(7), using average breadths and heights. We would appreciate any other comments to help us improve the format or other aspects of this product set.

IMO CORRESPONDENCE GROUP: The TM Convention Correspondence Group established at SLF 54 is tasked with developing an updated version of TM.5/Circ.5, along with any amendments to the TM Convention, to improve the Convention's integrity and uniform application. As the Coast Guard formulates its position on these matters, we will take into consideration input from measurement organizations and the public. We intend to solicit such input via email notification at several key milestones during the correspondence group's work, as well as through public meetings held in preparation for SLF 55. Another important avenue for your input is through IACS. Please note that this is an unprecedented opportunity to address some of the known gaps within the TM Convention, and it may be many years before a similar opportunity presents itself again.

SLF 54 DISCUSSIONS: At SLF 54, a view was expressed that the TM Convention discourages the provision of adequate crew accommodation spaces, and otherwise adversely affects ship designs, and that a more comprehensive review of the TM Convention is in order. However, the Sub-Committee concluded that such a review was outside the scope of work previously authorized by the Maritime Safety Committee.

UPDATED TONNAGE GUIDE: The MSC has updated Tonnage Guide (TG) 2, Measurement of Navy and Coast Guard Vessels. The updated version, TG 2 CH-2, is available on the Coast Guard's Homeport website.

Measurement Organization Weekly Notes - 1/25/2012

TONCALC: As a reminder, feedback on the recently released draft developmental version of the TonCalc tonnage calculation worksheet, and the work instruction for generating tonnage calculations and certificates, sent out to the authorized measurement organizations, is due February 1, 2012. Contractors: Feedback on the calculation worksheet and the work instruction should be provided through an authorized measurement organization.

SLF 54 OUTCOME: At last week's session, the SLF Sub-Committee supported the action plan and endorsed the format for the TM.5/Circ.5 replacement, proposed by the United States and seven other countries. The Sub-Committee also agreed to establish a correspondence group to move forward on the work to comprehensively review the measurement system of the TM Convention and make recommendations to improve its integrity and uniform implementation. A draft action plan for this group, which shows the actual work beginning on February 13, 2012, has already been circulated to the IACS representative and others for comment. The group is being coordinated by Mr. Peter Eareckson.

TONNAGE PERSONNEL: Mr. Marcus Akins will be out of the office 30JAN-03FEB and will return Monday, 06FEB2012. Please forward any questions on tonnage standards or CG Number/file requests to Mr. Brian Ellis (202) 475-5636.

Measurement Organization Weekly Notes - 1/17/2012

SLF 54 MEETING: The SLF Sub-Committee meets this week in London. At this meeting, the United States will participate in discussions regarding possible amendments to the TM Convention and the work needed to update the interpretations of TM.5/Circ.5. Mr. Peter Eareckson is attending the meeting and will return to the office on 23JAN2012.

TONNAGE PERSONNEL: Mr. Marcus Akins is out of the office and will return Thursday, 19JAN2012. If you have questions in his absence, please contact Mr. Brian Ellis (202) 475-5636.

SPACES WITHIN A HULL OPEN TO THE SEA: At the 2011 Tonnage Conference, whether spaces within a hull open to the sea should be included in the total volume of enclosed spaces was discussed. One participant began the discussion by noting that sea chests are included in tonnage. Another participant commented that underwater tanks are most often empty and are included because they add buoyancy when empty. Another stated that a space that affects stability and/or is used for floatation is included in tonnage. Some agreed that the functionality of the space needs to be examined before determining its eligibility for exclusion.

Measurement Organization Weekly Notes - 1/10/2012

REMEASUREMENT: The Tonnage Division recently discussed an inquiry regarding issuance of tonnage certificates following remeasurement. For self-propelled vessels over 79 feet in length that engage on domestic voyages only, and with keel laid dates before January 1, 1986, a convention measurement is required upon remeasurement. Accordingly, grandfathering remarks should be placed on the ITC should the vessel not lose its Article 3(2)(d) grandfathering provisions.

WATER BALLAST SPACES: The Tonnage Division recently discussed an inquiry regarding manhole and hatch requirements for water ballast spaces. All manholes providing access to a water ballast space must be oval or circular and not greater than 34 inches in diameter. An existing hatch over a space converted to a water ballast space must have a water tight cover plate welded to the hatch and a manhole, as previously described, fitted in the plating.

SLF 54 MEETING: Preparations for SLF 54 are effectively complete, with the session opening in London next Monday. By final count, 6 papers were submitted on the tonnage agenda item, which reflects a significant degree of interest and engagement. We are looking forward to a lively discussion and debate. If the U.S. and those of similar views are successful, the considerable amount of work needed to update the interpretations of TM.5/Circ.5 will commence immediately after this session.

Measurement Organization Weekly Notes - 1/3/2012

TONCALC: The tonnage division recently released a draft developmental version of the TonCalc tonnage calculation worksheet, along with a work instruction for generating tonnage calculations and certificates, to authorized measurement organizations. We are requesting feedback from them with the intent of using comments and concerns to revise and improve the worksheet and instructions. We anticipate publishing a final version for optional use by measurement organizations this spring.

SLF 54 PREPARATIONS: Preparations continue for the SLF 54 meeting in London, now just two weeks away. At this meeting, we hope to establish a correspondence group to carry out the extensive work to review and update international interpretations, and identify possible amendments to the TM Convention. We are expecting attendance by tonnage subject matter experts from the U.S. (Mr. Eareckson), Germany (Mr. Koch), Japan (Mr. Honda), and Panama (Mr. Jesús Caballero), and perhaps France (M. Marjoillet) and a few other countries as well. If any of you will be attending as members of the IACS (or any other) delegation, please let Mr. Eareckson know.

HAPPY NEW YEAR'S: Due to the holiday schedule, the weekly notes were not published last week. As of this week, we will resume our weekly publication. The MSC Tonnage Division would like to wish you a Happy New Year as we look forward to working with you all in 2012.

Measurement Organization Weekly Notes - 12/20/2011

SWIM PLATFORMS: A recent decision of the United States Court of Appeals for the Fourth Circuit (10-1906) addresses the award of damages to owners of the Bertram motor yacht Marquessa that was involved in an allision. The court commented that the Marquessa was originally built in 1982 and, “like many vessels of her kind, was subsequently extended.” After extension, the vessel “measured 70’ from bow to transom, with an additional four foot swim platform extending beyond the transom.” In making its decision, the court cited expert witness testimony that the “the four foot swim platform, which is irrelevant for purposes of determining a vessel’s length (as defined by Coast Guard standards), also did not make the Marquessa so unique that she could not be compared to the other extended Bertrams.”

CHRISTMAS HOLIDAY: The Marine Safety Center will be closed for the Christmas holiday, on Monday, December 26th. Happy Holidays to all our Tonnage friends, customers and colleagues.

MR. AKINS OUT OF THE OFFICE: Mr. Marcus Akins will be out of the office Dec 19 - 23, 2011. Please forward any tonnage requests to Mr. Brian Ellis at brian.t.ellis@uscg.mil.

Measurement Organization Weekly Notes - 12/13/2011

ALTERNATE TONNAGE: On December 12, 2011, the US Coast Guard published an interpretive rule establishing an alternate tonnage threshold at 6000 gross tonnage ITC (GT ITC) for oil spill response vessels (OSRVs) that are also certificated as offshore supply vessels (OSVs). Mr. Brian Ellis of the Tonnage Division staff had the lead on this rule. The notice announcing this rule (76 Fed. Reg. 77128) can be found at <http://www.gpo.gov/fdsys/pkg/FR-2011-12-12/pdf/2011-31708.pdf>. Comments should be submitted by February 10, 2012.

EMAIL INQUIRES: A gentle reminder to all concerned that once you submit an email to the MSC, even to a personal email address, your email becomes a federal record, subject to disclosure to the public under FOIA procedures (refer to Tonnage Bulletin 21). For this and other reasons, we continue to encourage you to discuss pertinent issues on the phone with the Tonnage Division staff before resorting to email. Of course, written inquiries are both appropriate and encouraged where interpretations of the tonnage regulations and associated requirements are needed. In such cases, send the email to: msc@uscg.mil, with a copy to the cognizant Tonnage Division staff member.

IMO IMPLEMENTATION and RO CODES: IMO is moving forward with initiatives to provide increased oversight and auditing of both governments and recognized organizations (ROs) (e.g., classification societies). The 27th IMO Assembly just updated the Implementation Code (Resolution A.1054(27)), and the FSI Sub-Committee is finalizing the new RO Code. Both Codes include training and survey requirements, and will affect tonnage measurement. IACS is representing member classification societies at IMO on these Codes.

Measurement Organization Weekly Notes - 12/09/2011

TONNAGE TRAINING: The Marine Safety Center conducted tonnage training for authorized measurement organizations and their contractors on Wednesday, November 30 at the 2011 International WorkBoat Show. Topics discussed included improvements to 'TonCalc' tonnage calculations tool and its future use by authorized measurement organizations, a standardized formal measurement application form, and grandfathering provisions. Participants generated discussion regarding ballast water justifications and tonnage division correspondence turn-around times.

WATER BALLAST SPACES: Prior to a 1989 rulemaking, the tonnage regulations required that qualifying water ballast spaces be exempted, and thus these spaces had to be addressed in water ballast justifications. MTN 01-99 CH-7, based on the current regulations, states that qualifying water ballast spaces may be exempt from gross tonnage if certain conditions are met. Accordingly, water ballast spaces are not required to be exempted, as are other exemptible spaces under Section 69.117 of the MTN, unless specifically requested to be exempted. As such, water ballast justifications need include only those tanks which are requested to be exempted.

SPACE BENEATH OVERHANGING STRUCTURES: At the 2011 Tonnage Conference, participants discussed pursuing establishing interpretations regarding spaces beneath overhanging structures due to the onset of complicated superstructure designs. There was general agreement that spaces like those beneath bridge wings are typically treated as unenclosed, and ignored from measurement. One participant expressed the opinion that existing national interpretations issued by one flag Administration are already overly prescriptive on ship features, and therefore less interpretive guidance would be better, allowing individual admeasurers to make the determination on a case basis. Finally, one participant offered the opinion that owners should not be penalized for design features that are included for safety reasons (e.g., requirements for bridge wings to extend all the way out to the sides of the hull for visibility purposes).

Measurement Organization Weekly Notes - 11/29/2011

WORKBOAT SHOW TRAINING: As discussed in a previous weekly note, the Marine Safety Center plans to conduct on-site tonnage training for authorized measurement organizations and their contractors on Wednesday, November 30 at the 2011 International WorkBoat Show in New Orleans, LA. This training session will be held at 2:00 PM in Conference Room B, located on the 3800 aisle of Hall D of the exhibit floor.

PUBLIC MEETING SLF 54: A reminder that the Coast Guard and the US Shipping Coordinating Committee (SHC) will meet at Coast Guard Headquarters in Washington, DC next Wednesday (December 7th) to prepare for the 54th session of the IMO Subcommittee on Stability and Load Lines and on Fishing Vessel Safety (SLF). There will be a discussion of the planned work to revise/update the interpretations of TM.5/Circ.5 and to make recommendations on any possible amendments to the TM Convention. The meeting is from 1:00 p.m. to 4:00 p.m. in Room 5-1224, and is open to the public.

PAPER ON SPACES OPEN TO SEA: IMO Secretariat has posted a new paper for SLF 54, submitted by Japan and Korea. It proposes the following new unified interpretation: "Volumes open to the sea should not be excluded from the total volume if the spaces are appropriated for holding cargo and/or contributing to obtain buoyancy of the ship." This paper is now available on the Coast Guard's IMO Tonnage Information website, along with all the other tonnage papers that have been submitted to SLF 54 so far: <http://www.uscg.mil/imo/slf/subcomdocs.asp>

TONNAGE STAFF AVAILABILITY: This week, Mr. Ellis and Mr. Akins will both be on travel. Please direct any questions on tonnage matters that cannot wait until their return to Mr. Peter Eareckson at 202 475-3395.

Measurement Organization Weekly Notes - 11/23/2011

U.S. INFO PAPER: A U.S. informational paper submitted to SLF 54 on the subject of alterations or modifications affecting tonnage has been posted by Secretariat. The paper offers a comparison of requirements in the 1969 TM Convention and associated interpretations, along with historical information, and a ship comparison to help illustrate the tonnage impacts of such changes. A link to the paper follows: [http://www.uscg.mil/imo/slf/docs/tonnage/SLF_54-INF.11 -
_Alterations or modifications affecting tonnage Comparison of requirements and in
terpretations \(United States\).pdf](http://www.uscg.mil/imo/slf/docs/tonnage/SLF_54-INF.11_-_Alterations_or_modifications_affecting_tonnage_Comparison_of_requirements_and_interpretations_(United_States).pdf)

OTHER SLF 54 PAPERS: Several other tonnage papers have also been posted recently, and we are working on getting them uploaded to the Tonnage CG website as well. This includes a second paper from IACS, a paper from Italy commenting on the earlier IACS paper, and a paper from International Transport Worker's Federation addressing the crew space issue. We hope to have these papers uploaded by next week, and plan to circulate additional information on this subject in next week's Weekly Notes edition.

TONNAGE RULES GRANDFATHERING: Appendix A of MTN 01-99 CH-7 provides for grandfathering of previous interpretations of the tonnage regulations for uncertified vessels contracted for on or before a MTN change, certified vessels which undergo modifications contracted for on or before a MTN change, and sister vessels that are "identical from the standpoint of tonnage measurement". Also, under unique circumstances, the Marine Safety Center will consider requests for extending grandfathering of previous interpretations to vessels other than aforementioned vessels. In all cases, requests must be made in writing to the Commanding Officer, Marine Safety Center, and be accompanied by information detailing the MTN interpretations requested to be grandfathered and the specific stage of design/construction of the vessel on the date those MTN interpretations were promulgated.

THANKSGIVING DAY CLOSURE: The Marine Safety Center will be closed for the Thanksgiving Day holiday, on Thursday, November 24. Normal business hours will resume on Friday, November 25.

Weekly Notes are issued by the Coast Guard Marine Safety Center's Tonnage Division (MSC-4) for use by organizations that perform measurement work on the Coast Guard's behalf. They are for informational purposes only, and are not intended as, nor should they be construed to represent, revisions of or substitutes for applicable statutes or regulations or established interpretations of either.

Measurement Organization Weekly Notes - 11/16/2011

TONNAGE TRAINING OPPORTUNITY: The Marine Safety Center plans to conduct on-site tonnage training for the authorized measurement organizations and their contractors attending the 2011 International Workboat Show in New Orleans, LA. This training session will cover topics such as new measurement tools to be required by the Coast Guard, common oversight nonconformities, fishing vessel measurement, and key elements from Coast Guard tonnage measurement policies.

PUBLIC MEETING SLF 54: The US Coast Guard and the US Shipping Coordinating Committee (SHC) will meet at Coast Guard Headquarters in Washington, DC on December 7 to prepare for the 54th session of the IMO Subcommittee on Stability and Load Lines and on Fishing Vessel Safety (SLF). Items on the agenda include the new work to revise/update the interpretations of TM.5/Circ.5 and make recommendations on any possible amendments to the TM Convention. A notice announcing the meeting appeared in the Federal Register (76FR70529) on November 14, 2011.

FISHING VESSEL SAFETY: On November 7th, the National Transportation Safety Board (NTSB) issued a safety recommendation to the Coast Guard regarding fishing vessels. The NTSB commented that “in the United States, deaths averaged 158 per 100,000 commercial fishing workers from 1992 to 2008, compared with an average of 4 fatalities per 100,000 workers in all occupations nationwide. The Bureau of Labor Statistics ranked commercial fishing the most dangerous occupation in the United States for 2007, 2008, 2009, and 2010.” The recommendation addresses, among other issues, stability, subdivision, and watertight integrity for vessels 79 feet or less in length. A link to the NTSB recommendation follows:

<http://www.nts.gov/doclib/reclatters/2011/M-11-023-027.pdf>

Measurement Organization Weekly Notes - 11/08/2011

IACS SLF TONNAGE PAPER: Further to our report last week on SLF Tonnage papers, IACS submitted a paper for the SLF Sub-Committee meeting in January. The IACS paper suggests solutions to the issues identified through the earlier SLF work as requiring further investigation to ensure the integrity and uniform implementation of the 1969 TM Convention. A link to the paper follows:

http://www.uscg.mil/imo/slf/docs/tonnage/SLF_54-9_-

[Proposals for solutions to the issues previously identified with the 1969 TM Convention \(IACS\)\[1\].pdf](#)

SPECIAL TONNAGE TAX EXEMPTION FOR THE COOK ISLANDS: US Customs and Border Protection (CBP) issued a final rule (76 Fed. Reg. 68066) exempting vessels flying the Cook Islands flag from special tonnage taxes and light money because that nation does not impose such duties on vessels owned by citizens of the United States. 19 CFR 4.22 now lists 120 nations which are exempt from special tonnage and light money.

VETERAN'S DAY CLOSURE: Veteran's Day falls on November 11, the anniversary of the signing of the Armistice that ended World War I. President Woodrow Wilson first proclaimed an Armistice Day for November 11, 1919. In 1953, an Emporia, Kansas man named Alvin King, the owner of a shoe repair shop, had the idea to expand Armistice Day to celebrate all veterans. President Dwight Eisenhower signed it into law on May 26, 1954. Friday the MSC and most federal offices will be closed in observance of this holiday.

Measurement Organization Weekly Notes - 11/02/2011

TONNAGE DATA SHEETS: The tonnage division is resuming inclusion of tonnage data sheets in file request responses. These sheets contain information to help determine whether the certificates or calculations are current (e.g., by matching the tonnages and registered dimensions with those shown in the Coast Guard's MISLE database). In addition, they include vessel details such as keel laid date, vessel service, and former names, that may be of use in other aspects of the certification process. A sample is attached.

SLF TONNAGE PAPER: We are starting to see papers posted for the upcoming SLF 54 meeting in January, as the first deadline was October 14th. The paper on the following link lays out an Action Plan for the extensive tonnage work that we anticipate: http://www.uscg.mil/imo/slf/docs/tonnage/SLF_54-9-1_Proposed_Plan_of_Action.pdf. It was co-sponsored by Canada, France, Germany, Japan, the Marshall Islands, Norway, Panama, and the United States.

APPENDAGES AND LINEAR HULL STRUCTURES: At the 2011 Tonnage Conference, participants discussed establishing interpretations requiring the inclusion of all hollow appendages and other linear hull elements larger than one cubic meter in volume to be included in tonnage and also to include provisions to approximate volumes of such items, especially those with cross sectional areas less than one square meter. Several participants voiced concerns over the difficulty in calculating the volumes, and commented to the effect that moveable appendages such as rudders should be ignored, regardless of size. One participant noted flag Administration requirements for the inclusion of appendages in tonnage only if they contribute to the positive buoyancy of the hull, noting that some solid appendages could have a specific gravity less than that of water, and therefore would be included.

Measurement Organization Weekly Notes - 10/26/2011

STANDARDIZED TONNAGE CALCULATIONS UPDATE: As we reported in August, the MSC is working on release of a tool for calculating standard and dual measurement system tonnage, using the Marine Safety Center's "TONCALC" Excel product set as its basis. A copy of output from the latest version is attached. Note that, for clarity, the worksheet is built using calculation "blocks". As before, deductions are grouped with each "space", now referred to as an "enclosure". We invite your comments/suggestions on this latest developmental version. Rollout is still scheduled for the beginning of next year. The MSC's POC for this effort is Mr. Marcus Akins.

DECK CARGO: At the 2011 Tonnage Conference, establishing interpretations deeming deck cargo as not part of the ship was discussed. One participant commented that in considering deck cargo, containers are freight and not a part of the ship, but that portable quarters are – in effect – a part of the ship. Another participant commented that TM.5/Circ.5 needs an interpretation to resolve the confusion. Another participant commented that for many different ship types, containers are being loaded with food for crew consumption. In general, there was some agreement that portable and movable spaces should be included as part of the ship, but that containers for cargo should be treated differently, with a possible approach offered of calculating a separate tonnage number that includes cargo containers.

USE OF NATIONAL TONNAGES: At the 2011 Tonnage Conference, establishing interpretations that describe national tonnage grandfathering provisions for application to tonnage-based international conventions was discussed. One participant commented that this is a very important topic, and that for the participant's Administration, the Interim Schemes are the only way to use national tonnage to apply to SOLAS and MARPOL. Another participant highlighted the language "relevant requirements under other existing International Conventions" in Article 3(2)(d) of the TM Convention, arguing that this language did, in effect, invoke SOLAS and MARPOL. This participant further commented that the confusion on Interim Schemes may stem from the fact that at the time they were written, the international community was focused on ships with keel laid dates immediately after 18 July 1982, and was seeking interim relief until a better solution could be found (e.g., possible elimination of tonnage thresholds in SOLAS and MARPOL).

Measurement Organization Weekly Notes - 10/19/2011

SUPERSTRUCTURE FRAMES: Section 69.113 of MTN 01-99, CH-7 provides the method of calculating the tonnage of all superstructures. Admeasurers are reminded that, per Section 69.113(b)(1) of the MTN, the length of each structure is measured to the line of the normal framing of each end. Superstructure lengths should not be measured to the skin of the superstructure if normal framing is present.

NOVEL CRAFT: At the 2011 Tonnage Conference, the need to establish interpretations of the novel craft provisions of Regulation 1(3) was discussed. A participant commented that specifying that the gross and net tonnages must be reflective of the ship's overall size and useful capacity, respectively is a good idea, but this may be difficult to apply or enforce. Other participants cited examples of the application of novel craft provisions for economic considerations. It was agreed that the number of times that flag Administrations have made novel craft determinations and not notified IMO is unknown.

CG NUMBER REQUEST: Submitting a complete tonnage application when requesting a CG number for any particular vessel is critical in creating vessel profiles in the MISLE database and avoiding vessel duplications. Information such as Vessel Type, Builder, Hull Number, HIN, and current and previous vessel names are among the most important details we use in our search and in vessel profile creation.

Measurement Organization Weekly Notes - 10/11/2011

PANAMA CANAL: New Tonnage Record. The Panama Canal Authority issued a press release stating that 322.1 million Panama Canal tons transited through the Canal during fiscal year 2011. This is an increase of 7.1% over the previous year and is a canal new record.

REQUEST FOR MSC TONNAGE DECISIONS: As vessel designs evolve, we have responded to an increased number of inquiries regarding the interpretations of the tonnage regulations. To aid in the accuracy and timeliness of our responses, we ask that all inquiries contain a minimum of: the vessel/space configuration in question and the question or questions regarding the configuration. We encourage the measurement organizations to also include the MTN 01-99 CH-7 interpretation, if any, which they feel most accurately describes the configuration and how it should be measured.

LENGTH ON THE ITC: At the 2011 Tonnage Conference, a number of issues were discussed relating to the term "length" as defined by the TM Convention. From our recent review of historical documents in preparation for SLF 54, we note that one participant at the 1969 Tonnage Conference stated that the reason for including the main dimensions on the International Tonnage Certificate (ITC) was to facilitate verification, but questioned whether the "length" could be easily verified. Another commented that the length on the certificate was intended only to show whether or not the ship was longer than 24 meters, and not to enable control officers to verify the length. One participant commented it was easier to speak of overall breadth. By a vote of 20 to 3, it was decided to retain the dimensions that appear on the front of the ITC today.

Measurement Organization Weekly Notes - 10/06/2011

RECESSES: The Tonnage Division recently responded to an inquiry regarding the convention measurement treatment of a car deck space bounded two deckhouses and a deck above. The treatment of this configuration under the TM Convention has been the subject of debate over many years. Under the interpretations of MTN 01-99 CH-7, such a space is not eligible to be excluded as a recess under Section 69.61(f) of the MTN because it is not bounded on at least two sides by the boundary bulkhead of the same structure.

COLUMBUS DAY CLOSURE: The Marine Safety Center will be closed for the Columbus Day holiday, on Monday October 10th. Columbus Day became a federal holiday in 1937, but was celebrated as far back as 1792, when U.S. cities celebrated the 300th anniversary of his landing in the “New World”. The holiday has been centered on patriotic rituals such as support for war, citizenship boundaries, and the importance of loyalty to the nation, and celebrating social progress since the 19th century.

CRITERIA ON ALTERATIONS: At the 2011 Tonnage Conference, harmonizing the criteria for tonnage certification (remeasurement) was discussed. One participant stated that a focus on the words to describe alteration may be needed, commenting that the terms “major character”, “substantial alteration”, and “alteration” are being used to describe modifications of a ship. Another participant observed that harmonizing criteria is not best done by picking a threshold of 5% or 1% or 10%, but rather by having owners report any change to the flag Administration for a determination on a case basis. Some participants expressed frustration with the degree to which there is enforcement of reporting requirements for ship modifications affecting tonnage.

Measurement Organization Weekly Notes - 09/26/2011

JIMENEZ FAREWELL: As some of you may already know, Mr. Javier Jimenez of the Tonnage Division staff recently accepted a position with an engineering firm in Florida. Friday was his last day at the MSC. We are grateful for his three years service with the Coast Guard, and wish him well in his new career. Until Mr. Jimenez's position is filled, please contact Mr. Marcus Akins at 202 475-3349 for those matters for which Mr. Jimenez was previously the POC.

UPDATED ORGANIZATION CHART: Further to the previous entry, we are attaching an updated organizational chart reflecting the Tonnage Division staff change.

SLF 54 PAPERS DEADLINE: The first papers deadline for the January meeting of the SLF Sub-Committee is now just over 2 weeks away (Friday, October 14th). The United States and several other countries plan to submit a joint (co-sponsored) paper that proposes a way forward for the new IMO tonnage work. We understand that IACS may also submit a paper.

Measurement Organization Weekly Notes - 09/20/2011

FEES FOR MEASUREMENT SERVICES: Under the tonnage regulations and Section 1.10 of MTN 01-98 CH-9, measurement organizations are authorized to charge fees for the measurement services they provide. This includes development of the necessary drawings, sketches and/or computer models in the event that required drawings are not included in the application package, should the measurement organization choose to accept such a package. The Coast Guard does not regulate the setting of these fees, although copies of fee schedules must be provided to the MSC.

GHS FLOW CALCULATIONS: We just learned that a recent release of the General HydroStatics (GHS) program includes the capability to perform progressive flooding and flow calculations. The MSC has obtained this new software, and is considering using it for evaluating spaces "open to the sea" and/or determining the impact of hull openings on length measurements.

SKETCH ON THE ITC: In conducting research in preparation for SLF 54, we came across documents from the 1969 Tonnage Conference that refer to the development of format of the International Tonnage Certificate (ITC)(1969). Interestingly, a proposed draft version of the ITC included a sketch of the vessel on the ITC, which was subsequently deleted by a vote of 20 in favor of deletion and 11 opposed to deletion. There were also discussions on the extent of the information that should be listed (including a proposal to include the name of the shipbuilder on the ITC, which was not approved by a tie vote of 12 in favor of inclusion and 12 opposed). Those who attended the 2011 Tonnage Conference may recall similarly opposing views expressed on the subject of information that appears on the ITC.

Measurement Organization Weekly Notes - 09/13/2011

TONNAGE CERTIFICATES: Sections 2 and 3 of MTN 01-98 CH-9 provide detailed instructions on preparing both U.S. and International tonnage certificates. Measurement organizations are reminded that departures from the certificate standards set forth in the MTN are not authorized. Specifically, the use of remarks not detailed in Section 2.4(g) and 3.4(c) may be included only when specifically authorized by the MSC. Measurement organizations should contact the Marine Safety Center if a deviation from the MTN may be required or if the necessary information to complete the tonnage certificate is not available.

GRANDFATHERING INTERPRETATIONS: At the 2011 Tonnage Conference, the issue of grandfathering provisions for superseded interpretations was discussed, including the possibility of using the keel laid or alterations date as the “cut-off”. One participant stated that the keel laid date is the only date that matters for the flag Administration and should be tied to the “cut-off” for interpretations. Another commented that the flag State uses contract dates, which is usually before the keel is laid. It was also expressed by another participant that this issue is not tied to the remeasurement of the vessel, because upon modification, the flag Administration remeasures the entire ship, and not just the portion that changed. Appendix A of MTN 01-99 CH-7 provides the categories for which grandfathering is authorized for U.S. flag vessels.

CATEGORIZING FINDINGS: The MSC is reviewing the current framework for categorizing findings from oversight reviews, including plan review, load line, and tonnage work. Although no final decisions have been made, the MSC is considering dropping the “category” numbering scheme. Category 2 nonconformities would be referred to as “Observations” (these are differences between how the classification society and the MSC interpret and apply governing requirements). Category 3 nonconformities would become “Major Non-Conformities”, while Category 1 nonconformities would simply be referred to as “Nonconformities”. Under this new framework, repeat nonconformities would be characterized as “Systematic Deficiencies”. The POC for this matter is Mr. Akins (202 475-3395).

Measurement Organization Weekly Notes - 09/06/2011

OPEN VESSELS: Section 69.109(o)(2) of MTN 01-99 CH-7 states that the line of the tonnage deck for an open vessel is the upper edge of the upper strake, with the depths of transverse sections taken from this line. Accordingly, a break, forecastle or poop on an open vessel is included in the under-deck measurement, with the upper strake located at the upper edge of the hull or qualifying bulwark. We intend to include more information on what constitutes the upper strake in a future revision to the MTN; in the meantime, please refer any questions on this subject to Mr. Marcus Akins (202 475-3349)

IMO TONNAGE CG WEBSITE UPDATE: In anticipation of the upcoming tonnage work at SLF 54 in January 2012, we've been updating the Tonnage CG website. As part of this effort, we have added some important historical documents, including a number related to the 1969 Tonnage Conference. These are of particular interest to anyone trying to ascertain why language that has proven problematic in the TM Convention ended up the way it did. If you have copies of any useful historical documents along these lines that you could share, we would be grateful to have them, and to post them as appropriate. The POC for the website is Mr. Javier Jimenez (202 475-3364). A link follows: <http://www.uscg.mil/imo/slf/tonnagecg.asp>.

ELECTRONIC COMMERCE: A gentle reminder that any request submitted to the MSC via email must be sent to the Electronic Commerce (EC) address (msc@uscg.mil). While we encourage you to copy such emails to the responsible person, it is essential that the "official" request be sent to the EC address, so that we can ensure it gets logged, tracked and responded to. This ultimately assures better service, especially in the event that the responsible person is out of the office (expected or otherwise).

Measurement Organization Weekly Notes - 08/29/2011

OBSTRUCTION IN WAY OF END OPENINGS: At the 2011 Tonnage Conference, the issue of obstructions in way of end openings was discussed. A participant commented that any object with a cross-sectional area of one square meter should be considered as an obstruction to an end opening. During the discussion it was also mentioned that a B/2 separation distance has been used when obstructions are evaluated, and that machinery or movable objects are not considered to be blocking end openings. Another participant stated that the obstruction itself is ignored if it's not included in gross tonnage. Until policy on this matter is established, measurement organizations should contact the MSC for direction when evaluating obstructions to end openings that are within a distance of half the breadth of the deck in way of the opening.

LABOR DAY CLOSURE: The Marine Safety Center will be closed for the Labor Day holiday, on Monday September 5th. As we reported last year, this holiday is devoted to the recognition of working people's contribution to society. It was first celebrated in New York City on September 5th, 1882, under the sponsorship of the Knights of Labor, the largest American labor organization of the 19th century. It became a national holiday in 1894.

Measurement Organization Weekly Notes - 8/23/2011

COURT VESSEL DETERMINATION: On a recent dispute between a municipal marina and the owner of a “Unnamed Gray, Two-Story Vessel Approximately Fifty-Seven Feet in Length”, the US Court of Appeals for the Eleventh Circuit affirmed a district court’s judgment that the watercraft was a vessel for purposes of admiralty jurisdiction. The owner characterized the watercraft as a “floating residential structure”. The district court concluded that since the watercraft was a “vessel” under the United States Code, it was liable for maritime trespass and that the defendant owed the City approximately \$3,000 under the maritime lien. For more information on the court ruling see <http://www.ca11.uscourts.gov/opinions/ops/201010695.pdf>. Please recall that per MTN 01-98 CH-9, measurement organizations must contact the MSC before accepting an application for measurement of any non-traditional watercraft.

LRIT FOR TOWING VESSELS: We have been involved in some recent inquiries from the towing industry regarding tonnage system applicability for Long Range Identification and Tracking (LRIT) system requirements. These requirements were provided for in an amendment to SOLAS (Resolution MSC.202(81) adopted on May 19, 2006), and apply to certain vessels of 300 GT ITC or more (there is no GRT tonnage grandfathering for LRIT). Generally speaking, upgrading a vessel with an existing Global Marine Distress Safety System (GMDSS) installation to meet LRIT requirements can be accomplished relatively easily. However, there are older vessels (including some towing vessels) for which LRIT compliance is more problematic because owners have elected to use GRT tonnage grandfathering to apply older SOLAS requirements, allowing the vessels to escape GMDSS requirements. If you have questions on this matter, please contact Mr. Brian Ellis (202-475-5636).

EAST COAST EARTHQUAKE: As most of you may have heard through the news media, a 5.8 magnitude earthquake hit Virginia and was felt through parts of the east coast including Washington, D.C. We apologize for any missed calls or unanswered e-mails as federal buildings in Washington were evacuated for safety precautions. We are happy to say that no major structural damage was reported to our building, and that the MSC is back in full operational mode.

Measurement Organization Weekly Notes - 8/16/2011

MARKING OF SPACES: One important aspect of the onboard survey is to verify the correctness of tonnage-related marking of the vessel (MTN 01-98 CH-9, Section 1.4(c)). Marking requirements are found in MTN 01-99 CH-7, which includes the requirement to mark ALL deductible spaces that are not propelling machinery spaces (e.g., "Seaman", "Generator", "Office of Chief", "Engineer", "Hospital", "Anchor Gear", etc.)

HARMONIZATION OF CRITERIA ON ALTERATIONS: At the 2011 Tonnage Conference, the issue of vessel alteration was discussed. One participant suggested that a focus on the words to describe alteration may be needed, commenting that different terms are being used to describe modifications of a ship. Another participant noted that criteria for remeasurement are not consistent among flag Administrations. A third participant mentioned that harmonizing is not best done by picking a threshold, but rather by treatment on a case-by-case basis by the flag Administration. U.S. interpretations on alterations and remeasurement are found in NVIC 11-93 CH-3.

TOPSIDE SPACES OF COMPLEX SHAPE: Also discussed was the issue of calculating volume of complex topsides. There was general agreement that measurement of these spaces on modern yachts is difficult and problematic. One participant commented that a space is ignored where the cross-sectional area at the point of attachment to a larger space is less than one square meter, even though the total volume of the appendage exceeds one cubic meter. Another commented that the TM Convention is unambiguous on this issue, and requires that such spaces be measured as enclosed volume. U.S. interpretations allow for approximating volumes of some complex shapes (e.g., MTN 01-99 CH-7, Section 69.65(c)(1)(v)), but preclude ignoring the attached spaces described above, unless they meet certain qualifications (e.g., are inaccessible per MTN 01-99 CH-7, Section 69.65(h)(3)).

Measurement Organization Weekly Notes - 8/9/2011

TONNAGE TRAINING: In lieu of a 2012 Tonnage Conference, the Marine Safety Center plans to conduct on-site tonnage training for the authorized measurement organizations and their contractors. These training sessions will cover topics typically covered during our annual conferences, new measurement tools required by the Coast Guard, and oversight results. Authorized measurement organizations will be contacted individually to schedule training.

LEGISLATION: A bill has been introduced re delegation of ship inspection services. Senator Collins (R-ME) introduced a bill (S. 1496) to prohibit the delegation by the United States of inspection, certification, and related services to a foreign classification society that provides comparable services to Iran, North Korea, North Sudan, or Syria, and for other purposes. Official text of the bill is not yet available.

COAST GUARD BIRTHDAY: August 4th 1790 marked the day President George Washington signed an act of the First Congress, creating the Revenue Cutter Service, thereby initiating what has become our modern day United States Coast Guard. This was done on behalf of the recommendations of our founding father Alexander Hamilton, who identified a need for a small fleet of cutters to be useful sentinels of the laws.

Measurement Organization Weekly Notes - 8/2/2011

STANDARDIZED TONNAGE CALCULATIONS UPDATE: Development continues on the tool/format for calculating standard and dual measurement system tonnage, using the Marine Safety Center's "TONCALC" Excel product set as its basis. We are making progress, and have attached an example of what the output looks like from this prototyped version. Note that it does not group the deduction calculations in a separate portion of the worksheet, as was done with the CG 1410 and the current versions of "TONCALC". Instead, the deductions are grouped with each "space". We invite your comments/suggestions on this approach, or other aspects of this developmental product. The MSC's POC for this effort is Mr. Marcus Akins.

INTERNATIONAL HYDROGRAPHIC ORGANIZATION (IHO): Similar to last week's note on IMO's tonnage assessment, this week focuses on IHO. The United States is one of 80 nations that belong to the 90 year old organization, who since WWI has been primarily focused on accuracy and reliability of nautical charts and documents, so as to promote and support the safety of navigation and the protection of the marine environment. IHO Member States are assessed a fee to support the operating expenses for the organization are also based on the nation's tonnage. This tonnage value includes all merchant vessels greater than 100 Gross Tonnage, as well as a percentage of the nation's warships greater than 100 Gross Tonnage. This tonnage is submitted by the National Geospatial Intelligence Agency to IHO every 5 years.

Measurement Organization Weekly Notes - 7/26/2011

SLF PUBLIC MEETING: The Shipping Coordinating Committee met last week at USCG Headquarters in Washington, DC to discuss preparations for SLF 54 (Jan 16-20, 2012) and obtain public comment. At the meeting, the Coast Guard expressed its intention to submit a paper outlining a way forward on the new tonnage agenda item under consideration by the Sub-Committee, including the recommendation to establish a tonnage correspondence group at SLF 54, and a tonnage working group at SLF 55. The Coast Guard also expressed its intention to submit an informational paper on the subject of criteria for remeasurement and substantial alterations.

FISHING VESSEL REQUIREMENTS: At the Shipping Coordinating Committee meeting, the Coast Guard presented an overview of fishing vessel safety requirements mandated by Congress in the 2010 Coast Guard Authorization Act. Of especial note is the establishment of uniform safety standards for all vessels, particularly those operating beyond three nautical miles of the baseline, thus removing the distinction between documented and state-registered vessels that operate on the same waters. Additionally, the Act also requires survey and classification of fishing vessels of at least 50 feet in overall length, built after July 1, 2012 and that operate beyond the three nautical mile limit. More information about the Act may be found in the Winter 2010-2011 edition of the "Coast Guard Proceedings of the Marine Safety and Security Council".

IMO GROSS TONNAGE ASSESSMENTS: The current 172 Member States are assessed fees annually by IMO to conduct its operations. These amounts are based from a Member State's flat fee and an apportionment calculated from the flag Administration's gross tonnage. The rules governing the apportionment of expenses are described in the IMO Resolution A. 726(17) which was adopted on November 7, 1991. The United States' contribution for 2011 is 875,202.00 British Pounds (about US \$1.4 million) which is approximately 3 percent of the total assessment. See attachment for more information on the IMO Resolution.

Measurement Organization Weekly Notes - 7/19/2011

STANDARDIZED TONNAGE CALCULATION FORMAT UPDATE: We continue to move forward on our initiative to standardize the tonnage calculation formats for standard and dual measurement. Although final decisions on this matter have not been made, we are proceeding down the path of using an improved version of the USCG's "TONCALC" Excel product set for this purpose, which incorporates interlocks and improved other features to make it more "user friendly". Per our current schedule, testing and release of this new product set will be complete this fall. This would support roll-out for use by measurement organizations in January 2012. If you have any questions or would like to share your views on this subject, please feel free to contact Mr. Marcus Akins.

RINA TONNAGE AUTHORIZATION: On July 6th, the Coast Guard and RINA signed a Memorandum of Agreement (MOA), authorizing RINA to perform formal tonnage measurement and certain other functions on behalf of the United States. A copy of this Agreement (along with those of all other authorized measurement organizations) is posted on the Coast Guard's ACP website at: <http://www.uscg.mil/hq/cg5/acp>.

APPROACH ON SHIP LENGTH MEASUREMENT: At the 2011 Tonnage Conference, the issue of measuring the length of ships was discussed. A participant mentioned the problem of establishing the length of ships that are not fitted with conventional rudders, but rather steering devices mounted aft of the transom. Another participant commented that in assigning the load line to the ship, only the length of the hull would be considered. Two other participants stated that under their interpretations, measurement is to the pivot point of the jets. The TM Convention defines "length" as 96 percent of the total length on a waterline at 85 percent of the least molded depth measured from the top of the keel, or the length from the fore side of the stem to the axis of the rudder stock on that waterline, if that be greater.

Measurement Organization Weekly Notes - 7/12/2011

RECESSES AND END OPENINGS: At the 2011 Tonnage Conference, the tonnage measurement treatment between end openings and recesses was discussed. A participant mentioned that when an end opening does not extend side to side, it is not an end opening, but a recess. Another participant suggested a better definition of boundary bulkhead is needed to improve the interpretation. The TM Convention requires recess openings to extend deck to deck, without means of closing, provided that the interior width is not greater than the width at the entrance and its extension into the erection is not greater than twice the width of its entrance.

LISTING OF SPACE LOCATIONS AND LENGTHS: The usefulness of listing spaces on the back of the certificate, specifically when dealing with ships of complex design, was also discussed. A participant suggested that rather than listing specific tiers, one could simply specify what is identified on the general arrangement drawing for each deck. Another stated a preference for listing tiers and their dimensions. A participant expressed the view that today a large amount of tonnage certificates cannot be used by boarding officers in any meaningful way to re-create the ship for verification purposes. Most agreed that this should be discussed further by the international community.

MOVABLE ENCLOSED SPACES: Several 2011 Tonnage Conference participants commented that they do not measure small movable enclosed spaces, such as cranes, azi pods, rudders and A-frames, consistent with the current interpretation. Another participant added that the term “movable” is too vague. The TM Convention states that all mobile cranes should be exempted.

Measurement Organization Weekly Notes - 6/28/2011

SLF PUBLIC MEETING: As announced in the Federal Register on June 22nd (76 FR 36613), the Shipping Coordinating Committee will be conducting an open meeting at USCG Headquarters in Washington, DC On Thursday, July 21, 2011 at 1300. The meeting's primary purpose is to prepare for SLF 54 (Jan 16-20, 2012). Among other matters, the meeting will address the new tonnage planned output, "Development of provisions to ensure the integrity and uniform implementation of the 1969 TM Convention", which was approved by the Maritime Safety Committee in May.

MSC ELECTRONIC COMMERCE: The MSC is experiencing some disruptions in its ability to process email submitted to its electronic commerce address msc@uscg.mil, following a recent hardware upgrade. We expect the problem to be resolved within the next several days. Until then, if you have issues of urgency, please be sure to send a copy of your email to the cognizant Tonnage Division staff member, or call to make sure that we have received it.

INDEPENDENCE DAY HOLIDAY CLOSURE: The Marine Safety Center will close on Monday, July 4th for the Independence Day holiday. Normal business hours will resume on Tuesday, July 5th.

EDITOR'S NOTE: On the weekly notes sent on June 15th we incorrectly identified the Senator from Louisiana who put an administrative hold on the TM Convention treaty. The Member of Congress who actually pursued this action was Senator Huey Long's son, Senator Russell Long. Our thanks to one of our alert readers for notifying us of this error.

Measurement Organization Weekly Notes - 6/21/2011

ENCLOSED VS EXCLUDED: At the 2011 Tonnage Conference, the issue of whether an excluded space is also enclosed was discussed. Most participants agreed that a space cannot be seen as excluded until it is defined as an enclosed space. A participant commented that there was confusion on this subject at the 1990 Tonnage Experts Meeting in Tokyo, and expressed the view that the language needs to explicitly state that all excluded spaces are a subset of enclosed spaces. The TM Convention is not entirely clear on this matter; however, it does provide conditions that define if a space shall be excluded. The U.S. Tonnage Regulations, as interpreted by TM.5/Circ.5, explicitly categorize excluded spaces as enclosed spaces.

MASTS AND SIMILAR STRUCTURES: Also discussed was the issue of whether the volume in masts and similar structures should be included in the total volume of all enclosed spaces. One participant noted that all such spaces have some means of access, and that it has been standard practice for shippers to make use of them. Another participant stated that masts that are used to support antennas and are not for cargo should be ignored. The interpretations of both TM.5/Circ.5 and MTN 01-99 CH-7 provide for ignoring the volumes of such spaces if the spaces are inaccessible, above the upper deck, and separated on all their sides from other enclosed spaces.

DEFINING "STORES": Interpretation on what "stores" means was also discussed at the 2011 Tonnage Conference. One participant commented that it was best to define stores as food and other consumable provisions for the direct use of passengers and crew, in accordance with the French translation of the TM Convention which uses the word "provisions" for stores. Interestingly, the French word for "stores" is "approvisionnement" in an older nautical dictionary at the MSC, which has the definition in English as "provisions, canvas, oils, paints, ropes, oakum with which a vessel is supplied for a voyage, or length of time, etc. Coals for a steamer's use are as a rule not classed as stores.

Measurement Organization Weekly Notes - 6/15/2011

TM CONVENTION RATIFICATION HISTORY: On June 15, 1972 (39 years ago tomorrow), President Richard Nixon transmitted a copy of the TM Convention to the Senate for advice and consent. According to our records, Senator Huey Long of Louisiana put an administrative hold on this treaty due to opposition from small vessel interests, and even as late as September, 1981, it was unclear as to whether the United States would ratify the treaty. The United States then successfully sought approval from IMO's 12th Assembly to extend the SOLAS Interim Scheme for certain vessels, which ultimately led to the Senate giving its advice and consent on September 30, 1982. It was then signed by President Ronald Reagan on October 28, 1982.

TREATMENT OF SEMI-PERMANENT ENCLOSED SPACES: At the 2011 Tonnage Conference, the inclusion of portable spaces in tonnage was discussed. While some participants agreed that such spaces must be included in tonnage, it was suggested that a more clear definition should be developed. Another participant argued that these spaces are not part of the original design of the ship and should not be included in tonnage. The TM Convention defines enclosed spaces as all those spaces which are bounded by the ship's hull, by fixed or portable partitions or bulkheads, by decks or coverings other than permanent or movable awnings.

SPACES WITHIN APPENDAGES: Appendages and similar hull structures were also discussed at the 2011 Conference. Some participants expressed concern over the difficulty of calculating the volumes and commented that moveable appendages such as rudders should be ignored. Another participant noted flag Administration requirements for the inclusion of appendages in tonnage only if they contribute to the positive buoyancy of the hull. The TM Convention states that the volumes of all appendages shall be included in the total volume. However, TM.5/Circ.5 clarifies that only those appendages having a volume of greater than or equal to 1 cubic meter are included in tonnage.

Measurement Organization Weekly Notes - 6/7/2011

TM CONVENTION DATES: Recently, a question came up regarding the date of February 10, 1983 that appears at the top of International Tonnage Certificates issued on behalf of the United States. This is the date that the Convention came into force for the United States, following its ratification by the President with the advice and consent of the Senate. More to follow on this subject next week.

POLICY VS. GUIDANCE: There has been some confusion of late over whether MTN 01-99 CH-7, Tonnage Technical Policy, is a policy document, as opposed to a guidance document, and the need for compliance with the interpretations of this document. As stated on its cover page, the MTN promulgates policy for use by authorized measurement organizations in interpreting and applying the provisions of 46CFR69, and that any deviation requires written approval from the MSC. On the other hand, the Tonnage Guides maintained by the MSC are guidance documents, and neither establish nor promulgate policy.

PHOTOS OF VESSELS: At the Conference, a participant commented that under flag Administration requirements for domestic measurement of some ships, the owner must provide a minimum of four photos showing different external views. Though this is not a requirement in the case of U.S. flag vessels, providing graphical images of this nature would be a helpful way to verify and match the vessel with its documents. This should not be confused with requirements of MTN 01-98 CH-9 related to photos. As a reminder, the MTN specifies the inclusion of sketches or scaled photographs in the tonnage file for those cases where dimensions do not come from drawings or computer models.

Weekly Notes are issued by the Coast Guard Marine Safety Center's Tonnage Division (MSC-4) for use by organizations that perform measurement work on the Coast Guard's behalf. They are for informational purposes only, and are not intended as, nor should they be construed to represent, revisions of or substitutes for applicable statutes or regulations or established interpretations of either.

Measurement Organization Weekly Notes - 5/31/2011

TONCALC EXCEL PRODUCT SET: The Marine Safety Center is starting a long overdue upgrade to the TONCALC product set, which some measurement organizations are currently using on an optional basis. Planned changes include: 1) improved picklist functionality; 2) error checking for insert and delete operations; 3) incorporation of the Visual Basic Code into the TONCALC workbook rather than as a separate workbook; and 4) better organization and labeling of exempted and deducted spaces. If you have any questions on this effort, or suggestions for improvements, please contact Mr. Javier Jimenez at 202 475-3364.

GRAPHICAL IMAGE OF SHIP ON ITC: At the Conference the issue of a proposal to include a graphical image of the ship in the remarks block of the International Tonnage Certificate was discussed. The argument for this was that one could easily match the information on the certificate with the vessel. Some members expressed concern over the consistency of the graphical representation of the vessel (e.g., Photo vs. Drawing).

NOTIFYING IMO OF INTERPRETATIONS: Also discussed was the issue of compliance with Article 15 of the TM Convention. Under Article 15 of the Convention, Contracting Governments must transmit to IMO copies of related laws, orders, decrees regulations and other instruments. While such documents are currently being posted on IMO's website as they are received, IMO did not retroactively post older documents that were transmitted. Some agreed that such documents could be useful to see how other Governments interpret the TM Convention.

Measurement Organization Weekly Notes - 5/24/2011

FABRIC PARTITIONS: At the Conference the issue of whether a space bounded by fabric partitions shall be considered enclosed was discussed. Most agreed that a space would not be counted in gross tonnage with the use of non-weathertight fabric partitions. One participant mentioned that the field in material science is becoming more advanced (Kevlar, Velcro, etc.) and the type of material should be considered.

TONNAGE CERTIFICATE ATTACHMENTS: Also discussed was the issue of attaching addendums to the International Tonnage Certificate (ITC). Some participants believed that this was necessary when the measurer runs out of space in the certificate. However the Convention is silent on what an Administration should do when this happens. A proposed approach was to establish some interpretations and guidelines for format and content of tonnage certificate attachments. The United States has not authorized attachments that are referenced by the ITC.

MEMORIAL DAY CLOSURE: The Marine Safety Center will be closed for the Memorial Day holiday, on Monday May 30th. Normal business hours will resume on Tuesday May 31st.

Measurement Organization Weekly Notes - 5/18/2011

GRATINGS AS DECKS: At the conference the issue of whether gratings should be considered as decks was discussed. Some were of the opinion that a deck is a structural and/or strength member, and gratings are not recognized as such. Other comments were that if air and water pass through, then the grating does not bound enclosed space. On the other hand, the TM Convention uses the terminology “decks or coverings” when describing the boundaries that enclose spaces.

EXCLUSION OF SPACES BENEATH AN AWNING: Also discussed was issue of whether spaces beneath an awning are treated as enclosed spaces. The majority agreed that the Convention is clear that spaces beneath a cover considered an “awning” are not considered enclosed, although there was not agreement on the definition of an awning.

MEANS DESIGNED FOR SECURING CARGO: Most participating members at the Conference agreed that if a space is fitted with means “designed” to secure cargo (as per the U.S. tonnage regulations), then it is ineligible for exclusion and must be included in the gross tonnage. It was less clear for spaces where cargo securing means were not designed for that specific purpose (e.g. a mooring cleat).

Measurement Organization Weekly Notes - 5/10/2011

2011 TONNAGE CONFERENCE: We would like to thank all who attended the 2011 Tonnage Conference for participation in this valuable information exchange forum. We had a total of 23 attendees representing six classification societies, four governments, and the Panama Canal Authority. We intend to develop meeting notes from the conference: if you wish to obtain an electronic copy, please contact Mr. Marcus Akins at marcus.j.akers@uscg.mil.

REDUCED GROSS TONNAGE: As discussed at the Conference, certain vessels assigned tonnage under the convention measurement system may qualify for assignment of a Reduced Gross Tonnage parameter upon request of the vessel owner. This parameter is intended to encourage favorable economic treatment of vessels whose designs incorporate specific features. A remark must be included on the ITC citing the Reduced Gross Tonnage and referring to the use of this parameter for the "calculation of tonnage based fees." Vessels with qualifying segregated ballast tanks and open-top containerships are two examples of where Reduced Gross Tonnage might be applicable. MTN 01-99 will be updated to reflect changes approved by the IMO Maritime Safety Committee (MSC Resolution 234(82)) to the reduced gross tonnage formula for open-top containerships.

IMO SLF TONNAGE CG WEBSITE REMINDER: As a reminder to those interested in tonnage-related work at IMO, the Tonnage Correspondence Group (CG) established at SLF 52 has a website which contains papers submitted by flag States to the various Committees and Sub-Committees, including SLF and the Marine Safety Committee (MSC). The website can be used as a resource for measurement organization representatives who wish to become more familiar with potential changes that may affect the Convention measurement system. The Tonnage CG website address is: <http://www.uscg.mil/imo/slf/tonnagecg.asp>.

Weekly Notes are issued by the Coast Guard Marine Safety Center's Tonnage Division (MSC-4) for use by organizations that perform measurement work on the Coast Guard's behalf. They are for informational purposes only, and are not intended as, nor should they be construed to represent, revisions of or substitutes for applicable statutes or regulations or established interpretations of either.

Measurement Organization Weekly Notes - 5/3/2011

Weekly Notes foregone due to Tonnage Conference

Weekly Notes are issued by the Coast Guard Marine Safety Center's Tonnage Division (MSC-4) for use by organizations that perform measurement work on the Coast Guard's behalf. They are for informational purposes only, and are not intended as, nor should they be construed to represent, revisions of or substitutes for applicable statutes or regulations or established interpretations of either.

Measurement Organization Weekly Notes - 4/27/2011

TONNAGE CONFERENCE: The 2011 Tonnage Conference will begin at 0800, May 3, 2011. If you have not submitted your questionnaire, please do so by close of business April 27, 2011. We look forward to your attendance. Business casual attire is encouraged. Should you have any questions regarding the questionnaire, lodging, or transportation please contact Mr. Marcus Akins at 202-475-3349 or marcus.j.akers@uscg.mil.

TONNAGE CALCULATIONS AND FRAME LOCATIONS: MTN 01-98 Section 6.2(a)(1) requires that tonnage calculations under the regulatory system (GRT/NRT) list the frame locations (or equivalent) of dimensions associated with spaces included in or exempted or deducted from tonnage(e.g., "Extended Forecastle Stem-Fr 52", "Galley FR 10-12". Oversights results reflect this is a common error with tonnage calculations. It is imperative that space descriptions establish a baseline for review or remeasurement (if the spaces in question are affected by the modifications).

STANDARDIZED TONNAGE CALCULATION FORMATS: As reported several weeks ago, the MSC has been reviewing tonnage calculation formats for standard and dual measurement. Our current intention is to go forward with a standardized format, as it had been done in the past with the CG-1410 forms, to facilitate record keeping and review, and to reduce nonconformity rates. We will solicit comments from the measurement organizations before making any changes affecting calculation formats. If you have any questions on this subject, please feel free to contact Mr. Marcus Akins.

Measurement Organization Weekly Notes - 4/19/2011

WATER BALLAST EXEMPTIONS: When evaluating water ballast exemptions, admeasurers should recall that under Section 69.117(f)(2) of MTN 01-99 Change 7, the primary purpose of the water ballast must be to afford a means of maintaining the vessel's stability, immersion, trim, pre-loading conditions, or sea-keeping capabilities. Each approval then must describe the primary purpose of the water ballast in accordance with Section 69.117, paragraphs (f)(4)(vi) through (f)(4)(ix).

U.S. BUILD DETERMINATION: The US Coast Guard issued a determination letter concluding that installation of a foreign-manufactured crane onto a new vessel when the vessel is not in the United States would cause the vessel to not qualify as US built. A determination was sought from the Coast Guard as to whether a deck crane manufactured abroad for the intended purpose of inclusion on the vessel could be installed on the vessel in that foreign port. The Coast Guard ruled that, because the deck crane was intended to be an integral part of the vessel, it must be installed into the vessel in the United States for the vessel to qualify as US built.

MR. EARECKSON OUT OF THE OFFICE: Mr. Eareckson will be out of the office the week of April 18-22, 2011. Please forward any questions during that time to Mr. Marcus Akins at 202-475-3349, or e-mail him at marcus.j.akers@uscg.mil.

Measurement Organization Weekly Notes - 4/12/2011

IMO SLF 53 REPORT: The SLF 53 Report to the Maritime Safety Committee (SLF 53/19) was posted on IMO's website last week. The report recommends that the Maritime Safety Committee authorize work on updating interpretations of the TM Convention, with a proposed target completion date of 2014.

OSV ALTERNATE TONNAGE: As we reported in December 2010, the 2010 Coast Guard Authorization Act removed the 6000 GT ITC tonnage cap on offshore supply vessels (OSVs), effectively allowing a vessel of unlimited tonnage to be regulated as an OSV (Subchapter L). Since its establishment in 1996, approx 248 US vessels were certificated under the offshore supply vessel alternate tonnage schema and were not assigned a regulatory tonnage.

MR. JIMENEZ OUT OF THE OFFICE: Mr. Javier Jimenez will be out of the office April 11-13, 2011. Please forward any tonnage requests to Mr. Marcus Akins at marcus.j.akers@uscg.mil.

Measurement Organization Weekly Notes - 4/05/2011

TONNAGE TAX LAW: Representative Herger (R-CA) introduced a tax bill to amend the Internal Revenue Code of 1986 to modify the application of the tonnage tax on certain vessels. There were no explicit tonnage impacts in this bill. This bill requires an electing corporation to be treated as continuing to use a qualifying vessel in the US foreign trade during any period of use in the US domestic trade. The corporation's gross income from trade qualifies as taxable income from transporting of goods or passengers.

COMPANIONS: A reminder that when considering space for exemption as companion space, only a companion protecting stairways (or equivalent) that lead to spaces below may be exempted from inclusion in gross tonnage. This means that the exemption is limited to the top tier. Note that the companion exemption derives from the way spaces on the weather decks of vessels were treated at the time that the Moorsom system came into being. Older versions of the U.S. tonnage regulations defined the term "companion" as "a small structure sheltering a deck opening affording entrance to a companionway". The term "companionway" was defined as "a stair or ladderway leading to a space above or below."

FEDERAL GOVERNMENT FUNDING UPDATE: The possibility of a government shutdown on April 8th is still being discussed by members of Congress. The President is set to meet this afternoon with the Senate Majority Leader and the House Speaker to discuss the budget and try to reach an agreement. We advise the measurement organizations to stay informed as is possible that there will be disruptions in service from the Tonnage Division if there is a government shutdown.

Measurement Organization Weekly Notes - 3/29/2011

TONNAGE CONFERENCE: The questionnaire for the 2011 Tonnage Conference has been distributed. Responses are due no later than April 22, 2011. If you are attending the Conference, please call the Channel Inn at 202-554-2400 prior to April 2, 2011 to make reservations if you have not already done so. The hotel will release the rooms from the block on April 3, 2011. Should you have any questions regarding the questionnaire or lodging, please contact Mr. Marcus Akins at 202-475-3349 or marcus.j.akers@uscg.mil.

ILO PAPER ON TONNAGE: The International Labour Organization (ILO) has submitted a paper for consideration by the Maritime Safety Committee. The paper notes ILO comments at SLF 53 to the effect that the 1969 TM Convention has led to an economic disincentive for shipowners to improve crew conditions, in particular by discouraging the provision of more than the minimum required accommodation space and related facilities and by raising the cost of providing ships with additional accommodation spaces for carrying cadets. The ILO paper comments that Germany's recent paper on reduced gross tonnage reflects the principle that owners should not be faced with an economic disincentive for providing larger crew spaces.

TONNAGE CALCULATIONS: The MSC is currently reviewing administrative requirements related to tonnage calculations for standard and dual measurement. Currently, a consistent format is not required, nor has the Coast Guard approved the various formats being used. Use of multiple formats makes it more difficult to review calculations, and could be a contributing cause for some nonconformities identified in recent oversight reviews. If you have any thoughts on this subject that you would like to share with us, please feel free to do so by contacting Mr. Marcus Akins.

Measurement Organization Weekly Notes - 3/22/2011

TONNAGE CONFERENCE PLANNING: As the 2011 Tonnage Conference nears, please take note of the following: Questionnaires are scheduled to be sent out on March 25, 2011; Foreign Visitor Request forms should be sent directly to Mr. Marcus Akins at marcus.j.akers@uscg.mil; Reservations at the Channel Inn should be made prior to April 2, 2011. The conference will span three full days, please plan accordingly.

IMO MARITIME SAFETY COMMITTEE Today was the final deadline for submission of comment papers for the Maritime Safety Committee's 89th Session (May 11-20). So far, the only comment paper on tonnage yet posted is Germany's paper on crew spaces, which we reported on last week. We are hopeful that the Maritime Safety Committee will authorize work on updating TM 5/Circ.5.

FEDERAL GOVERNMENT FUNDING UPDATE: As Congress continues debating the spending bill for the 2011 fiscal year, last week the President signed into law a temporary measure that would keep the government funded for another three weeks. Congress has to pass another bill to avoid a government shutdown on April 8th. We will continue to monitor this situation and try to keep the measurement organizations informed.

Measurement Organization Weekly Notes - 3/16/2011

IMO CREW SPACE PROPOSAL: Germany has submitted a paper for consideration by the IMO Maritime Safety Committee proposing a reduced gross tonnage parameter for crew space. The proposal defines “V crew” as the total volume of all enclosed spaces which are necessary for the accommodation and provision of the crew, including cabins, passageways, staircases, galleys, provision stores, mess rooms change rooms, hospitals, gymnasiums, recreation rooms, laundry, etc.

MIDDLE LINE OPENINGS: In recent months, the Tonnage Division has responded to several inquiries regarding middle line openings, for which the MTN requires the space below to “have a minimum length of four feet throughout its entire breadth and height and be in the clear at all times”. Consistent with previous decisions, the MSC interprets this language as requiring the space to extend “side to side” across the entire vessel. Please contact Mr. Marcus Akins at 202 475-3395 if you have questions on this requirement.

PRINCIPAL DIMENSIONS: As the Marine Safety Center continues to increase the amount of oversight, we offer a gentle reminder that if a vessel is selected, we will perform a complete verification of the assigned registered dimensions and overall length. Nonconformities of a magnitude beyond acceptable tolerances (usually 1%) will require recertification of the vessel. For documented vessels, this means the reissuance of the vessel’s COD, for which costs are involved and – in some cases – the permission of a mortgage company.

Measurement Organization Weekly Notes - 3/8/2011

RECESSES: The Tonnage Division recently responded to an inquiry regarding the treatment of a superstructure recess partially obstructed by a lifeboat. This is one of many subjects that will be addressed on an international basis if the IMO Maritime Safety Committee authorizes this work at its upcoming meeting in May. Until then, please refer questions on similar situations to Mr. Marcus Akins at 202-475-3349.

TONNAGE MEASUREMENT RECORDS GUIDE UPDATED: The Tonnage Guide for "Tonnage Measurement Records", TG 3, has been updated. This guide provides general information on records associated with the tonnage measurement of the United States flag vessels, including how members of the public may obtain copies of such records, including FOIA procedures that measurement organizations must use to obtain copies of tonnage records from the NVDC. A copy of the guide is attached. Please forward any questions or concerns on this guide to Mr. Javier Jimenez at 202-475-3364, or e-mail him at javier.jimenez@uscg.mil.

MODULAR VESSELS: Please contact the Tonnage Division staff if you are measuring a vessel made up of several different modules that, in and of themselves, could be considered separate vessels. An example is a Flexifloat barge which consists of individual modular barge units that can be assembled in various configurations. The documentation laws and the tonnage laws of the United States could treat the finally assembled vessel differently, depending on the individual circumstances.

Measurement Organization Weekly Notes - 3/1/2011

TONNAGE CONFERENCE MATTERS: As mentioned in previous weekly notes, the 2011 Annual Tonnage Conference will focus on discussion of the interpretations of the International Tonnage Convention. Questionnaires are anticipated to be emailed no later than March 25, 2011 to give participants time to complete and return them in advance of the Tonnage Conference, so that we can compile and present the results. Also, we have secured a block of rooms at the Channel Inn (Reference: Coast Guard Tonnage). Please contact Mr. Marcus Akins at marcus.j.akers@uscg.mil or 202-475-3349 with any comments, suggestions, or to RSVP for the conference.

STEPS UNDER DUAL MEASUREMENT: Under dual measurement, additional restrictions apply when exempting spaces below steps in the uppermost complete deck. Specifically, spaces between the line of the uppermost complete deck and the uppermost complete deck itself are not included in the superstructure tonnage. Please contact Mr. Marcus Akins (202)475-3364 if you have any questions on applying the dual measurement system to a vessel with steps in its uppermost complete deck.

GOVERNMENT SHUTDOWN: As some may be aware, Congress has not come to agreement on the continued funding of federal government. The current funding legislation is due to expire on March 4th. We want to let the measurement organizations know that we are closely monitoring this situation and will try our best to provide more updates.

Measurement Organization Weekly Notes - 2/22/2011

DUAL TONNAGE MEASUREMENT: We recently responded to a question regarding dual tonnage measurement methodologies. Specifically, an owner of a vessel fitted with stern notches had the notches closed-in. This invalidated what would have otherwise been the uppermost complete deck, thereby creating a second deck and resulting in loss of previously exemptible dry cargo and stores spaces.

FOREIGN MILITARY SALES: It has come to the attention of the MSC Tonnage Division that the Coast Guard will be reducing its current inventory of Cutters that are beyond their intended service life to make way for newly acquired Cutters. The scheduled decommissioning and transfer to foreign military sales are being done in accordance with the DHS 2011 Budget. Per Tonnage Guide 2 CH-1, "Measurement of Navy and Coast Guard Vessels", tonnage certificates issued by the Coast Guard are no longer valid after a vessel of war is transferred to another government. If you have questions regarding Navy or Coast Guard vessel measurement, please contact Mr. Javier Jimenez (202)475-3364.

IMPLEMENTATION OF MANDATORY IMO INSTRUMENTS: At the end of last year, the IMO Maritime Safety Committee tasked one of its Sub-Committees to begin drafting amendments to the 1969 TM Convention (along with other Conventions) to "make the code for the implementation of mandatory IMO instruments and auditing mandatory". Among other things, this Code establishes minimum qualifications/training requirements for surveyors. If you have questions regarding this matter, please contact Mr. Peter Eareckson (202) 475-3395.

Measurement Organization Weekly Notes - 2/15/2011

EXPANDED HIN's RULEMAKING: The Coast Guard decided to withdraw a rulemaking that would expand the existing 12 character HIN. For several years, the agency was looking into the possibility of adding more characters in order to provide additional information identifying vessels. After reviewing the comments received from the public for the proposed rulemaking, the Coast Guard withdrew the rulemaking stating the lack of sufficient data to demonstrate that the benefits outweigh the costs and burdens.

2011 TONNAGE CONFERENCE: As mentioned in previous weekly notes, the 2011 Annual Tonnage Conference will focus on discussion of the interpretations of the International Tonnage Convention. We have enclosed the provisional agenda and welcome any questions or comments. Please contact Mr. Marcus Akins at marcus.j.akins@uscg.mil or 202-475-3349 with any comments, suggestions, or to RSVP for the conference.

DYNAMIC POSITIONING SYSTEMS: An otherwise non-self-propelled watercraft operating offshore with a Dynamic Positioning (DP) System may be considered to be an underway, self-propelled vessel, and subject to all the regulatory requirements of "traditional" vessels. This is of particular importance to Mobile Offshore Drilling Units that use DP systems to maintain position vice physical anchoring systems to the sea floor. If such a vessel is greater than 79 feet in length and is deemed to be self-propelled, it would not be authorized to use the simplified measurement system in accordance with provisions outlined in NVIC 11-93 CH-3 and must be formally measured. If you have questions on whether or not a vessel with DP is a self-propelled vessel, our POC is Mr. Marcus Akins at (202) 475-3349.

Measurement Organization Weekly Notes - 2/8/2011

2 NET TON FISHING VESSELS: When researching another issue, we became aware of a net tonnage threshold which has been in law for many years, but was only recently codified in Title 46, United States Code, 53501. The Capital Construction Fund (CCF) was created under a Merchant Marine Act to assist fisherman to acquire fishing vessels or improve a current vessel. The CCF program allows taxpayers to defer taxable income by making contributions to a NMFS approved depository and eventually use the accumulated funds for purchasing or improving fishing vessels. Any U.S. citizen who owns or leases a U.S. built fishing vessel of at least two net tons and has an acceptable program for constructing, reconstructing, or acquiring a fishing vessel that meets the criteria, is eligible. The term "fishing vessel" includes vessels used commercially in the fisheries of the U.S. for catching, transporting, and processing fish. Also included are commercial passenger-carrying vessels used for fishing parties.

OPENINGS IN ORDINARY FRAMES: We recently responded to a question regarding the installation of openings in ordinary frames which meet requirements for personnel access of IMO Resolution A.673. Specifically, how are openings meeting the IMO Resolution A.673 minimum size requirements (e.g., 22 inches x 24 inches) treated during tonnage measurement? In accordance with MTN 01-99 (CH-7) Section 69.109(p)(2)(iii), an opening in an ordinary frame exceeding a diameter of 18 inches, or a size of 15 inches x 23 inches for fuel tanks, is considered oversized and the line of the ordinary frames shall be established as if the frame material above and inboard of the opening were not there.

COLLECTION OF INFORMATION: Under the Paperwork Reduction Act of 1995 we are periodically required to account for the burden imposed by the Federal government on the public for collecting certain information, which includes submission of measurement applications. We invite the measurement organizations to participate. Please feel free to provide us with information on how much time it takes a vessel owner to prepare, assemble, and submit all special plans and other "information" required for a "typical" vessel. The POC for this project is Mr. Javier Jimenez.

Measurement Organization Weekly Notes - 02/01/2011

TONNAGE AND CONTAINERSHIPS: We continue to seek information about the impact of tonnage-based fees on containership designs. There have been allegations that, in order to minimize these fees, designs have generally evolved since the 1960's to increase the number of containers carried on deck relative to the number carried below deck. It is unclear, however, whether other factors are influencing this apparent trend, such as the desire to reduce vessel displacement and associated construction and fuel costs. We would greatly appreciate any information – either anecdotal or otherwise – that you could share regarding the influence of tonnage-based fees on containership design. Our POC for this issue is Mr. Marcus Akins at (202) 475-3349.

CLEAN HULLS: The Coast Guard Authorization Act of 2010, signed by the President on 15 Oct 2010, contains general provisions for “clean hulls” in Title 10 of the Act. It requires that any vessel of at least 400 gross tonnage as measured under the International Tonnage Convention that engages on international voyages shall carry an International Antifouling System Certificate. Any vessel less than 400 GT but at least 24 meters in length that engages on international voyages must carry a declaration with a clear statement that the antifouling system on the vessel complies with the International Convention on the Control of Harmful Anti-Fouling Systems on Ships, 2001. Our POC for this issue is Mr. Brian Ellis at (202) 475-5636.

PROVISION OF FLEET TONNAGE INFORMATION: An IMO Circular was sent to all the Member States as a reminder of a procedure that must be followed to validate their fleet tonnage information. This must be done to ensure that the aggregate tonnage figures used to calculate their annual IMO assessment (dues) are accurate and up-to-date. See the attachment for more information on this Circular.

Measurement Organization Weekly Notes - 1/25/2011

TONNAGE CONFERENCE PLANNING: The Marine Safety Center plans to change the traditional format of the 2011 Tonnage Conference, which will be held from Tuesday May 3rd thru Thursday May 5th. We intend to circulate tonnage questionnaires prior to the conference to facilitate discussion. Questionnaires are anticipated be emailed no later than March 25 to allot participants time to complete them in advance of the Tonnage Conference.

REPORTING PROCESS UPDATE: The revised process for reporting tonnage measurement work has been working now for a year. We received a total of 693 certificates that have been or are in the process of being uploaded into our MISLE database. We like to remind the measurement organizations that the unique VIN field is required to be completed. We would like to thank all the measurement organizations for the work in making this possible.

OVERSIGHT: The Tonnage Division intends to increase the frequency for which tonnage work items are selected for oversight. We appreciate the timely submittal of the notification worksheets and look forward to your cooperation as we seek to improve the tonnage program through oversight.

Measurement Organization Weekly Notes - 1/18/2011

SLF 53 MEETING OUTCOME: At its fifty third session last week in London, the IMO Sub-Committee on Stability and Load Lines and on Fishing Vessels Safety (SLF) endorsed the updating of TM.5/Circ.5. If this update is authorized by the Maritime Safety Committee, SLF will begin work at its next meeting in January. We expect that SLF would set up correspondence groups and working groups to identify issues and accomplish the necessary drafting. Tentatively, the work would complete in January 2014.

CREW SPACE VOLUMES: There was mention at SLF of the possible certification of volumes of crew accommodation spaces, through the inclusion of remarks on International Tonnage Certificates. The idea was that ports and other entities could then “deduct” such spaces from the gross tonnage when calculating fees, thereby avoiding a disincentive for the fitting of additional crew accommodation spaces (including space for cadets).

TONNAGE EXPERTS MEETINGS IN LONDON: During SLF, “tonnage experts” met on an informal basis to discuss issues of mutual interest that were not immediately before the Sub-Committee. These meetings provided a valuable forum for the exchange of information. We hope to share some of this information at this year’s Tonnage Conference in May.

Measurement Organization Weekly Notes - 1/11/2011

MARTIN LUTHER KING JR.(MLK) HOLIDAY: The Marine Safety Center will be closed on Monday, January 17th, in observance of the Birthday of Martin Luther King Jr. We will resume normal business hours on January 18th.

SIMPLIFIED MEASUREMENT: The Marine Safety Center responded to a question seeking comment on the simplified measurement treatment of a recently modified fiberglass recreational vessel. Specifically, the overall length of the vessel was in question based on the additional of a swim platform supported by sponsons. Based on the pictures provided, the sponsons were determined to be a part of the vessel's buoyant hull envelope and should be included in the overall length.

DUAL TONNAGE MEASUREMENT CERTIFICATES: The 2010 Coast Guard Authorization Act updated the requirements in the tonnage statute (Sections 14513) to reflect that certificates may show two sets of tonnages for vessels measured under the dual tonnage measurement system, regardless of whether or not a load line is assigned to the vessel.

Measurement Organization Weekly Notes - 1/4/2011

SLF 53 MEETING NEXT WEEK: The SLF Sub-Committee meets next week in London. At this meeting, the United States will present the results of the Tonnage Correspondence Group's work on options to improve the effect on ship design and safety of the TM Convention. We are hopeful that the Sub-Committee will agree to implement Option A (updating the TM.5/Circ.5 interpretations), which would likely require several sessions and the establishment of a correspondence group.

TONNAGE VIOLATION: The Marine Safety Center recently issued a tonnage violation on a foreign flag vessel arriving at a U.S. port. The operator presented a "certificate" to boarding officers indicating that the vessel underwent a flag change, providing estimated values of gross and net tonnage pending issuance of an International Tonnage Certificate (1969). A tonnage violation was issued as such an interim certificate is not recognized by the Convention.

TONNAGE CONFERENCE: The Annual Tonnage Conference is tentatively scheduled for the first week of May 2011 at the Channel Inn. For the 2011 Conference, we are considering focusing solely on the Convention Measurement System. As always, we welcome any suggestions, comments, or topics for discussion. Similar to last year's conference, we will seek secure a block of rooms at the Channel Inn for conference attendees. Please send all requests and/or suggestions to Mr. Marcus Akins at marcus.j.akers@uscg.mil.

Measurement Organization Weekly Notes - 12/21/2010

HOLIDAY SCHEDULE: The Marine Safety Center will be closed this Friday (December 24th) and the following Friday (December 31st) due to the fact that they are legal public holidays that fall on Saturdays. Normal business hours will resume on both following Mondays, December 27th and January 3th. We wish everyone Happy Holidays!

NON-TRADITIONAL WATERCRAFT: A reminder that per MTN 01-98, CH-9, measurement organizations are required to contact the Tonnage Division staff for instructions before accepting the application for measurement of non-traditional watercraft. In this context, non-traditional watercraft are those that either by design or intent do not usually get underway and/or do not possess the practical capability or equipment for being used as a means of transportation on water. A floating dock structure is an example of a non-traditional watercraft.

WIGs: By Act of Congress, "Wing-in-ground craft" (WIGs) are defined as vessels capable of operating completely above the water on a dynamic air cushion created by the aerodynamic lift due to the ground effect between the vessel and the water's surface. A photo of a WIG is attached. While WIGs are not "Non-Traditional Watercraft" as described above, they would fall under "novel craft" provisions of MTN 01-99, CH-7.

Measurement Organization Weekly Notes - 12/14/2010

SLF SOLAS WORKING GROUP MEETING: The public meeting in preparation for SLF 53 was held at headquarters last Tuesday. At that meeting, the Coast Guard reviewed the two papers submitted on the tonnage item, including the paper co-sponsored by Norway and the United States that supports implementing option A (updating the TM.5/Circ.5 interpretations).

1993 TORREMOLINOS PROTOCOL: An information paper was submitted by Spain for SLF 53 that provides correlations between tonnage and length for fishing vessels. This is part of an ongoing effort to ascertain whether gross tonnage should be used as an equivalent to, or replacement for, length breakpoints in the Torremolinos Protocol. The Protocol provides minimum standards for safety requirements for the construction and equipment of seagoing fishing vessels of 24 meters in length and over, including those vessels also processing their catch.

OPEN VESSELS: A reminder that additional requirements apply when measuring a vessel under the Standard Measurement System whose tonnage length is less than 50 feet. In many cases, applying these requirements will result in measurement of the vessel as an open vessel. Refer to Section 69.109(o)(3) of MTN 01-99 CH-7.

Measurement Organization Weekly Notes - 12/6/2010

OSV TONNAGE LIMITS: The 2010 Coast Guard Authorization Act removed the tonnage threshold that bounds the upper limit of an offshore supply vessel (OSV), effectively allowing a vessel of unlimited tonnage to be regulated as an OSV (Subchapter L). As a result, Section 3.3(b)(3)(viii) of MTN 01-98 CH-9 is in conflict with the law, as this section states "in no case shall a vessel be classified as an offshore supply vessel if the vessel is assigned a regulatory measurement system gross tonnage of 500 GRT or above". We intend to update the MTN, accordingly, when it is next revised. Per the Auth Act, we are now entering the "interim period" in which the Coast Guard may issue Certificates of Inspection (COIs) while we develop regulations to address the change in law.

2010 TONNAGE PROGRAM REVIEW: We would like to thank all who attended the 2010 Tonnage Program Review at the WorkBoat show last week and made it a success. In large part due to admeasurer contributions, we were able to generate multiple avenues to improve the tonnage program. We look forward to working with admeasurers, consultants, and classification societies as we seek to act on the discussion points from the review. Most notably, we hope to build upon the discussions on tonnage outreach (general public/marine inspectors) and on how to better address vessel configuration changes. For questions and comments on the review, please contact Mr. Marcus Akins at marcus.j.akers@uscg.mil.

RECESSES: We recently responded to a question seeking comment on treatment of a semi-enclosed space in the aft end of a deck structure, specifically whether the space could be considered a deck recess or a end opening under the convention measurement system. In accordance with MTN 01-99, CH-7, an end opening must have an opening breadth measuring 90% of the breadth of the deck at the line of the opening. Furthermore, a space is ineligible for exclusion as a recess unless the recess is "exposed to the weather". In this case, side structures and associated hull plating served to protect the space on its sides from being exposed to the weather. We encourage anyone faced with a determination regarding an end opening or recess that does not exactly match the configurations depicted in the MTN to contact Mr. Marcus Akins at 202-475-3349 to discuss the configuration.

Measurement Organization Weekly Notes - 11/24/2010

THANKSGIVING DAY CLOSURE: The Marine Safety Center will be closed for the Thanksgiving Day holiday, on Thursday, November 25. Normal business hours will resume on Friday, November 26.

2010 TONNAGE PROGRAM REVIEW: The tonnage division will be out of the office beginning Tuesday, November 30th through Friday, December 2nd to attend the 2010 Workboat Show. Normal business hours will resume on Monday, December 6th.

MR. JIMENEZ OUT OF THE OFFICE: Mr. Javier Jimenez will be out of the office November 24, 2010. Please forward any immediate tonnage requests made after the close of business on November 22 to Mr. Marcus Akins at marcus.j.akers@uscg.mil.

Measurement Organization Weekly Notes - 11/16/2010

FISH AS DRY CARGO AND STORES: The U.S. dual measurement system stems from the 1964 IMCO Tonnage Mark Scheme, which came about in response to safety concerns over tonnage openings used in watertight bulkheads in open-closed shelter-deck vessels. Under dual measurement, tonnage openings are not recognized, and instead, spaces on or above the uppermost complete deck that are available for carrying dry cargo and stores are exempt from tonnage. Under U.S. rules, any space is considered available for carrying dry cargo and stores if that space is not: 1) occupied by liquids (e.g., a fuel oil tank); or 2) used for the accommodation or berthing of passengers or crew (e.g., staterooms, lounges, dining areas and any passageways that serve such spaces). This leads to the conclusion that spaces containing fish bins are “dry cargo and stores” spaces.

2010 TONNAGE PROGRAM REVIEW: The tonnage division will be attending the 2010 Workboat Show on December 1, 2010. During that day, we will entertain industry groups and/or admeasurers who desire to discuss the tonnage program. On Thursday, December 2nd, we will be conducting marine industry field familiarization. Please contact Mr. Marcus Akins at marcus.j.akers@uscg.mil with any questions.

FOREIGN/DOMESTIC VOYAGES: The 2010 Coast Guard Authorization Act expanded the requirements in the tonnage statute (Sections 14101, 14103, and 14301) to ensure that foreign flag vessels on domestic voyages (including Great Lakes voyages) out of U.S. ports are subject to the same requirements for convention measurement as foreign flag vessels on foreign voyages.

Measurement Organization Weekly Notes - 11/10/2010

CONVENTION MEASUREMENT APPLICABILITY: The requirements for convention measurement apply at all times to vessels that engage on foreign voyages and are not limited only to those times when the vessel is engaged on a foreign voyage.

SLF SOLAS WORKING GROUP MEETING: A reminder that a public SLF SOLAS working group meeting will be held at USCG Headquarters in Washington, DC on Tuesday, December 7th. The status of the completed Tonnage Correspondence Group (CG) report (SLF 53/5), and the U.S. position on that report, will be discussed at this meeting. We note that there has been interest expressed by the public on a number of tonnage technical issues to be addressed under Option A. However, it remains to be decided by the international community whether Option A will even be pursued, and if so, on what timetable.

VETERANS DAY CLOSURE: The Marine Safety Center will be closed for the Veterans Day holiday, on Thursday November 11th. Normal business hours will resume on Friday November 12th.

Measurement Organization Weekly Notes - 11/2/2010

MR. EARECKSON OUT OF THE OFFICE: Mr. Eareckson is out of the office the week of 1-5 Nov. Please forward any questions during that time to Mr. Marcus Akins at 202-475-3349, or e-mail him at marcus.j.akers@uscg.mil.

2010 TONNAGE PROGRAM REVIEW: The tonnage division is developing agenda items for a tonnage program review that will be held in a brown bag style lunch meeting at the 2010 Workboat Show. This will be primarily for admeasurers attending this year's Workboat Show and is tentatively scheduled to begin the afternoon of December 1, 2010. Please contact to Mr. Marcus Akins at marcus.j.akers@uscg.mil with agenda items for discussion.

MR. ELLIS ATTENDING NOSAC MTG: Mr. Ellis will be attending the semi-annual National Offshore Safety Advisory Committee (NOSAC) meeting in Houston, TX and providing a tonnage overview presentation. He will be out of the office 8-10 NOV 2010. Please forward any tonnage applicability questions during that time to Mr. Marcus Akins at 202-475-3349, or e-mail him at marcus.j.akers@uscg.mil.

Measurement Organization Weekly Notes - 10/27/2010

SLF TONNAGE CG UPDATE: With the posting of its report on IMO's website on Monday, the Tonnage Correspondence Group's work is finally done. The document is available at:

http://www.uscg.mil/imo/slf/docs/tonnage/SLF_53-5_Tonnage_CG_Report.pdf The U.S. position on this report will be discussed at the upcoming public SOLAS working group meeting, to be held at USCG Headquarters in Washington, DC on December 7th.

WARSHIP MEASUREMENT: The 2010 Coast Guard Authorization Act removed language from the tonnage statute suggesting that a U.S. warship is ineligible for convention measurement. This is helpful, as increasingly complex warship designs do not lend themselves well to measurement under the standard measurement system.

TONNAGE MEASUREMENT RECORDS GUIDE UPDATE: The Tonnage Guide for "Tonnage Measurement Records", TG 3, is currently being updated. This guide provides general information on records associated with the tonnage measurement of the United States flag vessels, including how members of the public may obtain copies of such records. Please forward any questions or concerns on this guide to Mr. Javier Jimenez at 202-475-3364, or e-mail him at javier.jimenez@uscg.mil.

Measurement Organization Weekly Notes - 10/20/2010

COAST GUARD AUTHORIZATION ACT: Last week the President signed into law the Coast Guard Authorization Act of 2010. As we mention previously, this bill amends the tonnage laws in an effort to strengthen tonnage requirements for foreign flag vessels, eliminate conflicts and inconsistencies, and incorporate clarifications, updates and corrections.

TONNAGE GRANDFATHERING: The CG Authorization Act amended Section 14301 of the tonnage law (46 USC 141) to remove language suggesting that only "existing vessels" are eligible for tonnage grandfathering under international agreements and laws of the United States.

MEASUREMENT SYSTEM ELIGIBILITY: The CG Authorization Act amended Section 14301 of the tonnage law (46 USC 141) to remove language suggesting a U.S. flag vessel is ineligible for regulatory measurement if the vessel was measured under the convention measurement system at the request of the owner.

MR. EARECKSON OUT OF THE OFFICE: Mr. Eareckson is out of the office until 01 November. Please forward any questions during that time to Mr. Marcus Akins at 202-475-3349, or e-mail him at marcus.j.akers@uscg.mil.

Measurement Organization Weekly Notes - 10/12/2010

ZONES OF INFLUENCE: In documenting the results of a recent oversight, MSC authorized calculation of a water ballast tank exemption without applying the zone of influence method of Section 117(g)(3) of MTN 01-99 CH-7. This was done for a specific case when the ordinary frames had the same “depth of frame” as defined in Section 69.103 of the MTN. Section 117(g)(3) of the MTN is currently under review in this regard. In the meantime, any deviation from the zone of influence method must be approved by MSC prior to tonnage calculation application.

VESSEL DELIVERY TO ANOTHER FLAG STATE: During the work of the SLF Tonnage Correspondence Group, one participant noted that under Articles 2(3), 3(1), 7(1) and 12(1)(a) of the TM Convention, a ship flying the flag of a country that is party to the Convention is subject to the Convention and must have an International Tonnage Certificate (ITC) onboard the ship when engaged on an international voyage. The participant sought consideration for exempting ships from these requirements when engaged on a single international voyage between the originating country and the ship's flag State for purposes of vessel delivery (e.g., after the ship is initially constructed or otherwise obtained). If you have any thoughts on this issue, please feel free to share them with Mr. Marcus Akins.

SIMPLIFIED MEASUREMENT AND REGISTERED LENGTH: A 1966 Act of Congress established simplified measurement as an option for measurement of a vessel “used exclusively for pleasure”. In 1980, Congress extended simplified measurement to commercial vessels meeting certain restrictions (e.g., self-propelled and 24 meters or under in length). Note that in accordance with Coast Guard regulations, registered length under simplified measurement is the overall length of the hull, whereas under formal measurement systems, a different registered length definition is used.

Measurement Organization Weekly Notes - 10/12/2010

ZONES OF INFLUENCE: In documenting the results of a recent oversight, MSC authorized calculation of a water ballast tank exemption without applying the zone of influence method of Section 117(g)(3) of MTN 01-99 CH-7. This was done for a specific case when the ordinary frames had the same “depth of frame” as defined in Section 69.103 of the MTN. Section 117(g)(3) of the MTN is currently under review in this regard. In the meantime, any deviation from the zone of influence method must be approved by MSC prior to tonnage calculation application.

VESSEL DELIVERY TO ANOTHER FLAG STATE: During the work of the SLF Tonnage Correspondence Group, one participant noted that under Articles 2(3), 3(1), 7(1) and 12(1)(a) of the TM Convention, a ship flying the flag of a country that is party to the Convention is subject to the Convention and must have an International Tonnage Certificate (ITC) onboard the ship when engaged on an international voyage. The participant sought consideration for exempting ships from these requirements when engaged on a single international voyage between the originating country and the ship's flag State for purposes of vessel delivery (e.g., after the ship is initially constructed or otherwise obtained). If you have any thoughts on this issue, please feel free to share them with Mr. Marcus Akins.

SIMPLIFIED MEASUREMENT AND REGISTERED LENGTH: A 1966 Act of Congress established simplified measurement as an option for measurement of a vessel “used exclusively for pleasure”. In 1980, Congress extended simplified measurement to commercial vessels meeting certain restrictions (e.g., self-propelled and 24 meters or under in length). Note that in accordance with Coast Guard regulations, registered length under simplified measurement is the overall length of the hull, whereas under formal measurement systems, a different registered length definition is used.

Measurement Organization Weekly Notes - 10/05/2010

WEB BASED TONNAGE APPLICABILITY TOOLS: The Tonnage Division has received approval to begin investing time and resources to develop a set of web based tonnage applicability tools. It is envisioned that the internet available tools would be used to assist users both in the U.S. Coast Guard and maritime industry to ascertain whether a specific threshold in an international convention or a U.S. statute or regulation is to be applied using Gross Register Tons (GRT) or the International Tonnage Convention gross tonnage (GT ITC). For more information on this effort please contact Mr. Brian Ellis at 202-475-5636 or e-mail him at brian.t.ellis@uscg.mil.

TONNAGE TECHNICAL AMENDMENTS: Last week, the Congress passed legislation that will amend the tonnage laws of the United States as part of the 2010 Coast Guard Authorization Act (HR 3619). The amendments are technical in nature and principally aim to: 1) strengthen tonnage requirements for foreign flag vessels, 2) eliminate conflicts and inconsistencies, and 3) incorporate clarifications, administrative updates and corrections. The legislation does not become law unless it is signed by the President.

SIZE LIMITS ON OSVs: Included in the 2010 Coast Guard Authorization Act is language that would remove the tonnage limits in the definition of an offshore supply vessel (e.g., 500 GRT/6000 GT ITC)

Measurement Organization Weekly Notes - 9/29/2010

2010 TONNAGE PROGRAM REVIEW: The tonnage division invites all admeasurers attending the 2010 Workboat Show to participate in a brown bag lunch style tonnage program review tentatively scheduled to begin the afternoon of December 1, 2010. Please respond to Mr. Marcus Akins at marcus.j.akers@uscg.mil with questions or comments.

MR. EARECKSON OUT OF THE OFFICE: Mr. Eareckson is out of the office. Please forward any questions during that time to Mr. Marcus Akins at 202-475-3349, or e-mail him at marcus.j.akers@uscg.mil.

TONNAGE CALCULATIONS AND FRAME LOCATIONS: We would like to reiterate that when developing tonnage calculations under the regulatory system (GRT/NRT), it's important (and required) to list the frame locations (or equivalent) of dimensions associated with spaces that are "grossed", as well as dimensions associated with exempted and deducted spaces (e.g., "Extended Forecastle Stem-Fr 52", "Galley FR 10-12". This facilitates review, helps avoid/resolve disputes regarding assigned tonnages, and is of critical importance in establishing a baseline for remeasurement if the spaces in question are affected by the modifications.

Measurement Organization Weekly Notes - 9/21/2010

SISTER VESSELS AND GRANDFATHERING: Section A.3 of MTN 01-99 CH-7 provides for grandfathering of previous interpretations of the tonnage regulations for sister vessels that are “identical from the standpoint of tonnage measurement”. Neither the MTN, nor any other USCG policy document, precludes applying these grandfathering provisions to a sister vessel solely because it is to be constructed at a different shipyard.

BASIS FOR GT ITC FORMULA: While researching a tonnage matter, we recently came across a computer output from work done in the spring of 1969, listing the sample population of 591 vessels used to develop and verify the GT ITC formula. Based on information in the accompanying report, the analysis showed that for this sample population, the standard deviation about the mean of the percent difference between GRT and GT ITC was 20.4%. The standard deviation dropped to 6.5% when 36 of the outliner vessels were omitted. That is a surprisingly good correlation, and reflective of how well GT ITC aligns with GRT for vessels that do not extensively employ tonnage reduction features.

SLF TONNAGE CG UPDATE: The work of the correspondence group is winding to a close, with comments on the draft final report due Friday. So far, participants from two countries have commented (IACS has not yet weighed in). The report is to be submitted to IMO on the following Friday (October 1st)

Measurement Organization Weekly Notes - 9/14/2010

PROGRESSION FROM SIDE RECESSES: We recently responded to an inquiry about progressing open space into a superstructure via side recesses fitted tonnage openings in the athwartships portions of the recess bulkheads. Per MTN 01-99 CH-7, this approach is not authorized.

TONNAGE DATA SHEETS: We've resolved the problem with generating tonnage data sheets, and will be including them in our future responses to vessel file requests. These sheets contain information to help determine whether the certificates or calculations are current (e.g., by matching the tonnages and registered dimensions with those shown in the Coast Guard's MISLE database). In addition, they include vessel details such as keel laid date, vessel service, and former names, that may be of use in other aspects of the certification process. A sample is attached.

MR. AKINS OUT ON TONNAGE EXCHANGE PROGRAM: Mr. Marcus Akins will be out of the office to participate in an MSC Exchange Program with ABS from Monday, September 13th until Friday, September 17th. Please forward any questions on tonnage standards during that time to Mr. Javier Jimenez at 202-475-3364, or e-mail him at javier.jimenez@uscg.mil.

Measurement Organization Weekly Notes - 9/7/2010

CHANGE OF FLAG STATE: The MSC recently responded to a question involving vessels that changed flag of registry but did not leave U.S. waters. These vessels present a unique challenge in determining their ability to retain their certified tonnages while registered under U.S. flag. While it is likely that a vessel that remains in the U.S. for repairs or to conduct voyages to “nowhere” while under foreign flag may retain its certified tonnage, you should contact Mr. Marcus Akins for an official determination.

TEMPORARY QUARTERS FASTENING: Based on recent discussions and queries from class societies, private industry, and industry groups, the following reiteration of temporary quarters is provided: temporary quarters for the purpose of tonnage calculations follow the same rules as temporary deck equipment per NVIC 11-93 CH-3, which is defined as any enclosed space of a semi-permanent nature located on the weather deck of a vessel. Method of fastening of temporary quarters is not a factor in establishing whether or not the quarters are treated as temporary deck equipment under the NVIC.

SLF TONNAGE CG UPDATE: The final draft report was circulated to the participants for comment, with comments due Friday, September 24th. A link to this draft document follows: http://www.uscg.mil/imo/slf/docs/tonnage/Tonnage_CG_Report_Draft_2.pdf. A related link providing updated summary results of the Round 2 questionnaires follows: http://www.uscg.mil/imo/slf/docs/tonnage/Options_Variants_Questionnaire_Results_Summary_Rev_1.pdf. Once the report is issued, the next step is for discussion by the Sub-Committee, which will occur at the SLF meeting in January, 2011.

Measurement Organization Weekly Notes - 9/1/2010

MSC INQUIRIES: In recent months, there has been an upward trend in our receipt of inquiries for tonnage interpretations. We are encouraged by this trend, and wish to reiterate our advice that if you are at all in doubt as to whether an existing policy document covers the matter in question, please give us a call. As always, we endeavor to respond to all requests for formal decisions within 10 business days. If you feel that this customer service standard does not meet your work flow demands, please feel free to call Mr. Marcus Akins at 202-475-3349, or e-mail him at marcus.j.akers@uscg.mil with any suggestions.

SLF TONNAGE CG UPDATE: The comment period for the preliminary draft report has closed. At present, the comments are being incorporated into the final draft report, or otherwise resolved. This version of the report will then be circulated for comment on Friday. IACS continues to be actively engaged in this process.

LABOR DAY CLOSURE: The Marine Safety Center will be closed for the Labor Day holiday, on Monday September 6. This holiday is devoted to the recognition of working people's contribution to society. It was first celebrated in New York City on September 5th, 1882, under the sponsorship of the Knights of Labor, the largest American labor organization of the 19th century. It became a national holiday in 1894.

Measurement Organization Weekly Notes - 8/24/2010

MTN 01-98 REVISION: We are currently in the process of developing a revision to MTN 01-98. In addition to administrative edits, we intend to incorporate a new application for formal measurement. We anticipate circulating the change to MTN 01-98 to the measurement organizations in the coming month for comments prior to its publication. For any comments or suggestions, please contact Mr. Javier Jimenez at (202) 475-3364 or javier.jimenez@uscg.mil.

TONNAGE DATA SHEET: Several months ago we stopped attaching the tonnage data sheets to the tonnage files that were requested by the measurement organizations. The tonnage sheets provided useful information such as vessel former names, registered dimensions and other MISLE data. However, due to some changes in our security system guidelines, the data sheets have not been available for release. We will resume releasing data sheets once this issue is resolved.

2010 TONNAGE PROGRAM REVIEW: The tonnage division will participate in a tonnage program review tentatively scheduled to begin November 30, 2010. We are considering convening the program review at 08:00 on Tuesday morning. In the interest of minimizing disruptions to attendee's work schedules, and recognizing that this is the day prior to the start of the International Workboat Show, we are soliciting for comments/suggestions on potential attendance. Please respond to Mr. Marcus Akins at marcus.j.akers@uscg.mil.

Measurement Organization Weekly Notes - 8/18/2010

DEFINITIONS FOR DIMENSIONS: We frequently encounter official correspondence and other documents that list vessel dimensions without reference to the associated definitions under which those dimensions were established (e.g, a “250X45X20 ft barge”). As there are many definitions on how dimensions should be taken, we would like to remind everyone to be cautious when using such documents in any aspect of the tonnage measurement process. Note that the term “registered length” is uniquely defined under 46 CFR 69, whereas the term “overall length” has a number of different definitions.

FORMAL MEASUREMENT APPLICATION UPDATE: Development continues on the formal measurement application: a draft version is complete and undergoing internal review this week. We hope to have the draft version finalized and distributed to the measurement organizations for comment by mid-September. In its current form, the application is two sided, with instructions on the reverse (much like the Simplified Application). We anticipate making the form available in a .pdf version that can be completed and submitted electronically (e.g, via email).

VESSEL NUMBERING: In May, we reported that the Coast Guard was proposing amendments to its rules related to numbering of undocumented vessels and reporting of casualties. The Coast Guard announced it is reopening the comment period until October 15th: <http://edocket.access.gpo.gov/2010/pdf/2010-20122.pdf>. The National Association of State Boating Law Administrators (NASBLA) and the National Marine Manufacturer’s Association (NMMA) each requested a 90 day extension of the comment period. The NASBLA comment letter noted that the Notice of Proposed Rulemaking would be a topic of discussion during their annual conference, which will be held from September 10–14, 2010.

Measurement Organization Weekly Notes - 8/10/2010

SLF TONNAGE CG UPDATE: Round 3 of the correspondence group's work has commenced, and a preliminary draft report to SLF was circulated to the correspondence group participants last Friday. Comments are due Friday, August 27th.

GRATINGS AND LOUVERS: MSC recently responded to a question involving gratings and louvers that serve as boundaries. Superstructure spaces that are bound by gratings, louvers, expanded metal or similar materials are subject to interpretation for inclusion in tonnage. We encourage admeasurers to contact Mr. Marcus Akins for open or enclosed space determinations when these materials form boundaries for superstructure spaces.

Measurement Organization Weekly Notes - 8/04/2010

MR. JIMENEZ OUT OF THE OFFICE: Mr. Javier Jimenez will be out of the office August 2-6, 2010. Please forward any questions during that time to Mr. Marcus Akins at 202-475-3349, or e-mail him at marcus.j.akers@uscg.mil.

MARPOL ANNEX II: It has been brought to the tonnage division's attention that the minimum frame opening size required by IMO Resolution A.673 and MARPOL Annex II Regulation 11 exceeds the maximum frame opening size allowed for tonnage openings under MTN 01-99 (CH-7) Section 69.109(p)(2)(iii). The offshore supply vessel industry has raised concerns regarding compliance with the Coast Guard's interpretation of IMO Resolution A.673 and interpretations of the standard measurement system. Please contact Mr. Brian Ellis at brian.t.ellis@uscg.mil with any comments or questions regarding this issue.

VESSEL REMEASUREMENT: During remeasurement, oftentimes admeasurers discover configurations that appear to be noncompliant with current interpretations. We encourage admeasurers to call Mr. Marcus Akins at 202-475-3349 to discuss the issue and determine if the configuration complied with interpretations of the tonnage regulations in effect at the time the vessel was measured/remeasured.

Measurement Organization Weekly Notes - 7/27/2010

TONNAGE REGULATIONS AMENDMENTS: The Coast Guard Director of Commercial Regulations and Standards has approved a plan to amend the tonnage regulations in 46 CFR Part 69. While regulation prohibits ex parte communications on proposed amendments to the tonnage regulations, we encourage public comment on all notices published in the Federal Register.

SLF TONNAGE CG UPDATE: The deadline for submittal of Round 2 Questionnaires was last Friday. Eight countries and two non-governmental organizations (including IACS) have completed and submitted questionnaires.

SLF SOLAS WORKING GROUP MEETING: A reminder that a public SLF SOLAS working group meeting will be held at USCG Headquarters in Washington, DC on Wednesday July 28th. The status of the ongoing Tonnage Correspondence Group (CG) work, including the position of the United States on the various Options and Variants, will be discussed at this meeting.

Measurement Organization Weekly Notes - 7/20/2010

SHELTER DECK: The shelter deck of a vessel represents the uppermost deck that would have qualified as the uppermost complete deck had it not been fitted with a middle line opening. A middle line opening must be at least four feet long in the clear and at least as wide as the after cargo hatch on the shelter deck, but not less than one-half the width of the vessel at the midpoint of the length of the opening. This definition comes from 46 CFR 69.103. The opening may have rounded corners not exceeding a nine inch radius. When a greater radius is required by the Coast Guard or a Coast Guard recognized classification society under 46 CFR 42.05-60, notification of that requirement must be submitted to the Commandant (Marine Safety Center).

REQUEST FOR CG TONNAGE RECORDS: A gentle reminder that when vessel owners contact the measurement organization for copies of Coast Guard tonnage records, they shall not be released without prior authorization from the MSC. These records are designated as "Permanent" records and remain the property of the Coast Guard. Parties interested in obtaining information from these records are to be directed to the MSC.

NEW CYPRUS TONNAGE TAX SCHEME: Mondaq, an electronic news source, reported on Monday June 28, 2010 that the new EU Tonnage Tax Law, enacted in April 2010, is retroactively effective from January 1st, 2010. The tax under the new law is determined on the basis of net registered tonnage. For more information see <http://www.mondaq.com/article.asp?articleid=103632>.

Measurement Organization Weekly Notes - 7/13/2010

CAR CARRIERS AND NET TONNAGE: As most of you are probably aware, the TM Convention net tonnage formula includes a freeboard correction aimed at assigning a proportionately lower net tonnage to open shelter deck vessels whose GT ITCs increased substantially over their GRTs. However, until it was recently pointed out by a participant in the SLF Tonnage Correspondence Group, we were unaware that on certain modern PCTCs (Pure Car Truck Carriers), the correction is so large, that NT ITC = 0.3 GT ITC, despite the very large enclosed cargo spaces on these vessel. If you are aware of any similar anomalies resulting from the TM Convention net tonnage formula, we would be most grateful if you could let Mr. Javier Jimenez know, so that we can take this information into consideration in the work of the group.

MR. EARECKSON OUT OF THE OFFICE: Mr. Peter Eareckson is out of the office and will be returning on Monday, July 26th. Please forward any questions during that time to Mr. Marcus Akins at 202-475-3349, or e-mail him at marcus.j.akers@uscg.mil.

FEEDBACK ON REPORTING: We have noticed that some of the tonnage work notification worksheets have been submitted with the unique VIN field left in blank. Measurement organizations are reminded that this field is required to be completed. Also, please note that we have uploaded hundreds of certificates to the MISLE database since the beginning of the year. These documents can now be viewed by all U.S. Coast Guard users throughout the world.

Measurement Organization Weekly Notes - 7/6/2010

FORMAL MEASUREMENT APPLICATION: Work continues on development of the new "Application for Formal Measurement" along the lines discussed at the 2010 Tonnage Conference. We expect to have a draft version developed and distributed to the measurement organizations for comment within the next several weeks. Further development and deployment of this document will be undertaken in consultation with measurement organization representatives, and the public where appropriate.

SLF SOLAS WORKING GROUP MEETING: Last week, a notice was circulated to a large number of stakeholders both within and outside of the Coast Guard on concerning the upcoming SOLAS Working Group meeting on July 28th at USCG Headquarters. The notice included the following statement about the tonnage work: "The Tonnage correspondence group continues to further consider and finalize information on the options presented at SLF 52, while examining improvement of crew accommodation and treatment of deck cargoes. Two variants of these options have been identified: 1) Variant D1 Maritime Real Estate (MRE) tonnage replaced with Deadweight Tonnage (DWT); and 2) Variant D2 (refined MRE tonnage based on block coefficient and vessel type). The U.S. participants provided input on the Round 1 questionnaires developed by the group, and offered general comments on the options and variants. The Round 2 work is scheduled to complete by August 6, 2010, after which time drafting of the final report will commence. Additional information on this item, including results of the Round 1 questionnaires, is available on the Tonnage correspondence group's web site at: <http://www.uscg.mil/imo/slf/tonnagecg.asp>"

LANDING CRAFT: In recent weeks, we have answered questions on the standard measurement system treatment of cargo wells of vessels formerly in service as landing craft. These vessels present unique challenges in that the length, height, and construction of side walls all play a role in how the tonnage is measured. When measuring a landing craft type vessel, we highly recommend you contact the Tonnage Division staff for assistance. Some factors which can affect the tonnage assignment include: a) area of the cargo well as a percentage of the overall deck area, b) height of the wing walls or side coamings above the cargo deck, c) wing wall construction, and d) tonnage length. Note that decking bounding wing wall voids from above could be considered as part of the uppermost complete deck.

Measurement Organization Weekly Notes - 6/29/2010

TONNAGE STAFF VISITS NVDC: The tonnage staff recently conducted a training session on simplified and formal measurement at the NVDC, and also toured the facilities to familiarize with their business processes. The NVDC is currently staffed with approximately 70 civilian personnel that process an enormous amount of documents every year. One important note we would like to share with the measurement organizations is that the NVDC is moving toward acceptance of fax/electronic documents of all kinds. In view of this, we are currently reviewing the MTN 01-98 requirement for mailing to the NVDC certified true copies of tonnage certificates.

SLF TONNAGE CG UPDATE: The group continues with Round 2 work, evaluating variants that are related to full load displacement tonnage and deadweight tonnage. Interestingly, back in the 1960's, the Tonnage Sub-Committee of IMCO (now IMO) gave serious consideration to displacement as a second tonnage parameter (to replace net tonnage). However, after debate at the 1969 Tonnage Conference in London, it was agreed that the old "net tonnage" parameter needed to be retained in some form. Ultimately, displacement was rejected in favor of the current method of computing net tonnage, primarily due to concerns over manipulating the load line, as well as the difficulty in establishing a displacement/net tonnage conversion factor that worked well for existing ships.

TONNAGE CONFERENCE: The Marine Safety Center is considering conducting a program review in conjunction with the 2010 International Workboat Show (December 1-3, 2010). Due to the complicated logistics of conducting this event during the Workboat Show, we are proactively seeking ideas for the program review and the anticipated availability of our classification society admeasurers and their contractors. Please contact Mr. Marcus Akins at marcus.j.akers@uscg.mil with any ideas for the program review or to comment on your potential availability.

MSC CLOSURE FRIDAY/MONDAY: The Marine Safety Center will be closed for the Independence Day holiday, beginning on Friday July 2nd at approximately noon. Normal business hours will resume on Tuesday July 6th. We hope everyone has a happy and safe July 4th weekend!

Measurement Organization Weekly Notes - 6/22/2010

SLF TONNAGE CG UPDATE: Friday, June 18th, was the deadline for comments on input gathered during Round 1. The next step is development of Round 2 questionnaires, which will be circulated by Friday, July 2nd. Also, a public meeting on SLF work in general is being scheduled for Wednesday, July 28th at USCG Headquarters in Washington DC, at which the tonnage issues will be discussed.

MR. BRIAN ELLIS JOINS TONNAGE STAFF: The MSC Tonnage Division welcomes a new staff member to its ranks. Brian graduated from the California Maritime Academy and served in the Coast Guard for 21 years as an active duty officer, including tours as: 1) Environmental Response Officer at a Marine Safety Office; 2) Engineer Officer aboard the Coast Guard Cutter HAMILTON; 3) Executive Officer aboard the Coast Guard Cutter MIDGETT; 4) Senior Port Engineer and Executive Officer at a Naval Engineering Support Unit; and 5) Program Manager at the Office of Naval Engineering. He is a licensed mariner and holds a Master's Degree in Mechanical Engineering from the Naval Postgraduate School.

TONNAGE DIVISION STAFF VISITING NVDC: The Tonnage Division staff will be out of the office on Thursday, June 24th. We will be traveling to the NVDC offices to conduct training on simplified and formal measurement. We apologize for any inconvenience that this may create on that day.

Measurement Organization Weekly Notes - 6/15/2010

TONNAGE DIVISION POC's: Please refer to the attached organizational chart for the appropriate Tonnage Division Points of Contact, which we failed to attach to an earlier Weekly Notes item on this subject. We ask that you contact Mr. Javier Jimenez for day to day questions or concerns regarding the administrative requirements for certification of tonnages and dimensions. For issues concerning interpreting and applying tonnage regulations, please contact Mr. Marcus Akins.

TONNAGE CERTIFICATE COPIES TO NVDC: For vessels that are documented, or are to be documented, the measurement organization must send a copy of the U.S. Tonnage Certificate (or the International Tonnage Certificate, if a U.S. Tonnage Certificate is not issued) to the USCG National Vessel Documentation Center (NVDC). The copy sent to the NVDC must be a valid certified copy. Refer to MTN 01-98 CH-9 for more information.

TONNAGE REGULATIONS INTERPRETATIONS: We recently fielded a question on openings installed in a bow in order to affect the overall length of a vessel per Section MTN 01-99 CH-7, Section 69.203. As with many interpretations, the amount of work necessary to complete a proper analysis on this request was sizeable. As such, we encourage owners, designers, and classification societies to contact us as early as possible with any requests for interpretation of the regulations and/or the tonnage technical policies.

Measurement Organization Weekly Notes - 6/8/2010

SLF TONNAGE CG UPDATE: Round 2 of the intersessional work is underway, with comments on the input gathered in Round 1 due Friday, June 18th. Compilations of the results of the Round 1 questionnaires have been posted, with a color coding system used to reflect relative degrees of consensus: [http://www.uscg.mil/imo/slf/docs/tonnage/Option A Questionnaire Results Summary.pdf](http://www.uscg.mil/imo/slf/docs/tonnage/Option_A_Questionnaire_Results_Summary.pdf) and [http://www.uscg.mil/imo/slf/docs/tonnage/Option B Questionnaire Results Summary.pdf](http://www.uscg.mil/imo/slf/docs/tonnage/Option_B_Questionnaire_Results_Summary.pdf). Two variants of Options A,B,C,D were proposed in Round 1 and are being evaluated: 1)MRE replaced with deadweight tonnage, and 2) MRE based on block coefficient and vessel type.

THE “E” WORD: At this year’s Conference, we had some discussion of the meaning of the term “erection” as used in the 1969 TM Convention. Although research on this matter is not complete, it appears that the Convention term comes from the 1913 Panama rules, and that the term was little used (or not used at all) in tonnage rules prior to 1913. A 1924 nautical dictionary defines “Deck-Erection; Superstructure” as “any construction on a vessel’s upper deck, such as a poop, forecastle, bridge-house, deck-house, etc.” Notwithstanding its origin, the term is causing problems with our modern day spam filters, which are aimed at stopping unwanted/offensive email. So do be careful with the “E” word in electronic transmissions (especially if you use it multiple times).

ALTERATION DATES: MSC recently responded to a request as to what date should be listed as the keel laid date on the International Convention Certificate for a modified vessel resulting in a calculated change in excess of 5% to the vessel’s regulatory gross tonnage. At the time of the modifications, the Coast Guard had not promulgated a specific criterion on the magnitude of a change in regulatory or convention gross tonnage that would cause a vessel to be considered substantially altered. In this case, we applied the 5% criterion subsequently promulgated in the NVIC and determined that table 7 of the NVIC applied, specified a date of substantial alteration date for both the U.S. and International Tonnage Certificates and required a remark on the reverse of the certificate referring to our letter.

Weekly Notes are issued by the Coast Guard Marine Safety Center’s Tonnage Division (MSC-4) for use by organizations that perform measurement work on the Coast Guard’s behalf. They are for informational purposes only, and are not intended as, nor should they be construed to represent, revisions of or substitutes for applicable statutes or regulations or established interpretations of either.

Measurement Organization Weekly Notes - 6/1/2010

TONNAGE DIVISION ORGANIZATION: As discussed at the recent Tonnage Conference, the MSC is in the process of updating its web site to reflect changes to Tonnage Division responsibilities resulting from the ongoing staff expansion. Until this work is complete, please refer to the attached organizational chart for the appropriate Tonnage Division Points of Contact.

ALTERNATE TONNAGE AND OSVs: We did not have a chance to cover it at the Conference, but please note that a vessel regulated under alternate tonnages may NOT have regulatory (GRT/NRT) tonnages assigned. As a consequence, under no circumstances may a vessel regulated under offshore supply vessel inspection standards (Subchapter L of Title 46 CFR) be assigned a regulatory tonnage of 500 GRT or above. As addressed in MTN 01-98 CH-9, please ensure that when issuing a U.S. Tonnage Certificate with vessel type "Offshore Supply Vessel", a GRT tonnage of 500 GRT or above is NOT assigned.

STANDARD NUMBERING SYSTEM: The Coast Guard proposes to amend its rules related to numbering of undocumented vessels and reporting of casualties. These changes would align and modernize terminology used in the Standard Numbering System (SNS), the Vessel Identification System (VIS), and casualty reporting; require validation of vessel hull identification numbers; require SNS vessel owners to provide personally identifiable information; and provide administrative flexibility for States. For more information on this proposal, see 75 Fed. Reg. 25137 (<http://edocket.access.gpo.gov/2010/pdf/2010-10723.pdf>).

Measurement Organization Weekly Notes - 5/18/2010

MR. JIMENEZ OUT OF THE OFFICE: Mr. Javier Jimenez will be out of the office starting Thursday, May 20th and returning on Monday, June 7th. Please forward any questions during that time to Mr. Marcus Akins at 202-475-3349, or e-mail him at marcus.j.akers@uscg.mil.

2010 TONNAGE CONFERENCE: We would like to thank all who attended the 2010 Tonnage Conference and made it a success. Thanks to your participation we had a total of 21 attendees to the conference. For those who wish to obtain an electronic copy of the sessions, please contact Mr. Marcus Akins at marcus.j.akers@uscg.mil with your mailing address.

LINE OF THE UPPERMOST COMPLETE DECK: During the 2010 Tonnage Conference, the issue of determining the line of the uppermost complete deck (UCD) on a sheer deck was discussed. The Marine Safety Center is considering issuing a formal interpretation on how the line of the UCD in the presence of a sheer deck is identified. We anticipate incorporating this interpretation into the next revision of MTN 01-99.

Measurement Organization Weekly Notes - 5/11/2010

WEEKLY NOTES FOREGONE DUE TO THE TONNAGE CONFERENCE

Weekly Notes are issued by the Coast Guard Marine Safety Center's Tonnage Division (MSC-4) for use by organizations that perform measurement work on the Coast Guard's behalf. They are for informational purposes only, and are not intended as, nor should they be construed to represent, revisions of or substitutes for applicable statutes or regulations or established interpretations of either.

Measurement Organization Weekly Notes - 5/4/2010

2010 TONNAGE CONFERENCE: The Annual Tonnage Conference will begin promptly at 8:00 AM Tuesday, May 11. CG transportation to and from the Channel Inn to the Conference will be provided for your convenience. Please remember to bring a copy of NVIC 11-93 CH-3, MTN 01-99 CH-7, and MTN 01-98 CH-9 to the Conference in order to facilitate Conference discussion. We look forward to your attendance and ask that you please contact Mr. Marcus Akins at marcus.j.akers@uscg.mil or 202-475-3349 with any logistics issues that may arise.

TONNAGE SURVEY PROCESS: At the Conference, we will be devoting several sessions to discussions and workshops on the onboard survey process, primarily for convention measurement. Items to be covered include verifying hull and superstructure dimensions, the presence and location of all topside spaces, cargo space markings, opening characteristics for excluded spaces, etc. This is part of the ongoing initiative to improve processes related to applications for formal measurement, including how drawings are verified.

EXCLUDED SPACES ON ITC: As many of you know, the "Excluded Spaces" block on the reverse side of the ITC is very limited to the amount of information that can be listed. Please be advised while there are not prohibitions against using addenda or similar attachments for ITC's, including a reference to the attachment on the ITC is not authorized for U.S. flag vessels. The MTN provides for listing a brief description of each space in the excluded space block, as illustrated in the sample ITC found in Appendix A of MTN 01-98 CH-9. In the case that the space in the block may not be sufficient, measurement organizations must contact the MSC for further instructions.

Measurement Organization Weekly Notes - 4/27/2010

OFFSHORE WORKERS ON OSVs: Under the definitions of the TM Convention, a passenger is “every person other than: (a) the master and the members of the crew or other persons employed or engaged in any capacity on board a ship on the business of that ship; and (b) a child under one year of age.” Accordingly, offshore workers transported by “supply boats” or “crew boats” are passengers, and must be accounted for when calculating net tonnage and on the reverse side of the tonnage certificate(s) of a vessel under the convention measurement system.

DATA CALL ON INTERNAL PROCEDURES: If you have not submitted to the MSC copies of your internal procedures on tonnage measurement applications, drawing requirements, incomplete submittals and on-board survey verifications, please do so right away. This information is needed ASAP as we move forward with development of comprehensive requirements on this subject. We will be covering the survey process in workshops at the Tonnage Conference.

2010 TONNAGE CONFERENCE: The Annual Tonnage Conference is two weeks away. As promised via email last week, we have enclosed the final agenda. Additional ideas for discussion, novel craft presentations, or questions pertinent to the agenda items are certainly welcome. We look forward to your attendance and ask that you please contact Mr. Marcus Akins at marcus.j.akers@uscg.mil or 202-475-3349 with any logistics issues that may arise.

Measurement Organization Weekly Notes - 4/20/2010

2010 TONNAGE CONFERENCE: The Tonnage Conference is just two weeks away. Last week, we mentioned that consideration was given to relocating the tonnage conference to an alternative site. Please note that the 2010 Tonnage Conference will remain where it has been at Coast Guard Headquarters (Jemal building). Additionally, we are planning to view the IMAX film HUBBLE 3D (4:20 showtime) as part of our tonnage outing Wednesday, May 12th. Advance tickets will be available for purchase on or after April 28, 2010 at <http://www.nasm.si.edu/visit/theaters/>.

TONNAGE CONVERSIONS: We recently responded to an inquiry on converting tonnage calculations from one measurement system to another. Please note that a conversion between GT ITC and GRT does not exist. Application of any tonnage-based requirements of U.S. laws (e.g., sea service credit for mariners) must be based on tonnages reflected on an appropriate tonnage certificate or, for eligible vessels, as established under simplified measurement.

SLF TONNAGE CG UPDATE: The questionnaires have been circulated to all Tonnage Correspondence Group participants last Friday, and are due on May 14th. The questionnaires were developed with input from a number of the participants. They are intended to gather information for further development of the two leading options: Option A (Improve the Integrity and Uniform Application of the Existing Gross and Net Tonnage Parameters) and Option B (Promote Use of Existing Net Tonnage for Tonnage-Based Fees).

Measurement Organization Weekly Notes - 4/13/2010

DATA CALL ON INTERNAL PROCEDURES: A reminder that this Friday is the deadline from providing copies of your internal procedures on tonnage measurement applications, drawing requirements, incomplete submittals and on-board survey verifications (or a statement certifying that you have no such procedures). Please contact Mr. Javier Jimenez at 202 475-3364 or javier.jimenez@uscg.mil. Our thanks to those who have already submitted this information.

MARKING OF TONNAGE: We recently became aware of some confusion regarding marking requirements for net tonnage. Prior to 1982, federal regulations required marking of a vessel's net tonnage on "the main beam at the expense of the owner or master, in Arabic numerals of the block type at least 3 inches in height". This requirement was deleted in a 1982 rulemaking that updated and simplified regulations relating to documentation, although a similar requirement for making a vessel's official number was retained (see 46 CFR 67.121). Hence, there is currently no requirement under U.S. law for marking the net (or gross) tonnage on a U.S. flag vessel.

TONNAGE CONFERENCE SITE: Due to increasing security requirements, we are attempting to relocate the site of the Conference from the Jemal Building (where previously held) to a commercial location nearby that is more convenient to the Channel Inn and public transportation. We'll advise you as soon as we know of any developments on this score.

Measurement Organization Weekly Notes - 4/7/2010

NVIC 11-93 CH-3: The period has ended for submitting comments to the Federal Register on proposed revisions to NVIC 11-93 CH-3 [Docket No. USCG-2010-0025]. Although the official comment period has ended, the Marine Safety Center will temporarily continue to accept informal feedback. Should you wish to submit comments on the proposed revisions to the NVIC, please contact Mr. Marcus Akins at 202-475-3349 or marcus.j.akins@uscg.mil.

TONNAGE REGULATIONS: The Marine Safety Center is considering revision to 46 CFR Part 69 for the purpose of updating it, and improving its usefulness to our customers in both the public and private sectors. We are currently formulating proposed revisions and request that any comments or suggestions be sent to Mr. Marcus Akins 202-475-3349 at marcus.j.akins@uscg.mil.

SLF TONNAGE CG UPDATE: The Tonnage Correspondence Group has completed the development phase of the Round 1 work. This includes identifying areas of the TM Convention requiring interpretation or that otherwise need improvement. Not surprisingly, treatment of semi-open spaces (e.g., uncovered spaces) and complex geometries (e.g., modern yacht superstructures) were among those areas highlighted. In addition, one participant advocated the use of deadweight tonnage for assessing fees.

Measurement Organization Weekly Notes - 3/30/2010

REFERENCES TO MTNs AND NVICs: You may have noted that in recent correspondence and other official documents, we are including reference to the specific change of an MTN or NVIC (or specified language along the lines of “as revised”, “most recent version” etc.) It was brought to our attention that MTNs and NVICs are technically not manuals, and therefore the complete and legally correct reference to the current revision should include the change number, or similar language. As before, if a change is not mentioned, we will continue to assume the current version of the document is being referred to, unless there is a statement to the contrary.

FRAME OPENINGS IN FUEL TANKS: We recently responded to an inquiry on treatment of oversized ordinary frame openings in fuel tanks under standard measurement. MTN 01-99 CH-7 provides equivalent area requirements for 15 X 23 inch fuel tank openings, without restriction to their maximum linear dimensions, or their orientation. If you have any questions on the MTN criteria, please contact Mr. Peter Eareckson.

CARGO SPACES: As we noted in January, under the IACS interpretations, a tank is not considered to be a dedicated seawater ballast tank if it is a space “included in Net Tonnage” under the 1969 Tonnage Convention. Therefore, such a tank would be exempt from the application and requirement of the IMO PSPC. Pending implementation of the new application/survey process that is currently being developed, vessel owners are encouraged to communicate the intended use of a ballast tank before the measurement process takes place. Such tanks are required to be labeled as “CC”, and certified on reverse side the International Tonnage Certificate (1969) as being included in net tonnage (Vc). Dual use spaces which are treated as cargo spaces for convention measurement must be identified as included in tonnage on the International Tonnage Certificate.

Measurement Organization Weekly Notes - 3/23/2010

APPLICATIONS AND SURVEYS: As first reported in November of last year, we are working to improve processes related to applications for formal measurement and associated drawing submittals, as well as onboard survey requirements. Shortly, we will provide the results of our preliminary assessment, and ask for input from measurement organizations. We have scheduled two sessions at the Tonnage Conference devoted to this subject.

IMPROVING TM CONVENTION: IACS has advised its Statutory Panel to provide input on issues where clarification/interpretation of the TM Convention is required. If you have any issues you would like addressed through IACS, please contact your classification society's representative on this panel. Deadlines are reasonably tight: IACS comments to the SLF Tonnage Correspondence group are due on Friday, April 2nd.

CONFERENCE ATTENDANCE: We would like to thank all who have sent in a RSVP for this year's tonnage conference. To date, we anticipate approximately seventeen (17) attendees. We are currently reviewing the feedback and suggestions that we've received on the conference agenda. Please note that we are still open to receiving more comments and suggestions. Lastly, if you plan to stay at the Channel Inn, please remember to reserve your room under "Coast Guard Tonnage" prior to April 10, 2010.

Measurement Organization Weekly Notes - 3/17/2010

FEEDBACK ON REPORTING: The revised process for reporting tonnage measurement work has been working smoothly since it was implemented at the beginning of the year. We have uploaded over a hundred certificates to the MISLE database. These documents can now be viewed by all U.S. Coast Guard users throughout the world. We would like to thank all the measurement organizations for the work in making this possible.

OCMI Information: Those seeking to contact a Coast Guard Officer in Charge, Marine Inspection (OCMI) should visit the USCG Homeport Main Page at <http://homeport.uscg.mil/mycg/portal/ep/home.do>. Under New CG Sector Commands, select Sector Map. Under Sector Map you will find a map of all OCMI zones of responsibility. If you scroll over the Sector name tab, a contact number will appear. Click on the Sector name tab for further information on the Sector. You may wish to contact an OCMI with questions on vessels that are subject to inspection or when a tonnage determination may affect a vessel's operating status.

SLF TONNAGE CG UPDATE: Last Friday, the Round 1 work commenced with issuance of the Action Plan. The correspondence group has started to identify areas where the TM Convention (or TM.5/Circ.5) is unclear and/or needs interpretation/revision to ensure the integrity and uniform implementation of the existing gross and net tonnage parameters. Questionnaires are under development (see the following link for a draft sample:

http://www.uscg.mil/imo/slf/docs/tonnage/Option_A_Questionnaire_Sample_Draft.pdf.)

Now is your chance to identify such issues. You may provide input via IACS, or you may bring individual issues to our attention by contacting Mr. Peter Eareckson.

Measurement Organization Weekly Notes - 3/9/2010

NVIC 11-93 CH-3: Last Friday, the Coast Guard published a Federal Register notice seeking public comment on a revision to the NVIC, which is under consideration. A link to this notice follows: [76FR10299](#). Mr. Marcus Akins has the lead on this project. We will devote one session to the NVIC at the upcoming Tonnage Conference.

CONFERENCE WORKSHOPS: For the Convention workshops, we intend to cover some of the situations being looked at by the SLF Tonnage CG. Per the Draft Tonnage CG schedule, questionnaires addressing areas where the Convention has yielded various interpretations among different flag States will have been developed and distributed by 16 April 2010.

SLF TONNAGE CG UPDATE: The comment period on the draft Action Plan closed last Friday. The plan is being finalized, and we anticipate it will be published next Friday. Development and expansion of the Tonnage CG website continues, with many older meeting documents uploaded (e.g., <http://wwwstage.uscg.mil/imo/slf/subcomdocs.asp>)

Measurement Organization Weekly Notes - 3/2/2010

DISCLAIMER LANGUAGE: Newer memoranda of agreement between the USCG and authorized measurement organizations include liability language on loss or damages due to a negligent act or omission on the part of the measurement organization. As part of our initiative to improve measurement application forms, we are examining the subject of liability disclaimers. In the interim, please contact the Marine Safety Center for further information if you are contemplating changes to processes or procedures that involve liability disclaimers.

TRANSLATION ISSUES: Through the SLF Tonnage Correspondence Group (CG), we intend to address differences in translations of TM.5/Circ.5 and the 1969 TM Convention itself. Examples include: (1) whether or not mobile crane spaces are included in V, (2) whether or not an uncovered space in the hull below a deck opening is eligible for exclusion, and (3) what is meant by the term "stores". You may have had other experiences with, or examples of, difficulties arising from translation differences. If so, we would be grateful if you would share them with us by contacting Mr. Marcus Akins at marcus.j.akers@uscg.mil or 202-475-3349. Interestingly, per Article 22 of the TM Convention, both the English and French versions of the Convention are "equally authentic".

COMMENTS ON TONNAGE CG ACTION PLAN: Speaking of the SLF Tonnage CG, comments on the proposed action plan are due by COB this Friday (March 5th). IACS is represented on the Correspondence Group, and you are welcome to provide input through your IACS rep. The draft action plan is available on the Tonnage CG website: <http://www.uscg.mil/imo/slf/tonnagecg.asp>.

Measurement Organization Weekly Notes - 2/23/2010

USCG FIELD OFFICE INQUIRIES Occasionally, we receive word that a Coast Guard field unit, in seeking information from a vessel tonnage file, has contacted a measurement organization directly, without our prior knowledge. Unless the information request is part of an official Coast Guard investigation, we would ask that you - politely – respond by referring such requests to the Tonnage Division staff. We'll do our best to help out our own customers within the Coast Guard, and avoid any unnecessary burden on the measurement organizations.

CG NUMBER REQUEST: We wish to highlight the importance of submitting a complete tonnage application when requesting a CG number for any particular vessel. This helps us perform a thorough search in the MISLE database and avoid vessel duplications. While we continue to work on the development of a new tonnage application, keep in mind that information such as Builder, Hull Number, HIN, and current and previous vessel names are among the most important details we use in our search.

VESSEL REMEASUREMENT: During the initial vessel measurement process, we encourage measurement organizations to inform owners of requirements for reporting changes that may affect tonnage. These requirements are found in 46 CFR 69.19.

Measurement Organization Weekly Notes - 02/16/2010

SNOW CLOSINGS: We apologize for any inconvenience that the MSC may have caused last week due to the unexpected closings. As some of you may know, the DC area was targeted by two major snow storms which disrupted all federal government services for the entire week in the VA, MD, and DC area. The first storm was of historical proportions, with a record snowfall of up to 23 inches which prompted most news sources to call it "Snowmagedon".

2010 TONNAGE CONFERENCE: The Annual Tonnage Conference is rapidly approaching. We have enclosed the draft agenda and welcome any questions or comments. Please contact Mr. Marcus Akins at marcus.j.akers@uscg.mil or 202-475-3349 with any comments, suggestions, or to RSVP for the conference

IMO TONNAGE DEVELOPMENTS: A draft plan and schedule has been issued for the Tonnage Correspondence Group (CG) established at SLF 52, showing three rounds for further development of options, with the final report to be submitted to SLF 53 on October 1, 2010. A website for the Tonnage CG is being set up, and may be found at: <http://www.uscg.mil/imo/slf/tonnagecg.asp>.

Measurement Organization Weekly Notes - 02/01/2010

ONBOARD SURVEYS AND REMEASUREMENT: Regarding the item on remeasurement appearing in our last Weekly Notes edition, we received several questions along the lines of: “what should be done if a surveyor notices a clear nonconformity on a portion of the vessel not being remeasured?” The Coast Guard intends to address this matter as part of the ongoing review of survey requirements. In the meantime, one possible approach is for the measurement organization to notify the owner in writing of the nonconformity, and provide a copy of that written notification to the MSC.

SLF 52 MEETING IN LONDON: At its meeting in London last week, the SLF Subcommittee agreed to re-establish the Tonnage correspondence group under the coordination of the United States. The correspondence group was tasked to further consider and finalize options to improve the effect of the 1969 TM Convention on ship design and safety, examining improvement of crew accommodation and tonnage measurement of ships carrying deck cargos. Representatives from 18 countries and 4 non-governmental organizations participated in the discussions on Tonnage at SLF.

TONNAGE OPENINGS: We recently fielded a question on openings installed in end bulkheads per Sections 69.117(d)(2) of Marine Safety Center Technical Note (MTN) 01-99, Tonnage Technical Policy. Prior to 1989, the tonnage regulations (Title 46, Code of Federal Regulations, Part 69) included a requirement that such an opening be located as near as is practicable to the centerline of the space. Please note that there are currently no restrictions on the transverse location of a qualifying single end opening.

Measurement Organization Weekly Notes - 01/26/2010

ONBOARD SURVEYS AND REMEASUREMENT: Under the tonnage statute, a vessel is remeasured only “to the extent necessary” following alterations, changes of a use of a space, or allegation of error. During a recent oversight, we ascertained that when surveying an existing unaltered vessel assignment for the purpose of assigning convention tonnage, a measurement organization verified certain tonnage reduction features (under standard measurement), but not others. This practice could lead to an incorrect perception on the part of an owner that a full recertification of regulatory tonnage is being done when – in fact – it is not. We intend to address this matter in a comprehensive fashion as we work toward improving the measurement application form and better addressing survey requirements. Until that time, measurement organizations should refrain from “remeasuring” unaffected portions of a vessel as part of a formal tonnage survey process, without further direction from the Marine Safety Center Tonnage Division.

REVISED REPORTING PROCESS: The revised process for reporting tonnage measurement work has been working smoothly. We have been receiving the tonnage certificates, and for the first time, are being uploaded to our MISLE database. These documented and undocumented vessel certificates will now be available to all U.S. Coast Guard users throughout the world.

SLF 52 MEETING IN LONDON: The SLF meeting is taking place in London this week. One of the many agenda items being discussed will be on developing options to improve the effects on ship design and safety of the TM Convention. Mr. Eareckson is representing the United States on the drafting group addressing this subject. In preparations for the meeting, the option for developing updated consolidated interpretations to the Convention (e.g., amending TM.5/Circ.5) has continued to receive the most support, both domestically and internationally.

Measurement Organization Weekly Notes - 01/19/2010

CG NUMBER REQUEST: When tonnage measurement applications are submitted to the MSC for the purpose of requesting a CG number to be assigned for the subject vessel, we may instead provide you with one of the other two Unique Vessel ID (e.g., ON or IMO) if it already exist in our database. However, a CG number can still be assigned at the owner's request.

2010 TONNAGE CONFERENCE: This is a reminder that the Annual Tonnage Conference scheduled for the week of May 10th at the Coast Guard Marine Safety Center. The conference will convene at 08:00 on Tuesday morning, concluding Thursday afternoon. We welcome any suggestions on topics for discussion. We also encourage classification society tonnage representatives to participate in presenting tonnage topics this year. Please contact Mr. Marcus Akins at marcus.j.akers@uscg.mil with any comments, suggestions, or if you would like to present during the conference.

Weekly Notes are issued by the Coast Guard Marine Safety Center's Tonnage Division (MSC-4) for use by organizations that perform measurement work on the Coast Guard's behalf. They are for informational purposes only, and are not intended as, nor should they be construed to represent, revisions of or substitutes for applicable statutes or regulations or established interpretations of either.

Measurement Organization Weekly Notes - 01/12/2010

SOLAS CHAPTER IX AND THE ISM CODE: Per MSC.1/Circ. 1231, cargo vessels and special purposes ships engaged on international voyages that are 500 GT ITC and over and, and which have not conformed with the requirements of SOLAS chapter IX and the ISM Code by virtue of their GRT tonnage, must comply with those requirements no later than January 1, 2010. In the past, a number of vessels were not required by their flag States to comply with these requirements, on the grounds that the provisions of resolution A.494(XII), Revised Interim Scheme for Tonnage Measurement for Certain Ships, applied to the 500 gross tonnage breakpoint for the ISM Code.

CARGO SECURING METHODS: On January 8, 2010, the Coast Guard released a federal notice seeking public comment on methods of securing cargo in order to determine if a standardized approval or certification process or improved performance criteria for flexible strapping securing systems is needed. The broader issue is one that has some relevance to tonnage measurement, as "means for securing cargo and stores" has been the subject of much debate over the years in the context of excluded spaces. Comments on Docket No. USCG-2009-1079 may be made at <http://www.regulations.gov> on or before March 9, 2010.

SLF PREP MEETING: At the public SLF prep meeting at USCG Headquarters last week, there was some discussion of a proposal from India to exempt from gross tonnage (GT ITC) accommodation spaces that are designated for trainees/cadets. India has cited an acute world-wide shortage of qualified mariners, and is pushing to increase incentives on the part of ship owners to ensure adequate trainee accommodations. Please feel free to share any thoughts on this subject with us prior to the SLF meeting from January 25-29, 2010. The POC is Peter Eareckson (202) 475-3395.

Measurement Organization Weekly Notes - 01/08/2010

REVISED REPORTING PROCESS: We have implemented the revised process for reporting tonnage measurement work that is completed on behalf of the Coast Guard. Under this revised process: 1) unique VIN's (i.e., Official Number, IMO Number or CG Number) must be reported on the Excel notification worksheets along with the other information previously required; AND 2) electronic copies of the issued tonnage certificates must be attached to the associated reporting emails. Please contact Mr. Javier Jimenez if you have any questions on the revised reporting process.

DUAL-USE BALLAST TANKS: Last month, we noted that under the IACS interpretations, a tank is not considered to be a dedicated seawater ballast tank if it is a space "included in Net Tonnage" under the 1969 Tonnage Convention. To ensure that a dual-use ballast tank is properly documented and included in the tonnage measurement, vessel owners are encouraged to communicate the intended use of a ballast tank prior to the measurement process. Such tanks are required to be labeled as "CC", and certified on reverse side the International Tonnage Certificate (1969) as being included in net tonnage (Vc). We are addressing this matter in our ongoing project to revise the measurement application.

FOREIGN REBUILD DETERMINATIONS: We sometimes receive inquiries concerning the relationship between foreign rebuild criteria for vessel documentation purposes and substantial alteration criteria for tonnage measurement purposes. Please be aware that there is no direct linkage between the two: a vessel may have been deemed by the NVDC to have been "rebuilt" foreign, and yet from a tonnage perspective, the vessel may not have undergone changes of sufficient magnitude to cause the vessel to be "substantially altered" under the criteria of NVIC 11-93. The NVDC has started posting rebuild determinations on their web site if you care to see an example of such a determination.

Measurement Organization Weekly Notes - 12/28/2009

MTN 01-98 SAMPLE TONNAGE CERTIFICATES: Recently, we found missing information in the tonnage certificate samples under Appendix A. Per section 2.3 (b)(2) and section 3.3 (b)(2) of the MTN, the measurement organization must specify the unique vessel ID number along with the prefix (e.g., ON, IMO, CG) under the Vessel's Number (or Distinctive Number or Letters) block. However, this prefix specification is not reflected in either of the samples illustrated in the Appendix. We would like to remind the measurement organizations that a prefix **MUST** be specified along with the unique vessel ID number. We intend to correct this omission in the next change to the MTN.

SOLAS WORKING GROUP MEETING: This is general reminder that there will be a SOLAS Working Group meeting at USCG Headquarters on January 7, 2010. This meeting is to prepare for the SLF 52 gathering in London at the end of January. Included on the agenda is the item on tonnage measurement that will be discussed at SLF 52. The SOLAS Working Group meeting is open to the public.

POLICY DISCLAIMER LANGUAGE: The latest version of COMDTINST M16703-1 requires newly issued policy/guidance documents such as NVIC's, MTN's and Tonnage Guides to include a standard disclaimer statement, indicating that the guidance "is not intended to nor does it impose legally-binding requirements on any party". When tonnage policy/guidance documents are developed or updated, they will bear this disclaimer language. Please note that the disclaimer does not excuse measurement organizations from compliance with existing requirements to adhere to the Coast Guard interpretations that are reflected within the associated documents.

NEW YEAR HOLIDAY CLOSURE: The Marine Safety Center will close on Thursday, December 31st at noon for the New Year holiday. Normal business hours will resume on Monday January 4th.

Measurement Organization Weekly Notes - 12/22/2009

TONNAGE MEASUREMENT RECORDS: Measurement organizations are reminded that to obtain copies of MSC tonnage measurement records, they must submit a written request referencing the section per MTN 01-98 CH-9. An email submittal to msc@uscg.mil is all that is needed: the "Request Forms" formerly used to obtain the copies have been superseded. A sample request in e-mail format is included in Appendix A of the MTN.

CHINA TONNAGE PAPER: China submitted a paper for SLF 52, expressing support for the option to ensure the integrity and uniform implementation of the existing gross and net tonnage parameters (now referred to as Option A). Under China's tonnage rules that apply to inland waterways, container volume is included in gross tonnage. China observed that inclusion of container volume does not correlate with improvements in ship safety levels.

HOLIDAY CLOSINGS: The Marine Safety Center will be closed for both, the Christmas day (December 25th) and New Year holiday (January 1st). Normal business hours will resume on both following Mondays, December 28th and January 4th. We wish everyone Happy Holidays!

EDITOR'S NOTE: We are resuming publication of the weekly notes with this addition after not being able to distribute them last week. We apologize for the interruption of this service.

Weekly Notes are issued by the Coast Guard Marine Safety Center's Tonnage Division (MSC-4) for use by organizations that perform measurement work on the Coast Guard's behalf. They are for informational purposes only, and are not intended as, nor should they be construed to represent, revisions of or substitutes for applicable statutes or regulations or established interpretations of either.

Measurement Organization Weekly Notes - 12/8/2009

DEDICATED BALLAST TANKS: We recently fielded questions on an IACS interpretation (SC227) regarding ballast tank coating requirements under SOLAS. Under the IACS interpretations, a tank is not considered to be a dedicated seawater ballast tank if it is a space "included in Net Tonnage" under the 1969 Tonnage Convention. The questions on tank coating standards in this case are only peripherally related to tonnage measurement. However, the issue highlights the importance of ensuring that multi-use "ballast tanks" which carry cargos other than water ballast are certified as cargo spaces and included in Vc.

TEMPLATE FOR ACS PLAN REVIEW OVERSIGHT: As reported last week, we are moving forward with developing changes to the reporting process for tonnage measurement work. In addition to changes to the reporting template, we are considering a requirement to attach ".pdf" copies of the issued tonnage certificates to the emails forwarding completed templates to the MSC, so that the MSC can upload the certificates into the MISLE database. We will formally solicit input from measurement organizations before implementing any changes.

MR. JIMENEZ OUT ON TONNAGE EXCHANGE PROGRAM: Mr. Javier Jimenez will be out of the office to participate in an MSC Exchange Program with ABS from Monday, December 7th until Friday, December 11th. Please forward any questions during that time to Mr. Marcus Akins at 202-475-3349, or e-mail him at marcus.j.akers@uscg.mil.

Measurement Organization Weekly Notes - 12/2/2009

SOLAS WORKING GROUP: As mentioned in the SOLAS Working Group email, which you hopefully received last week, there will be a meeting at USCG Headquarters on January 7, 2010 to prepare for the SLF 52 meeting in London at the end of January. Included on the agenda is the item on tonnage measurement that will be discussed at SLF 52. Within the Correspondence Group, the U.S. has favored the option to improve the integrity and consistency of the existing gross and net tonnage parameters, and has opposed the Maritime Real Estate parameter. The SOLAS Working Group meeting is open to the public.

TEMPLATE FOR ACS PLAN REVIEW OVERSIGHT UPDATE: We are assessing and have tested a draft revised template of the Notification for ACS Plan Review Oversight that measurement organizations regularly submit to the MSC Assessment e-mail address (Assessment-msc@uscg.mil). The draft template has two new fields: "Unique Vessel ID Number Type" and "Unique Vessel ID Number". The "Unique Vessel ID Number Type" is for entry of one of the three current ID number types (e.g., ON, IMO or CG). The "Unique Vessel ID Number" is for entry of the ID number that corresponds to the "Unique Vessel ID Number Type". The MSC will seek input from measurement organizations before implementing any changes to the template.

FINNISH TONNAGE TAX REFORM TO THE PARLIAMENT: Mondaq, an electronic news resource, reports that the Finnish government issued a bill proposing amendments to the Finnish tonnage tax regime. The new tonnage tax regime offers tax incentives to Finnish ship owners and encourages ship owners to new investments and to bring ships under the Finnish flag. The tax under the tonnage tax system is determined on the basis of net registered tonnage. The most significant amendments relate to the dividend distribution provisions of the tonnage tax regime, relieved flag requirements, increased flexibility of ship owners' activities, alleviated tax debt provisions and relieved sanction mechanism. For more information, see <http://www.mondaq.com/article.asp?articleid=89986>.

Weekly Notes are issued by the Coast Guard Marine Safety Center's Tonnage Division (MSC-4) for use by organizations that perform measurement work on the Coast Guard's behalf. They are for informational purposes only, and are not intended as, nor should they be construed to represent, revisions of or substitutes for applicable statutes or regulations or established interpretations of either.

Measurement Organization Weekly Notes - 11/23/2009

NVIC 11-93 UPDATE: The MSC has begun a project to revise NVIC 11-93 Ch. 3 "Applicability of Tonnage Measurement Systems to U.S. Flag Vessels". The goal of this project is to ensure that the NVIC continues to provide clear and concise applicability guidance as vessels become subject to new regulations and statutes. We welcome any input from measurement organizations as we move forward with this project. Please forward all thoughts or comments to Mr. Marcus Akins at 202-475-3349, or e-mail him at marcus.j.akers@uscg.mil.

ONBOARD SURVEYS AND EXCLUDED SPACES: Measurement organizations are reminded that surveyors must verify that excluded spaces meet requirements of Section 69.61(g) of MTN 01-99 (e.g., spaces are not fitted with shelves or other means designed for securing cargo or stores, openings are not fitted with means of closure, etc.) The MSC is currently reviewing survey requirements, with the view toward developing guidance to assistant measurement organizations with internal processes related to onboard surveys.

THANKSGIVING DAY CLOSURE: The Marine Safety Center will be closed for the Thanksgiving Day holiday, on Thursday November 26. Normal business hours will resume on Friday November 27.

Measurement Organization Weekly Notes - 11/16/2009

MR. AKINS JOINS TONNAGE STAFF: The MSC Tonnage Division has recently added a new staff member to its ranks. Marcus hails from Savannah, Georgia and served in the Coast Guard for 10 years as an active duty officer, including tours as: 1) Project Engineer at the CG Maintenance and Logistics Center, Norfolk; 2) Assistant Chief of Inspections, Sector St. Petersburg; and 3) Program Manager for vessel security policy in CG-5432.

2010 TONNAGE CONFERENCE: The Annual Tonnage Conference is tentatively scheduled for the week of May 10th at the Coast Guard Marine Safety Center. This time, we are considering convening the conference at 08:00 on Monday morning and concluding Wednesday afternoon, in the interest of minimizing disruptions to attendee's work schedules, but we are open to your comments/suggestions on this score. We also welcome any suggestions on topics for discussion. Similar to last year's conference, we will secure a block of rooms at the Channel Inn for conference attendees. Please send all requests and/or suggestions to Mr. Marcus Akins at marcus.j.akins@uscg.mil.

IMO TONNAGE CG FINAL REPORT: Last week, IMO posted the Final Report of the SLF Tonnage Correspondence Group on its "Documents" web site. The report recommends four options for further development: Option A - Ensure Integrity of Existing Parameters; Option B - Promote Net Tonnage; Option C - Establish Net Tonnage Parameter That Includes Deck Cargo; Option D - Establish Maritime Real Estate Parameter. The report also recommends convening a Working Group at SLF 52 to further develop these options. A copy of the report is attached.

CONGRESSIONAL ACTION NEED NOT BE RATIONAL: Last week Bryant's Maritime blog (<http://brymar-consulting.com/>) posted an interesting comment that was part of the US Court of Appeals for the Ninth Circuit's decision on a dispute regarding the constitutionality of a federal statute. Though this case has no relation to the maritime industry, we thought we could share the court's wisdom as Mr. Bryant shared with his readers. In upholding the statute, the court stated on page eight of its decision: "There is not, however, a free-floating requirement that all congressional action be rational". As Mr. Bryant stated, who could argue with that? *Matsuo v. United States*, No. 08-15553 (9th Cir., November 12, 2009).

Measurement Organization Weekly Notes - 11/10/2009

GRANDFATHERING REMARKS AND STCW: We continue – on occasion - to see recently issued ITC's with grandfathering remarks referencing the STCW interim scheme (A.530(13)). THIS IS INCORRECT, and could result in detentions of U.S. flag vessels whose mariners believe they are entitled to match their licenses to the vessel's GRT tonnage as opposed to the GT ITC. Change 5 to MTN 01-98 deleted reference to the A.530(13) Interim Scheme to reflect the full coming into force of the 1995 Amendments to STCW. In reissuing tonnage certificates with outdated grandfathering remarks, please ensure that remarks reflect current requirements (Section 1.8(d) of MTN 01-98).

MEASUREMENT APPLICATIONS: The MSC is launching a project to evaluate the application forms that vessel owner's must submit for formal measurement. This project has two overarching goals: 1) improve the information being provided by owners; and 2) alert owners to relevant options and requirements. We will formally solicit input from measurement organizations as we move forward with this project. However, if you have any questions regarding the project, or thoughts or comments that you wish to share at this early stage, please call Mr. Javier Jimenez at 202-475-3364, or e-mail him at javier.jimenez@uscg.mil.

VETERANS DAY CLOSURE: The Marine Safety Center will be closed for the Veterans Day holiday, on Wednesday November 11th. Normal business hours will resume on Thursday November 12.

Measurement Organization Weekly Notes - 11/4/2009

COASTWISE TRADE: Coastwise trade is generally defined as the transportation of merchandise or passengers between points in the U.S. or the Exclusive Economic Zone (EEZ). For more information, refer to 46 CFR 67, Documentation of Vessels, or visit the NVDC's web site at <http://www.uscg.mil/hq/cg5/nvdc>.

REQUIREMENTS FOR DOCUMENTATION: Vessels of five net tons or more used in fishing activities on navigable waters of the U.S. or in the EEZ, or used in coastwise trade must be documented unless the vessel is exempted from documentation. In addition, towboats operating between points in the U.S. or the EEZ or between the EEZ and points in the U.S. and dredges operating in the U.S. or the EEZ must be documented. Vessels that do not operate on the navigable waters of the U.S. or in the fisheries in the EEZ, are exempt from the requirement to be documented. Also exempt are Coastwise qualified, non-self-propelled vessels used in coastwise trade within a harbor, on the rivers or lakes (except the Great Lakes) of the U.S. or the internal waters or canal of any state.

NET TONNAGE FOR VESSELS WITH DIFFERENT LOAD LINE ASSIGNMENTS: Per MTN 01-99, a vessel concurrently assigned load lines under both the International Convention on Load Lines (parts 42, 44, 45, or 47 of this chapter) and either the International Convention for the Safety of Life at Sea (SOLAS) (part 46 or 47 of this chapter) or other international agreement must be assigned only one net tonnage. The net tonnage assigned must be the net tonnage applicable to the load line assigned under the International Convention on Load Lines or SOLAS for the trade in which the vessel is engaged.

Weekly Notes are issued by the Coast Guard Marine Safety Center's Tonnage Division (MSC-4) for use by organizations that perform measurement work on the Coast Guard's behalf. They are for informational purposes only, and are not intended as, nor should they be construed to represent, revisions of or substitutes for applicable statutes or regulations or established interpretations of either.

Measurement Organization Weekly Notes - 10/29/2009

COASTWISE TRADE AND 5 NET TONS: The Customs and Border Protection (CBP) Service in Washington, DC is responsible for U.S. policy on coastwise determinations, whether a vessel is documented or not. Although for documented vessels the NVDC is a good starting point, inquiries from customers seeking information on coastwise trade eligibility for vessels that measure under 5 net tons should be referred directly to CBP. The CBP phone number for such inquiries is (202) 325 0030. The CBP's web-based CROSS system may be used to find previous Customs rulings on this subject at <http://rulings.cbp.gov/>; however, CROSS relies on a keyword search, and users are at risk of not finding relevant rulings if appropriate keywords are missed. Look for more details on coastwise trade in our next Weekly Notes edition.

EMAIL INQUIRES: A gentle reminder to all concerned that once you submit an email to the MSC, even to a personal email address, your email becomes a Federal Record, subject to disclosure to the public under FOIA procedures (refer to Tonnage Bulletin 21). For this and other reasons, we continue to encourage you to discuss pertinent issues on the phone with the Tonnage Division staff before resorting to email. Of course, written inquiries are both appropriate and encouraged where interpretations of the tonnage regulations and associated requirements are needed. In such cases, send the email to: msc@uscg.mil, with a copy to the cognizant Tonnage Division staff member.

UPPERMOST COMPLETE DECK AND DECK RECESSES: Per MTN 01-99, deck recesses that are not "through hull" (e.g., cockpits and swimming pools) for which the depth of the deck recess at its deepest point is more than 5 feet below adjacent portions of the deck, and whose area (as viewed from above) is more than 10% of the total deck area from stem to stern (as viewed from above) will invalidate the associated deck from qualifying as the uppermost complete deck.

Measurement Organization Weekly Notes - 10/20/2009

IMO DEVELOPMENTS ON TONNAGE: The tonnage correspondence group is completing work in preparation for the SLF 52 meeting in January 2010. At this point, a number of group members (including the IACS member) have voiced support for the proposal to enhance the integrity of the TM Convention, in lieu of more radical changes (such as introducing a Maritime Real Estate parameter); however, discussions on this subject continue. The final report is expected to be available within several weeks.

THE NETHERLANDS TONNAGE TAX REGIME LIBERATED: Linex Legal reports that a proposal to allow cable and pipeline installation vessels, research vessels and crane ships to be considered under the tonnage tax regime has been subjected for approval by the European Commission. A Dutch shipping company may opt between the "ordinary tax system" and the tonnage tax system. The tax under the tonnage tax system is determined on the basis of net registered tonnage. For more information, see http://www.linexlegal.com/content.php?content_id=118492.

DATE AND PLACE OF ORIGINAL MEASUREMENT FOR ITC: Per MTN 01-98, measurement organizations should note that the date and certification of tonnages and dimensions may or may not coincide with the date and place of the onboard survey of the vessel.

Measurement Organization Weekly Notes - 10/13/2009

LOSS OF TONNAGE GRANDFATHERING: Recently, a detention action almost resulted against a U.S. flag vessel that had lost its GRT tonnage grandfathering a number of years ago, but where the owner/operator was apparently unaware of this fact. A detention may not only have severe economic consequences for the owner/operator involved, but also affect the gray list / black list status of the United States, thereby impacting other U.S. flag vessels as well. Although not required, it is extremely helpful when classification societies alert owners to possible implications of grandfathering loss when tonnage certificates are to be reissued to reflect grandfathering loss.

ZERO NET TONS: We've been working an issue with another flag state concerning a vessel having an assigned domestic net tonnage (NRT) of zero (0). Recall that the 1.75 propelling machinery deduction factor under Moorsom measurement systems can drive the net tonnage down to some very low numbers on vessels with large propelling machinery spaces (e.g., towing vessels). A quick look at MISLE data shows a number of documented U.S. flag vessels with GRTs over 100 and NRTs less than 10. Note that a U.S. flag vessel must be 5 net tons or over to qualify for documentation, so it may not be in the owner's interest to have a net tonnage as low as zero.

CANCELLATION OF TONNAGE CERTIFICATES: Tonnage certificates issued under the provisions of MTN 01-98 do not have expiration dates. However, tonnage certificates cease to be valid and are considered cancelled under any of the following circumstances: the flag changes to another state, the vessel's owner elects to have the vessel measured only under 46 CFR 69 Subpart E, the vessel is under violation of the tonnage laws, or the tonnage laws of the United States no longer apply to the vessel.

Measurement Organization Weekly Notes - 10/6/2009

FOREIGN VOYAGES: The U.S. tonnage statute and tonnage regulations are virtually unique in their use of the expression “foreign voyage”: most laws, regulations and international instruments (including the 1969 Tonnage Convention) use the expression “international voyage”, which is defined differently. We recently encountered a situation where the terms “foreign voyage” and “international voyage” were (incorrectly) being used interchangeably, with NVIC 11-93 (incorrectly) cited as the basis for applying SOLAS requirements to a U.S. flag vessel operating between ports within a single foreign country.

MSC TONNAGE FILES: MSC Tonnage measurement records consist of tonnage calculations, certificates and/or water ballast justification approval letters issued by the Coast Guard (or predecessor agencies) and for which the MSC remains responsible. The records are collectively referred to as a vessel’s “tonnage file”. The records may reside at the MSC, a Federal Records Center (FRC), or a measurement organization in original, copy and/or microfiche form.

MANDATORY REISSUANCE OF TONNAGE CERTIFICATE: Per MTN 01-98 CH-9, a tonnage certificate must be reissued to reflect tonnage and/or dimension changes resulting from remeasurement, reflect changes to applicability of tonnage measurement systems and (where applicable) associated grandfathering provisions, correct errors in assigned tonnages and dimensions, and (in the case of the International Tonnage Certificate) replace a required lost original for a vessel that engages on foreign voyages.

NIMASA ORDERS VESSELS TO CARRY AIS: Vanguard news, reports that the Nigerian Maritime Administration and Safety Agency (NIMASA) has directed all passenger vessels, cargo vessels of 500 GT or more which are not engaged on international voyages, and all vessels of 300 GT or more that are engaged in international voyages to carry a fully functional Automated Identification System (AIS). This directive is in line with IMO Safety of Lives at Sea (SOLAS) Convention of 1974 which requires mandatory carriage of AIS systems onboard all vessels. For more information on this item, see <http://www.vanguardngr.com/2009/10/05/nimasa-orders-vessels-to-carry-automated-identification-systems-ais/>

Weekly Notes are issued by the Coast Guard Marine Safety Center’s Tonnage Division (MSC-4) for use by organizations that perform measurement work on the Coast Guard’s behalf. They are for informational purposes only, and are not intended as, nor should they be construed to represent, revisions of or substitutes for applicable statutes or regulations or established interpretations of either.

Measurement Organization Weekly Notes - 9/29/2009

OWNER'S QUESTIONS ON CG NUMBERS: We have received feedback that some owners are questioning the placement of a CG number (in lieu of a '-') on a tonnage certificate for a vessel that is in the process of being documented, and are concerned that this may invalidate the tonnage certificate once the official number (ON) is assigned. The short answer is that CG numbers are valid identifying numbers, stay with the vessel for the life of the vessel and, therefore, the certificates do not need to be reissued. Of course, owners are welcome to have their certificates reissued at their own expense, and if they are concerned about CG numbers, they should be encouraged to apply for documentation as early as possible and before the tonnage certificate is issued. Note that the NVDC will assign an official number when processing an application for documentation, and the official number will stay with the vessel even if the vessel ultimately is not documented (or is taken out of documentation).

VESSEL DETERMINATIONS ON NON-TRADITIONAL WATERCRAFT: Per MTN 01-98 CH9, measurement organizations are required to contact the Tonnage Division staff for instructions as to whether a vessel determination is required before accepting an application for measurement. Non-traditional watercraft are those that either by design or intent do not usually get underway and/or do not possess the practical capability or equipment for being used as a means of transportation on water.

UNIQUE VESSEL IDENTIFICATION NUMBER ON TONNAGE CALCULATIONS: Per MTN 01-98 CH9, the measurement organization shall specify in the calculations the vessel's name and official number (or IMO number or Coast Guard number if an official number is not assigned).

Measurement Organization Weekly Notes - 9/22/2009

TONNAGE-BASED SEWAGE REQUIREMENTS: Effective January 1, 2010, MARPOL Annex IV requires certain vessels that engage in international voyages to have a valid International Sewage Pollution Prevention Certificate (ISPPC) or Statement of Voluntary Compliance (SOVC), or risk detention. While the U.S. is not party to this Annex, U.S. vessels may subject to Annex IV requirements while operating in waters under the jurisdiction of another port State. The requirements apply to vessels of 400 GT and above. Refer to NVIC 1-09 for further details.

U.S. TONNAGE CERTIFICATE REMARK FOR VESSELS EQUAL TO OR GREATER THAN 24 METERS BUT LESS 79 FEET IN LENGTH: For vessels that are 24.0 meters or more but less than 79 feet in convention length, the following remark must be added to the U.S. Tonnage Certificate per MTN 01-98 CH 9: "Under United States interpretations, the 1969 Tonnage Convention does not apply to this vessel, regardless of the voyage type, based on its length as expressed in English units."

ELECTRONIC COMMERCE SUBMITTALS: This is a reminder that any request submitted to the MSC via e-mail must be sent to Electronic Commerce (EC) address (msc@uscg.mil). It is strongly suggested that a copy be sent to the responsible person to reduce the 'waiting time' as there may be delays in the EC screening process.

Measurement Organization Weekly Notes - 9/15/2009

PUBLIC VESSEL MEASUREMENT: Per the Tonnage Regulations, the Coast Guard measures all U.S. Coast Guard vessels and all U.S. Navy "vessels of war". The legal definition for "vessel of war" specifies, among other things, that the vessel be under the command of a commissioned officer. Although the U.S. Coast Guard has the option to measure other public vessels (e.g., Army landing craft, NOAA research vessels, etc.), the regulations provide for formal measurement of such vessels by authorized measurement organizations.

UPDATE TO MSC MAIL ADDRESS: As we reported in June, a new mail stop has been added to the MSC mailing address. Please remember that any "regular" mail submitted to the MSC Tonnage Division must be sent to:

Commanding Officer
Marine Safety Center (MSC-4)
2100 Second Street, SW Stop 7102
Washington, DC 20593-7102

OFFICIAL NUMBER PREFIX ON INTERNATIONAL TONNAGE CERTIFICATES: Per MTN 01-98 CH 9, if an IMO number is not available for a documented vessel of the United States, specify the six or seven digit official number assigned by the USCG National Vessel Documentation Center (or its predecessors) with the prefix "ON" (e.g., "ON 234567").

Weekly Notes are issued by the Coast Guard Marine Safety Center's Tonnage Division (MSC-4) for use by organizations that perform measurement work on the Coast Guard's behalf. They are for informational purposes only, and are not intended as, nor should they be construed to represent, revisions of or substitutes for applicable statutes or regulations or established interpretations of either.

Measurement Organization Weekly Notes - 9/8/2009

NTVRP TONNAGE REQUIREMENTS: The Coast Guard issued a Notice of Proposed Rulemaking (NPRM) addressing Nontank Vessel Response Plans NTVRPs. A nontank vessel is defined as a self-propelled vessel of 400 gross tons or greater, which carries oil as fuel for main propulsion and operates on the navigable waters of the United States. The 400 gross ton breakpoint is applied using convention measurement system tonnage (if assigned) or regulatory measurement system tonnage if convention tonnage is not assigned. To avoid NVTRP requirements, an owner may seek to have his/her vessel remeasured under the regulatory system only where allowed by NVIC 11-93 (e.g., a qualifying older "domestic voyage only" vessel). The proposed rule exempts nontank vessels with an oil capacity of less than 250 barrels (10,500 gal) from the requirement to ensure, by contract, that response resources are available.

IMO AND MOLDED DIMENSIONS: IMO recently issued a Circular (MSC-MEPC.5/Circ.5) that provides for measuring distances under the SOLAS, Load Line and MARPOL Conventions using molded dimensions.

CG NUMBER REQUEST: Please note that our procedures have recently changed. Per MTN 01-98 CH-9, a copy of a completed measurement application must be submitted to the MSC in order to obtain a CG number if no unique vessel identification number is available (e.g., ON, IMO number). The MSC's response time is 2 business days from the receipt of the request.

EDITOR'S NOTE: We are resuming publication of the weekly notes with this edition after several weeks of interruptive service due to an unexpected staffing shortfall. We apologize for the interruption of this service, and based on your feedback, we consider the service useful and intend to continue publishing the notes on a weekly basis in the future.

Weekly Notes are issued by the Coast Guard Marine Safety Center's Tonnage Division (MSC-4) for use by organizations that perform measurement work on the Coast Guard's behalf. They are for informational purposes only, and are not intended as, nor should they be construed to represent, revisions of or substitutes for applicable statutes or regulations or established interpretations of either.

Measurement Organization Weekly Notes - 7/14/2009

TONNAGE STAFF FAREWELL: Effective last Friday, LCDR Weinbecker has been transferred to a new assignment in the Eighth Coast Guard District in New Orleans. Please join us in wishing him farewell. Mr. Javier Jimenez has assumed LCDR Weinbecker's previous responsibilities, and can be reached at javier.jimenez@uscg.mil or (202) 475-3364.

SWEDISH TONNAGE TAX: The Universal Maritime Union reports that at least two Swedish vessels have left the country's register because of Sweden's decision to maintain its existing tax system for shipping companies, as opposed to adopting an EU-styled tonnage tax system. The EU systems are based on aggregate net tonnage. For more information on item, see <http://www.maritime-union.org/?page=news&id=5384>

Seatrade Asia Maritime news report that the Marshall Islands Registry has seen its registered tonnage surpass the 50m GT mark following the launch of the 11,259 GT tanker Songa Emerald at Samho Shipbuilding in Korea. The vessel is managed by Songa Ship Management of the UK. In less than six years, the Marshall Islands fleet has grown from 18.5m GT and 626 vessels at the end of 2003 to 50m GT and 2044 vessels in July 2009 reflecting an average annual growth rate of 23% in terms of gross tonnage. The Registry, which is administered by International Registries, Inc. (IRI), attributes its success to the decentralization of registry services to its 20 worldwide offices. For more information on this item, see <http://www.seatradeasia-online.com/News/4358.html>

Measurement Organization Weekly Notes - 7/6/2009

TONNAGE CERTIFICATES FOR DOCUMENTED VESSELS: This is a reminder that measurement organizations do NOT need to submit copies of tonnage certificates of DOCUMENTED vessels to the MSC. However, for any UNDOCUMENTED vessel that has been issued a Tonnage Certificate with a CG number, a copy of the certificate must be sent to us for record keeping purposes.

TONNAGE-BASED MARPOL REQUIREMENTS: The Coast Guard recently issued a NVIC (1-09) providing guidance on voluntary compliance with international sewage regulations in Annex IV to MARPOL 73/78. On January 1, 2010, revised requirements (for which there is a 400 gross ton threshold) enter into force internationally. Although the U.S. is not party to Annex IV, vessels registered in the U.S. visiting nations that are party to this Annex may need to demonstrate compliance with MARPOL Annex IV.

TONNAGE TAXES: On June 25, 2009, Congressman Blumenauer introduced a Bill to modify the tonnage tax under the Internal Revenue Code of 1986 (H.R. 3049). This tax is applied based on a vessel's net tonnage.

Measurement Organization Weekly Notes - 6/30/2009

Tonnage Item and SLF: The attached email provides an update for SOLAS Working Group members regarding the International Maritime Organization SLF Sub-Committee, including status of the work program item to improve the 1969 Tonnage Convention. If you know of any stakeholders who would like to provide input on the tonnage item (e.g., support/oppose proposals to establish a new Maritime Real Estate parameter or ensure the integrity and consistency of the existing gross and net tonnage parameters), please have them contact Mr. Peter Eareckson of the Tonnage Division (202 475-3395).

CG Numbers and MISLE: The MSC will assign a Coast Guard (CG) Number to a vessel upon request, if a unique identification number is not already available. However, this requires a careful search of the MISLE database to avoid creating "duplicate" vessels, and sometimes the information provided on the measurement application is marginally sufficient for this purpose. Pending a review of, and possible changes to, the measurement application itself, we encourage you to provide the MSC with any additional vessel information you may have to help establish whether a vessel already exists in MISLE / PSIX by some other name (e.g., vessel former names, the names of former owners, state numbers, etc).

MSC Closure Thursday/Friday: The Marine Safety Center will be closed for the Independence Day holiday, beginning on Thursday July 2nd at approximately noon. Normal business hours will resume on Monday July 6th. We hope everyone has a happy and safe July 4th weekend!

Measurement Organization Weekly Notes - 6/23/2009

MSC MAILING ADDRESS: Effective immediately, if you mail something to the MSC Tonnage Division (either by the USPS or a commercial service like FEDEX) you must specify additional information in our mailing address. Specifically “Stop 7102” needs to be included after our street address, and “7102” included as the “Plus 4” of our Zip Code. An example of an MSC mailing address is found on the following link: <http://www.uscg.mil/HQ/msc/>. As before, please include an “Attn: Tonnage Division (MSC-4)” line to help ensure the item is more quickly routed within the MSC.

BOW HOLES: At the Tonnage Conference last month, reference was made to press reports of bow modifications to a New Zealand flag vessel for the purpose of averting certain regulatory requirements based on length. A link to one such report is attached for information: <http://www.stuff.co.nz/dominion-post/news/2316068/Holes-bored-to-shorten-ship>. In measuring U.S. flag vessels, design features of this nature must be referred to the MSC Tonnage Division for evaluation of impact on tonnage and length, under novel craft provisions of the tonnage regulations.

MTN 01-98 CHANGE: We are finalizing the change to the MTN which we circulated to the measurement organizations two months ago. If you have any last minute issues that need to be addressed, please let us know ASAP.

Measurement Organization Weekly Notes - 6/16/2009

NET TONNAGE FEES: As reported on Dennis Bryant's Maritime Blog, the UK Department of Transport is proceeding with an increase in Light dues based on "net registered tons" or "NRT" (presumably, this is the convention net tonnage: NT), despite many adverse comments and opposition voiced in press accounts. In this case, the intensity of the protests highlights the importance of the NT parameter, at least in some locations/markets. Generally speaking, light dues are a form of user fee collected to maintain lighthouses and other navigational aids/facilities. For more information on this item, see the June 11, 2009 entry on <http://bryantsmaritimeblog.blogspot.com>

UNDER-DECK TONNAGE: MEASURING SPACES HAVING CEILING: As defined in MTN 01-99, Section 69.109, the maximum allowance for terminating measurements on ceiling is three inches on the bottom frames or tank top and three inches on each side frame. When ceiling is less than three inches thick, only the actual thickness is allowed. When ceiling is fitted on a platform to the upper side of the frames and the allowable ceiling on the platform is then deducted.

U.S. CONSTITUTION AND TONNAGE According to the Blog of LegalTimes, the Supreme Court recently ruled that a ship tax imposed by the City of Valdez, AK was a tonnage duty, and not a property tax, and therefore unconstitutional. Per Article 1, Section 9 of the U.S. Constitution, "No State shall, without the Consent of Congress, lay any duty of Tonnage, keep Troops, or Ships of War in time of Peace, enter into any Agreement or Compact with another State, or with a foreign Power, or engage in War, unless actually invaded, or in such imminent Danger as will not admit of delay." For more information on this item, see <http://legaltimes.typepad.com/blt/2009/06/tonnage-clause-day-at-the-supreme-court.html>

Measurement Organization Weekly Notes - 6/9/2009

TONNAGE CALCULATIONS AND FRAME LOCATIONS: When developing tonnage calculations under the regulatory system (GRT/NRT), it's important (and required) to list the frame locations (or equivalent) of dimensions associated with spaces that are "grossed", as well as dimensions associated with exempted and deducted spaces (e.g., "Extended Forecastle Stem-Fr 52", "Galley FR 10-12", "Crew Space Fr 17-23". This facilitates review, helps avoid/resolve disputes regarding assigned tonnages, and is of critical importance in establishing a baseline for remeasurement if the spaces in question are affected by the modifications.

SIMPLIFIED MEASUREMENT FORM: A new version of the Simplified Measurement form is now available in the MSC homepage (http://www.uscg.mil/hq/msc/interactive_tonnage.asp). The new form should work with the latest version of Adobe. Any questions about this new form should be directed to Mr. Javier Jimenez at (202) 475-3364.

BOXSHIP FLEET WILL KEEP GROWING: Lloyd's Register- Fairplay (LRF) Research reports that despite the current overcapacity and low shipping rates, the world containership fleet is expected to continue its rapid growth curve, though at a slightly reduced rate, as deliveries are taken from shipyards and new shipbuilding orders start to pick up late this year. Spot rates of as low as \$250 USD to move a container from Hong Kong to Rotterdam are being quoted by some lines. That compares with \$1,400 a year ago. The global containership fleet stands at 4,671 ships with a total capacity of 12.4m TEU. It is expected to grow by 13 percent in 2009, as new ships ordered during the boom years are delivered to their owners. The report also says that South Korea is expected to continue its domination of the shipbuilding market for very large containerships, while China will continue to capture a larger market in the smaller containership sector. For more information on this report see: <http://www.mgn.com/news/dailystorydetails.cfm?storyid=9967> .

Measurement Organization Weekly Notes - 6/3/2009

2009 TONNAGE CONFERENCE SURVEY RESULTS: We appreciate the valuable input from the conference survey. In summary, of the 15 measurement organization employees and contractors, 12 rated the conference the highest for overall usefulness. The Open Vessels lecture and workshop received the highest rating for the individual sessions with average scores of 2.9 and 2.8 out of 3.0. The majority favored an annual 3-day conference format. As far as preference of location for the next conference, there were 5 votes that favored DC, 4 votes for New Orleans, 1 vote for Texas, and 1 vote for NY. The comments are being taken into consideration as we plan for next year's conference.

ASSIGNING CG NUMBERS TO UNDOCUMENTED VESSELS: Measurement organizations are reminded to forward an electronic copy of the tonnage application to the MSC for each undocumented vessels being measured, so that we can assign the vessel a Coast Guard (CG) number. The CG number is a unique vessel identification number, and is not be confused with the official number (ON). Unique identification numbers help interested parties link tonnage certificates to vessels. Place the CG Number on the tonnage certificate in the vessel number block using the form "CG XXXXXXX" (e.g., "CG 995611"). Once the certificate is issued, send a copy of the certificate to the MSC for upload into the Coast Guard's MISLE database.

JAMAICAN FLEET GROWS: Maritime Global Net, an international maritime industry web portal, reports that the Jamaica Registry has set itself the target of reaching 1 million GT within the next four years. Currently there are 68 merchant vessels and 664 small craft registered under the Jamaican Flag which equates to 264,392 GT. The Jamaican Flag is said to be enticing Europeans owners to its register. Over the first quarter of 2009 the flag has added 35,669 GT through the signing of six new German owned and managed container vessels. Over recent months the Jamaica Ship Registry has been strengthening its network of regional offices as well as offering enhanced services to its owners. For more information on this report see: <http://www.mgn.com/news/dailystorydetails.cfm?storyid=9934> .

Measurement Organization Weekly Notes - 5/19/2009

VESSEL DETERMINATIONS: On May 11th, the Coast Guard published a policy notice in the Federal Register (74 FR 21814) regarding permanently moored craft (“craft routinely operated dockside”). Under this notice, determinations of whether a specific craft is (or will be) a vessel are made by the cognizant Office in Charge, Marine Inspection (OCMI). This subject is being addressed in the forthcoming change to MTN 01-98. In the meantime, before accepting an application for measurement of any craft that does not routinely get underway, please continue to contact the Tonnage Division staff for assistance.

IMO TONNAGE MATTERS: Last Friday, the U.S. submitted a proposal to ensure the integrity and uniform implementation of the existing gross and net tonnage parameters under the 1969 Tonnage Convention. This was offered as an alternative to other proposals (including one to amend the Convention to introduce a new “Maritime Real Estate” tonnage parameter).

PANAMA CANAL TO TRIM TRANSIT RATES: The Panama Canal will cut rates temporarily as the global economic slowdown damps trade. Supertankers that navigate the 50-mile canal will pay \$5,000 USD less for a reservation fee. The move is a response to a 1.4 percent drop in first-quarter traffic. Supertanker and other big vessel transits decreased 2.9 percent and net tonnage dropped 3.3 percent from a year earlier. For more information on this report see:

<http://insidecostarica.com/dailynews/2009/may/18/cam02.htm>

Measurement Organization Weekly Notes - 5/12/2009

2009 TONNAGE CONFERENCE: Once again, the MSC would like to thank those 15 measurement organization employees and contractors who attended and participated in this year's Tonnage Conference. Survey results are currently being processed. Once they are finalized, we will share the details with the rest of the tonnage measurement community.

DOCUMENTATION QUESTIONS: A gentle reminder that questions about documentation matters should ALWAYS be referred to the NVDC. Recently, an owner was told that the charterer's name should be shown on the COD as the managing owner. In fact, the managing owner must be the actual owner of the vessel and cannot be the charterer, even in a demise charter situation. For some vessels, that are documented under the lease financing provisions of the law, the charterer is shown in the remarks section of the COD. Regardless, please let the specialists at the NVDC handle these kinds of questions.

TAIWAN TAX PANEL RECOMMENDS TONNAGE TAX: Dow Jones Newswires, a provider of global business news services, reported that an advisory committee to Taiwan's government has recommended the implementation of an optional tonnage tax in the shipping industry to boost international competitiveness. This tax option is intended to provide shipping companies the flexibility in deciding on how to pay their taxes, and encourage local shipping companies to have their ships registered in Taiwan. Increasingly, we are seeing press reports about efforts to establish taxes based on the tonnage of the vessel as a lump-sum, rather than on the profits it makes. For more information on this report see:

<http://online.wsj.com/article/BT-CO-20090501-705749.html> .

Measurement Organization Weekly Notes - 4/28/2009

TONNAGE CONFERENCE: One more week before the 2009 Tonnage Conference! Attached is an agenda of this year's topics and workshops. Now would be a good time to take a look at the topics and write down any related questions that you wish to have answered at the Conference. If you need any last minute directions, Foreign Visitor Forms, etc., please contact the Tonnage Division staff.

OPEN TO THE SEA: If you have any doubt as to whether a space is eligible for exclusion from tonnage as open to the sea, contact the Tonnage Division staff for assistance and/or a decision. The MTN 01-99 criteria do not permit a space to be excluded as open to the sea if there would be a detrimental effect on the operation of the vessel, should the space fill with water. Novel arrangements such as standpipes that prevent free communication of water between the space and the sea DO NOT qualify the space as open to the sea.

SIMPLIFIED MEASUREMENT FORM: We have been receiving e-mails regarding difficulty in using the Simplified Measurement form with the latest version of Adobe. Until our IT personnel continue to come up with a fix, we recommend you try an older version of Adobe if you are experiencing problems with the form.

PERSONNEL CHANGES: As some of you are aware, this summer LCDR Bill Weinbecker is departing to New Orleans to begin a new Coast Guard tour. As part of this transition, Mr. Javier Jimenez is now handling most of the day-to-day service responsibilities that LCDR Weinbecker has been providing, including file requests and assignment of CG numbers.

Measurement Organization Weekly Notes - 4/21/2009

Length Overall: Buoyant hull structures both fixed and removable are included in the overall length, and consequently in tonnage. Portions of watertight bulwarks and similar structures that function as a continuation of the vessel's hull and extend for a length of 10% or more of the overall length (with the structures included) are considered to be part of the buoyant hull envelope, provided there are no hull openings (such as an anchor hawsepipe) that could cause the associated space to flood. For definition of Overall Length and watertight, see section 69.203 and 69.53 of MTN 01-99.

Calls for Postponement of Tonnage Back Tax in Norway: The Guardian, a UK based newspaper, reported that Norwegian shipping groups have clashed with the Labour-led government over a tonnage tax system presented in 2007 under which back taxes are being imposed on undistributed profits retained by companies over many years. The plan was presented to make it similar to the current tonnage tax system in the European Union. Numerous companies have called the new tax a betrayal of a 1996 deal, meant to keep them competitive under Norwegian flag. Norway, which controls around 5 percent of the world's merchant fleet, has been a major player in international shipping for more than 150 years. For more information on this report see:

<http://www.guardian.co.uk/business/feedarticle/8463864>

Tonnage Conference: The 2009 Tonnage Conference is quickly approaching and we want to wrap up an important pre-conference item. If you are not a U.S. Citizen, ensure that you complete and return the Foreign Visitor Request Form sent out as an e-mail attachment on April 10. If you still require this form, please contact the tonnage staff at the Marine Safety Center for assistance.

Measurement Organization Weekly Notes - 4/7/2009

Tonnage Tax: The Journal of Commerce Online reported that Japan will apply the tonnage tax system to 10 domestic ocean-going shipping companies over five years from fiscal 2009, which starts in April. The tonnage tax is imposed in lieu of the normal corporate income tax with respect to the operation of the taxpayer's qualifying vessels. According to this report, the system is already in place in Greece, the Netherlands, Norway, Germany, the United Kingdom, Denmark, Finland, Ireland, France, Spain, Belgium, the United States, South Korea, Italy, India, Lithuania and Poland.

Measurement System Hierarchy: For most self-propelled vessels 79 ft and over in length, the Convention system is the primary tonnage measurement system. However, law permits any vessel to be measured under the "optional" Regulatory system regardless of length, for the purpose of applying domestic laws in effect prior to July 19, 1994. For vessels less than 79 ft in length, the regulatory system is used in all cases. See NVIC 11-93 for more details.

Oversight Nonconformities: Oversight is conducted to ensure that the requirements of USCG regulations and policy are being properly applied. Nonconformities are indicators used to determine the level of agreement between tonnage regulations/policy and their application by the measurement organizations. A nonconformity uncovered during an oversight review is not intended to serve as a penalty. These data points (nonconformities) should be used as part of a feedback process to improve the overall performance of the tonnage measurement system.

Measurement Organization Weekly Notes - 3/31/2009

Tonnage Conference Planning: Preparations continue for the Tonnage Conference, which will be held May 5th thru 7th here at the MSC. So far, we have commitments from 17 measurement organization representatives to attend, and there is still room for more (but we need names ASAP). This year, representatives from the National Vessel Documentation Center (NVDC) will join us for several sessions.

IMO Tonnage Issues Update: Work continues on the initiative to amend/improve the 1969 Tonnage Convention. This was the subject of several sessions at last year's Tonnage Conference. The work is being done through a Correspondence Group co-chaired by representatives from Australia and the Netherlands to support the next Stability, Load Line and Fishing Vessel Safety (SLF) Subcommittee meeting. This meeting has just been scheduled for the 25th thru the 29th of January 2010 in London.

Volume Calculations: Measurement organizations are reminded to use accepted naval architectural practices (as described in MTN 01-99) when determining volumes of spaces with curved geometry, under convention measurement. Calculation of volume for such spaces does not provide sufficient accuracy if such spaces are incorrectly modeled as geometric shapes.

Measurement Organization Weekly Notes - 3/25/2009

USCG Headquarters Mail Service: Overnight does not necessarily mean overnight when it comes to delivery of mail at the Marine Safety Center. All incoming courier deliveries are sent to a facility in Washington and processed prior to delivery at the MSC. This processing could take up to four days. Please keep this in mind when sending items into the MSC.

Reflags: A reminder that the 1969 Tonnage Convention provides for a three month "grace period" following flag transfer among signatory nations. During this time, the old International Tonnage Certificate (ITC) remains valid, unless it is otherwise superseded. The NVDC has accepted ITCs from other flag States as evidence for the tonnages that appear on a vessel's COD, but only during the grace period, through issuance of what is effectively a temporary Certificate of Documentation. Remember that after a vessel changes to U.S. flag, tonnages must be completely recertified, including an onboard survey (as if the vessel were being measured for the first time) for a formally measured vessel. Refer to Section 1.9 of MTN 01-98 for more information.

Major Conversion: Please be aware that additional regulatory requirements may apply to certain inspected vessels based on whether or not they undergo a "major conversion". The United States Code provides a definition for major conversion which involves consideration of a number of factors, including changes to dimensions, carrying capacity, vessel type, life of the vessel, etc. The MSC makes major conversion determinations. Sometimes customers confuse "major conversion" with "substantial alteration" (as used in the tonnage program): the terms apply to two different situations.

Weekly Notes are issued by the Coast Guard Marine Safety Center's Tonnage Division (MSC-4) for use by organizations that perform measurement work on the Coast Guard's behalf. They are for informational purposes only, and are not intended as, nor should they be construed to represent, revisions of or substitutes for applicable statutes or regulations or established interpretations of either.

Measurement Organization Weekly Notes - 3/16/2009

Tonnage Conference Accommodations: Rooms have been made available for 2009 Tonnage Conference attendees. A block of rooms has been reserved at the Channel Inn Hotel for a special rate of \$179.00. If you desire to stay at this hotel, reservations should be made using the following confirmation number: 138766

Listing Excluded Spaces: Per MTN 01-98 and the 1969 Tonnage Convention, tonnage certificates must list ALL measurable excluded spaces, and identify the surrounding enclosed spaces through annotation using asterisks. These requirements notwithstanding, we have observed a tendency to avoid accounting for excluded spaces on the tonnage certificate, either by failing to list the space altogether, or omitting the annotation for the associated surrounding space. This can cause confusion, and raises potential liability issues should the total enclosed volume of a vessel in such a case be extrapolated from the gross tonnage listed on the tonnage certificate (e.g., for the purpose of applying remeasurement criteria).

Passenger Definition: Under the International Tonnage Convention a passenger is defined as a person onboard a vessel other than: (a) the master, a member of the crew, or other person employed or engaged in any capacity in the business of the vessel; and (b) a child less than one year of age.

Weekly Notes are issued by the Coast Guard Marine Safety Center's Tonnage Division (MSC-4) for use by organizations that perform measurement work on the Coast Guard's behalf. They are for informational purposes only, and are not intended as, nor should they be construed to represent, revisions of or substitutes for applicable statutes or regulations or established interpretations of either.

Measurement Organization Weekly Notes - 3/2/2009

Vessel Identification: The Coast guard may assign two types of unique identifiers to vessels. The first is the official number (ON) and is assigned by the National Vessel Documentation Center when the vessel is processed for documentation. When the vessel has not been, or will not be documented, the Coast Guard may assign another unique identifier known as the Cost Guard Number (CG #). The CG # is assigned for the life of the vessel and is the unique identifier used by the CG until another is assigned (e.g., IMO # or ON).

Electronic Records: MTN 01-98 gives measurement organizations flexibility to "go paperless" through the use of electronic tonnage records. While electronic records have many advantages, care must be taken to ensure the records are in a format that can be accessed down the road. We recently encountered a case where offsets could not be extracted from electronic hull model because the associated software is no longer available. If paper records are not being kept, we strongly recommend that electronic tonnage measurement records be saved in a form that will be widely accessible in the foreseeable future (e.g., Adobe Portable Document Format (pdf)).

Oversight Drawings: Copies of drawings used as the basis for obtaining dimensions or other information used in establishing tonnages or registered dimensions must be included in the oversight submittal per MTN 01-98, 6.2(a)(4). If drawings or computer models were not used as this basis, sketches and/or scaled photographs providing equivalent information must be included.

Measurement Organization Weekly Notes - 2/17/2009

2009 Tonnage Conference Agenda: The tonnage staff at the MSC is preparing the agenda for the 2009 Tonnage Conference. We are offering an opportunity to those interested to present a topic of interest at the conference. Please let us know if you want to make a presentation at the conference. Also, please submit any topics that you want to see covered during the conference. To allow adequate preparation time, please submit your topics you would like to see or requests to present by the end of February.

Updated Simplified Guide: The Tonnage Guide for Simplified Measurement, Tonnage Guide 1, has been updated and is now posted on our webpage on Coast Guard Homeport (<http://homeport.uscg.mil>). This tonnage guide explains the Simplified tonnage measurement system with regard to other available tonnage measurement systems; vessel eligibility for Simplified measurement; the use of tonnage in the vessel documentation process; the responsible Coast Guard offices; and calculating Simplified Tonnage.

Updated Navy and USCG Vessel Measurement Guide: The Tonnage Guide for Measurement of Navy and Coast Guard Vessels, Tonnage Guide 2, was also recently updated and is posted on our webpage on Coast Guard Homeport (<http://homeport.uscg.mil>). This tonnage guide provides general information about measurement requirements and procedures for "vessels of war". The update addresses current Panama procedures for displacement measurement, in which the vessel's full load displacement, as opposed to the arrival displacement, is used for assessing transit fees.

Measurement Organization Weekly Notes - 2/9/2009

2009 Tonnage Conference Dates: The 2009 Tonnage Conference will be held on May 5, 6, & 7 in Washington, D.C. Tuesday, Wednesday, and Thursday were chosen based on input and feedback from last year's conference attendees. The venue is the conference room at the Marine Safety Center as it was last year. Note: There is now a cafeteria located within the building that houses the MSC.

Tonnage Calculation Requirement: For vessels being initially measured the calculations must include the vessel's name and official number and provide a location in the vessel to at least the nearest frame for all dimensions used in tonnage calculations (e.g. "2nd tier Fr 2-12").

Coast Guard Tonnage Files: Between 1993 and 2003 the coast guard transferred tonnage files to measurement organizations for vessels that were being remeasured. These records remain property of the Coast Guard. Information from these files shall not be released to other parties without prior authorization from the MSC. Parties interested in obtaining information from these files should be directed to the MSC.

Weekly Notes are issued by the Coast Guard Marine Safety Center's Tonnage Division (MSC-4) for use by organizations that perform measurement work on the Coast Guard's behalf. They are for informational purposes only, and are not intended as, nor should they be construed to represent, revisions of or substitutes for applicable statutes or regulations or established interpretations of either.

Measurement Organization Weekly Notes - 1/27/2009

TRANSPARENCY AND OPEN GOVERNMENT: The White House Office of the Press Secretary issued a memorandum to the heads of executive departments and agencies stating that an Open Government Directive is being developed. This Directive will instruct the agencies to take specific actions implementing the principles set by this memorandum. Those principles are: Transparency, Participation, and Collaboration. A copy of the memorandum, which is being published in the Federal Register, is attached.

MTN 01-98 CHANGE AND FILE REQUESTS: The MSC is continuing to develop an update to this MTN, a draft of which will be distributed to the measurement organizations for their comment before it is finalized. Among other changes, we are considering streamlining the file request process (e.g., eliminating the attachment). If you have any ideas along these lines, please feel free to discuss them at any time with Mr. Javier Jimenez.

MTN 01-99 METHODS FOR MEASURING EXEMPT SPACES: As defined in sect. 69.177, if the exempt water ballast space is located under-deck, the space is measured using the zone of influence method. Procedures on how to lay out the zones of influence are shown in the section.

Measurement Organization Weekly Notes - 1/16/2009

MSC Closed Monday/Tuesday: The Marine Safety Center will be closed on Monday and Tuesday, January 19 and 20, in observance of Martin Luther King Day and the presidential inauguration. We will resume normal business hours on January 21.

Oversight Reporting: The MSC management team has increased the emphasis on oversight of third parties performing work on behalf of the Coast Guard. The Tonnage Division has accordingly stepped up oversight goals for the year. We prefer to select the most recent tonnage measurement activities for review. To help facilitate our effort, we ask that the notification worksheets be sent to the MSC in a timely manner (refer to paragraph 2.b of MTN O4-03 for more specifics). A successful oversight program will ensure that a more accurate and consistent product is delivered to our customers.

Principal Dimension Tonnage Guide: A new Tonnage Guide to determine principal dimensions under our formal measurement systems is currently being developed. Comments on this project were solicited back in 2005 with little response. If there are any questions or additional comments, please e-mail them to javier.jimenez@uscg.mil or call Mr. Jimenez at 202-475-3364.

Weekly Notes are issued by the Coast Guard Marine Safety Center's Tonnage Division (MSC-4) for use by organizations that perform measurement work on the Coast Guard's behalf. They are for informational purposes only, and are not intended as, nor should they be construed to represent, revisions of or substitutes for applicable statutes or regulations or established interpretations of either.

Measurement Organization Weekly Notes - 1/12/2009

New Tonnage Guide: Tonnage Guide 3, "Tonnage Measurement Records", has been released. Tonnage Bulletin 37 has been sent to all Measurement Organizations with details and is now available on the MSC's webpage, found on the Coast Guard's Homeport website (<http://homeport.uscg.mil>) by searching on "tonnage measurement."

Spaces Included in Vc: Under the Convention Measurement System, the total volume of all cargo spaces is used to calculate net tonnage. Section 69.62 of MTN 01-99 lists examples of spaces that are categorized as cargo spaces. However, note that the list is not all inclusive: a space not listed may still be considered a cargo space. See the definition of Cargo Space in section 69.53 of the MTN for additional guidance in making this determination. If in doubt, call a member of the Tonnage Staff at the Marine Safety Center.

Weekly Notes are issued by the Coast Guard Marine Safety Center's Tonnage Division (MSC-4) for use by organizations that perform measurement work on the Coast Guard's behalf. They are for informational purposes only, and are not intended as, nor should they be construed to represent, revisions of or substitutes for applicable statutes or regulations or established interpretations of either.

Measurement Organization Weekly Notes - 1/5/2009

Undocumented Vessel Process: All measurement organizations were recently sent out a correspondence outlining the new undocumented vessel tonnage assignment process. There are no actions required of the measurement organizations at this time. When received, just submit the measurement applications for undocumented vessels to the MSC. The appropriate changes will be made in the next revision of the MTN.

EPA Sets 300 GT Threshold: In accordance with the National Pollution Discharge Elimination System all vessels greater than 300 GT must submit a notice of intent (NOI) to receive permit coverage to cover discharges incidental to the normal operation of vessels. Originally the EPA had stated that the threshold was 300 gross registered tons, but has now changed it to 300 gross tons as measured under the convention (GT ITC). It is unclear how the EPA will enforce this requirement for vessels that do not have GT ITC tonnage assigned.

Measurement Organization Weekly Notes - 12/22/2008

IMO Extends Tonnage Deadline: The International Maritime Organization Maritime Safety Committee agreed to extend the deadline for work being done on the third tonnage parameter as recommended by the sub-committee on Stability and Load Lines and on Fishing Vessel Safety (SLF).

Long Range Identification and Tracking System (LRIT): The Maritime Safety Committee recommended the compliance date for implementation of LRIT as December 31, 2009. However, administrations may allow for earlier implementation if desired.

Measurement Organization Weekly Notes - 12/8/2008

Recreational Vessel Tonnage Measurement: A recreational vessel with an overall length of 79 feet and over may be assigned tonnages under either the regulatory measurement system, the convention measurement system, or both systems. Under the regulatory system the vessel may be assigned tonnages under the simplified measurement system (subpart E) if the vessel is engaged on domestic voyages only and has a keel laid/altered date prior to January 1, 1986. If you have any questions dealing with the many permutations of tonnage applicability call the Tonnage Staff at the MSC.

Tonnage Fees: Measurement organizations may charge fees for the measurement services they perform on behalf of the U.S. Coast Guard. The MSC does not review or control fees charged by the authorized measurement organizations. However, copies of the current schedules of measurement fees and related charges shall be provided to the MSC following any changes to those schedules.

Revisions to Tonnage Certificates: When a tonnage certificate is revised, the certificate must meet all current requirements. For example, a required remark cannot be omitted from a revised tonnage certificate on the basis that the remark was not required at the time the original certificate was issued.

Measurement Organization Weekly Notes - 12/1/2008

Autocad 2007: Due to constraints of our engineering software package at the MSC we are unable to read AutoCAD 2007 files. If you are sending AutoCAD 2007 files into the MSC please save the file as an earlier version prior to emailing. Another option is to save the file as a PDF and send that as an attachment instead of the AutoCAD file. You can check the version of the AutoCAD file by opening it in Notepad where a code will be given as follows:

AC1015- DWG from AutoCAD 2000/2000i/20002

AC1018- DWG from AutoCAD 2004/2005/2006

AC1021- DWG AutoCAD 2007/2008/2009

Miscellaneous Enclosed Space: The following are considered enclosed spaces: a) Temporary deck equipment with enclosed volume (e.g., housed portable machinery), b) Spaces below cargo hatches of multipurpose vessels which have the facility to trade with cargo hatches open or closed, regardless of the hatch position when the vessel is measured, c) Appendages which have enclosed volume (except for movable items such as rudders which can be considered as unenclosed machinery and thereby ignored from measurement), and d) Uncovered spaces bounded on three sides by bulwarks – or portions of bulwarks – that exceed 5 feet in height.

Tonnage Staff Out of Office: LCDR Bill Weinbecker and Javier Jimenez will be out of the office attending the Workboat Show and on other travel from Dec 1 thru Dec 4. If you have tonnage matters requiring attention during this period, please contact Mr. Peter Eareckson at the MSC.

Measurement Organization Weekly Notes - 11/24/2008

2009 Tonnage Conference: The MSC Tonnage Staff will be hosting a Tonnage Conference in Washington D.C. in May of 2008. Specific dates will follow as conference room reservations become available. The format will be similar to that of the 2008 conference. There is much to be learned from other's experiences. Therefore we are providing an opportunity for conference attendees to make presentations on tonnage related topics at this year's conference. Consider topics that may be of interest to you and others at the conference and contact LCDR Bill Weinbecker to discuss your ideas.

IMO and Third Tonnage Parameter: The IMO Maritime Safety Committee is meeting in London from Wednesday Nov 26th thru Friday Dec 5th. We anticipate that the Committee will approve the SLF recommendation to extend the deadline for the SLF work program item on the third tonnage parameter.

Oversight Nonconformity Corrective Action: Unless otherwise directed by the MSC, the measurement organization shall complete corrective actions within 3 weeks of receipt of results as follows:

Category 1 – Correction at the discretion of the measurement organization. If no correction made within the 3 weeks include a note in the vessel file describing the nonconformity and make corrections the next time the vessel is remeasured and/or the certificate is reissued.

Category 2 – Correction is at the discretion of the measurement organization.

Category 3 – Correct and reissue the associated tonnage certificate. Initiate process to preclude recurrence in the future.

Measurement Organization Weekly Notes - 11/18/2008

Restriction on Excluded Spaces: Under the Convention measurement system a space may not be excluded from gross tonnage if it is fitted with means of securing cargo or stores, has an opening fitted with a means of closure, or has an opening that can otherwise be closed. Refer to the Tonnage Technical Policy section 69.61(g) for details.

Space Open to the Sea: An enclosed space that is open to the sea is an excluded space. The space must be located on the seaward side of the vessel's buoyant hull envelope and must fill with water if the vessel is immersed to the upper deck. There must also be no detrimental effect on the operation of the vessel. Contact the MSC Tonnage Staff with any questions or situations regarding spaces open to the sea.

Measurement Organization Weekly Notes - 11/10/2008

Cargo Tank Measurement: Under the convention measurement system, the volume of independent cargo tanks constructed within the vessel should be calculated to the structural boundary. The calculations must be included in the tonnage file (e.g., tank dimensional data or model geometries). Capacities of cargo tanks supplied by the manufacturer in hold and tank plans cannot be verified and may include a permeability factor for the tanks resulting in inaccurate volumes.

Workboat Show: Two members of the Coast Guard Tonnage Office will be attending the Workboat Show in New Orleans this year. If you have an issue to discuss or just want to talk to a CG Tonnage representative in person, contact LCDR Bill Weinbecker to arrange a meeting.

Measurement Organization Weekly Notes - 11/3/2008

Tonnage File Photos: If you physically measure a vessel (as opposed to obtaining dimension from drawings/computer models), you must develop sketches and/or include scaled photographs that show ALL dimensional information used in the measurement process. Because it is difficult to meet this requirement with sketches alone, photographs are almost always necessary for a "physically measured" vessel. Including photos in the vessel file also helps resolve disputes that may arise in the future over the actual configuration of the vessel at the time of measurement.

Measurement Organization Weekly Notes - 10/27/2008

REDUCED GROSS TONNAGE: Certain vessels assigned tonnage under the convention measurement system may qualify for Reduced Gross Tonnage upon request of the vessel owner. This is intended to encourage favorable economic treatment of vessels whose designs incorporate specific features. A remark must be included on the ITC citing the Reduced Gross Tonnage and referring to the use of such for the “calculation of tonnage based fees.” Vessels with qualifying segregated ballast tanks and open-top containerships are two examples of where Reduced Gross Tonnage might be applicable. MTN 01-99 will be updated to reflect changes approved by the IMO Maritime Safety Committee (MSC Resolution 234(82)) to the reduced gross tonnage formula for open-top containerships.

BULWARK: As defined in MTN 01-99, sect. 69.53, a bulwark is a part of the vessel’s side above the upper deck that serves to protect the upper deck from exposure to the sea. However, structures at the vessel’s side that contain enclosed volume are not considered bulwarks under the convention measurement system. Instead, these structures are considered superstructure spaces.

Measurement Organization Weekly Notes - 10/20/2008

VARIANCE FROM THE PRESCRIBED METHOD OF MEASUREMENT: When applying the convention measurement system to a novel type vessel produces unreasonable or impractical results, the Commandant of the Coast Guard may determine a more suitable method of measurement. A request must be made for a determination of such a situation by submission to the Marine Safety Center Tonnage Division of an explanation of the problem, with included plans and sketches.

OFFSHORE SUPPLY VESSELS: The uncovered deck space on an OSV is not considered an enclosed space under the provisions of section 69.73(a) of the Tonnage Technical Policy, notwithstanding the presence of bulwarks or other enclosing structures that exceed the 5 foot height criteria. The cargo deck is defined as the open space on the main deck aft of the forecastle that is exposed to weather and used for stowage of deck cargo or processing equipment.

Measurement Organization Weekly Notes - 10/6/2008

MR. JIMENEZ JOINS TONNAGE DIVISION: The MSC Tonnage Division has recently added a new staff member to its ranks. Mr. Javier Jimenez has accepted a position as a Tonnage Staff Engineer. Javier hails from New York and has most recently worked in the field of jet engine design associated with the aircraft industry.

WATER BALLAST JUSTIFICATION: Water ballast justification must meet all of the requirements and be approved by a letter issued by the measurement organization and addressed to the submitter. A copy of this letter must be retained in the tonnage file and must contain the following: vessel's name, official number, purpose of water ballast, and ballast tank information. Details can be found in the Tonnage Administrative Policy.

Measurement Organization Weekly Notes - 9/29/2008

ISPS AND ISM CODE INTERIM SCHEMES: There is a 500 gross tonnage threshold in both the ISPS Code (Security) and ISM Code (Management), which are part of SOLAS. These should be applied using a vessel's GT ITC tonnage, regardless of keel laid/substantial alteration date. Note that IMO gave transitional relief in the form of "Interim Schemes" to vessels of other flag States that were using GRT tonnage to apply these thresholds on older grandfathered vessels. However, in the case of ISPS code, the Interim Scheme expired on July 1, 2008, meaning that vessels of all flags must now apply ISPS using GT ITC tonnage (where applicable). The Interim Scheme for ISM Code expires on January 1, 2010.

PRE-1990 VESSEL DIMENSIONS: Dimensions assigned under CFR definitions prior to October 12, 1989 should be shown on the U.S. Tonnage Certificate if the vessel has not undergone changes which affect any of the dimensions or has not been remeasured at the request of the owner to reflect the new definitions. If an ITC is issued with pre-1990 dimensions, those dimensions should be placed in the appropriate blocks with an "X" placed in the corresponding "Registered Dimensions" block.

Measurement Organization Weekly Notes - 9/23/2008

VESSEL NAME CHANGES: Recently, we handled an enforcement issue regarding the validity of an International Tonnage Certificate where the vessel name on the certificate differed from that appearing on all other documents onboard. Under U.S. regulations, a tonnage certificate is not required to be reissued as a result of a name change, although this may be done at the owner's request. For certain vessels, interested parties may verify that a current certificate reflects a vessel's former name if they examine the Continuous Synopsis Record (CSR). The CSR is required on cargo vessels greater than 500 gross tons and passenger vessels carrying more than 12 passengers on international voyages. The CSR contains the ship name and will capture future name changes. The CSR was incorporated in Chapter XI-5 of SOLAS and has been in force since July 2004.

THIRD TONNAGE PARAMETER: As a follow-up to a Weekly Notes item from August, the final SLF 51 report is now posted. As was the case in the earlier draft report, the report recommends an extension of this work program item to 2011. If the extension is endorsed by the Maritime Safety Committee, SLF will establish a Correspondence Group to continue with development of options, "taking into account the potential effects on safety, ship design, human factors, economic and other operational considerations." The report is posted on SNAME's website:

http://www.sname.org/committees/tech_ops/O44/slf51.html

WEINBECKER ON TRAVEL: LCDR Bill Weinbecker is out of the office this week, on a visit to ABS in Houston. He will return on Monday, September 29th. Please refer all tonnage questions to me (Peter Eareckson) in Bill's absence.

Measurement Organization Weekly Notes - 9/15/2008

LRIT TONNAGE APPLICABILITY Earlier this year, the Coast Guard published a final rule requiring certain ships of 300 gross tonnage (ITC) or more to report identifying and position data using a Long Range Information Tracking (LRIT) system. According to the rule, "ships that are exempt from the GMDSS equipment carriage requirements should also be exempt from the LRIT requirements, based on their limited areas of operation". However, questions have arisen regarding LRIT applicability to vessels over 300 GT ITC that do not have GMDSS equipment on board, due to grandfathering using regulatory tonnage. For the time being, refer owners with questions about tonnage applicability of LRIT requirements to the Tonnage Division staff.

VOLUME CALCULATION CONSIDERATIONS: According to the Tonnage Technical Policy the volume calculations made under the convention measurement system must be made on a worksheet and must be sufficiently detailed to permit easy review. If the calculations were performed using computer software, printed output showing a description of all dimensional information upon which volumes are based can be substituted for a worksheet. The precision of the measurements must be to the nearest one-twentieth of a foot (English units), or to the nearest centimeter (metric units).

POST HURRICANE IKE THOUGHTS: Our thoughts and prayers go out to all of those in the Gulf areas affected by the recent Hurricane. We hope that all of our friends and associates fared well and can get back to normal ops before too long. We understand that the ABS Tonnage Staff and families are safe, but in one case suffered the loss of a home, and that ABS Houston will be closed until Wednesday, September 17, 2008.

Measurement Organization Weekly Notes - 8/28/2008

RETENTION OF TONNAGE FILE INFORMATION: Long term records (i.e., tonnage calculations, tonnage certificates, water ballast justification approval letters, and tonnage mark certification records) shall be retained until the Organization's Memorandum of Agreement (MOA) with the Coast Guard is cancelled. All other vessel file material is to be retained for at least one year, or until the organization's MOA with the Coast Guard is cancelled. Additional tonnage file requirements can be found in MTN 01-98 CH-8.

SOLAS INTERIM SCHEME: The SOLAS interim scheme allows certain vessels to use regulatory measurement system tonnages for the application of SOLAS provisions that were in effect on July 18, 1982. Those SOLAS requirements that came into effect after that date must be applied using convention measurement tonnages. Consequently, both the International Management Code for the Safe Operation of Ships and for Pollution Prevention (ISM) and the International Code for Ship and Port Facility Security (ISPS) must be applied to all vessels using convention measurement system tonnages if applicable.

Measurement Organization Weekly Notes - 8/22/2008

IMPROPER CERTIFICATES: A foreign vessel was recently detained while making a U.S. port call for not possessing appropriate international documents. A Captain of the Port (COTP) order was issued stating that the vessel was not to return to U.S. waters until a valid International Tonnage Certificate and International Oil Pollution Prevention (IOPP) Certificate were obtained. A civil penalty of up to \$32,500 could be given for violating this order. Additionally, each day of a continuing violation is considered a separate violation. The violation is considered a Class D felony and could also result in imprisonment for the violator(s).

TONNAGE FILE REQUESTS: Tonnage files may be requested from the Marine Safety Center (MSC) as routine or urgent. Per MTN 01-98, if an urgent request for tonnage file information is made it must be telephoned to the Chief, Tonnage Division, giving an explanation for the immediate need. This request is to be followed by a submission of the request form.

Measurement Organization Weekly Notes - 8/18/2008

THIRD TONNAGE PARAMETER: The draft report from the SLF 51 meeting in July has been posted on IMO's web site. Based on this report, and feedback from our representatives who attended the session, there was considerable discussion in London on this issue, and exhaustive work by a drafting group. The outcome was a recommendation to extend the deadline for completing this item until 2011. If this recommendation is approved by the Maritime Safety Committee, we expect work to resume on this item within about 4 months.

UPDATE TO MTN 01-98: The MSC has commenced work on a long overdue update to MTN 01-98. The update will include streamlining the vessel file request process, and enhancements to requirements related to the vessel remeasurement certification process. We intend to obtain your input on this update before it is published.

Measurement Organization Weekly Notes - 8/11/2008

GMDSS APPLICABILITY: GMDSS stands for Global Maritime Distress and Safety System. The 300 gross tonnage breakpoint for current SOLAS GMDSS applicability predates 18 July 1982, and therefore may be applied using GRT tonnage for older qualifying "grandfathered" vessels (in the same manner as the SOLAS 500 gross tonnage breakpoint is applied for cargo ship safety standards). A GMDSS information bulletin on this subject may be found on the GMDSS Implementations Task Force's main page at <http://www.navcen.uscg.gov/marcomms/Gmdss/gmdsstf.htm>.

TEMPORARY DECK EQUIPMENT AND SUBSTANTIALLY ALTERED: As noted in NVIC 11-93, in most cases the addition or removal of temporary deck equipment does not affect the keel laid/substantially altered date. This is because typically such an action does not involve "alterations or modifications" to the existing vessel in order to accommodate the "deck package". It is important to remember that even if the keel laid/substantially altered date remains unchanged, installing a "deck package" or other temporary deck equipment can result in the need to remeasure the vessel (depending on the size of the associated spaces). Refer to the remeasurement criteria of the NVIC.

REMARKS ON REISSUED CERTIFICATES: Please note there are no "grandfathering" provisions that would permit remarks or other information currently required by MTN 01-98 to be omitted from a reissued tonnage certificate. For example, the required remark concerning a water ballast justification approval letter may not be omitted from a newly issued U.S. Tonnage Certificate merely because the original tonnage certifying document failed to include reference to the letter. If the needed information is not available, call the MSC Tonnage Division for further instructions.

Measurement Organization Weekly Notes - 8/1/2008

SPACES IGNORED FROM VOLUME CALCULATIONS: The following spaces are not included in volume calculations under the convention measurement system: Air trunks less than 1 square meter, Volumes less than 1 cubic meter, Mast-like structures, machinery not enclosed, and appendages not having enclosed volume.

MARKING OF CARGO SPACES: Under the convention measurement system, cargo spaces used in determining volume (V_c) for calculating net tonnage must be at least four inches in height and positioned so as to be visible at all times. This is one of the many items to be verified during the onboard survey.

Measurement Organization Weekly Notes - 7/25/2008

REGISTERED LENGTH FACTOR: If a vessel is fitted with an alternate steering device installed in place of the rudder (e.g., trainable propulsion units, cycloidal propeller, etc.), the centerline of the axis of rotation of the device is considered equivalent to the axis of the rudder stock for the purpose of establishing the registered length. Note: This does not apply to the simplified measurement system.

MEASUREMENT OF CARGO HOLDS: When determining the volume of a cargo space, measurements must be taken without consideration for insulation, sparring, or ceiling fitted within the space. A ceiling is the permanent planking or plating fitted directly on the inboard side of frames, floors, or double bottom and includes cargo battens and refrigeration insulation but does not include false ceiling which stand off from the framing.

Measurement Organization Weekly Notes - 7/18/2008

DECK CARGO: Both NVIC 11-93 and MTN 01-99 define deck cargo as "freight carried on the weather decks of a vessel for the sole purpose of its transport between two separate and distinct locations and which is off-loaded from the vessel in its original container (if applicable) without undergoing any processing or other use while onboard the vessel". Any similar item that does not fully meet this definition is treated as temporary deck equipment.

INTERPRETATIONS: You are reminded to adhere to the interpretations of the latest MTN 01-99 change, except where allowed by the grandfathering provisions of Appendix A of the MTN. The Appendix addresses the process for submitting written requests for grandfathering authorization.

THIS DAY IN HISTORY: On July 18, 1980, Japan acceded to the 1969 Tonnage Convention. Through Japan's action, a sufficient number of nations representing not less than 65% of gross tonnage of the world's merchant shipping had adopted the Convention, triggering the coming into force of the Convention on July 18, 1982, and the "full" coming into force of the Convention on July 18, 1994. You should recognize these latter dates for their importance as breakpoints in applying tonnage grandfathering provisions under the Convention.

Measurement Organization Weekly Notes - 7/11/2008

TONNAGE & PORT STATE CONTROL: At the Tonnage Conference in May 2008, we discussed the guidance in IMO Resolution A.787(19) concerning actions to be taken if a vessel is without a valid ITC or if the vessel characteristics on the ITC do not match the vessel. A correspondence group of the Flag State Implementation Sub-Committee (FSI) of IMO is reviewing this resolution, and is considering changes to strengthen the language about vessels for which a valid ITC is not on board.

SIMPLIFIED APPLICATION WEB PAGE: As part of an ongoing Coast Guard effort to upgrade its web sites, a new web page with a new web address was created for the simplified measurement application (where the Adobe application form that calculates tonnages resides). We are working to ensure all the links to the old address correctly map over to the new. If you are experiencing problems in accessing this page, it would be helpful if you could report them to the Tonnage Division (MSC-4) as soon as practicable.

NON-TRADITIONAL WATERCRAFT: As a second reminder, before measuring a non-traditional watercraft, you **MUST** first contact the MSC (see the letter we sent you in April 2008). The letter defines non-traditional watercraft in this context as those that "either by design or intent will not routinely get underway and/or do not possess the practical capability or equipment for being used as a means of maritime transportation." In 2006, the 5th Circuit Court of Appeals upheld a lower court's ruling that a gaming watercraft that "has not been used as a seagoing vessel since March 28, 2001" is not a "vessel", noting that the watercraft "is indefinitely moored to the land by lines tied to steel pilings" and "receives water, telephone lines, sewer lines, cable television and data processing lines from land-based sources".

Measurement Organization Weekly Notes - 7/3/2008

CONVENTION MOLDED DRAFT: On the back of the International Tonnage Certificate the draft (moulded draught) is assigned as follows:

- 1) For vessels assigned a load line under 46 CFR part 42, 44, 45, or 47 and other vessels where parts 42, 44, 45, 46, or 47 do not apply, but have otherwise been assigned a load line, the draft corresponds to the summer load line
- 2) For passenger vessels assigned a load line under part 46, the draft corresponds to the deepest subdivision load line assigned.
- 3) For vessels where no load line is assigned, but restricted under any Coast Guard requirement, the draft corresponds to the maximum draft permitted under that restriction
- 4) For all other vessels the draft is 75 percent of the molded depth

SPACES INCLUDED IN V_c : The total volume of all cargo spaces (V_c) include the following spaces under the convention measurement system: Clean ballast tanks, slop tanks, fish processing spaces, refrigeration machinery spaces, dual purpose spaces, automobile spaces, passenger service spaces, space in pontoon hatch covers, dock deck areas, cargo spaces temporarily open to the sea, and hoppers on deck barges. See MTN 01-99 for more detail on these spaces and call the Tonnage Division at the Marine Safety Center with any questions or issues.

PREPARATIONS FOR SLF 51: The SLF 51 meeting will take place during the week of July 14th in London. So far, only two papers were submitted on tonnage measurement: the final Correspondence Group report submitted by Australia and a paper submitted by Germany commenting on that report. In summary, the report recommends that an SLF work program item be established to evaluate options for improvements to the TM Convention (two sessions). Comments from the United States participants were incorporated.

Measurement Organization Weekly Notes - 6/27/2008

RESPONSE PLANS AND TONNAGE: The US Coast Guard issued a notice in the Federal Register stating that, effective August 22, it will enforce requirements on nontank vessel response plans (NTVRPs). A nontank vessel is defined as a self-propelled vessel of 400 gross tons or greater, which carries oil as fuel for main propulsion and operates on the navigable waters of the United States (effectively not a tank vessel). The 400 gross ton breakpoint is applied using convention measurement system tonnage (if assigned) and regulatory measurement system tonnage if convention tonnage is not assigned. To avoid NVTRP requirements, an owner may seek to have his/her vessel remeasured under the regulatory system only where allowed by NVIC 11-93 (e.g., a qualifying older "domestic voyage only" vessel).

EMAIL INQUIRIES: As discussed at the Tonnage Conference and described in Tonnage Bulletin 21, an email submitted to the MSC is considered to be a Federal Record, subject to disclosure under the Freedom of Information Act. Further, Commandant policy prohibits use of individual e-mail as a vehicle for establishing policy. We encourage discussion of pertinent issues by telephone, to direct customers to interpretive material already available in the public domain, and/or to ensure an issue is well defined before a written request for a determination is submitted. If a written determination is ultimately required, you may submit the request for a determination electronically via email to the MSC's electronic commerce mailbox (msc@uscg.mil).

INTERNATIONAL TONNAGE CERTIFICATE DATE: Specify the date as defined by the asterisk notation on the certificate. For the definitions of "alterations or modifications of a major character" use the definition of "substantially altered" in NVIC 11-93. Specify the year only unless that year is 1982 or 1994, in which case the day and month must be specified as well.

Measurement Organization Weekly Notes - 6/19/2008

FEES FOR TONNAGE WORK: Measurement organizations may charge fees for the measurement services they perform on behalf of the U.S. Coast Guard. The MSC does not review or control fees charged by the authorized measurement organizations. However, copies of the current schedules of measurement fees and related charges shall be provided to the MSC following any changes to those schedules.

REVISIONS OF CERTIFICATES: Revisions of tonnage certificates are required to reflect remeasurement, the issuance of a new water ballast justification approval letter, and changes in applicability of measurement systems to a given vessel, as well as to correct errors. A revised U.S. Tonnage Certificate must also be issued if a vessel is remeasured solely for the purpose of being issued an ITC.

Measurement Organization Weekly Notes - 6/13/2008

DEFINITION OF PASSENGER: Under the convention measurement system definition, a passenger is a person on board a vessel other than the master, a member of the crew, or other person employed or engaged in any capacity in the business of the vessel; and a child under one year of age. Compensation (e.g., whether or not they are “paying” passengers) is not taken into consideration in determining passenger status.

CANCELLATION OF TONNAGE CERTIFICATES: Tonnage certificates issued under the provisions of MTN 01-98 do not have expiration dates. However, the certificates cease to be valid, and are considered cancelled under the following circumstances:

- 1) If the vessel changes flag state. In this instance the ITC remains valid for three months following the vessel’s flag state change, or until the administration issues a new ITC, whichever comes first. Note: There are no provisions for interim certificates.
- 2) If the vessel is subsequently measured under 46 CFR 69 Subpart E, the simplified measurement system.

SUBSTANTIALLY ALTERED: Refers to the date a substantial alteration was **commenced**. A vessel is considered to have been substantially altered if it undergoes alterations or modifications which result in an increase or decrease of more than 5% in either the regulatory measurement system gross tonnage (if assigned) or the convention measurement system gross tonnage (whether assigned or not).

Measurement Organization Weekly Notes - 6/6/2008

NON-TRADITIONAL WATERCRAFT: As a reminder, before measuring a non-traditional watercraft, you must first contact the MSC (see the letter we sent you in April 2008). The letter defines non-traditional watercraft in this context as those that "either by design or intent will not routinely get underway and/or do not possess the practical capability or equipment for being used as a means of maritime transportation." For example, typically floating drydocks do not "routinely get underway", and therefore fall into the non-traditional watercraft category. **THERE COULD BE SIGNIFICANT LEGAL RAMIFICATIONS IF YOU MEASURE A WATERCRAFT WHICH THE COAST GUARD DEEMS NOT TO MEET THE LEGAL DEFINITION OF "VESSEL".**

CERTIFIED COPIES OF TONNAGE CERTIFICATES: There are four methods to certify copies of tonnage certificates as follows: 1) A statement (e.g., "I certify this to be a true copy of the original") with a signature, date, and title of the authorized representative of the organization, 2) Stamped impression without seal containing words such as "Certified Copy", signed and dated with title of authorized measurement organization representative, 3) Stamp impression containing words as stated in method 2, with official seal of the measurement organization, and 4) Stamped words as stated in method 2 with the paper watermarked, or embossed with the official seal of the measurement organization.

STANDARD SYSTEM FRAMING TERMS: Normal frames are the smallest frames used to stiffen a structure and ordinary frames are the primary floors and frames used for strengthening the hull. A floor is a vertical athwartship plate extending from bilge to bilge. In a wooden vessel, the floor is the lowermost timber connecting the main frames at the keel when that timber extends the full depth of the frames to which it is fastened.

Measurement Organization Weekly Notes - 5/28/2008

RECONCILIATION LETTERS: In the past, Coast Guard field units and, in some cases, classification societies have issued so-called tonnage reconciliation letters. Typically, these documents have sought to explain or amplify GRT grandfathering privileges under international conventions that are being claimed for a qualifying vessel. The need for these documents was largely eliminated with the adoption of IMO Resolutions A.758(18) and MSC/CIRC.654, which provided for tonnage grandfathering remarks to be included, where applicable, on international certificates. Tonnage reconciliation letters have caused, and continue to cause, confusion, and are not authorized by the MSC.

UMS UNITS: We recently provided assistance in a matter involving the use of the expression "UMS Units" in the gross and net tonnage blocks of an International Tonnage Certificate (1969) issued under the authority of another flag State. The expression was meant to refer to the "Universal Measurement System" of the 1969 Tonnage Convention, but ended up causing confusion. We caution that use of the expression "UMS Units" is not authorized on tonnage certificates issued on behalf of the United States.

CERTIFICATE REQUIREMENTS: The original tonnage certificate is provided to the vessel's owner. The original U.S. Tonnage Certificate is not required to be maintained on board the vessel and the original ITC certificate is only required to be maintained on board the vessel if engaged on a foreign voyage. However, even when not required, it is strongly recommended that either the originals, or copies, of all tonnage certificates be maintained on board the vessel at all times.

Measurement Organization Weekly Notes - 5/23/2008

TONNAGE DATA SHEETS: The MSC has developed tonnage data sheets that will be included in future responses to file requests. A sample is attached. These data sheets are intended to provide useful information that resides in MSC and MISLE databases. As indicated on the data sheets, information from these sheets **MUST NOT** be used as the basis for tonnage certification actions unless the accuracy of the information is verified.

TONNAGE OVERSIGHT: The MSC is the Coast Guard's program office for performing tonnage oversight functions. If you are contacted by Coast Guard field personnel who are seeking to perform tonnage oversight on a vessel you have measured (e.g., they request tonnage calculations for review), please immediately refer those requests to the MSC Tonnage Division.

OPEN TO THE SEA Section 69.61(f) of MTN 01-99 provides criteria for evaluating whether a space qualifies as one that is "open to the sea", and therefore eligible for consideration as an excluded space. These criteria include identification of whether the space is outside the vessel's buoyant hull envelope and if it can fill without detrimental effect on the operation of the vessel. As discussed at the 2008 Tonnage Conference, the MSC has at its disposal engineering tools to establish whether a space is open to the sea. If you have any questions on applying criteria related to "open to the sea" exclusions, please contact the MSC Tonnage Division.

Weekly Notes are issued by the Coast Guard Marine Safety Center's Tonnage Division (MSC-4) for use by organizations that perform measurement work on the Coast Guard's behalf. They are for informational purposes only, and are not intended as, nor should they be construed to represent, revisions of or substitutes for applicable statutes or regulations or established interpretations of either.

Measurement Organization Weekly Notes - 5/15/2008

WEEKLY NOTE FORMAT: As a result of the feedback received at the Tonnage Conference, we are going to continue with the Weekly Notes. As an aid to finding topics from the Notes, key words will now be put in the subject block of the e-mails. Another way to search for particular items contained within the weekly notes is to use the search function in Outlook. Also, each year, upon request, we can provide a consolidated searchable document with all the weekly notes issued that year.

2008 TONNAGE CONFERENCE SURVEY RESULTS: We appreciate the valuable input from the conference surveys. In summary, of the 14 measurement organization representatives who attended (8 class society employee/ 6 contractor) 12 rated the conference the highest for overall useful. The workshops for both the convention and standard rules received the highest ratings for the individual sessions (average scores of 2.8 and 2.9 out of 3.0). With several exceptions, attendees favored a 3 day (or longer) format. Varying views were expressed on frequency (most favored annually). A number of areas for improvement were identified, which will be addressed in planning for the next conference.

FILE REQUESTS: Please continue to send your file requests to the MSC's electronic commerce email address: msc@uscg.mil. Although not a requirement, we encourage you to copy the current file request manager (LCDR Weinbecker) on such requests, especially in situations where quick turnarounds are needed. We are looking at making improvements to this process, which time limitations prevented us from addressing at the conference. More to follow on this subject in the near future.

Weekly Notes are issued by the Coast Guard Marine Safety Center's Tonnage Division (MSC-4) for use by organizations that perform measurement work on the Coast Guard's behalf. They are for informational purposes only, and are not intended as, nor should they be construed to represent, revisions of or substitutes for applicable statutes or regulations or established interpretations of either.

Measurement Organization Weekly Notes - 04/29/2008

2008 TONNAGE CONFERENCE: An e-mail containing important conference details has been sent out to all those identified as planning on attending the conference for tonnage measurement in Washington next week. If you know of an employee / contractor of a measurement organization who has not received this information, but is planning on attending the conference, please let the appropriate measurement organization representative know ASAP so that the individual may be included on the invitation list.

CONVENTION MEASUREMENT SYSTEM AND ITCs: As a reminder, only a vessel that is 79 feet and over in convention length may be issued an International Tonnage Certificate 1969 (ITC). A vessel of the United States that is less than 79 feet in convention length may not be issued an ITC under any circumstance (even if it measures over 79 feet in overall length). When issuing an ITC, always check to ensure that the "LENGTH" block shows a dimension of 79.0 feet or greater.

TONNAGE TECHNICAL AMENDMENTS: On April 24th, the House of Representatives adopted the Coast Guard Authorization Act (H.R. 2830), and is forwarding it to the Senate for consideration. It includes technical amendments to the tonnage statute, to eliminate conflicts and inconsistencies and incorporate clarifications, corrections and administrative updates.

Measurement Organization Weekly Notes - 4/18/2008

TONNAGE CONSULTING: Tonnage consulting (giving advice regarding the assignment of tonnage for a fee) may not be performed on a vessel for which the tonnages will be certified by the same measurement organization. More specifically, a measurement organization may not certify tonnages on a vessel for which either an employee of the measurement organization has engaged in tonnage consultation, or for which an employee of a contractor or subcontractor of the measurement organization has engaged in tonnage consulting and also has provided measurement services on the measurement organization's behalf on the same vessel.

SUBSTANTIALLY ALTERED VESSEL: A vessel is considered to have been substantially altered if alterations or modifications resulted in an increase or decrease of more than 5% of gross tonnage in either the regulatory measurement system (if assigned) or the convention measurement system (whether assigned or not). The applicable date of the substantial alteration to the vessel is to be the date on which the alteration commenced.

Measurement Organization Weekly Notes - 4/8/2008

SPECIFYING OFFICIAL NUMBERS: Based on feedback received during a recent NVDC site visit, we wish to emphasize the importance of specifying the official number on tonnage certificates, if an official number is assigned. The NVDC receives many thousands of mail items each week, and uses a highly automated process for scanning and workflow management. Matching tonnage certificates without official numbers to vessels in the database can be problematic, and add to the time required to issue a Certificate of Documentation. Requirements for specifying official numbers on tonnage certificates are found in MTN 01-98, Sections 2.3(b)(2), 2.4(g)(1) and 3.3(b)(2). Please note that owners are required by law to include official numbers (if assigned) on applications for measurement (see 46 CFR 69.55, 69.105 and 69.159, and the corresponding sections in MTN 01-99).

PSIX: As most of you know, the publicly available PSIX system is a good source for vessel information, including official numbers. This system pulls vessel information from a copy (updated daily) of the Coast Guard's MISLE database. MISLE is the source of information printed on the CODs, including tonnages and dimensions. A link to PSIX follows: <http://psix.uscg.mil/PSIX/PSIXSearch.aspx>

PSIX SEARCH TIPS: To find vessels in PSIX, be sure to make full use of the PSIX wildcard (the "%" character). For example, in trying to find a vessel that someone tells you is named the "MR. BUCK", you might want to enter the following search "%MR%BUCK%". Otherwise, you might miss the vessel you were looking for (in this example, the name in MISLE is the "MR BUCK", formerly the "M/V MR BUCK", formerly the "MR. BUCKY"). Note also that you may search for a vessel's hull identification number (HIN), or a fragment thereof, in the Hull Number field. For example, you can find all 1985 model year Hatteras Yachts in the database by searching on "HAT%85" in the Hull Number field.

Measurement Organization Weekly Notes - 3/31/2008

LINK TO MARINE SAFETY CENTER HOME PAGE The Marine Safety Center's homepage is located on the Coast Guard's Homeport system. You can set up a shortcut on your computer and save time while accessing important tonnage information located on the MSC homepage by using the following link:
<http://homeport.uscg.mil/mycg/portal/ep/channelView.do?channelId=-24502&channelPage=%2Fep%2Fchannel%2default.jsp>

MEASUREMENT OF VESSELS OF WAR Vessels of war are not eligible for admeasurement by tonnage measurement organizations. This includes U.S. Navy warships and auxiliaries not operated by the Military Sealift Command, and Coast Guard cutters and boats. Military Sealift Command ships, even though they may perform similar functions to vessels of war, are eligible to be admeasured the same as commercial vessels.

OPEN VESSEL MEASUREMENT The 50 foot length cutoff of Section 69.109(o)(3) of MTN 01-99 may have a significant impact on assigned tonnages, as it could cause an otherwise "closed" vessel to be measured as an open vessel. This comes into play especially in the case of fishing vessels, whose owners may be seeking a low net tonnage assignment (e.g., less than 5 net tons).

Measurement Organization Weekly Notes - 3/25/2008

LINE OF THE UPPER DECK: According to MTN 01-99 CH-7 and in reference to the convention measurement system, discontinuities in the upper deck must be greater than one meter in length and must extend from side to side of the vessel to establish the line of the upper deck. Additionally, if the discontinuities are outside the boundaries of the registered length, they do not affect the line of the upper deck. This is important because the line of the upper deck is a critical factor in determining the molded depth.

AUTHORITY FOR MAKING INTERPRETATIONS: As a reminder, the Marine Safety Center is responsible for "approval of issues involving interpretation of, equivalency to, or exemption from a relevant policy or standard" (MTN 04-03 CH-1). If you have even the slightest doubt about something you've encountered, give us a call and we can discuss it.

IMO TONNAGE CORRESPONDENCE GROUP: The tonnage correspondence group is finalizing its report on the development of options to improve the effect on ship design and safety of the 1969 TM Convention. This report is being prepared for the SLF 51 meeting in July.

Measurement Organization Weekly Notes - 3/17/2008

DEFINITION OF VESSEL A 2005 Supreme Court ruling (Willard Stewart v. Dutra Construction Company) addressed the definition of the term "vessel". Under this ruling, one determinant of qualification of a watercraft as a "vessel" is whether it has been permanently moored or otherwise rendered practically incapable of transportation or movement. If you have any question on whether a watercraft qualifies as a "vessel" eligible for tonnage measurement, please notify us at the USCG Marine Safety Center Tonnage Division to discuss.

SIMPLIFIED MEASUREMENT FORM A new electronic form, Application for Simplified Measurement (CG-1261), is available to owners applying for measurement under the simplified measurement system. The form calculates gross and net tonnages from owner furnished input. The form can be accessed on the Coast Guard's Homeport Webpage under the Marine Safety Center Tonnage Section.

ORIGINAL ITCs: U.S. tonnage regulations do not require the U.S. Tonnage Certificate to be maintained on board the vessel. However, the regulations do require that the International Tonnage Certificate (1969) be maintained on board the vessel when it is engaged on a foreign voyage (46 CFR 69.69). An IMO Circular (MSC-MEPC.4/Circ1 dated 26 September 2005) stressed the importance of maintaining ORIGINAL international convention documents on board.

Weekly Notes are issued by the Coast Guard Marine Safety Center's Tonnage Division (MSC-4) for use by organizations that perform measurement work on the Coast Guard's behalf. They are for informational purposes only, and are not intended as, nor should they be construed to represent, revisions of or substitutes for applicable statutes or regulations or established interpretations of either.

Measurement Organization Weekly Notes - 3/11/2008

AMEND TM CONVENTION At a SOLAS (SLF) Working Group meeting to be held on April 30, 2008 at USCGHQ in Washington DC, the group will discuss the proposal to introduce a third tonnage parameter based on "maritime real estate" principles (length x breadth x summer draught). The U.S. has raised objections to "maritime real estate", due to the consequences that it could have on ship designs. Several alternative options to improve the Convention have been proposed within the Tonnage Correspondence Group. The U.S. supports the draft recommendation of the Correspondence Group that the work item be extended to allow a thorough evaluation of the options.

TEMPORARY DECK EQUIPMENT Measurement organizations are reminded that temporary deck equipment which has enclosed volume (e.g., processing tanks, seismic trailers, housed portable equipment) is included in tonnage, regardless of the method of attachment. For information on treatment of temporary deck equipment, refer to Sections 69.53 and 69.59(b) of MTN 01-99, and the definitions of "Substantially Altered" and "Temporary Deck Equipment" of NVIC 11-93.

24 METERS (79 FEET) The applicability of tonnage rules is dependent on many factors – one of them is vessel length. For example, NVIC 11-93 gives a cut-off length (overall and convention) as "24 meters (79 feet)" for certain regulations, laws, and conventions. However, a vessel's overall length could be greater than 24 meters and less than 79 feet. If you encounter a vessel that falls within this narrow band of length please notify us at the USCG Marine Safety Center Tonnage Division to discuss applicability.

Measurement Organization Weekly Notes - 3/4/2008

INTRODUCTION: This is the first of a series of weekly emails intended to provide authorized measurement organizations with lessons learned and other information of a general nature that can help improve the quality of the tonnage measurement services they provide. At the 2008 Tonnage Measurement Conference, we will solicit input concerning the usefulness of these emails, along with suggestions for any changes to the scope and/or format. The Weekly Notes supplement, but not replace, Tonnage Bulletins, which will continue to be used to notify measurement organizations of important developments.

PROVISIONAL TONNAGE CERTIFICATES: The U.S. recently informed another flag state of a tonnage violation involving a "provisional" International Tonnage Certificate (ITC). In this case, the other flag state issued a "provisional" ITC, when the tonnage recertification process could not be completed within the 3 month "grace" period following flag transfer. The owner presented this "provisional" ITC to U.S. boarding officials, in lieu of a valid ITC. The U.S. does not recognize such "provisional" certificates.

STCW INTERIM SCHEME: A recently issued tonnage certificate reportedly included a reference to the STCW interim scheme, IMO Resolution A.540(13), in addition to other Interim Schemes, in the remarks block. With the full coming into force of the 1995 Amendments to STCW, use of regulatory tonnage for applying STCW is no longer authorized. Accordingly, reference to IMO Resolution A.540(13) should NOT appear in the grandfathering remark of any recently issued (or reissued) International Tonnage Certificate.

REGISTERED LENGTH AND MULTIHULLS: Measurement organizations are reminded that in establishing the registered length of a multihull vessel under the convention measurement system, the simplified measurement system definition for registered length (which is an overall length measurement) is used. Refer to Section 69.203 of the MTN for the definition of a multihull vessel in this context.

TONNAGE THRESHOLDS IN ILO CONVENTIONS: The 2006 Maritime Labor Convention and 2007 Work in Fishing Convention include a number of new tonnage-based thresholds relating to accommodation and recreational facilities. These include thresholds at 200 and 3000 GT ITC for cargo ships and 75 GT ITC and 950 GT ITC for fishing vessels. Neither of these conventions have yet come into force.

Weekly Notes are issued by the Coast Guard Marine Safety Center's Tonnage Division (MSC-4) for use by organizations that perform measurement work on the Coast Guard's behalf. They are for informational purposes only, and are not intended as, nor should they be construed to represent, revisions of or substitutes for applicable statutes or regulations or established interpretations of either.