

Marshall-Tufflex

PVC-U General Trunking

CI/SfB
(62) In6



www.marshall-tufflex.com



PVC-U General trunking from Marshall-Tufflex

A range of high-quality general trunking systems for a variety of installations within commercial, healthcare, education and domestic environments. These include Conduit, Sterling Profile 1, 2 and 3, Mini Trunking and Maxi Trunking;

- Sterling Profile systems provide installers with popular and stylish looking perimeter dado and skirting trunking options.
- Maxi Trunking offers the installer a mid-size feeder and distribution trunking that can be sub-divided to carry power and data.
- Mini Trunking provides an economical feeder trunking system.
- Round and oval PVC-U conduit and fittings.



Contents	page
Environmental	3
Conduit	4-9
Mini Trunking	10-15
Maxi Trunking	16-19
Sterling Profile	20-24
Additional features	25

MARSHALL-TUFFLEX

Marshall-Tufflex manufactures and supplies a comprehensive range of PVC-U perimeter trunking systems to ensure that, whatever the building design and specification, we will always have a product fit for purpose.

Marshall-Tufflex is the UK's leading manufacturer and supplier of cable management systems and our manufacturing facilities are based here in Britain. We are dedicated to achieving high service levels and reacting quickly to your requirements. Our network of sales engineers is supported in-house by our technical and design teams to ensure you receive immediate assistance and complete peace of mind.



Environmental



Marshall-Tufflex actively pursues a comprehensive programme to develop material formulations based on environmentally acceptable materials, whilst still maintaining and, where possible, improving on long-term performance properties.

Jim Fletcher, Managing Director

Carbon assessment

The Carbon Trust was set up by Government in 2001 as an independent company. Their mission is to accelerate the move to a low carbon economy by working with organisations to reduce carbon emissions and develop commercial low carbon technologies.

Marshall-Tufflex was assessed by the Carbon Trust in 2007 and received an excellent report.

Sustainability

Conduit, Sterling Profile, Maxi and Mini Trunking are manufactured from PVC-U. This material is 100% recyclable and has an excellent Fire Performance.

(See BEAMA report on www.beamainstallation.org.uk > technical bulletins)

RECYCLING

Marshall-Tufflex is active in and financially supports various industry bodies in driving the industry forward in the use and control of PVC-U based materials, with the aim of increasing awareness and use of recycled material.



Certificate No. Q05393
Registration
BS EN ISO 9001:2008

Quality Management Systems:

Marshall-Tufflex is totally committed to quality and customer satisfaction and the Company is recognised by the British Standards Institution as a firm of Assessed Capability to BS EN ISO 9001:2008.



Certificate No. EMS 539245
Registration
BS EN ISO 14001:2004

Environmental Management Systems:

Marshall-Tufflex is totally committed to achieving high environmental standards. The Company is recognised by the British Standards Institution as a firm of Assessed Capability to BS EN ISO 14001:2004.

Marshall-Tufflex and Vinyl 2020

The company continues to support the Voluntary Commitment to the European Commission with its ongoing Vinyl 2020 programme.

Conduit

PVC-U Round conduit and fittings are made from recyclable PVC-U.

Product information

CONDUIT

- Light or heavy gauge options
- Exceeds BS and EN standards

BOXES

- Provision for MET1 brass earth terminal
- Meet requirements for BS 4607, BS EN 50086 and BS EN 61386 where applicable
- All boxes have brass inserts

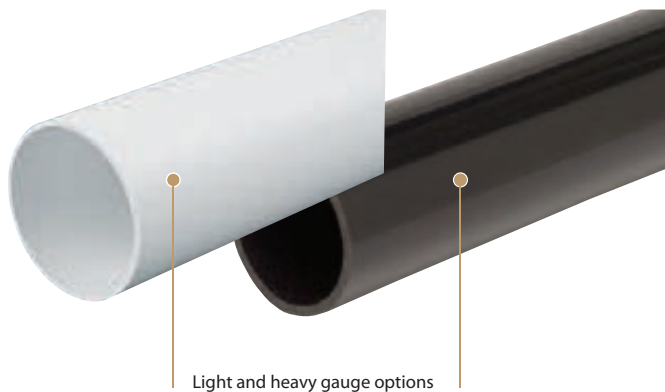

Light and heavy gauge options

Light & heavy gauge



Light gauge



Heavy gauge

Prod Code	O.D	Pack
CR2WH	20mm	30 x 3m
CR3WH	25mm	30 x 3m
CR4WH	32mm	10 x 3m
CR9WH	38mm	10 x 3m
CR10WH	50mm	10 x 3m

Prod Code	O.D	Pack
CR6WH	20mm	30 x 3m
CR7WH	25mm	30 x 3m
CR8WH	32mm	10 x 3m
CR11WH	38mm	10 x 3m
CR12WH	50mm	10 x 3m

For black replace the last two letters of the code with BK.

STANDARD COLOUR

WH	White
BK	Black

Round conduit fittings



Expansion couplers



Straight couplers



Reducers

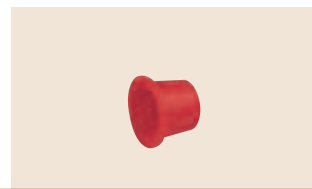

Plastic plugs - red only
(for heavy gauge conduit)

Prod Code	Size	Pack
MEC2WH	20mm	25
MEC3WH	25mm	10
MEC4WH	32mm	10
MEC5WH	38mm	10
MEC6WH	50mm	5

Prod Code	Size	Pack
MC2WH	20mm	100
MC3WH	25mm	50
MC4WH	32mm	25
MC5WH	38mm	10
MC6WH	50mm	10

Prod Code	Size	Pack
MR2WH	25 x 20mm	50

Prod Code	Size	Pack
MPP2	20mm	100
MPP3	25mm	100
MPP4	32mm	50
MPP5	38mm	50
MPP6	50mm	50

Should be fitted over a clear gap between two round rigid conduits.



Inspection elbows



Inspection bends

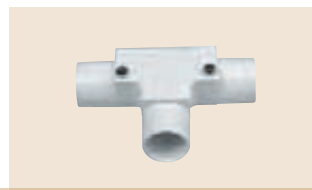

Inspection tees

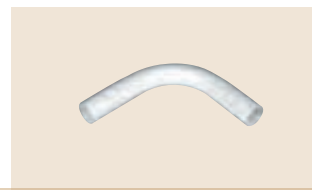

Plain bends

Prod Code	Size	Pack
MIE2WH	20mm	20

For 25mm size use Inspection bend

Prod Code	Size	Pack
MIB2WH	20mm	20
MIB3WH	25mm	20

Prod Code	Size	Pack
MIT2WH	20mm	20
MIT3WH	25mm	20

Prod Code	Size	Pack
MNB2WH	20mm	25
MNB3WH	25mm	10
MNB4WH*	32mm	20
MNB5WH*	38mm	5
MNB6WH*	50mm	2

*Couplers required.

Round conduit fittings



Adaptors (Female thread)

Prod Code	Size	Pack
MAB2WH	20mm	100
MAB3WH	25mm	50
MAB4WH	32mm	25
MAB5WH	38mm	15
MAB6WH	50mm	10



Adaptors (Male thread)

Prod Code	Size	Pack
MA7WH	20mm	100
MA8WH	25mm	50



Adaptors (Clip-in spout)

Prod Code	Size	Pack
MCA2WH	20mm	100
MCA3WH	25mm	50



Male bushes

Prod Code	Size	Pack
MMB2WH	20mm	100
MMB3WH	25mm	100
MMB4WH	32mm	25
MMB5WH	38mm	10
MMB6WH	50mm	10



Threaded lockrings

Prod Code	Size	Pack
MLR2WH	20mm	100
MLR3WH	25mm	50



Round 'U' clips

Prod Code	Size	Pack
MMC2WH	20mm	100
MMC3WH	25mm	50
MMC4WH	32mm	25



Strap saddles

Prod Code	Size	Pack
MSS2WH	20mm	100
MSS3WH	25mm	100
MSS4WH	32mm	50
MSS5WH	38mm	25
MSS6WH	50mm	25



Spacer bar saddles

Prod Code	Size	Pack
MSB2WH	20mm	100
MSB3WH	25mm	100
MSB4WH	32mm	50
MSB5WH	38mm	10
MSB6WH	50mm	10



Spacer bar snap saddle

Prod Code	Size	Pack
MSB2WH	20mm	100



Threaded cable gland

Prod Code	Size	Cable size	Pack
MCG2WH	20mm	ø7-10.5	100
MCG2AWH	20mm	ø4-7	25
MCG3WH	25mm	ø8-13	25
MCG3AWH	20mm	ø12-18	25
MCG4WH	32mm	ø18-24	10



Locknut (for use with cable gland)

Prod Code	Size	Pack
MLN2WH	20mm	100
MLN3WH	25mm	25
MLN4WH	32mm	10



Plain body cable gland

Prod Code	Size	Cable size	Pack
MCGP2WH	20mm	ø7-10.5	25
MCGP2AWH	20mm	ø4-7	25



Conduit to mini adaptor

Prod Code	Size	Pack
TAC1/2WH	MMT1/20mm round	20

Circular boxes & fittings



Loop-in boxes

Prod Code	Size	Pack
0MRB12WH	plain	20
2MRB12WH	4 x ø20mm KO	20
3MRB12WH	4 x ø25mm KO	20



Terminal

Prod Code	Size	Pack
2MRB2WH	20mm	20
3MRB2WH	25mm	20



Through

Prod Code	Size	Pack
2MRB3WH	20mm	20
3MRB3WH	25mm	20

Circular boxes
 PVC-U plain bored circular boxes are suitable for suspending loads of up to 3kg centrally at 60°C maximum. Fixing centres are at 50.8mm and fitted with M4 brass inserts.



Angle

Prod Code	Size	Pack
2MRB4WH	20mm	20
3MRB4WH	25mm	20



Tee

Prod Code	Size	Pack
2MRB5WH	20mm	20
3MRB5WH	25mm	20



4-way

Prod Code	Size	Pack
2MRB6WH	20mm	20
3MRB6WH	25mm	10



Branch 2-way or U

Prod Code	Size	Pack
2MRB13WH	20mm	20
3MRB13WH	25mm	20



Branch 3-way or Y

Prod Code	Size	Pack
2MRB14WH	20mm	20
3MRB14WH	25mm	20



Twin through way or H

Prod Code	Size	Pack
2MRB15WH	20mm	20
3MRB15WH	25mm	10



Back outlet

Prod Code	Size	Pack
2MRB1WH	20mm	20
3MRB1WH	25mm	10



Terminal/back outlet

Prod Code	Size	Pack
2MRB7WH	20mm	20
3MRB7WH	25mm	10



Through/back outlet

Prod Code	Size	Pack
2MRB8WH	20mm	20
3MRB8WH	25mm	10



Angle/back outlet

Prod Code	Size	Pack
2MRB9WH	20mm	20
3MRB9WH	25mm	10



Tee/back outlet

Prod Code	Size	Pack
2MRB10WH	20mm	20
3MRB10WH	25mm	10



4-way/back outlet

Prod Code	Size	Pack
2MRB11WH	20mm	20
3MRB11WH	25mm	10



Circular rubber gasket

Prod Code	Size	Pack
MKG1BK	66mm diam	100

** Black only



Circular lids

Prod Code	Size	Pack
MCL1WH	Flush fitting 65mm diam	100
MCL2WH	Overlapping 85mm diam	100



Brass earthing terminal

Prod Code	Size	Pack
MET1	15Amp	100

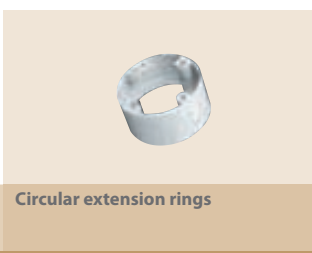

Circular extension rings

Prod Code	Size	Pack
MER1WH	12mm	20
MER2WH	20mm	20
MER3WH	25mm	20
MER4WH	32mm	20
MER5WH	38mm	10

Circular Extension Rings have two lugs fitted with M4 brass inserts and two plain bored lugs.

Square adaptable boxes



Terminal

Prod Code	Size	Pack
4SJB1WH	32mm	1
5SJB1WH	38mm	1

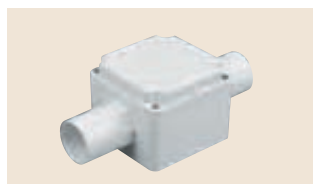

Through

Prod Code	Size	Pack
4SJB2WH	32mm	1
5SJB2WH	38mm	1

Square boxes

PVC-U square adaptable boxes have 32mm or 38mm entries. Boxes have a 75 x 75 x 60mm internal size.



***Conduit solvent cement**
code _____ pack _____
MSC20 1x250ml
*Child resistant lid

HEALTH & SAFETY DATA SHEETS ARE AVAILABLE FROM THE MARSHALL TUFFLEX WEBSITE www.marshall-tufflex.com AND IN THE INTEREST OF SAFETY THE SOLVENT CEMENTS ARE REGISTERED WITH THE NATIONAL POISON INFORMATION SERVICE

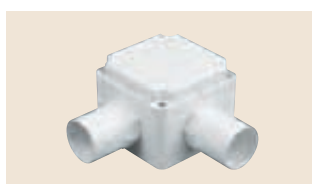

Angle

Prod Code	Size	Pack
4SJB3WH	32mm	1
5SJB3WH	38mm	1



Tee

Prod Code	Size	Pack
4SJB4WH	32mm	1
5SJB4WH	38mm	1



Four-way

Prod Code	Size	Pack
4SJB5WH	32mm	1
5SJB5WH	38mm	1

Accessories



Bended spring Heavy gauge (green end)

Prod Code	Size	Pack
MBSH2	20mm	1
MBSH3	25mm	1
MBSH4	32mm	1
MBSH5	38mm	1
MBSH6	50mm	1



Bended spring Light gauge (white end)

Prod Code	Size	Pack
MBSL2	20mm	1
MBSL3	25mm	1
MBSL4	32mm	1
MBSL5	38mm	1
MBSL6	50mm	1



Nylon draw tape

Prod Code	Pack
MDT10	1 x 10
MDT20	1 x 20
MDT30	1 x 30



Cheese head screws

Prod Code	Pack
M4 x 8mm	200
M4 x 12mm	200
M4 x 20mm	100
M4 x 25mm	100



Channel (white only)

Prod Code	Size	Pack
ECC21WH	13 x 8mm	50 x 2m
ECC22WH	25 x 9mm	50 x 2m
ECC23WH	38 x 9mm	50 x 2m

Corrugated conduit

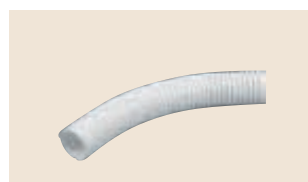

Corrugated conduit (PVC-U) (white)

Prod Code	O.D	Pack
CC2000WH	20mm	1 x 50mm
CC2000BK	20mm	1 x 50mm
CC2500WH	25mm	1 x 50mm
CC2500BK	25mm	1 x 50mm

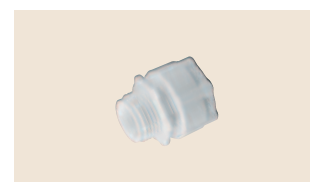

Straight adaptors (nylon)

Prod Code	Size	Pack
CC2010WH	20mm	25
CC2010BK	20mm	25
CC2510WH	25mm	25
CC2510BK	25mm	25

Surface mounted

											
1 gang – square corners			2 gang – square corners			1 gang – radius corners			2 gang – radius corners		
Prod Code	Size	Pack	Prod Code	Size	Pack	Prod Code	Size	Pack	Prod Code	Size	Pack
*MSSB10KWH	32mm	20	*MSSB11KWH	32mm	20	MSSB19KWH	32mm	20	MSSB48KWH	28mm	10
MSSB17KWH	44mm	10	MSSB23KWH	44mm	5	MSSB46KWH	28mm	20	MSSB21KWH	32mm	10
						MSSB40KWH	44mm	10	MSSB41KWH	44mm	5

*All standard surface boxes have 20mm KOs except MSSB10K and MSSB11K which have 20mm pre-punched holes.

Flush mounted

								
1 gang – adjustable lug			1 gang – fixed lug			2 gang – adjustable lug		
Prod Code	Size	Pack	Prod Code	Size	Pack	Prod Code	Size	Pack
MSSB25WH	25mm	20	MSSB2WH	35mm	12	MSSB3WH	35mm	6
MSSB25WH	35mm	12						
MSSB25WH	47mm	10						

Entries: 2 x ø20mm on each of 3 sides (MSSB25) Entries: 2 x ø20mm on each of 4 sides (MSSB1 and MSSB47)

Entries : 2 x ø20mm on each of 4 sides.







Entries : 4 x ø20mm on horizontal sides, 2 x ø20mm on vertical sides.

Surface and flush mounted boxes

Surface mount boxes
 1 gang = 87 x 87mm with 60.3 fixing centres
 2 gang = 147 x 87mm with 120.6 fixing centres

Flush mount boxes
 1 gang = 74 x 74mm with 60.3 fixing centres
 2 gang = 134 x 74mm with 120.6 fixing centres

Cover plates

											
1 gang – flat			1 gang – raised			Flush mounted 1 gang cover – clip-on			2 gang – flat		
Prod Code	Size	Pack	Prod Code	Size	Pack	Prod Code	Size	Pack	Prod Code	Size	Pack
MSCP2WH	2mm	20	MSSP10WH	9mm	10	MSCP1WH	5.3mm	20	MSCP3WH	2mm	10
Size: 86 x 86mm O/A.			Size: 85 x 85mm O/A.			Size: 78 x 78mm O/A.			Size: 86 x 146mm O/A.		
											
2 gang – raised			Brass earthing terminal								
Prod Code	Size	Pack	Prod Code	Size	Pack						
MSSP20WH	9mm	2	MET1	15Amp	100						
Size: 85 x 145mm O/A.											

PVC-U Oval conduit and fittings are typically used to protect cables buried in shallow voids or chased into walls.

Product information

- Low depth conduit
- PVC-U conduit is a recyclable material
- PVC-U is a non-flame propagating material
- The range exceeds BS and EN standards

STANDARD COLOUR	
WH	White



Oval conduit and fittings



Prod Code	O.D	Dimensions	Pack
ECO16WH	13mm	13 x 8mm	50 x 3mm
ECO17WH	16mm	16 x 10mm	50 x 3mm
ECO18WH	20mm	23 x 11mm	50 x 3mm
ECO19WH	25mm	29 x 11mm	20 x 3mm
ECO20WH	32mm	32 x 11mm	20 x 3mm



Prod Code	Size	Pack
MOC1WH	13mm	100
MOC2WH	16mm	100
MOC3WH	20mm	100
MOC4WH	25mm	100
MOC5WH	32mm	100



Prod Code	Size	Pack
MOCSS20WH	20mm	50
MOCSS25WH	25mm	50



Prod Code	Size	Pack
MOCB20WH	20mm	25
MOCB25WH	25mm	25



Prod Code	Size	Pack
MOCC20WH	20mm	25
MOCC25WH	25mm	25



Prod Code	Size	Pack
MOR2WH	20mm oval/ø20mm	50

Flush & Surface mounted boxes



Prod Code	depth	Pack
MSSB6WH	16mm	20

Entries: 2 x 16mm oval for ECO17,
1 x 20mm oval for ECO18.
O/D = 74 x 74mm Fixing centre: 60.3mm



Prod Code	depth	Pack
MSSB1S0WH	35mm	12

Entries: 1 x 20mm oval for ECO18,
1 x 25mm oval for ECO19.
O/D = 74 x 74mm Fixing centre: 60.3mm



Prod Code	depth	Pack
MSSB3S0WH	35mm	6

Entries: 1 x 20mm oval for ECO18,
1 x 25mm oval for ECO19.
O/D = 134 x 74mm Fixing centre: 120.6mm



Prod Code	depth	Pack
MSSB7WH	19mm	20

Entries: 1 x 16mm oval in top for surface entry.
O/D = 87 x 87mm
Fixing centre: 60.3mm



Prod Code	depth	Pack
MSSB12WH	25mm	20

Entries: 2 x 16mm oval in top for surface entry.
O/D = 87 x 87mm Fixing centre: 60.3mm

Mini trunking

Mini trunking is an economical feeder trunking system with easy accessibility for wiring and re-wiring.

Product information

- A variety of sizes from 10 x 8mm to 75 x 16mm
- Single or divided compartment options
- Self-fix systems available

Data information

- 50mm radius fittings available for MMT4

STANDARD COLOUR	
WH	white

Options: optional colours and finishes are available but these may be subject to minimum quantity orders and longer lead times. For more information contact the Technical Team on 01424 856688.

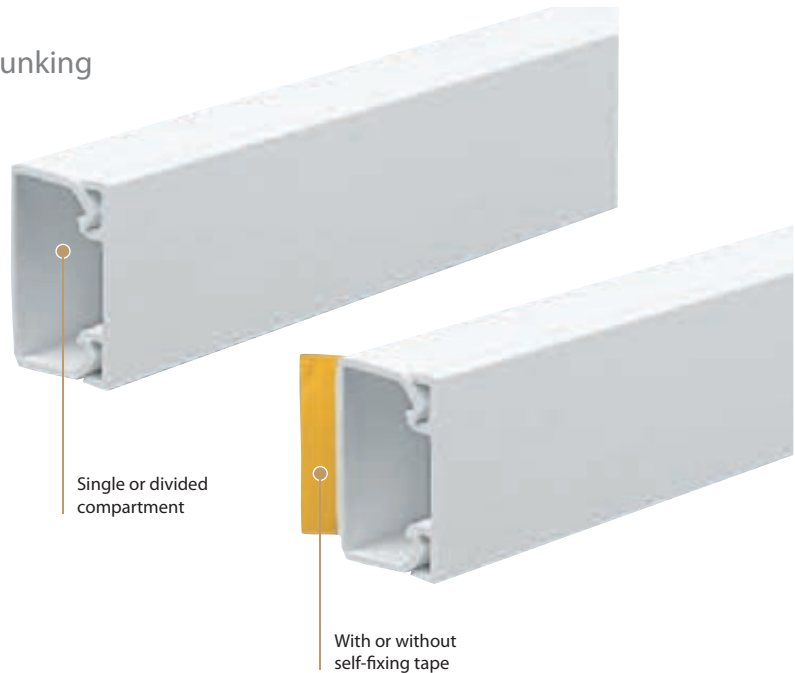

Standard profiles



MMT0

Prod Code	Size	Pack
MMT0WH	16 x 10mm	40 x 3m



MMT1

Prod Code	Size	Pack
MMT1WH	16 x 16mm	30 x 3m



MMT2

Prod Code	Size	Pack
MMT2WH	25 x 16mm	30 x 3m



MMT3

Prod Code	Size	Pack
MMT3WH	38 x 16mm	15 x 3m



MMT3C

Prod Code	Size	Pack
MMT3CWH	38 x 16mm	15 x 3m



MMT4

Prod Code	Size	Pack
MMT4WH	38 x 25mm	15 x 3m



MMT4C

Prod Code	Size	Pack
MMT4CWH	38 x 25mm	15 x 3m



MMT5

Prod Code	Size	Pack
MMT5WH	50 x 25mm	12 x 3m



MMT6

Prod Code	Size	Pack
MMT6WH	38 x 38mm	12 x 3m



MMT7

Prod Code	Size	Pack
MMT7WH	75 x 16mm	12 x 3m

Self fixing profiles



MMT00SF

Prod Code	Size	Pack
MMT00SFWH	10 x 8mm	40 x 3m



MMT0SF

Prod Code	Size	Pack
MMT0SFWH	16 x 10mm	40 x 3m



MMT1SF

Prod Code	Size	Pack
MMT1SFWH	16 x 16mm	30 x 3m



MMT2SF

Prod Code	Size	Pack
MMT2SFWH	25 x 16mm	30 x 3m



MMT3SF

Prod Code	Size	Pack
MMT3SFWH	38 x 16mm	15 x 3m



MMT4SF

Prod Code	Size	Pack
MMT4SFWH	38 x 25mm	15 x 3m

Components



Ceiling rose adaptor

Prod Code	Size	Pack
TCR2WH	2 KO. for MMT1	10
	2 KO. for MMT2	

Designed to accept all popular makes of ceiling rose. Supplied with fixing screws. Fixing centres 50.8mm. Internal depth 12mm. External diameter 81mm.



Surface box adaptors MMT0/1/2/3

Prod Code	Size	Pack
TA0WH	MMT0	50
TA1WH	MMT1	50
TA2WH	MMT2	50
TA3WH	MMT3	50

TAO fits MMT1 - KO



Tapered adaptors
MMT1 & 2 to fit TA3 aperture

Prod Code	Size	Pack
TA3/1LHWH	MMT1	20
TA3/1RHWH	MMT1	20
TA3/1CWH	MMT1	20
TA3/2LHWH	MMT2	20
TA3/2RHWH	MMT2	20
TA3/2CWH	MMT2	20



Conduit to mini adaptor

Prod Code	Size	Pack
TAC1/2WH	MMT1/20mm round	20

Self fixing capping

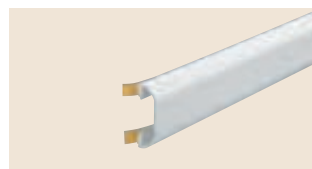

Capping

Prod Code	Size	Pack
14000SFWH	29.5 x 10mm	10 x 3m



Capping

Prod Code	Size	Pack
14010SFWH	41.5 x 12.5mm	10 x 3m

Mini trunking fittings chart

		Couplers		End caps		Internal bends		External bends		Flat angles	
		External coupler		End cap		Square internal bend		Square external bend		Square angle	
											
<u>MMT00SFWH</u> 10 x 8mm		-	-	-	-	-					
<u>MMT0WH</u> <u>MMT0SFWH</u> 16 x 10mm		-	-	-	-	-					
<u>MMT1WH</u> <u>MMT1SFWH</u> 16 x 16mm		TC1WH Pack 40	TEC1WH Pack 100	TIB1WH Pack 50	TEB1WH Pack 50	TFB1WH Pack 60					
<u>MMT2WH</u> <u>MMT2SFWH</u> 25 x 16mm		TC2WH Pack 40	TEC2WH Pack 100	TIB2WH Pack 30	TEB2WH Pack 30	TFB2WH Pack 30					
<u>MMT3WH</u> <u>MMT3SFWH</u> 38 x 16mm		TC3WH Pack 25	TEC3WH Pack 50	TIB3WH Pack 25	TEB3WH Pack 25	TFB3WH Pack 25					
<u>MMT3CWH</u> 38 x 16mm		TC3WH Pack 25	TEC3WH Pack 50	TIB3WH Pack 25	TEB3WH Pack 25	TFB3WH Pack 25					
<u>MMT4WH</u> <u>MMT4SFWH</u> 38 x 25mm		TC4WH Pack 25	TEC4WH Pack 30	TIB4WH Pack 25	TEB4WH Pack 25	TFB4WH Pack 20					
<u>MMT4CWH</u> 38 x 25mm		TC4WH Pack 25	TEC4WH Pack 30	TIB4WH Pack 25	TEB4WH Pack 25	TFB4WH Pack 20					
<u>MMT5WH</u> 50 x 25mm		TCSWH Pack 20	TECSWH Pack 20	TIB5WH Pack 20	TEB5WH Pack 20	TFB5WH Pack 20					
<u>MMT6WH</u> 38 x 38mm		TC6WH Pack 10	TEC6WH Pack 20	TIB6WH Pack 10	TEB6WH Pack 10	TFB6WH Pack 10					
<u>MMT7WH</u> 75 x 16mm		-	-	-	-	-					

Tees

Square equal tee

Square unequal tee

Ceiling tee

Offset ceiling tee

Angle tee



-	-	-	-	-
-	-	-	-	-
TT1-1WH Pack 20	-	TCT1/1WH Pack 10	-	-
TT2-2WH Pack 30	TT2-1WH Pack 30	TCT2/1WH TCT2/2WH Pack 10	TOCT2/1WH TOCT2/2WH Pack 10	TAT2LHWH TAT2RHWH Pack 10
TT3-3WH Pack 25	TT3-1WH TT3-2WH Pack 20	-	-	-
TT3-3WH Pack 25	TT3-1WH TT3-2WH Pack 20	-	-	-
TT4-4WH Pack 20	TT4-1WH TT4-2WH TT4-3WH Pack 20	TCT4/1WH TCT4/2WH Pack 10	-	-
TT4-4WH Pack 20	TT4-1WH TT4-2WH TT4-3WH Pack 20	TCT4/1WH TCT4/2WH Pack 10	-	-
TT5-5WH Pack 20	-	-	-	-
TT6-6WH Pack 10	-	-	-	-
-	-	-	-	-

Mini surface accessory boxes – 1 gang

1 gang accessory boxes

Depth	Square or radius	Mini trunking sizes	Knockout entries	Code	Pack
19mm	Square	MMT1/2	LH, RH, Centre	MSSB28WH	20
19mm	Radius	MMT1/2	LH, RH, Centre	MSSB27WH	20
19mm	Square	MMT3	LH, RH, Centre	MSSB110WH	20
19mm	Radius	MMT3	LH, RH, Centre	MSSB112WH	20
25mm	Square	MMT1/2	LH, RH, Centre	MSSB14WH	20
25mm	Square	MMT3	LH, RH, Centre	MSSB114WH	20
28mm	Square	MMT1/2	LH, RH, Centre	MSSB44WH	20
28mm	Radius	MMT3	LH, RH, Centre	MSSB115WH	20
32mm	Square	MMT1/2	LH, RH, Centre	MSSB35WH	20
32mm	Square	MMT3	LH, RH, Centre	MSSB116WH	20
32mm	Radius	MMT1/2	LH, RH, Centre	MSSB20WH	20
32mm	Radius	MMT3	LH, RH, Centre	MSSB118WH	20
44mm	Square	MMT2/3	Centre entry for both MMT2 and MMT3. RH and LH side entry for MMT2.	MSSB18WH	10
44mm	Radius	MMT2/3	For MMT2 = 1 top entry centre For MMT3 = 1 bottom entry centre	MSSB42WH	10
44mm	Square	MMT3	LH, RH, Centre	MSSB120WH	10
44mm	Radius	MMT3	LH, RH, Centre	MSSB122WH	10



1 gang shrouded entry boxes

Depth	Square or radius	Mini trunking sizes	Knockout entries	Code	Pack
32mm	Square	MMT2	With integral moulded MMT2 adaptor	MSSB15WH	20
32mm	Square	MMT4	With integral moulded MMT4 adaptor	MSSB37WH	20
35mm	Square and radius	MMT2/3	Side entries permit horizontal and vertical accessory mounting Shrouded 2-part entry boxes for use with MMT2 and 3 (25 x 16mm and 38 x 16mm)	MSSB100	10



Cover plates

Depth	Square or radius	Mini trunking sizes	Description	Code	Pack
2mm	Square and radius	N/A	Flat	MSCP2WH	20
9mm	Square and radius	N/A	Raised	MSSP10WH	10



Fixing pads and earth terminal

Size	Square or radius	Mini trunking sizes	Description	Code	Pack
19 x 75mm	N/A	N/A	Fixing pads – 2 required per box	MSFP1WH	50
-	-	-	Brass earthing terminal – 15Amp rating	MET1	100



Mini surface accessory boxes – 2 gang

2 gang boxes

Depth	Square or radius	Mini trunking sizes	Knockout entries	Code	Pack
25mm	Square	MMT2	LH, RH, Centre	MSSB13WH	10
25mm	Square	MMT3	LH, RH, Centre	MSSB214WH	10
28mm	Square	MMT2	LH, RH, Centre	MSSB45WH	10
28mm	Radius	MMT3	LH, RH, Centre	MSSB215WH	10
32mm	Square	MMT2	LH, RH, Centre	MSSB36WH	10
32mm	Radius	MMT2	LH, RH, Centre	MSSB22WH	10
32mm	Square	MMT3	LH, RH, Centre	MSSB216WH	10
32mm	Radius	MMT3	LH, RH, Centre	MSSB218WH	10
44mm	Square	MMT2	LH, RH, Centre	MSSB24WH	10
44mm	Radius	MMT2/3	Centre entry	MSSB43WH	10
44mm	Square	MMT3	LH, RH, Centre	MSSB220WH	10
44mm	Radius	MMT3	LH, RH, Centre	MSSB222WH	10



2 x 1 gang box

Depth	Square or radius	Mini trunking sizes	Knockout entries	Code	Pack
32mm	Radius	MMT2	2 x 1 gang MMT2 centre and side entry	MSSB82WH	10



2 gang shrouded entry boxes

Depth	Square or radius	Mini trunking sizes	Knockout entries	Code	Pack
35mm	Square and radius	MMT2/3	Side entries permit horizontal and vertical accessory mounting Shrouded 2-part entry boxes for use with MMT2 and 3 (25 x 16mm and 38 x 16mm)	MSSB200	10

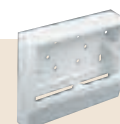

Cover plates

Depth	Square or radius	Mini trunking sizes	Description	Code	Pack
2mm	Square and radius	N/A	Flat	MSCP3WH	20
9mm	Square and radius	N/A	Raised	MSSP20WH	2



Earth terminal

Depth	Square or radius	Mini trunking sizes	Description	Code	Pack
-	-	-	Brass earthing terminal – 15Amp rating	MET1	100



Maxi Trunking

Maxi trunking is a mid-size feeder trunking that can be sub-divided to carry power and data. Larger sizes can also accommodate wiring accessories.

Product information

- A variety of sizes from 50 x 50mm to 150 x 150mm
- Single or divided compartment options

Data information

- Fabricated data slow bends

STANDARD COLOUR	
WH	white

Options: optional colours and finishes are available but these may be subject to minimum quantity orders and longer lead times. For more information contact the Technical Team on 01424 856688.

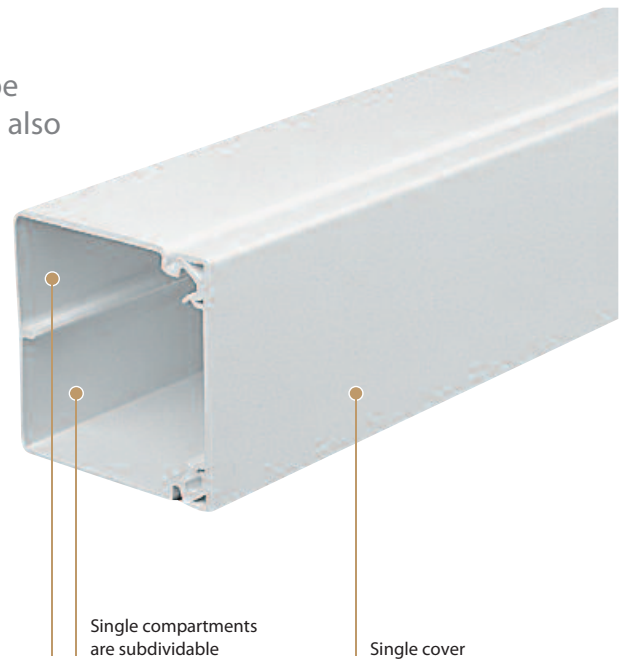

Trunking profiles



Prod Code	Size	Pack
MTRS50WH	50 x 50mm	8 x 3m



Prod Code	Size	Pack
MTRS75/50WH	75 x 50mm	4 x 3m



Prod Code	Size	Pack
MTRS75WH	75 x 75mm	4 x 3m



Prod Code	Size	Pack
MTRS100/150WH	100 x 50mm	4 x 3m



Prod Code	Size	Pack
MTRS100WH	100 x 100mm	4 x 3m



Prod Code	Size	Pack
MTRS150WH	150 x 150mm	2 x 3m

Components

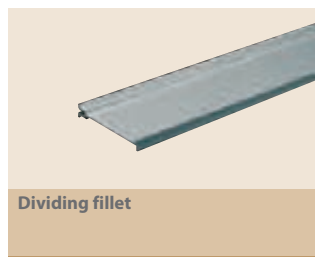

Prod Code	Size	Pack
MDFS50	50 x 50mm 75 x 50mm 100 x 50mm	10 x 3m
MDFS75	75 x 75mm	10 x 3m
MDFS100	100 x 100mm	10 x 3m
MDFS150	150 x 150mm	10 x 3m

Clear maxi trunking

Clear maxi trunking is available and particularly useful for high security installations. For further information please contact our technical team on 01424 856688.

Fittings



Clip on fittings

For individual components and part numbers please refer to fittings chart on next page.



Fabricated fittings

For individual components and part numbers please refer to fitting chart on next page.

Components

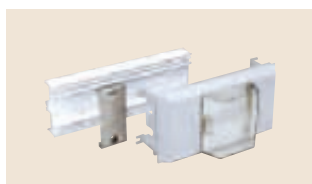

RCD/MCB housing*

Prod Code	Pack
TAHC1WH	1

*Up to 4 modules can be accommodated

Note: RCDs are not supplied by Marshall-Tufflex



Mini trunking adaptor

Prod Code	Size	Pack
TTA2WH	MMT2	10
TTA4WH	MMT4	10

Note: only for 50mm trunking depth

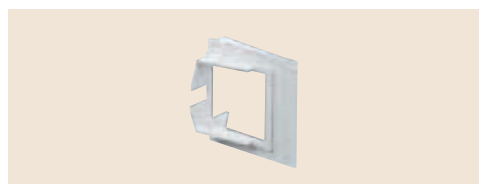

Flanged coupler

Prod Code	Size	Pack
TTRS1WH	MTRS100 TO MTRS100/50	1
TTRS2WH	MTRS100 TO MTRS75	1
TTRS3WH	MTRS100 TO MTRS75/50	1
TTRS4WH	MTRS100 TO MTRS50	1
TTRS5WH	MTRS100/50 TO MTRS75/50	1
TTRS6WH	MTRS75 TO MTRS50	1
TTRS7WH	MTRS75 TO MTRS75/50	1
TTRS8WH	MTRS75 TO MTRS50	1
TTRS9WH	MTRS75/50 TO MTRS50	1
TTRS10WH	MTRS150 TO MTRS100	1
TTRS11WH	MTRS150 TO MTRS75	1
TTRS12WH	MTRS150 TO MTRS100/50	1



Accessory box dividing fillet

Prod Code	Box size	Pack
MDFS15/3	TSS03	2
MDFS15/4	TSS04	2

MTRS100/50 only



Spacer - 25mm

Prod Code	Pack
MTRS100LID25WH	20

For use between accessory boxes.

Boxes



1 gang accessory box

Prod Code	Depth	Pack
TSS03WH*	30mm	20

For MTRS100/50 and MTRS100.



2 gang accessory box

Prod Code	Depth	Pack
TSS04WH*	30mm	10

For MTRS100/50 and MTRS100.



1 gang accessory plate

Prod Code	Pack
MTSPS1WH	15

For MTRS100/50 and MTRS100.



















2 gang accessory plate

Prod Code	Pack
MTSP2WH	15

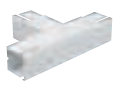
For MTRS100/50 and MTRS100.

Maxi trunking fittings chart

		Fittings					
		Dividing fillet	Cable retainer	External coupler	Internal coupler	Flanged coupler	End cap
MTRS50WH 50 x 50mm							
		MDFS50 Pack 10 x 3m	TCRS50 Pack 10	TCCS50WH Pack 10	TICS50WH Pack 10	TFCS50WH Pack 1	TECS50WH Pack 10
MTRS75/50WH 75 x 50mm		MDFS50 Pack 10 x 3m	TCRS75 Pack 10	TCCS75/50WH Pack 10	TICS75/50WH Pack 10	TFCS75/50WH Pack 1	TECS75/50WH Pack 10
MTRS75/75WH 75 x 75mm		MDFS75 Pack 10 x 3m	TCRS75 Pack 10	TCCS75WH Pack 10	TICS75WH Pack 5	TFCS75WH Pack 1	TECS75WH Pack 5
MTRS100/50WH 100 x 50mm		MDFS50 Pack 10 x 3m	TCRS100 Pack 10	TCCS100/50WH Pack 10	TICS100/50WH Pack 5	TFCS100/50WH Pack 1	TECS100/50WH Pack 5
MTRS100WH 100 x 100mm		MDFS100 Pack 10 x 3m	TCRS100 Pack 10	TCCS100WH Pack 2	TICS100WH Pack 5	TFCS100WH Pack 1	TECS100WH Pack 5
MTRS150WH 150 x 150mm		MDFS150 Pack 10 x 3m	TCRS150 Pack 5	-	TICS150WH Pack 5	TFCS150WH Pack 2	TECS150WH Pack 1

		Flat angles		Tees			
		90° flat angle (clip-on)	90° flat angle (fabricated)	Flat tee (moulded)	Flat tee (fabricated)	External edge tee (fabricated)	Internal edge tee (fabricated)
MTRS50WH 50 x 50mm							
		TFAS50CWH Pack 1	TFAS50FWH Pack 1	-	TFTS50WH Pack 1	TTES50WH Pack 1	TTIS50WH Pack 1
MTRS75/50WH 75 x 50mm		-	TFAS75/50FWH Pack 1	-	TFTS75/50WH Pack 1	TTES75/50WH Pack 1	TTIS75/50WH Pack 1
MTRS75WH 75 x 75mm		-	TFAS75FWH Pack 1	TFTS75/50MWH Pack 1	TFTS75WH Pack 1	TTES75WH Pack 1	TTIS75WH Pack 1
MTRS100/50WH 100 x 50mm		TFAS100/50CWH Pack 1	TFAS100/50FWH Pack 1	-	TFTS100/50WH Pack 1	TTES100/50WH Pack 1	TTIS100/50WH Pack 1
MTRS100WH 100 x 100mm		-	TFAS100FWH Pack 1	-	TFTS100WH Pack 1	TTES100WH Pack 1	TTIS100WH Pack 1
MTRS150WH 150 x 150mm		-	TFAS150FWH Pack 1	-	TFTS150WH Pack 1	TTES150WH Pack 1	TTIS150WH Pack 1

Internal bends		External bends		
Internal 90° bend (clip-on)	Internal 90° bend (fabricated)	External 90° bend (clip-on)	External 90° bend (moulded)	External 90° bend (fabricated)
TIAS50CWH Pack 1	TIAS50FWH Pack 1	TOAS50CWH Pack 1	TOAS50MWH Pack 1	TOAS50WH Pack 1
-	TIAS75/50FWH Pack 1	-	-	TOAS75/50WH Pack 1
-	TIAS75FWH Pack 1	-	-	TOAS75WH Pack 1
-	TIAS100/50FWH Pack 1	TOAS100/50CWH Pack 1	-	TOAS100/50WH Pack 1
TIAS100/50CWH Pack 1	TIAS100FWH Pack 1	-	-	TOAS100WH Pack 1
-	TIAS150FWH Pack 1	-	-	TOAS150WH Pack 1

Crossovers
Flat crossover (fabricated)
TCUS50WH Pack 1
TCUS75/50WH Pack 1
TCUS75WH Pack 1
TCUS100/50WH Pack 1
TCUS100WH Pack 1
TCUS150WH Pack 1



Sterling Profile 1, 2 and 3

Sterling Profile systems 1 to 3 are popular and stylish looking perimeter dado and skirting systems that are easy and cost effective to use. The range has been tried and tested within commercial areas over many years.



Product information

- 167 x 50mm
- 3 segregated compartments
- Can be sub-divided
- Suitable for dado and skirting application
- Can be fed from larger trunking systems for increased cable distribution
- Boxes available to comply with Part M (DDA)
- Comprehensive range of flush power and data accessories

Data information

- Standard bend radius 25mm (Cat 6)
- Data fittings available for bend radius up to 50mm
- Compartment can be screened against EMI with no reduction in cable capacity
- Adjustable data box 32-40mm
- Screened data boxes
- Steel screening divider available



STANDARD COLOUR	
WH	white

Options: Optional colours and finishes are available but these may be subject to minimum quantity orders and longer lead times. For more information contact the Technical Team on 01424 856688.

Part M
Boxes that meet the requirements of Part M (DDA) are available. Please contact the Technical Team for more information 01424 856688.

Trunking profiles

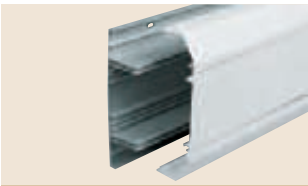

Sterling Profile 1

Size	167 x 50mm
-------------	------------

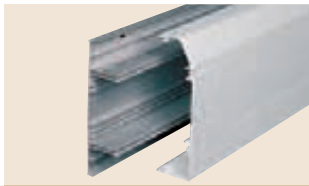

Sterling Profile 2

Size	167 x 50mm
-------------	------------

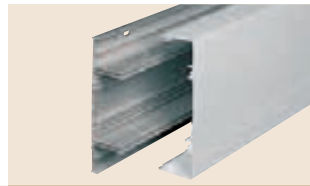

Sterling Profile 3

Size	167 x 50mm
-------------	------------

Basic components

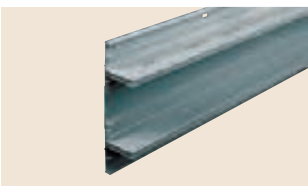

Base unit

Prod Code	Pack
ETB1	4 x 3m



Main compartment cover

Prod Code	Pack
ETL1WH	8 x 3m



Angled cover

Prod Code	Pack
ETAC1WH	8 x 3m

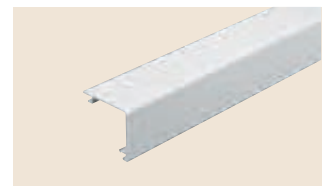

Square cover

Prod Code	Pack
ETSC1WH	8 x 3m

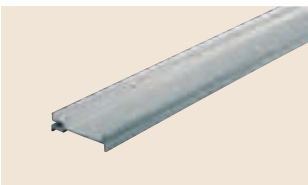

Dividing fillet

Prod Code	Pack
EDF1	8 x 3m



Cable tray

Prod Code	Pack
ECT1	8 x 3m



Dividing tray

Prod Code	Pack
EDF2	8 x 3m

Fittings



Profile 1 Coupler

Prod Code	Description	Pack
ECP1WH	3 piece	5
ECHP1WH	1 piece	5



Profile 2 Coupler

Prod Code	Description	Pack
ECP2WH	3 piece	5
ECHP2WH	1 piece	5



Profile 3 Coupler

Prod Code	Description	Pack
ECP3WH	3 piece	5
ECHP3WH	1 piece	5

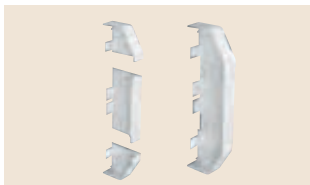

Profile 1 End cap

Prod Code	Description	Pack
EECP1WH	3 piece	5
EECHP1WH	1 piece	5
Universal for both LH & RH		

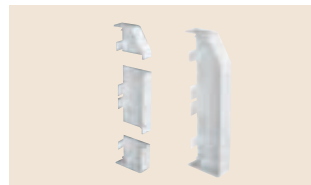

Profile 2 End cap

Prod Code	Description	Pack
EECP2LHWH	(left) 3 piece	5
EECP2RHWH	(right) 3 piece	5
EECHP2LHWH	(left) 1 piece	5
EECHP2RHWH	(right) 1 piece	5

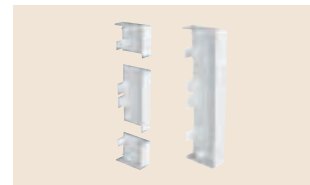

Profile 3 End cap

Prod Code	Description	Pack
EECP3WH	3 piece	5
EECHP3WH	1 piece	5
Universal for both LH & RH		



Profile 1 Internal bend

Prod Code	Description	Pack
EIBP1WH	3 piece	5
EIBHP1WH	1 piece	5



Profile 2 Internal bend

Prod Code	Description	Pack
EIBP2WH	3 piece	5
EIBHP2WH	1 piece	5

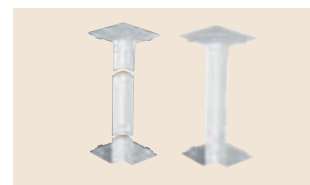

Profile 3 Internal bend

Prod Code	Description	Pack
EIBP3WH	3 piece	5
EIBHP3WH	1 piece	5



Profile 1 External bend

Prod Code	Description	Pack
EXBP1WH	3 piece	5
EXBHP1WH	1 piece	5

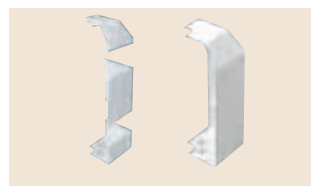

Profile 2 External bend

Prod Code	Description	Pack
EXBP2WH	3 piece	5
EXBHP2WH	1 piece	5

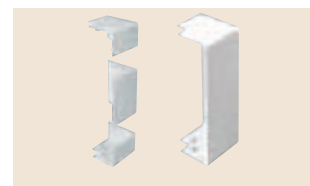

Profile 3 External bend

Prod Code	Description	Pack
EXBP3WH	3 piece	5
EXBHP3WH	1 piece	5

Fittings



Profile 1 Flat angle - up/down

Prod Code	Pack
EFA1WH	5



Profile 2 Flat angle - upward

Prod Code	Pack
EFA2UWH	1



Profile 3 Flat angle - downward

Prod Code	Pack
EFA2DWH	1



Profile 3 Flat angle - up/down

Prod Code	Pack
EFA3WH	1



Profile 1 Flat tee

Prod Code	Pack
EFT1WH	1



Profile 3 Flat tee

Prod Code	Pack
EFT3WH	1

Sterling Profile 2 flat tees

Where profiles have one angled cover and one square cover, as with Sterling Profile 2, it is possible to create a tee by changing the top or bottom cover so that covers match the profile of the trunking.

For example:

- Upward tee – select Profile 1 tee remove the angled bottom cover and replace with square cover.
- Downward tee – select Profile 3 tee remove the square top cover and replace with angled cover.

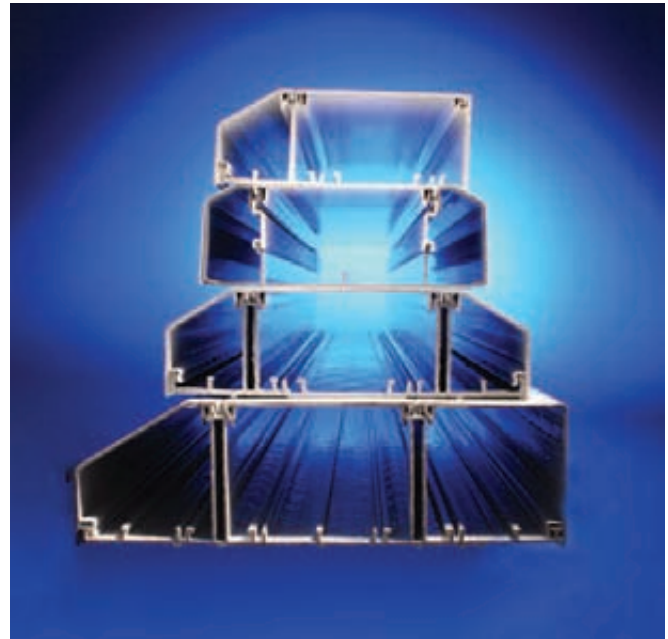

Components

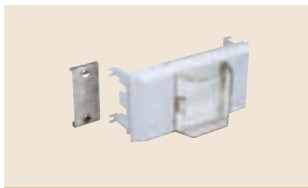

RCD/MCB Housing*

Prod Code	Pack
EAHC1WH	1



Segregated flush back box
280 x 150mm
Steel

Prod Code	Depth	Pack
ESFBB1	35mm	1



Main crossover bridge

Prod Code	Pack
EMCB1	5

*Up to 4 modules can be accommodated

Note: RCDs are not supplied by Marshall-Tufflex



Angled crossover bridge

Prod Code	Pack
EACB1	5



Square crossover bridge

Prod Code	Pack
ESCB1	5

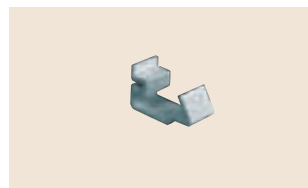

Angled cable retainer

Prod Code	Pack
EACR1	10



Main cable retainer

Prod Code	Pack
EMCR1	10



Angled mini trunking adaptor MMT2

Prod Code	Pack
EATA2	5



Angled mini trunking adaptor MMT4

Prod Code	Pack
EATA4	5



Square mini trunking adaptor MMT2

Prod Code	Pack
ESTA2	5



Square mini trunking adaptor MMT4

Prod Code	Pack
ESTA4	5

Boxes and plates



1 gang accessory box

Prod Code	Depth	Pack
ESSB1WH	30mm	20



2 gang accessory box

Prod Code	Depth	Pack
ESSB2WH	30mm	10

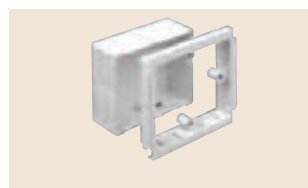

1 gang adjustable depth box

Prod Code	Depth	Pack
EAB1WH	32-40mm	10

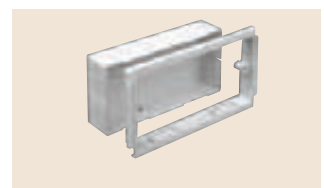

2 gang adjustable depth box

Prod Code	Depth	Pack
EAB2WH	32-40mm	5

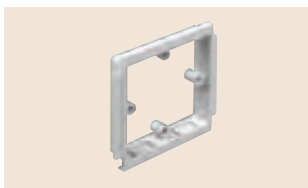

1 gang accessory plate

Prod Code	Pack
ESSP1WH	10

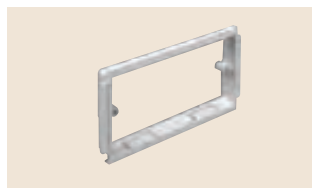

2 gang accessory plate

Prod Code	Pack
ESSP2WH	5

Part M

1 and 2 gang box assemblies with contrasting coloured flush plates are available to comply with the requirements of Part M (DDA).



code	description	pack
ESPM1BU	1 gang - blue plate	1
ESPM1CH	1 gang - charcoal plate	1
ESPM1RD	1 gang - red plate	1
ESPM2BU	2 gang - blue plate	1
ESPM2CH	2 gang - charcoal plate	1
ESPM2RD	2 gang - red plate	1

Sterling Profile 1, 2 and 3 component chart

		3 compartment		
		Profile 1	Profile 2	Profile 3
		167 x 50mm	167 x 50mm	167 x 50mm
				
Base unit		ETB1	ETB1	ETB1
Pack	4 x 3m			
Main compartment cover		ETL1WH	ETL1WH	ETL1WH
Pack	8 x 3m			
Angled cover		2 x ETAC1WH	ETAC1WH	–
Pack	8 x 3m			
informative text				
Square cover		–	ETSC1WH	2 x ETSC1WH
Pack	8 x 3m			
informative text				
Couplers		ECP1WH or ECHP1WH	ECP2WH or ECHP2WH	ECP3WH or ECHP3WH
Pack	5			
3 piece or 1				
End caps		EECP1WH or EECHP1WH	EECP2LHWH EECP2RHWH or EECHP2LHWH EECHP2RHWH	EECP3WH or EECHP3WH
Pack	5			
Left or right handed.				
3 piece or 1 piece				
Internal bend		EIBP1WH or EIBHP1WH	EIBP2WH or EIBHP2WH	EIBP3WH or EIBHP3WH
Pack	5			
3 piece or 1 piece				
External bends		EXBP1WH or EXBHP1WH	EXBP2WH or EXBHP2WH	EXBP3WH or EXBHP3WH
Pack	5			
3 piece or 1 piece				
Flat angles up or down		EFA1WH	EFA2UWH EFA2DWH	EFA3WH
Pack	1			
Flat tees up or down		EFT1WH	†	EFT3WH
Pack	1			

† Sterling Profile 2 flat tees

Where profiles have one angled cover and one square cover, as with Sterling Profile 2, it is possible to create a tee by changing the top or bottom cover so that covers match the profile of the trunking.

For example:

- Upward tee – select Profile 1 tee remove the angled bottom cover and replace with square cover.
- Downward tee – select Profile 3 tee remove the square top cover and replace with angled cover.

Additional features

Our trunking systems have many other competitive 'add-on' features designed to speed up, simplify and enhance an installation.

- **Better data performance needed?**

Use Cat 6 and 6a fittings and copper spray screening against EMI.

- **Hygiene and welfare a priority?**















Opt for Bio trunking and Part M box assemblies.

- **Project time savings vital?**

MT32 prefabricated wiring will give you plug and play installation with easy future reconfiguration.

- **Branding and style required?**

Go for colours and woodgrain finishes to create something special.

	 Sterling Profile	 Maxi Trunking	 Mini Trunking
Cat 6 and 6a Bends, angles and tees that provide compliance with category standards for 6 and 6a.	 50mm bend radius on internal and external bends	 Slow bends, gusseted tees and crossovers for generous data compliance	 50mm bend radius on internal and external bends, flat angles and tees
Part M Colour contrasting boxes and box assemblies for DDA compliance or company branding.		-	-
Bio trunking Integral antimicrobial protection that kills 99.9% of bacteria, helping to stop the spread of infection via surfaces.		-	-
MT32 Prefabricated and modular wiring For plug and play connection from main distribution boards to final accessories, outlets or applications.		-	-
Electromagnetic shielding Unique internal copper spray finish that provides EMI screening without loss of cable capacity.		-	-
Solid colours A variety of solid colours are available but always subject to minimum quantity orders and increased lead times.			
Woodgrain finishes Woodgrain finishes in Light Oak, Mahogany and Ebony are available but subject to minimum quantity orders and increased lead times.		-	-

Please note: if you are interested in any of the above, we would always recommend that you call our Technical Team for advice: 01424 856688. Minimum order quantities may apply.

Marshall-Tufflex Ltd

Churchfields Industrial Estate
Hastings, East Sussex TN38 9PU
United Kingdom

Telephone: 01424 856600

Fax: 01424 856611

International Tel: +44 (0)1424 856000

International Fax: +44 (0)1424 856666

Email: sales@marshall-tufflex.com

Web: www.marshall-tufflex.com

Technical Hotline: +44 (0)1424 856688

Republic of Ireland & Northern Ireland distributor

Core Electrical Ltd
17b Goldenbridge Industrial Estate
Tyrconnell Road, Inchicore
Dublin 8

Telephone: +353 (0)1453 7033

Fax: +353 (0)1453 8911

In pursuance of our policy of continued product improvement Marshall-Tufflex reserve the right to change the design or specification of its products without notification.

EL179/11028

www.marshall-tufflex.com

