

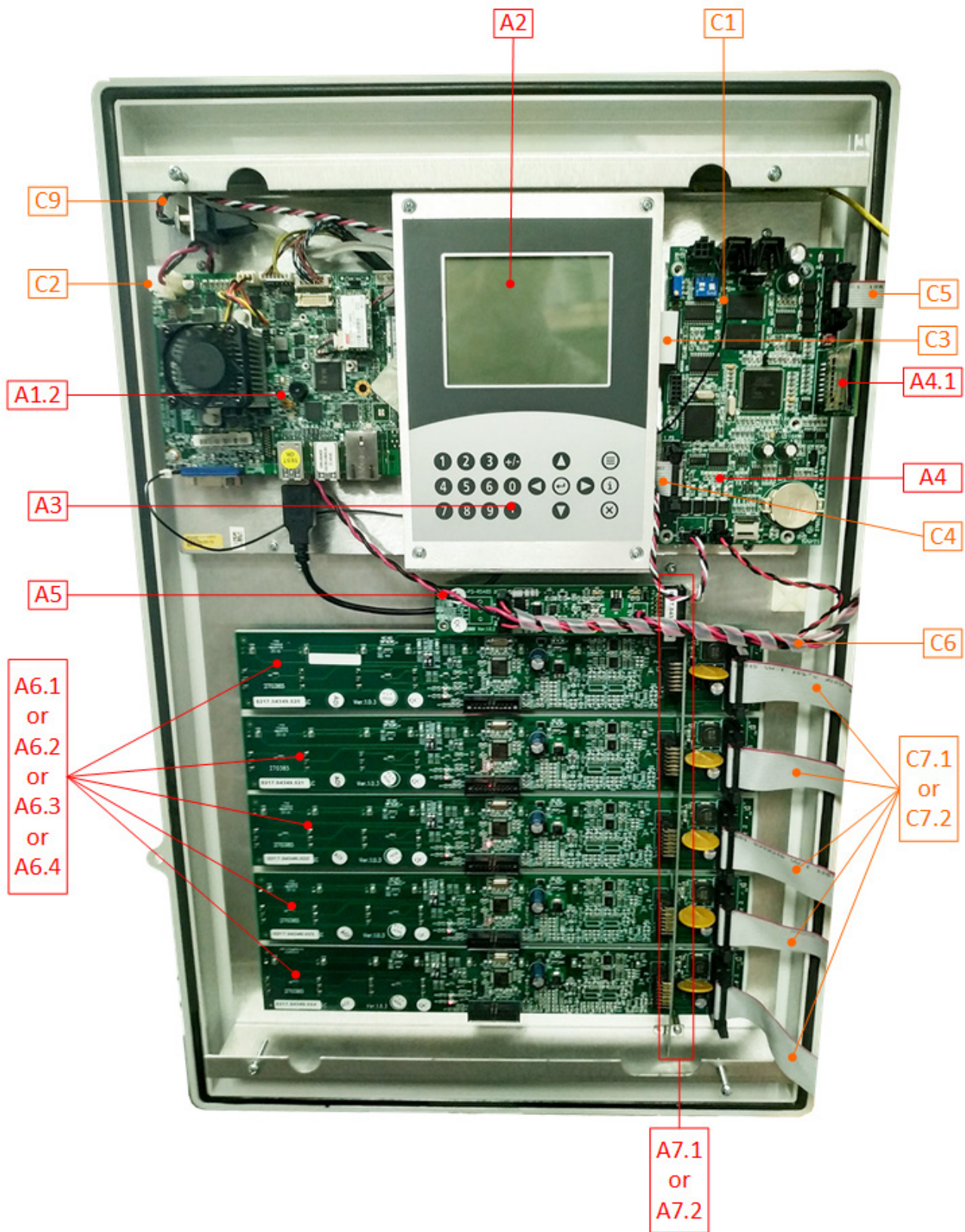

# Platinum Touch/Platinum Pro/ Platinum Expansion/IO Expansion Spare Parts

# Platinum Touch Spare Parts





ID No.	Description	Order Catalog Number	Remarks
A1	ROTEM ONE PC AND DISPLAY SET (SP-204050): (LCD + LVDS CARD + SET OF CABLES + PC)	MPN: 999-99-00433	
		DPN: <b>78SP204050</b>	
A1.1	TOUCH DISPLAY LCD 10.1", KIT + LVDS + USB TOUCH CABLE	MPN: 900-99-00248	
		DPN: <b>78SPTLCDLED</b>	
A1.2	PC BOARD	MPN: 900-99-00247	
		DPN: <b>78SP208014</b>	
A2	TOUCH INTERNAL LCD (SET + FFC CABLE SET)	MPN: 900-99-00205	
		DPN: <b>78SPPPLCDLEDONE</b>	
A3	KEYBOARD (P3-KBD-TOUCH))	MPN: 900-99-00203	
		DPN: <b>78CPPKBDLEDONE</b>	
A4	CPU CARD (P3-ARM)	MPN: 900-99-00108	
		DPN: <b>784CPPARMPRO</b>	
A4.1	SD-CARD 8G (SP: 220206)	MPN: 900-99-00123	
		DPN: <b>78SDCARD</b>	
A5	RS485 CARD WITH MOLEX 90° ON PRINT SIDE (P4-RS-485-90)	MPN: 900-99-00231	
		DPN: <b>78COMMDPONE</b>	
A6.1	N.O. SWITCH CARD (P3-NO-SC)	MPN: 900-99-00172	
		DPN: <b>784SWONPRO</b>	
A6.2	N.C. SWITCH CARD (P3-NC-SC)	MPN: 900-99-00140	
		DPN: <b>784SCNCPRO</b>	
A6.3	WINCH SWITCH CARD (2 X WINCHES) (P3-WC-SC)	MPN: 900-99-00144	
		DPN: <b>784PPROSOWC</b>	
A6.4	CURRENT SENSE N.O. SWITCH CARD	MPN: 900-99-00202	
		DPN: <b>784SWONCSPRO</b>	
A7.1	SWITCH BUS 50 CARD (P3-RSB50)	MPN: 900-99-00157	
		DPN: <b>784SBUSPRO</b>	
A7.2	SWITCH BUS 30 CARD (P3-RSB30)	MPN: 900-99-00158	
		DPN: <b>784SBUSXPRO30</b>	

ID No.	Description	Order Catalog Number	Remarks
C1	RESET CABLE	MPN: 900-99-00178	
		DPN: 784CRESETONE	
C2	MULTI-CABLE 42 CM & 18 CM (P4) V1.0.4	MPN: 900-99-00220	
		DPN: 784CPOWERPCONE	
C3	FLAT 24 POTION FFC CABLE 0.039" (1.00 mm/152.40 mm)	MPN: 900-99-00221	
		DPN: 784CRLCDDISPONE	
C4	FLAT CABLE CPU TO KSB (SP: PP-F-KBD)	MPN: 999-99-00061	
		DPN: 784CKEY	
C5	FLAT FF10P28 CM <F"D_F"D> (SP-141163)	MPN: 999-99-00425	
		DPN: 784CMAIPRO	
C6	MULTI CABLE 45CM 4X18 AWG (P4) V1.02	MPN: 900-99-00222	
		DPN: 784CPSLDRCOMONE	
C7.1	FLAT FF20P 35CM <F"D_F"D>	MPN: 900-99-00223	
		DPN: 784CRSWITCHONE	
C7.2	FLAT CABLE 30P CURRENT SENSE RELAY	MPN: 999-99-00123	
		DPN: 784CRCURSWONE	
C8	MULTI CABLE 17 CM 4X22AWG WIRE (P4)	MPN: 900-99-00224	
		DPN:784CPSLBKCOMONE	
C9	INT. CABLE RS-232, PC TO CPU	MPN: 900-99-0251	
		DPN:	

# TOUCH Main Container Spare Parts

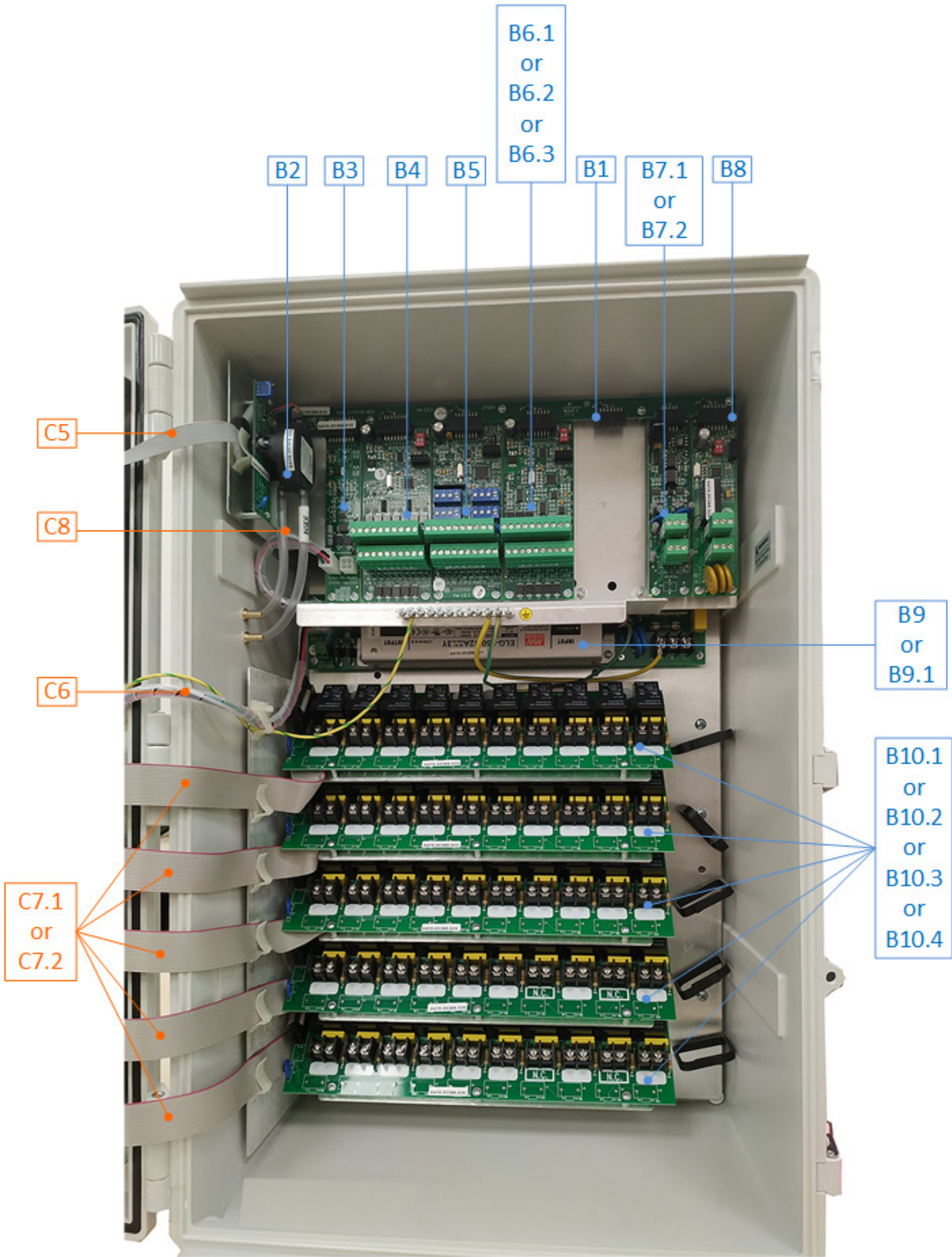

ID No.	Description	Order Catalog Number	Remarks
B1	INPUT / OUTPUT BUS CARD (P3-IO-BUS)	MPN: 900-99-00156	
		DPN: <b>784IBUSPRO</b>	
B2	STATIC PRESSURE CARD SETRA TYPE (RPS3-ST)	MPN: 900-99-00052	
		DPN: 784STAT	
B3	RS485 CARD (P4-RS485)	MPN: 900-99-00200	
		DPN: <b>78CBOARDONE</b>	
B4	DIGITAL INPUT CARD (P3-RDIC12)	MPN: 900-99-00099	
		DPN: <b>78RDICPRO</b>	
B5	ANALOG INPUT CARD (P3-RAIC12)	MPN: 900-99-00109	
		DPN: <b>784ANOUPRO</b>	
B6.1	ANALOG OUTPUT CARD (P3-RAOC10)	MPN: 900-99-00110	OR
		DPN: <b>784ANACPRO</b>	
B6.2	PRO & ROTEM ONE SCALE CARD 2H (P3-RSC-2)	MPN: 900-99-00267	OR
		DPN: <b>78P3RSC2</b>	
B6.3	PRO & ROTEM ONE SCALE CARD 6H (P3-RSC-6)	MPN: 900-99-00268	
		DPN:	
B7.1	RS485 ISO NETWORK & 485 EXT (P3-485ISO-485)	MPN: 900-99-00101	OR
		DPN: <b>78CPPISO485PRO</b>	
B7.2	RS232 ISO NETWORK & 485 EXT (P3-232ISO-485)	MPN: 900-99-00112	
		DPN: <b>8CPPISO232PRO</b>	
B8	ALARM CARD (P3-ALARM)	MPN: 900-99-00100	
		DPN: <b>784ALARPRO</b>	
B9	TOUCH-POWER SUPPLY 150WT (P3-PS150)	MPN: 900-99-00149	
		DPN:	
B9.1	"MEAN Well ELG-150-12A" POWER SUPPLY 150WT 12V 10A	MPN: 900-99-00226	
		DPN: <b>784PS150SONE</b>	

ID No.	Description	Order Catalog Number	Remarks
B10.1. 1	N.O RELAY CARD (P3-NO-RC)	MPN: 900-99-00161  DPN: <b>784REONPRO</b>	
B10.1. 2		DPN:	
B10.2. 1	N.C. RELAY 30A CARD (P3-NC-RC-30A)	MPN: 900-99-00159  DPN: <b>784RONCPRO</b>	
B10.2. 2		DPN:	
B10.3.1	WINCH RELAY CARD (2 X WINCHES) (P3-WC-RC)	MPN: 900-99-00143  DPN: <b>784PPROWCCR</b>	
B10.3. 2		DPN:	
B10.4	CURRENT SENSING RELAY 30A CARD (P3-CSNO-RC-30A)	MPN: 900-99-00153 DPN: <b>784REONCSPRO</b>	



# Platinum Pro Spare Parts



# Pro Door Spare Parts

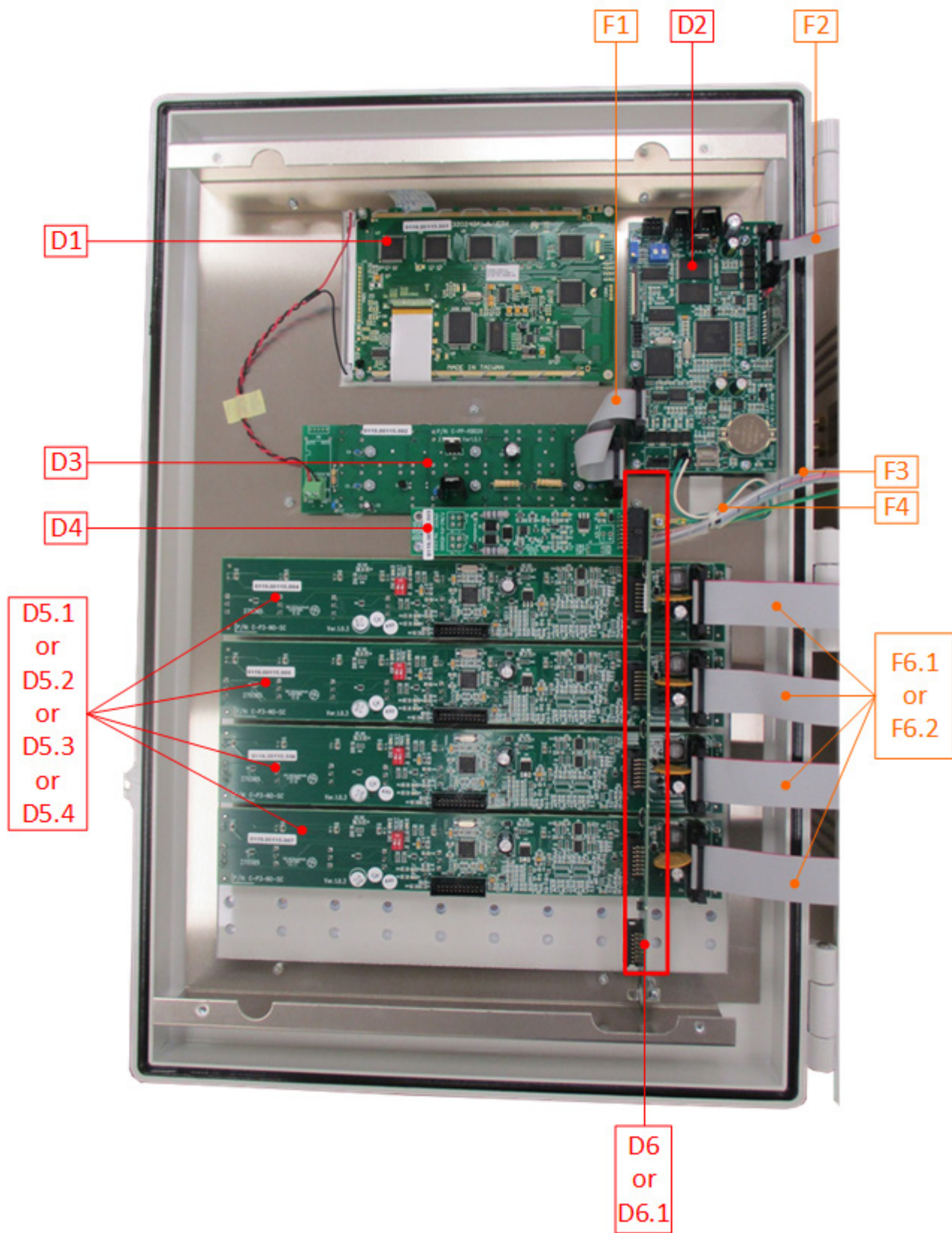

ID No.	Description	Order Catalog Number	Remarks
<b>D1</b>	LED LCD DISPLAY (SP-PPXL-LCDLED)	MPN: 999-99-00067	
		DPN: <b>78SPPPXLCDLED</b>	
<b>D2</b>	CPU CARD (P3-ARM)	MPN: 900-99-00108	
		DPN: <b>784CPPARMPRO</b>	
<b>D3</b>	KEYBOARD CARD FOR LED LCD (P3-KBDLED)	MPN: 900-99-00242	
		DPN: <b>78CPPKBDLEDPRO</b>	
<b>D4</b>	RS485 CARD WITH MOLEX 90' ON PRINT SIDE (P4-RS485-90)	MPN: 900-99-00231	
		DPN: <b>78COMMDPONE</b>	
<b>D5.1</b>	N.O. SWITCH CARD (P3-NO-SC)	MPN: 900-99-00172	
		DPN: <b>784SWONPRO</b>	
<b>D5.2</b>	N.C. SWITCH CARD (P3-NC-SC)	MPN: 900-99-00140	
		DPN: <b>784SCNCPRO</b>	
<b>D5.3</b>	WINCH SWITCH CARD (2 X WINCHES)(P3-WC-SC)	MPN: 900-99-00144	OR
		DPN: <b>784PPROSOWC</b>	
<b>D5.4</b>	CURRENT SENSE N.O. SWITCH CARD	MPN: 900-99-00202	
		DPN: <b>784SWONCSPRO</b>	
<b>D6.1</b>	SWITCH BUS 50 CARD (P3-SW-BUS50)	MPN: 900-99-00157	
		DPN: <b>784SBUSPRO</b>	
<b>D6.2</b>	SWITCH BUS 30 CARD (P3-SW-BUS30)	MPN: 900-99-00158	
		DPN: <b>784SBUSXPRO30</b>	

## Pro Main Container Spare Parts

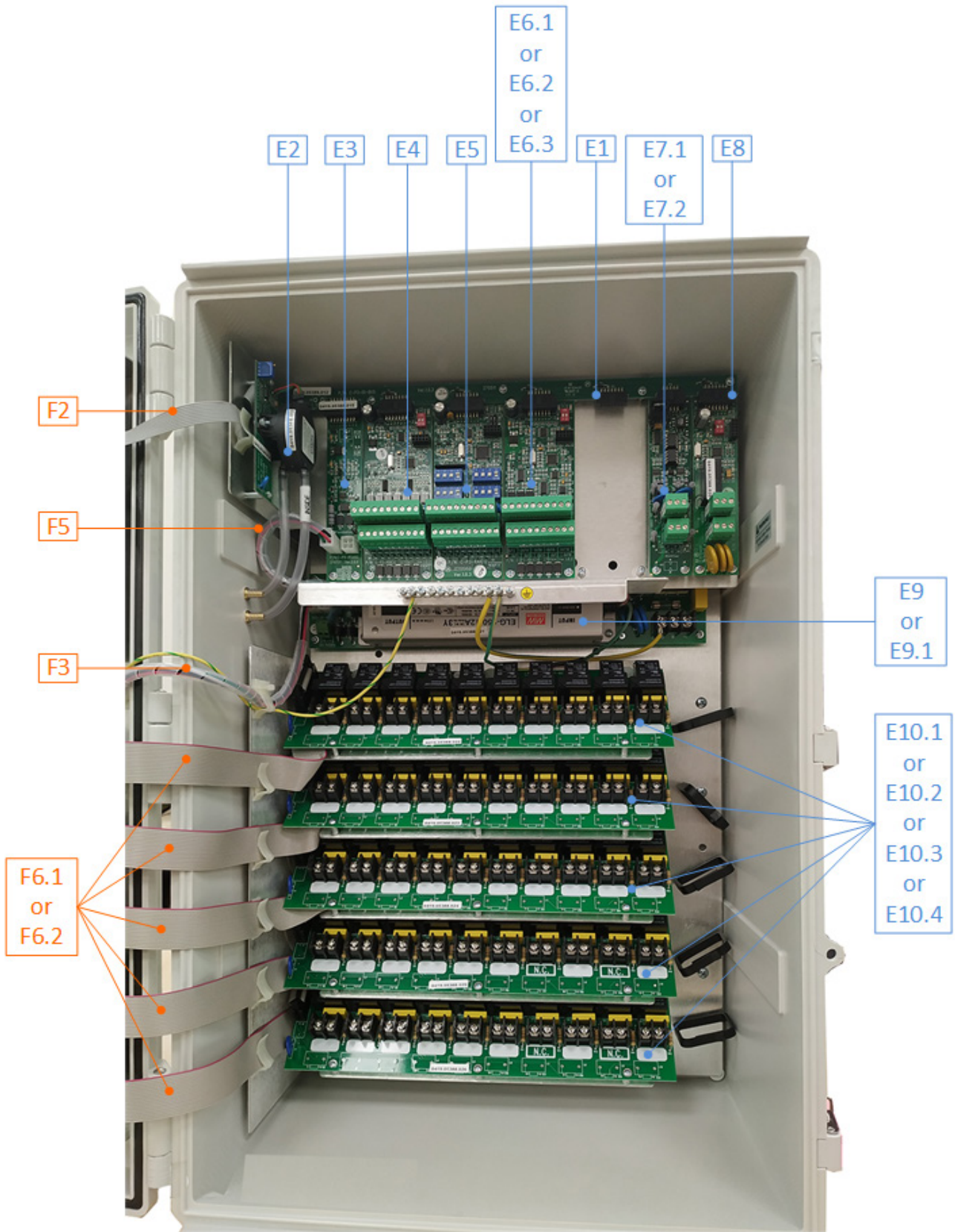

ID No.	Description	Order Catalog Number	Remarks
E1	INPUT / OUTPUT BUS CARD (P3-IO-BUS)	MPN: 900-99-00156	
		DPN: <b>784IBUSPRO</b>	
E2	STATIC PRESSURE CARD SETRA TYPE (RPS3-ST)	MPN: 900-99-00121	
		DPN: <b>784STAT</b>	
E3	RS485 CARD (P4-RS485)	MPN: 900-99-00200	
		DPN: <b>78CBOARDONE</b>	
E4	DIGITAL INPUT CARD (P3-RDIC12)	MPN: 900-99-00099	
		DPN: <b>784RDICPRO</b>	
E5	ANALOG INPUT CARD (P3-RAIC12)	MPN: 900-99-00109	
		DPN: <b>784ANOUPRO</b>	
E6.1	ANALOG OUTPUT CARD (P3-RAOC10)	MPN: 900-99-00110	OR
		DPN: <b>784ANACPRO</b>	
E6.2	PRO & ROTEM ONE SCALE CARD 2H (P3-RSC-2)	MPN: 900-99-00267	OR
		DPN: <b>78P3RSC2</b>	
E6.3	PRO & ROTEM ONE SCALE CARD 6H (P3-RSC-6)	MPN: 900-99-00268	
		DPN:	
E7.1	RS485 ISO NETWORK & 485 EXT (P3-485ISO-485)	MPN: 900-99-00101	OR
		DPN: <b>78CPPISO485PRO</b>	
E7.2	RS232 ISO NETWORK & 485 EXT (P3-232ISO-485)	MPN: 900-99-00112	
		DPN: <b>78CPPISO232PRO</b>	
E8	ALARM CARD (P3-ALARM)	MPN: 900-99-00100	
		DPN: <b>784ALARPRO</b>	
E9	TOUCH-POWER SUPPLY 150WT (P3-PS150)  Replace with Power Supply Kit For Pro 50 - DPN:78PRO50PS For Pro 30- DPN: 78PROPS	MPN: 900-99-00149	
		DPN:	
E9.1	"MEAN Well ELG-150-12A" POWER SUPPLY 150WT 12V 10A	MPN: 900-99-00226	
		DPN: <b>784PS150SONE</b>	

ID No.	Description	Order Catalog Number	Remarks
E10.1.1	N.O RELAY CARD (P3-NO-RC)	MPN: 900-99-00161 DPN: <b>784REONPRO</b>	OR
E10.2.1	N.C. RELAY 30A CARD (P3-NC-RC-30A)	MPN: 900-99-00159 DPN: <b>784RONCPRO</b>	OR
E10.3.1	WINCH RELAY CARD (2 X WINCHES) (P3-WC-RC)	MPN: 900-99-00143 DPN: <b>784PPROWCCR</b>	OR
E10.4	CURRENT SENSING RELAY 30A CARD (P3-CSNO-RC-30A)	DPN: <b>784REONCSPRO</b>	

ID No.	Description	Order Catalog Number	Remarks
F1	FLAT CABLE CPU TO KBD (SP-PP-F-KBD)	MPN: 999-99-00061 DPN: <b>784CKEY</b>	
F2	FLAT FF10P 28 CM (SP-141163)	MPN: 999-99-00425 DPN: <b>784CMAIPRO</b>	
F3	MULTI CABLE 45 CM 4X18AWG V1.0.2	MPN: 900-99-00222 DPN: <b>784CPSLDRCOMONE</b>	
Note 4 F4	MULTI CABLE 30 CM GREEN WHITE 2X20 AWG V1.0.1 (SP-143102)	MPN: 900-99-00241 DPN: <b>784CCPUDOR</b>	
F5	MULTI CABLE 17 CM 4X22AWG WIRE	MPN: 900-99-00224 DPN: <b>784CPSLBKCOMONE</b>	
F6.1	FLAT FF20P 35 CM <F"D_F"D>	MPN: 900-99-00223 DPN: <b>784CRSWITCHONE</b>	
F6.2	FLAT CABLE 30P 30 CM-PPXL CPU or PPRO CURRENT SENSE RELAYS	MPN: 999-99-00123 DPN: <b>784CRCURSWONE</b>	

# Platinum Pro Expansion, 50 Relays





## Expansion 50 Door Spare Parts

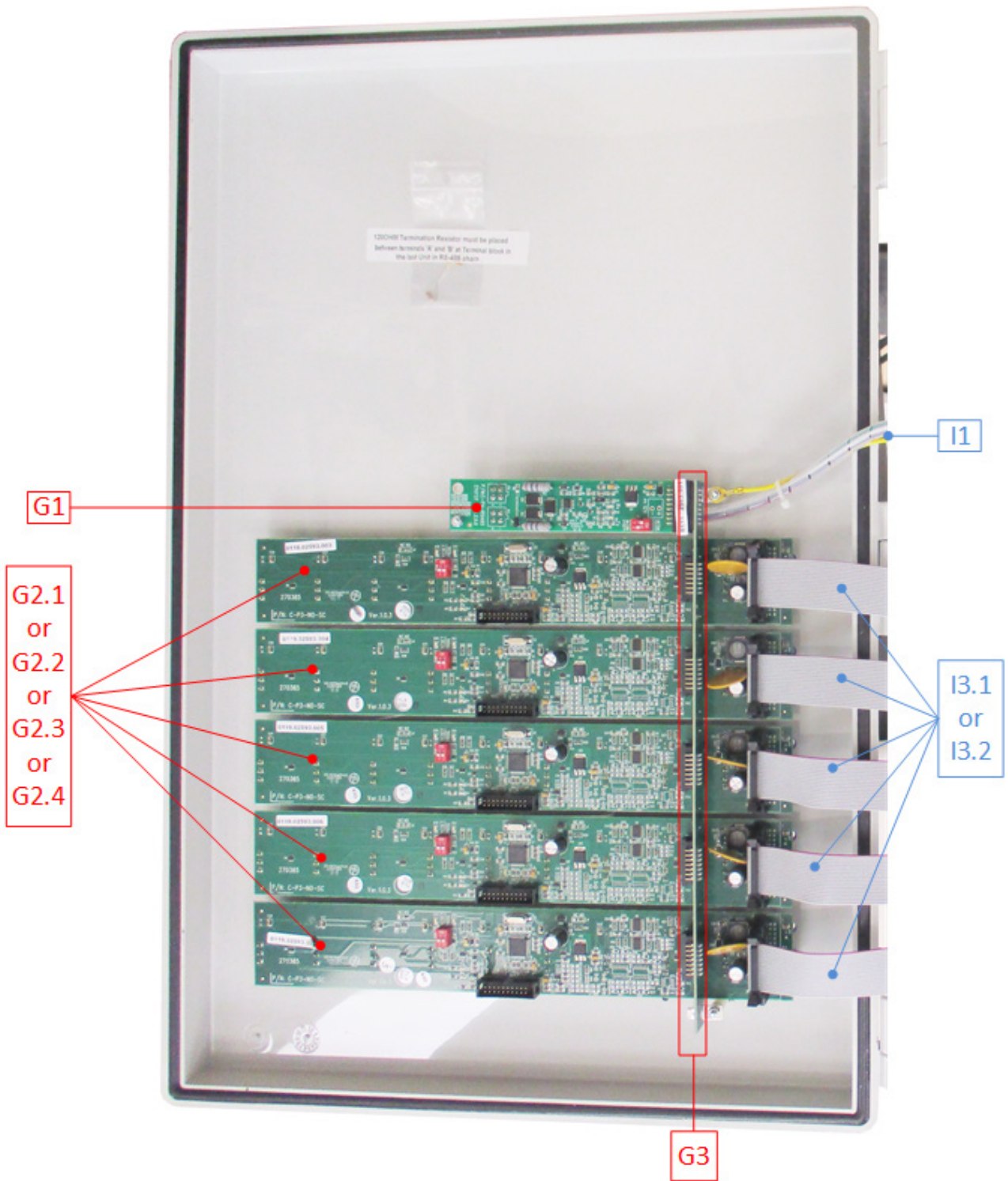

ID No.	Description	Order Catalog Number	Remarks
G1	RS485 CARD (P4-EXP-485-90)	MPN: 900-99-00233	
		DPN: <b>78COMMPPRO</b>	
G2.1	N.O. SWITCH CARD (P3-NO-SC)	MPN: 900-99-00172	
		DPN: <b>784SWONPRO</b>	
G2.2	N.C. SWITCH CARD (P3-NC-SC)	MPN: 900-99-00140	
		DPN: <b>784SCNCPRO</b>	
G2.3	WINCH SWITCH CARD (2 X WINCHES) (P3-WC-SC)	MPN: 900-99-00144	
		DPN: <b>784PPROSOWC</b>	
G2.4	CURRENT SENSE N.O. SWITCH CARD	MPN: 900-99-00202	
		DPN: <b>784SWONCSPRO</b>	
G3	SWITCH BUS 50 CARD (P3-RSB50)	MPN: 900-99-00157	
		DPN: <b>784SBUSPRO</b>	

ID No.	Description	Order Catalog Number	Remarks
I1	MULTI CABLE 45CM 4X18 AWG (P4) V1.02	MPN: 900-99-00222	
		DPN: <b>784CPSLDRCOMON</b>	
I2	MULTI CABLE 17 CM 4X22AWG WIRE (P4)	MPN: 900-99-00224	
		DPN: <b>784CPSLBKCOMONE</b>	
I3.1	FLAT CABLE 20P 35 CM <F"D_F"D>	MPN: 900-99-00223	
I3.2	FLAT CABLE 30P 30 CM-CURRENT SENSE RELAYS	DPN: <b>784CRSWITCHONE</b>	
		MPN: 999-99-00123	
		DPN: <b>784CRCURSWONE</b>	

## Expansion 50 Main Container Spare Parts

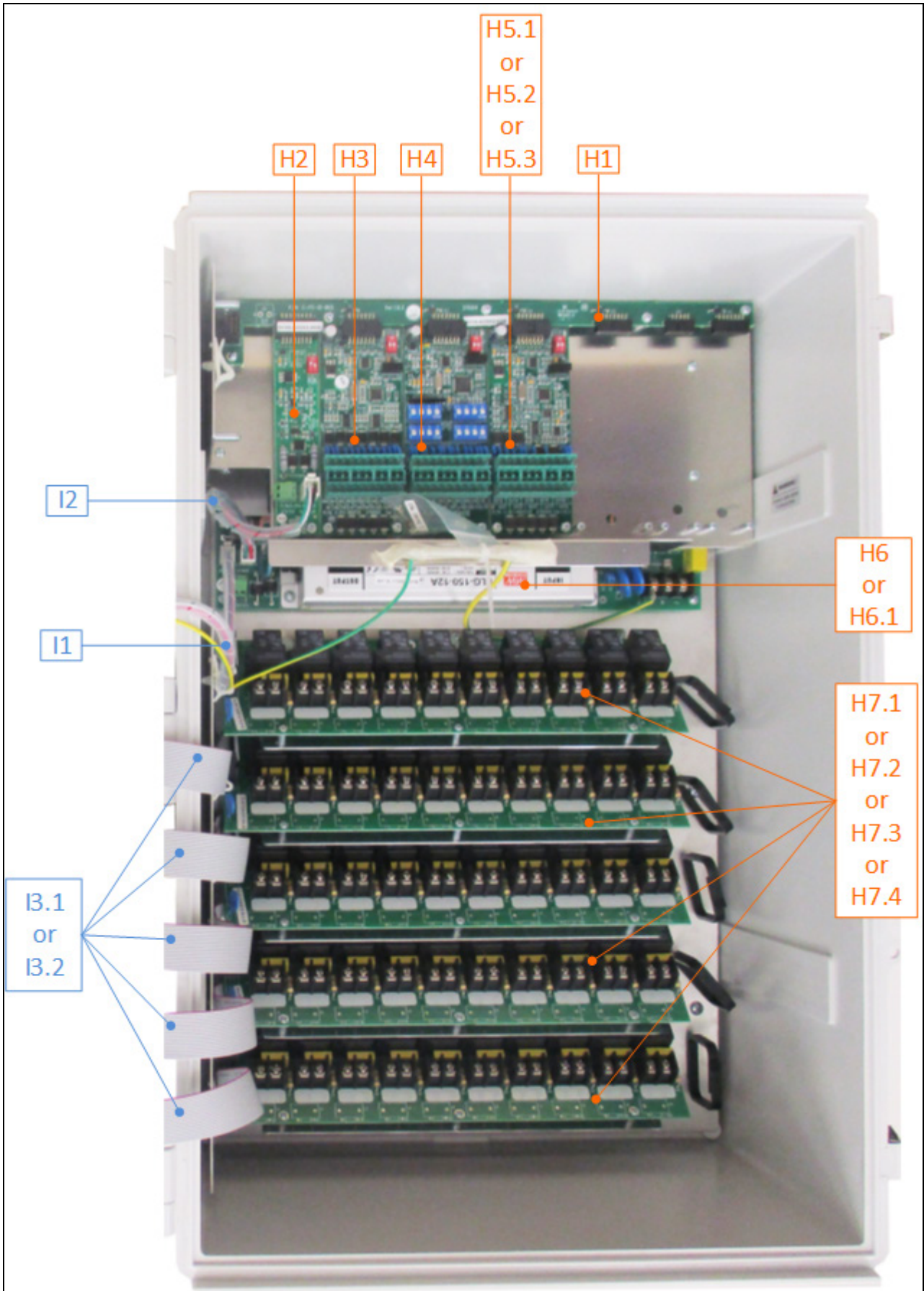

ID No.	Description	Order Catalog Number	Remarks
H1	INPUT / OUTPUT BUS CARD (P3-IO-BUS)	MPN: 900-99-00156	
		DPN: <b>784IBUSPRO</b>	
H2	RS485 CARD (P4-EXP-485)	MPN: 900-99-00232	
		DPN: <b>78COMMBPPRO</b>	
H3	DIGITAL INPUT CARD (P3-RDIC12)	MPN: 900-99-00099	
		DPN: <b>784RDICPRO</b>	
H4	ANALOG INPUT CARD (P3-RAIC12)	MPN: 900-99-00109	
		DPN: <b>784ANOUPRO</b>	
H5.1	ANALOG OUTPUT CARD (P3-RAOC10)	MPN: 900-99-00110	OR
		DPN: <b>784ANACPRO</b>	
H5.2	PRO & ROTEM ONE SCALE CARD 2H (P3-RSC-2)	MPN: 900-99-00267	OR
		DPN: <b>78P3RSC2</b>	
H5.3	PRO & ROTEM ONE SCALE CARD 6H (P3-RSC-6)	MPN: 900-99-00268	
		DPN:	
H6	TOUCH-POWER SUPPLY 150WT (P3-PS150)	MPN: 900-99-00149	
		DPN:	
H6.1	"MEAN Well ELG-150-12A" POWER SUPPLY 150WT 12V 10A	MPN: 900-99-00226	
		DPN: <b>784PS150SONE</b>	
H7.1.1	N.O RELAY CARD (P3-NO-RC)	MPN: 900-99-00161	
		DPN: <b>784REONPRO</b>	
H7.1.2	PLATINUM PRO N.O RELAY 30A NON-US (P3-NO-RC-30A-NUS)	MPN: 900-99-00272	
		DPN:	
H7.2.1	N.C. RELAY 30A CARD (P3-NC-RC-30A)	MPN: 900-99-00159	
		DPN: <b>784RONCPRO</b>	
H7.2.2	PLATINUM PRO N.C RELAY 30A NON-US (P3-NC-RC-30A-NUS)	MPN: 900-99-00274	
		DPN:	

ID No.	Description	Order Catalog Number	Remarks
H7.3.1	WINCH RELAY CARD (2 X WINCHES) (P3-WC-RC)	MPN: 900-99-00143 DPN: <b>784PPROWCCR</b>	OR
H7.3.2	PLATINUM PRO WINCH RELAY CARD (2 X WINCHES) NON USA (P3-WC-RC-NUS)	MPN: 900-99-00276 DPN:	
H7.4	CURRENT SENSING RELAY 30A CARD (P3-CSNO-RC-30A)	MPN: 900-99-00153 DPN: <b>784REONCSPRO</b>	

# Platinum Pro Expansion, 30 Relays



## Expansion 30 Door Spare Parts

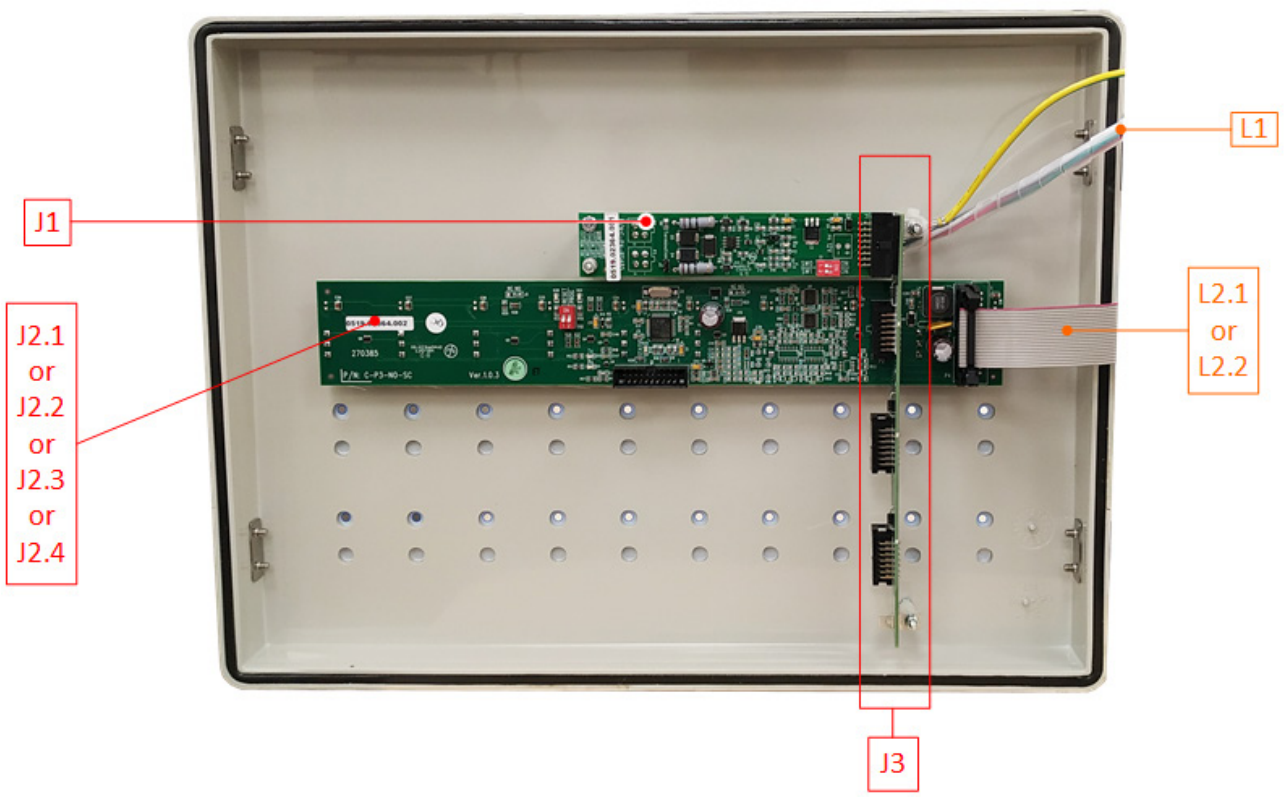

ID No.	Description	Order Catalog Number	Remarks
J1	PRO RS485 EXPANSION CARD (P4-EXP-485-90)	MPN: 900-99-00233	
		DPN: <b>78COMMDPPRO</b>	
J2.1	N.O. SWITCH CARD (P3-NO-SC)	MPN: 900-99-00172	
		DPN: <b>784SWONPRO</b>	
J2.2	N.C. SWITCH CARD (P3-NC-SC)	MPN: 900-99-00140	
		DPN: <b>784SCNCPRO</b>	
J2.3	WINCH SWITCH RELAY CARD (2 X WINCHES) (P3-WC-SC)	MPN: 900-99-00144	
		DPN: <b>784PPROSOWC</b>	
J2.4	CURRENT SENSE N.O. SWITCH CARD	MPN: 900-99-00202	
		DPN: <b>784SWONCSPRO</b>	
J3	SWITCH BUS 30 CARD (P3-SW-BUS30)	MPN: 900-99-00158	
		DPN: <b>784SBUSXPRO30</b>	

ID No.	Description	Order Catalog Number	Remarks
L1	MULTI CABLE 45CM 4X18 AWG (P4) V1.02	MPN: 900-99-00222	
		DPN: <b>784CPSLDRCOMONE</b>	
L2.1	FLAT CABLE 20P 35 CM <F"D_F"D>	MPN: 900-99-0223	
		DPN: <b>784CRSWITCHONE</b>	
L2.2	FLAT CABLE 30P 30 CM-CURRENT SENSE RELAYS	MPN: 999-99-00123	
		DPN: <b>784CRCURSWONE</b>	

## Expansion 30 Main Container Spare Parts



ID No.	Description	Order Catalog Number	Remarks
K1	PRO EXPANSION 30 POWER SUPPLY 60W	MPN: 900-99-00235	
		DPN: 78CPPX30PS	
K1.1	SWPS LPV-60-12 MEAN WELL 12, 60W	MPN: 900-99-00264	
		DPN:	
K2.1.1	N.O RELAY CARD (P3-NO-RC)	MPN: 900-99-00161	
		DPN: <b>784REONPRO</b>	
K2.1.2	PLATINUM PRO N.O RELAY 30A NON-US (P3-NO-RC-30A-NUS)	MPN: 900-99-00272	
		DPN:	
K2.2.1	N.C. RELAY 30A CARD (P3-NC-RC-30A)	MPN: 900-99-00159	
		DPN: <b>784RONCPRO</b>	
K2.2.2	PLATINUM PRO N.C RELAY 30A NON-US (P3-NC-RC-30A-NUS)	MPN: 900-99-00274	
		DPN:	



ID No.	Description	Order Catalog Number	Remarks
K2.3.1	WINCH RELAY CARD (2 X WINCHES) (P3-WC-RC)	MPN: 900-99-00143	
		DPN: <b>784PPROWCCR</b>	
K2.3.2	PLATINUM PRO WINCH RELAY CARD (2 X WINCHES) NON USA (P3-WC-RC-NUS)	MPN: 900-99-00276	
		DPN:	
K2.4	CURRENT SENSING RELAY 30A CARD (P3-CSNO-RC-30A)	MPN: 900-99-00153	
		DPN: <b>784REONCSPRO</b>	

# IO Expansion Spare Parts



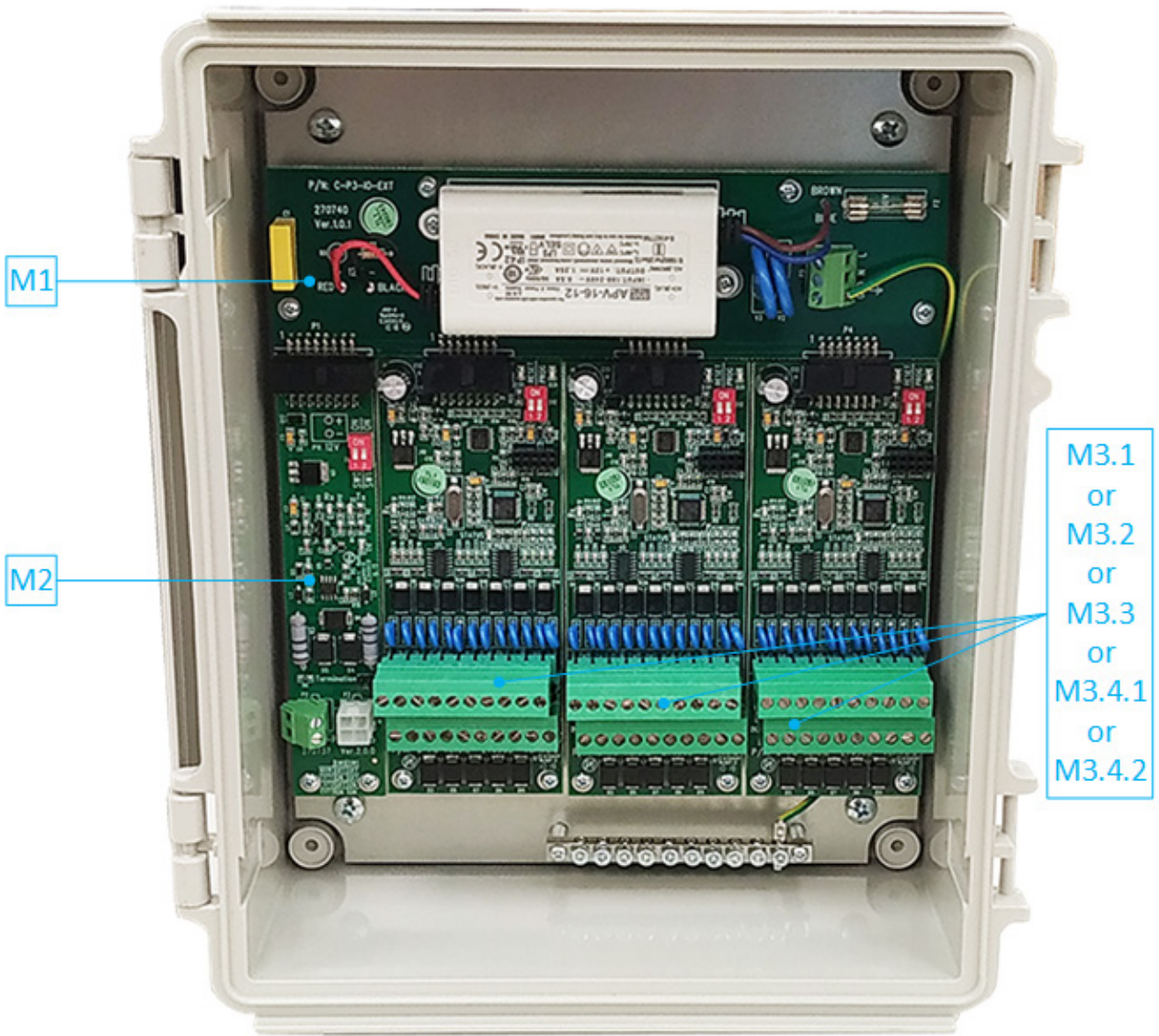

ID No.	Description	Order Catalog Number	Remarks
<b>M1</b>	PRO INPUT/OUTPUT EXPANSION	MPN: 900-99-00269 DPN:	
<b>M2</b>	EXPANSION P4-EXP-CARD	MPN: 900-99-00232 DPN: 78COMMBPPRO	
<b>M3.1</b>	DIGITAL INPUT CARD (P3-RDIC12)	MPN: 900-99-00099 DPN: 784RDICPRO	
<b>M3.2</b>	ANALOG INPUT CARD (P3-RAIC12)	MPN: 900-99-00109 DPN: 784ANOUPRO	

ID No.	Description	Order Catalog Number	Remarks
M3.3	ANALOG OUTPUT CARD (P3-RAOC10)	MPN: 900-99-00110	
		DPN: 784ANACPRO	
M3.4.1	PRO & ROTEM ONE SCALE CARD 2H (P3-RSC-2)	MPN: 900-99-00267	
		DPN: 78P3RSC2	
M3.4.2	PRO & ROTEM ONE SCALE CARD 6H (P3-RSC-6)	MPN: 900-99-00268	
		DPN:	

# Additional Options

ID No.	Description	Order Cat. No.	Remarks
ADO 1.1	PLATINUM PRO N.O. SET 30A (P3-NO-SET)	MPN: 900-99-00120	OR
		DPN: 78RELAPRO	
ADO 1.2	PLATINUM PRO N.O. SET 30A NON-US (P3-NO-SET-NUS)	MPN: 900-99-00273	
		DPN:	
ADO 2.1	PLATINUM PRO N.C. SET 30A (P3-NC-S-30A)	MPN: 900-99-00154	
		DPN:	
ADO 2.2	PLATINUM PRO N.C. SET 30A NON-US (P3-NC-S-30A-NUS)	MPN: 900-99-00275	
		DPN:	
ADO 3.1	PLATINUM PRO WINCH NON-SPRING SET (P3-WCNS-S-MUN)	MPN: 900-99-00104	
		DPN:	
ADO 3.2	PLATINUM PRO WINCH CARD SE NON-US (P3-WC-SET-NUS)	MPN: 900-99-00277	
		DPN:	
ADO 4	PLATINUM PRO CURRENT SENSE N.O. SET (P3-CSNO-S-V2)	MPN: 900-99-00119	
		DPN: 78PPPCSS30APRO	
ADO 5	RTS 2-TEMPERATURE SENSOR-TYPE 2 BLACK CVILUX	MPN: 918-01-00001	
		DPN: 784TEMP	
ADO 6	P-RHS-10PL SE ROTEM	MPN: 917-02-00003	
		DPN: 784HUMD	
ADO 7	FAMILY-POU-STATIC PRESSURE SETRA SET (WITH TUBES)	MPN: 900-99-00052	
		DPN: 784STAT	
ADO 8	CO2 SENSOR	MPN: 919-01-00002	
		DPN: 78PCO2	

ID No.	Description	Order Cat. No.	Remarks
ADO 9.1	PLATINUM PRO/ONE 2 SCALE & POWER SUPPLY 230V (P3-BIRD-S-V2)	MPN: 900-01-00261	
		DPN:	
ADO 9.2	PLATINUM PRO/ONE 6 SCALE & POWER SUPPLY 230V (P3-SILO & BIRD-S-V2)	MPN: 900-01-00179	
		DPN:	

# Cards and Cables

## Internal RS485 Communication Cards

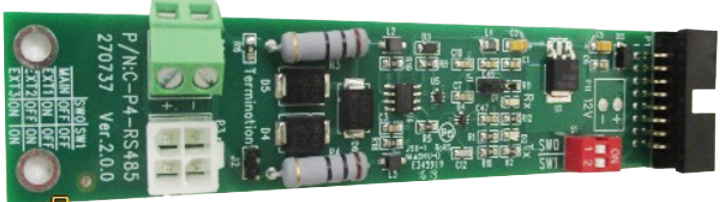
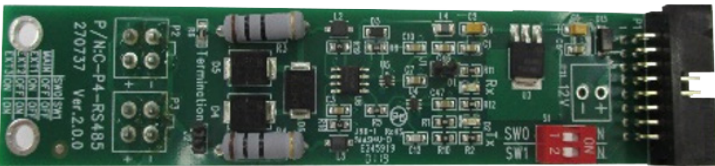
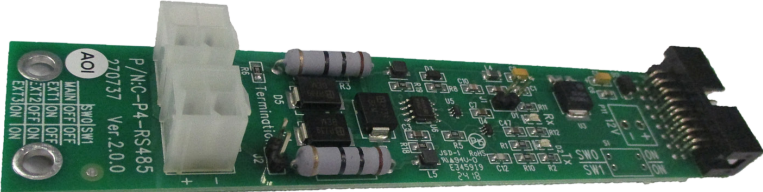
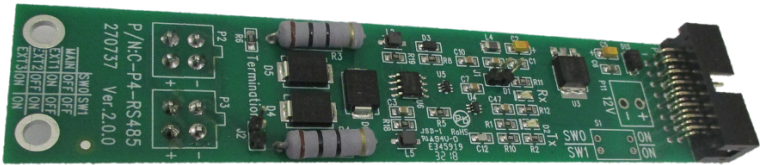
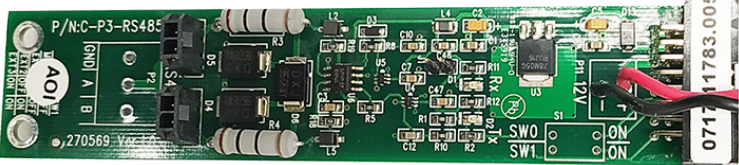

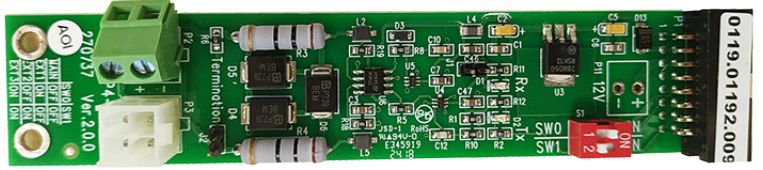

Card	Description	Munters Ordering Number
 <p>P/N:C-P4-RS485 270737 Ver. 2.0.0 MAIN OFF/ON EXT1 ON/OFF EXT2 ON/OFF EXT3 ON/OFF EXT4 ON/OFF</p>	R-P4-EXP-485	900-99-00232 78COMMBPPRO
 <p>P/N:C-P4-RS485 270737 Ver. 2.0.0 MAIN OFF/ON EXT1 ON/OFF EXT2 ON/OFF EXT3 ON/OFF EXT4 ON/OFF</p>	R-P4-EXP-485-90	900-99-00233 78COMMDPPRO
 <p>P/N:C-P4-RS485 270737 Ver. 2.0.0 MAIN OFF/ON EXT1 ON/OFF EXT2 ON/OFF EXT3 ON/OFF EXT4 ON/OFF</p>	R-P4-RS485	900-99-00200 78CBOARDONE
 <p>P/N:C-P4-RS485 270737 Ver. 2.0.0 MAIN OFF/ON EXT1 ON/OFF EXT2 ON/OFF EXT3 ON/OFF EXT4 ON/OFF</p>	R-P4-RS485-90	900-99-00231 78COMMDPONE
 <p>P/N:C-P3-RS485 270569 Ver. 2.0.0 MAIN OFF/ON EXT1 ON/OFF EXT2 ON/OFF EXT3 ON/OFF EXT4 ON/OFF</p>	R-P3-RS485	900-99-00173 78CBOARDPRO

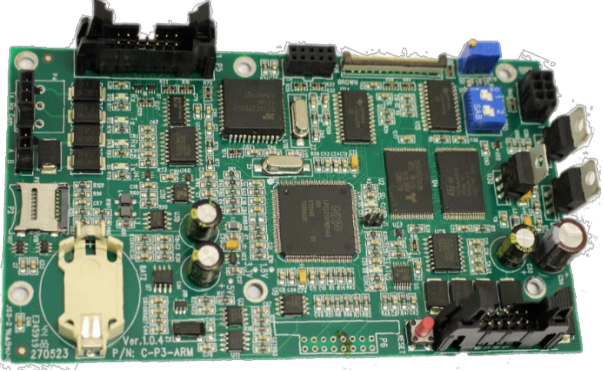
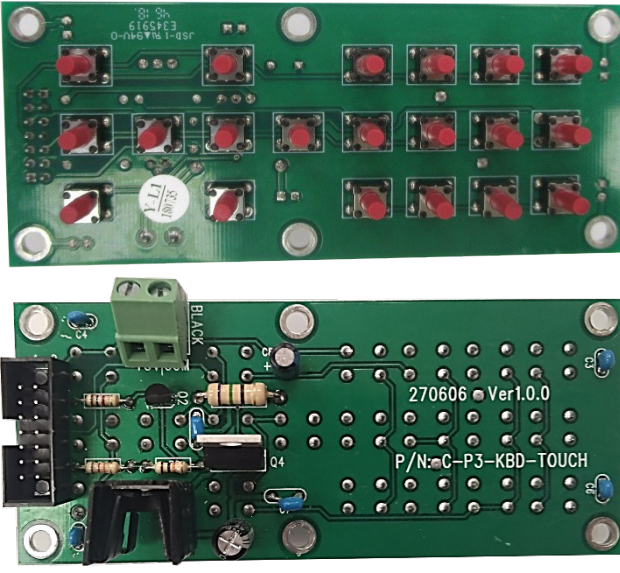
Card	Description	Munters Ordering Number
 <p>A green printed circuit board (PCB) for RS485 communication. It features a central integrated circuit, several resistors, and a terminal block on the left. A label on the right edge reads '0119.01192.009'. Other markings include 'Ver. 2.0.0' and 'R-P3-RS485EX'.</p>	R-P3-RS485EX	900-99-00183 78CCOMMEXT485

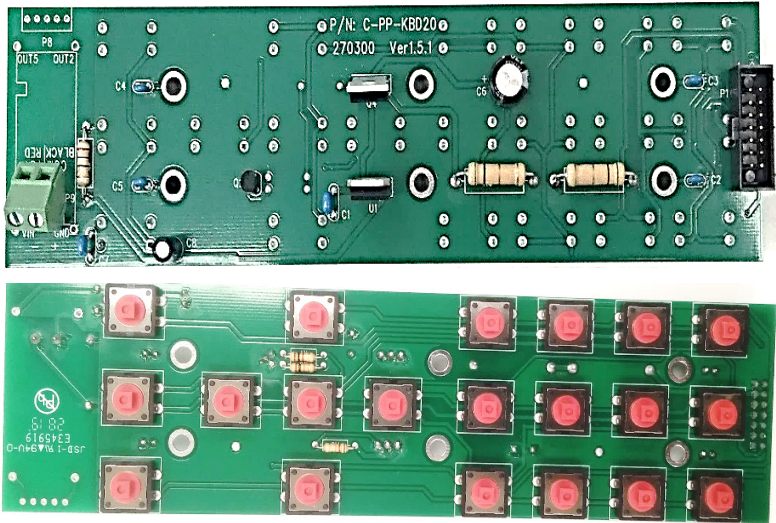

**Door Cards**

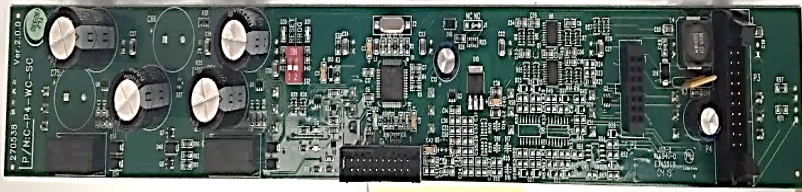
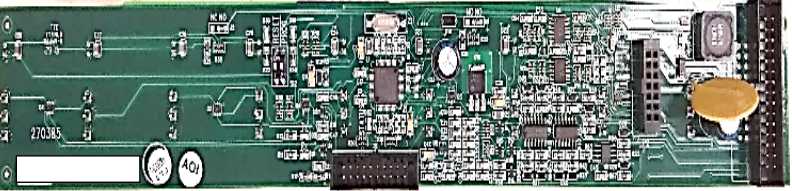
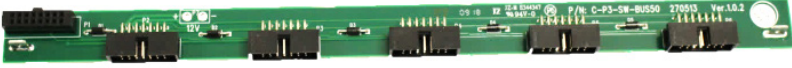
Card	Description	Munters Ordering Number
 <p>A complex green PCB with multiple integrated circuits, capacitors, and connectors. A label at the bottom left indicates 'Ver. 1.0.4' and 'P/N: C-P3-ARM'. The board is densely packed with electronic components.</p>	R-P3-ARM: PLATINUM PRO CPU CARD	900-99-00108 784CPPARMPRO
 <p>Two views of a green PCB for a touch keyboard. The top view shows a grid of red touch buttons. The bottom view shows the reverse side with a terminal block, a green connector, and various electronic components. Labels include '270606 Ver1.0.0' and 'P/N: C-P3-KBD-TOUCH'.</p>	R-P3-KBD-TOUCH: KEYBOARD FOR PLATINUM TOUCH	900-99-00203 78CPPKBDLEDONE





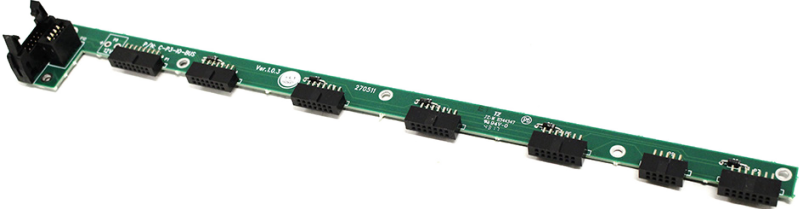

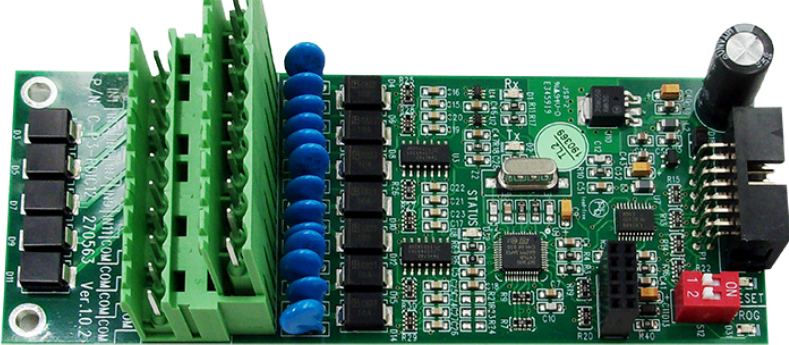
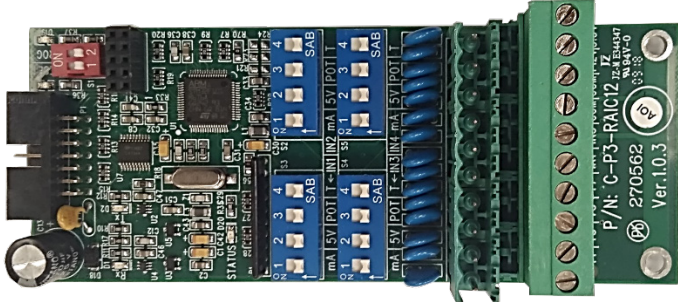
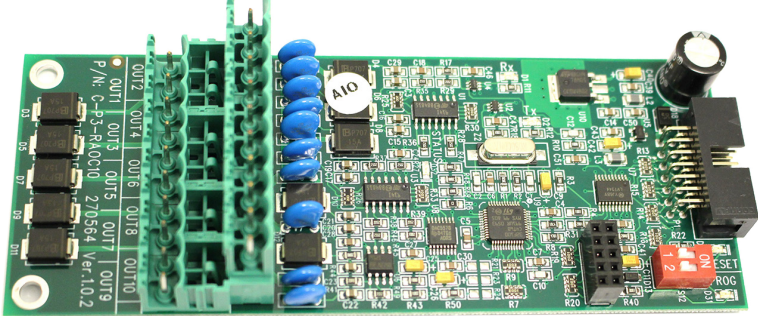
Card	Description	Munters Ordering Number
	<p>R-P3-KBDLED: P3 KEYBOARD CARD FOR LED LCD</p>	<p>900-99- 00242 78CPPKBDLEDPRO</p>
	<p>R-P3-NO-SC: PRO N.O SWITCH CARD</p>	<p>900-99- 00172 784SWONPRO</p>
	<p>R-P3-NC-SC: P3 N.C SWITCH CARD</p>	<p>900-99- 00140 784SCNCPRO</p>
	<p>R-P3-WC-SC: PRO WINCH SWITCH CARD (2 X WINCHES</p>	<p>900-99- 00144 784PPROSOWC</p>
	<p>R-P3-CS-NO-SC: P3 CURRENT SENSE N.O SWITCH CARD</p>	<p>900-99- 00202 784SWONCSPRO</p>
	<p>R-P3-SW-BUS50: PRO SWITCH BUS 50 CARD</p>	<p>900-99- 00157 784SBUSPRO</p>
	<p>R-P3-SW-BUS30: PRO SWITCH BUS 30 CARD</p>	<p>900-99- 00158 784SBUSXPRO30</p>

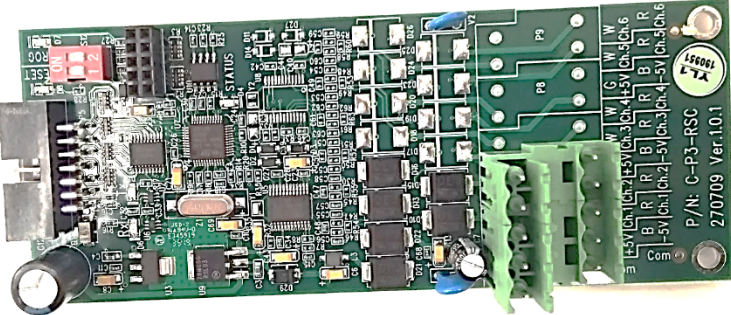
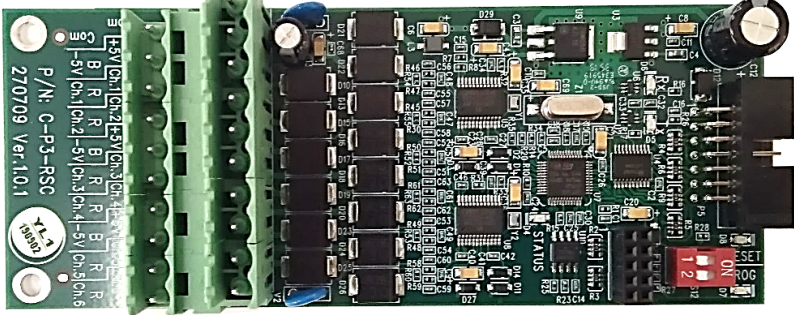
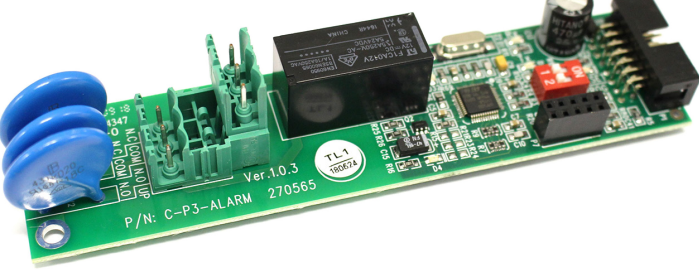
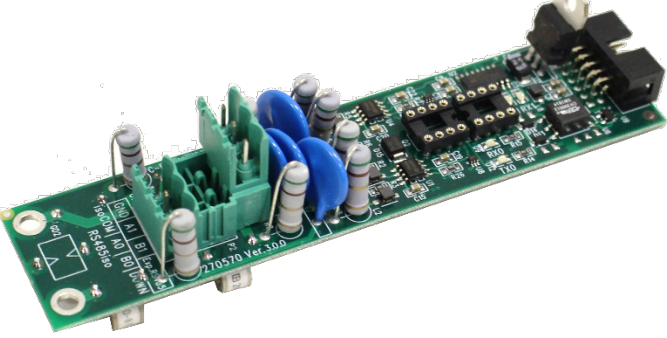
## Main Container Cards

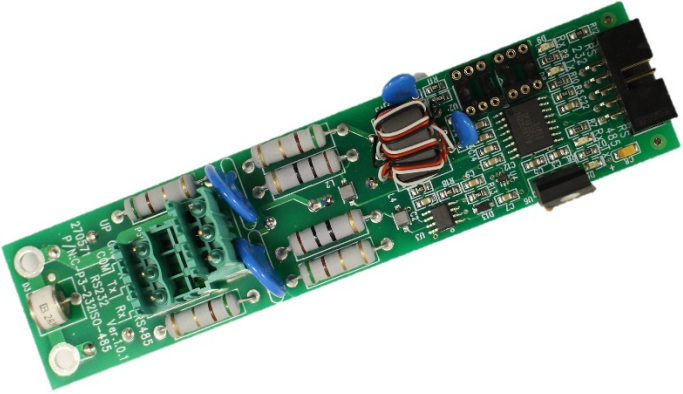
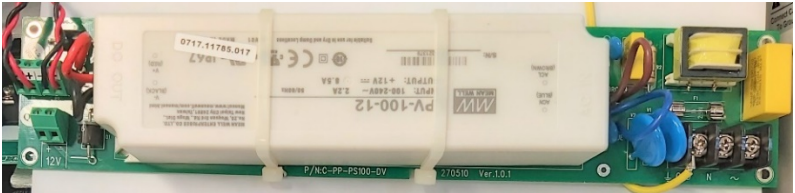
Card	Description	Munters Ordering Number
	R-P3-IO-BUS: PRO INPUT/OUTPUT BUS	900-99- 00156 <b>784IBUSPRO</b>
	R-PP-RPS3-ST: PP STATIC PRESSURE CARD(SETRA)	900-99- 00121 <b>784STAT</b>
	R-P3-RDIC12: PRO DIGITAL INPUT CARD	900-99- 00099 <b>784RDICPRO</b>
	R-P3-RAIC12: PRO ANALOG INPUT CARD	900-99- 00109 <b>784ANOUPRO</b>
	R-P3-RAOC10: PRO ANALOG OUTPUT CARD	900-99- 00110 <b>784ANACPRO</b>

Card	Description	Munters Ordering Number
 <p>A green printed circuit board (PCB) for a scale card. It features a large integrated circuit (IC) in the center, several resistors, and a green terminal block on the right side with two channels. The PCB is populated with various electronic components. Text on the board includes 'P/N: C-P3-RSC Ver.1.0.1' and '270709'.</p>	<p>R-P3-RSC-2: PRO &amp; ROTEM 1 SCALE CARD 2CH</p>	<p>900-99-00267 78P3RSC2</p>
 <p>A green PCB for a 6-channel scale card. It has a similar layout to the 2-channel version but with a larger IC and more complex circuitry. It features a green terminal block with six channels. Text on the board includes 'P/N: C-P3-RSC Ver.1.0.1' and '270709'.</p>	<p>R-P3-RSC-6: PRO &amp; ROTEM 1 SCALE CARD 6CH</p>	<p>900-99-00268 SOLD AS PART OF KIT 784SCALPRO- COMBO</p>
 <p>A green PCB for an alarm card. It is smaller than the scale cards and features a large black integrated circuit, a red push-button, and a green terminal block. Text on the board includes 'P/N: C-P3-ALARM Ver.1.0.3' and '270565'.</p>	<p>R-P3-ALARM: PRO ALARM CARD</p>	<p>900-99-00100 784ALARPRO</p>
 <p>A green PCB for an RS485 interface card. It features a large integrated circuit, several resistors, and a green terminal block. Text on the board includes 'P/N: C-P3-485ISO-485 Ver.3.0.0' and '270570'.</p>	<p>R-P3-485ISO- 485: PRO RS485 ISO NETWORK &amp; 485 EXT</p>	<p>900-99-00101 78CPPISO485PRO</p>

Card	Description	Munters Ordering Number
	R-P3-232ISO-485: PRO RS232 ISO NETWORK & 485 EXT	900-99-00112 <b>78CPPISO232PRO</b>
	R-P3-PS100: P3 POWER SUPPLY 100WT	900-99-00124 <b>78CPPPS100DVPRO</b>
	PLATINUM PRO - POWER SUPPLY 150WT-UPGRAD KIT FOR V100	900-99-00310 <b>78PRO50PS for PRO50 OR 78PROPS for PRO 30</b>
	R-P3-PRO EXPANSION 30 POWER SUPPLY 60 WT	900-99-0235 <b>78CPPX30PS</b>
	R-P3-NO-RC: PRO N.O RELAY CARD	900-99-00161 <b>784REONPRO</b>