

DIVE SUPPLY

CATALOGUE
2020



DIVE
SUPPLY
DIVING & WATER SPORT EQUIPMENT SPECIALIST

SUUNTO D5

LET'S EXPLORE TOGETHER

 Bluetooth™

NEW



INDEX

REGULATORS	2-10
BCD'S	11-16
INSTRUMENTS	17-21
DIVE COMPUTERS	22-29
MASKS & SNORKELS	30-43
GOGGLES & MASK SETS	44-48
FINS	49-54
NEOPRENE PRODUCTS	55-65
CAMERAS	66-70
BAGS & CASES	71-79
TORCHES	80-81
KNIVES	82-84
ACCESSORIES	85-99
TOOLS & SERVICE PARTS	100-101
TANKS, VALVES & AIR	102-105
COMPRESSORS	106-109
MARINE BOOKS	110
CUSTOM PRINTS & EMBROIDERY	111
SHOP DISPLAYS / FITTINGS	112-113

www.divesupply.com



HIGH TECHNOLOGY & MAXIMUM BREATHING COMFORT WITH SCUBAPRO REGULATORS

SCUBAPRO FIRST STAGE REGULATORS

First stage regulators are divided into piston & diaphragm categories.

SCUBAPRO PISTON TECHNOLOGY

The general advantage of a piston first stage lies in its reliability & reduced maintenance requirements. More importantly, no other design can reach the high air delivery rate of a balanced piston controlled first stage. First stages with air-balanced pistons deliver significantly more air to the second stage than any other first stage. This technology is featured in our MK25 EVO first stages.

Classic downstream piston - The classic downstream valve is the first choice of diving centers & rental facilities worldwide for warm & moderate water temperatures. This technology is featured in our MK2 EVO first stage.

FIRST STAGE PRODUCT FEATURES						
	MK25T EVO	MK25 EVO	MK21	MK2 EVO	MK17 EVO	MK11
Technology						
Air-balanced-flow-through	✓	✓	✓			
Classic downstream				✓		
balanced diaphragm					✓	✓
Materials						
Chrome plated brass body		✓	✓	✓	✓	✓
Full titanium body	✓					
Cold water						
Anti-freeze protection (AF)	✓	✓	✓		✓	
Dry chamber					✓	
XTIS antifreeze system	✓	✓		✓		
Ports						
Intermediate pressure Ports (IP)	5	5	4	4	4	4
High Flow Ports (HFP)	5	5	4	-	2	2
High Pressure (HP) Ports	2	2	2	1	2	2
Swivelling turret with IP ports	✓	✓				
Cap with 5 HFP ports (optional)			✓			
Configuration						
INT 230 bar (3336 psi)	✓	✓	✓	✓	✓	✓
DIN 300 bar (4351 psi)	✓	✓	✓	✓	✓	✓
Externally adjustable intermediate pressure						
	✓	✓	✓		✓	✓
Weight DIN 300 (g/oz)						
	350 / 12.4	572 / 20.1	555 / 19.6	454 / 16	625 / 22	470 / 16.6
Weight INT (g/oz)						
	480 / 16.9	790 / 27.9	744 / 26.2	673 / 23.7	850 / 30	692 / 24.4
Air Flow at 200 bar (l/min / SCFM)						
	>8500 / 301	>8500 / 301	>7500 / 265	3000 / 106	>6500 / 230	>5500 / 195
Intermediate pressure (bar/psi)						
	9-9.8/130-142	9-9.8/130-142	9-9.8/130-142	8.5-9.8/123-142	9-9.8/130-142	9-9.8/130-142

SCUBAPRO DIAPHRAGM TECHNOLOGY

Diaphragm-based first stages are environmentally sealed so water cannot enter the inner mechanism. Diaphragm first stages have been the favored choice of cold water divers & those working in contaminated or muddy water. This technology is featured in our MK17 EVO & MK11 first stages.

SCUBAPRO SECOND STAGE REGULATORS

A high quality second stage can significantly reduce stress & enhance diver safety by providing a smooth, low-effort breathing response, resulting in ample yet controllable quantities of air.

AIR-BALANCED VALVE TECHNOLOGY

The air-balanced valve technology of SCUBAPRO second stages features a balancing chamber in the second stage mechanism, slightly offsetting the force of the downstream air entering from the first stage. Air-balanced valve technology is featured in X-Series, S-Series & G-Series second stages. For best results, they should be teamed with balanced first stages like the MK25 EVO or MK17 EVO.

SECOND STAGE PRODUCT FEATURES							
	A700	S600	S560	C370	G260	R195	R095
Technology							
Air-balanced	✓	✓	✓	✓	✓		
Classic downstream valve						✓	✓
Materials							
Precision molded carbon fiber & technopolymer housing			✓	✓			
Full metal valve housing	✓	✓			✓	✓	✓
Full metal case	✓						
Breathing comfort							
Coaxial flow	✓			✓			
Diver's adjustable inhalation effort	✓	✓	✓	✓	✓		
Diver's adjustable VIVA	✓	✓	✓	✓	✓	✓	
VIVA preset							✓
Hose							
Sturdy super-flow hose for extra durability & flawless air delivery	✓	✓	✓	✓	✓	✓	✓
Left & right attachment for extra convenience					✓	✓	✓
Mouthpiece							
Supercomfort HF (High Flow)	✓	✓	✓	✓	✓	✓	✓
Weight (g/oz)							
	265 / 9.3	193 / 6.8	172 / 6.1	158 / 5.6	275 / 9.7	198 / 7.0	165 / 5.8
Air Flow at 200 bar (l/min / SCFM)							
	>2000 / 71	1850 / 66	1850 / 66	1850 / 66	18000 / 64	1400 / 50	1400 / 50

MK25T EVO / S620X TITANIUM



First stage

- Titanium construction
- Cold water XTIS (external thermal insulating system)
- Improved cold water performance by 30% in waters down to 2°C

Second stage

- Rugged reinforced technopolymer case
- Titanium barrel
- New exhaust tee increases performance while directing bubbles out of the field of view
- Compact Hi-Flow mouthpiece, exclusive to the S620 Ti - improved airflow & mouth comfort



X12.620.400

MK25 EVO / A700 CARBON BLACK TECH



First stage

- DLC (Diamond-like Carbon) black finish
- Cold water XTIS (external thermal insulating system)
- Improved cold water performance by 30% in waters down to 2°C

Second stage

- Precision handcrafted construction (full metal case)
- NEW carbon fibre cover that's virtually bulletproof
- Exceptional breathing performance at any depth
- Diver adjustable venturi-initiated vacuum assist (VIVA)
- High comfort orthodontic mouthpiece



X12.770.700

MK25 EVO / S600



First stage

- Double chrome plated marine brass
- Cold water XTIS (external thermal insulating system)
- Improved cold water performance by 30% in water down to 2°C

Second stage

- Technopolymer body & components
- Diver adjustable venturi-initiated vacuum assist (VIVA)
- High comfort orthodontic mouthpiece



X12.971.050

MK25 EVO / D420



First stage

- Double chrome plated marine brass
- Cold water XTIS (external thermal insulating system)
- Improved cold water performance by 30% in water down to 2°C

Second stage

- NEW. Uniquely shaped casing carries on the D-Series heritage with the latest advances in breathing performance technology
- NEW. Air-balanced Progressive Flow Control Valve is able to deliver abundant airflow with a natural smoothness comparable to breathing on the surface
- NEW casing design features inner winglets that direct airflow towards the exhaust valve, creating a dramatic improvement in exhalation effort
- NEW. Diaphragm is located in the lower section of the casing to take advantage of the pressure gradient in the upright position, making breathing even easier



X12.420.000

MK19 EVO / D420



First stage

- Air balanced diaphragm delivers constant & effortless airflow unaffected by depth, tank pressure, or breathing rate
- Dry ambient pressure chamber increases freezing resistance, ensuring consistent airflow in the coldest conditions
- Environmentally sealed system prevents water & pollutants from fouling the inner mechanism
- Five high-flow low pressure ports on a swivel turret maximize hose routing options (same as MK25)
- Double high pressure outlets

Second stage

- NEW. Uniquely shaped casing carries on the D-Series heritage with the latest advances in breathing performance technology
- NEW. Air-balanced Progressive Flow Control Valve is able to deliver abundant airflow with a natural smoothness comparable to breathing on the surface
- NEW casing design features inner winglets that direct airflow towards the exhaust valve, creating a dramatic improvement in exhalation effort
- NEW. Diaphragm is located in the lower section of the casing to take advantage of the pressure gradient in the upright position, making breathing even easier



X12.425.000



SIDEMOUNT REGULATOR SET



Offering effortless air delivery and outstanding reliability, this is the go-to air delivery system for cold water or technical diving. There's no better example of solid first stage performance in all water temperatures than the MK25 EVO. Teamed with the venerable G260, this system can be relied upon to deliver top-of-the-line performance in the most extreme conditions.

Set Contains

- 2 x MK25 EVO DIN 300
- 2 x G260
- 2 x Compact Guages

Plus

- 2 x HP hose 20cm
- LP hoses: 20cm (x2), 64cm (x1), 200cm (x1)
- BPI quick coupling x 2
- LP hose elbow x 1
- Regulator Necklace x 1
- Plug x 2



X12.252.060

MK21 / S560



First stage

- Compact design 20% smaller than the MK25
- Air-balanced flow through piston design
- Optional replaceable head ideal for technical diving
- 4 LP ports & 2 HP ports

Second stage

- Lightweight techno-polymer barrel
- Diver adjustable inhalation effort
- Diver-adjustable venturi-initiated vacuum assist (VIVA)
- Ultra comfortable orthodontic mouthpiece



X12.974.000

MK21 / C370



First stage

- Compact design 20% smaller than the MK25
- Air-balanced flow through piston design
- Optional replaceable head ideal for technical diving
- 4 LP ports & 2 HP ports

Second stage

- Compact body & exhaust tee
- Optimal flow design incorporates a special barrel & balanced poppet valve to produce maximum airflow under any diving conditions
- Diver-adjustable inhalation effort
- Venturi-Initiated Vacuum Assist (VIVA)
- Ultra-comfortable orthodontic mouthpiece



X12.979.000

MK17 EVO / S600



First stage

- Air balanced diaphragm
- New machined body
- 4 high flow LP ports & 2 HP ports
- Environmentally sealed mechanism
- New cover & caps

Second stage

- Technopolymer body & components
- Diver adjustable venturi-initiated vacuum assist (VIVA)
- High comfort orthodontic mouthpiece



X12.927.050

MK11 / C370



First stage

- Balanced diaphragm design
- Cold water – anti-freeze protection
- Chrome plated brass body in compact design
- 4 LP ports & 2 HP ports

Second stage

- Compact body & exhaust tee
- Optimal flow design incorporates a special barrel & balanced poppet valve to produce maximum airflow under any diving conditions
- Diver-adjustable inhalation effort
- Venturi-Initiated Vacuum Assist (VIVA)
- Ultra-comfortable orthodontic mouthpiece



X12.175.000

MK2 EVO / R095



First stage

- Increased performance at low tank pressure
- Cold water XTIS (external thermal insulating system)
- Improved positioning – 5% reduced in length
- New piston design with 15% increased airflow

Second stage

- Classic downstream valve
- Preset VIVA
- Reversible LP hose attachment



X12.096.000

MK25 EVO



- Consistently ranked as the top-performing first stage
- Air-balanced flow through piston design
- NEW XTIS (external thermal insulating system)
- 30% increase in freezing resistance
- 5 extra high airflow LP ports on a rotating turret
- 2 HP ports



INT (Yoke)... X10.713.010
DIN... X10.713.030

MK21

- Compact design 20% smaller than the MK25
- Air-balanced flow through piston design
- Optional replaceable head ideal for technical diving
- 4 LP ports & dual HP ports
- Adjustable intermediate pressure

INT (Yoke)... X10.721.000
DIN... X10.721.300



MK17 EVO

- Air balanced diaphragm
- New machined body
- 4 high flow LP port & 2 HP ports
- Environmentally sealed mechanism
- New cover & caps
- DIN wheel (new design)

INT (Yoke)... X10.714.010
DIN... X10.714.030



MK11

- Balanced diaphragm design
- Cold water – anti-freeze protection
- Chrome plated brass body in compact design
- 4 LP ports & 2 HP ports

INT (Yoke)... X10.708.000
DIN... X10.708.300



MK2 EVO

- NEW XTIS (external thermal insulating system)
- Industry renowned 'workhorse' regulator for Dive Schools
- New piston design with 15% increased airflow
- 50% increase in freezing resistance
- 4 LP ports & 1 HP port

INT (Yoke)... X10.063.000
DIN... X10.063.300



A700

- Precision handcrafted construction with polished chrome exterior & full metal case
- Air balanced valve & coaxial flow
- Diver-adjustable inhalation effort
- Diver-adjustable venturi-initiated vacuum assist (VIVA)
- Super-flow hose & high comfort orthodontic mouthpiece



X11.700.000

S600 / S620Ti

- Air balanced flow valve
- Diver-adjustable venturi-initiated vacuum assist (VIVA)
- Diver-adjustable inhalation effort
- Full metal valve housing
- Super-flow hose
- High comfort orthodontic mouthpiece
- Titanium available



X11.620.000



X11.603.000



S560

- Lightweight techno-polymer barrel
- Air balanced flow valve
- Diver adjustable inhalation effort
- Diver-adjustable venturi-initiated vacuum assist (VIVA)
- High flow exhaust valve
- Super flow hose & ultra comfortable orthodontic mouthpiece



X11.560.000



G260

- Air balanced flow valve
- Diver-adjustable inhalation effort
- Diver-adjustable venturi-initiated vacuum assist (VIVA)
- High flow exhaust valve
- Ultra comfortable orthodontic mouthpiece
- Full metal valve housing



X11.263.000



C370

- Compact body & exhaust tee
- Optimal flow design incorporates a special barrel & balanced poppet valve to produce maximum airflow under any diving conditions
- Diver-adjustable inhalation effort
- Venturi-Initiated Vacuum Assist (VIVA)
- Ultra-comfortable orthodontic mouthpiece



X11.370.000



R195



- Classic downstream valve
- Diver-adjustable venturi-initiated vacuum assist (VIVA)
- Reversible hose attachment
- Super-flow hose
- Super comfort orthodontic mouthpiece
- Metal valve housing



X11.331.000

R095



- Classic downstream valve
- Preset VIVA tuned for safe, uncomplicated use
- Super-flow hose
- High comfort orthodontic mouthpiece
- Full metal valve housing
- Reversible hose attachment



X11.330.500

R195 OCTOPUS



- Classic downstream valve
- Diver-adjustable venturi-initiated vacuum assist (VIVA)
- Super-flow hose
- High comfort orthodontic mouthpiece
- Full metal valve housing
- Reversible hose attachment
- 1m yellow super flow hose



X11.331.200

R095 OCTOPUS



- Classic downstream valve
- Preset VIVA
- High comfort orthodontic mouthpiece
- Full metal valve housing
- Reversible hose attachment
- 1m yellow super flow hose



X11.330.400

AIR 2 BLACK 5th Generation

- Downstream valve
- Air-balanced power inflator valve
- Pre-tuned fixed VIVA flow vane
- Improved design, control & safety for BC inflating
- Larger deflation button & high comfort mouthpiece



X21.090.000

DIVE CENTRE PACKAGE



“DEEP DOWN YOU WANT THE BEST”
Now you can have the best at a price you can afford

A combination of the bulletproof Scubapro MK2 Evo regulator set & the outstanding T-One BCD. The MK2 has an unrivaled reputation within the dive industry for unhindered and continued use, a reputation improved further with this latest Evo model: Reduced size & weight, yet increased performance (air flow increased by 15% > 3,000 L/min) . The practical T-One BCD sets a new standard in looks and longevity.



The SCUBAPRO set includes:

T-One BCD - 4TH Generation

- Heavy duty 'colour lock' cordura 1000 denier exterior
- Comfortable nylon 420 denier interior
- Carbon reinforced shoulders
- Balanced power inflator
- Internal octopus/console holder
- Padded cummerbund & backpack
- Color coded size tabs

T-One Size	XXS	XS	S	M	L	XL	XXL
Colour Coded	Pu	Pi	G	B	Li	O	Gp
Lift Capacity in Kg.	9	11	14	17	18	21	22

R095/R095 Octopus

- Classic downstream valve
- Full metal valve housing
- Preset VIVA
- Left or Right hose configuration
- Superflow hose
- High comfort orthodontic mouthpiece



MK2 EVO 1st Stage

- Industry renowned 'workhorse' regulator
- Standard piston design
- New XTIS (extended thermal insulating system)
- 15% increase in flow rate (>3,000LPM)
- 4 LP ports & 1 HP port



Console 2

- Genuine SCUBAPRO hose & gauges
- Pressure gauge 300bar
- Depth gauge 60m with parabolic scale & maximum depth indicator
- Lightweight & compact
- Loop on case to attach a safety lanyard
- Fluorescent dials

HYDROS PRO BCD



- Winner 'BEST IN SHOW' - DEMA 2015
- Innovative high tech modular system
- Monprene® TPE (thermoplastic elastomer)
 - Unrivalled strength & durability
 - Water resistant
 - Super quick drying
- Integrated weights system, 3 dump valves, 6 D-rings with adjustable height, trim pockets
- Colours for Men: Black, Blue, Orange, White, Yellow
- Colours for Women: Pink, Purple, Black, White
- Converts into a lightweight travel BCD with free backpack
- Sizes for Men: S, M, L, XL-XXL
- Sizes for Women: XS-S, M, L

Introducing the key to transforming your dive experience. Hydros Pro is an incredible feat of engineering offering unprecedented convenience, on-the-go configuration & specialized fits. Hydros Pro isn't just for professionals, it's for anyone who loves to dive & wants the best

Instant Dry & Durable

No water absorption means neutral buoyancy & a light weight BC that is dry when it comes out of the water. Hydros Pro also stands up to UV, chemicals & abrasion

Smart-Pack Design

Pack your entire kit into the small backpack (included) & get going



Hydros Pro Man... X21.73
Hydros Pro Lady... X21.73

2-in-1 BC

With a quick switch of clips, Hydros Pro transforms from a basic harness travel BC to a jacket with fully integrated weight pockets

HYDROS PRO BCD ACCESSORIES



X21.746.400



X21.746.002



X21.745.100



X21.745.200



X21.745.250



X21.745.010



X21.746.500



X21.745.700



X21.745.500



X21.745.400



X21.746.005



X21.746.006



X21.745.710



X21.745.600

- Colour Kit Army Green... X21.745.010
- Colour Kit Black... X21.745.100
- Colour Kit Blue... X21.745.200
- Colour Kit Turquoise... X21.745.250
- Colour Kit Orange... X21.745.400
- Colour Kit Yellow... X21.745.500
- Colour Kit White... X21.745.600
- Colour Kit Pink... X21.745.700
- Colour Kit Purple... X21.745.710
- Mini D-ring Set... X21.746.002
- Ninja Pocket... X21.746.005
- Cargo Thigh Pocket... X21.746.006
- Hydros Carry Bag... X21.746.007
- Accessory Bungee Set - M... X21.746.400
- Accessory Bungee Set - L... X21.746.500

HYDROS X BCD



NEW

- HYDROS X is based on the same modular Monprene® harness and backpack design popularized by the Hydros Pro back-inflation BCD
- NEW EndurTex high-tenacity 420 nylon fabric bladder is lightweight yet extremely durable
- Monprene® thermoplastic harness is extremely resistant to UV, chemicals and abrasion, plus it doesn't absorb water to minimize drying time
- Rotating quick-release shoulder buckles allow you to route your shoulder straps to optimize fit
- Super Cinch tank buckle system locks the tank in solid for maximum stability at depth
- Integrated front weight system is based on the same Monprene® pockets found on the HYDROS PRO
- Two big zippered cargo pockets offer great gear-carrying capacity and are easily accessible even when the weight pouches are fully loaded
- Two stainless steel D-rings provide clip-on points for additional gear
- Includes Multi-Mount Accessory Matrix with multiple D-rings and mounting points that easily attach various dive accessories
- Color kits available pg 65
- Buoyant lift ranges from 13kg to 20kg for men, and 13kg to 17kg for women, depending on size



Men:

- S... X21.900.200
- M... X21.900.300
- L... X21.900.400
- XL-2XL... X21.900.500

Women:

- XS-S... X21.901.100
- M... X21.901.300
- L... X21.901.400

EQUATOR BCD



- New easy-to fold small back pack for lightweight travel
- Super cinch tank band with redesigned double tank straps
- Integrated weight pockets with low-profile buckles
- High quality anti-scratch patches on sides & shoulders
- 6 Stainless steel D-Rings
- Knife grommets
- 2 Zipper pockets
- Rotating shoulder buckles
- Low profile dump valves
- Balanced power inflator
- Soft neck finishing
- 420D nylon material
- Octopus pockets on both sides



- XS... X21.725.100
- S... X21.725.200
- M... X21.725.300
- L... X21.725.400
- XL... X21.725.500

T-ONE BCD



- Heavy duty Cordura 1000D exterior & lightweight 420D interior
- Adjustable chest strap
- Comfort backpack
- 2 Pockets with restyled graphics & internal octopus holder
- Adjustable padded cummerbund
- Available in 7 sizes
- Balanced power inflator



- 2XS... X21703XXS
- XS... X21703XS
- S... X21703S
- M... X21703M
- L... X21703L
- XL... X21703XL
- 2XL... X21703XXL

SEAHAWK 2 BCD

NEW



- Ergonomic shoulder design with rotating buckles improves fit
- Reinforced soft backpack with high-grip tank patch and inner padding
- Super Cinch stainless steel tank band system
- 50mm waist strap with lightweight plastic buckle
- Two large zippered pockets providing lots of cargo-carrying capability
- 6 Stainless Steel D-Rings
- Constructed of 1000 denier nylon and 420 denier nylon for maximum durability
- Air cell offers substantial buoyant lift when inflated.
- Balanced power inflator
- Soft neoprene neck roll and padded back pad.
- Quick-release integrated weight pouches secured with low-profile buckles
- Two rear trim pouches help create a comfortable swimming position



S... X22.142.210-S
M... X22.142.310-M
L... X22.142.410-L

GLIDE BCD



- Constructed of 420 denier nylon for lightweight & long-lasting durability
- Two large zippered pockets w. knife grommets
- 4 Angled stainless steel D-rings along with two smaller stainless D-rings
- Wrap around air bladder
- New Y-Fit shoulders to maximize fit & comfort
- Soft neoprene neck & padded backpack
- Super cinch tank buckle system
- Adjustable cummerbund
- Quick-release integrated weight pouches
- Counter balance trim pockets

Grey:

XS... X22.285.120-XS
S... X22.285.220-S
M... X22.285.320-M
L... X22.285.420-L
XL... X22.285.520-XL

Blue:

XS... X22.284.120-XS
L... X22.284.420-L



REBEL BCD KIDS



- Constructed of 420 denier nylon
- Padded backpack, adaptable sternum strap
- Optional gravity release weight pouches
- Balanced inflator & 3 dump valves
- Two zippered cargo pockets

X21.222.010



CHILD BCD



- 1000 Denier Cordura
- Velcro pocket & zippered pocket
- Adjustable cummerbund waistband
- Quick release shoulder straps
- Sub-Alert Power Inflator
- Soft Backpack Pad
- 3 dump valves
- Plastic tank cam lock buckle

UBC3S



SIDEMOUNT

- Modular approach
- Compact independent aircell
- Two aircell sizes: 12 / 20 liters lift (25 / 45lbs.)
- Soft Airnet finished backpack
- Compatible with X-TEK steel & aluminum back plates
- Stainless steel grommets, D-rings & handles
- New Dump valve, corrugated hose & BPI
- Specific streamlined elbow
- Bungee & hooks for tank support
- Fully adjustable, easy to wear & configure
- Harness includes crotch strap
- Side bungees for streamlined shape
- Optional top cover for total streamlining & increased durability



X21.726.200



X21.726.400



X21.726.117



X21.726.001

- Wing 12L... X21.726.200
- Wing 20L... X21.726.400
- Harness Backpad System... X21.726.001
- Wing Cover... X21.726.117



X-TEK PURE SINGLE SYSTEM

- Legendary PURE harness with stainless steel backplate
 - Single tank adapter with two super cinch straps
 - Stainless steel shoulder & waist D-rings
 - 50cm wide croch strap with two D-rings
 - 1680 Denier ballistic nylon outer shell
 - 420 Denier inner bladder
 - Tek balanced inflator
 - 13kg / 28lb donut wing



X22.195.010



DONUT WING

- Provides unprecedented buoyancy control regardless of diving position
- 1680 Denier ballistic nylon outer shell
- 420 Denier nylon inner bladder
- Tek balanced power inflator
- 13kg or 18kg lift capacity



- 13kg for Singles... X22.193.010
- 18kg for Twins... X22.183.010

PURE HARNESS



- Stainless steel back plate with "tri-glide" fasteners
- Secure continuous webbing provides custom fit
- Stainless steel waist buckle
- Back plate storage pack to fit large SMB
- 2 Shoulder & 1 left D-ring on waist belt
- 50mm crotch strap with two stainless steel D-rings



X22.179.000

FORM HARNESS



- Shoulder straps adjust in length & alignment
- 50mm crotch strap with 2 stainless steel D-rings
- 6 Large & 6 regular stainless steel D-rings
- Anatomically optimized back padding
- 3 Piece comfort-harness-system
- Stainless steel back plate



X22.182.000

BACKPLATE



Available in stainless steel or lightweight aluminum



Stainless Steel... X23.800.000
Aluminum... X23.801.000

BACKPLATE STORAGE PACK



X23.808.000

SOFT TRAVEL BACKPLATE



- Replaces metal backplate
- Includes 2 x super cinch tank straps
- Only compatible with FORM harness



X23.807.000

WEIGHT POCKETS

- Weight pocket system w. quick release buckle & D-ring



X23.803.000

SHOULDER PADS



Shoulder pads for ultimate comfort



X23.809.000

SINGLE TANK ADAPTER



X23.802.000

TRIM WEIGHT POCKET KIT



X23.721.010

CONSOLE 3 SLIM



- Compact pressure gauge (0-400bar) w. brass case
- Oil-filled analog depth gauge w. linear Bourdon tube design
- 35-degree tilt, oil-filled compass



X05.011.753

CONSOLE 2



- Pressure gauge 300bar
- Depth gauge 60m with parabolic scale & maximum depth indicator
- Lightweight & compact
- Loop on case to attach a safety lanyard
- Fluorescent dials



X05.012.210

PRESSURE METAL GAUGE



- Rated to 400bar
- Low Pressure 50bar red area for easy visibility
- Luminous dial for visibility, even in low-light
- Robust nylon protective housing
- 90cm HP Hose



X05.023.112

FS-2 COMPASS



Northern & Southern hemispheres compatible

- FS-2 w. Mount for Retractor... X05.017.111
- FS-2 w. Mount & Retractor... X05.017.121
- FS-2 Capsule only... X05.017.001



X05.017.111



X05.017.001



X05.017.121

DIGITAL 330M



Electronic data delivery system provides actual & maximum depth, ascent speed, dive time & temperature. Rated to 330m



Capsule only... X05.014.010



Wrist Mount... X05.014.110

CB-TWO IN LINE

SUUNTO

- Depth gauge 70m
- Pressure gauge 300bar
- Modular housing



FSS005249220

CB-TWO IN LINE ZOOPO NOVO

SUUNTO

- Zoop Novo dive computer
- Pressure gauge 300bar
- Modular housing



Lime... FSS022217000
Black... FSS022218000

CB-ONE

- Console housing & hose
- SM-36 pressure gauge 300bar

SUUNTO



FSS005240200

SK-8

SUUNTO

- High tilt compensation
- Phosphorescent compass card



Bungee Mount NH... FSS021118000
Bungee Mount SH... FSS021119000



Wrist Compass NH... FSS020981000
Wrist Compass SH... FSS020982000

CLIPPER COMPASS

SUUNTO

- Liquid filled compass
- Rotating bezel with 10 degree increments
- A fun, super-compact aid for underwater navigation
- Fits to almost any watch strap or wrist strap, sleeve, backpack strap, etc.



FSS004102011

BOOT & BUNGEE CORD

SUUNTO

for SK7 & SK8



FSS020627000

CB-71 / SK-8 CONSOLE MOUNT

SUUNTO

- High tilt compensation
- Phosphorescent compass card



NH - Front... FSS021122000
SH - Front... FSS021160000



NH - Back... FSS021123000
SH - Back... FSS021161000



SUUNTO



CONSOLE 2 SLIMLINE



- Robust & compact console
- PG nickel plated brass, 0-300bar
- DG w. luminous display, 70m
- Easy to read
- HP hose included



DBT30030

CONSOLE 2 MINI 2K

- Sleek & compact console
- Slimline PG 0-400bar
- DG w. luminous display, 70m
- Easy to read
- HP hose included



DBT30026

SPG MINI 2K



- Sleek & compact
- Low profile boot
- Slimline PG 0-400bar



DBT30013

HOUSING CONSOLE MINI 2K



DBT30026E

SPG 2010 MINI 2K



- Slimline pressure gauge with boot, 0-400bar
- HP hose included

Yellow Dial w. Black Boot... DBT30038-K
 Yellow Dial w. White Boot... DBT30038-W
 Black dial w. Black Boot... DBT30038-KK



DBT30038-K

DBT30038-W

DBT30038-KK

STANDARD COMPASS



- Large tilt potential and still respond quickly and accurately
- High strength magnets for fast stabilization
- Bold numbers for ease of reading
- Firm-grip ratcheting bezel
- Luminescent compass card
- Oil filled
- Easy to read lubber line
- Top or side reading
- Diameter 60mm



DBT30008



PRO COMPASS



- Exceptional tilt allows the compass to be held at an angle of up to 30degree and still respond quickly and accurately
- High strength magnets for fast, positive action
- Bold numbers for ease of reading
- Firm-grip ratcheting bezel
- Luminescent floating card
- Filled with liquid silicone
- Easy to read lubber line
- Top or side reading
- Diameter 56mm



DBT30002



CAPSULE

Capsule for Pro Compass... DBT30001
 Capsule for Standard Compass... DBT30009



DBT30009



DBT30001



PRESSURE GAUGES CAPSULE

SCUBAPRO
 X28.163.002 X28.152.002 X28.163.202 X28.152.202 X05.012.012 X05.022.012

SUUNTO
 FSS05108M200

SCUBAPRO
 X28.039.302

SEAC
 BS224001

DEEPBLUE
 DBT30012 DBT30039NS

SAP-0018

- PG capsule-Dia 63mm-Black Dial... X28.163.002
- PG capsule-Dia 52mm-Black Dial... X28.152.002
- PG capsule-Dia 63mm-White Dial... X28.163.202
- PG capsule-Dia 52mm-White Dial... X28.152.202
- Compact Press. Gauge... X28.039.302
- U-Line PG... X05.012.012
- U-Line Metal PG... X05.022.012
- SM-36/300 PG Module... FSS05108M200
- Pressure Gauge Module... BS224001
- PG for Mini 2K - 48mm dia... DBT30012
- PG for Slimline - 52mm dia... DBT30039NS
- Miniature SPG (Pony Gauge) CE... SAP-0018

DEPTH GAUGES CAPSULE

SCUBAPRO
 X28.860.005

SCUBAPRO
 X05.012.011

DEEPBLUE
 DBT30040C

DEEPBLUE
 DBT30007

SUUNTO
 FSS05040M020

SUUNTO
 FSS05040M010

SEAC
 BS226001

- Compact Depth Gauge... X28.860.005
- U-Line DG... X05.012.011
- Depth Gauge for Slimline... DBT30040C
- Depth Gauge for Mini 2K... DBT30007
- Depth Gauge Module... BS226001
- SM-16/45 Depth Module... FSS05040M010
- SM-16/70 Depth Module... FSS05040M020

COMPASS CAPSULE

- SK-8 Replacement Compass Capsule

SUUNTO



- SK-8 Capsule NH... FSS021120000
- SK-8 Capsule SH... FSS021121000

GALILEO G2



Intuitive, reliable & bulletproof, SCUBAPRO has combined everything you love about the Galileo with everything you've dreamed of in a dive computer. It's everything you expect from SCUBAPRO in full colour

Easy to read, Easy to use, Easy to love

Spend less time reading manuals & more time enjoying the experience

Easy to manage

- Bluetooth compatible, the G2 easily syncs with your PC, Mac, Android or iOS
- Stores up to 1,000hrs of dive profiles
- Rechargeable battery lasts up to 50 dives

Make it your own

- Customize your screen, colours, orientation & even the attachments to make the G2 truly your own
- Customized menu listings give you the ability to use as much or as little of the technology as you want; with easy activation of freediving, trimix, CCR & sidemount modes without downloading or upgrading
- The G2 is targeted to quickly become the favorite computer for all divers of all skill levels & goes wherever your passion for diving takes you
- Even your dive profile is one of a kind-based upon your real-time breathing rate, your skin temperature & your heart rate



Galileo G2 Wrist Only... X05.080.101
Galileo G2 Console... X05.081.111

ACTION / ACTION HR

seac



- Easy to use, with 3 main modes:
 1. SCUBA MODE: full management of recreational dive profiles with a Bühlmann ZHL-16C decompression algorithm for 1 or 2 mixes (air, Nitrox, & mixes with O₂ concentrations up to 99%)
 2. GAUGE MODE: Depth gauge & stopwatch for managing your dive profiles independently.
 3. FREEDIVING MODE: Dive/surface time, current/maximum depth
- LOGBOOK MEMORY: SCUBA mode: 40 hours with records every 5". FREEDIVING mode: 18 hours of activity with records every 2"
- SAFETY WARNING: MOD exceeded alarm, deco stop violated alarm, ascent speed alarm, NoFly time & desaturation calculations, maximum permitted altitude warning
- "NDL only" Dive Planner
- Dive Manager software for MAC/PC (requires Windows 10)
- Download data via USB cable (optional accessory)
- Ultra-durable structure treated for improved resistance to blows, corrosion, & swings in temperature
- LCD screen with contrast & adjustable-intensity backlighting
- Long-lasting CR2450 battery
- Available in version with crown, buttons, & buckle in stainless steel (Action) or with HR treatment (Action HR)



HR - Black



HR - Red



Black



White

Black... B16006-K
Black/Red... B16006-KR
Black... B16005-K
Black/White... B16005-KW

ACCESSORIES



Transmitter LED smart+

X05.055.030



D6i NOVO ZULU

SUUNTO



Black Nylon

Blue Nylon*

* Blue Nylon for Dive Professionals only

- Steel case & sapphire crystal glass with anti-reflective coating
- Full continuous decompression algorithm - Suunto RGBM
- Gas-switching between up to three gases
- Five modes: air, nitrox, gauge, free & off
- Innovative apnea timer & timer in air/nitrox modes
- Integrated tilt-compensated 3D digital compass
- Updateable firmware
- Optional wireless air integration – current cylinder pressure, remaining air time
- Built-in dive planner
- Detailed graphical logs & dive data on your PC/Mac using PC/MAC with Suunto DM5 software & USB cable

D6i NOVO



Black



White

- Black... FSS021956000
- White... FSS021951000
- Black w. Nylon Strap... FSS022617000
- Blue w. Nylon Strap (for Instructor)... FSS022910000

DIVE COMPUTER ACCESSORIES

SUUNTO



Boot & Bungee Cord



Tank Pod
for Eon Core, Eon Steel, D5



Transmitter LED
for DX, D9tx, D6i, D4i, Vytec,
Vyper Air & HelO2

- Tank Pod Transmitter... FSS020306000
- EON Steel Scratch Guard (1 Piece)... FSS021027000
- Tank Pod Battery Kit... FSS020308000
- Bungee Adapter EON Steel... FSS020309000
- Boot for EON Steel... FSS020310000
- EON Elastomer Strap Replacement Kit... FSS020311000
- SUUNTO Charger... FSS018799000
- Boot & Bungee Cord... FSS020628000
- Transmitter LED... FSS019098000

SUUNTO
CONQUER NEW TERRITORY

D5

LET'S
EXPLORE
TOGETHER

**"The Future of Dive Computers
Innovative and easy to use"**

MAIN FEATURES



100m
WATER
RESISTANCE



WIRELESS TANK
PRESSURE



VIBRATION
ALARMS



DIGITAL
COMPASS



USER EXCHANGEABLE
STRAPS



RECHARGEABLE
BATTERY



USER UPDATABLE
SOFTWARE



WIRELESS MOBILE
CONNECTION



Transfer your dive logs easily over Bluetooth to your mobile after diving. In the Suunto app you can re-live your dives, add photos and share your underwater adventures with friends



Key Features:

- Simple and easy-to-use interface
- Easy to read (High contrast colour screen with large numbers)
- 4 modes: Air, nitrox, freedive & gauge
- Vibration alarms
- Rechargeable battery
- Connect over Bluetooth to Suunto app
- User updatable software
- Integrated tilt-compensated 3D digital compass
- Wireless air integration (up to 3 Suunto Tank PODs)
- Suunto Fused 2™ RGBM for maximum dive time
- Reinforced composite case rated to 100 m depth
- User exchangeable straps (multiple optional straps available)
- 4 models: All-Black, Black/Lime, Black & White
- Multi user exchangeable straps to match your style in and out of water

D5 STRAPS DESIGNED FOR DIVING

NEW

SUUNTO



FSS050244000 FSS050241000 FSS050242000 FSS050243000 FSS050240000 FSS050206000 FSS050207000 FSS050208000



FSS050228000 FSS050229000 FSS050263000 FSS050264000 FSS050265000

DIVE 1 Silicone Strap, LiMe/Black, M... FSS050208000
 DIVE 1 Silicone Strap, Black/Steel, M... FSS050206000
 DIVE 1 Silicone Strap, White/Steel, M... FSS050207000
 DIVE 1 Silicone Strap, Blue/Black, M... FSS050240000
 DIVE 1 Silicone Strap, Sakura/Black, M... FSS050241000
 DIVE 1 Silicone Strap, Ocean/Black, M... FSS050242000
 DIVE 1 Silicone Strap, Coral/Black, M... FSS050243000
 DIVE 1 Silicone Strap, AMber/Black, M... FSS050244000

EXPLORE 2 Textile Strap, Black/Black, M+L... FSS050228000
 EXPLORE 2 Textile Strap, Foliage/Grey, M+L... FSS050229000
 DIVE 2 Textile Zulu Strap, Stealth/Black, L... FSS050264000
 DIVE 2 Textile Zulu Strap, Black/Black, L... FSS050263000
 DIVE 2 Textile Zulu Strap, Blue/Black, L... FSS050265000

D5 STRAPS DESIGNED FOR EVERYDAY WEAR

NEW

SUUNTO

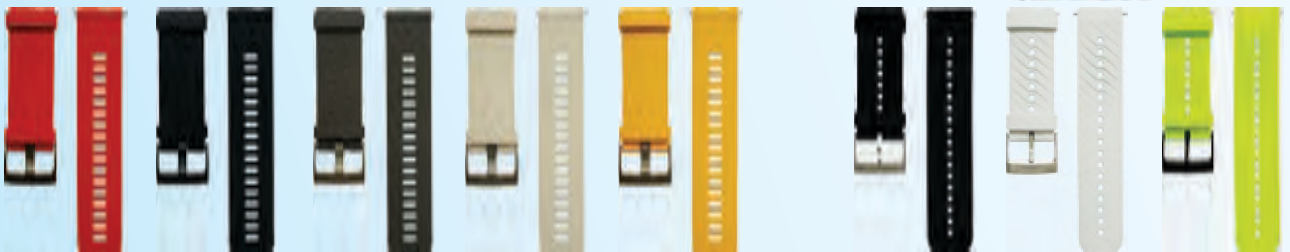

FSS050220000 FSS050221000 FSS050222000 FSS050223000 FSS050012000 FSS050155000 FSS050156000 FSS050157000



FSS050158000 FSS050013000 FSS023313000 FSS023314000 FSS023485000 FSS050231000 FSS050232000

EXPLORE 1 Silicone Strap, Amber/Gray, M... FSS050012000
 EXPLORE 1 Silicone Strap, Coral/Gray, M... FSS050220000
 EXPLORE 1 Silicone Strap, Black/Black, M... FSS050221000
 EXPLORE 1 Silicone Strap, Graphite/Gray, M... FSS050222000
 EXPLORE 1 Silicone Strap, Sandstone/Gray, M... FSS050223000

EXPLORE 2 Silicone Strap, Black/Black, M... FSS050158000
 EXPLORE 3 Silicone Strap, Stealth/Black, M... FSS050013000

ATHLETIC 3 Silicone Strap, Black/Steel, M... FSS050155000
 ATHLETIC 3 Silicone Strap, White/Steel, M... FSS050156000
 ATHLETIC 3 Silicone Strap, Lime/Black, M... FSS050157000

ATHLETIC 4 Silicone Strap, Black/Copper, M... FSS023313000
 ATHLETIC 4 Silicone Strap, Forest/Copper, M... FSS023314000
 ATHLETIC 4 Silicone Strap, White/Gold, M... FSS023485000

URBAN 2 Leather Strap, Black/Black, M... FSS050231000
 URBAN 2 Leather Strap, Brown/Black, M... FSS050232000

D4i

SUUNTO

- Soft silicone strap
- Metal buttons
- Full continuous decompression algorithm
- Three dive modes: air, nitrox, free
- Innovative apnea timer
- Optional wireless air integration (Transmitter)
- Detailed graphical logs on PC/MAC with Suunto DM5 software & USB cable
- Updateable firmware
- USB interface cable sold separately - Black, Lime & White



Lime



White



Black

Black... FSS050277000
Lime... FSS050279000
White... FSS050278000

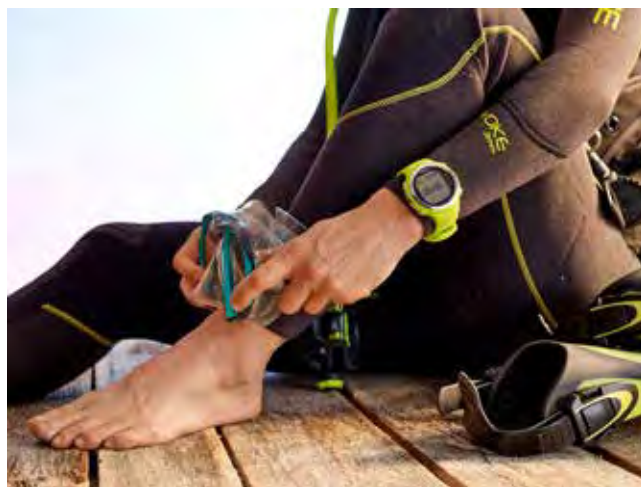

EON CORE

SUUNTO

- User configurable Custom Display with up to 4 screens per mode
- Flip display option
- Wireless connectivity via Bluetooth
- Up to 10 tank pressure readings with Suunto Tank PODs
- User-updatable software
- Lightweight (154g) reinforced composite case rated to 80m (EON Steel = 347g)
- Modes: Air/Nitrox/Gauge/Trimix/CCR (fixed point)
- Suunto Fused™ RGBM decompression model
- Tilt compensated 3D digital compass
- Rechargeable lithium-ion battery 930 mAh (10-20hrs diving)
- PC/MAC with Suunto DM5 software & USB cable
- 17 languages



Black... FSS022740000
 White... FSS023081000
 Lime... FSS023082000

VYPER NOVO

SUUNTO

- Optional wireless air integration – current cylinder pressure, remaining air time
- Integrated tilt-compensated 3D digital compass
- Gas-switching between up to three gases (Oxygen up to 99 %)
- Cable optional for connecting to detailed graphical logs & dive data with your PC/Mac using Suunto DM5 software
- Full continuous decompression algorithm – Suunto RGBM
- Five modes: air, nitrox, gauge, free & off
- Innovative apnea timer for free diving & a timer in air Nitrox modes
- Built-in dive planner



White... FSS050433000
 Graphite... FSS050434000

ZOOP NOVO

SUUNTO

- Five modes: air, nitrox, gauge, apnea & off
- Full continuous decompression algorithm - Suunto RGBM
- Built-in dive planner
- Detailed graphical logs & dive data with your PC/Mac using Suunto DM5 software (no cable in the package – sold as an accessory)
- Innovative apnea timer for freediving & timer in air/nitrox modes



Lime... FSS021643000
 Blue... FSS021644000
 Black... FSS021645000
 Rental, Lime... FSS022692000



	D4i	D5	D6i Novo
Glass material:	Mineral crystal	Mineral crystal	Sapphire crystal
Case material:	Composite	Reinforced composite	Steel
Strap material:	Silicone	Silicone	Silicone / metal
Water resistance	100 m	100 m (ISO 6425, EN 13319)	150 m
Battery life in time mode	2 years	-	2 years
Battery life 100 dives/year	1.5 years	-	1.5 years
Battery type	CR 2450	rechargeable lithium-ion	CR 2450
UI languages	EN	EN, FR, ES, IT, NL, PT, SV, FI, RU, PL, KO, ZH, DE, NO, CS, DA, JA, ZH, TW	EN
Backlight	electro-luminescent	LED	electro-luminescent
Configurable backlight	duration: off, 5, 10, 20, 30, 60 s	Yes	duration: off, 5, 10, 20, 30, 60 s
Firmware upgradable	yes	Yes	yes
Digital compass	-	Yes	yes
Tilt compensation	-	up to 45°	up to 45°
Maximum operating depth(EN 13319)	100m	100 m / 328 ft (EN 13319, ISO 6425)	120m
Nitrox (and air)	yes	Yes	yes
Freedive	yes	Yes	yes
Gauge	yes	Yes	yes
Dive time	0 to 999 min	0 to 999 min	0 to 999 min
Wireless air integration	optional	optional (up to 3 different tanks with Suunto Tank POD)	optional
Decompression model	RGBM	Suunto Fused™ RGBM 2	RGBM
Personal adjustment	0 - 2	P+2, P+1, P0, P-1, P-2	0 - 2
Altitude adjustment	0-300m / 300-1500m / 1500-3000m	0 - 300 m / 300 -1500 m / 1500 - 3000 m	0-300m / 300-1500m / 1500-3000m
Gases	1 gas (O ₂ 21 - 50%)	up to 3 gases (Oxygen 21 - 99%)	up to 3 gases (O ₂ 21 - 99%)
Gas max pO₂	1.2 - 1.6	1.6	1.2 - 1.6
Timer	yes	Yes	yes
No-decompression planner	yes	Yes	yes
Logbook memory	~140 h (20s sampling rate)	200h or 400 dives which comes first	~140 h (20s sampling rate)
Gas switching	-	Yes	yes
Trimix (mixed gas)	-	-	-
Rebreather (CCR)	-	-	-
Custom displays	-	4 per dive mode	-
Dive time	yes	Yes	yes
Maximum depth	yes	Yes	yes
Tank pressure	yes	Yes	yes
Apnea timer (O₂/CO₂ tables)	yes	-	yes
Diluent	-	-	-



	ZOOP Novo	VYPER Novo	Eon Core
Glass material:	Acrylic	Acrylic	Mineral crystal
Case material:	Composite	Composite	Reinforced composite
Strap material:	Elastomer	Elastomer	Elastomer
Water resistance	120 m	120 m	80 m
Battery life in time mode	2 years	2 years	2 months
Battery life 100 dives/year	1.5 years	1.5 years	-
Battery type	CR 2450	CR 2450	rechargeable lithium-ion
UI languages	EN	EN	EN, CS, DA, DE, ES, FI, FR, IT, JA, KO, NL, NO, PL, PT, RU, SV, ZH
Backlight	electro-luminescent & phosphor-luminescent	electro-luminescent & phosphor-luminescent	LED
Configurable backlight	duration: off, 5, 10, 20, 30, 60 s	duration: off, 5, 10, 20, 30, 60 s	yes
Firmware upgradable	-	-	yes
User replaceable battery	yes	yes	-
Digital compass	-	yes	yes
Tilt compensation	-	up to 45°	up to 45°
Maximum operating depth(EN 13319)	80m	80m	80m
Nitrox (and air)	yes	yes	yes
Freedive	yes	yes	yes
Gauge	yes	yes	yes
Dive time	0 to 999 min	0 to 999 min	0 to 999 min
Wireless air integration	-	optional	optional
Decompression model	RGBM	RGBM	FUSED RGBM
Personal adjustment	0 - 2	0 - 2	from -2 to 2
Altitude adjustment	0 - 300m / 300 -1500m / 1500 - 3000m	0 - 300m / 300 -1500m / 1500 - 3000m	0-300m / 300-1500m / 1500-3000m
Gases	1 gas (O ₂ 21 - 50%)	up to 3 gases (O ₂ 21 - 99%)	up to 10 gases (O ₂ 5 - 99% / Helium 0 -95%)
Gas max pO₂	1.2 - 1.6	1.2 - 1.6	manual 0.5-1.6/ fixed 1.6
Timer	yes	yes	yes
No-decompression planner	yes	yes	yes
Logbook memory	~140 h (20 s sampling rate)	~140 h (20 s sampling rate)	200 h
Gas switching	-	yes	yes
Trimix (mixed gas)	-	-	yes
Rebreather (CCR)	-	-	yes
Custom displays	-	-	4 per dive mode
Dive time	yes	yes	yes
Maximum depth	yes	yes	yes
Tank pressure	-	yes	yes
Apnea timer (O₂/CO₂ tables)	yes	yes	-
Diluents	-	-	up to 10 diluents (O ₂ 5 - 99% / Helium 0 - 95%)

BORA PLUS MASK



- Silicone skirt & strap
- Easily replaced twist-on buckles
- Twin lens with tempered glass

Clear Skirt:

- Black... DBMA36+-K
- Blue Trans... DB1MA36+-BT
- Yellow... DB1MA36+-Y

Black Skirt:

- Black... DB1MA36+-KK
- Orange... DB1MA36+-KO
- Yellow... DB1MA36+-KY



MAKO MASK



- Silicone skirt & strap
- Easily replaced clip-on buckles
- Twin lens with tempered glass

Clear Skirt:

- Blue Trans... DBMC23-BT
- Yellow... DBMC23-Y

Black Skirt:

- Black... DBMC23-KK



COVERT MASK



- Silicone skirt & strap
- Swivel buckles
- Twin lens w. tempered glass
- Extra low volume

Black Skirt:

- Black... DBMC24-KK
- Blue... DBMC24-KB
- Pink... DBMC24-KPi
- White... DBMC24-KW



ORCA MASK



- Silicone skirt & Unique Elastomer strap
- Replaceable skirt-mounted buckles
- Twin lens w. tempered glass
- Low volume

SUPER COMFORTABLE



B Pi



Y

Clear Skirt:
Blue... DBMD89-B
Pink... DBMD89-Pi

Black Skirt:
Yellow... DBMD89-KY

XTREME MASK



- Silicone skirt & strap
- Swivel Buckles
- Twin lens w. tempered glass



B Pi

W Y

Clear Skirt:
Blue... DBM282-B
Pink... DBM282-Pi

Black Skirt:
White... DBM282-KW
Yellow... DBM282-KY



HAWAII MASK

- Replaceable standard buckles
- Twin lens w. tempered glass
- PVC skirt & strap



Y BT

Clear Skirt:
Blue Trans... DB3MD05P-BT
Yellow... DB3MD05P-Y



BALI MASK

- Single lens w. tempered glass
- Silicone skirt & strap
- Swivel buckles
- Extra low volume



DBMA69-KK

K

FIJI MASK FOR KIDS



- Silicone or PVC skirt & strap
- Replaceable clip-on buckles
- Single lens w. tempered glass
- Ideal for rental & retail



DB8MB52CL



DB8MB52



DB4MB52P

BT Pi T Y

Silicone Skirt:
Blue Trans... DB8MB52-BT
Pink Trans... DB8MB52-PiT
Yellow... DB8MB52-Y

PVC Skirt:
Blue Trans... DB4MB52P-BT
Pink Trans... DB4MB52P-PiT
Yellow... DB4MB52P-Y

Silicone Skirt w. Clamshell:
Blue Trans... DB8MB52CL-BT
Pink Trans... DB8MB52CL-PiT
Yellow... DB8MB52CL-Y

VYPER MASK



- Silicone skirt & strap
- Replaceable clip-on buckles
- Single lens w. tempered glass
- Extra low volume



●
K

DBMD56-KK

ACCENT MASK



- Single lens w. tempered glass
- Ultra Soft Silicone skirt (Black matte)
- Silicone strap (Black)
- Standard buckles, easy to adjust
- Available in Black/Yellow w. Black Skirt



DBMG01-KY

CORAL MASK



- Single lens w. tempered glass
- Silicone skirt & strap (Clear)
- Standard buckles, easy to adjust
- Available in Turquoise w. colourful coral motive



DBMCORAL

FULL FACE SNORKELLING MASK



- EASY BREATHING - Natural breathing through the nose or mouth
- EASY DRESSING - Adjustable elastic textile strap
- ANTI-FOGGING - An exclusive air circulation concept, that prevents the formation of fog
- WATERPROOF - The "Dry Top" snorkel system limits water entry through the top of the snorkel
- FIELD OF VISION - Panoramic field of vision
- WATER DRAINAGE - Purge valve at the bottom of the mask, to drain water when the head is raised
- Action camera mount
- Sizes: S, L



Size S, Blue... DBFfaceS-B
 Size S, Pink... DBFfaceS-Pi
 Size L, Blue... DBFfaceL-B
 Size L, Pink... DBFfaceL-Pi



MAUI MASK

Features :

- Swivel buckles
- Extra low volume
- Silicone skirt & strap
- Single lens w. tempered glass
- Available in blue, pink & yellow



ITEM CODE: DBME60-B, Pi, Y

NEW ARRIVAL

YELLOW



BLUE



PINK



SPECTRA METALLIC MASK



- Silicone skirt & strap
- Swivel buckles
- Twin lens w. tempered glass
- Re-usable mask box included



Clear Skirt:
Blue... X24.847.210

Black Skirt:
Full Black... 24.847.100
Silver... X24.847.110
Solid Blue... X24.847.230
Bronze... X24.847.830

Black Skirt w. Mirror Lens:
Black... X24.847.140
Bronze... X24.847.840

SYNERGY TWIN TRUFIT MASK



- Tru-fit silicone skirt (extra soft & super comfortable)
- Silicone mask strap
- Replaceable clip-on buckles
- Twin lens with tempered glass
- Low volume & provides excellent field of view
- Re-usable mask box included

Clear Skirt:
Pink... X24.713.700

Black Skirt:
Turquoise... X24.713.230
Red... X24.713.310
Yellow... X24.713.510
Solid Pink... X24.713.730
Pink... X24.713.701

Black Skirt w. Mirror Lens:
Black... X24.713.140



SYNERGY 2 TRUFIT MASK



- Tru-fit silicone skirt (extra soft & super comfortable)
- Silicone mask strap
- Swivel buckles
- Single lens with tempered glass
- Low volume & provides excellent field of view
- Re-usable mask box included



Black Skirt w. Mirror Lens:
Silver... X24.838.140

While Stock List:
Yellow... X24.838.500

D MASK



- Sleek design matches the new D420 regulator
- UV+420cut™ lens technology filters out HEV and UV light without affecting how colors appear
- Interchangeable lens system makes it easy to install optional optical lenses
- Available with a choice of skirts to suit western or Asian dive markets as well as divers with small face shapes
- Rotating buckles work with a new black-on-black Comfort Strap to optimize range of motion and achieve a comfortable, watertight fit
- Includes an adapter for mounting a HUD hands-free dive computer
- Packaged in a durable molded fabric transport box.
- Optional lenses available: Optical lenses (6x positive +1.5 to +4.0/8x negative -1.5 to -5.0); Bi-Focus lenses (3x positive +1.0 to +3.0)

NEW



FSS050155000



- D Mask, Black Asian ...** X24.250.099
- Black...** X24.252.101
- Blue...** X24.252.102
- Turquoise...** X24.252.103
- Pink...** X24.252.104
- Yellow...** X24.252.105



X24.252.101

X24.252.102

X24.252.103

X24.252.104

X24.252.105

SYNERGY TWIN TRUFIT MASK w. COMFORT STRAP

NEW



- Tru-fit silicone skirt (extra soft & super comfortable)
- Comfort strap
- Replaceable clip-on buckles
- Twin lens with tempered glass
- Low volume & provides excellent field of view
- Re-usable mask box included



Black Skirt:

- Silver...** X24.813.130
- Red...** X24.813.310
- Yellow...** X24.813.510
- Solid Pink...** X24.813.730
- Turquoise...** X24.813.230

Black Skirt w. Mirror Lens:

- Silver...** X24.813.140

SYNERGY 2 TRUFIT MASK w. COMFORT STRAP

NEW



- Tru-fit silicone skirt (extra soft & super comfortable)
- Comfort strap
- Swivel buckles
- Single lens with tempered glass
- Low volume & provides excellent field of view
- Re-usable mask box included



Black Skirt w. Mirror Lens:

- Silver...** X24.839.140

Black Skirt:

- Silver...** X24.839.130

CRYSTAL VU METALLIC MASK



- Silicone skirt & strap
- Swivel buckles
- Single lens with seamless side windows & tempered glass
- Re-usable mask box included



Clear Skirt:

- Blue... X248551-B
- Red... X248551-R
- White... X248551-W
- Yellow... X248551-Y

Black Skirt:

- Orange... X248551-KO
- Black... X248551-KSi

TRINIDAD MASK



- Silicone skirt & strap
- Swivel buckles
- Single lens w. tempered glass
- Frameless, low-volume design
- Re-usable mask box included



X24.156.100



SOLO MASK



- Silicone skirt & strap
- Swivel buckles
- Single lens w. tempered glass
- Extra low volume
- Re-usable mask box included



X24.849KS



FLUX TWIN MASK



- High-impact polycarbonate frame delivers durability & strength
- Dual lenses are designed to accept optical lenses to improve the underwater view
- Hypoallergenic silicone skirt with double-feathered edge is super-comfortable & keeps water out.
- Non-slip strap & easy adjust buckles provide the perfect fit for enjoyable diving



Clear Skirt:

- Metallic Blue... X24.833.205
- White... X24.833.600
- Pink... X24.833.700
- Blue... X24.833.200

Black Skirt:

- Metallic Black... X24.833.100
- Metallic Red... X24.833.320



STEEL COM MASK



- Silicone skirt & strap (ultra soft)
- Unique collapsible frame
- Swivel buckles
- Nose pocket w. anti-slip
- Twin lens w. tempered glass
- Extra low volume
- Ideal for APNEA



- Black... X24.108.100
- White... X24.108.600

POPULAR FOR APNEA

FRAMELESS HUD MASK

- Single-Lens Design
- Extremely Low Volume
- Soft Black Silicone Skirt
- Available with an integrated holder to mount the new HUD hands-free dive computer

NEW



●
K

X24.343.100

MARINA MASK KIDS

- Silicone skirt & strap
- Replaceable standard buckles
- Single lens w. tempered glass
- Packaging: plastic mask box

● ● ●
B Y Pi



SEAC

Blue... B9426-B
Pink... B9426-P
Yellow... B9426-Y

CAPRI MASK

- Silicone skirt & strap
- Replaceable standard buckles
- Twin lens w. tempered glass
- Packaging: plastic mask box



●
K



● ●
B K

SEAC

Clear Skirt:
Blue... B9420-B
Black... B9420-K

Black Skirt:
Black... B9421KS-K

EXTREME MASK for small faces

- Silicone skirt & strap
- Easy adjustable buckles
- Twin lens w. tempered glass
- Re-usable mask box included



● ●
B YT



●
K

SEAC

Clear Skirt:
Blue... B939-B
Yellow... B939-Y

Black Skirt:
Black... B936KS-K

JUNIOR MASK



- Silicone skirt & strap
- Replaceable twist-on buckles
- Single lens w. tempered glass



Clear Skirt:
 Blue Trans... SMS102-BT
 Neon Green... SMS102-FG
 Yellow... SMS102-Y



WIDE VISION MASK



- Silicone skirt & strap
- Replaceable standard buckles
- Single lens w. tempered glass
- High volume, wide vision



SMM108KS-K



RUNNER MASK



- Silicone skirt & strap
- Replaceable standard buckles
- Twin lens w. tempered glass
- Optical Lenses available

ALL TIME FAVORITE

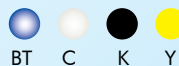

Clear Skirt:
 Blue Trans... S1083S-BT
 Clear... S1083S-C
 Black... S1083S-K
 Yellow... S1083S-Y

Black Skirt:
 Blue Trans... S1083KS-BT
 Green... S1083KS-G
 Black... S1083KS-K
 Yellow... S1083KS-Y

OPTICAL LENSES



Myopia Lens (Nearsighted) :

- ▶ Available from -1.0 through -7.0 in 0.5 increments
- ▶ Available from -7.0 through -10.0 in 1.0 increments

Bi-Focal Presbyopia Lens :

Myopia Lens	Presbyopia Lens		
-1.0	+1.0	+2.0	+3.0
-2.0	+1.0	+2.0	-
-3.0	+1.0	-	-

Myopia Lens:

- Lens -1.0... S1083OP-1.0
- Lens -1.5... S1083OP-1.5
- Lens -2.0... S1083OP-2.0
- Lens -2.5... S1083OP-2.5
- Lens -3.0... S1083OP-3.0
- Lens -3.5... S1083OP-3.5
- Lens -4.0... S1083OP-4.0
- Lens -4.5... S1083OP-4.5
- Lens -5.0... S1083OP-5.0
- Lens -5.5... S1083OP-5.5
- Lens -6.0... S1083OP-6.0
- Lens -6.5... S1083OP-6.5
- Lens -7.0... S1083OP-7.0
- Lens -8.0... S1083OP-8.0
- Lens -9.0... S1083OP-9.0
- Lens -10.0... S1083OP-10.0

Bi-Focal Lens:

- Lens -2/+1 Left... S1083P6L-2/1L
- Lens -2/+2 Left... S1083P6L-2/2L
- Lens -3/+1 Left... S1083P6L-3/1L
- Lens -2/+1 Right... S1083P6L-2/1R
- Lens -2/+2 Right... S1083P6L-2/2R
- Lens -3/+1 Right... S1083P6L-3/1R



FRAMELESS MASK

- Silicone skirt & strap
- Replaceable standard buckles
- Extra low volume
- Ideal for APNEA
- Single lens w. tempered glass



SMM107KS



STEALTH MASK

- Silicone skirt
- 'Easy-adjust' buckles
- Twin lens
- Curved lenses (180-Degree field of vision)
- Extreme Low volume

NEW



SM205KS-K



PRO EAR 2000 MASK

- Silicone skirt & strap
- Replaceable standard buckles
- Twin lens w. tempered glass
- Complete ear protection

PROEAR²⁰⁰⁰



MPE10



DIVE OPTX Flexible Mask Magnifier Kit

- Available from +1.0 through +3.0 diopter in 0.5 increments



- TFM98 +1.00
- TFM98 +1.50
- TFM98 +2.00
- TFM98 +2.50
- TFM98 +3.00



SCUBAPRO

MANTA PLUS SNORKEL



- Comfortable silicone mouthpiece
- Purge valve for effortless clearing
- Semi-dry top design prevents water entry into tube
- Standard universal snorkel keeper
- PVC Flex tube



Clear Mouthpiece:

Blue Trans... DB1SA106-BT
Yellow... DB1SA106-Y

Black Mouthpiece:

Black... DB1SA106-K
Orange... DB1SA106-O



MARLIN SNORKEL



- Comfortable silicone mouthpiece
- Silicone snorkel holder
- Simple J-Tube



Clear Mouthpiece:

Blue Trans... DBSA91-BT
Clear... DBSA91-C
Black... DBSA91-K
Yellow... DBSA91-Y

Black Mouthpiece:

Black... DBSA91-KSK
Yellow... DBSA91-KSY



SHARKY SNORKEL



- Ergonomic silicone mouthpiece for added comfort
- Purge valve at lowest point for effortless clearing
- Semi-dry top design prevents water entry into tube
- Standard universal snorkel keeper
- Flexible, corrugated joint drops snorkel from face when not in use

Clear Mouthpiece:

Blue Trans... DBSB47-BT
Clear... DBSB47-C
Black... DBSB47-K
Yellow... DBSB47-Y

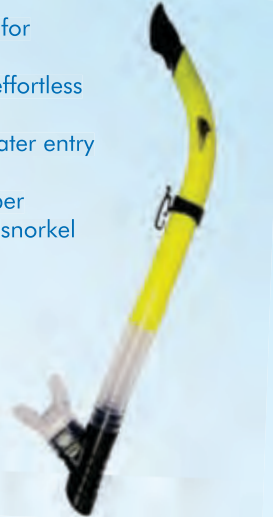

STINGRAY SNORKEL



- Ergonomic silicone mouthpiece for added comfort
- Purge valve at lowest point for effortless clearing
- Semi-dry top design prevents water entry into tube
- Standard universal snorkel keeper
- Flexible, corrugated joint drops snorkel from face when not in use



Clear Mouthpiece:

Blue Trans... DBSA105-BT
Clear... DBSA105-C
Black... DBSA105-K
Yellow... DBSA105-Y

Black Mouthpiece:

Black... DBSA105-KK

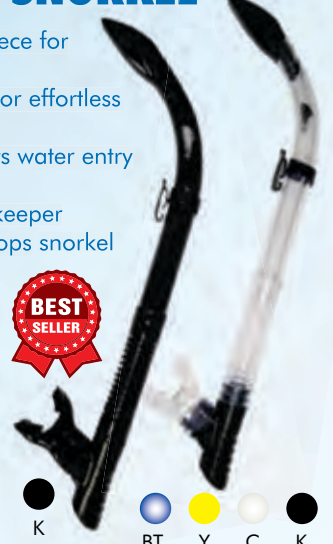

BALI SNORKEL



- Ergonomic silicone mouthpiece for added comfort
- Purge valve at lowest point for effortless clearing
- Semi-dry top design prevents water entry into tube
- Standard universal snorkel keeper
- Flexible, corrugated joint drops snorkel from face when not in use

Diva Pink... DBSD95-PD
Yellow Mango... DBSD95-YM



CORAL SNORKEL



- Comfortable silicone mouthpiece (for kids)
- Purge valve at lowest point for effortless clearing
- Semi-dry top design prevents water entry into tube
- Standard universal snorkel keeper
- Simple J-Tube (for kids)
- Available in Turquoise w. colourful coral motive

DBSCORAL



GOBY SNORKEL



- PVC mouthpiece for kids
- Semi-dry top design prevents water entry into tube
- Unique strap holder built into the tube
- Simple J-Tube

Clear Mouthpiece:

- Blue Trans... DBSB36-BT
- Green Trans... DBSB36-GT
- Pink Trans... DBSB36-PiT
- Yellow... DBSB36-Y

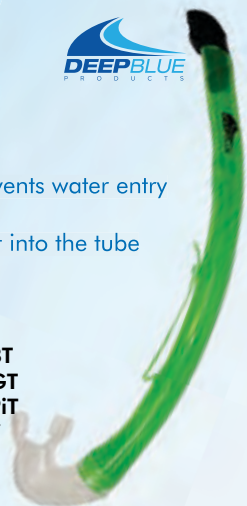

DAMSEL SNORKEL



- Comfortable silicone mouthpiece
- Purge valve at lowest point for effortless clearing
- Semi-dry top design prevents water entry into tube
- Standard universal snorkel keeper
- Simple J-Tube

Clear Mouthpiece:

- Blue Trans... DB8SA102-BT
- Pink Trans... DB8SA102-PiT
- Yellow... DB8SA102-Y



COVERT SNORKEL



- 100% Silicone Snorkel
- Foldable - always bounces back into shape
- Silicone mouthpiece
- Silicone snorkel holder

DBSE13-KK

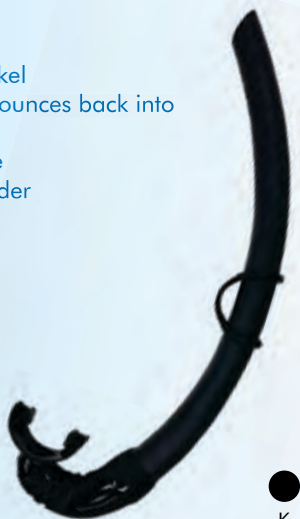

MAKO SNORKEL



- PVC mouthpiece
- Purge valve at lowest point for effortless clearing
- Semi-dry top design prevents water entry into tube
- Unique strap holder built into the tube
- Simple J-Tube

Clear Mouthpiece:

- Blue Trans... DB3SB35-BT
- Yellow... DB3SB35-Y

Black Mouthpiece:

- Black... DB3SB35-KK

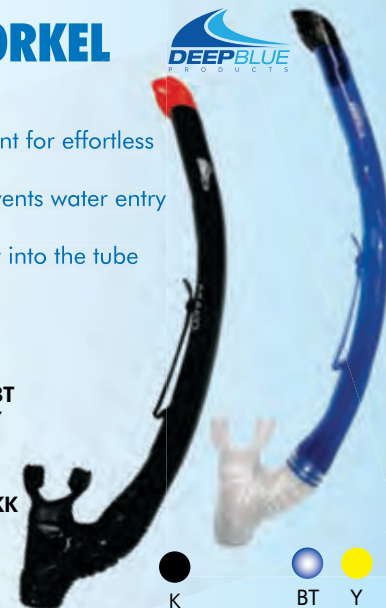

ORCA SNORKEL



- Sealed dry top (100% dry)
- Purge valve at lowest point for effortless clearing
- Soft silicone flex
- Comfortable silicone mouthpiece

Clear Mouthpiece:

- Blue... DBSE42-B
- Pink... DBSE42-Pi

Black Mouthpiece:

- Yellow... DBSE42-KY



XTREME SNORKEL



- Sealed dry top (100% dry)
- Purge valve at lowest point for effortless clearing
- Soft silicone flex
- Comfortable silicone mouthpiece
- Standard universal snorkel keeper

Clear Mouthpiece:

- Blue... DBSN134-B
- Pink... DBSN134-Pi

Black Mouthpiece:

- White... DBSN134-KW
- Yellow... DBSN134-KY



SPECTRA SNORKEL

- Ergonomic regulator style mouthpiece for added comfort
- Purge valve at lowest point for effortless clearing
- Semi-dry top design helps prevent water entry into tube
- Quick-release clip for easy removal from mask strap
- Flexible, corrugated joint drops snorkel from face when not in use

DIVE PRO FAVORITE

Clear Mouthpiece:

- Blue... X26.704.200
- Yellow... X26.704.500
- Pink... X26.704.710
- Red... X26.706.320
- White... X26.706.600
- Pink... X26.706.720

Black Mouthpiece:

- Purple... X26.704.750
- Bronze... X26.706.830
- Silver... X26.706.130



NEXUS SEMI DRY SNORKEL

- Ergonomic regulator style mouthpiece for added comfort
- Angled purge valve directs bubbles out of your sight line
- Splashguard top helps keep water from entering the large bore barrel
- Quick-connect clip makes it easy to attach or remove snorkel from mask strap
- Flexible upper barrel allows snorkel to be folded for storing
- Flexible, corrugated joint drops snorkel from face when not in use

Clear Mouthpiece:

- Black... X26.810.100
- Blue... X26.810.220

Black Mouthpiece:

- Red... X26.810.320



PHOENIX 2 SNORKEL

- Comfortable, high grade silicone mouthpiece
- Purge valve for ease of clearing
- Patented dry snorkel design (Sealed dry top)
- Durable universal snorkel keeper w. removable clip
- Flexible, corrugated joint drops snorkel from face when not in use

X267111B



TRINIDAD SNORKEL



NEW

- Semi-dry top design prevents water entry into tube
- Flexible, corrugated joint drops snorkel from face when not in use
- Ergonomic, replaceable high-grade silicone mouthpiece
- Purge valve for ease of clearing
- Adjustable snorkel keeper w. removable clip
- Integrated whistle for added safety (NEW)



X26.070.000



APNEA SNORKEL



- Utilitarian - always bounces back into shape
- Silicone mouthpiece
- Lightweight
- Soft tube

Black... X26.130.000
White... X26.130.600



VORTEX SNORKEL



- Ergonomic liquid silicone mouthpiece for extra comfort
- Purge valve at lowest point for effortless clearing
- Semi-rigid J-tube in soft PVC
- Innovative anti-splash top prevents water entry into tube
- Standard universal snorkel keeper
- Flexible, corrugated joint drops snorkel from face when not in use
- Stylish Italian design

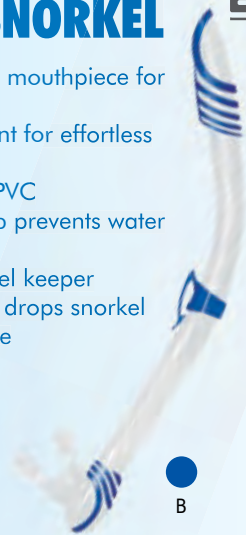

B48401-B



STANDARD SNORKEL



- Silicone or Rubber mouthpiece
- PVC snorkel keeper
- Simple J-Tube

Black Mouthpiece:

Black... S1052-K
Yellow... S1052-Y

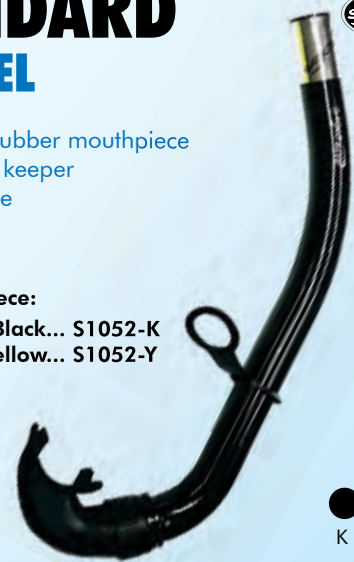

VISION HD GOGGLES

seac

- Oversized & durable frame reduces drag
- Comfortable leak-resistant hypoallergenic bio-silicone skirt
- Crystal clear wrap-around lens provides clear 180-degree visibility
- Anti-fog & scratch resistant lenses provide 100% UV protection
- Pulsar buckle system allows for quick strap adjustment with just a touch
- Protective storage pouch



Blue... B9908-B
Red... B9908-R



MARINER UV GOGGLES

- Anti-fog lens w. enhanced peripheral vision
- Soft silicone watertight seal
- Comfortable wrap-around lens provides high visibility
- Quick release buckle system & silicone strap
- Protective storage pouch included
- Anti-fog lens with enhanced peripheral vision & UV protection



Blue... SK5UV-B
Black... SK5UV-K

EAR PLUGS



- Easy-to-use ear plugs
- Keep your ear canal perfectly dry during water activities
- Helps prevent ear infections
- Made from silicone

Not suitable for SCUBA diving



SE4

NOSE CLIP



- Ideal for swimmers & other water sports
- Comfortable nose clip
- Flexible steel frame with latex pads
- Comfortably pinch the nostrils shut
- Designed to pinch the nose to keep water out
- Weight: 50 grams (including packaging)



SN2

WAVE GOGGLES



- Comfortable silicone seal
- Lenses w. 100% UV protection & anti-fog coating
- Easy adjustable head strap
- Interchangeable nose bridge



Blue... S1281AS-B
Blue Lagoon... S1281AS-BL
Black... S1281AS-K

WAVE JUNIOR GOGGLES



- Comfortable silicone seal
- Lenses w. 100% UV protection & anti-fog coating
- Easy adjustable head strap
- Interchangeable nose bridge



Blue... SS5-B
Black... SS5-K
Yellow... SS5-Y



BORA MASK & SNORKEL SET w. SPEED3 FINS

- Mask "Bora Plus" w. silicone skirt (Mask details page 30)
- Snorkel "Manta Plus" w. Semi-dry top design (Snorkel details page 39)
- Fins "Speed 3" Adjustable, sizes: S-M, L-XL (Fins details page 48)
- Re-useable large mesh bag with shoulder strap

- S-M, Blue... DB1SP3-SM-B
 S-M, Black... DB1SP3-SM-K
 S-M, Black/Yellow... DB1SP3-SM-KY
 S-M, Orange... DB1SP3-SM-O
 S-M, Yellow... DB1SP3-SM-Y
 L-XL, Blue... DB1SP3-LXL-B
 L-XL, Black... DB1SP3-LXL-K
 L-XL, Black/Yellow... DB1SP3-LXL-KY
 L-XL, Orange... DB1SP3-LXL-O
 L-XL, Yellow... DB1SP3-LXL-Y



BORA MASK & SNORKEL SET

- Mask "Bora Plus" w. silicone skirt (Mask details page 30)
- Snorkel "Manta Plus" w. Semi-dry top design (Snorkel details page 39)
- Clamshell or re-useable mesh bag

Mesh bag:

- Blue... DB2Bag-B
 Black... DB2Bag-KK
 Black/Yellow... DB2Bag-KY
 Orange... DB2Bag-O
 Yellow... DB2Bag-Y

Clamshell:

- Blue... DB2Clam-B
 Black... DB2Clam-KK
 Black/Yellow... DB2Clam-KY
 Orange... DB2Clam-O
 Yellow... DB2Clam-Y



MAKO MASK & SNORKEL SET

- Mask "Mako" w. silicone skirt (Mask details page 30)
- Snorkel "Mako" w. Semi-dry top design (Snorkel details page 40)
- Clamshell or re-useable mesh bag

Mesh bag:

- Blue Trans... DBMakoB-BT
 Black... DBMakoB-KK
 Yellow... DBMakoB-Y

Clamshell:

- Blue Trans... DBMakoC-BT
 Black... DBMakoC-KK
 Yellow... DBMakoC-Y



ORCA MASK & SNORKEL SET



- Mask "Orca" w. silicone skirt (Mask details page 31)
- Snorkel "Orca" 100% Silicone (Snorkel details page 40)
- Clamshell or re-useable mesh bag

Mesh bag:

- Blue... DBOrcB-B
- Yellow... DBOrcB-KY
- Pink... DBOrcB-Pi

Clamshell:

- Blue... DBOrcC-B
- Yellow... DBOrcC-KY
- Pink... DBOrcC-Pi

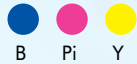

COVERT MASK & SNORKEL SET



- Mask "Covert" w. silicone skirt (Mask details page 30)
- Snorkel "Covert" 100% Silicone (Snorkel details page 40)
- Clamshell or re-useable mesh bag

Mesh bag:

- Blue... DBCvtB-KB
- Black... DBCvtB-KK
- Pink... DBCvtB-KPi
- White... DBCvtB-KW

Clamshell:

- Blue... DBCvtC-KB
- Black... DBCvtC-KK
- Pink... DBCvtC-KPi
- White... DBCvtC-KW



XTREME MASK & SNORKEL SET



- Mask "Xtreme" w. silicone skirt (Mask details page 31)
- Snorkel "Xtreme" w. Dry Top (Snorkel details page 40)
- Clamshell or re-useable mesh bag

Mesh bag:

- Blue... DBXtrB-B
- White... DBXtrB-KW
- Yellow... DBXtrB-KY
- Pink... DBXtrB-Pi

Clamshell:

- Blue... DBXtrC-B
- White... DBXtrC-KW
- Yellow... DBXtrC-KY
- Pink... DBXtrC-Pi



HAWAII MASK & SNORKEL SET



- Mask "Hawaii" w. PVC skirt
(Mask details page 31)
- Snorkel "Mako" w. Semi-dry top design
(Snorkel details page 40)
- Re-useable mesh bag

Mesh bag:

- Blue Trans... DB3Bag-BT
- Yellow Trans... DB3Bag-YT



FIJI JUNIOR MASK & SNORKEL SET



- Mask "Fiji" w. silicone skirt
(Mask details page 31)
- Snorkel "Damsel" w. Semi-dry top design
(Snorkel details page 40)
- Clamshell or re-useable mesh bag

Mesh bag:

- Blue... DB8Bag-B
- Pink Trans... DB8Bag-PiT
- Yellow... DB8Bag-Y

Clamshell:

- Blue... DB8Clam-BT
- Pink Trans... DB8Clam-PiT
- Yellow... DB8Clam-Y



FIJI PVC JUNIOR MASK & SNORKEL SET



- Mask "Fiji" w. PVC skirt
(Mask details page 31)
- Snorkel "Goby" w. Semi-dry top design
(Snorkel details page 40)
- Re-useable mesh bag

Mesh bag:

- Blue Trans... DB4Bag-BT
- Pink Trans... DB4Bag-PiT
- Yellow Trans... DB4Bag-YT



CORAL "JUNIOR" MASK & SNORKEL SET

- Mask "Coral" w. Silicone skirt
(Mask details page 32)
- Snorkel "Coral" w. Semi-dry top design
(Snorkel details page 39)
- Re-useable mesh bag

Mesh Bag... DBCoralB
Clamshell... DBCoralC



SPEED 2 FINS FULL FOOT



- Soft & flexible blade
- Flexible centre section to channel water
- Ergonomic foot pocket
- Non slip protection
- Ideal for snorkeling

Black, S... DBF367-S-K
 Black, M... DBF367-M-K
 Black, L... DBF367-L-K
 Black, XL... DBF367-XL-K

Blue, 5XS... DBF367-5XS-B
 Blue, 4XS... DBF367-4XS-B
 Blue, XS... DBF367-XS-B
 Blue, S... DBF367-S-B
 Blue, M... DBF367-M-B
 Blue, L... DBF367-L-B
 Blue, XL... DBF367-XL-B

Yellow, 5XS... DBF367-5XS-Y
 Yellow, XS... DBF367-XS-Y
 Yellow, M... DBF367-M-Y
 Yellow, L... DBF367-L-Y
 Yellow, XL... DBF367-XL-Y



SPEED3 FINS ADJUSTABLE



- Travel-friendly short blade design
- Adjustable strap allows for wide foot range
- Soft & flexible blade
- Ergonomic foot pocket
- Ideal for snorkeling
- Non slip protection



Adults:

Black, S-M... DBFB86SM-K
 Black, L-XL... DBFB85LXL-K
 Blue Trans, S-M... DBFB86SM-BT
 Blue Trans, L-XL... DBFB85LXL-BT
 Orange, S-M... DBFB86SM-O
 Orange, L-XL... DBFB85LXL-O
 Yellow, S-M... DBFB86SM-Y
 Yellow, L-XL... DBFB85LXL-Y

Kids:

Blue Trans, S-M, ... DBFB87SM-BT
 Blue Trans, M-L... DBFB88ML-BT
 Blue Trans, L... DBFB89L-BT
 Pink Trans, S-M... DBFB87SM-PiT
 Pink Trans, M-L... DBFB88ML-PiT
 Pink Trans, L... DBFB89L-PiT
 Yellow, S-M... DBFB87SM-Y
 Yellow, M-L... DBFB88ML-Y
 Yellow, L... DBFB89L-Y

Kids



Adults



DBF770 FINS ADJUSTABLE



- Travel-friendly short blade design
- Adjustable strap allows for wide foot range
- Soft & flexible blade
- Ergonomic foot pocket
- Non slip protection
- Ideal for snorkeling



Black, S-M... DBF770-S/M-K
 Black, ML-XL... DBF770-ML/XL-K
 Blue, S-M... DBF770-S/M-B
 Blue, ML-XL... DBF770-ML/XL-B
 Pink, S-M... DBF770-S/M-Pi
 Yellow, S-M... DBF770-S/M-Y
 Yellow, ML-XL... DBF770-ML/XL-Y



DBFA22 FINS KIDS ADJUSTABLE



- Travel-friendly short blade design
- Adjustable strap allows for wide foot range
- Soft & flexible blade
- Ergonomic foot pocket
- Non slip protection
- Ideal for snorkeling



Green, S-M... DBFA22SM-G
 Green, ML-XL... DBFA23MLXL-G
 Pink, S-M... DBFA23MLXL-Pi
 Pink, ML-XL... DBFA22SM-Pi
 Yellow, S-M... DBFA22SM-Y
 Yellow, ML-XL... DBFA23MLXL-Y



JET FINS CLASSIC OPEN HEEL



- Proven vented design decreases drag on the upstroke & enhances thrust on the down-stroke
- Choice of combat & tactical units worldwide
- Water flows-thru vents on weaker down-stroke
- Vents reduce pressure, providing less strain on the leg
- Angle of the vent acts as a solid blade on up-stroke
- Up-stroke provides maximum power & propulsion
- Ideal for Diving

VIRTUALLY INDESTRUCTIBLE
used by Navy Divers world-wide



●
K

REGULAR STOCK:

- Black, M... X25.365.300M
- Black, L... X25.365.400L
- Black, XL... X25.365.500XL
- Black, XXL... X25.365.600XXL

LIMITED STOCK SPECIAL ORDER :

- Red, L... X25.370.400L
- Camo Pink/White, M... X25.372.300M
- Camo Pink/White, L... X25.372.400L
- Blue Camo, XL... X25.376.500XL
- Blue Camo, XXL... X25.376.600XXL
- Camo Grey/White, M... X25.380.300M
- Camo Grey/White, XXL... X25.380.600XXL

Special Order



SEAWING NOVA & GORILLA FINS OPEN HEEL



- Award-winning design
- Fine-tuned to provide increase in stiffness & snap
- Ergonomic foot pocket with extended heel plate
- Wing tips arc upwards, increasing high-speed stability
- Better frog-kick-ability
- Marine quality bungee heel straps
- Ideal for Diving



REGULAR STOCK:

Seawing Nova:

- Black, XS... X25.731.100XS
- Black, S... X25.731.200S
- Black, M... X25.731.300M
- Black, L... X25.731.400L
- Black, XL... X25.731.500XL
- White, XS... X25.732.100XS
- White, S... X25.732.200S
- White, M... X25.732.300M
- White, L... X25.732.400L
- White, XL... X25.732.500XL
- Pink, XS... X25.735.100XS
- Pink, S... X25.735.200S
- Pink, M... X25.735.300M

LIMITED STOCK SPECIAL ORDER:

Seawing Nova Gorilla:

- Orange, S... X25.734.200S

Seawing Nova:

- Turquoise, XS... X25.729.100XS
- Turquoise, S... X25.729.200S
- Turquoise, M... X25.729.300M
- Yellow, S... X25.737.200S
- Yellow, M... X25.737.300M



Special Order



SUPER COMFORTABLE
INSTRUCTORS LOVE THE GORILLA

GO FINS OPEN HEEL

NEW



- The new phenomenon in fin rental; comfortable, practical durable & affordable
- Monprene® TPE (Thermoplastic Elastomer)
- Made from monprene using single mould construction - virtually indestructible
- Bootless open heel configuration
- Marine grade bungee, name plate, integral storage feature
- Colour coded fin strap colours: Blue, Green, Grey, Orange, Purple, Yellow. Also available in all sizes with a black strap for retail



Black, Travel 2XS... X25.740.000/2XS
 Black, Travel XS-S... X25.740.150/XS-S
 Black, Travel M-L... X25.740.300/M-L
 Black, Travel XL... X25.740.500/XL
 White, Travel XS-S... X25.741.150XS-S
 White, Travel M-L... X25.741.300M-L
 White, Travel XL... X25.741.500XL

Purple, Rental 3XS... X25.743.090/3XS
 Green, Rental 2XS... X25.743.000/2XS
 Blue, Rental XS-S... X25.743.150/XS-S
 Yellow, Rental M-L... X25.743.300/M-L
 Orange, Rental XL... X25.743.500/XL
 Grey, Rental 2XL... X25.743.600/2XL

Strap Colours



TOUGH AS NAILS, DIVE SCHOOL FAVORITE

GO FIN RESORT SIZE CHART



International Sizing				3XS	2XS	XS-S	M-L	XL	XXL
♂ US	♀	UK	EU						
10 KIDS		9	27	●	---	---	---	---	---
11 KIDS		10	28	●	---	---	---	---	---
12 KIDS		11	29	●	---	---	---	---	---
13 KIDS		12	30	●	○	---	---	---	---
1 KIDS		13	31-32	○	●	---	---	---	---
2 KIDS		1	33	---	●	---	---	---	---
3	4	2	34	---	●	---	---	---	---
4	5	3	35-36	---	●	○	---	---	---
5	6	4	37	---	○	●	---	---	---
6	7	5	38	---	---	●	---	---	---
7	8	6	39-40	---	---	●	○	---	---
8	9	7	41	---	---	○	●	---	---
9	10	8	42	---	---	---	●	---	---
10	11	9	43-44	---	---	---	●	○	---
11	12	10	45	---	---	---	○	●	---
12	13	11	46	---	---	---	---	●	○
13	14	12	47	---	---	---	---	●	●
14	15	13	48-49	---	---	---	---	○	●

SCUBAPRO GO SPORT FINS



**SCUBALAB
TESTER'S
CHOICE**

2 0 1 9

Features:

- Open heel "Boot-Fit" design w. self-adjusting bungee heel strap
- Revised Ergo3 foot pocket is re-profiled for maximum comfort and power transfer.
- Ultra-strong 100% Monprene® construction, making it ideal for long-term, heavy-duty use.
- 25 degree pre-angled blade provides longitudinal rigidity and creates a channeling effect.
- Power Bars on the underside of the rails prevent over-flex.
- Delivers speed, power, stability and maneuverability with a minimum of effort.
- Fins fit easily in IATA carry-on compliant luggage for divers (Travel friendly)
- Lightweight design XS – 1.15 kg / XL – 1.80 kg (Travel friendly)

Sizes available:

- X-Small
- Small
- Medium
- Large
- X-Large

LIMITED STOCK SPECIAL ORDER:

Blue, XS... X25.764.100XS
 Blue, S... X25.764.200S
 Blue, M... X25.764.300M
 Blue, L... X25.764.400L
 Blue, XL... X25.764.500XL
 Yellow, XS... X25.763.100XS
 Yellow, S... X25.763.200S
 Yellow, M... X25.763.300M
 Yellow, L... X25.763.400L



B Y

REGULAR STOCK:

Black, XS... X25.761.100XS
 Black, S... X25.761.200S
 Black, M... X25.761.300M
 Black, L... X25.761.400L
 Black, XL... X25.761.500XL
 White, XS... X25.762.100XS
 White, S... X25.762.200S
 White, M... X25.762.300M
 White, L... X25.762.400L
 White, XL... X25.762.500XL



K W

FIN SKEGS SET:

Army Green... X25.328.000
 Green... X25.328.010
 Silver... X25.328.025
 Purple... X25.328.050
 Blue... X25.328.200
 Turquoise... X25.328.250
 Orange... X25.328.400
 Yellow... X25.328.500
 Pink... X25.328.700

SEAC **FINS**

PROPULSION S

Features:

- Large blade for a more powerful response in the water
- Flexible water channels for increased efficiency
- External ribbings for blade support
- Ergonomic open heel foot pocket w. non slip protection
- Ideal for Scuba Diving
- Propulsion w. rubber strap
- Propulsion S w. sling strap



PROPULSION

Item code: B538-B540

PROPULSION (w. Rubber Strap)

Available: Black, Blue, Pink & Yellow



PROPULSION S

Available: Black, Blue, Yellow & White



PROPULSION S (w. Sling Strap)

Item code: B71043

F100 PRO FINS

FULL FOOT

- Researched & created for heavy duty intensive use
- Large blade for a more powerful response in the water
- Flexible water channels for increased efficiency
- Extra solid external ribbings
- Ergonomic foot pocket w. non slip protection
- Ideal for Dive Centres

CHOICE OF DIVE PRO'S

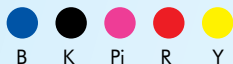

SEAC

- Black, 40/41... B9292-K
- Black, 42/43... B9293-K
- Black, 44/45... B9294-K
- Black, 46/47... B9295-K
- Blue, 36/37... B9290-B
- Blue, 38/39... B9291-B
- Blue, 40/41... B9292-B
- Blue, 42/43... B9293-B
- Blue, 44/45... B9294-B
- Blue, 46/47... B9295-B
- Pink, 36/37... B9290-P
- Pink, 38/39... B9291-P
- Red, 36/37... B9290-R
- Red, 38/39... B9291-R
- Red, 42/43... B9292-R
- Red, 40/41... B9293-R
- Yellow, 36/37... B9290-Y
- Yellow, 38/39... B9291-Y
- Yellow, 40/41... B9292-Y
- Yellow, 42/43... B9293-Y
- Yellow, 44/45... B9294-Y
- Yellow, 46/47... B9295-Y

JET FINS OPEN HEEL

- Durable rubber construction
- Drag-reducing vents
- Soft foot pocket
- Semi rigid side rails for blade stability
- Adjustable rubber heel straps
- Ideal for Diving



K

- Black, XL... S2030
- Black, L... S2031
- Black, M... S2032

JET FINS PRO OPEN HEEL

- Material: 100% Rubber
- Proven Vented Design (Excellent propulsion)
- Provides Exceptional Speed with Minimal Effort
- Vents Reduce Pressure, Providing less strain on leg
- Angle of the vent reacts as a solid blade on up-stroke
- Slightly positive buoyant in saltwater, neutrally fin in fresh water
- Preferred fin type by Scuba Instructors & Diving Professionals
- Open heel with heavy duty dual bungee cord straps
- Colours: Black, Green, Orange, Pink, Red, White, Yellow
- Sizes: M, L, XL



- Black, M... SJFPRO1/M-K
- Black, L... SJFPRO2/L-K
- Black, XL... SJFPRO3/XL-K
- Green, L... SJFPRO2/L-G
- Pink, M... SJFPRO1/M-P
- Pink, L... SJFPRO2/L-P
- Red, L... SJFPRO2/L-R
- White, L... SJFPRO2/L-W
- Yellow, L... SJFPRO2/L-Y
- Yellow, XL,... SJFPRO3/XL-Y

SCUBAPRO BOOTS

- Delta boot, 5mm comfort & protection, available in 3XS-3XL
- Delta short boot, 3mm low-cut & lightweight, available in 3XS-2XL

High Boots:

- 2XS/5... X57138/2XS
- XS/6... X57138/XS
- S/7... X57138/S
- M/8... X57138/M
- L/9... X57138/L
- XL/10... X57138/XL
- 2XL/11... X57138/2XL
- 3XL/12... X57138/3XL



High Boots

Short Boots:

- 3XS/4... X57166/3XS
- 2XS/5... X57166/2XS
- XS/6... X57166/XS
- S/7... X57166/S
- M/8... X57166/M
- L/9... X57166/L
- XL/10... X57166/XL
- 2XL/11... X57166/2XL



Short Boots

SEAC BOOTS

- Basic HD boots, 5mm available in 2XS-2XL

High Boots:

- 2XS... B67900-XXS
- XS... B67900-XS
- S... B67900-S
- M... B67900-M
- L... B67900-L
- XL... B67900-XL
- 2XL... B67900-XXL



DEEP BLUE BOOTS

- Nautilus boots, 5mm available in 2XS-2XL
- High boots w. orange insert, 5mm available in 2XS-2XL
- Half boots w. pull cord, 3mm available in 3XS-2XL

High Boots:

- 2XS... DBB01B-XXS
- XS... DBB01B-XS
- S... DBB01B-S
- M... DBB01B-M
- ML... DBB01B-ML
- L... DBB01B-L
- XL... DBB01B-XL
- 2XL... DBB01B-XXL



High Boots

Nautilus Boots:

- 2XS... DBB01C-XXS
- XS... DBB01C-XS
- S... DBB01C-S
- ML... DBB01C-ML
- L... DBB01C-L
- XL... DBB01C-XL



Nautilus Boots

Half Boots:

- 3XS... DBB02A-XXXS
- 2XS... DBB02A-XXS
- XS... DBB02A-XS
- S... DBB02A-S
- M... DBB02A-M
- ML... DBB02A-ML
- L... DBB02A-L
- XL... DBB02A-XL
- 2XL... DBB02A-XXL



Half Boots

BOOT SIZE CHART :

Size	3XS	2XS	XS	S	SM	M	ML	L	XL	2XL	3XL
Deep Blue	4	5	6	7	n/a	8	9	10	11	12	n/a
Scubapro	5	5.5	6	7	n/a	8	8.5	9	10	11	11.5
Seac	n/a	23 / 36-37	24 / 37-38	25 / 38-39	n/a	26 / 40-41	n/a	27 / 42-43	28 / 43-44	29 / 45-46	n/a

DEEP BLUE SOCKS

- Neoprene sock, 2mm Size XXS - XXL



- 2XS... DBB03-XXS
- XS... DBB03-XS
- S... DBB03-S
- M... DBB03-M
- L... DBB03-L
- XL... DBB03-XL
- 2XL... DBB03-XXL

BEACH WALKER



- Available in 30, 31, 32, 33, 34, 35, 36, 37, 38, 39, 40, 41, 42, 43, 44, 45, 46

Aloha - Orange:

- 30... DBB04-30
- 31... DBB04-31
- 32... DBB04-32
- 33... DBB04-33
- etc.
-
-
- 44... DBB04-44
- 45... DBB04-45
- 46... DBB04-46



Aloha - Orange

Aloha - Blue:

- 30... DBB05-30
- 31... DBB05-31
- 32... DBB05-32
- etc.
-
-
- 44... DBB05-44
- 45... DBB05-45
- 46... DBB05-46



Aloha - Blue

Aloha - Blue Trim:

- 35... DBB06-35
- 36... DBB06-36
- 37... DBB06-37
- 38... DBB06-38
- etc.
-
-
- 44... DBB06-44
- 45... DBB06-45



Aloha - Blue Trim

DEEP BLUE GLOVES



- Tropic glove, 1.5mm Size XS - XL

- XS... DBG01-XS
- S... DBG01-S
- M... DBG01-M
- L... DBG01-L
- XL... DBG01-XL



SCUBAPRO GLOVES 1.5mm



Tropic Gloves, Flamingo

- 2XS... X580340/XXS
- XS... X580341/XS
- S... X580342/S
- M... X580343/M



Tropic Gloves, Aegean

- 2XS... X580320/XXS
- XS... X580321/XS
- S... X580322/S
- M... X580323/M
- L... X580324/L



Tropic Gloves, Black

- 2XS... X580350/XXS
- XS... X580351/XS
- S... X580352/S
- L... X580354/L
- XL... X580355/XL



Tropic Gloves

- XL... X58325/XL
- 2XL... X58325/XXL



Tropic Gloves, Black

- 2XS... X58326/XXS
- XS... X58326/XS
- XL... X58326/XL
- 2XL... X58326/XXL



Seamless Gloves

- XS... X580001/XS
- S... X580002/S
- M... X580003/M
- L... X580004/L
- XL... X580005/XL

DEEP BLUE GLOVES



- Tropic glove, 1.5mm Size XS - XL

- XS... DBG01-XS
- S... DBG01-S
- M... DBG01-M
- L... DBG01-L
- XL... DBG01-XL



SEAC GLOVES

- Tropic HD glove, 1.5mm Size XS - XL



- XS... B64600-XS
- S... B64600-S
- M... B64600-M
- L... B64600-L
- XL... B64600-XL

WETSUIT SIZE CHART:



DEEP BLUE SHORTY DBADS01 / DBADS02 / DBADS04

Position	XXS	XS	S	M	L	XL	XXL	XXXL
Chest	79	83	87	91	95	99	103	107
Waist width	65	69	73	77	81	85	89	93
Hip width	80	84	88	92	96	100	104	108
Length of neck to crotch	65	67	69	71	73	75	77	79
Neck circumference	33	34	35	36	37	38	39	40

UNISEX SHORTY



- Add your own logo on chest
- 3mm shorty / Black
- Quality CR neoprene (CR = Chloroprene Rubber)
- Back zipper, YKK
- Rolled seams on edges
- Flat comfortable seams
- Sizes: XXS-XXXL
- Size indication on zipper band

- Add your own logo on chest
- 3mm shorty / black w. blue panels
- Standard neoprene
- Back zipper, YKK
- Rolled seams on edges
- Flat comfortable seams
- Sizes: 2XS-XXXL
- Size indication on zipper band

- Add your own logo on chest
- 3mm shorty / black w. blue stitching
- Standard neoprene
- Back zipper, YKK
- Rolled seams on edges
- Flat comfortable seams
- Sizes: 3XS-XXXL
- Size indication on zipper band



2XS... DBADS01-XXS
 XS... DBADS01-XS
 S... DBADS01-S
 M... DBADS01-M
 L... DBADS01-L
 XL... DBADS01-XL
 2XL... DBADS01-XXL
 3XL... DBADS01-XXXL



XS... DBADS02-XS
 S... DBADS02-S
 M... DBADS02-M
 L... DBADS02-L
 XL... DBADS02-XL
 2XL... DBADS02-XXL



3XS... DBADS04-XXXS
 2XS... DBADS04-XXS
 XS... DBADS04-XS
 S... DBADS04-S
 M... DBADS04-M
 L... DBADS04-L
 XL... DBADS04-XL
 2XL... DBADS04-XXL
 3XL... DBADS04-XXXL

STEAMER SIZE CHART:

Position	XS	S	M	L	XL	XXL	XXXL
Chest	84	88	92	96	100	104	108
Waist width	69	73	77	81	85	89	93
Hip width	84	88	92	96	100	104	108
Length of neck to crotch	68	70	72	74	76	78	80
Neck circumference	35	36	37	38	39	40	41

UNISEX STEAMER

3mm

- 3mm durable black neoprene
- Back zipper
- Rolled seams on edges
- Flat comfortable seams
- Sizes: XS-XXXL
- Size indication on zipper band
- Wrist & ankle zipper



XS... DBADS03-XS
S... DBADS03-S
M... DBADS03-M
L... DBADS03-L
XL... DBADS03-XL
2XL... DBADS03-XXL
3XL... DBADS03-XXXL



LOOSE FIT LYCRA

- The optimal body wear for water sports or any outdoor activities
- Light weight & instant drying
- Unisex design
- Tie down loop for surfers
- UPF-50 (Ultraviolet Protection Factor)
- Material: 82% Nylon, 18% Spandex



2XS... DBLRLF-XXS
XS... DBLRLF-XS
S... DBLRLF-S
M... DBLRLF-M
L... DBLRLF-L
XL... DBLRLF-XL
2XL... DBLRLF-XXL

LYCRA RASHGUARD

- The optimal body wear for water sports or any outdoor activities
- Light weight & instant drying
- Tie down loop for surfers
- Colours: Black, Black/Blue, Black/Grey & Black with Blue screen

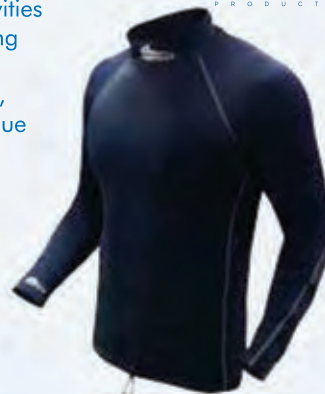

Black, 2XS... DBLR1K-XXS
Black, XS... DBLR1K-XS
Black, S... DBLR1K-S
Black, M... DBLR1K-M
Black, L... DBLR1K-L
Black, XL... DBLR1K-XL
Black, 2XL... DBLR1K-XXL

Black/Blue, 2XS... DBLR1KB-XXS
Black/Blue, XS... DBLR1KB-XS
Black/Blue, S... DBLR1KB-S
Black/Blue, M... DBLR1KB-M
Black/Blue, L... DBLR1KB-L
Black/Blue, XL... DBLR1KB-XL
Black/Blue, 2XL... DBLR1KB-XXL



Black/Grey, 2XS... DBLR1KGy-XXS
Black/Grey, XS... DBLR1KGy-XS
Black/Grey, S... DBLR1KGy-S
Black/Grey, M... DBLR1KGy-M
Black/Grey, L... DBLR1KGy-L
Black/Grey, XL... DBLR1KGy-XL
Black/ Grey, 2XL... DBLR1KGy-XXL



Black, M... DBLR2K-M
Black, L... DBLR2K-L
Black, XL... DBLR2K-XL
Black, 2XL... DBLR2K-XXL

EVERFLEX STEAMER

3mm

- X-Foam eco-friendly neoprene & solvent free glue for better health & environmental protection
- Smooth-cut neckline
- New PVC zip ends adds stylish & durable finishing
- Glideskin seals
- New heliospan torso lining for added protection & insulation
- 3D design shoulder pads & Tatex kneepads
- Powertex anti-abrasion
- 2x I-Safe straps
- Compression lumbar & spine pad

Men, XS... X63353/XS

Lady, XXS... X63354/L

Lady, M... X63354/M

Lady, L... X63354/XXS



THERMAL TEC STEAMER

3mm & 5mm

A serious suit for serious divers.
The Thermal TEC is a perfect combination of advanced materials & thoughtful construction, creating a suit of outstanding durability, comfort & insulation. Main suit sections are made of durable & fast drying N2S neoprene. Wrist & ankle zippers for divers ease of wear.

Lady, 5mm, XL... X64464XL

Lady, 3mm, XXS... X64469XXS

Lady, 3mm, XXS... X64471XXS

Lady, 3mm, XS... X64471XS

Lady, 3mm, M... X64471M

Lady, 3mm, L... X64471L

Men, 3mm, S... X64470S

Men, 3mm, M... X64470M

Men, 3mm, L... X64470L

Men, 3mm, XL... X64470XL

Men, 5mm, XL... X64473XL



PROFILE 0.5mm



- 0.5mm nylon neoprene outside for durability & Silverskin inside for easy wear. Silverskin is an ultra-smooth interior finish. It consists of a cell finish with 'metalite' coating for extra warmth retention. It dries fast & seals extremely well. It is also used on hood & glove interiors
- Non-chaffing flat seams for insured comfort directly against your skin. Flat seam construction is a stitching pattern that provides comfort, strength & flexibility on warm water suits
- Thumb & foot straps, for added convenience
- Back zipper for great ergonomics
- Men's & women's dedicated sizes & colours



Lady, 2XS... X63346/XXS



Lady, 2XS... X63447/XXS



Men, S... X630372/S
Men, M... X630373/M
Men, L... X630374/L
Men, XL... X630375/XL



DEFINITION 3mm



- Made from X-Foam neoprene, the only "green" neoprene that complies with P.A.H. regulations
- The "body map" system uses special tailoring & material inserts to compensate for the stresses of the human body
- Ultraspan chest panel & Stretchtec side panels work together to produce a highly flexible & snug fit
- Infrared (IR) fleece interior lining reflects body heat for extra thermal insulation & is extremely soft against the skin
- Zippered seals at wrists & ankles plus a rear diagonal zipper block water entry, are comfortable & make the suit easy to put on & take off
- Abrasion resistant fabric on shoulders & seat, along with elbow pads & kneepads, increase long-term durability
- Spine pad cushions the tank, providing additional comfort during extended dives
- Small neck zipper enhances topside comfort, eliminating the need to remove the suit between dives
- I-Safe strap keeps a wrist instrument securely attached



Men, S... X639302/S
 Men, M... X639303/M
 Men, L... X639304/L
 Men, XL... X639305/XL
 Men, 2XL... X639306/XXL

Lady, 2XS... X639310/XXS
 Lady, XS... X639311/XS
 Lady, S... X639312/S
 Lady, M... X639313/M
 Lady, L... X639314/L

HOODED VEST



- 2.5mm throughout
- 100% Everflex neoprene
- Light graphic print on side panels & head
- Glide skin interior (black)



2XS... X64062XXS
 XS... X64062XS
 S... X64062S
 M... X64062M
 ML... X64062ML
 L... X64062L
 XL... X64062XL
 2XL... X64062XXL
 3XL... X64062XXXL

HOOD EVERFLEX 5/3mm



- Constructed of high-stretch 100 percent Everflex neoprene for maximum comfort & durability
- Extremely stretchy Silverskin lining feels good against the skin & provides a good seal to minimize water transfer



S... X67.052.200S
 M... X67.052.300M
 L... X67.052.400L
 XL... X67.052.500XL

BEANIE



- One size fits all - 22 x 21cm, Black & Grey



X50.021.000

MICROFIBER TOWEL



- Large 160x80cm, Blue



X50.582.000

HYBRID SHORT w. CARGO POCKETS



Unique styling keeps you warm,
comfortable & looking good.
Worn alone or over a dive suit, their
added pockets are a diver's favorite.



S... X653512S
M... X653513M
MT... X653513MT
L... X653514L
XL... X653515XL
2XL... X653516XXL

HYBRID SHORTS



The newest addition to the hybrid line,
the hybrid shorts can be worn alone,
under a suit, or paired with hybrid
T-Flex rash guard for a great warm
water combo.



M... X63056M
L... X63056L
XL... X63056XL
2XL... X63056XXL

CAMO LONG SLEEVE



- Ultra UV protection rating SPF80
- Breathable high-tech hollow fiber
- Extremely water resistant,
quick-drying



S... X636602/S



T-FLEX LONG SLEEVE

- Scubapro-designed T-Flex Rash Guard / Lycra shirt
- High quality, UV-rated FlexTec shirts with close-to-body fit to wear under a suit for added warmth, or used solely as a rash guard for your snorkeling & swimming activities
- Extremely flexible & stretchy, making it super comfortable to wear
- Available with long sleeves & in various colour combinations with two-colour style accents & contrasting outside stitching



Black/Blue

XS... X63180/XS
M... X63180/M

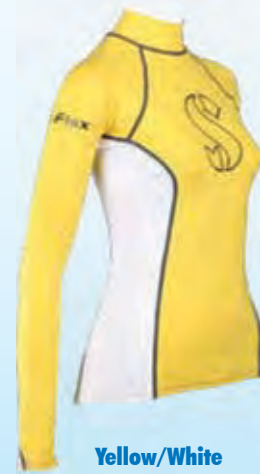

Yellow/White

XS... X63172/XS



T-FLEX LONG SLEEVE

- Scubapro-designed T-Flex Rash Guard / Lycra shirt
- High quality, UV-rated FlexTec shirts with close-to-body fit to wear under a suit for added warmth, or used solely as a rash guard for your snorkeling & swimming activities
- Extremely flexible & stretchy, making it super comfortable to wear
- Available with long sleeves & in various colour combinations with two-colour style accents & contrasting outside stitching



Lady, Blue/White

XS... X63280/XS



Lady, Black

XL... X63264/XL



Men, Black

XS... X63283/XS



T-FLEX LONG SLEEVE UPF 80

- Look sharp while enjoying outstanding protection with the stylish T-FLEX rashie. Made from water-repellant Flex-Tec, the T-FLEX doesn't trap water & it dries quickly
- The thumb-hole wrist design on the long sleeve models makes it easy to wear beneath a wetsuit. When topside, its UPF80 (Ultraviolet Protection Factor) rating provides ample protection from the sun's rays



Men, Black

S... X652312/S
M... X652313/M
L... X652314/L
XL... X652315/XL
2XL... X652316/XXL



Men, Graphite

S... X652322/S
M... X652323/M
L... X652324/L
XL... X652325/XL
2XL... X652326/XXL



Lady, Onyx

XS... X657361/XS
S... X657362/S
M... X657363/M
L... X657364/L
XL... X657365/XL



RASHGUARD

LONG SLEEVE UPF 50

- UPF 50 rating (blocks 98% of UV radiation)
- High quality polyester: durable, abrasion-resistant, good color fastness
- Form-fitting design wears easily under a wetsuit & retains its shape after repeated use
- Flattering color panels & high neck line to prevent uncomfortable chafing
- Material dries quickly to enhance comfort between dives



Men, Black

S... X650312/S
 M... X650313/M
 L... X650314/L
 XL... X650315/XL
 2XL... X650316/XXL

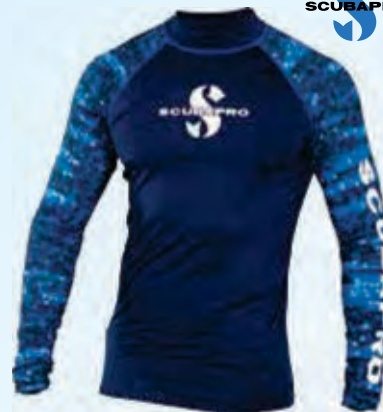

Men, Aegean

S... X650332/S
 M... X650333/M
 L... X650334/L
 XL... X650335/XL
 2XL... X650336/XXL



RASHGUARD

LONG SLEEVE UPF 50

A garment with a rating of UPF 50 blocks 98% of UV radiation. UPF ratings 50 & above are considered to be in the "Excellent" Protection Category.

- Stylish skin protection increases comfort during diving
- Made from high quality polyester fabric
- Form-fitting
- Dries quickly

FUNCTIONAL GEAR THAT LOOKS GREAT



Lady, Caribbean

XS... X655351/XS



Lady, Flamingo

XS... X655371/XS
 S... X655372/S



SWIM RASHGUARD

LONG SLEEVE UPF 50

- Stylish polyester skin protection; increases comfort when diving & on the surface
- UPF 50 rating blocks 98% of UV radiation
- Features a chlorine-resistant treatment for pool training
- High quality polyester offers good color fastness
- Durable, abrasion-resistant, retains its shape after repeated use & wears easily under a wetsuit
- Highly versatile – ideal for divers, snorkelers, paddle boarders, swimmers & other water enthusiasts too



S... X620312/S
 M... X620313/M
 L... X620314/L
 XL... X620315/XL
 2XL... X620316/XXL



T-FLEX LONG SLEEVE UPF 80



- UPF 80 rating (awarded by UV standard 801)
- Made from a blend of 86% super-soft nylon & 14% highstretch spandex
- The nylon is lightweight & quick drying
- The spandex provides more fabric stretch & allows for comfort & form-fitting styling
- Exceptional strength, abrasion resistance moisture control
- Form-fitting for that sleek hydrodynamic look & feel
- Slimming color panels & cut compliment the female body



XS... X657351/XS
S... X657352/S

T-FLEX LEGGINGS UPF 80



- Rated UPF 80 by UV Standard 801 - the highest UV protection rating available in the industry
- Made from a blend of 86% super-soft nylon & 14% high-stretch spandex
- Maximum comfort - maximum stretch
- Looks great with the T-Flex rash guards
- Slimming color panels & cut compliment a female's body
- Highly versatile - ideal for divers, snorkelers, swimmers & other water enthusiasts



Lady, Caribbean

XS... X657751/XS
S... X657752/S



Lady, Jewel

XS... X657791/XS
S... X657792/S
M... X657793/M
L... X657794/L

LOVE T-SHIRT



- 100% Cotton, 150 GSM
- Scubapro logo on front
- "LOVE" on back
- Available in Blue and Pink screen



Size 2XS, Blue... X003.34-2XS
Size XS, Blue... X003.36-XS
SSize S, Blue... X003.38-S
Size M, Blue... X003.40-M
Size L, Blue... X003.42-L
Size XL, Blue... X003.44-XL
Size 2XL, Blue... X003.46-2XL
Size 3XL, Blue... X003.48-3XL
Size 4XL, Blue... X003.50-4XL
Size 2XS, Pink... X004.34-2XS
Size XS, Pink... X004.36-XS
SSize S, Pink... X004.38-S
Size M, Pink... X004.40-M
Size L, Pink... X004.42-L
Size XL, Pink... X004.44-XL

SCUBAPRO T-SHIRT



- 100% Cotton, 150 GSM
- "Deep Down You Want The Best" on front
- Scubapro logo on back



2XS... X002.34-2XS
XS... X002.36-XS
S... X002.38-S



M... X002.40-M
L... X002.42-L
XL... X002.44-XL
2XL... X002.46-2XL
3XL... X002.48-3XL
4XL... X002.50-4XL

UNDERWATER HOUSING

OLYMPUS

- For TG-6 digital camera
- Depth rating: 45m
- Retains access to all camera controls
- Can accommodate 2 external flashes
- Supports optional lens accessories
- Dimensions: 6.2 x 4.8 x 3.2" / 157 x 122 x 81mm
- Weight: 1.1 lb / 484g



OL-PT059

TG-6 STYLUS TOUGH CAMERA SET

OLYMPUS

- TG-6 digital camera
- Underwater housing



Black... OL-TG6Set-K
Red... OL-TG6Set-R

TG-6 STYLUS TOUGH CAMERA

OLYMPUS

- 12MP - 1/2.3 BSI-CMOS sensor
- ISO 100 - 12800
- 25-100 mm F2.0-4.9 zoom lens
- Sensor-shift image stabilization
- 3 Fixed type screen
- 20.0 fps continuous shooting
- 4K - 3840 x 2160 video resolution
- Built-in wireless
- Built-in GPS
- 253g 113 x 66 x 32mm
- Weather sealed body

Black... OL-TG6-K
Red... OL-TG6-R



M2500 WSRBA SMART FOCUS VIDEO LIGHT

OLYMPUS

- Emission angle: 100°
- Color temperature: 5500K
- Total luminous flux/burn time:
 - Wide light: 2500lm (3 levels of brightness) @60min (SupportAuto Shut-off)
 - Red light: 200lm (3 levels of brightness) @250min. (SupportAuto Shut-off)
- Blue Light: 6W @120min
- Battery level indication
- Control methods: 2 x push buttons
- Power supply: Rechargeable Li-ion battery, 3.7V 5000mAh
- Depth rated: 100m, IPX8 (JIS protection class 8)
- 1 x Li-ion battery, 1 x USB charger, 1 x YS adapter, 2 x spare o-rings



OL-M2500

YS-D2J STROBE

- Guide number (ISO 100/m) (land) : 32, 24 (with diffuser 100 attached), 20 (with diffuser 120 attached)
- Beam angle : 80°x80° (without diffuser), 100°x100°(diffuser 100), 120° x 120° (diffuser 120)
- Batteries : 4xAA A: 6V Ni-MH: 4.8V
- Number of Flashes *1 : A: 150 Ni-MH: 200
- Recycle time (full) *2 : A: 3.0 sec. Ni-MH: 1.5 sec
- Color temperature : 5600K
- Color temperature w/diffuser : 5250K
- Depth rating : 100m / 330ft
- Weight : 618g / 21.0oz (w/o batteries) (excluding YS-base)
- Underwater weight : Approx.+40g / 1.4oz (incl. batteries)
- DS-TTL II function
- Slave function
- Auto power OFF function
- Sync cord: 5-pin Sync cord/N, Fiber-Optic Cable
- Over-pressure relief valve
- LED target light (output is adjustable in 2 steps)
- Audible charge signal



OL-YSD2J

UFL-3 UNDERWATER STROBE

- Depth rating: 246' / 75m
- Guide number: 22 m / 72' at ISO 100 when used above water at full power
- Effective flash range: not specified by manufacturer
- Angle of coverage: above water: equivalent to that of a 24mm lens (35 mm format)
- Color temperature: 5400K
- Connectivity: PTCB-E02 fiber-optic cable (not included)
- Flash Modes: TTL, Slave & Manual: 10 steps
- Mounting: YS mount (bolt included)
- Recycle time: approx. 2.0 sec
- Power source: 4 AA alkaline, NiMH, lithium, or oxy nickel hydroxide (Oxyride) batteries (not included)
- Dimensions: 2.7 x 4.3 x 5.2" / 6.9 x 10.9 x 13.2cm
- Weight: 1.0lb / 0.45kg



OL-UFL3

WIDE ANGLE WET LENS

- Description: 0.50X underwater wide angle conversion wet lens
- Lens Coating: all glass lens elements with multi-layers AR coating
- Front PC dome lens with hard coating
- Field of view (diagonal): underwater 120°(with 25mm lens)
- Magnification: 0.50X (on land / underwater)
- Mount system: M52 thread
- Bezel / body material: ABS / hard anodized aluminum alloy
- Weight: 591g (on land) / 200g (underwater)
- Dimensions: 121.8mm (D) X76mm (H)
- Standard accessories
- Neoprene dome cover, rear cap, lens secure line (LSL-03)



OL-UWL400A

SEA TOUCH 2 PRO

OLYMPUS

NEW

- Underwater touch screen
- Underwater touch screen focus
- Access to all apps underwater
- Wireless charge
- Waterproof 80m
- Button free design
- Pressure balance
- Interchangeable lens
- Waterproof pretest system
- IPX8 Standard
- Touch screen life 100,000 times
- Weight 290g
- Applicable model iphone 6s / 7 / 8 / 6s+ / 7+ / 8+ / X / XR / XS / XS MAX

OL-ST2PRO80

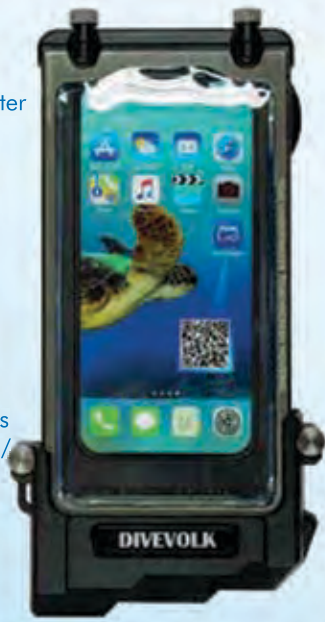

SEATOUCH 2 PIONEER

OLYMPUS

NEW

- Underwater touch screen
- Underwater touch screen focus
- Access to all apps underwater
- Wireless Charge
- Waterproof 10m
- Button free design
- Pressure balance
- IPX8 Standard
- Touch screen life 100,000 times
- Weight 290g
- Applicable model iphone 6s+ / 7+ / 8+ / X / XR / XS / XS MAX

OL-ST2PIO10



OLYMPUS

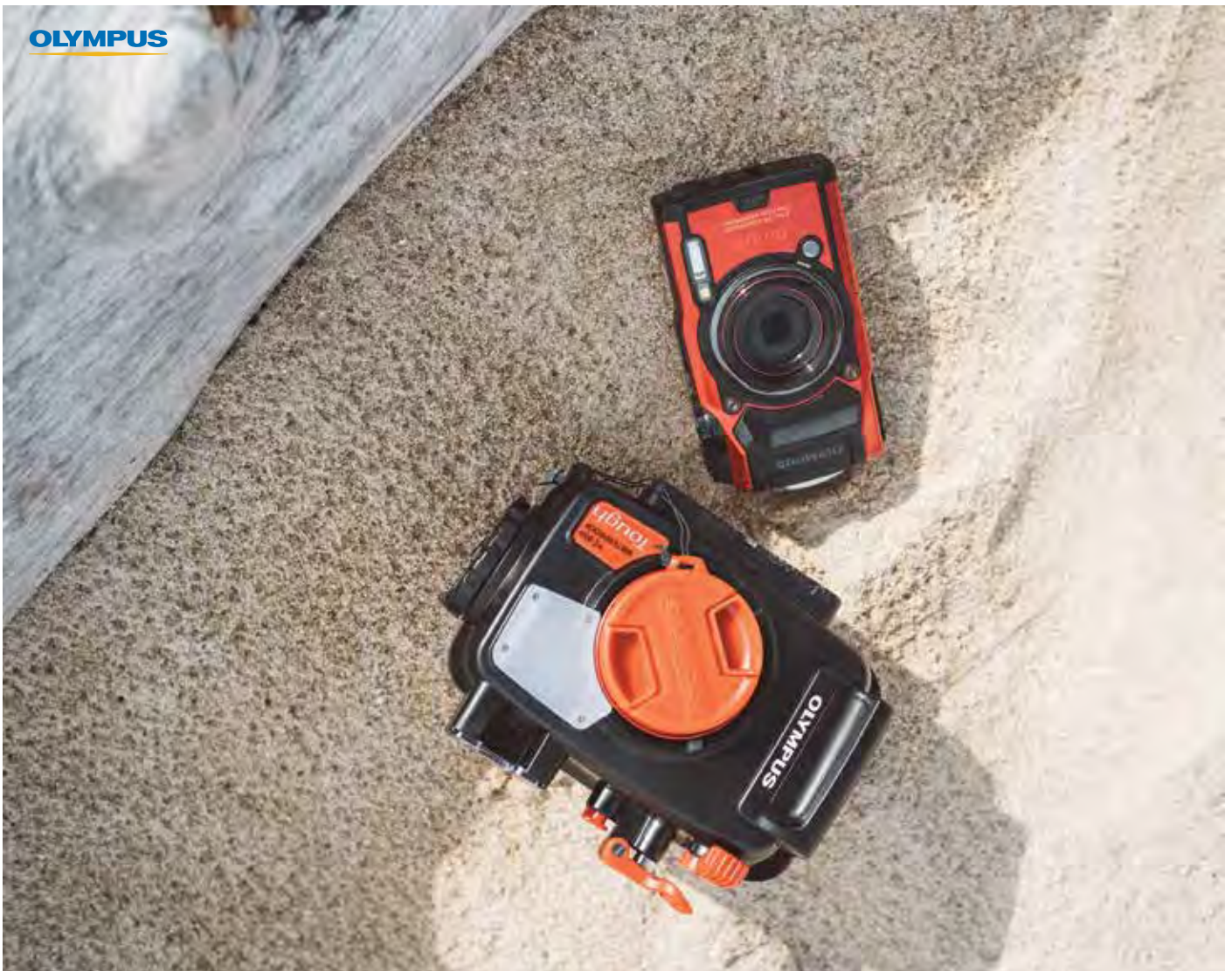

ACCESSORIES FOR OLYMPUS CAMERA

OLYMPUS

NEW



OL-L12



OL-L09

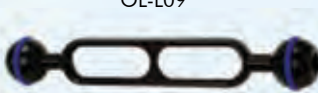

OL-L06



OL-TR03



OL-MACRO



OL-WIDE



OL-L192B



OL-CHARGER

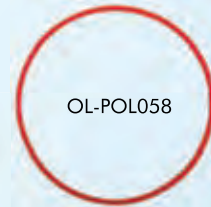

OL-POL058



OL-QRS



OL-RED-HI /
OL-RED-STD



OL-CL01



OL-UC92



OL-Shoe



OL-5012B



OL-ADAP37



OL-FCA01

- O-ring TG5/TG6... OL-POL058
- Spare Battery... OL-L192B
- Handle Tray Set... OL-TR03
- Shoe Base Ball... OL-Shoe
- Double Ball Arm 6"... OL-L06
- Double Ball Arm 9"... OL-L09
- Double Ball Arm 12"... OL-L12
- Aluminium Clamp (Black)... OL-CL01
- Fiber Optic Cable Adap. for TG... OL-FCA01
- Quick Release System for AO1 UWL-400a... OL-QRS
- Lithium-Ion Battery Charger for LI-92B (Fast: 5 Hrs)... OL-UC92
- Fibre Optic Cable II/M (Length 453mm/17.8 inch)... OL-5012B
- Wide Angle Lens Set, 105 degree, for SeaTouch PRO... OL-WIDE
- Macro Lens Set, stackable, for SeaTouch PRO... OL-MACRO
- Adapter for ST PRO 37cm... OL-ADAP37
- SeaLens™ High End Red Filter for ST2... OL-RED-HI
- SeaLens™ Filter Red for ST2... OL-RED-STD
- SeaCharge™ Wireless Charging - Water Repellent... OL-CHARGER

ACCESSORIES FOR CAMERA

INTOVA



MSSP1-HELM



MSSFMG01



MSSP1-HBM



MSSTKR



MSSP1-INTPOD



MSSCCK



MSSP1-CS

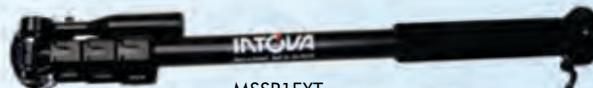

MSSP1EXT



MSSTMA



MSSP1-CHS

- Chest Strap... MSSP1-CS
- Intova Pod... MSSP1-INTPOD
- Helmet Mount... MSSP1-HELM
- Bar / Pole Mount... MSSP1-HBM
- Camera Hand Strap... MSSP1-CHS
- Tripod Mount Adapter... MSSTMA
- Floating Multi Grip... MSSFMG01
- Silica Sticker 5 pack... MSSTKR
- Camera Care Kit... MSSCCK
- Extension Pole... MSSP1EXT

ACCESSORIES FOR NAUTICAM CAMERA



ONAU.72204



ONAU.72205



ONAU.72503



ONAU.72505



ONAU.72501



ONAU.25411



ONAU.25412



ONAU.25321



ONAU.25311



ONAU.72301



ONAU.25322



ONAU.25312



ONAU.71311



ONAU.25016



ONAU.71207



ONAU.71206

- Easitray II with left handle (with 2pcs 1/4" screws)... ONAU.71206
- Flexitray II with left handle (with 2pcs 1/4" screws)... ONAU.71207
- Adjustable right handle II (for Easitray II & Flexitray II)... ONAU.71208
- Strobe mounting ball for Easitray & Flexitray... ONAU.71311
- 200mm double ball arm... ONAU.72204
- 300mm double ball arm... ONAU.72205
- 50mm single ball arm... ONAU.72301
- Standard clamp... ONAU.72501
- Long standard clamp... ONAU.72503
- Triple Clamp... ONAU.72505
- Strobe mounting ball for cold shoe... ONAU.25311
- Light mounting stem for cold shoe... ONAU.25312
- 18cm lanyard with 2 snap hooks... ONAU.25411
- 23cm lanyard with 2 snap hooks... ONAU.25412
- Long light mounting stem for cold shoe... ONAU.25322
- Long strobe mounting ball for cold shoe... ONAU.25321
- Nauticam lubricant (Christo Lube)... ONAU.25016



GEAR BAG



- Add your custom logo
- Oversize gearbag, 70 x 35 x 35cm (~ 90L)
- Colours: Black, Blue & Red



Blue... DB8020-B
Black... DB8020-K
Red... DB8020-R

GEAR BAG



- Add your custom logo
- Large gearbag, 70 x 30 x 30cm (~ 65L)
- Colours: Black, Blue & Red



Blue... DB8010-B
Black... DB8010-K
Red... DB8010-R

MESH GEAR BAG



- Nylon mesh gear bag
- Lightweight & tough
- Length 63cm



DBBL3176

REGULATOR BAG



- Designed for optimum protection of your regulator
- 8.5L capacity size 32 x 32 x 10cm



DB8001

SNORKELING BAG



- Lightweight & convenient for mask, snorkel & fins 75 x 25cm
- Colours: Black & Blue



Blue... DB8040-B
Black... DB8040-K



WATERPROOF POUCH



- Perfect to store your documents & course materials
- Add your custom logo
- Size: 38 x 30cm



Normal Print... DB8044
Custom Logo... DB8044-C

MESH BAG



- DB8065: fits mask & snorkel 48 x 20cm with shoulder strap, colours: Blue & Yellow
- DB8066: fits mask, snorkel & fins 70 x 30cm with shoulder strap, colour: Blue



Blue 48x20cm... DB8065-B
Yellow 48x20cm... DB8065-Y
Blue 70x30cm... DB8066-B



ADVENTURE DRY PACK



- Super heavy duty waterproof fabric
- 100% waterproof RF-welded seams
- Perfect for all outdoor activities
- Folding locking system
- Shoulder strap included
- Protects contents from water, sand, dust & dirt
- Not suitable for full submersion



	1.5L	3L	5L	10L	15L	20L	30L	40L
Blue	DBBA02-B	DBBA03-B	DBBA05-B	DBBA10-B	DBBA15-B	DBBA20-B	DBBA30-B	DBBA40-B
Black	DBBA02-K	DBBA03-K	DBBA05-K	DBBA10-K	DBBA15-K	DBBA20-K	DBBA30-K	DBBA40-K
Red	DBBA02-R	DBBA03-R	DBBA05-R	DBBA10-R	DBBA15-R	DBBA20-R	DBBA30-R	DBBA40-R
Yellow	DBBA02-Y	DBBA03-Y	DBBA05-Y	DBBA10-Y	DBBA15-Y	DBBA20-Y	DBBA30-Y	DBBA40-Y
Sky Blue	DBBA02-BL	DBBA03-BL	DBBA05-BL	DBBA10-BL	DBBA15-BL	-	-	-
Citrus	DBBA02-Ci	DBBA03-Ci	DBBA05-Ci	DBBA10-Ci	DBBA15-Ci	-	-	-
Orange	DBBA02-O	DBBA03-O	DBBA05-O	DBBA10-O	DBBA15-O	-	-	-
Pink	DBBA02-Pi	DBBA03-Pi	DBBA05-Pi	DBBA10-Pi	DBBA15-Pi	-	-	-
Purple	DBBA02-Pu	DBBA03-Pu	DBBA05-Pu	DBBA10-Pu	-	-	-	-

For Custom Print

	5L	10L	15L
Blue	DBBV05-B	DBBV10-B	DBBV15-B
Sky Blue	DBBV05-BL	DBBV10-BL	DBBV15-BL
Citrus	DBBV05-Ci	DBBV10-Ci	DBBV15-Ci
Black	DBBV05-K	DBBV10-K	DBBV15-K
Orange	DBBV05-O	DBBV10-O	DBBV15-O
Pink	DBBV05-Pi	DBBV10-Pi	DBBV15-Pi
Red	DBBV05-R	DBBV10-R	DBBV15-R
Yellow	DBBV05-Y	DBBV10-Y	DBBV15-Y
Purple	DBBV05-Pu	DBBV10-Pu	-



ADVENTURE DRY PACK



Destination Bag

- PHUKET
- PHI PHI
- KRABI
- KOH LIPE



	Krabi		Lipe	
	5L	10L	5L	10L
Sky Blue	DBBC05Kr-BL	DBBC10Kr-BL	DBBC05Li-BL	-
Citrus	DBBC05Kr-Ci	DBBC10Kr-Ci	DBBC05Li-Ci	DBBC10Li-Ci
Orange	DBBC05Kr-O	DBBC10Kr-O	DBBC05Li-O	DBBC10Li-O
Yellow	DBBC05Kr-Y	DBBC10Kr-Y	DBBC05Li-Y	DBBC10Li-Y

	Phuket		Phi Phi
	5L	10L	5L
Sky Blue	DBBC05Ph-BL	DBBC10Ph-BL	-
Citrus	DBBC05Ph-Ci	DBBC10Ph-Ci	-
Orange	DBBC05Ph-O	DBBC10Ph-O	-
Yellow	DBBC05Ph-Y	DBBC10Ph-Y	-

ADVENTURE DRY POUCH

- Perfect for all outdoor activities
- Waterproof ultra light 210T polyester w. clear window
- Durable, wipe clean & easy to store away
- Folding locking system
- Shoulder strap included
- Protects contents from water, sand, dust & dirt
- Not suitable for full submersion



DBBA01-O



ADVENTURE BACK PACK

- Super heavy duty waterproof fabric
- 100% waterproof RF-welded seams
- Additional outside pocket w. waterproof zipper
- Folding locking system
- Comfortable shoulder straps
- Sternum strap
- Air-Net padded backpack
- Protects contents from water, sand, dust & dirt
- Not suitable for full submersion

- Blue... DBBACK1-B
- Sky Blue... DBBACK1-BL
- Citrus... DBBACK1-Ci
- Black... DBBACK1-K
- Yellow... DBBACK1-Y



WATERPROOF BAG for CAMERA / PHONE



- 100% waterproof bag
- Fits most pocket size cameras
- Vision panel to allow clear photographs or video
- Protects contents from water, sand, dust & dirt
- Adjustable nylon lanyard included
- Protected against water submersion (IPX-8)
- Sizes: Large



DBNCA-L

WATERPROOF EARPHONES

- The 3.5mm stereo jack provides compatibility with most smart phones & music players
- 100% waterproof to 3m (10ft)
- On/Off switch for clarity when using a telephone
- Excellent sound quality in & out of water



w. Microphone... DBNEARP



w/o Microphone... DBNEARP2



REGULATOR BAG w. INSTRUMENT BAG

- Constructed from a combination of 420D Nylon NT & 450D Rip-stop
- The interior lining is 150D Polyester
- Internal Velcro straps secure a coiled regulator or console with hoses
- Double slider zipper
- Padded handle & shoulder strap
- Transparent zippered pouch inside
- Regulator Bag dimensions: 35 x 26 x 10cm, Weight: 0.35kg
- Instrument Bag dimensions: 11.5 x 7 x 15cm, Weight: 0.1kg



X53.309.000



TRAVEL REGULATOR BAG VINTAGE

- Constructed of 500D water-resistant tarpaulin with a lined interior to hold all the essentials
- Dimensions: 32 x 32 x 10cm, Weight: 0.8kg



X53.309.100



DIVE'N ROLL BAG LITE



- Two in one concept, rigid case + detachable backpack
- Exterior material combination of 420D Nylon NT, 450D Ripstop & 600D Polyester/PU
- Inside lining 150D Polyester/PU
- Coil double slider zippers
- Telescopic handle & reinforced saltwater resistant wheels
- 1 main rigid case + 1 detachable backpack
- Dimensions: 66 x 40 x 32cm, Weight: 3.98kg, Volume 84L



REMOVABLE BACKPACK INCLUDED

X53.360.170

PORTER BAG



- Foldable rolling backpack bag with large volume
- Exterior material combination of 420D Nylon NT, 450D Ripstop & 600D Polyester/PU/Inside lining 150D Polyester/PU
- YKK salt water resistant double slider zippers
- Top handle & backpack system with reinforced in-line "off road" style skate wheels
- 3 pockets (1 front & 2 inside)
- Dimensions: 85 x 57 x 36cm Weight: 2.65kg, Volume 174L



FOLDED

X53.310.120

CARAVAN BAG



- Ideal travel bag with large volume
- Exterior material combination of 420D Nylon NT, 450D Ripstop & 600D Polyester/PU
- Inside lining 150D Polyester/PU
- YKK salt water resistant double slider zippers
- Polyester thread
- External compression straps, retractable double bar trolley handle, side, top & bottom carry handles & reinforced saltwater resistant wheels
- Main compartment with U-shaped top, 2 sides + 1 top flat pockets
- Dimensions: 70 x 40 x 35cm Weight: 3.9kg, Volume 98L



X53.350.120

MESH SACK



- Bag opening secures with a top rope fitted with a sliding, spring-loaded button closure
- Main compartment handles the larger-sized gear while the front exterior pocket is perfect for small items
- Padded shoulder strap makes it easy to sling the bag for the hike down to the boat or beach
- Folds into a compact size for storage
- Dimensions: 66 x 39cm diameter Weight: 0.5kg, Volume 80L



X53.369.000

CARRY-ON FOLDABLE BAG

- 120D Nylon
- 600D Polyester Straps
- Designed to fit/slide on top cabin bag handle
- Great reusable shopping bag too

X53.338.190



DRY BAG w. BACKPACK STRAP

- Made of 500D heavy-duty PVC Tarpaulin
- Watertight due to heat sealed construction
- Padded backpack system equals convenient, hands-free carrying
- Roll-and-close opening makes for easy access to contents
- Dimensions: 50 x 30 x 20cm, Weight: 0.97kg, Volume 30L
- Dimensions: 76 x 33 x 20cm, Weight: 0.61kg, Volume 45L



45L... X53.399.180

30L... X53.399.000

MESH BAG

- Made of nylon mesh
- Top loading with U-shaped zipper
- Saltwater-resistant YKK vision zipper features double sliders
- Padded carry handles
- Dimensions: 70 x 40 x 30cm
Weight: 0.45kg
Volume 84L



X53.379.000

CABIN BAG 4 WHEELS

- Made of 500D heavy-duty PVC Tarpaulin
- Retractable double bar trolley handle with reinforced in-line skate wheels, side & top carry handles
- Large main compartment with U-shaped double-slide coil zipper
- Smaller pockets on the inside & outside
- Conforms to new IATA size regulations
- Side & top carry handles make easy work of lifting the bag into overhead compartments
- Dimensions: 53 x 37 x 19cm, Weight: 3.18kg, Volume 37L



X53.365.170

DUFFLE BAG HD

- Made of a durable yet lightweight combination of 420D nylon NT, 450D Ripstop and 600D polyester with polyester thread stitching
- Inside lining is made of 150D polyester/PU
- Ultra-soft construction makes it super easy to fold and store when not being used
- Main zippers are YKK saltwater resistant and feature double sliders for easy access
- Padded carry handle lets you conveniently tote or lift the bag over uneven terrain
- Dimensions: 80 x 40 x 35cm
Weight: 900g
Volume: 112L



X53.339.190



MICRO CASE

- N1010: 11.1 x 7.3 x 4.3cm
- N1020: 13.5 x 9.0 x 4.3cm
- N1030: 16.2 x 6.7 x 5.2cm
- N1040: 16.5 x 9.8 x 4.4cm
- N1050: 16.0 x 9.3 x 7.0cm



N1040

N1050



	N1010	N1020	N1030	N1040	N1050
Blue	N1010-B	N1020-B	N1030-B	-	-
Black	N1010-K	N1020-K	-	N1040-K	N1050-K
Red	-	N1020-R	N1030-R	N1040-R	N1050-R
Yellow	N1010-Y	-	N1030-Y	N1040-Y	-

THE PELICAN UNCONDITIONAL
LIFETIME GUARANTEE

CASE 1120

- Interior: 18.5 x 12.1 x 8.5cm
- Exterior: 21.4 x 17.2 x 9.8cm
- Colour: Black



N1120

CASE 1150

- Interior: 21.1 x 14.7 x 9.5cm
- Exterior: 24 x 19.8 x 10.9cm
- Colour: Black



N1150

CASE 1170

- Interior: 26.8 x 15.3 x 8cm
- Exterior: 29.6 x 21.2 x 9.6cm
- Colours: Black, Green, Orange, Yellow, Silver



N1170

CASE 1200

- Interior: 23.5 x 18.1 x 10.5cm
- Exterior: 27 x 24.6 x 12.4cm
- Colour: Black



N1200

CASE 1300

- Interior: 23.3 x 17.8 x 15.5cm
- Exterior: 27 x 24.6 x 17.4cm
- Colour: Black



N1300

CASE 1400

- Interior: 30 x 22.5 x 13.2cm
- Exterior: 34 x 29.5 x 15.2cm
- Colour: Black



N1400

CASE 1450

- Interior: 37.2 x 26 x 15.5cm
- Exterior: 41.8 x 33 x 17.3cm
- Colour: Black



N1450

LAPTOP CASE

- Interior: 45.1 x 28.9 x 10.5cm
- Exterior: 50.5 x 35.4 x 11.9cm
- Colour: Black



N1490CC#2

CASE 1500

- Interior: 42.5 x 28.4 x 15.5cm
- Exterior: 47 x 35.7 x 17.6cm
- Colour: Black



N1500

CASE 1510

- Interior: 50.2 x 27.9 x 19.3cm
- Exterior: 55.9 x 35.1 x 22.9cm
- Colours: Black, Tan



N1510

CASE 1520

- Interior: 45.9 x 32.7 x 17.1cm
- Exterior: 50.2 x 40.1 x 18.8cm
- Colour: Black



N1520

CASE 1550

- Interior: 47.3 x 36 x 19.6cm
- Exterior: 52.5 x 43.7 x 21.3cm
- Colour: Black



N1550

CASE 1560

- Interior: 50.6 x 38 x 22.9cm
- Exterior: 56.1 x 45.5 x 26.5cm
- Colour: Black



N1560

CASE 1600

- Interior: 54.6 x 42 x 20.3cm
- Exterior: 62 x 49.2 x 22.3cm
- Colour: Black



N1600

CASE 1610

- Interior: 55.3 x 42.4 x 27cm
- Exterior: 63.1 x 50 x 30.2cm
- Colour: Black



N1610

CASE 1620



- Interior: 54.6 x 41.7 x 31.9cm
- Exterior: 62.9 x 49.7 x 35.3cm
- Colour: Black



N1620

CASE 1650



- Interior: 72.6 x 44.5 x 27.1cm
- Exterior: 80.2 x 52 x 31.6cm
- Colour: Black



N1650

CASE 1660



- Interior: 71.6 x 49.9 x 44.8cm
- Exterior: 80.2 x 58.4 x 49.5cm
- Colour: Black

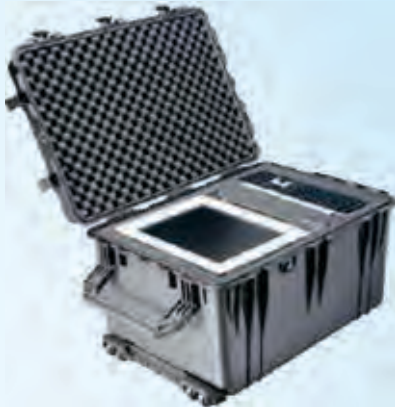

N1660

CABLE PADLOCK

- Fits all Pelican cases
- TSA approved
- No key required; choose from 999 combinations



N1506TSA



STORM LED LIGHT

1,050 Lumens



- Aviation aluminum body
- Battery type: 1 x 18650 lithium battery (included)
- Charger for 18650 (included)
- Waterproof to 150m (500ft)
- Drop resistant 1.5m
- Burn time 2 hrs
- LED Cree XM-L2
- Tempered glass
- Rotary switch



DBBRDIV05

LED STROBE LIGHT



- Waterproof: 60m (200ft)
- Battery: 3 x AA (not included)
- Strobe burn time: 72+ hours
- Flash Rate: 36~40 times per minute
- Dimensions: (L x Dia.) 12cm x 5cm



SAL15A

TORNADO LED LIGHT

1,050 Lumens



- Battery type: 1 x 18650 lithium battery (included)
- Charger for 18650 (included)
- Battery indicator: Green 100-30%, Red 30-10%, Flashing Red > 10%
- Waterproof to 100m (330ft)
- Burn time Full 2 hrs, Low 5 hrs
- Drop resistant 1.5m
- Aviation aluminum body
- LED Cree XM-L2
- Push switch
- Tempered glass



DBBRDIV12S

LED FLASHING LIGHT



- Automatically turns on in water
- Diameter 2.54 x 4.3cm
- Bright flashing LED
- Depth: approx. 60m (200ft)
- Life rating: 300hrs
- Led colour: Green



SAL-73

UNDERWATER KINETICS BEACON CYALUME LIGHT



- Length 22.86cm (9")
- Battery: 2 x AAA (included)
- Electric cyalume light, with backup glow in the dark plastic head and lanyard strap

TDL27



LED LIGHT



- High intensity
- 150 lumens
- Burn time 2.5 hrs
- Battery 2 x AA (not included)
- Waterproof to 60m (200ft)
- Easy to grip housing
- Simple rotary switch
- Bulb: CREE XPE-R5 LED
- Dimension: 16cm
- Lanyard (included)
- Available in yellow



SAL02-FY

RECHARGEABLE BATTERY & CHARGER



Rech Battery 18650 Li-ion... M18650BAT
Charger for Battery 18650 Li-ion... M18650CHR



FUSION 1500

1500 Lumens

TOVATEC

NEW

- 1500 lumens of maximum power
- 180 minutes of autonomy at 100%
- Lit in 3 positions 100%, 50%, 30% and SOS
- Submersible up to 100m
- Measures 190mm x 40mm (48mm head)
- Weight: 490 grams without batteries
- Battery 26650 of 4500mAh (included)
- Supports tye 32650 battery (not included)
- Can work with three AA batteries
- USB and 220v charger



MSSFUS1500

COMPACT TORCH

285 Lumens

TOVATEC

NEW

- Battery: 3 x AAA (not included)
- Burn time: 3hrs
- Variable Power: Full / 30% / strobe
- Depth rating 328ft / 100m
- Multi function magnetic side switch



MSSICOM-II

FUSION 1050

1050 Lumens

TOVATEC

NEW

- 1050 lumens of maximum power
- 150 minutes of autonomy at 100%
- Lit in 3 positions 100%, 50%, 30% and SOS
- Submersible up to 100m
- Measures 173mm x 31mm (31mm head)
- Weight: 273 grams without batteries
- It can work with three AAA batteries
- USB charger
- Delivered with 18650 battery 2200mAh



MSSFUS1050

SEA SQUIRT TORCH

TOVATEC

- Battery: 4 x AAA (not included)
- Waterproof to 30m (100ft)
- Burn time: 6hrs
- 5 LED (1W), 25 lumens



MSSTORCH-HL1

BATTERIES



Intova CR123 Lith. Battery 3V... MSSIT123
 Energizer MAX AA (4Pack)... MAA4
 Energizer MAX AAA (4Pack)... MAAA4
 CR2 Battery, Lithium... MCR2BAT

FUSION 260 LIGHT

260 Lumens

TOVATEC

- Beam angle: 12-100° Zoom beam angle
- Dimensions 13.7 x 2.8cm & weight 147g
- Switch slide with multi function operation
- Battery choices: rechargeable CR14500 Li-ion with circuit protection or 2 x AA
- Burn time 2hrs
- Waterproof to 100m (328ft)



MSSFUS260

MAKO KNIFE

TITANIUM / STAINLESS



- Features a conventional edge, line cutting notch, serrated edge for rope cutting, bottle opener & QR sheath with locking mechanism
- Titanium: extreme resistance to corrosion with durable edge
- Stainless Steel: excellent cutting edge & high resistance to rust
- Blade length: 8.5cm
- Overall length: 19cm



Stainless Steel



Titanium

Titanium... X32022
Stainless Steel... X32023

WHITETIP BCD KNIFE



- Compact stainless steel classic blade plus multi-use serrated edge
- Includes locking sheath & kit for BC/hose attachment
- Blade length: 6.6cm
- Overall length: 14.7cm



X32002

FOLDING KNIFE

BLACK SS BLADE



- Blade: 304 stainless steel with black electro-plating
- Blade length: 9.1cm
- Corrosion resistant & non-reflective black blade
- Sharp tip with half serrated edge & line cutter
- Adjustable wrist lanyard
- Compact, lightweight & perfect for carrying on all your diving trips
- Colours: Black, Blue, Green, Pink, Purple, Orange, Yellow



Blue... S3118-B
Green... S3118-G
Black... S3118-K
Orange... S3118-O
Pink... S3118-Pi
Purple... S3118-Pu
Yellow... S3118-Y



K6 KNIFE



- Classic 15.5cm stainless steel blade with hammer in handle
- QR locking sheath



X320061

MESH CUTTER



- Lanyard eyelet in handle for easy attachment
- Unique curved cutting edge design for pull cutting rather than push cutting, for better safety against accidents
- Contoured shackle spanner tool especially useful for boat divers
- Includes polyester case for safe storage & transport
- Overall length of cutter 7.5cm



X32065

SEA SNIP



- Cuts through line, net, rope, kelp & thin steel cable
- Works well in emergency situations where a knife might not
- New connector allows for mounting on BCD, weight belt or leg



SAS11N

TITANIUM / STAINLESS KNIFE

- Quality rubber strap with quick-release buckle
- Quick-release locking plastic sheath
- Blade length: 14cm



Stainless Steel

Titanium

Stainless Steel... S3006
Titanium... S3006T

STAINLESS DIVE KNIFE

- Mount to belt, BCD strap or BCD pocket
- Sharp tip with serrated edge plus line cutter
- Colours: Black, Blue, Yellow, Green & Clear
- Blade length: 8cm



Blue... S3007-B
Clear... S3007-C
Green... S3007-G
Black... S3007-K
Yellow... S3007-Y

FOLDING KNIFE

- Titanium: no rust, no magnetism, & no maintenance
- Stainless Steel: made of 301 S.S., no rust, durable knife blade
- Versatile lanyard included
- Foldable; easy to carry in sheath or pocket
- Blade length: 10cm
- Optional sheath available

Stainless Steel... S3008
Titanium... S3008T
Nylon Sheath... SAH12



Stainless Steel

Titanium

Sheath

STAINLESS KNIFE

- Sharp tip with serrated edge & line cutter
- Attaches permanently to BC or regulator hose
- Plastic sheath with hose mount included
- Blade length: 8cm



S3009

LINE CUTTER

- Includes extra blades



SAC03



GALAXY MINI FOLDING KNIFE

AQUATEC

"Big enough to slice an apple & small enough to store in a small pocket.

The serrated blade is made from surgical quality 420 stainless steel blade. It's tough enough to handle years of use & abuse.

- Material: 420 Stainless steel
- Over-all length: 95mm
- Blade length: 28mm
- Blade thickness: 2mm
- Weight: 21.5 gram



NEW

UKN100

RAPTOR KNIFE

AQUATEC

The AQUATEC Raptor Dive knife is perfect for diving. The advantages of this type of one-piece knife blade is its thin profile & less weight to make it more portable. The Raptor Scuba knife has an ergonomically shaped handle with a thin plastic insert to give the handle a very comfortable feel.

- Material: 304 Stainless steel
- Over-all length: 170mm
- Blade length: 80mm
- Blade thickness: 4mm
- Weight: 75 gram
- Standard accessories: Sheath, Hose clip, BC mount



NEW

UKN170

T-REX KNIFE

AQUATEC

- Material: 304 Stainless steel
- Over-all length: 200mm
- Handle length: 110mm
- Blade length: 90mm
- Blade thickness: 4mm
- Weight: 123 gram
- Standard accessories: Strap, Sheath, Hose clip, BC mount
- Straps: 1 x 470mm & 1 x 390mm



NEW

UKN200



SCUBAPRO

SOFT POCKET WEIGHT BELTS



3 Pockets... DB5000
4 Pockets... DB5001



DB5000

WEIGHT KEEPER

Plastic Weight Keeper... SAW03
Weightbelt Keeper, SS... SAW06
Weightbelt Keeper, SS... SAW07
Weightbelt Keeper w. D-Ring, SS... SS103
D-Ring for Weightbelt, SS... SS-928
Bent D-Ring for Weightbelt, SS... SS-929B



SAW03



SAW07



SAW06



SS103



SS-928



SS-929B

WEIGHTBELT WEBBING

Webbing Roll (50m), Blue... M1998B
Webbing Roll (50m), Yellow... M1998Y
Webbing Roll (50m), Black... M1998K
Webbing 1.4m, Blue... M1999-1.4B
Webbing 1.4m, Yellow... M1999-1.4Y
Webbing 1.4m, Black... M1999-1.4K
Webbing 1m, Blue... M1999-1B
Webbing 1m, Yellow... M1999-1Y
Webbing 1m, Black... M1999-1K



M1998



M1999



B Y K

WEIGHT BELT BUCKLES

Plastic Buckles, Yellow... S4001-Y
Plastic Buckles, Black... S4001-K
SS Buckle - 2 Slots... UBK304
SS Buckle - 3 Slots... UBK504



UBK 304



UBK504



Y K



S4001

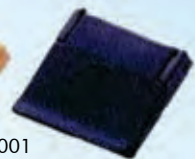

WEIGHT BELT & BUCKLE

Scubapro Weightbelt w. Stainless Buckle - Black... X23.029.100
Scubapro Weightbelt w. Nylon Buckle - Black... X23.030.100
Saekodive Weighbelt w. Buckle - Blue... SAW02-B
Saekodive Weighbelt w. Buckle - Yellow... SAW02-Y
Saekodive Weighbelt w. Buckle - Black... SAW02-K
Deep Blue Weighbelt w. Buckle 1.4m - Blue... M1999+Buc-B
Deep Blue Weighbelt w. Buckle 1.4m - Yellow... M1999+Buc-Y
Deep Blue Weighbelt w. Buckle 1.4m - Black... M1999+Buc-K
Seac Rubber Weightbelt w. Stainless Buckle... B1971
Seac Rubber Weightbelt w. Nylon Buckle... B198



SAW02



B Y K



X23.029.100



X23.030.100



B Y K



M1999+Buc



B198



B1971

STICKERS & TAPE



M99997



TDS07



M99998



M99999

Oxygen Sticker for Tank... M99997
O2 Clean Sticker... M99998
EAN Tank Sticker... M99999
Nitrox Valve Tape... TDS07

LEAD WEIGHTS

New round shape:

- Avoids equipment entanglement
- More ergonomic fit



M6000-S

M6000-B

0.8kg Lead... M6000-S
1.5kg Lead... M6000-B

SCUBA ALERT SIGNAL DEVICE

AQUATEC



UAH150-01

SCUBA HORN

Duo Alert Standard Fitting



AQUATEC

UAH380-01

UNDERWATER RATTLER



Blue... DB6700-B
Yellow... DB6700-Y
Red... DB6700-R
Black... DB6700-K



WHISTLE



High Pitch... SAW10
Standard... SAW11
Wind Storm - Yellow... TD611-Y
Wind Storm - Orange... TD611-O
Wind Storm - Black... TD611-K
SOS Whistle... TDA14
SOS Whistle Pink... DBYWH001-Pi
SOS Whistle Yellow... DBYWH001-Y

TANK ANTI SLIP PAD



UNS234

CAM LOCK BUCKLE

for Tank Strap



UCL201

TANK BOOTS

Rubber for LL63, LL80... SAT01
Rubber 18.4cm for 12L Steel Tank... SAT02
Rubber 20.3cm for 15L Steel Tank... SAT03
Plastic 17.5cm for LL50... TA56



TA56

SAT01

SAT02

SAT03

TANK BAND



X20.135.005

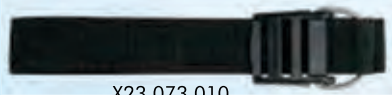

X23.073.010



UTB201

Scubapro Super Cinch Band... X20.135.005
Assy Super Cinch Plastic... X23.073.010
Aquatec Tank Band... UTB201

TANK MESH

Tank Mesh - Black... TA65-K
Tank Mesh - Yellow... TA65-Y



VALVE CAPS



LVC-K

SA05

TRP66



Rubber... SA05
Cupped - Blue... TRP66-B
Cupped - Yellow... TRP66-Y
Cupped - Green... TRP66-G
Cupped - Black... TRP66-K
Thermo Pro... LVC-K

TANK BANGER

Tank Banger - Pink... TTA20-Pi
 Tank Banger - Yellow... TTA20-Y
 Tank Banger - Green... TTA20-G
 Tank Banger - Black... TTA20-K

UW Pointer / Tank Banger... SAT-29
 UW Pointer Aluminium Gray... DBYP001-Gy
 UW Pointer Aluminium Pink... DBYP001-Pi
 UW Pointer Aluminium White... DBYP001-W
 UW Pointer Aluminium Yellow... DBYP001-Y



SAT-29



Gy Pi G Y

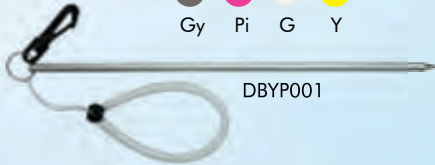

DBYP001



TTA20



Pi K G Y

SEAMATE INFLATABLE FLOAT SEAC

- 420D polyester
- 7 D-rings under the keel for towing, anchoring, or fixing supplementary equipment
- 2 Handles on the bow to be used during handling
- 3 Independent air chambers to guarantee maximum safety
 - 1 Alpha flag on the bow
- Dimensions: 85x60cm, Weight: 1.7kg



B37001

LIFT BAG SEAC

Lift Bag 100kg... B1900
 Lift Bag 200kg... B1910



INFLATABLE SURFACE / RESCUE FLOAT DEEP BLUE



DBYFB005

LIFE VEST



Government approved
 Adult (fits: S-XXL)



DBJ02



DBJ03

SNORKELING VEST



DBLSTRAP



DBL30

Junior - XS... DBL309-XS
 Junior - S... DBL309-S
 Adult - M... DBL302-M
 Adult - L... DBL302-L
 Adult - XL... DBL302-XL
 Adult - XXL... DBL302-XXL
 Crotch Strap XS-L... DBLSTRAP-A
 Crotch Strap XL-XXL... DBLSTRAP-B

POCKET RESCUE MARKER DEEP BLUE

- 152cm x 14cm (60" x 5.5")
- Signal Orange / Neon Yellow combo
- Durable 210 denier nylon
- Securely retained by an elastic bungy cord



DBSM01

RESCUE MARKER w. BAG DEEP BLUE

- 145cm(57") x 15.5cm (6")
- Signal Orange / Neon Yellow combo
- Durable 210 denier nylon fabric
- Webbing strap with marine grade stainless steel ring & snap hook
- Compact carry pouch for BCD attachment



Rescue Marker with Bag... DBSM02
Rescue Marker w/o Webbing... DBSM04

DBSM02

SAFETY BALLOON DEEP BLUE



DB6691



DB6690

Safety Balloon... DB6690
Safety Balloon with Bag... DB6691
Safety Balloon Bag... DB8004

SURVIVAL SAUSAGE SAEKODIVE



SB-06



SB-02

Survival Sausage with Pouch... SB-06
Survival Sausage... SB-02

MARKER BUOY SCUBAPRO



X40.312.001
X40.316.000

210D Nylon, 140x18cm... X40.312.001
210D Nylon, 180x18cm... X40.316.000

DIVE MARKER DEEP BLUE

- 180cm x 18cm (6ft)
- dump open end
- Available in Pink & Yellow



Yellow... DBYSMB1-FY
Pink... DBYSMB1-Pi

WEBBING STRAP DEEP BLUE

Webbing Strap for Rescue Marker, 5.5m



DBSM03

LIFT BAG TRIDENT



Lift Bag 35kg w. Dump Valve... TLS15
Lift Bag 75kg... TLS20

DIVER'S FLOAT DEEP BLUE



DBS30

SLATE

Slate w. Quick Connect 15x13cm... DBWR1
Slate A4... SAW13
Wrist Slate 3 Piece Multi Page... SAW15
Slate & Graphite Pencil... TSL-19-Y
Graphite Pencil... TSL-13-Y
Quest Magnetic Slate... TSL05



DBWR1



SAW13



TSL-19-Y



TSL-13-Y



SAW15



TSL05

LANYARD



TRP09

Lanyard... SAL21
Camera Lanyard with Brass Clip... TRP09
Deluxe Stretch Lanyard... TRP08



SAL21

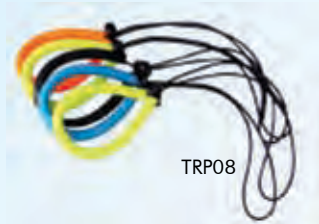

TRP08

RETRACTOR



SAR13A



SAR13C



SAR03A



SAR03C

Auto Lock Retractor 90cm... SAR03A
Retractor 3m... SAR03C
40cm SS Line - 2 Clips... SAR13A
40cm SS Line - Clip/Ring... SAR13C



COIL/NECKLACE



SAR07



SAR-0



SAR08



SAR09

Quick Release Coil Lanyard... SAR-0
Regulator Necklace - Black... SAR07-K
Regulator Necklace - Yellow... SAR07-Y
Quick Release Coil Lanyard - Black... SAR08-K
Quick Release Coil Lanyard - Blue... SAR08-B
Cable Wire Coil Lanyard... SAR09

EQUIPMENT CONNECTORS

Equipment Connector... SAC01A
Swivel Plastic Hook & Looped End... SAC01B
Octopus Holder - Black... SAC01D-K
Octopus Holder - Yellow... SAC01D-FY
Fin Holder... SAC01E



SAC01B

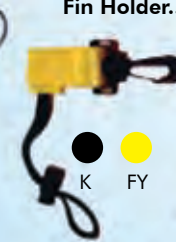

SAC01D



SAC01A



SAC01E

REEL

- Scubapro Multifunction Reel 80m... X40.122.000
- Wreck Reel Auto Stop 85m... SAR05
- Wreck Reel Auto Stop 45m... SAR15
- Wreck Reel 45m... SAR14
- Finger Reel 45m, black reel - white line... SAR06
- Finger Reel 45m, orange reel - yellow line... SAR06-O/Y
- Finger Reel 45m, yellow reel - orange line... SAR06-Y/O
- Finger Reel 30m, black reel - white line... SAR16
- Finger Reel 30m, orange reel - yellow line... SAR16-O/Y
- Finger Reel 30m, yellow reel - orange line... SAR16-Y/O
- Finger Reel 30m, Stainless reel - orange line... SAR16S-O
- Finger Reel 30m, Stainless reel - yellow line... SAR16S-Y
- Finger Reel 15m, black reel - white line... SAR26
- Finger Reel 15m, orange reel - yellow line... SAR26-O/Y
- Finger Reel 15m, yellow reel - orange line... SAR26-Y/O
- Finger Reel 15m, Stainless reel - orange line... SAR26S-O
- Finger Reel 15m, Stainless reel - yellow line... SAR26S-Y
- Finger Reel Alu, 15m, Blue... DBYAR01-B
- Finger Reel Alu, 15m, Pink... DBYAR01-Pi
- Finger Reel Alu, 15m, Red... DBYAR01-R
- Finger Reel Alu, 30m, Blue... DBYAR02-B
- Finger Reel Alu, 30m, Pink... DBYAR02-Pi
- Finger Reel Alu, 30m, Red... DBYAR02-R



X40.122.000



SAR05



SAR15



SAR14



SAR06

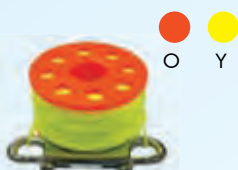

SAR06-

O Y



SAR16



SAR16-



SAR16S

O Y



SAR26



SAR26-



SAR26S

O Y



DBYAR01

B Pi R



DBYAR02

B Pi R

MASK BOX



DBS1

LOGBOOK



DBS9020



DBS9010



DBS9011

- Log Pages for All Standard Binders... DBS9020
- Divers Log Book 15cm x 12cm... DBS9010
- Divers Log Book 14.5cm x 20.5cm... DBS9011

FISH ID SLATE

- Fish Card - Fish & Nudibranchs... M21001
- Fish Card - Fish & Corals... M21002



M21001



M21002

LOGBINDER

- "DIVE LOG"... DB8005
- Add Your Custom Logo... DB8005-C
- "DIVE NOW..."... DB8006
- "BORN TO DIVE"... DB8007



SNORKEL HOLDER



S1060



DBZ08-K



DBZ20

Plastic, Black... DBZ08-K
 Plastic, Black... S1060
 Silicone, Clear... DBZ20-C
 Silicone, Black... DBZ20-K

MASK STRAP RETAINER



DBZ01-K



SHLT



X26.021.002

Mask Strap ... SHLT
 Mask Strap, Black... DBZ01-K
 Quick Clip... X26.021.002

BUCKLES

BS75106

BS75073

BS75076

BS75107

BS75074

BS75075

Male Buckle 25mm... BS75106
 Female Buckle 25mm... BS75107
 Male Buckle 40mm... BS75073
 Female Buckle 40mm... BS75074
 Male Buckle 50mm... BS75075
 Female Buckle 50mm... BS75076

MASK BUCKLES

Mask Buckle - Black... S083-K

Mask Buckle - Clear... S083-C

Buckle Set BORA+ - Black, Orange... DBZ06-QR

Bora+ Roller Pin for Mask Buckle... DBZ19

Buckle & Housing Set (Fiji Mask)... DBZ07

Buckle Set (Fiji Mask)... DBZ12-K

Buckle (Bali Mask)... DBZ15

Buckle (Covert Mask)... DBZ17

Buckle (Mako Mask) 1 pcs... DBZ16



S083



DBZ07



DBZ17



DBZ12-K



DBZ16



DBZ06-QR-O

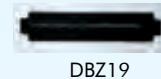

DBZ19



DBZ15



DBZ06-QR



MASK & GOGGLE STRAPS



X24.730.0x0



X24.700.0x0



S1072



S1073S

XZ24.845.102

XZ24.845.104



DBZ33

- Neoprene Cover 2.5mm Blk/Gry... X24.700.030
- Neoprene Cover 2.5mm Blk/Pur... X24.700.040
- Neoprene Cover 2.5mm Blk/Yel... X24.700.050
- Rubber - width 2cm... S1072
- Silicone - width 2cm... S1073S
- Black Silicone... S1074KS
- Clear Silicone... S1074S
- Clear Silicone, Spectra/Marin... XZ24.845.102
- Black Silicone, Spectra/Marin... XZ24.845.104
- 22mm Clear Silicone, BORA... DBZ33-C
- 22mm Black Silicone, BORA... DBZ33-KS
- Swimgoggle Black... S1079KS
- Swimgoggle Clear... S1079S



DB6689-1



DB6688-1



DB6689



DB6688



S1074



S1079

- Velcro Strap w. Print, Black/Blue... DB6688-1-KB
- Velcro Strap w. Print, Black/Black... DB6688-1-KK
- Velcro Strap w. Print, Black/Red... DB6688-1-KR
- Velcro Strap w. Print, Black/Yellow... DB6688-1-KY
- Velcro Strap w/o Print, Black/Blue... DB6688-KB
- Velcro Strap w/o Print, Black/Black... DB6688-KK
- Velcro Strap w/o Print, Black/Red... DB6688-KR
- Velcro Strap w/o Print, Black/Yellow... DB6688-KY
- Neoprene w. Print, Black/Blue... DB6689-1-KB
- Neoprene w. Print, Black/Black... DB6689-1-KK
- Neoprene w. Print, Black/Yellow... DB6689-1-KY
- Neoprene w/o Print, Black/Blue... DB6689-KB
- Neoprene w/o Print, Black/Black... DB6689-KK
- Neoprene w/o Print, Black/Yellow... DB6689-KY
- Comfort - B,K, K/K, K/Y, Pi/Pu, Tq... X24.730.0x0

FIN SPRING STRAPS



S1875



B730023 / B730024



S1775

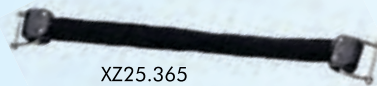

XZ25.365

- Sling Strap - Propulsion Fin, S/M... B730023
- Sling Strap - Propulsion Fin, M/L, L/XL... B730024
- Spring Strap w. Buck. S, Set... 1775-S
- Spring Strap w. Buck. M, Set... S1775-M
- Spring Strap w. Buck. L, Set... S1775-L
- Spring Strap size S (Set)... S1875-S
- Spring Strap size M (Set)... S1875-M
- Spring Strap size L (Set)... S1875-L
- Spring Strap size XL (Set)... S1875-XL
- Spring Heel Straps - Jet Fin M... XZ25.365.305
- Spring Heel Straps - Jet Fin L... XZ25.365.405
- Spring Heel Straps - Jet Fin XL... XZ25.365.505
- Spring Heel Straps-Jet Fin XXL... XZ25.365.605

FIN STRAPS / BUCKLES

- Strap Kit for Fin DBF770... DBF770KIT
- Fin Buckle for DBF770... DBF770BUCKLE
- Fin Strap for DBF770... DBF770STRAP
- Quick Release Fin Buckle... S271
- Propulsion Fin Buckle... BZ513
- Twin Jet Strap Kit... XZ25.071.005
- Twin Jet Max Strap Kit... XZ25.078.000
- 2 Buckles for Speed 3... DBZ52



BZ513



DBF770KIT



S271



XZ25.071.005

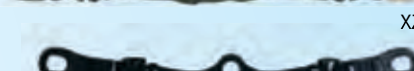

XZ25.078.000



DBZ52

FIN STRAPS

- Saekodive Fin Strap / 1 Piece... S1075
- Seac Sprint Fin Strap, XXS/S... BZ07001
- Seac Sprint Fin Strap, S/XL... BZ07002
- Saekodive Jet Fin Strap... SA004A



BZ07001-2



S1075



SA004A

BRASS CLIPS

- Brass Clip (S) 95mm... S4002-95
- Brass Clip (S) 88mm... S4003-88
- Brass Clip (L) 120mm... S4003-120
- Brass Clip (L) 120mm... S4002-120



S4002-95

S4003-88

S4003-120

S4002-120

KNIFE STRAP

- Quick Release Knife Strap...S1077-2
- Rubber Knife Strap...S1077
- Knife Strap with Spring...TKN02



S1077-2



S1077

TKN02

REEF HOOK



TDF82

DOUBLE ENDED SNAP HOOK

- Hook, 90mm...SS161-90
- Hook, 100mm...SS162-100
- Hook, 115mm...SS163-115



SS161-90

SS162-100

SS163-115

SWIVEL BOLT SNAP HOOK

- Hook, 92mm



SS225-92

EYEGGLASS HOLDER STRAP

- 1pc. - Blue... TDA93-1-B
- 1pc. - Green... TDA93-1-G
- 1pc. - Black... TDA93-1-K
- 1pc. - Yellow... TDA93-1-Y



NECK LATEX EYEWEAR STRAP

- 1pc. - Blue... TDA03-1-B
- 1pc. - Green... TDA03-1-G
- 1pc. - Blac/Grey... TDA03-1-K/Gr
- 1pc. - Orange... TDA03-1-O
- 1pc. - Pink... TDA03-1-P
- 6pc. - Yellow... TDA03-1-Y
- 6pc. - Blue... TDA03-6-B
- 6pc. - Green... TDA03-6-G
- 6pc. - Black... TDA03-6-K
- 6pc. - Orange... TDA03-6-O
- 6pc. - Pink... TDA03-6-P
- 6pc. - Yellow... TDA03-6-Y



TDA02-72

STAINLESS SNAP HOOK

- Stainless Steel Snap Hook... S2450-80
- Stainless Steel 60mm Hook... SS243-6
- Stainless Steel 80mm Hook... SS243-8



S2450-80

SS243-6

SS243-8

MOUTHPIECE HOLDER



SAM-050

ALUMINIUM SNAP HOOK

- Snap Hook 50mm...SAS-12DF-5
- Snap Hook 60mm...SAS-12DF-6
- Snap Hook 70mm...SAS-12DF-7
- Snap Hook 80mm...SAS-12DF-8



HOSE CLIP/CLAMP

- Ergonomic Swivel Hose Clip... SAH23
- Double Hose Clamp - Black... SAH01-K
- Double Hose Clamp - Yellow... SAH01-Y
- Triple Hose Clamp - Blue... SAH09-B
- Triple Hose Clamp - Black... SAH09-K
- Triple Hose Clamp - Yellow... SAH09-Y
- Double Hose Clip - Green... UHH07-G
- Double Hose Clip - Black... UHH07-K
- Ergonomic Swivel Hose Clip, Pi... DBYPC001-Pi
- Ergonomic Swivel Hose Clip, W... DBYPC001-W
- Ergonomic Swivel Hose Clip, Y... DBYPC001-Y

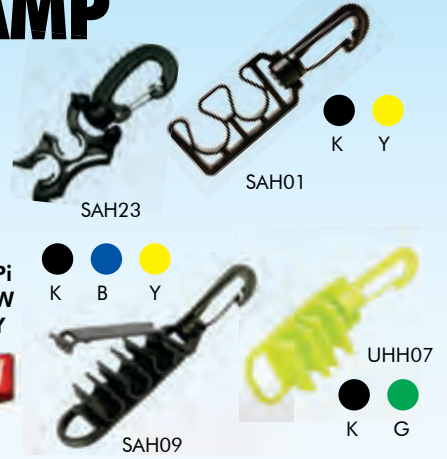

OCTOPUS HOLDER / RETAINER



- Octopus Holder - Green... SAM-02-G
- Octopus Holder - Yellow... SAM-02-Y
- Magnetic Octopus Holder... SAC06
- Non-Magnetic Octopus Holder... SAC06A
- Octopus Retainer... XZ01.097.134

GEAR HANGER

- Universal - Blue... SAH06-B
- Universal - Black... SAH06-K
- Universal - Yellow... SAH06-Y



POWER INFLATOR

- Scubapro Balanced Power Inflator... X21.610.000
- Seac Piston Power Inflator... B77454
- Seac Power Inflator... B75039
- Power Inflator... UPI201
- Compact Power Inflator... UPI208
- Inflator w/o Hose (fits Subgear)... SAK04PIN



TANK BACK PACK COMPLETE



VALVE DUST CAP



- DIN Protection Cap... BS2011
- Dust Cap DIN... XZ10.101.211
- Dust Cap INT... XZ10.101.212
- Rubber Cap... SAD01
- Plastic Cap... SAD02

REAR WEIGHT HOLDER



B769

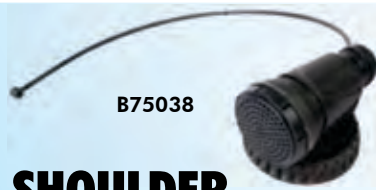

B75038

SHOULDER DUMP VALVE

SWIVEL

Seakodive Swivel - 360°... SAS-16
 Uwatec Swivel w. O-Rings... XZ06.203.548
 Suunto HP Swivel... F1000V5593
 HP Swivel Disc & O-Rings... DBT30019



XZ06.203.548

DBT30019

F1000V5593

SAS-16



DIN ADAPTOR

SAA08

WMDCH-DIN

SDY-1

SDY-3F#1

300BAR Din To Yoke... WMDCH-DIN
 DIN Adaptor Saekodive... SDY-1
 Yoke Screw for DIN Adaptor... SDY-3F#1
 Pin Index to DIN Adaptor... SAA08

DIN CONVERSION KIT



X10.045.030



RETAINER

SAK04-9

XZ21.626.102

Retainer... XZ21.626.102
 Nipple for Inflator... SAK04-9

SCHRADER VALVE



MA59

XZ21.562.106

Scubapro... XZ21.562.106
 For Most Inflators... MA59

REGULATOR ADAPTER / SWIVEL



WMDAB-05

WMDAB-07

WMDAB-12

WMDUA-8



WMDUA-1

WMDUA-4

WMDUA-7

WMDUA-16

WMDUA-23

WMDUA-9

LP 90° Adapter... WMDAB-05
 LP 110° Adapter... WMDAB-07
 9/16" M to 3/8" F... WMDUA-1
 3/8" M to 1/2" F... WMDUA-4
 1/2" M to 3/8" F... WMDUA-7
 LP Swivel 90°... WMDUA-8
 HP Splitter... WMDUA-9
 9/16" Y-Adapter FFxM... WMDAB-12
 HP Swivel 90°... WMDUA-16
 360° LP Adapter... WMDUA-23



XZ21.200.003

B55006

UOV1811

OVERPRESSURE VALVES

Seac... B55006
 Pull Ball... UOV1811
 Kit Overpressure Valve... XZ21.200.003



LOW PRESSURE HOSES



- Regulator hose 75cm... SAH-03-K-75
- Octopus hose 95cm, Black... SAH-03-K-95
- Octopus hose 95cm, Yellow... SAH-03-Y-95
- Regulator hose 210cm... SAH-03-K-210
- Regulator hose 150cm, Black... SAH-03-K-150
- LP inflator hose 65cm... SAH-04-K-65
- Scubapro hose 2nd Stage 65cm... XZ01.310.026
- Scubapro hose 2nd Stage 75cm... XZ01.309.035
- Scubapro octopus hose 100cm... XZ01.310.040
- LP inflator hose air 2, 64cm, Black... ULP350-02
- Adaptor, Inflator quick connector... XZ21.626.013
- Tire Inflator... SAT19
- Tire Inflator... SAT20



XZ21.626.013

HIGH PRESSURE HOSES

- Scubapro hose 80cm... X01.044.031
- Scubapro Hose Quick Connector... XZ01.334.005
- Hose (made in Italy) 31.5"/80cm, dia 10.8mm... DBT30016-01
- Hose (made in Italy) 6"/15cm, dia 12.5mm... DBT30017-01



XZ01.344.005

CORRUGATED HOSES

- Seac Corrugated Hose... B75020
- Scubapro 11", T-Series, Classic... X01.030.118
- Scubapro 14", Classic Plus/Sport... X01.030.113
- Scubapro 16", Classic Plus/Sport... X01.030.114



COMPLETE INFLATOR SYSTEM

B75040



HOSE PROTECTORS

- Plastic Wrap - Blue... SAH02-B
- Plastic Wrap - Yellow... SAH02-Y
- Plastic Wrap - Green... SAH02-G
- Scubapro- Black... XZ11.700.010
- Scubapro - Yellow... XZ11.700.030
- Scubapro - Green... XZ11.700.050
- Deep Blue - Black... M20070-07-K
- Deep Blue - Yellow... M20070-07-Y
- Hose Protector Black... S4004-K
- Hose Protector Blue... S4004-B
- Hose Protector Yellow... S4004-Y
- Hose Protector - Black... DBT30018

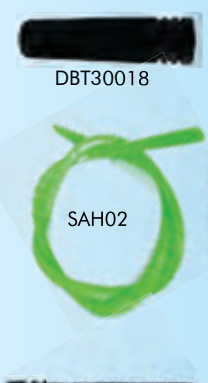

XZ11.700.0x0 S4004 M20070-07
 K G Y B G Y K Y

MOUTHPIECE & HOSE PROTECTOR

MP & Hose Protector Kit:

- Hydros Blue... XZ01.040.330
- Hydros Yellow... XZ01.040.360
- Hydros Pink... XZ01.040.370
- Hydros Orange... XZ01.040.390
- White... XZ01.040.080
- Purple... XZ01.040.019



Hose protector:

- Black... XZ11.700.010
- Purple... XZ11.700.019
- Yellow... XZ11.700.030
- Green... XZ11.700.050
- Hydros Blue... XZ11.700.223
- Hydros Yellow... XZ11.700.225
- Hydros Orange... XZ11.700.226
- Hydros Pink... XZ11.700.227



MOUTHPIECE

- Mouthpiece Black with dots... DBZ1463KS
- Mouthpiece Clear with dots... DBZ1463S
- Rubber Mouthpiece... S1063
- Silicone with bridge (Clear)... S1163S
- Silicone with bridge (Black)... S1163KS
- Small Silicone Mouthpiece... S1363S
- Long Bite Silicone (Clear)... S1563S
- Long Bite Silicone (Black)... S1563KS
- Silicone Black/Yellow... S1663KS-Y
- Silicone Black/Orange... S1663KS-O
- Reshapeable Mouthpiece - Black... S1763KS-K
- Reshapeable Mouthpiece - Clear... S1763S-C
- Moldable M'piece, Silicone-BT... S1863-BT
- Moldable M'piece, Silicone-Pt... S1863-Pt
- Moldable M'piece, Silicone-W... S1863-W
- Moldable M'piece, Silicone-YT... S1863-YT
- Mouthpiece Vinyl... XZ01.040.131
- Mouthpiece Black Silicone... XZ01.040.141
- Mouthpiece with Clip... XZ01.040.051
- Reusable Clip... XZ01.040.025
- Reusable Clip Light... XZ01.040.026
- Mouthpiece Air2 4th... XZ01.040.133
- Mouthpiece Escape... XZ01.040.705



SNORKEL MOUTHPIECE

- Mouthpiece for J Snorkel, Black... DBZ02-K
- Mouthpiece for J Snorkel, Clear... DBZ03-C
- Mouthpiece for Manta/Sharky, PVC Clear & Black... DBZ04
- Mouthpiece for Manta/Sharky, Clear Silicone... DBZ05-C
- Purge Valve Manta, Mako, Stingray... DBZ13
- Mouthpiece S1052 Silicone... S1052MS
- Mouthpiece S1052 PVC... S1052MP
- Mouthpiece S1052 Rubber... S1052MR
- Snorkel Valve for S1156S... S1055
- Silicone Mouthpiece for 1156... S1156MS
- PVC Mouthpiece for 1156... S1156MP
- Rubber Mouthpiece for 1156... S1156MR



RESCUE TAPE

- 1" Rescue Tape - Clear... TFA64-CL
- 1" Rescue Tape - Black... TFA64-K
- 1" Rescue Tape - Green... TFA64-G
- 1" Rescue Tape - Orange... TFA64-O
- 1" Rescue Tape - Red... TFA64-R



MARKER

- Brite Mark Paint - Black... TPA60-K
- Brite Mark Paint - Red... TPA60-R
- Brite Mark Paint - White... TPA60-W
- Brite Mark Paint - Yellow... TPA60-Y

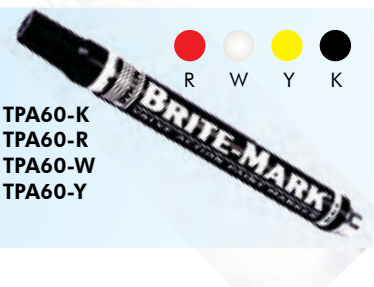

NEOPRENE GLUE

SAS12K



LUBRICANTS

- Silicone Grease 16oz... TSA66
- Silicone Grease 2oz... SAS01
- Nitrox Lube 1/4oz... TNT60
- Zipper Lube Stick... TLP25
- Silicone Pump 8oz... TLP27
- Christo Lube 2oz... TNT72
- Christo Lube, in preloaded Syringe... DBSY1
- Silicone Lube Container 1/20z... SAS03-1
- Valve Sil. & Sealant Container 20z... TNT79



LIQUIDS & CLEANERS



Mask Cleaner 1oz... TLP75
Ear Drops... TFA20

O-RING KIT

- Mini O-ring Kit 10pcs... TD601
- "Save a Dive" 40pcs + Silicone... TD602
- Mini Viton Kit 10pcs... TD603
- Viton O-ring Kit 20pcs... TD604



KEY RING STAINLESS

SAR-0-2



LITTLE ANNE

The Little Anne manikin is a realistic, inexpensive, lightweight, adult CPR trainer that offers all the essential features. Designed with both the user & instructor in mind. Includes 2 economical, disposable airways for quick & easy cleanup & 2 removable, reusable faces.



DA1016

DEFOG



Fog Off... TLP85
Mask Defog... TLP81
No Fog... TLP80
Defog 2oz... TLP81
Silicone Spray 2oz... TLP80
Fog off... TLP85

TANK KEY RING

- Tank Key Ring... SAD07
- Alu Tank w. Brass Pick & O-rings... SAD08



AIRWAY for LITTLE ANNIE

Disposable non-rebreathing airways with one-way valve should be changed after each class for maximum instructor convenience & student safety.



D020300

KEY RING CPR MASK

CPR pocket size resuscitator mask (S) with key ring



SAR20

VELCRO BAND



TDA69

CPR RESCUE MASK



SAR10

PORTABLE OXYGEN FIRST AID KIT

NEW

Includes:

- Oxygen 2 pin index regulator
- 3 litre oxygen tank
- Non rebreather mask
- 2 pin index fill adaptor



MO2FILL

MO2KIT-2

Oxygen First Aid Kit... MO2KIT-2
Pin-Index - CGA 540 Adaptor... MO2FILL

EMERGENCY OXYGEN FIELD KIT

Includes:

- 1 x Oxygen pressure reducer with 2 x demand valve connections, 1 x adjustable 0-25l/min constant flow connection with miniature pressure gauge
- 1 x Demand valve with connection hose LP
- 1 x Adaptor Oxygen Bull nose (CGA540) to DIN (G5/8)
- 1 x Adaptor PIN Index to DIN (G5/8)
- 1 x Pocket mask for demand valve & adaptor
- 1 x Constant flow mask with reservoir, LP hose & coupling
- 1 x transport bag



MO2KIT-1



MO2RegW

MO2Reg1

Oxygen Field Kit... MO2KIT-1
Oxygen Regulator, Pin-index, 0-25LPM... MO2Reg1
Brass/Viton Washer for Oxy Reg... MO2RegW

NON REBREATHER MASK

This disposable mask provides oxygen for breathing divers who cannot tolerate demand valve oxygen regulators or when you have 2 divers who need emergency oxygen.



DA1015

OXYGEN SENSOR for MAXO2[®] ANALYZER



MR125P01-011



MR125P03-004

for MaxO2[®]+A... MR125P01-011
for MaxO2[®]+AE... MR125P03-004

MAX O2 ACCESSORIES



MR218P19

MRP11P28

MR207P17

OX-SNSR

XA11.452

OxyKnob... MR218P19
BC Adapter Maxtec... MRP11P28
Barbed Adapter w. Tubing... MR207P17
OMS O2 Fuel Cell... OX-SNSR
Oxy Spy Sensor Only... XA11.452

MAXO2 + OXYGEN ANALYZER

- MaxO2[®]+A Oxygen Analyzer (incl. Sensor & OxyKnob)
- Comfortable handheld design
- Impact resistant & drip proof
- Large 3-digit LCD display
- Long battery life (approx. 5,000hrs)

MaxO2[®]+A Oxygen Analyzer (Internal Sensor)... MR217P42
MaxO2[®]+AE Oxygen Analyzer (External Sensor)... MR217P52



MR217P52



MR217P42

WORKSHOP TOOLS



Adjusting Tool 2nd Stage... SAP-0002A
 Intermediate Pressure Gauge... SAP-0001
 6mm Extension Drive... Msocket-6MM
 Cover Tool R395 / S600 / Air2... XZ43.403.000
 Covers tool C200, C300 Insert... XZ43.403.001
 HP-Seat Tool MK2... XZ43.300.210
 Flow Vane Tool - 2nd Stages... XZ43.300.225
 Scubapro Universal Tool... XZ43.040.000
 1st Stage Holding Tool... M51
 Plastic Syringe... XZ41.496.101
 Schrader Valve Tool... TSA58
 Yoke Nut Socket... XZ43.191.107
 O-ring Pick Plastic / Stainless Steel... XZ43.300.107

O-ring Pick Brass... XZ43.300.017
 O-Ring Tool Kit + Silicone... TDA79
 Nut Driver 1/4"... XZ43.300.002
 Nut driver 5.5mm... XZ43.300.003
 Tank Valve Knob Removal Tool... TSA99
 Divers Deluxe Tool Kit... TS105
 Multi Tools Stainless Steel with 12 Tools... S7402
 Multi Tools Stainless Steel with 9 Tools... S7407
 Hose Protector Installation Tool... TSA05
 Hose Protector Installation Tool... XZ43.018.000
 Torque Wrench 5 - 35N... XZ43.300.998
 Air Nozzle Rubber... SAA06
 Air Nozzle Stainless Steel... SAA01
 Stainless Multipurpose Tool... DBBRT00L

WORKSHOP TOOLS



V1117



SAP-0003A1



QN1315



QN4101



M2310



XZ43.404.001P



SAP-0003A



SAP0004A



WMDOW-03

NEW



TSA83



M99 / M97



NEW



WMDMT-610

- Oil Filled Pressure Gauge Stainless... V1117
- Gauge for HP Checker... SAP-0003A1
- Gauge Bauer 315bar... QN1315
- Gauge Bauer 400bar... QN4101
- Magnehelic Mouthpiece... XZ43.404.001P
- Analogue Guage 5-0-5" WC... M2310
- Tank Pressure Checker INT... SAP-0003A
- Tank pressure checker DIN 300bar... SAP0004A
- Cable Tie 3.5x150mm, Pack of 100pcs... M99
- Cable Tie 4.8x250mm, Pack of 100pcs... M97
- Cable Tie Installation Gun... TSA83

ULTRASONIC CLEANING DEVICE

- Ultrasonic frequency: 40,000 Hz
- Tank material: stainless steel SUS304
- Shell material: SUS304
- Tank capacity: 4.5 L
- Ultrasonic power: 180 W, 3 transducers
- Heating power: 200 W
- Tank size: 300 x 150 x 100 mm (L x W x H)



MJPO30

ULTRASONIC SOLUTION

- Mixing ratio 100g powder to 2L water
- Powder dissolves in water
- 500g or 1000g Container



- Ultrasonic Solution (500 gram)... TSA65-500
- Ultrasonic Solution (1 Kg)... TSA65-1000

CLEANING SOLUTION

- Mixing ratio 1kg powder to 20L water
- Powder dissolves in water
- 3kg or 5kg Container



DBESAFE-3



DBESAFE-5

- Ultrasonic Solution (500 gram)... DBESAFE-3
- Ultrasonic Solution (1 Kg)... DBESAFE-5

THERMO & XS SCUBA VALVE PARTS

- LVK01-AIR Overhaul Kit Thermo K-Valves (Air)
(MA015-U, L35069-K, L5270-16N, L3100-9-U, L5270-5N)
- LVK01-EAN Overhaul Kit Thermo INT/DIN Valves (Nitrox)
(MA015V-U, L35069-K, L5270-16N, L3100-9E-U, L5270-5N)
- L3990-5000N 1. Safety Assembly (3,000 psi), EAN ready
- TR014 2. O-Ring Valve Outlet
- TR014S 2. O-Ring Valve Outlet Polyurethane
- LGR014P9 2. O-Ring Valve Outlet Viton
- MA015 3. O-Ring Tank Neck
- MA015V 3. Viton O-Ring Tank Neck
- L5270-15N 4. Dip Tube plated (VP04 Pre 10/09), EAN ready
- LVX04 4. Dip Tube plated (VX04 Post 10/09), EAN ready
- L35069-K 5. HP-Seat, O2 ready
- L5270-16N 6a. Bonnet Gasket, EAN ready
- LVX17-E 6b. O-Ring EPDM (Bonnet)XS Scuba
- L5270-8PN 7. Stem EAN ready
- L3100-9 8. O-Ring for Stem, Thermo Valve, AIR
- L3100-9E 8. Viton O-Ring Stem Thermo
- L5270-5N 9. Stem Packing, Ean ready
- L5270-4PN 10a. Bonnet Nut, EAN ready
- LVX10 10b. Bonnet Nut, XS Scuba
- L5240-10 11. Handwheel Washer, EAN ready
- L5240-6A 12. Handwheel - Black
- L5270-6N 12. Handwheel - Green
- L5240-9 13. Spring EAN ready
- L5203-7P 14. Handwheel Nut, EAN ready
- LVP15V 15. Viton O-Ring (Thick) Outlet DIN/INT -Thermo Pro Valve
- MP31B 15. O-Ring (Thick) Outlet DIN/INT - Thermo Pro Valve
- L5440-23 16. DIN / K Insert w. Viton O-rings, EAN ready
- LVX22 17. Safety Handwheel only - black XS Scuba
- LVX20 18. Safety Hand Wheel insert Red & Green XS Scuba



SMT VALVE PARTS



- LGVP00-AIR Service Kit SMT Valve
(LGVP07/09/45, MA015-U, 2 x LGR010E-U, LGRM075E-U)
- LCV04-A 1. Complete Stem Assembly Incl. 7, 2x8, 9, 10
- LGVP45 4. HP-Seat SMT Valve, Oxygen ready
- LGVP07 7. Gasket
- LGR010E 8.O-Ring Stem
- LGVP09 9. Backup Ring
- LGRM075E-U 10. O-Ring Bonnet
- LGVP20 20. Handwheel Elastomer
- LGVP99 20. Handwheel Green (Nitrox)
- LGVP22 22. Handwheel Nut
- LCV26-30 25.&26. Safety Plug & Burst Disk 3,000 psi (5,000 burst)
- LGVP28 28. Dip Tube
- 2. See Thermo Valve Parts above
- 3. See Thermo Valve Parts above

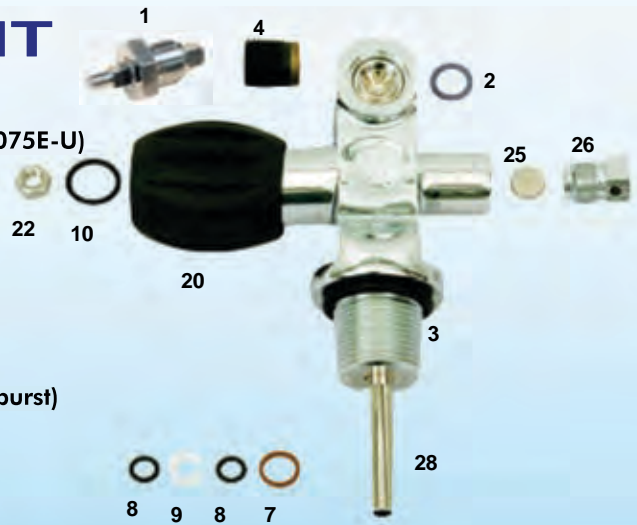

SHERWOOD VALVE PARTS

- L350620-AIR Overhaul Kit Sherwood Valve
(MA015-U, L350067, L350069, L350610, L350618)
- L5203-7P 1. Handwheel Nut, EAN ready
- L350611A 11. Spring - Sherwood valve
- L60002 13. Handwheel Sherwood - Black
- L1413 4. Handwheel Washer, Sherwood valve
- L5270-4PN 5. Bonnet Nut, EAN ready
- L350610 6. Copper Gasket
- L35067 7. Thick Teflon Ring (new style seal)
- L350618 8. Thin Teflon Ring (new style seal)
- L9350612 9. Stem/Spindle
- L35069 10. Plug Assembly HP-Seat
- L35069-K 10. Plug Assembly HP-Seat O2 ready
- L400012048 12. Safety Plug Assembly 3,000 psi
- 2. See Thermo Valve Parts above
- 3. See Thermo Valve Parts above



Sherwood Valve

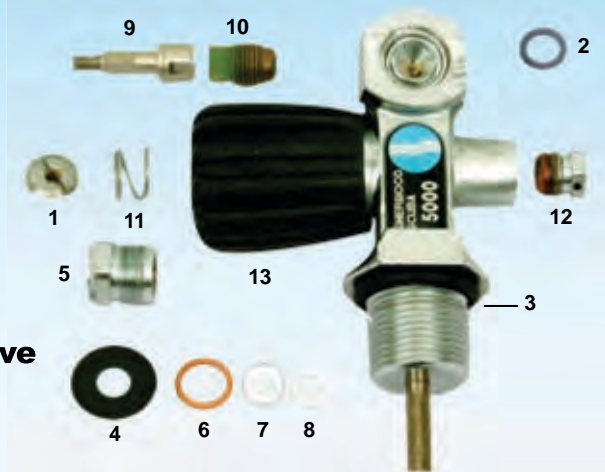

DEEP BLUE VALVE PARTS

NEW



- DBMV01-AIR** Overhaul Kit for DEEP BLUE valves (Air)
(MA015, DBMV10BKA, DBMVG061C, L3100-9, DBMVG07-2T)
- DBMV01-EAN** Overhaul Kit for DEEP BLUE valves (Nitrox)
(MA015V, DBMV10BKA, DBMVG061C, L3100-9E, DBMVG07-2T)
- DBMVA5000**
TR014
TR014S
LGR014P9
MA015
MA015V
DBMVT15-2
DBMVT15-3
DBMV10BKA
DBMVG061C
DBMV09-3BP
L3100-9
L3100-9E
DBMVG07-2T
DBMV05-2BP
DBMVW04-1
DBMVW03-2
DBMVP02-3
DBMV01BP
LVP15V
MP31B
DBMVDP13
1. Safety Assembly (3,000 psi), EAN ready
 2. O-Ring K Valve Outlet (NBR)
 2. O-Ring K Valve Outlet (Polyurethane)
 3. O-Ring Tank Neck
 3. Viton O-Ring Tank Neck
 4. Dip Tube plated (Pre 10/09), EAN ready
 4. Dip Tube plated (Post 10/09), EAN ready
 5. Deep Blue HP Seat Assembly, O2 ready
 6. Bonnet Gasket, Copper, EAN ready
 7. Stem EAN ready
 8. O-Ring for Stem, DeepBlue & ThermoValve, AIR
 8. Viton O-Ring for Stem, DeepBlue & ThermoValve
 9. Stem Packing, EAN ready
 10. Bonnet Nut, EAN ready
 11. Handwheel Washer, EAN ready
 12. Handwheel - Black
 13. Spring EAN ready
 14. Handwheel Nut, EAN ready
 15. Viton O-Ring (Thick) Outlet DIN/INT -Thermo Pro Valve
 15. O-Ring (Thick) Outlet DIN/INT - Thermo Pro Valve
 16. Deep Blue DIN / K Insert w. Viton O-rings, EAN ready

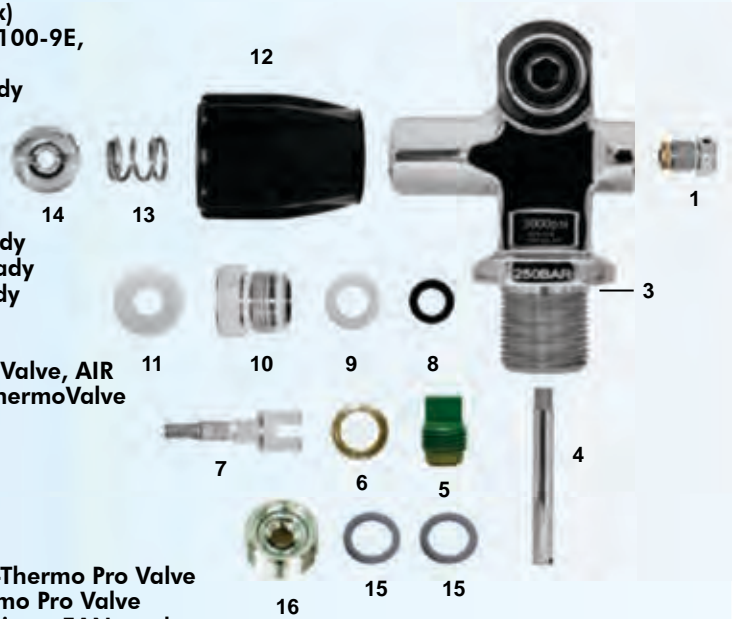

K VALVE INT

- EAN ready
- 3,000 psi / 207 bar pressure
- Thermo compatible parts

NEW



DBMV4030

PRO VALVE INT / DIN

- EAN ready
- 3,000 psi / 207 bar pressure
- Thermo compatible parts

NEW



DBMV4035

MODULAR VALVES

NEW



DBMV-SET

1. Deep Blue Modular Valve, Left Hand... DBMV-1L
 2. Deep Blue Modular Valve, Right Hand... DBMV-1R
 3. Deep Blue Modular Valve, Centre... DBMV-CTR
- Deep Blue Twin Isolation Valve Complete Set... DBMV-SET

TANK VALVE



LVCA4030

L5440-23

LVCA4035

DIN/INT AIR/EAN
Nitrox Ready

LVH200R-N

Thermo Valve INT... LVCA4030

Thermo Pro Valve... LVCA4035

Thermo Pro H Adapter Left... LVH200L-N

Thermo Pro H Adapter Right... LVH200R-N

DIN / K Insert w. Viton O-rings, EAN ready... L5440-23

THERMO TWIN ISOLATION VALVES

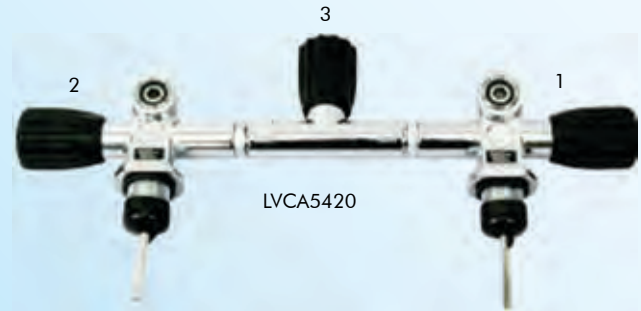

LVCA5420

Thermo Twin Isolation... LVCA5420

1. Modular Valve Left Hand... LVCA8044LH

2. Modular Valve Right Hand... LVCA8044RH

3. Modular Valve Centre... LVCA8033CTR

ALUMINIUM TANK



Luxfer® Gas Cylinders

Cylinder	Service Pressure		Capacity Air		Outside Diameter		Overall Length		Empty Weight		Min. Internal Volume	
Item No.	psi	bar	cu.ft.	litres	In.	mm	In.	mm	lbs.	kg.	cu.in	ltrs
LL19	3,000	207	19.9	563.6	4.38	111.132	18.6	471.4	8.2	3.7	175	2.9
LL40	3,000	207	40.0	1,132.8	5.3	133.4	24.6	628.7	15.3	6.9	350	5.7
LL50	3,000	207	48.4	1,370.7	6.89	175.01	19.0	482.6	21.2	9.6	424	6.9
LL63	3,000	207	63.0	1,784.2	7.25	184.15	21.9	555.0	26.7	12.1	552	9.0
LL80	3,000	207	77.4	2,192.0	7.25	184.15	26.1	661.9	31.4	14.2	678	11.1
LL100	3,300	224	98.8	2,798.0	8.00	203.20	26.2	665.7	41.0	18.6	804	13.2



Luxfer®
Gas Cylinders



104 Tanks, Valves & Air Parts

DIVE
SUPPLY

MINERAL OIL



MM05



MM03



MM01

Mineral Oil - 1L... MM01
 Mineral Oil - 3L... MM03
 Mineral Oil - 5L... MM05

BAUER SYNTHETIC OIL



QN28355-1



QN28355-5

Synthetic Oil - 1L... QN28355-1
 Synthetic Oil - 3L... QN28355-3
 Synthetic Oil - 5L... QN28355-5

MOLECULAR SIEVE

1000g



M100-S

ACTIVATED CARBON



M100-C

500g carbon... M100-C
 1kg Molec. Sieve & 500g Carbon... M100-Pack

FILLING VALVE



SDY-3



Q071343



Q071744

Filling Valve PN200 - No gauge... Q071744
 Filling valve PN300 - No gauge... Q071743
 Filling valve PN200 w gauge... Q071343
 Filling valve PN300 w gauge... Q071344
 Filling Valve w/o gauge... SDY-3

FELT FOR FILTERS



M109



M111

PER SQ. METER... M105
 Felt for Coltri 40mm (20pcs)... M106
 BAUER P41 (5set)... M107
 BAUER P31 (5set)... M108
 LW 260-450 (5set)... M109
 LW 160-245 (5set)... M110
 BAUER P21 (5set)... M111

FILLING HOSE HP



Filling Hose HP 1m SS... M112SS
 Filling Hose HP 1.5m SS... M113SS
 Filling Hose HP 2m SS... M114SS
 Filling Hose HP 3m SS... M115SS
 Filling Hose HP 4m SS... M117SS
 Filling Hose HP 5m SS... M118SS
 Bauer-Filling Hose 1m... QN2817
 Bauer-Filling Hose 2m... QN2818
 Flexible O2 Hose R1/4" SS... MFLEX-O2-SS

AIR STORAGE & PURIFICATION



B-KOOL

The B-KOOL refrigeration dryer from BAUER considerably reduces the running costs of the compressor whilst protecting the environment at the same time.

At locations with particularly high ambient temperatures, B-KOOL assures a remarkably longer life time of the filter cartridge. You will benefit from a lower cost of purchase & storage of filter cartridges, a longer uninterrupted compressor operation & a lower consumption of filter cartridges.

- 200 - 680 l/min
- 100 - 350bar
- Up to 11 times longer life for your filter cartridges!
- Environmentally sound
- Integrated or as stand-alone version
- Easy to retrofit

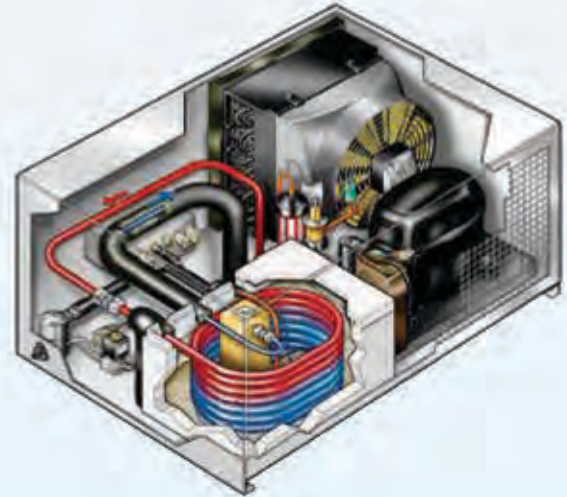

AIR STORAGE CYLINDERS

MAB1

Air Storage Cylinders

50 Liter Pressure Vessel with valve

300bar working pressure

Steel cylinders with 10 year Hydro test

Can be connected to custom specifications

Dive Supply's work shop facilities can clean, hydrostatically test & certify cylinders of all sizes

DIN VALVE FOR AIR BANK

Din Valve 300bar for Air Bank... MAB900



BAUER PureAir Certification

"PureAir – Safe Diving": High quality breathing air is the most important element of your diving equipment. Insufficiently or even non-filtered air from the compressor may jeopardize the health & even the life of any sports diver.

The [BAUER PureAir Campaign](#) offers any diver an easy to use guide for selecting trustworthy filling stations. By choosing to use [BAUER](#) state-of-the-art technology diving centers are able to meet the highest standards of Air Quality & are recognized with the award of the [BAUER Pure Air Seal](#).

The exclusive [BAUER PureAir Seal](#) guarantees any diver that he or she really receives only the purest breathing air. Learn more at www.bauerpureair.com/diving



To find out how to get your [BAUER PureAir Certification](#) please contact our Sales & Service team.

JUNIOR II

The most compact & highly mobile model in our diving compressor range. Due to its toughness & reliability the JUNIOR has become a global classic. JUNIOR II offers an even more compact design & numerous improvements in details. The patented TRIPLEX filter system guarantees purest breathing air according to DIN EN 12021.

Now available with optional automatic condensate drain & final pressure switch off.



MARINER 250

Even more performance & equipped with the TRIPLEX P31 / P41 filter in series.



MARINER 200



With 200 l/min. It is the most versatile among the new units of the PROFI-LINE II. Crash frame in series.



MARINER 320

With 320 l/min. the new Mariner 320 is the most powerful portable compressor worldwide!



TECHNICAL DATA

Type max. 330bar / 5000 psig	Drive	FAD L/min*	RPM min	Drive		Filter System TRIPLEX	Dimensions (app.cm)			Weight net (app.kg)
				kW	HP		L	W	H	
JUNIOR II - B	4-stroke petrol	100	2300	4.0	5.5	P21	78	34	42	44
JUNIOR II - W	Single phase	100	2300	2.2	3.0	P21	66	39	42	46
MARINER 200 - B	4-stroke petrol	200	1,300	6.1	8.0	P21	125	59	63	115
MARINER 200 - E	3-phase	200	1,300	4.0	5.5	P21	125	59	63	115
MARINER 250 - B	4-stroke petrol	250	1,450	6.6	9.0	P31/P41	125	59	63	120
MARINER 250 - E	3-phase	250	1,450	5.5	7.5	P31/P41	125	59	63	135
MARINER 320 - B	4-stroke petrol	320	1,450	9.6	13	P31/P41	130	64.5	70	138
MARINER 320 - E	3-phase	320	1,450	7.5	10	P31/P41	130	64.5	70	154

Also available with switchover device 330 /225bar (5000/3300 psi)



MINI-VERTICUS



Now significantly quieter, thanks to the new anti-vibration frame & noise-optimised Super Silent housing;
Available with a higher charging rate of 320 l/min & with an open design as standard.

Fully automatic B-CONTROL MICRO compressor control with colour display

B-DRAIN: New automatic condensate drain is quieter & saves energy

Ergonomic design: optimum accessibility & operation

Long unit service life: use of high-quality materials that have been optimised for continuous use

Optional - Super Silent version, P61 Purification system, B-APP

- 225 & 330 Bar
- 150-320 l/min

Type	Charging rate ¹		Max. operating	Speed	Motor	Purification	Net	Dimensions
Designation	l/min	m ³ /h	Pressure		Output	System	Weight	
			bar	rpm	kW		kg	L × W × H
								cm
MV 150	150	9	350	1340	4	P 41	324	120 × 79 × 138
MV 200	200	12	350	1270	4	P 41	324	120 × 79 × 138
MV 250	250	15	350	1470	5.5	P 41	333	120 × 79 × 138
MV 320	320	19.2	350	1450	7.5	P 41	350	120 × 79 × 138

VERTICUS

For use in professional applications: High charging rate in continuous operation
Now significantly quieter: thanks to the new anti-vibration frame & noise-optimised Super Silent housing

B-DRAIN: New automatic condensate drain is quieter & saves energy

Fully automatic compressor control: B-CONTROL MICRO with colour display

Optional oil level monitoring system: For safely switching off the compressor unit when the oil level is low.

The VERTICUS series has been developed & built specifically to meet high performance requirements in continuous operation in professional applications.

- 225 & 330 Bar
- 450 – 680 l/min



Type	Charging rate ¹			No. of	Speed	Motor	Purification	Net	Dimensions
Designation	l/min	m ³ /h	cfm	Compr. Stages		Output	System	Weight	
					rpm	kW		kg	L × W × H
									cm
V 450	450	25.2	15.9	4	1320	11	P 61	402	120 × 79 × 153
V 540	540	32.4	19.1	4	1230	11	P 61	402	120 × 79 × 153
V 680	680	40.8	24	4	1400	15	P 61	416	120 × 79 × 153

The POSEIDON EDITION represents an excellent value-for-money range of compressors without compromising typical BAUER quality. This product range has been developed for uncomplicated operation, combining proven core components from BAUER with a simple but robust chassis.



- > 250 - 300 l/min
- > 225 / 330bar

The PE-MVE is BAUER's compact all-in-one solution, offering high quality at outstanding value for money. Standard with Super Silent housing, automatic condensate drain system & the user friendly BHW-CONTROL control unit.



- > 300 - 850 l/min
- > 225 / 330 / 420bar

The new generation VE range excels through its high delivery rates of up to 850 l/min. Tailored for breathing protection & scuba diving requirements, the new compressor control offers quick & easy access to all important functions.



- > 100 l/min
- > 225 / 330bar

The PE 100 is the smallest & lightest compressor unit of the PE range. With its three drive variants (petrol, three-phase & single-phase alternating current).



- > 200 - 300 l/min
- > 225 / 330bar

The PE 200 - 300-TE models offer the optimum weight / price ratio. Owing to their compact construction, the units are easy to transport & to load onto vehicles.



- > 200 - 300 l/min
- > 225 / 330bar

The PE 200 - 300-HE horizontal models are by far the most compact high pressure breathing air compressors in their class.

The standard version comes already equipped with automatic condensate drain & easy-to-use control. Ideal for use on dive boats

SIMILAN ISLANDS

including KOH BON, KOH TACHAI, RICHELIEU ROCK
(2nd Edition)

This convenient reference book is a must-have if you're planning a visit to the Similan Islands & surrounding areas. There are also lots of colourful dive site diagrams, descriptions of area dive characteristics & an abundance of practical information you'll need to know before you go.

- Information on the area, from topography to getting ready to dive there
- Detailed explanation of every dive site
- 20 full-colour illustrated underwater maps

English... MPD01



INDIAN OCEAN REEF GUIDE

by Helmut Debelius

Maldives - Sri Lanka - Thailand
South Africa - Mauritius
Madagascar - East Africa -
Seychelles

The author made his first dives in tropical waters around Sri Lanka 25 years ago. Since then he explored virtually the entire Indian Ocean with his camera, diving not only in the tourist centers like the Maldives or Seychelles, but also taking UW-Photos at remote islands like Cocos-Keeling in the East or Aldabra in the West. The results are shown in this book including more than 1,000 photos from the natural habitat of the marine animals. Special emphasis was given to rare species like sharks & rays.

English... K1105

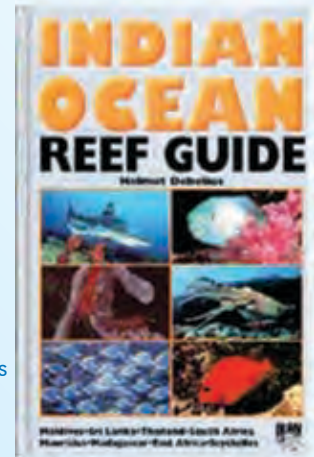

INDIAN OCEAN MARINE GUIDE

Marine Pictolife describes more than 250 marine species.

- Totally waterproof
- Multilingual (5 languages as well as in Latin)
- Almost 250 species packed into 64 pages
- Paper captions in all 5 languages
- 2 indexes including 5 phyla (mobile & stationary species)
- Format: 12.5 X 16.3 cm
- Weight: 177 g

Multi Lingual... KP107



TROPIC PACIFIC MARINE GUIDE

Marine Pictolife describes more than 250 marine species.

- Totally waterproof
- Multilingual (5 languages as well as in Latin)
- Almost 280 species packed into 64 pages
- Paper captions in all 5 languages
- 2 indexes including 5 phyla (mobile & stationary species)
- Format: 12.5 X 16.3 cm
- Weight: 177 g



Multi Lingual... KP109

ASIA PACIFIC MARINE GUIDE

NEW

Marine Pictolife describes more than 250 marine species.

- Totally waterproof
- Multilingual (5 languages as well as in Thai)
- Almost 280 species packed into 64 pages
- Paper captions in all 5 languages
- 2 indexes including 5 phyla (mobile & stationary species)
- Format: 12.5 X 16.3 cm
- Weight: 177 g



Multi Lingual... KP113

We can print YOUR COMPANY LOGO on these items:



**WATERPROOF POUCH
DB8044**



**LOG BINDERS
DB8005**



**ADVENTURE DRY PACK
DBBV05-DBBV15**



**MASK STRAP
DB6688**



**GEAR BAG - 65 Liter
DB8010
Black, Blue & Red**



**GEAR BAG - 90 Liter
DB8020
Black, Blue & Red**



**MASK STRAP
COVER DB6689**



**SHORTY 3MM WETSUIT
DBADS01**



**STEAMER 3MM WETSUIT
DBADS03**



**SHORTY 3MM WETSUIT
DBADS02**



**SHORTY 3MM WETSUIT
DBADS04**

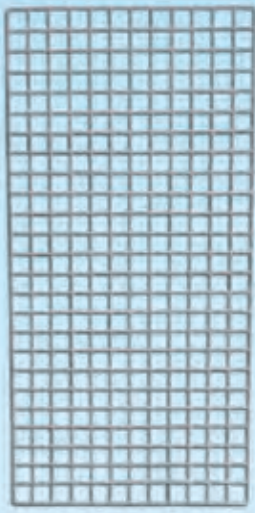

Mesh Display (PVC Coated)
White 50cm x 100cm

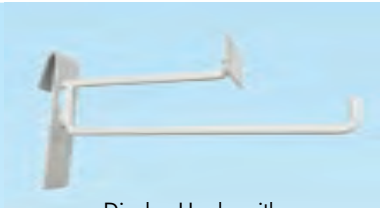

Display Hooks with
price tag 20cm



Display Hooks with
price tag 10cm



Acrylic A4 Flyer Display
Stand (Landscape format)

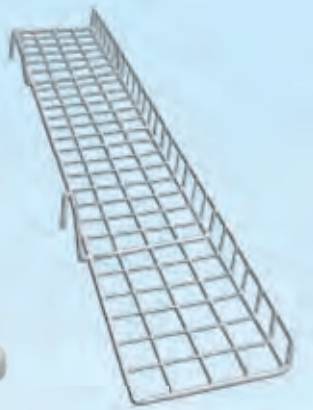

Mesh Shelf
PVC coated
White 17cm x 100cm



Acrylic A4 Flyer Display
Stand (Portrait format)



Acrylic A4 Flyer Display
Stand (Portrait format)



Mesh Joiner



Mask Stand - Free
Standing (Clear)



Acrylic Hook Display Shelf
for Grid/Mesh frame
(W 19cm x D 11.5cm x H 6.5cm)
or
(W 19cm x D 7.5cm x H 8.5cm)



Free Standing Display (Mesh)
White 100 x 200 cm



Free Standing Display (Mesh)
White 100 x 150 cm



Free Standing Display (Mesh)
White 60 x 130 cm

WALL RAILS CHROMIUM

Available in: 60, 90, 120, 150, 180cm

Cross Bar Brackets, Left
"Chromium"



Cross Bar Brackets, Right
"Chromium"

Accessory Hooks 25cm
"Chromium"



Wood Shelve Brackets
30cm "Chromium"

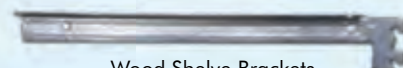

Glass Shelve Brackets
25cm "Chromium"



Fin Hooks "Chromium"
4 hooks



Cross Bars 90cm
"Chromium"





SCUBAPRO

**DEEP DOWN
YOU WANT THE BEST**



DIVE SUPPLY HISTORY

Diving & Snorkeling Equipment Wholesale Specialist

Dive Supply is the leading distributors and wholesaler of major brand names in South East Asia and is the exclusive distributor for Scubapro, Suunto, Seac, Pelican, Saekodive, Bauer, Luxfer, Tovatec, Deep Blue, XS Scuba and Maxtec.

We operate from our 1,500 sqm custom built warehouse in Chalong, Phuket, where we have a fully equipped service center.

If you are looking for the leading brands in Diving and Snorkeling Equipment along with value for money and excellent customer service then Dive Supply is the place to come.

We have a product portfolio which is second to none and we are the main distributor for PADI materials throughout Thailand.



Tel : +66 (0) 76 383 414-6
Fax : +66 (0) 76 281 525



Dive Supply Co., Ltd.
88/5 Moo10 Patak Road,
Chalong,Phuket,Thailand



sales@divesupply.com
www.divesupply.com
facebook/DiveSupply



“new ways to contact us”

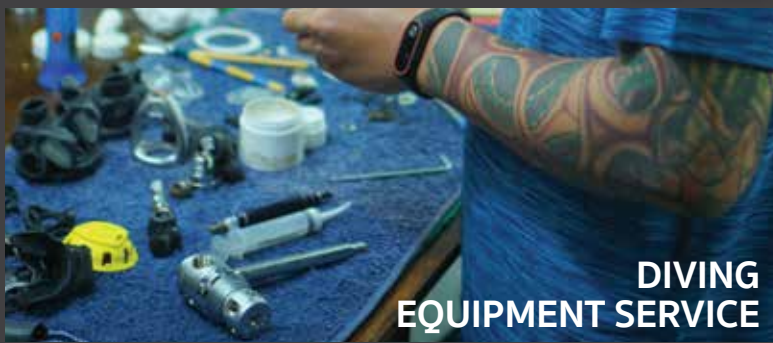



Dive Supply Main Office (Phuket)

88/5 Moo 10 Patak Road, Chalong
Muang, Phuket, 83130 Thailand
Tel: 076 383 414-6 Fax: 076 281 525
Email: sales@divesupply.com
Website: www.divesupply.com
Facebook: www.facebook.com/DiveSupply

Koh Tao Dive Supply
info@kohtaodivesupply.com
Tel: +66 (0) 77 456 162
Fax: +66 (0) 77 456 163

Bangkok Dive Supply
contact@divesupplybkk.com
Tel: +66 (0) 2 354 4815
Fax: +66 (0) 2 354 4819

Samui Dive Supply
info@samuidivesupply.com
Tel: +66 (0) 77 230 063
Fax: +66 (0) 77 230 186

Koh Chang Dive Supply
info@kohchangdivesupply.com
Tel: +66 (0) 39 551 518
Fax: +66 (0) 39 551 519