



ULTIMATE Nobelium SERIES SUBWOOFERS

Nobelium 10i
Nobelium 12i
Nobelium 15

WELCOME

Thank you for buying a DLS ULTIMATE Nobelium subwoofer. The subwoofer must be installed correctly in order to work well. This manual will show you how to install it like a pro. Please read the entire manual before beginning the installation. Install the subwoofer yourself if you feel confident with our instructions and if you have the proper tools. However if you feel unsure, turn over the installation job to someone better suited to it.

The speakers are designed for enclosure mounting. In "open air" installations the power handling capacity is reduced by 30% from the nominal value. We don't recommend "open air" installations for Ultimate Nobelium subwoofers.

CONNECTION OF SUBWOOFER

How to connect depends on what type of amplifier you use. The best is to follow the instructions given in the manual for the amplifier. Most amplifiers today have built-in lowpass crossover and possibilities to connect your subwoofer in bridge mode. Two 4 ohm subwoofers are often connected in stereo mode since most amplifiers can't handle bridge mode loads below 4 ohms.

The Iridium subwoofers have dual, four ohm, voice coils. Each voice coil has an impedance of 4 ohms. If they are connected in series the resulting impedance is 8 ohms. If they are connected in parallel the resulting impedance is 2 ohms. Make sure to connect in a way that don't ruin the amplifier. If you have a DLS Ultimate amplifier it's possible to connect the voice coils in parallel, these amplifiers are 1 ohm stable.

We also recommend the use of a subsonic highpass filter. This gives a better bass reproduction with less "rumble". In most DLS amplifiers this feature is already built-in. For wiring use high class speaker wires, min AWG13 (2.5 mm²). For example **DLS SC 2x4**.

ENCLOSURE DAMPING

Most enclosures should be damped inside with syntetic (acoustic) wool or damping mat (line). Attach the damping material on the wall opposite from the speaker and port. A sealed enclosure should be filled up to 70-100% with acoustic wool.

RUNNING-IN PERIOD

Allow the speaker to play for at least 15-20 hours. After this time the performance is correct.



Technical Assistance

For technical assistance ask the shop where the product was sold or the distributor in your very country. You can always phone the DLS Helpdesk in Sweden + 46 31 840060 or send an e-mail to info@dls.se. Information can also be found on our WEB-site www.dls.se

We follow a policy of continuous advancement in development. For this reason all or part of specifications & designs may be changed without prior notice.

SUBWOOFER ENCLOSURES, GENERAL

Build your enclosure in a stable and airtight material. The best is MDF-board, 19 mm, or particle board, 22 mm. Larger enclosures must have bracing inside to avoid vibrations. The enclosure must be completely airtight. Use sealing compound in all joints, also around the cable terminals. The size of the enclosure is decided by the speaker data.

SEALED ENCLOSURES

Sealed enclosures are easy to build. The size is not critical, but it can't be too small. The speaker data such as Fs, Qts, Vas and X-max decides the size of the enclosure.

Large speakers need larger boxes. Two speakers need a box of the double size etc. The enclosure must be completely airtight.

A sealed enclosure should be filled with acoustic wool up to 75 - 100%.

A sealed enclosure has a lower efficiency than a vented enclosure, but they can handle high power and are easy to build. A subwoofer in a sealed enclosure creates a tight bass suitable for the audiophiles listening to classical music, jazz and soft rock.

VENTED ENCLOSURES

A speaker in a vented enclosure has a higher efficiency (+3 dB) and higher power handling capacity than in a sealed enclosure. In a vented enclosure the sound from the speaker and the port work together creating a higher sound level. The sound from the port must come out in the same phase as from the speaker otherwise the result is bad.

The size of the vented enclosure is decided by the speaker data just as for the sealed one.

The size of the vehicle often decides the practical size of the enclosure. A smaller enclosure has a higher resonant frequency than the larger one. The size of the enclosure should not be so big that the speaker plays below it's own free air resonance (Fs), then it loose in power handling capacity.

The port does not have to be fully inside the enclosure as long as the area and length are correct. Sometimes you need two or more ports in an enclosure. You can convert from one to two or more ports as long as the total port area is the same.

IMPORTANT!

Think of the speaker weight when you install it. If you don't mount it properly it can come loose.

WARRANTY SERVICE

This speaker is covered by warranty, depending on the conditions in the country where it is sold. If the speaker is returned for service, please include the original dated receipt with the product.



DLS Svenska AB

P.O. Box 13029

SE-40251 Göteborg, Sweden

Tel: +46 31 840060

Fax: +46 31 844021

E-mail: info@dls.se

www.dls.se

Technical specifications for DLS ULTIMATE Nobelium 10i

Nobelium 10i		Voice coils connected in parallel to 2 ohm	
Size	25 cm (10")	Re, DC-resistance	1,9 ohm
Impedance	2 x4 ohm	BL product	13,77
Nom. power (RMS)	500 W (max 800)	Sensitivity (SPL 1W/1m)	83 dB
Freq. range	25 Hz - 2,5 kHz	Resonant freq. (Fs)	41 Hz
Voice coil, diameter	75 mm (3")	Vas (litre)	12
Voice coil, length	40 mm (1,57")	Vas (ft³)	0,42
X-max	+/-14 mm (0,55")	Qms	4,66
Cms	58	Qes	0,66
SD	380 cm²	Qts	0,57
Cone material	Aluminium		
Magnet weight	180 oz (5,1 kg)		
Magnet, diameter	180mm (8,7")		
Installation depth	150 mm (5,91")		
Mounting hole	236 mm (9,29")		
Outer diameter	266 mm (10,47")		
Weigth	9,8 kg (21,6 lbs)		

Technical specifications for DLS ULTIMATE Nobelium 12i

Nobelium 12i		Data that can vary depending on how the voice coils are connected:		
		Single voice coil	Voice coils in parallel to 2 ohm	
Size	30 cm (12")	Re, DC-resistance	3,5 ohm	1,9 ohm
Impedance	2 x4 ohm	BL product	12,5	11,88
Nom. power (RMS)	600 W (max 1000)	Sensitivity (SPL 1W/1m)	85,2 dB	88,5 dB
Freq. range	20 Hz - 2,5 kHz	Resonant freq. (Fs)	33 Hz	33,8 Hz
Voice coil, diameter	75 mm (3")	Vas (litre)	49	53,2
Voice coil, length	40 mm (1,57")	Vas (ft³)	1,73	1,88
X-max	+/-14 mm (0,55")	Qms	3,93	3,77
Cms	143	Qes	0,81	0,44
SD	510 cm²	Qts	0,67	0,39
Cone material	Aluminium			
Magnet weight	180 oz (5,1 kg)			
Magnet, diameter	220mm (8,7")			
Installation depth	153 mm (6")			
Mounting hole	282 mm (11,1")			
Outer diameter	313 mm (12,32")			
Weigth	12,7 kg (28 lbs)			

Technical specifications for DLS ULTIMATE Nobelium 15

Nobelium 15		Data that can vary depending on how the voice coils are connected:		
		Single coil	Voice coils in parallel 2 ohm	
Size	37,5 cm (15")	Re, DC-resistance	3,6 ohm	1,7 ohm
Impedance	2 x4 ohms	Z, impedance	4 ohm	2 ohm
Nom. power (RMS)	600 W (max 1000)	Cms	142,5	142,5
Frequency range	15 Hz - 2,5 kHz	Zo, Z max at Fs)	19,4 ohm	17,18 ohm
Voice coil, diameter	75 mm (3")	BL product	11,8	11,4
Voice coil, length	40 mm (1,57")	Sensitivity	90 dB	92,3 dB
X-max	+/-14 mm (0,55")	Resonant freq. (Fs)	34,7 Hz	34,7 Hz
SD	779 cm²	Vas (litre)	130,7	130,7
Cone material	Aluminium	Vas (ft³)	4,6	5,6
Upper suspension	Rubber	Qms	3,62	3,77
Magnet weight	200 oz (5,67 kg)	Qes	0,82	0,49
Magnet, diameter	220mm (8,7")	Qts	0,67	0,43
Installation depth	176 mm (6,93")			
Mounting hole	360 mm (14,17")			
Outer diameter	390 mm (15,35")			
Weight	13,8 kg (30,4 lb)			

THE SUBWOOFER

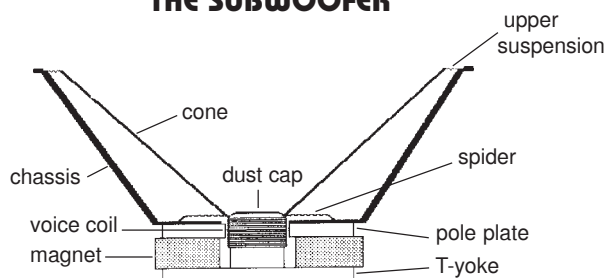

ABOUT THE RECOMMENDED ENCLOSURES

The performance of these recommended enclosures will vary from vehicle to vehicle. It is more difficult to get a tight and well defined bass in a SEDAN vehicle because of the tightness between trunk and interior. In most cases the recommended enclosures below is the best choice. The vented box is to be preferred.

- The given enclosure volume is the inner volume.
- Volumes occupied by speaker and ports have already been added to the given enclosure volumes so don't add any volume.
- Use conical bass ports for best result. (DLS BP-75). Cut the tube to its correct length. There are two flanges coming with this kit. The larger one is for the outside, and the smaller one should be attached to the tube inside the enclosure. Make a round hole in the box where you want to mount the bass port. Mounting hole for the port is 115 mm. The larger flange should be attached to the outside of the box. Fasten it to the box with screws or with some glue. There are prepared drill holes on the back of the flange. The smaller flange is for the inner end of the tube. Use a PVC-glue to attach it on the tube. Then glue the tube to the port mounted in the box. Use sealing compound round the flange to make the box as airtight as possible.

ENCLOSURE PLACING IN DIFFERENT TYPES OF VEHICLES

In **small vehicles** like VW Golf, Peugeot 306 and similar the bass box should be installed with both speaker and port directed backwards. Alternatively both speaker and port can be directed upwards. This way of mounting is valid for all types of vehicles where the trunk is incorporated with the inner compartment.

In **sedan vehicles** with the passenger compartment separated from the trunk, the enclosure should be installed with both speaker and port directed towards the rear seat. Some cars have an opening in the middle of the rear seat for loading skis etc. You can install the enclosure behind this opening and direct speaker or port through this opening. There must be some free space in front of the port, (between the rear seat and the port opening).

In **large vehicles** like station wagons the best sound is achieved with the enclosure installed behind the rear seat with both speaker and port directed backwards. Alternatively you can install the enclosure on one side of the luggage compartment.

CALCULATE YOUR OWN ENCLOSURE

Box volumes:

When calculating the inner volume of an enclosure you just multiply the width (W) x height (H) x depth (D). Use measures in dm and you will get the answer in liters.

A trapezoid box is calculated as this:

$$\text{Vol} = \frac{\text{width (W)} \times \text{height (H)} \times (\text{upper depth (UD)} + \text{lower depth (LD)})}{2}$$

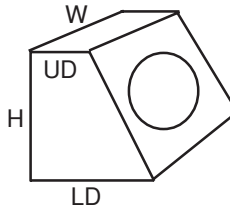

Be sure to measure the inside dimensions.

RECOMMENDED ENCLOSURES Nobelium 10i

Sealed enclosure:

Wiring : Use Parallel V/C
 Volume : 25 / 0,88 (litre / ft³)
 Damping : Acoustic wool
 F3 : 56,2 Hz

Outside box dimensions:

Width : 599 mm (23,58")
 Height : 320 mm (12,60")
 Lower depth : 247 mm (9,72")
 Upper depth : 147 mm (5,79")
 Material : MDF 19 mm (3/4")

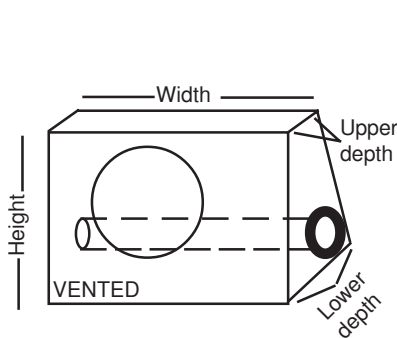
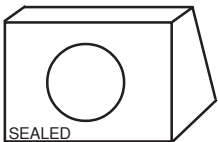

For best result, use any of these recommended enclosures. If you want to modify the dimensions, use the calculation methods described above.

Vented enclosure:

Wiring : Use parallel V/C
 Volume : 25 / 0,88 (litre / ft³)
 Port* : 3" (6,8 cm) x 38 cm / 15"
 Damping : Line inside
 F3 : 31 Hz

* Use the BP 75 port kit. Mount the flanges on the tube ends. The port should be on the side of the enclosure. Cut the tube to its correct length.

Outside box dimensions:

Width : 599 mm (23,58")
 Height : 320 mm (12,60")
 Lower depth : 247 mm (9,72")
 Upper depth : 147 mm (5,79")
 Material : MDF 19 mm (3/4")

Technical drawing for a 25 litre enclosure.

The Nobelium 10i can work either in a 25 litre sealed or vented enclosure. This is a drawing for the box and the separate boards needed to build a suitable enclosure.

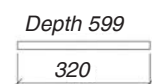
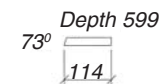
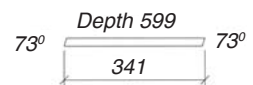
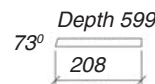
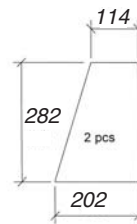
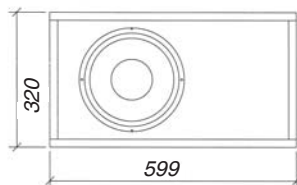

RECOMMENDED ENCLOSURES for Nobelium 12i

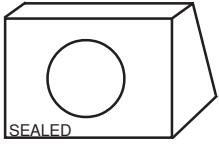

Sealed enclosure:

Wiring : Use single voice coil
 Volume : 34 / 1,2 (litre / ft³)
 Damping : Acoustic wool
 F3 : 42 Hz

Outside box dimensions:

Width : 550 mm (17,72")
 Height : 350 mm (13,78")
 Lower depth : 302 mm (11,89")
 Upper depth : 202 mm (7,95")
 Material : MDF 19 mm (0,75")

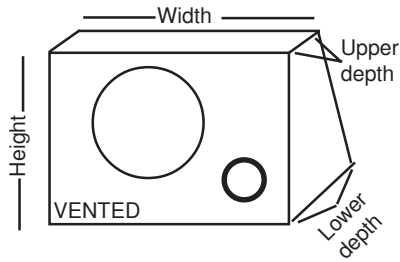

For best result, use any of these recommended enclosures.
 If you want to modify the dimensions, use the calculation methods described above.

Vented enclosure:

Wiring : Parallel V/C
 Volume : 34 / 1,20 (litre / ft³)
 Port* : 3"(6,8 cm) x 15 cm / 5,91"
 Damping : Line inside
 F3 : 41,3 Hz

* Use the port included in the subwoofer packing. Mount the flanges on the tube ends. Don't cut the tube, it has the correct length.

Outside box dimensions:

Width : 550 mm (17,72")
 Height : 350 mm (13,78")
 Lower depth : 302 mm (11,89")
 Upper depth : 202 mm (7,95")
 Material : MDF 19 mm (0,75")

Technical drawing for a 34 litre enclosure.

The Nobelium 12i can work either in a 34 litre sealed or vented enclosure. This is a drawing for the box and the separate boards needed to build a suitable enclosure.

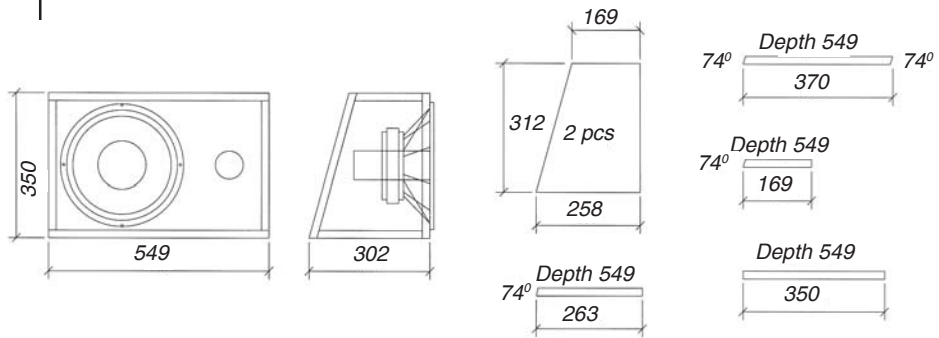

RECOMMENDED ENCLOSURES for Nobelium 15

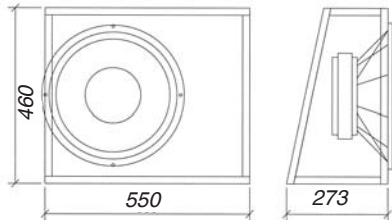
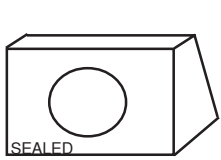

Sealed enclosure 1:

Wiring : Single VC
 Volume : 45 / 1,59 (litre / ft³)
 Damping : Acoustic wool
 F3 : 51,5 Hz

Outside box dimensions:

Width : 600 mm (23,62")
 Height : 460 mm (18,11")
 Lower depth : 278 mm (10,94")
 Upper depth : 178 mm (7,01")
 Material : MDF 19 mm (3/4")

Technical drawing for a 45 litre enclosure.

The Nobelium 15 can work either in a 45 or 40 litre sealed enclosure. This is a drawing for the 45 litre box and the separate boards needed to build a suitable enclosure.

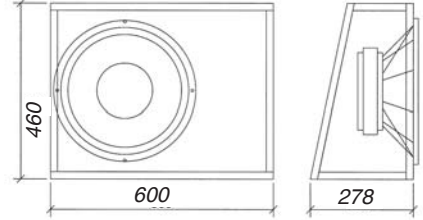
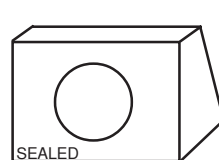
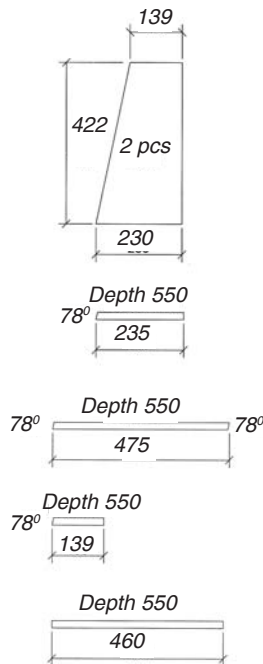

Sealed enclosure 2:

Wiring : Parallel VC
 Volume : 40 / 1,41 (litre / ft³)
 Damping : Acoustic wool
 F3 : 64,5 Hz

Outside box dimensions:

Width : 550 mm (21,65")
 Height : 460 mm (18,11")
 Lower depth : 273 mm (11,75")
 Upper depth : 173 mm (6,81")
 Material : MDF 19 mm (3/4")

Technical drawing for a 40 litre enclosure.

The Nobelium 15 can work either in a 45 or 40 litre sealed enclosure. This is a drawing for the 40 litre box and the separate boards needed to build a suitable enclosure.

