

PHILIPS

PrimeSet
RDL500 / 510



Technical leaflet

Freezer cabinets

Lighting food. Brightening faces.

Philips LED lighting for refrigeration cases has a proven track record as a sustainable and energy-efficient way to create an enjoyable shopping experience for customers – while at the same time supporting retailers' brand values.

Thanks to their new, slim design, the PrimeSet RDL500 / 510 modules can be aesthetically integrated in the door frames of vertical door freezers.

The modules' unique integrated optical system directs the light in such a way that the products on display are presented uniformly, while reducing glare and dark spots.

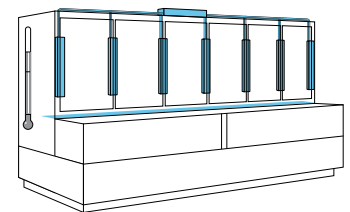
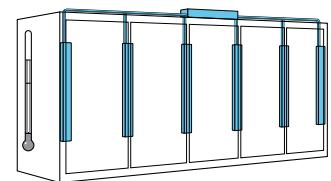

www.philips.com/ledrefrigeration





Design highlights

- Improved visibility and presentation of the frozen food on display; uniform light distribution throughout the entire cabinet.
- Two light levels.
- Reduced complexity as each module can be center or side lit.
- Aesthetic integration of the modules into door frames, enabling better visibility of the products on display and increased storage space.
- Virtually maintenance-free throughout the lifetime of the cabinets, since the LEDs have a long lifetime of 50,000 hours with excellent lumen maintenance.
- Ideal for integration in mullions of vertical refrigeration cabinets.



“ Ideal for **vertical integration** in millions of vertical refrigeration cabinets.”



Environment

Significantly improved sustainability due to lower energy consumption, reduced waste and elimination of hazardous substances such as mercury and lead.

Product features

- Ultra slim design with integrated optics.
- Waterproof (IP rating: 65).
- Two typical lighting levels of 1600 lux and 850 lux for excellent illumination of products on the display.
- Each module can be center or side lit by applying a center or side cable.
- Together with the center mounting profile the light distribution will be in two directions. With the side mounting profile the light distribution will be in one direction.
- DLC listed as vertical and horizontal refrigeration display case luminaire.
- 5-year Philips warranty for the modules in combination with the Philips LED power driver.



PrimeSet RDL500 / 510 module

Specifications

- The rated average life of the module, in combination with a Philips LED power driver, is L70B50 at 50,000 hours (70% lumen maintenance). This rated average life is based on three switching cycles per day.
- Operating temperature (performances) min -30 °C / max +30 °C.
- Storage temperature min -30 °C / max +60 °C.
- Housing color: black.
- Safety Extra Low Voltage (SELV).
- Compliance and approval; ENEC, UL, CE, Product safety class III, RoHS, WEEE, EU directive 2002/95/EC, NSF, CSA, REACH. Relevant clauses of IEC/EN 60335-1 Annex BB of IEC/EN 60335-2-89 Annex CC of IEC/EN 60335-2-24
- The color consistency of the modules is 5 SDCM.
- Instant start-up with full illumination.
- The rated peak intensity is 430 cd for RDL500/510 Vision and 215 cd for RDL500/510.
- The Rated beam angle is 30°.
- The Power Factor with Philips LED Power driver is > 0.9.

Light distribution

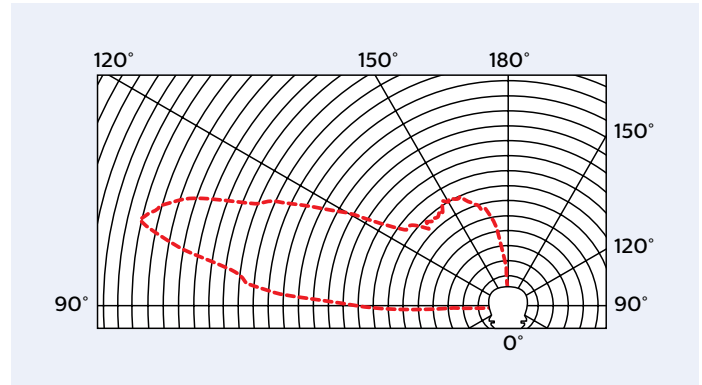

asymmetrical 30° (side)

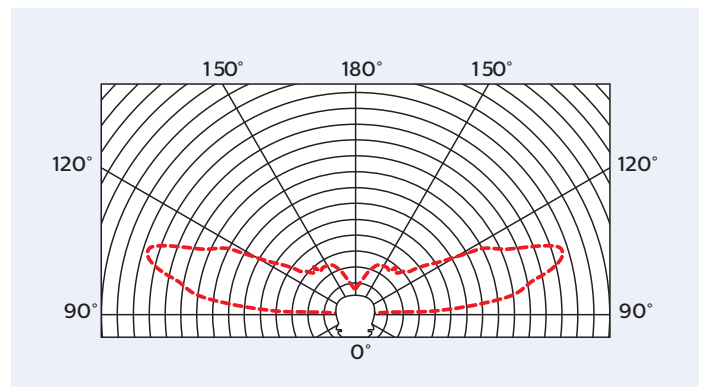

symmetrical 30° both directions (center)

Spectral power distribution

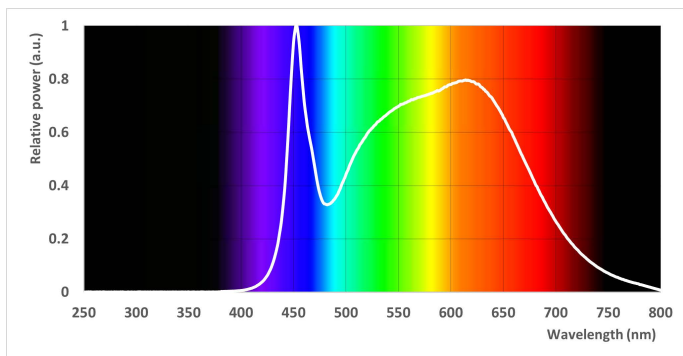

4100K

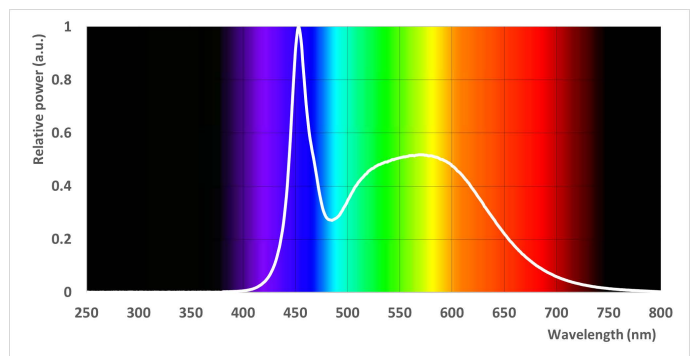

5600K

Chromaticity coordinates

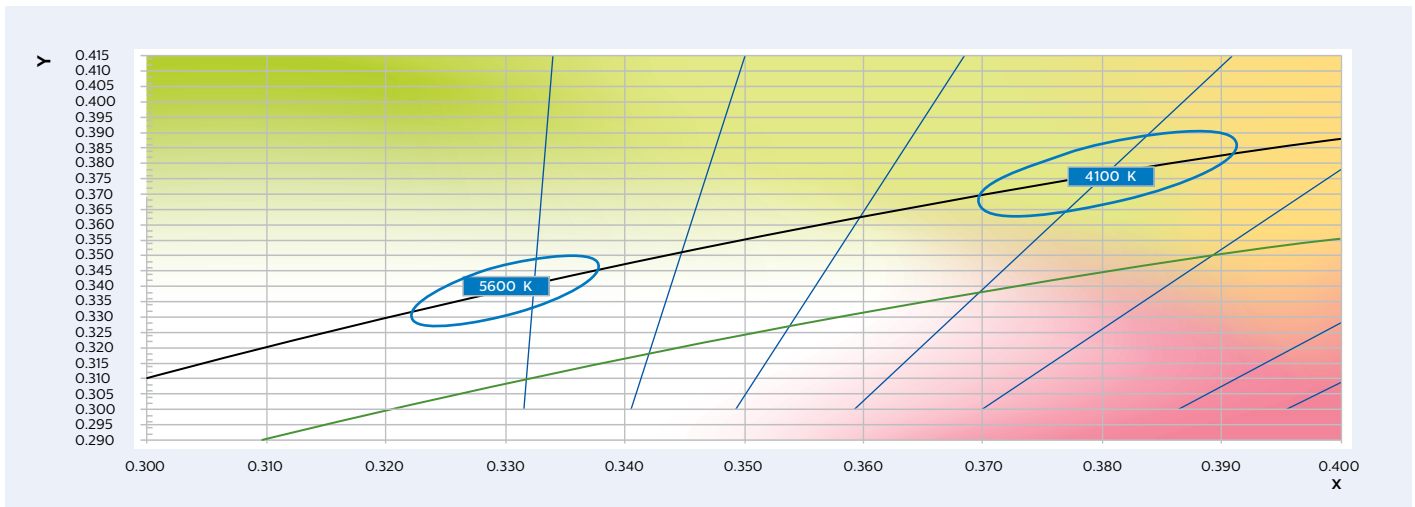

Lumen Maintenance

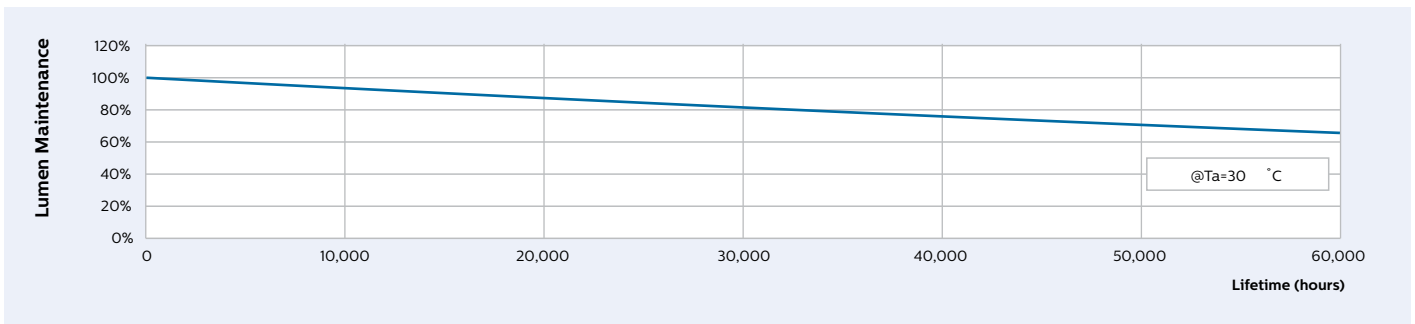

Technical Specifications

Product type	Light color	Rated power	Rated luminous flux (lumen)	Color Rendering Index		Correlated Color Temperature K (CIE x, CIE y)
		W	lm	CRI	R9	
PrimeSet RDL500 / 510 Vision - 1600 lux						
PrimeSet RDL510 Vision 750mm (30") 841 G1	Neutral White	9.3	1100	84	0	4100 (0.379, 0.373)
PrimeSet RDL510 Vision 750mm (30") 856 G1	Cool White	10.2	1150	85	0	5600 (0.330, 0.344)
PrimeSet RDL510 Vision 850mm (34") 841 G1	Neutral White	10.8	1260	84	0	4100 (0.379, 0.373)
PrimeSet RDL510 Vision 850mm (34") 856 G1	Cool White	12	1350	85	0	5600 (0.330, 0.344)
PrimeSet RDL510 Vision 950mm (37") 841 G1	Neutral White	11.8	1400	84	0	4100 (0.379, 0.373)
PrimeSet RDL510 Vision 950mm (37") 856 G1	Cool White	12.9	1440	85	0	5600 (0.330, 0.344)
PrimeSet RDL500 Vision 1200mm (47") 841 G1	Neutral White	17.8	1855	85	0	4100 (0.379, 0.373)
PrimeSet RDL500 Vision 1200mm (47") 856 G1	Cool White	17	1940	85	0	5600 (0.330, 0.344)
PrimeSet RDL500 Vision 1500mm (59") 841 G1	Neutral White	19.4	2200	84	0	4100 (0.379, 0.373)
PrimeSet RDL500 Vision 1500mm (59") 856 G1	Cool White	22	2400	85	0	5600 (0.330, 0.344)
PrimeSet RDL500 Vision 1700mm (67") 841 G1	Neutral White	21.9	2500	84	0	4100 (0.379, 0.373)
PrimeSet RDL500 Vision 1700mm (67") 856 G1	Cool White	24.7	2700	85	0	5600 (0.330, 0.344)
PrimeSet RDL500 / 510 - 850 lux						
PrimeSet RDL500 1200mm (47") 841 G1	Neutral White	7.9	900	83	0	4100 (0.379, 0.373)
PrimeSet RDL500 1200mm (47") 856 G1	Cool White	9	1000	85	0	5600 (0.330, 0.344)
PrimeSet RDL500 1500mm (59") 841 G1	Neutral White	9.9	1200	83	0	4100 (0.379, 0.373)
PrimeSet RDL500 1500mm (59") 856 G1	Cool White	11.7	1300	85	0	5600 (0.330, 0.344)
PrimeSet RDL500 1700mm (67") 841 G1	Neutral White	11	1300	84	0	4100 (0.379, 0.373)
PrimeSet RDL500 1700mm (67") 856 G1	Cool White	12.9	1400	85	0	5600 (0.330, 0.344)

Note: - The rated power is based on DC input
- @ -20 °C

PrimeSet RDL500 / 510 module

Example of RDL modules with center and side mounting profiles placed in a five door freezer (top view).

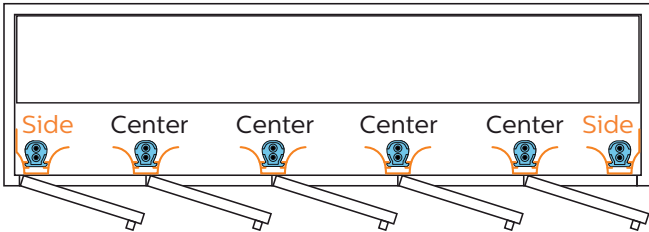

Dimensions (mm) PrimeSet RDL500 / 510 module

Type	A1	A3	B1	C1	mass (g)
PrimeSet RDL510 750mm (30")	748	770	20.5	23	170
PrimeSet RDL510 850mm (34")	848	870	20.5	23	200
PrimeSet RDL510 950mm (37")	948	970	20.5	23	220
PrimeSet RDL500 1200mm (47")	1198	1220	20.5	23	280
PrimeSet RDL500 1500mm (59")	1498	1520	20.5	23	250
PrimeSet RDL500 1700mm (67")	1698	1720	20.5	23	400

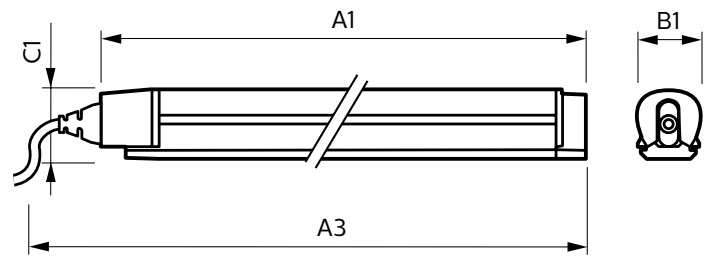

LED power driver

Power supply: Philips LED power driver

Philips PrimeSet LED display modules are only suitable for connection to a circuit from a class 2 power source with a limited energy supply. We have developed a LED power driver which is ideal for powering the PrimeSet modules.

To allow for variance in the installation, we recommend you do not load the power driver beyond 90% (20 W, 80 W and 100 W driver) of its rated maximum power. Please refer to the wiring diagram in the installation guide for more details.



Dimensions LED power driver

Type	A	B	C
LED Power driver 20W 24V	241	43	30
LED Power driver 80W 24V	241	43	30
LED Power driver 100W 24V 100/240V	150	36	27
Xitanium 77W 100-277V 3.2A XI077C320V024FNS1M	240	43.1	28.5
Xitanium 100W 100-277V 4.1A XI100C410V024FNS1M	240	43.1	28.5
LED driver outdoor 100W 100-240V 24V	150	36	27

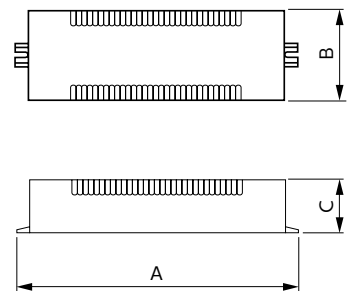
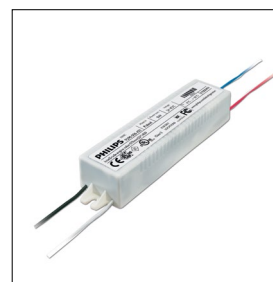
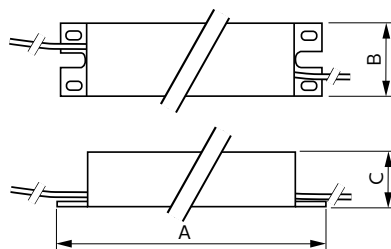

Xitanium Constant Voltage Outdoor driver 80 W and 100 W

Xitanium Constant Voltage Outdoor driver 20 W

Accessories

Mounting profiles with options for glare shielding

Our mounting profiles make it easy to install the modules. Thanks to the 'click-in' feature, the installation time is shortened considerably. The glare-free mounting profiles reduce glare to a minimum.

To ensure easy installation we supply mounting profiles that can be used to fix the modules in the mullions. They are available in two versions:

- Glare-free mounting profile for center module
- Glare-free mounting profile for side module

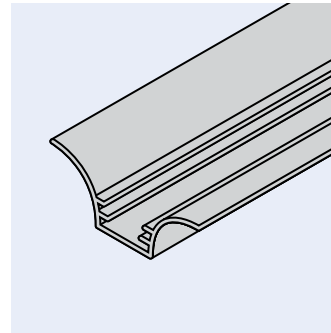

Glare-free mounting profile center

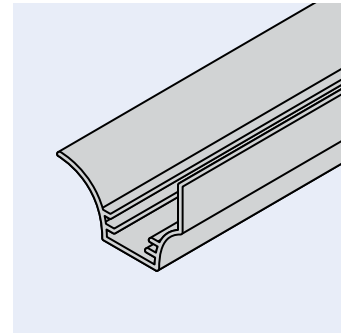

Glare-free mounting profile side

Dimensions mounting profile

Type	A	B1 Center	B1 Side	B2	C Center	C Side
PrimeSet RDL510 750mm (30")	715	56	46	23	23	40
PrimeSet RDL510 850mm (34")	815	56	46	23	23	40
PrimeSet RDL510 950mm (37")	915	56	46	23	23	40
PrimeSet RDL500 1200mm (47")	1167	56	46	23	23	40
PrimeSet RDL500 1500mm (59")	1468	56	46	23	23	40
PrimeSet RDL500 1700mm (67")	1668	56	46	23	23	40

Note: Standard glare free mounting shields are grey in color. Black glare shields are also available for North America the in select lengths.

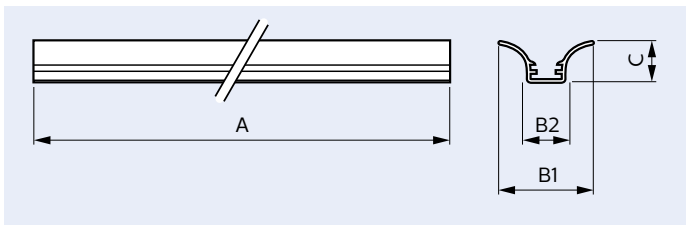

Glare-free mounting profile center

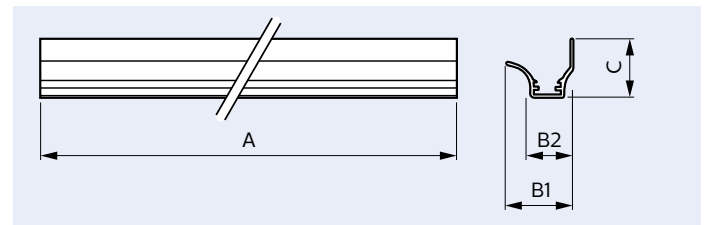

Glare-free mounting profile side

Ordering information

PrimeSet LED modules

Type	Minimum order quantity (per box)	Ordering code
Vision - 1600 lux		
PrimeSet RDL510 Vision 750mm (30") 841 G1	12	9290 009 34506
PrimeSet RDL510 Vision 750mm (30") 856 G1	12	9290 009 34406
PrimeSet RDL 510 Vision 850mm (34") 841 G1	12	9290 015 02006
PrimeSet RDL 510 Vision 850mm (34") 856 G1	12	9290 015 02106
PrimeSet RDL510 Vision 950mm (37") 841 G1	12	9290 009 34306
PrimeSet RDL510 Vision 950mm (37") 856 G1	12	9290 009 34206
◆ PrimeSet RDL500 Vision 1200mm (47") 841 G1	12	9290 015 01806
PrimeSet RDL 500 Vision 1200mm (47") 856 G1	12	9290 015 01906
◆ PrimeSet RDL500 Vision 1500mm (59") 841 G1	12	9290 009 34106
PrimeSet RDL500 Vision 1500mm (59") 856 G1	12	9290 009 34006
◆ PrimeSet RDL500 Vision 1700mm (67") 841 G1	12	9290 009 33906
PrimeSet RDL500 Vision 1700mm (67") 856 G1	12	9290 009 33806
Standard - 850 lux		
◆ PrimeSet RDL500 1200mm (47") 841 G1	12	9290 008 91106
PrimeSet RDL500 1200mm (47") 856 G1	12	9290 008 91006
◆ PrimeSet RDL500 1500mm (59") 841 G1	12	9290 008 90706
PrimeSet RDL500 1500mm (59") 856 G1	12	9290 008 90606
◆ PrimeSet RDL500 1700mm (67") 841 G1	12	9290 008 90306
PrimeSet RDL500 1700mm (67") 856 G1	12	9290 008 90206

Xitanium Constant Voltage Outdoor LED Power Driver

Type	Minimum order quantity (per box)	Ordering code
LED power driver 20W 24VDC 100-240V	10	9290 006 54006
LED power driver 80W 24VDC 120-240V	10	9290 016 69406
LED power driver 100W 24VDC 120-240V	10	9290 016 69506
LED power driver 150W 24VDC 120-240V	10	9290 021 01980
LED power driver 240W 24VDC 120-240V	10	9290 021 02080
LED transformer 20W 24VDC 120-277V	10	9290 021 05580
LED transformer 40W 24VDC 120-277V	10	9290 021 05680
LED transformer 60W 24VDC 120-277V	10	9290 021 05780
LED transformer 60W 24VDC 220-240V	10	9137 100 32267
LED transformer 100W 24VDC 120-277V	10	9290 021 05880
LED transformer 120W 24VDC 220-240V	10	9137 100 32567
LED transformer 150W 24VDC 220-240V	10	9290 021 05980
Xitanium 77W 100-277V 3.2A XI077C32OV024FNSIM *	20	9290 017 08113
Xitanium 100W 100-277V 4.1A XI100C41OV024FNSIM*	20	9290 007 71913
LED driver outdoor 100W 100-240V 24V**	10	9290 004 85303

* Only for NAM Region

** Only for Japan

© 2022 Signify Holding. All rights reserved. The information provided herein is subject to change, without notice. Signify does not give any representation or warranty as to the accuracy or completeness of the information included herein and shall not be liable for any action in reliance thereon. The information presented in this document is not intended as any commercial offer and does not form part of any quotation or contract, unless otherwise agreed by Signify.

Philips and the Philips Shield Emblem are registered trademarks of Koninklijke Philips N.V. All other trademarks are owned by Signify Holding or their respective owners. UK importer address: 3 Guildford Business Park, GU2 8XG



Accessories: Cables

Type	Minimum order quantity (per box)	Ordering code
Cable length - 2.5 meter		
PrimeSet RDL - Centre Cable 2.5m (98") B	24	9290 009 57206
PrimeSet RDL - Side Cable 2.5m (98") B	24	9290 009 57306
Cable length - 1 meter		
PrimeSet RDL - Centre Cable 1m (39") B	24	9290 008 92706
PrimeSet RDL - Side Cable 1m (39") B	24	9290 008 92806

Accessories: Mounting profiles for PrimeSet RDL500 / 510

Type	Minimum order quantity (per box)	Ordering code
750 mm length		
PrimeSet RDL-mount prof CTR 750mm	12	9290 008 94006
PrimeSet RDL-mount prof SD 750mm	12	9290 008 94706
850 mm length		
PrimeSet RDL-mount prof CTR 850mm	12	9290 015 07306
PrimeSet RDL-mount prof SD 850mm	12	9290 015 07406
950 mm length		
PrimeSet RDL-mount prof CTR 950mm	12	9290 008 94106
PrimeSet RDL-mount prof SD 950mm	12	9290 008 94806
1200 mm length		
PrimeSet RDL-mount prof CTR 1200mm	12	9290 008 94206
PrimeSet RDL-mount prof SD 1200mm	12	9290 008 94906
PrimeSet RDL-mount prof CTR 1200mm-47" B*	12	9290 008 97706
PrimeSet RDL-mount prof SD 1200mm-47" B*	12	9290 008 97806
1500 mm length		
PrimeSet RDL-mount prof CTR 1500mm	12	9290 008 94306
PrimeSet RDL-mount prof SD 1500mm	12	9290 008 95006
PrimeSet RDL-mount prof CTR 1500mm-59" B*	12	9290 008 94506
PrimeSet RDL-mount prof SD 1500mm-59" B*	12	9290 008 95206
1700 mm length		
PrimeSet RDL-mount prof CTR 1700mm	12	9290 008 94406
PrimeSet RDL-mount prof SD 1700mm	12	9290 008 95106
PrimeSet RDL-mount prof CTR 1700mm-67" B*	18	9290 008 94606
PrimeSet RDL-mount prof SD 1700mm-67" B*	12	9290 008 95306

* Black for North American Market

◆ Some PrimeSet are Design Lights Consortium qualified. Please see the DLC QPL list for exact catalog numbers www.designlights.org/QPL

www.philips.com/oem