

LIGHTBARS

SIRENS

SPEAKERS

WARNING LIGHTS

BEACONS

CAMERA SYSTEMS



THE DRIVING FORCE

DRIVING TECHNOLOGY TO PROVIDE EMERGENCY WARNING FOR FIRST RESPONDERS



Federal Signal is **The Driving Force™** behind the technology that provides safe and reliable emergency warning for first responders. It is our commitment to engineer the most reliable and high-performing products for your emergency vehicle.

Exclusive to Federal Signal, these technologies are identified on the following product pages. *Ask your local FS Representative how you can experience the latest in lighting and siren systems.*

Solaris® LED Reflector Technology



Federal Signal's Solaris® LED reflector design is engineered to significantly increase off-axis warning. The high-efficiency Solaris reflector maximizes the LED light source to eliminate dark spots and distribute 360-degrees of light coverage.



ROC (Reliable Onboard Circuitry™)

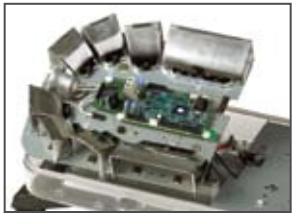

Federal Signal introduced a breakthrough in lightbar construction with the revolutionary ROC (Reliable Onboard Circuitry™) technology. ROC is manufactured to eliminate approximately 85% of the connection failure points found in a typical lightbar assembly. Wires, connections and assemblies have been replaced by PCB assemblies — reducing labor repair time and increasing the road time for emergency vehicles.



FS Convergence Network



The FS Convergence Network provides “plug-n-play” installation from Federal Signal's SmartSiren® Platinum, amplifier and controller, to our family of serial communication lightbars and the Solaris ILS Interior Lighting System (ILS).



SpectraLux™ Multicolor LED Technology



Exclusive to Federal Signal, SpectraLux™ multicolor LED technology provides the ability for a lighthouse to change color while in operation. SpectraLux is available in Vision SLR and Valor lightbars.



SLR (Solaris LED Rotator)



Federal Signal's Solaris SLR design significantly maximizes the LED light source for full light coverage. SLR rotators in the Vision SLR, provide rotating, oscillating, flashing and flood lighting functionality.





Lightbars/Mini-Lightbars

Vision® SLR4-5
 NFPA Vision® SLR 6
 3 Pod Vision® SLR 7
 Split Vision® SLR..... 7
 Valor™8-9
 Legend®..... 10
 LPX..... 11
 Arjent® S2..... 12
 JetSolaris®..... 13
 AeroDync® 14
 EMS Escape®..... 15
 HighLighter™ LED 16

Hook Kit Reference Guide 17

Lightbar Common Replacement Parts..... 18-19

Sirens/Speakers

SmartSiren® Platinum20
 PA300-CN 21
 PA300 22
 PA300R 22
 e-Q2B® Siren..... 23
 Q-Siren® 23
 Rumbler®..... 24
 PA640 24
 650 Series 25
 MS4000 25
 PA4000 25
 Touchmaster™ Delta/Touchmaster™ 26
 80K 27
 DynaMax®/ES100 28
 AS124 28
 BP Series..... 29
 TS100-N 29

Beacons

MicroEscape LED 30
 IVP SLR 30
 LED Rotator Beacon..... 31
 Pulsator® LED 31
 Sentry® 31

Exterior Mount/Perimeter Warning Lights

QuadraFlare® 9x7 32
 QuadraFlare® 6x4 34
 9x7 Scene Lights..... 34
 GHSCENE 34
 QuadraFlare® 7x3 34

Exterior Mount/Perimeter Warning Lights - continued

Signaltech® Lights..... 35
 Viper® EXT 35
 IPX6 IMPAXX® 36
 IPX3 IMPAXX® 36
 IMPAXX®/Viper™ EXT Brackets..... 37
 In-Line Corner LED Systems 38
 Corner LED Systems..... 38
 Silver Series™ SLD Systems 39
 MicroPulse™..... 40

Directional Warning Lights

SignalMaster™ Controllers 40
 VPX SignalMaster™ 41
 LED SignalMaster™ Plus 41
 SignalMaster™ 41

Interior Mount Warning Lights

Solaris® ILS 42
 Viper® S2 43

Area Lighting

VisiBeam® 44
 Night-Fighter® 44

Accessories

Opticom®..... 45
 Headlight/Taillight Flashers 46
 Littlite® 47
 Voice Gun 47
 Intelli-Flash® Flashers..... 48
 Switch Controls 48
 Evacuator® Back-up Alarms..... 48
 Reverse Cameras/Monitor Systems..... 49

Reference Guides

Fire Apparatus Product Reference 50
 Ambulance Product Reference 51
 Caprice Product Reference..... 52
 Impala Product Reference 52
 Charger Product Reference 53
 Motorcycle Product Reference 53

Lamp Replacement Parts..... 54

Terms and Conditions 58

General Price List Notes

1. Detailed product data sheets are at www.fedsig.com
2. For detailed information on how to order, consult the product data sheets or contact the factory at 800-264-3578.
3. All voltage is 12V unless marked otherwise. Contact the factory for pricing and availability of 24V models.
4. Most products are available in Amber, Blue, Clear and Red. Some products are available in Green. Consult product data sheet or contact the factory for more information.
5. "Specify All Options" base models are not available for sale without options.
6. When installing equipment inside airbag equipped vehicles, the installer must ensure that the equipment is installed only in areas recommended by the vehicle manufacturer.

Basic Terms and Conditions

1. Minimum billing on finished goods order is \$50.00 and parts order is \$25.00.
2. Prices are in U.S. dollars, FOB-University Park, IL or Anaheim, CA.
3. Past Due Interest: Amounts not paid when due shall be subject to past due interest at the rate of 18% per year or the highest rate permitted by law, whichever is less.
4. Authorized returns are subject to a 25% restocking charge. Returns of obsolete products, custom-configured products (such as custom lightbars), and products older than one year from original shipment by Federal Signal will not be accepted. A copy of the Product Returns Policy can be obtained from a Customer Support Representative.
5. Federal Signal is not responsible for equipment returned to Federal Signal without a valid Return Material Authorization. Call 800-264-3578 or 800-433-9132 to obtain a Returned Merchandise Authorization number (RMA number) or see www.fedsig.com
6. Prices and specifications subject to change without notice.
7. This document is not to be reprinted or reproduced without written permission of Federal Signal.

Vision® SLR

- SpectraLux™ Multicolor LED Technology available in combinations of Amber, Blue, Red and White
- Solaris® LED reflector technology for better optical efficiency and superior off-axis warning
- FS Convergence Network for “plug-n-play” installation and programming
- Individual pod replacement for easy servicing
- Optional LED HotFoot® mounting for LED takedowns or Slate (ALPR cameras)
- Single-color pod LEDs offered in Amber, Blue, Green, Red or White
- Optional LED alley caps
- Available in 46", 53" and 60" lengths
- LED aerial view reflector



Model	Description	List Price
46" Models - Choice of hook kit or permanent mount kit included		
VSLR46-00012	Red/Clear/Blue, (3) All Red LED rotators, (2) all Blue LED rotators, (2) multi-colored LED rotators, no controller-must use with SSP 3000, Red, Clear and Blue domes, no SignalMaster, Black hook-on mount	\$3,995.00
VSLR46-00003	Red/Clear/Blue, (3) All Red LED rotators, (2) all Blue LED rotators, (2) Multi-colored LED rotators, eight-head SignalMaster, no controller-must use with SSP3000, Red, Clear and Blue domes, Black hook-on mount	4,595.00
VSLR46-00004	Red/Clear/Blue, (3) All Red LED rotators, (3) all Blue LED rotators, (1) all White LED rotator, (2) LED alley lights, eight-head SignalMaster, HotFoot with (2) LED takedowns, no controller-must use with SSP3000, Red, Clear and Blue domes, HotFoot hook-on mount	5,015.00
53" Models - Choice of hook kit or permanent mount kit included		
VSLR53-00007	Red/Clear/Blue, (3) All Red LED rotators, (2) all Blue LED rotators, (2) multi-colored LED rotators, no controller-must use with SSP3000, Red, Clear and Blue domes, no SignalMaster, Black hook-on mount	4,195.00
VSLR53-00003	Red/Clear/Blue, (3) All Red LED rotators, (2) all Blue LED rotators, (2) multi-colored LED rotators, eight-head SignalMaster, no controller-must use with SSP3000, Red, Clear and Blue domes, Black hook-on mount	4,795.00
VSLR53-00004	Red/Clear/Blue, (3) All Red LED rotators, (3) all Blue LED rotators, (1) all White LED rotator, (2) LED alley lights, eight-head SignalMaster, HotFoot with (2) LED takedowns, no controller-must use with SSP3000, Red, Clear and Blue domes, HotFoot hook-on mount	5,215.00
60" Models - Choice of hook kit or permanent mount kit included		
VSLR60-00007	Red/Clear/Blue, (3) All Red LED rotators, (2) all Blue LED rotators, (2) multi-colored LED rotators, no controller-must use with SSP3000, Red, Clear and Blue domes, permanent mount	4,295.00

Accessories and Kits

HKB-Model	Hook, required with hook-on mount, specify vehicle (see page 17)	42.50
795H-EXT-VD	795H Opticom in sealed housing with bracket for “driver-side” mounting on Vision SLR lightbars	2,399.00
795H-EXT-VP	795H Opticom in sealed housing with bracket for “passenger-side” mounting on Vision SLR lightbars	2,399.00

Notes

- See page 18 for common replacement parts.
- See page 20 for SSP3000 models.
- Go to www.fedsig.com/products/296/vision_slr to view flash pattern videos

How to Order

Choose one of the popular models above, customize your own lightbar with our online configurator or contact a local Federal Signal representative or distributor.

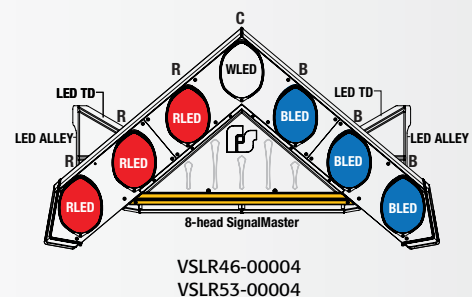
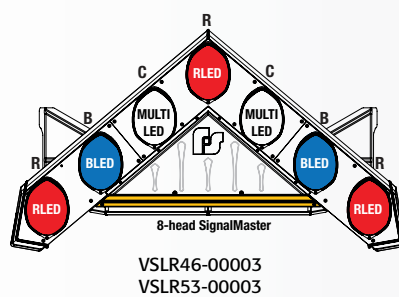
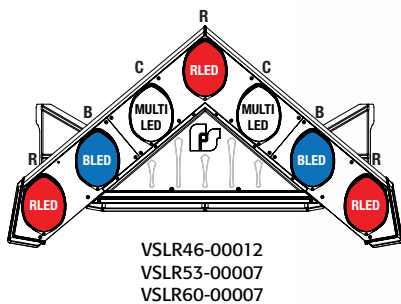



Vision® SLR

Superior Off-Axis Warning

Working with its unique V-shaped design, Vision SLR's microprocessor LED "Smart Pods" create superior off-axis warning, providing 360-degree coverage and critical off-axis intersection clearing.



SpectraLux™ Multicolor LED Technology

Exclusive to Federal Signal, SpectraLux provides the ability for a single light source to change colors. Individual Vision SLR Smart Pods can flash between Red, Blue, Amber or White.



Solaris® LED Reflector Design

Vision SLR's, patent-pending, Smart Pods are equipped with Federal Signal's Solaris® SLR designed to significantly maximize the LED light source for full light coverage. What's more impressive, each reflector features two LEDs that project light upward for easy aerial location of law enforcement vehicles.

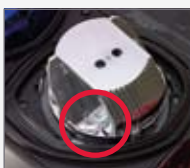

Stepper Motor

Provides a variety of flash rate options, oscillation angles, and the ability to jog a lighthead to desired fixed position.



Flood Light Capability

At a steady position, in all white mode, SpectraLux provides an impressive flood light to quickly illuminate an emergency scene.

Versatile Mounting

The mount brackets accommodate optional HotFoot® LED Take Down lights, or Federal Signal's Slate® cameras for ALPR (Automatic License Plate Recognition).



SignalMaster™

The Vision SLR offers an optional 8-head LED SignalMaster™ for directional warning.

Simple Installation

The Vision SLR lightbar can be controlled with SmartSiren® Platinum for use on the Federal Signal Convergence Network. The Vision SLR can be easily programmed using either a SmartSiren Platinum system or Vision control head and a standard laptop.



A serial interface module with your existing light controller can also be used to program and operate the features and function of the Vision SLR.



Easy Service

As simple as one-two-three: Remove screw, twist pod to remove from base and unplug the connection from the lightbar.

Dimming Feature

When activated, the dimming feature significantly reduces the light output intensity.

Available LED Colors

Single-color pods are available in Red, Amber, Blue, White or Green. SpectraLux option for pods provides Red, Amber, Blue and White.

Number of LEDs

- 12 LEDs per pod (7 pods)
- 48 LEDs in SML (8-heads, 6-LEDs per head)
- 6, 12, or 18 LEDs per HotFoot light
- 6 LEDs in Alley light

Current Draw

2.5 amps per pod x 7 pods = approx 18 amps
1 amp per SML head = total 8 amps

Vision® SLR NFPA



- SpectraLux™ Multicolor LED Technology available in combinations of Amber, Blue, Red or White
- Solaris® LED reflector technology for better optical efficiency and superior off-axis warning
- FS Convergence Network for “plug-n-play” installation and programming
- Individual Pod replacement for easy servicing
- Optional LED HotFoot® mounting for LED takedowns or Slate® (ALPR cameras)
- Single-color pod LEDs offered in Amber, Blue, Green, Red and White
- Optional LED alley caps
- Available in 46", 53" and 60" lengths
- LED aerial view reflector



Model	Description	List Price
46" Models - Choice of hook kit or permanent mount kit included		
VSLR46S-NFPA1	Red/Multi/Red, (5) All Red LED rotators, (2) multi-colored LED rotators, interface module, Red and Clear domes, no SignalMaster, Black hook-on mount	\$3,995.00
VSLR46S-NFPA2	Red/Multi/Red, (4) All Red LED rotators, (3) multi-colored LED rotators, interface module, Red and Clear domes, no SignalMaster, Black hook-on mount	4,270.00
VSLR46S-NFPA3	Red/Multi/Red, (5) All Red LED rotators, (2) multi-colored LED rotators, interface module, Clear domes, no SignalMaster, Black hook-on mount	3,995.00
VSLR46S-NFPA4	Red/Multi/Red, (4) All Red LED rotators, (3) multi-colored LED rotators, interface module, Clear domes, no SignalMaster, Black hook-on mount	4,270.00
VSLR46S-FIRE1	Multi, (7) multi-colored LED rotators, interface module, Clear domes, no SignalMaster, Black hook-on mount	5,370.00
53" Models - Choice of hook kit or permanent mount kit included		
VSLR53S-NFPA1	Red/Multi/Red, (5) All Red LED rotators, (2) multi-colored LED rotators, interface module, Red and Clear domes, no SignalMaster, Black hook-on mount	4,195.00
VSLR53S-NFPA2	Red/Multi/Red, (4) All Red LED rotators, (3) multi-colored LED rotators, interface module, Red and Clear domes, no SignalMaster, Black hook-on mount	4,470.00
VSLR53S-NFPA3	Red/Multi/Red, (5) All Red LED rotators, (2) multi-colored LED rotators, interface module, Clear domes, no SignalMaster, Black hook-on mount	4,195.00
VSLR53S-NFPA4	Red/Multi/Red, (4) All Red LED rotators, (3) multi-colored LED rotators, interface module, Clear domes, no SignalMaster, Black hook-on mount	4,470.00
VSLR53S-FIRE1	Multi, (7) multi-colored LED rotators, interface module, Clear domes, no SignalMaster, Black hook-on mount	5,570.00
60" Models - Choice of hook kit or permanent mount kit included		
VSLR60S-NFPA1	Red/Multi/Red, (5) All Red LED rotators, (2) multi-colored LED rotators, interface module, Red and Clear domes, no SignalMaster, permanent mount	4,295.00
VSLR60S-NFPA2	Red/Multi/Red, (4) All Red LED rotators, (3) multi-colored LED rotators, interface module, Red and Clear domes, no SignalMaster, Black hook-on mount	4,570.00
VSLR60S-NFPA3	Red/Multi/Red, (5) All Red LED rotators, (2) multi-colored LED rotators, interface module, Clear domes, no SignalMaster, Black hook-on mount	4,295.00
VSLR60S-NFPA4	Red/Multi/Red, (4) All Red LED rotators, (3) multi-colored LED rotators, interface module, Clear domes, no SignalMaster, Black hook-on mount	4,570.00

Accessories and Kits

HKB-Model	Hook, required with hook-on mount, specify vehicle (see page 17)	42.50
795H-EXT-VD	95H Opticom in sealed housing with bracket for "driver-side" mounting on Vision SLR	2,399.00
795H-EXT-VP	95H Opticom in sealed housing with bracket for "passenger-side" mounting on Vision SLR	2,399.00

Note

- See page 18 for common replacement parts.

How to Order

Choose one of the popular models above, customize your own lightbar with our online configurator or contact a local Federal Signal representative or distributor.

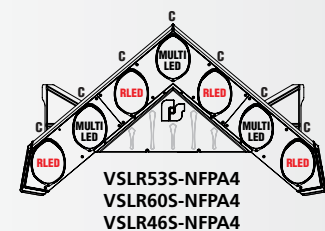
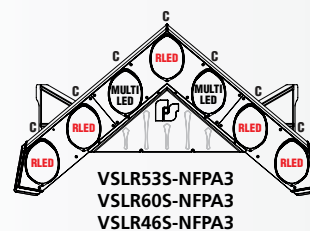
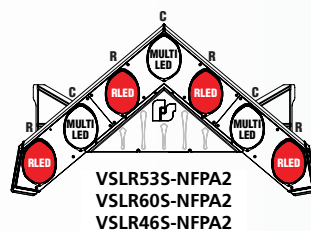
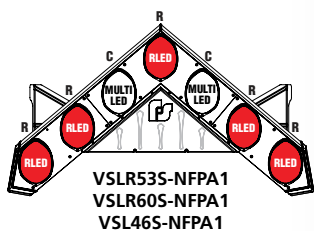

3 Pod Vision® SLR



- SpectraLux™ Multicolor LED Technology
- Solaris® LED reflector technology for better optical efficiency
- Individual Pod replacement for easy service

Model	Description	List Price
3-Pod Models - discrete wiring, permanent mount included		
VSLR3S-NFPA1	Red/Multi/Red, (2) All Red LED rotators, (1) multi-colored LED rotators, discrete wiring, Red and Clear domes, permanent mount	\$1,750.00
VSLR3S-NFPA3	Red/Multi/Red, (2) All Red LED rotators, (1) multi-colored LED rotators, discrete wiring, Clear domes, permanent mount	1,750.00

How to Order

Choose a pre-selected model above or contact your Federal Signal representative or distributor.

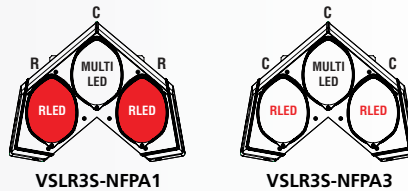

Split Vision® SLR



- Available in 6-Pod or 8-Pod models
- SpectraLux™ Multicolor LED Technology
- Solaris® LED reflector technology for better optical efficiency
- Individual Pod replacement for easy service
- May be used as part of NFPA 1901 compliant package

Model	Description	List Price
6-Pod Models - discrete wiring, permanent mount included		
VSLR6S-NFPA1	Red/Multi/Red, (4) All Red LED rotators, (2) multi-colored LED rotators, discrete wiring, Red and Clear domes, no SignalMaster, permanent mount	\$3,495.00
VSLR6S-NFPA3	Red/Multi/Red, (4) All Red LED rotators, (2) multi-colored LED rotators, discrete wiring, Clear domes, no SignalMaster, permanent mount	3,495.00
8-Pod Models - discrete wiring, permanent mount included		
VSLR8S-NFPA1	Red/Multi/Red, (6) All Red LED rotators, (2) multi-colored LED rotators, discrete wiring, Red and Clear domes, permanent Mount	3,995.00
VSLR8S-NFPA3	Red/Multi/Red, (6) All Red LED rotators, (2) multi-colored LED rotators, discrete wiring, Clear domes, permanent mount	3,995.00
VSLR8S-NFPA2	Red/Multi/Red, (4) All Red LED rotators, (4) multi-colored LED rotators, discrete wiring, Red and Clear domes, permanent mount	4,595.00
VSLR8S-NFPA4	Red/Multi/Red, (4) All Red LED rotators, (4) multi-colored LED rotators, discrete wiring, Clear and Clear domes, permanent mount	4,595.00

How to Order

Choose a pre-selected model above or contact your Federal Signal representative or distributor.

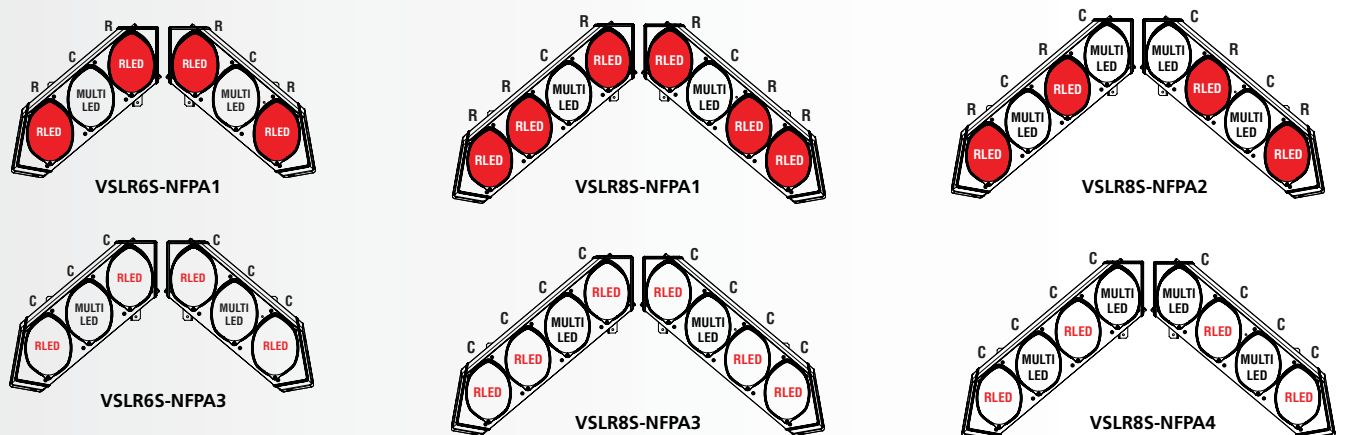

Valor™



- SpectraLux™ Multicolor LED Technology available in combinations of Amber, Blue, Red or White
- Patented ROC (Reliable Onboard Circuitry™) technology
- Solaris® LED reflector technology for better optical efficiency
- FS Convergence Network for "plug-n-play" installation and programming
- Quick disconnect for easy service removal from vehicle
- Optional LED HotFoot® mounting for LED alley and takedown lights or Slate® (ALPR cameras)
- Single-color lighthead offered in Amber, Blue, Green, Red or White
- Only 2-inches tall (not including mounts)
- Available in 44" and 51" lengths



Model	Description	List Price
	44" - Choice of hook kit or permanent mount included	
VALR44-00001	44", (6) Red LED reflectors, (6) Blue LED reflectors, (2) Blue/White LED reflectors (takedowns and alleys), (2) Red/White LED reflectors (takedowns and alleys), (4) Red/Amber LED reflectors, (4) Blue/Amber LED reflectors, Black hook mount, interface module	\$3,350.00
VALR44-00002	44", (6) Red LED reflectors, (6) Blue LED reflectors, (2) Blue/White LED reflectors (takedowns and alleys), (2) Red/White LED reflectors (takedowns and alleys), (4) Red/Amber LED reflectors, (4) Blue/Amber LED reflectors, HotFoot with (2) White LED takedowns, (2) White LED alley lights, Black hook mount, no controller - use with SSP3000	3,850.00
VALR44-00004	44", (1) Red LED reflector, (1) Blue LED reflector, (7) Red/White LED reflectors (takedowns and alleys), (7) Blue/White LED reflectors (takedowns and alleys), (4) Amber/Red LED reflectors, (4) Amber/Blue LED reflectors, Black hook mount, no-controller - use with SSP3000	3,800.00
	51" Models - Choice of hook kit or permanent mount included	
VALR51-00001	51", (24) Red LED reflectors, (4) Red/White LED reflectors (takedowns and alleys), Black hook mount, interface module	3,775.00
VALR51-00019	51", (2) Red LED reflectors, (2) Blue LED reflectors, (8) Red/White LED reflectors (takedowns and alleys), (8) Blue/White LED reflectors (takedowns and alleys), (4) Amber/Red LED reflectors, (4) Amber/Blue LED reflectors, Black hook mount, interface module	4,315.00
VALR51-00020	51", (8) Red LED reflectors, (8) Blue LED reflectors, (2) Red/White LED reflectors (takedowns and alleys), (2) Blue/White LED reflectors (takedowns and alleys), (4) Amber/Red LED reflectors, (4) Amber/Blue LED reflectors, Black hook mount, interface module	3,775.00

Accessories and Kits

HKB-Model	Hook required with hook-on mount, specify vehicle (see page 17)	42.50
LPO-HOOK	Kit, hook-on foot (require use of hook kit)	175.00
LPO-PERM	Kit, permanent mount	175.00
795H-EXT-VALRD	795H Opticom in sealed housing with bracket for "driver-side" mounting on Valor lightbars	2,399.00
795H-EXT-VALRP	795H Opticom in sealed housing with bracket for "passenger-side" mounting on Valor lightbars	2,399.00

Note

- See page 18 for common replacement parts.
- Go to www.fedsig.com/products/297/valor to view flash pattern videos

How to Order

Choose one of the popular models above, customize your own lightbar with our online configurator or contact a local Federal Signal representative or distributor.

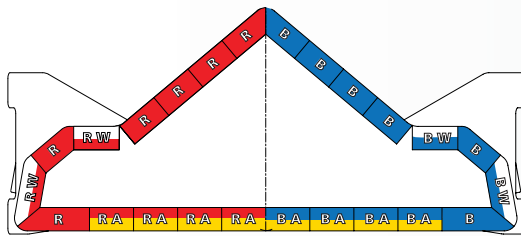

VALR44-00001

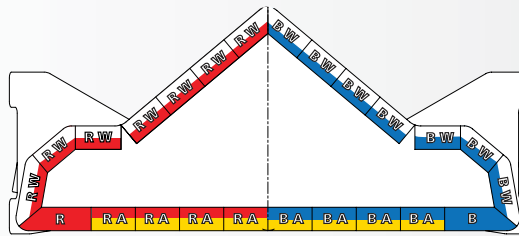

VALR44-00004

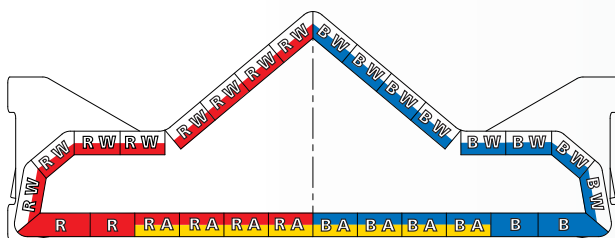

VALR51-00019

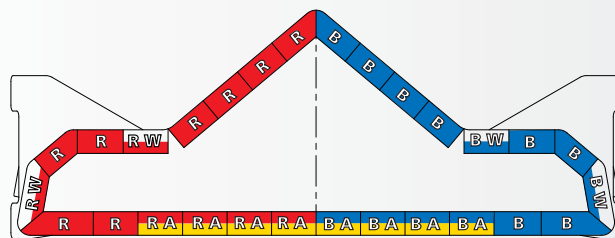

VALR51-00020

Valor™

SpectraLux™ Multicolor LED Technology

Exclusive to Federal Signal, SpectraLux provides the ability for a LED light head to change colors. Individual Valor lightheads can flash between Red, Blue, Amber or White.



Solaris® LED Reflector Design

Federal Signal's Solaris® LED reflector technology is engineered to significantly increase off-axis warning and maximize the LED light source to eliminate dark spots and distribute 360-degrees of light coverage.



ROC (Reliable Onboard Circuitry™) Technology

Federal Signal's patented ROC technology is manufactured to eliminate approximately 85% of the connection failure points found in a typical lightbar assembly. Wires, connections, and assemblies have been replaced by PCB assemblies — reducing labor repair time and increasing the road time for emergency vehicles.

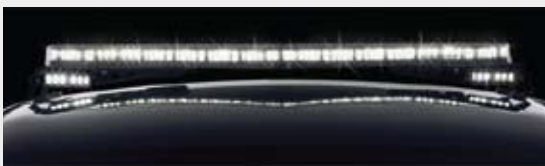

Flood Light Capability

At a steady position, in all white mode, SpectraLux provides an impressive flood light to quickly illuminate an emergency scene.

Versatile Mounting

The mount brackets accommodate optional HotFoot® LED Take Down and LED Alley Lights, as well as Federal Signal's Slate® cameras for ALPR (Automatic License Plate Recognition).



SignalMaster™

The Valor is built with an 8-head LED SignalMaster™ capability for directional warning.

Simple Installation

For maximum performance, the FS Convergence Network provides literal "plug-n-play" installation. Utilizing standard RJ45 connections, the Valor can be easily programmed using a SmartSiren® Platinum system. With control head programmability, the user can customize the keypad to meet their needs.



A serial interface module with your existing light controller can also be used to program and operate the features and functions of the Valor.



Easy Service

Valor can be serviced while on the roof top. Remove the single dome and easily disconnect the ROC board.

Dimming Feature

When activated, the dimming feature significantly reduces the light output intensity.

Clear Domes

For a sleek and stealthy appearance the Valor is available with Clear domes only.

Available LED Colors

Single-color options are available in Red, Amber, Blue, White or Green

Number of LEDs

In the 44-inch lightbar, if all positions are single-color:

1. Main bar: 24 heads x 6 LEDs each = 144 LEDs
2. HotFoot Takedown: 6, 12 or 18 LEDs per foot
3. Alley HotFoot: 6 LEDs

Current Draw

Without HotFoot lights - 24 amp - STEADY (44-inch)
With HotFoot lights - 28 amp -STEADY (44-inch)

Legend®

- Ultra bright White LED takedowns and alleys in main bar or HotFoot®
- Lightbar can be reconfigured on the vehicle
- Patented ROC (Reliable Onboard Circuitry™) technology
- Solaris® LED technology maximizes warning signals at 360-degrees and 90-degrees off-axis
- Built-in SignalMaster™ directional warning
- FS Convergence Network compatible for "plug-n-play" installation and programming
- Three or six-button serial controller available for light control only
- 24", 45", 53", 61" and 70" versions fit a wide variety of vehicle sizes
- LEDs offered in Amber, Blue, Green, Red and White
- Top covers offered in Amber, Blue, Clear and Red



Model	Description	List Price
LGD24Y-00065	24" Models - Permanent mount included Clear/Clear, (2) Red corner LED reflectors, (2) Red 5" LED reflectors, (1) Red 2" LED reflector, (2) Blue corner LED reflectors, (2) Blue 5" LED reflectors, (1) Blue 2" LED reflector, interface module, permanent mount	\$1,213.50
LGD45HY-00017	45" Models - Hook-on mount included Red/Blue, LED HotFoot with (2) LED takedowns and (2) LED alley lights, (2) Red corner LED reflectors, (1) Red 2" LED reflector, (3) Red 5" LED reflectors, (2) Blue corner LED reflectors, (1) Blue 2" LED reflector, (3) Blue 5" LED reflectors, (6) Amber 5" LED reflectors, interface module, Black hook mount	3,732.00
LGD45Y-00100	Red/Blue, (2) LED alley lights, (2) LED takedowns, (2) Red corner LED reflectors, (2) Red 5" LED reflectors, (2) Blue corner LED reflectors, (2) Blue 5" LED reflectors, (6) 5" Amber LED reflectors, interface module, Black hook mount	2,835.25
LGD53HY-00045	53" Models - Hook-on mount included Red/Clear/Blue, LED HotFoot with (2) LED takedowns and (2) LED alley lights, (2) Red corner LED reflectors, (1) Red 2" LED reflector, (3) Red 5" LED reflectors, (1) Red 4" LED reflector, (2) Blue corner LED reflectors, (1) Blue 2" LED reflector, (3) Blue 5" LED reflectors, (1) Blue 4" LED reflector, (6) Amber 5" LED reflectors, (2) Amber 4" LED reflectors, interface module, Black hook mount	4,360.25
LGD61NFPA-LA2	61" Models - Flat mount included Clear/Clear/Clear/Clear, (2) flashing LED takedowns, (4) Red 5" LED reflectors, (4) Red 4" LED reflectors, (4) Red corner LED reflectors, (2) Red 2" LED reflectors, interface module, flat mount	3,023.25

Accessories and Kits

660000	Six-button programmable controller, light control only	283.25
660300	Three-button programmable controller, light control only	170.00
HKB-(Model)	Hook required with hook-on mount, specify vehicle (see page 17)	42.50
Z8653168A	BP flat mount kit	110.25
Z8653134B	Hook mount kit	188.00
Z8653134B-01	Permanent mount kit	188.00
Z8653178A	Flat surface mount kit	125.00
795H-EXT-LGDD	795H Opticom in sealed housing with bracket for "driver-side" mounting on Legend lightbars	2,399.00
795H-EXT-LGDP	795H Opticom in sealed housing with bracket for "passenger-side" mounting on Legend lightbars	2,399.00

Notes

- Models listed above include an interface module unless otherwise noted
- Interface module not needed if lightbar is controlled with a SmartSiren Platinum (see page 20) or PA300-CN (see page 21).
- See page 18 for common replacement parts.
- Go to www.fedsig.com/products/263/legend to view flash pattern videos

How to Order

Choose one of the popular models above, customize your own lightbar with our online configurator or contact a local Federal Signal representative or distributor.

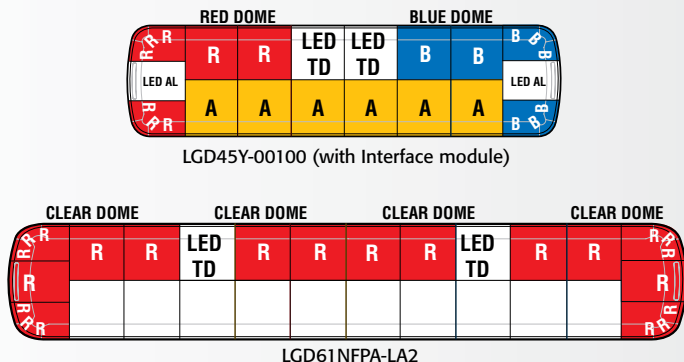
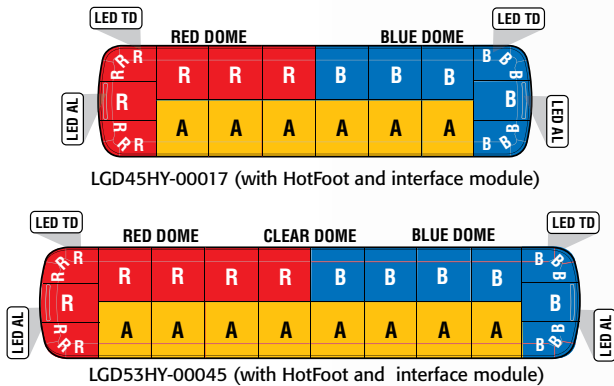

LPX Series



- Solaris® LED reflector technology
- Patented ROC (Reliable Onboard Circuitry™) technology
- FS Convergence Network compatible for “plug-n-play” installation and programming
- All-LED lightbar – LED alleys and LED takedowns available
- LEDs offered in Amber, Blue, Green, Red and White
- Top covers offered in Amber, Blue, Clear and Red
- Built-in SignalMaster, front/rear cut-off, intersection warning and “dimming” functions
- Same flash patterns, controller options and mounting option as standard Legend lightbars
- Available in 45", 53" and 61" lengths



Model	Description	List Price
45" Models - Hook-on mount included		
LPX45Z-00009	Red/Blue, (2) LED alley lights, (2) LED takedowns, (2) Red corner LED reflectors, (5) Red 5" LED reflectors, (2) Blue corner LED reflectors, (5) Blue 5" LED reflectors, interface module, Black hook mount	\$1,750.00
LPX45Z-00010	Red/Blue, (2) LED alley lights, (2) LED takedowns, (2) Red corner LED reflectors, (2) Red 5" LED reflectors, (2) Blue corner LED reflectors, (2) Blue 5" LED reflectors, (6) Amber 5" LED reflectors, interface module, Black hook mount	1,750.00
53" Models - Hook-on mount included		
LPX53Z-00018	Red/Blue, (2) LED alley lights, (2) LED takedowns, (2) Red corner LED reflectors, (2) Red 5" LED reflectors, (1) Red 4" LED reflector, (2) Blue corner LED reflectors, (2) Blue 5" LED reflectors, (1) Blue 4" LED reflector, (6) Amber 5" LED reflectors, (2) Amber 4" LED reflectors, interface module, Black hook mount	1,920.00
LPX53Z-00019	Red/Blue, (2) LED alley lights, (2) LED takedowns, (2) Red corner LED reflectors, (5) Red 5" LED reflectors, (2) Red 4" LED reflectors, (2) Blue corner LED reflectors, (5) Blue 5" LED reflectors, (2) Blue 4" LED reflectors, interface module, Black hook mount	1,920.00

Accessories and Kits

HKB-(Model)	Hook required with hook-on mount, specify vehicle (see page 17)	42.50
795H-EXT-LGDD	795H Opticom in sealed housing with bracket for “driver-side” mounting on Legend lightbars	2,399.00
795H-EXT-LGDP	795H Opticom in sealed housing with bracket for “passenger-side” mounting on Legend lightbars	2,399.00

Notes

- Models listed above include an interface module unless otherwise noted.
- Interface module not needed if lightbar is controlled with a SmartSiren Platinum (see page 20) or PA300-CN (see page 21).
- See page 18 for common replacement parts.

How to Order

Choose one of the popular models above, customize your own lightbar with our online configurator or contact a local Federal Signal representative or distributor.

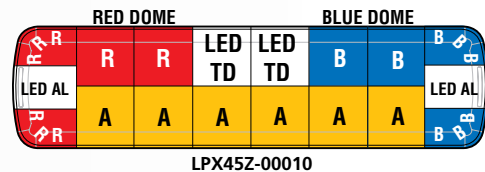
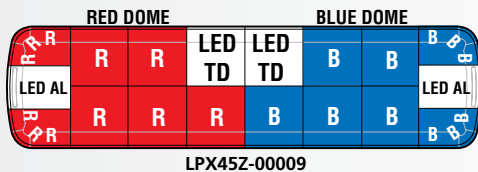

Arjent® S2



- Patented ROC (Reliable Onboard Circuitry™) technology eliminates approximately 85% of the potential failure points in a typical lightbar
- Solaris® LED reflector technology for better optical efficiency
- LED alley lights available
- Ultra bright White LED takedowns available
- Built-in SignalMaster™ directional warning in rear of lightbar
- FS Convergence Network compatible for true "plug-n-play" installation and programming
- Six-button serial controller available for light control only
- 36", 44" and 53" versions fit a wide variety of vehicle sizes
- LEDs offered in Amber, Blue, Green, Red and White
- Top cover colors are offered in Amber, Blue, Clear and Red



Model	Description	List Price
583002Y-00002	36" Model - Permanent mount included 36", Red/Blue, (8) Red 6-LED reflectors, (8) Blue 6-LED reflectors, (2) LED alley lights, Black permanent mount	\$2,607.75
583004Y-00002	44" Models - Hook-on mount included 44", Red/Clear/Blue, (2) LED takedowns, (2) LED alley lights, (6) Red 6-LED reflectors, (6) Blue 6-LED reflectors, (6) Amber 6-LED reflectors, Black hook mount	3,485.00
583004Y-00003	44", Red/Clear/Blue, (2) LED takedowns, (2) LED alley lights, (8) Red 6-LED reflectors, (8) Blue 6-LED reflectors, (2) Amber 6-LED reflectors, Neutral hook mount	3,485.00
583006Y-00003	53" Models - Hook-on mount included 53", Red/Red/Red/Red, (22) Red 6-LED reflectors, (2) LED takedowns, (2) LED alley lights, Black hook mount	4,002.25
583006Y-00004	53", Red/Clear/Clear/Blue, (2) LED takedowns, (2) LED alley lights, (7) Red 6-LED reflectors, (7) Blue 6-LED reflectors, (8) Amber 6-LED reflectors, Black hook mount	4,306.00

Accessories and Kits

660000	6-button programmable controller, light control only	283.25
HKB-(Model)	Hook required with hook-on mount, specify vehicle (see page 17)	42.50
XHK-SD	Kit, hook mount, Black	181.25
XHKN-SD	Kit, hook mount, Neutral	175.75
XPK-SC	Kit, permanent mount, Black	161.50
XPKN-SC	Kit, permanent mount, Neutral	161.50
795H	Installed Opticom option	1,565.00
795H-EXT-ARJD	795H Opticom in sealed housing with bracket for "driver-side" mounting on Arjent S2 lightbars	2,399.00
795H-EXT-ARJP	795H Opticom in sealed housing with bracket for "passenger-side" mounting on Arjent S2 lightbars	2,399.00

Notes

- Opticom available as installed option only.
- Models listed above include an interface module unless otherwise noted.
- Interface module not needed if lightbar is controlled with a SmartSiren Platinum (see page 20) or PA300-CN (see page 21).
- See page 18 for common replacement parts.

How to Order

Choose one of the popular models above, customize your own lightbar with our online configurator or contact a local Federal Signal representative or distributor.

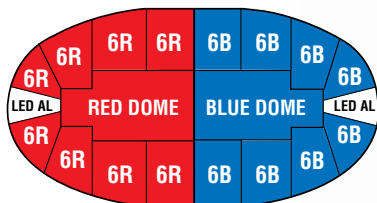

583002Y-00002

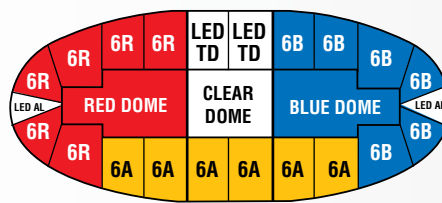

583004Y-00002

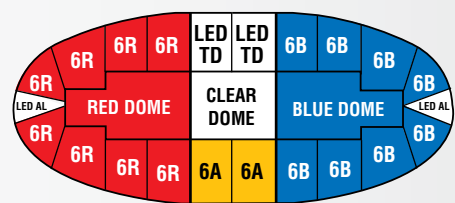

583004Y-00003

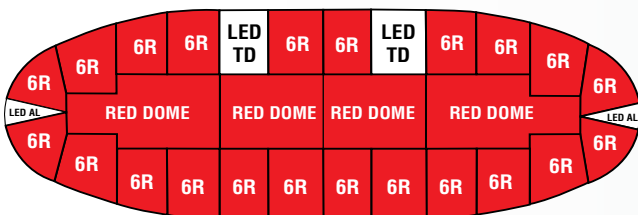

583006Y-00003

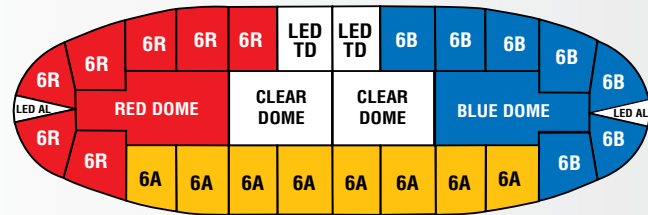

583006Y-00004

JetSolaris®

- Patented ROC (Reliable Onboard Circuitry™) technology
- All models feature Solaris® LED reflector technology
- Can be configured to meet NFPA and SAE requirements
- Available in 21", 48", 54", 60" and 72" lengths
- LEDs offered in Amber, Blue, Green, Red and White



Model	Description	List Price
	JetSolaris - mount kit included	
JLX48L2S-X2	48", Clear/Clear/Clear, (3) Red 6-LED reflectors, (3) Red 3-LED reflectors, (3) Blue 6-LED reflectors, (3) Blue 3-LED reflectors, (2) LED takedowns, (2) LED alley lights, six-head Amber LED SignalMaster made up of (4) Amber 6-LED reflectors and (2) Amber 3-LED reflectors	\$1,902.50
JLX4801-NFPA	48", Red/Clear/Red, (12) Red 6-LED reflectors, (6) Red 3-LED reflectors, (1) halogen traffic clearing light	1,815.00
JLX5401-NFPA	54", Red/Red/Red/Red, (8) Red 6-LED reflectors, (6) Red 3-LED reflectors, no rear lighting	1,555.00
JLX54LLS-X2	54", Clear/Clear/Clear/Clear, (4) Red 6-LED reflectors, (2) Red 3-LED reflectors, (4) Blue 6-LED reflectors, (2) Blue 3-LED reflectors, (2) LED takedowns, (2) LED alley lights, six-head Amber LED SignalMaster made up of (4) Amber 6-LED reflectors and (2) Amber 3-LED reflectors	2,115.00
JLX5498-NFPA	54", Red/Red/Red/Red, (16) Red 6-LED reflectors, (6) Red 3-LED reflectors	1,835.00
JLX6001-NFPA	60", Red/Red/Red/Red/Red, (9) Red 6-LED reflectors, (6) Red 3-LED reflectors, no rear lighting	1,852.00
JLX6002-NFPA	60", Red/Red/Clear/Red/Red, (8) Red 6-LED reflectors, (6) Red 3-LED reflectors, (1) halogen traffic clearing light, no rear lighting	1,990.00
JLX7250-NFPA	72", Clear/Clear/Clear/Clear/Clear/Clear, (8) Red 6-LED reflectors, (3) White 6-LED reflectors, (6) Red 3-LED reflectors, no rear lighting	2,275.00
	Mini-JetSolaris - mount kit included	
JLX2108-NFPA	21", (3) Red 6-LED reflectors (6) Red 3-LED reflectors, Red dome, no rear lighting	891.75

Kits

HKB-(Model)	Hook required with hook-on mount, specify vehicle (see page 17)	42.50
JNHK	Kit, hook mount brackets, Jet	91.25
UNPK	Kit, permanent mount, universal	84.75
JMPK	Kit, permanent mount, 21" Mini-JetSolaris	88.00

Note

See page 18 for common replacement parts.

How to Order

- Choose one of the popular models above, customize your own lightbar with our online configurator or contact a local Federal Signal representative or distributor.

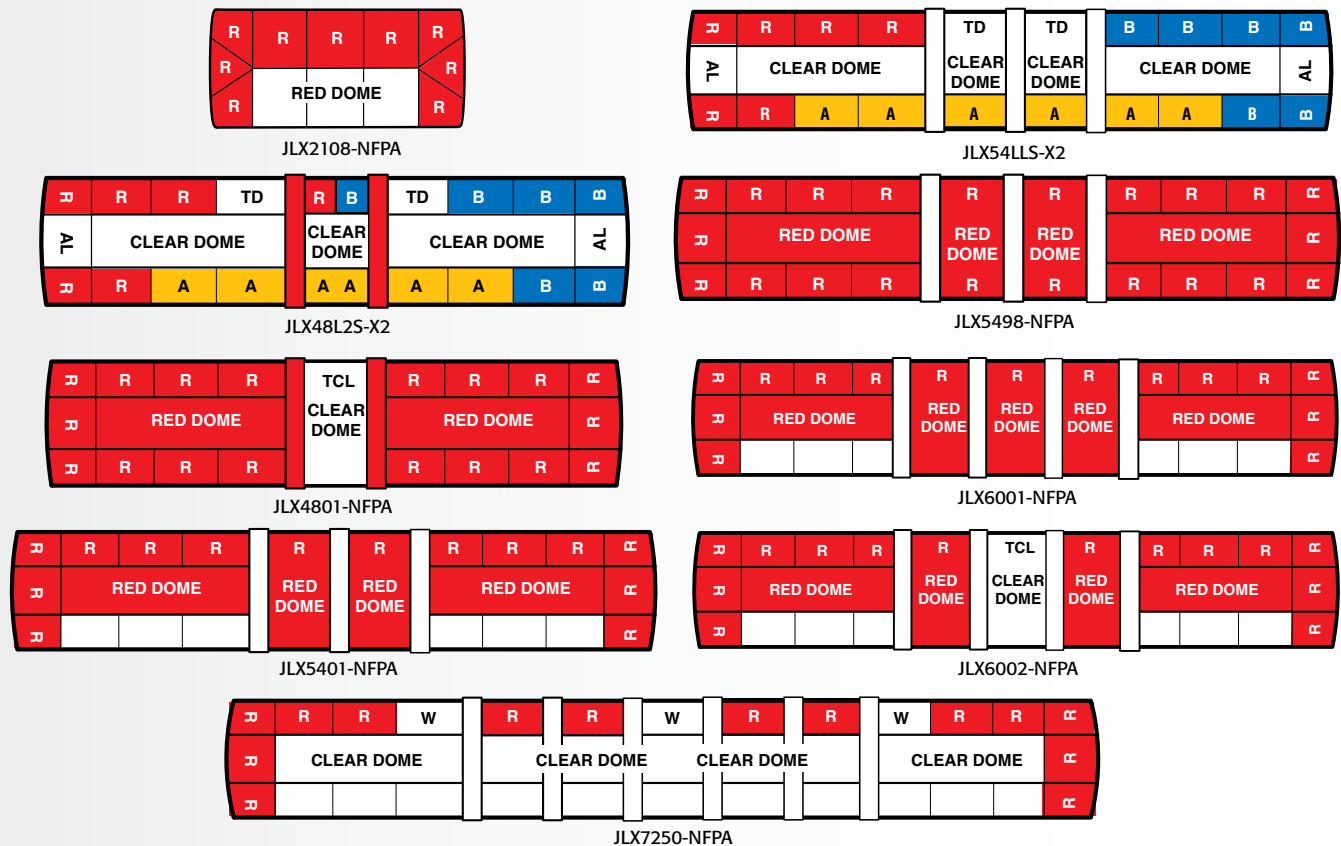

AeroDync®



- Traditional "candy-stripe" dome color configuration available
- Two-tier lightbar provides additional warning power
- Solaris® LED reflector technology provides a significant amount of warning power and attention-getting flash activity
- NFPA 1901 upper level compliant models available



Model	Description	List Price
	Solaris LED reflectors, purchase mount kit separately	
ADX2201	22", (8) Red large reflectors, no rear lighting	\$1,538.50
ADX5250	52", (Candy-Stripe), two-tier LEDs, (16) Red small reflectors, (8) White small reflectors, no rear lighting	3,702.75
ADX7205	72", two-tier LEDs, (12) Red large reflectors, (2) traffic clearing lights, no rear lighting	3,332.00
ADX7250	72", (Candy-Stripe), two-tier LEDs, (4) Red large reflectors, (12) Red small reflectors, (12) White small reflectors, no rear lighting	4,084.50
Kits		
22PK	Kit, Mini-AeroDync, 22", permanent mount	94.50
22MK	Kit, Mini-AeroDync, 22", magnetic mount	159.00
UNPK	Kit, permanent mount	84.75

Notes

- For 72" lightbars, two mounting kits are recommended.
- Before ordering replacement domes, contact the Federal Signal Service Department at (800) 433-9132 for a Dome Color Order form.
- See page 19 for common replacement parts.

How to Order

Choose one of the popular models above or customize your own lightbar by contacting a local Federal Signal representative or distributor. Do-it-yourself with the Specify All Options worksheet form AERO-WKS (halogen) available at www.fedsig.com. Contact your local Federal Signal representative for option details regarding the ADX LED models.

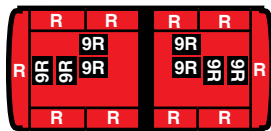

ADX2201

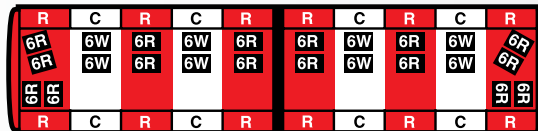

ADX5250

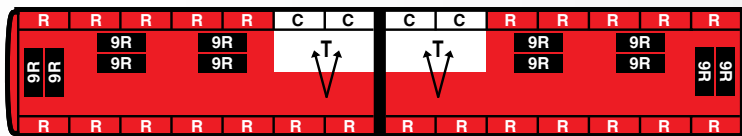

ADX7205

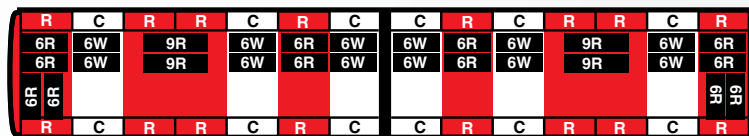

ADX7250

EMS Escape®



- Available with new QuadraFlare® LED reflectors
- Surface mount lightbar ideal for ambulances and rescue vehicles
- Custom lightbar lengths are available to fit any vehicle size
- Innovative Quick Track® mounting system eases OEM installation and allows for off-the-vehicle maintenance



Model	Description	List Price
ELX8847	88", (6) Red QuadraFlare LED reflectors, (1) Clear halogen flashing light	\$2,266.75
ELX8848	88", (6) Red QuadraFlare LED reflectors, (2) load lights, (1) Amber halogen flashing light	2,435.75
ELX9001	90", (6) Red QuadraFlare LED reflectors, (1) Clear halogen flashing light	2,266.75
ELX9002	90", (6) Red QuadraFlare LED reflectors, (2) load lights, (1) Amber halogen flashing light	2,435.75
Quick Track Mounting System		
QT2232	Use with 22" to 32" lightbars	149.50
QT52	Use with 52" lightbar	167.25
QT72	Use with 72" lightbar	185.50
QT8292	Use with 82" to 92" lightbars	197.25

Notes

- Flashers sold separately. [See page 48.](#)
- [See page 19](#) for common replacement parts.

How to Order

Choose one of the popular models above or customize your own lightbar by contacting a local Federal Signal representative or distributor. Do-it-yourself with the Specify All Options (SAO) worksheet EMSEscape-WKS available at www.fedsig.com.

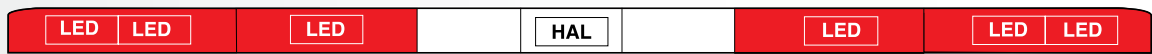

ELX8847/ELX9001 (front lightbar)



ELX8848/ELX9002 (rear lightbar)

Quick Track Mounting System



Step 1.
Mount Quick Track mounting plate to vehicle body.



Step 2.
Hook the top edge of the EMS Escape lightbar extrusion to the mounting plate.

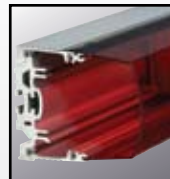

Step 3.
Allow the bottom of the lightbar to rest flush against the mounting plate.



Step 4.
Secure the EMS Escape to Quick Track mounting plate with supplied mounting hardware.



HighLighter® LED

- Solaris® LED reflector technology
- 21 Selectable flash patterns with synchronization capability
- Low-profile, only 2.6" tall
- 15" long



Model	Description	List Price
-------	-------------	------------

Split-color models with Clear dome only

Suction-cup magnet mount models include cigarette plug with on/off switch

454300C-AR	Amber/Red LEDs	\$684.50
454300C-AB	Amber/Blue LEDs	684.50
454300C-AW	Amber/White LEDs	709.50
454300C-BR	Blue/Red LEDs	684.50
454300C-BW	Blue/White LEDs	709.50
454300C-RB	Red/Blue LEDs	684.50
454300C-RG	Red/Green LEDs	709.50
454300C-RW	Red/White LEDs	709.50
454300C-GW	Green/White LEDs	734.50
454300CS-BWB	Blue/White/Blue LEDs	694.50
454300CS-RWR	Red/White/Red LEDs	694.50

Permanent mount models

454301C-AR	Amber/Red LEDs	645.25
454301C-AB	Amber/Blue LEDs	645.25
454301C-AW	Amber/White LEDs	670.25
454301C-BR	Blue/Red LEDs	645.25
454301C-BW	Blue/White LEDs	670.25
454301C-RB	Red/Blue LEDs	645.25
454301C-RG	Red/Green LEDs	670.25
454301C-RW	Red/White LEDs	670.25
454301C-GW	Green/White LEDs	695.25

Solid-color models

Suction-cup magnet mount models include cigarette plug with on/off switch

454200-02SC	Amber LEDs with Amber dome	598.75
454200-03SC	Blue LEDs with Blue dome	598.75
454200-04SC	Red LEDs with Red dome	598.75
454200-05SC	White LEDs with Clear dome	619.50
454200-06SC	Green LEDs with Green dome	619.50
454200-25SC	Amber LEDs with Clear dome	598.75
454200-35SC	Blue LEDs with Clear dome	598.75
454200-45SC	Red LEDs with Clear dome	598.75
454200-65SC	Green LEDs with Clear dome	619.50

Model	Description	List Price
-------	-------------	------------

Permanent mount models

454201-02SC	Amber LEDs with Amber dome	559.00
454201-03SC	Blue LEDs with Blue dome	559.00
454201-04SC	Red LEDs with Red dome	559.00
454201-05SC	White LEDs with Clear dome	579.00
454201-06SC	Green LEDs with Green dome	579.00
454201-25SC	Amber LEDs with Clear dome	559.00
454201-35SC	Blue LEDs with Clear dome	559.00
454201-45SC	Red LEDs with Clear dome	559.00
454201-65SC	Green LEDs with Clear dome	579.00
454216-04SC	Red LEDs with Red dome, no rear-facing LEDs	546.50
454216-45SC	Red LEDs with Clear dome, no rear-facing LEDs	546.50

Accessories and Kits

452340	Magnetic mount kit, cigarette plug included	40.25
452341	Suction cup magnetic mount, cigarette plug included	50.75
454217	Riser mount kit	59.50
454218	Flat mount kit	36.00
210883	Self-leveling bracket	67.00
Z8560109A	Magnet select key chain	15.00

Common Replacement Parts

Z8560095B-02	Dome, LED HighLighter, Amber; -03(Blue); -04(Red); -05(Clear)	19.75
Z124161A	Kit, Base, LED HighLighter	40.00

Notes

- If ordering a dome for a unit older than Series C, you must order a base kit (Z124161A)
- Go to www.fedsig.com/products/259/highlighter_led to view flash pattern videos

For the most up-to-date hook mount information, contact Customer Support at 800-264-3578.

CARS, VANS AND SUV'S			
MAKE/MODEL	YEAR	HOOK KIT MODEL #	ROOF WIDTH
FORD			
Crown Victoria	1992-11	HKB-CV92	46.0"
Edge	2012	HKB-FRD7	52.0"
Escape	2007-12	HKB-ESC7	49.5"
	2005-06	HKB-ESC5	49.0"
Expedition	2003-12	HKB-FTEX	52.0"
Explorer	2011-12	Permanent Mount	55.0"
	2008-10	HKB-XPL8	51.0"
	2000-06	HKB-WSTR	49.0"
Flex	2012	HKB-CHGR11	57.0"
Focus	2011-12	HKB-CHGR	48.0"
Fusion	2011-12	HKB-CHGR	48.5"
Mustang	2012	Permanent Mount	46.0"
Taurus	2011-12	HKB-TAR11	52.5"
	2009	HKB-TAR9	49.0"
Van	1987-11	HKB-SAV	65.0"
CHEVROLET/GM			
Camaro	2011-12	Permanent Mount	50.0"
Caprice	2011	HKB-CAP11B	49.25"
Cruze	2012	HKB-MAG7	46.5"
Equinox LS (NO Roof Rails)	2012	HKB-IMP7	48.5"
Express Van	2003-12	HKB-SAV	61.0"
Impala	2006-12	HKB-IMP7	46.5"
Malibu	2012	HKB-CHGR11	48.0"
	2008-11	HKB-MAL8	47.0"
	2007	HKB-MAL7	44.0"
Suburban (NO Roof Rails)	2007-12	HKB-TA10	55.0"
	2000-06	HKB-CK2	52.0"
Tahoe	2007-12	HKB-TA10	55.0"
	2000-06	HKB-CK2	52.0"
Trail Blazer/Envoy	2007-10	HKB-CK2	51.0"
	2006	HKB-S10	48.0"
Traverse	2012	Permanent Mount	53.0"
Uplander	2007-08	HKB-UPL7	50.0"
Volt	2012	HKB-CHGR11	47.50"
CHRYSLER/DODGE/JEEP			
200	2012	HKB-FRD4	50.0"
Challenger	2012	Permanent Mount	54.5"
Charger	2011-12	HKB-CHGR11	50.25"
	2006-10	HKB-CHGR	47.0"
Commander	2010	HKB-CK2	56.0"
Durango	2008-09	HKB-DUR8	48.0"
	2011-12	HKB-MAL7	54.0"
Durango (Slick Top)	2011-12	HKB-MAL7	54.0"
	2004-07	HKB-CK2	48.0"
Durango (Roof Rack)	2005-07	HKB-DURR	48.0"
Grand Caravan/Town & Country	2008-12	HKB-CAR8	60.0"
	1996-07	HKB-CARV	48.5"
Grand Cherokee	2011	HKB-MAL7	54.0"
Liberty	2012	HKB-CAR8	55.0"
Wrangler	2012	Permanent Mount	N/A

All Federal Signal lightbars may be permanent or hook-on mounted. When using a hook-on mount, a separate hook kit is required for the make, model and year of your vehicle. Use the hook kit reference guide to find your vehicle's appropriate hook kit. Measurements for the roof width are determined by the style of the vehicle. These measurements may help you in choosing the lightbar length best suited for you vehicle.

Permanent Mounting: (no hook kit required)

Vision and Vector models use VMPK permanent mount kit.

Vista models use XPK permanent mount kit.

JetStream, JetStrobe, AeroDync and All StreetHawk lightbars use UNPK permanent mount kit.

Hook-on Mounting: (refer to hook kit reference guide)

Vision and Vector models use VM-SB mounting brackets plus hook kit.

Vista models use XHK-SC brackets plus hook kit.

AeroDync and All StreetHawk lightbars use UNHK mounting brackets plus hook kit.

JetStream and JetStrobe use JNHK mounting brackets plus hook kit.

TRUCKS				
MAKE/MODEL	CAB STYLE	YEAR	HOOK KIT MODEL #	ROOF WIDTH
FORD				
F150	Reg	2009-10	HKB-FRD9	57.0"
		2007-08	HKB-FRD7	57.0"
		2004-06	HKB-FRD4	57.0"
	Ext/SuperCab	2009-11	HKB-FRD9	57.0"
		2007-08	HKB-FRD7	57.0"
		2004-06	HKB-FRD4	57.0"
	Crew/SuperCrew	2009-11	HKB-FRD9	57.0"
		2007-08	HKB-FRD7	57.0"
		2004-06	HKB-FRD4	57.0"
F250/350/450	Reg	2007-11	HKB-FHD7	58.5"
		2004-06	HKB-DKTA	58.5"
	Ext/SuperCab	2007-11	HKB-FHD7	58.5"
		2004-06	HKB-DKTA	58.5"
	Crew	2007-11	HKB-FHD7	58.5"
		2004-06	HKB-DKTA	56.5"
Ranger	Reg	2002-10	HKB-DKTA	48.5"
	Ext/SuperCab	2002-10	HKB-DKTA	48.5"
CHEVROLET				
Avalanche	Crew	2002-12	HKB-CK2	55.0"
Colorado/Canyon	Reg	2007-12	HKB-COL7	45.5"
		2004-06	HKB-COLO	45.0"
	Ext	2007-12	HKB-COL7	45.5"
		2004-06	HKB-COLO	45.0"
	Crew	2007-12	HKB-COL7	45.5"
		2004-06	HKB-COLO	45.0"
Silverado Classic/Sierra Classic (1500, 2500, 3500)	Reg	2001-07	HKB-CK2	52.0"
	Ext	2001-07	HKB-CK2	52.0"
	Crew	2001-07	HKB-CK2	52.0"
Silverado/Sierra (1500, 2500, 3500)	Reg	2007-12	HKB-TA07	55.0"
	Ext	2007-12	HKB-TA07	55.0"
	Crew	2007-12	HKB-TA07	55.0"
DODGE				
Dakota	Club	2005-07	HKB-DKTA	45.5"
	Quad	2005-11	HKB-DKTA	45.5"
Ram (1500, 2500, 3500)	Reg	2010-12	HKB-FRD9	57.5"
		2003-05	HKB-RAM2	48.5"
		2010-12	HKB-FRD9	57.5"
	Mega	2003-07	HKB-RMQ4	51.0"
		2010-12	HKB-FRD9	57.5"
		2007	HKB-RMQ4	52.5"

Notes

The hook kit reference guide is updated on an ongoing basis as information becomes available. Please check the hook kit reference guide online at www.fedsig.com for up-to-date vehicle and hook kit listings. For older vehicle make and model year hook kit offerings, please contact Customer Support at (800) 264-3578.

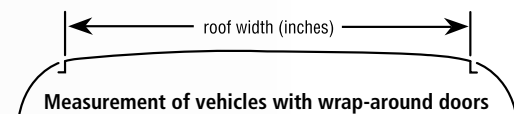
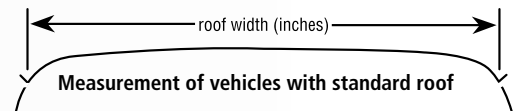



COMMON REPLACEMENT PARTS

Model	Description	List Price
Vision SLR		
Z1461855A-252	Harness, power/ground	\$119.75
Z1751575A-300	Cable, communication, external	78.75
Z2005639B	Controller replacement board	440.00
Z8652106A	Dome, POD, Clear	33.75
Z8652249A-MA	POD assembly, multi-color	1,458.50
Valor		
Z1461855A-252	Harness, power/ground	\$119.75
Z1751575A-300	Cable, communication, external	78.75
Z2005653A	Controller replacement board	341.25
Z8651101A	Lens, 44" Valor	146.00
Raydian S2		
Z1751357A-02	RS485, 25-ft interface cable assembly	\$23.25
Z1751364B	Cable, interface, 36"	62.00
Z8572029C	Mounting pad, rubber	10.00
Z8583446D	Interface module with cable assembly	306.75
Z8654101D	Dome end and dome screws, Clear; -03(Blue); -04(Red)	59.25
Z8654113C	Dome, Raydian S2, HotFoot, passenger front/driver rear, Clear	15.25
Z8654114C	Dome, Raydian S2, HotFoot, passenger rear/driver front, Clear	15.25
Z8654228A	Lens, main bar, extruded, fits 42" lightbar	78.75
Z8654234B	Dome, seal, Raydian S2 only	21.75
Z8583469D	Serial interface module	240.50
Legend/ LPX Legend		
Z1751357A-02	RS485, 25-ft Interface cable assembly	\$23.25
Z1751364B	Cable, Interface, 36"	62.00
Z8107169A	Bulb, GH8, Bi-pin alley/takedown light, 50W halogen	10.50
Z8107241A	Bulb, alley light, 35W, 10-degrees spot, MR-11	18.00
Z8583020B-01	Gasket, dome, Clear, 6-ft required per base, sold by the foot	4.25
Z8583446D	Interface module with cable assembly	306.75
Z8583469D	Serial interface module	240.50
Z8653100A	Base, end, Clear	42.50
Z8653101A	Dome, end, Clear; -02(Amber); -03(Blue); -04(Red)	45.00
Z8653102A	Base, center, Clear	25.00
Z8653103A	Dome, center, Clear; -02(Amber); -03(Blue); -04(Red)	28.50
Arjent S2		
Z1751357A-02	RS485, 25-ft Interface cable assembly	\$23.25
Z1751364A	Cable, interface, 36"	62.00
Z8107169A	Bulb, GH8, Bi-pin alley/takedown light, 50W halogen	10.50
Z8107241A	Bulb, alley light, 35W, 10-degrees spot, MR-11	18.00
Z8583218A	Dome, outboard, Clear; -01(Red); -02(Amber); -03(Blue)	50.25
Z8583219A	Dome, center, Clear; -01(Red); -02(Amber); -03(Blue)	50.25
Z8583446D	Interface module with cable assembly	306.75
Z8583469D	Serial interface module	240.50
JetSolaris		
Z8107141A	Bulb, JetSolaris/JetStream/JetStrobe, traffic clearing light, 50W	\$10.50
Z8552314C	Dome, JetSolaris/JetStream/JetStrobe, center, Clear	27.00
Z8552348A-02	Bulkhead and gasket assembly, Amber	19.25
Z8552348A-05	Bulkhead and gasket assembly, Clear	19.25
Z8552D054D	Dome, JetSolaris/JetStream/JetStrobe, outboard, Clear; -01(Red); -02(Amber); -03(Blue)	98.25
Vector/Smart Vector		
Z2001128C	PC board, Smart Vector lightbar controller (software not included)	\$498.75
Z8107141A	Bulb, Smart Pod, Vision/Vision SL, 50W	10.50
Z8107A119A	Bulb, alley/takedown light, 50W	10.50
Z8440A265A-02	Bulb, rotator/oscillating light, 55W	15.00
Z8548A028A	Bulb, flashing light, 35W	15.00
Z8572001A	Dome, Vector/Vision/Vision SL/ViewPoint, Clear; -01(Red); -02(Amber); -03(Blue); -04(Green)	20.75
Z8573007A	Bulb, SignalMaster, 27W	10.50
Z8573229A-02	LED module/lens, Vector/Vision, SignalMaster, Amber LEDs, Clear lens	101.00
Z8573229A-05	LED module/lens, SignalMaster, Amber LEDs, Amber lens	101.00
Z8573180A	Reflector and terminal assembly, SignalMaster, Vision	15.00



Model	Description	List Price
ViewPoint/Vector-Fire/EMS		
Z8572001A	Dome, Vector/Vision/Vision SL/ViewPoint, Clear; -01(Red); -02(Amber); -03(Blue); -04(Green)	\$20.75
Z8654167A	6-LED, Solaris assembly; -02(Amber), -04(Red)	178.50
Z8654167A-03	6-LED, Solaris assembly, Blue	214.50
Z8654167A-05	6-LED, Solaris assembly, White	214.50
Z8654167A-06	6-LED, Solaris assembly, Green	280.00
Vision SL		
Z146863B	Cable, RJ11 telephone cable, 25-ft, all models	\$17.00
Z146903B	Cable assembly, RJ45, 25-ft	21.00
Z2005325C	PC board, Smart Pod, SignalMaster controller board	260.75
Z8572001A	Dome, Vector/Vision/Vision SL/ViewPoint, Clear; -01(Red); -02(Amber); -03(Blue); -04(Green)	\$20.75
Z8572101A	Smart Pod assembly, Vision/Vision SL, driver side, no dome	155.00
Z8572101A-02	Smart Pod assembly, Vision/Vision SL passenger side, no dome	155.00
Z8572191C-S	Amplifier assembly, Vision/Vision SL	839.00
Z8572294C	Legend inserts	10.00
Z8572311A-02	Control head, Vision/Vision SL	393.75
Z8572473B-VSL	PC board assembly	462.00
MNCT-SB	Microphone, noise-cancelling, PA/Radio	48.75
RMK	Kit, microphone extension, SmartSiren/Vision amplifiers	101.00
RMK-V	Kit, microphone extension with PA volume control, SmartSiren/Vision amplifiers	136.75
UPKM-3	Kit, Park Siren Deactivator module, all siren models	50.75
Z8654167A	6-LED Gen III, Solaris Assembly; -12(Amber), -14(Red)	178.50
Z8654167A-13	6-LED Gen III, Solaris Assembly, Blue	214.50
Z8654167A-15	6-LED Gen III, Solaris Assembly, White	214.50
Z8625159B-A	Cuda SignalMaster assembly, Amber	244.50
Vector SL/Smart Vector SL		
Z2005325C	PC board, SmartPod, SignalMaster controller board	\$260.75
Z8572001A	Dome, Vector/Vision/Vision SL/ViewPoint, Clear; -01(Red); -02(Amber); -03(Blue); -04(Green)	\$20.75
Z8572496A-SVS	PC board assembly, Smart Vector SL with SignalMaster, software included	309.75
Z8572496A-VC	PC board assembly with software, Vector SL	309.75
Z8654167A	6-LED, Solaris assembly; -12(Amber), -14(Red)	178.50
Z8654167A-13	6-LED, Solaris assembly, Blue	214.50
Z8654167A-15	6-LED, Solaris assembly, White	214.50
Z8654167A-16	6-LED, Solaris assembly, Green	280.00
Z8625159B-A	Cuda SignalMaster assembly, Amber	244.50
EMS Escape		
Z8003016A	Rotator assembly, EMS Escape, 95 FPM	\$155.00
Z8003016A-01	Rotator assembly, EMS Escape, 175 FPM	111.50
Z8003016A-02	Rotator assembly, EMS Escape, 120 FPM	155.00
Z8003032B	Reflector assembly, halogen, EMS Escape	118.75
Z8003043A	Scene light assembly, EMS Escape	117.00
Z8003053A	Alley light assembly, EMS Escape	187.00
Z8107141A	Bulb, rotator	10.50
Z8107152A	Bulb, EMS Escape, flashing light	10.50
Z8003003A-02	Lens, Endcap, Amber	16.50
Z8003003A-03	Lens, Endcap, Blue	46.25
Z8003003A-04	Lens, Endcap, Red	25.75
Z8003003A-05	Lens, Endcap, Clear	25.75
Z8003004A	Gasket, Endcap	22.25
Z8003055A	Gasket, spacer	15.00
Z8003105B-01	9-LED Gen III, Solaris assembly with bracket, Red	288.75
Z8003105B-02	9-LED Gen III, Solaris assembly with bracket, Blue	288.75
Z8003105B-04	9-LED Gen III, Solaris assembly with bracket, White	288.75
AeroDync		
8542538A-SPEC	Dome, AeroDync, 48", All-light (4 1/2 panels)	\$170.25
8542AH2-SPEC	Dome, AeroDync, 72", All-light	263.75
8542D032A-SPEC	Dome, AeroDync, 52", (4 panels)	164.50
8542D168A-SPEC	Dome, AeroDync, 52", All-light (5 panels)	170.75
8542D170A-SPEC	Dome, AeroDync, 22", All-light (2 panels)	105.50
8542D217A-SPEC	Dome, AeroDync, 48" (3 1/2 panels)	154.00
Z288933B-A	9-LED Gen III, Solaris assembly, Amber	254.25
Z288933B-B	9-LED Gen III, Solaris assembly, Blue	254.25
Z288933B-R	9-LED Gen III, Solaris assembly, Red	254.25
Z288933B-W	9-LED Gen III, Solaris assembly, White	254.25



SmartSiren® Platinum

- FS Convergence Network compatible
- Simple Windows® based programming
- Total system diagnostics
- Provides serial communication to all ROC (Reliable Onboard Circuitry™) technology enabled lightbars
- Fourteen discrete and programmable outputs for non-serial products
- Four auxiliary inputs
- Locking, rugged power connectors
- Familiar and functional control head design



Model	Description	List Price
SSP3000	100/200W, programmable, diagnostic and full-featured light and siren controller including SignalMaster, microphone included	\$1,699.00

Common Replacement Parts

Z1751357A-02	RS485 cable, 25-ft	23.25
Z1751357A-06	Cable to link boards, 8"	10.00
Z1751530A	Cable assembly, amplifier control	108.75
Z1751532A	Cable assembly, ethernet	15.00
Z1751541A	Relay cable assembly	31.25
Z1751542A	Cable assembly, SignalMaster and input	52.00
Z1751543A	Cable, control head	19.75
Z258B577B-03	Replacement microphone	61.50
Z85361208A	Control head assembly, SSP3000	889.50
Z85361211A	Amplifier assembly, SSP3000	1,426.50
Z85361214A	Kit, accessory, SSP3000	23.25
Z85361215C	Kit, software, CD, SSP3000	46.25
Z8572294C	Legend inserts	10.00



Fourteen Relay Outputs

More than ever before.

SmartSiren Platinum has the flexibility for more control in your vehicle with up to 14 relay outputs.



SignalMaster Functionality

Form meets function.

SmartSiren Platinum features four 3-amp auxiliary outputs and SignalMaster control outputs in the rear of the unit – plus four control inputs for additional automation.



Siren Control and Diagnostics

Total Control & Confirmation.

Easily accessible, the external volume adjustment for radio rebroadcast and public address is at your finger tips – and at a glance visual confirmation that power is being supplied to the unit.



Visual Communication

Improved visual communications.

For convenient visual reference, the SmartSiren Platinum control system emulates the selected pattern of the SignalMaster operation.



Simple Siren Maintenance

Easy maintenance and trouble-shooting.

Finding short circuits and changing fuses for horns and sirens has never been simpler.



Smart Software / Fleet Management

Brilliance multiplied.

SmartSiren Platinum gives you the ability to clone an entire fleet of remote control head functions. Simply connect the SmartSiren to the PC and download the functions of the programmed software from one head to another...and another.



Serial Communication

Brilliantly simple Convergence Network.

Six plug-n-play serial ports on SmartSiren Platinum can be used with Federal Signal's unique Convergence Network for connection to the remote control head and all compatible lightbars and Federal Signal's Internal Lighting System.



FS Convergence Products:

- Vision SLR
- Legend
- Arjent S2
- Solaris ILS
- Valor
- LPX
- PA300-CN

Warning: Sirens and Speakers may produce LOUD sounds necessary to request the right-of-way. Siren and Speakers may cause hearing damage. Wear hearing protection.

PA300-CN

- 100/200-Watt siren with lighting and SignalMaster control capability
- Siren tones include: Wail, Yelp, Priority, Air Horn and Manual
- Programmable, remote control head with noise-cancelling microphone
- FS Convergence Network compatible



Model	Description	List Price
690200	PA300-CN, 100W/200W electronic siren and light controller with "FS Convergence Network" capability. Includes amplifier, control head, noise-cancelling microphone, serial relay module and hardware/accessory kit	\$999.00



Control Head

- 17 push-buttons and 4-position slide-switch
- Programmable using configuration software
- Same control head as used in SmartSiren Platinum
- Capable of SignalMaster control in FS Convergence Network lightbars and Solaris ILS



Amplifier

- Traditional PA300 siren tones
- PA and radio rebroadcast with volume control
- TAPII horn ring transfer



Relay Module

- 4 Relay outputs (two 10-amp and two 15-amp) max not to exceed 40 amps
- Enables installer to connect discrete-wired lights and other equipment to the FS Convergence Network so they can be controlled by the siren control head



Serial Communication Brilliantly simple Convergence Network.

Plug-n-play serial ports on PA300-CN can be used with Federal Signal's unique Convergence Network for connection to the remote control head and all compatible lightbars and Federal Signal's Internal Lighting System.



FS Convergence Products:

- Vision SLR
- Valor
- Legend
- LPX
- Arjent S2
- Solaris ILS
- SmartSiren Platinum



New Product Available 2nd Quarter 2012

690200

Warning: Sirens and Speakers may produce LOUD sounds necessary to request the right-of-way. Siren and Speakers may cause hearing damage. Wear hearing protection.



PA300

- High-reliability with durable switching
- External PA gain control
- Full featured siren in compact package
- Built-in noise-cancelling microphone
- Easily accessible fuse protection
- Effective TAP II intersection clearing feature
- Meets Class A sound output requirements



Siren tones available online

Model	Description	List Price
690000	100W, PA300-012MSC, hi-lo tone, hard-wired microphone	\$412.25
690002	100W, PA300-012MSCPTY, priority tone, hard-wired microphone	412.25
690009	200W, PA300-024MSC, hi-lo tone, hard-wired microphone, 24V	435.25
690010	200W, PA300-012MSC, hi-lo tone, hard-wired microphone	435.25

Accessories and Kits

761300	Kit, PA300 Series, adapter cable harness converts to new 690000 PA300 design	16.50
MNCT-SB	Microphone, noise-cancelling, PA/Radio	48.75
DSM	Kit, PA300 Series, bezel for dash mount	49.25

Common Replacement Parts

Z122376A	Switch, 690 Series, function/tone selector	18.00
Z122377A	Switch, 690 Series, air horn	15.00
Z125467A	Transistor, 690 Series, output	28.75
Z141A102	Knob, PA300, gain control	4.25
Z141A111	Knob, PA300, function/tone selector	10.00
Z1461360A	Wire harness, 690 Series, 4-ft length, 12VDC	42.00
Z258B577B-03	Microphone, PA300, use with 690 models	61.50
Z8537561A	Accessory kit, connectors, bracket, hardware	83.00

Notes

- To use Park Siren feature on '98 or newer Ford vehicles and '01 and newer Chevrolet vehicles, the UPKM-3 Park Siren Deactivator must be used (purchased separately).
- California Code of Regulations (CCR) Title 13, Article 5, states "Electronic sirens shall have a wail function and may also have manual and yelp functions. No other function is permitted on sirens sold (in CA) after January 1, 1982, except for voice communications".

PA300R

- Available in single and dual remote mounted control versions
- Includes remote mount noise-cancelling microphone and volume control
- Siren features Wail, Yelp, Air-horn, Hi/Low tones, Manual, and Tap II intersection clearing
- Use with (1) or (2) 100-watt speakers or (1) 200-watt speaker
- Control heads feature illuminated legends, LED indicators and large durable switches for easy control



Siren tones available online

Model	Description	List Price
690014	100/200, remote mounted control, dual control head, noise-cancelling microphone	\$822.25
690015	100/200, remote mounted control, single control head, noise-cancelling microphone	689.75

Common Replacement Parts

Z85837589A	Replacement control head	297.25
------------	--------------------------	--------

Notes

- To use Park Siren feature on '98 or newer Ford vehicles and '01 and newer Chevrolet vehicles, the UPKM-3 Park Siren Deactivator must be used (purchased separately).
- California Code of Regulations (CCR) Title 13, Article 5, states "Electronic sirens shall have a wail function and may also have manual and yelp functions. No other function is permitted on sirens sold (in CA) after January 1, 1982, except for voice communications".

Warning: Sirens and Speakers may produce LOUD sounds necessary to request the right-of-way. Siren and Speakers may cause hearing damage. Wear hearing protection.

Electronic Q-Siren (e-Q2B®)

- Redesigned for increased reliability and improved functionality
- Features the traditional trademarked Q-Siren sound
- New keypad features backlit membrane switches with tactile feel
- New easy-to-read external diagnostics
- Improved power connector ensures increased reliability and connection strength
- Smaller foot print on amplifier - 10.5" L x 3.9" H x 7.7" D
- Same 200-watt power with lower amp draw - 20 amps
- Horn ring transfer feature now available
- Features Q-wail, Yelp, Priority, Airhorn, PA and Radio Re-broadcast



 Siren tones available online

Model	Description	List Price
EQ2B-200	200W, remote amplifier, surface mount control head	\$1,587.50
EQ2B-200FM	200W, remote amplifier, flush mount control head	1,587.50

Common Replacement Parts for EQ units prior to 2011 redesign

Z140417A-04	Connector, male plug, 4-position, EQ2B speaker	15.00
Z140418A-07	Connector, male plug, 7-position, EQ2B control head	15.25
Z140418A-08	Connector, male plug, 8-position, EQ2B control head	17.50
Z140535A	Connector, male plug, 50A	26.75
Z258B577B-03	Microphone, EQ2B, noise-cancelling	61.50
Z8616015A	Control head, EQ2B	379.50
Z8616019A	Accessory kit, series B amplifiers	92.50
Z8616033B-03	Amplifier, EQ2B, DB9 connector compatible, fits directly in legacy amp mounting holes	1,476.50

Common Replacement Parts for EQ units newly released in 2011 redesign

Z8616026A	Control head, EQ2B-200	595.00
Z8616033A	Amplifier, EQ2B-200 or EQ2B-200FM	1,476.50
Z258B577B-03	Microphone, EQ2B-200 or EQ2B-200FM	61.50
Z140417A-04	Connector, male plug, 4-position, EQ2B	15.00
Z140535A	Connector, male plug, 50A	26.75

Q-Siren®

- Distinct sound provides recognizable long distance warning
- The sound of the Q-Siren is a registered trademark of Federal Signal Corporation
- Utilizes a unique clutch design that provides a longer coast down sound while reducing the amp draw
- Beautifully streamlined and polished electro-mechanical siren produces 123 decibels at 10-ft



Model	Description	List Price
Q2B-012NNSD	Q2B, mechanical siren, chrome, recess mount	\$2,130.50
Q2B-012PSD	Q2B, mechanical siren, chrome, pedestal mount	2,374.25

Kits

Q2FSK	Kit, Q2B, foot switch	44.75
Q-MT	Kit, Q2B, bracket for recess mounting Q2B siren	178.25

Common Replacement Parts

Z8280080B	Motor, Q2B siren	752.25
Z8280084A	Clutch assembly	77.50
Z8280104B	Front grille, Q2B siren/BP200-Q	370.50
Z8280106A	Stator guard, Q2B siren	92.50
Z8280B003J-02	Brake assembly	147.00
Z8280C077A	Mounting base, Q2B siren, highly polished	241.50
ZH5205-03	Rear housing, Q2B siren, polished stainless steel	357.75

Warning: Sirens and Speakers may produce LOUD sounds necessary to request the right-of-way. Siren and Speakers may cause hearing damage. Wear hearing protection.



Rumbler®

- Intersection clearing system
- Upgrades user safety and siren effectiveness
- Can be used with most available siren products
- Vibrating tones provide feel with emergency warning sound
- Vehicle specific mounting brackets available for commonly used vehicles
- Ideal for use in highly populated urban environments



Model	Description	List Price
RUMBLER-3	Siren amp, Rumbler, secondary warning system, 12V, low frequency tones, hardware kit, housing bands and cradles	\$657.00

Accessories and Kits

RB-CVIC05	Kit, pair of mount brackets with hardware for Ford Crown Victoria police package vehicles	42.00
RB-ES08	Kit, pair of mount brackets with hardware for 2008 Ford E-Series Chassis	42.00
RB-CAP11	Kit, pair of mount brackets with hardware for 2011 Chevrolet Caprice	125.00
RB-CRG11	Kit, pair of mount brackets with hardware for 2011 Dodge Charger police package vehicles	42.00
RB-IMP08	Kit, pair of mount brackets with hardware for 2008 or newer Chevrolet Impala police package vehicles	42.00
RB-TAHO08	Kit, pair of mount brackets with hardware for 2008 or newer Chevrolet Tahoe/Suburban vehicles	42.00
RB-EXP08	Kit, pair of mount brackets with hardware for 2008 or newer Ford Expedition vehicles	42.00
RB-FHD08	Kit, pair of mount brackets with hardware for 2008 or newer Ford F-250 Super Duty vehicles	42.00

Common Replacement Parts

Z82831070B	Replacement woofer	94.50
Z82831071A	Kit, connector/bracket, Rumbler speaker	81.00
Z82831072A	Rumbler Speaker	255.00
Z82831080A	Rumbler body	91.00
ZRUMBLER-2	Amp, RUMBLER-2	548.25

PA640

- Combined light/siren controls with PA and microphone
- 100-Watt SAE J1849 and Class A sound output
- Internal programmable siren functions
- Four-position progressive slide switch
- Six backlit and rubberized relay push-button switches
- Scrolling TAP II intersection clearing feature



Siren tones available online

Model	Description	List Price
640000	Siren, 640 Series, 100W, programmable slide switch and light control	\$606.25

Common Replacement Parts

Z122374A	Slide switch	41.00
Z140338A-11	Connector, 11-position, right angle	16.50
Z141A102	Knob, gain control	4.25
Z141A111	Knob, function/tone selector	10.00
Z258B577B-03	Microphone replacement, 640 Series	61.50
Z8536C1041A	Knob, slide switch, plastic	10.00

Note

- California Code of Regulations (CCR) Title 13, Article 5 states "Electronic sirens shall have a wail function and may also have manual and yelp functions. No other function is permitted on sirens sold (in CA) after January 1, 1982, except for voice communications".

Warning: Sirens and Speakers may produce LOUD sounds necessary to request the right-of-way. Siren and Speakers may cause hearing damage. Wear hearing protection.

650 Series

- Full-featured 100-watt remote siren with PA and light control
- Integrated microphone and switch controls in handset
- Progressive push button control mimics slide switch action
- Eight 10-amp light and auxiliary relay positions



 Siren tones available online

Model	Description	List Price
650001	Siren, 650 Series, 100W, microphone push-button controlled, full-featured, Wail/no Wail one activation, (8) 10A relay outputs	\$521.00
650003	Siren, 650 Series, 100W, microphone push-button controlled, full-featured, Wail-to-Priority tone activation, (8) 10A relay outputs	521.00

Common Replacement Parts

Z146903B	Cable assembly, RJ45, 25-ft	21.00
Z8615011A	Amplifier replacement, 100W, 650001	630.00
Z8615011A-03	Amplifier replacement, 100W, 650003	630.00
Z8615012A	Bracket, mounting/support, 650 Series	24.25
Z8615013A	Kit, cable harness	93.50
Z8615014A	Connection box	55.75
Z8615015A	Cable, controller	18.75
Z8615016A	Microphone and controller replacement, 650001	178.00
Z8615016A-03	Microphone, controller, 650003	178.00
Z8615017A	Mount, controller	18.25
Z8615018A	Kit, hardware, siren support	10.00
Z8615019A	Kit, connector, relay output	4.25

Note

- California Code of Regulations (CCR) Title 13, Article 5 states "Electronic sirens shall have a wail function and may also have manual and yelp functions. No other function is permitted on sirens sold (in CA) after January 1, 1982, except for voice communications".

MS4000

- Mini-siren with intersection clearing tones
- Faceplate switching or remote control style
- Compact and easy to operate
- 100-Watt Class A and SAE sound output
- Great for undercover and administrative vehicles



 Siren tones available online

Model	Description	List Price
MS4000	MS4000 Mini-Siren, 100W, Air horn, Manual, Wail, Yelp, Priority intersection tone	\$249.00
MS4000U	MS4000 Undercover, 100W, Air horn, Manual, Wail, Yelp, Priority intersection, remote	269.00

Note

- California Code of Regulations (CCR) Title 13, Article 5 states "Electronic sirens shall have a wail function and may also have manual and yelp functions. No other function is permitted on sirens sold (in CA) after January 1, 1982, except for voice communications".

PA4000

- 200-Watt electronic siren
- Flush mount controller with remote amplifier
- Noise-cancelling microphone included
- Diagnostic feature checks system status



Model	Description	List Price
PA4000	200W, flush mount control, remote amplifier	\$557.00

Common Replacement Parts

Z146903B	Cable assembly, RJ45, 25-ft	21.00
Z1461029A	Cable assembly, control head	17.00
Z258B577B-02	Microphone, PA4000	61.50
Z85361106A	Control head assembly, PA4000	335.00
Z85361108A	Amplifier assembly, PA4000	603.75

Note

- California Code of Regulations (CCR) Title 13, Article 5 states "Electronic sirens shall have a wail function and may also have manual and yelp functions. No other function is permitted on sirens sold (in CA) after January 1, 1982, except for voice communications".

Warning: Sirens and Speakers may produce LOUD sounds necessary to request the right-of-way. Siren and Speakers may cause hearing damage. Wear hearing protection.



Touchmaster™ Delta/Touchmaster™



- Totally enclosed full-function featured sirens with PA available
- High current switching - up to 205-amps of total switching capacity
- Rugged high current (60 amp) slide switch
- Quick installation with marked wires and screw-down terminals
- Five tone intersection clearing sweep available
- Adjustable external PA volume controls
- Common microphone adapters allow both radio and siren to operate from a single microphone

Siren tones available online

Model	Description	List Price
	Touchmaster Delta, 58/110/200W	
UTMD	60A progressive slide switch, 205A switch capacity, Manual, Air Horn, Wail, Yelp, (5) Override/Sweep tones, (6) rubberized 20A accessory switches (5 latching, 1 momentary)	\$775.00
UTMD-MB	60A progressive slide switch, 205A switch capacity, Manual, Air Horn, Wail, Yelp, (5) Override/Sweep tones, (6) rubberized 20A accessory switches (5 latching, 1 momentary), microphone and bracket included	795.00
	Touchmaster, 58/100/200W	
UTM1	35A switch capacity, (1) 15A warning light circuit, Manual, Wail, Yelp, Air Horn, (5) Sweep tones	574.50
UTM3	80A switch capacity, (5) light circuits (60A), Horn Ring, Manual, Air Horn, Wail, Yelp, (5) Sweep tones	841.00
UTM4	205A switch capacity, (5) light circuits (60A), (6) accessory switches, Manual, Air Horn, Wail, Yelp, (5) Sweep tones	939.25
UTM4-1	160A switch capacity, (5) light circuits (60A), (4) accessory switches, Manual, Air Horn, Wail, Yelp, (5) Sweep tones	925.50
UTMPA1	Siren/PA, Touchmaster, 100/200W, PA/Air Horn only	462.00
UTMPA6	PA/Air Horn, Touchmaster, 58/100W, 60A progressive slide switch, (4) on/off 20A accessory switches	667.25

Accessories and Kits

ULM10	Common microphone adapter, Touchmaster/Omega sirens, Motorola 9000/Syntor/Spectra radios	209.25
ULM16	Common microphone adapter, Touchmaster/Omega sirens, Motorola Maxtrac 300T/Radius/Astro radios	328.75
ULM19	Common microphone adapter, Touchmaster/Omega sirens, Motorola MCS2000 radios	344.75
UOP10	Kit, Touchmaster, dual mode amplifier modification	80.25
UOP13	Touchmaster, radio power control transfer modification	81.00
UOP20	Kit, Touchmaster, plug-in gun lock timer	67.50
UOP25	Kit, Touchmaster, Jog switches for Smart Vector	92.75
UOP-VLR	Kit, TouchMaster, flood switches for Valor	122.50
USGT	Kit, Gun Lock Timer, Touchmaster/Omega/80K	53.50
UMNCT-SB	Microphone, Omega/Touchmaster/80K, standard noise-cancelling	48.75
UPKM-3	Kit, Park Siren Deactivator module, all siren models	50.75
UOP100	Black out	63.50
HK-05	Knob, volume and mode	5.25
HK-07	Knob, master switch, replacement	12.50

Notes

- To use the Park Siren feature on '98 and newer Ford vehicles and '01 and newer Chevrolet vehicles, the UPKM-3 Park Siren Deactivator must be used (purchased separately)
- California Code of Regulations (CCR) Title 13, Article 5 states "Electronic sirens shall have a wail function and may also have manual and yelp functions. No other function is permitted on sirens sold (in CA) after January 1, 1982, except for voice communications".
- Products are upgraded on a regular basis. Call the factory for other options or common microphone adapters.
- Option pricing applies to new orders. Retrofitting existing equipment will require an additional service charge.
- Most options require factory installation.
- Customer needs to specify radio used when ordering common mic adaptor.

Warning: Sirens and Speakers may produce LOUD sounds necessary to request the right-of-way. Siren and Speakers may cause hearing damage. Wear hearing protection.

80K

- Compact “plug-n-play” cable connectors for fleet-wide solutions
- Wide variety of control head and auxiliary switch choices
- Toughest high current (60 amp) slide switch available
- ACP (Automatic Component short circuit Protection)
- No battery drain in standby mode



 Siren tones available online

Model	Description	List Price
U180K	Undercover/motorcycle, UM180K controller, UMCO29, CO63 pigtail, (1) warning light control circuit	\$653.25
U183K-15	Undercover, UM183K controller, 80K amp, UMCO30-15, UCAR-183K, CO63 pigtail, (4) warning light circuits, 15-ft cable length	757.25
U183K-4	Undercover/motorcycle, UM183K controller, 80K amp, UMCO30-4, UCAR-183K, CO63 pigtail, (4) warning light circuits, 4-ft cable length	721.75
U280K-15	UM280K controller, 80K amp, UMCO30-15 cable, CO60 pigtail, (1) warning light control circuit, 15-ft cable length	940.25
U280K-4	UM280K controller, 80K amp, UMCO30-4 cable, CO60 pigtail, (1) warning light control circuit, 4-ft cable length	899.00
U480K-15	100/200W, 60A, UM480K controller, UM80K amp, (5) warning light control circuits, 15-ft cable harness	1,113.50
U480K-4	100/200W, 60A, UM480K controller, UM80K amp, (5) warning light control circuits, 4-ft cable harness	1,058.25
U480K-SU	100/200W, 60A, UM480K controller, UM80K amp, (5) warning light control circuits	986.00

Amplifier

UM80K	80K Series, 100/200W	583.00
UDMK	80K Series, dual mode siren with cable	642.50

Controllers

UM180K	80K, (1) amplifier warning light control circuit	70.75
UM183K	80K, (3) 20A warning light control circuits	284.00
UM280K	80K, PA, (3) 20A warning light circuits	418.25
UM480K	80K, PA, (5) 20A warning light circuits	442.00

Cables

UCAR-183K	80K, remote microphone/PA connection, 183K controller	93.75
UCARK	80K, remote microphone jack, 180K controller	58.50
UMCO30-4	80K, amplifier to controller connection, 4-ft cable length	68.00
UMCO30-15	80K, amplifier to controller connection, 15-ft cable length	105.00
UMCO30T	80K, dual mode amplifier to controller connection	55.75
UMCO29	80K, connects amplifier to (1) 80K controller	32.75

Custom Auxiliary Switches

AC3	Switchpack controller, 80K, (3) 20A on/off or momentary switch options	116.75
AC4	Switchpack controller, 80K, (4) 20A on/off or momentary switch options	128.00

Accessories and Kits

UPA1	Kit, 80K, public address microphone	132.25
UPA2	Kit, 80K, public address microphone specific to 183K controller	132.25
UPKM-3	Park Siren Deactivator	50.75
UMNCT-SB	Microphone, 80K/Omega/Touchmaster standard noise-cancelling	48.75
USGT	Gun lock timer 80K/Omega/Touchmaster	53.50

Notes

- To use the Park Siren feature on '98 and newer Ford vehicles and '01 and newer Chevrolet vehicles, the UPKM-3 Park Siren deactivator must be used (purchased separately).
- California Code of Regulations (CCR) Title 13, Article 5 states "Electronic sirens shall have a wail function and may also have manual and yelp functions. No other function is permitted on sirens sold (in CA) after January 1, 1982, except for voice communications".

Warning: Sirens and Speakers may produce LOUD sounds necessary to request the right-of-way. Siren and Speakers may cause hearing damage. Wear hearing protection.



DynaMax®/ES100



- Features Neodymium driver for increased dependability
- Quick, easy and cost efficient installations
- 100-Watt high output power
- Black, corrosion-resistant aluminum housing
- Sound output meets SAE J1849 and Class A
- Compact size: 5.9"W x 5.5"H x 2.7"D / 5.5 lbs
- Vehicle specific mounting brackets available for most commonly used vehicles

Model	Description	List Price
ES100	Speaker, ES100/DynaMax, 100W, high output, compact, Class A	\$299.00
ES100-DEU	Speaker, ES100/DynaMax, 100W, high output, compact, Class A, with Deutsch connector	314.00

Accessories and Kits

ESB-U	Universal bail bracket, all vehicles	25.00
ESB-V08	Ford Crown Vic Interceptor, '02-'11	25.00
ESB-TAH08	Chevrolet Tahoe, '03-'11	25.00
ESB-IMP08R	Chevrolet Impala, '06-'12	25.00
ESB-EXP07	Ford Expedition, '07-'08	25.00
ESB-DHDD11	Dodge Ram Chassis cab, driver side	25.00
ESB-DHDP11	Dodge Ram Chassis cab, passenger side	25.00
ESB-CAP11	Chevrolet Caprice, '11	25.00
ESB-TAR11	11 Ford Taurus, and '11 Dodge Charger	25.00
ESBMT-SB	Bumper/surface mount bracket	55.50
ESFMT	Recess mount, polished trim ring	84.00
ESFMT-EF	Recess mount, stainless steel "Electric F" grille	74.25

Note

- Speakers noted as Class A meet CCR, Title 13, Class A, and SAE J1849 specifications when used with a Class A approved Federal Signal siren amplifier.

AS124



- Economically priced and full 100-Watt output power
- Field-replaceable neodymium driver
- Moisture, heat and corrosion-resistant PET housing
- Sound output meets SAE J1849 and Class A
- 7.7"W x 5.7"H x 4.45"D / 6.5 lbs

Model	Description	List Price
750501	Speaker, 100W, with universal mount bolts and hardware, high output, Class A	\$189.00

Accessories and Kits

750501-00	Mounting bracket, no grille removal, '02-'11 Ford Crown Victoria Interceptor	40.00
750501-02	Mounting bracket, no grille removal, '06-'11, Chevrolet Impala both civilian and police package	40.00
750501-03	Mounting bracket, no grille removal, '11-'12 Ford Expedition	40.00
750501-04	Mounting bracket, no grille removal, Dodge Charger	40.00
750501-05	Mounting bracket, no grille removal, '11 Chevrolet Caprice	40.00

Common Replacement Parts

Z8280090A	Driver, AS124	165.00
Z8556120B	Kit, BP100/BP200/AS124, speaker head	125.00
Z8650106A	Housing assembly with labels, AS124	100.75

Note

- Speakers noted as Class A meet CCR, Title 13, Class A, and SAE J1849 specifications when used with a Class A approved Federal Signal siren amplifier.

Warning: Sirens and Speakers may produce LOUD sounds necessary to request the right-of-way. Siren and Speakers may cause hearing damage. Wear hearing protection.

BP Series

BP100

- Features sturdy neodymium driver
- Unique design projects sound evenly to the front as well as to the sides of the vehicle
- Black finish helps prevent corrosion and increase service life
- 100-Watt speaker meets Class A standards when used with any Federal Signal siren

BP200

- 200-Watt speaker features neodymium driver for increased service life
- Designed to be attractively recess-mount through the bumper of a vehicle
- Available with the stainless steel "Electric F" grille or the traditional chrome Q-Siren® grille
- Sound output meets SAE J1849 and Class A
- 7.7"W x 5.7"H x 4.45"D / 6.5 lbs
- Pre-assemble grille light mounting brackets available



BP200-EF



BP100

Model	Description	List Price
BP100	100W, Black	\$480.00
BP200-EF	200W, stainless steel "Electric F" grille, recess mount	715.00
BP200-Q	200W, Chrome Q-Siren grille, recess mount	975.00

Kits

BPGR	Kit, grille mount	57.50
BPMT	Kit, universal bumper mount	57.50

Common Replacement Parts

Z8280090A	Driver, 100W, neomagnet	165.00
Z8280104B	Front grille, Q2B siren/BP200-Q, chrome-plated Q-Siren emblem	370.50
Z8556120B	Kit, BP100/BP200/AS124, speaker head	125.00
Z8567102A	Grille, MSFMT-EF/BP200-EF, stainless steel "Electric F"	24.50
Z8567144A	Standoff, Z8280090A required when replacing old style driver	10.00

Note

- Speakers noted as Class A meet CCR, Title 13, Class A, and SAE J1849 specifications when used with a Class A approved Federal Signal siren amplifier.

TS100-N

- Highly-efficient neodymium driver
- Weather-resistant housing
- Full 100-Watt output power
- Sound output meets SAE J1849 and Class A



Model	Description	List Price
TS100-N	Speaker, 100W, high-output, standard bracket, Class A	\$215.00

Common Replacement Parts

Z8470D118	Projector, molded plastic, TS100-N, Black	24.50
Z8556082C	Kit, speaker head, TS100-N/CP100	125.00
Z8556B096A	Cone, 3.25", Black, TS100/TS100-N	25.00
Z8619145A	Driver, TS100-N	165.00

Note

- Speakers noted as Class A meet CCR, Title 13, Class A, and SAE J1849 specifications when used with a Class A approved Federal Signal siren amplifier.

Warning: Sirens and Speakers may produce LOUD sounds necessary to request the right-of-way. Siren and Speakers may cause hearing damage. Wear hearing protection.

MicroEscape LED

- Features QuadraFlare® LED reflectors
- Built-in Intelli-Flash™ Flasher
- Permanent mount kit included
- NFPA compliant models available



ME4QL-A



ME4QL-R



Model	Description	List Price
Items below are driver and passenger specific and should be purchased as a pair		
ME2QLPC-R	(2) Red QuadraFlare LED reflectors, Clear dome, passenger side specific	\$602.00
ME2QLDC-R	(2) Red QuadraFlare LED reflectors, Clear dome, driver side specific	602.00
ME2QLPC-A	(2) Amber QuadraFlare LED reflectors, Clear dome, passenger side specific	602.00
ME2QLDC-A	(2) Amber QuadraFlare LED reflectors, Clear dome, driver side specific	602.00
Items below are not driver and passenger specific		
ME4QL-A	(4) Amber QuadraFlare LED reflectors, Amber dome, built-in flasher	829.50
ME4QL-R	(4) Red QuadraFlare LED reflectors, Red dome, built-in flasher	829.50
ME4QLC-A	(4) Amber QuadraFlare LED reflectors, Clear dome, built-in flasher	829.50
ME4QLC-B	(4) Blue QuadraFlare LED reflectors, Clear dome, built-in flasher	894.50
ME4QLC-R	(4) Red QuadraFlare LED reflectors, Clear dome, built-in flasher	829.50

CLEAR DOME

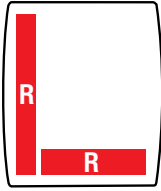

ME2QLDC-R

CLEAR DOME

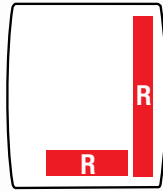

ME2QLPC-R

CLEAR DOME

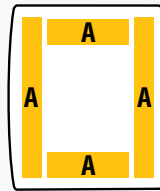

ME4QLC-A

CLEAR DOME

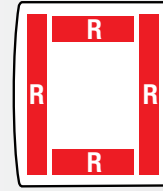

ME4QLC-R

IVP SLR

- Modern dome design complements the appearance of the Vision® SLR family of lightbars
- Domes are available in Clear or Red



Model	Description	List Price
Vision Solaris LED Rotator, 90 FPM		
VSLR-R	Red LEDs, Red lens	\$725.00
VSLR-R2	Red LEDs, Clear lens	725.00
VSLR-IPX-R	Red LEDs, Red lens, (1) Amber IPX6, Clear lens	925.00
VSLR-IPX-R2	Red LEDs, Clear lens, (1) Amber IPX6, Clear lens	925.00

SLR Beacon

- Rotating LED beacon with 12 high-powered LEDs
- Utilizes Federal Signal's patented Solaris Technology
- 75/90/120 FPM



Model	Description	List Price
Models with permanent/pipe mount		
262650-02	Amber LEDs, Amber dome	\$499.00
262650-04	Red LEDs, Red dome	499.00

Pulsator® LED

- LEDNode™ technology for zero maintenance
- Ten selectable "strobing" flash patterns
- Permanent mount kit included
- Class 1 and Class 2 models available



Model	Description	List Price
212650-02	Amber LED, Amber dome, Class 2	\$184.75
212650-25	Amber LED, Clear dome	218.50
212660-02	Amber LED, Amber dome, Class 1	204.25
212660-25	Amber LED, Clear dome	204.25

Common Replacement Parts

208567-95	Dome, short, Amber	21.25
208667-95	Dome, tall, Amber	21.25

Sentry®

- Rugged, polycarbonate housing features twist-off dome for easy maintenance
- Compact size allows for a variety of mounting options
- Large parabolic reflector and 55-Watt halogen bulb produce an attention-getting 80,000 candelas per flash
- Permanent and magnetic mount versions available
- Domes are available in Amber, Blue, Clear, and Red



Model	Description	List Price
449142-02	SY12FM, 175 FPM rotator, magnetic mount, Amber; -03(Blue); -04(Red); -05(Clear)	\$116.00
449112-02	SY12FS, 175 FPM rotator, permanent mount, Amber; -03(Blue); -04(Red); -05(Clear)	88.50
448142-02	SY12SM, 95 FPM rotator, magnetic mount, Amber; -03(Blue); -04(Red); -05(Clear)	114.50
448112-02	SY12SS, 95 FPM rotator, permanent mount, Amber; -03(Blue); -04(Red); -05(Clear)	88.50

Common Replacement Parts

Z8433001A	Dome, Clear; -01(Red); -02(Amber); -03(Blue)	15.25
Z8440A265A-02	Bulb, Sentry, 55W	15.00
Z8559A055A	Motor and worm gear, 95 FPM rotator, 12 VDC	35.75
Z8559A055A-01	Motor and worm gear, 175 FPM rotator, 12 VDC	35.75



9x7 QuadraFlare®

- Advanced Solaris® LED reflector technology in a 9x7 package
- Meets NFPA and GSA K-spec compliant upper and lower level requirements
- Features unique Quad-X patterns
- Available with built-in flasher featuring a variety of OEM friendly selectable patterns
- LEDs offered in Amber, Blue, Green, Red, or White
- Optional chrome-plated trim bezel available



QL97XF-R
with QL97MC



QL975FC0RC
with QL97MC

Model	Description	List Price
9x7 Warning lights with color lens and built-in flasher		
QL97XF-(color)	Amber, Blue or Red	\$279.00
QL97XF-G	Green	359.00
9x7 Warning lights with Clear lens and built-in flasher		
QL97XFC-(color)	Amber, Blue or Red	279.00
QL97XFC-C	White	323.00
QL97XFC-G	Green	359.00
9x7 Split-LED warning lights with color lens and built-in flasher		
QL97SF-AA	Amber/Amber	279.00
QL97SF-BB	Blue/Blue	279.00
QL97SF-GG	Green/Green	259.00
QL97SF-RR	Red/Red	279.00
9x7 Split-LED warning lights with Clear lens and built-in flasher		
QL97SFC-AA	Amber/Amber	279.00
QL97SFC-AC	Amber/White	323.00
QL97SFC-BA	Blue/Amber	279.00
QL97SFC-BB	Blue/Blue	279.00
QL97SFC-BC	Blue/Clear	323.00
QL97SFC-CC	White/White	323.00
QL97SFC-GG	Green/Green	359.00
QL97SFC-RA	Red/Amber	279.00
QL97SFC-RB	Red/Blue	279.00
QL97SFC-RC	Red/White	323.00
QL97SFC-RG	Red/Green	359.00
QL97SFC-RR	Red/Red	279.00

Model	Description	List Price
Accessories		
QL97MB	Trim bezel, Black with gasket	21.50
QL97MC	Trim bezel, Chrome with gasket	21.50
650205	LED flasher, (2) 10A channels, (10) flash patterns, high-side switching	113.75
650302	LED flasher, (16) channels, 40A total capacity, K-spec compliant	284.00
Common Replacement Parts		
Z8012111A	Gasket, 9X7 base/lens, molded	15.00
Z8012062C-02	Lens, fluted, Clear	15.00

Five Pattern Arrangements in One Model (QL97SF-RR)

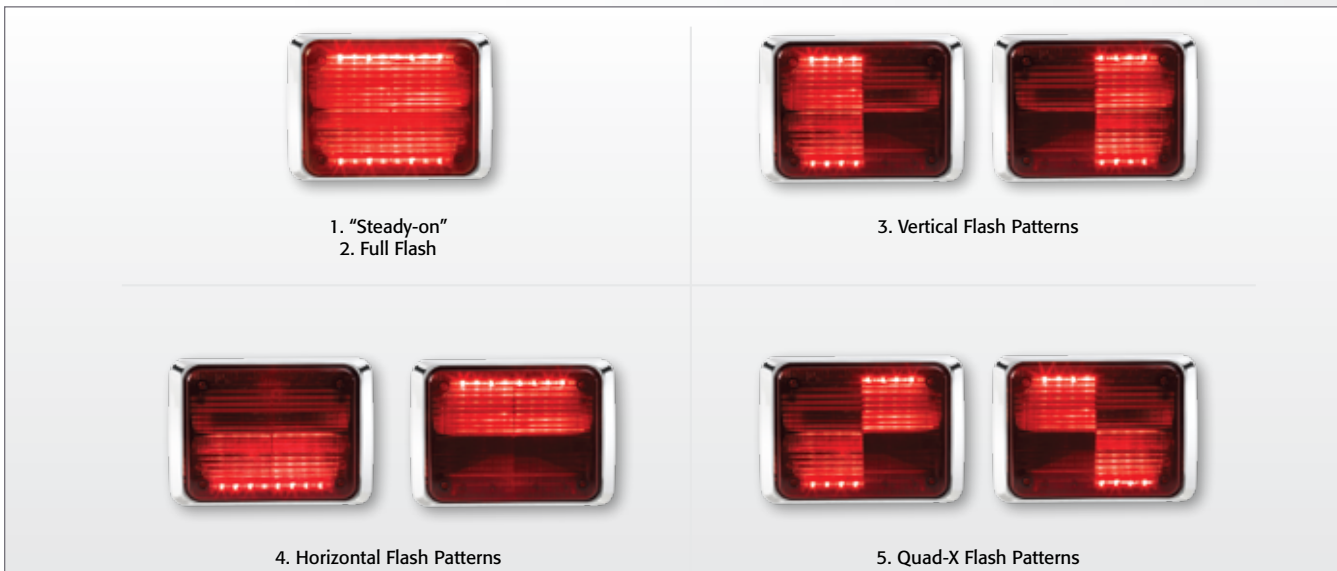



6x4 QuadraFlare®

- Advanced Solaris® LED reflector technology in a 6x4 package
- Surpasses NFPA and GSA K-spec compliant upper and lower level requirements
- LEDs available in Amber, Blue, Green, Red or White
- Offered with built-in flasher featuring a variety of selectable patterns
- Optional chrome-plated trim bezel
- Brake/Tail/Turn, Turn Arrow and Back-up light models also available



QL64XF-R
with QL64MC



QL64SFC-RC
with QL64MC

Model	Description	List Price
Warning lights with color lens and built-in flasher		
QL64XF-(color)	Amber, Blue or Red	\$175.00
QL64XF-G	Green	220.00
Warning lights with Clear lens and built-in flasher		
QL64XFC-(color)	Amber, Blue or Red	175.00
QL64XFC-G	Green	220.00
QL64XF-C	White	209.00
Split-LED warning lights with color lens and built-in flasher		
QL64SF-AA	Amber/Amber	214.00
QL64SF-BB	Blue/Blue	214.00
QL64SF-RR	Red/Red	214.00
QL64SF-GG	Green/Green	235.00
Split-LED warning lights with Clear lens and built-in flasher		
QL64SFC-(Color/Color)	Combinations of Amber/Blue/Red	214.00
QL64SFC-(Color/Color)	Combinations of Amber/Blue/Red with Green/White	242.25
Brake/Tail/Turn and Back-up lights		
QL64Z-BTT	Brake/Tail/Turn, Red LED, Red lens	169.00
QL64Z-ARROW	Turn arrow, Amber LED, Amber lens	125.00
QL64Z-TURN	Turn light, Amber LED, Amber lens	169.00
QL64Z-BACKUP	Back-up light, White LED, Clear lens	198.00
3-Position Vertical Casting		
QL64Z3V-LEFT	Installed QL64Z-BTT, QL64Z-ARROW (left facing), QL64Z-BACKUP	653.00
QL64Z3V-RIGHT	Installed QL64Z-BTT, QL64Z-ARROW (right facing), QL64Z-BACKUP	653.00
QL64Z3V-LED	Installed QL64Z-BTT, QL64Z-TURN, QL64Z-BACKUP	698.00
QL64Z3V	Casting with gasket	183.75

Model	Description	List Price
3-Position Horizontal Casting		
QL64Z3H-LEFT	Installed QL64Z-BTT, QL64Z-ARROW (left facing), QL64Z-BACKUP	653.00
QL64Z3H-RIGHT	Installed QL64Z-BTT, QL64Z-ARROW (right facing), QL64Z-BACKUP	653.00
QL64Z3H-LEDLEFT	Installed QL64Z-BTT, QL64Z-TURN, QL64Z-BACKUP	698.00
QL64Z3H-LEDRIGHT	Installed QL64Z-BTT, QL64Z-TURN, QL64Z-BACKUP	698.00
QL64Z3H	Casting with gasket	183.75
4-Position Vertical Casting		
QL64Z4V-LEFT	Installed QL64Z-BTT, QL64Z-ARROW (left facing), QL64Z-BACKUP, QL64XF-R	884.00
QL64Z4V-RIGHT	Installed QL64Z-BTT, QL64Z-ARROW (right facing), QL64Z-BACKUP, QL64XF-R	884.00
QL64Z4V-LED	Installed QL64Z-BTT, QL64Z-TURN, QL64Z-BACKUP, QL64XF-R	929.00
QL64Z4V	Casting with gasket	241.50
Accessories and Kits		
650205	LED Flasher, (2) 10-amp channels, (10) flash patterns, high-side switching	113.75
650302	LED Flasher, (16) channels, (40) amp total capacity, K-spec compliant	284.00
QL64MHL	Headlight mount kit	45.00
QL64MC	Trim bezel, Chrome with gasket	14.00
QL64MB	Trim bezel, Black with gasket	14.00

Common Replacement Parts

Z8012109A	Gasket, 6x4 base/lens molded	10.00
Z8012013B	Lens, fluted, 6x4, Red; -01(Amber); -02(Clear); -03(Blue); -04(Green)	15.00





7x3 QuadraFlare®

- Advance Solaris® LED reflector technology in a 7x3 package
- Surpasses NFPA and GSA K-spec compliant upper and lower level requirements
- Offered with built-in flasher featuring a variety of selectable patterns
- LEDs offered in Amber, Blue, Green, Red or White
- Optional Chrome-plated trim bezel available



QL73SFC-RC

Model	Description	List Price
Warning lights with color lens and built-in flasher		
QL73XF-(color)	Amber, Blue or Red	\$175.00
QL73XF-G	Green	220.00
Warning lights with Clear lens and built-in flasher		
QL73XFC-(color)	Amber, Blue or Red	175.00
QL73XFC-C	White	209.00
QL73XFC-G	Green	220.00
Split-LED warning lights with color lens and built-in flasher		
QL73SF-AA	Amber/Amber	214.00
QL73SF-BB	Blue/Blue	214.00
QL73SF-GG	Green/Green	235.00
QL73SF-RR	Red/Red	214.00
Split-LED warning lights with Clear lens and built-in flasher		
QL73SFC-AC	Amber/White	242.25
QL73SFC-BA	Blue/Amber	214.00

Model	Description	List Price
Split-LED warning lights with Clear lens and built-in flasher - continued		
QL73SFC-RA	Red/Amber	214.00
QL73SFC-RB	Red/Blue	214.00
QL73SFC-RC	Red/White	242.25
QL73SFC-RG	Red/Green	242.25
QL73SFC-RR	Red/Red	214.00
Accessories		
QL73MB	Trim bezel, Black with gasket	14.00
QL73MC	Trim bezel, Chrome with gasket	14.00
Common Replacement Parts		
Z8012078A	Lens, fluted, Red; -02(Clear)	10.00
Z8012110A	Gasket, 7x3 base/lens, molded	10.00

9x7 Scene Lights

- Available in halogen or LED models
- LED models feature Solaris® LED reflector technology
- Surface mount LED model
- Industry standard mounting dimensions



QL97LEDSCENE

Model	Description	List Price
QL97HSCENE	Scene light, 9x7, halogen	\$125.00
QL97LEDSCENE	Scene light, 9x7, LED, surface mount	399.00
Common Replacement Parts		
Z8012075B	Lens, fluted, Clear	10.00

GHSCENE

- Two 20-watt halogen fixtures adjust vertically and horizontally for maximum effectiveness
- Recess mount area light in the same compact housing as the FireRay® warning light
- Internal electrical connections are protected from outside elements for increased service life
- Thick foam gasket provides snug seal even on diamond plate surface
- Replacement lamps are available at local hardware centers



GHSCENE

GHFLANGE

Model	Description	List Price
GHSCENE	Area Light, GHSCENE, (2) 20W adjustable lamps, Clear lens	\$139.00
Accessory		
GHFLANGE	Rectangular shaped GHSCENE trim ring	26.25
Common Replacement Parts		
Z8575105A	Trim ring, chrome	18.75
Z8575107A	Lamp and reflector assembly, 20W, 35-degrees	18.50
Z8575108A	Lens, Clear	16.50



Signaltech® LED S/T/T Lights

- Reflector cell technology enhances brightness and reduces sunlight washout
- Enhanced lens design for a uniform pattern
- Solid-state components are potted to withstand rugged road conditions
- FMVSS 108 compliant



Model	Description	List Price
Kits includes LED light, rubber mounting grommet, sealed wire harness		
4" Round LED Light Kits, 12-24V		
607100-04	LED Stop/Tail/Turn light, Red	\$46.50
607102-02	LED Turn light, Amber	46.75
607124-05	LED Back-up light, White	124.75
6" Oval LED Light Kits, 12-24V		
607105-04	LED Stop/Tail/Turn light, Red	49.75
607106-02	LED Turn light, Amber	51.00
607125-05	LED Back-up light, White	128.75

Model	Description	List Price
Kits		
605520	Kit, rubber mounting grommet, 4" round	5.75
605510	Kit, rubber mounting grommet, 6" oval	5.75
607110	Kit, anti-theft stainless steel flange, 4" round	7.25
607111	Kit, anti-theft stainless steel flange, 6" oval	7.25

Signaltech® Compartment Lights

- Small compact design
- Low current consumption
- Sealed wiring harness



Model	Description	List Price
607141-05	White LED, 12-24VDC, Black grommet	\$120.75
607141-05GRAY	White LED, 12-24VDC, Gray grommet	120.75

Signaltech® Marker/Clearance Lights

- Excellent visibility
- 2" and 2.5" round and 4" rectangle
- All models operate at 12VDC



Model	Description	List Price
607119-04	2" round, Red	\$13.25
607120-02	2.5" round, Amber	13.25
607120-04	2.5" round, Red	13.25
607122-02	4" rectangle, Amber	14.75
607122-04	4" rectangle, Red	14.75

Viper® EXT

- High-output Solaris® LED reflector technology
- Wide angle lens for better off-axis warning
- Wide variety of synchronized patterns
- Models come standard with Black bezel
- LEDs offered in Amber, Blue, Red and White



Model	Description	List Price
Clear off-axis lens		
VPX800-2	Amber, (8) high-powered LEDs	\$175.00
VPX800-3	Blue, (8) high-powered LEDs	175.00
VPX800-4	Red, (8) high-powered LEDs	175.00
VPX800-5	White, (8) high-powered LEDs	204.75
Colored off-axis lens		
VPX802-2	Amber, (8) high-powered LEDs	175.00
VPX802-3	Blue, (8) high-powered LEDs	175.00
VPX802-4	Red, (8) high-powered LEDs	175.00

Model	Description	List Price
Accessory		
VPXM-1	Chrome bezel, all models	11.25
Common Replacement Part		
Z8613144B	Lens, fluted, Clear; -A(Amber); -B(Blue); -R(Red)	15.00



IPX6 IMPAXX®

- SpectraLux™ Multicolor LED Technology
- Available in 6-LED, 12-LED or 18-LED versions
- 23 Flash patterns available
- High-output Solaris® LED reflector technology
- Fully encapsulated waterproof housing
- LEDs offered in Amber, Blue, Green, Red and White



Model	Description	List Price
Single color, Clear off-axis lens, horizontal mount		
IPX600-A	(6) Amber LEDs	\$145.00
IPX600-B	(6) Blue LEDs	145.00
IPX600-G	(6) Green LEDs	199.00
IPX600-R	(6) Red LEDs	145.00
IPX600-W	(6) White LEDs	199.00
Single color, Colored off-axis lens, horizontal mount		
IPX602-A	(6) Amber LEDs	145.00
IPX602-B	(6) Blue LEDs	145.00
IPX602-R	(6) Red LEDs	145.00
Single color, Clear off-axis, vertical mount		
IPX603-A	(6) Amber LEDs	145.00
IPX603-B	(6) Blue LEDs	145.00
IPX603-R	(6) Red LEDs	145.00
IPX603-W	(6) White LEDs	145.00
Single color, Colored off-axis lens, vertical mount		
IPX604-A	(6) Amber LEDs	145.00
IPX604-B	(6) Blue LEDs	145.00
IPX604-R	(6) Red LEDs	145.00

Model	Description	List Price
Dual color, Clear off-axis lens, horizontal mount		
IPX620-BA	(12) LEDs, Blue/Amber	165.00
IPX620-BR	(12) LEDs, Blue/Red	165.00
IPX620-BW	(12) LEDs, Blue/White	165.00
IPX620-RA	(12) LEDs, Red/Amber	165.00
IPX620-RW	(12) LEDs, Red/White	165.00
IPX620-WA	(12) LEDs, White/Amber	165.00
Triple color, Clear off-axis lens, horizontal mount		
IPX630-BRA	(18) LEDs, Blue/Red/Amber	195.00
IPX630-BRW	(18) LEDs, Blue/Red/White	195.00
Triple color, Clear off-axis lens, vertical mount		
IPX633-BRA	(18) LEDs, Blue/Red/Amber	195.00
IPX633-BRW	(18) LEDs, Blue/Red/White	195.00
Accessory		
IPX6M-1	Chrome bezel, for all models	11.75

IPX3 IMPAXX®

- High-output Solaris® LED reflector technology
- Fully encapsulated waterproof housing
- Wide angle lens for better off-axis warning
- Center focus lens also available
- Wide variety of synchronized patterns
- LEDs offered in Amber, Blue, Green, Red and White



Model	Description	List Price
Clear lens, advanced off-axis lens		
IPX300-2	Amber, (3) high-powered LEDs	\$105.00
IPX300-3	Blue, (3) high-powered LEDs	105.00
IPX300-4	Red, (3) high-powered LEDs	105.00
IPX300-5	White, (3) high-powered LEDs	105.00
IPX300-6	Green, (3) high-powered LEDs	105.00
Clear lens, center focused lens		
IPX310-2	Amber, (3) high-powered LEDs	105.00
IPX310-3	Blue, (3) high-powered LEDs	105.00
IPX310-4	Red, (3) high-powered LEDs	105.00
IPX310-5	White, (3) high-powered LEDs	105.00
IPX310-6	Green, (3) high-powered LEDs	105.00

Model	Description	List Price
Colored lens, advanced off-axis lens		
IPX302-2	Amber LEDs, (3) high-powered LEDs	105.00
IPX302-3	Blue LEDs, (3) high-powered LEDs	105.00
IPX302-4	Red LEDs, (3) high-powered LEDs	105.00
IPX302-6	Green LEDs, (3) high-powered LEDs	105.00
Colored lens, center focused lens		
IPX312-2	Amber LEDs, (3) high-powered LEDs	105.00
IPX312-3	Blue LEDs, (3) high-powered LEDs	105.00
IPX312-4	Red LEDs, (3) high-powered LEDs	105.00
IPX312-6	Green LEDs, (3) high-powered LEDs	105.00
Accessory		
IPXM-1	Chrome bezel, all models	6.00



Grille Brackets



IPX-GRL1 **\$19.00**

IPX3/IPX6/VPX8, (1) grille brackets with hardware, vertical mount orientation, Ford Crown Victoria Police Package vehicles, '02 - '11



IPX-GRL2 **\$19.00**

IPX3/IPX6/VPX8, (1) grille brackets with hardware, horizontal mount orientation, Ford Crown Victoria Police Package vehicles, '02 - '11

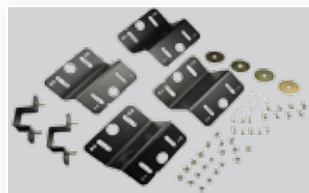

IPX-GRL3 **\$19.00**

IPX3/IPX6/VPX8, pair of grille brackets with hardware, 2011 Dodge Charger

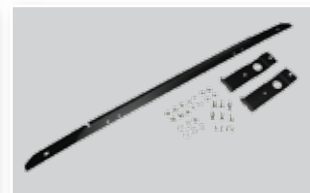

IPX-GRL4 **\$19.00**

IPX3-only, pair of grille brackets with each bracket holds (2) IPX3 light in a vertical orientation, 2011 Chevrolet Caprice

Rear Side Window Brackets



IPX-SW1 **\$25.00**

IPX3/VPX8, pair of rear side window mount brackets, '02 - '11 Ford Crown Victoria Police Package vehicles

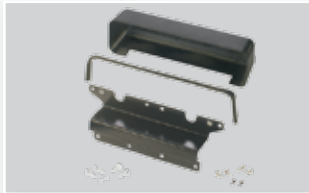

VPX-SW **\$69.00**

VPX8, pair of rear side window mount brackets, each bracket hold (2) Viper EXT lights, late model Ford Crown Victoria Police Package vehicles



IPX-RDW2 **\$69.00**

IPX3/IPX6/VPX8, pair of rear side window mount brackets and covers, each bracket holds (2) IMPAXX or Viper Ext lights, Chevrolet Caprice



IPX-ROW1 **\$25.00**

IPX3/IPX6, pair of rear side "Opera" window mount brackets, Chevrolet Caprice



IPX-RSW1 **\$69.00**

IPX3/IPX6/VPX8, pair of rear side window mount brackets and covers, Dodge Charger



IPX-RSW2 **\$69.00**

IPX3/IPX6/VPX8, pair of rear side window mount brackets and covers, Chevrolet Caprice

Trunk Lid Brackets

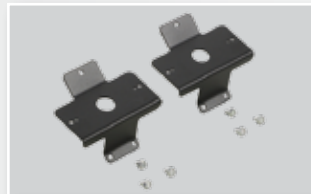

IPX-TRNK1 **\$25.00**

IPX3/IPX6/VPX8, pair of inner trunk lid brackets with hardware, '02-'11 Ford Crown Victoria Police Interceptor package

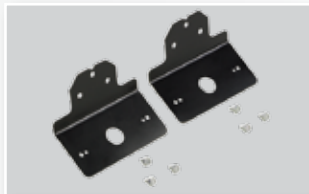

IPX-TRNK2 **\$25.00**

IPX3/VPX8, pair of inner trunk lid brackets with hardware, '07 - '10 Dodge Charger



IPX-TRNK3 **\$25.00**

IPX3/IPX6/VPX8, pair of inner trunk lid brackets with hardware, 2011 Dodge Charger

Push-bumper Brackets



IPX-PB45H **\$25.00**

IPX3/IPX6/VPX8, pair of 45-degree slanted push bumper mounts with hardware, horizontal light orientation, fits most push bumpers



IPX-PB45V **\$25.00**

IPX3/IPX6/VPX8, pair of 45-degree slanted push bumper mounts with hardware, vertical light orientation, fits most push bumpers

Universal Mount

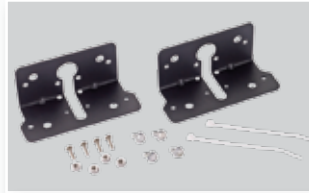

IPX-PBL1 **\$25.00**

IPX3/IPX6/VPX8, pair, universal "L" bracket, horizontal orientation

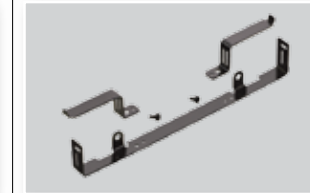

IPX-LPF1 **\$30.00**

IPX3 only, generic low side license plate holder for horizontal IMPAXX install, most vehicles

License Plate

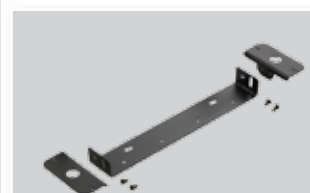

IPX-LPV1 **\$25.00**

IPX3/IPX6/VPX8, flat surface license plate mount, various vehicles without recessed plate mounting locations

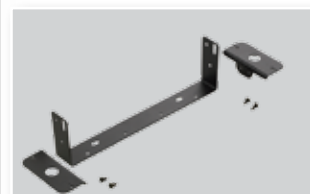

IPX-LPVX1 **\$25.00**

IPX3/IPX6/VPX8, extended license plate bracket for vehicles with a recessed license plate mount location including but not limited to the '02 - '11 Ford Crown Victoria Police Package

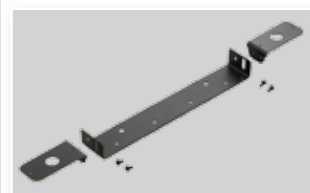

IPX-LPH1 **\$25.00**

IPX3/IPX6/VPX8, generic high side license plate holder with horizontal mount tab on each side, fits most vehicles



In-Line Corner LED Systems (416200)

- Built-in (19) selectable flash patterns
- Multiple units can be synchronized and can flash simultaneously or alternately
- Maintenance free
- Low-profile design
- Three-year warranty



Model	Description	List Price
	Two-head in-line Corner LED Systems: (2) LED heads with In-Line flasher and cables	
416200-22	Amber/Amber, (2) LED heads with In-Line flasher	\$255.00
416200-33	Blue/Blue, (2) LED heads with In-Line flasher	305.00
416200-44	Red/Red, (2) LED heads with In-Line flasher	255.00
416200-55	Clear/Clear, (2) LED heads with In-Line flasher	305.00

Common Replacement Parts

416201-02	LED lighthouse, Amber	90.00
416201-03	LED lighthouse, Blue	115.00
416201-04	LED lighthouse, Red	90.00
416201-05	LED lighthouse, Clear	115.00
416205	Flasher with cable, 2-channel	75.00

Corner LED Systems (CLED)

- LED assemblies mount inside the headlight, taillight and back-up light housings
- Amp or Deutsch connectors
- Remote six-head flasher provides twenty-two flash patterns, front and rear cut-off and two modes of operation
- LEDs are available in Amber, Blue, Red and White
- All necessary hardware included



Model	Description	List Price
	Two-head Kit: (2) single headlight assemblies with flasher and cables	
CLED2A-XX	(2) Single-head assemblies with AMP connectors, -A(Amber); -B(Blue); -R(Red); -W(Clear)	\$450.50
CLED2D-XX	(2) Single-head assemblies with Deutsch connectors, -A(Amber); -B(Blue); -R(Red); -W(Clear)	450.50
	Four-head Kit: (4) single headlight assemblies with flasher and cables	
CLED4A-XXXX	(4) Single-head assemblies with AMP connectors, -A(Amber); -B(Blue); -R(Red); -W(Clear)	755.00
CLED4D-XXXX	(4) Single-head assemblies with Deutsch connectors, -A(Amber); -B(Blue); -R(Red); -W(Clear)	755.00
	Four-head Kit for Heavy Duty Application: (4) single headlight assemblies with flasher and cables	
CLED4A-WWWW-16	(4) Single-head assemblies, Clear, (2) 16-ft cables	765.50
CLED4A-WWWW-HD	(4) Single-head assemblies, Clear, (2) 16-ft cables, (2) 30-ft cables	765.50
	Six-head Kit: (6) single headlight assemblies with flasher and (6) cables	
CLED6A-WWWWRR	(6) Single-head assemblies with AMP connectors, (4) Clear, (2) Red	839.00
CLED6D-WWWWRR	(6) Single-head assemblies with Deutsch connectors, (4) Clear, (2) Red	839.00
CLED6A-WWWW	(6) Single-head assemblies with AMP connectors, Clear	839.00
CLED6D-WWWW	(6) Single-head assemblies with Deutsch connectors, Clear	839.00

Accessories and Kits

501903	Flasher Individual flasher, 6-Channel, Corner LED	164.25
	Corner LED Cables (Amp connectors)	
413210	10-ft length	18.75
413216	16-ft length	31.25
413222B	25-ft length	37.25
413230	30-ft length	43.00
413251	50-ft length	51.00

Common Replacement Parts

Z8622158A-02	Bulb, Amp connector, Amber	208.50
Z8622158A-03	Bulb, Amp connector, Blue	208.50
Z8622158A-04	Bulb, Amp connector, Red	208.50
Z8622158A-05	Bulb, Amp connector, White	208.50
Z8622158A-22	Bulb, Deutsch connector, Amber	208.50
Z8622158A-23	Bulb, Deutsch connector, Blue	208.50
Z8622158A-24	Bulb, Deutsch connector, Red	208.50
Z8622158A-25	Bulb, Deutsch connector, White	208.50

Silver Series™ SLD Systems

- 460L and 660L have built-in LED flashers to synchronize LED modules with strobe head action
- Variety of flash patterns available
- Prioritized three-mode operation
- Industry standard connectors supplied with all units



Model	Description	List Price
Silver Series Strobe Power Supplies		
415205	SS2W, two-channel, Weatherpack connectors	\$156.25
415207	SS2A, two-channel, Amp connectors	129.75
416104	460L, four-head, 60W, synchronized LED Flasher	225.25
416106	660L, six-head, 60W, synchronized LED Flasher	237.25
416108	SS4A, four-head, 50W, multiple patterns, Weatherpack connectors	191.00
416109	SS4A, four-head, 50W, multiple patterns, Amp connectors	165.75
Strobe Systems/Kits		
416110B	(1) 460L, (4) Clear corner tubes, (2) 10-ft cables, (2) 25-ft cables	454.25
416111	(1) 460L, (4) Clear corner tubes, (2) 16-ft cables, (2) 30-ft cables	472.50
416118	(1) 660L, (4) Clear corner tubes, (4) 16-ft cables	454.25
416119B	(1) 660L, (4) Clear corner tubes, (2) 10-ft cables, (2) 25-ft cables	454.25
416120	(1) 660L, (4) Clear corner tubes, (2) 16-ft cables, (2) 30-ft cables	472.50
416125B	(1) SS4A, (4) Clear corner tubes, (2) 10-ft cables, (2) 25-ft cables	316.75
416127	(1) SS4A, (4) Clear corner tubes, (2) 16-ft cables, (2) 30-ft cables	346.75
416129	(1) SS4A, (4) Clear corner tubes, (4) 16-ft cables	316.75
416139	(1) SS2A, (2) Clear corner tubes, (2) 16-ft cables	214.50
416140	(1) SS2A, (2) Clear corner tubes, (2) 30-ft cables	214.50
Weatherpack Systems		
416126	(1) SS4W, (4) Clear corner tubes, (2) 16-ft cables, (2) 30-ft cables	371.00
416128	(1) SS4W, (4) Clear corner tubes, (4) 16-ft cables	338.00
416132B	(1) SS4W, (4) Clear corner tubes, (2) 10-ft cables, (2) 25-ft cables	338.00
Strobe heads, AMP connectors		
413201	Corner strobe tube, Ricochet/Silver Series, 1" diameter rubber grommet, amp connector; -02(Amber); -03(Blue); -04(Red)	60.50
413201-05	Corner strobe tube, Ricochet/Silver Series, 1" diameter rubber grommet, amp connector, Clear	37.25
Strobe heads, Weatherpack connectors		
413300	Corner strobe tube, Silver Series, 1" diameter rubber grommet, Weatherpack connector; -02(Amber); -03(Blue); -04(Red)	60.50
413300-05	Corner strobe tube, Silver Series, 1" diameter rubber grommet, Weatherpack connector, Clear	37.25
Strobe Cables		
413123	Cable, 500-ft, bulk package	518.00
413124	Bulk packaging amp connector kit (approximate installation capacity of (5) police cruisers)	84.75
413202	Kit, adapter cables, strobe power supply, (2) 12" cables	14.25
Cable kit, AMP connectors		
413210	10-ft cable length	18.75
413216	16-ft cable length	31.25
413222B	25-ft cable length	37.25
413230	30-ft cable length	43.00
413241	40-ft cable length	49.00
413251	50-ft cable length	51.00
Silver Series, cable kit, Weatherpack connectors		
413310	10-ft cable length	22.25
413316	16-ft cable length	35.50
413322B	25-ft cable length	43.00
413330	30-ft cable length	49.00
413340	40-ft cable length	54.75
413350	50-ft cable length	56.75
Cable kit, AMP and Weatherpack connectors		
413410	10-ft cable length	21.00
413416	16-ft cable length	34.25
413422B	25-ft cable length	40.75
413430	30-ft cable length	46.25

Notes

- Power supplies with Weatherpack connectors are only compatible with cables and strobe heads with Weatherpack connectors.
- Purchase cables separately unless otherwise noted, one per strobe head.
- Equipment provided with Amp connectors unless being noted as Weatherpack.



MicroPulse™

- Multiple mounting options for various applications
- Superior warning with (6) high-powered LEDs
- Single/multi-unit synchronization
- Three-year LED warranty

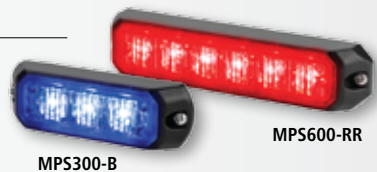

Model	Description	List Price
MicroPulse 6		
Surface mount, 12-24 VDC		
MPS600-AA	6-LED lighthead, Amber/Amber	\$139.00
MPS600-BA	6-LED lighthead, Blue/Amber	139.00
MPS600-BB	6-LED lighthead, Blue/Blue	139.00
MPS600-RB	6-LED lighthead, Red/Blue	139.00
MPS600-RR	6-LED lighthead, Red/Red	139.00
MPS600-RW	6-LED lighthead, Red/White	139.00
MPS600-WW	6-LED lighthead, White/White	139.00
Hood/Grille mount, 12-24 VDC		
MPS650-AA	6-LED lighthead, Amber/Amber	139.00
MPS650-BA	6-LED lighthead, Blue/Amber	139.00
MPS650-BB	6-LED lighthead, Blue/Blue	139.00
MPS650-RB	6-LED lighthead, Red/Blue	139.00
MPS650-RR	6-LED lighthead, Red/Red	139.00
MPS650-RW	6-LED lighthead, Red/White	139.00
MPS650-WW	6-LED lighthead, White/White	139.00

Model	Description	List Price
MicroPulse 3		
Surface mount, 12-24 VDC		
MPS300-A	3-LED lighthead, Amber	95.00
MPS300-B	3-LED lighthead, Blue	95.00
MPS300-R	3-LED lighthead, Red	95.00
MPS300-W	3-LED lighthead, White	95.00
Hood/Grille mount, 12-24 VDC		
MPS350-A	3-LED lighthead, Amber	95.00
MPS350-B	3-LED lighthead, Blue	95.00
MPS350-R	3-LED lighthead, Red	95.00
MPS350-W	3-LED lighthead, White	95.00

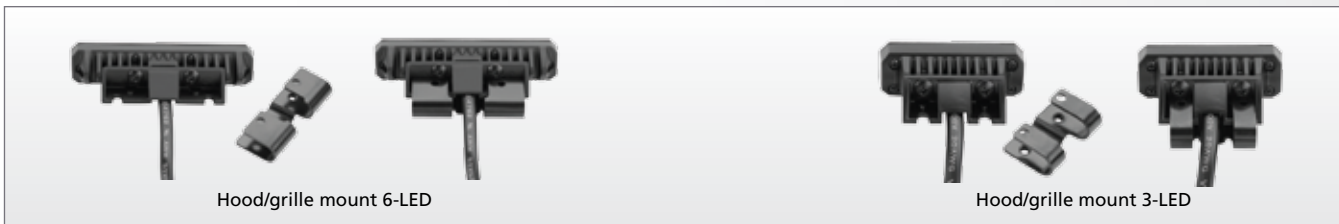

SignalMaster™ Controller

- Controls six or eight lamp directional lights
- Installer selectable flash patterns
- Tactile membrane keypad



Model	Description	List Price
330104	Six or eight-lamp, 12 or 24V (multiple installer-selectable flash patterns, fuse protected)	\$253.50
331105	Heavy Duty six or eight-lamp, 12 or 24V (slide switch, multiple installer-selectable flash patterns, heavy duty ground, fuse protected, controls two halogen SignalMasters simultaneously)	310.00

Common Replacement Parts

Z140325A-13	Plug, controller 330105	33.75
Z8536C1041A	Knob	10.00

VPX SignalMaster™



320862

- Viper EXT LED modules provide superior light intensity
- Extrusion is designed to block sunlight, increasing warning effectiveness
- Low amp draw, long life product



Model	Description	List Price
320810-RB	42", (8) lamp, 30-ft cable, R-A-A-A-A-A-A-B	\$1,254.75
320810-R4B4	42", (8) lamp, 30-ft cable, R-R-R-R-B-B-B-B	1,493.50
320810-RAR	42", (8) lamp, 30-ft cable, R-A-A-A-A-A-A-R	1,352.75
320810-BAB	42", (8) lamp, 30-ft cable, B-A-A-A-A-A-A-B	1,254.75
320810-AAB	42", (8) lamp, 30-ft cable, A-A-A-A-A-A-A-B	1,313.25
320842	20", (4) lamp, 30-ft cable, A-A-A-A	783.00
320852	31", (6) lamp, 15-ft cable, A-A-A-A-A-A	1,055.75
320862	31", (6) lamp, 30-ft cable, A-A-A-A-A-A	1,075.50
320866	31", (6) lamp, 60-ft cable, A-A-A-A-A-A	1,236.00
320872	42", (8) lamp, 15-ft cable, A-A-A-A-A-A-A-A	1,313.25
320882	42", (8) lamp, 30-ft cable, A-A-A-A-A-A-A-A	1,336.00
320886	42", (8) lamp, 60-ft cable, A-A-A-A-A-A-A-A	1,493.50
320892	51", (8) lamp, 30-ft cable, A-A-A-A-A-A-A-A	1,336.00
320893	51", (8) lamp, 50-ft cable, A-A-A-A-A-A-A-A	1,493.50

Common Replacement Parts

Z8613194A-01	Replacement module, Amber LEDs with Amber lens	276.25
Z8613194A-02	Replacement module, Blue LEDs with Blue lens	276.25
Z8613194A-03	Replacement module, Red LEDs with Red lens	276.25
Z8613194A-04	Replacement module, Amber LEDs with Clear lens	276.25
Z8613194A-05	Replacement module, Blue LEDs with Clear lens	276.25
Z8613194A-06	Replacement module, Red LEDs with Clear lens	276.25

LED SignalMaster™ Plus



SMLED-PLS-8

- Individually sealed LED modules with wide-angle lens
- Sturdy aluminum extrusion
- Internal or external mounting applications
- Each LED module contains (3) high-powered LEDs

Model	Description	List Price
SMLED-PLS-6	28", (6) LED modules, 30-ft cable, Clear Lens with Amber LEDs	\$437.75
SMLED-PLS-8	37", (8) LED modules, 50-ft cable, Clear Lens with Amber LEDs	493.50

SignalMaster™



320172

- Housing blocks sunlight to increase warning effectiveness
- Unique lens spreads light horizontally for increased warning coverage
- Easy to maintain and service
- Halogen models

Model	Description	List Price
320142	20", (4) lamp, 30-ft cable	\$179.75
320162	31", (6) lamp, 15-ft cable	247.25
320172	42", (8) lamp, 15-ft cable	299.50
320182	42", (8) lamp, 30-ft cable	330.50
320192	42", (8) lamp, 50-ft cable	493.25

Kits

320310	Kit, bracket, flush mount system	35.50
320320	Kit, bracket, double "L" mount	40.25
320330	Kit, bracket, system mount	37.50
320340	Kit, bracket, universal vehicle mount	83.75
320350	Kit, bracket, foot adaptor	29.25

Common Replacement Parts

Z8573001B-02	Lens, SignalMaster, Amber; -01(Red); -03(Blue)	15.00
Z8573007A	Bulb, SignalMaster, 27W	10.50
Z8573180A	Reflector and terminal assembly, SignalMaster	15.00

Solaris® ILS



- FS Convergence Network compatible
- Patented ROC (Reliable Onboard Circuitry™) technology
- Solaris® LED assemblies for the highest optical efficiency
- Perfect for slicktop, highway and undercover applications
- Ultra bright White LED takedowns
- Built-in SignalMaster™ in rear models
- Front and rear models function together as a lightbar, offering front and rear cut-off along with dimming features
- LEDs offered in Amber, Blue, Red and White



Model	Description	List Price
	2011 Dodge Charger "Split" Front Headliner	
ILSSF-00001	(4) Red 6-LED reflectors, (4) Blue 6-LED reflectors, interface module	\$1,332.00
ILSSF-00007	(2) LED takedowns, (3) Red 6-LED reflectors, (3) Blue 6-LED reflectors, interface module	1,372.00
	2011 Dodge Charger Passenger Side Front Headliner	
ILSPF-00002	(4) Blue 6-LED reflectors, interface module	866.00
	2011 Dodge Charger Rear Deck	
ILSFD-00242	(1) Red 6-LED reflector, (1) Blue 6-LED reflector, (8) Amber 6-LED reflectors, splitter	1490.00
ILSFD-00259	(5) Red 6-LED reflectors, (5) Blue 6-LED reflectors, splitter	1490.00
	2011 Chevrolet Caprice "Split" Front Headliner	
ILSSF-00030	(4) Red 6-LED reflectors, (4) Blue 6-LED reflectors, interface module	1,332.00
ILSSF-00029	(2) LED takedowns, (3) Red 6-LED reflectors, (3) Blue 6-LED reflectors, interface module	1,372.00
	2011 Chevrolet Caprice Passenger Front Headliner	
ILSPF-00010	(4) Blue 6-LED reflectors, interface module	866.00
	2011 Chevrolet Caprice Rear Deck	
ILSFD-00252	(5) Red 6-LED reflectors, (5) Blue 6-LED reflectors, splitter	1490.00
ILSFD-00253	(1) Red 6-LED reflector, (1) Blue 6-LED reflector, (8) Amber 6-LED reflectors, splitter	1490.00
	Chevrolet Impala Front Headliner	
ILSSF-00040	(5) Red 6-LED reflectors, (5) Blue 6-LED reflectors, interface module	1490.00
ILSSF-00038	(2) LED takedowns, (4) Red 6-LED reflectors, (4) Blue 6-LED reflectors, interface module	1530.00
	Chevrolet Impala Rear Deck	
ILSFD-00146	(1) Red 6-LED reflector, (1) Blue 6-LED reflector, (8) Amber 6-LED reflectors, splitter	1490.00
ILSFD-00101	(5) Red 6-LED reflectors, (5) Blue 6-LED reflectors, splitter	1490.00
	Chevrolet Tahoe Front Headliner	
ILSFF-00059	(2) LED takedowns, (4) Red 6-LED reflectors, (4) Blue 6-LED reflectors, interface module	1490.00
ILSFF-00061	(5) Red 6-LED reflectors, (5) Blue 6-LED reflectors, interface module	1490.00
	Ford Explorer Front Headliner	
ILSFF-00111	(5) Red 6-LED reflectors, (5) Blue 6-LED reflectors, interface module	1490.00
ILSFF-00112	(2) LED takedowns, (4) Red 6-LED reflectors, (4) Blue 6-LED reflectors, interface module	1530.00
	Ford F-150 Front Headliner	
ILSFF-00058	(2) LED takedowns, (4) Red 6-LED reflectors, (4) Blue 6-LED reflectors, interface module	1490.00
ILSFF-00062	(5) Red 6-LED reflectors, (5) Blue 6-LED reflectors, interface module	1490.00
	2011 Ford Expedition "Split" Front Headliner	
ILSSF-00021	(4) Red 6-LED reflectors, (4) Blue 6-LED reflectors, interface module	1332.00
ILSSF-00019	(2) LED takedowns, (3) Red 6-LED reflectors, (3) Blue 6-LED reflectors, interface module	1372.00
	2011 Ford Expedition Passenger Front Headliner	
ILSPF-00008	(4) Blue 6-LED reflectors, interface module	866.00

Notes

- Front headliner models listed include an interface module. All rear deck models listed include a splitter.
- The interface module and splitter are not needed if controlled by a SSP300 amplifier.

Solaris® ILS (continued)

Front Headliner

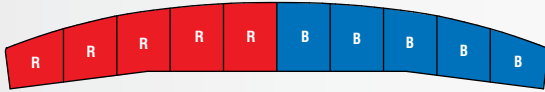

Impala - ILSFF-00040
 Explorer - ILSFF-00111
 Tahoe - ILSFF-00061
 F-150 - ILSFF-00062

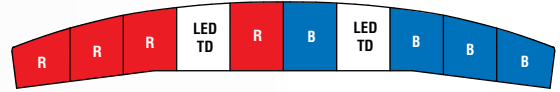

Impala - ILSFF-00038
 Explorer - ILSFF-00112
 Tahoe - ILSFF-00059
 F-150 - ILSFF-00058

Split Front Headliner

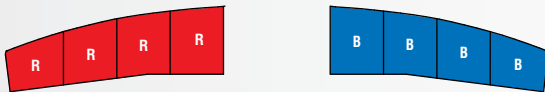

Expedition - ILSFF-00021
 Charger - ILSFF-00001
 Caprice - ILSFF-00030



Expedition - ILSFF-00019
 Charger - ILSFF-00007
 Caprice - ILSFF-00029

Rear Deck



Charger - ISLFD-00092
 Impala - ILSFD000242
 Caprice - ILSFD-00253



Charger - ISLFD-00259
 Impala - ILSFD-00101
 Caprice - ILSFD-00252

Viper® S2

- Solaris® LED reflector technology provides bold blocks of light and superior off-axis warning capability
- Single and dual light head models
- Cigarette plug with LED on/off switch and synchronized models
- Simple push-button pattern control and 2-phase pattern synchronization
- Versatile mounting brackets with "snap-on" flash guard
- Library of more than 20 flash patterns
- LEDs available in Amber, Blue or Red



Model	Description	List Price
Single-head models with cigarette plug		
329000	-2(Amber); -3(Blue); -4(Red)	\$207.25
Single-head models with wire leads (synchronization capable)		
329001	-2(Amber); -3(Blue); -4(Red)	227.25
Dual-head models with cigarette plug		
329000-22	Amber/Amber	390.75
329000-23	Amber/Blue	390.75
329000-24	Amber/Red	390.75
329000-32	Blue/Amber	390.75
329000-33	Blue/Blue	390.75
329000-34	Blue/Red	390.75
329000-42	Red/Amber	390.75
329000-43	Red/Blue	390.75
329000-44	Red/Red	390.75

Model	Description	List Price
Dual-head models with wireleads (synchronization capable)		
329001-22	Amber/Amber	400.25
329001-23	Amber/Blue	400.25
329001-24	Amber/Red	400.25
329001-32	Blue/Amber	400.25
329001-33	Blue/Blue	400.25
329001-34	Blue/Red	400.25
329001-42	Red/Amber	400.25
329001-43	Red/Blue	400.25
329001-44	Red/Red	400.25

Accessories

Model	Description	List Price
350701-01	Bracket, rear deck brake light/dual, Crown Victoria	14.75
350701-02	Bracket, rear view mirror/headliner/single, Crown Victoria	16.50
350701-03	Bracket, rear view mirror/headliner/dual, Crown Victoria	19.25

Wireless VisiBeam®/VisiBeam® II

- Ergonomically designed wireless transmitter operates at over 100 feet
- Up to four transmitters programmable to operate one light
- Graduated start for pinpoint light beam placement
- Continuous 360-degrees horizontal and 140-degrees vertical adjustment



Model	Description	List Price
Wireless VisiBeam models include wireless controller		
620200	100W, 12VDC, permanent mount	\$410.75
620201	100W, 12VDC, magnetic mount with cigarette lighter plug	449.50
VisiBeam II		
620102	55W, 12VDC, adjustable spot light surface mount	361.25
620122	100W, 12VDC, adjustable spot light, surface mount	365.50
620142	100W, 12VDC, adjustable spot light, magnetic mount with cord and cigarette plug	406.75
620152	100W, 12VDC, adjustable spot light, pipe mount	406.75

Common Replacement Parts

Z146903B	Cable Assembly, RJ45, 25-ft	21.00
Z8107152A	Bulb, VisiBeam, 55W, for model 620102	10.50
Z8107158A	Bulb, VisiBeam, 100W, for models 620122, 620142, and 620152	10.50
Z8422B399A-01	Motor, 12V	35.75
Z8433001A	Dome, VisiBeam, Clear	15.25
Z8433039B	Remote control, VisiBeam	115.50
Z8433113A	Control assembly, Wireless VisiBeam	146.50

Night-Fighter®

- Powerful, effective three-lamp unit provides both spot and flood capability
- Lighthead easily adjusts both vertically and horizontally to direct light where it is needed
- Classic, polished appearance complements other polished or chrome accessories on the vehicle



Model	Description	List Price
FL3SF-LC	Area light, low current, three-lamp spot/flood light	\$1,148.00
FL3SF-R-LC	Area light, low current, three-lamp spot/flood light with remote power switch	1,244.75
FL3SF-012SB	Area light, 12V, spot/flood light	1,157.25

Kit	Description	List Price
FL3TK-1	Kit, 4" telescopic pole	285.50

Common Replacement Parts

Z122A212B	Toggle switch, use with model FL3SF-LC	36.00
Z122A217B	Toggle switch, use with model FL3SF-012SB	36.75
Z8107A117A	Incandescent lamp, use with models FL3SF, FL3SF-LC and FL3SF-012SB	29.50
Z8107A117-01	Halogen lamp, use with model FL3SF-LC	111.00

Opticom®



- Infrared LED and strobe traffic pre-emption emitters
- Internal-mount and external-mount emitter available
- Some models available with mounting brackets for attachment to FS lightbars

Model	Description	List Price
Opticom emitters		
794-AH	794 infrared LED emitter, suitable for external use	\$2,039.00
3M792H	792 strobe emitter, suitable for external use	2,039.00
795H-INT	795 infrared LED emitter/bracket for dash/deck mounting, suitable for internal use only	1,565.00
Opticom emitters with lightbar mounting brackets		
795H-EXT-VALRD	795H Opticom in sealed housing with bracket for "driver-side" mounting on Valor lightbars	2,399.00
795H-EXT-VALRP	795H Opticom in sealed housing with bracket for "passenger-side" mounting on Valor lightbars	2,399.00
795H-EXT-VD	795H Opticom in sealed housing with bracket for "driver-side" mounting on Vision SLR lightbars	2,399.00
795H-EXT-VP	795H Opticom in sealed housing with bracket for "passenger-side" mounting on Vision SLR lightbars	2,399.00
795H-EXT-LGDD	795H Opticom in sealed housing with bracket for "driver-side" mounting on Legend lightbars	2,399.00
795H-EXT-LGDP	795H Opticom in sealed housing with bracket for "passenger-side" mounting on Legend lightbars	2,399.00
795H-EXT-ARJD	795H Opticom in sealed housing with bracket for "driver-side" mounting on Arjent S2 lightbars	2,399.00
795H-EXT-ARJP	795H Opticom in sealed housing with bracket for "passenger-side" mounting on Arjent S2 lightbars	2,399.00
25-3M792H-A	792 emitter and bracket installed in JetSolaris and AeroDync lightbars	2,141.00
EMS-3M792H-A	792 emitter and bracket installed in EMS Escape lightbars	2,099.00

Accessory

350701-03	Optional headliner mounting kit for 795H-INT	19.25
-----------	--	-------

Note

- Opticom emitters must be mounted behind clear domes.

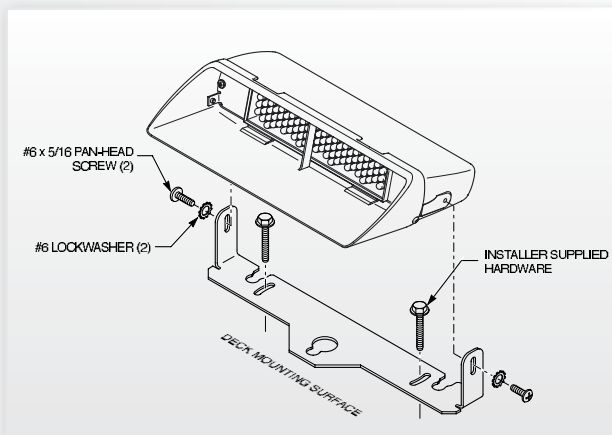

795H-INT

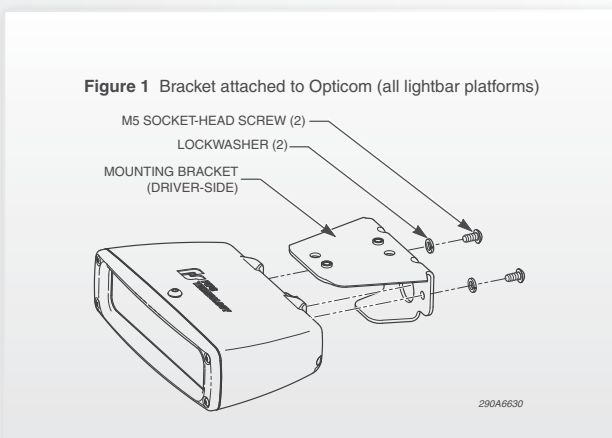
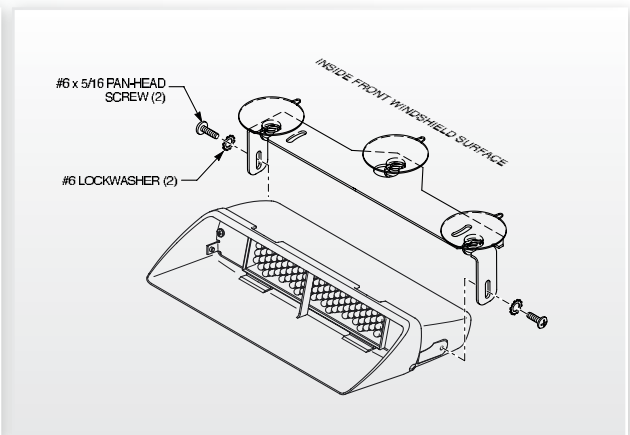

795H-EXT

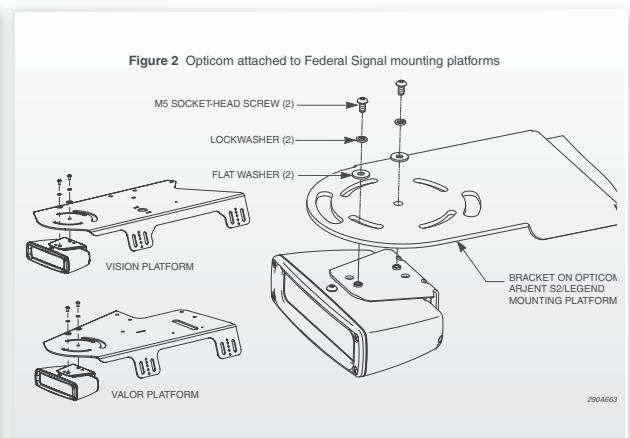

Headlight/Taillight Flashers

- Headlight and Taillight flashers for today's most popular vehicles
- New "plug-n-play" models available
- Multiple flash rates
- Easy to install

Model	Description	List Price
FHLP-CV	Flasher, Headlight, '06-newer, (CVPI) Crown Victoria Police Interceptor flasher, "plug-n-play" connector, multiple flash patterns	\$88.00
FHLP-IMP	Flasher, Headlight, '06-newer, Chevrolet Impala Police Package with "plug-n-play" connectors	132.00
FHLP-TAH	Flasher, Headlight, '06-newer, Chevrolet Tahoe with "plug-n-play" connectors	132.00
FHL-CHG	Flasher, Headlight, '06-newer, Dodge Charger	132.00
FHL-HL	Flasher, Headlight, positive-side switched systems, 18" wire leads, (2) 10 amp outputs, multiple flash patterns	88.00
FHL2-SC	Flasher, Headlight, 90 FPM, positive-side switched systems, high-beam override, (2) 10 amp loads	73.00
FHL-TAIL	Flasher, Taillight, universal applications, 18" wire leads	88.00

Vehicle	Headlight	Taillight
Crown Victoria Police Interceptor	FHLP-CV	FHL-TAIL
Ford Expedition	FHL-HL	FHL-TAIL
Ford Explorer	FHL-HL	FHL-TAIL
Chevrolet Impala Police Package	FHLP-IMP	FHL-TAIL
Chevrolet Tahoe	FHLP-TAH	FHL-TAIL
Dodge Charger	FHL-CHG	FHL-TAIL



FHLP-CV



FHL-HL



FHLP-IMP



FHLP-TAH



FHL-CHG



FHL-TAIL

Littlite®

- Durable, high-quality lighting for a vehicle's console
- Flexible gooseneck allows easy movement
- Clear bright light with either rheostat or on/off switch controls
- LED or halogen models available
- LED units offer choice of Red or White light from toggle switch selector
- Green or Red filters available



Model	Description	List Price
LED LITTLITE MODELS		
Neck extends from top of chassis, horizontal mount		
LF6MOTO-LED	6", Switch control, wired base, motorcycle application	\$152.25
LF12TSB-LED	12", On/Off switch control, wired base	152.25
LF12TS-LED	12", On/Off switch control	152.25
LF18TSB-LED	18", On/Off switch control, wired base	152.25
LF18TS-LED	18", On/Off switch control	152.25
Neck extends from end of chassis, vertical mount		
LF12ES-LED	12", On/Off switch control	152.25
LF18ES-LED	18", On/Off switch control	152.25
HALOGEN LITTLITE MODELS		
Neck extends from end of chassis, vertical mount		
LF6ESB	6", Switch control, wired base	63.50
LF12ER	12", Rheostat control	63.50
LF12ERB	12", Rheostat control, wired base	63.50
LF12ERC	12", Rheostat control, cigarette plug	63.50
LF12ES	12", On/Off switch control	63.50
LF12ESB	12", On/Off switch control, wired base	63.50
LF18ER	18", Rheostat control	63.50
LF18ERB	18", Rheostat control, wired base	63.50
LF18ERC	18", Rheostat control, cigarette plug	63.50
LF18ES	18", On/Off switch control	63.50
LF18ESB	18", On/Off switch control, wired base	63.50

Model	Description	List Price
Neck extends from top of chassis, horizontal mount		
LF6MOTO	6", Switch control, wired base, motorcycle application	63.50
LF6TR	6", Rheostat control	63.50
LF6TRB	6", Rheostat control, wired base	63.50
LF12TR	12" Rheostat control	63.50
LF12TRB	12", Rheostat control, wired base	63.50
LF12TRC	12", Rheostat control, cigarette plug	63.50
LF12TS	12", On/Off switch control	63.50
LF12TSB	12", On/Off switch control, wired base	63.50
LF18TR	18", Rheostat control	63.50
LF18TRB	18", Rheostat control, wired base	63.50
LF18TS	18", On/Off switch control	63.50
LF18TSB	18", On/Off switch control, wired base	63.50

Common Replacement Parts

Part Number	Description	List Price
Z8550250A	Lamp, bi-pin	24.25
Z8550251A	Filter, Red; -01(Clear); -02(Green)	10.00
LFHK	Hood kit	13.75

Voice Gun

- High-power electronic megaphones
- Lightweight, less than 4-lbs each
- Trouble free, solid-state design



Model	Description	List Price
A12SA	16W, 1320-ft range, requires (8) AA batteries	\$674.50

Intelli-Flash® Flasher

- Specifically designed for use with auxiliary LED lighting
- Designed to perform in a variety of applications
- Can be used to synchronize multiple light heads



650302

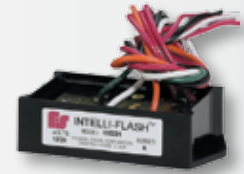

650201

Model	Description	List Price
Intelli-Flash series flashers (auxiliary lighting flashers - do not use for headlight or taillight applications)		
650201	(2) 6A loads, (8) flash patterns, ground-side switching	\$91.75
650202	(4) 4A loads, (8) flash patterns, ground-side switching	91.75
650205	(2) 10A loads, (10) flash patterns, high-side switching	113.75
650206	(2) 6A loads, (8) flash patterns, ground-side switching	91.75
650302	Fire/EMS application, K-spec compliant, zoning capable, 16 outputs, 40A total capacity, high-side switching	284.00
FA3-SC	90 FPM, (2) 10A loads, high-side switching	28.75

Switch Control

- Switching of up to seven auxiliary functions
- 20-Amp fuses and 20-amp switches are standard
- Standard, high current slide switch and non-slide switch models available
- Backlit or LED function identification
- Customized switch types available with Unitrol® models



Model	Description	List Price
SW200-012	SW200 Series, (4) 20A fused switches	\$168.75
SW200-024	SW200 Series, (4) 20A fused switches, 24V	172.00
SW30	SW30 Series, (3) 20A toggle switches on L bracket housing	44.00
SW300-012	SW300 Series, (1) 40A and (5) 20A fused switches	202.25
SW400SS	SW400 Series, slide control and (4) 20A switches	259.25
U330-5	Unitrol 330 Series, 60A slide-bar (1) 15A switch circuit	200.75
U330-55	Unitrol 330 Series, 60A slide-bar (2) 15A switch circuits	209.75
U330-5555	Unitrol 330 Series, 60A slide-bar (4) 15A switch circuits	221.50

Common Replacement Parts

Z122283A	Rocker switch, 20A, momentary	17.00
Z122385B	Rocker switch, 20A, on/off, illuminates, Red	10.00
Z124102A	Kit, circuit breaker, 40A	18.00
Z124A058A	Kit, multiple legends, backlit	15.00

Evacuator® Back-up Alarms

- Back-up alarms have a wide range of decibel and voltage options
- Solid-state design protects and resists the effects of vibration
- Sealed unit protects internal components from moisture and contaminants



Model	Description	List Price	Model	Description	List Price
Evacuator Plus, Dual Functions, 12-48V			Evacuator, Single Functions, 12-24V		
210330	87dB	38.75	210339	97dB	26.75
210331	97dB	41.50	210340	102dB	33.25
210333	107dB	52.50	210341	107dB	40.00
210335	112dB	61.50			

Reverse Camera/Monitor Systems



- All cameras are high-resolution, color Sony CCD cameras
- TFT-LCD color monitors available in 5.6" or 7.0"
- Most cameras equipped with automatic day/night sensor and infrared LEDs for night vision

- Multiple camera cable lengths available
- Digital Video Recorder (DVR) with video and audio feed available
- Wide operating temperature range for all cameras: -22°F to 149°F
- Multi-voltage capability (12/24 VDC)

Model	Description	List Price
Systems		
CAMSET56-NTSC-2	5.6" Monitor with two camera inputs, (1) standard rear-view camera, and (1) 65.5-ft camera-to-monitor extension cable	\$664.75
CAMSET70-NTSC4B	7.0" Monitor with four camera inputs, (1) standard rear-view camera, and (1) 65.5-ft camera-to-monitor extension cable	790.00
Monitors - Camera cables not included		
CAMLCD-70	7.0" TFT-LCD monitor (for use with CAMDVR-SD or CAMDVR-4-B)	472.50
CAMLCD-INT-56	5.6" TFT-LCD monitor with two camera inputs	451.00
CAMLCD-INT-70-B	7.0" TFT-LCD monitor with four camera inputs and intelligent split-screen capability	541.50
CAMLCD-MIR	4.3" TFT-LCD rear-view mirror monitor with two camera inputs	333.75
Cameras - Camera cables not included		
CAMCCD-REARNTSC	Standard rear-view CCD camera with photosensor, 16 infrared LEDs, and microphone, IP68	212.25
CAMCCD-SIDENTSC	Standard rear-view CCD camera with photosensor, 16 infrared LEDs, and microphone, IP68	212.25
CAMCCD-FLSHNTSC	Bullet/flush-mount CCD camera, IP68, U-bracket included	212.25
CAMCCD-FLS2NTSC	Bullet/flush-mount CCD camera with photosensor & 10 infrared LEDs for night vision, IP68	212.25
CAMCCD-BALLNTSC	Standard rear-view CCD camera with photosensor & 16 infrared LEDs for night vision, microphone, IP68	212.25
CAMCCD-DOMENTSC	Dome CCD camera with photosensor & 18 infrared LEDs for night vision, microphone, IP65	212.25
DVR		
CAMDVR-4-B	Digital video recorder, 250GB hard drive, (2) 33-ft and (2) 45-ft camera cables	1299.00
CAMDVR-SD	Digital video recorder, 32GB SD card, (2) 33-ft and (2) 45-ft camera cables	871.75
Cables		
CAMCABLE-5	Camera-to-monitor extension cable, 16.5-ft/5-m	23.50
CAMCABLE-10	Camera-to-monitor extension cable, 33-ft/10-m	28.00
CAMCABLE-15	Camera-to-monitor extension cable, 49-ft/15-m	36.00
CAMCABLE-20	Camera-to-monitor extension cable, 65.5-ft/20-m	43.50
CAMCABLE-40	Camera-to-monitor extension cable, 131-ft/40-m	96.50
CAMCABLE-TRK	Truck/trailer camera connection kit	148.50
CAMCABLE-SHORT	Camera-to-monitor extension cable, 4-in/102-mm	13.50

Accessories and Kits

CAMADP-EXT	Camera cable adapter for connecting two camera-to-monitor extension cables together	14.75
CAMADP-RCA-IN	System adapter for connecting external RCA equipped video source to FS monitor or DVR	14.75
CAMADP-RCA-OUT	System adapter for connecting CAMCCD-XXXXNTSC to external RCA destination input	14.75
CAMBRK-HD	Heavy-duty monitor mount	36.25
CAMLCD-BRACKET	Replacement mounting bracket for monitor	30.00
CAMADP-Y2	System adapter for splitting camera or monitor into two branches	14.75

Common Replacement Parts

CAMADP-INT-2	Replacement wiring harness, CAMLCD-INT-56/CAMLCD-INT-70	19.75
CAMADP-INT-4	Replacement wiring harness, CAMLCD-INT-70-B	19.75





FIRE APPARATUS PRODUCT REFERENCE

Model	Description	List Price
Lightbars		
LGD61NFPA-LA1	61" Legend lightbar, Red LEDs, no rear lighting, all Clear domes	\$3,178.25
LGD61NFPA-LA2	61" Legend lightbar, Red LEDs, flashing LED takedowns, no rear lighting, all Clear domes	3,174.50
VSLR605-NFPA1	Red/Multi/Red, (5) All Red LED rotators, (2) multi-colored LED rotators, interface module, Red and clear domes, no SignalMaster, permanent mount	4,295.00
VSLR605-NFPA2	Red/Multi/Red, (4) All Red LED rotators, (3) multi-colored LED rotators, interface module, Red and clear domes, no SignalMaster, Black hook-on mount	4,570.00
ADX5250	52", (Candy-Stripe) AeroDync, two-tier LEDs, no rear lighting	3,702.75
ADX7250	72", (Candy Stripe) AeroDync, two-tier LEDs, no rear lighting	4,084.50
JLX6001-NFPA	60", JetSolaris, All Red domes, (9) Red 6-LED reflectors, (6) Red 3-LED reflectors, no rear lighting	1,852.50
JLX6002-NFPA	61", Red/Red/Clear/Red/Red, (8) Red 6-LED reflectors, (6) Red 3-LED reflectors, (1) halogen traffic clearing light, no rear lighting	1,990.00
Perimeter Warning Lights		
QL64XF-(color)	QuadraFlare, 6x4, Amber, Blue, or Red, built-in flasher	175.00
QL64XF-C	QuadraFlare, 6x4, White, built-in flasher	209.00
QL64MC	QuadraFlare, 6x4, Chrome bezel	14.00
QL73XF-(color)	QuadraFlare, 7x3, Amber, Blue, or Red, built-in flasher	175.00
QL73XF-C	QuadraFlare, 7x3, White, built-in flasher	209.00
QL73MC	QuadraFlare, 7x3, Chrome bezel	14.00
QL97XF-(color)	QuadraFlare, 9x7, Amber, Blue or Red, built-in flasher	279.00
QL97XF-C	QuadraFlare, 9x7, White, built-in flasher	323.00
QL97MC	QuadraFlare, 9x7, Chrome bezel	21.50
VPX802-4	Viper EXT, Red, (8) prime output LEDs, colored off-axis lens	175.00
VPXM-1	Viper EXT, Chrome bezel	11.25
IPX302-4	IMPAXX, Red, (3) prime output LEDs, colored off-axis lens	105.00
IPXM-1	IMPAXX, Chrome bezel	6.00
Stop/Tail/Turn/Back-up Lights		
QL64Z3V-LEFT	3-position casting with installed QL64Z-BTT, QL64Z-ARROW and QL64Z-BACKUP	653.00
QL64Z3V-RIGHT	3-position casting with installed QL64Z-BTT, QL64Z-ARROW and QL64Z-BACKUP	653.00
LED Beacons		
ME2QLPC-R	MicroEscape LED, (2) Red QuadraFlare LED reflectors, Clear dome, passenger side specific	602.00
ME2QLDC-R	MicroEscape LED, (2) Red QuadraFlare LED reflectors, Clear dome, driver side specific	602.00
ME2QLPC-A	MicroEscape LED, (2) Amber QuadraFlare LED reflectors, Clear dome, passenger side specific	602.00
ME2QLDC-A	MicroEscape LED, (2) Amber QuadraFlare LED reflectors, Clear dome, driver side specific	602.00
VSLR1-R	Red LEDs, Red lens	925.00
Area/Scene Lighting		
QL97LEDSCENE	LED Scene light, 9x7, surface mount	399.00
QL97HSCENE	Halogen Scene light, 9x7	125.00
GHSCENE	Area light, GHSCENE, (2) 20W adjustable lamps, Clear lens	139.00
620200	Wireless Visibeam, 100W, 12VDC, permanent mount	410.75
FL35F-LC	NightFighter, area light, low current, three-lamp spot/flood light	1,148.00
Sirens		
EQ2B-200	Electronic, 200W, remote amplifier, surface mount control head	1,587.50
Q2B-012NNSD	Q2B, mechanical siren, Chrome, recess mount	2,130.50
Q2B-012PSD	Q2B, mechanical siren, Chrome, pedestal mount	2,374.25
690010	200W, PA300-012MSC, hi-lo tone, hard-wired microphone	435.25
690014	100/200, remote mounted control, dual control head, noise-cancelling microphone	822.25
690015	100/200, remote mounted control, single control head, noise-cancelling microphone	689.75
Speakers		
ES100	Speaker, DynaMax/MS100, 100W, high output, compact, Class A	299.00
BP200-EF	200W, stainless steel "Electric F" grille, recess mount	715.00
BP200-Q	200W, Chrome Q-Siren grille, recess mount	975.00
ESFMT-EF	Kit, recess mount, stainless steel "Electric F" grille	74.25
Additional Products		
CAMSET56-NTSC-2	5.6" Monitor with two camera inputs, (1) standard rear-view camera, and (1) 65.5-ft camera-to-monitor extension cable	664.75
CAMSET70-NTSC4B	7.0" Monitor with four camera inputs, (1) standard rear-view camera, and (1) 65.5-ft camera-to-monitor extension cable	877.00
320892	51" VPX SignalMaster, (8) lamp, 30-ft cable	1,336.00
330104	Six or eight-lamp, 12 or 24V (multiple installer-selectable flash patterns, fuse protected)	253.50
LF18ES-LED	18" LED Littlite, on/off switch control	152.25
210339	Evacuator, back-up alarm, single-function, 97dB	26.75

AMBULANCE APPARATUS PRODUCT REFERENCE

Model	Description	List Price
Lightbars		
ELX8847	88", (6) Red QuadraFlare LED reflectors, (1) Clear halogen flashing light	\$2,266.75
ELX8848	88", (6) Red QuadraFlare LED reflectors, (2) load lights, (1) Amber halogen flashing light	2,435.75
ELX9001	90", (6) Red QuadraFlare LED reflectors, (1) Clear halogen flashing light	2,266.75
ELX9002	90", (6) Red QuadraFlare LED reflectors, (2) load lights, (1) Amber halogen flashing light	2,435.75
QT8292	Quick track mounting system, use for 82" to 92" EMS Escape lightbars	197.25
VSLR46S-NFPA1	Red/Multi/Red, (5) All Red LED rotators, (2) multi-colored LED rotators, interface module, Red and Clear domes, no SignalMaster, Black hook-on mount	3,995.00
Perimeter Warning Lights		
QL64XF-(color)	QuadraFlare, 6x4, Amber, Blue or Red, built-in flasher	175.00
QL64XF-C	QuadraFlare, 6x4, White, built-in flasher	209.00
QL64MC	QuadraFlare, 6x4, Chrome bezel	14.00
QL73XF-(color)	QuadraFlare, 7x3, Amber, Blue, or Red, built-in flasher	175.00
QL73XFC-C	QuadraFlare, 7x3, White, built-in flasher	209.00
QL73MC	QuadraFlare, 7x3, Chrome bezel	14.00
QL97XF-(color)	QuadraFlare, 9x7, Amber, Blue or Red, built-in flasher	279.00
QL97XFC-C	QuadraFlare, 9x7, White, built-in flasher	323.00
QL97MC	QuadraFlare, 9x7, Chrome bezel	21.50
VPX802-4	Viper EXT, Red, (8) high-powered LEDs, colored off-axis lens	175.00
VPXM-1	Viper EXT, Chrome bezel	11.25
IPXM-1	IMPAXX, Chrome bezel	6.00
Stop/Tail/Turn/Back-up Lights		
QL64Z3V-LEFT	3-position casting with installed QL64Z-BTT, QL64Z-ARROW and QL64Z-BACKUP	653.00
QL64Z3V-RIGHT	3-position casting with installed QL64Z-BTT, QL64Z-ARROW and QL64Z-BACKUP	653.00
Scene/Load Lights		
QL97LEDSCENE	LED Scene light, 9x7, surface mount	399.00
QL97HSCENE	Halogen Scene light, 9x7	125.00
QL97MC	Chrome bezel, 9x7 QuadraFlare lights	21.50
GHSCENE	Area light, GHSCENE, (2) 20W adjustable lamps, Clear lens	139.00
Sirens and Speakers		
EQ2B-200	Electronic, 200W, remote amplifier, surface mount control head	1,587.50
690010	200W, PA300-012MSC, hi-lo tone, hard-wired microphone	435.25
PA4000	200W, flush mount control, remote amplifier	557.00
RUMBLER-3	Siren amp, Rumbler, secondary warning system, 12V, low frequency, hardware kit, housing bands and cradles	657.00
RB-E508	Kit, pair of mount brackets for 2008 Ford E-Series Chassis	42.00
ES100	Speaker, ES100/DynaMax, 100W, high output, compact, Class A	299.00
ESFMT-EF	Kit, recess mount, stainless steel "Electric F" grille	74.25
ESBMT-SB	Bumper/surface mount bracket	55.50
750501	AS124 Speaker, 100W, with universal mount bolts and hardware, high output, Class A	189.00
Additional Products		
CAMSET56-NTSC-2	5.6" Monitor with two camera inputs, (1) standard rear-view camera, and (1) 65.5-ft camera-to-monitor extension cable	664.75
320892	51" VPX SignalMaster, (8) lamp, 30-ft cable	1,336.00
330104	Six or eight-lamp, 12 or 24V (multiple installer-selectable flash patterns, fuse protected)	253.50
LF18ES-LED	18" LED Littlite, on/off switch control	152.25
210339	Evacuator, back-up alarm, single-function, 97dB	26.75
650302	Flasher, Fire/EMS application, K-spec compliant, zoning capable, 16 outputs, 40A total capacity, high-side switching	284.00



CAPRICE PRODUCT REFERENCE

Model	Description	List Price
Lightbar Mounts		
HKB-CAP11B	Hook required with Hook-on mount, Chevrolet Caprice	\$42.50
Audible Warning Brackets		
ESB-CAP11	ES100 speaker bracket, Chevrolet Caprice	25.00
RB-CAP11	Rumbler brackets, Chevrolet Caprice	125.00
750501-05	AS124 speaker bracket, Chevrolet Caprice	40.00
Grille Light Brackets		
IPX-GRL4	IMPAXX, (2) grille bracket with hardware, vertical oriented mount, Chevrolet Caprice	19.00
License Plate Light Bracket		
IPX-LPH1	IPX3/IPX6/VPX8, generic high-side license plate holder with horizontal mount tab on each side	25.00
IPX-LPV1	IPX3/IPX6/VPX8, flat surface license plate mount, various vehicles without recessed plate mounting locations	25.00
IPX-LPF1	IPX3 only, generic low side license plate holder for horizontal IMPAXX install	30.00
Rear Side Window Light Brackets		
IPX-RSW2	IPX3/IPX6/VPX8, pair rear side window mount brackets and covers, Chevrolet Caprice	69.00
IPX-RDW2	IPX3/IPX6/VPX8, pair rear side window mount brackets and covers, each bracket holds two lights, Chevrolet Caprice	69.00
IPX-ROW1	IPX3/IPX6, pair of rear side "Opera" window mount brackets, Chevrolet Caprice	25.00
Push Bumper Light Bracket		
IPX-PB45H	IPX3/IPX6/VPX8, pair, 45-degree slanted push bumper mounts, horizontal light orientation	25.00
IPX-PB45V	IPX3/IPX6/VPX8, pair, 45-degree slanted push bumper mounts, vertical light orientation	25.00

IMPALA PRODUCT REFERENCE

Model	Description	List Price
HKB-IMP7	Hook required with Hook-on mount, Impala '06-'12	\$42.50
Audible Warning Brackets		
ESB-IMP08R	ES100 speaker bracket, Chevrolet Impala, '06-'12	25.00
RB-IMP08	Rumbler mount kit, pair of mount brackets with hardware for 2008-2012 Chevrolet Impala police package vehicles	42.00
License Plate Light Bracket		
IPX-LPV1	IPX3/IPX6/VPX8, flat surface license plate mount, various vehicles without recessed plate mounting options	25.00
IPX-LPH1	IPX3/IPX6/VPX8, generic high side license plate holder with horizontal mount tab on each side, fits most vehicles	25.00
IPX-LPF1	IPX3 only, generic low side license plate holder for horizontal IMPAXX install, most vehicles	30.00
Trunk Lid Light Bracket		
IPX-PBL1	IPX3/IPX6/VPX8, pair, universal "L" bracket, horizontal light orientation	25.00
Push Bumper Light Bracket		
IPX-PB45H	IPX3/IPX6/VPX8, pair, 45-degree slanted push bumper mounts, horizontal light orientation	25.00
Headlight/Taillight Flashers		
FHLP-IMP	Flasher, headlight, '06-newer, Chevrolet Impala Police Package, "plug-n-play" connectors	131.75
FHL-TAIL	Flasher, taillight, universal applications, 18" wire leads	85.50

CHARGER PRODUCT REFERENCE

Model	Description	List Price
Lightbar Mounts		
HKB-CHGR11	Hook required with Hook-on mount, Charger '11	\$42.50
Audible Warning Brackets		
ESB-TAR11	ES100 speaker bracket, '11 Charger, '11 Ford Taurus	25.00
RB-CRG11	Rumbler mount kit, pair of mount brackets with hardware for 2011 Dodge Charger police package vehicles	42.00
750501-04	Mounting bracket, no grille removal, Dodge Charger	40.00
License Plate Light Bracket		
IPX-LPV1	IPX3/IPX6/VPX8, flat surface license plate mount, various vehicles without recessed plate mounting options	25.00
IPX-LPH1	IPX3/IPX6/VPX8, generic high side license plate holder with horizontal mount tab on each side, fits most vehicles	25.00
IPX-LPF1	IPX3 only, generic low side license plate holder for horizontal IMPAXX install, most vehicles	30.00
Trunk Lid Light Bracket		
IPX-TRNK3	IPX3/IPX6/VPX8, pair of inner trunk lid brackets with hardware, '07-'10 Dodge Charger	25.00
Push Bumper Light Bracket		
IPX-PB45H	IPX3/IPX6/VPX8, pair, 45-degree slanted push bumper mounts, horizontal light orientation	25.00
IPX-PB45V	IPX3/IPX6/VPX8, pair, 45-degree slanted push bumper mounts, vertical light orientation	25.00
Headlight/Taillight Flashers		
FHL-CHG	Flasher, headlight, '06-newer, Dodge Charger	131.75
FHL-TAIL	Flasher, taillight, universal applications, 18" wire leads	85.50
Grille Light Brackets		
IPX-GRL3	IPX3/IPX6/VPX8, pair of grille brackets with hardware, '11 Charger	19.00
Rear Side Window Light Brackets		
IPX-RSW1	IPX3/IPX6/VPX8, pair rear side window mount brackets and covers, Dodge Charger	69.00

MOTORCYCLE PRODUCT REFERENCE

Model	Description	List Price
Warning Lights Engine Guard 1.25" Diameter		
760002G-02	Amber LED, Clear lens	\$374.25
760002G-022	Amber LED, Amber lens	374.25
760002G-03	Blue LED, Clear lens	396.25
760002G-033	Blue LED, Blue lens	396.25
760002G-04	Red LED, Clear lens	374.25
760002G-044	Red LED, Red lens	374.25
760002G-05	White LED, Clear lens	396.25
Telescopic Strobe Pole		
CO220-A	Amber	195.25
CO220-B	Blue	195.25
CO220-R	Red	195.25
Telescopic LED Pole		
CO301-B	(10) 1W Blue LEDs, needs UC300 control unit	412.50
CO301-R	(10) 1W Red LEDs, needs UC300 control unit	412.50
Additional Warning Lights		
LD300L-B	LD300 left side motorcycle LED warning light, (5) 3W Blue LEDs	214.25
LD300R-B	LD300 right side motorcycle LED warning light, (5) 3W Blue LEDs	214.25
LD320L-B	LD320 left side motorcycle LED warning light, (4) 3W Blue LEDs	221.00
LD320R-B	LD320 right side motorcycle LED warning light, (4) 3W Blue LEDs	221.00
Accessories and Kits		
UC300	Control Unit for LD300 and CO301	214.25
LF6MOTO-LED	6" LED Littlite, horizontal mount, switch control, wired base	152.25
LF6MOTO	Halogen Littlite, horizontal mount, switch control, wired base	63.50
Sirens and Speakers		
2020200-UP	30W Specialty Vehicle siren/speaker combo	229.75
MC100-02	Speaker, 100W, polished stainless steel projector	0.00
U750-HON	Motorcycle siren amplifier, 100W, water resistant, Honda	618.00
U750M	100W, water resistant, Harley Davidson	618.00
Accessories and Kits		
MC100-MNT	Mounting kit, MC100 motorcycle speaker	81.25
8216090-UP	Switch kit, used with SCS1000 Soundstar, 30W siren/speaker combo	21.50
8216113-UP	Microphone kit, used with SCS1000 Soundstar, 30W siren/speaker combo	90.75
8299306-UP	Vibration mount kit, used with SCS1000 Soundstar, 30W siren/speaker combo	34.50
4004233-01	Switch kit, handlebar	83.75



REPLACEMENT LAMPS



Z8107141A \$10.50

Lamp, rotator, vertical filament, 795X, 50W, bayonet



Z8107146C \$50.50

Strobe tube, Fireball



Z8107152A \$10.50

Bulb, H3 halogen, 55W 12VDC



Z8107156A \$18.75

Bulb, 25W, G4, 12V, halogen, GH1



Z8107158A \$10.50

Bulb, H3 halogen, 100W, 12VDC



Z8107165A \$19.25

Bulb, 35W, G4, 12V, halogen, GH1F



Z8107169A \$10.50

Bulb, GH8, Bi-pin alley/takedown light, 50W halogen



Z8107170A \$10.50

Bulb, GH9, Bi-pin flashing light, 35w halogen



Z8107231A-01 \$19.50

Bulb, HotFoot, takedown, 50W, MR16, 12-degrees



Z8107231A-02 \$19.50

Bulb, MR16, HotFoot alley 24-degrees



Z8107232A \$60.25

Strobe tube assembly, 413250/GS1/GS1F



Z8107241A \$18.00

Lamp, alley, Arjent SL, MR11, 10-degrees



Z8107A027 \$23.25

Bulb, 4505, 50W, 24VDC, Model 14



Z8107A033 \$21.75

Bulb, 4416, 30W, Model 14



Z8107A095A \$4.25

Bulb, Stop/Tail/ Turn, GE1157, dual filament



Z8107A117-01 \$111.00

Halogen lamp, Night-Fighter, use with model FL3SF-LC



Z8107A117A \$29.50

Incandescent lamp, Night-Fighter, use with models FI3sf and FI3sf-lc



Z8107A119A \$10.50

Bulb, alley/takedown light, horizontal filament, 50W bayonet



Z8440A265A-02 \$10.50

Bulb, Rotator, H1 vertical filament, long life, 12VDC



Z8444A151A \$15.75

Bulb, H1, vertical filament, 70W halogen, 24VDC



Z8548A028A \$15.00

Bulb, flashing light, horizontal filament, 796, 35W



Z8550250A \$24.25

Lamp, Littlite, Bi-pin



521592 \$80.25

Strobe tube and reflector assembly, Jetstrobe



Z8573007A \$10.50

Bulb, Gh22 Bi-pin, SignalMaster, 27W halogen



Z8575067A \$94.00

Strobe tube and reflector assembly, GS2



Z8575107A \$18.50

Lamp and reflector assembly, GHSCENE



Z8575189A \$93.50

Strobe tube assembly, GS5



Z8583052A \$43.50

Strobe tube, Vistabeam/directional, helical, lower level



Z8583292A \$98.00

Strobe tube and reflector assembly, linear, upper level



Z8583302A \$114.50

GS5 strobe head assembly Vista/ Ricochet



602111-02/03/04 \$81.25

Corner strobe tube, Amber, Blue, or Red CS1



602111-05 \$48.00

Corner strobe tube, Clear CS1



413201-05 \$37.25

Strobe tube, Ricochet/ Silver Series Clear with amp connector

STINGER

Tire Deflation System

According to U.S. Department of Justice statistics, a majority of the largest police and sheriff departments are enacting restrictive pursuit driving policies in order to reduce the injuries and property damage associated with high-speed chases. The Stinger Spike System® allows law enforcement officers to control those situations by stopping fleeing vehicles effectively, reliably, and safely.



Stinger Spike® System

Federal Signal is committed to producing quality, cost-effective tire deflation devices to assist law enforcement personnel in bringing pursuits to a safe and quick conclusion. We feel so strongly in the safety of law enforcement personnel and the public that we offer free Stinger Spike System training.



Rock and Tilt Mechanism

Stinger Spike System uses the patented 'Rock and Tilt Mechanism' to deflate all four tires, safely slowing and stopping the vehicle in just minutes for a more controlled stop.

Standard models are available in 10', 15' and 25' lengths to handle a variety of situations. The Stinger XL 15.5' model employs a new longer spike length designed for penetrating thicker tires, to safely and quickly end pursuits.



Rat Trap II

Reduce your liability by preventing pursuits before they happen. The pocket-sized Rat-Trap® II tire deflator is perfect for neutralizing a vehicle from being used to flee authorities. Simply open the device and place it under the tire of an unoccupied, stationary vehicle. Any attempt to drive the vehicle will immediately deflate the tire, eliminating the possibility of a high-speed getaway attempt.

Go to <http://fedsig.com/solutions/tire-deflation> for a video demonstration.



The Digital In-Car Video system you can depend on – from the company you trust.

Regardless of the situation, the enhanced intelligence and documentation capabilities of video recording **can prove indispensable to the safety of officers and citizens alike.**

Though analog and digital video share the same basic function, digital technology offers a much higher standard of security and improved video quality. **DTX digital video also offers a greater degree of flexibility** by simplifying searches, viewing, transfer, storage and management of video files. From routine traffic stops to corroboration of probable cause, DTX is a critical asset for a wide range of law enforcement scenarios.

Digital video is shown to support a measurable increase in conviction rates, and the availability of recordings can reduce litigations against officers while providing a corresponding improvement in officer awareness with regard to their own conduct. **Officer safety is dramatically improved via live video feeds** to dispatch, and the enhanced ability to monitor suspects in custody by a camera facing the rear seat of the vehicle. Digital video also serves as a valuable training tool, providing recordings of “real life” situations to reinforce the effectiveness of proven law enforcement procedures.



Federal Signal's DTX Digital In-Car Video System provides an **additional networked layer of intelligence** for law enforcement operations, resulting in increased safety, security and effectiveness.





Software Capabilities

Live streaming, remote viewing. DTX-COMMAND software makes search and review of recorded files faster and simpler. When teamed with a 3G network, it also supports live video streaming, enabling computers at the station to monitor officers' cameras in real-time. **DTX-Client** software facilitates search and review of all recorded video, while providing "live" views of all cameras within the vehicle.

Video Classification and Upload Prioritization

The department has the ability to label each video prior to shutting down the system. Each type of video can then be prioritized and placed in a separate file to efficiently download videos according to their evidence ranking.

Fleet Health Monitoring. DTX-Fleet allows each DVR to report its health back to the Command Center to help alert technical services of the systems condition. It can also be used to track system configurations and issue system updates via a Wi-Fi network to each DVR.

Real-time Fleet Tracking. DTX-Link allows the Command Center to monitor and geographically locate all of the vehicles in the fleet. It can also provide streaming video for every vehicle within the fleet.

Auto Download Software. DTX-ADS (auto download software) automatically downloads video from the mobile DVR via wireless or a wired network connection. Emergency response and law enforcement vehicles can all benefit from the software's ability to automatically download video to a central location enabling multiple users to view stored video files.

Hardware Capabilities

Easy capture of critical events. DTX provides an industry-leading sixty minutes of pre-event recording, which can be drawn from live memory just before an officer begins to record. Additionally, cameras can be prompted to record situations automatically with the activation of an officer's microphone, the vehicle light and siren system, the opening of a gunlock, or even preset GPS threshold.

Wireless uploading of video. Automatic uploading of video files begins once the vehicle comes within wireless range of the station (approximately 300-ft). If the vehicle drives out of range before video transfer is complete, uploading stops and then resumes once the vehicle returns within range.

Speed Radar Interface. DTX now allows for the integration of Speed Radar into the video files. When recording a video, the meta-data from the radar gun will be included within the video file if that file was triggered by the radar gun.

Four-camera system. The two primary cameras cover the front of the vehicle and the rear seat. Not only can the rear-facing camera be helpful in encouraging suspects to control their behavior, it can also be employed to covertly record conversations that may later be used as evidence. Two additional cameras can be added to extend the viewing area around the vehicle.

Powerful wireless microphone. DTX comes with a wireless microphone capable of providing two officers with over 95 channels in frequencies from 2400-2483 MHz, capable of performing in a 1,500-ft line of sight range.

DTX
Federal Signal...
your trusted partner in law enforcement.



TERMS AND CONDITIONS

- (1) **AGREEMENT AND LIMITATIONS.** The agreement between Seller and Buyer (the "sales contract") with respect to the sale of goods (the "goods") described herein shall consist of the terms appearing herein with any additions or revisions of such terms mutually agreed to in writing by Seller and Buyer. Seller objects to and shall not be bound by any additional or different terms, whether printed or otherwise, in Buyer's purchase order or in any other communication from Buyer to Seller unless specifically agreed to by Seller in writing. Except as expressly stated in the sales contract, no reference to Buyer's purchase order or other communication from Buyer shall be deemed to incorporate by reference any terms appearing therein. The sales contract shall be for the benefit of Seller and Buyer and not for the benefit of any other person. Prior courses of dealing, trade usage and verbal agreements not reduced to a writing signed by Seller, to the extent they modify, add to, detract from, supplant or explain the sales contract, shall not be binding on Seller.
- (2) **TERMINATION OR MODIFICATION.** The sales contract may be modified or terminated only upon Seller's written consent except that stenographic and clerical errors are subject to correction by Seller or upon Seller's written consent. If Seller shall declare or consent to a termination of the sales contract, in whole or in part, Buyer, in the absence of contrary written agreement signed by Seller, shall pay termination charges based upon expenses and costs incurred in the production of the goods or in the performance of the services to the date such termination is accepted by Seller including, but not limited to, expenses of disposing of materials on hand or on order from suppliers and the losses resulting from such disposition, plus a reasonable profit. Notwithstanding the foregoing any goods substantially completed or services performed on or prior to such termination shall be accepted and paid for in full by Buyer.
- (3) **PRICE AND PAYMENT.** Prices are subject to increase by Seller based on Seller's prices in effect at the time of shipment in all instances where specified shipment date is later than 30 days from date of order. Unless otherwise specified in the sales contract or Seller's applicable price list, prices are F.O.B. Seller's point of shipment, and the terms of payment are NET 30 days from the date of invoice. If the sales contract is for more than one unit of goods, the goods may be shipped in a single lot or in several lots at the discretion of Seller. In such event each such shipment shall be paid separately and Buyer shall be responsible for all transportation charges. Seller may require full or partial payment or payment guarantee in advance of shipment whenever, in its opinion, the financial condition of Buyer so warrants. Payment by credit card may be subject to a service charge.
- (4) **PAST DUE INTEREST:** Amounts not paid when due shall be subject to past due interest at the rate of 18% per year or the highest rate permitted by law, whichever is less.
- (5) **RISK OF LOSS.** The risk of loss of the goods or any part thereof shall pass to the buyer upon delivery thereof by Seller to the carrier. Buyer shall have sole responsibility for processing and collection of any claim of loss against the carrier.
- (6) **TAXES.** Prices do not include taxes. Buyer shall pay Seller, in addition to the price of the goods, any applicable excise, sales, use or other tax (however designated) imposed upon the sale, production, delivery or use of the goods ordered to the extent required or not forbidden by law to be collected by Seller from Buyer, whether or not so collected at the time of the sale, unless valid exemption certificates acceptable to the taxing authorities are furnished to Seller before the date of invoice.
- (7) **DELIVERY.** Promises of delivery from stock are subject to prior sale. Delivery dates are not guaranteed but are estimated on the basis of immediate receipt by Seller of all information to be furnished by Buyer and the absence of delays, direct or indirect, resulting from or contributed to by circumstances beyond Seller's reasonable control. Seller shall in good faith endeavor to meet estimated delivery dates but shall not be liable to Buyer for any damages as a result of any delay caused or contributed to by circumstances beyond Seller's reasonable control.
- (8) **DEDUCTIONS AND RETURNS.** Please contact the factory before returning any merchandise. A Return Material Authorization (RMA) must be obtained before returning merchandise for credit. All returns are subject to inspection of merchandise and any defects in the units will be charged back to the Buyer at the cost of parts and labor. Credit deductions will not be honored unless covered by a credit memorandum. Goods shipped to the Buyer may be returned to Seller for credit only upon the Seller's prior written consent (such consent to be in the sole discretion of Seller) and upon terms specified by Seller, including prevailing restocking, freight, and handling charges. Buyer assumes all risk of loss for such returned goods until actual receipt thereof by Seller. Agents of Seller are not authorized to accept returned goods or to grant allowances or adjustments with respect to Buyer's account.
- (9) **INSPECTION.** Buyer shall inspect the goods immediately upon the receipt thereof. All claims for any alleged defect in Seller's performance under this sales contract, capable of discovery upon reasonable inspection, must be fully set forth in writing and received by Seller within thirty days of Buyer's receipt of the goods. Failure to make any such claim within said thirty-day period shall constitute a waiver of such claim and an irrevocable acceptance of the goods by Buyer.
- (10) **LIMITED WARRANTY** Federal Signal Corporation, Emergency Products, (Federal) warrants each new product, except speakers, to be free from defects in material and workmanship, under normal use and service, for a period of (3) years on parts replacement from the date of manufacture stamped on the product and (1) year on labor from the date of delivery to the first user-purchaser except for noted products. Speakers are warranted for a period of (2) years on parts replacement from the date of manufacture stamped on the product and (1) year on labor from the date of delivery to the first user-purchaser. The following products are warranted for (5) years on parts replacement from the date of manufacture stamped on the product and (1) year on labor from the date of delivery to the first user-purchaser: "Light Emitting Diode" (LED) products (Signaltech and SignalMaster Plus LED products not included), "Ricochet" strobe power supplies, "Unitrol" brand products, rotating light assemblies from all lightbars, all rotating beacons and mini-lightbars (Sentinel not included), all Phase II strobe beacon models, all 901 and 951 strobe beacon models, all 651 and 851 strobe beacon models, all US5, US6, and US7 UltraStar strobe beacon models, and all Arctic strobe beacon models.
- Strobe flashtubes are warranted for (1) one year parts replacement from the date of delivery of the first user-purchase. During this warranty period, the obligation of Federal is limited to repairing or replacing, as Federal may elect, any part or parts of such product which after examination by Federal, is found to be defective as the result of a defect in material and/or workmanship. Federal will provide warranty for any unit which is delivered, transported prepaid, to the Federal factory or designated authorized warranty service center for examination and such examination reveals a defect in material and/or workmanship. This warranty does not cover travel expenses, the cost of specialized equipment for gaining access to the product, or labor charges for removal and re-installation of the product. Domes & lenses, lamps or batteries are not covered under warranty. This warranty does not extend to any unit which has subjected to abuse, misuse, improper installation or which has been inadequately maintained, nor damage resulting from incompatible chemicals or cleaning material, nor to units which have problems relating to service or modification at any facility other than the Federal factory or authorized service centers.
- This warranty is in lieu of all other warranties, express or implied, including warranties of merchantability and fitness for a particular purpose.
- (11) **REMEDIES AND LIMITATIONS OF LIABILITY.** In the event Seller is claimed to have breached any of its obligations under the sales contract, whether of warranty or otherwise, Seller may repair any defective goods, request the return of the goods and tender, at Seller's options, a replacement shipment of goods or the purchase prices theretofore paid to Seller. Seller shall tender a refund of the purchase price at its option upon actual receipt of the goods by Seller. If Seller so requests the return of the goods, the goods will be re-delivered to Seller, transportation prepaid, in accordance with Seller's instructions. The remedies contained in this and the preceding paragraph constitute the sole recourse against Seller for breach of any of Seller's obligations under the sales contract whether of warranty or otherwise. In no event shall Seller be liable for consequential damages nor shall Seller's liability on any claim for any direct, incidental, consequential or special damages arising out of or connected with the sales contract or the manufacture, sale, delivery or use of the goods exceed the purchase price of the goods.
- Seller shall not be liable for failure to perform its obligations under the sales contract, resulting directly or indirectly from or contributed to by acts of God; acts of Buyer; civil or military authority; priorities; fires; war; riot; delays in transportation; lack of or inability to obtain raw materials, components, labor, fuel or supplies; or other circumstances beyond Seller's reasonable control, whether similar or dissimilar to the foregoing.
- (12) **PATENTS.** Seller shall hold Buyer harmless, to the extent herein provided, against any rightful claim of any third person by way of infringement of any United States Letters patent by such goods as are of Seller's own manufacture, but if Buyer furnished specifications to Seller, Buyer shall hold Seller harmless against any such infringement claims which arise out of compliance with such specifications. Seller's agreement in this paragraph to hold Buyer harmless shall not apply to any infringement consisting of the use of goods manufactured by Seller as a part of any combination with goods manufactured by Buyer or others. In the event that any goods manufactured by Seller are in any suit held to constitute infringement and their use is enjoined, Seller, if unable within a reasonable time to secure for Buyer the right to continue using such goods, either by suspension of the injunction, by securing for Buyer a license, or otherwise, shall at its own expense, either replace such goods with non-infringing goods or modify such goods so that they become non-infringing, or accept the return of the enjoined goods and refund the purchase price theretofore paid by Buyer less allowance for any period of actual use thereof.
- Except as in this paragraph provided, Seller makes no warranty that the goods will be delivered free of the rightful claim of any third person by way of infringement or the like and Buyer's remedies will be limited to those provided in this paragraph.
- (13) **ASSIGNMENT AND DELEGATION.** No right or interest in this sales contract shall be assigned by Buyer without Seller's prior written consent, and no delegation of any obligation owed, or of the performance of any obligation, by Buyer shall be made without Seller's prior written consent. Any attempted assignment or delegation shall be void and totally ineffective for all purposes unless made in conformity with this paragraph 9, 10 and 11 hereof, and if effective shall be subject to all limitations of this sales contract.
- (14) **SEVERABILITY.** If any term, clause or provision contained in the sales contract is declared or held invalid by a court of competent jurisdiction, such declaration or holding shall not affect the validity of any other term, clause or provision herein contained.
- (15) **INSTALLATION.** Installation shall be by Buyer unless otherwise specifically stated on the sales contract.
- (16) **GOVERNING LAW AND LIMITATIONS.** The formation and performance of the sales contract shall be governed by the laws of the State of Illinois. Whenever a term defined by the Uniform Commercial Code as adopted in Illinois is used in these standard terms, the definition contained in said Uniform Commercial Code is to control. Any action for breach of the sales contract or any covenant or warranty contained herein must be commenced within one year after the cause of action accrued.



**ON THE ROAD.
ON THE SCENE.
AND ON THE JOB
FOR MORE THAN 50 YEARS.**

For more than 50 years, Federal Signal has taken pride in building lights and sirens critical to safeguarding first responders. Our dedicated workforce in University Park, IL and Anaheim, CA strive for the highest levels of quality, performance and reliability. Before leaving our door, each one of our audible and visual signaling products is thoroughly tested to meet industry standards...and yours.

It is also worth pointing out that Federal Signal has a tradition for innovation. That story begins with the industry's first revolving light for emergency vehicles, and continues today with the most advanced LED lighting and convergence network technologies.

Be assured that our employees know how much is riding on the products you depend on for your safety. That's precisely why they are driven to succeed every day.

To know more about Federal Signal's long-standing commitment to first-responder safety, please take a few minutes to view a brief video at: www.fedsig.com

Federal Signal is ISO 9001:2000 Certified.



Contact Information

Federal Signal

2645 Federal Signal Drive
University Park, IL 60484
Customer Orders and Support Hours:
7:00 am-5:00 pm CST
Phone: (800) 264-3578 / (708) 534-3400
Fax: (800) 682-8022 / (708) 534-4869
Email: policefireorders@fedsig.com

Customer Service

Repair: (800) 433-9132
Unitrol Repairs: (800) 854-3375

Law Enforcement

Phone: (800) 264-3578
Marketing Fax: (708) 534-9307
www.fedsig.com
lawenforcementinfo@fedsig.com

Fire/Ambulance

Phone: (800) 264-3578
Marketing Fax: (708) 534-9307
www.fedsig.com
fireinfo@fedsig.com

U.S. Federal Government Inquiries

Phone: (800) 264-3578 / (708) 534-3400
Fax: (800) 682-8022 / (708) 534-4869
Email: gsa@federalsignal.com



www.fedsig.com

Join Us:  
FederalSignalFR

Europe

Federal Signal VAMA
C/Dr. Ferran 7
08339 Vilassar de Dalt
Barcelona Spain
Phone: (34) 93 741 79 00
Fax: (34) 93 753 03 62
www.fedsigvama.com
Email: marketing@vama.es

Latin & South America/Caribbean/ Asia-Pacific/Middle East/Africa

2645 Federal Signal Drive
University Park, IL 60466 USA
Phone: (708) 587-3212
(708) 534-3400
Fax: (708) 534-9307



Opticom, Littlite, Motorola, Harley Davidson, Crown Victoria, Impala, Charger, Packard, Kenwood, Velcro, Kawasaki, Honda, Chevrolet, General Motors, Chrysler, Dodge, Jeep and Sony are trademarks of their respective owners. All others indicated are trademarks of Federal Signal Corporation.