



Tools, Supplies & Equipment

Quality Products & Service Since 1933



Automotive • Truck • OTR • Retreading

We help increase your profits by expanding your capabilities.

It may be as simple as a new set of wheel clamps allowing you to expand wheel services and profits or as technical as the newest alignment system. Depend on your Myers Tire Supply sales representative to keep you current on the newest labor-saving products, helping your business run smoothly and profitably whether it's in the passenger, fleet, OTR or retread market.



Memphis Distribution Center

Myers Tire Supply was founded in 1933 with the philosophy that our success comes from helping our customers be successful. Although markets have changed over 80 years, our philosophy hasn't. Our sales force of professionals offer the broadest range of products, plus training and customer service to help you run your business efficiently and profitably.



◀ *Myers can keep your inventory stocked at the designated levels you need to run your business.*



◀ *The V2B Inflate-Thru valve cap eliminates removing the cap to check tire pressure saving time and money. See pg 32.*

▶ *Myers is your single source for TPMS tools and sensors. We have technical experts on-hand to answer your questions.*



▶ *Myers offers free passenger and truck tire puncture repair classes to assure technicians are following industry-approved standards.*



◀ *Myers has the most complete line of retreading equipment, supplies and tools in the industry.*



◀ *Proper truck wheel torquing is essential for fleet operations. Myers offers an exclusive program to recalibrate and certify torque wrenches. See pg 89.*

▶ *Myers offers a complete line of OTR products including valve hardware, tire changing and tire section repair.*



▶ *Myers branded tools to deliver durable performance at competitive prices.*



Technical Assistance You Can Rely On

Experts are available to help you solve product, application and production problems.

www.myerstiresupply.com

We are continuously adding to and improving our service to you through the web.

Check out our online catalog at:

www.myerstiresupply.com or email us at: sales@myerstiresupply.com

Member of:

SEMA, TIA, TMC, TRIB, RTA



Myers® **Government Services** Tire Supply A Myers Industries Company

The Government Sales office is organized to offer all Myers Industries' products to federal, state, county, municipalities, or local agencies. We offer GSA competitive pricing, and fast bid and quote response via email, fax, or phone on any product. We have been serving our customers since 1933 and our reputation as a reliable supplier is unsurpassed. We are experienced in all facets of export shipping and offer military packaging if necessary.



Myers Tire Supply Federal, State, Local Entities

Email: govsales@myersind.com

Tel: 1-800-644-5592

Fax: 330-761-6187

Myers® **Key Accounts Support** Tire Supply A Myers Industries Company

National and regional accounts know the value of a single-source, national supplier who provides a dedicated Account Manager. Customers choose from the widest selection of tire and undervehicle service supplies and equipment in the country. Celebrating our 80th year in business, our experts are available for problem-solving and education on TPMS, Tire Repair, etc.



Myers® Tire Supply **International, Inc.** A Myers Industries Company

Myers Tire Supply has fully stocked branch/warehouses in Canada and Central America as well as stocking distributors in Europe, Russia, the Far East, and Australia. Our multilingual sales and customer service staff offer international experience in business, shipping, and document preparation as well as an in-depth knowledge of our vast product lines and services.

Myers Tire Supply International, Inc.

Tel: 1-330-253-5592

Fax: 330-761-6226

Guatemala

Tel: 502-24989292

Fax: 502-24989262

El Salvador

Tel: 503-2260-7636

Fax: 503-2260-7176

Panama

Tel: 507-2290926

Fax: 507-2290338

Ontario

Tel: 519-451-3430

Fax: 519-451-6843

Edmonton

Tel: 780-469-3300

Fax: 780-466-2125

Quebec

Tel: 418-948-0770

Fax: 418-948-0771

Important Information About Our Prices & Terms Of Sale

Prices: Prices are subject to change without notice.

Warranties: All applicable product warranties are provided by each product's manufacturers. Myers makes no warranty, expressed or implied, and expressly disclaims any and all implied warranties including the implied warranty of merchantability and the warranty of fitness for a particular purpose. In no event shall Myers be liable to the buyer for any special, indirect, indirect incidental or consequential damages.

Product Illustrations and Data: Myers Tire Supply has made every effort to illustrate and describe the products in this catalog accurately; however, these illustrations are for identification only and products may vary due to manufacturing improvements or changes.

Credit: Open account terms of net 15 days are available to customers with approved credit. Mastercard, VISA, and American Express are accepted.

Lease Plans: Equipment in this catalog is available on easy lease plans. Advise us of your needs and complete information will be sent to you immediately. Applicable sales taxes will be payable according to state laws.

Freight: Freight is F.O.B. Origin.

Minimum Billing: A minimum of \$50.00 will be invoiced for any single order totaling less than \$50.00. Please order accordingly.

Sales Tax: Applicable state and local sales tax will be added on every item, and freight if taxable, unless a valid sales tax exemption certificate has been provided for said items at the time the order is placed.

Material Safety Data Sheets: Material safety data sheets are available on request or online at www.myerstiresupply.com

Shipping Errors: You must report any errors in shipping within 48 hours of delivery.

Damaged Shipments: For your own protection, inspect shipments before signing freight bill. If a shipment is damaged, note damage on freight bill and file a claim with the carrier immediately.

Return Policy: To return any item contact Myers Tire Supply to obtain a Return Material Authorization (RMA) before shipping product. We will pay the return shipping cost if the product is visibly defective upon receipt or the return is a result of our error.

If the item is being returned for any other reason, we will accept unused items, with the exception of equipment and special orders, for return within 30 days of the original delivery. Equipment and certain special orders may be subject to a 20% restocking fee. We will credit you in the same manner as your original payment within 10 days of receiving the returned item.

Used items and items that fail to meet the warranty offered by the original manufacturer should generally be returned directly to the manufacturer pursuant to the manufacturer's warranty terms. On occasion, we will facilitate the return of non-conforming goods to a manufacturer through our Return Material Authorization system. In the event we offer to facilitate warranty returns to the original product manufacturer, compensation for the return goods remains subject to inspection of the goods and the manufacturer's original product warranty. Under no circumstances should any such facilitation be construed as the offering of any additional product warranty by Myers Tire Supply Distribution, Inc.

Credit will only be given if shipped back to Myers Tire Supply, Inc.

Ship merchandise returns with the RMA enclosed to:

Myers Tire Supply, Inc., ATTN: Returned Goods, 1293 S. Main St., Akron, OH 44301

Printed in U.S.A.

A Myers Industries, Inc.® Company

Myers Tire Supply is a trademark of Myers Tire Supply Distribution, Inc., a subsidiary of Myers Industries, Inc. The Company is the largest U.S. distributor of tools, supplies, and equipment for tire, wheel, and under-vehicle service. Myers Industries is also an international manufacturer of plastic and rubber products for industrial, agricultural, automotive, commercial, and consumer markets.



Look for
Made in USA

Myers
Tire Supply

Table of Contents

Valves & TPMS

Pages 16-52



Air Service

Pages 53-74



Impact Wrenches

Pages 75-105



Tire Changers

Pages 106-140



Tire Balancing

Pages 141-168



Lifts & Alignments

Pages 169-196



Service Equipment

Pages 197-224



Shop Equipment & Supplies

Pages 225-247



Patch Rubber

Pages 248-265



Puncture & Section Repair

Pages 266-295



Retread

Pages 296-329



Parts / Index

Pages 330-337



Table of Contents

A

A/C

Cool-Tech ID Plus	209
Coolant Test Strips	210
CoolXChange	210
Electronic Leak Detector	209
Filters	209
Maintenance Kits	209
Manifold Hose Kit	209
Pump Oil	209
Recovery/Recycle/Recharging Stations	208
Refractometer	209
Refresher Service	210
Refrigerant Identifier	209
Sealant Filter System	210
Service Couplers	209
Vinyl Dust Covers	209

Absorbent, Safe T Sorb	228
Accessories for Air-Liquid Valves	37
Accu-Read Tapered Dual Foot Gauge	49
ACCUTORQ Truck Torque Bar Set	86
Acid Proof Gloves	244
Adapter Extensions	182, 322
Adapters, Flexible Shaft	277
Adhesive Wheel Weights . 154, 157, 159, 161, 162	
Adhesive Weight Removal Tool	149

Adjustable

Locking Tire Sling	135
Tire Spreader	123
Torque Wrench	87
Wrenches	241

Advance Sealing Truck Tire Valve	29
After Coolers, Compressors	71
Alignment Lifts	186, 187
Air Bags for Section Molds	295
Air Conditioning	See A/C

Air

Chucks	57
Chucks, Large Bore	51
Compressors	69-74
Cooled Buffing & Finishing Wheels	284
Coupler & Adapters	66, 317
Drills	84
Gauge Checking Station	50
Gauge, Digital	48
Pressure Gauges	48, 49, 50
Hammers	83

Air Hose

Clamps	64
End Fittings	64
Fitting Adapters	64
Repair Parts	64
Splicers	64
Green	60
Hoses	63, 64

Air

Lift Jack & Support Stand	174
Line Filters	67
Liquid Grader Valves	37
Liquid Rubber Snap-In Valve	37
Liquid Valve Extensions	37
Liquid Valves	37
Pressure Regulators	67
Ratchets	85
Stapler	308
Tank	63
Tool Antifreeze Lubricant	82
Tool Conditioner	75
Tool Covers	82
Tool Oil	75
Vac.	239

AIR-FLEXX Valve Extensions	36
---	----

Air-Rid Cord	309
Air-Water Tractor Gauge	50

Air/Hydraulic

Jack	173, 174
Pumps	135

Air/Liquid

Bushing Assembly	37
Gauge	50
Hydroflating Valve	37
Master Gauge	52

Air/Manual Bottle Jack	170
Aircraft Tire Gauges	50
Airless Hydra-Sprayer	307
Airplane Valve Core	33

AKRO-MILS

Bench Rack	153
AkroBins	234
Alignment Lift	184
Alignment Systems	189
All Metal Tread Depth Gauge	47
All-Purpose Gum	261
All-Purpose Service Gauge	48

ALLIGATOR

Grommet Seal Valves	30
---------------------------	----

High Pressure Snap-In Valves	26
O-Ring Seal Valves	31
sens.it Tool Kit	17
sens.it TPMS System	17
TPMS Valve Repair Kits	22
Tubeless Tire Snap-In Valves	25
Tubeless Truck Clamp-In Valves	28
V2B Double Seal Valve Cap	32

Alloy Rim Mount/Demount Tool Head	131
Alloy Wheel Gauge	163
Aluminum Jacks	135
Aluminum Wheel Axle Extensions	195
Aluminum Wheel Protector	114

AME

Aluminum Jack	137
Bottle Jack	170
Cribbing Blocks	137
Diamondback Aluminum Bead Breaker	137
Dual Agricultural Tire Bead Breaker	137
Manual Bead Breaker	137
OTR Urethane Wheel Chocks	137
Pumps	137
Service Jack	174
Tire Bead Breaker Kit	137

AMERICAN FORGE & FOUNDRY

Jacks	170, 171, 173
Jack Stands	170

AMERMAC

Spinner & Strobe Balancer	151
Tire Truer & Balancer	151

AMMCO

Arbor Set	200
Brake Drum Micrometers	203
Brake Lathe Adapter Kits	200
Brake Lathe Enclosure	198
Brake Shop Accessories	201
Brake Washer	198
Disc Rotor Silencer	201
Double Chuck	199
Brake Lathes	198, 199
Truck Brake Lathe Adapter	200

Angle Faced Rasps	284
Anti-Seize Compound	98
Anti-Vibration Gloves	243

ARMSTRONG Steam Traps	329
Aro & Dill Style Coupler & Adapters	65

ASSOCIATED

Amp Load Tester	205
-----------------------	-----

Table of Contents

Battery & Electrical System Tester.....	206
Battery Chargers.....	206, 207
Assurance Wiper Blades.....	224
ATEC	
Envelope Release Lubricant.....	316
Final Touch Water Base Tire Paint.....	324
Inspection/Painting Station.....	327
Inspection/Repair Station.....	300
NDT Inspector.....	300
ATEQ	
TPMS Check Box.....	23
TPMS Service Tools.....	16
ATV Bead Breaker.....	115
Auto Drain, Compressor.....	73
Auto Fill Automatic Digital Tire Inflator.....	54
Auto Interior Protection.....	215
Automatic	
Air Line Lubricators.....	67
Hose Reels.....	62
Inflation Kit for Tire Cages.....	139
Inflation Systems.....	54
Tank Drain.....	68
Tire Inflators.....	54
Automotive Style Couplers & Adapters.....	65, 66
Automotive Tools For Air Hammers.....	83
Awl.....	266
Axle Jack.....	174
Axle Stand.....	176
AZ Extruder Garter Spring.....	302
B	
B&J	
Air-Cooled Spacers.....	304, 305
Buffing Blades.....	303, 304, 305, 306
Buffing Hubs.....	303, 306
Buffing Rasp.....	286
Mulching Rasp Hub.....	303
OTR Detreader Buffing Blade.....	303
Outer Support Spacers.....	304, 305
Precure Envelope Tester.....	316
Replacement Pins for Rasp Hubs.....	304, 305
Replacement Spacers.....	304, 305
Rotary Gouger.....	286
Rotary Gouger Sharpeners.....	286
Squiggly Rasps.....	286
Back Buddy Brake Drum Removal Cart.....	197
Back Support Belt.....	237
BADA Wheel Weights.....	162, 163, 164, 165, 166
Bail Cutting Knife.....	269

Baird-Style Couplers & Adapters.....	317
Balance Pads.....	255
Balancers, Tire.....	141-152
Ball	
Bearing Stitchers & Rollers.....	268
Foot Chucks.....	57
Joint Gauge.....	203
Rasps.....	284
Barrel Cradle.....	227
Barrel Pump.....	221
BARTEC TPMS Pad & Tools.....	18
Battery	
Carrier.....	207
Chargers.....	206, 207
Refractometer.....	209
Reset Procedures Manual.....	206
Terminal Clamp & Post Cleaner.....	207
Water Jug.....	207
Bayonet Style Air Pressure Gauges.....	56
BEA Authentic Stapler.....	308
Bead Breaker	
Leverage Bar.....	106
OTR.....	133, 134, 135, 136, 137
Passenger.....	107
Wood Handled.....	108
Tools.....	106
Wedge With Polymer Handle.....	108
Bead	
Expanders.....	139
Hook, Earthmover.....	136
Keepers.....	114
Lock.....	114
Notcher.....	247
Sealers.....	253, 259
Seater.....	114
Seating Stand.....	114
Spotter.....	289
Bench	
Grinder.....	240
Mount Spreader.....	123
Rack.....	234
Bent Equal Valve.....	28
BERU Valves & Sensors.....	19
BESSER Green Machine.....	61
Bias Tire Repairs.....	251, 259
Black & Tan Rope Rubber.....	263
BLACK MAGIC Plastic Staples.....	308

Black	
Nitrile Gloves.....	243
Repair Cement.....	262
String Repairs.....	252
Tire Paint.....	324
BLACKHAWK	
Motorcycle Lift.....	179
Quick Load Service Jack.....	171
Bladders, Continental.....	321
Block Chek Coolant Test Strips.....	210
Blow Guns.....	62
Blue Cobra Tire Demount Tool.....	113
Boiler Water Treatment.....	329
Boilers.....	329
Bolt Hole Chamfer Wear Gauge.....	99
Bolt Pattern Gauge.....	91
Boots, Oval.....	255
BOSCH	
Tire Changers.....	130
Tire Balancers.....	150
Tire Changer & Balancer Combination.....	151
Bottom Mount Valve.....	28
Bow Tie Inserts.....	250
Brake	
Bleeder.....	202
Cleaners.....	223
Drum Dolly.....	198
Drum Removal Cart.....	197
Drum Wear Limit Gauge.....	203
Lining Wear Gauge.....	203
Pedal Depressor.....	190
Rotor Chatter Silencers.....	201
Branders, Tire.....	326, 327
BRANICK	
Customer Retention Program.....	58
EF & EF/HD Spreader Parts.....	332
Envelope Sealer Rings.....	310
Nitrogen Generators.....	58, 59
Smart-O Drain Plug Kits.....	217
Strut Spring Compressor.....	195
Tire Cart.....	227
Tire Cutter.....	247
Tire Spreaders.....	297, 298, 332
Tire Tool Station.....	82
Brass	
Bristle Tire Brush.....	268
Hub Stems.....	302
Sidewall Buffing Brushes.....	288

Table of Contents

BRITE-MARK Marker.....	271	Sprayers, Retread	307	Balancer Accessories	144, 145 146
Broom.....	231	Tire Repair.....	262	Balancer Adapter Kits.....	141
Brown		CENTOR Balancer Adapter Kits.....	146	Balancer Mate	145
Jersey Gloves.....	244	CHALLENGER Lifts.....	185, 186	Bump-N-Roll	121
Multi-Fold Towels.....	230	Chamber Inflation & Exhaust Hoses	319	Changer Access. & Repl. Parts ..	121, 122, 123
Roll Towels.....	230	Chamfer Wear Gauge.....	99	Combination Tool	123
Single-Fold Towels.....	230	CHAMPION		Express Lane Inflation System	120
Bubble Wheel Balancer	151	Air Compressors	69, 70, 71	Fixed Finger Plate System	145
Bucket, Cleaning.....	231	Compressor Accessories	69, 71	Manual Tire Changer.....	120
BUCKHORN Collapsible Bulk Box	227	Compressor Oil.....	71	Motorcycle Tire Changer	120
Budd		Nitrogen Inflation	59	On-Board Operating Training	121
Nut Removers.....	99, 100	CHANNELLOCK Hand Tools.....	240	Robo-Arm Pneumatic Drop Center Tool	120
Nut Sockets.....	97	Check Valve.....	328	Tire Changers.....	118, 119, 120, 123, 131, 132
Nut Wrench	105	Checkpoint Loose Nut Indicators.....	103	Wheel Balancers.....	141, 142, 143, 152
Nuts & Studs for Disc Wheels.....	104	CHEETAH		Wheel Lift, Tire Balancer	143
Buffer Exhaust		Bead Seaters.....	138	Wheel Lift, Tire Changer	121
Blower	301	Magnum Inflation Barrels	138	Color Coded Tread Depth Gauge.....	47
Hose	301	Stud Extractor Kit.....	101	Combination	
Buffers, Flexible Shaft	277	CHICAGO PNEUMATIC	See CP	Buffer/Reamer	274
Buffing		Chrome		Cap & Core Tool.....	45
Brushes, Sidewall	288	Ball Stud Setter	99	Cap Nut Wrench	105
Hood Brush Holders.....	301	Low Profile Valve	26	Valve Core Tool.....	45
Hood Brushes.....	301	Nut Cover Remover.....	99	Combustion Leak Test Fluid.....	210
Stone	285	Performance Valve.....	26	COMPAIR Rotary Screw Air Compressors	329
Templates, Retread	301	Plated Brass Valve Caps.....	33	Compact Fluorescent Lights.....	241
Texture Pad.....	303	Valve Caps	33	Compressor Oil, Champion	71
Bulk Box.....	227	Sleeve Snap-In Valves.....	26	Compressor, Air	69, 70, 71, 72, 73, 74
Bullseye Radial OTR Repair Units.....	256	CIMS Date Code Tags.....	317	CONTINENTAL Bladders	321
Butyl		Circumference-Diameter Tape	270	Contour Buffing Stone.....	285
Innerliner Gum.....	261	Citra-Clean Pre-Buff Cleaner Fluid.....	253	Conveyor Belt	226
Innerliner Sealer.....	262	Clamp-In		Cool-Tech ID Plus	209
Buzzout Cord	309	Chrome TPMS Valve.....	20	Coolant Refractometer.....	209
		Enkei Valves	27	Coolant Test Strips.....	210
		Valve Tool.....	45	Cooling System Pressure Checker.....	211
		Tubeless Metal Valves	26	Cooling Systems, Port-A-Cool.....	238
		Clean Out Rope for Extruder Guns.....	263	Cooling Test Kit.....	211
		Cleaner Fluid.....	253	Cordless LED Inspection Light	241
		Cleaner/Degreaser.....	223	Core Ejector.....	43
		Cleaning Bucket.....	231	Core Ejector Repl. Parts	43
		Clever Lever.....	177	Core Removing Tool	46
		Clip-On Air Chuck	123	CORGHI	
		Clock Gauges	320	Tire Changer Accessories.....	124, 125, 128
		Closed Eye Pistol Grip Tool	267	Tire Changers.....	124, 125, 127, 132
		Clutch Caddy.....	178	Wheel Balancers.....	149
		CMT Envelopes.....	311, 312, 313, 314	Cotton Gloves.....	244
		Coalescing Filters, Airline.....	73	Cotton Mop Head.....	231
		COATS		COUNTERACT Stud Cleaning Tool.....	101
		Auto-Flate Digital Inflator.....	121	Coupler & Adapter for Hydro Inflation	44
		Auxiliary Bead Seater.....	120		

C

C-Fold Towels.....	230
Cabinet Benches.....	235
Cabinet Desk.....	235
Cable Fishing Tool	46
Cages, Inflation.....	140
Camber Adjustment Tool.....	195
Cap & Core Tool.....	45
Cap Nut Wrenches.....	105
Carb & Choke Cleaner.....	222
Carbide Rasps	286
Carbide Tipped Delugger Blades	303
Cement	
Dispensers.....	239
Spray Booths.....	307

Table of Contents

Cowhide Driving Gloves.....	244	Brake Drum Gauges.....	203	Dual Cure Tube Patches.....	251
CP		Disc Rotor Micrometer.....	203	Dual	
Air Compressors.....	74	Inflation Gauges.....	56	Foot Angled Chuck.....	49
Air Drills.....	84	Inflator.....	55, 57	Foot Chucks.....	57
Air Hammers.....	83	Pyrometer.....	323	Foot Pressure Gauge.....	49
Air Ratchets.....	85	Thermocouple.....	323	Tire Inflators.....	55
Impact Wrenches.....	77, 79, 81	Tread Depth Gauge.....	47	Tire Mater.....	191
Tire Buffers.....	273, 275	DILL		Tire Pressure Equalizer.....	35
Crayon Holder.....	271	Anodized Aluminum Valve with Plastic Cap....	20	Wheel Extension.....	34
Creepers.....	237	Dual Foot Pressure Gauge.....	49	Wheel Flexible Valve Extensions.....	36
CREW CHIEF Oil Change Station.....	216	Grommet Removal Tool.....	23	DUO-FAST Staplers.....	308
Crib Stand Set.....	134	Redi-Sensor.....	21	DURA-GRIP Latex Gloves.....	242
Crimping Tool, Hose Ferrule.....	64	Redi-Sensor Service Kit.....	21	DURO Automatic Hose Reels.....	62
CROSSFIRE Dual Tire Pressure Equalizer.....	35	Rubber Snap-In Valve.....	20	Duro-Max Hub & Refill Blades.....	306
CRS		Safety Blow Gun.....	62	Durometer "A" Type.....	323
Expandable Rim Assemblies.....	302	TPMS Sensor for Prevost Buses.....	30	Dust Pan.....	231
Tire Buffers.....	300	TPMS Snap-In Valve.....	20	Dust/Mist Masks.....	237
Cup Cutter.....	303	TPMS Valve Repair Kit Assortment.....	22	DVT Sensors.....	21
Cup Rasps.....	281	Disc		E	
Curing Chamber		Brake Lining Wear Gauge.....	203	E-Z Mount Heavy Paste.....	116
Charts.....	318	Rotor Ball Joint Gauge.....	203	E-Z Out Broken Core Remover.....	46
Hose Tester.....	320	Rotor Micrometer.....	203	Earplugs.....	236
Hoses.....	319	Disposable		Earth Soap Cleaner/Degreaser.....	223
Paint.....	323	Dust/Mist Masks.....	237	Earthmover Bead Hook.....	136
Sealing Rings.....	318	Earplugs.....	236	Earthmover Tire Inflation Cage.....	140
Curing		Filter Masks.....	237	EcoSeal High Temperature Tire Sealant.....	265
Bladders.....	321	Do It Right		EF-10 Retread Cement.....	262
Rims.....	310	Tire Repair Kit.....	249	Electric Knife Heaters.....	270
Tubes.....	315, 321, 322	Training Classes.....	248	Electric Water Drain.....	68
Curved Cup Rasps.....	282	Dome Type Valve Cap.....	33	Electrical System Checker.....	205
Cushion Gum.....	261	Door Ports, Exhaust.....	214	Electronic Leak Detector.....	209
CX Bias Repairs.....	254	DOTCO Buffers.....	273, 274, 275	ELRICK	
D		Double		Brander Body for Interchangeable Plates.....	327
DATA-TORQ Wheel Lug Tightening System.....	89	Bend Tubeless Truck Valves.....	31	Brander Replacement Parts.....	330, 331, 332
Date Code Tags.....	317	Dot Curing Tubes.....	322	Branders.....	326, 327
Dayton		End Mill Knife.....	269	Custom Plates.....	326
Spoke Wheel Nuts & Studs.....	105	End Truck Wrenches.....	107	Interchangeable Plates.....	327
Wheel Clamps.....	105	Faced Sledge Hammers.....	109	Letter & Number Sets.....	326
Wheel Sockets.....	97	Sided Truck Wheel Adapters.....	144	Stop Spacers & Blank Spaces.....	326
Dead Blow Hammer.....	109	Drink Cups.....	232	EM Bias Repair Units.....	258
Delrin Plugs.....	44	Drive-On Broken Stud Removers.....	99	EMR Radial Repair Units.....	257
Desk, Shop.....	235	Drive-On, Rib-Grip Lug-Off Tools.....	100	EMR-K Giant Tire Radial Repairs.....	257
Detreader Cup Cutter.....	303	Drop Center Tire Tool.....	110	Encapsulated Wire Brushes.....	287
DICKSON		Drum		End Lifts.....	175
Pressure Charts.....	318	Containment Pallet.....	227	Engine	
Temperature Charts.....	318	Plug Wrench.....	227	Degreaser.....	222
Digital		Truck & Barrel Cradle.....	227	Stands.....	176
Air Gauge.....	48	Drum Shop Towels.....	108		

Table of Contents

Enkei Valves	27		
Envelope		Expandable	
Coupler & Adapters	317	Hub Lubricant	302
Expander	316	Hub Rebuild Kits	302
Inside	315	Hubs	302
Lube	316	Rim Assemblies	302
Outside	311, 312, 313, 314	Extended Clip Lock-On Air Chuck	57
Repair Kit	310	Extension	
Repair Spotter	289	Long Collar	34
Seal Couplers & Adapters	317	Stabilizers for Aluminum Wheels	35
Sealer Rings	310	Valve	34
Storage Carts	316	Extruder	
Tester	316, 328	Gun Replacement Parts	334
With Valves	313	Guns	264
Without Valve	313	Ropes	263
Epoxy Glue Kit	109	Eye Protection	236
EQUAL		EZ Tire Rotator	140
Filtered Valve Core	167		
Motorcycle Tire Balancing Formula	166	F	
Portable Applicator	166	Face Shield	236
Truck Tire Balancing Formula	167	FASCO Stapler & Staples	308
Yellow Identification Sleeve	166	Fast	
ESCO		Flow Air Liquid Valves	37
Bead Breakers	133, 134	Trim Vent Knife	270
Crib Stand Set	134	Fast-Dry Self-Vulcanizing Cement	253
Earthmover Bead Hooks	134	Fiber Bond Cement	262
Jack Plate Kit	134	Fiberglass Handled Bead Breakers	108, 109
Liquid Tire Balance	167	Filter	
Mammut Jacks	175	Crushers, Oil	218
Pyrosafe Valve	133	Kit for Refrigerated Air Dryers	71
Ringmaster Installation Tool	134	Masks	237
Shur-Lok Rim Kit	133	Regulator-Lubricators	67
Torque Master	89	Regulators	67
Truck Tire Double Bead Breaker	112	Flammable Liquids Storage Cabinets	238
Tubeless Tire Demounting System	113	Flange Ring Clamp, OTR	136
Tuffbar Tire Tool	118	Flanged Cap Nut Sockets	97
Euro-Style Lube Brushes	117	Flaps, Retread	310
EuroPaste	116	Flarelock Replacement Hose	214
EUROVENT Exhaust Extraction System	213	FLEETLINE PROFESSIONAL	
Exhaust		Air/Hydraulic Jack	173
Blower	301	Axle Stand	176
Buffer	301	Bottle Jacks	169
Door Ports	214	Digital Air Gauge	48
Extraction System	213	Engine Stand	176
Replacement Hose	214	Hydraulic Press	177
Splice Connectors	214	Inspection Lights	241
Telescoping Overhead Kit	214	Jack Repl. Parts	173
		Jack Stands	170
		Stand	176
		Transmission Jacks	176
		Flexible	
		Blade Skiving Knives	269
		Braided Wire Extensions	36
		Extensions, Large Bore	40
		Rubber Extension	36
		Shaft & Drill Adapters	277
		Shaft Buffers	277
		Shaft Lubricant	276
		Stems, Super Large Bore	42
		Flip Sockets	92
		Floater Gum	261
		Floor	
		Jacks	171, 172
		Mats	215
		Squeegee	231
		Fluid Evacuator	219
		Fluorescence Glasses	213
		Fluorescent Lights	241
		Flush Mount Tire Valve	27
		Fork Lift Mount/Demount Set	110
		Forklift Jacks	171
		Four	
		Post Alignment Racks	183, 186, 187
		Post Lifts	183, 184, 186
		Four-Way	
		Valve Repair Tools	46
		Lug Wrenches	107
		FREYLUBE Prema No Rim Rust	116
		G	
		GAITHER	
		Air/Hydraulic Jack	174
		Bead Bazookas	139
		Bead Saver System	112
		Mount/Demount Tool	112
		Slide Hammer	112
		Super Slick'Em Tire Lube	117
		Tire Dolly	177
		Garage Broom	231
		Garter Spring for AZ Extruder	302
		Gas Caddy Fuel Transfer & Storage Unit	219
		Gauges	
		Digital	48
		Dry	320
		Liquid	320
		Pressure	48, 49, 50
		Tread Depth	47, 52
		Geared Clamps, Air Hose	64
		GEORGIA-PACIFIC Towel Dispenser	230

Table of Contents

Giant Tire Extruder Rope.....	263
Giant Tire Spotter.....	291
Glass Cleaner.....	222
Glasses, Eye Protection.....	236
Gloves.....	242, 243, 244
GM Chrome Sleeve Snap-In Valve.....	20
Go Green Auto Club.....	61
Go Green Savings Calculator.....	61
Go-No-Go Ultra Precision	
Air Pressure Gauge.....	49
Digital Inflation Gauges.....	56
Goggles.....	236
GOJO	
Dispensers.....	215
Fast Wipes.....	228
Foam Hand Soap.....	232
Hand Cleaners.....	232
Heavy-Duty Scrubbing Wipes.....	228
HiTactile Gloves.....	243
GOODYEAR	
Racing Winter Wiper Blades.....	224
Wiper Application Charts.....	224
Wiper Blades.....	224
Wiper Display Racks.....	224
GoRag Automatic Wiping System.....	229
GRACO MONARK Airless Hydra-Sprayer.....	307
Graphite Lubricating Stick.....	321
Grease Gun for Impact Wrenches.....	82
Grease Guns.....	220
Green	
Air Hose for Nitrogen Inflation.....	63
Anodized Valve Caps.....	33
Cleaner.....	229
Machine.....	61
Plastic Cap.....	33
Valve Stem Rings.....	33
Grinding Stones.....	278
GripRight HiTactile Gloves.....	243
Grommet Seal Valve.....	30, 31
H	
H.V. Chemical Cement.....	253
HALTEC	
Large Bore Valves & Hardware.....	37-44
Nitrogen Inflation.....	59, 60
Nitrogen Purity Gauge.....	60
Hammers.....	109
Hands Free Budd Nut Wrench.....	105
Hanging Panels for Akro-Bins.....	234

HANSON Steam Coupler & Adapter.....	320
Hard Hats.....	237
HAWEKA	
Pro Collet Kit “Clad Solver”.....	148
Pro Expert System “Clad Solver Premium”... ..	148
QuickNut Adapters.....	147
Hawk Bill Notch Ply Knife.....	269
HAWKINSON	
NDT Replacement Chains & Wires.....	299
NDTII Inspection Repl. Parts.....	336
Probe Assemblies.....	299
Tire Inspectors.....	299
Truck Probe Repl. Parts.....	336
Headlight	
Aligners.....	204
Restoration Kit.....	204
Health Gards Toilet Seat Covers.....	229
Hearing Protector.....	236
Heat	
Insulated Gloves.....	244
Pads, Section Repair.....	295
Resistant Rim Flaps.....	310
Resisting Valve Cap.....	33
Knives.....	270
Heavy-Duty Torque Wrench.....	87
HEIN-WERNER	
Air Operated End Lifts.....	175
Air/Hydraulic Jack.....	174
Air/Manual Hydraulic Jacks.....	172
Service Jack Replacement Parts.....	172
Transmission Jack.....	176
Wheel Dolly.....	179
HENDRIX “Hands Free” Budd Nut Wrench.....	105
Hex Head Chrome Valve Cap.....	33
Hi Flo Tire Inflator.....	55
High	
Heat Chamber Paint.....	323
Pressure Snap-In Valves.....	26
Speed Grinding Stones.....	278
Volume Blow Gun.....	62
HOFMANN	
Alignment Lifts.....	187
Alignment Wheel Clamps.....	189
Drum/Disc Lathe.....	202
Geoliner Alignment Systems.....	188
Passenger Tire Balancers.....	148
Rim Gauge.....	148
Steering Wheel Holder.....	188

HOFMANN	
Tire Changer Changers & Accessories.....	129
Truck Tire Balancer.....	152
Wheel Weights.....	154, 155
HONEYWELL Recorder Chart.....	318
HOPPY Headlight Aligner.....	204
Hose	
Ends, Air.....	64
Ferrule Crimping Tool.....	64
Reel Ball Stops.....	63
Reels.....	62
Steam.....	319
Hot Mill Gloves.....	244
Hub	
Cap & Wheel Lock Removal Kits.....	90
Centric Nut.....	104
Centric Nut Locks.....	104
Nuts.....	146
Stems.....	302
HUB-SHARK	190
HUNTER Tire Changer Replacement Parts.....	121
Hydraulic	
Forklift Jacks.....	171
Hand Pump.....	135
Jack Oil.....	169
Jacks.....	169, 170, 171, 172, 173, 174
Press.....	177
Rams.....	169
Stud Remover & Installer.....	100
Transmission Jacks.....	176
I	
IDEAL Tire Regroover.....	325
Identification Labels.....	255
Impact	
Bead Breaker.....	112
Socket Adapters.....	97
Socket Extensions.....	97
Socket Sets.....	93 thru 98
Wrenches.....	76, 77, 78, 79, 80, 81
Imprinted Air Gauges & Tread Depth Gauges.....	47
IMT	
Aluminum Jacks.....	137
Bead Breakers.....	136
IN-20 Core Removing Tool.....	46
Indoor/Outdoor Broom.....	231
Industrial Shears.....	268
Industrial Style Coupler & Adapters.....	65
Inflatable Hub Gauge.....	301

Table of Contents

Inflation			
Cage Inflator.....	139	Jump-N-Carry	207
Cages	140	Jump-Starter	207
Gauges	55, 56	K	
Hose Assembly	123	KEN-TOOL	
System, Tire	54	Air Blast Bead Seater	114
Inflator Adapter	43	ATV Bead Breaker.....	115
Infrared Thermometer.....	212	Bead Breaker	107
INGERSOLL-RAND	See IR	Bead Seating Stand	114
Inner Budd Nut Remover	99	Blue Cobra Tire Demount Tool	113
Inner Tube Buffing Brush.....	287	Fork Lift Mount/Demount Set.....	110
Innerliner		Impact Bead Breaker	112
Markers	271	IronMan Wheel Lifting Bar	111
Scraper	268	Mount/Demount Tool Set.....	112
Insert Tools, Tire Repair	267	Power Wrenches.....	106
Inside Heat Pads.....	295	Small Tire Changers.....	114
Inspection Spreaders.....	298, 299, 300	Tire Irons.....	106, 107, 110, 111
Insulated		Tire Cart & Display.....	227
Gloves.....	243	Tire Snake.....	115
Heater Knives	270	Valve Breakers.....	46
Interior Protection	215	KIENE	
IR		Clutch Caddy	178
Air Compressors	72, 73	Wheel Grabber Hub-Piloted Wheel Remover.....	178
Air Drills	84	KILFROST Air Tool Antifreeze Lubricant.....	82
Air Hammers	83	King Pin	
Air Ratchets.....	85	Cap Tool Kit	196
Angle Grinder	276	Pin Extension.....	195
Compressor Accessories	73	Knife Heaters.....	270
Compressor Installation Kits	73	Knives.....	269, 270
Grease Gun For Impact Wrenches	82	KIT TPMS Tool.....	16
Impact Wrenches.....	76, 78, 80	KZ Regroover.....	325
Refrigerated Air Dryers.....	73	L	
Start-Up/Maintenance Kits.....	73	L-Rings for OTR Tires.....	44
Tire Repair Buffers.....	273, 274, 275	L.R. OLIVER Rotary Knife.....	308
IronMan Wheel Lifting Bar	111	Large Bore	
J		Air Gauges	52
J Hooks.....	328	Clip-On Air Chucks	51
Jacks		Close Clearance Gauge.....	52
Forklift.....	171	Component Parts.....	41
Handle Protector	171	Coupler & Adapter for Hydro Inflation	44
Oil.....	169	Dual Chuck Tire Inflation Device	52
Service.....	169-176	Extensions.....	40
Stands.....	170	High Pressure Inflation Connection.....	51
Transmission	176	Inflation Adapter	43
Jacobs Chucks & Adapters.....	276	Lock-On Air Chucks	51
JENSEN Rasps	285	Right Angle Dual Purpose Air Chucks.....	51
Jet Rasp Sharpener	270	Rim Nuts.....	37
Jet-Vac.....	239	Screw-On Valves	38
		Spud Adapter	38
		Spuds for Swivel-Type Valves	39
		Straight Push-On Gauge	52
		Straight Tubeless Valve.....	39
		Large Bore	
		Swivel Valves.....	39
		Tank Valve.....	40
		Tube Deflator.....	51
		Valve Adapters.....	38
		Valve Caps & Cores	38
		Valve Nut.....	38
		Valve Tools	39, 40, 51
		Latex Gloves.....	243
		Leak Detection Flashlight.....	212
		Leak Test Fluid.....	210
		Leather Palm Gloves.....	244
		Lever Style Inflation Gauges	56
		Lifts	179-186
		Light Weight Alloy Racing Valve.....	27
		Lightning Gloves	244
		LIGHTRITE Headlight Restoration Kit	204
		Lights.....	241
		Lightweight	
		Aluminum Studs	246
		Steel Studs.....	246
		LINCOLN	
		Air Operated Grease Pump.....	221
		Grease Injection Tool	220
		High Pressure Control Valve	220
		Impact Fitting Cleaner	220
		Lube Accessory Kit	220
		Manual Gear Lube Dispenser	221
		Oil Drains	216, 217
		PowerLuber	220
		Spigot Pump.....	221
		Suction Gun	220
		LINCOLN MFR.	
		Spotter Repl. Parts.....	335
		Spotter Plates.....	337
		Tire Repair Spotters	289, 290, 291
		Lincoln Style Coupler & Adapters	64
		Liquid Tire Balance	167
		Liquid-Filled Gauge	320
		LISTO Marking Pencil	271
		Loader Tire Valve	40
		Lobby Broom.....	231
		Lobby Dust Pan	231
		Lock Ring Removers	110
		Lock-On Air Chucks	57
		Locking Valve Core Remover	45

Table of Contents

Long Dual Foot Chucks	57
Long Handled Valve Cap Tool	45
Loose Nut Indicators	103
Low Pressure Passenger Tire Gauge	48
Low Profile	
Air/Manual Bottle Jack	170
Jack Stands	170
Truck Oil Drains	218
Valve	26
Low Speed Buffers	273, 274
Lube	
Bottles	123
Swabs	117
Tire	115, 116, 117
Lubricant, Flexible Shaft	276
Lug Nut & Wheel Lock Remover	90
Lug Nut Removal Sockets	92
M	
Mack Truck King Pin Cap Tool Kit	196
Mammut Jacks	175
Manual	
Bead Breaker	136
Tire Spreader	123
MARKAL	
Paintstik	271
Fugitive Yellow Marker	271
Marking Pencil	271
MARVEL Air Tool Oil	75
Master Budd Nut Remover Kit	100
Master Test Gauges	50
Matrix Vent Drill Bits	321
Measuring Tape	195
Mechanics	
Creepers	237
Gloves	243
Metal	
Bead Keepers	114
Dome Type Valve Cap	33
Screwdriver Type Valve Cap	33
Truck Valve Extensions	34
Valve Extensions	34
Metric Double-End Truck Wrenches	107
Metric Socket Sets	93 thru 98
Micro One Latex	242
MICROFLEX Diamond Grip Latex	242
Micrometer, Disc Rotor	203
MIDTRONICS Battery & Electrical Testers	205
Mill Blade	269

Mini Extruder Gun	264
Mini Filter-Regulator-Lubricator	67
MITY VAC	
Fluid Evacuator	219
Vacuum Brake Bleed Kit	202
Mobile Work Station	80
Mold Lubricant	322
MONAFLEX Systems	292, 293
Mono-Fil Inserts	252
Monorail	
Cable Lift Cylinder	327
Components	328
“T” Switch	328
Mop Handle	231
Mop, Cotton	231
Motorcycle	
ATV Lift	179
Tire Studs	246
Tire Valves	27
Mount/Demount Tire Spoons	110
MRT Outside Envelopes	314
Multi-Station Digital Thermocouple	323
MURPHY'S Tire & Tube Compound	116, 117
MYERS	
Air Gauge Check Station	50
Air Tool Conditioner	75
Black Tire Stain	324
Brake & Parts Cleaner	223
Chamber Hose Tester	320
Combination Buffer/Reamer	274
Concentrate Green Cleaner	229
Deluxe Tread Depth & Air Gauge Set	48
Digital Tire Air Pressure Gauge	48
Dual Foot Angled Chuck	49
Dual Foot Gauges	48, 49
Dualife Rasps	281
Durometer “A” Type	323
E-Z Mount Heavy Paste	116
Engine Degreaser	222
EuroPaste	116
Extruder Gun	333
Low Pressure Gauge	48
Lube	116
Mega-Wheels	283
Mold Lubricant	322
Nailhole Extruder Gun Repl. Parts	333
Nailhole Leak Detector	299
New Look Water Base Black Tire Paint	324

MYERS

Penetrating Oil	115
Recalibratable Air Gauges	49
Regroover	325
Reusable Mechanics Gloves	243
Rim Non-Rust	116
RuGlyde	117
Skid Rubber Loosener & Rust Remover	115
Sliptac Bead Lubricant	117
Steam Coupler & Adapter	320
Super Purple Cleaner	223
Tire & Tube Mounting Compound	116
Tire Changers	126
Tire Marking Crayons	271
Tire Repair Buffers	273, 275
Tire Repair Rasps	282, 283, 284
Tire Shine	221
TPMS Digital Inflation Gauge	53
TPMS Torque Wrench	24
Truck Tire Dunker	245
V2B Inflate Thru Valve Cap	32
V2BG Cap with Nitrogen Inflation Ring	32
Valve Core Torque Tool	24
Wheel & Tire Cleaner	221

N

Nailhole

Filler Extruder Gun	264
Leak Detector	299
NATIONAL Expandable Hub Lubricant	302
NDT Inspectors	299
New Look Water Base Black Tire Paint	324
NEXT DIMENSION	
A/C Refresher Service	210
Service Bay Chemicals	210
Nitrile Gloves	242
Nitrogen	
Hose Reel	63
Tire Inflation Wand	60
Valve Caps	60
No Hands Mounting Clamp	121
No-Mar Rim Guard	98
NO-MAR Socket Set	91
NORBAR Truck Torque Wrenches	88
NORCO Low Profile Jack Stands	170
Notched Blade Trim Knives	270
Nut & Stud Cleaning Kit	101
Nuts & Studs, Truck	105
Nylon Valve Extensions	34

Table of Contents

O

O-Ring

Valves for Aluminum Wheels.....	31
Valves for Steel Wheels.....	31
Truck, OTR & Earthmover.....	44
OBDII Memory Saver Connector.....	207
Offset Double-Sided Truck Wheel Adapters.....	144

Oil

Change Station.....	216
Drains.....	216, 217, 218
Drain Funnel & Adapter.....	219
Drain Plug Removal Kit.....	91
Filter Crushers.....	218
Resistant Air Hoses.....	64
Hydraulic Jack.....	169

OLSON Envelope Expander.....	316
-------------------------------------	-----

On-the-Car Brake Lathe.....	202
-----------------------------	-----

Organizers.....	234
-----------------	-----

OSHA Poster Kits.....	140
-----------------------	-----

OTC

Air Lift Jack & Support Stand.....	174
Air Under-Axle Jack.....	174
Battery Reset Procedures Manual.....	206
Brake Drum Dolly.....	198
Easy Roller.....	176
Low Profile Oil Drain.....	218
Multi-Purpose Electrical System Checker.....	205
Support Stand.....	170
Transmission Jack.....	176
Truck & Trailer End Lift.....	175
Truck Clutch & Flywheel Handler.....	175
Truck Ramps.....	178

OTR

Bead Breakers.....	133, 134, 135, 136, 137
Bead Repair System.....	292
Bead Seat Band/Pulling Tool.....	135
Carbide Tipped Delugger Blades.....	303
Delugger-Buffer Cup Cutter.....	303
Envelopes.....	313
Extruder Gun.....	264
Flange Ring Clamp.....	136
InsertTools.....	267
Repair Inserts & Tools.....	260
Sidewall Repair System.....	292
Tire Repair Clamp.....	294
Tire Seal.....	265
Tire Spotter.....	291
Tread Depth Gauges.....	52

Outer Budd Nut Removers.....	99
Outside Heat Pads, Section Repair.....	295
Oval Boots.....	255
Oval Rim Hole Valve.....	27

P

Paint Spray Booths.....	307
-------------------------	-----

Paint

Retread Chamber.....	323
Sprayer.....	324, 327
Tire.....	324

PAINTSTIK Holders.....	271
-------------------------------	-----

PAKPRESS Wheel Stud Remover & Installer.....	100
--	-----

PARKER BOILER	329
----------------------------	-----

Parker Nitrogen Tire Inflation Wand.....	60
--	----

PARKER Steam Coupler & Adapters.....	320
---	-----

PARTLOW

Controller Recorder Charts.....	318
Temperature Charts.....	318

Parts Bags.....	215
-----------------	-----

Passenger Tire Dunker.....	245
----------------------------	-----

Passenger & Truck

Scribe Toe Gauges.....	190
Tire Bead Seaters.....	139

Passenger

Tire Gauges.....	48
Tire Mount/Demount Tool.....	111
Tire Spotter.....	289
Tire Valves.....	25, 26, 27
Valve Tool.....	45, 46, 47
Wheel Alignment.....	188, 189

PATCH RUBBER

Tire Repair & Retread Materials.....	240-263
Tire Lube Concentrate.....	117

PAX Tire Gel Pack Kits.....	117
-----------------------------	-----

PB BLASTER Nut Loosener.....	222
-------------------------------------	-----

PCL

Automatic Tire Inflator.....	54
Qube4 Digital 4-Tire Inflator.....	54
Penetrant Lubricant.....	222
Penetrating Oils:.....	115

PENRAY

Non-Chlorinated Brake Cleaners.....	223
Non-Flammable Brake Cleaner.....	223

PERFECT Wheel Weights.....	156, 157, 158, 159
-----------------------------------	--------------------

Perforated Roll Towels.....	230
-----------------------------	-----

Pigtail for Steam Gauge.....	329
------------------------------	-----

Pipe Thread Tape.....	64
-----------------------	----

Piranha Carbide Rasps.....	286
----------------------------	-----

Pistol Grip

Probe/Rasp Tool.....	267
Spiral Cement Tool.....	267
PIV Curing Tubes.....	321

Plastic

Encapsulated Brushes.....	287
Staples.....	308
Valve Caps.....	33

Pli-Vent.....	309
---------------	-----

Pneumatic Bead Expanders.....	139
-------------------------------	-----

Pneutorque Torque Wrench.....	89
-------------------------------	----

Pocket Dual Foot Gauge.....	48
-----------------------------	----

Pocket Tire Service Kit.....	45
------------------------------	----

Poly.....	309
-----------	-----

Poly Waste Can.....	239
---------------------	-----

Pop-Off Valve.....	68
--------------------	----

Pork Chop, Cap Nut Wrench.....	105
--------------------------------	-----

PORT-A-COOL Cooling Systems.....	238
---	-----

Portable Air Tank.....	63
------------------------	----

Portable Hydraulic Jacks.....	169
-------------------------------	-----

Power Gold Hand Cleaner.....	232
------------------------------	-----

Power Wrenches.....	106
---------------------	-----

Pre-Bent Tubeless Truck Clamp-In Valves.....	29
--	----

Precure

Chamber Inflation & Exhaust Hoses.....	319
Cushion Gum.....	260
Cushion Strip.....	260
Vacuum Envelope Tester.....	328

Prema No Rim Rust.....	116
------------------------	-----

Preset

Torque Wrenches.....	87, 89
Truck Valve Torque Wrenches.....	29

Pressure Gauges, Air.....	48, 49, 50
---------------------------	------------

PREVOST Couplers.....	65, 66
------------------------------	--------

Pricking Awl.....	266
-------------------	-----

Pro 2000 Hand Cleaner.....	232
----------------------------	-----

PRO CHEM Tire Release Mount/Demount Compound.....	115
--	-----

Pro Super Hub-Shark.....	190
--------------------------	-----

PRO-CUT On-the-Car Brake Lathe.....	202
--	-----

Probe/Rasp Tool.....	267
----------------------	-----

Protective Eyewear.....	236
-------------------------	-----

PT Valve System.....	41
----------------------	----

Pull Thru Wires.....	268
----------------------	-----

Pump, Barrel.....	221
-------------------	-----

Puncture Pac Tire Repair Kits.....	249
------------------------------------	-----

Push-In Valve.....	321
--------------------	-----

Table of Contents

PVC		Repair Kits, TPMS..... 22	ROBINAIR	
Air Hoses..... 63		Repair Sealer..... 253, 259	Filters..... 209	
Coated Bead Keeper..... 114		Respiratory Protection..... 237	High Vacuum Pump Oil..... 209	
Pyrometer..... 323		Restore Tire Paint..... 324	Manifold Hose Kit..... 209	
Pyrosafe Valve..... 38		Retail Passenger Tire Gauges..... 48	Recovery/Recycle/Recharging Stations..... 208	
	Q	Reusable Mechanics Gloves..... 243	Service Couplers for Automotive 134a..... 209	
Qube4 Digital 4-Tire Inflator..... 54		Reversible Air Drill..... 84	Vinyl Dust Covers..... 209	
Quick		REVOLUTION Lifts..... 179, 180	Rollers, Tire Repair..... 268	
Change Chuck & Adapters..... 276		Rhein Chemie (Curing Bladders)..... 321	ROLLOCK Wheel Nut Clamps..... 103	
Chuck Balancer Adapter..... 146		Rib Nut Salvage Tool Kit..... 100	ROOVERS Aluminum Embossing Tape..... 317	
Chuck Brake Lathe Adapter..... 200		Rib-Grip Lug-Off Tools..... 100	Rotary	
Cure Tube Gum..... 260		Right Angle High Speed Buffer..... 275	Barrel Pump..... 221	
Inflate Dual Tire Inflators..... 55		Rigid Metal Valves..... 41	Knife..... 308	
Quilled Patch Plugs..... 250		RILLFIT	ROTARY LIFTS	
	R	Regroover..... 325	Accessories..... 182	
R.M.A. Buffing Texture Pad..... 303		Regroover Repl. Parts..... 332	Extended Height Adapters..... 182	
Racing		Rim	Lifts..... 181, 182, 183, 184	
Tire Gauge..... 49		Buffing Brush..... 287	Polymer Pad Adapter Kit..... 182	
Tire Valve..... 27		Clamp Tire Spreader Adapter..... 123	Rolling Jacks..... 183	
Winter Wiper Blades..... 224		Flaps..... 310	Rotary Screw Air Compressors..... 71, 74, 329	
Radial		Guard Kit for Hunter Alignment Heads..... 190	Roto-Shelf..... 233	
Commander Valve..... 28		Hole Bushing for Tube Type Valves..... 32	Roughener-Stitcher..... 268	
Patches..... 259		Hole Plugs..... 37	Round Carbide Bits..... 201	
Repairs..... 252		Non-Rust..... 116	Rubber	
Run-Out Gauge..... 151		RINGERS Tire Buddy Gloves..... 243	Encapsulated Wire Brushes..... 287	
Radiator Adapter Kit..... 211		Ringmaster OTR Installation Tool..... 134	Mallet..... 109	
Radiator Filler..... 216		Road Rims..... 310	Snap-In Valve..... 20	
Radius Cup Rasps..... 281, 282		ROBBINS	Solvent..... 258	
Rag-In-A-Box..... 228		Accu-Fit II Envelopes..... 315	Wheel Chock..... 226	
Rasp		CMT Envelopes..... 311, 312, 313, 314	Wick Pads..... 309	
Blades..... 304, 305		Double Dot Curing Tubes..... 322	RUBBERHOG Rasps..... 279, 280	
Hubs..... 306		Envelope Lube..... 316	RuGlyde..... 117	
Tire Repair..... 279-286		Envelope Repair Kit..... 310	Rust Breaker..... 222	
RAYTEK Infrared Thermometer..... 212		Envelopes with Valve..... 315		S
Re-Coil Air Hoses..... 63		Euro-Tubes..... 321	Saf-Tee Tire Siper..... 247	
Reamer, T-Handle..... 267		MRT Outside Envelopes..... 314	SAFE T SORB Safety Absorbent..... 228	
Rear Wheel Slip Plate Set..... 190		OTR Envelopes..... 313	Safegrip Latex..... 242	
Rebuild Kits, Expandable Hub..... 302		PIV Curing Tubes..... 321	Safety Can..... 239	
Recalibratable Air Gauges..... 49		Rubber Wick Pads..... 309	Safety Sign, Wet Floor..... 231	
Recessed Valve Core Tool..... 45		Uni-Tubes..... 315	Sanding Drums..... 285	
Redi-Sensor..... 21		ROBINAIR	SARCO Thermodynamic Steam Traps..... 328	
REDLINE Smoke Pro Leak Detector..... 211		A/C Maintenance Kits..... 209	SAV-A-STUD Tool Set..... 91	
REELCRAFT		Cool-Tech ID Plus..... 209	Scalpel Knife..... 269	
Automatic Hose Reels..... 62		Coolant & Battery Refractometer..... 209	SCHRADER	
Nitrogen Hose Reel..... 63		Coolant Test Strips..... 210	Couplers & Adapters..... 66	
Refrigerated Air Dryers..... 71		CoolXChange..... 210	EZ-sensors..... 21	
Regroovers, Tire..... 325		DiscovR R134a Refrigerant Identifier..... 209	Stem Only Service Pack..... 20	
Remote Mount Automatic Inflation Kit..... 140		Electronic Leak Detector..... 209	Scissors..... 268	

Table of Contents

Scissors Wheel Lift.....	152	SLIP-N-GRIP		Steering Wheel Covers.....	215
Screw-On Valves.....	31	White Key Tags.....	215	Steering Wheel Holder.....	188, 190
Scribe Toe Gauges.....	190	Work Ticket Holders.....	215	Stem Brushes.....	288
Sealing Ring Installation Stand.....	327	Sliptac Bead Lubricant.....	117	Stippling Brush.....	307
Seat Protectors.....	215	Slotted Angle Tire Racks.....	225	Stitchers & Rollers.....	268
Section Repair Heat Pads.....	295	Small		STONER Spray Lube.....	322
Self-Evacuating Oil Drain.....	217	Parts Storage.....	240	Stones, Wire Grinding.....	278
Self-Vulcanizing Cement.....	258	Tire Changers.....	114	Storage Cabinets, Flammable Liquids.....	238
sens.it		Tire Irons.....	115	Straight Lock-On Chucks.....	57
Programmable TPMS Sensors.....	17	Smart-O Drain Plug Kits.....	217	STRIKE PRO Dead Blow Hammer.....	109
TPMS Tool Kit.....	17	SMARTFIT		String Repairs.....	252
Serial Number Remover/Defacer.....	270	Universal Cooling Test Kit.....	211	STRIP DIP	203
Service		Universal Radiator Adapter Kit.....	211	Stripping Stock.....	261
Jacks.....	172	SMOKE PRO Leak Detector.....	211	Strut Spring Compressor.....	195
Reminder Stickers.....	216	Snap-In TPMS Sensor & Valve Assembly.....	20	Stud	
Station Kits.....	214	Snap-In Valves.....	26	Cleaning Tool.....	101
Sharp Point Knife.....	269	Socket Adapters & Extensions.....	97	Feeder Boy.....	246
Sharpening Stone, Knife.....	270	Socket Sets.....	93 thru 98	Feeder.....	246
Sharpening Stones for Buffers.....	303	Soft Frame Goggles.....	236	Gun Repl. Parts.....	247
Shears.....	268	Solvent Dispensing Cans.....	239	Guns.....	247
Shelf Bins.....	234	Spare Tire Tool Set.....	110	Installation Work Station.....	246
Shop Desk.....	235	Special Clamp-In Valve.....	27	Tire.....	246
Short Chrome Cap.....	33	SPECIALTY ALIGNMENT	192, 193, 194	Super Large Bore	
Sidewall		Speed Tire Spreader.....	297	Core Housing.....	42
Buffing Brushes.....	288	Spiral Cement Tool.....	267	Flexible Extension Kits.....	42
Buffing Stone.....	288	Spline Dr. Socket Sets.....	97	Flexible Stems.....	42
Repair Identification Labels.....	255	Split Eye Insert Tools.....	267	Inflation Adapter.....	43
Silicone Spray.....	222	Spray Booths.....	307	Spuds.....	42
Silver Tire Marking Pen.....	271	Spray Lube.....	322	Straight Valve Assembly.....	42
Single		Spray-N-Mount Tire Lube.....	117	Swivel Connectors.....	42
Direction Torque Wrench.....	87	Sprayer, Sure Shot.....	316	Valve Assembly.....	42
End Mill Knives.....	269	Square Budd Wheel Sockets.....	97	Valves.....	41
Hand Lock-On Chuck.....	57	Square Point Knives.....	269	SUPER MUTT	204
Sided Bin Rack.....	233	Stabilizers for Aluminum Wheels.....	35	Super Purple Cleaner.....	223
Slot Tandem Truck Shims.....	194	Standard Socket Sets.....	93 thru 98	Super Sharpener.....	270
Siphon for Steam Gauge.....	329	STANT Cooling System Pressure Checker.....	211	Super Slick'Em Tire Lube.....	117
Skid Rubber Loosener & Rust Remover.....	115	Staple Pulling Tape.....	309	Super-Blue Windshield Washer Solvent.....	223
Skidder/Tractor Bias Repairs.....	260	Staplers.....	308	Supreno Nitrile Gloves.....	242
Skiving Brush & Double Adapter.....	287	Staples.....	308	Supro Max Hand Cleaner.....	232
Sledge Hammers.....	109	Stationary Tire Meter.....	191	SURE-SHOT Sprayer.....	316
Slic-Tite Pipe Thread Tape.....	64	Steam		SURESEAL Envelope Sealer Rings.....	310
SLIP-N-GRIP		Ball Valves.....	328	Surface Conditioning Pads.....	85
Floor Mats.....	215	Coupler & Adapters.....	320	Surge Tank.....	63
Parts Bags.....	215	Hoses.....	319	Swivel Valve Assembly.....	41
Seat Protectors.....	215	Reducing Valve Repair Kits.....	329	SYMTECH Headlight Aligners.....	204
Start-Up Package.....	215	Reducing Valves.....	329		
Steering Wheel Cover.....	215	Traps.....	328		
Tire Bags.....	215	Steel Measuring Tapes.....	244		
		Steel Wheel Brush.....	288		

Table of Contents

T

T-Handle	
Reamer.....	267
Spiral Probe Cement Tool.....	267
Split Eye Tool.....	267
T-TECH Transmission Fluid Exchange.....	210
T.O.M.C.A.T. Camber Adjustment Tool.....	195
Tac-A-Disc.....	286
Tack Rasps & Hubs.....	286
Tailpipe Adapters.....	214
Tandem Axle Spacing Caliper.....	195
Tank Valves.....	32, 40
Tape Measures.....	270
Taper Point Knife.....	269
Tapered Rasps.....	284
TELECHEM Super-Blue Windshield Washer Solvent 223	
TEMCO	
Sanding Drums.....	285
Tungsten Carbide Abrasive Sleeves.....	285
Templates, Buffing.....	301
Terminal Clamp & Post Cleaner.....	207
Texturing Brushes.....	287
Therm-O-Blue PVC Air Hoses.....	63
Thermocouple.....	323
Thermometer, Chamber.....	320
TIDE All Purpose Cleaner.....	231
TIGER TOOL	
Hydraulic Stud Remover & Installer.....	100
Universal Joint Puller.....	196
Yoke Puller.....	196
Tilt Table, Monorail.....	328
Tire & Rim Brush.....	268
Tire	
Air Pressure Gauges.....	48, 49, 50
Automatic Inflation System.....	54
Bags.....	215
Balancers.....	141-152
Bar/ Tire Bead Tool.....	118
Bead Seaters.....	138, 139
Branders.....	326, 327
Brush, Brass Bristle.....	268
Tire Buffers,	
Retread.....	300
Tire Repair.....	273, 274, 275
Tire	
Buffing Brush.....	287
Caliper.....	191

Tire	
Cart.....	226, 227
Changers.....	118-132
Changing Tools.....	113
Curing Bladders.....	321
Curing Tubes.....	315, 321, 322
Cutter.....	247
Dollies.....	177
Dunkers.....	245
Filling Check Valve.....	44
Hammers.....	109
Inflation Cages.....	140
Inflator.....	55
Irons.....	110
Knocker.....	109
Leak Detector.....	265
Life & Tire Life Bag.....	265
Lubes.....	115, 116, 117
Machines, Retread.....	300

Tire Marking

Crayons.....	271
Pen.....	271

Tire

Mating Square.....	191
Merchandiser.....	226
Meter.....	191
Paints.....	324
Paint Sprayer.....	324, 327
Painting Mitt.....	244
Pressure Gauges.....	48, 49, 50
Probing Awl.....	266
Racks.....	225, 226
Reamers.....	267
Regroovers.....	325
Release Mount/Demount Compound.....	115
Repair Insert Tools.....	267
Repair Kits.....	249
Seal Liqui-Fill Concentrate.....	265
Seal.....	265
Service Kit.....	45
Shine.....	221
Sidewall Brush.....	287
Siper.....	247
Snake.....	115
Spoons.....	110
Spreader.....	123, 296, 297, 298
Step.....	237
Stippling Brushes.....	307

Tire

Studs.....	246
Talc (MICA).....	316
Test Tanks.....	245
Topping System.....	54
Track.....	255

TNT

100 Tire Changing Tool.....	113
200 Tire Changing Tool.....	113
300 Tubeless Truck Tire Demount Tool.....	113

Toilet

Paper.....	230
Paper Dispenser.....	230
Seat Covers.....	229

Tool

Boxes.....	240
Pouch.....	45
Stand Cabinet.....	235
TORQCHECK Torque Tester.....	90
Torque Bar with Built-In Socket.....	86

Torque

Wrenches.....	89
Wrench Checkers.....	90
Wrench, TPMS.....	24
TorqueBar Extensions.....	86
Total II Tire & Wheel Protection.....	265
Towel Dispenser.....	230
Towels.....	230

TPMS

4-Way Valve Tool.....	24
Band-Mounted Sensor Kit.....	19
Chrome Sleeves & Caps.....	23
Core Removal Tool.....	24
Countertop Display.....	21
Digital Inflation Gauge.....	53
DVT Sensors.....	21
Grommet Installation & Removal Tool.....	24
Relearn Chart.....	23
Repair Kits.....	22
Sensor & Valve Assembly.....	20
Sensor for Prevost Buses.....	30
Snap-In Valve.....	20
Tire Valves.....	19, 20, 21
Tool Sets.....	17, 18
Torque Tools.....	24
Valve Caps.....	23
Valve Holding Tool.....	24
Valve Repair Kits.....	22

Table of Contents

TRACERLINE

Automotive Dyes.....	212, 213
Blue Light Leak Detection Lamp.....	212
EZ-Shot Kit.....	212
Leak Detection Flashlight.....	212
Motorcycle Valve.....	27
Stick Capsules.....	213
Tractor Front Wheel Valves.....	37
Tractor Tire Gauge.....	50

Transmission

Drain Pan Adapter.....	219
Fluid Exchange.....	210
Jacks.....	176

Tread

Builder/Stitcher.....	308
Cutting Blades.....	308
Depth Gauges.....	47, 52
Gum.....	261
Rope.....	263

TRIPLEMATIC

Extruder Gun Repl. Parts.....	333
Extruder Gun.....	264
Trouble Lights.....	241

TRU ALIGN Wheel Alignment System.....

TRU BALANCE Radial Run-Out Gauge.....

TRU-BALANCE

Accessories.....	103
Front Brake Drum Spacers.....	103
Wheel Centering Pin Sets.....	103
Truck Tire Spotters.....	289, 290

TRU-FLATE Safety Blow Gun.....

TRU-LINE Laser Alignment System.....

TRUCHECK Torque Wrench Checkers.....

Truck & Trailer End Lift.....

Truck

Clamp-In Valves.....	29
Clutch & Flywheel Handler.....	175
Flexible Rubber Extensions.....	36
Four-Way Wrenches.....	107
Front Slip Plate Set.....	191
Oil Drains.....	218
Ramps.....	178
Shims.....	194

Truck Tire

Balancers.....	152
Balancing Formula.....	167
Bead Breaker.....	112
Bead Seater.....	139

Truck Tire

Changers.....	131, 132
Changing Stand.....	111
Dunker.....	245
Section Repair.....	292, 293, 294
Spreaders.....	296, 298
Storage Racks.....	225
Tread Depth Gauge.....	47
Tube Dunker.....	245
Valve Nut Splitter.....	29

Truck

Toe Alignment Check Set.....	191
Torque Wrenches.....	88

Truck Valve

Lock.....	32
Protector Shim.....	32
Truck Valves.....	28, 29, 30, 31

Truck Wheel

Alignment.....	191
Bearing Locknut Sockets.....	98
Torque Bar Extensions.....	86

TSI

Small Tire Changer.....	114
Wheel Cleaners.....	168

Tube

Deflators.....	46
Gum.....	260
Patches.....	259
Plate Spotters.....	289

Tubeless

Large Bore Valve Spud.....	39
Motorcycle Valve.....	27
Tire Snap-In Valves.....	25
Tire Tester.....	323
Tire Irons.....	111
Truck Clamp-In Valves.....	28, 29
Truck Tire Mount/Demount Tool Set.....	111
Valve Tools.....	47
Tubeless Valves for Aluminum Disc Wheels.....	31
Tuffbar Tire Tool.....	118
Tungsten Carbide Abrasive Sleeves.....	285
Turntable Set.....	191
Turret Valve Assembly.....	41
Turret Valves for Planetary Gear Wheels.....	40
Tweel Handler Tire & Wheel Handling System... ..	179
Twisted Wire Rim Buffing Brush.....	287

TwistSocket

Damaged Fastener Remover.....	92
Hex Socket Set.....	91
Two Bar Push Tool.....	135
Two-Post Lifts.....	180, 181, 182, 185

U

Ultra Precision

Digital Inflation Gauges.....	56
Master Gauge.....	50
Repl. Digital Gauge.....	56
Ultra-High Temperature Truck Valves.....	29
Uncured OTR Bias Repair Units.....	258
Under Tread Repairs Bias Repairs.....	258
Underhood Lights.....	241
Uni Tubes, Robbins.....	315

Universal

Axle Extensions.....	195
Band TPMS Adapter.....	19
Clamp Tire Cart.....	227
Joint Puller.....	196
Nitrogen Valve Caps.....	33
Patches.....	251
Urethane Fill Adapter.....	44

Urinal

Blocks.....	229
Screen with Para Block.....	229

URYU Buffer/Skivers.....

Utility Vise.....

UWT Wheel Weight Tools.....

V

V-10 Extruder Cement.....

V-Bond Absorbent Pads.....

V2B Inflate Thru Valve Cap.....

V2BG Double-Seal Valve Cap.....

VACULA Vacuum Brake Bleeder.....

Valve

Adapter & Core Ejector.....	43
Breakers.....	46
Caps.....	33
Cap Tool.....	45
Caps.....	33
Core Deflator.....	23
Core Remover.....	45
Core Removing Tool.....	46
Core Screwdriver.....	45
Core Tools.....	45
Core Torque Tool.....	24
Cores.....	33

Table of Contents

Valve

Extension Tool	34
Extensions.....	34, 36
Fishing Tools.....	46
Hole Cleaning Brushes.....	45
Nut Torque Wrenches.....	32
Nut Ratchet Wrenches	45
Nut Splitter	29
Pal Valve Cap Remover & Installer	45
Pullers.....	47
Repair Kits, TPMS	22
Repair Tool, Large Bore	51
Stem Filter	167
Tools	45, 46, 47
Valves for Ford Trucks.....	30
Vehicle Lifts	179-186
Vent Knife.....	270
Venting Materials.....	309
Vibration Mounts.....	73
Vinyl Deodorizing Urinal Screens.....	229
VIPER A/C Sealant Filter System	210
Vise Grips.....	240
Vises.....	240
Visitor's Spectacles.....	236
VULCAN-VULCAP	
Lug Filler Bags	292
OTR Tire Repair Clamp.....	294
Section Mold Components.....	295
Section Molds.....	294
Tread Builder/Stitcher.....	308
Vulcanize-On Valves.....	32
VULCATEK Tire Repair	258, 259

W

Walton Cast Wheel Screw-In Valve.....	31
Water Adapter Set for Core Ejector	44
Water Base EF-10 Retread Cement.....	262
Water Drain, Compressor	68
Wet Floor Sign.....	231
Wet Mop Handle.....	231
Wheel & Tire Cleaner.....	221

Wheel

Balancer, Bubble.....	151
Balancers.....	141-152
Centering Products	102
Cleaners.....	168
Cover Puller/Replacers.....	107
Dollies.....	179
Grabber Hub-Piloted Wheel Remover.....	178

Wheel

Guards.....	101
Lift.....	143
Lug Tightening System.....	89
Nut & Stud Cleaning Kit	101
Nut Clamps	103
Nuts & Studs.....	105
Protector "Booties".....	123
Shield Wheel Protector.....	99
Spreader.....	190

Wheel Stud

Extractor Kit.....	101
Installers	92
Remover & Installer.....	100

Wheel

Torque Specification Chart.....	88
Weight Adhesive Removal Kit	149
Weight Storage Rack	153
Weight Tools.....	153
Weights.....	154-166
Whip Hoses.....	63

White

C-Fold Towels.....	230
Jumbo Toilet Paper.....	230
Key Tags	215
Lithium Grease.....	222
Sidewall Buffing Stone	288
Wicking Materials	309

Wide Base

EMR Repair Units.....	257
Envelope Valves.....	317
Window Inflation Gauge.....	55
Windshield Towels.....	228

WINNER

Bead Spotter	289
Spotter Repl. Parts.....	334
Tire Spotter	292
Wiper Blades.....	224
Wiper Display Racks.....	224

Wire

Cord High Speed Grinding Stones.....	278
Cutting Drill Bit	268
Wheel Brushes	288, 307
Wonder Air Vacuum.....	239
Wonder Pump Tire Filling System.....	43
Wood Handled Hammers.....	109

Work

Benches.....	235
Station	80
Ticket Holders.....	215
Worn Lug Nut Removal Sockets.....	92
WYCO Flexible Shaft Buffers.....	277

WYPALL

Economical Wipers.....	228
Shop Towels in a Bucket	228

X

XACT Cleaner	166
--------------------	-----

Y

Y-Connectors.....	214
Y-Strainers.....	328
Yoke Puller.....	196

Z

Zafety Lug Locks	104
------------------------	-----

Zip Gun

Retainer Chuck.....	83
Gun Retainer Spring.....	83
Zip Guns	83

Tire and Rim Servicing can be dangerous, and should be done by trained personnel using proper tools and procedures. The Occupational Safety and Health Administration has a safety standard for the servicing of single-piece and multi-piece rim wheels (OSHA std 29 CFR 1910.177) to include requirements for the safe servicing of rims used on passenger, truck, trailers, buses and off-road vehicle equipment.

All tire servicing should be performed by persons trained properly. Myers has copies of this safety standard available. Ask for the standard entitled Servicing Single-Piece and Multi-Piece Rim Wheels. Failure to comply with these procedures as well as procedures recommended by Tire Manufacturers and Wheel and Rim Manufacturers may result in faulty positioning of the tire and rim and cause the assembly to burst with explosive force sufficient to cause serious physical injury or death.

Valves & Accessories

Myers Tire Supply is your tire valve & valve accessory headquarters. We are your single-source for passenger tire valve cores to Super Large Bore. We stock a complete line of TPMS sensors, service tools & replacement components. **SENS.IT** is a programmable **TPMS** sensor that covers 95% of OE sensors. **ALLIGATOR**, **ATEQ**, **BARTEC**, **DILL**, **SCHRADER**, **EHA** & **HALTEC** are just a few of the manufacturers we stock for your valve service needs. The original "Alligator" V2B double seal valve is an exclusive Myers Tire Supply product. A wide variety of truck valves, stabilizers & extensions for steel & aluminum rims for standard & high heat applications are available.



ATEQ VT55 with OBDII

- The most economical tool available for servicing vehicles requiring an OBDII connection
- Services Toyota, Honda, Subaru, Scion & Hyundai
- Use to program sens.it
- Use to Program EZ-Sensor



Compatible with sens.it Sensors

Triggers and decodes 100% of all TPMS sensors available. Resets 98.6% of all the vehicles requiring OBDII relearn. On board direct and indirect relearn procedures. Displays psi, ID, frequency battery level of TPM sensor and accelerometer. Lexus, Toyota and Scion ECU unlock. Pass/Fail/Transmission lights indicate when sensor information is received. Kit includes VT55 activation tool, OBDII cable, USB cable, magnet, 110V charger, printed quick reference guide, CD with manual and software, rubber protection boot, and carrying pouch.

Order No.	Description	Ship Wt.
27151	VT55 With OBDII Connection TPMS Valve Service Tool	4 lbs. - 2 kg
27148	VT55 TPMS Valve Service Tool Only - No OBDII Cable	4 lbs. - 2 kg
27166	SD Card Update for VT55	
27167	CD Card Update for VT55	
27157	Replacement Storage Case for VT55	2 lbs. - 1 kg

ATEQ VT30 TPMS Service Tool

- Low cost, entry level TPMS tool
- Use to make sure TPMS sensors are working before beginning service. Test before you touch!
- Displays tire pressure, temperature & sensor ID
- Large LC display



Reads and decodes 100% of all TPMS sensors. Select vehicle by make and the VT30 finds the correct sensor protocol. The VT30 displays sensor ID, psi, frequency battery level of TPM sensor and accelerometer. Prints the TPMS data. The tool is protected by a rubber cushion and includes start up CD and USB cord.

Order No.	Mfr. No.	Description
27164	VT30	TPMS Service Tool

KTI P.S.T.

- TPMS tool kit

Keep the tools at hand to test and service TPMS valves. Kit includes Tire Pressure Sensor Activation Tool, the Program Interface Module (PIM), Holster, Guide Book on CD, 4-Way Nut Wrench, Valve Core Torque Tool, 24-page laminated Quick Start Guide and 25 1/2" x 33" Procedures Poster. Components available separately.



Order No.	Description	Ship Wt.
27136M	Kit Complete Includes All The Items Listed Above	9 lbs. - 4 kg



SENS.IT Programmable TPMS Sensors

- 95% Of OE sensors replaced by 3 sensors with a snap-in or clamp-in valve option
- Cover 315MHz versions for Ford, GM, Chrysler, Toyota, Nissan & Honda
- Eliminates re-learning procedure by replacing sensor in the same position & programing with the same ID
- NO ANNUAL FEES for program updates, program use or support
- Compatible with all TPMS tools - Bartec, ATEQ, OTC & KTI



21183 Black Clamp-In Valve



21185 Snap-In Valve



21184 Chrome Clamp-In Valve



21192 Sensor with 21194 Metal Valve



21187 Sensor with 21194 Clamp-In Valve



21193 Sensor with 21195 Snap-In Valve



21502 Sensor with 21195 Snap-In Valve

Sens.it is an affordable, easy-to-use TPMS programmable sensor system designed for any size automotive service location. Sens.it reduces TPMS parts inventory, cuts tire and wheel service time, and increases profits.

The Sens.it (Sensor Intelligent Technology) TPMS specifications Programming System from Alligator is a web-based system that identifies individual vehicle TPMS specifications and programs the new Sens.it sensor in less than a minute. Simply enter the vehicle VIN (Vehicle Identification Number) and the faulty/broken sensor serial number into the online Sens.it programming screen on your PC and select "Program." The sensor data specific for that vehicle application is downloaded and embedded in the Sens.it sensor. It's now ready to install.

Direct download means current TPMS data from the Sens.it database is programmed to the sensor. There's no need to "look up" each sensor by application. Since the system is web based new specs are constantly updated. There is no need to refer to application charts.

Free optional reporting program allows the dealer or chain to track important service information, i. e.; types and number of vehicles serviced.

Online Access Required: Microsoft Windows XP, Vista and 7; install size 10MB of space; plug direct into USB port or powered hub.



21191 Programming Tool

Order No.	Mfr. No.	Description
21191	590922	Programming Tool
21192	590902	315MHz Ball Joint Sensor
21193	590912	315MHz Snap-In Sensor
21187	590914	433MHz Ball Joint Sensor
21205	590918	433MHz Snap-In Sensor
21194	590906	Metal Valve Replacement
21195	590916	Snap-In Valve Replacement
21183	590908	Black Clamp-In Valve
21184	590910	Chrome Clamp-In Valve
21197	590904	Grey Clamp-In Valve

See pg 22 for Valve Repair Kits



SENS.IT TPMS Tool Kit

The preset torque screwdriver ensures the components are tightened to the right torque and the sensors are correctly installed. The kit includes adapter, #15 Torx bit, #20 Torx bit, 11 and 12mm drive socket, clamp-in valve tool and calibrated torque screwdriver preset to 3.3 Nm

Order No.	Description
21188	TPMS Tool Kit



Test Before You Touch!



BARTEC Tech500 TPMS Tool

- Wireless & Bluetooth connectivity
- Program sens.it & EZ-sensor replacement sensors
- OBD Relearns on Asian & domestic vehicles including Ford & GM



Tech500 combines high powered diagnostics with wireless connectivity making it easier to retrieve TPMS repair data. "Test Before You Touch" data can be forwarded to the front counter to inform the customer before service begins. Complete relearns through the OBDII port for domestic and imports. Kit includes Tech500 tool, OBDII cable, USB cable, relearn magnet, power supply, quick start guide, tutorial CD and plastic storage case.

Order No.	Mfr. No.	Description	Ship Wt.
27022	WRT500	Tech500 TPMS Tool	10 lbs. - 5 kg

BARTEC TPMS Pad

- For businesses that don't have a Bartec & want to program the EZ Sensor or Bartec tool owners who need a second programming method
- Just two EZ Sensors (315 MHz & 433 MHz) cover 90% of the TPMS replacement market



Features make, model and year look up eliminating ID formatting errors and VIN entries. The pad does not require the internet so it can be operated anywhere when it's connected to a PC. Software for the pad can be downloaded from the internet. If the internet is not available a CD or memory stick will be provided. Includes TPMS pad, 1-year registration, USB cable, quick start guide and a CD containing a software user guide and EZ Sensor coverage chart. **Note:** Bartec tools must be updated.

Order No.	Mfr. No.	Description
27017	WRTPAD1	TPMS Pad for EZ Sensor
27018	WRTPADSUL1	TPMS Pad One Year Pad Registration for Bartec Customers
27019	WRTPADSUL2	TPMS Pad One Year Pad Registration for Non-Bartec Customers

TPMS Mechanical Tool Set



Digital Tire Pressure Gauge accurate to .5 psi; Toyota TPMS System Reset Tool to reset the looping condition found with Toyota and Lexus vehicles; Blue T-10 Torque Tool preset at 35 inch/lbs. for Beru valves; Red T-20 Torque Tool preset at 12 inch/lbs. for snap-in valves; Snap-In Sensor Torque tool preset to 12 inch/lbs. with 11 and 12mm sockets; Valve Core Torque Tool; Grommet Tool for removing 11 and 12mm nuts and seating sensor grommets; TPMS Valve Holding Tool with core depressor and valve core removal/replacement tool and storage case.

Order No.	Description
27020	TPMS Mechanical Tool Set

BARTEC Tech400SD TPMS Tool

- Replaces #27002 & 27002A
- Program sens.it & EZ-sensor replacement sensors
- OBD Relearns on Asian & domestic vehicles including Ford & GM



Re-Learn procedures are on the tool. Data includes sensor ID, psi, battery charge or no charge and temperature. Features raised buttons and SD card software option - no internet required. Includes Tech400SD tool, USB cable, quick start user guide, activation magnet, OBD cable, power supply, CD user guide, carrying case and 1-year of updates.

Order No.	Mfr. No.	Description	Ship Wt.
27012	WRT400SD	Tech400SD TPMS Tool	10 lbs. - 5 kg

BARTEC 400 Tool Update Certificates

- License must be paid & current to upgrade to Schrader EZ-sensor



License Kit includes instruction sheet, hard copy and CD of "What's New in TPMS" bulletin, and update certificate with authorization code. License must be used within 30 days of purchase.

Order No.	Mfr. No.	Description
27005	WRT400SUL1	Bartec 1-Year License
27006	WRT400SUL2	Bartec 2-Year License
27007	WRT400SUL3	Bartec 3-Year License

BARTEC Tech200 TPMS Activation Tool

- Entry level TPMS activation tool with Bluetooth
- Test before you touch
- Checks sensor status & tire pressure



Comprehensive coverage includes 2013 models. Features make, model and year menu, a rechargeable battery and USB port. The Tech200 activates and decodes over 98% of the TPMS sensors in the market. Operates with only 3 keys. The Bluetooth data connects to PC software or printer.

Order No.	Mfr. No.	Description
27168	WRT200BT	Tech200 Activation TPMS Tool

Myers Tire Supply is Your TPMS Headquarters!

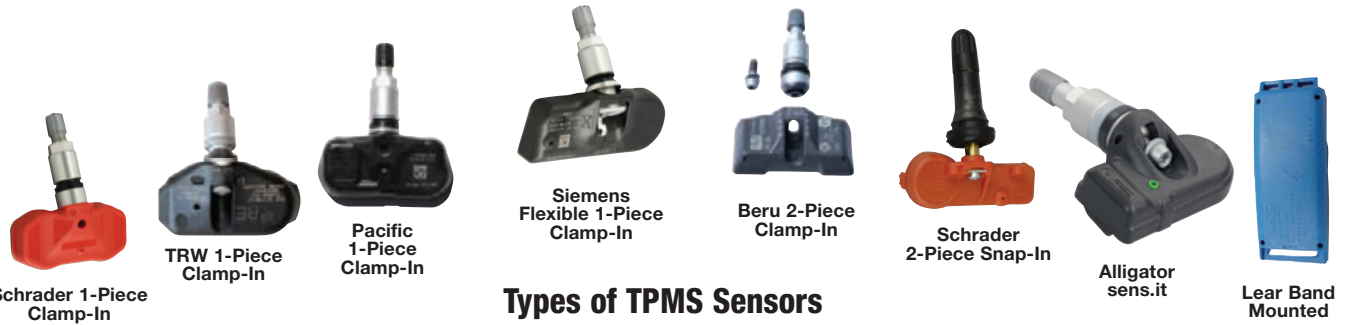

Types of TPMS Sensors

Online Application Database

New applications are constantly being updated at www.myerstiresupply.com

We Have What You Need

Our distribution points stock the most common replacement sensors in your area

Count On Our Experience

Our sales reps deal with TPMS problems & solutions everyday. Count on our expertise

BERU Valves & Sensors

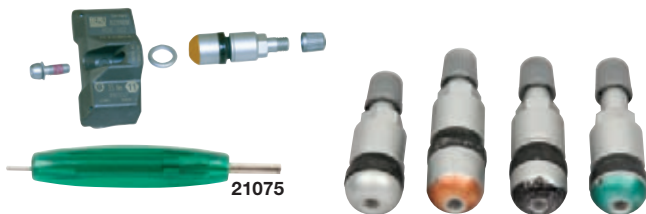

Valve and transmitter are separate. The two-piece design allows the valve to adapt to the rim configuration. Valves are make and model specific, refer to the color on the base of the valve for proper identification. Use the #21075 Mounting Tool to hold the valve while screwing it into the sensor.

Sensors		Sensors	
Order No.	Description	Order No.	Description
21022	Beru RDE 001 Sensor	21025	Beru RDE 005 Sensor
21023	Beru RDE 002 Sensor	21026	Beru RDE 007 Sensor
21024	Beru RDE 003 Sensor		

Replacement Valves (Includes mounting screw)			
Order No.	Mfr. No.	Length	Color
21079	59.0337	43mm	Aluminum
21078	59.0307	48mm	Green
21077	59.0387	49mm	Black
21076	59.0357	51mm	Orange
21075	Valve Mounting Tool		
21106	Beru Service Kit		

SENS.IT Programmable TPMS Sensors

- 95% Of OE sensors replaced by 3 sensors with a snap-in or clamp-in valve option
- Compatible with all TPMS tools - Bartec, ATEQ, OTC & KTI



Order No.	Mfr. No.	Description
21192	590902	315MHz Ball Joint Sensor
21193	590912	315MHz Snap-In Sensor
21187	590914	433MHz Ball Joint Sensor
21205	590918	433MHz Snap-In Sensor
21194	590906	Metal Valve Replacement
21195	590916	Snap-In Valve Replacement
21183	590908	Black Clamp-In Valve
21184	590910	Chrome Clamp-In Valve
21197	590904	Grey Clamp-In Valve

Universal Band Adapter for Clamp-In & Snap-In Sensors

- Convert a clamp-in sensor to a band mounted sensor



For use where OEM or replacement TPMS valves will not fit a custom rim. The sensor attaches to the Universal Cradle and Band and installed in the wheel well. Install new valve stem in rim hole and use a sensor tool to confirm TPMS valve is operational.

Order No.	Description
21572	Universal Sensor Cradle
21579	Universal TPMS Band

TPMS Band-Mounted Sensor Kit

- Fits 14" thru 26" wheels
- 21576 Kit includes sensor, universal band, cradle & clip



Complete kit (21576) contains sensor, universal band, cradle and clip. Components may be ordered separately.

Band Mounted Sensor (21575) includes (2) clips (1 required), mounting and installation instructions.

Universal Band (21579) fits 14" through 26" wheels. Install with screwdriver or thinwall socket to 27 to 31 in/lbs.

Metal cradle (21573) has double-sided adhesive for easy installation.

Order No.	Description
21576	Universal Mounting Band Kit Complete
Individual Components - Order as Required	
21575	Sensor Only
21579	Universal Band Only
21573	Metal Cradle Only
21574	Plastic Clip

Attaching New Valve to TPMS Snap-In Sensor

- Use Myers 27121 T-10 Torque Tool
- Valve & Screw included in Service Pack



IMPORTANT: Make sure the flat of the valve lines up with the flat of the snap-in enclosure as shown.



1. Grip the valve stem and body and start the screw for the first couple of turns. The self-tapping screw will create the threads as the screw is tightened into the valve.
2. Grip the valve stem and ensure the body and stem remain together. Tighten the screw.

3. DO NOT hold the snap-in enclosure while fixing the screw as this will lead to over-tightening
4. Tighten the screw to a torque value of 11.5 in./lbs. (1.3Nm) using the preset 27121 torque tool



5. Make sure the screw is installed correctly by looking at the head of the screw. The head of the screw MUST be in contact with the metal tag in the body.

GM Rubber Chrome Sleeve Snap-In Valve

Fits .453 rim hole. Ozone resistant with a decorative chrome finish. Includes valve, core, cap, and sensor mounting screw.

Order No.	Description
21058	Rubber GM Chrome Snap-In Valve



Clamp-In Chrome TPMS Valve

Replaces OEM snap-in TPMS valve for .453 rim hole. EPDM grommet. Ozone resistant with a decorative chrome finish. Includes valve, core, cap, grommet, hex nut with plastic washer, and sensor mounting screw.

Order No.	Mfr. No.	Description
21057	VS-925C	Chrome Finish Snap-In Valve



DILL VS-950 TPMS Snap-In Valve

- Maximum inflation 115 psi

Replaces OEM snap-in valves on Ford, GM, and Dodge applications

Order No.	Description
21060	VS-950 TPMS Replacement Snap-In Valve



DILL VS-1010 TPMS Rubber Snap-In Valve

- For 2010 & 2011 Sante Fe

Order No.	Description
21061	TPMS Rubber Snap in Valve



SCHRADER Stem Only Service Pack

- Eliminates the need to order a complete sensor when only the stem is needed

Kit contains (1) stem used for replacement on the following sensors: 21122 (20066), 21132 (28154), 28155 (28155), 21137 (28214), and 21062 (28291). Stem only, does not include cap, core, grommet or nut.

Order No.	Mfr. No.	Description
20020	20020	Replacement Stem Only



DILL VS-925A Anodized Aluminum Valve with Plastic Cap

- Metal clamp-in replacement valve for TPMS snap-in valve
- Better look on custom wheels

Looks more like a TPMS valve which may eliminate damaging the sensor by pulling it through the rim. Screw torque 12.5 in./lbs. Packed one valve and one T-10 screw per poly bag.

Order No.	Mfr. No.	Description
21051	VS-925A	Anodized Aluminum Valve with Plastic Cap



TPMS Snap-In Valve

- GM Snap-In Valve Assembly

Order No.	Economy	Description
21131	23131	TPMS Snap-In Valve



Snap-In TPMS Sensor & Valve Assembly



20018



21001

Self-tapping screw holds the valve onto the sensor and requires a #10 torx tool. Recommended torque on the screw is 12 inch pounds. Order replacement long black plastic caps for TPMS valves.

Order No.	Description
20018	Snap-In Valve Assembly with Cap & Screw
20995	Cap Only for 20018
21001	Green Cap for 21131

DILL Rubber Snap-In Valve

- For 2013 Dodge Dart & Cadillac ATS

Order No.	Mfr. No.	Description
21599	VS-90	TPMS Rubber Snap in Valve



DILL Redi-Sensor

- Multi-Application TPMS sensor
- 315 & 433 MHz Frequencies covers over 90% of GM, Ford & Chrysler
- 21632 Fits most, Toyota, Lexus, Scion, Honda, Kia & Hyundai



Works with all major TPMS scan tools. Ready to install, no programming required.

Order No.	Mfr. No.	Description
21630	7001	Redi-Sensor 315 MHz
21631	7004	Redi-Sensor 433 MHz
21632	7002	Redi-Sensor 315 MHz
21633	7001R	Redi-Sensor 315 MHz with Rubber Stem
21634	VS-80	Replacement Rubber Valve Stem for 7001R Redi-Sensor

DILL Redi-Sensor Service Kit

- Kit includes cap, core, grommet & nut
- All TPMS manufacturers recommend servicing the TPMS valve assembly anytime the tire is removed



Order No.	Mfr. No.	Description
21111	7020K	TPMS Service Kit

SCHRADER EZ-sensors

- Sensor is blank until programmed, then install as any other replacement
- Program the sensor & the car with the same tool



Order No.	Description
21620	Schrader EZ Sensor 315 MHz with Snap-In Rubber Valve
21621	Optional Schrader Aluminum Valve
21622	Schrader EZ Sensor 433 MHz with Snap-In Rubber Valve

DVT Sensors

- Six sensors & two valves for over 80% coverage
- Rubber Snap-In & Metal Clamp-In valves use the same sensor
- Install out of the box, complete the relearn & done
- Compatible with all TPMS activation/scan tools

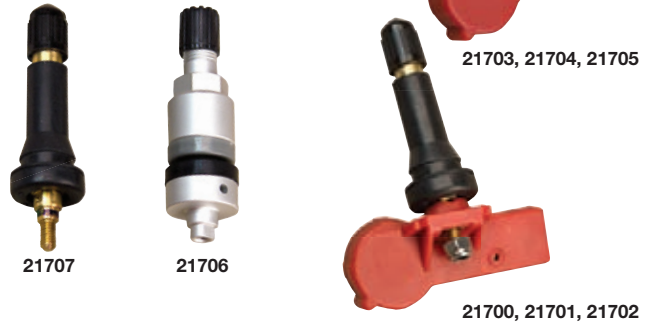

The DVT (Dual Valve Technology) sensor reduces inventory to six sensors and two valves. No sensor programming is required. One brand of sensor works with all models of that brand. Coverage includes GM 314.9/315 MHz, Ford/Chrysler 315 MHz, Ford/Chrysler 433 MHz, Toyota/Nissan, Honda and Hyundai/Kia. The DVT sensor constantly monitors pressure so the driver knows instantly if there's a pressure change. The integral valve stem antenna design transmits 30% farther. Test results show the battery life exceeds OEM requirements.

Order No.	Mfr. No.	Description
21700	DVT-1001	GM 314.9 & 315 MHz TPMS Sensor
21701	DVT-1002	Ford/Chrysler 315 MHz TPMS Sensor
21702	DVT-1003	Ford/Chrysler 433 MHz TPMS Sensor
21703	DVT-1004	Toyota/Nissan TPMS Sensor
21704	DVT-1005	Honda TPMS Sensor
21705	DVT-1006	Hyundai/Kia TPMS Sensor
21706	DVT-SV-1	Clamp-In Valve for DVT Sensor
21707	DVT-CV-1	Snap-In Valve for DVT Sensor

TPMS Countertop Display

- Hands-On marketing tool to explain TPMS service
- Allows the customer to see the components of the components being serviced



Kit includes Counter Display with removable sample sensor, corroded valve and snap-in valve, 100 TPMS educational brochures and a 22" x 28" wall poster.

Order No.	Description
21209	TPMS Consumer Education Kit
Individual Components - Order as Required	
21210	Counter Display Only with Valves
21211	100 TPMS Educational Brochures
21212	22" x 28" Educational TPMS Poster

TPMS Valve Repair Kits

- Tire dealers are charging \$6.00 to \$7.00 for servicing TPMS sensor valves
- All TPMS manufacturers recommend servicing the TPMS valve assembly anytime the tire is removed
- A TPMS Accessory kit costs less than \$3.00
- If you are not providing TPMS Accessory kits to customers you are losing money with each tire sale



It's not as simple as a rubber valve stem but for a minute of work the profit is worth it. Remove the old cap, core, grommet nut and grommet and replace with them with new components.



1 Remove & replace the cap & core using the 27144 Valve Core Torque Tool.



2 Remove & replace the grommet nut using the 27111 TPMS 4-Way Valve Tool.



3 Remove & replace the rubber grommet with the 27122 Grommet Installation & Removal Tool.



4 **Note:** Installed TPMS valves must be torqued to specifications. Use the 07126 TPMS Torque Wrench.

Premium TPMS Valve Repair Kits

- The most popular service kit



USA/Germany		China		
Order No.	Order No.	Dill Ref. No.	Alligator Ref. No.	Schrader Ref. No.
21027	21716	1030K	591300	20017
21208	21723	1031K		
21028	21726	1040K	591314	20016
21102	21711	1050K	591301	20030
20002	21710	1060K	591302	20002
20004	21708	1070K	591303	20004
20003	21709	1080K	591304	20003
21106	21713	1090K	591305	20023
21038	21729	1098K		
21029	21714	1100K	591306	20032

USA/Germany		China		
Order No.	Order No.	Dill Ref. No.	Alligator Ref. No.	Schrader Ref. No.
21030	21717	1110K	591307	20006
21231	21718	1120K		
20005	21715	1130K	591308	20005
21032	21712	2000K	591309	20021
20010	21720	2010K	591310	20010
21036	21721	2020K	591311	20015
21037	21719	2030K	591312	20014
21138	21722	2040K	591313	20019
21113	21725	7000K		
21111	21724	7020K		

TPMS Valve Repair Kit Assortment

- The most popular service kit & tools
- Includes a color-coded application chart



27159

Kit Includes

Order No.	Dill Ref. No.	Qty. In Kit
21102	1050K	12
21029	1100K	12
20003	1080K	12
21032	2000K	10
20004	1070K	6
21060	VS-950	8
20002	1060K	6
21106	1090K	6
21138	2040K	6
21030	1110K	6
21027	1030K	4
21037	2030K	4

Order No.	Dill Ref. No.	OE No.
21036	2020K	4
20005	1130K	4
20010	2010K	4
21028	1040K	4
27145	Core Tool	1
21097	Nickel Cores	100
21095	Plastic Caps	100
21096	Aluminum Caps	100
27192	Grommet Tool	1
27111	4-Way Tool	1
98620	Rack & Bins	1

Order No. Description

27159 TPMS Valve Repair Kit Assortment

DILL TPMS Valve Repair Kit Assortment

- Includes 82 kits & 4 chrome sleeves



Kit Includes

Order No.	Dill Kit No.	Qty. In Kit
21102	1050K	6
21029	1100K	6
20003	1080K	6
21032	2000K	6
20004	1070K	6
21060	VS-950	6
20002	1060K	6
21106	1090K	4
21138	2040K	4

Order No.	Dill Kit No.	OE No.
21030	1110K	6
21027	1030K	4
21037	2030K	4
21036	2020K	4
20005	1130K	6
20010	2010K	4
21113	7000K	4
21111	7020K	4
21002	950SC Chrome Sleeves	4

Order No.	Mfr. No.	Description
21000	7100	TPMS Accessory Kit Assortment

TPMS Valve Caps & Cores

- Nickel plated for TPMS with aluminum valve stems
- Plastic for use on aluminum or brass valves



Order No.	Mfr. No	Description
22504	VK-12	Dome Type
21531	V2	Metal Screwdriver Type
22503	VK-11	Dome Skirt Type
22501	VK2	Dome Type
22500	VK1	Dome Type
21095	20395	Plastic TPMS Valve Caps 100 Per Box
21096	20495	Aluminum TPMS Valve Caps 100 Per Bag
21097	20055	Electrolis TPMS Valve Cores 100 Per Box

TPMS Chrome Sleeves & Caps

- For snap-in TPMS valves
- Four sleeves & caps per pack



Order No.	Description
21002	TPMS Chrome Sleeves & Caps

ATEQ TPMS Check Box

- For use on all types of direct TPMS sensors
- Helps eliminate transmitter defects or failures before installation



Identifies if the pressure sensor chamber is leaking due to a manufacturing defect. Alerts the technician if the wrong pressure range is applied to the sensor providing a difference between the operator's gauge and TPMS reading.

Order No.	Description
27153	TPMS Check Box

Portable Organizers

- Combination small & large parts storage
- Configures 12 to 62 compartments

Unique design won't allow parts and equipment to gravitate to other compartments when lids are shut. Separate lid compartment holds small items. The main compartment holds larger items. Organizers are blue with clear lids and black latches.



Order No.	Description
06118	Large Lid Organizer

(Parts not included)

TPMS Relearn Chart

- Includes all domestic & import models
- Vehicles listed by make, model & year
- Indicates direct or indirect type TPMS & manufacturer
- Produced by the Tire Industry Association



Three columns of data indicate when a system relearn is necessary, such as after a change in air pressure, tire rotation, or tire/sensor replacement. Includes a reference number corresponding to the vehicle's procedure for initiating the sensor relearn mode. Vehicle relearns are located in the back of the corresponding domestic or import section. Torque specifications for the sensor nut, torx bolt, worm gear and lug nuts are also included. The spiral bound, laminated chart includes cross-references for OEM, Schrader, Dill, NAPA, Orange and Myers Tire Supply replacement sensors and kit numbers.

Order No.	Description
27165	TPMS Relearn Chart

SENS.IT TPMS Tool Kit



The preset torque screwdriver ensures the components are tightened to the right torque and the sensors are correctly installed. The kit includes adapter, #15 Torx bit, #20 Torx bit, 11 and 12mm drive socket, clamp-in valve tool and calibrated torque screwdriver preset to 3.3 Nm

Order No.	Description
21188	TPMS Tool Kit

15 Drawer Metal Cabinet

- Ideal cabinet for storing TPMS sensors & service kits



Cabinet dimensions: 11" high x 11" deep x 17" wide. Drawer size: 3.125" tall x 11" deep x 3.25" wide. Includes drawer dividers.

Order No.	Description
30007	15 Drawer Metal Cabinet

Valve Core Deflator

Deflate tire without removing the core.



Order No.	Description
27117	Valve Core Deflator

Grommet Removal Tool

Aluminum tool removes TPMS grommet and provides a hole to help install a new grommet



Order No.	Description
27192	4700 Grommet Removal Tool

MYERS TPMS Torque Wrench



05847 & 05840
Optional Sockets

According to manufacturers specs: Tire Pressure Monitoring System replacement transmitters, and reinstalled valves, must be torqued with an inch/lb. torque wrench to the vehicle manufacturers specifications. To change from right to left operation, push the square end drive through and turn the wrench. *Click-type torque wrench, 5 to 25 inch/lbs, +/- 3% accuracy. 1/4" drive with plastic storage case. Calibration compliance certification and 1-year warranty.*

Order No.	Description
07112	Myers TPMS Torque Wrench
05847	Optional 1/4" Dr. 11mm Deep Socket
05848	Optional 1/4" Dr. 12mm Deep Socket

MYERS Valve Core Torque Tool



"Slip-Clutch" mechanism in tool slips when proper torque is reached. 2 to 5 inch lbs. Also use for core removal.

Order No.	Description
27144	Valve Core Torque Tool

Valve Core Torque Tool



Tire & Rim Association has raised the recommended torque specification from 1.5 - 4 inch/lbs to 2 - 5 inch/lbs. "Slip-Clutch" mechanism in tool slips when proper torque is reached. Also use for core removal.

Order No.	Description
27145	Valve Core Torque Tool

Deflate TPMS Valves Without Removing the Core

- Eliminate broken cores by not having to remove them to deflate the tire

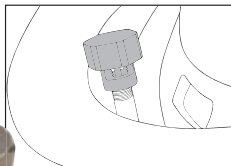

Remove the cap and screw on the deflator cap that depresses the core. The large opening on the sides of the cap allows the air to quickly escape. The tools are marked so the tires can be returned to their original position on the vehicle so the TPMS will not need to be re-set.

Order No.	Mfr. No.	Description
27156	19680	Tire Deflator Caps Set of 4

TPMS 4-Way Valve Tool



For removing the sensor nuts and seating the sensor grommets. Removes both 11mm and 12mm nuts and seat both beveled and non-beveled grommets.

Order No.	Description
27111	TPMS 4-Way Valve Tool

T-10 Torque Tool



Pre-set torque tool designed for use with the TPMS snap-in sensor. It properly installs the T-10 screw to the specified torque of 12 inch lbs. +/- 10% and removes the T-10 screw.

Order No.	Description
27121	T-10 Torque Tool

T-20 Torque Tool

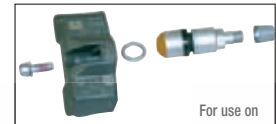

Pre-set torque tool designed for use with the TPMS snap-in sensor. It properly installs the T-20 screw to the specified torque and removes the T-20 screw.

Order No.	Description
20145	T-20 Torque Tool

TPMS Valve Holding Tool



Keeps the sensor in position when changing tires. T-shaped end includes valve core depressor and valve core removal/replacement tool.

Order No.	Description
27147	TPMS Valve Holding Tool

Grommet Installation & Removal Tool



For removing the rubber grommet from one-piece aluminum stem TPMS sensors. Small lip slides under grommet for removal, slides over the threads for installation.

Order No.	Description
27122	Grommet Installation & Removal Tool

Core Removal Tool

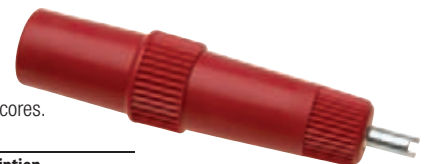

Installs and removes caps and cores. No torque feature.

Order No.	Mfr. No.	Description
21092	20250	Core Removal Tool

Tire Valve Characteristics, Specifications & Testing

Characteristics

Look for the manufacturer's name or trademark, part number and country of origin. Many manufacturers of snap-in valves have mold cavity numbers on their valves for better traceability. Not all manufacturers supply the proper information on their valves, but the more information you see, the more likely the manufacturer is reputable, produces a quality product and stands behind it.

Testing

All snap-in valve stems must be made with EPDM synthetic rubber rather than natural rubber to meet SAE ozone requirements. EPDM rubber also has a broader temperature range than natural rubber and will remain flexible in extremely cold weather.

What to look for

No brand name or country of origin. Who is the manufacturer? Can consistent product quality be verified? Who is responsible in case of a valve failure?

Specifications

Good quality valve stems conform to SAE J1205 – J1206 Standards setting the performance criteria for heat resistance, aging and ozone resistance. Most valves have a Tire & Rim Association TR number, for example TR413, TR 418 etc. This number does not guarantee a specific level of quality; however it does indicate that the manufacturer should have produced the product to conform to published dimensional standards. The Tire & Rim Association publishes a yearbook listing standards for valve stem dimensional tolerances, but the group does not get involved with performance standards.

Rubber Snap-In Valve Markings

The TR 413 valves are marked as follows:

Order No.	Bottom of Valve
21173	03 TR-413 036 EHA Germany
25401	H.M.T. 242B TR413
22182	TR413 Schrader China
25301	07 TR413 104 DILL-ACP TR 413 XXX
22201	TR 413 PREMIER B019



Cracks or cross threads



Inspect brass for cracks

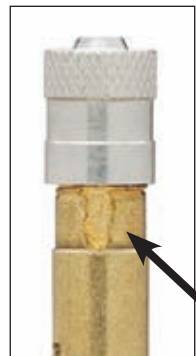

Improper welds



Typically, ozone damage or cracks are seen in low cost valves

Tubeless Tire Snap-In Valves

- Maximum air pressure 65 psi



Myers EHA/Germany	Value China	Schrader China	Dill China	TR No.	Effective Length	Case Qty
Fits rim hole .453"						
26118	22200			412	¾"	500
21173	22201	22182	25301	413	1¼"	500
21174	22202	22183	25302	414	1½"	500
21175	22203	22184	25304	418	2"	500
		22186	25305	423	2½"	500
Fits rim hole .625"						
21170		22187	25303	415	1¼"	500
			25306	425	2"	500

Chrome-Sleeve Snap-In Valves

- Maximum air pressure 65 psi.
- Fits rim hole .453".



Premium Extended Chrome covers 22% more of the rubber valve for a cleaner appearance. Premium Extended Chrome Sleeve is now sold with premium EHA rubber snap-in valve. Sleeves are sold & priced per bag of 100. Caps are packaged 100 per bag and priced each.

Myers No.	Value Line	Value Line II	TR No.	Effective Length	Case Qty
21119			412CS	7/8"	500
22130	25407	22207	413CS	1 1/4"	500
	25408		414CS	1 1/2"	500
	25409		418CS	2"	500
27021					
22130					

Order No.	Description	Quantity
27021	Full Length Chrome Valve Sleeve Only	100 Per Bag
22529	Chrome Valve Cap Only	100 Per Bag

TR416 Clamp-In Tubeless Metal Valves

- For small or large passenger rim holes



Maximum air pressure 200 psi. Includes grommets for .453" and .625" rim holes.

Order No.	Value No.	TR No.	Schrader Equiv.	Dill Equiv.	Effective Length
21583	25437	TR416	3640K2-5	VS-902CR	1 1/4"
22176		TR416L	3641D		2"
21584		RG54	.453 Rim Hole Grommet		
21582		RG39	.625 Rim Hole Grommet		
21581		RW13	.625 Rim Hole Washer		
21580		HN4	Hex Nut		

High Pressure Snap-In Valves



Differences are not always easy to see. Note the extended brass insert that adds structural strength on the Myers 24120 versus others

Caution: For maximum rim thickness of .205 (13/64"). Not to be used with metal valve extensions.

Maximum air pressure 80 psi. Light truck replacement valve.



Myers EHA/Germany	Value Line	TR No.	Fits Rim Hole	Effective Length
24120*	21597	TR600HP	.453"	1 1/4"
24121		TR602HP	.453"	2"
21120		TR600HP	Chrome Sleeve	1 1/4"
23190	22190	TR801HP	.625"	1 1/4"
23191		TR802HP	.625"	2"

* Maximum air pressure 100 psi.

Chrome Performance Valve

- With long nut for recessed valve hole

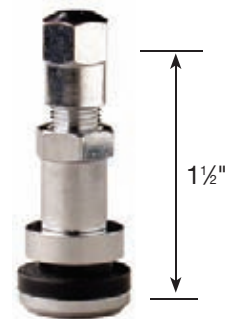

Corvette and other chrome performance wheels. Fits rim hole .453". Maximum air pressure 200 psi.

Order No.	Value Line	Description	Height
24194	25194	Chrome Performance Valve	1.50"

Chrome Low Profile Valve

- Includes grommets for .453" & .625" rim holes

Chrome plated valve and sealing cap. Especially suited to custom wheels. Maximum air pressure 200 psi.

Order No.	Value Line	TR No.	Effective Length
22000	25436	5591B	3/4"
21580		Hex Nut	



Light Weight Alloy Racing Valve



A light alloy valve used on racing and light alloy wheels. With O-Ring seal. Maximum air pressure 200 psi. Fits rim hole .453".

Order No.	Mfg. No.	Effective Length
22001	H-523MS	1 1/2"

Flush Mount Valve



Eliminates the valve stem for custom applications. The adapter is used for pressure checks and inflation. 200 PSI maximum air pressure. Includes inflation adapter and grommet for .453" and .625" rim holes.

Order No.	Mfg. No.
24132	VS-SP

Special Clamp-In Valve

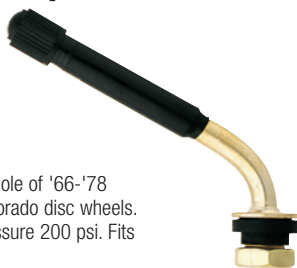

Fits unusual rim hole of '66-'78 Toronado and Eldorado disc wheels. Maximum air pressure 200 psi. Fits rim hole .453".

Order No.	Equiv. or TR No.	Schrader Equiv.	Dill Equiv.
22417	417	5976A	VS-911-R

Racing Tire Valve

- Maximum air pressure 200 psi
- Includes grommets for .453" & .625 rim holes



Maximum air pressure 200 psi. Includes grommets for .453" or .625" rim holes.

Order No.	Mfg. No.	Effective Length
22133	TV6008C	9/16"

Motorcycle Tire Valve

- 90° Bend

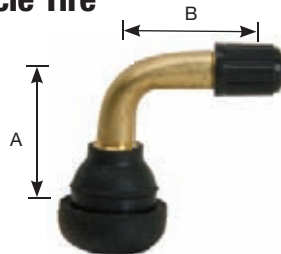

Order No.	Mfr. No.	Rim Hole	Height A	Length B
22418	PVR70	.453	1.28	1.18

TR430 Tubeless Motorcycle Valve



O-Ring seal. Maximum air pressure 200 psi. Fits rim hole .327".

Order No.	TR No.	Mfg. No.	Effective Length
21178	TR430	T-430	1 3/16"

Oval Rim Hole Valve

- Converts 16 x 6KS 750-16 GM rims to tubeless

CAUTION: This valve can be used only with a 16" tubeless tire.



All brass construction valve. Includes 2 oval washers for uniform pressure. Longer threads for improved rim clamping pressure. Maximum air pressure 200 psi. Fits rim hole 3/8" x 7/8" oval.

Order No.	Mfr. No.	Effective Length
22050	H501-OV	1 1/4"

General Valve Installation Specifications

- Maximum operating pressures:
Rubber snap-in valves 65 PSI
High pressure snap-in valves 100 PSI
Metal Clamp-in valves 200 PSI

Metal Clamp-In Valve Installation Torque:

Style	Torque (Inch/Pounds)
TR 416, TR 430, TR435	25 - 45
TR 500, TR 501, TR 570 Series	35 - 55
TR 509 Series	100 - 125
TR 540 Series	80 - 125
TR 550 Series	80 - 125
TR 618 Air/Water Series	45 - 75
All Large Bore & Super Large Bore Spuds	175 - 200
Large Bore Swivel Stems	70 - 80
Super Large Bore Flexible Adapters	25 - 40

Valve Core Torque:

Standard Bore	2 - 5
Large Bore	2 - 5
Super Large Bore CH8	10 Max.

Valve Cap Torque:

Standard Bore	1.5 - 30
Large Bore	5 - 15

Clamp-In Enkei Valves

Special valves that fit Enkei OE and aftermarket custom wheels. Maximum air pressure 200 psi. Fits rim hole .453".

Order No.	Description	Height A	Length B	B Angle
24117	3/4" Straight	3/4"	Straight	Straight
24123	1 1/8" Straight	1 1/8"	Straight	Straight
24124	1 3/8" Straight	1 3/8"	Straight	Straight
24118	45° Enkei	1/2"	1"	45°
24131	85° Enkei	1/2"	1"	85°

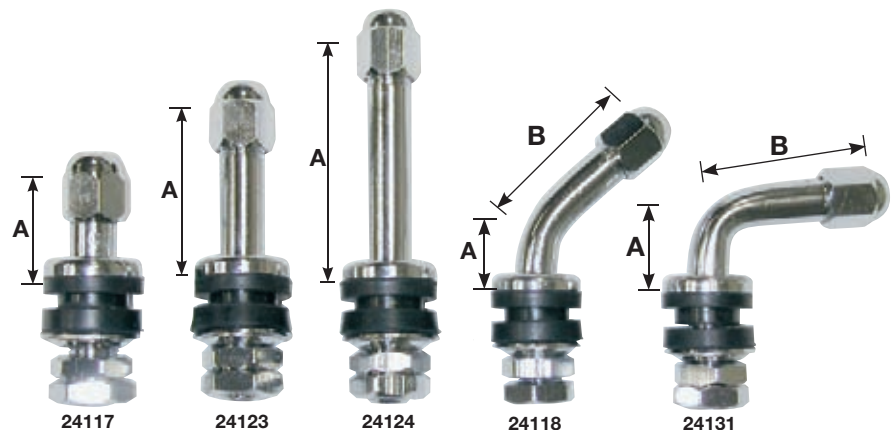

Tubeless Truck Clamp-In Valves

- For drop center rims with 5/8" holes

What to look for

No brand name or country of origin. Who is the manufacturer? Can consistent product quality be verified? Who is responsible in case of a valve failure?



Inspect brass for cracks



Improper welds

Metal clamp-in type valves for use on rims where the rim hole is located on the side of the rim. Complete with all fittings, valve cap and valve core.



Myers EHA/Germany	Haltec China	Value China	Schrader China	Dill China	TR No.	Effective Length	Case Qty
24109	25410	22210			575	1 1/8"	300
23149	25411	22211	24159	24021	501	1 1/2"	300
23150	25412		24160	24020	500	2"	
23151	25413		24161	24022	570	3 1/8"	
23152	25414		24162	24023	571	3 3/8"	
23153	25415	22215	24163	24024	572	3 3/4"	300
23154	25416	22216	24164	24025	573	4 3/8"	300
23155	25417		24165	24026	574	5"	

Replacement parts for above valves.

Order No.	TR No.	Schrader Equiv.	Dill Equiv.	Description
24166	RG15	595-3	462	Heat Resistant Grommet
24167	RG15			High Temp. Grommet
24168	HN13			Replacement Nut
24170	RW8			Replacement Washer

Replacement parts for above valves.

Order No.	TR No.	Schrader Equiv.	Dill Equiv.	Description
24166	RG15	595-3	462	Heat Resistant Grommet
24148	RG15		462-F	High Temp. Grommet
24168	HN13			Replacement Nut
24170	RW8			Replacement Washer

Bent Equal Valve

- Without a cap & core

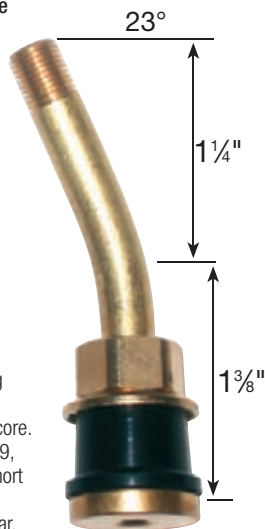

UPS package vans using Equal to balance tires - long enough for a filter core. Used in place of a 24169, when a V2B is used - short enough to accept a V2B and not extend out too far.

Order No.	Mfr. No.
23160	Bent Equal Valve

Radial Commander Valve

- For 15° disc wheels



Clamp-in type valve for 5/8" rim hole. The 23° angle bend provides adequate clearance for brake drum.

Order No.	Mfr. No.	Effective Length
24169	VS-1223R	1 1/4"

Bottom Mount Valve

- 21° Bent valve



For 19.5 x 6.75 rims. 21° Bent valve. Fits standard 5/8" diameter hole. Bolts in from bottom.

Order No.	Mfr. No.	Effective Length
24265	VS943	1"

Pre-Bent Tubeless Truck Clamp-In Valves



- For drop center rims with 5/8" hole
- High temperature ozone resistant grommet
- Heat resistant cap & core (red collar)
- 13° Bend

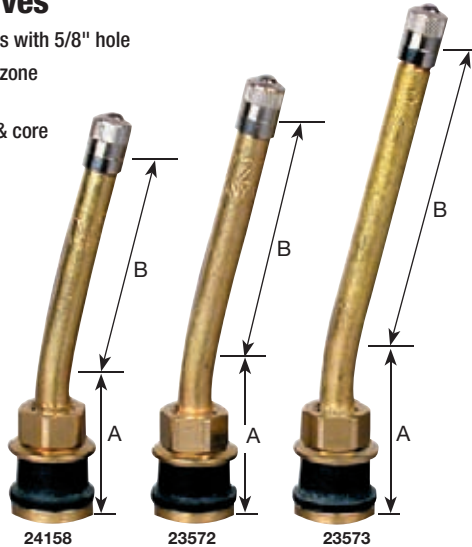

Many valves used in truck service must be bent to allow access of gauges and chucks. Installing straight valves and bending them often causes leakage at the grommet. A slight cut in the surface of the grommet where it contacts the inside of the rim hole grows and will eventually work through the grommet providing a leak path. The slow leak may be stopped by tightening the valve nut, but it usually results in over torquing the valve and eventual failure of the grommet. To provide for the longest service life and prevent grommet damage installing a pre-bent valve is recommended in applications where required.

Order No.	Mfr. No.	Height A	Height B
24158	571 with 13° bend	.98"	2.375"
23572	572 with 13° bend	.98"	2.75"
23573	573 with 13° bend	.98"	3.38"

Additional bend angles available upon request.

Preset Truck Valve Torque Wrenches



Use for fast, accurate torquing of truck valve nuts. Over-torquing or under-torquing may cause valve leaks. Red indicator "pops out" when torque is reached and retracts when removed from the nut. 1-Year warranty.

Order No.	Use On	For Nut Size	Pre-Set Torque
07198	570 Series Valves	3/16" Hex	42 Inch Pounds
07200	540 & 550 Series Valves	3/8" Hex	100 Inch Pounds

Valve Hole Cleaning Brushes



42058 For .453" Valve Hole

42059 For 5/8" Valve Hole

Order No.	Description
42058	Valve Hole Cleaning Brush for .453 Valve Hole
42059	Valve Hole Cleaning Brush for 5/8" Valve Hole

Truck Tire Valve Nut Splitter



Splits the brass nuts on 570 series valves. A strike with a hammer neatly splits the nut freeing the valve stem. The slot side of the tool allows it to be used with bent valves.

Order No.	Mfr. No	Description
27150	X10-NS58B	Valve Nut Splitter for Truck Valves

Important - Bending a valve after it is in the wheel will often ruin the grommet and will cause a valve leak.

Ultra-High Temperature Truck Valves



- Ultra high temperature green grommet
- Designed to operate at temperatures over 400° F
- Heat resistant cap & core (red collar)

For Drop Center Rims With 5/8" Hole



Valve stems used on waste haulers, cement trucks, buses, and other vehicles generating high heat due to operating conditions are vulnerable to leakage at the grommet. The standard Myers valve stem has out-performed most other valves on the market in these applications, but some conditions are even beyond this range. Ultra-high temperature valves designed to operate at temperatures over 400° F. The valve is identified with a green grommet to distinguish it from the imitations on the market. Look for EHA on the valve stem and the green grommet to be sure.

Order No.	TR. No.	Mfr. No.	Effective Length	Height A	Height B
24191	572	V-572	3 3/4"		
24192	573	V-573	4 3/8"		
24215	572 with 13° bend			.98"	2.75"
24216	573 with 13° bend			.98"	3.38"
24172	Ultra High Temperature Grommet - Green				

Advance Sealing Truck Tire Valve

- Combines benefits of an O-Ring & grommet seal
- Ideal for bus fleets, trash haulers & cement trucks



Provides the benefit of an O-Ring and a grommet seal with the grommet recessed in the valve base

High heat conditions damage standard tire valve O-Rings and grommets. This valve features a high temperature sealing cap, short heat resistant core, brass nut, brass ring washer and an ultra-high temperature green ASC grommet recessed inside the base providing a superior seal. For drop center rims with 5/8" valve hole and designed to operate in over 400°.

Order No.	Torque	Bend	Effective Length
24202	80-125 Inch Pounds	13°	3 3/4"



TR572-F19 31° Bend Truck Valve



Newer trucks with air disc brakes have a 31° bend to prevent interference with the brake caliper. Recommend using the 07198 valve nut torque wrench.

Order No.	Mfr. No.
89002	TR572 with 31° bend

DILL Replacement TPMS Sensor & Valve Stems for Prevost Buses

- Improves safety by preventing heat build-up caused by under inflation
- Increases vehicle uptime & eliminates manual pressure checks
- Recommended torque is 35 inch/lbs
- Self-Contained system requires no programming or activation tools



Order No.	Mfr. No.	Description	Qty. Per Box
21569	VS-9013	High Heat Stem for Bus OEM Sensor	10
21568	VS-9980	Stem for Bus OEM Sensor	10
21567	9010	Prevost Bus Sensor	Each

Grommet Seal Valve

- For aluminum Alcoa wheels with 9.7mm rim hole
- Grommet seal is more forgiving of rough or scratched surfaces than standard O-Ring seals
- Maximum air pressure 200 psi.

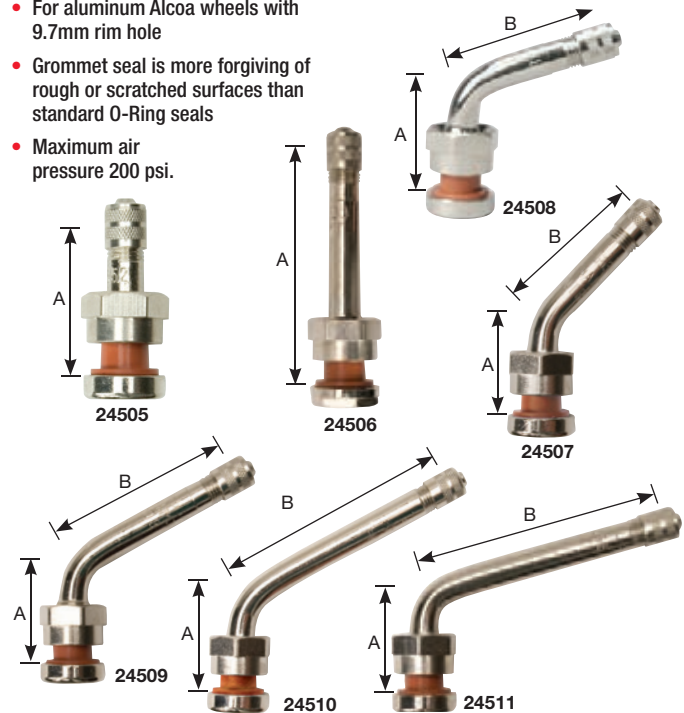

Myers EHA/Germany	Value Line	Mfr. No.	A Height	Bend Angle	B Length
24505	25505	TR552	1.26	-	-
24506	25506	TR553	2.4	-	-
24507	25507	TR553C	.93	45°	1.43
24508	25508	TR553E	.98	75°	1.38
24509	25509	TR554D	.98	60°	1.94
24510	25510	TR555D	.98	60°	2.6
24511	25511	TR555E	.98	75°	2.6
21578		G550 Replacement Grommet			
24256		HN-22 Replacement Nut			

Valves for Ford Trucks

- Also used on trucks in place of TR600
- Maximum air pressure 200 psi



Application: Ford "cut-away" series with dual wheels, Accuride steel 16" x 6", front and rear wheels. Nickel finish, fits rim hole .453".

Order No.	Mfr. No.	Haltec No.	Description
24190	VS-938-F	TV-416LF	16" x 6" Accuride Steel

Application: Ford "F" series trucks with dual wheels, Accuride steel 16" x 6", front and rear wheels. Nickel finish, 23° bend, fits rim hole .453".



Order No.	Mfr. No.	Haltec No.	Description
24186	VS-962C	TV-416MC	16" Accuride Steel

Application: Ford "Cut-Away" and Cargo Van series with single rear wheels, Accuride Steel 16" x 7" wheels, front and rear wheels. Chrome finish. Fits rim hole .453".

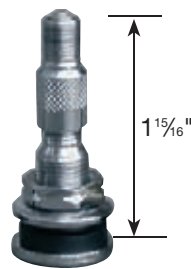

Order No.	Mfr. No.	Haltec No.	Description
24189	VS-944-F	TV-575HP/DS-1	1"

Application: Ford "F" series trucks with dual wheels, Alcoa Aluminum 16", front and rear wheels. Chrome finish. Fits rim hole .453".



Order No.	Mfr. No.	Haltec No.	Description
24188	VS-902WP	N-1600	16" Alcoa Aluminum

Application: Ford "F" series trucks with dual wheels, Accuride steel 19.5", front and rear wheels. Brass finish, fits rim hole .453".

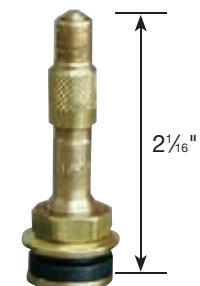

Order No.	Mfr. No.	Haltec No.	Description
24187	VS-902K	TV-416/DS-1	19.5" Accuride Steel

70MS-7 Grommet Seal Valve

- Nickel plated
- Maximum air pressure 200 psi.

Application: 335mm bolt circle wheels with a drilled 9.7mm valve hole. Fits rim hole 9.7mm, 7° valve bend.

Order No.	Description	Height
24101	Grommet Seal Valve	2 1/2"



O-Ring Seal Valves for Steel Wheels

- For Isuzu, Iveco, Mack, Volvo, White & Chevy, GMC imported trucks

For steel truck wheels with 9.7 mm (.390") rim holes. Complete with cap, core and built-in O-Ring. 24105 For use on the "new" style 16" wheels on Isuzu trucks, 24116 For use on "old" style 16" wheels on Isuzu trucks, 24107 For use on new style "Budd" wheels on imported 2-ton trucks including imports under the Chevy and GMC names. The wheels are 17.5 and 19.5 tubeless with dish on the "short side" of the rim. On some vehicles the number PV119 is stamped on the side of the valve.

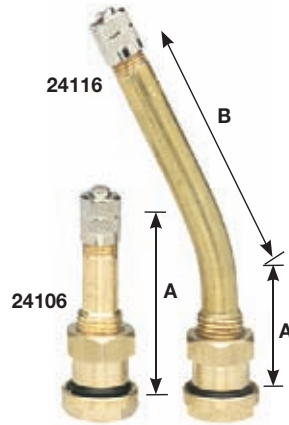

Order No.	ERTRO No.	Mfr. No.	Height A	Height B	Angle
24106	V3-20-1	41MS-00	1.42"	Straight	Straight
24104		60MS-27N	1.17"	1.18"	27°
24105	V3-20-5	70MS-27	.98"	1.57"	27°
24107	V3-20-7	80MS-27 (PV119A)	.98"	1.97"	27°
24116	V3-20-4	90MS-27	.98"	2.36"	27°
24108	V3-20-6	115MS-27	.98"	3.35"	27°

Screw-On Valves

Replace broken truck stems. Saw off old valve at threads and screw repair valve into place. With bridge washer, cap and core. 24503 converts Michelin valve base with 3/16"-32" thread to accept standard screw-on valves.



Order No.	TR. No.	Mfr. No.	Fits Tube Size	Horizontal Length
23114	1177A	V-1177A	7" To 8.00"	3 3/4"
23115	1175A	V-1175A	8" To 9.00"	4 1/2"
23116	1078A	V-1078A	9.75 To 11"	5"
23117	1179A	V-1179A	12.00" & Over	5 9/16"
24503	Reducer Bushing			

Double Bend Tubeless Truck Valves

- Extra low vertical for 5/8" diameter bottom hole demountable rims

Attached by tightening steel lock nut against inside of rim.



Order No.	TR. No.	Dill No.	Horizontal
24136	513	7004A	2 5/8"
24135	515	7005A	3 1/4"

Walton Cast Wheel Screw-In Valve

Replacement screw-in valve for Dayton Walton cast wheels. Complete with cap and core. 1/8" M.P.T.

Order No.	TR. No.	Effective Length
26550	SK2924	1 3/4"



O-Ring Seal Valves for Aluminum Wheels

- For Alcoa wheels with 9.7mm rim holes

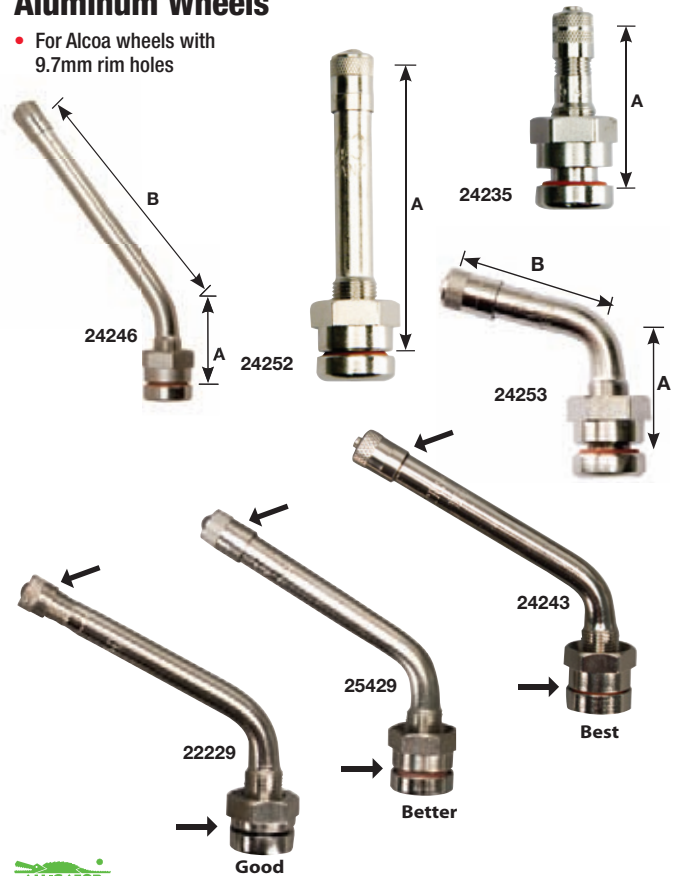

Myers EHA Germany	Value Line	TR No.	A Height	Bend Angle	B Length
24235	25421	542	1.26"	Straight	
24252	25422	543	2.31"	Straight	
24236	25423	543C	.93"	45°	1.38"
24251	25424	543D	.98"	60°	1.38"
24253	25425	543E	.98"	75°	1.38"
24240	25426	544	2.86"	Straight	
24250	25427	544D	.98"	60°	1.94"
24242	25428	545	3.50"	Straight	
24243	25429*/22229	545D	.98"	60°	2.60"
24237	25430	545E	.98"	75°	2.60"
24238	25431	546	4.27"	Straight	
24244	25432	546D	.98"	60°	3.35"
24239	25433	546E	.98"	75°	3.35"
24246	25434	546G	.98"	36°	3.35"
24247	25435	547D	.98"	60°	3.78"

* 25429 Heavy Duty Value

24256	HN22 Replacement Nut
24255	RG60 Replacement O-Ring

Tubeless Valves for Aluminum Disc Wheels

Used in drop-center aluminum disc wheels with 5/8" bottom hole. Rubber grommet and hex nut tighten to assure positive seal in rim hole.

Myers No.	Value Line	TR No.	Effective Length	Case Qty
24112	25420	511	4 1/4"	250
24111	25418	509	4 3/4"	250
24110	25419	510	5 1/2"	250
24113	RG46 Replacement Rubber Grommet	523		
24114	RG46 Rubber Grommet High Temp.	523-A		

V2B Valve Cap

Tank Valves

For tanks, steel barrels, compressors and other pneumatic devices. Standard type tire valve core and sealing cap.



Order No.	Haltec No.	Schrader No.	Dill No.	Thread Size	Overall Length
23123	TV-399	645L-6	02500	1/8" NPT	1 5/16"
23124	TV-400	1498A-6	02529	1/4" NPT	1 5/16"
23125	TV-401	9166L-8	SK-20420	1/8" NPT	7/8"

Valve Nut Ratchet Wrenches

For fast installation of clamp-in valve stems. Fits easily over straight or bent valves.



Order No.	Description
27115	Valve Nut Ratchet for 570 Series Valves with 3/8" Hex Nut
27116	Valve Nut Ratchet for 540 Series Valves with 3/8" Hex Nut

Truck Valve Protector Shim

Use over valve stem between flap and rim. Eliminates damage to tube or flap caused by valve stem slot in rim. For all size truck tubes, a must for 12.00 and larger.



Order No.	Mfr. No.	Description
23515	V2-88	Valve Shim

Truck Valve Lock

Simple to install. Holds tube in place when tire is flat. Prevents valve from being pulled into tire, ruining tire or tube.

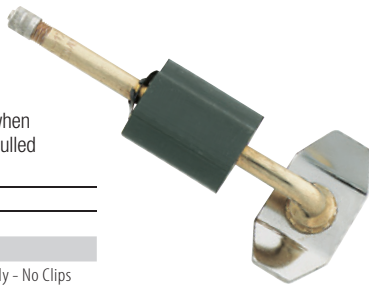

Order No.	Mfr. No.	Description
23500	V2-51	Lock and Clip
23501	V2-51C	Extra Clips
23498		Valve Lock Only - No Clips

Vulcanize-On Tube Type Valves

- For passenger & light trucks

Standard valves with base prepared for "HOT" or "COLD" application. Complete with valve cap, core and all necessary fittings. **Apply Cold:** Use Patch Self-Vulcanizing Cement and stitch down. Ready for immediate use.

Apply Hot: Apply same as any vulcanize-on type rubber valve stem.



Order No.	TR. No.	Mfr. No.	Type	Length
21100	13	V-13	Industrial	1 1/2"
21101	15	V-15	Passenger	1 1/2"

B-6 Plastic Rim Hole Bushing for Tube Type Valves

- For reducing rim holes from .625" to .453".



Order No.	Haltec No.	Dill No.	Description
22160	B-6	588	996 Rim Hole Bushing

MYERS V2B Double Seal Inflate Thru Valve Cap



The Original "ALLIGATOR"

A Time, Money and Labor Saving Alternative to Common Valve Caps

Reduce Pressure Check Time By 65%



Designed for high pressure truck tire service. Inflate, deflate or gauge directly thru the V2B saving time during inflation and pressure checks. Automatic inflation systems lock right onto the V2B. Seals like a high pressure cap, yet offers the convenience of an inflate thru extension. The V2B performs like a check valve – the seal becomes tighter in the event of a core failure. Heat resistant grommets provide additional protection for extended high temperature running. Features tough all metal housing, precision fit brass components and durable self sealing O-Ring. This is the original inflate thru valve cap proven in millions of miles of service by the nation's largest trucking companies.

Installation and Usage

Purpose –

- The V2B is an inflate thru sealing valve cap.
- The V2B is used in place of a standard valve cap.
- The V2B Saves Time – It does not have to be removed and replaced to check air pressure or to add air.
- The V2B is more "permanent" than a cap. Caps are often left off after checking pressure; the V2B doesn't have to come off, so it won't be lost.

Installation –

- Inspect the valve stem to make sure it is not damaged and does not have a protruding valve core. Core pin must not be above top of valve mouth.
- Install the V2B onto the valve, finger tight. Do not use pliers.
- The V2B is a cap. It does not require an additional cap.
- Installation torque 1 1/2 - 3 inch pounds

Usage –

- Gauge and inflate directly through the V2B. Do not remove it.
- The V2B is grooved at the top to accommodate various lock on chucks and automatic inflation devices.
- Effective length 3/4".

Order No.	Description	Per Box
21534	V2B Valve Cap	50

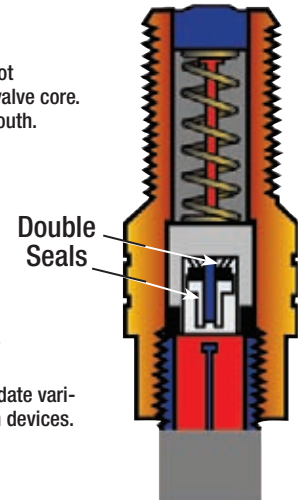

MYERS V2BG Double Seal Cap with Nitrogen Inflation Ring

- Green ring indicates tires are nitrogen filled



Order No.	Description	Per Box
21535	V2BG Green Ring Valve Cap	50

TPMS Valve Caps

Heat Resisting Valve Cap

- Nickel plated aluminum valves for TPMS



Dome type, Schrader 440V, or Dill 632.

Order No.	Mfr. No.	Per Box
22504	VK-12	100

Metal Screwdriver Type Valve Cap

- Nickel plated, for TPMS valves



Highest quality nickel-plated brass. Has screwdriver top for removing valve cores. Positive seal washer.

Order No.	TR No.	Mfr. No.	Per Box
21531	VC2	V-2	100

Dome Skirt Type Valve Cap

- Nickel plated, for TPMS valves



Dill 658.

Order No.	Mfr. No.	Per Box
22503	VK-11	100

Dome Type Valve Cap

- Nickel plated, for TPMS valves



Schrader 7572V, Dill 655.

Order No.	TR No.	Mfr. No.	Per Box
22501	VC3	VK-2	100

Standard Valve Cap

- Nickel plated, for TPMS valves



Screwdriver type, Dill 643.

Order No.	TR No.	Mfr. No.	Per Box
22500	VC2	VK-1	100

Aluminum TPMS Valve Cap

- For use with TPMS valves



Order No.	Mfr. No.	Description
21096	20495	Aluminum TPMS Valve Caps 100 Per Bag

Plastic Valve Cap

- For all TPMS valves



Order No.	Mfr. No.	Description
21095	20395	Plastic TPMS Valve Caps 100 Per Box

Plastic Valve Cap

Resistant to weather, heat, oil, and grease. Made of high quality synthetic.



Order No.	TR No.	Mfr. No.	Qty. Box
21539	VC8	X2-25	100

Hex Head Chrome Valve Cap

Solid hexagon rod construction. Fits standard chrome sleeve and metal clamp-in valves.



Order No.	Mfr. No.	Per Box
22529	5998	100

Short Chrome Cap

Dome-style Chrome Cap.



Order No.	Mfr. No.	Per Box
22532	MT135C	100

Chrome Valve Cap

Chrome valve cap for chrome valves.



Order No.	Mfr. No.	Per Box
22508	692	100

Valve Cores

- Guaranteed top quality
- Highest value



Guaranteed highest quality, manufactured to rigid specifications, inspected and tested working pressure 300 psi.

Order No.	Economy Line	TR No.	Mfr. No.	Per Box
21546		C1	V1-A Short	100
21547	25600	C1	V1-AH Heat Short Resistant	100
21097		C1	Nickel Cores for TPMS	100

Chrome Valve Cap

Chrome Hex cap with heat resisting gasket.



Order No.	Mfr. No.	Per Box
22507	697	100

Metal Dome Type Valve Cap

Nickel plated brass dome top cap. Guaranteed highest quality positive air seal washer.



Order No.	TR No.	Mfr. No.	Per Box
21532	VC3	V-2A	100

Green Plastic Cap

- For nitrogen inflated tires



Caps with internal seal for use on any automotive or light truck valve stem application.

Order No.	Description	Per Box
59131	Green Plastic Valve Caps	1,000

Chrome Plated Brass Valve Caps

- For nitrogen inflated tires



Caps for use on brass valve stems only. Not for use on TPMS valves.

Order No.	Description	Per Box
59357	Chrome Plated Brass Valve Caps	100

Green Anodized Aluminum Valve Caps

- For nitrogen inflated tires



Caps with internal seal for use on TPMS aluminum stems and all other aluminum valve stems.

Order No.	Description	Per Box
59358	Green Anodized Aluminum Valve Caps	100

Universal TPMS Nitrogen Valve Caps

- For nitrogen inflated tires



Caps of composite material with internal O-Ring seal for any snap-in, brass, aluminum, or TPMS valve.

Order No.	Description	Per Box
59365	Universal Nitrogen Cap	100

Green Valve Stem Rings

- For nitrogen inflated tires



Sleeves slip over the top of a rubber valve stem.

Order No.	Description	Per Box
59138	Green Valve Stem Rings	500

Airplane Valve Core

USAF approved for aircraft tires. Heat resisting core with temperature range -65°F to +350°F. Operating pressure range 0 to 550 psi. Meets MIL-V27317 specifications.



Order No.	TR No.	Mfr. No.	Dill No.	Per Box
22531	C4	6035	402AH Short	100

EQUAL Filtered Valve Core

The stainless steel filter seats into the valve preventing dirt or debris from reaching the valve core. Use with flow thru caps, valve stem extensions, pressure equalization devices and on-board central inflation systems. Fits valve stems that accommodate a long core.



Order No.	Description
21116	Filtered Valve Core Pkg of 20

Valve Extensions

Metal Truck Valve Extensions



Light-Weight Extensions with Long Collar

For use on tube-type or tubeless valves. Double seal assures positive seal.
.305-32 Cap Thread

Order No.	Mfr. No.	Ref. No.	Effective Length
23428	M2512N	346	1 3/16"
23430	M2518N	HE-391	2 1/16"
23432	M2526N	HE-392	5 1/8"
23434	M2530N	HE-393	6"

Light-Weight Extensions with Short Collar



For use on tube-type or tubeless valves. Double seal assures positive seal.
.305-32 Cap Thread

Order No.	Mfr. No.	Ref. No.	Effective Length
23412	M2412N	6358 /356	1 3/16"
23414	M2414N	HE370	2"
23418	M2418N	HE371	2 1/16"
23422	M2422N	HE372	3 1/16"
23426	M2426N	HE373	5 1/8"

Standard Extensions with Long Collar



Makes valve mouth accessible for servicing. 305-32 Cap Thread

Order No.	Ref. No.	Effective Length
22570	7381 /347/HE381	3 1/16"
22571	7382 /348/HE382	5 1/16"
22572	7383 /349/HE383	6 1/16"
22573	S-K1492	8"

Valve Extension Tool



Designed specifically for Myers valve extensions with metric hex nut, and all other extensions with hex base.

Order No.	Mfr. No.	Description
27103	M-EXT	Valve Extension Tool

TYPE C Curved Extensions



Order No.	Ref. No.	Bend	Vertical Height	Horizontal Length
22591	1073	90°	1/2"	1 1/2"
22596	8028	45°	3/4"	1 3/8"

Metal Extensions

Extend any snap-in or clamp-in valve to length required for various cars and ornamental wheel covers.



Order No.	Schrader Equiv.	Description	Effective Length
21556	V-241-M	Metal Extension	3/4"
21557	V-241-G	Metal Extension	1 1/4"

Metal Extensions

- Schrader & Dill



Order No.	Schrader Equiv.	Dill Equiv.	Effective Length
22609		6241-B	1/2"
22610	3680C	6241-M	3/4"
22612		6241-J	1"
22611	3680G	6241-G	1 1/4"

Nylon Valve Extensions

Provide necessary length to inflate and gauge valves hidden by ornamental rim covers.



Order No.	Schrader Equiv.	Dill Equiv.	Effective Length
22617		685	1/2"
22623	5066C	686	3/4"
22618		687	1"
22624	5066G	688	1 1/4"
22625	5066J		1 1/2"
22626			2"

Dual Wheel Extension

Dual Wheel Extension for the outside wheel to route the valve opening back through the hand hole for easy access.

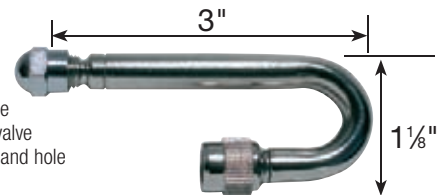

Order No.	Description
22063	Dual Wheel Extension

WARNING SAFETY PRECAUTION

Products illustrated in this catalog should never be used by persons unless they have been properly trained in tire service according to O.S.H.A. Regulation #29CFR 1910.177 entitled Servicing Single-Piece & Multi-Piece Rim Wheels. Myers has copies of this regulation available.

Extension Stabilizers for Aluminum Wheels

- Designed to reduce vibration of the extension to avoid valve breakage



For Accuride Wheels



Order No.	Diameter Hand Hold	Valve Hole Position
23525	2"	Center
23526	2.5"	Off-Center
23527	2.8"	Center
23517	3.0" Triangle - for Freightliner	Center

For ALCOA Wheels



Fit 19.5" to 24.5" diameter wheels.

Order No.	Ref. No.	Fits Wheel Size	Diameter Hand Hole	Valve Hole Position
23499	2125	19.5"	1.5"	Center
23502	2126	19.5"	1.5"	Off-Center
23503	2127	22.5" x 9"	1.5"	Center
23504	2225	22.5"	2.0"	Center
23505	2245	24.5"	2.2"	Off-Center
23506	2246	Peterbilt	3.5" Oval	Center
23518	2227	22.5"	2.5"	Center
23519	2247	24.5"	2.375"	Off-Center
23497	H-8864	22.5" & 24.5"	2.5"	Off-Center
23496	H-27245	22.5" & 24.5"	2.7"	Off-Center

CROSSFIRE Dual Tire Pressure Equalizer

- Maximizes tire life
- Leak safeguard will not allow one leaking tire to drain the other
- Single-Point inflation & visual pressure gauge cuts maintenance time



The inner tire temperature increases due to in-board brakes and poor air circulation causing increased air pressure that expands the inner tires' diameter. As a result, the diameters of the dual tires are unequal. The Crossfire keeps the psi equal. Yellow indicator verifies air is flowing freely from one tire to the other, equalizing the load. Visual gauge window shows black if the tires are under-inflated and red if over-inflated. Crossfire automatically isolates the "good" tire in the event of a blowout. Should a blowout occur, the internal safety valve closes immediately with only a slight loss of pressure to the "good" tire. In slow leak situations, the valve isolates both tires after a pressure drop of approximately 10 P.S.I. Bolts easily to the lug, hub cap, or drive axle end. Sold Each. **Need 2 per axle.**

Order No.	Desc.	PSI	Ship Wt.
54745	Equalizer	60	4 lbs. - 2 kg
54746	Equalizer	65	4 lbs. - 2 kg
54747	Equalizer	70	4 lbs. - 2 kg
54748	Equalizer	75	4 lbs. - 2 kg
54749	Equalizer	80	4 lbs. - 2 kg
54750	Equalizer	85	4 lbs. - 2 kg
54751	Equalizer	90	4 lbs. - 2 kg

Order No.	Desc.	PSI	Ship Wt.
54752	Equalizer	95	4 lbs. - 2 kg
54753	Equalizer	100	4 lbs. - 2 kg
54754	Equalizer	105	4 lbs. - 2 kg
54755	Equalizer	110	4 lbs. - 2 kg
54756	Equalizer	115	4 lbs. - 2 kg
54757	Equalizer	120	4 lbs. - 2 kg

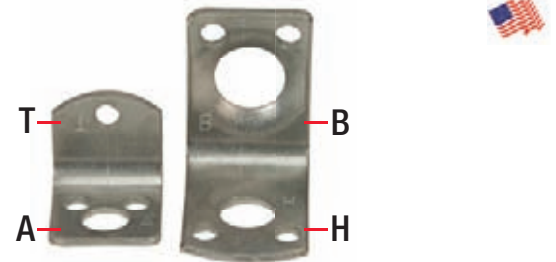

Includes four mounting brackets

Includes four mounting brackets

A.) Installed on the 5/8" or 3/4" drive axle bolts of both disc and spoke wheels. If the wheel has a hub cap, it can be snapped on over the bracket.

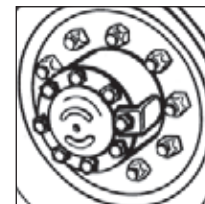

Bracket A

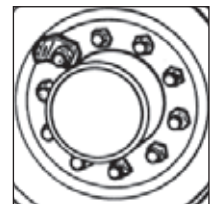

Bracket B

B.) Mounts directly on the 1 1/4" lug bolt.

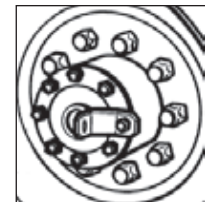

Bracket T

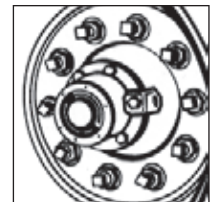

Bracket H

T.) Mounts on the 1/4" bolt that secures the hub cap to either a disc or spoke wheel.

H.) Mounts directly on lug with a hub-piloted nut.

Additional mounting brackets available if required. Specify on order.

C.) Mounts directly on the 5/8" or 3/4" drive axle bolts of both disc and spoke wheels.

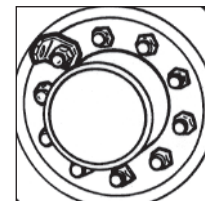

Bracket C

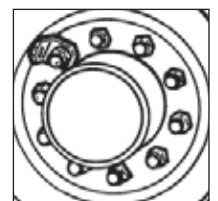

Bracket M

M.) Fits a 22mm stud.

Valve Extensions

AIR-FLEXX Valve Extensions



Conventional extensions hold the full air pressure in the extension chamber. Damage to the extension through wear or accident may mean the loss of a tire



Air-Flexx valve extensions are flexible but rigid enough to be used without a rim holder, clamp or stabilizer

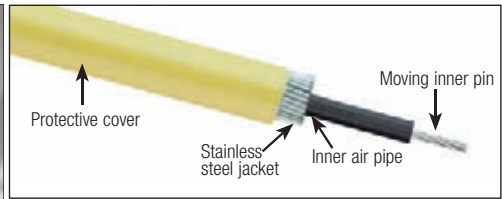

Use with a V2B (21534) Inflate-Thru cap to save time



Air-Flexx valve extensions are flexible but rigid enough to be used without a rim holder, clamp or stabilizer saving time and money. The extension withstands severe cold and heat without becoming brittle. The plastic casing will not corrode. The pin in the extension opens the tire valve only when checking pressure or inflating. If the extension is cut in half or broken no pressure is lost from the tire.

Order No.	Mfr. No.	Application	Length
22300	AF-0075-GE	Steer & Single Wheels with Hubcaps*	2 1/16" (75mm)
22301	AF-0085-GE	Steer & Single Wheels with Hubcaps*	3 5/16" (85mm)
22302	AF-0105-GE	Inner Dual Tires or Steer & Single Wheels with Hubcaps*	4 1/8" (105mm)
22303	AF-0145-GE	Inner Dual Tires*	5 1/16" (145mm)
22304	AF-0185-GE	Inner Dual Tires*	7 1/4" (185mm)
22305	AF-0215-GE	Inner Dual Tires*	8 7/16" (215mm)
22306	AF-0315-GE	Inner Dual Tires or Spare Wheels**	12 3/8" (315mm)
22307	AF-0415-GE	Inner Dual Tires or Spare Wheels**	16 5/16" (415mm)
22308	AF-1000-GE	Inner Dual Tires or Spare Wheels**	39 3/8" (1000mm)

* No need for clamp, holder or stabilizer

** For use on spare wheels with angled extension of 45°, 90°, 135° or 180°



22301



22303



22305

Flexible Braided Wire Extensions

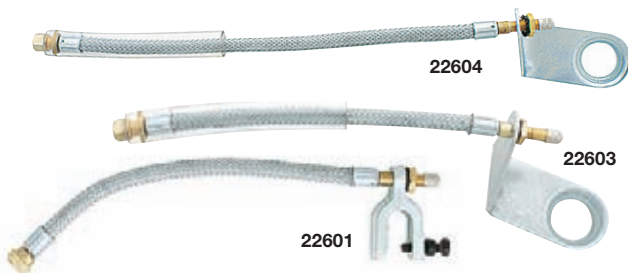

Braided wire covered flexible extensions screw onto the inner valve stem and come out through the outside wheel and, depending on type, they fasten under lug nut or clamp onto the rim.

Order No.	Mfr. No.	Fastener Type	Effective Length
22601	621	Swivel Clamp	5 5/8"
22602	624	Swivel Clamp	9 1/2"
22603	664	Rigid	9 1/2"
22604	666	Rigid	13 1/2"

Valve Extension & Fastener for Steel Disc Wheels

Universal bracket holds extension in place. Designed for 14" to 24.5" wheels. Stainless steel braided cover protects hose. 7" Extension. Each package includes 2 extensions, brackets, nuts and caps.



Order No.	Mfr. No.	Description
22060	2022	7" Extension Kit Pair

MYERS V2B Double Seal Inflate Thru Valve Cap

- The Original "Alligator"
- Reduce pressure check time by 65%



Order No.	Description	Per Box
21534	V2B Valve Cap	50

Dual Wheel Flexible Valve Extensions



Provides easy access to the inner dual tire found on campers, recreational vehicles and light trucks. Fits standard valve cap threads. Comes with clamp to secure extension to wheel cut-out.

Order No.	Mfr. No.	Description	Length
22619	FE-300-7	Dual Wheel Extension	7"
22620	FE-300-9	Dual Wheel Extension	9"
22621	FE-300-11	Dual Wheel Extension	11"

*Additional sizes available upon request.

Valve Extensions & Fasteners for Dayton & Aluminum Hub Covers

- Mount to oil seal

Simple mounting bracket fastens to wheel or cap. For 14" to 24 1/2" wheels. Stainless steel braided cover protects hose. Extension is 15". Each package includes 2 extensions, brackets, nuts and caps.



Order No.	Mfr. No.	Description
22062	2021	15" Extension Kit Pair

Flexible Rubber Extension

Includes cap and swivel clamp.



Order No.	Mfr. No.	Fastener Type	Effective Length
22605	634	Swivel Clamp	5 1/2"

Fast Flow Air Liquid Valve

- For grader & tractor tubes

When the core housing is removed, large opening in valve base allows fast filling of tires with anti-freeze solution. Base prepared for "HOT" or "COLD" application. .625" valve hole.



Order No.	TR. No.	Mfr. No.	Haltec No.	Base Dia.	Stem Length	Per Box
21108	220A		TV220R	2 1/2"	2 1/4"	5
21109	218A	V-218XLG		4 1/4" Base Only - No Valve		

TR LN-10 Rim Nuts

See page 46 for 27107 Nut Driver Tool for use on 26649 Nylon Nut. For use on 21108 and 21109 Tractor Tube valves shown above.



Order No.	Mfr. No.	Haltec No.	Schrader No.	Dill Equiv.	Description
25519	218B	LN-10B	2582	8771	Metal Nut
26649		LN-10	5370A		Nylon Nut

TRB9A Bushing Assembly

Fits TR218A and TR220A valve to allow use of valve in the 19/16" valve hole. Consists of B9 Bushing and LN13 nut. This nut replaces the LN10 that comes with the inner tube and valve.



Order No.	Haltec No.	Description
26125	B9A	Bushing Assembly

Accessories for Air-Liquid Valves

- Core housing



Order No.	TR. No.	Mfr. No.	Haltec No.	Dill Equiv.	Description
25517	CH1	V-218A	TV-CH-1	6489	Standard Air
25518	CH3	V-218AB	TV-CH-3	6489A	Fast Flow Air

Tractor Front Wheel Valves

Low profile tubeless valve offers minimum protrusion above rim hole. Brass finish.

Order No.	Mfr. No.	Description	Effective Length
24260	VS-936A-R	Fits .453 Dia. Valve Hole	3/8"
24261	VS-936B-R	Fits .625 Dia. Valve Hole	3/8"



Rim Hole Plugs



Order No.	Dill No.	Haltec No.	Description
26240	VS-977-P	T-30	Plug for 13/16" Rim Hole
26239	VS-902-P	N1012S	Plug for 3/8" Rim Hole
26134		P-15	Plug for 3/8" Tube Type Rim Hole

Air Liquid Grader Valves

- Tubeless, clamp-in 5/8" rim hole

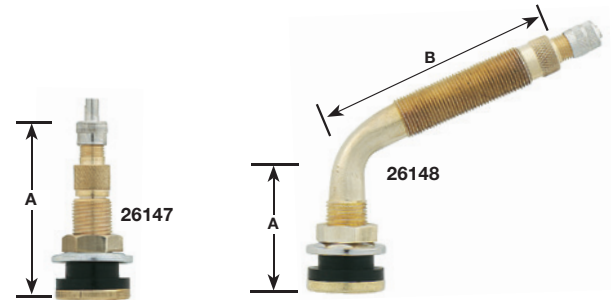

Metal clamp-in type valves make filling with liquid ballast easy. By removing core housing, a large opening is provided. .625" valve hole.

Order No.	Value Line	TR. No.	Haltec No.	Dill No.	Blend	Vertical Height(A)	Horiz. Length(B)
26147	25601	618A	TV-618A	VS-714A-R	Straight	1 7/8"	
26148		621A	TV-621A	VS-921A-R	65° Bend	1 1/2"	3"
26150		623A	TV-623A	VS-932A-R	65° Bend	1 1/2"	2 1/4"
26149		622A	TV-622A	VS-922A-R	90° Bend	1 3/4"	4 1/2"
26152		RG7			Replacement Grommet		

Air Liquid Rubber Snap-In Valve

For foam filled tires. Fits .625 valve hole. Effective length 1.88". Includes CH3 core housing, C1 valve core, and VC8 valve cap. Max. air pressure 65 psi, TR618A Equivalent.



Order No.	Description
26196	Air/Liquid Valve

Air Liquid Valve Extensions

Converts straight tubeless air-liquid valves to single bend type. Horizontal length is with core housing installed.

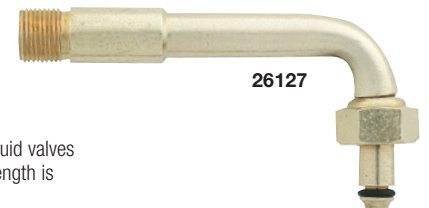

Order No.	Dill Equiv.	Bend	Horiz. Length	For Use With
26128	302-A	80°	2 1/2"	25518 Core Housing & TR618A Spud
26127	301-A	90°	3 3/4"	25518 Core Housing & TR618A Spud

Hydroflating Valve

- For .812" valve holes

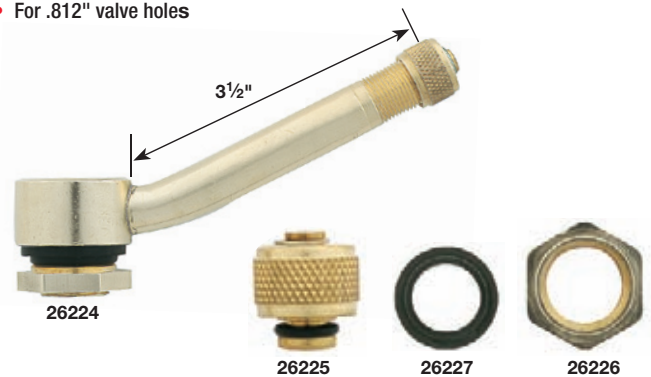

Order No.	Mfr. No.	TR. No.	Haltec No.	Bend	Description
26224	VS-993	JF994	WF-JF-994	28°	Hydroflating Valve
26225	615				Cap
26226	265				Hex Nut
26227	454				Grommet

Large Bore Valves

Large Bore Valve Cores

Short and long heat-resistant valve cores. Fits .305"-32 threads.



Order No.	Mfr. No.	TR No.	Schrader No.	Description	Std. Pkg.
25500	V-1J	C2	1449T	Valve Core - Long	25
26520		C2	6231	Valve Core - Short	25

Large Bore Valve Caps



Order No.	TR No.	Mfr. No.	Haltec No.	Dill No.	Description	Std. Pkg.
25501	VC6	V-2J	A-148	8971	Cap-Removes Insides .482"-26 Thread	25
26513	VC7	4659	A-149	8971H	Cap-Hex Top, .482"-26 Thread	25
25502	VC4	V-2JA	8807N-3	636	Cap-Standard Bore Thread, Screwdriver fits Large Bore Cores	25
25513			A-150		Large Bore Short Hex Cap	

Large Bore Valve Adapters

- 25503 Adapts large bore valve down to standard bore. Fits on .305"-32 valve core threads.
- 25504 Adapts large bore valve down to standard bore. Fits on .482"-26 valve cap threads.



Order No.	TR No.	Mfr. No.	Haltec No.	Dill No.	Description	Std. Pkg.
25503	AD1	V-3J	AD-1	8807	Adapter	25
25504	AD1	V-3JA	8807N-4		Adapter	25

Large Bore Valve Nut

- Hexagon nut fits .482"-26 thread



Order No.	TR No.	Mfr. No.	Haltec No.	Dill No.	Description	Std. Pkg.
26517	HN1	464	725-2	211	Hexagon Nut	100

Spud Adapter

- Standard to large bore



Order No.	TR No.	Mfr. No.	Schrader No.	Description
26524	AD4	VS-704R	5290K	Spud Adapter

Large Bore Screw-On Valves



Large bore screw-on repair valves supplied in either straight or bent, ready for installation.

Order No.	TR No.	Haltec No.	Angle Bend	Horiz. Length	Vertical Height
26175	J1014	LB-216	Straight-Full Threaded/Non-convertible		1 29/32"
26165	J1076A	LB-217	Straight		4 3/32"
26166	J1076D	LB-220	90°	2 5/16"	2 1/16"
26167	J1175A	LB-223	Straight		5 9/32"
26168	J1175B	LB-224	82°	4 1/4"	1 1/4"
26169	J1175C	LB-225	88°	4 1/8"	1 3/8"
26170	J1078A	LB-226	Straight		5 29/32"
26171	J1078B	LB-227	82°	4 5/8"	1 3/8"
26172	J1078C	LB-228	90°	4 7/8"	1 1/8"
26173	J1179A	LB-229	Straight		6 13/32"
26174	J1179B	LB-230	88°	5 1/4"	1 3/8"
26176	J1076B	LB-218	86°	3 1/4"	1 1/8"
26177	J1076C	LB-219	90°	2 7/8"	1 1/2"
26178	J1076E	LB-221	88°	3"	1 3/8"
26179	J1177A		Straight		4 1/2"

Pyrosafe Valve

- Releases lethal air pressure before an explosion can take place



Exhaust air from the tire when the temperature reaches 200° F. or 190 psi. Use on rims from 25" through 63". Simple shop installation. Does not void wheel/tire warranty.

Order No.	Mfr. No.	Description	Ship Wt.
54513	10030	Pyrosafe Valve	1 lbs. - 1 kg

MICROFLEX Diamond Grip Latex

- Textured & powder-free
- More gloves see pages 242, 243, 244



Fits the right or left hand, beaded cuff, powder-free interior, texturized exterior. White, for single use only.

Order No.	Mfr. No.	Description	Size	Quantity Per Box
45368	MF-300	Diamond Grip	Small	100
45356	MF-300	Diamond Grip	Medium	100
45357	MF-300	Diamond Grip	Large	100
45358	MF-300	Diamond Grip	Extra Large	100

Large Bore Straight Tubeless Valve

- Includes tubeless spud & valve assembly

Tubeless spud can be installed by tightening hex nut against rubber grommet and rim. Valve stem assembly has O-Ring seal.



Order No.	TR. No.	Haltec No.	Description	Effective Length
26187	J-670-03	H-45	Straight with Spud	1 3/8"
26189	J-670-2	H-42	Stem Only for 670 (26187)	
26120	SP2	H-41	Clamp-In Tubeless Spud Fits 1 3/16" Rim Hole	

Large Bore Single Bend, Swivel Valves

- Includes tubeless spud & valve assembly

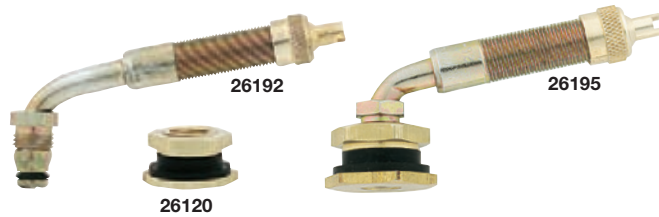

Stem swivels to any position for air service. Tighten hex nut to lock stem into position after installation. Has removable stem and O-Ring seal.

Order No.	TRJ. No.	Schrader No.	Haltec No.	Description
26195	J653		WH-300-J653C	Swivel with Spud 2 1/2"
26191	J650	650	WH-300-J650C	Swivel with Spud 3 1/8"
26192		650-198	WH-300-J650	Stem Only for 650 (26191)
26120	SP2	650-197	H-41	Clamp-In Tubeless Spud Fits 1 3/16" Rim Hole

Outside-In Tubeless Large Bore Valve Spud

Outside-in tubeless spud tilts through the rim hole and is secured by tightening the hex nut while holding the spud with an Allen wrench. Do not use for continuous service. Temporary use only.

Order No.	Haltec No.	Description
26121	K-431	Large Bore Valve Spud
01835		Allen Wrench



Spuds for Swivel-Type Valves



26120
H-41 Swivel-Type Spud for Tubeless



26103
C-10 Large Bore Screw-In Spud

Order No.	TR. No.	Haltec No.	Description
26120	SP2	H41	Clamp-In Tubeless Spud, Fits 1 3/16" Rim Hole
26103	SP3	C-10	C-10 Large Bore Screw-In Spud

Swivel-Type Large Bore Valves

- Interchangeable on tube or tubeless spud
- Single-Bend type

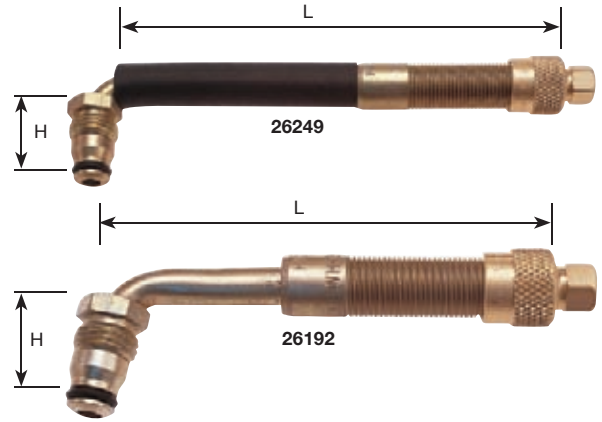

For front wheels and outside duals. Complete with cap, core and 2 hex nuts. Fits 26119 tube spud or 26120 tubeless spud listed below.

Order No.	TR. No.	Mfr. No.	Haltec No.	Angle Bend	Horiz. Length	Vert.
26241	J653	VS977-J-653R	WH-300-J-653	80°	2 1/2"	1 5/64"
26192	J650	VS977-J-650R	WH-300-J-650	80°	3 3/8"	1 5/64"
26243	J657	VS977-J-657R	WH-300-J-657	80°	4"	1 5/64"
26244		VS977-4 1/2R	WH-300-4 1/2	80°	4 1/2"	1 5/64"
26245	J658	VS977-J-658R	WH-300-J-658	80°	5 1/2"	1 5/64"
26246		VS977-9-R	WH-300-9	80°	9"	1 5/64"
26247	J669	VS980-J-669R	WH-45-2 1/2	90°	2 1/2"	1 5/64"
Tubeless Only:						
26248	J4000-2 1/2	VS980-2 1/2R	WH-45-2 1/2	90°	2 1/2"	1 5/64"
26249	J4000-4 1/2	VS980-4 1/2R	WH-45-4 1/2	90°	4 1/2"	1 5/64"
26250	J4000-6	VS980-6R	WH-45-6	90°	6"	1 5/64"
26251	J4000-7 1/2	VS980-7 1/2R	WH-45-7 1/2	90°	7 1/2"	1 5/64"
26265	J4000-8	VS980-8R	WH-45-8	90°	8"	1 5/64"
26252	J4000-9	VS980-9R	WH-45-9	90°	9"	1 5/64"
26266	J4000-10	VS980-10R	WH-45-10	90°	10"	1 5/64"
26267	J4000-20	VS980-20R	WH-45-20	90°	20"	1 5/64"
26268	J4000-24	VS980-24R	WH-45-24	90°	24"	1 5/64"
26269	J4000-25 1/2	VS980-25 1/2R	WH-45-25 1/2	90°	25 1/2"	1 5/64"
26253	J4000-28	VS980-28R	WH-45-28	90°	28"	1 5/64"
26254	J4000-29 1/2	VS980-29 1/2R	WH-45-29 1/2	90°	29 1/2"	1 5/64"
26255		VS982-4 1/2R	WH-46-4 1/2	90°	4 1/2"	1 17/64"
26256	J651	VS982-J-651R	WH-46-J-651	90°	4 11/64"	1 17/64"
26257		VS982-9R	WH-46-9	90°	9"	1 17/64"
26258		VS983-4 1/2R	WH-47-4 1/2	86°	4 1/2"	1 5/64"
26259	J652	VS983-J-652R	WH-47-J-652	86°	5 1/2"	1 5/64"
26260		VS983-9R	WH-47-9	86°	9"	1 5/64"
26261	J655	VS989-J-655R	WH-48-J-655	74°	3 3/8"	1 5/64"
26262	J654	VS991-J-654R	WH-49-J-654	60°	3 3/8"	1 5/64"
26263	J659	VS998-J-659R	WH-50-J-659	90°	3 1/2"	1 57/64"
26264	J660	VS998-J-660R	WH-50-J-660	90°	8 3/4"	1 57/64"
26270	J656	VS999-J-656R	WH-59-J-656	90°	3 11/64"	2 5/8"
Double Bend:						
26271		VS981-25 1/2R		82°+8°	25 1/2"	1 7/8"
26275	Replacement O-Rings for Above Valves					

Large Bore Valve Tools

- For complete valve tool listing see page 51

Ruggedly made with tough, shock-resistant plastic handles. Particularly valuable where valve is located in difficult or awkward position.



Order No.	Mfr. No.	Description
27233	AH-5260	Complete Kit - 8 Tools In Pouch

Large Bore Valves

Turret Valves for Planetary Gear Wheels

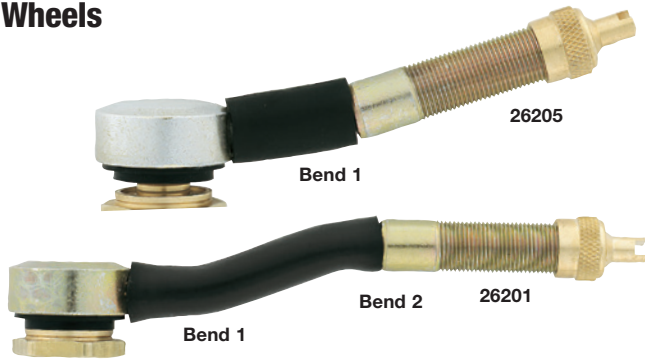

Designed for integral wheel construction. Low protrusion above rim for maximum drum clearance.

Order No.	TR. No.	Haltec No.	Angle Bend 1	Offset Inches	Horizontal Length	Angle Bend 2
26201	J690	WH-330-J-690	28°	9/16"	4 1/4"	28°
26205	J691	WH-330-J-691	18°		3 5/8"	
26210	J692	WH-330-J-692	28°	9/16"	4 1/4"	18°
26211	J693	WH-330-J-693	45°	1"	5"	45°
26212	J694	WH-330-J-694	28°		3 1/2"	
26213	J695	WH-330-J-695	50°	1"	4 1/8"	50°
26214	J696	WH-330-J-696	42°	29/32"	4 1/4"	42°

Rim Hole Plugs



Order No.	Dill No.	Haltec No.	Description
26240	VS-977-P	T-30	Plug for 1 3/16" Rim Hole
26239	VS-902-P	N1012S	Plug for 5/8" Rim Hole
26134		P-15	Plug for 5/8" Tube Type Rim Hole

Loader Tire Valve



Order No.	Haltec No.	Eff. Length	Thread Size
26124	T-670	1 29/32"	1 1/16-12

Tank Valve



Order No.	Ref. No.	Haltec No.	Eff. Lgth.	Thread Size
26122	J-671	H-47	1 19/32"	1/4"

Large Bore Valve Repair Tool

- See pages 51 & 52 for large bore valve tools

Repairs internal and external threads on large bore and air/liquid valve bases.

Order No.	Mfr. No.	Description
27214	TL695	Large Bore Valve Repair Tool



Large Bore Jumbo Extensions



RIGID TYPE Non-Bendable Complete with Cap & Full-Length Core Depressor

Order No.	Haltec No.	Dill Equiv.	Eff. Lgth.	Order No.	Haltec No.	Dill Equiv.	Eff. Lgth.
26577	867-1 1/4	8966-1 1/4	1 1/4"	26599	867-8 1/2	8966-8 1/2	8 1/2"
26578	867-1 3/4	8966-1 3/4	1 3/4"	26600	867-9	8966-9	9"
26595	867-2	8966-2	2"	26601	867-10	8966-10	10"
26596	867-2 1/2	8966-2 1/2	2 1/2"	26586	867-10 1/4	8966-10 3/4	10 3/4"
26579	867-3	8966-3	3"	26587	867-12 1/2	8966-12 1/2	12 1/2"
26597	867-3 3/8	8966-3 3/8	3 3/8"	26588	867-18 7/8	8966-18 7/8	18 7/8"
26580	867-4	8966-4	4"	26589	867-20 1/4	8966-20 1/4	20 1/4"
26581	867-4 1/2	8966-4 1/2	4 1/2"	26594	867-21 3/8	8966-21 3/8	21 3/8"
26582	867-5	8966-5	5"	26590	867-22 1/2	8966-22 1/2	22 1/2"
26583	867-5 9/16	8966-5 9/16	5 9/16"	26591	867-23	8966-23	23"
26598	867-6 7/8	8966-6 7/8	6 7/8"	26593	867-24 1/4	8966-24 1/4	24 1/4"
26584	867-7 1/4	8966-7 1/4	7 1/4"	26592	867-25 5/8	8966-25 5/8	25 5/8"
26585	867-7 3/4	8966-7 3/4	7 3/4"				

FLEXIBLE EXTENSION - Rubber Hose Complete with Cap & Core



Order No.	Mfr. No.	Eff. Length
26605	AH-3912	9 1/16"
26606	AH-4334	12 13/16"
26607	AH-3986	13 5/8"
26608	AH-3987	20 1/4"
26609	AH-3988	21 3/8"
26610	AH-3989	23 5/8"
26611	AH-3990	24 1/4"

SEMI-FLEXIBLE - Hand Bendable



Cap and core not included. They should be removed from valve and transferred to extension.

Order No.	Haltec No.	Dill Equiv.	Eff. Length
26613	7535-3	8969-3	3"
26614	7535-3 1/2	8969-3 1/2	3 1/2"
26615	7535-4	8969-4	4"
26616	7535-4 1/2	8969-4 1/2	4 1/2"
26617	7535-8	8969-8	8"
26618	7535-9	8969-9	9"
26619	7535-10	8969-10	10"
26620	7535-11 1/2	8969-11 1/2	11 1/2"
26621	7535-12	8969-12	12"
26629	7535-12 3/4	8969-12 3/4	12 3/4"
26630	7535-13 1/2	8969-13 1/2	13 1/2"
26631	7535-16	8969-16	16"
26622	7535-19	8969-19	19"
26632	7535-20 1/2	8969-20 1/2	20 1/2"
26633	7535-21	8969-21	21"
26624	7535-23 1/2	8969-23 1/2	23 1/2"
26634	7535-24 1/2	8969-24 1/2	24 1/2"
26635	7535-25	8969-25	25"

Other lengths available upon request.

Large Bore or Super Large Bore Valves?

.19"
4.826mm

.44"
11.176mm



The air flow through a large bore valve is three times more air than through a standard bore valve. The super large bore valve air flow is four times more than the large bore valve.

Measured in the cost of downtime and the cost to service large off-the-road tires, Super Large Bore is a bargain.

As the trend towards larger vehicles and tires continues, the need is for faster, more efficient tire servicing.

M-2000 Swivel Valve Assembly

90° Swivel valve.
Length 3 1/8".



Order No.	TR. No	Description
26123	M-2000	Swivel Valve Assembly

Rigid Metal Valves

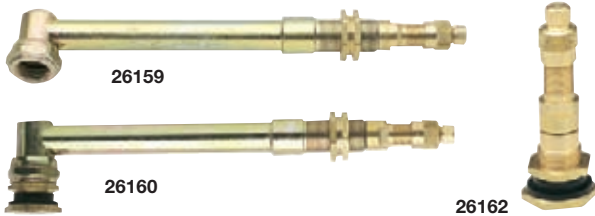

Swivel Stem Assembly

Order as a complete assembly in one inch increments. Specify length.

Order No.	TR. No.	Mfr. No.	Haltec No.	Description
26159	TRL8008**	L-8008R	MR-800-8*	8" Long Swivel Valve Stem

*Order other sizes in 1" increments
**Include CH8 Core housing

Swivel Valve Assembly

Consists of L800 swivel stem assembled with SP8 spud. Order complete assembly in one inch increments. Specify length.

Order No.	TR. No.	Mfr. No.	Haltec No.	Description
26160	L850-8	L-8508R	MR-850-8*	8" Long Swivel Valve Assembly

*Order other sizes in 1" increments

Straight Valve Assembly

Complete valve is combination of CH8 core housing and SP8 spud assembly. Specify length.

Order No.	TR. No.	Mfr. No.	Description
26162	TRL870	L-870-R	Straight Valve Assembly

Turret Valve Assembly



Used for vehicles with special requirements. Order in one inch increments. Specify length.

Order No.	TR. No	Description
26161	MR-890-8*	8" Long Turret Valve Assembly

* Order other sizes in 1" increments

When ordering valves: be sure to indicate exact length needed:
(Example) L800-17R for 17" length; L800-18R for 18".

Component Parts



Custom Super Large Bore Valves can be developed to meet special wheel mounting requirements.

Order No.	TR. No.	Haltec No.	Description
26142	SP8	T-81	Valve Spud Used w/ Swivel or Straight Valves, Length 1.06"
26190		T-82	Clamp-In Spud, Length 1.31"
26143	CH8	R-520	Core Housing w/ Cap & Core
26154	SP9	C-100	Rim Spud. Fits 23/32" Hole, Tapped for 1/2" NPT
26145	HN80		Hex Nut
26146	RG16		Rubber Grommet

PT Valve System

- Monitor tire pressure with the valve & gauge assembly
- Insure maximum tire life through proper inflation
- For Use on most large bore & super large bore applications

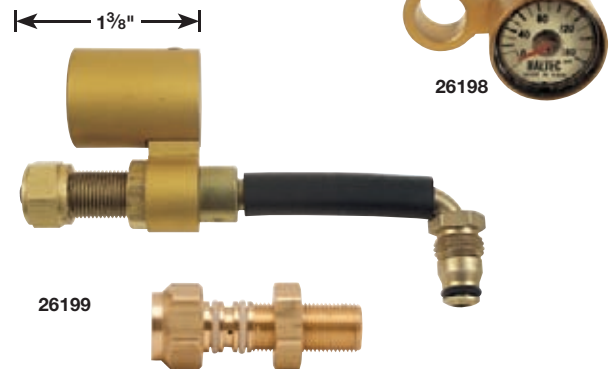

The PT tire valve and gauge assembly allows for constant visual pressure checks. The valves feature urethane O-Rings on the valve barrel. The Super Large Bore PT-R-520 core housing is compatible with the IN-80A Inflator Adapter. The easy-to-read gauge is attached to the valve and is calibrated from 0 to 160 psi. By selecting the proper PT valve, a gauge can be installed on virtually any tire without being exposed to damage. PTEX extension converts any large bore valve into a PT valve.

Order No.	Mfr. No.	Description
26198	67000	PT Gauge
26197	PT-R-520	Core Housing
26199		PTEX Extension

Super Large Bore Valves

- 26194: Long super large bore turret valve with 15° bend, used on Caterpillar applications
- 26193: Long super large bore turret valve with 15° bend, used on Caterpillar application

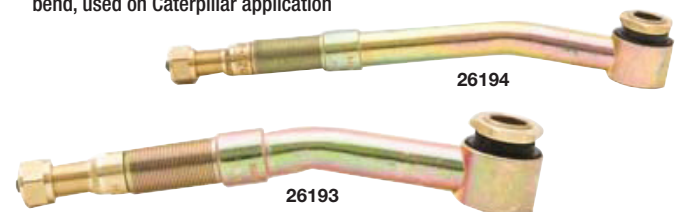

Order No.	Mfr. No	Length	Description
26194	N-1538B	7 7/8"	Super Large Bore Valve
26193	N-1543A	6 1/8"	Super Large Bore Valve

Super Large Bore Valves

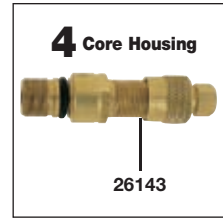
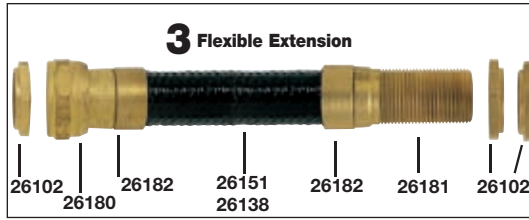
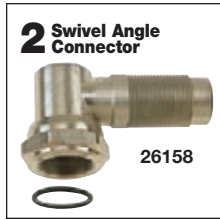

Flexible Stems



Flexible hose withstands vibration and fatigue. Field repairs are easy.

Order No.	TR. No	Description
26163	M-1900-8	8" Flex. Swivel Assembly w/o Spud
26164	M-1950-8	8" Flex. Swivel Assembly w/ Spud

Super Large Bore Spuds

Clamp-In Spud

Fits 3/8" diameter valve hole. Attaches to any super large bore valve through a standard 3/8" diameter valve hole. Tire must be dismantled to change spud.



Order No.	TR. No.	Haltec No.	Description
26142	SP8	T-81	Clamp-In Spud, Length 1.06"
26190		T-82	Clamp-In Spud, Length 1.31"

Outside Clamp-In Spud

Fits 3/8" diameter valve hole. Can be changed without dismantling the tire. Use 3/8" Allen wrench to hold spud while installing. Do not use in continuous service. For temporary use only.



Order No.	TR. No	Description
26153	K-665	Outside Clamp-In Spud

Screw-In Spuds

- 1/2" NPT tapped hole



Used to attach any of the Super Large Bore valves to the rim and is designed to screw into a 1/2" NPT tapped rim hole. The spud can be changed without dismantling the tire. Has internal thread for core housing.

Order No.	Haltec No	Description
26154	C-100(SP9)	Screw-In Spud
26155	S-85	Screw-In Spud, 85° Bend Angle
26156	S-85-D	Spud with Lock Nut & Teflon Seal so Direction Can Be Reversed. 85° Bend Angle

Swivel Connectors



Swivel connectors screw onto the spud.

Order No.	TR. No.	Haltec No.	Description
26157	AD5-75	R-675	75° Swivel Connector
26158	AD5-90	R-525	90° Swivel Connector

CH-16 Core Housing



Designed with two O-Ring seals to resist corrosion from calcium chloride solution. 1/2" N.P.T. For use with tube spud, SP-8, C100.

Order No.	TR. No.	Mfr. No.	Haltec No.	Description
26140	CH-16	CH-16	R-372	Core Housing

M-5000 Valve Assembly

Screw-in type spud with O-Ring seal. The core housing is not interchangeable in other super large bore spuds. 3/4"-16 thread size.



Order No.	Haltec No	Description
26135	M-5000	Valve Assembly

Straight Valve Assembly

Includes 26142 spud and 26140 core housing.



Order No.	Haltec No	Description
26117	H-50	Straight Valve Assembly

M-3000 Flexible Extension Kits

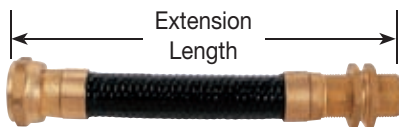

26151
26138

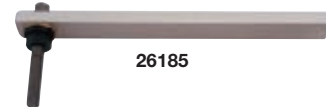

Make custom extensions to fit the wheel configuration. The specially manufactured fittings and thermoplastic hose will not fatigue or crush during service. 26185 Assembly Tool required.

26183 (R-969K-1) Kit includes 26180 swivel connector, 26181 straight tubing connector, two 26182 tubing connector sleeves and two 26102 nuts.

26184 (R-969K) Kit includes the above plus the 26143 core housing complete with core and cap. Extension tubing sold separately in 50' and 100' lengths.

Order No.	Haltec No.	Description
26183	R-969K-1	Flexible Ext. Kit
26184	R-969K	Flexible Ext. Kit with Core Housing
26185	T-620	Assembly Tool - Required

Replacement Parts	
26180	R-762S Swivel Connector
26181	R-763 Straight Tubing Connector
26182	R-764R Tubing Connector Sleeves
26102	B-222 Nuts
26143	R-520 Core Housing
26151	R-760-50 50' Extension Tubing
26138	R-760-100 100' Extension Tubing

30A Plus Wonder Pump Tire Filling System

- Complete with hoses, quick disconnect couplers & core ejector
- Pumps nearly anything that flows
- One control valve for ease of operation, no changing hoses to reverse flow
- 30 G.P.M.
- Lubrication not required



The self-priming, air powered pump delivers a controlled 30 gallons per minute at a low noise level. One control valve allows for easy operation. Unit is self priming and cannot be overloaded. There are no moving mechanical parts in contact with the liquid being pumped. Maximum air pressure not to exceed 100 psi. Complete with hoses, quick disconnect couplers and core ejector.

Order No.	Mfr. No.	Description	Ship Wt.
56245	30A	Wonder Pump	65 lbs. - 25 kg
Replacement Parts			
56342	30A-26	Air Gauge for 56340	1 lbs. - 1 kg
56344	30A-27	Gauge - Pressure Vacuum	1 lbs. - 1 kg
56346	30A-28	Fluid Directional Valve	4 lbs. - 3 kg
56347	30A-29	Wrench	1 lbs. - 1 kg
56348	30A-30	Supply Hose	5 lbs. - 3 kg
56350	30A-31	EVAC Hose	6 lbs. - 3 kg
56352	30A-32	PVC By Pass Hose	1 lbs. - 1 kg
56354	30A-33	1" Strainer - Old Style	2 lbs. - 1 kg
56356	30A-34	¾" Strainer - New Style	1 lbs. - 1 kg
56340	18A-25	Filter/Regulator/Lubricator for Older Style 18A Blue Pumps	2 lbs. - 1 kg
56341	30A-24	Filter/Regulator	2 lbs. - 1 kg

IN-95 Inflator Adapter

- For air or liquid fill OTR tires equipped with super large bore, Z-Bore & mega bore valves

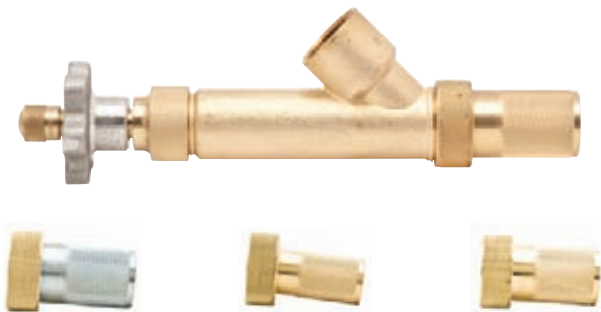

Will insert or extract R-372, R-520, Z10, or MB-50 core housing and hold it out of the way when filling or evacuating tires. Attach to any liquid filling tire pump with a ¾" pipe thread.

Order No.	Mfr. No.	Description	Ship Wt.
26130	IN-95	Inflator Adaptor	2 lbs. 1 kg

M-30 Valve Adapter & Core Ejector

- Standard & tractor valve



Attaches to any calcium chloride tire filling pump and will extract valve core from standard valve or core housing from tractor valve. This design permits faster evacuation of liquid than any other type of core ejectors. Made of machined brass. Has ½" female thread.

Order No.	Haltec No.	Description	Ship Wt.
54527	M-30	Valve Adapter & Core Ejector	2 lbs. - 1 kg
54553	F-134	Large Bore Core Remover	

Parts for M-30 Core Ejector 54527

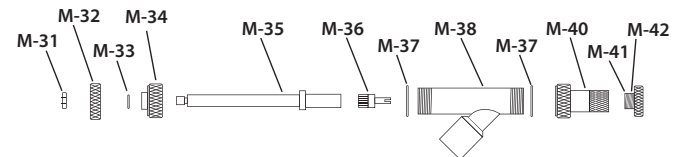

Order No.	Mfr. No.	Description	Order No.	Mfr. No.	Description
54528	M-42	Adapter for Standard Valve	54534	M-35	Stem
54529	M-41	O-Ring for Adapter	54535	M-38	Adapter Body
54530	M-36	Standard Valve Core Adapter	54536	M-34/FP142	Stem Sealing Nut
54532	M-40	Ejector Union	54537	M-33	O-Ring for Stem Seal
54533	M-37	Gasket	54539	M-32	Hand Wheel
			54540	M-31	Lock Nut

IN-80A Super Large Bore Inflation Adapter

- Reduces inflation time 60%, deflation time 80%
- ½" FPT air hose connection



The inflator adapter saves time by fast inflation or deflation on a tire. After removing the valve cap, the inflator is screwed onto the valve stem. The inflator stem is pushed in engaging the flats on the core housing. By rotating the stem counter clockwise, the core housing is removed without any danger to the person removing it. The core housing is pulled up into the inflator body and held during inflation or deflation. Can also be used for liquid-filling tires equipped with Super Large Bore valves.

Order No.	Haltec No.	Description	Ship Wt.
26126	IN-80A	Super Large Bore Inflator Adaptor	2 lbs. - 1 kg

Parts for IN-80A Core Ejector 26126

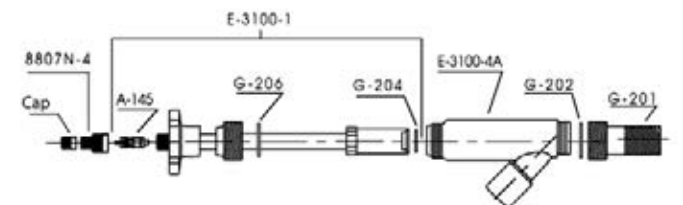

Order No.	Haltec No.	Description	Order No.	Haltec No.	Description
26108	G-201	Ejector Union	26116	G-206	Gasket for E-3100-1
26109	G-202	Gasket for G-201	26107	E-3100-4A	Adapter Body
26115	G-204	Snap Ring for Collet	25504	8807N-4	Cap Adapter
26104	E-3100-1	Complete Stem & Collet	26520	A-145	Large Bore Valve Core

307 Urethane Fill Adapter

- For urethane tire filling pumps



Attaches to the urethane pump discharge hose with a 1/2" fpt. Includes an adapter bushing to attach the gun union to a standard size tire valve. By removing the adapter bushing, the union can be attached to a tractor-type valve (TR218A), a grader valve (TR618A), or any large bore valve (TRJ650). Does not include Delrin Plugs. See below.

Order No.	Haltec No.	Description	Ship Wt.
54514	307	Urethane Fill Adapter	2 lbs. - 1 kg

Delrin Plugs

- For 307 urethane fill adapter



Used to seal the valve after the tire is filled with urethane to pressure. The plug permanently seals the valve and the adapter can be removed immediately.

Order No.	Mfr. No.	Description
54561	P-250	Standard Valve Delrin Plug
54562	P-251	Tractor & Grader Valve Plug
54563	P-252	Large Bore Valve Delrin Plug

Check Valve



For fast inflation and deflation. Does not need core housing or inflation adapter. Fits standard large bore swivel stems and extensions.

Order No.	Haltec No.	Dill No.	Description
26141	6185	L-860-R	Check Valves

Coupler & Adapter for Hydro Inflation

Straight-through 1/2" mpt brass coupler specially designed for liquid filling. Quickly disconnects from inflator. 1/2" mpt nipple screws into inflator to mate with quick coupler.



Order No.	Mfr. No.	Description
56265	BST4	Hydro Inflation Coupler 1/2" FPT
56266	BSTN4M	Adapter for 56265 Coupler

Water Adapter Set for Core Ejector

- Garden hose adapter

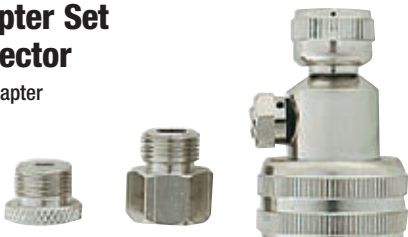

Order No.	Haltec No.	Dill No.	Description
26653	N-1091	4638-A	5791-C Adapter & 2 Bushings to Fit All Air-Water Valves

O-Rings for Truck, OTR & Earthmover

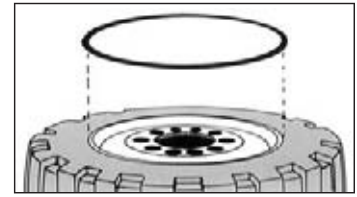

Seals tire beads on grader, earthmover, off-the-road, and transportation equipment. Temperature range -40° to +257°F. Priced each.

Order No.	Mfr. No.	Tire Type	Material O.D.	Rim Size	Package Qty.	Box Qty.
15475	OR-209T		.260"	9"	2	24
15476	OR-210T		.260"	10"	2	24
15477	OR-212T		.260"	12"	2	24
15438	OR-215T	Mining (Special)	.260"	15"	2	24
15480	OR-315T		.375"	15"	2	24
15439	OR-17T	Aircraft/Mining	.260"	17"	2	24
15478	OR-217L		.260"	17"	2	24
15440	OR-20JM	Highway (JM Rim)	.260"	20"	2	24
15444	OR-220TG	Grader	.260"	20"	2	24
15481	OR-320TG		.375"	20"	2	24
15435	OR-721T	Highway	.750"	21"	1	12
15443	OR-21T	Highway	.260"	21"	2	24
15447	OR-321T	Earthmover	.375"	21"	2	24
15441	OR-22JM	Highway (JM Rim)	.260"	22"	2	24
15442	OR-24JM	Highway (JM Rim)	.260"	24"	2	24
15445*	OR-224TG	Grader	.260"	24"	2	24
15482	OR-324TG		.375"	24"	2	24
15446	OR-25T	Earthmover (Small)	.260"	25"	2	24
15448	OR-325T	Earthmover	.375"	25"	2	24
15479	OR-26LT		.260"	26"	2	24
15449	OR-329T	Earthmover	.375"	29"	2	24
15436	OR-332TG	Grader	.375"	32"	2	24
15437	OR-232TG	Grader	.260"	32"	2	24
15450	OR-333T	Earthmover	.375"	33"	2	24
15483	OR-433T		.500"	33"	1	12
15451	OR-335T	Earthmover	.375"	35"	2	24
15452	OR-339T	Earthmover	.375"	39"	2	24
15457	OR-343T	Earthmover	.375"	43"	2	24
15453	OR-345T	Earthmover	.375"	45"	2	24
15484	OR-445T		.500"	45"	1	12
15454	OR-349T	Earthmover	.375"	49"	2	24
15461	OR-449T	Earthmover	.500"	49"	1	12
15455	OR-351T	Earthmover	.375"	51"	2	24
15456	OR-451T	Earthmover	.500"	51"	1	12
15458	OR-357T	Earthmover	.375"	57"	2	24
15459	OR-457T	Earthmover	.500"	57"	1	12
15417	OR-463TS	Earthmover	.500"	63" AEHD	1	12
15434	OR-463T	Earthmover	.500"	63"CSF	1	12

* Max Temp 158° F.

L-Rings for OTR Tires

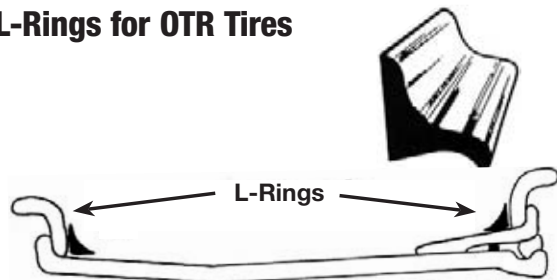

L-Rings are used when the bead condition makes it difficult to maintain proper air inflation pressure. L-Rings may be used to seal foam filled tires mounted on tube type rims. This allows tire beads to seal against rim flanges to avoid leaking of foam while filling. Two L-Rings are required for each tire (one rear, one front). Sold each.

Order No.	Mfr. No.	Rim Size	Order No.	Mfr. No.	Rim Size
15473	L-15	15"	15466	L-39	39"
15469	L-20	20"	15468	L-45	45"
15470	L-24	24"	15467	L-49	49"
15462	L-25	25"	15471	L-51	51"
15463	L-29	29"	15472	L-57	57"
15464	L-33	33"	15419	L-63	63"
15465	L-35	35"			

Valve Hole Cleaning Brushes



42058 For .453" Valve Hole

42059 For 5/8" Valve Hole

Order No.	Description
42058	Valve Hole Cleaning Brush for .453 Valve Hole
42059	Valve Hole Cleaning Brush for 5/8" Valve Hole

Valve Nut Ratchet Wrenches



For fast installation of clamp-in valve stems. Fits easily over straight or bent valves.

Order No.	Description
27115	Valve Nut Ratchet for 570 Series Valves with 9/16" Hex Nut
27116	Valve Nut Ratchet for 540 Series Valves with 3/4" Hex Nut

Tool Pouch

- Available with or without tools
- Belt-Style tire service tool pouch



98113

96997

Made of heavy-duty stitched nylon material. It has four small slots plus one large pocket in front and a short pocket on the side. Velcro strap belt loop. Pouch with tools includes 1 each of Cloth Tool Pouch, Tread Depth Gauge, 10-50 lbs. Tire Pressure Gauge, Yellow Crayon, and Core Remover

Order No.	Mfr. No.	Description
98113	600D	Belt Tool Pouch Only - Tools Sold Separately
96997	601D	Belt Tool Pouch with Tools

Pocket Tire Service Kit



The Tire Service kit contains a 10-50 psi passenger tire gauge, tread depth gauge, core remover/screwdriver and a yellow tire marking crayon.

Order No.	Description
98116	Tool Service Kit

Long Handled Valve Cap Tool



Designed to install and remove dome type caps in hard to reach spots.

Order No.	Mfr. No.	Description
27123	MT633	Valve Cap Tool

Locking Valve Core Remover



Locking ball in core slot grips the valve core. Nickel plated steel shaft.



Order No.	Description
27132	Locking Valve Core Tool

Valve Core Tools

Screwdriver simplifies installation and removal of standard valve cores.



Order No.	Mfr. No.	Description
27130	5411	41-444 Valve Core Tool

Recessed Valve Core Tool

Plastic handle tool with recessed core driver. Fits standard bore cores.



Order No.	Mfr. No.	Description
54847	AH 5412	Valve Core Tool

Combination Cap & Core Tool



One end core screwdriver, other end-socket for tightening, removing prong caps.

Order No.	Mfr. No.	Description
27349	X2-111	Combination Tool

Combination Valve Core Tool



Fits standard bore-other end fits large bore.

Order No.	Mfr. No.	Description
26188	TL-685	444 Combination Tool

Cap & Core Tool



Grips core to reach inner dual tire valve. Core screwdriver and socket for knurled valve caps.

Order No.	Mfr. No.	Description
27334	8769A	Cap & Core Tool - 9"

Valve Core Screwdriver



Long hex body makes it easy to remove ordinarily difficult to remove valve cores.

Order No.	Mfr. No.	Description
27126	AH-2688	Valve Core Screwdriver

Clamp-In Valve Tool



For fast installation of metal clamp-in valves. Fits all straight tubeless truck and passenger clamp-in valves.

Order No.	Mfr. No.	Description	Length
27351	AH-940	Clamp-In Valve Tool	8"

Valve Pal Valve Cap Remover & Installer



Rubber tip "grabs" all types of truck valves for easy removal, even the V2B. 15" length is ideal for dual wheels. Guides cap back preventing cross-threading.

Order No.	Description
22670	15" Valve Cap Tool

4-Way Valve Repair Tools

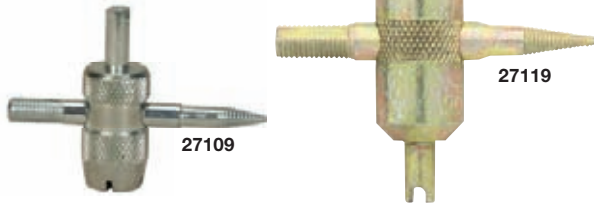

Removes core, rethreads inside of stem, extracts damaged core, rethreads outer part of stem and installs new stem in tubeless tires.

Order No.	Mfr. No.	Description
27119	HD-20	Heavy-Duty 4-Way Valve Tool
27109	AH-10	4-Way Valve Tool

Ken Tool Valve Breakers

- No hammer to swing - saves wrist & fingers



The slide hammer with an internal spring absorbs the shock. Place the point of the tool against the base of the valve. One or two blows knocks the valve through the hole by shearing the bottom flange off the valve.

Order No.	Mfr. No.	Description	Ship Wt.
27098	T34B	27" Valve Breaker for Service Truck Applications	9 lbs. - 4 kg
27099	T36B	45" Valve Breaker for Additional Leverage	16 lbs. - 7 kg
52510		Parts Kit for Valve Breaker	

Truck Tire Valve Nut Splitter



Splits the brass nuts on 570 series valves. A strike with a hammer neatly splits the nut freeing the valve stem. The slot side of the tool allows it to be used with bent valves.

Order No.	Mfr. No.	Description
27150	X10-NS58B	Valve Nut Splitter for Truck Valves

E-Z Out Broken Core Remover

Left handed thread for removing valve cores with broken swivel.



Order No.	Mfr. No.	Description
27127	AH-6129	Broken Core Remover

Broken Core Removing Tool



Designed for turning out broken cores. Plastic handle gives screwdriver grip

Order No.	Mfr. No.	Description
27125	AH-567	Broken Core Remover Tool

Tube Deflators



Connects to air line and tire valve. Draws all the air out of tubes. Pressure action siphons air from tube.

Order No.	Mfr. No.	Description
27163	AH-W1A	Wonder Deflating Tool
27341	6108	Tube Deflator

3-Purpose Tool

Extension for mounting. Valve core screwdriver. Deflates tubes.



Order No.	Mfr. No.
27117	AH-11

Valve Fishing Tools

Deluxe Fishing Tool

Combines valve core wrench and deflating pin with flexible cable for fishing valve through rim hole.



Order No.	Mfr. No.	Length
27106	TL-64524	24"

Cable Fishing Tool

Kant Kink, contains valve core screwdriver and deflator.



Order No.	Mfr. No.	Length
27112	AH-12	8"

Standard Valve Fishing Tool

Aligns and holds valve in position with valve hole while mounting tire. Fits all size valve holes.



Order No.	Mfr. No.	Length
56459	AH-8909	10"

Valve Core Removing Tool

- Ideal for nitrogen filled tires



Lock-On chuck attaches securely to the valve. Valve core tool prevents core loss during tire inflation and deflation. Full bore inflator/deflator allows for rapid tire inflation and deflation.

Order No.	Description
54353	Valve Core Removing Tool

IN-20 Core Removing Tool

- Decreases inflation & deflation time
- Use with nitrogen-filled tires

Use when adding tire seal to the tire. Works great for nitrogen inflation since no nitrogen is lost when inserting the core.

Order No.	Description
54355	Core Removing Tool

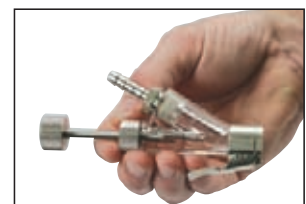

Tubeless Valve Tools

- Pull-A-Stem



Pulls old valves out and pulls new valves in. Removes broken valves. One tool fits all sizes and lengths.

Order No.	Description
27140	Pull-A Stem

Valve Pullers

- 22632 For valve installation only - not for removal

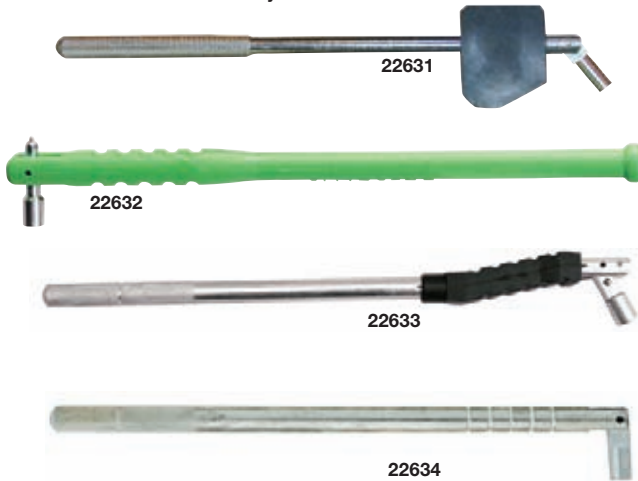

Note: Always lubricate the valve before installing with a valve tool.

Order No.	Mfr. No.	Description
22631		Valve Remover with Rubber Pad
22632	MTS 999	Poly Valve Tool for Custom Wheels
22633	992	Rubber Guard Bent Tool for Any Length Snap-In Valve In Any Width Rim
22634	5407	Straight Tool Installs Any Length Snap-In Valve In Any Width Rim

Valve Stem Puller

- Protects the wheel & rim
- Screw the pivoting head onto the valve stem

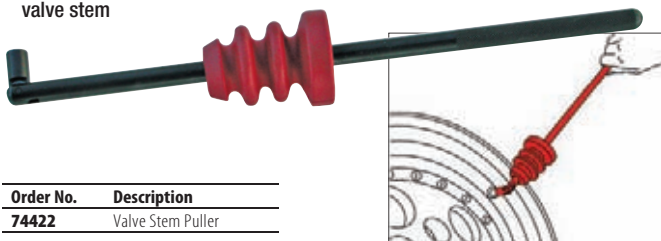

Order No.	Description
74422	Valve Stem Puller

Imprinted Air Gauges & Tread Depth Gauges

- Promote your business & driver safety
- Minimum order 500, call for quote



Order No.	Description
54831	Imprinted Tire Pressure Gauges

Tread Depth Gauge

- Inches or millimeters



Wide 1 1/4" base to span truck treads. Calibrated in 1/2 inches or from 0 to 25 mm. Blade probe also measures passenger tires. Convenient pocket clip.

Order No.	Mfr. No.	Description
56454	599B	Tread Depth Gauge 1/2" & mm

Color Coded Tread Depth Gauge

- A visual indicator to show the customer

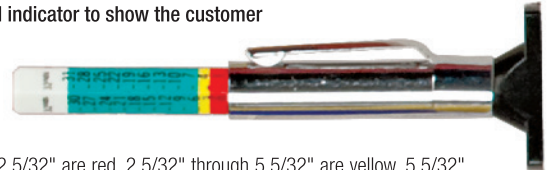

0 through 2.5/32" are red. 2.5/32" through 5.5/32" are yellow. 5.5/32" through 32/32" are green. Includes pocket clip.

Order No.	Mfr. No.	Description
56449	599B	Color Coded Tread Depth Gauge

All Metal Tread Depth Gauge

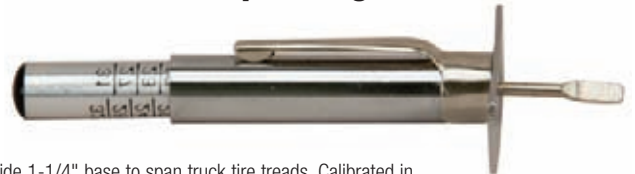

Wide 1-1/4" base to span truck tire treads. Calibrated in 1/32". Convenient pocket clip

Order No.	Description
53832	Metal Tread Depth Gauge

Digital Tread Depth Gauge

- Large LCD display holds the measurement until reset
- Also use for brake shoe & pad wear



Eliminates questionable readings on slide-type gauges. Reads in 1/2" increments on an easy-to-read display. Features zero setting in any position, metric/inch system interchange manual power on/off. Range 0" to .98", working temperature 0° to 104°, CR2032 3V battery and includes instructions.

Order No.	Description
56460	Digital Tread Depth Gauge

Professional Truck Tire Tread Depth Gauge



A quality, accurate tread depth gauge designed for use on truck tires. Ideal for tire adjustment centers, commercial truck tire dealers and fleet maintenance managers. Calibration in 1/2 inches and 0 to 25 mm.

Order No.	Mfr. No.	Description
56451	N1420	Truck Tread Depth Gauge

Tire Pressure Gauges

MYERS Deluxe Tread Depth & Air Gauge Set



Both gauges feature black slides with white numerals making them easier to read in bright conditions and convenient pocket clips. Low pressure air gauge calibrated 10 to 75 psi in 1 lb. increments. The tread depth gauge is calibrated in 1/32". Includes a brushed aluminum case.

Order No.	Description
54842	Deluxe Tread Depth & Air Gauge Set

Retail Air Gauge Color Pack



10 gauge package of pencil gauges. Calibrated 10 to 75 lbs. in 1 lb. units. Carton-to-counter shelf display. 5 pastel colors. Metal barrels, Nylon bar.

Order No.	Mfr. No.	Description	Calibration
54832	21-DIS	10 Gauge Pkg.	10-75 lbs.

Retail Passenger Tire Gauge



Promote correct tire inflation. Calibrated 10 to 50 lbs. in 1 lb. units. Nylon bar.

Order No.	Mfr. No.	Description	Calibration
54830	211	Retail Air Gauge	10-75 lbs.

MYERS Low Pressure Passenger Tire Gauge



With pocket clip and metal barrel. Calibrated 10 to 75 lbs. in 1 lb. units. Nylon bar.

Order No.	Mfr. No.	Description	Calibration
54838	X2-10A	Low Pressure Gauge	10-75 lbs.

MYERS Extra Low Pressure Gauge



Calibrated 1-20 lbs. in 1/2 lb. units. Nylon bar.

Order No.	Mfr. No.	Description	Calibration
54846	X2-10L	Extra Low Pressure Gauge	1-20 lbs.

All-Purpose Service Gauge



With pocket clip. Calibrated 20 to 120 lbs. in 2 lb. units. Nylon bar.

Order No.	Mfr. No.	Description	Calibration
54839	X2-10B	High Pressure Gauge	20-120 lbs.

MYERS Digital Tire Air Pressure Gauge



Bright, easy to read display holds reading until reset. Heavy duty commercial head. Features audible signal and automatic shut off. Accuracy +/- .5 psi from 2 - 100 psi; +/- 1 psi from 101 - 150 psi.

Order No.	Description
54963	Digital Tire Pressure Gauge

MYERS Dual Foot Pocket Gauges

Straight and 30° reverse chuck or angled chuck



Handy pocket size with clip. Straight chuck with 30° reverse angle. Calibrated 20-120 lbs. in 2 lb. units.

Order No.	Mfr. No.	Description	Bar	Calibration
54849	AH 7278	Pencil Gauge	Nylon	20-120 lbs.
Handy pocket size w/ clip 5 7/8" long. Calibrated 20 to 120 lbs. in 2 lb. units				
54841	X2-10D	Dual Foot Gauge	Nylon	20-120 lbs.

Pocket Tapered Dual Foot Gauge

- Straight & 30° reverse chuck



Extended tapered end on the straight end for easier gauging. Calibrated 20-120 lbs. in 2 pound units.

Order No.	Mfr. No.	Description	Bar	Calibration
54857	1317T-SP	Pocket Style	Nylon	20-120 lbs.

FLEETLINE Digital Air Gauge

- Bleed button
- Quality dual foot chuck
- Automatic shut off after 90 seconds to save battery



Push the power button "on". Gauge automatically calibrates and is accurate to +/- 1%. Press the air chuck onto the valve stem and the pressure is indicated on the large, easy-to-read digital display. Remove the gauge and it is ready for the next reading. Gauge is encased in a protective cushion for long lasting service. Normal operating temperature range 0°F. to 100°F, average battery life 5 years. Replace with a cr2032 or equivalent battery. Calibrated 0 to 100 in 1/2 lb. units, 100 to 160 lbs. in 1 lb. units

Order No.	Mfr. No.	Description	Calibration
54912	DT150-33CH	Digital Air Gauge	0-160 lbs.

Accu-Read Tapered Dual Foot Gauge

- Straight & 30° reverse chuck



Aluminum laser engraved bar with clear protective coating for easy reading

Calibrated 10-150 lbs. in 2 pound units. Exceeds CA CARB requirements for accuracy. Length 12"

Order No.	Description	Bar	Calibration
54859	Accu-Read Tapered Dual Foot Gauge	Metal	10-150 lbs.

MYERS Dual Foot Gauges

- 30° Reverse chuck ideal for inside dual wheels



Aluminum laser engraved bar with clear protective coating for easy reading

Accurate to within 1 psi per Myers specifications. Deeper recess in the head provides better contact with the valve. 6" extension. Exceeds CA CARB requirements for accuracy. Slide bar reads 10 to 150 lbs. in 2 lb. units.

Order No.	Mfr. No.	Description	Bar	Calibration
54860	X2-10SC	Myers Straight/Dual Foot Gauge	Metal	10-150 lbs.

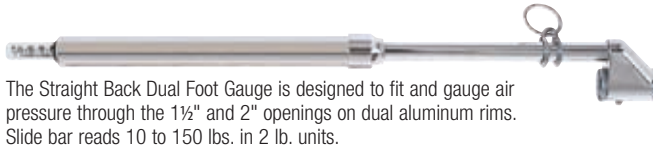

The Straight Back Dual Foot Gauge is designed to fit and gauge air pressure through the 1½" and 2" openings on dual aluminum rims. Slide bar reads 10 to 150 lbs. in 2 lb. units.

Order No.	Mfr. No.	Description	Bar	Calibration
54834	X2-10SB	Straight & 180° Reverse Chuck	Metal	10-150 lbs.

DILL Dual Foot Gauge

- 30° Reverse chuck ideal for inside dual wheels



6" extension. Hang-up ring. Slide bar reads 10 to 150 lbs. in 2 lb. units. Straight and reverse 30° angle chuck.

Order No.	Mfr. No.	Description	Bar	Calibration
54821	7125-H	Dill Straight/Dual Foot Gauge	Nylon	10-150 lbs.

MYERS Dual Foot Angled Chuck

- 30° Reverse chuck ideal for inside dual wheels



6" extension, dual foot, hang-up ring. Calibrated 10 to 150 lbs. in 2 lb. units.

Order No.	Mfr. No.	Description	Bar	Calibration
54837	X2-10	Dual Foot Gauge	Metal	10-150 lbs.

Racing Tire Gauge

Dial-type indicator calibrated 5-160 lbs. in 2 lb. units. 7" flexible hose with swivel chuck. Packed in metal box, 0-1100 KPA Metric.



Order No.	Mfr. No.	Description	Calibration
54825	8939	Racing Gauge	5-160 lbs.

Recalibratable Air Gauge



Recalibrating Instructions

- 1.) Turn the hex nut in the middle of the gauge to separate the halves
- 2.) Remove the rubber cover on top of the adjustment screw.
- 3.) Turn 360° clockwise to decrease 1 psi. Turn 360° counter clockwise to increase 1 psi.



Calibrated 10-150 lbs. in 2 pound units.

Order No.	Mfr. No.	Description	Bar	Calibration
54811	7285R	Dual Straight Foot	Metal	10-150 lbs.

MYERS Recalibratable Air Gauge

- Recalibrate without disassembling the gauge
- Metal bar calibrated 10 to 150 lbs. in 2 lb. units



Recalibrating Instructions

- 1.) Use a flat screwdriver with a maximum OD of 0.1" to adjust the scale bar.
- 2.) Turn 360° clockwise to increase 1 psi. Turn 360° counter clockwise to decrease 1 psi.



Order No.	Mfr. No.	Description	Calibration
54881	EZ CAL400	Recalibratable Air Gauge	10-150 lbs.

MYERS Recalibratable Go-No-Go Air Gauge

- Visual green bar between 80 & 100 psi
- Recalibrate without disassembling the gauge
- Metal bar calibrated 10 to 150 lbs. in 2 lb. units



See 54881 above for calibration instructions.

Order No.	Description	Calibration
54826	Recalibratable Go-No-Go Air Gauge	10-150 lbs.

Go-No-Go Ultra Precision Digital Air Pressure Gauge

- For use by truck fleet maintenance facilities who dictate a set pressure for all tires in the fleet
- Compensates for altitude & ambient temperature
- 85 to 115 psi, can be set in 5 lb. increments
- Green display indicates correct pressure within 2 psi, Red display indicates incorrect pressure
- 0 to 150 psi



Correct Pressure

Incorrect Pressure



Order No.	Description
54958	Go-No-Go Digital Gauge

Master Pressure Gauges

Ultra Precision Master Gauge

- Includes Certificate of Calibration to meet the ASME B40.1 Grade B accuracy requirement
- Use weekly to check accuracy of tire gauges

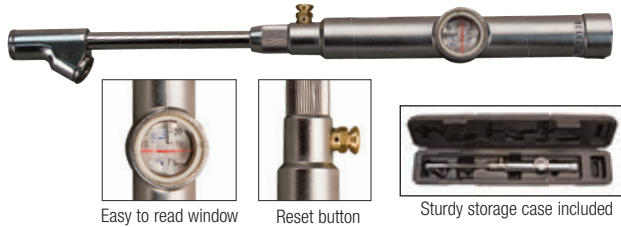

Easy to read window

Reset button

Sturdy storage case included

Order No.	Description
54817	Master Gauge

Master Test Gauges



Precision-engineered instrument not intended for regular checking of tires but for master checking of other tire gauge equipment. Designed and calibrated for highest degree of accuracy. 10-160 lbs. in 2 lb. units.

Order No.	Mfr. No.	Description.	Bar	Calibration
54845	1075	Master Test Gauge	Nylon	10-160 lbs.



For checking accuracy of other gauging devices. Calibrated from 5-160 lbs. in 2 lb. units, and 0-1100 KPA Metric. Packed in a metal box.

Order No.	Mfr. No.	Description.	Calibration
54823	8860C	Master Gauge	5-160 lbs.

Air-Water Tractor Gauge



With pocket clip. Special gauge construction enables you to check liquid-filled tires without damage to the gauge. Calibrated 5 to 45 lbs. in one pound units.

Order No.	Mfr. No.	Description	Bar	Calibration
54840	X2-10C	Air-Water Gauge	Nylon	5-45 lbs.

Tractor Tire Gauge



With hose extension and swivel chuck. Check liquid-filled tires without damage to the gauge. Calibrated 0-100 lbs. in 1 lb. units, and 0-700 KPA Metric.

Order No.	Mfr. No.	Description	Calibration
54822	8810H	Air-Water Gauge	0-100 lbs.

Standard & Large Bore Air/Liquid Gauge



Includes hose extension, chuck and bleeder valve. Calibrated from 0-160 lbs. in 5 lb. units, and 0-1100 KPA Metric. Holds pressure read-out until released. 14" Flexible hose.

Order No.	Mfr. No.	Description	Calibration
54829	GA-274	Air-Liquid Gauge	0-160 lbs.

Myers Ultra-Precision Air Gauge Check Station

- Check master & shop gauges



54614
Optl. Regulator

54667
Optl. Filter

Shown with optional
regulator & filter

The ideal solution for checking standard or large bore tire pressure gauges for accuracy.

The ultra precision digital gauge reads from 0 to 150 psi and has been calibrated to meet the plus or minus 0.3 psi accuracy requirement. **NOTE** – Myers 54906 does not include an air regulator or airline filter. The filter and regulator should be attached to the 1/4 inch male pipe thread on the side of the Gauge Check Station.

Order No.	Description	Ship Wt.
54906	Master Air Gauge Checking Station	11 lbs. - 5 kg
Optional Parts		
54614	Airline Regulator	
54667	Airline Filter	

Air Gauge Checking Station

- A fast, easy way to check air gauges for accuracy



Check air gauges for accuracy quickly and easily. Mount the station in an accessible location. Connect it to an air line and set the pressure to the most common psi the air gauges will be testing, then simply apply the air gauge to the valve. If the reading is not within tolerance, it is inaccurate and should be replaced. The air gauge checking station consists of a 0 - 160 psi gauge, tank valve, air regulator, and a block to keep the assembly dry, all mounted on a pressure reservoir. Note: A certificate of accuracy suitable for ISO records is included.

Order No.	Description	Ship Wt.
54905	Air Gauge Checking Station	6 lbs. - 3 kg
Replacement Parts		
44639	Replacement Gauge	1 lbs. - 1 kg
54667	1/4" Block Filter	1 lbs. - 1 kg
54668	1/4" Block Element	1 lbs. - 1 kg
54614	Replacement 1/4" Regulator	

Aircraft Tire Gauges

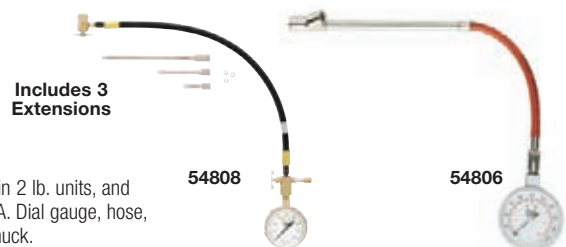

Includes 3
Extensions

54808

54806

0-200 lbs. in 2 lb. units, and 0-1400 KPA. Dial gauge, hose, dual foot chuck.

Order No.	Mfr. No.	Description	Calibration
54806	8885	Aircraft Gauge	0-200 lbs.

0-400 lbs. in 5 lbs. units and 0-2800 KPA. Dial gauge, hose, dual foot chuck.

Order No.	Mfr. No.	Description	Calibration
54807	8844	Aircraft Gauge	0-400 lbs.

0-400 lbs. for tires and hydraulic shock struts. Includes operating instructions and metal box with 3 extensions.

Order No.	Mfr. No.	Description	Calibration
54808	8874	Aircraft Gauge	0-400 lbs.

Large Bore Valve Tools

Ruggedly made with tough, shock-resistant plastic handles. Particularly valuable where valve is located in difficult or awkward position.

Order No.	Mfr. No.	Description
27225	AH-5261	Hex Valve Cap Tool
27226	AH-5262	Valve Stem Refacer
27227	AH-5263	Valve Stem Rethreader – Female
27228	AH-5264	Valve Stem Reseater
27229	AH-5265	Valve Core Screw Driver
27230	AH-5266	Valve Stem Rethreader – Male
27231	AH-5267	Valve Inside Extractor
27232	AH-5268	Screwdriver Valve Cap Tool
27233	AH-5260	Complete Kit – 8 Tools In Pouch



27233



27225 27226 27227 27228 27229 27230 27231 27232

Large Bore Nut Driver



Use to install LN-10 nylon nut onto the TR218A series tractor tube valve. For use on outer cap nuts.

Order No.	Mfr. No.
27107	TL-LN-10

For Use On



Large Bore Jumbo Multi-Purpose Valve Repair Tool

Removes or installs jumbo cores, extracts damaged core, rethreads both inside and outside of stem.

Order No.	Description
27212	Jumbo Tool



Large Bore Valve Repair Tool

Repairs internal and external threads on large bore and air/liquid valve bases.

Order No.	Mfr. No.	Description
27214	TL695	Large Bore Valve Repair Tool



Large Bore Valve Core Wrench

For large bore valve cores.

Order No.	Mfr. No.
27213	AH-2661

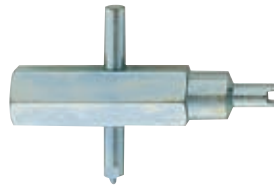

Large Bore Valve Fishing Tool

Pulls valve into position thru rim hole. Cap fits .482-26 thread.

Order No.	Mfr. No.	Length
27268	8909-C	31"



High Pressure Inflation Connection

Fits .305-32" thread size with 1/8" mpt. Has a core depressor pin and copper sealing washer. Maximum working pressure 3,000 psi.

Order No.	Mfr. No.
27108	H-556



Large Bore Valve Core Tool



Order No.	Mfr. No.	Length
26136	N-1710	10"

Slide sleeve for positive grip on valves.

Large Bore Hex Cap Remover



Length 10".

Order No.	Mfr. No.
26137	N-1810

Large Bore Clip-On Air Chucks

Attached to 1/4" NPT hose fittings. Snaps on, releases by pulling sleeve.



Order No.	Mfr. No.	Description
27273	4660A	Air Chuck
27274	4660-103	Repair Kit for 4660A
27315	9038	Air Chuck

Large Bore Right Angle Dual Purpose Air Chucks

Right angle dual foot fits both standard .305" and Large Bore .482" valve mouths. 1/4" fpt.



Order No.	Mfr. No.	Description
27283	AH-1417	Dual Foot Gauge -6" Extension
27316	AH-7245	Dual Foot Gauge -12" Extension

Large Bore Lock-On Air Chucks

Locks on when pushed against valve and tilted up or down. 1/4" fpt.



27318

Order No.	Mfr. No.	Description
27318	8914-L	Ref.5562
27267	AH-5483	
27314	8911-L	

27314
27267

Large Bore Tube Deflator

Standard air chuck is applied to side inlet and pressure deflates tire.

Order No.	Mfr. No.
27272	6108-J



Large Bore Gauges

Large Bore Swivel Foot Gauge



Fits .482-26 Large Bore or .305-32 Truck Tire valves. Specially designed single swivel-foot adjusts to straight push-on or right angle approach to valve mouth. Calibrated 10 to 150 lbs. in 2 lb. units.

Order No.	Mfr. No.	Description.	Bar	Calibration
27189	AH-5566	Swivel Foot Gauge	Nylon	10-150 lbs.

Large Bore Swivel Foot Gauge



A turn of swivel chuck makes it easy to service valves at any angle from 90° to straight on. Automatically locks on and won't slip off. Services standard bore as well as large bore valves. Calibrated 10-150 lbs. in 2 lb. units.

Order No.	Mfr. No.	Description.	Bar	Calibration
27193	AH-7233	Swivel Foot Gauge	Nylon	10-150 lbs.

Large Bore Recalibratable Air Gauge

- Recalibrate without disassembling the gauge

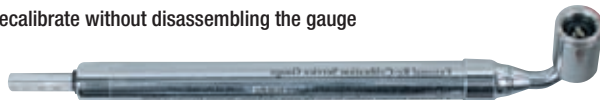

A turn of swivel chuck makes it easy to service valves at any angle from 90° to straight on. 10 to 150 in 2 lb. increments.

Order No.	Description.	Bar	Calibration
27129	Large Bore Gauge	Metal	10-150 lbs.

Large Bore Straight Push-On Gauge



Fits both standard truck and oversize valves. 6" barrel, straight push-on type. Calibrated 20 to 120 lbs. in 2 lb. units.

Order No.	Mfr. No.	Description.	Bar	Calibration
27301	AH-7226-H	Push-On Gauge	Nylon	20-120 lbs.

Large Bore Close Clearance Gauge



Straight push-on, small foot diameter to reach in where valves have least clearance. 10 to 60 in 2 lbs., 60 to 160 in 5 lb. increments.

Order No.	Mfr. No.	Description.	Bar	Calibration
27188	4663	Close Clearance Gauge	Metal	10-160 lbs.

Air/Liquid Master Gauge



For checking accuracy of service gauges. Has 15" flexible hose and straight chuck. For use on oversize or standard valves. 5-160 lbs. in 2 lb. units and 0-1100 KPA Metric. May be used for air-water gauging. Metal box.

Order No.	Mfr. No.	Description.	Calibration
27303	AH-8810J	Air-Liquid Master Gauge	5-160 lbs.

Large Bore Dual Chuck Tire Inflation Device



Dual chuck assembly – attaches to air hose for inflating standard or large bore valves. Screws on valve. Has application point for gauging pressure without removing. Two 5' hoses

Order No.	Mfr. No.	Description
27279	AH-3946E	Inflator with Clip-On Chuck

Same as above but with right angle chuck in place of clip-on chuck.

Order No.	Mfr. No.	Description
27280	3946	Inflator with Right Angle Chuck

Replacement Chuck

Order No.	Mfr. No.	Description
27273	427-189	For AH-3946E(27279)

90° Replacement Chuck

Order No.	Mfr. No.	Description
27282	3946-197	Chuck



27273



27282

OTR Tread Depth Gauge

Two-piece gauge spans tread lugs on giant OTR tires. Accurately measures tread depth for matching dual tires, amount of wear, and tread life remaining. Calibrated 0" to 6" in 1/32" (7 to 152 mm).

Order No.	Mfr. No.	Description
56461	5131	OTR Tread Depth Gauge

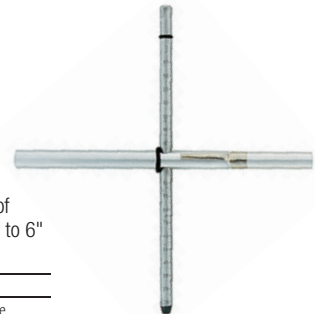

Deluxe OTR Tread Depth Gauge

The 7-3/4" bar easily spans the tread lugs of OTR tires. Magnified sight glass for readability. Calibrated 0" to 6" in 1/32" (0 to 152 mm). Features a steel bar and machined aluminum frame. The slide bar stores in the back of the frame when not in use.

Order No.	Description
42590	OTR Tread Depth Gauge Deluxe

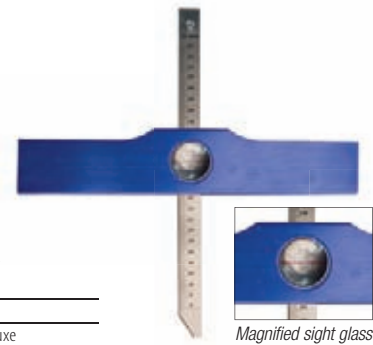

Magnified sight glass

OTR Tread Depth Gauge

- Professional



Indicating bar is calibrated in 32nds or millimeters. Magnified sight-glass for easy readability. Steel bar, machined aluminum frame.

Order No.	Mfr. No.	Description
56457	N1410	OTR Tread Depth Gauge

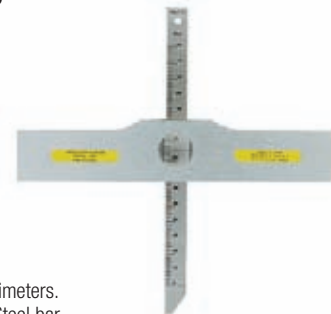

Myers Tire Supply is your air service headquarters. Take advantage of the most complete line of air service & accessories in the industry. We stock automatic one & four tire inflators to inflate or top off fleet vehicles & hand-held inflators for use in the PM lane or service truck applications. **BRANICK, HALTEC & CHAMPION** nitrogen inflation systems are available plus nitrogen color coded valve caps, hoses and hose reels. We now offer **ULTRA PRECISION** gauges & inflators that automatically compensate for altitude & temperature. Standard hose reels, hose repair parts, air couplers & filter-regulator-lubricators are in stock & ready for shipment. Take advantage of our complete line of **INGERSOLL-RAND, CHICAGO PNEUMATIC & CHAMPION** air compressors.



MYERS TPMS Digital Inflation Gauge

- Compensates for altitude & ambient temperature
- 6 to 174 psi
- Accuracy +/- 1.5 psi.



The gauge contains a computer chip that reads the outside temperature, the temperature of the air inside the tire chamber and the external barometric pressure. The display provides the same pressure reading as the TPM sensor is transmitting to the vehicle regardless of weather, temperature and elevation. Includes a Certificate of Calibration. Requires (2) AAA batteries.

Order No.	Description	Ship Wt.
27170	TPMS Digital Inflation Gauge	2 lbs. - 1 kg

Premium Single Hand Lock-On Chuck



Order No.	Description
54360	Single Hand Lock-On Chuck

SAFETY PRECAUTION

These products, as well as all tire tools, should never be used by persons unless they have been trained properly according to O.S.H.A. Regulation #29CFR 1910.177 entitled Servicing Single-Piece & Multi-Piece Rim Wheels.

Tire Inflators

PCL Automatic Digital Tire Inflator

- Accurate, low cost tire inflator
- Wall mounted for convenience
- Inflates one tire at a time with audible beep when complete
- Nitrogen compatible
- 3 Programming options



Automatic inflator recommended for service centers, specialty wheel shops, tire dealers, and automobile dealerships. Automatically inflates or deflates any tire in seconds. Pressure reading is displayed on back lighted LCD screen. Features an adjustable over pressure setting. Three modes for standard, Over Pressure Setting and nitrogen purging/inflation. Includes touchscreen technology, automatic start feature, calibration certificate, manual, mounting bracket, , and 16' 1/4" air hose with clip-on chuck. 1-Year warranty. *Specs.:* power 110v; unit of measurement 1 psi; operating range 0 -145 psi; max. inflation pressure 145 psi; accuracy +/- 0.5 psi; air inlet 1/4"; ship. wt. 8 lbs.

Order No.	Description
54954	Automatic Digital Tire Inflator

Single Tire Automatic Inflation System

- For cars & light trucks - inflates one tire at a time
- Built-in computer constantly monitors tire inflation
- For indoor & outdoor use



Only one tire can be inflated at a time but multiple hoses can be run from the assembly to supply separate areas and switched using a control valve. Pressure readings displayed on large LCD screen. An in-line filter should be installed between the air compressor and the inflator. Inflation time varies depending on incoming psi versus desired pressure. Optimum pressure from the shop air compressor is 145 psi. *Specs.:* power 110v or 12v DC; unit of measurement 1 psi; operating range 5 -145 psi; accuracy .3 psi entire range; operating temp. 14°F to 122°F; air inlet 1/4"; filtered air req. 150 psi max.

Order No.	Mfr. No.	Description
54952	89XDA	Automatic Inflator with 24' Hose & Flow-Thru Clip On Chucks

AUTO FILL Automatic Digital Tire Inflator

- Provides accurate inflation to eliminate TPMS accuracy issues
- Set the pressure desired & walk away
- For cars & light trucks, inflates one tire at a time
- Audible beep when finished
- Nitrogen compatible

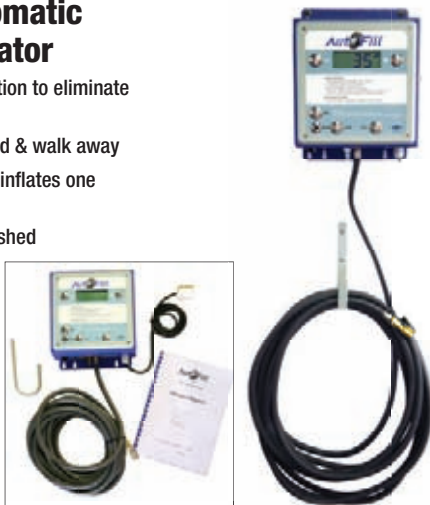

Automatic inflator recommended for service centers, quick lube shops, car rental facilities, and automobile dealerships. Automatically inflates or deflates any tire in seconds. Pressure reading is displayed on back lighted LCD screen. The unit is self-calibrating and self-diagnostic. Features an adjustable over pressure setting. Includes mounting bracket, hose storage hook, and 32' 1/4" airhose with clip-on chuck. *Specs.:* power 110v; unit of measurement 1 psi; operating range 5 -102 psi; accuracy +/- 0.5 psi; air inlet 1/4";

Order No.	Description
54613	Auto Fill Digital Tire Inflator

PCL Qube4 Automatic Digital 4-Tire Inflator

- Accurate, low cost tire inflator
- Wall mounted for convenience
- Inflates four tires at a time with audible beep when complete
- 3 Programming options



Features an adjustable over pressure setting. Three modes for standard, Over Pressure Setting and nitrogen purging/inflation. Includes touchscreen technology, automatic start feature, calibration certificate, manual, mounting bracket, manifold, and (4) 25' 1/4" air hose with lock-on chucks. 1-Year warranty. For indoor use only. *Specs.:* power 120v; unit of measurement 1 psi; oper. range 0 -145 psi; max. inflation pressure 145 psi; accuracy +/- 1 psi; air inlet 1/4"

Order No.	Mfr. No.	Description	Ship Wt.
54619	Qube 4	Digital 4-Tire Inflator	20 lbs. - 9 kg

Automatic Inflation Systems

- For truck tires 19.5 & larger
- Inflate one to four tires from 5 to 145 psi in four minutes
- Built-in computer constantly monitors inflation & deflation
- Self-Calibrating



High volume inflator recommended for fleet operations, large tire mounters, heavy-duty tire centers, OTR and mining operations. Pressure readings displayed on large LCD screen. An inline filter should be installed between the air compressor and the inflator. Inflation time varies depending on incoming psi. vs. desired pressure. Optimum pressure from the shop air compressor is 145 psi. *Specs.:* power 110v or 12v DC; unit of measurement 1 psi; operating range 5 - 145 psi; accuracy .3 psi entire range; operating temp. 14°F to 122°F; air inlet 1/2"; filtered air req. 150 psi max.

Order No.	Mfr. No.	Description
54945	89XDB-1	Single Tire Inflator with 20' Hose & Dual Chuck
54946	89XDB-4	Four Tire Inflator with Four 24' Hoses & Clip-On Chucks

Tire Topping System

- Equalize four tires to correct pressure at the same time
- 4 Dual foot lock-on chucks



Simply dial to the desired pressure, connect the inflation lines and flip the inflation switch. Inflate one to four tires to the desired pressure equally at the same time. Each individual tire pressure displayed on gauge. Tire pressure is operator adjustable to 125 psi.

Order No.	Description	Ship Wt.
54380	Tire Topping System	55 lbs. - 26 kg

Hi Flo Inflator

- Compliant to CA 2 psi standard

100% tested and includes individual calibration certificate. Inflate, deflate and read pressure without removing the chuck. Press lever down to inflate and half way down to deflate. Displays 0 through 138 psi and accuracy greater than +/- 2 psi. Optional hose lengths and styles available. Includes dual foot lock-on chuck and 21" hose.

Order No.	Mfr. No.	Description	Ship Wt.
54843	ALG3A09	Tire Inflation Gauge	2 lbs. - 1 kg



Window Inflation Gauge

- Easy to read magnifying lens window

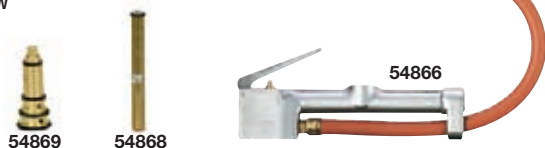

Heavy-duty gauge with dual face swivel chuck. Indicator ring allows full view of scale in 2 lb. graduations from 10 lbs. to 160 lbs. Service without removing gauge from air line.

Order No.	Mfr. No.	Description
54866	S506	Gauge with 45°, Dual Chuck (Full Swivel) 15" Hose
54870	501M	Gauge with Straight Dual Chuck 5' Hose

Replacement Parts

54868	507	Replacement Gauge Cartridge
54869	512	Replacement Valve Cartridge
54867	509	Whip Hose Assembly Complete (Dual Head Chuck, 15" Hose, 3/8"-24 Thread)

Quick-Inflate Dual Tire Inflators

- Inflate Dual Tires at the same time



Inflate both tires at the same time to equal pressure. The lock-on chuck assembly can be quickly engaged and disengaged from valve stems. Same air source serves both legs so both tires are automatically equalized. Use with standard truck valve or Myers V2B inflate-thru valve cap. Ideal for fleets and truck maintenance facilities.

Order No.	Mfr. No.	Description	Flow
54936	1408	Dual Inflator Assembly w/ Gauge Unit	Non Flow Thru
54934	1408-HC	Dual Inflator Assembly Only	Non Flow Thru
54932	1408-2	Dual Inflator Assembly Only	Flow Thru
54933	1408-I	Straight Leg Inflator Only	Flow Thru
54938	1408-IC	Straight Leg Inflator Only	Non Flow Thru
54939	118	Replacement Dual Foot Chuck	Non Flow Thru

Digital Inflator

Inflate, deflate and read pressure without removing the chuck. Deflate button below the digital display. 100% tested and includes individual calibration certificate. 0 to 174 lbs. in 0.2 psi increments and accurate +/- 0.2 psi. Standard 1 year warranty.

Order No.	Description	Ship Wt.
54950	6' Hose with Clip-On Chuck	2 lbs. - 1 kg



Inflation Gauges

- Inflate & deflate
- Dial gauge

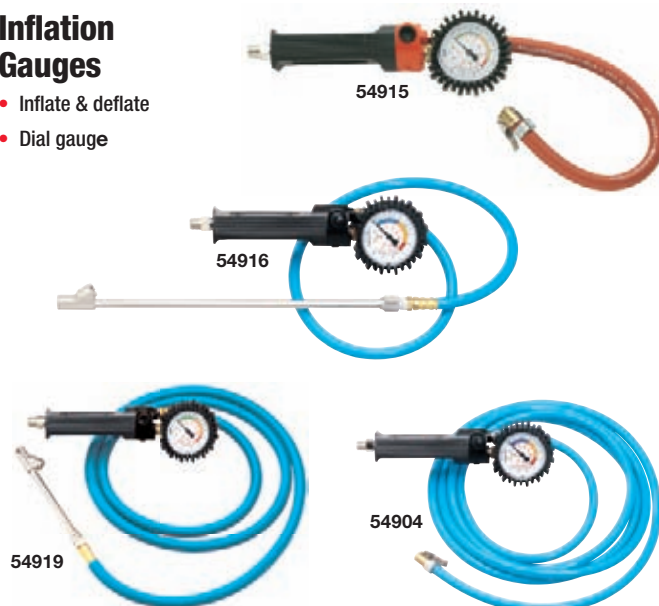

Excellent all purpose inflation gauges. Large, easy to read dial gauge calibrated 0 to 140 psi and 0 to 10 bar scale. Encased in a protective cushion for long lasting service.

Order No.	Description	Chuck Style
54915	Gauge with 18" Hose	Straight Clip-On Chuck
54904	Remote Inflation Gauge with 12' Hose	Straight Clip-On Chuck
54919	Remote Inflation Gauge with 7' Hose	Dual Foot Tilt Lock Chuck
54916	Gauge with 3' Hose	Long Reach 14' Straight 30° Dual Foot Lock-On Chuck

3910 Inflation Gauges

- Dial Gauge
- Rugged enough for any shop
- Tilt lock or clip-on chuck

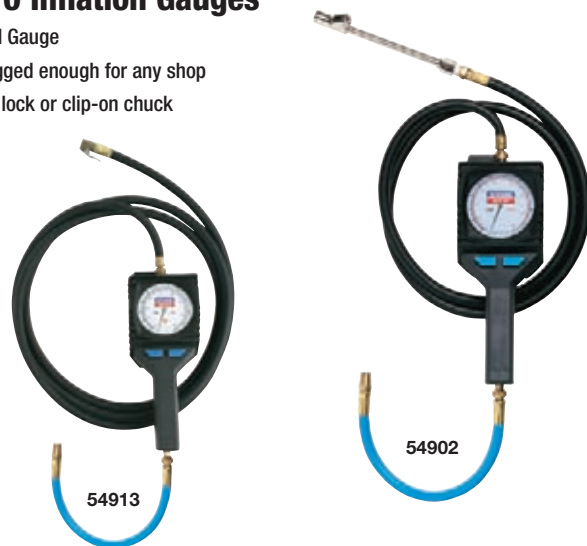

The gauges are enclosed in a strong polymer casing. Push button inflate/ deflate buttons allow accurate adjustments. Calibrated in 2 lb. increments from 10 to 170 lbs. and 1 to 12 bar scale. Includes 5' or 11' hose and choice of chucks, straight clip-on or 6" dual foot tilt lock, hanging bracket and comfortable grip handle. Swivel air inlet eliminates hose kinking. Includes 1' inlet hose.

Order No.	Mfr. No.	Chuck Type	Hose Length	Ship Wt.
54902	3910DF5	Dual Foot Tilt Lock	5'	3 lbs. - 2 kg
54930	3910DF11	Dual Foot Tilt Lock	11'	3 lbs. - 2 kg
54913	3910CS	Clip-On Chuck	5'	3 lbs. - 2 kg
54931	3910C11	Clip-On Chuck	11'	3 lbs. - 2 kg

Replacement Hoses

Order No.	Description	Hose Length
54153	Inlet Hose Metric FPT to 1/4" MPT Thread	1'
54154	Inflation Hose 6" Dual Ft. Tilt Lock	5' w/ Metric FPT
54158	Inflation Hose 6" Dual Ft. Tilt Lock	11' w/ Metric FPT
54453	Inflation Hose w/ Clip-On	5' w/ Metric FPT
54454	Inflation Hose w/ Clip-On	11' w/ Metric FPT

Inflation Gauges

Lever Style Inflation Gauges

- Calibrated 14-120 lbs. in 2 lb. units

Bayonet Gauge with Clip-On Chuck



Order No.	Dill. No.	Haltec No.	Description	Ship Wt.
54922	7253-3	1405-3M	Lever Type Inflator with 3' Hose	2 lbs. - 1 kg
54925	7253-6	1405-6M	Lever Type Inflator with 6' Hose	2 lbs. - 1 kg

Bayonet Gauge with Straight Chuck



Calibrated 10-80 lbs. in 2 lb. units. Small straight chuck fits all passenger and truck valves.

Order No.	Mfr. No.	Description	Ship Wt.
54920	7250	Straight Chuck Inflator	2 lbs. - 1 kg

Bayonet Gauge with Dual Foot Chuck

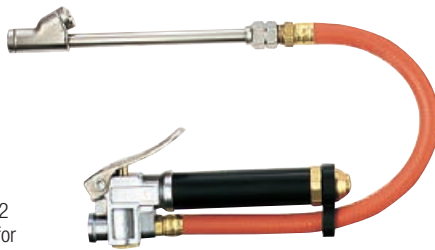

Calibrated 14-120 lbs. in 2 lb. units. Dual foot chuck for truck and bus use.

Order No.	Dill.No.	Haltec No.	Description	Ship Wt.
54921	7252	1406-M	Dual Foot Chuck Inflator	2 lbs. - 1 kg

Bayonet Gauge With Long Reach Dual Foot Chuck



Calibrated 14-120 lbs. in 2 lb. units. Has 19 3/4" (33 cm) rigid extension with swivel dual foot chuck for servicing dual tire assemblies on trucks and buses.

Order No.	Mfr. No.	Description	Ship Wt.
54923	7255	Long Reach Inflator	2 lbs. - 1 kg

Replacement Ultra Precision Digital Inflation Dial

- Replacement dial for the 54957, 54959, 54060 & 54906 Ultra Precision inflators
- 0 to 150 psi



The Digital Inflation Dial contains a computer chip that reads the outside temperature, the temperature of the air inside the tire chamber and the external barometric pressure. Using these readings it automatically calculates the adjustment to standard operating pressure allowing for the proper tire pressure inflation. **Note:** If pressure is over 155 psi, the gauge displays "OFL".

Order No.	Description
54965	Ultra Precision Digital Inflation Dial

Ultra Precision Digital Inflation Gauges

- Compensates for altitude & ambient temperature
- 0 to 150 psi
- Features 6' hose & swivel neck
- Clip-On or Lock-On flow thru chucks



The Ultra Precision Digital Gauge contains a computer chip that reads the outside temperature, the temperature of the air inside the tire chamber and the external barometric pressure. Using these readings it automatically calculates the adjustment to standard operating pressure allowing for the proper pressure compensation. The display shows the technician the standard operating pressure relieving him from making the calculations to achieve proper inflation pressures. Low battery warning does not effect the accuracy of the gauge. Includes a Certificate of Calibration ensuring accuracy from the factory. **Note:** If pressure is over 155 psi, the gauge displays "OFL".



54957
Standard Clip-On
Flow Thru Chuck



54960
Large Bore Clip-On
Flow Thru Chuck



54959
Straight Dual Foot
Lock-On Flow Thru Chuck

Order No.	Description
54957	Ultra Precision Digital Inflation with Standard Clip-On Flow Thru Chuck
54960	Ultra Precision Digital Inflation with Large Bore Clip-On Flow Thru Chuck
54959	Ultra Precision Digital Inflation with Straight Dual Foot Lock-On Flow Thru Chuck

Go-No-Go Ultra Precision Digital Inflation Gauge with Lock-On Dual Foot Chuck

- For use by truck fleet maintenance facilities who dictate a set pressure for all tires in the fleet
- 0 to 150 psi
- Compensates for altitude & ambient temperature
- 85 to 115 psi, can be set in 5 lb. increments
- **Green** display indicates correct pressure within 2 psi, **Red** display indicates incorrect pressure



The Go-No-Go Inflation Gauge contains a computer chip that reads the outside temperature, the temperature of the air inside the tire chamber and the external barometric pressure. Using these readings it automatically calculates the adjustment to standard operating pressure allowing for the proper tire pressure inflation. The display shows the technician the pressure relieving him from making the calculations to achieve proper inflation pressures. Low battery warning does not effect the accuracy of the gauge. **Note:** If pressure is over 155 psi, the gauge displays "OFL".

Order No.	Description
54962	Go-No-Go Digital Inflation Gauge

Digital Inflator



Large digital display protected by a heavy-duty plastic housing. 3 to 175 lbs. in 1 lb. increments and +/- 1% accuracy. One position inflates, the second position deflates the tire. 90 Second automatic shut-off. 21" Hose with clip-on chuck. LCD back light.

Order No.	Description
54947	Digital Inflator with 21" Hose & Clip-On Chuck
54927	21" Replacement Hose

Air Chucks

Ball Foot Chucks



Order No.	Ref. No.	Description	
54324	AH-5499	¼" FPT	
54327	AH-6293	Clip-On, ¼" FPT	
50223	AH-6923B	Clip-On, Flow-Thru, ¼" FPT	
54323	AH-5495	¼" Air Hose Barb	
54328	AH-6658	Clip-On, ¼" Air Hose Barb	
Replacement Washers & Parts		Per Pack	
54329	AH-6529	Clip for Ball Foot Chucks	1
54343	AH-2866	Rubber Washers for Ball Foot Chucks	10

Straight Lock-On Chucks



Order No.	Ref. No.	Description
54809	5570-SP	Euro-Style Chuck, ¼" FPT
54861	5570FTSP	Euro-Style Chuck, Flow Thru, ¼" FPT
50075	410419	Tire Changer Chuck, Flow Thru, ¼" Air Hose Barb
50076		Repl. Washer for 50075 Package Of 10
54345	AH-8159-11	Repl. Rubber Washer for 54809, 54861 Package Of 10

Lock-On Air Chucks

Locks onto valve when sleeve is pushed forward. Pull sleeve back to release.



Order No.	Schrader. No.	Dill No.	Description
54368		7150	Lock-On Air Chuck, ¼" FPT
54366	5265		Lock-On Air Chuck, ¼" FPT
54364		7148	Lock-On, Flow Thru, ¼" FPT
Repair Kits for 54366		Fits Chuck	
54367	5265-103		54366

Core Removing Tool

- Prevents loss of nitrogen when inserting the core

Decreases inflation and deflating time and prevents loss of nitrogen while inserting the valve core. Also used when adding tire seal to the tire.

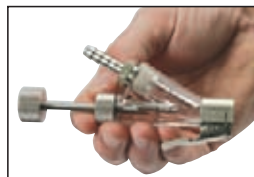

Order No.	Mfr. No.	Description
54355	IN-20	Core Removing Tool

Extended Clip Lock-On Air Chuck

- 13" Long, easily reaches the inner wheel



Push clip, slide over valve and release. Push clip again to release. Will not slip or leak. 1/4" FPT.

Order No.	Description
22671	Extended Clip Lock-On Air Chuck

Premium Single Hand Lock-On Chuck

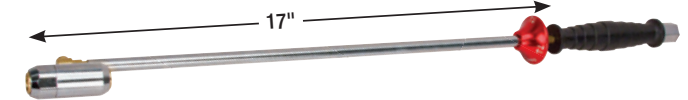

Pull handle to lock on valve. 17" Long for easy access to inner dual wheels.

Order No.	Description
54360	Single Hand Lock-On Chuck

Dual Foot Chucks

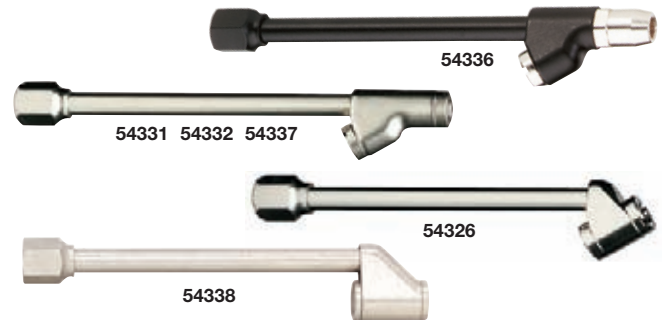

Order No.	Ref. No.	Description
54336	6568T-SP	Tapered Dual Foot, Lock-On, ¼" FPT
54331	AH-6999	Straight Dual Foot Chuck, ¼" FPT
54332	AH-6999-L	Straight Dual Foot Chuck, Lock-On, Non-Flow Thru ¼" FPT
54337	6568T-SP	Straight Dual Foot Chuck, Lock-On, Flow Thru, ¼" FPT
54326	AH-8159B	Angle Dual Foot Chuck, ¼" FPT
54338	CH-370-LO	Straight Back Lock-On, ¼" FPT

Washers and Parts		Per Pkg.	
54345	AH-8159-11	Repl. Rubber Washers for 54326, 54332, 54337, 54331, 54809, 54861, 54335, 54333, 54334, 54336	10

Long Dual Foot Chucks



Order No.	Ref. No.	Description
54335	6566LB-SP	13" Long Angle Dual Foot, ¼" FPT
54333	MT 569L	14" Long Dual Foot Chuck, ¼" FPT
54334	MT 568L	14" Long Dual Foot Chuck, Lock-On, ¼" FPT

Valve Core Removing Tool



Lock-On chuck attaches securely to the valve. Valve core tool prevents core loss during tire inflation and deflation. Full bore inflator/deflator.

Order No.	Description
54353	Valve Core Removing Tool

Nitrogen Inflation

BRANICK Nitrogen Inflation Systems

- Dial to adjust to any purity level desired, high volume & high purity
- All units feature 2 pre-filters, 3/8" input & outlet ports, auto shut-off, outlet pressure gauges & filter maintenance indicators

The Branick Nitrogen Tire Inflation Systems are free-standing units using an internal membrane to separate nitrogen from the air compressor. Tires may be inflated directly from the station or nitrogen can be stored in a backup tank for additional capacity.

59105 Model 500 for automotive and light volume truck. *Specs.: Air input 13.8 cfm @ 160 psi/75° F; air input range 100 to 175 psi; N2 output 7.1 cfm.*

59109 Model 1000 for medium volume truck and OTR. *Specs.: Air input 27.6 cfm @ 160 psi/75° F; air input range 100 to 175 psi; N2 output 14.2 cfm.*

59110 Model 1500 for high volume truck and OTR. *Specs.: Air input 41.4 cfm @ 160 psi/75° F; air input range 100 to 175 psi; N2 output 21.3 cfm.*

Order No.	Mfr. No.	Description	C.F.M. Output
59105	500	Floor Model Nitrogen Generator Single Membrane System	7.1
59109	1000	Floor Model Nitrogen Generator Double Membrane System	14.2
59110	1500	Floor Model Nitrogen Generator Triple Membrane System	21.3



BRANICK 60 & 120 Gallon Tank Packages

Tower & Wall Mount Generators are not shipped with tanks or accessories



Inflation Packages include: 60-gallon tank, hose & valve assembly, nitrogen analyzer, banner, 6-month web banner ad on www.getnitrogen.org locator, 2 Tsunami coalescent filters, 500 point-of-purchase brochures, tri-fold "Get Nitrogen" display with 200 cards, 1,000 green caps, and high-end green valve cap kit.

Order No.	Description
59309	60-Gallon Inflation Package
59355	120-Gallon Inflation Package

Replacement Nitrogen Tanks & Filter Kits

Order No.	Description
59128	240-Gallon Green Tank, Rated @ 200 PSI
59127	120-Gallon Green Tank, Rated @ 200 PSI
59126	60-Gallon Green Tank, Rated @ 200 PSI
59137	Tsunami Coalescent Filter Kit (2) Elements
59312	Tire Nitrogen Analyzer (Reads % in Tire)
59130	Nitrogen Hose & Valve Assembly
59125	Nitrogen Advertising Banner

BRANICK Wall Mount Nitrogen Inflation Systems

- All units deliver 95% to 99.5% purity
- Dial to adjust to any purity level desired, high volume & high purity
- All units feature 2 pre-filters, 3/8" input & outlet ports, auto shut-off, outlet pressure gauges, & filter maintenance indicators



59353 Model 450 for automotive. *Specs.: Air input 8.4 cfm @ 160 psi/75° F; air input range 100 to 175 psi; N2 output 4.30 cfm @ 160 psi*

59354 Model 650 for automotive and light volume truck. *Specs.: Air input 16.8 cfm @ 160 psi/75° F; air input range 100 to 175 psi; N2 output 8.60 cfm @ 160 psi*

Order No.	Mfr. No.	Description	C.F.M. Output
59353	450	Nitrogen Single Membrane System - Wall Mount	4.3
59354	650	Nitrogen Double Membrane System -Wall Mount	8.6

BRANICK 110 Mobile Nitrogen Inflation Carts



Bottle configuration

Generator configuration

Connect to a generator or use the cylinder configuration to deliver high purity nitrogen. Includes 4 hoses with clip chucks and the option of adding 2 additional hoses. The unit can operate all day on battery or can be plugged into a 120v outlet. Features full programmability, top off and pressure range to 145 psi.

Order No.	Mfr. No.	Description	Ship Wt.
110		Bottle Configuration Nitrogen Inflation Cart	71 lbs. - 32 kg
110		Generator Configuration Nitrogen Inflation Cart	71 lbs. - 32 kg

BRANICK Customer Retention Program

- Provides customers with tire hazard & roadside assistance program
- Offers a network of over 40,000 service providers



Dealer receives 50 bags containing 5 Universal nitrogen valve caps, nitrogen window sticker for the vehicle, key tag registration card plus free listing on getnitrogen.org and access to all marketing materials on the website including full use of dashboard tools for sending quarterly e-newsletters, coupons, etc. Consumer receives nitrogen valve caps, window sticker, dealer generated service coupons, reimbursements of up to \$150.00 for tire replacement or repair and complimentary services including towing, flat tire, lockout, and battery assistance.

Order No.	Description
59364	Nitrogen Cap Kit with Tire Hazard & Roadside Assist

BRANICK Mobile Nitrogen Inflation Systems

- Units deliver 95% to 99.5% purity
- "Purge'n Flate" allows 4-tire inflation
- Model 485 includes hose reels



59367

"Purge'n Flate" automatic inflation allows servicing 1 to 6 tires at a time. The units include 4 hoses. Both units feature 30-gallon tank, 2 pre-filters, 3/8" input and inlet and tank ports, auto shut-off, outlet pressure gauges, and filter maintenance indicators.

Models 475 and 485 for automotive. Specs.: Air input 7.8 cfm @ 150 psi/75° F; air input range 100 to 175 psi; N2 output 4cfm @ 150 psi / 75°

Models 675 and 685 for automotive. Specs.: Air input 15.6 cfm @ 150 psi/75° F; air input range 100 to 175 psi; N2 output 8 cfm @ 150 psi / 75°

59362 Mobile Nitrogen Accessory Package includes: nitrogen analyzer, banner, 6-month web banner ad on www.getnitrogen.org locator, (2) Tsunami coalescent filters, 500 point-of-purchase brochures, tri-fold "Get Nitrogen" display with 200 cards, 1,000 green caps, and high-end green valve cap kit.

Order No.	Mfr. No.	Description	C.F.M. Output
59360	475	Nitrogen Single Membrane Mobile System	4
59367	485	Nitrogen Single Membrane Mobile System w/4 Hose Reels	4
59361	675	Nitrogen Double Membrane Mobile System	8
59368	685	Nitrogen Double Membrane Mobile System w/4 Hose Reels	8
59362	04-0069	Mobile Nitrogen Accessory Package	

BRANICK 370 PSA Nitrogen Generator

- Fully automated mobile system
- For automotive & motorcycle



Economical way to enter the nitrogen inflation business. Features visual and audio signals for progress and completion with error reporting and self-diagnostics. Includes (4) hoses. Specs.: max. air input 135 psi; N2 output 5.3 cfm; purity 97%; accuracy +/- 0.5%; ship. wt. 340 lbs.

Order No.	Description	Ship Wt
59537	PSA Nitrogen Generator	340 lbs. - 154 kg

BRANICK Dakota Service Truck Nitrogen Inflation Systems

- High output triple membrane system
- Takes up minimum space in the truck bed



59578 Dakota 8 Service Truck System. Specs.: Air input: 10.7 scfm @ 140 psi/75°; air input range: 100 to 200 psi; N2 Output: 4 scfm @ 140 psi; N2 purity: 98%; Operating temperature: -30° to 150° F; inlet & outlet ports: 3/8"; pre-filters: 3; dimensions: 48" x 27" x 18"

59579 Dakota 12 Service Truck System. Specs.: Air input: 16 scfm @ 140 psi/75°; air input range: 100 to 200 psi; min. elec. req. current 55A, inverter (12V DC to 120V AC) 660w; N2 Output: 6 scfm @ 140 psi; N2 purity: 98%; Operating temperature: -30° to 150° F; inlet & outlet ports: 3/8"; pre-filters: 3; dimensions: 48" x 27" x 18"

Order No.	Description	Ship Wt.
59578	Dakota 8 Nitrogen Inflation System	250 lbs. - 113 kg
59579	Dakota 12 Nitrogen Inflation System	270 lbs. - 122 kg

CHAMPION Nitrogen Inflation

Units are pre-mounted on the tank and can be piped to any air compressor system. The tanks are ASME code receivers. Coalescing and particulate filters eliminate moisture and contamination before entering the membrane, no carbon prefilter required. Features filter replacement indicator, automatic shut-off while not in operation and a 5-year limited membrane warranty. Optional **59351** Point of Purchase Kit includes a Tire Stack Cover, a 3' x 5' Banner, a Counter Mat, 1,000 Green Valve Caps and Point of Purchase Brochures.



Order No.	Rec. Use	Tank Size	Compressor Input Reg.	Nitrogen Output	Ship Wt.
59346	Automotive	60 Gallon	8 SCFM	4 SCFM	279 lbs. - 127 kg
59347	Auto, Lt. Tr	80 Gallon	14 SCFM	7 SCFM	391 lbs. - 177 kg
59348	Med. Tr., OTR	80 Gallon	28 SCFM	14 SCFM	416 lbs. - 189 kg
59349	FIL14CE	Replacement Particulate Filter			
59350	FIL14FE	Replacement Oil Filter			
59351	Promotional Kit				

HALTEC Nitrogen Inflator

Purges air and re-inflates the tire with nitrogen with a .3 psi accuracy. Service up to six tires. Operator can designate the number of purges to guarantee the purity level. Self-calibrates every 6 minutes or when turned on.



Order No.	Mfr. No.	Description
59570	89TRL-6B	Nitrogen Inflator

Nitrogen Inflation

HALTEC NIT Nitrogen Trolley

- Provide nitrogen inflation without the expensive investment
- Excellent way to get into the market



Excellent way to get into the market. Uses industry standard bottles as nitrogen source. No expensive filtration system to buy. Fills up to 55 passenger tires per bottle. Rechargeable NiMH batteries last for days. Automatic filling & purging software. Includes power-saving auto power off, vandal resistant switches, backlit LCD display, emergency relief valve, extra universal multi coupling, and international approvals. Nitrogen tank not included.

Order No.	Description
59899	Single Tire Nitrogen Inflator Trolley

HALTEC Nitrogen Inflator

"Top off" nitrogen inflated tires or "Purge" and convert air inflated tires with nitrogen. 1-tire or 4-tire inflator units available. Connect to nitrogen generator, set desired pressure and attach. Self-calibrates every 6 minutes or when turned on. Operating range 5 to 145 psi. Inflator automatically purges air out and re-inflates with nitrogen to within .3 psi of setting. Inflator includes green hose with chuck and air flow control valves



Order No.	Description
59898	Single Tire Nitrogen Inflator
59897	Four Tire Nitrogen Inflator

HALTEC Nitrogen Purity Gauge

Accurate and compact design. Features battery charge indicator, auto-power off function, replaceable battery and sensor.



Order No.	Mfr. No.	Description
54813	Nitro-1	Nitrogen Purity Gauge

Lock-On Chuck

Designed with a spring-loaded deflector pin to ensure a proper seal during multi-tire and nitrogen inflation applications.



Order No.	Mfg. No.	Description
54812	CH-360S	Lock-On Chuck

V2BG Double-Seal Valve Cap

- Green ring indicates nitrogen-filled tires

Designed for high pressure truck tire service. Inflate, deflate or gauge directly thru the V2BG saving time during inflation and pressure checks.



Order No.	Description	Per Box
21535	V2BG Green Ring Valve Cap	50
21534	V2B Standard Valve Cap	50

PARKER N2 Nitrogen Tire Inflation Wand



Connects to standard airline and automatically generates nitrogen from compressed air. TyreSaver has an exchangeable membrane cartridge supplying thousands of tire inflations. Warranty grip 1 year or 50,000 tire fills, whichever comes first. Do not feed liquid condensate, water or oil into the TyreSaver. Includes grip, cartridge, manual, 12" hose (500) Parker Tire valve caps, and desktop flyer holder. Specs.: air input range 72 to 160 psi; N2 output 1.8 cfm @ 145 psi / 68°; max. tire pressure 50% of inlet pressure; purity 95% N2.

Order No.	Description	Ship Wt.
59575	Nitrogen Tire Inflation Wand	10 lbs. - 5 kg
59576	Replacement Cartridge	

Valve Core Removing Tool

- Ideal for nitrogen filled tires



Lock-On chuck attaches securely to the valve. Valve core tool prevents core loss during tire inflation and deflation. Full bore inflator/deflator allows for rapid tire inflation and deflation.

Order No.	Description
54353	Valve Core Removing Tool

REELCRAFT 3/8" Nitrogen Hose Reel

Green hose differentiates from standard shop air. 3/8" hose, 50' length, includes 300 psi hose. Lightweight composite spool, weighs only 29 lbs. 1/2" fpt inlet, 1/4" mpt end.



Order No.	Mfr. No.	Hose Length	Ship Wt.
82425	RT650-OLPG	50'	29 lbs. - 13 kg

Green Air Hose for Nitrogen Inflation

Oil and abrasion resistant. 50' length, 1/4" mpt. 350 psi working pressure.



Order No.	Description
54010	3/8" Green Air Hose

Nitrogen Valve Caps



Order No.	Description	Per Box
59131	Green Plastic Valve Caps for Any Automotive or Truck Stem	1,000
59357	Chrome Plated Brass Valve Caps for Brass Valve Stems Only Not for TPMS	100
59358	Green Anodized Valve Caps for Aluminum TPMS & Other Aluminum Valves	100
59365	Universal Nitrogen Cap for Any Snap-In, Brass, Aluminum or TPMS Valve	100
59138	Green Valve Stem Rings Slip Over All Rubber Valve Stems	500

Go Green Countertop Savings Calculator

- Allows the dealer or customer to instantly see the savings by converting from air to Go Green nitrogen
- Keep it prominently on the sales desk
- The service pays for itself & then saves



Miles Traveled Per Year	Cost Per Tire	Cost Per Gallon of Fuel	Vehicle MPG	Total Annual Savings
10,000	\$100.00	\$3.75	14	\$274.28
12,000	\$150.00	\$3.75	18	\$282.66
15,000	\$200.00	\$3.75	25	\$296.85
18,000	\$250.00	\$3.75	15	\$547.55

Order No.	Description
59599	Go Green Calculator

BESSER Green Machine

- Compact size & portability provides a single nitrogen solution for almost any application



59541
Optional 30
gallon tank



The Green Machine combines high output, up to 12 cfm, and complete automation. Attach the quick connect tire service hoses, select the final inflation pressure, turn the fill valve to "Fill", press the start button and walk away. The Green Machine equalizes and balances the pressure to within .3 psi and emits an audible signal the service is complete. Limited 5 year warranty.

59540: NCS 8 Unit *Specs.:* power req. 100 - 120 v, oper. temp. -4° F to 158° F; air input range 100 to 200 psi; N2 purity 95 99+% (adjustable); N2 output 12 cfm @ 160 psi / 80°; oper. range 5 - 160 psi; accuracy +/- 0.5 psi.

59539: NCS 6 Unit *Specs.:* power req. 100 - 120 v, oper. temp. -4° F to 158° F; air input range 125 to 150 psi; N2 purity 95 99+% (adjustable); N2 output 6 cfm @ 116 psi / 80°; oper. range 5 - 90 psi; accuracy +/- 0.5 psi.;

Order No.	Mfr. No.	Description
59540	NCS 8	Green Machine
59539	NCS 6	Green Machine
59541		Optional 30 Gallon Tank

Customer Retention Program Increases Customer Traffic & Sales!

- Cap Kit program includes Auto club membership
- Compatible with your existing nitrogen equipment
- Monthly personalized newsletters, emails & text messages to your customers



59545

Enroll your customers in the GO Green Tire Inflation Maintenance Program and enjoy the profits repeat business provides. The Go Green program offers monthly Tire Inflation Reminders sent via text message, Facebook and email, plus customized monthly newsletters, all of which can include customer coupons, interactive surveys and much more. Program also provides extensive data sorting and reporting features.

Each "Cap Kit" includes 5 vinyl sleeved, machined aluminum self-sealing valve caps, windshield cling, key ring, program registration card, 12 month membership in the Go Green Auto Club and customer retention program including thank you and service reminder e-mails, texts, monthly newsletters and many other customer management and marketing features.

Go Green Auto Club

Benefits:

24 Hour Emergency Towing Service:

Your vehicle may be towed to the destination of your choice.

Lost Key or Lockout Service:

If your keys are lost, broken or you are accidentally locked out of your vehicle, you will be covered.

Tire Repair & Replacement Coverage:

We will cover the costs of repairing or replacing your tires should you experience a flat tire or tire failure due to a road hazard. \$200.00 Aggregate and a \$100.00 per occurrence limit.

Travel Benefits:

Members receive unbeatable travel pricing on hotels, airfare and rental cars.

24 Hour Emergency Road Service:

You are covered for emergency road service throughout the U.S. and Canada.

Trip Routing Service:

We will, at no charge, produce full color, wire bound trip routings for member's road trips including turn by turn directions, enhanced mapping for metropolitan areas, points of interest and fun games.

24 Hour Emergency Battery Service:

You are covered to boost batteries and perform minor adjustments to alternators, starters, etc. while on the road.

Theft & Hit & Run Protection:

A \$500 reward is offered for information leading to the arrest and conviction of anyone responsible for hit and run damages or stealing your vehicle.

24 Hour Emergency Delivery:

A service truck will deliver emergency supplies of gasoline, water, oil or other necessary supplies. You only pay for the cost of the supplies.

Trip Interruption Coverage:

You are entitled up to \$300 in reimbursements for meals, lodging and transportation charges when you are involved in a collision away from home.

Hose Reels

TYPHOON Blow Guns

High Volume Blow Gun

- High flow, 34 cfm @ 125 psi
- Maximum power, 2.1 lbs. of thrust
- Meets or exceeds OSHA regulations

The ideal blow gun for heavy-duty clean up. Features a variable flow trigger and is lightweight and ergonomic. 1/4" FPT with a high flow tip. Length 10-1/2", width 5-3/4" and height 2-1/8".



54577

Pro High Volume Blow Gun

- High flow, 34 cfm @ 125 psi
- Maximum power, 2.1 lbs. of thrust
- Meets or exceeds OSHA regulations

All the features of the High Volume Blow Gun (54577) but with an all metal design. Chrome plating on the aluminum body resists chemicals and solvents. Silicone-free for paint applications. Chrome-plated brass tip. Can be disassembled for cleaning and maintenance. 1/4" FPT with a high flow tip. Length 10-1/2", width 5-3/4" and height 2-1/8".



54576

Blow Gun Accessories



54578

54578 24" Extension with tip for Typhoon Blow Guns.

54579 5-Piece Typhoon Blow Gun Tips Kit includes Typhoon Blow Gun Adapter and (3) different needle tips, a safety rubber tip and standard rubber tip.



54579

Order No.	Mfr. No.	Description
54577	A680CS	High Volume Blow Gun
54576	A681CS	Pro High Volume Blow Gun
54578	A680-24cn-PB	24" Typhoon Blow Gun Tip
54579	A680-TK01	Typhoon Blow Gun Adapter Kit

TRU-FLATE Safety Blow Gun

Tamper-proof pressure reducer built into valve to limit air pressure at the nozzle. Nozzle pressure less than 30 psi. Conforms to Federal safety regulations. 1/4" fpt.



Order No.	Mfr. No.	Description
54582	410-S	Safety Blow Gun

DILL Blow Gun

The built-in restrictor cannot be removed and limits tip pressure to 30 psi and inlet pressure to 150 psi or less. Conforms to Federal safety regulations. 1/4" fpt.



Order No.	Mfr. No.	Description
54583	5114	Safety Blow Gun

Blow Gun

Angled nozzle easily gets into tight places. Comfortable lever control and insulated handle. Ergonomic grip. High impact plastic body with built-in hanger slot. Brass inlet with 1/4" fpt. Recommended air pressure 90-120 psi.



Order No.	Mfr. No.	Description
54586	759	Plastic Blow Gun

REELCRAFT Automatic Hose Reels

1/2" Hose

- Heavy-Duty models for service trucks & shop applications
- Complete with 300 psi air hose



82422

Easily installed on ceiling, wall or floor in any central position where it will serve several operations or tools. Full flow shaft and a ball bearing swivel assure maximum service. Structurally reinforced dual pedestal base and guide arm design.

1/2" Air Hose with 1/2" Male Fittings

Order No.	Mfr. No.	Hose Length	Ship Wt.
82422	7850 OLP	50'	60 lbs. - 27 kg
82424	82100 OLP	100'	99 lbs. - 45 kg

Recommended Accessories

54148	2' of 1/2" Hose with 1/2" Male Fittings
04521	Repl. Ball Stop for 1/2" Hose Reel

DURO Automatic Hose Reels

1/4" or 3/8" Hose

- Heavy-Duty open models for service stations, garages, & tire centers
- Complete with 300 psi air hose

Easily installed on ceiling, wall or floor in any central position where it will serve several operations or tools. Sealed and lubricated motor springs assure longer life. Adjustable, aluminum hose guides for quiet, friction free operation.



80422

1/4" Air Hose with 1/4" Male Fittings

Order No.	Mfr. No.	Hose Length	Ship Wt.
80422	1402	25'	27 lbs. - 12 kg
80430	1404	35'	31 lbs. - 14 kg
80426	1406	50'	35 lbs. - 16 kg
04520	Repl. Ball Stop for 1/4" Hose Reel		

3/8" Air Hose with 1/4" Male Fittings

80424	1414	25'	31 lbs. - 14 kg
80432	1416	35'	37 lbs. - 17 kg
80428	1418	50'	43 lbs. - 20 kg
04522	Repl. Ball Stop for 3/8" Hose Reel		

Automatic Hose Reels

3/8" Or 1/2" Hose

- Standard-duty open models
- Complete with 250 psi air hose

Eliminates looping of hose on floor. Easy mounting.

3/8" Air Hose with 1/4" Male Fittings

Order No.	Mfr. No.	Hose Length	Ship Wt.
80435	3688	50'	50 lbs. - 23 kg

1/2" Air Hose with 1/2" Male Fittings

80436	3690	50'	54 lbs. - 25 kg
-------	------	-----	-----------------



Economy Hose Reel

- Mount on floor, wall or ceiling. 300 psi.

3/8" Air Hose with 3/8" Male Fittings

Order No.	Mfr. No.	Hose Length	Ship Wt.
80438	3682	50'	29 lbs. - 54 kg



REELCRAFT 3/8" Nitrogen Hose Reel



Green hose differentiates from standard shop air. 3/8" hose, 50' length, includes 300 psi hose. Lightweight composite spool, weighs only 29 lbs. 1/2" fpt inlet, 1/4" mpt end.

3/8" Air Hose with 1/4" Male Fittings

Order No.	Mfr. No.	Hose Length	Ship Wt.
82425	RT650-OLPG	50'	29 lbs. - 13 kg

Replacement Ball Stops

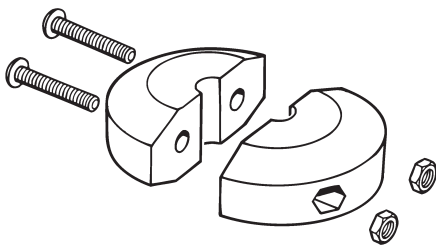

Order No.	Description
04520	Ball Stop for 1/4" Hose Reel
04522	Ball Stop for 3/8" Hose Reel
04521	Ball Stop for 1/2" Hose Reel

Portable Air Tank



Lightweight, rugged construction with fitting on top of tank for protection. Tank: 10" dia., 25" long, 1,962 cu. inch capacity. Complete with 160 lbs. pressure gauge, slide shut off valve, filter valve, 6' hose and air chuck. Sturdy carrying handle.

Order No.	Description	Ship Wt
82413	Portable Air Tank	26 lbs. - 12 kg
44676	Repl. Shut-Off Valve	1 lbs. - 1 kg
44648	Repl. Air Gauge	1 lbs. - 1 kg

Re-Coil Air Hoses

- Extends & retracts like a telephone cord
- Retracts to 3 1/2% of working length. Eliminates "drag" & expensive coiling mechanisms
- Lighter & more versatile than conventional rubber hose
- Abrasion & weather resistant



Operates efficiently at temperatures ranging from -40°F to 200°F. No oil absorption. Working length 95%. Working pressure to 175 psi.

With reusable fittings 1/4" I.D. Hose with 1/4" N.P.T.

Order No.	Mfr. No.	Length	Working Length	Storage Length
54013	AHN-12F	12'	11'	4"
54014	AHN-25F	25'	23'	8"
54015	AHN-50F	50'	46'	18"

3/8" I.D. Hose with 1/4" N.P.T.

Order No.	Mfr. No.	Length	Working Length	Storage Length
54026	A-12G	12'	11'	4.5"
54027	A-25G	25'	22'	8"
54028	A-50G	50'	44'	18"
54029	A-100G	100'	100'	36"

3/8" I.D. Hose with 3/8" N.P.T.

Order No.	Mfr. No.	Length	Working Length	Storage Length
54034	A-12L	12'	11'	4.5"
54035	A-25L	25'	22'	8"
54036	A-50L	50'	44'	18"
54037	A-100L	100'	100'	36"

Replacement Fittings With Springs



Fitting for 1/4" I.D. Hose

Order No.	Mfr. No.	Description
54200	98-109	1/4" MPT, Swivel

Fitting for 3/8" I.D. Hose

54208	98-227	1/4" MPT, Swivel
54201	98-213	3/8" MPT, Swivel

Whip Hoses



Length 24"

Order No.	Hose I.D.	MPT Ends
54150	1/4"	1/4"
54145	3/8"	1/4"
54146	3/8"	3/8"

3/8" Green Air Hose for Nitrogen Inflation



Oil and abrasion resistant. 50' length, 1/4" mpt. 350 psi working pressure.

Order No.	Size
54010	3/8" Green Air Hoses

Economy Air Hose



Working pressure 300 psi, burst strength 1,200 psi.

3/8" I.D. Hose 1/4" Male pipe thread fittings both ends.

Order No.	Length
54415	25'
54416	50'

1/2" I.D. Hose 1/2" Male pipe thread fittings both ends.

54417	50'
-------	-----

Therm-O-Blue PVC Air Hoses



Therm-O-Blue air hose is specially formulated with additives to increase the amount of oil resistance normally provided by PVC hoses. Lightweight and highly flexible, it is ideal for around-the-shop applications. Working pressure 300 psi, operates efficiently at temperatures from -20°F to +150°F. Bursting strength 900 psi. Use of reusable fittings with PVC hose is discouraged.

3/8" I.D. 4 1/4" O.D. Hose 1/4" mail pipe thread fittings both ends.

Order No.	Length
54159	25'
54161	50'

Oil Resistant Air Hoses

- Extra heavy-duty



Thick SBR rubber cover and nitrile inner core. Resistant to oil, acid, chemicals, weather deterioration and abrasion. Two heavy braids of cord for maximum strength. Working pressure 300 psi. Maximum bursting strength 1,200 psi.

1/4" I.D. 19/32" O.D. Hose
1/4" Male pipe thread fittings both ends.

Order No.	Mfr. No.	Length
54102	AHS-3/4	25'
54103	AHS-3/4A	50'

3/8" I.D. 23/32" O.D. Hose
1/4" Male pipe thread fittings both ends.

Order No.	Mfr. No.	Length
54110	AHS-3/8	25'
54111	AHS-3/8A	50'

1/2" I.D. 7/8" O.D. Hose
1/4" Male pipe thread fittings both ends.

Order No.	Mfr. No.	Length
54116	AHS-1/2	25'
54117	AHS-1/2A	50'

1/2" I.D. 7/8" O.D. Hose
1/2" Male pipe thread fittings both ends.

Order No.	Mfr. No.	Length
54125	AHS-A-1/2	25'
54126	AHS-A-1/2A	50'

500 Ft. Spool

500 ft. total per spool. No single piece less than 50'. Priced per spool.

Order No.	Mfr. No.	Size
54020	AHS-3/4R	1/4"
54021	AHS-3/8R	3/8"
54023	AHS-1/2R	1/2"

Bulk Air Hose Without Fittings

- Available up to 100'

Specify hose length required in feet. Available in lengths up to 100 ft. Priced per foot.

Order No.	Mfr. No.	Size
54133	AHS-3/4B	1/4"
54134	AHS-3/8B	3/8"
54135	AHS-1/2B	1/2"

See pg 75 for
Air Tool Conditioner



Slic-Tite Pipe Thread Tape



High-density 1/2" x 300" roll

Order No.	Description
46157	Pipe Thread Tape

Hose Ferrule Crimping Tool



Order No.	Mfr. No.	Description
56513	1626	Ferrule Crimping Tool 1/4" Single to 3/8" Double Braid
53838	1626-1	3/16" Die for Crimping Welding Hose
53839	1626-2	1/16" Die for Crimping 1/2" ID x 7/8" OD Hose

Air Hose Splicers



Makes an air-tight splice between two pieces of air hose. Most economical way of adding an extra length to air hose. Leak-proof. Installs instantly with wrench or pliers.

Order No.	Mfr. No.	I.D. Hose	Max. O.D. Hose
54231	AH-199	1/4"	19/32"
54232	AH-200	1/4"	3/8"
54233	AH-200A	3/8"	3/4"

1/4" Female Pipe Thread Hose Ends



Order No.	Mfr. No.	Description
54291	AH-7	For 1/4" I.D. Hose
54292	AH-7A	For 3/8" I.D. Hose

Geared Clamps



Order No.	Mfr. No.	Description
54294	B6H	For 3/8" to 7/8" I.D. Hose
04061	B12H	For 1/4" to 1/4" I.D. Hose

Air Hose Fitting Adapters



Order No.	Mfr. No.	Description
54309	AH-8204	1/4" MPT Both Ends
54310	AH-8208	1/4" MPT Both Ends
54311	AH-8207	3/8" F, 1/4" M Reducer Bushing

Air Hose End Fittings



Makes an air-tight connection on end of air hose. Leak-proof. Installs instantly with wrench or pliers.

Order No.	Mfr. No.	MPT End	I.D. Hose	Max. O.D. Hose
54215	AH-99	1/4"	1/4"	19/32"
54216	AH-100	1/4"	1/4"	5/8"
54217	AH-100A	1/4"	3/8"	3/4"
54218	AH-100B	1/4"	1/2"	7/8"
54219	AH-100C	3/8"	3/8"	3/4"
54220	AH-100D	3/8"	1/2"	7/8"
54221	AH-100E	1/2"	1/2"	7/8"

Air Hose Repair Parts

Male Pipe Thread Hose Ends



Order No.	Mfr. No.	Description
54241	AH-3	For 1/4" I.D. Hose

1/4" Male Pipe Thread Hose End

Order No.	Mfr. No.	Description
54242	AH-5	For 1/4" I.D. Hose
54243	AH-5D	For 3/8" I.D. Hose
54244	AH-5A	For 3/8" I.D. Hose
54245	AH-5B	For 1/2" I.D. Hose

3/8" Male Pipe Thread Hose End

Order No.	Mfr. No.	Description
54255	AH-4	For 3/8" I.D. Hose
54256	AH-4A	For 1/2" I.D. Hose

1/2" Male Pipe Thread Hose End

Order No.	Mfr. No.	Description
54264	AH-5E	For 3/8" I.D. Hose
54263	AH-5C	For 1/2" I.D. Hose

Double Male Hose Splicers



Order No.	Mfr. No.	Description
54269	AH-6	For 1/4" I.D. Hose
54270	AH-6A	For 3/8" I.D. Hose
54271	AH-6B	For 1/2" I.D. Hose

1/4" Lincoln Style Coupler & Adapters



54590



54592



54594

Couplers

Order No.	Mfr. No.	Lincoln Equiv.	Thread Type
54590	790	S815	1/4" FIP Coupler

Adapters

Order No.	Mfr. No.	Lincoln Equiv.	Thread Type
54592	791	S11659	1/4" MPT
54594	792	S11661	1/4" FPT

1/4" Automotive Style Couplers & Adapters



Couplers

Order No.	Mfr. No.	Thread Type
54410	A-3	1/4" FPT, Sleeve Body
54432	A-13	1/4" FPT, Smooth Body
54411	A-3-90	1/4" FPT, 90° Angle Thread, Sleeve Body
54431	A-12	1/4" MPT, Smooth Body

Repair kits and washers for couplers listed above:

Order No.	Mfr. No.	Thread Type
54413	A-3K	Kit Contains Repl. Valve, Washer, Spring
54414	A-3W	Washer (10 Per Pkg.)
54995	9031132	Viton High Temp. Seal



Adapters

Order No.	Mfr. No.	Adapter Thread
54400	A-3C	1/8" MPT
54401	A-3D	1/4" MPT
54403	A-3E	1/4" FPT
54404	A-3A	.482F Curing Tube FTP
54405	A-3AA	.482F Curing Tube FTP 2 3/4"
54406	A-3B	.305F Valve Thread Inside & 1/4" MPT Outside
54407	A-3F	1/4" Hose Barb End
54409	6C	.305F Valve Thread

1/4" Industrial Style Coupler & Adapters



Couplers

Order No.	Mfr. No.	Thread Type
54473	1000	1/4" FPT
54483	Standard	Washer for Old Style Pre-2006
54484	Hi-Temp	Washer for Old Style Pre-2006
54496	Hi-Temp	Washer for New Style Since 2006

Adapters

Order No.	Mfr. No.	Adapter Thread
54474	12	1/8" MPT
54475	10	1/4" MPT
54476	14	3/8" MPT
54477	11	1/4" FPT
54478	15	3/8" FPT
54479	E	.305F Valve Cap Thread
54480	F	.482F Valve Stem Thread
54481	16	1/4" Hose Barb End
54482	17	1/4" Hose Barb End

PREVOST 1/4" Automotive Style Couplers

- One hand push button design
- Fits all 1/4" automotive style adapters



Manufactured from high impact composite materials with nitrile seals. Smooth finish will not scratch finished surfaces. O-Ring design prevents leakage. The black coupler has a push button and air release design. The first push releases the air from the adapter, the second push release the adapter. **For use with Myers Adapters 54400, 54401, 54403, 54404, 54405, 54406, 54407, 54409.**

Order No.	Mfr. No.	Description
54427	URI061201	1/4" FPT Automotive Coupler
54428	URI061251	1/4" MPT Automotive Coupler
54429	USI061201	1/4" FPT Automotive Safety Coupler

1/4" ARO & DILL Style Coupler & Adapters



Couplers

Order No.	Aro No.	Dill No.	Thread Type
54459	210	8888	Coupler 1/4" FTP



Adapters

Order No.	Aro No.	Dill No.	Thread Type
54461	A-2608	8891	1/4" MPT
54462	A-2609	8889	1/4" FPT

PREVOST 1/4" Industrial Style Couplers

- One hand push button design
- Fits all 1/4" industrial style adapters



Manufactured from high impact composite materials with nitrile seals. Smooth finish will not scratch finished surfaces. O-Ring design prevents leakage. The black coupler has a push button and air release design. The first push releases the air from the adapter, the second push release the adapter.

Order No.	Mfr. No.	Use With Myers Coupler	Description
54425	ISI061201	Replacement for 54473	1/4" FPT Industrial Coupler
54426	ISI061201	Replacement for 54473	1/4" FPT Industrial Safety Coupler

Air Couplers & Adapters

SCHRADER 1/4" Couplers & Adapters

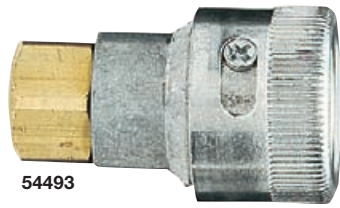

54493

SCHRADER Couplers

Order No.	Mfr. No.	Description
54493	8052C-12	Swivel Type Coupler



54505



54508

SCHRADER Adapters

Order No.	Mfr. No.	Description
54505	8050-11	1/4" MPT
54508	8787-11	With Barb for 1/4" I.D. Hose

3/8" Automotive Style Couplers & Adapters



54436

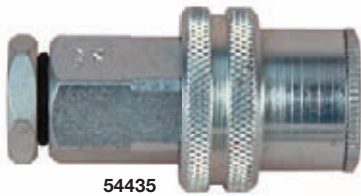

54435

Has 3/8" fpt with reducer bushing to 1/4". 54435 is equipped with a handy "Sleeve Ring" making it easy to couple and uncouple, even with heavy gloves or greasy hands.

Couplers

Order No.	Mfr. No.	Description
54436	D-15	Smooth Body
54435	A-2	Sleeve Ring Body

Repair kits for Myers A-2 & D-15 Air Couplers

(Contains replacement valve, washer, spring)

Order No.	Mfr. No.	Description	Per Pkg.
44511	A-2K	Kit for Above Couplers	
44512	A-2W	Washer for Above Couplers	10



44519



44520



44522

Adapter for A-2 and D-15 Coupler

Order No.	Mfr. No.	Thread Type
44519	A-2D	1/4" MPT
44520	A-2H	3/8" MPT
44522	A-2E	1/4" FPT
44525	A-2L	3/8" FPT

PREVOST 3/8" Automotive Style Couplers

- One hand push button design
- Fits all 3/8" automotive style adapters



54439



54438

Manufactured from high impact composite materials with nitrile seals. Smooth finish will not scratch finished surfaces. O-Ring design prevents leakage. The black coupler has a push button and air release design. The first push releases the air from the adapter, the second push release the adapter. **For use with Myers Adapters 44519, 44520, 44522, 44525**

Order No.	Mfr. No.	Description
54439	URC081201	1/4" FPT Automotive Coupler
54438	USC081201	1/4" FPT Automotive Safety Coupler

1/2" Automotive Style Couplers & Adapters



54437



54424

Has 1/2" fpt. Full-flow 1/2" bore, enabling air tools to operate at maximum efficiency.

Couplers

Order No.	Mfr. No.	Description
54424	A-17	Smooth Body
54437	D-17R	Sleeve Ring Body

Repair kits for A-17 & D-17R Air Couplers

(Contains replacement valve, washer, spring)

Order No.	Mfr. No.	Description	Per Pkg.
54422	A-17K	Kit for Above Couplers	
54423	A-17W	Washer for Above Couplers	1



54419



54420



54421

Adapter for A-17 Coupler

Order No.	Mfr. No.	Thread Type
54419	A-17H	3/8" MPT
54420	A-17A	1/2" MPT
54421	A-17B	1/2" FPT

Slic-Tite Pipe Thread Tape

High-density 1/2" x 300" roll

Order No.	Description
46157	Pipe Thread Tape



Air Line Filters

- All metal bowl



Remove condensation and foreign matter from air flowing to pneumatic equipment and devices. Large particles and condensation are "thrown out" by downward helical pattern of incoming air and collected in bowl then removed through drain cock. For pressure up to 250 psi.

Order No.	Mfr.No.	Size	Ship Wt.
54760	602-02-W	¼" FPT	2 lbs. - 1 kg
54761	602-03-W	⅜" FPT	
54762	602-04-W	½" FPT	4 lbs. - 2 kg
54623	602-06-W	¾" FPT	5 lbs. - 2 kg
54624	602-08-W	1" FPT	

Automatic Air Line Lubricators

- With metal bowl



Supplies mist adjustable from low to high of oiled air automatically as lubrication for air operated tools and equipment. Reduces costly maintenance. Lengthens tool life. Visible oil supply. For supply pressure up to 250 psi, temperature 120°F maximum.

Order No.	Mfr. No.	Size	Ship Wt.
54766	606-02-W	¼" FPT	2 lbs. - 1 kg
54767	606-03-W	⅜" FPT	2 lbs. - 1 kg
54768	606-04-W	½" FPT	3 lbs. - 2 kg
54688	606-06-W	¾" FPT	6 lbs. - 3 kg
54689	606-09-W	1" FPT	6 lbs. - 3 kg
Repair Kit for All Sizes			
54609	RK606SY		

Air Pressure Regulators



Relieving type air pressure reducing valve. Will maintain working pressure constantly within precise limits. Extremely accurate for initial pressure up to 300 lbs. and reduced pressure of 0-250 lbs. Equipped with 0-300 lb. clock gauge.

Order No.	Mfr. No.	Size	Ship Wt.
54600	R119-2DG	¼" FPT	2 lbs. - 1 kg
54601	R119-3DG	⅜" FPT	2 lbs. - 1 kg
54602	R119-4DG	½" FPT	4 lbs. - 2 kg
54603	R119-6DG	¾" FPT	7 lbs. - 3 kg
54604	R119-8DG	1" FPT	7 lbs. - 3 kg
Repair Kit for All Sizes			
54610	RK-119Y Repair Kit for 54600, 54601		
54611	RK-119A Repair Kit for 54602		
54612	RK-119B Repair Kit for 54603, 54604		

Filter-Regulator-Lubricators



All combination units with manual drain filter, lubricator, and regulator are supplied with 0-300 lb. pressure gauge and 0 to 250 psi reduced pressure range. Furnished assembled. Available for ¼", ⅜", ½", ¾" and 1" lines.

Order No.	Mfr. No.	Size	Ship Wt.
54769	C628-02-FRL	¼"	6 lbs. - 3 kg
54770	C628-03-FRL	⅜"	6 lbs. - 3 kg
54771	C628-04-FRL	½"	10 lbs. - 5 kg
54739	C628-06-FRL	¾"	19 lbs. - 9 kg
54741	C628-08-FRL	1"	19 lbs. - 9 kg

Filter-Regulators



Order No.	Mfr. No.	Size	Ship Wt.
54772	644-2W	¼"	4 lbs. - 2 kg
54773	644-3W	⅜"	4 lbs. - 2 kg
54774	644-4W	½"	8 lbs. - 4 kg
54740	644-6W	¾"	12 lbs. - 5 kg
54742	644-8W	1"	12 lbs. - 5 kg

Air Line Filter with Automatic Drains

Automatic drain works on the pilot principle. When liquid rises, float admits air, opening a scavenger valve, allowing liquid and impurities to be blown out of the drain opening. For pressure up to 250 psi. Metal bowl.



Order No.	Mfr. No.	Size	Ship Wt.
54763	602-02-WMD	¼"	2 lbs. - 1 kg
54764	602-03-WMD	⅜"	2 lbs. - 1 kg
54765	602-04-WMD	½"	3 lbs. - 2 kg
54633	602-06-WMD	¾"	6 lbs. - 3 kg
54634	602-08-WMD	1"	6 lbs. - 3 kg

Air Line Moisture Protection

- Blocks all air line moisture & contaminants
- Protects air tools, tires & rims



The Block is 100% protection from air line moisture and contaminants that destroy air operated equipment, tools, tires and rims. The Block will not allow moisture or water to pass through the replaceable element. If the element becomes completely saturated, it stops all movement of air and/or moisture. Simply replace the element. Note: The Block should be used before the oiler, since it blocks oil as well as moisture.

Order No.	Mfr. No.	Description
54667	CAM-BLK-50	¼" Block Filter
54668	CAM-BLK-ADE	¼" Replacement Filter

Replacement Bowls

- All metal for standard lubricators & filters

Order No.	Mfr. No.	Size	Ship Wt.
54606	BK605WY	¼" & ⅜"	2 lbs. - 1 kg
54607	BK605WA	½"	2 lbs. - 1 kg
54608	BK605WB	¾" & 1"	2 lbs. - 1 kg

Replacement Sight Glass

- All metal bowls

Order No.	Mfr. No.	Size
54716	RBK-605WY	¼" & ⅜"
54717	RBK-605WA	½"
54718	RBK-605WB	¾" & 1"

Mini Filter-Regulator-Lubricator

- For compact applications where space is critical, & modest air flow is required.



Order No.	Mfr. No.	Description
54628	F504-02DH	¼" FPT Mini Filter
54629	R384-02CG	¼" FPT Mini Regulator
54630	L508-02D	¼" FPT Mini Lubricator

18 Gallons Of Water Vapor In Your Air Lines!

Under average conditions of 75° F and 75% relative humidity, a compressor takes in about 18 gallons a day of water vapor! It shows up in impact tools, tire changers, in-ground hydraulic lifts, etc. Replacing equipment due to water corrosion is expensive and inefficient.

When air is compressed, it takes a large amount of outside air, called ambient air, and squeezes it into a small space. This compresses the air and the water in the air.

To remove the water, the temperature of the air must be lowered, so the water vapor forms water droplets. First, air is cooled with an Aftercooler. The most common type is an air cooled aftercooler.

The next step is a Refrigerated Air Dryer. This unit chills the air and evaporates the water using a refrigeration unit. For all practical purposes there will not be water in the air lines again. The additional two pieces of equipment can pay for themselves when compared to the cost of replacing tire changers, lifts, etc.

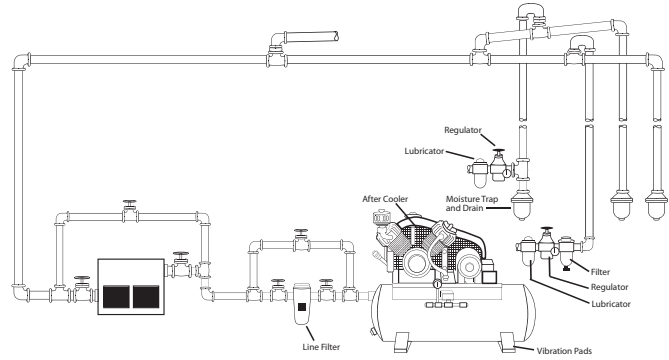

Definitions:

AIR COOLED AFTERCOOLER is a radiator connected in the discharge line of the compressor cooling the compressed air, causing moisture in the air to condense and drop into the air receiver. Used with an automatic tank drain, this helps keep water out of the compressed air and the receiver tank. The unit must be installed at the factory with any new compressor.

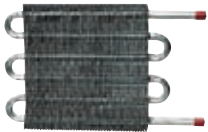

REFRIGERATED AIR DRYERS are used in humid or high temperature climates where dry compressed air is a necessity. The refrigerated air dryer chills compressed air to as low as 35° F condensing most of the moisture and releasing it through a trap. The heat from the refrigeration process is used to reheat the dry compressed air, increasing the compressed air effective volume and preventing pipe sweating downstream. Can be installed with any existing air system. Compressor must have an after cooler.



Vibration Mounts isolate the compressor from the foundation or floor. They reduce noise and protect the unit from an out of level floor situation that could cause vibration and damage.



AUTOMATIC TANK DRAINS remove water from the compressor receiver automatically during each operating cycle. Keeps water from collecting in the tank reducing the tanks air volume and compressor efficiency. Should be factory installed on new compressors.



LOW OIL MONITORS are switches wired through a magnetic starter which shut the compressor down if the oil level in the compressor crankcase is too low for safe operation. A small investment when ordering a new compressor can save the cost of a new pump unit if the compressor loses oil pressure. Should be factory installed.



MAGNETIC STARTERS provide thermal overload protection for the compressor motor and must be used for compressors of 5 HP and up. We recommend ordering the magnetic starters mounted and wired by the manufacturer. This is a must for any new compressor. Starter must be sized to match motor horsepower and voltage. Can be ordered with compressor or separately.

Air Safety Pop-Off Valve



Valve is ASME standard, National Board certified. Preset, tested and rated at factory. 25 to 250 psi for 1/4", 60 to 275 psi for 1/2".

Order No.	PSI	Size
5473225	25	1/4" MPT
5473260	60	1/4" MPT
5473270	70	1/4" MPT
5473275	75	1/4" MPT
5473280	80	1/4" MPT
5473290	90	1/4" MPT
54732100	100	1/4" MPT
54732125	125	1/4" MPT
54732150	150	1/4" MPT

Order No.	PSI	Size
54732160	160	1/4" MPT
54732175	175	1/4" MPT
54732180	180	1/4" MPT
54732185	185	1/4" MPT
54732190	190	1/4" MPT
54732200	200	1/4" MPT
54732210	210	1/4" MPT
54732250	250	1/4" MPT

Order No.	PSI	Size
5473365	65	1/2" MPT
54733125	125	1/2" MPT
54733150	150	1/2" MPT
54733175	175	1/2" MPT
54733180	180	1/2" MPT

Order No.	PSI	Size
54733190	190	1/2" MPT
54733200	200	1/2" MPT
54733220	220	1/2" MPT
54733250	250	1/2" MPT
54733275	275	1/2" MPT

Clock Gauges

- 1/4" MPT



For use on air, steam or any other pressure medium which does not attack brass. Install siphon under gauge when used on steam. For use on any compressor or air system to gauge air pressure, on vulcanizing molds to gauge steam pressure.

Order No.	Mfr. No.	Dial Size	lbs. Pressure
44645*	AS-7D	2"	0-300
44641	AS-7G	2 1/2"	0-60
44642	AS-7A	2 1/2"	0-160
44643	AS-7B	2 1/2"	0-200
44644	AS-7C	2 1/2"	0-300
44646	AS-7BB	3 1/2"	0-300
44647	AS-7E	4 1/2"	0-200

*With 1/4" MPT Back Connection.

Automatic Tank Drain

Automatically removes water, sludge, etc. from compressor tank. 100% automatic 30 psi minimum pressure required. IPTF connection to tank shut-off valve. 1/4" IPTF side discharge outlet, 1/8" fpt for tubing to air unloader. Maximum operating pressure 300 psi.



Order No.	Mfr. No.	Description
50823	AS-620	Automatic Tank Drain

Electric Water Drain



Install at the drop leg on the air line.

Order No.	Description
50807	Electric Water Drain

CHAMPION Heavy-Duty R Series Compressors

- Two stage design provides 125-175 pressure rating
- Splash lubricated eliminates oil filters
- Disc-Type valve provides long life & easy service
- 5-Year limited warranty on pump



50773

WARNING: Ordering a compressor with incorrect voltage may seriously effect compressor operation. Check the electrical panel where service enters the building to verify requirements. Specify 208V, 230V, or 460V

CHAMPION Electric Compressor Accessories

Order No.	Description
50694	3" Vibration Pads for 80, 120, & 250 Gal. Simplex Tanks
50696	Low Oil Monitor
50699	Automatic Tank Drain Pneumatic - Factory Installed
50807	Automatic Tank Drain Electric - Factory Installed
50684	Flexible Hose Connector for 7 1/2, 10 & 15 HP "F" Models 16" x 3/4" NPT
50686	Flexible Hose Connector for 15 to 30 HP Models 24" x 1 1/4"
50789	Repl. Filter Element for 5, 7 1/2 & 10 HP Models
50803	Repl. Filter Element for 15, 20, 25 & 30 HP Models

Basic Compressors

Specifically designed for the automotive service industry. Heavy-duty two stage compressors, with NEMA design motor, multiple V-belt drive, and totally enclosed belt guard. Gasket free integral heads eliminate blown head gaskets. Automotive-type pistons deliver more air. Mounted and wired magnetic starter UL approved automatic start and stop control. ASME air receiver with fittings included.

Order No.	Mfr. No.	HP	Electrical Spec.	CFM @ 175	Tank Gal.	Tank Style	Mineral Oil Kit	Synthetic Oil Kit	Ship. Wt.
50679	HR5-8	5	Spec. V/1 Ph.	16.5	80	Horiz.	59580	59581	525 lbs. - 240 kg
50680	VR5-8	5	Spec. V/1 Ph.	16.5	80	Vert.	59580	59581	525 lbs. - 240 kg
50681	HR5-8	5	Spec. V/3 Ph.	16.5	80	Horiz.	59580	59581	525 lbs. - 240 kg
50682	VR5-8	5	Spec. V/3 Ph.	16.5	80	Vert.	59580	59581	525 lbs. - 240 kg
50604	HR7-12	7.5	Spec. V/1 Ph.	25.8	120	Horiz.	59582	59583	860 lbs. - 390 kg
50605	VR7-12	7.5	Spec. V/1 Ph.	25.8	120	Vert.	59582	59583	860 lbs. - 390 kg
50661	HR7-12	7.5	Spec. V/3 Ph.	25.8	120	Horiz.	59582	59583	860 lbs. - 390 kg
50662	VR7-12	7.5	Spec. V/3 Ph.	25.8	120	Vert.	59582	59583	860 lbs. - 390 kg
50683	HR10-12	10	Spec. V/3 Ph.	34.8	120	Horiz.	59582	59583	890 lbs. - 405 kg
50663	VR10-12	10	Spec. V/3 Ph.	34.8	120	Vert.	59582	59583	890 lbs. - 405 kg
50688	HRA15-12	15	Spec. V/3 Ph.	53.7	120	Horiz.	59584	59585	1,110 lbs. - 505 kg
50689	HRA15-25	15	Spec. V/3 Ph.	53.7	250	Horiz.	59584	59585	1,495 lbs. - 680 kg
50690	HRA20-12	20	Spec. V/3 Ph.	76.7	120	Horiz.	59586	59587	1,325 lbs. - 600 kg
50691	HRA20-25	20	Spec. V/3 Ph.	76.7	250	Horiz.	59586	59587	1,790 lbs. - 810 kg
50692	HRA25-12	25	Spec. V/3 Ph.	90.1	120	Horiz.	59586	59587	1,365 lbs. - 620 kg
50693	HRA25-25	25	Spec. V/3 Ph.	90.1	250	Horiz.	59586	59587	1,735 lbs. - 785 kg
50606	HRA30-12	30	Spec. V/3 Ph.	101.0	120	Horiz.	59586	59587	1,404 lbs. - 640 kg
50607	HRA30-25	30	Spec. V/3 Ph.	101.0	250	Horiz.	59586	59587	1,774 lbs. - 800 kg

Please specify Voltage: 208V, 1 ph.; 230V, 1 ph.; 208V, 3 ph.; 230V, 3 ph.; 460V, 3 ph.

Fully Packaged Compressors

- Prevent electrical problems, low oil problems, & provide drier air

Fully packaged compressors include mounted magnetic starter, vibration isolators, automatic tank drain, low oil level switch and an air cooled aftercooler.

Order No.	Mfr. No.	HP	Electrical Spec.	CFM @ 175	Tank Gal.	Tank Style	Mineral Oil Kit	Synthetic Oil Kit	Ship. Wt.
50530*	ADV-VR5-8	5	230V/1 Ph.	16.5	80	Vert.	59580	59581	535 lbs. - 241 kg
50531***	ADV-VR5-8	5	230V/3 Ph.	16.5	80	Vert.	59580	59581	535 lbs. - 241 kg
50532*	ADV-HR5-8	5	230V/1 Ph.	16.5	80	Horiz.	59580	59581	535 lbs. - 241 kg
50534***	ADV-HR5-8	5	230V/3 Ph.	16.5	80	Horiz.	59580	59581	535 lbs. - 241 kg
50772	ADV-MHR5-8	5	230V/1 Ph.	16.5	80	Horiz.	59580	59581	500 lbs. - 225 kg
50773	ADV-MVR5-8	5	230V/1 Ph.	16.5	80	Vert.	59580	59581	600 lbs. - 270 kg
50774**	ADV-MHR5-8	5	230V/3 Ph.	16.5	80	Horiz.	59580	59581	500 lbs. - 225 kg
50775**	ADV-MVR5-8	5	230V/3 Ph.	16.5	80	Vert.	59580	59581	600 lbs. - 270 kg
50776	MHR7-8	7.5	230V/1 Ph.	25.8	80	Horiz.	59582	59583	925 lbs. - 416 kg
50777	MHR7-8	7.5	230V/3 Ph.	25.8	80	Horiz.	59582	59583	925 lbs. - 416 kg
58995	MVR7-8	7.5	230V/1 Ph.	25.8	80	Vert.	59582	59583	
58996	MVR7-8	7.5	230V/3 Ph.	25.8	80	Vert.	59582	59583	
59001	MHR7-12	7.5	230V/1 Ph.	25.8	120	Horiz.	59582	59583	860 lbs. - 390 kg
59002	MHR7-12	7.5	230V/3 Ph.	25.8	120	Horiz.	59582	59583	860 lbs. - 390 kg
58997	MVR7-12	7.5	230V/1 Ph.	25.8	120	Vert.	59582	59583	
58998	MVR7-12	7.5	230 V/3 Ph.	25.8	120	Vert.	59582	59583	
50552	ADV-VR7F-8	7.5	208 V/1 Ph.	23.5	80	Vert.	59580	59581	570 lbs. - 257 kg
50528	ADV-VR7F-8	7.5	230 V/1 Ph.	23.5	80	Vert.	59580	59581	570 lbs. - 257 kg
50529**	ADV-VR7F-8	7.5	Spec. V/3 Ph.	23.5	80	Vert.	59580	59581	570 lbs. - 257 kg
50778	MHR10-8	10	Spec. V/3 Ph.	34.4	80	Horiz.	59582	59583	985 lbs. - 443 kg
50779**	ADV-HR10-12	10	Spec. V/3 Ph.	34.4	120	Horiz.	59582	59583	955 lbs. - 429 kg
50558**	ADV-VR10-12	10	Spec. V/3 Ph.	34.4	120	Vert.	59582	59583	955 lbs. - 429 kg
50785**	ADV-HRA15-12	15	Spec. V/3 Ph.	53.7	120	Horiz.	59584	59585	1,095 lbs. - 492 kg
59003	MHRA15-25	15	Spec. V/3 Ph.	53.7	250	Horiz.	59584	59585	1,495 lbs. - 678 kg
50786	MHRA20-12	20	Spec. V/3 Ph.	77.6	120	Horiz.	59586	59587	1,300 lbs. - 585 kg
59004	MHRA20-25	20	Spec. V/3 Ph.	76.7	250	Horiz.	59586	59587	1,600 lbs. - 726 kg
50787**	ADV-HRA 25-12	25	Spec. V/3 Ph.	91.1	120	Horiz.	59586	59587	1,750 lbs. - 787 kg
59005	MHRA25-25	25	Spec. V/3 Ph.	90.1	250	Horiz.	59586	59587	1,735 lbs. - 787 kg
59006	MHRA30-25	30	Spec. V/3 Ph.	101.0	250	Horiz.	59586	59587	1,774 lbs. - 805 kg

Please specify Voltage: 208V, 1 ph.; 230V, 1 ph.; 208V 3 ph.; 230V 3 ph.; 460V, 3 ph.

* Does not have aftercooler

** 460V/3ph. Requires conversion kit at additional cost

See Electric Compressor Accessories for Optional Flexible Hose Connectors

CHAMPION Centurion II Basic Compressors With Starter

- Automatic start/stop operation
- Enclosed, hinged belt guard
- NEMA-rated electric motors
- Deep finned intercooler



50856

WARNING: Ordering a compressor with incorrect voltage may seriously effect compressor operation. Check the electrical panel where service enters the building to verify requirements. **Specify 208V, 230V, or 460V**

An excellent price competitive alternative. Features a magnetic starter-mounted and wired with the exception of the 5 hp economy units which have built-in thermal overload protection. Includes 0 - 300 PSI air pressure gauge, industrial grade intake filter/silencer, deep finned intercooler, preset pressure switch, and oil level sight glass. Features with a 2-year pump warranty. 100% American Made with full cast iron construction.

Order No.	Mfr. No.	HP	Electrical Spec.	CFM @ 175	Tank Gal.	Mineral Oil Kit	Synthetic Oil Kit	Tank Style	Ship. Wt.
59076	HRV5-6-Econ	5	230V, 1ph	16.5	60	59580	59581	Horiz.	445 lbs. - 202 kg
59077	VRV5-6-Econ	5	230V, 1ph	16.5	60	59580	59581	Vert.	450 lbs. - 204 kg
59078	HRV5-8-Econ	5	230V, 1ph	16.5	80	59580	59581	Horiz.	530 lbs. - 240 kg
59079	VRV5-8-Econ	5	230V, 1ph	16.5	80	59580	59581	Vert.	530 lbs. - 240 kg
50849	HRV5-8	5	230V, 1ph	16.5	80	59580	59581	Horiz.	530 lbs. - 240 kg
50851	HRV5-8	5	230V, 3ph	16.5	80	59580	59581	Horiz.	530 lbs. - 240 kg
50850	VRV5-8	5	230V, 1ph	16.5	80	59580	59581	Vert.	530 lbs. - 240 kg
50852	VRV5-8	5	Spec.V, 3ph	16.5	80	59580	59581	Vert.	530 lbs. - 240 kg
50553	HRV7F-8	7.5	208V/1 Ph.	23.5	80	59580	59581	Horiz.	595 lbs. - 270 kg
59080	HRV7F-8	7.5	230V, 1ph	23.5	80	59580	59581	Horiz.	595 lbs. - 270 kg
59081	HRV7F-8	7.5	Spec.V, 3ph	23.5	80	59580	59581	Horiz.	595 lbs. - 270 kg
50557	VRV7F-8	7.5	208V/1 Ph.	23.5	80	59580	59581	Vert.	595 lbs. - 270 kg
59082	VRV7F-8	7.5	230V, 1ph	23.5	80	59580	59581	Vert.	595 lbs. - 270 kg
59083	VRV7F-8	7.5	230V, 3ph	23.5	80	59580	59581	Vert.	595 lbs. - 270 kg
50555	HRV7F-12	7.5	230V/1 Ph.	23.5	120	59580	59581	Horiz.	820 lbs. - 372 kg
50853	HRV7F-12	7.5	230V, 1ph	23.5	120	59580	59581	Horiz.	820 lbs. - 372 kg
59084	HRV7F-12	7.5	Spec.V, 3ph	23.5	120	59580	59581	Horiz.	820 lbs. - 372 kg
50556	VRV7F-12	7.5	208V/1 Ph.	23.5	120	59580	59581	Vert.	820 lbs. - 372 kg
50854	VRV7F-12	7.5	230V, 1ph	23.5	120	59580	59581	Vert.	820 lbs. - 372 kg
59085	VRV7F-12	7.5	Spec.V, 3ph	23.5	120	59580	59581	Vert.	820 lbs. - 372 kg
59086	HRV10-8	10	Spec.V, 3ph	34.8	80	59582	59583	Horiz.	675 lbs. - 306 kg
59087	VRV10-8	10	Spec.V, 3ph	34.8	80	59582	59583	Vert.	675 lbs. - 306 kg
50856	HRV10-12	10	Spec.V, 3ph	34.8	120	59582	59583	Horiz.	890 lbs. - 401 kg
59088	VRV10-12	10	Spec.V, 3ph	34.8	120	59582	59583	Vert.	890 lbs. - 401 kg
59090	HRV15F-12	15	Spec.V, 3ph	49.0	120	59582	59583	Horiz.	960 lbs. - 435 kg
59091	VRV15F-12	15	Spec.V, 3ph	49.0	120	59582	59583	Vert.	980 lbs. - 445 kg

CHAMPION Duplex Fully Packaged Compressors

- Built-in, back-up compressor or extra air when needed
- Flexibility of single operation



Includes: 2 each Mounted Mag Starters, Low Oil Level Switches, and Air Cooled After Coolers plus Alternator, Vibration Isolators and Auto Tank Drain

Order No.	Mfr. No.	HP	Electrical Spec.	CFM @ 175	Tank Gallon	Tank Style	Mineral Oil Kit	Synthetic Oil Kit	Ship. Wt.
59007	ADV-HR5D-12	(2) 5	230V/1 Ph.	33.0	120	Horiz.	59580*	59581*	980 lbs. - 445 kg
59008	ADV-HR5D-12	(2) 5	230V/3 Ph.	33.0	120	Horiz.	59580*	59581*	980 lbs. - 445 kg
59009	MHR7D-25	(2) 7.5	230V/1 Ph.	51.6	250	Horiz.	59582*	59583*	1,675 lbs. - 754 kg
59010	MHR7D-25	(2) 7.5	230V/3 Ph.	51.6	250	Horiz.	59582*	59583*	1,675 lbs. - 754 kg
59011	ADV-HR10D-25	(2) 10	230V/3 Ph.	69.6	250	Horiz.	59582*	59583*	1,725 lbs. - 782 kg
59012	MHRA15D-25	(2) 15	Spec. V/3 Ph.	107.4	250	Horiz.	59584*	59585*	2,460 lbs. - 1,116 kg
59013	MHRA20D-25	(2) 20	Spec. V/3 Ph.	153.4	250	Horiz.	59586*	59587*	2,845 lbs. - 1,290 kg
59014	MHRA25D-25	(2) 25	Spec. V/3 Ph.	180.2	250	Horiz.	59586*	59587*	2,940 lbs. - 1,334 kg
59015	MHRA30D-25	(2) 30	Spec. V/3 Ph.	202.0	250	Horiz.	59586*	59587*	3,018 lbs. - 1,369 kg
59056	CA Frame Kit For 5, 7.5 & 10 HP Duplex Units								

* Two kits required for duplex compressors

CHAMPION Gasoline Engine Driven Air Compressors

- Truck bed mounting design ideal for field service applications
- Includes vibration isolators
- Filled with oil & ready to go



50700

Heavy-duty two-stage compressors, 12V electric starter, multiple V-belt drive, totally enclosed belt guard, and constant speed control. Centrifugal un-loader for loadless start. No head gasket eliminates leaks. Splash lubrication eliminates oil pump. Includes vibration isolators, alternators, ASME air receiver with fittings, 175 psi, automatic engine throttle. Five year parts and labor warranty.

Order No.	Mfr. No.	Engine Type	HP	Tank Size	Del'y CFM @175 PSI	Mineral Oil Kit	Synthetic Oil Kit	Ship. Wt.
50824	HGR7-3K	Kohler	14	30-Gal.	23.2	59580	59581	409 lbs. - 186 kg
50783	HGR7-6K	Kohler	14	60-Gal.	23.2	59580	59581	470 lbs. - 213 kg
50700	HGR7-3H	Honda	13	30-Gal.	23.2	59580	59581	409 lbs. - 186 kg
50608	HDR5-3Y	Diesel	10	30-Gal.	16.5	59580	59581	500 lbs. - 227 kg
50603	Forest Green Waterproof Canvas Cover							
5 lbs. - 3 kg								

50783 does not include vibration isolators. Order 50694 vibration isolators separately.

CHAMPION Vision Series Rotary Screw Air Compressors

- Base & tank mounted compressors



Standard fully equipped compressors available base mount, separate air receiver required, and tank mounted configurations. Tank mount units complete with mounted refrigerated air dryer with 3-valve by-pass and zero loss auto tank drain.

Order No.	Mfr. No.	HP	Electrical Spec.	CFM @ 175 Tank	Ship. Wt.
	Vision5-1	5	230V/1 Ph.	13	Base Mount 540 lbs. - 245 kg
	Vision5-3	5	208-230 / 460 V/3 Ph.	13	Base Mount 540 lbs. - 245 kg
	Vision5-8D-1	5	230V/1 Ph.	13	80 Horiz. 1,150 lbs. - 522 kg
	Vision5-8D-3	5	208-230 / 460 V/3 Ph.	13	80 Horiz. 1,150 lbs. - 522 kg
	Vision7-1	7.5	230V/3 Ph.	18.5	Base Mount 585 lbs. - 265 kg
	Vision7-3	7.5	208-230 / 460 V/3 Ph.	18.5	Base Mount 585 lbs. - 265 kg
	Vision7-8D-1	7.5	230V/3 Ph.	18.5	80 Horiz. 1,150 lbs. - 522 kg
	Vision7-8D-3	7.5	208-230 / 460 V/3 Ph.	18.5	80 Horiz. 1,150 lbs. - 522 kg
	Vision10-3	10	208-230 / 460 V/3 Ph.	26.5	Base Mount 615 lbs. - 279 kg
	Vision10-12-3	10	208-230 / 460 V/3 Ph.	26.5	120 Horiz. 1,275 lbs. - 578 kg
	Vision15-3	15	208-230 / 460 V/3 Ph.	41	Base Mount 615 lbs. - 279 kg
	Vision15-12-3	15	208-230 / 460 V/3 Ph.	41	120 Horiz. 1,330 lbs. - 603 kg

"Add-On" Refrigerated Air Dryers



Designed as add-on units to existing air compressor installations. Pipe air from the compressor into the dryer. 115V. Includes an after cooler, refrigerated air dryer, automatic drain and air reheater. Maintenance kit includes filter element, wave spring, bowl O-ring, inlet strainer screen, ambient air filter and service decal.

Order No.	Mfg. No.	Elec. Specs.	Compressor Sizes	Air In/Out	Maintenance Kit	Ship Wt
50895	CRH20	115V/ 1 Ph.	5 HP	½" NPT	59592	79 lbs. - 30 kg
50896	CRH25	115V/ 1 Ph.	7.5 HP	½" NPT	59592	80 lbs. - 30 kg
50897	CRH35	115V/ 1 Ph.	10 HP	½" NPT	59592	81 lbs. - 31 kg
50898	CRH50	115V/ 1 Ph.	15 HP	¾" NPT	59593	150 lbs. - 56 kg
50899	CRH75	115V/ 1 Ph.	20 HP	¾" NPT	59594	155 lbs. - 58 kg
59095	CRH100	230V/ 1 Ph.	25 - 30 HP	1" NPT	59595	170 lbs. - 64 kg

CHAMPION Compressor Oil



A specially-blended lubricant specifically for compressor service. Non-detergent reciprocating oil is blended from high quality, chemically stable, high viscosity index stock. Oil should be changed every 90 days.

Order No.	Mfr. No.	Description
45248	P09479A	Compressor Oil - Quarts Case of 12
45242	P08909A	Compressor Oil - Gallons Case of 4
45240	P08908A	Compressor Oil - 5 Gallon Pail
59596	P13179A	Synthetic Compressor Oil - Quarts Case of 12
59597	P13180A	Synthetic Compressor Oil - Gallons Case of 6
59598	P11506A	Synthetic Compressor Oil - 5 Gallon Pail
50789	P05050A	Filter Element 5 - 10 HP
50803	P05051A	Filter Element 15 - 30 HP

CHAMPION Electric Compressor Accessories

- Magnetic starters



Compressors must be protected by a magnetic starter upon installation.

Order No.	HP	Electical Spec.
50818	5	Specify V/1 Ph.
50819	5	Specify V/3 Ph.
50858	7.5	Specify V/1 Ph.
59016	7.5	Specify V/3 Ph.
50820	10	Specify V/3 Ph.

Order No.	HP	Electical Spec.
50821	15	230V/3 Ph.
50822	20	230V/3 Ph.
59017	25	208 or 230V/3 Ph.
59018	30	230V/3 Ph.

Please Specify Voltage: 208V, 1ph; 230V, 1ph; 208V, 3ph; 230V, 3ph; 460V, 3ph

After Coolers

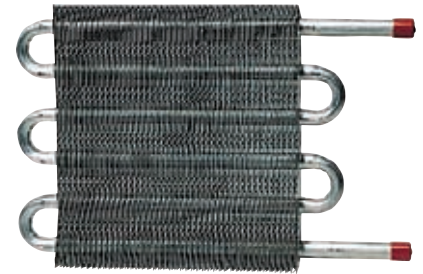

An air cooled After Cooler is a recommended option which is installed on the compressor at the factory.

Order No.	Description
50702	After Cooler for 5 HP & 7.5 HP "E" Models
50703	After Cooler for 7½, 10 & 15 HP "E" Models
50704	After Cooler for 15, 20, 25 & 30 HP Models

Refrigerated Air Dryers



Units are equipped with a built-in 3 micron pre-filter. 115V, 1 ph. Note: An additional filter kit is required to validate lifetime heat exchanger warranty. See below. Maintenance kit includes separator element, drain tube, hose fastener, wave spring, head O-rings, lube packet and service decal.

Order No.	Mfr. Code	For Compressor Size	Maintenance Kit	Air In/Out	Ship Wt
50659	CRN15	5 HP	N/A	¾" OD	60 lbs. - 22 kg
50660	CRN25	7½HP	59589	¾" NPT	95 lbs. - 36 kg
50716	CRN35	10 HP or 5 HP Duplex	59589	¾" NPT	105 lbs. - 40 kg
50717	CRN50	15 HP or 7½HP Duplex	59590	1" NPT	121 lbs. - 45 kg
50718	CRN75	20 HP or 10 HP Duplex	59591	1" NPT	155 lbs. - 58 kg
50719	CRN100	25-30 HP or 15 HP Duplex	59591	1" NPT	160 lbs. - 60 kg

Note: The compressor must be equipped with an air cooled after cooler before installing an air dryer.

Filter Kit For Refrigerated Air Dryers

Includes a 3 micron prefilter with internal auto drain and 0.01 micron coalescing after filter with auto drain.

Order No.	Mfr. No.	For Compressor Sizes	Air In/Out
59154	CFE20BAP & CFF20EAP	5 & 7.5 HP	¾" NPTF
59155	CFE35BAP & CFF35EAP	10 HP	½" NPTF
59156	CFE60BAP & CFF60EAP	15 HP	½" NPTF
59157	CFE100BAP & CFF100EAP	20, 25 & 30 HP	¾" NPTF

IR Heavy-Duty Type 30 Compressors

- Two stage, 175 psi
- 100% Cast iron frame

The Type-30 Value Package offers customers an economical and dependable compressed air solution. It is perfect for commercial, automotive, and light industrial applications.



IR Value Package Compressors

- Durable 100% cast iron construction
- Automatic start/stop pressure switch operation
- Intermittent duty cycle

Value package 2 Stage Air Compressor NENA 1, ODP Motor, ASME coded air receiver, mounted starter, and oil level sight glass.

Order No.	Mfr. No.	HP	Electrical Spec.	CFM @ 175	Tank Gal.	Tank Style	Ship Wt.
50012	2340LS-V	5	230V 1 Ph.	14.0	60	Vertical	400 lbs. - 180 kg
59962	2340LS-V	5	230V 3 Ph.	14.0	60	Vertical	400 lbs. - 180 kg
50791	2475NS-V	5	230V 1 Ph.	16.8	80	Vertical	500 lbs. - 225 kg
50793	2475NS-V	5	230V 3 Ph.	16.8	80	Vertical	500 lbs. - 225 kg
59963	2475NS-V	5	460V 3 Ph.	16.8	80	Vertical	500 lbs. - 225 kg
50881	2475NS-V	5	200V 3 Ph.	16.8	80	Vertical	500 lbs. - 225 kg
50865	2475N7.5	7.5	230V 1 Ph.	24.0	80	Vertical	500 lbs. - 225 kg
50867	2475N7.5	7.5	230V 3 Ph.	24.0	80	Vertical	500 lbs. - 225 kg
59965	2475N7.5	7.5	460V 3 Ph.	24.0	80	Vertical	500 lbs. - 225 kg
59966	2475N7.5	7.5	200V 3 Ph.	24.0	80	Vertical	500 lbs. - 225 kg
50650	2545E10V	10	230V 3 Ph.	35.0	120	Horiz.	835 lbs. - 376 kg
59967	2545E10V	10	460V 3 Ph.	35.0	120	Horiz.	835 lbs. - 376 kg
59968	2545E10V	10	200V 3 Ph.	35.0	120	Horiz.	835 lbs. - 376 kg
59970	2545K10V	10	230V 3 Ph.	35.0	120	Vertical	985 lbs. - 443 kg
59971	2545K10V	10	460V 3 Ph.	35.0	120	Vertical	985 lbs. - 443 kg
59972	2545K10V	10	200V 3 Ph.	35.0	120	Vertical	985 lbs. - 443 kg
50652	7100E15V	15	230V 3 Ph.	50.0	120	Horiz.	1,035 lbs. - 466 kg
59973	7100E15V	15	460V 3 Ph.	50.0	120	Horiz.	1,035 lbs. - 466 kg
59974	7100E15V	15	200V 3Ph.	50.0	120	Horiz.	1,035 lbs. - 466 kg

NOTE: All compressors must be shipped with the proper Start-Up Kit.

Order No.	Description	For Compressor	Type
50844	Start-Up Kit	5 HP & 7.5 HP	Electric
50805	Start-Up Kit	10, & 15 HP	Electric

IR Fully Packaged Compressors

- Fully packaged for improved air quality & safety monitoring
- Automatic start/stop pressure switch operation (5-7.5 HP)
- Centrifugal unloader (10-25 HP)
- Extended duty cycle



WARNING: Ordering a compressor with incorrect voltage may seriously effect compressor operation. Check the electrical panel where service enters the building to verify requirements. Specify 208V, 230V, or 460V

Fully packaged 2 Stage Air Compressor NENA 1, ODP Motor, ASME coded air receiver, mounted starter, dual controls (10 - 15 hp) low oil level switch, electric drain and air cooled aftercooler.

Order No.	Mfr. No.	HP	Electrical Spec.	CFM @ 175	Tank Gal.	Tank Style	Ship Wt.
50870	2475NS FP	5	230V 1 Ph.	16.8	80	Vert.	500 lbs. - 225 kg
59975	2475NS FP	5	230V 3 Ph.	16.8	80	Vert.	500 lbs. - 225 kg
59976	2475NS FP	5	460V 3 Ph.	16.8	80	Vert.	500 lbs. - 225 kg
59977	2475NS FP	5	200V 3 Ph.	16.8	80	Vert.	500 lbs. - 225 kg
50859	2475N7.5 FP	7.5	230V 1 Ph.	24.0	80	Vert.	500 lbs. - 225 kg
50864	2475N7.5 FP	7.5	230V 3 Ph.	24.0	80	Vert.	500 lbs. - 225 kg
59981	2475N7.5 FP	7.5	460V 3 Ph.	24.0	80	Vert.	500 lbs. - 225 kg
59982	2475N7.5 FP	7.5	200V 3 Ph.	24.0	80	Vert.	500 lbs. - 225 kg
59983	2545E10V FP**	10	230V 3 Ph.	35.0	120	Horiz.	860 lbs. - 390 kg
59984	2545E10V FP**	10	460V 3 Ph.	35.0	120	Horiz.	860 lbs. - 390 kg
59985	2545E10V FP**	10	200V 3 Ph.	35.0	120	Horiz.	860 lbs. - 390 kg

****Does not have the low oil light or dual controls, as found on the other Fully Packaged units.**

50874	2545E10 FP	10	230V 3 Ph.	35.0	120	Horiz.	835 lbs. - 376 kg
59986	2545E10 FP	10	460V 3 Ph.	35.0	120	Horiz.	835 lbs. - 376 kg
59987	2545E10 FP	10	200V 3 Ph.	35.0	120	Horiz.	835 lbs. - 376 kg
50829	2545K10 FP	10	230V 3 Ph.	35.0	120	Vertical	850 lbs. - 386 kg
59988	2545K10 FP	10	460V 3 Ph.	35.0	120	Vertical	850 lbs. - 386 kg
59999	2545K10 FP	10	200V 3 Ph.	35.0	120	Vertical	850 lbs. - 386 kg
50875	7100E15 FP	15	230V 3 Ph.	50.0	120	Horiz.	1,035 lbs. - 466 kg
59998	7100E15 FP	15	460V 3 Ph.	50.0	120	Horiz.	1,035 lbs. - 466 kg
59997	7100E15 FP	15	200V 3 Ph.	50.0	120	Horiz.	1,035 lbs. - 466 kg

18 Gallons Of Water Vapor In Your Air Lines!

Under average conditions of 75° F and 75% relative humidity, a compressor takes in about 18 gallons a day of water vapor! It shows up in impact tools, tire changers, in-ground hydraulic lifts, etc. Replacing equipment due to water corrosion is expensive and inefficient.

To remove the water, the temperature of the air must be lowered, so the water vapor forms water droplets. First, air is cooled with an aftercooler. The most common type is an air cooled aftercooler.

The next step is a Refrigerated Air Dryer. This unit chills the air and evaporates the water using a refrigeration unit. For all practical purposes there will not be water in the air lines again. The additional two pieces of equipment can pay for themselves when compared to the cost of replacing tire changers, lifts, etc.

IR Start-Up/Maintenance Kits for Gasoline Compressors



Start-up kits contains synthetic lubricant, 2 filters & motor oil for gasoline engine models. IR compressors are shipped without oil.

Order No.	Mfr. No.	Engine Type	Ship Wt.
50869	32498511	Start-Up Kit for Kawasaki	3 lbs. - 2 kg
50847	32305872	Start-Up Kit for Kohler	3 lbs. - 2 kg
50879	32312936	Start-Up Kit for Honda	3 lbs. - 2 kg
50782	46821567	Start-Up Kit for Kohler 50781 (Added 5-5-11)	3 lbs. - 2 kg

IR Electric Compressor Accessories

Auto Drain

Removes water from the compressor receiver automatically during each operating cycle. Recommended factory installed on new compressors.

Order No.	Description
50842	Auto Drain
50809	Electric Auto Drain

Vibration Mounts

Isolates the compressor from the foundation or floor, reduces noise and protects the unit from an out of level floor.

Order No.	Description
50840	Vibration Pads -- Set Of 4

IR Refrigerated Air Dryers



Dry Star refrigerated air dryer for use with compressors equipped with air cooled after coolers. Select based on compressor CFM. 115 volt.

Order No.	Mfr. Code	Air Flow (SCFM)	Max. PSI	Voltage	Ship Wt.
59953	D42IN	25	232	115-1-60	70 lbs. - 32 kg
59954	D54IN	42	232	115-1-60	74 lbs. - 33 kg
59955	D108IN	85	232	115-1-60	100 lbs. - 45 kg
59956	D144IN	106	232	115-1-60	122 lbs. - 55 kg

IR Coalescing Filters

For use with refrigerated air dryer. Select based on CFM.

Order No.	Mfr. Code	Air Flow (SCFM)	Max. PSI	Height	Ship Wt.
59958	IRHE19	19	232	10"	3 lbs. - 2 kg
59959	IRHE40	40	232	11"	3 lbs. - 2 kg
59960	IRHE64	64	232	12"	3 lbs. - 2 kg
59961	IRHE123	123	232	14"	5 lbs. - 3 kg

IR Gasoline Air Compressors

- Truck bed mounting design ideal for field service applications
- Overhung crankshaft allows smooth & quiet operation
- Two-Stage design provides 175 psi operation



Constant speed control with engine slow down device. 100% cast iron design. Finned copper intercooler runs cooler in demanding conditions. Removable cylinders for simple maintenance. Splash lubrication eliminates oil pump. Corrosive resistant powder coat paint finish. ASME receiver tank with manual drain. Meets California emission codes. Extended TWO YEAR warranty available with use of all season T30 select lubricant included in start-up kit. IR Compressors are shipped without oil.

Order No.	Mfr. Code	Engine Type	HP	Tank Size/Gal	Del'y CFM @175 PSI	Ship Wt.
50781	2475F14G	Kohler	14	30	24	455 lb s. - 206 kg
50788	2475F13GH	Honda	13	30	25	430 lbs. - 194 kg

IR Start-Up/Maintenance Kits for Electric Compressors



IR compressors are shipped without oil. Maintenance kit includes initial fill of manufacturer recommended all season T30 select lubricant, provisions for one oil change, two intake air filter elements (change every 6 months), product data and instruction sheet. Everything needed for the first year of operation. All Type 30 compressors initially filled and run with all season T30 select lubricant receive a two year warranty on the compressor pump.

Order No.	Description	For Compressor	Type
50844	Start-Up Kit	5 HP & 7.5 HP	Electric
50805	Start-Up Kit	10 & 15 HP	Electric

IR Installation Kits For Electric Compressors

Everything needed to perform easy, quick installation to existing air system piping. Kit contains: stainless steel braided hose with JIC connections, (2) JIC to mpt adaptors, (4) vibration pads, (4) foundation mounting bolts, and instruction sheet.

Order No.	Description	For Compressor	Type
59969	Install Kit	5 HP thru 15 HP	Electric
59992	Install Kit	20 HP	Electric

CP Standard Two Stage Electric Air Compressors



No Starter Required

Includes start-stop pressure switch control, ASME safety valves, fully enclosed belt guard, tank drain and discharge valve

Order No.	Mfr. No.	HP	Electrical Spec.	CFM @ 100	Tank Gal.	Tank Style	Ship Wt.
53713	RCP-561VNS	5	208 /230V/1 Ph.	15.3	60	Vert	300 lbs. - 13.6 kg
53714	RCP-581VNS	5	208 /230V/1 Ph.	15.3	80	Vert	382 lbs. - 173 kg

CP Premium Two Stage Electric Air Compressors

- Cast iron construction



A solid cast iron cylinder, crankshaft and valve plates provide the strength needed for heavy-duty use. The aluminum head and deep fins allow efficient heat dissipation. Includes magnetic starter, low oil switch and automatic tank drain. 5 and 7.5 HP models include triple-pass pump mounted aftercooler. 10 HP includes belt guard aftercooler.

Order No.	Mfr. No.	HP	Electrical Spec.	CFM @ 100	Tank Gal.	Tank Style	Ship Wt.
53715	RCP-581V	5	208 /230V/1 Ph.	18.5	80	Vert.	467 lbs. - 212 kg
53716	RCP-583V	5	208 /230V/3 Ph.	18.5	80	Vert.	453 lbs. - 205 kg
53717	RCP-584V	5	460V/3 PH	18.5	80	Vert.	453 lbs. - 205 kg
53718	RCP-581H	5	208 /230V/1 Ph.	18.5	80	Horiz.	501 lbs. - 227 kg
53719	RCP-583H	5	208 /230V/3 Ph.	18.5	80	Horiz.	481 lbs. - 218 kg
53720	RCP-584H	5	460V/3 Ph.	18.5	80	Horiz.	481 lbs. - 218 kg
53721	RCP-7581V	7.5	208 /230V/1 Ph.	25.3	80	Vert.	489 lbs. - 221 kg
53724	RCP-7581H	7.5	208 /230V/1 Ph.	25.3	80	Horiz.	489 lbs. - 221 kg
53722	RCP-7583V	7.5	208 /230V/3 Ph.	25.3	80	Vert.	477 lbs. - 216 kg
53723	RCP-7583VS4	7.5	460V/3 Ph.	25.3	80	Vert.	477 lbs. - 216 kg
53724	RCP-7584H	7.5	208 /230V/1 Ph.	25.3	80	Horiz.	481 lbs. - 218 kg
53725	RCP-7583H	7.5	208 /230V/3 Ph.	25.3	80	Horiz.	481 lbs. - 218 kg
53726	RCP-7583H4	7.5	460V/3 Ph.	25.3	80	Horiz.	491 lbs. - 223 kg
53727	RCP-10123V	10	208 /230V/3 Ph.	37.2	120	Vert.	854 lbs. - 387 kg
53728	RCP-10124V	10	460V/3 Ph.	37.2	120	Vert.	854 lbs. - 387 kg
53729	RCP-10123H	10	208 /230V/3 Ph.	37.2	120	Horiz.	765 lbs. - 347 kg
53730	RCP-10124H	10	460V/3 Ph.	37.2	120	Horiz.	765 lbs. - 347 kg

CP QRS Quiet Rotary Screw Air Compressors

- Lowest noise level available
- Maximum 150 psi Pressure
- Includes air dryer



The compressor can operate fully loaded – 24 hours a day / 7 days a week. The oil cooling system, A-T-L starter, TEFC motor, air dryer, sound enclosure and receiver tank are factory assembled. The packages are mounted, piped, wired and tested for easy installation. Includes tank mounted refrigerated air dryer, oil temperature shut down, full voltage starter, start/stop control and cold weather start. Note: Separate 110V plug is required for the air dryer.

Order No.	Mfr. No.	HP	Phase	Sound Level	CFM @ 150	Horiz. Tank/Gal.	Ship Wt.
53707	QRS5.0HPD	5	3 Ph*	62db	16.6	60	565 lbs. - 255 kg
53711	QRS 5.0HPD	5	1 Ph 230v	62db	16.6	60	565 lbs. - 255 kg
53708	QRS7.5HPD	7.5	3 Ph*	64db	21.2	60	570 lbs. - 257 kg
53712	QRS7.5HPD	7.5	1 Ph	64db	21.2	60	570 lbs. - 257 kg
53709	QRS10HPD	10	3 Ph*	66db	30.0	120	920 lbs. - 414 kg
53710	QRS15HPD	15	3 Ph*	66db	45.0	120	960 lbs. - 435 kg

* 3 Phase motors are Tri-Voltage 208 /230 /460

CP Two-Stage Gasoline Service Truck Compressors



Includes 12v electric start and recoil start, oil monitor, pilot valve engine slowdown, fully enclosed belt guard, EZ pull tank drain, ASME tank and safety valves and 3/4" tank discharge valve.

Order No.	Mfr. No.	HP	Motor	CFM @ 100	Tank Gal.	Tank Style	Ship Wt.
53731	RCP-1030G	10	Intek	16	30	Horiz.	328 lbs. - 149 kg
53732	RCP-1130G	11	Honda	18.5	30	Horiz.	358 lbs. - 162 kg
53733	RCP-1230G	12.5	Kohler	25.3	30	Horiz.	369 lbs. - 167 kg
53734	RCP-1330G	13	Honda	25.3	30	Horiz.	378 lbs. - 171 kg

Air Tools & Accessories

Make **Myers Tire Supply** your headquarters for a complete line of impact wrenches, air hammers, air ratchets & accessories. We stock the most popular models of **CP & IR** 1/2", 3/4", and 1" drive impact wrenches, tools for body shop applications, tire shops & general vehicle repair. We are also introducing the new **MTS PNEUMATIC** 1/2" & 1" impact wrenches delivering the power & service you would expect from a Myers branded product. We feature passenger & truck torque sticks & heavy-duty **NORBAR**, **DATA-TORQ** & **PNEUTORQUE** torque wrenches. Myers offers a complete torque recalibration service to assure your wrenches are in OSHA compliance, see page 89. You can rely on our inventory of socket sets, Budd nuts & studs & wheel clamps to keep your business running smoothly.



Protective Eyewear

- Reduce the chance of eye injury from dust & debris
- More protective eyewear see page 236



Scratch resistant and lightweight for comfort. Snug fit minimizes discomfort.

Order No.	Description
82662	Protective Eyewear with Amber Lens
82663	Protective Eyewear with Blue Mirror Lens
82664	Protective Eyewear with Clear Lens

MARVEL Air Tool Oil

- For all piston-type & rotary air tools
- Oil daily

The #1 contributing factor to air tool failure is lack of lubrication. At the beginning and end of each day, squirt or drop an approved air tool oil directly into the tool whip hose or air inlet and run the tool for 1 or 2 seconds to disperse the oil in the tool.



Order No.	Mfr. No.	Description	Size
45206	085	Air Tool Oil	1 Qt.
45203		Air Tool Oil	4 Oz.

Air Tool Maintenance Chart

- How often should an air compressor tank be drained?
- What are the warning signs of wear?
- How important is air pressure?
- Why use a whip hose?
- Ask your Myers sales professional for your free air tool maintenance chart

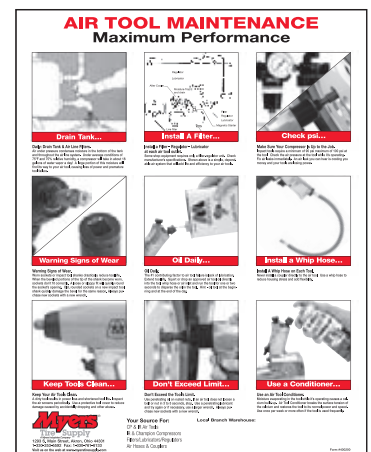

MYERS Air Tool Conditioner

- For all piston-type & rotary air tools

Moisture evaporating in the tool while it is operating causes a calcium build-up. Air Tool Conditioner breaks the surface tension of the calcium and restores the tool to its normal power and speed. Use once per week or more often if the tool is used frequently.



Order No.	Description	Size
45201	Air Tool Conditioner	12.2 Oz. Can

1/2" Impact Wrenches

IR 2135Ti-2 Max 1/2" Impact Wrenches

- 1,000 ft. lbs. of nut busting torque*
- Titanium weighs just 3.95 Lbs.



The 7-vane motor delivers nut busting torque that loosens a nut tightened to over 1,000 ft. lbs. in 6 seconds. Touch trigger modulates power output. Four-position power management control. Push button forward/reverse controls. *Specs.: 1/2" sq. dr.; torque range 50-600 ft. lbs.; maximum torque - 625 ft. lbs. forward, 700 ft. lbs. reverse; avg. air cons. 5 cfm.; air inlet 1/4"; min. hose size 3/8"; std. bolt size 3/8".*

Order No.	Mfr. No.	Description	Ship Wt.
52963	IR2135TI	Max Premium 1/2" Drive - Short Shank	4 lbs. - 3 kg
52962	IR2135TI-2	Max Premium 1/2" Drive - Long Shank	4 lbs. - 3 kg

IR 244A & 244A-2 1/2" Impact Wrenches

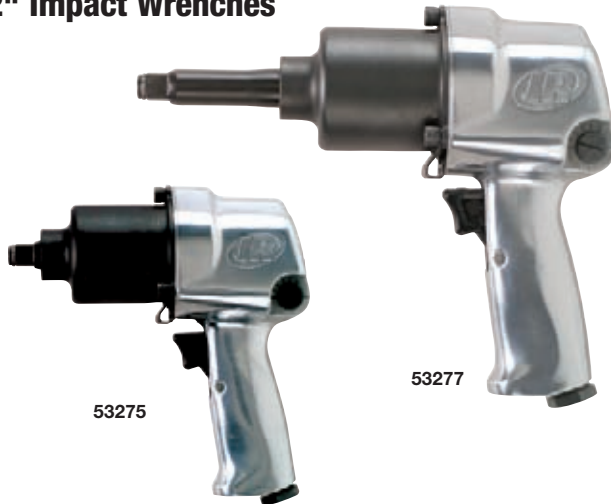

IR's most powerful 1/2" impact wrench. Ideal for heavy automotive and truck work such as tire changing, shocks and springs, and front-end work. *Specs.: 1/2" sq. dr.; 40-350 ft. lb. working torque range; 500 ft. lb. max torque; 1,300 blows per minute; 7,000 rpm free speed; 3/8" bolt size; avg. air cons. 5.4 cfm; air inlet 1/4"; min. hose size 3/8".*

Order No.	Mfr. No.	Description	Ship Wt.
53275	IR244A	1/2" Impact Wrench	6 lbs. - 3 kg
53277	IR244-A2	Impact Wrench w/ 2" Anvil	6 lbs. - 3 kg
Accessories			
53288	IR244-P32	Protective Tool Cover	1 lbs. - 1 kg
53189	IR244-TK2	Tune-Up Kit for 244A Series	1 lbs. - 1 kg

Specifications:

Mfr. No.	Description	Working Torque Range	Ultimate Torque @ 90 psi	Avg. Air Consumption	Air Inlet Size	Minimum Hose Size
IR244A Series	Super-Duty	40-350 ft. lbs.	500 ft. lbs.	5.4 cfm	1/4"	3/8" ID
IR231HA Series	Heavy-Duty	50-400 ft. lbs.	450 ft. lbs.	4.2 cfm	1/4"	3/8" ID
IR2135Ti Series	Premium	50-600 ft. lbs.	625 ft. lbs. for/700 ft. lbs. Rev.	5 cfm	1/4"	3/8" ID
IR2135QTI-2	Quiet	50-600 ft. lbs.	625 ft. lbs. for/700 ft. lbs. Rev.	5 cfm	1/4"	3/8" ID

IR 231HA & 231HA-2 1/2" Impact Wrenches

- The standard of the industry



Specs.: 1/2" sq. dr.; 25-300 ft. lb. working torque range; 231H, 25-300 ft. lb., 231H-2, 50-400 ft. lb. max. torque; 1,200 blows per minute; 8,000 rpm free speed; 3/8" std. bolt size; avg. air cons. 4.2 cfm; air inlet 1/4"; min. hose size 3/8".

Order No.	Mfr. No.	Description	Ship Wt.
53225	IR232HA	1/2" Impact Wrench	5 lbs. - 2 kg
53208	IR231HA-2	Impact Wrench w/ 2" Anvil	5 lbs. - 2 kg
Accessories			
53703		Protective Tool Cover	1 lbs. - 1 kg
52975	IR231TK2	Tune-Up Kit for 231 Series	1 lbs. - 1 kg

IR 2135QTI-2 Max 1/2" Quiet Impact Wrench

- Delivers full power with almost 12 dBA of noise reduction



One hand push button forward/reverse. Strong composite housing with steel hammer case. 360° swivel inlet and handle exhaust. *Specs.: 1/2" sq. dr.; 3/8" std. bolt size; working torque range 50-600 ft lbs.; NBT 1,000 ft. lbs.; ultimate torque, 625 ft lbs. forward, 700 ft lbs. reverse; avg. air cons. 5 cfm; air inlet 1/4"; min. hose size 3/8".*

Order No.	Mfr. No.	Description	Ship Wt.
53234	IR2135QTI-2	Max Quiet Impact Wrench w/ 2" Anvil	5 lbs. - 2 kg



CP 7749-2 1/2" Super-Duty Impact Wrench

- Change from forward to reverse with one hand in any position without moving the tool
- 2-Year warranty*



Full teasing trigger allows full control. Lightweight composite weighs 4.5 lbs., less than standard metal impact wrenches. Three position power setting regulator in forward and full power reverse for maximum control. Impacts come with a 1 year warranty. For the 2 year warranty the tool must be registered on www.cp.com. *Specs.: max. torque 725 ft./lbs.; work torque range 75 - 580 ft./lbs.; free speed 9,000 rpm; aver. air cons. 4.8 cfm, actual air cons. @ load 19.1 cfm; air inlet 1/4"*

Order No.	Mfr. No.	Description	Ship Wt.
53060	CP7749-2	High Performance 1/2" Impact Wrench	5 lbs. - 2 kg
53062	CP7749	Short Shank High Performance 1/2" Impact Wrench	5 lbs. - 2 kg
53061	8940167487	Protective Cover for 7749-2	

CP 7733 & 7733-2 1/2" Heavy-Duty Impact Wrenches

- 5 Forward speeds & 1 reverse
- Steel clutch housing



Streamline housing for better styling and reduced weight. Ergonomic grip and trigger. Durable 6 vane rotor. Patented Spring Hammer Clutch increases life by 35%. *Specs.: 1/2" sq. dr.; working torque range 25-400 ft. lbs.; max. torque at 90 psi - 550 ft. lbs. reverse; avg. air cons. 4.75 cfm.; air inlet 1/4"; min. hose size 3/8"*

Order No.	Mfr. No.	Description	Ship Wt
53697	CP7733	1/2" Impact Wrench	6 lbs. - 3 kg
53696	CP7733-2	Impact Wrench w/ 2" Anvil	6 lbs. - 3 kg

1/2" Impact Wrench

- 13% Quieter than other well known brands
- Torque range 25 to 400 ft. lbs.
- Light weight aluminum housing & comfort grip
- 5 Power settings



The MTS Pneumatics 1/2" impact wrench features: twin hammer, 2" anvil, aluminum housing, handle exhaust with comfort handle grip. Includes a 1 year warranty. *Specs.: 1/2" sq. dr.; torque range 25-400 ft. lbs.; maximum torque - 600 ft. lbs. reverse; average air consumption 4.2 cfm.; air inlet 1/4"; minimum hose size 3/8"*

Order No.	Mfr. No.	Description	Ship Wt.
53371		1/2" MTS Pneumatic Impact Wrench	6 lbs. - 3 kg
Accessories			
53703		Protective Tool Cover	1 lbs. - 1 kg

1/2" Lightweight Impact Wrench

- Variable speed trigger
- Composite housing



Features Lightweight composite housing, only 4.3 lbs., twin hammer clutch with 3 forward speeds. *Specs.: 1/2" sq. dr.; 50-580 ft. lb. working torque range; 950 ft. lb. working torque reverse; avg. air cons. 4 cfm; air inlet 1/4"; min. hose size 3/8"*

Order No.	Mfr. No.	Description	Ship Wt.
53374		1/2" Impact Wrench	5 lbs. - 2 kg
53372		Impact Wrench w/ 2" Anvil	5 lbs. - 2 kg

Specifications:

Mfr. No.	Description	Working Torque Range	Ultimate Torque @ 90 psi	Avg. Air Consumption	Air Inlet Size	Minimum Hose Size
MTS 1/2"	General-Duty	25-400 ft. lbs.	600 ft. lbs.	4.2 cfm	1/4"	3/8" ID
CP7733 Series	Super-Duty	25-400 ft. lbs.	550 ft. lbs.	4.75 cfm	1/4"	3/8" ID
CP7749 Series	High Performance	75-580 ft. lbs.	725 ft. lbs. for./Rev.	4.8 cfm	1/4"	3/8" ID
MTS 1/2" Lightweight	Lightweight	50-580 ft. lbs.	950 ft. lbs. for./Rev.	4 cfm	1/4"	3/8" ID

3/4" Impact Wrenches

IR 2145QiMAX 3/4" Impact Wrench

- Weighs only 7 lbs.
- Best power to weight ratio available



One hand forward/reverse for easy operation



Four position power regulator delivers maximum 1,350 ft. lbs. in reverse and 900 ft. lbs. in forward. Handle exhaust directs exhaust air away from the work. Features a twin hammer mechanism for long life. *Specs.: 3/4" sq. dr.; 1" std. bolt size; working torque range 200-900 ft. lbs.; ultimate torque at 90 psi - 900 ft. lbs. forward, 1,350 ft. lbs. reverse; avg. air con. 8.5 cfm.; air inlet 1/2" NPTF"; min. hose size 1/2".*

Order No.	Mfr. No.	Description	Ship Wt.
53046	IR2145QiMAX	3/4" Impact Wrench	7 lbs. - 3 kg

Accessories			
52995	2141-P32	Protective Cover	1 lbs. - 1 kg
53103	2141-TK1	Tune-Up Kit for 2141	1 lbs. - 1 kg

IR 2161XP & IR 2161XP-6 3/4" Impact Wrenches



Combines the twin hammer mechanism with a six-vane, high-output air motor. Three position forward and full power reverse. *Specs.: 3/4" sq. dr.; 300-1,000 ft. lb. working torque range; 1,250 ft. lb. max torque; 1,025 blows per minute; 6,000 rpm free speed; 1" std. bolt size; avg. air cons. 10 cfm; air inlet 3/8"; min. hose size 1/2".*

Order No.	Mfr. No.	Description	Ship Wt.
53216	IR2161XP	3/4" Impact Wrench	11 lbs. - 5 kg
53220	IR2161XP-6	3/4" Impact Wrench w/ 6" Shank	13 lbs. - 7 kg

Accessories			
53705	2161-P32	Protective Tool Cover	1 lbs. - 1 kg
53104	2161-TK2	Tune Up Kit for 2161 Series	1 lbs. - 1 kg

Specifications:

Mfr. No.	Description	Working Torque Range	Ultimate Torque @ 90 psi	Avg. Air Consumption	Air Inlet Size	Minimum Hose Size
IR259	Heavy-Duty	200-800 ft. lbs.	1,050 ft. lbs.	8 cfm	3/8"	3/8" ID
IR261 Series	Super-Duty	200-900 ft. lbs.	1,100 ft. lbs.	9.5 cfm	3/8"	1/2" ID
IR2145QiMAX	Ultra-Duty	200-900 ft. lbs.	1,350 ft. lbs.	8.5 cfm	1/2"	1/2" ID
IR2161 Series	Ultra-Duty	300-1000 ft. lbs.	1,250 ft. lbs.	10 cfm	3/8"	1/2" ID

IR 261/IR 261-3 & IR 261-6 3/4" Impact Wrenches

- Available with short, 3" or 6" shank



Great for off-highway and farm maintenance. The 261-6 extended shank is designed for truck tire changing. All models feature: variable speed throttle; handle exhaust; pressure feed lubrication for extended tool life. *Specs.: 3/4" sq. dr.; 200-900 ft. lb. working torque range; 1,100 ft. lb. max. torque; 1,000 blows per minute; 5,500 rpm free speed; 1" std. bolt size; avg. air cons. 9.5 cfm; air inlet 3/8"; min. hose size 1/2".*

Order No.	Mfr. No.	Description	Ship Wt.
53270	IR261	3/4" Impact Wrench	12 lbs. - 5 kg
53245	IR261-3	3/4" Impact Wrench w/ 3" Shank	13 lbs. - 6 kg
53240	IR261-6	3/4" Impact Wrench w/ 6" Shank	14 lbs. - 7 kg

Accessories			
53287	IR261-P32	Protective Tool Cover	1 lbs. - 1 kg
53283	261-TK2	261 Series Tune Up Kit	1 lbs. - 1 kg

IR 259 3/4" Impact Wrench



1,050 Maximum torque in forward and reverse and two power settings in each direction. Handle exhaust directs air away from the work. *Specs.: 3/4" sq. dr.; 1" std. bolt size; working torque range 200-800 ft. lbs.; ultimate torque at 90 psi - 1,050 ft. lbs.; avg. air cons. 8 cfm.; air inlet 3/8"; min. hose size 3/8".*

Order No.	Mfr. No.	Description	Ship Wt.
53271	IR259	3/4" Impact Wrench	11 lbs. - 5 kg

Accessories			
53228	IR255-P32	Protective Tool Cover	1 lbs. - 1 kg

CP 7763 & 7763-6 3/4" Super-Duty Impact Wrenches

- For high-volume truck spring, truck maintenance, & heavy-duty equipment shops
- 1,200 ft. lbs of ultimate torque



Features an adjustable three position regulator with forward/reverse directional control. *Specs.: 3/4" sq. dr.; working torque range 100-950 ft. lbs.; 1,200 ft. lb. max. torque at 90 psi; avg. air cons. 7.5 cfm; air inlet 3/8"; min. hose size 3/8".*

Order No.	Mfr.No.	Description	Ship Wt.
53317	CP7763	3/4" Impact Wrench	11 lbs. - 5 kg
53318	CP7763-6	3/4" Impact Wrench w/ 6" Shank	12 lbs. - 6 kg

Specifications:

Mfr. No.	Description	Working Torque Range	Ultimate Torque @ 90 psi	Avg. Air Consumption	Air Inlet Size	Minimum Hose Size
CP772H/CP772H-6	Heavy-Duty	150-700 ft. lbs.	1,000 ft. lbs.	8 cfm	3/8"	1/2" ID
CP7763/CP7763-6	Super-Duty	100-950 ft. lbs.	1,200 ft. lbs.	7.5 cfm	3/8"	3/8" ID

Insulated Gloves

- 3mm shock absorbing "Gel" palm padding

Full grain leather on the entire palm area insuring water resistance and durability. Flex Airprene knuckle and index finger protection system. Tough insulated spandex top material and hidden seam design eliminates snagging. Snug fit with insulated palm and fingers. Not machine washable. Color - black.



Order No.	Mfr. No.	Description	Size
45346	123-09	Insulated Gloves	Medium
45347	123-10	Insulated Gloves	Large
45348	123-11	Insulated Gloves	Extra Large

RINGERS Tire Buddy Gloves

High abrasion-resistant palm and padding on the lower palm reduces fatigue. Rubberized fingers.



Order No.	Description
45397	Medium Pair Tire Buddy Gloves
45398	Large Pair Tire Buddy Gloves
45399	Extra-Large Pair Tire Buddy Gloves

CP 772H & 772H-6 3/4" Heavy-Duty Impact Wrenches

- 40% more power than the CP-772



The all-around 3/4" impact wrench for truck shops and light spring work. Features an adjustable four position regulator for greater control in forward while delivering full power in reverse. *Specs.: 3/4" sq. dr.; working torque range 150-700 ft. lbs.; 1,000 ft. lb. max. torque at 90 psi; std. bolt size 1 1/8"; avg. air cons. 8 cfm; air inlet 3/8"; min. hose size 1/2".*

Order No.	Mfr. No.	Description	Ship Wt.
53310	CP772H	3/4" Impact Wrench	11 lbs. - 5 kg
53299	CP772H-6	3/4" Impact Wrench w/ 6" Shank	12 lbs. - 6 kg
Accessories			
53144	FC772	Protective Tool Cover	1 lbs. - 1 kg
53100	CA149746	Tune-Up Kit for 772 Series	1 lbs. - 1 kg

MYERS Reusable Mechanics Gloves

- Outstanding gripping power & superior flexibility

Nitrile-coated palm protects hands against oil, grease and other shop grime. Rolled cuff and breathable fabric keeps hands cool in the heat and warm in the cold. Machine washable, will not shrink. Air dry.



Order No.	Description	Size
45378	Mechanics Gloves	Large
45379	Mechanics Gloves	Extra Large

Anti-Vibration Gloves

- 3Mm shock absorbing "Gel" palm padding

Flex Airprene knuckle and index finger protection system. Unique split palm design enhances fit. Snug fit design allows greater dexterity. Machine washable, air dry.



Order No.	Mfr. No.	Description	Size
45343	143-09	Anti-Vibration Gloves	Medium
45344	143-10	Anti-Vibration Gloves	Large
45345	143-11	Anti-Vibration Gloves	Extra Large

1" Impact Wrenches

IR 295A 1" Impact Wrench



For truck and heavy equipment maintenance. Compact for working on suspension components, tractor pads, and other big capacity repair jobs. Three position power regulator. *Specs.: 1" sq. dr.; 100-1,000 ft. lb. working torque range; 1,450 ft. lb. max torque at 90 psi; 1 1/4" std. bolt size; avg. air cons. 10 cfm; air inlet 1/2"; min. hose size 1/2".*

Order No.	Mfr. No.	Description	Ship Wt.
53280	IR295A	1" Sq. Dr. Wrench — Short Shank	22 lbs. - 10 kg
Accessories			
53706	295-P32	Protective Tool Cover	1 lbs. - 1 kg

IR 2190TI-6 1" Impact Wrenches

- Maximum torque 1,600 ft. lbs.

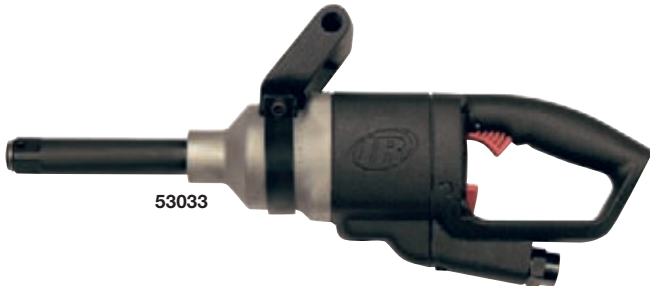

Larger, more durable front bushing than previous models. 7-vane motor for more power, durable heavy-duty extended anvil and angled down exhaust. *Specs.: 1" sq. dr.; 1 1/4" std. bolt size.; working torque range 150-1,200 ft. lbs.; ultimate torque at 90 psi, 1,600 ft. lbs.; avg. air cons. 12 cfm; air inlet 1/2"; min. hose size 1/2".*

Order No.	Mfr. No.	Description	Ship Wt.
53033	IR2190TI-6	"Chainsaw" Handle w/6" Shank	25 lbs. - 12 kg
53031	IR2190TI	"Chainsaw" Handle w/Short Shank	18 lbs. - 9 kg
53038	IR2190DTI-6	"D" Handle w/6" Shank	25 lbs. - 12 kg

Mobile Wheel Work Station

- Decrease potential back problems & reduce tire changing time
- Gas strut raises, lowers & locks wrench in any position



Universal holder allows wrench movement in all directions & locks in a horizontal plane to prevent rounding the lug nuts. Extra storage space for accessories & room for a 20-ton bottle jack. Large rear wheels & single front wheel for easy positioning.

Order No.	Description	Ship Wt.
52078	2003 Mobile Wheel Work Station	82 lbs. - 38 kg

Specifications:

Mfr. No.	Description	Working Torque Range	Ultimate Torque @ 90 psi	Avg. Air Consumption	Air Inlet Size	Minimum Hose Size
IR295	Heavy-Duty	100-1,000 ft. lbs.	1,450 ft. lbs.	10 cfm	1/2"	1/2" ID
IR285B Series	Heavy-Duty	100-1,000 ft. lbs.	1,450 ft. lbs.	10 cfm	1/2"	1/2" ID
IR280 Series	Super-Duty	150-1,000 ft. lbs.	1,600 ft. lbs.	10 cfm	1/2"	1/2" ID
IR2190TI Series	Heavy-Duty	150-1,200 ft. lbs.	1,600 ft. lbs.	12 cfm	1/2"	1/2" ID

IR 285B-6 1" Impact Wrenches

- Short shank available

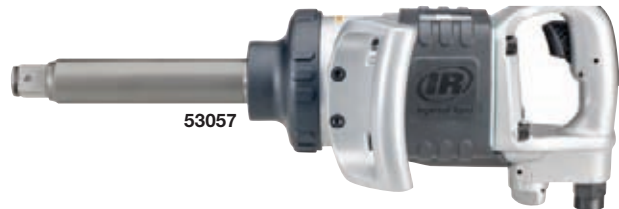

Made for the demanding world of truck tire service and work. The 360° swivel inlet eliminates kinked hoses, and the swept-back side handle provides excellent maneuverability. High efficiency 6-vane motor. Angled down exhaust. *Specs.: 1" sq. dr. or #5 spline dr.; 1 1/4" std. bolt size.; working torque range 100-1,000 ft. lbs.; ultimate torque at 90 psi - 1,450 ft. lbs.; avg. air con. 10 cfm.; air inlet 1/2"; min. hose size 1/2".*

Order No.	Mfr. No.	Description	Ship Wt.
53057	IR285B-6	1" Impact Wrench w/ 6" Shank	25 lbs. - 12 kg
53058	IR285B-S6	#5 Spline Dr. w/ 6" Shank	25 lbs. - 12 kg
53056	IR285B	1" Short Shank Impact	22 lbs. - 10 kg
Accessories			
53194	285-P32	Protective Tool Cover	1 lbs. - 1 kg
53285	285-TK1	Tune-Up Kit for IR285 Series	

IR 280-6 1" Impact Wrench

- Short shank available

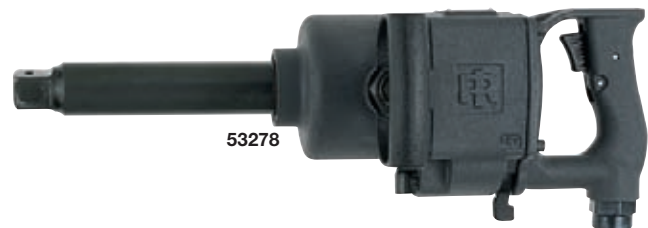

Designed for high production truck tire changing. The 6" extended shank is ideal for deep truck wheels. Features a built-in oil reservoir to provide continuous motor oiling, multi-position side handle, and pressure feed lube system. *Specs.: 1" sq. dr. or #5 spline dr.; 150-1,000 ft. lb. working torque range; 1,600 ft. lb. max. torque; 750 blows per minute; 6,000 rpm free speed; 1 1/4" std. bolt size; avg. air cons. 10 cfm; air inlet 1/2"; min. hose size 1/2".*

Order No.	Mfr. No.	Description	Ship Wt.
53278	IR280-6	1" Sq. Dr. w/ 6" Shank	25 lbs. - 12 kg
53279	IR280-S6	#5 Spline Dr. w/ 6" Shank	25 lbs. - 12 kg
53042	IR280	1" Short Shank Impact	22 lbs. - 10 kg
Accessories			
53284	280-TK2	Tune-Up Kit for IR280 Series	1 lbs. - 1 kg

Air Tool Conditioner

- For all piston-type & rotary air tools



Moisture evaporating in the tool while it's operating causes a calcium build-up. Air Tool Conditioner breaks the surface tension of the calcium and restores the tool to its normal power and speed. Use once per week or more often if the tool is used frequently.

Order No.	Description	Size
45201	Air Tool Conditioner	12.2 oz. Can

CP 7782-6 1" Impact Wrench

- For service trucks & high volume shops
- Powerful - 2,140 ft. lbs. ultimate torque



Specs.: 1" sq. dr.; working torque range 440-1,850 ft. lbs.; ultimate torque at 90 psi, 2,140 ft. lbs.; avg. air cons. 10 cfm; air inlet 1/2"; min. hose size 1/2"; ship. wt. 26 lbs.

Order No.	Mfr. No.	Description	Ship Wt.
53094	CP7782-6	1" Drive with 6" Extended Shank	26 lbs. - 12 kg

CP 7780-6 1" Impact Wrench

- Weighs only 17 lbs.



Ideal for deep truck wheels. High performance motor maximizes output while minimizing air consumption. Teasing throttle and reverse valve for easy directional changes. Specs.: 1" sq. dr.; 260-1,220 ft. lb. working torque range; 1,550 ft. lb. max. torque reverse; 1 1/4" std. bolt size; avg. air cons. 12 cfm; air inlet 1/2"; min. hose size 1/2".

Order No.	Mfr. No.	Description	Ship Wt.
53071	7780-6	1" Sq. Dr. Wrench w/ 6" Shank	17 lbs. - 8 kg

FLORIDA PNEUMATIC 1" Impact Wrench

- 8" Shank
- 2,300 ft/lbs. of torque
- 2-Year Warranty



Specs.: 1" sq. dr.; 1 1/4" std. bolt size.; working torque range 100-1,000 ft. lbs.; ultimate torque at 90 psi - 2,300 ft. lbs.; avg. air con. 14 cfm.; air inlet 1/2"; min. hose size 1/2".

Order No.	Description	Ship Wt.
53351	1" Sq. Dr. Wrench w/ 8" Shank	17 lbs. - 8 kg

Protective Eyewear

- For protective eyewear see page 236



82664

Specifications:

Mfr. No.	Description	Working Torque Range	Ultimate Torque @ 90 psi	Avg. Air Consumption	Air Inlet Size	Minimum Hose Size
CP7782 Series	Extra Heavy-Duty	440-1,850 ft. lbs.	2,140 ft. lbs.	10 cfm	1/2"	1/2" ID
CP7780 Series	Heavy-Duty	260-1,220 ft. lbs.	1,550 ft. lbs.	12 cfm	1/2"	1/2" ID
MTS Pneumatics 1"	Extra Heavy-Duty	450-1,650 ft. lbs.	2,000 ft. lbs.	10 cfm	1/2"	1/2" ID
CP797 Series	Extra Heavy-Duty	150-900 ft. lbs.	1,400 ft. lbs.	12 cfm	1/2"	1/2" ID
Florida Pneumatic	Extra Heavy-Duty	100-1,000 ft. lbs.	2,300 ft. lbs.	14 cfm	1/2"	1/2" ID

1" Impact Wrench



- Torque & durability improved by pinless clutch design
- Torque range 400 to 1,650 ft. lbs.



The New MTS Pneumatics 1" Impact Wrench features twin hammer and pinless clutch, handle with inside trigger and a side support handle for better control. The steel ring retains the socket. One year warranty. Specs.: 1" sq. dr.; torque range 400-1650 ft. lbs.; maximum torque - 2,000 ft. lbs. reverse; average air consumption 10 cfm.; air inlet 1/2"; minimum hose size 1/2"; weight: 26.2 lbs

Order No.	Mfr. No.	Description	Ship Wt.
53370		1" Drive with 6" Extended Shank	26 lbs. - 12 kg
Accessories			
53059		Protective Tool Cover	1 lbs. - 1 kg

CP 797-6 1" Super-Duty Impact Wrenches

- For service trucks & high-volume tire shops
- Durable rocking dog clutch is ideal for tire work



53342

Teasing throttle for easy bolt starting. 6" Extended anvil makes is ideal for deep truck wheels. High performance motor maximizes output while minimizing air consumption. Convenient reverse valve for easy directional changes. Specs.: 1" sq. dr. or #5 spline dr.; 150-900 ft. lb. working torque range; 1,400 ft. lb. max. torque; 1 1/4" std. bolt size; avg. air cons. 12 cfm; air inlet 1/2"; min. hose size 1/2".

Order No.	Mfr. No.	Description	Ship Wt.
53342	CP797-6	1" Sq. Dr. Wrench w/ 6" Shank	30 lbs. - 14 kg
53340	CP797SP-6	#5 Spline Dr. w/ 6" Shank	30 lbs. - 14 kg
Accessories			
53145	CA-139818	Protective Tool Cover	1 lbs. - 1 kg
53398	CA-131501	Tune-Up Kit for CP797-6	1 lbs. - 1 kg

Socket Retainer Clips & O-Rings



For 1/2" Drive impact guns

Order No.	Mfr. No.	Description
52965	IR-R500	1/2" 6 Piece Kit, contains (3) Clips & (3) "O" Rings
52966	CP-C500	1/2" 6 Piece Kit, contains (3) Clips & (3) "O" Rings
Accessories		
52967	All	1" Kit, contains (1) Clip & (1) "O" Ring

IR Grease Gun For Impact Wrenches

For use with all Ingersoll-Rand impact wrenches equipped with flush-type fittings. Capacity 3 ounces.



Grease Guns		
Order No.	Mfr. No.	For Use On
53193	RA2-228	IR231 & IR2131 Series
53178	IR-P25-228	IR2080 Series Impacts
Grease		
53197	IR100	Grease for IR231
53199	IR115	Grease for IR2131
53179	IR170	Grease for IR2080-6

Air Tool Covers



Protect air tools from accidental impact. Thick resilient vinyl and "cushion ribbed" to absorb shock. Oil resistant, available in sizes to fit most tools.

Order No.	Fits Tool
53196	IR212/IR202
53288	IR244A/IR244A-2
53703	CP731/CP731-2/IR231/IR231-2/CP733/ CP733-2/Myers
52961	IR2135TI-P32
53083	CP749/CP749-2
3/4" Air Tool Covers	
53144	CP772/CP772-6
53081	CP776/CP776-6
53287	IR261/IR261-3/IR261-6
53228	IR255
53705	IR2161XP/IR2161XP-6
52995	IR2141
1" Air Tool Covers	
53145	CP797-6/CP797-SP6
53194	IR281-6/IR281-S6/IR285-6

PB Blaster Nut Loosener

A powerful, penetrating lubricant that frees everything faster! Displaces moisture. Use on nuts and bolts, rusted joints, automatic chokes, to start wet engines and more. Just saturate troubled area and allow to stand for a few minutes.



Order No.	Description	Case Qty.
45217	11 Oz. Spray	12
45218	1 Gallon	4

NEXT DIMENSION Penetrant Lubricant Spray

- Prevents corrosion & displaces moisture
- Penetrates & lubricates
- No ozone depleters or chlorinated solvents

A unique blend of concentrated, fast-acting, powerful penetrating solvent quickly loosens rusted nuts, bolts, and frozen parts in seconds. 4 in 1 chemistry penetrates, lubricates, displaces moisture, and prevents corrosion. Ideal for shop, garage, and industrial applications.



Order No.	Description	Case Qty	Fill	Container
11053	Penetrant Lubricant	12	12 Oz.	16 Oz.

BRANICK 2400 Tire Tool Station

- Organize your tire service area

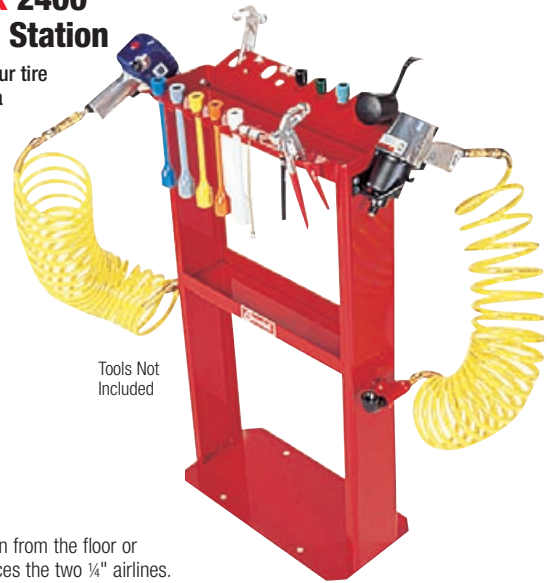

Tools Not Included

A 1/2" connection from the floor or overhead services the two 1/4" airlines. Top tray features slots for torque sockets and other tire service tools plus a lower tray for additional storage. Includes two 3/8" x 25' recoil air hoses with 1/4" swivel fittings. Use whip hoses to provide a straight flexible connection to the coil hose.

Order No.	Mfr. No.	Description	Ship Wt.
84079	2400	Tire Tool Station	58 lbs. - 26 kg
54145	CA-88140A	3/8" Whip Hose w/ 1/4" Fittings (Two Recommended)	

KILFROST® Air Tool Antifreeze Lubricant

Absorbs moisture to reduce air tool icing. Ideal for cold weather tire work and service trucks. Use when the temperature drops below 45°F. Apply directly into air inlet. KilFrost keeps tools working to -60°F, absorbs moisture, de-ices frozen tools. DO NOT MIX WITH OTHER AIR TOOL LUBRICANTS.



Order No.	Description	Size
46040	Antifreeze Lubricant	16 Oz.

Hub Centric Nut

- True black oxide coating, not painted
- Special steel blend for extra strength
- Zinc yellow coating offers extended corrosion resistance
- 33mm Hex, 22mm x 1.5 thread



Installing a fastener on every stud stops the rim from shifting forward or backward helping to maintain the torque of the nut initially applied and reducing the chance of a loose wheel. Complete coverage for liability by an A+ American insurance company.

Order No.	Order No.	Description
72650	X10-PN22B	Hub Centric Nut - Black
72651	X10-PN22Z	Hub Centric Nut - Zinc
72652	X10-DW22B	Dual Wheel Hub Centric Nut - Black
72653	X10-DW22Z	Dual Wheel Hub Centric Nut - Zinc

CP 714 Air Hammer

- .401 Shank
- Most control



Remove king pins, shackle pins, ball joints, universal joints, idler arm bushing, etc. .401 chisel shank opening. 2,000 blows per minute at 90 psi; avg. air cons. 5 cfm.; air inlet 1/4"; min. hose size 3/8".

Order No.	Mfr. No.	Description	Ship Wt.
02667	CP714	Hi-Power Zip Gun	4 lbs. - 2 kg

CP 717 Air Hammer

- .498 Shank



Most powerful zip gun for automotive and truck use. Easily removes frozen king pins, shackle pins, splits bushings and rusted nuts. Requires .498 dia. chisels. 1,800 blows per minute. avg. air cons. 7 cfm.; air inlet 1/4"; min. hose size 3/8".

Order No.	Mfr. No.	Description	Ship Wt.
02693	CP717	Super-Power Zip Gun	5 lbs. - 2 kg

CP 711 Air Hammer

- .401 Shank



For muffler, brake and body shop use. Remove exhausts, shocks, brake drums, and light front end work. .401 chisel shank opening. 3,500 blows per minute at 90 psi., avg. air cons. 4 cfm.; air inlet 1/4"; min. hose size 3/8".

Order No.	Mfr. No.	Description	Ship Wt.
02665	CP711	Hi-Speed Zip Gun	4 lbs. - 2 kg

IR 121 Air Hammer

- .401 Shank



Super-duty for general body service work. .401 chisel shank diameter. 3,000 blows per minute at 90 psi; avg. air cons. 3 cfm., air inlet 1/4", min. hose size: 3/8".

Order No.	Mfr. No.	Description	Ship Wt.
02679	IR121	Super-Duty Air Hammer	4 lbs. - 2 kg

Air Hammer Specifications:

Mfr. No.	Shank	Blows Per Min. @ 90 psi.	Avg. Air Cons.	Air Inlet Size	Min. Hose Size
IR 121	.401	3,000	3 cfm	1/4"	3/8"
CP711	.401	3,500	4 cfm	1/4"	3/8"
CP714	.401	2,000	5 cfm	1/4"	3/8"
CP717	.498	1,800	7 cfm	1/4"	3/8"

Zip Gun Retainer Spring

- .401 Shank

Reduces the risk of accidental shank release. The retainer ring grips the shank tighter as hammering force increases.

Order No.	Mfr. No.	Description
02301	1988	Retainer Spring



Zip Gun Retainer Chuck

- .401 Shank

A pneumatic tool holder that locks the tool firmly in place. Tool can be changed quickly. Note: At first sign of cracking or distortion of the chuck it should be replaced.

Order No.	Mfr. No.	Description
54340	2053	Retainer Chuck



Automotive Tools For Air Hammers



02509
02526
02596

02512
02600

02517
02634

02519

02520

53078

02296



02521

02522
02604

02523

02524

02528

02633

02635

Order No.	Mfr. No.	Description
-----------	----------	-------------

With .401 Diameter Shank

02509	1972	6" Cold Chisel
02526	1986	18" Cold Chisel
02512	1975	Rivet & Bolt Cutter
02517	1993	Tie Rod Sleeve Breaker
02519	1996	1 5/16" Ball Joint Separator
02520	1976	8" Scraper with 1 1/8" Wide Blade
02521	1977	6" Sharp Point Taper Punch
02522	1997	1/8" Taper Punch
02523	1979	3/8" Taper Punch 6" Long
02524	1980	1/2" Taper Punch 6" Long
02528	1995	2 1/2" Tie Rod Separator

With .498 Diameter Shank

02596	H-1972	6" Cold Chisel
02600	H-1975	Rivet Cutter
02634	CP-A047057	Universal Joint & Tie Rod Tool
53078	CP-A047071	Twin Blade Cutter
02296	H-1981	1 1/4" Smoothing Hammer
02604	H-1997	Tapered Punch 3/16" Point
02633	CP-A047052	Bushing Splitter
02635	CP-A047059	1" Separator Fork

Air Drills

IR 7803A 1/2" Air Drill

- 500 RPM



Economical 1/2 H.P. drill for hole sawing, honing and all general purpose applications. Features include auxiliary handle, and double reduction planetary gearing. *Specs.: 500 rpm; 1/2 hp motor; avg. air cons. 4 cfm; air inlet 1/4"; min. hose size 3/8".*

Order No.	Mfr. No.	Description	Ship Wt.
52989	IR 7803A	1/2" Air Drill	3 lbs. - 2 kg

CP 789HR 1/2" Reversible Air Drill

- 500 RPM
- Molded grip for comfort



Ideal for drilling, reaming and jobs requiring a lot of torque. Teasing throttle delivers precise control. Handle exhaust directs air away from the operator. Needle bearing gearing and oil-free operation. *Specs.: Chuck size 1/2"; 500 rpm; avg. air cons. 4 cfm; air inlet 1/4"; air hose size 3/8".*

Order No.	Mfr. No.	Description	Ship Wt.
02686	CP789HR	1/2" Reversible Air Drill	3 lbs. - 2 kg

1/2" Reversible Air Drill

- 500 RPM
- 1/2" Jacobs Chuck



For heavy drilling and plug cutting especially in truck tire treads. Reverse switch on side near trigger, auxiliary handle. *Specs.: 1/2" jacobs chuck; 1/2 HP motor; 500 rpm; avg. air cons. 4 cfm; air inlet 1/4"; min. hose size 3/8".*

Order No.	Mfr. No.	Description	Ship Wt.
31200M	527C	1/2" Reversible Drill	3 lbs. - 2 kg
53413	MT127175	Rear Exhaust Kit	

Air Drill Specifications:

Mfr. No.	Cap	RPM	Avg. Air Cons.	Air Inlet Size	Min. Hose Size
IR 7803A	1/2"	500	4 cfm	1/4"	3/8"
IR 7802A	3/8"	2,500	4 cfm	1/4"	3/8"
CP789HR	1/2"	500	4 cfm	1/4"	3/8"
CP789R-26	3/8"	2,600	4 cfm	1/4"	3/8"
527C	1/2"	500	4 cfm	1/4"	3/8"

IR 7802A 3/8" Air Drill

- 2,500 RPM



For drilling, hole cutting and general purpose applications. 1/2 H.P., variable speed throttle. Positive action trigger lets operator set max. speed. *Specs.: 3/8" chuck; 2,500 rpm free speed; avg. air cons. 4 cfm; air inlet 1/4"; min. hose size 3/8".*

Order No.	Mfr. No.	Description	Ship Wt.
52988	IR 7802A	3/8" Variable Speed Air Drill	2 lbs. - 1 kg

CP 789R-26 3/8" Reversible Air Drill

- 2,600 RPM
- Molded grip for comfort



Use for screwdriving, honing and heavy drilling. Teasing throttle delivers precise control. Handle exhaust directs air away from the operator. Needle bearing gearing and oil-free operation. Easy access reversing. *Specs.: 3/8" chuck size; 2,600 rpm free speed, avg. air cons. 4 cfm; air inlet 1/4"; air hose size 3/8".*

Order No.	Mfr. No.	Description	Ship Wt.
02684	CP789R-26	3/8" Reversible Air Drill	3 lbs. - 2 kg

Jacobs Chuck & Adapters

- Drill Adapters

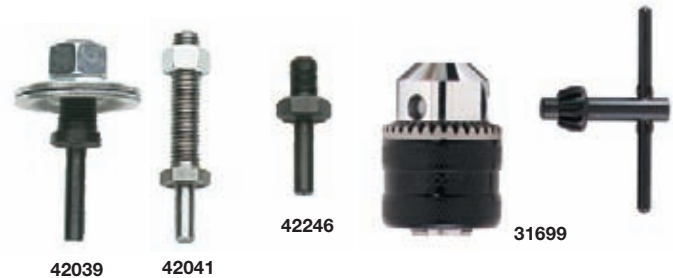

Order No.	Mfr. No.	Description
42039	TB-310-D	1/4" Shank to 1/2" SAE Male
42041	TB-320-D	1/4" Shank to 3/8" USS Male
42246	K-345	For 1/4" Drill to 3/8" USS Male
31699	30247	3/8" Jacobs Chuck & Key

Matrix Vent Drill Bits

- For cleaning matrix vent holes



Order No.	Mfr. No.	Description
02439	THD-332	3/32" x 4" Matrix Vent Drill Bits
02440	THD-564	3/64" x 5" Matrix Vent Drill Bits

Surface Conditioning Pads

- Use with high speed angle head grinder
Order No. 31642 (See page 260)



Use to quickly remove old gaskets from engine blocks, valve covers, water pump mounts and transmission housings. Adapter with 1/4" shank attaches to high speed grinder. Pads and discs mounted on a base that locks onto a Rolock adapter. Simply turn to lock on or remove from the adapter.

Order No.	Mfr. No.	Description	Units Per Box
17018	7480	2" Coarse Conditioning Pads	25
17019	7481	2" Medium Conditioning Pads	25
17020	7485	3" Coarse Conditioning Pads	25
17021	7486	3" Medium Conditioning Pads	25
17010	3R024	3", 24 Grit Sanding Disc	25
17011	3R036	3", 36 Grit Sanding Disc	25
17012	3R050	3", 50 Grit Sanding Disc	25
17003	3R0120	3", 120 Grit Sanding Disc	25
17022	5539	2" Rolock Adapter	1
17023	5540	3" Rolock Adapter	1

CP 861 High Speed Cutter



Cuts through sheet metal, fiberglass muffler clamps, hangers and bolts. Variable speed, lever throttle. Specs.: 1/2 hp motor; 20,000 rpm free speed; avg. air cons. 5 cfm; air inlet 1/4"; min. hose size 3/8"; rear exhaust.

Order No.	Mfr. No.	Description	Ship Wt.
53389	CP861	Hi-Speed Cutter	2 lbs. - 1 kg
02491	25-10	Replacement Wheels Pkg. 10	

CP 7830Q 3/8" Super-Duty Quiet Air Ratchet

- Up to 90 ft. lbs. of torque
- Lightweight & balanced, designed for comfort



No spread ratchet head increases durability and extends tool life. Specs.: 3/8" sq. dr.; 10-90 ft. lb. working torque range; 90 ft. lb. max. torque; air cons. 5 cfm; 190 rpm; min. hose size 3/8"; 1/4" fpt.

Order No.	Mfr. No.	Description	Ship Wt.
53055	CP7830Q	3/8" Quiet Air Ratchet	3 lbs. - 2 kg

Air Ratchet Specifications:

Mfr. No.	Drive	Working Torque Range	Free Speed	Avg. Air Cons.	Air Inlet Size	Min. Hose Size
CP7830Q	3/8"	10-90 ft. lbs	190 RPM	5 cfm	1/4"	3/8" ID
CP828	3/8"	10-50 ft. lbs	150 RPM	4 cfm	1/4"	3/8" ID
IR105-L2	1/4"	5-20 ft. lbs	250 RPM	3 cfm	1/4"	3/8" ID
IR107XPA	3/8"	10-45 ft. lbs	160 RPM	4 cfm	1/4"	5/16" ID
2015Max	3/8"	45-160 ft. lbs	9,000	3.5 cfm	1/4"	3/8" ID
2025Max	1/2"	45-160 ft. lbs	9,000	3.5 cfm	1/4"	3/8" ID

IR 105-L2 1/4" Air Ratchet

- 250 RPM, maximum torque 25 ft. lbs.



Specs.: 1/4" sq. dr.; working torque range 5-20 ft. lbs.; free speed 250 rpm; min. hose size 3/8"; air inlet 1/4"; avg. air cons. 3 cfm; std bolt size 3/8"; length 8".

Order No.	Mfr. No.	Description	Ship Wt.
53015	IR105-L2	1/4" Drive Air Ratchet	2 lbs. - 1 kg

IR 107XPA 3/8" Air Ratchet

- 160 RPM, maximum torque 50 ft. lbs.



Specs.: 3/8" sq. dr.; working torque range 10-45 ft. lbs.; free speed 160 rpm; min. hose size 3/8"; air inlet 1/4"; avg. air cons 4 cfm; std bolt size 3/8"; length 10.5".

Order No.	Mfr. No.	Description	Ship Wt.
02716	IR107XPA	3/8" Drive Heavy Duty Air Ratchet	3 lbs. - 2 kg

CP 828 3/8" Heavy-Duty Air Ratchet

- 150 RPM, maximum torque by hand 125 ft. lbs.



Two year warranty. Specs.: 3/8" sq. dr.; working torque range 10-50 ft. lbs.; max. torque by hand 125 ft. lbs.; free speed 150 rpm; min. hose size 3/8"; air inlet 1/4"; avg. air cons. 4 cfm; std bolt size 3/8"; length 10".

Order No.	Mfr. No.	Description	Ship Wt.
01287	CP828	3/8" Drive Heavy Duty Air Ratchet	3 lbs. - 2 kg

IR 3/8" or 1/2" Hammerhead Air Ratchets

- Head height under 2" for operating in tight spaces
- 7,100 RPM



Specs. same for 2015 and 2025: Maximum torque in reverse 180 ft./lbs; working torque range 45-160 ft. lbs.; impacts per minute 2,100; average air consumption 3.5 cfm; 94 dBA; maximum free speed 9,000 rpm; air inlet 1/4" fpt.; minimum hose size 3/8"; length 13.1".

Order No.	Mfr. No.	Description	Ship Wt.
53025	2015MAX	3/8" Air Ratchet	4 lbs. - 2 kg
53017	2025MAX	1/2" Air Ratchet	4 lbs. - 2 kg

Torque Bars

1/2" Drive Torque Bar with Built-In Socket

- No calibration or maintenance (No moving parts)
- Designed for use with a 1/2" drive impact wrench
- Custom molded storage/carrying case
- Color coded chart included



Color coded for easy identification

Tighten wheel nuts to the correct torque the first time, every time. Avoid over-torquing wheel nuts. Just attach the proper torque bar socket to your 1/2" impact wrench and tighten the nuts in proper sequence. Once correct torque is acquired, any excess torque will be absorbed by the Torque Bar. (Do not use Torque Bar for wheel removal.)

Order No.	Description	Ship Wt.
02760	10 Piece Torque Kit	8 lbs. - 4 kg

Included In 10-Piece Set

Order No.	Ref.	Color	Socket	Torque Level ft. lbs.
02742	H	Hunter Green	17mm	45
02741	G	Red	17mm	80
02738	F	Yellow	3/4" & 19mm	65
02737	E	Blue	3/4" & 19mm	80
02735	C	Gray	3/4" & 19mm	100
02733	A	Brown	13/16"	100
02736	D	Black	21mm	60
02734	B	Orange	21mm	80
02743	I	White	7/8"	120
02759	Q	Aqua	7/8"	140

Individual Torque Bar Sockets

Order No.	Ref.	Color	Socket	Torque Level ft. lbs.
02651	UU	Dark Purple	14mm	75
02762	K	Purple	17mm	110
02649	NN	Gold	3/4" & 19mm	90
02650	OO	Neon Green	13/16"	75
02652	BB	Turquoise	21mm	150
02653	Z	Cream	7/8"	65
02767	Y	Navy Blue	7/8"	100
02766	T	Neon Green	13/16"	135
02761	J	Tan	1"	140
02763	L	Green	1"	170
02748	V	Plum	1 1/16"	140
02603	XX	Vanilla	13/16"	160
01670	CC	Light Pink	17mm	90
01675	S	Light Blue	19mm	55
01674	KK	Quartz Grey	19mm	120
01673	JJ	Yellow	19mm	145
01672	FF	Yellow Grey	19mm	180
02638	DD	Light Blue	21mm	100
01606	SS	Sparkle	21mm	110
01665	AA	Neon Green	22mm	80
01671	EE	Safety Purple	22mm	140
02637	LL	Fuchsia	22mm	175
01667	GG	Sunburn Tan	1 1/16"	80
01668	HH	Light Orange	1 1/16"	100
01680	QQ	Salmon	22mm	95
02744		Optional Metal Storage Rack		
02990		Laminated Plastic Torque Chart		

1/2" Drive Torque Bar Extensions

Designed for use with a 1/2" drive extra thin wall socket, allowing the Torque Extensions to be used on alloy wheels with tight clearance between the rim and the lug. (Do not use Torque Extensions for wheel removal). Kit includes: 5 sizes of torque bars listed below in a plastic storage case with a color coded torque chart.



Order No.	Description	Ship Wt.
01679	5-Piece 1/2" Drive Torque Bar Extension Set	5 lbs. - 3 kg

Individual Torque Bars

Order No.	Ref.	Color	Torque Level Ft.
02770	F	Yellow	65 lbs.
02771	E	Blue	80 lbs.
02772	C	Grey	100 lbs.
02773	I	White	120 lbs.

Order No.	Ref.	Color	Torque Level Ft.
02774	Q	Aqua	140 lbs.
*02702	S	Lt. Blue	55 lbs.
*02689	B	Orange	160 lbs.

* Not included in 01679 kit

3/4" & 1" Truck Wheel Torque Bar Extensions

- Achieve manufacturer's specified torque every time using an impact wrench
- Prevent loose components & damage to wheels, studs & nuts



The Torque Bar extensions are manufactured with 3/4" or 1" square end with socket retainer for use with any socket. Easy to use, attach the proper torque bar and socket to your impact wrench and tighten the nuts in proper sequence. Once correct torque is acquired, any excess torque will be absorbed by the Torque Bar. (Do not use Torque Bar for wheel removal.)

Order No.	Refer.	Male/Female	Torque Level
02626	O	3/4" Dr.	175 ft./lbs.
02628	T	1" Dr.	175 ft./lbs.
02618	N	3/4" Dr.	250 ft./lbs.
02620	R	1" Dr.	250 ft./lbs.
02619	Q	1" Dr.	300 ft./lbs.
02630	U	3/4" Dr.	350 ft./lbs.

Order No.	Refer.	Male/Female	Torque Level
02632	S	1" Dr.	350 ft./lbs.
02623	B	1" Dr.	400 ft./lbs.
02622	M	3/4" Dr.	475 ft./lbs.
02624	P	1" Dr.	475 ft./lbs.
02617	Y	1" Dr.	550 ft./lbs.
02764	W	1" Dr.	650 ft./lbs.

ACCUTORQ 1" Drive Truck Torque Bar Set

- Reduces proper wheel installation time by 65%
- Built-in sockets



Heat treated Swedish spring steel for durability. No danger of damage from being dropped or bounced. CAUTION: For use with 1" drive air gun with 650 to 1,000 ft. lbs. of output and air line pressure of 90 to 110 psi. Never use a torque socket to remove lug nuts. Lifetime guarantee (paint not included).

Order No.	Description	Ship Wt.
02636	ACCUTORQ Truck Torque Stick Set	20 lbs. - 9 kg

Individual Replacement Sticks

02625	1 1/4" Hex 250 ft. lbs., Red	4 lbs. - 2 kg
02627	33mm Hex 475 ft. lbs., Brown	4 lbs. - 2 kg
02629	1 1/2" Hex 475 ft. lbs., Black	4 lbs. - 2 kg
02631	1 3/16" Square 475 ft. lbs., Yellow	4 lbs. - 2 kg

1/2" Drive Digital Torque Wrench

- Five preset torque settings
- Audible beep signals over-torque



Five preset torque settings of 80, 100, 120, 140, and 150 ft./lbs. Torque value key locks in setting and must be unlocked to change to a new setting. An audible "beep" and green light indicates correct torque. Accuracy of +/- 2% of reading. Operating temperature of 40° to 110° F. Two CR123 lithium batteries provide 80 hours of continuous use. Flashing LED signals low battery. Automatic shut-off after 2 minutes with no torque applied.

Order No.	Description	Ship Wt.
07164	1/2" Drive Digital Torque Wrench	5 lbs. - 3 kg

1/2" Drive Single Direction Heavy-Duty Torque Wrench

- 50 - 250 ft. lb. range of adjustment



Covers the entire torque specification range from 50 to 250 ft. lbs. It features a protective, oil-resistant hand grip and ratchet boot cover and a quick release button providing good socket retention and easy removal. The 24" length provides leverage when high torque is needed. Cannot be used as a breaker bar.

Order No.	Description	Ship Wt.
07186	1/2" Drive Single Direction Torque Wrench	5 lbs. - 3 kg

1/2" Drive Adjustable Torque Wrench

- "Split Beam" torque measuring mechanism requires only fingertip force to adjust

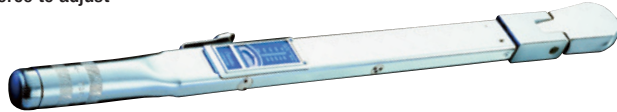

Adjustment requires little effort since there is no spring tension in the tool. Turn the adjustment wheel, then lock the setting in place. The tool can be stored at any value without degradation of the accuracy. Made in USA. 40-250 lb.ft. in 5 ft. lb. increments. 1 year manufacturer warranty, including a dated calibration compliance certificate. Accurate to within ±4% of the reading. Includes a molded storage case.

Order No.	Ref. No.	Description	Ship Wt.
07121	C3FR250F	Adjustable, Flex Head Torque Wrench (40-250 ft.lbs)	5 lbs. - 3 kg

1/2" Drive Preset Torque Wrench Set

- No need to set & reset torque

The single direction ratchet prevents use as a breaker bar. Includes 3/4", 13/16", 7/8", 17mm, 19mm, and 21mm deep sockets; 6" extension; color coded application chart; and a blow molded rack for wall mounting. Sockets are not designed for use with an impact wrench. One year warranty against defects in material and workmanship.



Order No.	Description	Ship Wt.
07165	1/2" Dr. 4 Pc. Preset Torque Wrench Set w/Sockets	28 lbs. - 13 kg

Set Includes		
07166	80 ft. lbs. Blue Preset Torque Wrench	4 lbs. - 2 kg
07167	100 ft. lbs. Grey Preset Torque Wrench	4 lbs. - 2 kg
07168	120 ft. lbs. White Preset Torque Wrench	4 lbs. - 2 kg
07169	140 ft. lbs. Green Preset Torque Wrench	4 lbs. - 2 kg
Optional Torque Wrench		
07187	65 ft. lbs. Yellow Preset Torque Wrench	4 lbs. - 2 kg

1/2" Heavy-Duty Torque Wrench

- Designed for the tire dealer
- 6" Extension included



Extra heavy-duty 1/2" drive torque wrench designed for tire dealer service. 30 to 250 ft. lbs., micrometer style. 1 year warranty against defect in material and workmanship.

Order No.	Description	Ship Wt.
07179	1/2" Drive Torque Wrench with Extension	5 lbs. - 3 kg
07181	Replacement 1/2" Drive Extension	

1/2" Preset Torque Wrenches

- Fixed head eliminates ratchet wear & tear
- No need to set & reset torque - Eliminates dialing error & incorrect torque settings
- 80 & 100 lbs. are the most popular settings
- Unique curved head design eliminates the need for a socket extension



Fully heat treated handle. Guaranteed to meet ISO 6789, U.S. Fed. GGG-W-686D and ANSI Spec. B107.14M. Accuracy +/- 4%.



02740



Order No.	Description	Torque Setting	Color Ring
07150	1/2" Preset Torque Wrench	60 Ft. Lb/90 Nm	Black
07151	1/2" Preset Torque Wrench	70 Ft. Lb/100 Nm	Yellow
07152	1/2" Preset Torque Wrench	80 Ft. Lb/110 Nm	Blue
07153	1/2" Preset Torque Wrench	90 Ft. Lb/120 Nm	Gold
07154	1/2" Preset Torque Wrench	100 Ft. Lb/130 Nm	Grey
07156	1/2" Preset Torque Wrench	120 Ft. Lb/140 Nm	White
07157	1/2" Preset Torque Wrench	140 Ft. Lb/150 Nm	Purple
02990	Laminated Torque Chart 18" x 28"		
02740	Storages Rack for Preset Torque Wrenches		

Torque Wrenches

3/4" Drive Truck Torque Wrench

- 100-600 ft. lbs range in 5 lb. increments
- 140-800 Newton meters in 10 mm increment



+ -3% accuracy between 200 and 600 lbs. Ratchet audibly clicks when proper torque is reached. The wrench is bi-directional and reads right or left torque. Dial setting is in the handle. One year warranty. Re-calibration service available. The optional 3/4" drive 13" extension provides access to deep Budd wheels. 40" long.

Order No.	Description	Ship Wt.
07182	3/4" Drive Torque Wrench	13 lbs. - 7 kg
01474	Optional 3/4" Drive 13" Extension	3 lbs. - 2 kg

PB Blaster Nut Loosener

A powerful, penetrating lubricant that frees everything faster! Displaces moisture. Use on nuts and bolts, rusted joints, automatic chokes, to start wet engines and more. Just saturate troubled area and allow to stand for a few minutes.

Order No.	Description	Case Qty.
45217	11 Oz. Spray	12
45218	1 Gallon	4



Wheel Torque Specification Chart

A large format 17" x 23" recommended Commercial Wheel Torque Specification Chart is available free from Myers Tire Supply. The chart covers torque recommendations for hub and stud piloted wheels and demountable rims. Also included are oiling recommendations and service suggestions. The charts are designed to be hung prominently in the service area to remind technicians of proper wheel torque processes to help prevent premature tread wear or even potential wheel off situations. The chart also outlines the Tire Industry Association's R.I.S.T. program. REMOVE debris from mating surfaces; INSPECT components; SNUG lug nuts in a star pattern; and TORQUE to specification.

Contact your local Myers Tire Supply salesperson or call 800-998-9897 to get your copy today.

NORBAR Heavy-Duty Truck Torque Wrenches

- Accuracy +/- 4%
- Myers No. 07194 & 07202 200-750 ft. lb.
- Myers No. 07203 100-500 ft. lb.
- Myers No. 07174 100-600 ft. lb.



Works in right or left direction.



Adjust the torque by turning the nut at the end of the handle.



07194 1" Square Drive - 58" Long



07202 3/4" Square Drive - 58" Long



07203 1" Square Drive - 45" Long



07510 Optional Case for 07203

Cover the common 475 ft. lb. and 650 ft. lb. requirement. The breakback design breaks slightly at a hinge point when torque is reached. Rugged, does not rely on a delicate micrometer instrumentation. Works right or left direction by removing the drive and replacing it in the other side. Includes a certificate of calibration and recalibration service is available. One year warranty. Optional 13" extension provides access to deep Budd wheels.

Order No.	Description	Torque Range	Ship Wt.
07194	1" Sq. Dr. Wrench - 58" Long, 16 lbs.	200-750 Ft. lbs.	22 lbs. - 10 kg
07203	1" Sq. Dr. Wrench - 45" Long, 14 lbs.	100-500 Ft. lbs.	16 lbs. - 8 kg
07174	1" Sq. Dr. Wrench - 42" Long, 13 lbs.	100-600 Ft. lbs.	14 lbs. - 6 kg
07204	3/4" Sq. Dr. Wrench - 45" Long, 14 lbs.	100-500 Ft. lbs.	16 lbs. - 8 kg
07202	3/4" Sq. Dr. Wrench - 58" Long, 16 lbs.	200-750 Ft. lbs.	22 lbs. - 10 kg
07510	Optional Case for 07203 Torque Wrench		
Optional Extensions			
01494	Optional 3/4" Dr. Male 13" Extension		3 lbs. - 2 kg
07199	3/4" Sq. Dr. Male - 1" Sq. Dr. Male, 13" Extension		6 lbs. - 3 kg
Adapters			
07195	3/4" Adapter Converts 1" Dr. to 3/4" Dr.		
07196	Replacement 1" Dr. Adapter		



1" Drive Dial-Type Truck Torque Wrench

- 0-1,000 ft. lb. range in 20 ft. lb. increments
- Large easy-to-read dial



Dual scales, English 0 - 1,000 ft. lbs. and metric 0 - 1,400 Nm, permits accurate reading of both scales with follower needle. Accurate in left and right hand directions. Torsion beam design provides long life and accuracy. Includes storage box. Weighs 18 lbs. - 74" long

Order No.	Mfr. No.	Description	Ship Wt.
07185	8470	1" Drive Truck Torque Wrench	18 lbs. - 9 kg
01493		Optional 1" Drive 13" Extension	5 lbs. - 3 kg

Preset 1" Drive Torque Wrench



Preset 1" Drive Torque Wrench is locked in at 475 ft. lbs. and cannot be changed. 54" Handle.

Order No.	Description	Ship Wt.
07175	1" Drive 475 ft. lb. Preset Torque Wrench	20 lbs. - 9 kg
01493	Optional 1" Drive 13" Extension	5 lbs. - 3 kg

DATA-TORQ Wheel Lug Tightening System

- Snug...final torque...print
- Walks the technician through the process
- Prints on completion of every job



Enter in the number of wheels and number of lugs. The first pass "snugs" each lug to about 50% then on the next pass completes the process. With each fastening cycle, Data-Torq tracks the tightening sequence, counts the lugs and advances through the process from snug torque to final torque. Red light/green light indicates the process has been successfully completed. The printed label includes date, time, torque of each lug nut and calibration due date of the Data-Torq unit. Annual calibration tool exchange service assures accuracy. Units require shop air and two power and mounting options.

Order No.	Mfr.No.	Max. Torque	Description	Ship Wt.
53120	ADT009	165 Ft/Lbs	½" Drive Wall Mount 110V	75 lbs. - 34 kg
53121	24N100008	165 Ft/Lbs	½" Drive Portable 12V	75 lbs. - 34 kg
53124	ADT011	1,100 Ft/Lbs	1" Drive Wall Mount 110V	85 lbs. - 39 kg
53125	24N100006	1,100 Ft/Lbs	1" Drive Portable 12V	85 lbs. - 39 kg

ESCO Torque Master

- Powerful nut removal & precision torque on
- Set torque from 10 to 1,150 ft./lbs., accuracy +/- 5%
- OSHA requires accurate torquing of wheels

Designed to torque a complete range of wheel types and sizes. Easily set to a wide range of torque values. Includes a filter, regulator, and lubricator to supply clean, dry air. 13-month warranty with a loaner program for recalibration. Made in U.S.A.



Order No.	Description	Ship Wt.
07130	Torque Master	20 lbs. - 9 kg

MYERS Torque Recalibration Service

Welcome to Myers Torque Tracker™

Myers Tire Supply offers a complete torque recalibration service for any passenger or truck torque wrench on the market.

USERNAME

 PASSWORD

800-998-9897 or torquewrench@myerstiresupply.com

View wheel off video

Calibration is maintenance function, not a repair
 *The only accurate way to consistently achieve a specific torque is with a torque wrench or torque control device. Whether nuts are tightened with hand tools or an impact wrench, manufacturers recommend a specific torque range for lug nut installation. *Tire Maintenance Council 2008/003/RF-237-4

Must a torque wrench be recalibrated?	We are your electronic file cabinet	Why Myers Tire Supply?
How do I get started?	Fast turn-around	
Wheel off condition video	What brands do we service?	

To get started:
 Call for quote: **800-998-9897**
 Email: torquewrench@myerstiresupply.com
 New Torque Wrenches

Myers Tire Supply 1493 South Main Street, Akron, OH 44301

Must a torque wrench be recalibrated?

O.S.H.A. and the American Trucking Institute recommend that torque wrenches be calibrated yearly to verify accuracy and repeatability. Adjustments must be performed to meet the tolerances specified by the manufacturer.

What is a torque wrench calibration program?

Careless installation of wheels on a vehicle is a major cause of tire and wheel problems. Improper torque can cause distortion, fatigue cracks, or alignment problems. There are few things more dangerous than a wheel-off condition. This may be caused by incorrectly installing and torquing truck and passenger wheel lugs. In an effort to eliminate such a dangerous incident truck maintenance facilities and service centers are asking for a system to calibrate and track their torque wrenches. To prove compliance they must keep a certificate of recalibration on file in case an O.S.H.A. inspector asks to see it.

How does the program work?

Your local Myers Sales Office handles all phases of the torque wrench calibration program. Call our local number or 1-800-998-9897 or email us at torquewrench@myerstiresupply.com. We will fax or email the shipping paperwork. The recalibration process takes 3 to 5 business days plus shipping. Contact your Myers Sales Office at anytime to check the recalibration progress of your wrench.

You will receive a certificate of calibration from us with your wrench. We will identify your recalibrated tool with a sticker indicating when it was calibrated and keep a digital copy of your certificate on file. If you misplace your copy we will email a copy to you at no charge. Also, Myers Tire Supply will automatically contact you when your current certificate is ready to expire.

Pneutorque Torque Wrench

- Ideal for fleet maintenance & bus garages
- Accuracy +/- 5%
- Up to 750 ft. lbs. of torque



An ideal torque wrench where a high volume of tires and wheels must be torqued to the same specification. An adjustable air regulator is set to obtain a specific torque at a predetermined air pressure. The nut is run up at 125 rpm, then tightened to final torque within 5% +/- before stalling. Includes an air pressure graph, filter, regulator, lubricator control unit used to set the torque output, sockets, and carrying case. The tool is certified NIST/NRC Traceable. *Specs.: bi-directional operation; ¾" sq. dr.; range 150-750 ft./lbs.; no load speed 125 rpm; +/- 5% repeatable stall accuracy.*

Order No.	Description	Ship Wt.
07191	Pneutorque Torque Wrench with 33mm Socket	15 lbs. - 7 kg
The Pneutorque requires a special socket designed to fit the working area. Shipped with a 33mm socket. Additional sizes must be ordered separately.		
07506	Optional 1¼" Socket	
07508	Optional 1½" Socket	
07509	Optional 1¾" Square Socket	
07507	Replacement 33mm Socket	

Wheel Service Products

TRUCHECK Torque Wrench Checkers

- No set up or training
- Supplied with traceable certification
- Made by NORBAR



A quick, easy way to verify the accuracy of click and dial-type torque wrenches. Four-digit LED displays in foot pounds. Accurate to +/- 1%. Two second auto reset hold time. Includes transducer, 110v power supply and plastic carrying case.

07159 Passenger TruCheck 1/2" sq. dr.; 10 - 250 ft/lbs

07160 Truck TruCheck includes 1" dr. torque wrench socket; 75 - 750 ft/lbs

Order No.	Description
07159	Passenger 10 - 250 Ft/Lbs
07160	Truck 75 - 750 Ft/Lbs

TORQCHECK 1/2" Torque Tester

- For use with all 1/2" torque wrenches



Accurately inspect torque wrenches daily. Needle gauge measures from 0 to 180 ft. lbs. Guaranteed accurate to +/- 2%. Does not require calibration.

Order No.	Description
07155	Torque Wrench Checker

1/2" & 3/4" Drive Torque Comparators

- Check & verify torque wrench accuracy
- Includes calibration compliance certificate



Note the reading at the time of the click, NOT after the click.



Easily check 1/2" and 3/4" drive torque wrenches quickly and accurately. Reduce unnecessary new torque wrench purchases. Features a large easy-to-read dial and an exercise adapter to "warm up" the torque wrench before use. The 1/2" and 3/4" female adapters are locked onto the unit. The adapters will not fall off like those who use a ball and spring lock. 1-Year warranty on defective parts or workmanship. Includes user manual and calibration compliance certificate.

Order No.	Mfr. No.	Description	Capacity Dial lb. ft.	Accuracy	Ship Wt.
07155	TC3F175F	1/2" Torque Comparator	0 - 175	+/- 2%	6 lbs. - 3 kg
07127	TC4F600F	3/4" Torque Comparator	0 - 600	+/- 2%	10 lbs. - 5 kg

Hub Cap & Wheel Lock Removal Kits

- Easily removes aftermarket wheel locks, locking covers & even some damaged wheel lugs
- 13-Piece deluxe set for widest coverage or 9-piece standard set



All the tools and instructions to remove wheel locks without damage to lock or stud and to remove wheel covers with variable inside drivekeys on GM, Ford and Chrysler products. Includes three fluted flip sockets and an extension.

Order No.	Mfr.No.	Description	Ship Wt.
02692	4000A	13 Piece Deluxe Wheel Lock Kit	5 lbs. - 3 kg
02703	LT400	9-Piece Standard Lock Kit	4 lbs. - 2 kg
02709*	400-20	For GM Spline Hubcap Locks	
02710*	400-10	For Large GM Triangular Well Hubcap Locks	
02715*	400-80	Insert Punch	
02720*	400-40	For Stripped 18mm Lug Nuts, GM Wheel Cover Locks, 88-89 Ford Wheel Locks	
02680	400-45	For Stripped 18mm Nuts, Corvette & GM Wheel Locks	
02721*	400-60	For Standard McGard Wheel Locks, Large GM Wheel Cover Locks	
02722*	400-90	For Large Diameter Chrysler Lock	
02727*	400-30	For GM Hubcap Locks	
02728*	400-50	For Corvette, GM "N" & "F" Body Wheel Locks (Grand AM, Firebird, Bonneville, Olds Calais, Buick Regal)	
02729*	400-70	For Oversized McGard Wheel Locks	
01492	400-EXT	1/2" Drive 3" Extension	
02682	2301-A	For 19MM, 3/4" Damaged Wheel Lugs	
02683	2301-B	For 7/8" Damaged Wheel Lugs	

* Included in 02703 9-Piece Standard Set

Double Duty Lug Nut & Wheel Lock Remover Sockets For VW

- For Volkswagons with spline wheel lock studs



Shown with Extension



A 17mm and 19mm Hex Socket/Twist Socket Flip and 1/2" Drive Extension. The hex fits the lug nuts as well as the spline key with hex head. The Twist Socket can be used to remove the spline lug nut if the Key is lost.

Order No.	Mfr No..	Description
01676	0760	VW 17MM & 19MM Twist Socket/Flip Socket Set W/Extension
01677	0760A	Replacement 17MM VW Twist Socket/Flip Socket
01678	0760B	Replacement 19MM VW Twist Socket/Flip Socket
01492		Replacement 1/2" Drive x 3" Extension

Portable Wheel Cleaner



The wire brush removes scale and rust buildup in the bead seat and wheel flange area. The cast aluminum main head swivels easily following the wheel flange. The wheel does not need to be rotating. 120 volt. 15 amps. Note: Always wear eye protection when operating.

Order No.	Mfr.No.	Description	Ship Wt.
84012	WC-10	Rim Cleaner	8 lbs. - 4 kg

9 Pc. Oil Drain Plug Removal Kit

- 3/8" Drive



Removes rounded or damaged oil drain plugs in the same way a Twist Socket works. The 3/8" drive sockets covers standard and metric sizes. Includes 10mm, 7/8" & 11mm, 12mm, 13mm, 9/8" & 14mm, 15mm, 5/8" & 16mm, 17mm, 3/4" - 19mm.

Order No.	Description	Ship Wt.
02562	Drain Plug Removal Kit	2 lbs. - 1 kg

SAV-A-STUD

- Plus tool set
- Improved two-piece hinged die



Repairs stripped or damaged studs in minutes, does not cut new threads. Lightly grease stud, clamp rethread around stud, place socket over rethread and back rethread off stud. Four quick steps save you the time and cost of replacing an accidentally cross-threaded stud. Includes: SAE 7/16"-20 1/2"-20, 9/16"-18, 5/8"-18, Metric 12mm-1.25, 12mm-1.5, 14mm-1.5, and 1/2"-20 SAE left. NOTE: Use of any electric or pneumatic wrench with these tools voids lifetime warranty.

Order No.	Description	Ship Wt.
04920	8 Pc Sav-A-Stud Passenger Set	2 lbs. - 1 kg

Replacement Parts

Order No.	Description
04921	SAE 7/16" - 20
04922	SAE 1/2" - 20
04924	SAE 9/16" - 18
04925	SAE 5/8" - 18

Replacement Parts

Order No.	Description
04927	12mm - 1.5
04960	12mm - 1.75

Heavy-Duty SAV-A-STUD Plus Tool Set

- Improved two-piece with hinged die



Order No.	Description
04918	3 Pc. Heavy-Duty Sav-A-Stud Plus
Replacement Parts	
04954	3/4" - 16 Left Hand Rethreader
04955	3/4" - 16 Right Hand Rethreader
04956	22mm x 1.5 Rethreader

Bolt Pattern Gauge

- Complete set measures 30 different bolt patterns, standard & metric dimensions

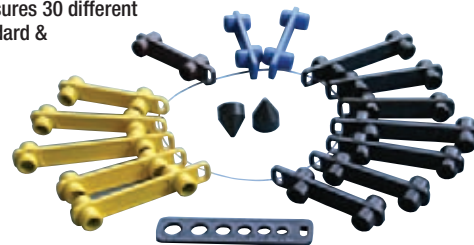

Slides over disc or drum brake studs to measure the vehicle bolt pattern. Aluminum wheels without conical seats are measured by fitting the ends of the Wheel Gauge completely into two adjacent lug holes. Wheels with conical seat lug holes (most wheels today) are measured using the two conical adapters. Using the adapters allows the Wheel Gauge to center on two adjacent lug holes. Make the measurement from the front or back of the wheel. Includes gauges for ten 4-lug, fourteen 5-lug, four 6-lug and two 8-lug patterns plus a nylon strap and tool to measure stud diameters.

Order No.	Description	Ship Wt.
52394	Bolt Pattern Gauge Set	2 lbs. - 1 kg

NO-MAR 7 Piece Socket Set

- Protects expensive alloy wheels & nuts



Remove wheel nuts without scratching the wheel or nuts. Protective poly sleeve and internal plastic insert protects alloy wheels and decorative lug nuts. Includes 17mm, 21mm, 3/4", 13/16", 7/8", 1", and 1 1/16" deep thinwall sockets.

Order No.	Mfr. No.	Size	Ship Wt.
01201	No-Mar Sockets	17mm, 21mm, 3/4", 13/16", 7/8", 1", 1 1/16"	5 lbs. - 3 kg
Replacement Sockets			Color
01204		17mm No-Mar Socket	Blue
01206		19mm/ 3/4" No-Mar Socket	Gold
01207		21mm No-Mar Socket	Red
01203		13/16" No-Mar Socket	Purple
01208		7/8" No-Mar Socket	Green
01202		1" No-Mar Socket	Brass
01205		1 1/16" No-Mar Socket	Black

1/2" Sq. Dr. Double-Duty TwistSocket Hex Socket Set

- Use the twistsocket to remove a damaged lug nut
- Metric & standard 6-piece set



Twistsocket end is for use on wheel lugs, wheel locks or any hard to remove nut, bolt, stud or nipple that cannot be removed with a socket. The large, fluted spiral locks onto a fastener and removes it in seconds. The fastener is easily dislodged from the Twistsocket. 3" extension included for small sockets that won't fit extended shank on impact wrench.

Set Includes			
01660	17mm	01663	13/16"
01661	19mm	01664	7/8"
01662	21mm	01492	3" Extension

Order No.	Description	Ship Wt.
01655	6 Pc. Standard & Metric Flip Socket Set	3 lbs. - 2 kg



Double Duty - Hex Socket on one end and Twist Socket on the other.

1/2" Drive Flip Sockets

- For passenger & light truck wheels

Thin Wall Sockets



Combination double end reversible impact socket. Fits most passenger and light truck wheel nuts. One end 3/4" hex, other end 13/16" hex, 1/2" drive. Metric sizes 19mm and 21mm. Outside diameters 3/4" - 13/32", 13/16" - 19/32", 19mm - 13/32" o.d., 21mm - 19/32" o.d.

Order No.	Description	Outside Diameter
01491	3/4"-13/16"	3/4" - 13/32"; 13/16" - 19/32"
01610	19mm-21mm	19mm - 13/32"; 21mm - 19/32"

Extra-Thin Wall Sockets for Close Clearance

Outside diameters 3/4" - 1 1/2" o.d., 13/16" - 1 3/32" o.d., 19mm - 1 1/2" o.d., 21mm - 1 3/32" o.d. Note: Extra Thin Wall Sockets are not covered by warranty.

Order No.	Description	Outside Diameter
01486	3/4"-13/16"	3/4" - 1 1/32"; 13/16" - 1 3/32"
01488	19mm-21mm	19mm - 1 1/32"; 21mm - 1 3/32"

17MM & 19MM Extra-Thin Wall Sockets

Order No.	Description
01489	17mm & 19MM Extra-Thinwall Flip Socket

1/2" Drive Special Purpose Flip Sockets

- Remove over-torqued or distorted chrome capped lug nuts



Set includes (4) flip sockets and extractor punch.

Order No.	Description	Ship Wt.
01468	5-Piece Socket Lug Nut Removal Kit with Punch	4 lbs. - 2 kg

Order No.	Mfr. No.	Size	Applicaton
01475	LT1250	18.5mm x 19.5mm	Many GM & Chrysler Vehicles
01476	LT1260	22mm x 22.5mm	16 & 17 Dodge Aluminum Wheels
01479	LT1240	21mm x 21.5mm	Chrysler & Dodge 21mm Chrome Cap
01485	LT1270	1 1/16" x 27.5mm	Range Rover & Land Rover Vehicles

Worn Lug Nut Removal Sockets



Tapered threads grip the worn lug nut for easy removal

Designed for use with a 1/2" drive impact wrench operating in reverse. Tapered threads grip the worn lug nut for easy removal. Remove the lug nut from the socket by clamping in a vise or operating the impact wrench in the forward direction.

For use on 19mm - 21mm and 3/4" - 13/16" Hex Lug Nuts

Order No.	Mfr. No.	Description
02433	LRT-500	3/4" - 13/16" Worn Lug Nut Removal Socket

For use on 3/4" - 13/16" Hex Lug Nuts

Order No.	Mfr. No.	Description
02435	LRS-600	3/4" - 13/16" Worn Lug Nut Removal Socket

Twistsocket Damaged Fastener Remover



Use on wheel lugs, wheel locks or any hard to remove nut, bolt, stud or nipple that cannot be removed with a socket. The large, fluted spiral locks onto a damaged fastener and removes it in seconds. The fastener is easily dislodged from the Twistsocket. The set includes 3/4", 13/16", 7/8", 15/16" and 1" sockets.

Order No.	Mfr. No.	Size	Ship Wt.
02560	TwistSocket	3/4", 13/16", 7/8", 15/16" & 1"	2 lbs. - 1 kg

Replacement Twistsockets - Order as required

02542	TS24	3/4" Twistsocket
02543	TS26	13/16" Twistsocket
02544	TS28	7/8" Twistsocket
02545	TS30	15/16" Twistsocket
02546	TS32	1" Twistsocket

Wheel Stud Installers



Self-centering installer provides the correct angle every time. Heat treated for strength and durability. Impact gun compatible. Will not damage wheel stud threads. Kit contains: 4 Installer Nuts, Washer, and Spacer.

Order No.	Mfr. No.	Sizes	Ship Wt.
02579	Automotive	7/16"-20, 1/2"-20, 12mm-1.25, 12mm-1.5	3 lbs. - 2 kg
02578	Light Truck & SUV	1/2"-20, 9/16"-18, 12mm-1.75, 14mm-1.5	3 lbs. - 2 kg

NEXT DIMENSION Penetrant Lubricant

- Prevents corrosion & displaces moisture
- No ozone depleters or chlorinated solvents

A unique blend of concentrated, fast-acting, powerful penetrating solvent quickly loosens rusted nuts, bolts, and frozen parts in seconds. 4 in 1 chemistry penetrates, lubricates, displaces moisture, and prevents corrosion. Ideal for automotive aftermarket and fleet service.

Order No.	Description	Case	Fill	Container
11053	Penetrant Lubricant	12	12 Oz.	16 Oz.



WARNING SIGNS OF WEAR



Worn sockets or impact tool shanks drastically reduce tool life. When the beveled portions of the tip of the shank become worn, sockets don't fit correctly. A loose or sloppy fit will quickly round the socket's opening. Old, rounded sockets on a new impact tool shank quickly damages the bevel for the same reason. Always purchase new sockets with a new wrench.

1/2" Dr. 4 Pc. Extensions Impact Set



Set Includes

3" Extension	10" Extension
5" Extension	15" Extension

Order No.	Mfr. No.	Description	Ship Wt.
04620	2500	1/2" Drive Impact Extension Set	0 lbs. - 0 kg

1/2" Dr. 10 Pc. Hex Driver Impact Socket Set



Set Includes

1/4"	1/2"
9/32"	9/16"
5/16"	3/8"
3/8"	11/16"
7/16"	3/4"

Order No.	Mfr. No.	Description	Ship Wt.
04621	2638	1/2" Dr. Impact Hex Driver 10 Pc. Set	4 lbs. - 2 kg

1/2" Dr. 10 Pc. Hex Driver Metric Impact Socket Set



Set Includes

6 mm	14 mm
7 mm	15 mm
8 mm	17 mm
10 mm	18 mm
12 mm	19 mm

Order No.	Mfr. No.	Description	Ship Wt.
04622	2639	1/2" Drive Metric Impact Hex Driver 10 Pc. Set	

1/2" Dr. 7 Pc. Metric Impact Socket Set



Set Includes

13 mm	18 mm
14 mm	19 mm
15 mm	17 mm
16 mm	

Order No.	Mfr. No.	Description	Ship Wt.
04624	2655	1/2" Dr. Metric Socket Set 7 Pc.	4 lbs. - 2 kg

Replacement Sockets Available.
Contact your Myers Representative

1/2" Dr. 13 Pc. Metric Impact Socket Set



Set Includes

12 mm	19mm
13 mm	20mm
14 mm	21mm
15mm	22mm
16mm	23mm
17 mm	24mm
18 mm	

Order No.	Mfr. No.	Description	Ship Wt.
04625	2665	1/2" Dr. Metric Socket Set 13 Pc.	9 lbs. - 4 kg

1/2" Dr. 26 Pc. Deep Metric Impact Socket Set



Set Includes

10mm	20mm	
11mm	21mm	
12mm	22mm	
13mm	23mm	
14mm	24mm	30mm
15mm	25mm	32mm
16mm	26mm	33mm
17mm	27mm	34mm
18mm	28mm	35mm
19mm	29mm	36mm

Order No.	Mfr. No.	Description	Ship Wt.
04623	2646	1/2" Drive Deep Metric 26 Pc. Set	0 lbs. - 0 kg

1/2" Dr. 39 Pc. Impact Socket Set



19 Standard Sockets

3/8"	1"
7/16"	1 1/16"
1/2"	1 1/8"
9/16"	1 3/16"
5/8"	1 1/4"
11/16"	1 3/8"
3/4"	1 3/8"
13/16"	1 7/16"
7/8"	1 1/2"
15/16"	

19 Deep Sockets

3/8"	1"
7/16"	1 1/16"
1/2"	1 1/8"
9/16"	1 3/16"
5/8"	1 1/4"
11/16"	1 3/8"
3/4"	1 3/8"
13/16"	1 7/16"
7/8"	1 1/2"
15/16"	

Universal Joint

Order No.	Mfr. No.	Description	Ship Wt.
04626	2668	1/2" Dr. Impact Socket Set 39 Pc.	25 lbs. - 11 kg

Socket Sets

1/2" Dr. 39 Pc. Metric Impact Socket Set



19 Deep Sockets

9 mm
10 mm 19mm
11 mm 20mm
12 mm 21mm
13 mm 22mm
14 mm 23mm
15 mm 24mm
16 mm 26mm
17 mm 26mm
18 mm 30 mm

19 Standard Sockets

9 mm
10 mm 19mm
11 mm 20mm
12 mm 21mm
13 mm 22mm
14 mm 23mm
15 mm 24mm
16 mm 26mm
17 mm 26mm
18 mm 30 mm

Universal Joint

Order No.	Mfr. No.	Description	Ship Wt.
04628	2669	1/2" Dr. Metric Impact Socket Set 39 pc	19 lbs. - 9 kg

1/2" Dr. 8 Pc. 12 Pt. Metric Deep Spindle Nut Impact Socket Set



Set Includes

29mm 35mm
30mm 36mm
32mm 38mm
34mm 39mm

Order No.	Mfr. No.	Description	Ship Wt.
04629	2835	1/2" Drive Spindle Nut Socket 8 Pc. Set	13 lbs. - 6 kg

1/2" Dr. 4 Pc. 12 Pt. Metric Spindle Nut Impact Socket Set



Set Includes

30mm
32mm
34mm
36mm

Order No.	Mfr. No.	Description	Ship Wt.
04630	2837	1/2" Drive Spindle Nut Socket 4 Pc. Set	6 lbs. - 3 kg

1/2" Dr. 7 Pc. Deep Spindle Nut Metric Impact Socket Set



Set Includes

29mm 35mm
30mm 36mm
32mm 38mm
34mm

Order No.	Mfr. No.	Description	Ship Wt.
04632	2839	1/2" Drive Spindle Nut Socket 7 Pc. Set	12 lbs. - 6 kg

1/2" Dr. 29 Pc. Deep Standard & Metric Impact Socket Set



13 Deep Sockets

7/16" 3/4" 1 1/16"
1/2" 13/16" 1 1/8"
9/16" 7/8" 1 1/4"
5/8" 15/16"
11/16" 1"

2 Deep Flip Sockets

3/4" x 13/16"
19mm x 21mm

14 Deep Metric Sockets

10mm 15mm 21mm
11mm 16mm 22mm
12mm 17mm 26mm
13mm 18mm 27mm
14mm 19mm

Order No.	Mfr. No.	Description	Ship Wt.
04640	5153DD	1/2" Dr. & Metric Double Deep Impact Socket 29 Pc. Set	19 lbs. - 9 kg

1/2" Sq. Dr. 13 Pc. Deep Impact Socket Set



Set Includes

7/16" 3/4" 1 1/16"
1/2" 13/16" 1 1/8"
9/16" 7/8" 1 1/4"
5/8" 15/16"
11/16" 1"

Order No.	Description	Ship Wt.
01602	Complete 13 Pc. Set with Box	10 lbs. - 5 kg

1/2" Sq. Dr. 14 Pc. Deep Metric Impact Socket Set



Set Includes

10mm 15mm 21mm
11mm 16mm 22mm
12mm 17mm 26mm
13mm 18mm 27mm
14mm 19mm

Order No.	Description	Ship Wt.
01604	Complete 14 Pc. Set with Box	9 lbs. - 4 kg

Replacement Sockets Available.
Contact your Myers Representative

1/2" Sq. Dr. 13 Pc. Impact Socket Set

Set Includes

7/16"	7/8"
1/2"	15/16"
9/16"	1"
5/8"	1 1/16"
1 1/16"	1 1/8"
3/4"	1 1/4"
13/16"	



Order No.	Description	Ship Wt.
01601	Complete 13 Pc. Set	4 lbs. - 2 kg

1/2" Sq. Dr. 14 Pc. Metric Impact Socket Set

Set Includes

10mm	17mm
11mm	18mm
12mm	19mm
13mm	21mm
14mm	22mm
15mm	26mm
16mm	27mm



Order No.	Description	Ship Wt.
01603	Complete 14 Pc. Set	4 lbs. - 2 kg

1/2" Sq. Dr. 11 Pc. Metric & Standard Extra-Thin Wall Deep Impact Set



Set Includes

13/16"	15/16"	14mm	21mm
7/8"	1 1/16"	17mm	22mm
1"		19mm	24mm

Order No.	Description	Ship Wt.
01654	11 Pc. Std. / Metric Extra-Thin Wall Socket Set	7 lbs. - 4 kg

3/4" Sq. Dr. 5 Pc. Metric Truck Wheel Socket Set



Set Includes

17mm Standard	30mm Standard	35mm Standard
27mm Standard	33mm Standard	

Order No.	Description	Ship Wt.
02591	Complete 5 Pc. Set with Box	6 lbs. - 3 kg

3/4" Dr. 8 Pc. Deep Impact Socket Set



Set Includes

1"	1 5/16"
1 1/16"	1 3/8"
1 1/8"	1 7/16"
1 1/4"	1 1/2"

Order No.	Mfr No.	Description	Ship Wt.
04633	4681	3/4" Dr. Deep Impact Socket 8 Pc. Set	13 lbs. - 6 kg

3/4" Sq. Dr. 10 Pc. Impact Socket Set

Set Includes

3/4"	1 1/16"
13/16"	1 1/8"
7/8"	1 3/16"
15/16"	1 1/4"
1"	1 1/2"



Order No.	Description	Ship Wt.
01384	Complete 10 Pc. Set with Box	9 lbs. - 5 kg

3/4" Sq. Dr. 11 Pc. Truck Wheel Service Set



Set Includes

3/4" Deep	1 1/16" Thinwall Deep	33mm Deep
13/16" Deep	1 1/8" Thinwall Deep	1 1/2" Limited Hex Bud
7/8" Deep	1 3/16" Deep	1 3/16" Square
1" Deep	1 1/4" Thinwall Deep	

Order No.	Description	Ship Wt.
01434	Complete 11 Pc. Set with Box	13 lbs. - 6 kg

3/4" Dr. 17 Pc. Metric Impact Socket Set

Set Includes

26mm	38mm
27mm	40mm
28mm	41mm
29mm	42mm
30mm	43mm
32mm	44mm
33mm	45mm
35mm	46mm
36mm	



Order No.	Mfr No.	Description	Ship Wt.
04636	4684	3/4" Dr. Metric Impact Socket 17 Pc. Set	23 lbs. - 11 kg

3/4" Dr. 17 Pc. Deep Impact Socket Set

Set Includes

1"	1 9/16"
1 1/16"	1 5/8"
1 1/8"	1 11/16"
1 3/16"	1 3/4"
1 1/4"	1 13/16"
1 5/16"	1 7/8"
1 3/8"	1 15/16"
1 7/16"	2"
1 1/2"	



Order No.	Mfr No.	Description	Ship Wt.
04637	4685	3/4" Dr. Deep Drive Impact Socket 17 Pc. Set	36 lbs. - 17 kg

Socket Sets

3/4" Drive 17 Pc. Impact Socket Set

Set Includes

1"	1 1/16"
1 1/16"	1 5/8"
1 1/8"	1 11/16"
1 3/16"	1 3/4"
1 1/4"	1 13/16"
1 5/16"	1 7/8"
1 3/8"	1 15/16"
1 7/16"	2"
1 1/2"	



Order No.	Mfr No.	Description	Ship Wt.
04634	4683	3/4" Dr. Impact Socket 17 Pc. Set	25 lbs. - 11 kg

3/4" Dr. 29 Pc. Standard Impact Socket Set

Set Includes

3/4"	1 1/16"	1 3/8"	1 11/16"	2"	2 3/16"
13/16"	1 1/8"	1 7/16"	1 3/4"	2 1/16"	2 3/8"
7/8"	1 3/16"	1 1/2"	1 13/16"	2 1/8"	2 7/16"
15/16"	1 1/4"	1 9/16"	1 7/8"	2 3/16"	2 1/2"
1"	1 5/16"	1 5/8"	1 15/16"	2 1/4"	

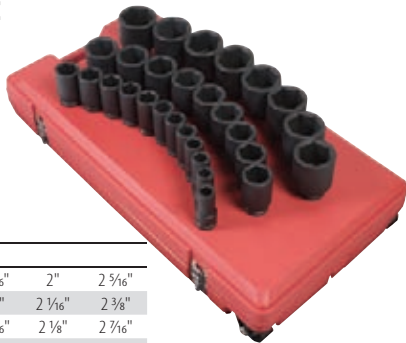

Order No.	Mfr No.	Description	Ship Wt.
04639	4696	3/4" Dr. Standard Impact Socket 29 Pc. Set	72 lbs. - 33 kg

3/4" Dr. Deep 29 Pc. Impact Socket Set

Set Includes

3/4"	1 1/16"	1 3/8"	1 11/16"	2"	2 3/16"
13/16"	1 1/8"	1 7/16"	1 3/4"	2 1/16"	2 3/8"
7/8"	1 3/16"	1 1/2"	1 13/16"	2 1/8"	2 7/16"
15/16"	1 1/4"	1 9/16"	1 7/8"	2 3/16"	2 1/2"
1"	1 5/16"	1 5/8"	1 15/16"	2 1/4"	

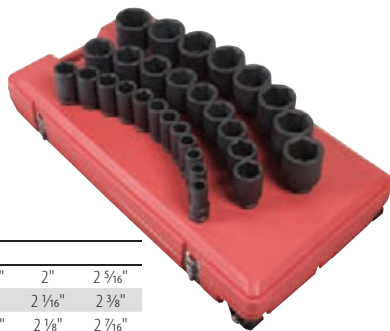

Order No.	Mfr No.	Description	Ship Wt.
04638	4695	3/4" Dr. Deep Impact Socket 29 Pc. Set	72 lbs. - 33 kg

1" Sq. Dr. 7 Pc. Metric Socket Set

Set Includes

17mm Square	33mm Deep Hex	41mm Deep Hex
21mm Square	35mm Deep Hex	
30mm Square	38mm Deep Hex	



Order No.	Description	Ship Wt.
07494	1" Sq Dr. 7 Piece Impact Metric Socket Set	16 lbs. - 7 kg

1" Sq. Dr. 8 Pc. Deep Impact Socket Set

Set Includes

7/8"	1 1/16"	1 1/4"
15/16"	1 1/8"	1 1/2"
1"	1 3/16"	



Order No.	Description	Ship Wt.
01459	1" Sq Dr. 8 Piece Impact Deep Socket Set	21 lbs. - 10 kg

1" Sq. Dr. 8 Pc. Impact Socket Set

Set Includes

7/8"	1 1/16"	1 1/4"
15/16"	1 1/8"	1 1/2"
1"	1 3/16"	



Order No.	Description	Ship Wt.
01408	1" Sq Dr. 8 Piece Impact Socket Set	12 lbs. - 5 kg

1" Dr. Wheel 10 Pc. Standard & Metric Impact Socket Set

Set Includes

4 Deep Sockets	3 Deep Thin Wall Sockets	2 Square Sockets	1 Controlled Depth Socket
1"	1 1/16"	13/16"	1 1/2"
1 3/16"	1 1/8"	15/16"	
1 3/8"	1 1/4"		
33mm			



Order No.	Mfr No.	Description	Ship Wt.
04641	5690A	1" Dr. Standard & Metric Wheel Impact Socket 10 Pc. Set	23 lbs. - 11 kg

1" Sq. Dr. 10 Pc. Socket Set

Set Includes

13/16" Square
7/8" Standard
15/16" Standard
1" Standard
1 3/16" Standard
33mm Standard
1 1/4" Thin Wall Deep
1 1/8" Thin Wall Deep
1 1/4" Thin Wall Deep
1 1/2" Deep



Order No.	Description	Ship Wt.
01478	1" Sq Dr. 10 Piece Impact Socket Set	17 lbs. - 8 kg

Impact Socket Extensions

Order No.	Male End	Female End
01492	3"	1/2"
01470	5"	1/2"
01472	7"	3/4"
01474	13"	3/4"
01473	7"	1"
01493	13"	1"
01349	8"	#5 Spline
01348	15"	#5 Spline



Impact Socket Adapters

Order No.	Male End	Female End
01480	3/8"	1/2"
01482	1/2"	3/4"
01483	3/4"	1"
06469	1"	3/4"
01513	1"	#5 Spl.



1-1/2" Budd Nut Sockets

Order No.	Nut Size	Drive
01407	1 1/2" Standard	1"
01458	1 1/2" Deep	1"
01561	1 1/2" Deep - Shallow Broach	1"



Square Budd Wheel Sockets

Order No.	Nut Size	Drive
01499	13/16"	3/4"
01500	13/16"	1"
01498	13/16"	#5 Spline
Deep Length		
01501	13/16"	3/4"
07375	15/16" Not deep	1"



41mm Thin Wall Deep Impact Socket

Order No.	Nut Size	Drive
07493	41mm	1"
01512	41mm	#5 Spline



1-5/16" Impact Deep Sockets

Order No.	Nut Size	Drive
06438	1 5/16" Deep	3/4"
07386	1 5/16" Deep	1"
06462	1 5/16" Deep	Spline



Dayton Wheel Sockets

- Deep hex thinwall 6 point

Order No.	Size	Drive
01461	1 1/16"	1"
01462	1 1/8"	1"
01463	1 1/4"	1"
#5 Spline Drive		
01540	1 1/16"	#5 Spline
01547	1 1/8"	#5 Spline
01541	1 1/4"	#5 Spline



1" Square Drive

33mm Flanged Cap Nut Sockets

- Budd uni-mount 10

Order No.	Size	Drive
02496	33mm Std.	3/4"
07410	33mm Std.	1"
07470	33mm Std.	#5 Spline
04642	33mm Deep	3/4"
07479	33mm Deep	1"
07469	33mm Deep	#5 Spline



#5 Spline Dr. Impact Sockets



01505

01511

#5 Spline Dr. Standard Length Hex Sockets

Order No.	Nut Size
01503	7/8"
01504	15/16"
01505	1"
01506	1 1/16"
01507	1 1/8"

Order No.	Nut Size
01508	1 3/16"
01509	1 1/4"
01510	1 1/2"
07470	33mm

#5 Spline Dr. Deep Hex Socket

Order No.	Nut Size
06462	1 3/16"
01511	1 1/2"

Order No.	Nut Size
07469	33mm
01512	41mm

1" Sq. Dr. Metric Impact Sockets



Order No.	Size	Length
07382	19mm	Standard
07477	22mm	Standard
07478	24mm	Standard
07397	27mm	Standard
07400	28mm	Standard
07404	30mm	Standard
07410	33mm	Standard
07480	35mm	Standard
07414	36mm	Standard
07482	38mm	Standard

Order No.	Size	Length
07483	41mm	Standard
07426	46mm	Standard
07398	27mm	Deep
07405	30mm	Deep
07479	33mm	Deep
07481	35mm	Deep
07484	41mm	Deep
07493	41mm	Thin Deep
07485	17mm Sq.	Standard
07486	21mm Sq.	Standard

1" Sq. Dr. Standard Length Impact Sockets



Order No.	Nut Size
01400	3/8"
01401	1/2"
01402	1"
01403	1 1/16"
01404	1 1/8"
01405	1 3/16"
01406	1 1/4"
01562	1 5/16"
01563	1 3/8"
01564	1 7/16"
01407	1 1/2"
01566	1 9/16"
01567	1 5/8"
01568	1 11/16"
01569	1 3/4"
01570	1 13/16"
01571	1 7/8"
01572	1 15/16"
01573	2"
01574	2 1/16"

Order No.	Nut Size
01575	2 1/8"
01576	2 3/16"
01577	2 1/4"
01579	2 3/8"
01580	2 7/16"
01581	2 1/2"
01582	2 9/16"
01583	2 5/8"
01584	2 11/16"
01585	2 3/4"
01586	2 13/16"
01587	2 7/8"
01588	2 15/16"
01589	3"
01590	3 1/8"
01591	3 1/4"
01592	3 3/8"
01593	3 1/2"

Truck Wheel Bearing Locknut Sockets



Each socket has a 3/4" square drive opening allowing use of a torque wrench to tighten the lock nut as recommended. Made of high strength steel; openings resist "rounding out".

Order No.	OTC No.	Ref. No.	Point	Size	Shape
04739	1901	1201	6	2 3/32"	Hex
04759	1920	1220	6	2 1/4"	Hex
04740	1902	1202	6	2 3/8"	Hex
04758	1936	1236	6	2 3/8"	Rounded Hex
04843	1921	1221	6	2 1/2"	Hex
04741	1904	1204	6	2 9/16"	Hex
04745	1905	1205	8	2 9/16"	Octagonal
04815	1928	1228	6	2 9/16"	Rounded Hex
04844	1922	1222	6	2 5/8"	Hex
04884	1923	1223	6	2 3/4"	Hex
04859	1932	1232	6	2 7/8"	Hex
04742	1906	1206	6	3"	Hex
04743	1908	1208	6	3 1/4"	Hex
04790	1909	1209	8	3 1/4"	Octagonal
04746	1910	1210	6	3 1/2"	Hex
04885	1925	1225	8	3 3/4"	Octagonal
04747	1912	1212	6	3 7/8"	Hex
04750	1913	1213	8	3 7/8"	Octagonal
04751	1914	1214	6	4"	Hex
04752	1915	1215	6	4 1/8"	Hex
04753	1917	1217	8	4 3/8"	Octagonal
04755	1916	1216	6	4 3/8"	Hex
04754	1919	1219	8	4 7/8"	Octagonal
04756	1918	1218	6	4 7/8"	Hex

No-Mar Rim Guard

- Fits 10-hole 22.5, 24.5 disc wheels

Prevents impact wrenches from leaving damaging grooves in aluminum, chrome or painted truck wheels. Made of flexible high impact nylon.

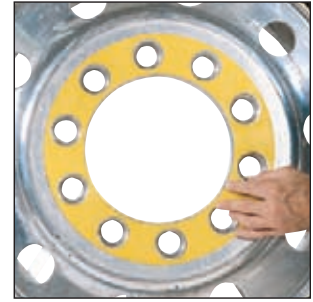

Order No.	Description
52680	No-Mar Rim Guard

PB BLASTER Nut Loosener

A powerful, penetrating lubricant that frees everything faster! Displaces moisture. Use on nuts and bolts, rusted joints, automatic chokes, to start wet engines and more. Just saturate troubled area and allow to stand for a few minutes.



Order No.	Description	Case Qty.
45217	11 Oz. Spray	12
45218	1 Gallon	4

NEXT DIMENSION Penetrant Lubricant

- Prevents corrosion & displaces moisture
- Fortified with PTFE

A unique blend of concentrated, fast-acting, powerful penetrating solvent quickly loosens rusted nuts, bolts, and frozen parts in seconds. 4 in 1 chemistry penetrates, lubricates, displaces moisture, and prevents corrosion. Ideal for automotive aftermarket and fleet service.



Order No.	Description	Case	Fill	Container
11053	Penetrant Lubricant	12	12 Oz.	16 Oz.

Anti-Seize Compound

A copper-based, high temperature, anti-seize and lubricating compound recommended for coating nuts, bolts, valves, flanges, and splines for easy breakout after years of service. Protects against galling, seizing, corrosion. Resists temperatures to 1,800°F.



Order No.	Description	Size
45155	E-Z Break Brush-On	10 Oz. Can
45158	E-Z Break Spray	14 Oz. Can

30 LED Work Light

- Lithium-Ion battery holds charge longer with no memory effect
- Weatherproof body & switch
- 5-1/2 Hours use



Allows freedom of movement and to work without worrying about tangled cords. 360° Rotating nylon swivel hook at the head. 30 LED super-bright, long-life LEDs provide forward directed pure white light. LEDs produce very little heat. 4-hour recharge time provides up to 5-1/2 hours of continuous operation. 7.2v rechargeable lithium battery. Includes LED charge indicator. Slim design allows access into tight areas.

Order No.	Description
84502	Cordless LED Inspection Light

Fleetline
PROFESSIONAL
by Myers Tire Supply

Adjustable Chrome Nut Cover Remover



Removes and installs chrome wheel nut covers without scratching or damage. Adjustable. Formed steel jaws with Non-Mar protective coating.

Order No.	Description	Ship Wt.
52440	Adjustable Chrome Nut Cover Remover	2 lbs. - 1 kg

Chrome Nut Cover Remover

- Won't break or collapse
- Unique head design for round or hex nut covers of all sizes



This rugged set of pliers is designed specifically for removing chrome-plated nut-covers, quickly. Unique head design handles all sizes without adjusting handle. No pinching. Heavy-duty handles always leave space for your fingers. Tough polypropylene jaws and plastic-coated steel handles make this tool almost unbreakable.

Order No.	Mfr. No.	Description	Ship Wt.
52660	CNP	Chrome Nut Cover Pliers	2 lbs. - 1 kg

Bolt Hole Chamfer Wear Gauge



Visually detect excessive wear in .875R spherical chamfers of bolt holes in disc wheels. Designed for use with stud piloted dual steel wheels with .875R spherical chamfered bolt holes $\frac{3}{8}$ " to $\frac{1}{2}$ " disc thickness. Not for use on aluminum wheels.

Order No.	Description
72806	Bolt Hole Chamfer Wear Gauge

"Wheel Shield" Wheel Protector

- Protects wheel surface from damage during service
- Fits 22.5 & 24.5 Disc wheels



Eliminates scratches and scars, reduces damage to the wheel from stray tool blows, and prevents scar rings on stud holes left by impact wrenches. Snaps into place into the center hub and covers the wheel face. Use on aluminum, chrome or steel wheels.

Order No.	Description	Ship Wt.
52651	Wheel Shield Wheel Protector	3 lbs. - 2 kg

13/16" Inner Budd Nut Remover

For Use On



Tool fits $\frac{13}{16}$ " socket. When square end breaks off, remover fits over remaining portion of stud and is driven on stud.

Order No.	Description
02701	$\frac{13}{16}$ " Inner Budd Nut Remover w/ Drive Pin

Chrome Ball Stud Setter

For Use On



- Drives $\frac{5}{8}$ & $\frac{3}{4}$ truck wheel studs



Sets studs so they won't loosen. Setter drives stud with force on internal ball, NOT on threads. Use impact or 4-way wrench.

Order No.	Description
02700	Set of 2 for Setting $\frac{5}{8}$ " & $\frac{3}{4}$ " USS. Studs
02706	$\frac{5}{8}$ " Stud Setter
02707	$\frac{3}{4}$ " Stud Setter

5/8" & 3/4" Drive-On Broken Stud Removers



Simply drive Stud Remover on. Sharp splines dig into broken stud so it may be spun out with a 4-way or impact wrench. The broken stud is knocked out of the remover with the pin supplied.

Order No.	Description
02699	Set of 2 Stud Removers (1 Ea. $\frac{5}{8}$ " & $\frac{3}{4}$ " USS.)
02697	$\frac{5}{8}$ " Stud Remover
02698	$\frac{3}{4}$ " Stud Remover

Outer Budd Nut Removers

For Use On

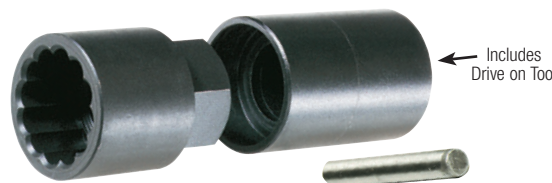

Includes Drive on Tool

Designed to remove rounded $\frac{1}{2}$ " or 33mm outer budd nuts. Drive it with drive on tool and sharp ribs bite into the rounded nut. Remove the nut with a $\frac{1}{2}$ " or 33mm socket and lug wrench or impact wrench. Includes drive on tool.

Order No.	Description
02696	$\frac{1}{2}$ " Outer Budd Nut Remover with Drive On Tool
02694	33mm Outer Budd Nut Remover with Drive On Tool

See Pages 88, 89 for Truck Wheel Torque Wrenches

Drive-On, Rib-Grip Lug-Off Tools

- Drive-on tool fits all rib nuts
- Fast & easy to use

Insert the proper rib nut into the Drive-On Tool with the non-beveled open end of the nut facing in. Position the beveled open end of the nut against the end of the damaged lug stud. Drive the rib nut on the lug stud by hammering on the Drive-On Tool. The ribs on the nut bite into and grip the lug stud. Remove the Drive-On Tool. Use a lug wrench or impact wrench to remove the rib nut and the damaged stud.

Master Budd Nut Remover Kit



Master Kit includes Drive-On Tool, 17mm, 21mm, and 1 1/8" dia. (1 1/8" square head) Rib Nuts, Salvage Cylinder, Drift Pin and Metal Storage Box.

Order No.	Mfr. No.	Description	Ship Wt.
02780	X10-LC56B	Master Budd Nut Remover Kit	6 lbs. - 3 kg

1 3/16" Budd Nut Remover Kit

1 3/16" Kit includes Drive-On Tool, 1 1/8" dia. (1 1/8" sq. head) Rib Nut and Drift Pin.



Order No.	Mfr. No.	Description
02775	X10-LT20B	1 3/16" Budd Nut Remover Kit

Triple Duty Kit

For removing 1 3/16" Budd wheel inner cap nuts, 3/4" and 5/8" lug studs. Kit includes Drive-On Tool, 1 1/8" dia. (1 1/8" square head), 3/4", and 5/8" Rib Nuts, and Drift Pin.



Order No.	Mfr. No.	Description
02776	X10-LT66B	Triple-Duty Kit

Replacement Rib Nuts

Order as required.

Order No.	Mfr. No.	Description
02777	X10-LN18B	1 1/8" Dia. (1 1/8" Square Head) Rib Nut
02778	X10-LN34B	3/4" Rib Nut
02779	X10-LN58B	5/8" Rib Nut
02782	X10-LN21B	21mm Rib Nut
02783	X10-LN17B	17mm Rib Nut

Rib Nut Salvage Tool Kit

- For Budd nut removal



Used to salvage rib nuts for reuse. Screw bolt, right or left hand thread as required, into damaged inner cap nut. Position assembly for salvage in recess of salvage cylinder. Drive drift pin against end of the bolt until the rib nut breaks free. Kit includes Salvage Cylinder, LH Thread Bolt, RH Thread Bolt and Drift Pin.

Order No.	Mfr. No.	Description
02781	X10-LS15B	Rib Nut Salvage Kit

TIGER TOOL 10603 Hydraulic Stud Remover & Installer

- Remove & install 10 studs in only 20-30 minutes without removing the hub



Pump not included



Eliminates the risk of damage to hubs, seals, wheel bearings and axle studs. Removes the most severely seized brake anchor pins and bushings. Kit includes: 10-ton hydraulic cylinder, rigid A.D.I. Press frames, threaded draw bar, spacer sleeve adapter, 5 wheel stud adapters (3/4" LH threaded, 3/4" RH threaded, 1 1/8" LH threaded, 1 1/8" RH threaded, 22mm RH threaded), 5 adapters for removing wheel studs and pressing anchor pins and bushings in and out, convenient carrying case. Pump not included, requires any 10,000 psi hydraulic power source or equivalent.

Order No.	Mfr. No.	Description	Ship Wt.
03795	10603	Hydraulic Stud Remover & Installer	39 lbs. - 18 kg

PAKPRESS™ Portable Wheel Stud Remover & Installer

- Brings the power of a 10-ton press to the truck
- Cuts a two hour job to 20 minutes



84412 Complete with Power Kit



Remove or install studs in seconds.

Remove and install studs without removing the hub. Eliminates the risk of damaging seals or bearings. The PakPress™ is manufactured from super-tough nickel alloy, cast and heat-treated for durability. Includes instructions.

Order No.	Mfr. No.	Description	Ship Wt.
84411	1-PPF	PakPress - Frame & 10-Ton Cylinder	42 lbs. - 19 kg
84412	1-PPK	PakPress with Optional Power Kit - Frame, 10-Ton Cylinder & PPHP Power Kit	70 lbs. - 32 kg
84413	1-PPHP	Optional Power Kit Only with 10,000 PSI. Air/Hydraulic Pump, 6' Hose, Tee Adapter, Glycerin-Filled Gauge	30 lbs. - 14 kg

MYERS Reusable Mechanics Gloves

- Outstanding gripping power & superior flexibility



Nitrile-coated palm protects hands against oil, grease and other shop grime. Rolled cuff and breathable fabric keeps hands cool in the heat and warm in the cold. Machine washable, will not shrink. Air dry.

Order No.	Description	Size
45378	Mechanics Gloves	Large
45379	Mechanics Gloves	Extra Large

Cheetah Stud Extractor Kit

- Accurately drills hole in the center of the broken axle stud for removal
- Removes a broken axle-housing stud without damaging the existing threads



Drilling a hole in the exact center of a broken axle stud is the most critical factor in removing it. The Stud Extractor Kit covers the eight most popular axes on the road. The only other tools needed are an electric drill and a tap and die wrench to turn the easy-out.

Order No.	Description
04959	Cheetah Stud Extractor Kit

Wheel Guards

- Prevents wheels from “freezing” or rusting to hubs
- Prevent galvanic electrolysis between aluminum wheels & steel hubs

Use between inner and outer dual

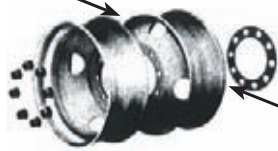

Use between inner dual and brake drum

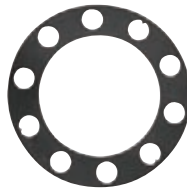

A black nylon separator plate approximately 1/2" thick placed between the hub and the wheel or between dual wheels. The wheel guard prevents corrosion and wear between surfaces. Use with steel or aluminum wheels.

Order No.	Mfr. No.	Application	Diameter Stud
72971	60100	10 Hole Stud Pilot 11 1/4" Bolt Circle	1 1/8" And 7/8"
72972	60101	10 Hole Stud Pilot 11" Bolt Circle	3/4"
72976	60105	8 Hole Hub Pilot 275mm Bolt Circle	20mm
72980	60102	10 Hole Hub Pilot 285.75mm Bolt Circle	22mm

Truck Wheel Guard

- Prevents wheels from “freezing” or rusting to hubs
- Prevent galvanic electrolysis between aluminum wheels & steel hubs

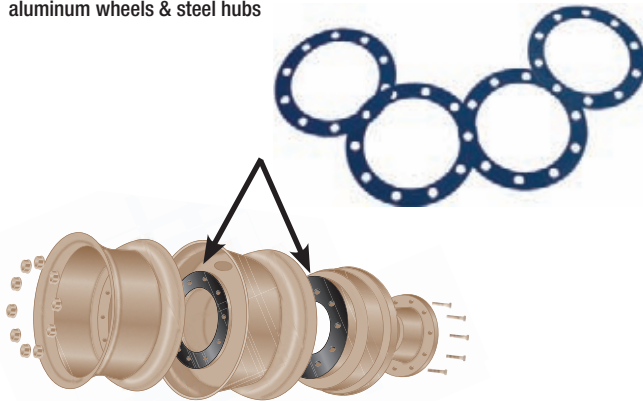

A composite separator plate to be placed between the hub or drum and the wheel and/or between two wheels in dual applications. Provides protection for wheels against corrosion and excessive wear and prevents galvanic electrolysis between aluminum and steel wheels.

Order No.	Mfr. No.	Application	Diameter Stud
85018	61020	10 on 285.75mm Hub Piloted	22mm

MYERS Wheel Nut & Stud Cleaning Kit

- Everything needed to easily clean tire nut & stud components
- Clean components are required for precise wheel torquing



Carrying case included

All wheel manufacturers recommend cleaning the nuts & studs whenever a tire is serviced. Includes reversible 1/4" air screwdriver with quick change retainer.

Includes (4) specialized bolt hole cleaning brushes, (4) stud cleaning brushes, (4) replacement stud cleaning brushes, air screwdriver & plastic carrying case. *Specs.:* 1,800 rpm; min. air hose 3/8"; air inlet 1/4" fpt; average air cons. 4 cfm; operating air pressure 90 psi.

Order No.	Description
64010	Wheel Nut & Stud Cleaning Kit

Components Also Available Separately

Order No.	Description	Order No.	Description
64011	1/4" Reversible Air tool	64018	Repl. Inner Brush for 64015
64015	Black Stud Cleaner	64019	Repl. Inner Brush for 64014
64014	Blue Stud Cleaner	64017	Repl. Inner Brush for 64013
64013	Grey Stud Cleaner	64016	Repl. Inner Brush for 64012
64012	Red Stud Cleaner		
64022	Bolt Hole Cleaner - M30		
64021	Bolt Hole Cleaner - M24		
64020	Bolt Hole Cleaner - M20		
64023	Bolt Hole Buff		

COUNTERACT Stud Cleaning Tool

- Cleans 10 studs in 3 minutes or less
- All wheel manufacturers recommend cleaning the nuts & studs whenever a tire is serviced
- Fits the most popular 10 hole hub piloted wheel
- Eliminates messy hand brushes



NOTE: For optimum performance minimize the rpm of the air wrench with an air regulator. Always use eye protection and respiratory mask.

Order No.	Description
64008	Stud Cleaning Tool
64009	Replacement Brush

Wheel Centering Products

Wheel Centering Products

- Internal centering sleeves
- Stays on the wheel at all times
- Use for steer axles only with universal brake drums

The wheel centering sleeve aligns the brake drum and the wheel. Used on the universal brake drum and stays on the stud permanently. Zinc-plated to resist corrosion. Three sleeves are threaded on the studs at the 12, 4 and 8 o'clock position. Sold in sets of (6) per axle.



Out of center



Corrected with centering sleeve

Order No.	Tru-Balance No.	Order No.	Specialty No.	Wheel Type	Brake Drum Type	Dimensions
74105	B-1504-GA	74401	32120	Aluminum	Gunite: 3721AX, 3800X, 3774X, 3710X, 3596X, 3598X, 3686X, 3687X, 3726X, 3758X, Webb: 61528B, 65548B, Arvin Meritor: 53-123448-002, 53-12357-002, 53-123568-002	1.25" Hole/.5" Flange
74109	B-1794-GS	74405	32124	Steel	Gunite: 3721AX, 3800X, 3774X, 3710X, 3596X, 3598X, 3686X, 3687X, 3726X, 3758X, Webb: 61528B, 65548B, Arvin Meritor: 53-123448-002, 53-12357-002, 53-123568-002	1.25" Hole/.5" Flange
74106	B-1594-CA	74402	32121	Aluminum	Gunite 9001X, 9000X, 9035X, Centrifuse 90089BK, 89870BK, 90174BK, Arvin Meritor 53-123512-002, 53-123542-002	1.25" Hole/.25" Flange
74107	B-1688-CS			Steel	Gunite 9001X, 9000X, 9035X, Centrifuse 90089BK, 89870BK, 90174BK, Arvin Meritor 53-123512-002, 53-123542-002	1.25" Hole/.25" Flange
74110	B-1825-CON-A			Aluminum	Conmet: 100009920	1.34" to 1.37"Hole/.5" Flange
74111	B-1848-CON-S			Steel	Conmet: 100009920	1.34" to 1.37"Hole/.5" Flange
74112	B-1860-CON-A			Aluminum	Conmet: 107164, 107507, 107862, 107453, 10001781, 10001783, 10001531, 10005332	1.28" Hole/.5" Flange
74113	B-1861-CON-S			Steel	Conmet: 107164, 107507, 107862, 107453, 10001781, 10001783, 10001531, 10005332	1.28" Hole/.5" Flange
74108	B1781-M2-A			Aluminum	Gunite: 3754AX, 3753AX, 3596BX	1.0" Hole/.5" Flange

Wheel Centering Products External Centering Sleeves

- Stays on the wheel at all times
- Use for steer, drive & trailer axles
- Internal sleeve sets for Gunite, Centrifuse & Conmet brake drums

The wheel centering sleeve slides over the studs and seats against the wheel face. The sleeve stays on the wheel and helps to reduce "wheel-off" condition. Zinc-plated to resist corrosion. Three sleeves are threaded on the studs at the 12, 4 and 8 o'clock position. Sold in sets of (6) per axle.



Heavy-Duty Trucks & Trailers 22mm Stud Threads

Order No.	Tru-Balance No.	Order No.	Specialty No.	Steer Axle Position	Drive Axle Position	Wheel Size
74114	C-1600-S	74410	33140	Steel	N/A	22.5"/24.5"
74115	C-1611-AS	74411	33141	Aluminum	Steel/Steel	22.5"/24.5"
74116	C-1619-AA	74412	33142	N/A	Aluminum/Aluminum	22.5"/24.5"
74117	C-1620-AS	74413	33143	N/A	Steel/Aluminum	22.5"/24.5"
74118	C-1664-HDA	74414	33144	N/A	Aluminum Super Single	14" Wide
74119	C-1671-HD-S	74415	33145	N/A	Aluminum Super Single	14" Wide
74120	C-1742-HD-AS	74416	33146	Aluminum	N/A	9" Wide (Floaters)
74121	C-1744-AS	74417	33147	Aluminum	Steel/Steel	22.5"/24.5"



74114



74115



74117



74118



74119



74121

Heavy-Duty Trucks & Trailers 22mm Stud Threads

Centers wheel and brake drum on steer axle

Order No.	Tru-Balance No.	Order No.	Specialty No.	Description	Dimensions
74122	C-1773-WBDA	74418	33148	Aluminum Wheel & Brake Drum 3753AX, 3754AX, 3596BX	1.0" Hole/.5" Flange
74123	C-1833-M2-GA	74419	33149	Aluminum Wheel & Brake Drum	1.0" Hole/1.0" Flange



74122



74123

GMC/GM Kodiak/4500/5500 20mm Stud Threads

Order No.	Mfr. No.	Steer Axle Position	Drive Axle Position	Wheel Size
74136	C-1880-GMC-S	Steel	N/A	19.5"/22.5"
74137	C-1882-GMC-SS	N/A	Steel/Steel	19.5"/22.5"
74138	C-1913-GMC-A	Aluminum	N/A	19.5"/22.5"
74139	C-1914-GMC-AS	N/A	Steel/Aluminum	19.5"/22.5"
74140	C-1915-GMC-AA	N/A	Aluminum/Aluminum	19.5"/22.5"



74136



74138



74140

Ford 450/550 14mm Stud Threads

Order No.	Mfr. No.	Steer Axle Position	Drive Axle Position	Wheel Size
74131	C-1896-FSS	N/A	Steel/Steel	19.5"/22.5"
74132	C-1898-FS	Steel	N/A	19.5"/22.5"
74133	C-1910-FA	Aluminum	N/A	19.5"/22.5"
74134	C-1911-FAS	N/A	Steel/Aluminum	19.5"/22.5"
74135	C-1912-FAA	N/A	Aluminum/Aluminum	19.5"/22.5"



74131



74133



74135

TRU-BALANCE Wheel Centering

Pin Sets

- Reusable shop tool
- Use when mounting the wheels



Reusable shop tool used when mounting the wheels. The three centering pins are removed once the wheel is mounted. Drive and steer axle pin sets are available. Each set includes three hardened steel pins with a case and instructions.

Order No.	Mfr. No.	Wheel Type	Wheel Size	Stud Threads	Axle Position
74101	A-1573	Steel or Aluminum	22.5"/24.5"	22mm	Steer & Drive
74100	A-1339	Steel or Aluminum	19.5"	22mm	Steer
74102	A-1557	Steel or Aluminum	19.5"	22mm	Steer
74103	A-1625	Steel or Aluminum	GMC Trucks	20mm	Steer
74130	A-1897	Steel or Aluminum	Ford Trucks	14mm	Steer & Drive
74104	A-1778-TN	Steel	Various	22mm	Steer

TRU-BALANCE Front Brake Drum Spacers

- Centers brake drum holes to the stud
- Stays on the wheel at all times



Use with centering pins or external sleeves. 22mm wheel studs.

Order No.	Mfr. No.	Brake Drum Type	Dimensions
74124	S-1707-G	Gunite: 3573X, 3710X, 3596X, 3721AX, 3597X, 3726X, 3598X, 3758X, 3686X, 3774X, 3687X, 3800X, Webb: 61528B, 65548B, Arvin Meritor: 53-123448-002, 53-123567-002, 53-123568-002	1.25" Hole/.5" Flange
74125	S-1708-C	Gunite: 9001X, 9000X, 9035X, Centrifuse: 90089BK, 89870BK, 90174BK, Arvin Meritor: 53-123512-002, 53-123542-002	1.25" Hole/1/4"-5/16" Flange
74126	S-1826-CON	Conmet 10009920	1.34"-1.37" Hole/.5" Flange

TRU-BALANCE Accessories

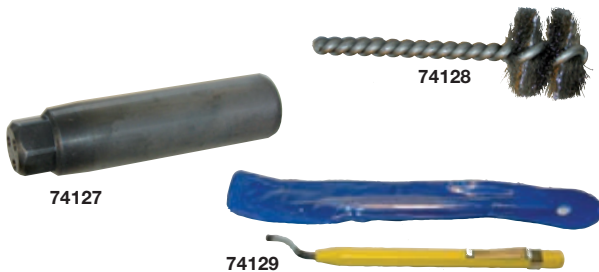

74127: Installation Pin aids in installing external sleeves for drive and trailer wheels.

74128: Wire Brush for electric drills to clean wheel studs before installation.

74129: Deburr Knife to remove damaged edges or burrs in wheel mounting hole.

Order No.	Mfr. No.	Description
74127	X-1745-IP	Installation Pin
74128	X-1755-WB	Wire Brush
74129	X-1757-DK	Deburr Knife

CHECKPOINT Loose Nut Indicators

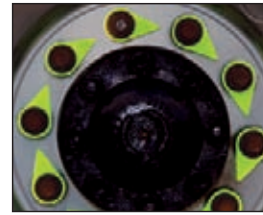

Safe

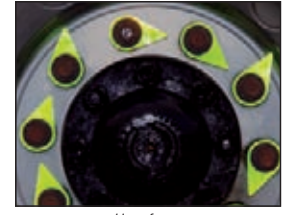

Unsafe

- Guard against a potential catastrophic loss caused by loose lug nuts
- Visually indicates if wheel nuts have moved
- No tools required

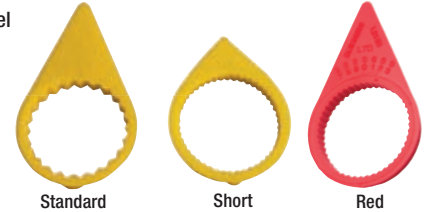

A simple and cost effective fleet safety measure. Place yellow Checkpoints and one red Checkpoint on wheel nuts after initial mounting torque. After 100 miles of use, re-torque and replace red Checkpoint with yellow; visually indicating nuts have been properly serviced.

High Temperature Yellow can be used in high heat applications such as waste haulers and buses.

The short arrow Checkpoint indicators, 72917, are used on wheels with a shorter distance between the nuts and studs.

Order No.	Mfr. No.	Description	Qty. Bag
72628	CPY19	Standard 19mm Yellow Indicators	100
72629	CPY21	Standard 21mm Yellow Indicators	100
72639	CPY22	Standard 22mm Yellow Indicators	100
72625	CPY27	Standard 27mm Yellow Indicators	100
72640	CPY30	Standard 30mm Yellow Indicators	100
72630	CPY32	Standard 32mm Yellow Indicators	100
72986	CPY33	Standard 33mm Yellow Indicators	100
72626	CPY34	Standard 34mm Yellow Indicators	100
72627	CPY35	Standard 35mm Yellow Indicators	100
72631	CPY38	Standard 38mm Yellow Indicators	100
72638	CPY41	Standard 41mm Yellow Indicators	100
72917	CPYSA	Short 33mm Yellow Indicators	100
72632	CTR32	32mm Red Indicators	100
72633	CTR33	33mm Red Indicators	100
72634	CTR38	38mm Red Indicators	100
72635	CPSY32	High Temp 32mm Yellow Indicators	100
72636	CPSY33	High Temp 33mm Yellow Indicators	100
72637	CPSY38	High Temp 38mm Yellow Indicators	100

ROLLOCK Wheel Nut Clamps

- Cost effective way to prevent wheel nuts from loosening
- Installs in seconds



Rollock helps prevent torque loss which could lead to a "wheel off" situation. Simply drive the clamp over the nut with the installation tool. When it's time to remove, unscrew the nut in the normal manner and it comes off easily. Galvanized steel will not rust, fade or warp, even in extreme heat. Most 22.5" wheels will require the 72680. The 72681 is for 22.5" European wheels and 19.5" wheels. Packed 25 per box, priced each.

Order No.	Mfr.No.	Description
72680	62000	4 1/2" Stud Spacing, 30 - 33mm Nut
72681	62500	3 1/2" Stud Spacing, 30 - 33mm Nut
72682	62050	Installation Tool for 72680
72683	62550	Installation Tool for 72681

Hub Centric Nut

- True black oxide coating, not painted
- Special steel blend for extra strength
- Zinc yellow coating offers extended corrosion resistance
- 33mm Hex, 22mm x 1.5 thread



72650



72651



72652



72653

Installing a fastener on every stud stops the rim from shifting forward or backward helping to maintain the torque of the nut initially applied and reducing the chance of a loose wheel. Complete coverage for liability by an A+ American insurance company.

Order No.	Order No.	Description
72650	X10-PN22B	Hub Centric Nut - Black
72651	X10-PN22Z	Hub Centric Nut - Zinc
72652	X10-DW22B	Dual Wheel Hub Centric Nut - Black
72653	X10-DW22Z	Dual Wheel Hub Centric Nut - Zinc

Hub Centric Nut Locks

- Instantly alerts driver to tampering or attempted theft

Install one security cap per wheel over existing Hub Nut and tighten to 100 - 150 ft. lbs. Press red cap over the security lock as far as it will go.

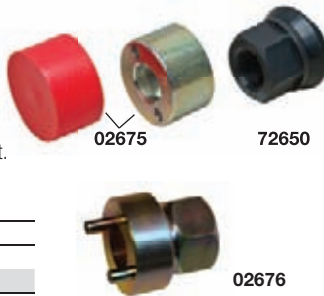

Order No.	Description
02675	Hub Centric Nut Lock & Cover
02676	Hub Centric Nut Lock Tool

Zafety Lug Locks

- Creates resistance between two nuts minimizing their potential to rotate
- Ideal for public transportation vehicles & refuse trucks
- Withstands temperature fluctuations from -40° to 248°
- Hi-Heat option withstands temperature fluctuations from -40° to 320°



629501



Provides a clear, visual check in all weather and lighting conditions. Install the lug locks by hand over two adjacent nuts. Lug nuts can be re-torqued with removing the lug locks. Easily removed by hand or with optional installation/removing tool. Zafety Lug Locks are manufactured in an ISO-9001-2008 certified facility.

Order No.	Type	Studs	Spacing		Nut Size	
			Inch	mm	Inch	mm
626901	Standard	8	2 1/2"	63.5	7/8"	22.2
626801	Standard	8	2 1/2"	63.5	1"	25.4
626001	Standard	10	3 1/2"	88.9	1 1/16"	33
627001	Hi-Heat	10	3 1/2"	88.9	1 1/16"	33
626701	Standard	10	3 1/2"	88.9	1 1/2"	38.1
628001	Standard	10	4 1/8"	104.8	1 1/16"	33
629001	Hi-Heat	10	4 1/8"	104.8	1 1/16"	33
629501	Installation Tool					

Order No.	Application
626901	Delivery & Step Vans, Smaller Type A & B School Buses, EMS Vehicles, F350 & 450, etc.
626801	Delivery Vans, Utility & Landscaping Trucks, Step Vans
626001	Large Trucks & Trailers, Type C & D School Buses, Utility & Ready Mix Trucks
627001	Large Trucks & Trailers, Type C & D School Buses, Utility & Ready Mix Trucks
626701	Some Prevost & MCI Coaches
628001	Transit Buses, Off Road Applications & Some Coaches
629001	Transit Buses, Off Road Applications & Some Coaches

Budd Nuts & Studs for Disc Wheels



72730

Standard Inner Cap Nut - Steel Wheels - 25 Per Package - Priced Each								
Order No.	Mfr. No.	Replace Budd	NWRA	Thread Inner/Outers	Thread Direct.	Length	Square Head	Grade
72730	M-128	10708	X-1828	3/4"-16 / 1 1/8"-16	Right	2 1/8"	1 3/16"	5
72731	M-129	10709	X-1829	3/4"-16 / 1 1/8"-16	Left	2 1/8"	1 3/16"	5
72738	M-130	35336	X-1835	3/4"-16 / 1 1/8"-16	Right	2 9/16"	1 3/16"	8
72739	M-131	35337	X-1836	3/4"-16 / 1 1/8"-16	Left	2 9/16"	1 3/16"	8



72736

Standard Inner Cap Nuts - Aluminum Wheels - 25 Per Package - Priced Each								
Order No.	Mfr. No.	Replace Budd	NWRA	Thread Inner/Outers	Thread Direct.	Length	Square Head	Grade
72736	M-136	70611	X-1801	3/4"-16 / 1 1/8"-16	Right	2 5/8"	1 3/16"	8
72737	M-137	70612	X-1802	3/4"-16 / 1 1/8"-16	Left	2 5/8"	1 3/16"	8
72750	M2400	5988R	X-1873	3/4"-16 / 1 1/8"-16	Right	2 15/16"	1 3/16"	8
72751	M2401	5988L	X-1874	3/4"-16 / 1 1/8"-16	Left	2 15/16"	1 3/16"	8



72618

Metric Inner Cap Nuts for HINO & ISUZU-25 Per Package							
Order No.	Thread	Repl. Hino	Repl. ISUZU	Thread Inner	Thread Outer	Length	Square Head
72618	Right	23101	42335	20mm-1.5	30mm-1.5	M62	21mm
72620	Left	24104	42336	20mm-1.5	30mm-1.5	M62	21mm



72732

Standard Outer Cap Nuts-Steel & Aluminum-25 Per Package						
Order No.	Mfr. No.	Replaces Budd/	NWRA	Thread	Hex	Pkg Qty.
72732	M-126	37891	X-1831	1 1/8"-16 Right	1 1/2"	25
72733	M-127	37892	X-1832	1 1/8"-16 Left	1 1/2"	25



72614

Metric Outer Cap Nuts for HINO & ISUZU-25 Per Package						
Order No.	Thread	Replaces Hino	Replaces ISUZU	Thread Inner	Thread Height	Hex
72614	Right	9004-21112	42333-0230	30mm-1.5	M25 1"	41mm
72616	Left	9004-22104	42334-0230	30mm-1.5	M25 1"	41mm



72776



72775

Motor Wheel Metric Flange Nut - 8 Stud Application-25 Per Package				
Order No.	Mfr. No.	Replaces Motor Wheel	Thread	Hex.
72776	M-3207	88881	M22 X 1.5 Metric	38mm

Budd Metric Flange Nut - Unimount 10 Stud Application				
Order No.	Mfr. No.	Budd No.	Thread	Hex
72775	M-3203	106333	M22 X 1.5 Metric	33mm

Dayton Style, Chamfered, Spoke Wheel Nuts & Studs

- 25 Per package

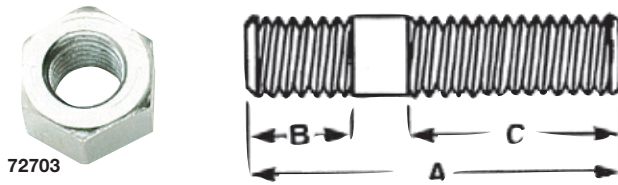

Dayton Style – Chamfered – Spoke Wheel Nuts

Order No.	Mfr. No.	Replaces Dayton	Erie	Gunite	Webb	NWRA	Thread	Hex
72703	M-43	08-005149	5270	WP-2	74611	N-26	5/8"-11	1 1/16"
72704	M-45	08-005716	5260	WP-148	74710	N-40	3/4"-10	1 1/4"

Dayton Style Wheel Studs

Order No.	Mfr. No.	Replaces Dayton	NWRA	Dia. Thread	A	B	C
72765	M-38	08-006654	B-601	5/8"-11	2 3/4"	1"	1 1/2"
72766	M-39	08-005715	B-602	3/4"-10	2 13/16"	1 1/16"	1 13/16"
72767	M-1102	08-008411	B-612	3/4"-10	3 1/8"	1"	1 7/8"

Dayton Wheel Clamps

- Dayton "F" style
- 25 Per package

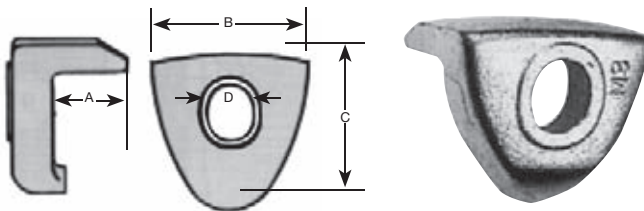

Order No.	Mfr. No.	Replaces Dayton	NWRA	A	B	C	D	Spacer Band Width
72700	M-3	09-612317	W-96	1 1/8"	2 7/8"	2 1/2"	3/4"	4"
72701	M-4	09-623517	W-97	1 3/4"	2 7/8"	2 1/2"	3/4"	3 3/8"
72702	M-8	09-699317	W-98	1 1/2"	2 7/8"	2 1/2"	3/4"	3 5/8"

PB BLASTER Nut Loosener

A powerful, penetrating lubricant that frees everything faster! Displaces moisture. Use on nuts and bolts, rusted joints, automatic chokes, to start wet engines and more. Just saturate troubled area and allow to stand for a few minutes.

Order No.	Description	Case Qty.
45217	11 Oz. Spray	12
45218	1 Gallon	4



Anti-Seize Compound

A copper-based, high temperature, anti-seize and lubricating compound recommended for coating nuts, bolts, valves, flanges, and splines for easy breakout after years of service. Protects against galling, seizing, corrosion. Resists temperatures to 1,800°F.



Order No.	Description	Size
45155	E-Z Break Brush-On	10 Oz. Can
45158	E-Z Break Spray	14 Oz. Can

HENDRIX "HANDS FREE" Budd Nut Wrench

Easily loosens frozen outer cap nuts and inner nuts on Budd-type steel and aluminum wheels. Clip onto wheel to secure outer nut. Apply impact wrench to inner nut to drive the frozen nut out. Eliminates holding the tool. Won't slip or rotate out of position.

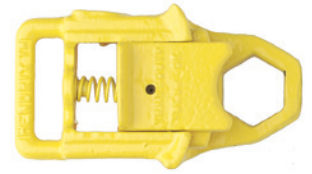

Order No.	Mfr No..	Description	Ship Wt.
52650	60300	"Hands Free" Budd Nut Wrench	4 lbs. - 2 kg

Cap Nut Wrenches

- Heavy-Duty non-slip

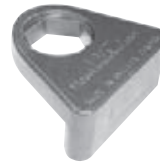

Wrenches hold outer cap nut on dual wheels while turning inner nut. Lip fits in hole to secure wrench in place. Sizes offered fit standard and metric Budd nuts.

Order No.	Mfr No..	Description	Ship Wt.
52318	TX200	SAE 1 1/2"	3 lbs. - 2 kg
52319	TX241	Metric 41mm	3 lbs. - 2 kg

Cap Nut Wrenches (Pork Chop)

Holds outer cap nut on dual wheels while turning inner nut. Lip fits in hole to secure wrench in place. Sizes fit standard and metric Budd nuts.



Order No.	Mfr No..	Description	Size
52804	TX9	SAE & Metric	1 1/2" (38mm)
52808	TX10	Metric	35 mm
52810	TX12	Metric	41 mm

Budd Nut Wrench

- For aluminum rims

Removes frozen outer cap nuts from inner cap nuts. 1 1/2" long tail made from tough polymer plastic to protect wheels from damage when tool is in bolt hole.



Order No.	Mfr No..	Description	Size
52622	HX-14	Budd Nut Wrench	1 1/2"
52624	HX-14-35	Budd Nut Wrench	35 mm
52626	HX-14-41	Budd Nut Wrench	41 mm
52628	HX-14-1	Replacement End	

Combination Cap Nut Wrench

Wrench holds outer cap nut on dual wheels while turning inner nut. Lip fits in hole to secure wrench in place. Slides under center disc reducing slipping during nut removal.



Order No.	Mfr No..	Description	Size
52317	TX50	SAE & Metric	1 1/2" (41mm)

Tire Changers

From small ATV to the largest OTR tire, **Myers Tire Supply** is your tire changing headquarters. We stock **BOSCH, COATS, CORGHI, MYERS & HOFMANN** passenger, truck & OTR tire changers. We have a complete line of tire changing accessories for all the tire changers we offer. There are **KEN-TOOL®**, **GAITHER, TNT, ESCO & IMT** manual tire changing tools offered. Tires cannot be mounted or demounted without tire lubes & we stock more than anyone. Our **CHEETAH** Bead Seaters are available from the standard 6-gallon size up to the 60-gallon Bead Seating System. The tire inflation cages on page 140 now includes a new OTR tire size.



KEN-TOOL Power Wrenches



3 to 1 ratio provides tremendous power and allows one man operation. Heat-treated portable components for extra strength. All sockets are 3/4" drive.

Basic Power Wrench Set Contains: Power Drive, TR45 20 1/2" Bar Handle, TR46 20" Tube Handle. **Budd Wheel Power Wrench Set Contains:** Power Drive, TR45 20 1/2" Bar Handle, TR53 36" Tube Handle TR52 1 3/8" Square Adapter, TR55 3/4" Service Adapter. The 3/4" service adapter allows you to use any 3/4" drive socket. **Universal Power Wrench Set Contains:** Power Drive, 7/8", 1 1/8", 1 1/4", 1 1/2", 1 3/4", "1 1/2" Impact Sockets TR45 20 1/2" Bar Handle, TR53 36" Tube Handle, TR52 1 3/8" Square Adapter, TR55 3/4" Service Adapter

Order No.	Mfr. No.	Description	Ship Wt.
52819	TR43	Basic Power Wrench	19 lbs. - 9 kg
52820	TR44X	Budd Power Wrench	20 lbs. - 9 kg
52821	TR445W	Universal Power Wrench	29 lbs. - 13 kg

Protective Eyewear

- More protective eyewear see page 223

Scratch resistant and lightweight for comfort. Snug fit minimizes discomfort.



Order No.	Description
82662	Protective Eyewear with Amber Lens
82663	Protective Eyewear with Blue Mirror Lens
82664	Protective Eyewear with Clear Lens

Bead Breaking Tools



Order No.	Mfr. No.	Description	Length	Bar Dia.	Ship Wt.
52376	T41	Swan Neck	30"	7/8"	5 lbs. - 3 kg



Forcing tool for 5° rims

Order No.	Mfr. No.	Description	Length	Bar Dia.	Ship Wt.
52380	T42	Forcing Tool	30"	7/8"	5 lbs. - 3 kg

Bead Breaker/Leverage Bar



Order No.	Mfr. No.	Description	Length	Bar Dia.	Ship Wt.
52364	T52	Bead Tool	33"	7/8"	6 lbs. - 3 kg

MYERS Reusable Mechanics Gloves

- Outstanding gripping power & superior flexibility

Nitrile-coated palm protects hands against oil, grease and other shop grime. Rolled cuff and breathable fabric keeps hands cool in the heat and warm in the cold. Machine washable, will not shrink. Air dry.



Order No.	Description	Size
45378	Mechanics Gloves	Large
45379	Mechanics Gloves	Extra Large

Four-Way Lug Wrenches

Available in sizes to fit all your tire changing needs: SAE and metric, passenger car, light truck, van, RV, and heavy-duty truck. Top quality steel and strengthened centers for tough, long lasting service. All lug wrenches have extra deep sockets to fit most standard lug nuts.

Professional Four-Way Wrenches

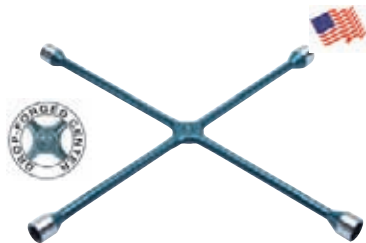

A professional lug wrench for cars, light trucks, RVs, and vans. Polished sockets, and drop-forged centers for extra strength.

Order No.	Mfr. No.	Description	Socket Sizes	Length	Bar Dia.	Ship Wt.
52522	T57	Passenger	3/4", 13/16", 7/8", 15/16"	23"	5/8"	5 lbs. - 3 kg
52521	T56	Passenger	17, 19, 21, 22 mm	23"	5/8"	4 lbs. - 2 kg

Standard Professional Four-Way Wrenches



Welded center construction for strength and durability. Premium grade, special bar quality steel.

Order No.	Mfr. No.	Description	Socket Sizes	Length	Bar Dia.	Ship Wt.
52523	T59	Passenger	3/4", 13/16", 7/8", 15/16"	22"	5/8"	5 lbs. - 3 kg
52530	T90	Light Truck	7/8", 15/16", 1", 1 1/16"	25"	3/4"	7 lbs. - 4 kg

Economy Four-Way Wrenches



Welded centers that stand up to everyday use.

Order No.	Mfr. No.	Description	Socket Sizes	Length	Bar Dia.	Ship Wt.
52525	T62	Passenger	3/4", 13/16", 7/8", 15/16"	18"	9/16"	3 lbs. - 2 kg
52536	T9520	Passenger	3/4", 13/16", 7/8", 15/16"	20"	9/16"	3 lbs. - 2 kg
52524	T61	Passenger	3/4", 13/16", 7/8", 15/16"	22"	9/16"	3 lbs. - 2 kg
52526	T63	Passenger	17, 19, 21, 22mm	18"	9/16"	3 lbs. - 2 kg

Heavy-Duty Truck Four-Way Wrenches



Use on heavy-duty truck, bus, and tractors. Drop forged or welded center provides strength and durability. T95, TM95, and T95A wrenches have center hole for a leverage bar. T95A has a 3/4" service end that will take any standard 3/4" service socket. Socket sizes fit most metric or SAE lug nuts on today's trucks.

Order No.	Mfr. No.	Socket Sizes	Length	Bar Dia.	Ship Wt.
52531	T95	1 1/8", 1 1/4", 1 1/2", 1 3/8" Square	27 1/2"	1"	14 lbs. - 7 kg
52533	T96	1 1/8", 1 1/4", 1 1/2", 1 3/8" Square	27 1/2"	1"	14 lbs. - 7 kg
52532	T95A	1 1/4", 1 1/2", 1 3/8" Square, 3/4" Service Arm	27 1/2"	1"	14 lbs. - 7 kg
52544	TM95	24, 27, 30, 33mm	27 1/2"	1"	14 lbs. - 7 kg
52320	TC95	1 1/2", 1 3/8" Square, 30, 33mm	27 1/2"	1"	14 lbs. - 7 kg

Double End Truck Wrenches

Sizes available for all SAE and metric lug nuts. All wrenches are constructed of 1" alloy steel. Wrenches have extra deep 1 1/2" socket. Length: 16". Use with TR5 3/4" leverage bar.



SAE Double-End Truck Wrenches

Order No.	Mfr. No.	Socket Sizes	Ship Wt.
52500	TR1	1 1/8" Hex w/ 1 3/16" Square x 1 1/2" Hex	5 lbs. - 3 kg
52502	TR2	1" Hex w/ 5/8" Square x 1 1/4" Hex	5 lbs. - 3 kg
52506	TR3	7/8" Hex x 1 1/16" Hex	5 lbs. - 3 kg
52507	TR3A	1 1/16" Hex x 1 1/8" Hex	5 lbs. - 3 kg
52505	TR3X	1 1/16" Hex x 1 3/16"	5 lbs. - 3 kg
52501	TR98	1 1/2" Hex x 1 3/16" Square	5 lbs. - 3 kg
52503	TR9	1 3/4" Hex x 1 1/16" Hex	5 lbs. - 3 kg

Metric Double-End Truck Wrenches

Order No.	Mfr. No.	Socket Sizes	Ship Wt.
52396	TRM2	24mm x 33mm	5 lbs. - 3 kg
52397	TRM3	27mm x 30mm	5 lbs. - 3 kg
52286	TRM6	21mm Square x 41mm	5 lbs. - 3 kg
52288	TRM7	30mm x 33mm	5 lbs. - 3 kg

Truck Wrench Handle



Handle is extra long for increased leverage and heat treated for extra strength.

Order No.	Mfr. No.	Description	Length	Bar Dia.	Ship Wt.
52508	TR5	Truck Wrench Handle	22"	3/4"	3 lbs. - 2 kg

Wheel Cover Puller/Replacers

- Replaceable rubber head helps prevent damage.

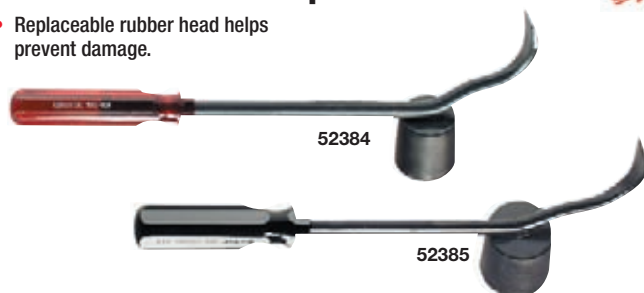

Order No.	Mfr. No.	Description	Length	Ship Wt.
52384	T67	Pro Wheel Cover Puller	17 1/2"	2 lbs. - 1 kg
52385	T68	Standard Wheel Cover Puller	14"	1 lbs. - 1 kg
52748	T11RH	Replacement Rubber Head for T67 & T68		1 lbs. - 1 kg

KEN-TOOL Bead Breaker



Ideal for stubborn tires. Use to prevent the bending of wheels. Ideal for custom and foreign wheels without center holes.

Order No.	Mfr. No.	Description	Tread Width	Ship Wt.
52866	T-98	Deluxe Bead Breaker	Up to 11"	30 lbs. - 14 kg

Tire Hammers

Fiberglass Handled Bead Breakers



Use on passenger, truck, bus, farm, and aircraft tires. Use with soft face hammers. Breaks beads quickly and easily. Handle serves as lever to push bead away from rim.

Order No.	Mfr. No.	Replacement Handle	Length	Ship Wt.
52725	TG11D	52726	18"	5 lbs. - 3 kg
52723	TG11E	52724	32"	9 lbs. - 4 kg

Replacement Fiberglass Handles



Order No.	Mfr. No.	Replacement Handle	Length	Ship Wt.
52726	TG11DH	TG11D	18"	3 lbs. - 2 kg
52724	TG11EH	TG11E	32"	4 lbs. - 2 kg

Replacement Nu-Lock Shim Adapter For Above

Order No.	Mfr. No.	For Hammer No.
52727	TG11DH-1	Nu-Lock Shim Adapter For TG11DH Handle
52742	TG11EH-1	Nu-Lock Shim Adapter For TG11EH Handle

Wood Handled Bead Breakers

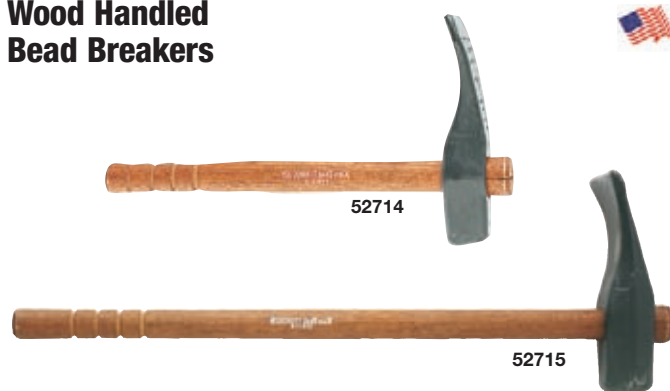

Use on passenger, truck, bus, farm, and aircraft tires. Use with soft face hammers. Breaks beads quickly and easily. Handle serves as lever to push bead away from rim.

Order No.	Mfr. No.	Replacement Handle	Length	Ship Wt.
52714	T11D	52732	17"	5 lbs. - 3 kg
52715	T11E	52733	30"	9 lbs. - 4 kg

Replacement Wood Handles



Order No.	Mfr. No.	Replacement Handle	Length	Ship Wt.
52732	T11DH	T11D	17"	1 lbs. - 1 kg
52733	T11EH	T11E	30"	2 lbs. - 1 kg

Bead Breaking Wedge with Polymer Handle

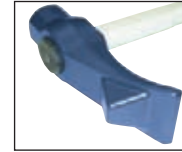

Hump design prevents tool from wedging between rim and bead.



Use with soft face hammers. Breaks beads quickly and easily. Handle serves as lever to push bead away from rim.

Order No.	Mfr. No.	Replacement Handle	Length	Ship Wt.
52695	T11K	52696	32"	11 lbs. - 5 kg
Replacement Polymer Handle				
52696	T11KH	T11K	32"	3 lbs. - 2 kg

Bead Driver



Driving iron used for loosening rusted truck and bus beads. Tool blade is forged extra wide and curved to fit the rim.

Order No.	Mfr. No.	Description	Length	Bar Dia.	Ship Wt.
52360	T26A	Bead Driver	11¾"	1¼"	4 lbs. - 2 kg

Aluminum Hammer Handle



Fits T11E and TG11E. The brass adapter holds the head in place. No shims are required. The rubber grip covers the handle and is thicker at the bottom for a cushioned grip.

Order No.	Mfr. No.	Description	Length	Ship Wt.
52698	T-11AH	T11E, TG11E	32"	4 lbs. - 2 kg

Heavy-Duty Brown Jersey Gloves

- More gloves pages 242, 243, 244



Clute cut, brown jersey with knit wrist. 9 oz.

Order No.	Mfr. No.	Description
45334	009-J	Jersey Knit Gloves

Dry Shop Towels

- More shop towels page 228

For shops and service trucks. Stand alone dispenser holds 200 9¾" x 13" absorbent towels.

Order No.	Description	Ship Wt.
11235	Dry Shop Towels, 200 Per Dispenser	4 lbs. - 2 kg



General Purpose Tire Hammers

- Wood Handled Hammers



Order No.	Mfr. No.	Replacement Handle	Length	Ship Wt.
52706	T33R	52730	14"	2 lbs. - 1 kg

Replacement Handles



Order No.	Mfr. No.	For Hammer No.	Length	Ship Wt.
52729	T11BH	T11B	14"	1 lbs. - 1 kg
52730	T11HN	T11R, T31, T33R	14"	1 lbs. - 1 kg
52748	T11RH	Replacement Rubber Head		1 lbs. - 1 kg

Fiberglass Handled Hammer



Order No.	Mfr. No.	For Hammer No.	Length	Ship Wt.
52737	TG11B	Fiberglass Hammer	16"	4 lbs. - 2 kg

Epoxy Glue Kit

For repairing and replacing fiberglass handles.



Order No.	Mfr. No.	Description	For Hammer No.
52306	T-12D	Epoxy Glue Kit	TG35, TG36
52305	T-12B	Epoxy Glue Kit	TG11B, TG11R, TG31, TG33R

Rubber Mallet



Rubber head prevents marring of surfaces.

Order No.	Mfr. No.	Description	Length	Ship Wt.
52700	T32	Rubber Mallet	17"	2 lbs. - 1 kg

STRIKE PRO Dead Blow Hammer



Head is shot filled for maximum force with no bounce effect. Handle is fiberglass for long life. Encased in specially formulated material to withstand years of use.

Order No.	Mfr. No.	Description	Length	Ship Wt.
52754	T336	Dead Blow Hammer	12"	2 lbs. - 1 kg

Tire Kicker



Order No.	Mfr. No.	Description	Length	Ship Wt.
52711	35110	Tire Kicker	18"	1 lbs. - 1 kg

Heavy-Duty Tire Hammers

Hammers are used for mounting and demounting tires. A variety of weights and sizes are offered to meet all your tire changing needs. Non-marring rubber can be used for driving on both tires and rims.

Heavy-Duty Wood Handled Hammers



Order No.	Mfr. No.	Replacement Handle	Length	Ship Wt.
52702	T34	52728	17"	6 lbs. - 3 kg
52704	T35	52728	16½"	7 lbs. - 3 kg
52705	T36	52728	16½"	6 lbs. - 3 kg

Replacement Handles



Order No.	Mfr. No.	For Hammer No.	Length	Ship Wt.
52728	T11CH	T34, T35, T36	16½"	1 lbs. - 1 kg
52749	T34RH	Replacement Rubber Head		1 lbs. - 1 kg

Replacement Wedges

Order No.	Mfr. No.	Description	For Hammer No.
52745	T11WH	Hammer Wedges	T34, T35, T36

Heavy-Duty Fiberglass Handled Hammers



Order No.	Mfr. No.	Replacement Handle	Length	Ship Wt.
52722	TG35	52717	18"	7 lbs. - 3 kg
52721	TG36	52717	18"	6 lbs. - 3 kg

Replacement Handle

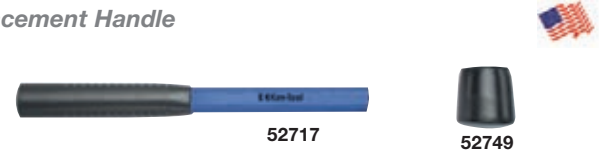

Order No.	Mfr. No.	For Hammer No.	Length	Ship Wt.
52717	TG11CH	TG35, TG36	16½"	1 lbs. - 1 kg
52749	T34RH	Replacement Rubber Head		

Double-Faced Sledge Hammers



High carbon steel, heat treated. Machined, polished face. Top grade U.S. hickory handle. Replacement handles available.

Order No.	Mfr. No.	Handle Length	Face	Head	Ship Wt.
52708	84H8	32"	2"	8 lbs.	9 lbs. - 4 kg
52709	84H10	36"	2½"	10 lbs.	11 lbs. - 5 kg

Tire Changing Tools

KEN-TOOL Lock Ring Removers



For Firestone RH and TI rims. Removes and replaces lock ring.

Order No.	Mfr. No.	Length	Bar Dia.	Ship Wt.
52337	T23	24"	1 1/16"	3 lbs. - 2 kg



Designed especially for Firestone RH and RI rims. Removes and replaces lock ring.

Order No.	Mfr. No.	Length	Bar Dia.	Ship Wt.
52339	T23A	30"	1 1/16"	3 lbs. - 2 kg



Combination ring tool with flat tapered end. Ideal for all round ring and rim work.

Order No.	Mfr. No.	Length	Bar Dia.	Ship Wt.
52344	T23B	23 1/2"	1 1/16"	3 lbs. - 2 kg



For servicing 5° wide base rims.

Order No.	Mfr. No.	Length	Bar Dia.	Ship Wt.
52338	T25	18"	5/8"	2 lbs. - 1 kg



Special long tapered curved end for R-1 continuous side rings; short curved end for Goodyear rims.

Order No.	Mfr. No.	Length	Bar Dia.	Ship Wt.
52340	T27	18"	5/8"	2 lbs. - 1 kg



For removal of continuous side rings on two piece truck rims.

Order No.	Mfr. No.	Length	Bar Dia.	Ship Wt.
52540	T27A	18"	5/8"	2 lbs. - 1 kg

KEN-TOOL Fork Lift Mount/Demount Set



- For removing & replacing lock rings on multi-piece industrial wheels

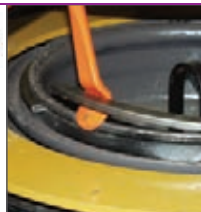

Order No.	Mfr. No.	Description	Ship Wt.
52390	32129	Forklift Mount/Demount Set	4 lbs. - 2 kg
52391	32131	Demount Tool Only	2 lbs. - 1 kg
52392	32130	Mount/Demount Tool	2 lbs. - 1 kg

Mount/Demount Tire Spoons



The 18" and 24" spoons are used to mount and demount passenger car, motorcycle, ATV, and light truck tires. The 30" spoons are for use on large truck, bus, off road vehicle, tractor, and aircraft tires.

Straight Spoon Tire Irons



Order No.	Mfr. No.	Length	Bar Dia.	Ship Wt.
52301	T1X	18"	1 1/16"	2 lbs. - 1 kg
52302	T19	24"	1 1/16"	3 lbs. - 2 kg
52303	T19A	30"	1 1/16"	3 lbs. - 2 kg
52304	T38	30"	7/8"	5 lbs. - 3 kg

Curved Spoon Tire Irons



Order No.	Mfr. No.	Length	Bar Dia.	Ship Wt.
52309	T2X	18"	1 1/16"	2 lbs. - 1 kg
52310	T20	24"	1 1/16"	3 lbs. - 2 kg
52311	T20A	30"	1 1/16"	3 lbs. - 2 kg
52312	T39	30"	7/8"	5 lbs. - 3 kg

Drop Center Tire Tool



Order No.	Mfr. No.	Length	Bar Dia.	Ship Wt.
52316	T21R	18"	1 1/16"	2 lbs. - 1 kg

Heavy-Duty Lock Ring Tool



For use on multi-piece wheels, especially hub type.

Order No.	Mfr. No.	Length	Bar Dia.	Ship Wt.
52334	T48A	37"	3/4"	5 lbs. - 3 kg

Spare Tire Tool Set

- Removes spare tires without damaging the pulley system
- Includes offset hand crank with square drive end - no ratchet or socket required



Order No.	Mfr. No.	Application	Ship Wt.
52070	4380	Spare Tire Tool Set Complete	15 lbs. - 7 kg
52061	4351	Yellow - Japanese Pick-Up	2 lbs. - 1 kg
52062	4352	Red - 98-01 Dodge Full Size Pick-Up, 2WD/4WD Stake Body	2 lbs. - 1 kg
52063	4353	Purple - Late Model GM S-10, Blazer, Jimmy	2 lbs. - 1 kg
52064	4354	Orange - Ford 150, Expedition, Explorer	2 lbs. - 1 kg
52065	4355	Green - Early Model Dodge Durango	2 lbs. - 1 kg
52066	4356	Violet - Early Model Fords	2 lbs. - 1 kg
52069	4359	White - Fords	2 lbs. - 1 kg
52071	4360	Light Green - Chevrolets	2 lbs. - 1 kg
52067	4357	Spare Tire Tool Crank	2 lbs. - 1 kg
52068	4358	Spare Tire Tool Rack	1 lbs. - 1 kg

KEN-TOOL

Tubeless Passenger Tire Mount/Demount Tool



Used in pairs to mount and demount small passenger, industrial, ATV, and motorcycle tires.

Order No.	Mfr. No.	Length	Bar Dia.	Ship Wt.
52371	T6A	16 1/2"	5/8"	2 lbs. - 1 kg

KEN-TOOL T-45 Tubeless Tire Tools

- Three styles available, classic, standard & heavy-duty



T-45AC Classic sold 1980's & re-designed in 2002. Order the preferred style. Used in pairs to mount and demount truck, agricultural, and industrial tires. 52367 Features added length and thickness for heavy-duty use.

Order No.	Mfr. No.	Length	Bar Dia.	Ship Wt.
52374	T45AC	37" Classic	3/4"	5 lbs. - 2 kg
52369	T45A	37" Standard	3/4"	5 lbs. - 2 kg
52367	T45HD	41" Heavy-Duty	3/4"	7 lbs. - 3 kg

KEN-TOOL

Tubeless Tire Tools

- Improved shape maintains better rim contact
- The wider blade grabs more of the bead



Redesigned Knob!



With Tip

An improved version of the T45A with a re-designed knob on the mount/ demount end. Designed for mounting and demounting tubeless tires. Hand forged chrome nickel steel. Use in pairs.

Order No.	Description	Length	Ship Wt.
52372	T45A2000K with Tip	38"	5 lbs. - 2 kg

Truck Tire Changing Stand

Handles rim diameters 20" thru 24" on all makes of wheels including Budd. Air hammers or other types of power tools don't cause stand to move around. Double adjusting slide prevents twisting.



Order No.	Mfr. No.	Description	Ship Wt.
52907	TT-1976	Truck Tire Changing Stand	21 lbs. - 10 kg

Tubeless Tire Iron Sets

All irons necessary for a variety of tire changing applications. Use "C" bar with the "B" extension bar for easier use on large, wide base truck tires. Use on standard and large truck tires, including industrial, farm, bus, and tractor.

Standard Tubeless Truck Tire Mount/Demount Tool Set



Order No.	Mfr. No.	Description	Length	Bar Dia.	Ship Wt.
52349	T46	Set of 3 Tools T46A, T46B, T46C		3/4"	11 lbs. - 5 kg
52350	T46A	Mount-Demount Tool	36"	3/4"	5 lbs. - 3 kg
52351	T46B	Mount-Demount Tool	36"	3/4"	5 lbs. - 3 kg
52352	T46C	Offset Mount Bar	22"	3/4"	3 lbs. - 2 kg

Heavy-Duty Tubeless Truck Tire Mount/Demount Tool Set

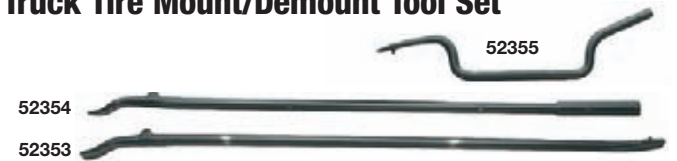

Order No.	Mfr. No.	Description	Length	Bar Dia.	Ship Wt.
52356	T47	Set of 3 Tools T47A, T47B, T47C	1"	30"	14 lbs. - 7 kg
52353	T47A	Mount-Demount Tool	52"	1"	11 lbs. - 5 kg
52354	T47B	Mount-Demount Tool	49 1/2"	1"	11 lbs. - 5 kg
52355	T47C	Offset Mount Bar	27"	1"	8 lbs. - 4 kg

KEN-TOOL IronMan Wheel Lifting Bar

- Easily lifts all sizes & types of small & large heavy truck wheels
- Helps eliminate back strain



With hub side up insert the knob end



With hub side down use the curved end

Specially designed ends slip into a wheel opening and allows the user to raise the tire and wheel assembly from flat to a standing position. The leverage created with the tool easily lifts the heaviest tires and wheels reducing the risk of back strain. The Ken-Tool IronMan has a specially designed knob on one end and a curved spoon on the other. Handles standard sizes including 22.5 and 24.5 wheels, European, super wide, and super singles.

Order No.	Mfr. No.	Description	Ship Wt.
52398	T950	IronMan Lifting Bar 58" Long	10 lbs. - 5 kg

Tire Changing Tools

KEN-TOOL Heavy-Duty Impact Bead Breaker



Loosens beads with bead-breaking foot and ram bar, but never cuts the bead of the tire. The wedge foot is forced between the bead and rim flange. No other bead breaking tools are necessary. Designed with an exclusive spring action reducing user fatigue associated with slide hammer kickback.

Order No.	Mfr. No.	Length	Extended Length	Ship Wt.
50235	T26B	50"	80"	24 lbs. - 11 kg

GAITHER Slide Hammer



The slide hammer wedge is forced between the bead and rim flange. A spring action reduces slide hammer kickback.

Order No.	Mfr. No.	Description	Ship Wt.
52570	12026B	Slide Hammer	27 lbs. - 12 kg

Big Buddy Slide Hammer



Easily breaks the most stubborn beads. A spring action tip reduces kickback.

Order No.	Mfr. No.	Description	Ship Wt.
85020	71500	Big Buddy Slide Hammer	24 lbs. - 11 kg

KEN-TOOL 19.5" Mount/DEMOUNT Tool Set

- Specially designed to clear the hub & handle stiff, high ply, thick tire beads
- Includes aluminum wheel protector & bead holders



The tire bar works on the hub side of the wheel where the hub protrudes above the rim. Tools are powder coated to protect against rust and corrosion. Manufactured from heat treated high grade carbon steel. Includes (2) tire mounting/demounting tools, bead holder for 19.5 aluminum wheels, brass bead holder for steel wheels, and leather aluminum wheel protector.

Order No.	Mfr. No.	Description	Ship Wt.
52278	33195	19.5 Mount/DEMOUNT Tool Set 38" Long	7 lbs. - 3 kg
Includes			
52280	33199	19.5 Mount/DEMOUNT Tools	
52279	33196	19.5 Bead Holder for Aluminum Wheels	
52333	31710	Brass Bead Holder	
52357	31810	Leather Wheel Protector for Aluminum Wheels	

ESCO Truck Tire Double Bead Breaker

- Breaks both tire beads at the same time
- Simple operation & compact storage
- Use on super singles & X-One wide base tires



Breaks tire beads on sizes to 19.5-24.5. Breaks beads with 5,000 lbs of force in seconds. The bead breaker helps comply with OSHA 29CFR1910.177 non-use of tire hammers. Requires 90 - 120 psi.

Order No.	Description	Ship. Wt.
52438	Truck Tire Double Bead Breaker	115 lbs. - 52 kg

GAITHER Bead Saver System

- Mount/DEMOUNT tubeless tires 17.5" thru 24.5"



Change tubeless truck tires quickly without bead damage. Designed to protect beads and reduce truck downtime. Complete Set mounts and demounts every tire from 17.5" to 24.5" including all wide base sizes. Portable, lightweight carrying case makes Bead Saver System ideal for service trucks.

Order No.	Mfr. No.	Description	Ship Wt.
52550	12880	Bead Saver System	45 lbs. - 20 kg
Options Required for Super Single			
52558	12898	Clevis Assist	1 lbs. - 1 kg
52565	12894C	Additional Bead Keeper	2 lbs. - 1 kg
Replacement Parts			
52551	12886	Lever Bar	8 lbs. - 4 kg
52552	12892	On-Off Plate	3 lbs. - 2 kg
52553	12902	Clevis	8 lbs. - 4 kg
52559	12897	Bolts for Clevis (2 per Set)	1 lbs. - 1 kg
52560	12903	Rollers for Clevis (2 rollers/2 pins)	8 lbs. - 4 kg
52554	12893	Wedge	3 lbs. - 2 kg
52565	12894C	Rubber Coated Bead Keeper	1 lbs. - 1 kg
52558	12898	Clevis Assist	1 lbs. - 1 kg
52557	12899	Beavertail Tool	9 lbs. - 4 kg

GAITHER J1 Mount/DEMOUNT Tool

- Mount/DEMOUNT all 19.5", 22.5" & 24.5" tires
- Easily dismount aluminum wheels without scratching
- Protects all tires from bead damage



Includes: J1 Bar, Clevis Assembly, (2) Rubber Protectors.

Order No.	Mfr. No.	Description	Ship Wt.
52545	J1	Mount/DEMOUNT Tool	20 lbs. - 9 kg

KEN-TOOL Blue Cobra Tire Demount Tool

- Demounts nearly any 20", 22.5" & 24.5" tube & tubeless truck tires up to 13" wide



Demounts the tire without lifting it off the ground. Made of high-quality steel with an aluminum bead support for super single and super wide tires. Replaceable nylon rollers.

Order No.	Mfr. No.	Description	Ship Wt.
52512	35440	Blue Cobra Demount Tool	22 lbs. - 10 kg
52514		Roller Repair Kit	

TNT-100 Tire Changing Tool

- Mount all tubeless tires 17.5" thru 24.5"
- Demounts tire in 8 seconds, remounts in 20 seconds without strain



Two simple tools do it all. Works on standard and super single duplex tires. The TNT-100 does not damage beads. Set includes tire mounting and demounting tools.

Order No.	Mfr. No.	Description	Ship Wt.
52487	TNT-100	Tire Changing Tool Set	37 lbs. - 17 kg
52488	TNT-100-1	Demounting Tool Only	25 lbs. - 13 kg
52489	TNT-200M	Mounting Tool Only	12 lbs. - 6 kg

ESCO Easy-Way Tubeless Tire Demounting System

- Eliminates lifting the tire to demount the bottom bead



Demount all tubeless tires 16.5" to 24.5" in diameter and some super single "floats." Will not damage aluminum or painted wheels. Includes top bead tool, bottom bead tool, and rim protector.

Order No.	Mfr. No.	Description	Ship Wt.
52009	70100	Easy-Way Tubeless Tire Demounting System	37 lbs. - 17 kg

TNT-200 Tire Changing Tool

- Ideal for demounting 445 x 22.5 tires



Mounts all tubeless tires 17.5" thru 24.5". For standard and super single duplex tires. Does not damage beads. Set includes tire mounting and demounting tools.

Order No.	Description	Ship Wt.
52601	TNT 200 Tire Changing Tool Set	28 lbs. - 13 kg
52602	TNT 200D Demount Tool Only	20 lbs. - 9 kg
52489	TNT 200M Mounting Tool Only	12 lbs. - 6 kg

Replacement Parts for TNT 100 and TNT 200

52614	TNT 100-9 Tire Roller	52593	TNT 200-3 Maxi Dismount Grip
52616	TNT 100-8 Roll Pin	52594	TNT 200-4 Maxi Dismount Handle
52618	TNT 100-10 Main Roller	52595	TNT 280-0 Optl. Bead Catcher
52620	TNT 100-11 Roll Pin	52596	TNT 200-7 Maxi Dismount Head
		52598	TNT 200-6 Loop Lock Pin

TNT-300 Tubeless Truck Tire Demount Tool

- Handles the new X-One super wide & super singles
- Made in the USA

Bead catchers allow for wider range of super single demounting

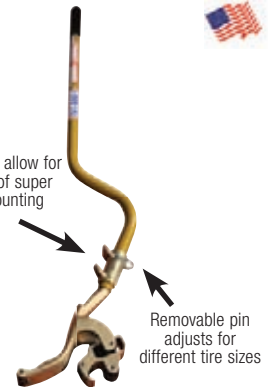

Quickly demounts 17.5" to 24.5" and super singles 315 through 445 including most radial and bias ply tires including the X-One super wide. The tool will not damage tire beads and it eliminates lifting the tire to remove the bottom bead.

Order No.	Description
52610	TNT 300 Truck Tire Demount Tool

Tire Changing Tools

- Mount all tubeless tires 17.5" thru 24.5"
- Demounts tire in 8 seconds, remounts in 20 seconds without strain



Order No.	Description	Ship Wt.
52165	Tubeless Truck Demount Tool	25 lbs. - 11 kg
52166	Tubeless Truck Mount Tool	8 lbs. - 4 kg
52167	Tubeless Truck Set	33 lbs. - 15 kg

Tire Changing Tools

Bead Keepers

- Prevents tire beads from slipping when mounting the top bead
- Ideal for super singles

PVC Coated Bead Keeper

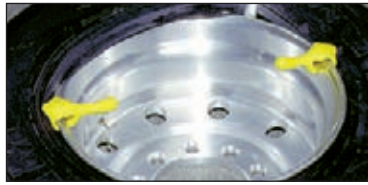

Metal construction coated with PVC will not scratch aluminum rims. (1 Each)

Metal Bead Keepers on a Cord

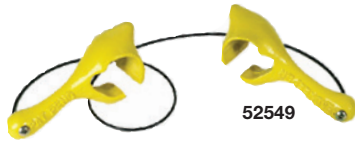

Two bead keepers eliminate standing on tires when mounting. (2 Each)

Order No.	Description
52565	PVC Coated Bead Keeper (1 Each)
52549	Metal Bead Keepers on a Cord (2 Each)

Aluminum Wheel Protector

- For aluminum & steel rims
- Protects inside of the rim well

Save expensive rims from damage during tire changing. The leather wheel protector helps prevent rim damage. When one side wears out, flip it over and use the opposite end.



Order No.	Mfr. No.	Description	Ship Wt.
52357	31810	Leather Wheel Protector	2 lbs. - 1 kg

Bead Lock

The large roller prevents damage to the rim and directs the bead into the drop center making tires easier to mount. Comfortable and durable chrome-plated handle.



Order No.	Mfr. No.	Description	Ship Wt.
52597	31810	Bead Lock	2 lbs. - 1 kg

KEN-TOOL Bead Seating Stand

- Reduces back strain handling 22.5" tire & wheel assemblies



Tire and wheel centers on the stand. Seat beads by inflating to 4 psi then easily lift into a vertical position to roll to the inflation cage.

Order No.	Mfr. No.	Description	Ship Wt.
52693	36016	Standard Crown for 8 3/4" Diameter Hubs	36 lbs. - 16 kg
52694	36017	Large Crown for 11" Euro Hubs	37 lbs. - 16 kg

TSI CH-22 Small Tire Changer

- Change 4" to 16 1/2" tires
- Optional CH-23 stand includes bead breaker & tool storage slots



Includes everything needed to change 4" to 16 1/2" tires. Set the two adjustable jaws to the wheel diameter and tighten the threaded jaw to hold the tire securely. The "Mongoose Tire Tool" easily mounts and demounts tires with a minimum of twisting and turning. The CH-22 fits on any rim clamp tire changer or can be bench-mounted.

Order No.	Mfr. No.	Description	Ship Wt.
51147	CH22	Small Tire Changer	23 lbs. - 11 kg
51148	CH23	Optional Stand with Bead Breaker	70 lbs. - 32 kg
51149	CH4	Mongoose Tool (Replacement)	2 lbs. - 1 kg

KEN-TOOL Air Blast Bead Seater

Ideal for lawnmower and ATV tires. Designed to seat tire beads from 4" to 12" where other bead seaters are too large. Remains connected to the air supply hose and quickly refills. Requires 80 - 150 psi.



Order No.	Mfr. No.	Description	Ship Wt.
52387	31440	Air Blast Bead Seater	6 lbs. - 3 kg

KEN-TOOL Small Tire Changers

- Lawnmower, golf cart, & ATV

A tapered bearing guide centers hubs of all diameters. An anti-rotation pin prevents wheels from turning. For lug-type rims with 2" and larger center holes. Handles bearing wheels without damaging the bearings. Slotted mounting plate fits 4 and 5 lug rims. Changes rim diameters from 4" to 15". Includes an adjustable bead breaker for rims up to 15" in diameter and 24" wide, and a 28" mount/demount tool, and hold down plate for mounting ATV tires and rims.



Order No.	Mfr. No.	Description	Ship Wt.
52876	T601	Floor Mount Small Tire Changer	33 lbs. - 15 kg

Bench Mount

Mount/demount tires with rim diameters from 4" to 12". Includes a hand held bead breaker and 22" mount/demount tool. Mounts on any standard four position rim clamp tire changer, or work bench. Square base prevents turning in the changer during use.



Order No.	Mfr. No.	Description	Ship Wt.
52877	T600	Rim Clamp/Bench Mount	26 lbs. - 12 kg

KEN-TOOL ATV Bead Breaker

- Break ATV beads fast



Uses a right-to-left leverage action, like an old can opener, breaking ATV beads quickly and easily. Works on 6" to 12" rims. Made of heavy-duty steel. Use with any center post tire changer. No additional tools required. Use with tire lubricant.

Order No.	Mfr. No.	Description	Ship Wt.
52386	38620	ATV Bead Breaker	5 lbs. - 3 kg

KEN-TOOL Tire Snake



Mounting and demounting tools for use with center post tire changers.

Order No.	Mfr. No.	Description	Length	Bar Dia.	Ship Wt.
52321	34672	Small Tool for 4"-12" Wheels	22"	5/8"	2 lbs. - 1 kg
52322	34674	Med. Tool for 4"-13" Wheels	28"	5/8"	3 lbs. - 2 kg

KEN-TOOL Small Tire Irons



Mounting and demounting tools for ATV, lawn tractor, golf carts and small tires by hand. Priced per pair.

Order No.	Mfr. No.	Description	Length	Bar Dia.	Ship Wt.
52323	T9C	Carded Set (2) T9A Bars	9"	7/16"	2 lbs. - 1 kg
52313	T16C	Carded Set (2) T16A Bars	16"	7/16"	3 lbs. - 2 kg

KEN-TOOL Small Tire Irons



Ideal for mounting and demounting motorcycle, ATV, lawn tractor, golf cart, and other small tires. Rounded ends will not pinch tubes.

Order No.	Description	Ship Wt.
52326	T5 Small Tire Tool 16" x 7/8" Stock	3 lbs. - 2 kg
52327	T8 Small Tire Tool 16" x 7/8" Stock	3 lbs. - 2 kg

OSHA Poster Kit

- Revised by OSHA 12-21-11
- Large 2' x 3' format required for compliance



Demounting and Mounting Procedures for Tube-Type Truck and Bus Tires; Demounting and Mounting Procedures for Tubeless Truck & Bus Tires and Multi-Piece Rim Matching Chart

Order No.	Description
84245	OSHA Poster Kit (includes 3 Posters)

Penetrating Oils:

Used to loosen the bead seal between tire and rim.

MYERS Penetrating Oil

- All-Purpose penetrating lubricant & cleaner for tire beads, metals & machinery



Order No.	Description	Size	Ship Wt.
89015	Myers Penetrating Oil	1-Gallon	7 lbs. - 3 kg
89016	Myers Penetrating Oil	5-Gallon Can	35 lbs. - 16 kg
89017	Myers Penetrating Oil	55-Gallon Can	495 lbs. - 225 kg

MYERS "Skid" Rubber Loosener & Rust Remover

- Safe for tire or tube



Liquid penetrates immediately for removal of stubborn tires. Will not harm tire or tube. Also useful for removal of rusty bolts, brake cables, etc. Flash point. 91°F.

Order No.	Mfr. No.	Description	Size	Ship Wt.
46515	A4090	Skid	10 Oz. Spray Can	1 lbs. - 1 kg
46512	TT-58A	Skid	1-Gallon Can	8 lbs. - 4 kg
46513	TT-58B	Skid	5-Gallon Can	40 lbs. - 18 kg
46514	TT-58C	Skid	55-Gallon Drum	500 lbs. - 225 kg

PRO CHEM Tire Release Mount/Demount Compound

- Retread safe, non-flammable & does not degrade rubber
- Contains rust inhibitors & low VOC



All-Purpose penetrant frees stubborn tires rusted studs and other fittings.

Order No.	Description	Size	Ship Wt.
46504	Tire Release	1-Gallon	7 lbs. - 3 kg
46505	Tire Release	5-Gallon Can	35 lbs. - 16 kg
46506	Tire Release	55-Gallon Can	495 lbs. - 225 kg

Gloves

- See pages 242, 243 & 244



Tire Lube Pastes

Used to lubricate the contact point between tool/tire when mounting and demounting. No alcohol or petroleum products. Soft, paste-like, grease texture

MYERS Tire & Tube Mounting Compound

- Vegetable base rust inhibitor
- For tube & tubeless tires
- Free lube swab with 25 lb. pail



Protect tire beads and tubes when mounting and demounting tires. Quick and easy to mix and ready for immediate use. The chance of damaging bead or tube during mounting procedure is reduced with the use of Myers compound. Economical, long lasting. 8 lb. can makes 5 gallons of liquid lubricant when mixed with water. 25 lb. pail makes 16 gals. of lubricant.

Order No.	Description	Ship Wt.
46632	8 Lb. Pail	8 lbs. - 4 kg
46633	25 Lb. Pail w/ Swab	25 lbs. - 12 kg
46657	Lube Swab	1 lbs. - 1 kg

MURPHY'S Tire & Tube Compound

- For mounting & demounting all types of tires
- Rust inhibitor added
- Biodegradable



Excellent for packing beads. Economical and long lasting 8 lb. pail makes 5 gallons when mixed with water. Also available premixed as a liquid.

Order No.	Mfr. Code	Size Pail	Per Case	Ship Wt.
46634	TT1952E	8 Lb	4	10 lbs. - 5 kg
46636	TT1952C	25 Lb	1	28 lbs. - 13 kg
46637	TT1952D	40 Lb	1	43 lbs. - 19 kg
46638	TT1952F	125 Lb	1	135 lbs. - 61 kg
46639	TT1952G	450 Lb	1	490 lbs. - 221 kg
Liquid Murphy's				
46643	TT1952J	1-Gallon	4	10 lbs. - 5 kg
46644	TT1952H	5-Gallon	1	45 lbs. - 20 kg
46647	TT1952I	55-Gallon	1	500 lbs. - 225 kg
46657	RK3	Lube Swab	1	1 lbs. - 1 kg

MYERS E-Z Mount Heavy Paste

- "Bead packing lube"



Concentrated tire mounting and rubber lubricant. Added rust inhibitor protects against oxidation. Mix one part compound to four parts water.

Order No.	Description	Ship Wt.
46629	E-Z Mount Heavy Paste	25 lbs. - 11 kg

MYERS EuroPaste

- Wax-Type
- Lubricant for alloy wheels, low profile & run flat tires



Extra-slippery lubricant for mounting tires with stiff beads and to aid in bead seating. No water or mixing required. Use directly from the container. Apply with optional 46659 brush.

Order No.	Description	Ship Wt.
46249	EuroPaste, 8 Lb. Bucket	8 lbs. - 4 kg
46255	EuroPaste, Low Profile 8 Lb. Bucket	8 lbs. - 4 kg
46253	EuroPaste, 25 Lb. Pail	24 lbs. - 11 kg
46659	Application Brush	

MYERS Lube

- Truck tire & rim
- Anti-Rust mounting lubricant
- Prevents rim rust & corrosion



Myers Lube is a black, viscous compound containing rust inhibitors, graphite and special lubricants that form a thin coating on the rim surface. Brushes on in seconds to protect rim investment and speed mounting and dismounting.

Order No.	Description	Size	Ship Wt.
46508	Myers Lube	4 1/2 Lb. Can	5 lbs. - 3 kg
46509	Myers Lube	25 Lb. Can	26 lbs. - 12 kg
46510	Myers Lube	120 Lb. Drum	122 lbs. - 55 kg

FREYLUBE Prema No Rim Rust

- Bead lubricant
- Rust inhibitor



Prevents corrosion caused by electrolysis as well as conventional rust. Reduces replacement expenses for flaps on conventional tires.

Order No.	Mfr. No.	Description	Size	Ship Wt.
46603	FL4-1	No Rim Rust	4 1/2 Lb. Can	5 lbs. - 3 kg
46604	FL25-1	No Rim Rust	25 Lb. Can	26 lbs. - 12 kg
46607	FL120-1	No Rim Rust	120 Lb. Drum	122 lbs. - 55 kg
46601		Applicator Brush		1 lbs. - 1 kg

MYERS Rim Non-Rust

- Rust preventive & lubricant
- Non-Petroleum base



Effective rust inhibitor recommended for use on heavy-duty truck rims, and earthmover equipment. Also used as mounting lubricant.

Order No.	Description	Size	Ship Wt.
46518	Rim Non-Rust	1-Gallon Can	9 lbs. - 4 kg
46519	Rim Non-Rust	5-Gallon Pail	44 lbs. - 20 kg

Tire Lube Liquids

Used to lubricate the contact point between tool and tire when mounting and demounting. No alcohol or petroleum products.

MYERS Sliptac Bead Lubricant

- Ready to use
- Dries fast, leaves no residue
- Prevents rim slippage & rust



A liquid bead lubricant for easier mounting of car, truck, bus and OTR tires. Non-combustible. Non-toxic.

Order No.	Description	Size	Ship Wt.
46250	Sliptac Bead Lubricant 1-Gallon	8 lbs. - 4 kg	
46251	Sliptac Bead Lubricant 5-Gallon	40 lbs. - 18 kg	
46252	Sliptac Bead Lubricant 55-Gallon	500 lbs. - 225 kg	

PATCH RUBBER Tire Lube Concentrate

- Major rubber company tested & approved

Mix one part concentrate to seven parts water, makes one gallon of lubricant for mounting and demounting tires. Standard carton of 10. Each packet makes one gallon of tire lubricant.



Order No.	Description	Size	Ship Wt.
46588	Patch Lube Concentrate	13 Oz. Packet	7 lbs. - 4 kg

MURPHY'S Tire Mounting Lubricant

- Ready to use
- Rust inhibitor added to protect rims



Order No.	Description	Ship Wt.
46643	Tire Mounting Lubricant 1-Gallon	8 lbs. - 4 kg
46644	Tire Mounting Lubricant 5-Gallon	40 lbs. - 18 kg
46647	Tire Mounting Lubricant 55-Gallon	500 lbs. - 225 kg

Lube Swabs

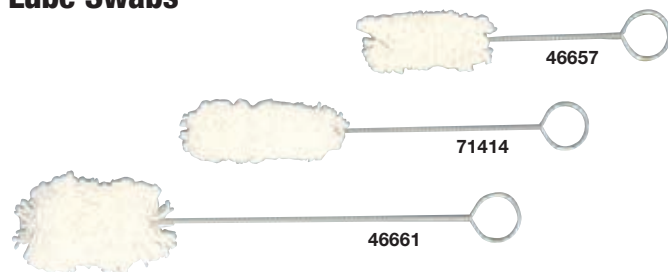

Order No.	Description	Overall Length	Brush Diameter
46657	Passenger	11"	2"
71414	Truck	15"	2"
46661	Large Truck	18"	3"

Spray-N-Mount Tire Lube

- Formulated for mounting & demounting high performance tires.



Ready-to-use tire lube dries fast and leaves no residue. 32 Ounce bottle with a spray nozzle.

Order No.	Description	Size	Ship Wt.
46248	Spray-N-Mount Tire Lube	32 Oz. Bottle	3 lbs. - 2 kg

GAITHER Super Slick'Em Tire Lube

- Contains rust inhibitors
- Non-Water base



Used to penetrate between the tire and rim to make bead breaking easier. Can be used in colder climates when other lubes may require thawing. Packed 4 per case. Each case includes a 1-quart spray bottle.

Order No.	Description	Ship Wt.
46649	Super Slick'Em 1-Gallon	9 lbs. - 5 kg

MYERS RuGlyde

- Rubber lubricant for mounting & demounting
- Lubricates rubber parts



Ru-Glyde is a triple purpose rubber lubricant for passenger and truck tires – tube or tubeless. Makes tire mounting faster, easier. Used to clean or dress up rubber and lubricate rubber parts.

Order No.	Mfr. No.	Description	Ship Wt.
46653	RG-18	1-Gallon	10 lbs. - 5 kg
46654	RG-20	5-Gallon	45 lbs. - 21 kg
46658	RG-55	55-Gallon Drum	509 lbs. - 229 kg
46657	RK3	Replacement Lube Swab	1 lbs. - 1 kg

PAX Tire Gel Pack Kits



Required kit for remounting a PAX tire. Kit Includes: Gel, scraper for gel, plastic wheel protector, and instruction sheet.

Order No.	Description	Ship Wt.
46014	Pax Gel Pack	3 lbs. - 2 kg
46015	Pax Gel Pack for Rolls Royce	3 lbs. - 2 kg

Euro-Style Lube Brushes

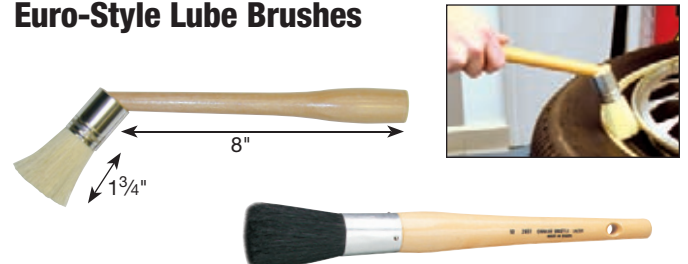

Order No.	Description	Overall Length	Brush Length
46660	Euro-Style Angled Brush	11"	1 3/4"
46659	Euro-Style Straight Brush	11"	3"

Tire Changers

ESCO Tuffbar Tire Tool

- 23-3/4" Long for greater leverage, 1-year warranty
- Surface is covered with tough polymer plates



Order No.	Mfr. No.	Description	Ship. Wt.
51000		Tuffbar Tire Tool	3 lbs. - 2 kg
51350	70208-2	Red Plate Insert w/Screws	
51351	70208-3	White Plate Insert w/Screws	
51352	70208-4	Blue Plate Insert w/Screws	

Mag Wheel Tool

- Will not damage aluminum or mag wheels



Works on all center post tire changers. Polymer inserts attach securely to the tool.

Order No.	Mfr. No.	Description
85022	72000	Mag Wheel Tool
85023	72010	Replacement Insert Kit (1 each Nose & Hook End)

COATS APX80 Tire Changer

- Handles performance & alloy rims & a wide variety of wheel combinations
- Clamping capacity up to 30" externally

RoboArm applies pressure to create bead lock providing leverage on run flat and low profile tires. Rollers keep tire beads in the drop center, provide easy bead and rim lubrication, assists in mounting, and demounts the lower bead without a tire tool. Handles negative offset or reverse mount assemblies without additional adapters. Optional PAX Kit available.

Specs.: Max. rim diameter 9"-30" external and 11"-22" internal; max. tire dia. 44"; bead loosener opening 16"; air req. 110 to 175 psi, 2 hp compressor capable of 14-15 cfm at 150 psi; 1 hp elec. motor, 110V, 1 ph, 25 amp (plus air supply).



Order No.	Mfr. No.	Description	Ship Wt.
59289	APX80A	Tire Changer - Air	1,380 lbs. - 626 kg
59288	APX80E	Tire Changer - Electric	1,380 lbs. - 626 kg

COATS APX90 Tire Changer

- All the features & benefits of the Coats APX80 plus an integrated wheel lift



Order No.	Mfr. No.	Description	Ship Wt.
59290	APX90A	Tire Changer - Air	1,510 lbs. - 680 kg
59291	APX90E	Tire Changer - Electric	1,510 lbs. - 680 kg

Specifications:

Mfr. No.	Inside Clamping	Outside Clamping	Max. Rim Width	Max. Tire Diameter	Bead Breaker Opening	Air Required	Electric Power	Ship Wt.
APX90A/APX90E	11"-22"	9"-30"	16"	44"	16"	110-175 psi	110V, 1 PH	1,510 lbs. - 680 kg
APX80A/APX80E	11"-22"	9"-30"	16"	44"	16"	110-175 psi	110V, 1 PH	1,380 lbs. - 626 kg
ProGuard L	Wheels 10" to 34"	8"-26"	16"	47"	15"	175 psi	220V, 1 PH	940 lbs. - 426 kg
9024E	12"-22"	10"-26"	15"		15"	110-175 psi	110V, 1 PH	1,025 lbs. - 465 kg

Tire Bar/ Tire Bead Tool

- Designed by technicians to assist with low profile tires
- 2" Longer than standard bead lever tools
- Knurled handle for a better grip



Order No.	Description	Ship. Wt.
71433	Tuffbar Tire Tool	3 lbs. - 2 kg

COATS ProGuard L Tire Changer

- Leverless power duckhead
- Built-in lift & Robo-Arm power assist



Engineered for oversized, run flat, and low profile applications. Power controls for lifting, bead loosening, demounting, and mounting. The Robo Arm keeps the top bead in the drop center while servicing the tire. The tool head and duckhead are mounted to the tilt back tower that stows out of the way when not in use. *Specs.: rim dia. 10"-34"; max. tire dia. 47"; max. tire width 16"; max wheel lift 175 lbs.; air req. 175 psi, 5 cfm.*

Order No.	Description	Ship Wt.
51117	ProGuard L Tire Changer	940 lbs. - 426 kg

COATS 9024E Low Profile Tire Changer

- 24" Capacity
- Optional extensions raise to 26" capacity
- Pneumatic drop center tool & power bead roller



The Pneumatic Drop Center (PDC) Tool holds the tire bead down when mounting. Position the PDC tool opposite the mount/demount head to aid removal of the upper and lower beads. The exclusive Power Taper Roller eliminates the need for manual hold down rollers or drop center tools and is used to loosen top beads on delicate wheels or wheels with run flat sensors. *Specs.: Max. rim diameter 10"-26" external, 12"-22" internal; bead loosener opening up to 15" wide; air req. 110 to 175 psi, 2 hp compressor capable of 5 cfm at 150 psi; 1 hp elec. motor, 110V, 1 ph.*

Order No.	Mfr. No.	Description	Ship Wt.
59258	9024E	Tire Changer	1,025 lbs. - 465 kg
59070	184262	26", 2-Position Clamp Extensions 13" - 26"	2 lbs. - 1 kg

COATS 70 Series Leverless Tire Changers

- Eliminate the tire tool that can damage expensive custom rims
- Plastic Duckhead inserts

Designed to handle low profile and run flat tires. The Robo-Arm Helper Device allows the technician to flex stiff sidewalls. It also aids in wheel clamping, second bead removal, and top bead mounting. Leverless Accessory Kit Includes plastic chassis storage, lube bracket and brush, lube, (4) Grip Max Clamps, (8) Grip Max Grips, (2) bead loosener shoe socks, premium storage cabinet and plastic inserts

Specs: Max. tire dia. 50"; max. rim dia. 6"-22" external, 8"-24" internal; max. rim width: 14" bead loosener opening: 2"-17"; air req.: 1.5 hp air drive motor, 110 to 175 psi; 5 hp compressor capable of 14-15 cfm at 150 psi; Elec.: 1 hp electric motor, 110V, 1 ph., 3A (plus air supply); ship. wt.: 700 lbs.

Order No.	Robo-Arm	Motor	Bead Loosener
70X AHL	Yes	Air	Hand
70XEHL	Yes	Electric	Hand



COATS 50 & 70 Series Tire Changer Packages

- "Build" the Coats Tire Changer the way you want it.
- Choose Robo-Arm, air or electric operation, hand or foot-operated bead breaker & the accessory kit you need

The Coats 50 series features a manual swing arm design and uses one control to adjust horizontal tool head position and a second control to adjust the vertical height. The 1.5 hp air drive system allows fast and powerful control of the wheel under heavy loads while allowing the user infinite control of wheel movement.

The Coats 70 series models are designed to handle low profile and run flat tires. The Robo-Arm Helper Device allows the technician to flex stiff sidewalls. It also aids in wheel clamping, second bead removal, and top bead mounting.

Specs.: See below. air req. 110 to 175 psi, 5 hp compressor capable of 14-15 cfm at 150 psi; 1 hp elec. motor, 110V, 1 ph, 13 amp (plus air supply).

Basic Accessory Kit: Lift tool, lube bottle, swab, and (4) 3 position clamps.

Extended Accessory Kit: Lift tool, lift tool socks, paste lube bracket, paste lube brush, paste lube, Grip Max Clamps (4), duckhead inserts (2), plastic duckhead, and bead loosener sock.

Premium Accessory Kit: Everything in Extended kit plus grey duckhead, duckhead roller, and storage cabinet

50 Series



70 Series



Order No.	Robo-Arm	Motor	Bead Loosener	Includes Access. Kit
50XAF1	No	Air	Foot	Basic
50XEF1	No	Electric	Foot	Basic
50XAH1	No	Air	Hand	Basic
50XEHL	No	Electric	Hand	Basic
50XAF2	No	Air	Foot	Extended
50XEF2	No	Electric	Foot	Extended
50XAH2	No	Air	Hand	Extended
50XEHL2	No	Electric	Hand	Extended
50XAF3	No	Air	Foot	Premium
50XEF3	No	Electric	Foot	Premium
50XAH3	No	Air	Hand	Premium
50XEHL3	No	Electric	Hand	Premium

Order No.	Robo-Arm	Motor	Bead Loosener	Includes Access. Kit
70XAF1	Yes	Air	Foot	Basic
70XEF1	Yes	Electric	Foot	Basic
70XAH1	Yes	Air	Hand	Basic
70XEHL	Yes	Electric	Hand	Basic
70XAF2	Yes	Air	Foot	Extended
70XEF2	Yes	Electric	Foot	Extended
70XAH2	Yes	Air	Hand	Extended
70XEHL2	Yes	Electric	Hand	Extended
70XAF3	Yes	Air	Foot	Premium
70XEF3	Yes	Electric	Foot	Premium
70XAH3	Yes	Air	Hand	Premium
70XEHL3	Yes	Electric	Hand	Premium

Specifications:

Mfr. No.	Inside Clamping	Outside Clamping	Max. Rim Width	Max. Tire Diameter	Bead Breaker Opening	Air Required	Electric Power	Ship Wt.
70X Series	8"-26"	6"-22"	14"	50"	2"-17"	110 to 175 psi	110V, 1 PH	700 lbs. - 315 kg
50X Series	12"-24"	10"-21"		50"	2"-17"	110 to 175 psi	110V, 1 PH	585 lbs. - 266 kg

Tire Changers

COATS 5040 Rim Clamp Tire Changer

- Electric or air models available.



Ideal entry level tire changer to handle the most common size rims up to 21". Manual swing arm & spring assisted vertical height adjustment. *Specs.:* Clamping range 10"-21" external and 12"-24" internal; max. tire width 10 1/2"; max. tire dia. 50"; air req. 1.5 hp air drive motor, 110 to 175 psi, 5 hp compressor capable of 14-15 cfm at 150 psi, 1 hp electric motor, 110V, 1 ph, 13 amp.

Order No.	Mfr. No.	Description	Ship Wt.
59342	5040A	Tire Changer – Air	585 lbs. - 264 kg
59343	5040E	Tire Changer – Electric 110V, 1 Ph	585 lbs. - 264 kg

COATS 5035E Tire Changer

- For alloy & steel wheels
- Expand service capabilities



Features self-centering clamps, up front controls and foot operated bead loosening system. Includes lube bucket, lube swab, bead lift tool, hose with air chuck, inflation limiter, and filter-lubricator. *Specs.:* Maximum rim diameter 12"-19" external and 15"-22" internal; max. tire dia. 40"; max. rim width 10"; air req. 110 to 175 psi, 110V, 1 ph.

Order No.	Mfr. No.	Description	Ship Wt.
59379	5035E	Tire Changer – Electric	450 lbs. - 204 kg

COATS EL-X Express Lane Inflation System

- Compatible with all Coats tire changers



Digital inflation system accurate to +/- .5 psi. Eliminates waiting for tire to inflate. 32" L x 24" W x 58" H.

Order No.	Mfr. No.	Description	Ship Wt.
70000	EL-X	Express Lane Inflation System	450 lbs. - 204 kg

Specifications:

Mfr. No.	Diameter Rim	Max. Rim Width	Max. Tire Diameter	Air Required	Electric Power	Ship Wt.
5040	10"-24"	10.5"	50"	110-175 psi	1 HP, 110V	585 lbs. - 264 kg
5035	12"-22"	10"	40"	110-175 psi	1 HP, 110V	450 lbs. - 204 kg

COATS RC-200 Motorcycle Tire Changer

- For motorcycles & ATVs
- Rim clamp pressure control system displays the amount of pressure being applied
- Optional Grip Max clamps clamp car & light truck wheels from 6" to 22"



Rim clamps provide extra clearance for sprockets and choice of three optimized positions. Clamp rims up to 23" and smaller ATV rims down to 6" to handle virtually any wheel. Two positions for wide chopper tires or narrow tires. Robo-Arm provides extra power for flexing stiff sidewalls. Bead loosener socks, clamp booties, and lift tool protection helps prevent metal-to-metal contact that causes scratching or marring. *Specs.:* rim diameter 6"-23"; rim width 12 1/2"; max. tire dia. 50"; 110V, 1 ph.

Order No.	Mfr. No.	Description	Ship Wt.
51061	RC-200	Motorcycle Tire Changer	700 lbs. - 318 kg
59270	850000758	Optional Grip Max Clamps Set of 4	2 lbs. - 1 kg

COATS Auxiliary Bead Seater

- Fits Coats 50 series, 70X & APX tire changers

Uses the surge tank to direct a blast of air and seat the bead of almost any tire and rim combination the first time.



Order No.	Mfr. No.	Description
59267	85606545	Auxiliary Bead Seater
59273	85606739	Auxiliary Bead Seater for ProGuard L

COATS Robo-Arm Pneumatic Drop Center Tool

- Fits Coats rim clamp tire changers

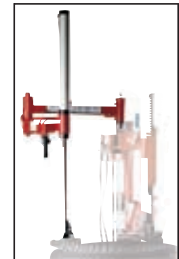

Upgrade Coats 5050, 5060, 5065, 6050, 6060, or 6065 tire changers. The arm holds the top bead down to aid positioning the insert tool and lifting it onto the duckhead. Arm can also be used to lift the bottom bead. DIY installation or use an authorized factory trained Coats Service Partner.

Order No.	Mfr. No.	Description	Ship Wt.
51057	184177	Robo-Arm Pneumatic Drop Center Tool	75 lbs. - 34 kg

COATS 310 Manual Tire Changer

A fully manual bead loosener and tire changer. Features a common upper and lower bead loosening tool. The lower bead loosening action has a special 3 position ratchet to provide a 7" travel for wide wheels. Handles passenger and light truck wheels 12" to 16 1/2" diameter and 3 1/2" to 8" wide.



Order No.	Mfr. No.	Description	Ship Wt.
50181	310	Manual Tire Changer	126 lbs. - 57 kg

"No Hands" Mounting Clamp

- For low profile tires



Holds tire bead below the rim flange for fast, damage free tire mounting. Fits all passenger rims. Impact resistant plastic will not scratch or damage custom wheels.

Order No.	Mfr. No.	Description	Ship Wt.
50200	8435685	Tire Mounting Clamp	2 lbs. - 1 kg

Aftermarket Replacement Parts for Hunter Tire Changers



71079



71215



71080

Order No.	Description
71079	Mount/Demount Head for Hunter Tire Changers
71215	Black Mount/Demount Head for Hunter Tire Changers
71080	"Tulip" Gripping Pads, Sold Each

COATS Auto-Flate Digital Inflator

- Compatible with any rim clamp tire changer on the market



Set the pressure and walk away. Assures all tires are equally inflated for sensitive TPMS systems. Inflates the tire in 40 seconds with 150 psi inlet pressure. Pre-programmed nitrogen-ready. UL approved. Accurate to 12 psi.

Order No.	Mfr. No.	Description
59230	85009184	Auto-Flate Digital Inflator

COATS Bump-N-Roll

Loosen the bead and roll the tire forward to the new loosening position. Rotate "SUV" and other heavy assemblies. Easy to install. Fits Coats 5060/5065, 6060/6065, and 7065 rim clamp series tire changers.



Order No.	Mfr. No.	Description	Ship Wt.
71663	183491	Bump-N-Roll	16 lbs. - 8 kg

COATS On-Board Operating Training

- For All APX, 50 & 70 series tire changers



The DVD player provides instructional video in real time for the APX, 70 series and soon the 50 Series tire changers. Includes mounting hardware. Installs quickly and is removed easily when not in use.

Order No.	Mfr. No.	Description
59402	85000401	Coats On-Board Operator Training

COATS Duckhead Roller

- Fits 50X, 60X & 70X series Coats Changers
- Keeps the toughest sidewalls in the drop center



Use for easy mounting of low profile and runflat tires. Easy to install and remove. Works best with the Coats Robo-Arm and is standard in all new Robo-Arm kits.

Order No.	Mfr. No.	Description
71668	85606462	Duckhead Roller

COATS Grip-Max Laminated Tire Changer Clamps

- Fits 50, 70 & APX series tire changers



Kit includes 4 clamps, 4 plungers, 1 extra set of grips.



59272



59271

Integrated plastic grips provide built-in protection and prevent metal-to-metal contact. Laminated grips last 30% longer than plastic covers and offer better outside clamping for tough tires.

Order No.	Mfr. No.	Description
59270	5000758	Grip Max Laminated Clamps
59271	500059408	Replacement Grips Set of 8
59272	5000768	Rebuild Kit for 4 Clamps

Clamp Extensions for 50X & 70X Series Tire Changers

24" Clamps

Changes external clamping capacity from 6"-22" to 13"-24". Includes (4) clamps, (4) buttons and 10 clamp covers.

Order No.	Mfr. No.	Description
59058	8184327	24" 2-Position Clamp Extensions

28" Clamps Grip Max

Changes external clamping capacity from 6"-22" to 16"-28". Includes (4) clamps, (4) buttons and 10 clamp covers.

Order No.	Mfr. No.	Description
59059	85606361	28" 2-Position Clamp Extensions



COATS Wheel Lift System

- For APX80, 50 & 70 series tire changers

Handles assemblies up to 150 lbs. Lift system is compatible with APX 80, A/E and AX/EX configurations of 7050, 7060, 7065, 5050, 5060, and 5065 model tire changers. Includes mounting instructions.

Order No.	Mfr. No.	Description
59229	85000440	Wheel Lift System



Tire Changer Accessories

Accessories for 9024E



Clamp Upgrade Kit

9010: Changes external clamping capacity from 10"-20" to 14"-22"

9024E: Changes external clamping capacity from 12"-24" to 14"-26"

Order No.	Mfr. No.	Description
59070	8184262	Clamp Extensions

4" Clamp Extensions

9010: Changes external clamping capacity from 10"-20" to 12"-24"

9024E: Changes external clamping capacity from 12"-24" to 12"-28"

Order No.	Mfr. No.	Description
59400	8185590	Clamp Extensions

4" Clamp Extensions with 2" Clamping Reducer

9010: Changes external clamping capacity from 10"-20" to 10"-24"

9024E: Changes external clamping capacity from 12"-24" to 10"-28"

Order No.	Mfr. No.	Description
59401	8185531	Clamp Extensions with Reducer



Order No.	Mfr. No.	Description
71422	8181354	Replacement Bead Lifting Tool
50135	8183605	Slide Cover for Bead Lifting Tool - Package of 10
50137	8183606	Bead Loosener Shoe Cover - Package of 2
71217	89209612	Clamp Cover - Package of 6
71395	820142501	Steel Duckhead Mount/Demount Head
71218	89209611	Plastic Inserts for Steel Duckhead - Pkg. of 6
71211	3008403	Plastic Duckhead
50200	435685	Plastic Tire Mounting Clamp

Optional Integrated Wheel Lift For 9024E

- Upgrades an existing Coats 9024E to include lifting capabilities

Helps get heavy tire and wheel assemblies up to tabletop height with minimal effort. Reduces operator fatigue, lifting injuries, and potential for expensive wheel damage. Handles assemblies up to 150 lbs.



Order No.	Mfr. No.	Description
59262	8184563	Wheel Lift Upgrade Plus \$100.00 Installation

COATS Rim Clamp Tire Changer Accessories & Replacement Parts

Lube Bottle

Fits all Coats rim clamp tire changers.

Order No.	Mfr.No.	Description
50225	106259	Lube Bottle



50225

Lube Swab

For applying lubricant to tire bead and rim.

Order No.	Mfr.No.	Description
50230	8000491	Lube Swab



50230

Air Chuck

Straight-on flow thru chuck for rim tire changers.

Order No.	Mfr.No.	Description
50075	410419	Flow Thru Chuck



50075

Bead Lifting Tool

Designed for ease of lifting the bead during tire changing.

Order No.	Mfr.No.	Description
71422	181354	Bead Lifting Tool



ATV Adapter Kit

1" or 1.75" table clamps for Coats rim clamp tire changers.

Order No.	Mfr.No.	Description
50065	183585	ATV Adapter Kit for Tall Clamp Carriers



50065

Quilted Clamp Cover

Protects custom rims. Fits all Coats rim clamp models. Package of 10.

Order No.	Mfr.No.	Description
50132	183604	Quilted Clamp Covers



50132

Slide Cover for Bead Lifting Tool

Protects custom rims. Package of 10.

Order No.	Mfr.No.	Description
50135	85000783	Slide Cover for Tip of Bead Lifting Tool



50135

Bead Loosener Shoe Cover

Slides over bead breaker shoe to protect custom rims. Package of 2.

Order No.	Mfr.No.	Description
50137	183606	Bead Loosener Shoe Cover

50137

Stainless Steel Mount/Demount Head Assembly

For all 50 and 70 series rim clamp tire changers. Requires taper end vertical shaft

Order No.	Mfr.No.	Description
71457	182788	Mount/Demount Head Assembly



71457

Plastic Inserts for Mount/Demount Head

Plastic inserts for 182788 mount/demount head. Package of 2.

Order No.	Mfr.No.	Description
71459	182961	Inserts for Mount/Demount Head



71459

Nylon Mount/Demount Head Kit for 50 & 70 Series

Reduces rim damage and allows the bead to flow easier into the drop center. For all 50 and 70 series.

Order No.	Mfr.No.	Description
71216	8183061	Black Nylon Head
71447		Economy Black Nylon Head



71216

Duckhead Bootie

Duckhead bootie for 9010 & 9024 Duckhead, 6 pack.

Order No.	Mfr.No.	Description
71218	9209611	Duckhead Bootie



71218

Mount/Demount Tool

- For mag, chrome & alloy wheels



51020



51022



51023



51021

Eliminates damage to "mag" chrome and alloy wheels. Fits all center post changers. Replaceable polymer inserts get 500 to 700 mounts/demounts. Not for use on steel wheels.

Order No.	Mfr. No.	Description	Ship Wt.
51020	70200	Tool Complete with 2 Sets of Inserts	5 lbs. - 3 kg
51021	70204	Small Poly Hook Insert Repl.	1 lbs. - 1 kg
51022	70201	Large & Small Poly Insert Repl.	1 lbs. - 1 kg
51023	70203	Small Poly Insert & Hook Body Repl.	1 lbs. - 1 kg

COATS Tire Changer Accessories & Replacement Parts

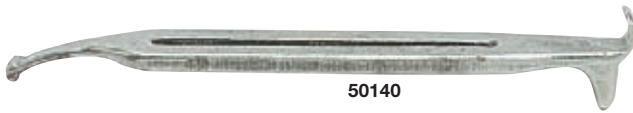

50140

Wheel Protector "Booties"

Protect alloy and chrome wheels from damage. Includes 10 plastic tool boots for the combo tool.

Order No.	Mfr. No.	Description	Ship Wt.
50151	1106268	Tool Boot Pkg. 10 Small, 10 Large	2 lbs. - 1 kg
50067	397	Small Boot Only Pkg. 20	2 lbs. - 1 kg
50068	398	Large Boot Only Pkg. 20	2 lbs. - 1 kg

Clip-On Air Chuck

Clip-On air chuck for all center post changers.

50223	103753	Clip-On Air Chuck	1 lbs. - 1 kg
-------	--------	-------------------	---------------

Combination Tool

Mount/Demount bar for COATS center post tire changers.

50140	000768	Combination Tool	6 lbs. - 3 kg
-------	--------	------------------	---------------

Straight Lock-On Chuck

50075	410419	Tire Changer Chuck 1/4" Air Hose Barb	1 lbs. - 1 kg
50076		Repl. Washer for 50075, Pkg. of 10	1 lbs. - 1 kg

Positioning Pin Extension

For use on wide wheels

Order No.	Mfr. No.	Description	Ship Wt.
71335	104319	Positioning Pin Extension	2 lbs. - 1 kg

Air Gauges

50224	107518	Air Gauge for 1010, 1010A, 2020, 2020A	1 lbs. - 1 kg
50228	107895	Air Gauge for 4040A, 4040SA, 4050A	1 lbs. - 1 kg

Hold Down Cone

Secure wheel to COATS center post changers during bead loosening, mount, and demount operations.

71375	108276	Hold Down Cone	5 lbs. - 3 kg
-------	--------	----------------	---------------

Inflation Hose Assembly

Inflation hose assembly for Coats center post tire changers

71359	000768	Combination Tool	6 lbs. - 3 kg
-------	--------	------------------	---------------

Lube Bottle

Bottle for tire lubricant on Coats center post changers.

71357	106572	Lube Bottle	1 lbs. - 1 kg
-------	--------	-------------	---------------

Lubricating Swab

For applying lubricant to tire beads and rims.

50230	000491	Lube Swab	1 lbs. - 1 kg
-------	--------	-----------	---------------

COATS 4050A Tire Changer



Contoured tabletop for proper rim support. Higher center post threads for high dish rims. 7½ Gallon surge tank to seal the toughest of beads. Super fast, one position operation. Specs.: Rim dia. 10"-17½", rim width 19", max. tire dia. 38", air req. 110-175 psi.

Order No.	Mfr. No.	Description	Ship Wt.
51040	4050A	Center Post Tire Changer	575 lbs. - 259 kg



50151



50224
50228



71375



71335



71359



50230



50075



50118



71357



50223



71380



50116



50134

Rim Clamp Tire Spreader Adapter

Allows use of manual tire spreader or adjustable tire spreader on rim clamp tire changers.

Order No.	Mfr. No.	Description	Ship Wt.
50134	181329	Tire Spreader Adapter	6 lbs. - 9 kg

Manual Tire Spreader

50118	000347	Manual Center Post Tire Spreader Range 4" to 10"	11 lbs. - 5 kg
-------	--------	--	----------------

Adjustable Tire Spreader

Locks into position for the various widths.

71380	108028	Adjustable Center Post Tire Spreader Range 0" to 10"	
-------	--------	--	--

Bench Mount Spreader

50116		Bench Mount Spreader	
-------	--	----------------------	--

Tire Changers

CORGHI AM26 Master Tire Changer

- No tire lever, no lifting, no damage or dangerous stresses to the tire or rim
- Range: 12" to 26"
- Electronic wheel diameter selection automatically positions bead breakers & mount/demount tool



Enter the diameter of the wheel and the machine automatically adjusts all the tools to remain away from the rim.

The demount finger grabs the bead and pulls it above the rim. There is no stress on the bead.

Designed to change low profile, high performance and run-flat types of tires on standard OE rally and steel wheels. Change any passenger or light truck tire assembly from 13" to 26" and up to 18" wide. The built-in lift eliminates the danger of lower back injuries to the operator. Simply select the diameter of the wheel and the machine automatically adjusts all the tools to remain 4mm from the rim. It will not scratch the rim. Pneumatically operated rollers loosen the upper and lower beads. *Specs.: rim size range 12"-26"; rim width 2"-15"; max. tire dia. 40"; max. tire width 18"; bead breaker opening 2"-15"; air req. 150 psi.; electric req. 110 volt./10 Amp. min.; workspace req. 48" W. x 96" D.; Ship. wt. 1,300 lbs.*

Order No.	Description	Ship Wt.
51245	AM26 Master 26"	900 lbs. - 405 kg

Optional Articulating Arm



Keeps the tire in the drop center for any run flat or low profile wheel. Available for Corghi AM26 Master, Corghi 50 and Corghi 500 tire changers.

Order No.	Mfr. No.	Description
51509	801263408	AM26 Master Optional Articulating Arm
51292	8-11100097	50 Optional Articulating Arm
51513	8-11100221	500 Optional Articulating Arm

CORGHI MASTER Standard Accessories



51184

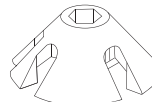

51185

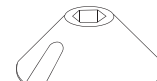

51182

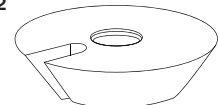

51225



51196



51077

Standard Accessories

Order No.	Mfr. No.	Description	For Serial Number
51184	462415	Small Diameter Cone (75mm)	All serial numbers
51185	900263161	Universal Cone (120mm)	Before CAN001164 hex center hole
51182	461668	Protector Shield for Cone Sold Each, 2 Req.	All serial numbers
51225	461667	Large Plastic Cone (177mm)	All serial numbers
51196	262417A	Locking Bead Clip	All Serial Numbers
51223		Extension for 51196 Locking Bead Clip	All Serial Numbers
51077	461489	Insert for Mount/Demount Head (Set 10)	All Serial Numbers

Optional Standard Bead Clamp

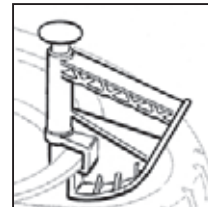

Order No.	Mfr. No.	Description
50200	801435685	Standard Bead Clamp

Reverse Mount Wheel Adapter

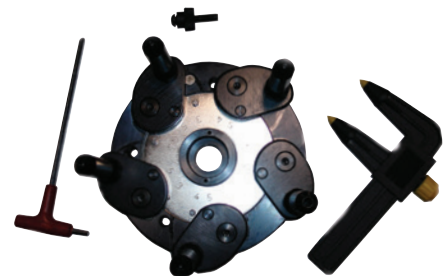

NOTE: The original 24" and 26" Corghi Master Tire Changers had a HEX center shaft hole. All 26" Corghi Masters manufactured after Jan. 2005 have a ROUND center shaft hole. Before placing an order for a Reverse Mount and Wire Wheel Combo Package or the Reverse Mount Kit please visually confirm if the shaft hole is HEX or ROUND.

Order No.	Mfr. No.	Description
51046	8-11100073	Reverse Mount Wheel Adapter for Use with Round Center Hole

Reverse Mount Adapter Extensions

For use with reverse mount rims with larger wheel stud holes and deep lug bolt offsets.



Order No.	Mfr. No.	Description
51254	90010046A	Reverse Mount Adapter Extensions

CORGI Artiglio 500 Tire Changer

- Dual bead breaking discs speeds operation
- No tire lever, no lifting, no damage or dangerous stresses to the tire or rim
- Range: 12" to 32"
- Bead lifter removes the tire without damaging the rim



Dual bead breakers work in unison to speed the operation



Bead lifter removes the tire without damaging the rim

Change standard & low profile custom tires from 12" to 30". Handles run flats and PAX* tires. Integrated tire lift for heavy wheel and rim assemblies. Pneumatic operated roller breaks upper and lower beads. Dual-drive motor operates 7-18 rpm. Pneumatically operated swing arm and speed lock centering cone for fast lockdown. *Specs.: rim dia. 12" - 32", max. tire dia. 47", max tire width 15", max wheel lift 187 lbs., power req. 120 psi, 110v.*

Order No.	Description	Ship Wt.
51511	Artiglio 500	838 lbs. - 380 kg

CORGI Optional Universal Lug Adapter

- For the Artiglio 50 & newer Master AM26 tire changer

For use with rims without center holes. Recommended for O.E. plastic-faced, chrome-look rims. Adjusts to any size lug and hole configuration. Includes adjustment wrench, calipers and manual.

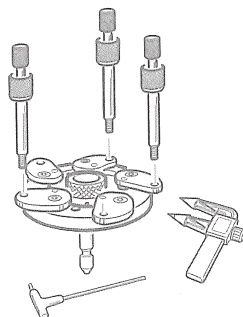

Order No.	Mfr. No.	Description
51291	8-11100087	Universal Lug Adapter for Corghi 50
51294	8-11100038	Universal Lug Adapter for Corghi AM26

CORGI Artiglio 50 Tire Changer

- Integrated wheel lift, 187 lb. capacity
- No tire lever, no lifting, no damage or dangerous stresses to the tire or rim
- Range: 12" to 30"
- Bead lifter removes the tire without damaging the rim



Integrated tire lift - 187 lb. capacity



Roller loosens the upper & lower beads



Bead lifter removes the tire without damaging the rim



Change standard & low profile custom tires from 12" to 30". Handles run flats and PAX* tires. Integrated tire lift for heavy wheel & rim assemblies. Pneumatic operated roller breaks upper & lower beads. Bead tool is virtually eliminated. Pneumatically operated swing arm and speed lock centering cone for fast lockdown. *Specs.: rim dia. 12" - 30", max. tire dia. 47", max tire width 15", max wheel lift 187 lbs., power req. 120 psi, 110v.*

Order No.	Description	Ship Wt.
51256	Artiglio 50	685 lbs. - 309 kg

Standard Accessories Shipped with the Artiglio 50 Tire Changer

51278	9005-101204	Extension For Locking Pistol
51279	9004-103235	58mm Plastic Cone
51280	9004-103234	75mm Plastic Cone
51281	9004-103230	120mm Metal Cone
51282	9004-103229	145mm Metal Cone
51283	9004-103232	Plastic Cup for 120mm Cone-Each
51284	9004-103502	Plastic Mount Head Inserts Sold Each
51196	801262417	Bead Pressing Clamp

*PAX Adapter required. Change over time less than 1 minute.

CORGI Reverse Mount Wheel Adapter

- For Corghi 50, 500 & AM26 Master tire changers



51046

Order No.	Description
51046	Reverse Mount Wheel Adapter
51292	Articulating Arm Bead Assist Kit

MYERS MTS40/20 Automatic Tire Changer

- Handles Alloy Chrome, Low Profile & "Run Flat" Tires
- 2-speed transmission for superior control
- Handles tire assemblies up to 26"
- Includes SP2000 bead loosener to aid mounting & demounting
- Change PAX tires with optional accessory kit



Bead depressing tool aids in demounting



The MTS40/20 features the distinct two-speed engagement "click" allowing the operator the option of stepping lightly for the slow speed or full press to go directly to fast start. The SP2000 Bead Loosener helps loosen the top bead for demounting and includes the Tire Lift Tool to assist demounting the bottom bead. The SP2000 also holds the bead in the drop center when mounting the tire. The mount/demount head does not come into contact with the rim. Air-operated tilt back tower allows for fast set-up. The MTS40/20 features a built-in table top inflator and a 3,500 lb. capacity bead breaker. *Specs.: Clamping range internal 13"-26", external 10"-24"; tire widths 3 1/2"-15"; max tire dia. 43"; bead breaker opening 2"-13"; 110v, 1ph.; air req. 150 psi.*

Order No.	Mfr. No.	Description	Ship Wt.
50189	MTS40/20	Automatic Tire Changer	760 lbs. - 342 kg

MYERS MTS40/2015 Automatic Tire Changer

- All the features of the MTS40/20 above plus the PU1500 power assist unit



The optional PU1500 Power Assist Tire Arm helps lift super wide profile tires from the bottom during dismounting. The bead pressing arm holds the bead in the drop center when mounting. 18-month warranty on parts and labor, 10-year warranty on transmission.

Order No.	Mfr. No.	Description	Ship Wt.
50191	MTS40/2015	Automatic Tire Changer with PU1500	885 lbs. - 399 kg

Standard Accessories Included with MTS24 & MTS24/20

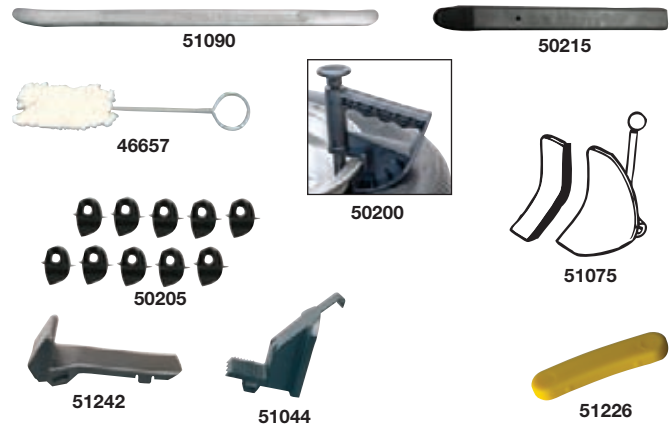

Order No.	Mfr. No.	Description
46657		Lube Brush 11" L. x 2" Diameter
51090	444238	Tire Bead Tool
50215	8-11100104	Bead Tool Cover - Sold Each
51242	8-11100108	Inside Jaw Protectors - Set of 12
51044	8-11100109	Outside Jaw Protectors with Teeth - Set of 12
51226	8-11100107	Mount/Demount Bottom Insert - Set of 5
50205	8-11100106	Plastic Inserts for Mount/Demount Head - Set of 10
50200	801435685	Tire Mounting Clamp
51075	8-11100105	Bead Loosener Shoe Cover - Pkg. of 6

Optional Accessories for MTS24 & MTS24/20



Order No.	Mfr. No.	Description
50038	450310A	Replacement Only Plastic Mount/Demount Head
51083	8-01263517	8"-26" Adapters for the MTS24 (8"-24" on MTS2010 with New Jaws) - Set of 4

Upgrade MTS40/20 with PU1500 Power Assist Package

- Power assist unit, mounting kit & bead press/lift unit required



Order No.	Mfr. No.	Description
51257	8-11100027	PU1500 Power Assist Unit
51259	8-11100031	Mounting Kit
51258	8-11100030	Bead Press Lift Unit

Protective Eyewear

- More protective eyewear see page 236



CORGI 2024TI & 2024TI/20 Tire Changers

- Designed for low profile, high performance & run flat tires
- Breaks the top bead on the table top to help protect expensive custom wheels
- One man operation on difficult & super wide tires



2024TI/2000
Shown with SP2000

Designed for changing low profile, high performance and run flat type tires. Heavy-duty tilt-back tower and mount/ demount head prevents flex that could cause rim damage. Two position bead breaking support pad. Four sliding clamps with built-in inflation jets. Limited Warranty: 1 year parts and labor; 10 years on transmission. Includes lube bucket, brush, bead tool, (12) inside jaw protectors, (12) outside jaw protectors, (5) Mount/demount head bottom inserts, (6) bead loosener shoe covers, and bead pressing lever. *Specs.: External clamps 10" to 24", internal 13" to 26", rim width 2"-15", rotational torque 700-750 ft.lbs., bead breaking power over 3,500 lbs. Requires 150 psi. air and 110V electric.*

Order No.	Mfr. No.	Description	Ship Wt.
51232	2024TI	Electric Tire Changer	560 lbs. - 252 kg
51233	2024TI/20	Electric Changer with SP2000	760 lbs. - 342 kg
2024TI/20 Includes everything listed above PLUS			
50205	8-11100106	Plastic Inserts- Set of 10	
50200	801435685A	Bead Clip	

CORGI 2024TI-2015 Tire Changer

- Same features as the 2024TI/20 above plus PU1500 power assist unit
- Pneumatically powered wheel & bead pressing arm



The PU1500 Power Assist Tire Arm helps lift super wide profile tires from the bottom during dismounting. The bead pressing arm holds the bead in the drop center when mounting.

Order No.	Mfr. No.	Description	Ship Wt.
51252	2024TI-2015	Electric Tire Changer	1,800 lbs. - 816 kg

CORGI 9824TI High Performance Tire Changers

- Change HP, and low profile tires quickly & easily
- Electric motor is 50% faster
- Includes high performance bead pressing lever



Protect expensive custom rims. The mount /demount head never comes into contact with the rim. The heavy-duty, stainless steel turntable rotates in either direction. The upper arm assembly swings out of the way for operator convenience. The stainless steel, dual air powered clamping cylinders are rebuildable. Warranty: 1 year on parts and labor; 10 years limited on transmission. Includes lube bucket, brush, (12) inside jaw protectors, (5) Mount/demount head bottom inserts, (10) plastic inserts, (6) bead loosener shoe covers, and bead pressing lever. *Specs.: External clamps 10" to 24", internal 13" to 26", rim width 2"-15", rotational torque 700-750 ft.lbs., bead breaking power over 3,500 lbs. Requires 150 psi. air and 110V electric.*

Order No.	Mfr. No.	Description	Ship Wt.
51231	9824TI-E	Electric Tire Changer	600 lbs. - 270 kg
51235	9824TI-A	Air Tire Changer	600 lbs. - 270 kg

CORGI 9824TI-1500 High Performance Tire Changer

- Same features as the 9824TI above plus PU1500 power assist unit
- Pneumatically powered wheel & bead pressing arm



The PU1500 Power Assist Tire Arm helps lift super wide profile tires from the bottom during dismounting. The bead pressing arm holds the bead in the drop center when mounting.

Order No.	Mfr. No.	Description	Ship Wt.
51249	9824TI-1500	Electric Tire Changer	829 lbs. - 376 kg
51251	9824TI-1500	Air Tire Changer	829 lbs. - 376 kg

Tire Changer Accessories

SILVERLINE @120 Tire Changer

- Entry level changer for light-duty applications



Sturdy four clamp design with dual power cylinders. Features dual action bead breaker, built-in inflation jets, plastic wheel protectors and steel mount/demount head with plastic protectors.
 Specs.: Clamping 10"-20" external and 12"-22" internal; max. rim width 11"; max. tire dia. 38"; 110V, 10 amp, 150 psi air. Warranty, 6 months on parts, 90 days labor.

Order No.	Mfr. No.	Description	Ship Wt.
50053	120	@120 Tire Changer	485 lbs. - 220 kg

"New Style" & "Old Style" Clamping Jaws

Before purchasing accessories for Corghi Tire Changers check the Jaws to determine if they are "old style" or "new style" clamping jaws.

"New Style Jaws"



Standard on new Corghi Rim Clamp Tire Changers and on:

- 9820 after SN: 010110483
- 9212 after SN: 010111235
- 2019 after SN: 9031389
- 2010 after SN: 9041149

including these serial numbers

"Old Style Jaws"



Old Corghi Rim Clamp Tire Changers:

- 9820 before SN: 010110483
- 9212 before SN: 010111235
- 2019 after before SN: 9031389
- 2010 before SN: 9041149

8" - 24" Wheel Adapter

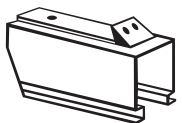

51083

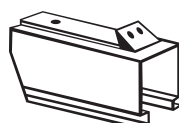

51082

Order No.	Mfr. No.	Description
51083	263517	Wheel Adapters for New Style Jaws
51082	263518	Wheel Adapters for Old Style Jaws

Plastic Jaw Protectors



51242



51044

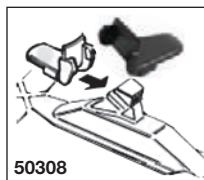

50308

Order No.	Mfr. No.	Description
51242	8-11100108	Inside Jaw Protectors for New Style Jaws - Set of 12
51044	8-11100109	Outside Jaw Protectors with Teeth For New Style Jaws - Set of 12
50308	900243268A	Jaw Protectors for Old Style Jaws - Sold Each (4) Required

Bead Loosener Shoe Cover



51075

Order No.	Mfr. No.	Description
51075	8-11100105	Bead Loosener Show Cover - Package of 6

CORGI Accessories for 9220, 9824, 2024 Tire Changers

Bead Breaker Pad



Order No.	Mfr. No.	Description
50212	900436199	Bead Breaker Pad

Inserts



Order No.	Mfr. No.	Description
51269	4-106611	Inserts

Locking Pin



Order No.	Mfr. No.	Description
51087	900339146	Locking Pin

Mount/Demount Heads

- Metal



50207



51226



50205

Order No.	Mfr. No.	Description
50207	258458	Metal Mount/Demount Head
51226	8-11100107	Mount/Demount Bottom Insert - Set of 5
50205	8-11100106	Plastic Inserts for Mount/Demount Head-Set of 10

Tire Bead Clamps



50200



51196

Order No.	Mfr. No.	Description
50200	801435685	Tire Bead Clamp
51196	262417A	Locking Bead Clamp Complete (Includes Extension)

Lube Buckets & Brushes

Order No.	Mfr. No.	Description
51095	423405	Lube Bucket for 9220, 9824

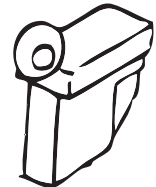

46657



46660



46659

Order No.	Description
46657	Lube Brush
46660	Angled Euro-Style Lube Brush 11" L. x 3" Dia.
46659	Straight Euro-Style Lube Brush 11" L. x 3" Dia.

HOFMANN 1620 High Volume, Heavy-Duty Tire Changers

Changes tires up to 50" outside diameter and 24" in rim diameter. Optional EasyMont Pro bead assist holds the bead in the drop center for 1-man operation in changing low profile & run flat tires. Powerful 2-position bead loosener & a ½" thick steel rim turntable. *Specs.: Clamping range 10"-21" external and 12"-24" internal; max. tire dia. 50"; max. rim width 15"; bead loosening pressure 6,000 lbs; air pressure req. 110 to 170 psi, 115V, 1 ph.*



Order No.	Description	Ship Wt.
59865	1620 High Volume Tire Changer - Electric	600 lbs. - 270 kg
59864	1620 High Volume Tire Changer - Air	600 lbs. - 270 kg

HOFMANN 3550em Low Profile Tire Changer

- For low profile, high performance, & run flat tires

Changes tires up to 47" outside diameter and 30" rim diameter. Easy Mount Pro bead assist holds the bead in the drop center changing low profile and run flat tires. Pneumatically controlled bead head lowers and locks into position. Plastic protection on all metal parts contacting the rim. *Specs.: Clamping range 12"-26" external and 14"-28" internal; max. tire dia. 47"; max. rim width 17"; bead loosening pressure 6,000 lbs; air pressure req. 110 to 170 psi, 115V, 1 ph.*



Order No.	Description	Ship Wt.
59858	3550EM Low Profile Tire Changer	975 lbs. - 434 kg

HOFMANN Monty 2800b Center Post Tire Changer

Includes mount/demount tool, lower bead breaker extension, hold down cone, nylon boot protectors, center post and positioning pin extension, lube bottle and brush. *Specs.: Rim diameter 10" to 17.5"; rim widths 3" to 19.75"; air supply 120 to 180 psi; center post torque 450 ft./lbs. @ 125 psi, 650 ft./lbs. @ 175psi; floor space req. 22" x 54.5" x 44*



Order No.	Description	Ship Wt.
59860	2800b Center Post Tire Changer	500 lbs. - 225 kg

Specifications:

Mfr. No.	Inside Clamping	Outside Clamping	Max. Rim Width	Max. Tire Diameter	Air Required	Electric Power	Ship Wt.
3550EM	14"-28"	12"-26"	17"	47"	110 to 170 psi	115V, 1Ph	975 lbs. - 434 kg
1625	12"-26"	10"-24"	15"	50"	110 to 175 psi	115V, 1Ph	620 lbs. - 279 kg
1620	12"-24"	10"-21"	15"	50"	110 to 170 psi	115V, 1Ph	600 lbs. - 270 kg

HOFMANN Monty 1625 High Volume Tire Changer

- 26" Rim capacity
- Air or electric models available

Handles tire and rim assembly diameters from 10" to 26", clamps rims up to 24" from the outside and 26" from the inside. 6,000 of bead breaking force. Includes lubricator and regulator. *Specs.: Clamping range 10"-24" external and 12"-26" internal; max. tire dia. 50"; max. rim width 15"; bead loosening pressure 6,000 lbs; air pressure req. air model 110 to 170 psi, elec. model 100 to 175 psi, 115V, 1 ph.*



Order No.	Description	Ship Wt.
59863	1625 High Volume Tire Changer - Electric	620 lbs. - 279 kg
59862	1625 High Volume Tire Changer - Air	620 lbs. - 279 kg

HOFMANN Monty 1625em High Volume Tire Changer

- Includes all the features & benefits of the Monty 1625 above plus the EasyMont Pro
- Air or electric models available

The EasyMont Pro features a top roller, pressing foot and lifting disc. Each piece provides a specialized function to aid the technician in mounting and demounting low profile and high performance wheel assemblies.

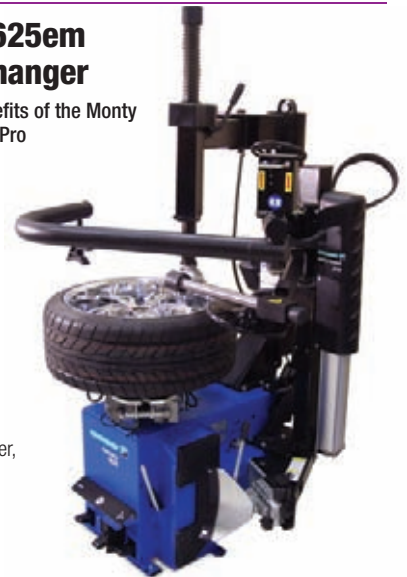

Order No.	Description	Ship Wt.
59861	1625em High Volume Tire Changer with EasyMont Pro - Electric	620 lbs. - 279 kg

HOFMANN Tire Changer Accessories



Order No.	Mfr. No.	Description
59838	0026582	Bead Breaker Protective Cover
59841	ST4027645	Outside Clamping Jaw Protectors (4 Each)
59845	EAA0247G15A	Protective Inserts for Mount/Demount Head (Pkg. 10)
59711	EAA0247G20A	Composite Mount/Demount Head
59843	ST0024335	Repl. Composite Head

Tire Changers

BOSCH TCE 4225 Entry Level Tire Changer

- 20" Outside clamping capacity
- Replaceable plastic inserts protect rim from metal-to-metal contact



57400

Order No.	Mfr. No.	Description	Ship Wt.
57400	TCE 4225	Swing Arm Tire Changer	539 lbs. - 245 kg

BOSCH Tilt Tower Tire Changers



57405



57416

Pneumatic tilt tower tire changers with 30" outside clamping capacity. The TCE 4465 THPL (57416) features a leverless mount/demount system and the dual cylinder pneumatic mounting system for faster operation. The TCE 4465 THP features the dual cylinder pneumatic mounting system with the standard mounting head.

Order No.	Mfr. No.	Description	Ship Wt.
57405	TCE 4465THP	Auto Tilt Tire Changer	656 lbs. - 298 kg
57416	TCE 4465THPL	Auto Tilt Tire Changer w/Leverless System	704 lbs. - 319 kg

BOSCH Center Post Hydraulic Leverless Tire Changer



57404

Versatile center post design. Dual clamping rollers loosen beads. Features an integrated control panel, an air operated follow arm to keep the top bead in the drop center when mounting and demounting tough tires and wheel lift.

Order No.	Mfr. No.	Description	Ship Wt.
57404	TCE 4540	Leverless Tire Changer	1,353 lbs. - 614 kg

Specifications:

Order No.	Mfr. No.	Leverless	Type	Inside Clamping	Outside Clamping	Max. Rim Width	Max. Tire Diameter	Air Required	Electric Power	Ship Wt.
57400	TCE 4225	No	Swing	12"-23"	10"-20"	10"	39 1/2"	100 to 170 psi	120V	539 lbs. - 245 kg
57401	TCE 4230	No	Swing	12"-28"	10"-26"	12"	44"	110 to 175 psi	120V	575 lbs. - 261 kg
57402	TCE 4230SFA	No	Swing	12"-28"	10"-26"	12"	44"	110 to 170 psi	120V	616 lbs. - 280 kg
57415	TCE 4335	No	Manual Tilt	12"-28"	10"-26"	12"	39 1/2"	100 to 170 psi	120V	598 lbs. - 271 kg
57403	TCE 4335THP	No	Manual Tilt	12"-28"	10"-26"	12"	39 1/2"	100 to 170 psi	120V	627 lbs. - 284 kg
57405	TCE 4465THP	Yes	Auto Tilt	14"-33"	12"-30"	15"	47"	100 to 170 psi	220V, 1 Ph	656 lbs. - 298 kg
57416	TCE 4465THPL	Yes	Auto Tilt	14"-33"	12"-30"	15"	47"	100 to 170 psi	220V, 1 Ph	704 lbs. - 319 kg
57404	TCE 4540	Yes	Full Auto	10"-30"	N/A	22"	59"	100 to 170 psi	220V, 1 Ph	1,353 lbs. - 614 kg

BOSCH Mid-Level Tire Changers

TCE 4335 & TCE 4335THP



57415



57403

Dual cylinder pneumatic mounting system on the 57403 offers three bead depressors for mounting and demounting low profile tires quick and easy. The heavy tower and cabinet provide maximum rigidity.

TCE 4230 & TCE 4230SFA



57401



57402

Swing arm tire changers with 26" outside clamping capacity without adapters. The following arm on the SFA model (57402) keeps the top bead in the drop center when mounting and demounting tough tires.

Order No.	Mfr. No.	Description	Ship Wt.
57401	TCE 4230	Swing Arm Tire Changer	575 lbs. - 261 kg
57402	TCE 4230SFA	Swing Arm Tire Changer w/Following Arm	616 lbs. - 280 kg
57403	TCE 4335THP	Manual Tilt Tire Changer w/Pneumatic Mounting	627 lbs. - 284 kg
57415	TCE 4335	Manual Tilt Tire Changer	598 lbs. - 271 kg

BOSCH Tire Changer & Balancer Combination

- TC 220S Entry level swing arm tire changer
- WBE 4100 Entry level digital wheel balancer
- See page 151 for details

Order No.
57406



COATS CHD-6330 Tire Changer

- Designed for moderate to high volume shops
- Handles rims from 13" to 27", tires up to 63" in diameter & 30.5" wide



Extended capacity four-chuck jaws allows multiple range of applications including demountable, reverse disc, standard disc, and off-road assemblies. Features a portable wired control unit.

Order No.	Mfr. No.	Description	Ship Wt.
50100	CHD-6330	Coats Truck Tire Changer 208 /220V, 3 Ph.	1,245 lbs. - 565 kg

COATS CHD-9041 Tire Changer

- Designed for moderate to high volume shops & fleets
- Handles rims from 14" to 46", up to 56" with optional clamp extensions, tires up to 90.5" in diameter & 42" wide



Extended capacity four-chuck jaws allows multiple range of applications. Features open range design for freedom of operator movement.

Order No.	Mfr. No.	Description	Ship Wt.
50099	CHD-9041	Truck Tire Changer 208 /220V, 3 Ph.	1,698 lbs. - 770 kg
50560	9299270	Optional Clamp Extensions 47" to 56", Set of 4	

COATS 6000 Tubeless Truck Tire Changer

Handles Dayton, Budd and standard disc wheels. Single mount, demount tool does all the work. No adapters required. Mounting is fast and easy using the two position chuck adjustment range and the pivoting tabletop that allows mounting/demounting in any position from near vertical to near horizontal. Air required.

Standard Equipment: 5' Pry Bar, swab, lube bucket, and a Duplex Combo Tool.

Order No.	Mfr. No.	Description	Ship Wt.
50204	6000	Truck Tire Changer, 1 Ph.	1,150 lbs. - 518 kg
50203	6000	Truck Tire Changer, 3 Ph.	1,150 lbs. - 518 kg

Specifications:

Mfr. No.	Tire Type	Min./Max. Rim Dia.	Max. Tire Diameter	Max. Tire Width	Max. Chuck Torque Ft./Lbs.	Electrical Specs.	Tool Arm Positioning	Tool Head Positioning	Max. Wheel Wt./lbs	Ship Wt.
6000	Tubeless	16½"-24½"	46"							1,150 lbs. - 518 kg
CHD-9551	Tube/Tubeless	14"-46"	95"	51"	7,017	230v, 3ph, 22A	Remote	Remote	3,970	2,282 lbs. - 1,035 kg
CHD-9041	Tube/Tubeless	14"-46"	90.5"	42"	5,262	230v, 3ph, 15A	Manual	Manual	3,300	1,698 lbs. - 770 kg
CHD-6330	Tube/Tubeless	13"-27"	63"	30.5"	4,816	230v, 3ph, 15A	Manual	Manual	3,300	1,245 lbs. - 565 kg

COATS CHD-9551 Tire Changer

- Designed for high-volume shops
- Handles rims from 14" to 46", up to 56" with optional clamp extensions, tires up to 95" in diameter & 51" wide



Handles super-single, skidder, agricultural, and off-the-road tires. Completely hydraulic operation. No heavy lifting of the tire and wheel assembly. Remote control rotating tool head/arm for fast tool changes. Two-speed motor for fast operation. Hydraulic chucking system.

Order No.	Mfr. No.	Description	Ship Wt.
50081	CHD-9551	Truck Tire Changer 208 /220V, 3 Ph.	2,282 lbs. - 1,035 kg
50562	9299234	Optional Remote Control	
50560	9299270	Optional Clamp Extensions 47" to 56", Set of 4	

COATS Accessories

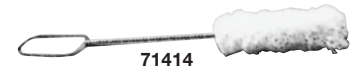

71414



71440

Order No.	Description
71440	Bottle for Coats 5000 & 6000
71414	Swab for Coats 5000 & 6000
71221	109346 Vise Grip Bead Holder

Alloy Rim Mount/Demount Tool Head for COATS 6000



Order No.	Mfr. No.	Description	Ship Wt.
51099	183945	Alloy Rim Tool Head	8 lbs. - 4 kg
51105	183950	Replacement Nylon Insert	1 lbs. - 1 kg

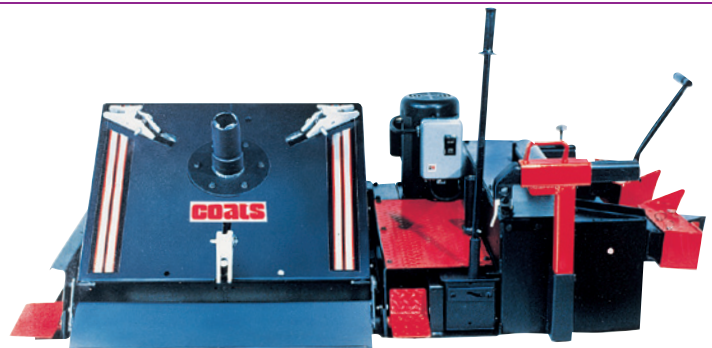

Truck Tire Changers

COATS CHD-4730 Tire Changer

- Designed for smaller fleets & tire shops
- Handles rims from 14" to 26", tires up to 47" in diameter & 30.5" wide



Manual hub nut and cone style mounting is simple and fast. Features swing-arm mounted controls.

Order No.	Mfr. No.	Description	Ship Wt.
50103	CHD-4730	Truck Tire Changer 208 /220V, 3 Ph.	981 lbs. - 445 kg

COATS 5000 Truck Tire Changer

- For tubeless & tube type
- Handles 15" thru 38" rims
- Electro-Hydraulic power for smooth operation



51137
Optional Adapter

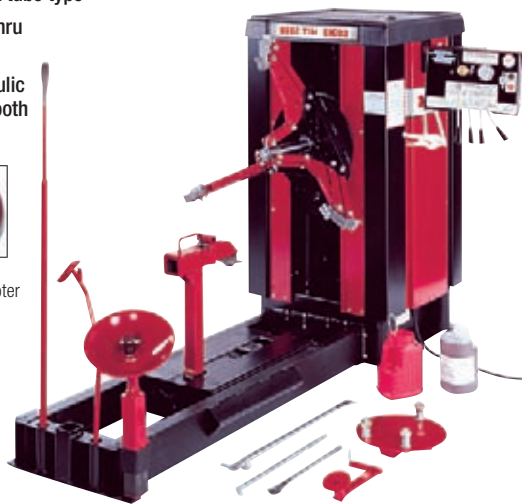

Hydraulic clamping chuck is self-centering and handles agricultural wheels up to 38". System provides smooth torque to remove all tires including super singles and off-highway tires. All activities are hydraulic powered, with pre-set pressure bypass valve to prevent system overload or wheel/tire damage. Includes earthmover bead loosener shaft, five foot pry bar, tubeless tire iron, lock ring tool, drop center tire iron, bead starting tool, vise grip, lube bucket, swab, stud piloted Budd adapter plate for protection of aluminum wheels, and a spreader adapter.

Order No.	Mfr. No.	Description	Ship Wt.
50070	5000	Truck Tire Changer 220V 1 Ph.	1,400 lbs. - 630 kg
50071	5000	Truck Tire Changer 220V 3 Ph.	1,400 lbs. - 630 kg
Optional Adapter for 10 bolt x 11.25" Hub Centered Budd Style Aluminum Rims			
51137	183803	Hub Piloted Budd Wheel Adapter	20 lbs. - 9 kg

Specifications:

Mfr. No.	Tire Type	Min./Max. Wheel Dia.	Max. Tire Diameter	Max. Section Width	Max Rim Width	Electrical Specs	Phase	Air Needed	Max. Wheel Wt./lbs.	Ship Wt.
5000	Tube/Tubeless	15"-38"	76"	25"		230v	1 or 3	No	1,400 lbs. - 635 kg	
CHD-4730	Tube/Tubeless	14"-26"	47"	30.5"		230v, 3ph, 12A	Manual	Manual	2,800	981 lbs. - 445 kg
AG52L	Tube/Tubeless	52"	87"		39"	230v	3	No	2,200	1,885 lbs. - 849 kg
HD1200	Tube/Tubeless	11" - 56"	98"		48"	230v	3	No	2,600	1,900 lbs. - 885 kg
AGTT	Tube/Tubeless		98"		63"	230v	3	No	3,748	2,866 lbs. - 1,300 kg

CORGHI AG 52L Tire Changer

- For tubeless & tube type

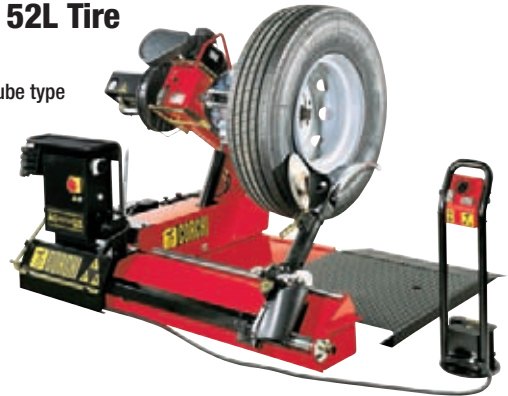

No adapters required for Budd or Dayton wheels. Ideal for aluminum wheels. Completely hydraulic operation. No heavy lifting of the tire and wheel assembly. Bead breaking, mounting and demounting all handled on the revolving turret assembly. Two-speed motor for fast operation. Hydraulic chucking system 220V, 3 ph.

Order No.	Mfr. No.	Description	Ship Wt.
50346	AG-52L	Truck Tire Changer	1,885 lbs. - 849 kg

CORGHI HD 1200 Tire Changer

- For tubeless & tube type
- Two hydraulically controlled speeds



Two hydraulically controlled speeds: a working speed, and a faster spindle/tool arm positioning speed. Hydraulic power pack is separate from the machine to make the best use of available space. Standard equipment: bead guide lever, short bead lifting lever, long bead lifting lever, tire mounting clamp, (4) extensions with gripper heads for 36" to 56" wheels, grease gun.

Order No.	Mfr. No.	Description	Ship Wt.
50312	HD1200	Truck Tire Changer	1,900 lbs. - 885 kg

CORGHI Monster AGTT Tire Changer

- For tires up to 98" in diameter
- Eliminates changing bars
- Radio-controlled operation



The hydraulic tilting jaws adapt to all types of rims up to 58". Maximum tire width is 63". Remote controlled operation allows technician complete maneuverability.

Order No.	Mfr. No.	Description	Ship Wt.
51512	AGTT	Monster Truck Tire Changer	1,885 lbs. - 849 kg

ESCO Maxi-Bead Breaker

- For truck, agricultural & light EM/OTR tires



Redesigned for newer heavy-duty 3-piece rims replacing 5-piece 25" and 29" rims. 4 1/4" stroke, 13-ton bead breaker. Air/hydraulic 10,000 psi pump required.

Order No.	Mfr. No.	Description	Ship Wt.
52437	10102	Maxi Bead Breaker	38 lbs. - 17 kg
52002	10501	Optional Air/Hydraulic Pump & Hose	24 lbs. - 11 kg

Economy Bead Breaker

- Service tractor & farm implement tires



5" Opening, works with any 10,000 psi pump. Options include an earthmover claw for tires up to 26" (52161) and a Truck Tire Claw (52162) that is 2" longer than the standard claw. Warranty 1-year parts, 90 days labor.

Order No.	Mfr. No.	Description	Ship Wt.
52160	BB-501	Economy Bead Breaker	5 lbs. - 3 kg
52161	V501-EM	Optional Earthmover Claw for 52160	
52162	V501-TRK	Optional Truck Tire Claw for 52160	

ESCO Shur-Lok Rim Kit

Fits all style earth mover bead breakers. For use with bead breakers, ESCO 1825 IMT 1800, FEC 1825, Branick EMB 10, Myers 16/18L, Goodyear TO-1600HA, OTR 1600.



Order No.	Mfr. No.	Description	Ship Wt.
52648	10607	Shur-Lok Rim Kit	2 lbs. - 1 kg

ESCO Pyrosafe Valve

- Releases lethal air pressure before an explosion can take place



Exhaust air from the tire when the temperature reaches 200° F. or 190 psi. Use on any rims from 25" through 63". Simple shop installation. Does not void wheel/tire warranty.

Order No.	Mfr. No.	Description	Ship Wt.
54513	10030	Pyrosafe Valve	1 lbs. - 1 kg

ESCO Combi Tire Bead Breaker

- For truck & farm tires



52001

52002

Handles single, two and three piece, 2-5-10 hole Budd, 7.5 x 16 and all tubeless truck tire and rims. No screws, bolts or attachments. Breaker assembly clamps hydraulically to all rims in seconds. Breaks beads with 10,000 lbs. of force. Not for E/M giant wheel and rim assemblies.

Optional 10620 Conversion Kit converts the 10101 Combi Bead Breaker to a 10102 Maxi Bead Breaker. Includes (2) replaceable teeth, claw and clamp.

Order No.	Mfr. No.	Description	Ship Wt.
52001	10101	Combi Head Assembly	27 lbs. - 13 kg
52002	10501	Optional 3 1/2 Qt. Air/Hyd. Pump & Hose	19 lbs. - 9 kg
52647	10620	Optional Conversion Kit	

ESCO TO-1600 Off-The-Road Tire Tool

- For 25" - 49" rims



52002

52442

For rims with pry bar pockets. Specifically designed to break earthmover tire beads on rusted rims.

Order No.	Mfr. No.	Description	Ship Wt.
52441	TO-1600	Tool with Hand Pump	47 lbs. - 22 kg
52442	TO-1600HA	Head Assembly Only	24 lbs. - 11 kg
52486	10508	Hand Pump & Hose Only	23 lbs. - 11 kg
52002	10501	Optional 3 1/2 Qt. Air/Hyd. Pump & Hose	19 lbs. - 9 kg

ESCO TO-2000 Off-The-Road Tire Removing Tool

- For 51" & larger OTR rims

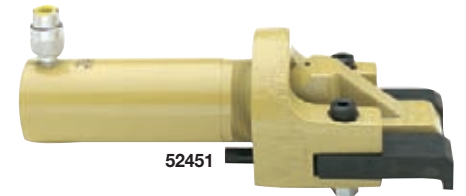

52004

52451

A portable hydraulically powered tire removing tool designed for unseating beads on all 39", 45", 51" and 57" rims. In most cases use two OTR 1825 or equivalent to start movement of the rim flange.

Component Parts

Order No.	Mfr. No.	Description	Ship Wt.
52450	TO-2000	Tool Complete (Head Assembly And Pump)	64 lbs. - 29 kg
52451	TO-2000HA	Head Assembly Only	40 lbs. - 18 kg
52472		Replacement 8' Hose with Coupler	12 lbs. - 6 kg
52004	10505	Optional 8 Qt. Air/Hyd. Pump with Hose	36 lbs. - 16 kg

OTR Tire Changing

ESCO 10106 Agricultural Tire Bead Breaker

Breaks inside bead on outside dual tractor tires with 10,000 lbs. of force. Requires 3" of operating space between tires. Maximum width is 24". Use with 10,000 lb. air/hydraulic pump.



Order No.	Mfr. No.	Description	Ship Wt.
52633	10106	Agricultural Tire Bead Breaker	20 lbs. - 9 kg
52002	10501	Optional 3½ Qt. Air/Hyd. Pump & Hose	19 lbs. - 9 kg

ESCO Crib Stand Set



All pieces in the set can be used individually or stacked for various lifting heights. Heavy-duty steel construction, capacity is 55-tons. Order the kit with all three crib stands or individually.

Order No.	Mfr. No.	Description	Ship Wt.
52656	12500	Crib Stand Set of Three	141 lbs. - 64 kg

ESCO Jack Plate Kit

- Complies to "...blocking for a firm foundation." OSHA Reg 29CFR 1926.305
- 20 To 100-ton capacities



Stabilizes jack when lifting. Polymer material will not corrode or rot. The plates double the surface area for the jack to sit on. Lifetime guarantee against breakage. Order the kit with all three jack plates or individually.

Order No.	Mfr. No.	Description	Ship Wt.
52655	10755	Jack Plate Kit With Three Plates	9 lbs. - 4 kg
52649	10753	20-Ton Jack Plate	
52631	10751	55-Ton Jack Plate	
52654	10751	100-Ton Jack Plate	

ESCO Earthmover Bead Hooks



Shaped to fit the bead of large tires. Steel hook with large eye inlet for hoist chain applications. Fits all truck mounted tire cranes. Prevents bead damage. Certified to meet OSHA and MSHA standards

Order No.	Mfr. No.	Capacity lbs.	Description	Ship Wt.
52657	90400	5,500	Bead Hook	33 lbs. - 15 kg
52658	90402	12,000	Bead Hook	39 lbs. - 18 kg
52659	90401	16,000	Bead Hook	59 lbs. - 27 kg

ESCO Ringmaster O-Ring & Lock Ring Installation Tool

- One man operation

Pushes and holds the rim flange and tire back for easy O-Ring and lock ring installation. It eliminates the use of a boom and fits in a tire truck tool box. Works on all 3 and 5-piece rim/wheels up to 30" in diameter.



Order No.	Mfr. No.	Description	Ship Wt.
52627	70162	Ring Master O-Ring & Lock Ring Installation Tool	22 lbs. - 10 kg

ESCO OTR-1825D Giant Tire/Earthmover Bead Breaker

- For 25" to 51" rims with pry bar pockets



An OTR/Giant Tire bead breaker for use on 5 piece rims 25" to 51" with pry bar bead loosening pockets. 4" Stroke for tough-to-break tire beads. Use with 52002 Air/Hydraulic pump or any equivalent 10,000 psi pump.

Order No.	Mfr. No.	Description	Ship Wt.
52427	OTR-1825D	Giant Tire Bead Breaker	20 lbs. - 9 kg
52002	10501	Optional 3½ Qt. Air/Hyd. Pump & Hose	19 lbs. - 9 kg

ESCO TO-100 OTR Tire Removing Tool

- Small rims without pry bar pocket



A rugged, portable hydraulic powered tire removing tool for fast and easy bead breaking on 16.00 and larger tube type and tubeless tires. Complete with easy to follow instructions.

Component Parts

Order No.	Mfr. No.	Description	Ship Wt.
52400	TO-100	Tool Complete (52430 & 52486)	82 lbs. - 38 kg
52430	TO-100-HA	Head Assembly Complete	62 lbs. - 28 kg
52429	TO-100-FA	Frame Assembly Only	20 lbs. - 9 kg
52486	TO-100-PA	Hand Pump Assembly & Hose	23 lbs. - 11 kg
52432	TO-100-RA	Ram Assembly Only	22 lbs. - 10 kg
Optional Pump			
52002	10501	Optional 3½ Qt. Air/Hyd. Pump & Hose	19 lbs. - 9 kg

ESCO Talon Bead Breaker

- For 3-piece rims with large flanges

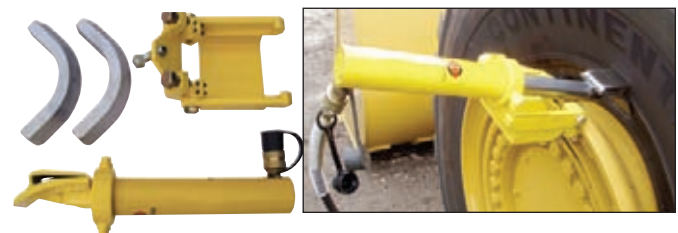

Designed for heavy-duty 3-piece rims that replace standard 5-piece rims, 20.5 x 25 thru 29.5 x 25. Head units clamps manually to the flange. Works on front and rear wheels without dismounting from the vehicle. Also works on wheels with CAT "Shur-Lok" feature.

Order No.	Mfr. No.	Description	Ship Wt.
52619	10109	Talon Bead Breaker	30 lbs. - 14 kg
52002	10501	Optional 3½ Qt. Air/Hyd. Pump & Hose	19 lbs. - 9 kg

Two Bar Push Tool

- For giant tire & earthmover tires

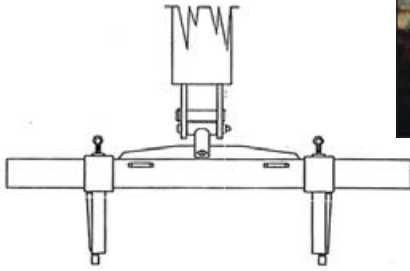

Attaches to the end of the boom with power extension. Used to push the bead seat band and flange ring for fast and easy dismounting of OTR/EM tires. Meets the OSHA requirement and acts as a tire inflation cage when left in place during inflation of OTR tires. Unit handles 25" through 51" rims.

Order No.	Mfr. No.	Description	Ship Wt.
52630	90200	2 Bar Push Tool	56 lbs. - 25 kg

Adjustable Locking Tire Sling

- For giant tire & earthmover tires

Fast and easy way to handle tires in the horizontal or vertical position. The endless chain and locking mechanism in the sling allow the operator to position the tire in any position needed.



Order No.	Mfr. No.	Description	Ship Wt.
52634	90100	Adjustable Locking Tire Sling	56 lbs. - 25 kg

Rim Base & Bead Seat Band/Pulling Tool

- For giant tire & earthmover tires

Designed to lift the rim base from the tire, remove the bead seat band from the tire, or aid in the seating of the bead seat band during inflation. Features a 4 point chain and hook assembly and attaches to the boom end.



Order No.	Mfr. No.	Description	Ship Wt.
52636	90300	Rim Base Tool	34 lbs. - 16 kg

100 & 55-Ton Aluminum Jacks



Suited for almost every heavy lifting situation, in the shop or the job site. Use with any 10,000 psi air over hydraulic pump with appropriate couplers. Shut-off valve included.

Order No.	Mfr. Code	Capacity Tons	Height		Ship Wt.
			Low	High	
52629	10312	55	10 1/2"	163/2"	29 lbs. - 13 kg
52460	10308	55	11"	17"	38 lbs. - 18 kg
52635	10314	55	14 3/8"	24 3/8"	41 lbs. - 19 kg
52435	10300	100	11 1/4"	17 3/4"	40 lbs. - 19 kg
52004	10505	Optional 8 Qt. Air/Hyd. Pump & Hose			36 lbs. - 16 kg

Air/Hydraulic Pumps

- 10,000 PSI rating



Use with truck, agricultural and OTR bead breakers. 8-Quart capacity with a steel reservoir recommended for 55 and 100-ton jacks and bead breakers. Includes 8' hose.

Order No.	Mfr. No.	Description	Ship Wt.
52002	10501	3 1/2 Qt. Air/Hydraulic Pump with Hose	12 lbs. - 5 kg
52639	10593	5-Qt. Air/Hydraulic Pump with Hose	30 lbs. - 14 kg
52004	10505	8-Qt. Air/Hydraulic Pump with Hose	36 lbs. - 16 kg
52472		Replacement Hose	

Hydraulic Hand Pump

Two-speed pump delivers 10,000 psi. Includes 8' hose.



Order No.	Mfr. No.	Description	Ship Wt.
52486	10508	Manual Pump with Hose	14 lbs. - 6 kg
52472	65590	Replacement Hose	5 lbs. - 3 kg

Replacement Hydraulic Couplers



Caution: Applications may change with ram manufacturer's model changes. Visually compare before ordering.

Order No.	Mfr. No.	Description
52483	H2-62	1/4" FPT Coupler for Older Elrick; IMT
52484	H2-63	1/4" FPT Adapter for 52483
52425	65582	3/8" MPT Coupler for Blackhawk, Hein-Werner or Goodyear TO-100, TO-1600 Rams
52433	65581	3/8" FPT Adapter for 52425
52459	9796	3/8" MPT High Flow Coupler for Branick, OTC or Goodyear & ESCO. 30% More Flow
52482	9798	3/8" FPT Adapter for 52459
50892	TC-371	3/8"-18 NPSF Coupler - Fast Flow 30% More Flow
50894	TC-372	3/8"-18 NPSF Adapter - Fast Flow 30% More Flow

Hydraulic Rams

- Used to push off rear beads on earthmover wheels.



Order No.	Mfr. No.	Capacity Tons	Stroke Inches	Ret. Height	Ship Wt.
52638	10301	10	2 1/8"	4 3/4"	5 lbs. - 3 kg
52640	10303	10	6 1/8"	9 3/4"	10 lbs. - 5 kg
52642	10305	10	10 1/4"	13 3/4"	14 lbs. - 6 kg
52644	10306	30	2 7/8"	4 5/8"	14 lbs. - 6 kg

OTR Tire Changing

IMT 300 Dual Bead Breaker

- For dual agricultural tires



Uses up to 10,000 lbs. of force to break inside beads on outside dual farm tractor tires. Requires just 4½" of operating space. Extends to 12" wide. Use with air/hydraulic pump.

Order No.	Mfr. No.	Description	Ship Wt.
50907	300	Dual Bead Breaker	20 lbs. - 9 kg
50906	200	Optional 5 Qt. Air/Hyd. Pump & Hose	22 lbs. - 10 kg

IMT 1000 Bead Breaker

- For up to 29" diameter tires



Breaks 3-piece earthmover rims with solid back flange/rim base assemblies and rims with lock ring retainers. Adjustable clamping jaw accommodates larger OTR rim flanges as on graders, wheel loaders and haul trucks. Works on single and multi-piece rims. 10,000 psi air/hydraulic pump required.

Order No.	Mfr. No.	Description	Ship Wt.
52653	51718925	1000 Bead Breaker	30 lbs. - 14 kg
50906	200	Optional 5 Qt. Air/Hyd. Pump & Hose	22 lbs. - 10 kg

IMT 150 Bead Push-Off Tool

- For agricultural tires

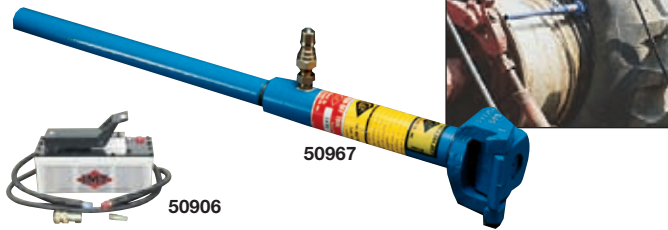

A lightweight tool for removing combine and tractor tires after breaking the bead. The push-off tool hooks between the rim and the tire bead and uses hydraulic pressure to force the tire off the rim. Features 8000 lb. pushing force, 5½" stroke and removable handle for compact storage.

Order No.	Mfr. No.	Description	Ship Wt.
50967	150	Push-Off Tool	7 lbs. - 4 kg
50906	200	Optional 5 Qt. Air/Hyd. Pump & Hose	22 lbs. - 10 kg

Manual Bead Breaker

Used on most drop center rims, from small all-terrain vehicles to large rear tractor tires. In many cases it's not necessary to remove the wheel from tractors or backhoes. Made from strong heat treated chrome-molybdenum steel. The bolts are made of high quality heat treated steel with a specially designed head to accept a ½" drive ratchet wrench (no need for a socket) and acme threaded bolts are used for long durable service.



Order No.	Mfr. No.	Description	Ship Wt.
52494	STBB	Manual Bead Breaker	27 lbs. - 13 kg

IMT 210 HP Portable Bead Breaker



Ideal for tractor, truck, grader, and farm implement tire bead breaking. Smooth air hydraulic action works on all types of rims. Breaks the inside and outside bead without removing the tire, and will not damage the bead or rim.



Order No.	Mfr. No.	Description	Ship Wt.
50959	210HP	210 HP Head Assembly	27 lbs. - 12 kg
50906	200	Optional 5 Qt. Air/Hyd. Pump & Hose	22 lbs. - 10 kg

OTR Flange Ring Clamp

- No hooks needed
- No more packing bead area with tire paste

Removes stuck rim flanges and bead seat bands from wheels 24" thru 64" in diameter. The clamp grips the flange from the outside and allows it to be maneuvered using the truck boom. Once in place, two clamps can be used to pull the flange out to seal at the O-ring. Weight capacity 3,000 lbs.



Order No.	Mfr. No.	Description	Ship Wt.
52079	90350	OTR Flange Ring Clamp (1 each)	9 lbs. - 5 kg

IMT 1800 OTR Bead Breaker

- For large OTR tires 25"-49" rims with pry bar pockets

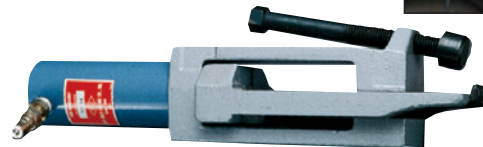

Designed to unseat tire beads on 25" to 51" OTR rims with pry bar pockets. Ideal for OTR field service repairs. Specs.: 4" stroke, 14-tons of force @ 10,000 psi, ram dia. 2 ½", ram length 17".

Order No.	Mfr. No.	Description	Ship Wt.
50905	1800HA	OTR Bead Breakers	28 lbs. - 13 kg
50906	200	Optional 5-Qt. Air/Hyd. Pump & Hose	22 lbs. - 10 kg

Earthmover Bead Hook

Shaped to fit the bead of large tires. Steel hook with large eye inlet for hoist chain applications. Fits all truck mounted tire cranes. Prevents bead damage.



Order No.	Mfr. No.	Capacity lbs.	Description	Ship Wt.
52462	52712702	18,000	Bead Hook	28 lbs. - 14 kg

IMT 100 & 55 Ton Aluminum Jacks



Jack/Rams are suited for almost every heavy lifting situation, in the shop or on the job-site. Use with any 10,000 psi air over hydraulic pump with appropriate couplers.

Order No.	Mfr. No.	Capacity Tons	Height		Ship Wt.
			Low	High	
52464	51704499	55	12"	18"	25 lbs. - 11 kg
52087	51712504	55	16"	26"	41 lbs. - 19 kg
52088	51704501	100	12"	18"	55 lbs. - 25 kg
50906	51705747	Optl. 5 Qt. Air/Hydr. Pump & Hose			22 lbs. - 16 kg

AME 11075 Diamondback Aluminum Bead Breaker

- Aluminum reduces tool weight by 40%



8" Long feet allows better fit into the wheel and rim. 14 Ton cylinder breaks all beads. Use with air/hydraulic pump.

Order No.	Mfr. No.	Description	Ship Wt.
85001	11075	Diamondback Aluminum Bead Breaker	31 lbs. - 14 kg
85015	15920	Optional 5 Qt. Air/Hyd. Pump & 8' Hose	23 lbs. - 11 kg

AME 11060 Dual Agricultural Tire Bead Breaker

- Compact design allows tool to go into a 3" wide space

Spreads to 26" wide. Used to break the inside bead of the outside tire on a dual assembly or break the inside bead of the inside tire when placed against the vehicle frame. 10 Ton cylinder delivers enough force to break tractor beads. Use with a 10,000 psi air/hydraulic pump.



Order No.	Mfr. No.	Description	Ship Wt.
85000	11060	Dual Agricultural Tire Bead Breaker	39 lbs. - 18 kg
85015	15920	Optional 5 Qt. Air/Hyd. Pump & 8' Hose	23 lbs. - 11 kg

AME Tire Bead Breaker Kit

- For the tire dealer who requires an occasional use of a bead breaker



The kit includes the Titan farm tire bead breaker and a 5 quart 10,000 psi air/hydraulic pump with an 8' hose and coupler. The 10 ton cylinder has the power to break most beads. Use on all single and two piece rims and most three piece wheels. The 5 quart pump has a high density polyethylene reservoir.

Order No.	Mfr. No.	Description	Ship Wt.
85002	12030	Tire Bead Breaker Kit	60 lbs. - 27 kg

AME Manual Bead Breaker

- For ATV, golf cart, truck, bus & agricultural tires



Requires air ratchet or manual wrench. Excellent for working on the tire without removing the wheel.

Order No.	Mfr. No.	Description	Ship Wt.
85021	71600	Manual Bead Breaker	12 lbs. - 5 kg

AME Air/Hydraulic Pumps

- 2.5 & 5 Quarts



85014



85015

2.5 Quart pump features high density polyethylene reservoir. The 5 quart pump has a steel reservoir. Both pumps include an 8' hose and coupler.

Order No.	Mfr. No.	Description	Ship Wt.
85014	15900	2.5 Qt. Air/Hyd. Pump & 8' Hose & Coupler	31 lbs. - 14 kg
85015	15920	5 Qt. Air/Hyd. Pump & 8' Hose & Coupler	23 lbs. - 11 kg

AME 13000 100 Ton Aluminum Jack

- 6" Stroke



Specs.: 11 3/4" low height; 17 3/4" maximum height, ship. wt. 53 lbs.

Order No.	Mfr. No.	Description	Ship Wt.
85003	13000	100 Ton Aluminum Jack	53 lbs. - 24 kg

AME Cribbing Blocks

- Certified & tested
- Made from 100% recycled plastic

The cribbing blocks are designed to provide superior stability over hardwood and softwood products. They will not splinter or absorb most fluids. Features carrying lanyards on 6" x 7" and yellow blocks.

85010 10 Piece Set includes (6) 85009, (3) 85007 and (1) 12" x 12" x 1 1/2" jack plate.

85011 12 Piece Set includes (12) 85009, 298,000 lb. capacity when used in three block configuration.



Order No.	Mfr. No.	Description	Size	Ship Wt.
85007	15210	Cribbing Block Black	4" x 4" x 18"	5 lbs. - 2 kg
85008	15220	Cribbing Block Yellow	4" x 4" x 18"	6 lbs. - 3 kg
85009	15230	Cribbing Block Black	6" x 7" x 24"	26 lbs. - 12 kg
85010	15255	10 Piece Cribbing Set		182 lbs. - 86 kg
85011	15260	12 Piece Cribbing Set		312 lbs. - 142 kg

AME OTR Urethane Wheel Chocks

- Designed for mining & construction industries

Resistant to oils, fuels and solvents. Features mounting hole for ropes, chains or brackets and replaceable rubber anti-slip traction pads.

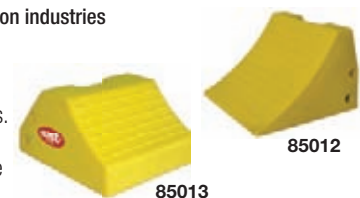

85013

85012

Order No.	Mfr. No.	Description	L x W x H	Ship Wt.
85012	15305	Wheel Chock	15" x 15" x 11"	19 lbs. - 9 kg
85013	15310	Wheel Chock for tire sizes up to 105"	17 3/4" x 15 1/4" x 10"	28 lbs. - 13 kg

Bead Seaters

CHEETAH 6 Gallon Bead Seater

- Seats the toughest beads
- Optional 18 lb. aluminum tank
- ASME tank



For commercial use on large truck, passenger, and ATV tires. ASME certified tank. With air hooked up to the tire valve, simply apply a blast from the Cheetah between the tire and rim to seat the toughest beads quickly and easily. The Cheetah tool is self-contained and includes an automatic pop-off valve and pressure gauge to show the amount of air in the tank. Fill the tank from any service station chuck or service truck air compressor. The **Aluminum Tank** model weighs only 18 lbs.

Order No.	Mfr. No.	Description	Ship Wt.
50909	CH-5	Cheetah with Steel Tank	27 lbs. - 13 kg
50971	CH-5-A	Cheetah with Aluminum Tank	18 lbs. - 8 kg

Replacement Parts for 50909/50971

Order No.	Mfr. No.	Description	Ship Wt.
50976	2.102	Discharge Valve	2 lbs. - 1 kg
50940	2.103	Threaded Barrel	3 lbs. - 2 kg
50942	1.106	200 PSI Gauge	1 lbs. - 1 kg
50941	4.103	Ball Valve	1 lbs. - 1 kg
50975	1.107	3/4" to 1/4" Bushing	1 lbs. - 1 kg
50943	3.104	90° Fitting	1 lbs. - 1 kg
50977	5.102	Safety Release Valve	1 lbs. - 1 kg

CHEETAH Magnum Inflation Barrels



Expands the range of the CHEETAH by blasting more air around a larger area. **50932 Magnum I Barrel** for use with the 6-gallon for small implement 15.5 to 16.1 applications. **50933 Magnum II Barrel** for use with the 10-gallon for medium implement and tractor tires 23.1/26 applications.

Order No.	Mfr. No.	Description	Ship Wt.
50932	2.106	Cheetah Magnum I Barrel	5 lbs. - 3 kg
50933	3.106	Cheetah Magnum II Barrel	10 lbs. - 5 kg

CHEETAH 60-Gallon Adjustable Bead Seating System

- For seating radial farm tires

Designed to seat the bead on large tractor tires in either the vertical or the horizontal position. Adjustable from 24" to 54" bead diameter. Use in the shop or on a service truck. Includes 60-gallon tank, adjustable barrel system, tractor tire stand, 20' whip hose, and two 2 1/2" diameter 8 foot long discharge hoses.



Order No.	Mfr. No.	Description	Ship Wt.
50938	CH60	Cheetah Adjustable Bead Seating System with Tank	300 lbs. - 135 kg
50908	-	Adjustable Barrel, Hose, Stand, Whip Hose Only without Tank	240 lbs. - 108 kg

CHEETAH 13-Gallon Magnum Bead Seater Package

- 36 lb. Aluminum tank
- Portable
- Ideal for tractor & heavy equipment tires



Larger discharge radius and increased volume seats the bead on wheel sizes 24" to 54". Used in the shop, with the tire horizontal or on the vehicle. Includes 36 lb. aluminum tank, Magnum I barrel and safety goggles.

Order No.	Mfr. No.	Description	Ship Wt.
50934	CH-13-AL-MTO	Cheetah 13-Gallon Aluminum Tank with Barrel	36 lbs. - 17 kg

CHEETAH 10-Gallon Bead Seater

- Lightweight aluminum tank



Ideal for use on small tractor tires, large truck, and passenger tires. ASME certified tank.

Order No.	Mfr. No.	Description	Ship Wt.
50904	CH-10	10-Gallon Cheetah Bead Seater	22 lbs. - 10 kg

GAITHER Bead Bazookas

- Easily seats truck & passenger tires & a wide range of OTR & AG tires
- ASME, CE & TUV certified



Double barrel delivers air charge over a larger area



Push button automatic release valve is 20% faster than a manual valve. Unique double barrel design shoots air over a larger part of the bead for fast seating

Order No.	Description	Ship Wt.
50947	Bead Bazooka 1.6 Gallon Tank	?? lbs. - ?? kg
50948	Bead Bazooka XL 2.3 Gallon Tank	?? lbs. - ?? kg

Passenger & Truck Tire Bead Seaters



One piece neoprene tube for mounting hard-to-seat radial, bias-belted, and conventional tires. As tire is inflated, lubricated expander forms a seal between the rim and the tire allowing the air pressure to force the beads into the wheel rim flange. Expander compresses, then automatically eases up & off rim. Three sizes for truck tires 16.5 thru 24.5 rims, 2 sizes for passenger.

Passenger

Order No.	Mfr. No.	Description	Ship Wt.
93300	31443	For 13" Rims	4 lbs. - 2 kg
93306	31446	For 14" & 15" Rims	4 lbs. - 2 kg
Truck			
50961	TC-50	For 16.5" & 17.5" Rims	4 lbs. - 2 kg
50962	TC-60	For 19.5" Rims	4 lbs. - 2 kg
50963	TC-70	For 22.5" & 24.5" Rims	5 lbs. - 2 kg

Pneumatic Bead Expanders



Expanders fit most bias ply passenger tires. A neoprene rubber tube is in a tough, long-lasting nylon cover. Expanders slip easily over tire and withstand contact with oil, grease, solvents, and acids. Draw the strap tight and lock with two rings. Inflate the unit to expand the bead against the rim and deflate after the tire is seated and inflated. Follow instructions included with tool. Use T-132 on bias ply, 14", 15", 70-series tires and larger. T132 for belted tires includes over-pressure release valve.

Order No.	Mfr. No.	Min/Max Diameter	Tube Diameter	Ship Wt.
50950	T-132	24"-34"	2 1/4"	3 lbs. - 1 kg
50930	T-133	22"-32"	3/4"	1 lbs. - 1 kg
50928	T-133-1	Replacement Inflate Thru Cap. T-132, T-133		1 lbs. - 1 kg

Truck Tire Bead Seater

Quickly and efficiently seats beads on all tubeless truck tires. Jet blast principle seats bead in seconds. For complete system order: 50984 hose & valve assembly, 50987 ring 22.5" to 24.5" or ring of your choice, 50996 surge tank. This includes the 50997 200 lb. pressure gauge and 50998 165 lb. safety valve. 145-175 PSI required. If supply line is less than 1" diameter, optional surge tank may be needed for sufficient air volume.



Order No.	Mfr. No.	Description	Ship Wt.
50984	31103	Hose Valve Assembly: 8' of Hose & Hand Operated Valve	7 lbs. - 4 kg
Rings			
50985	31212	For Rim Size 14.5" to 16.5"	5 lbs. - 3 kg
50986	31211	For Rim Size 17.5" to 19.5"	6 lbs. - 3 kg
50987	31210	For Rim Size 20" to 24.5"	8 lbs. - 4 kg
50989	31213	For Rim Size 17.5" Only	7 lbs. - 4 kg
50995	31214	For Rim Size 22.5" Only	8 lbs. - 4 kg
Optional Surge Tank			
50996	31701	20 Gal. Surge Tank	60 lbs. - 27 kg
Replacement Parts			
50997	31624	200 Lb. Pressure Gauge (Repl.)	1 lbs. - 1 kg
50998	31625	165 Lb. 3/4" MPT Pop Off Valve (Repl.)	1 lbs. - 1 kg
50983	31303	8' Hose	5 lbs. - 3 kg
44715	31401	1" Ball Valve	2 lbs. - 1 kg

Remote Mount Automatic Inflation Kit



Conforms with recommendations from the T.I.A. and the R.M.A. on tire inflation. Consists of a wall mounting bracket, adjustable regulator with pressure gauge to set tire pressure, On/Off lever, 20' of air hose, clip-on chuck and quick release coupler. Includes a disconnect at the regulator to deflate the tire in an emergency.

Order No.	Description	Ship Wt.
54615	Remote Mount Automatic Inflation Kit	8 lbs. - 4 kg

OSHA Poster Kits



Revised by OSHA 12-21-11. Large 2' x 3' format required for compliance. Demounting and Mounting Procedures for Tube-Type Truck and Bus Tires; Demounting and Mounting Procedures for Tubeless Truck and Bus Tires and Multi-Piece Rim Matching chart.

Order No.	Description
84245	OSHA Poster Kit



What Is A Zipper?

The violent rupture of the sidewall on an radial truck or light truck tire around the circumference of a sidewall.

What Causes A Zipper?

The sidewall cables are weakened or broken due to running tires underinflated and/or overloaded.

When Does A Zipper Rupture Occur?

A damaged tire can zipper at anytime. A critical and dangerous time is during inflation of the tire.

What Protection Is Available?

Follow OSHA procedure. *Always inflate tires in an approved inflation cage using a remote inflation device.*

Tire Inflation Cages

Tire Inflation Cages

- Tested & certified to 130 psi inflation levels



52925
Light Truck
& Run Flat



52870
2 Bar Portable
for Service Trucks



52878
For 445.50/22.5
Super-Wide Radial Tires



52927



52869

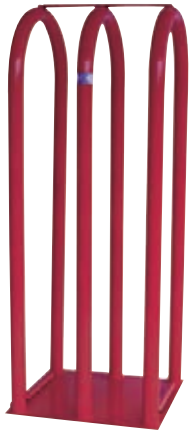

52916



52915



52921

Guard against blown lock rings, exploding rims, zippers and ruptured tire explosions. All cages conform to OSHA standard 1910.177 for multi-piece and single rim restraining devices. Always use with a remote inflation device. Cages are rated on 120 psi on multi-piece wheels per OSHA specifications.

Order No.	Mfr. Code	Description	Inside Height	Width	Base	Ship Wt.
52925	LT-1	Run Flat Cage	30"	16"	21½" 22"	80 lbs. - 36 kg
52870	T101	2 Bar Cage	41"	16"	7" Close 27"	60 lbs. - 27 kg
52878	T101A	Super-Wide	43½"	20½"	7" Close 27"	72 lbs. - 33 kg
52916	TT-106	3 Bar Cage	54½"	20½"	26" 26"	134 lbs. - 61 kg
52927	TT-104	4 Bar Cage	54½"	20½"	31½" 26"	146 lbs. - 66 kg
52915	TT-103	5 Bar Cage	54½"	20½"	41" 26"	182 lbs. - 83 kg
52921	TT-1007	7 Bar Cage	60"	27½"	34" 56"	485 lbs. - 218 kg
52869	T-104	Agricultural Cage	65"	24"	30" 27"	158 lbs. - 73 kg

WARNING: Do not alter cage in any way. Cage must be free standing and at least three feet from other objects.
DANGER: Discard cage if bent, cracked or otherwise damaged.

For reference only. Height "A" refers to the approximate height to the inside bend of the cage. May accommodate taller tires. "B" is the side-to-side inside measurement.

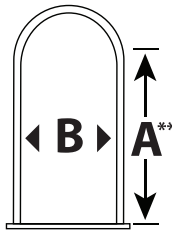

WARNING: Tire changing can be dangerous and should be done only by trained personnel using proper tools and equipment as directed by Federal OSHA Standard No. 29 CFR Part 1910.177. Tire may explode during inflation causing injury to operator or bystander. Keep all parts of body outside cage. Use extension hose, clip-on chuck and remote valve. See supervisor for safety procedures.

EZ Tire Rotator

- Easily rotates tire & wheel assembly when positioning the valve stem



For Ken-Tool 3, 4 and 5 bar inflation cages plus many competitive cages. Reduces back strain while handling tire and wheel assemblies.

Order No.	Description	Ship Wt.
52919	EZ Tire Rotator	19 lbs. - 9 kg

Earthmover Tire Inflation Cage

- For large earthmover & agricultural Tires
- For maximum tire inflation up to 100 lbs.
- Cage dimensions 48" x 72" x 89".



Base dimensions: 48" x 72".

Order No.	Description	Ship Wt.
52923	Earthmover Tire Inflation Cage	820 lbs. - 372 kg

Tire Balancing

Myers Tire Supply is your tire balancing headquarters. Custom automotive wheel and rim assemblies require specialized equipment & handling to balance properly. Myers Tire Supply offers **COATS**, **HOFMANN**, **CORGHI** & **BOSCH** passenger tire balancers as well as the required adapters and accessories. **COATS**, **CORGHI** & **HOFMANN** truck tire balancers are available for your heavy-duty needs. Myers also offers the most complete line of lead & environmentally-friendly steel & zinc wheel weights from **BADA**, **PERFECT** & **HOFMANN**. A list of states regulated using lead wheel weights is on page 165. A complete line of truck wheel weights, **ESCO** liquid balancing & **IMI** Equal truck tire balancing formula is available.



COATS ProRide Diagnostic Wheel Balancers

- Touchless radial runout diagnostics identifies problem wheel assemblies
- PL Model features Pneumatic Locking Mounting System
- Adapter Kits sold separately



Place the distance arm to the desired wheel weight location to automatically selected the weight mode. The position pedal holds the wheel assembly in position when applying weights. The balancer tracks the number of daily spins and the type and number of weights used. Both models offer self-calibration, 3 parameter automatic data entry, match mounting and 11 balancing modes plus radial runout. The PL model features the Pneumatic Locking Mounting System. The foot pedal activates the pneumatic shaft reducing mounting time and the constant pressure reduces mounting errors. *Specs.: cycle time 12 seconds; 1.4 hp indirect motor; max. tire diameter 42"; max. rim width 19"; mac. wheel assembly weight 160 lbs.; 40mm shaft diameter; 115.v, 50/60 Hz; footprint 45"w x 49" d.*

Order No.	Mfr.No.	Description	Ship Wt.
59405	ProRide	Balancer - 40 MM Shaft 115V	275 lbs. - 125 kg
59404	ProRide PL	Balancer - 40 MM Shaft 115V	275 lbs. - 125 kg

COATS Adapter Kits for ProRide Balancers

- 40mm Shaft
- Premium kit offers the greatest coverage
- PL Adapter Kits do not include the Slide Nut Package



Basic Kit: Includes 4 passenger cones, wheel weight hammer, calipers, weight scraper and slide nut package

Extended Kit: Includes 4 passenger cones, wheel weight hammer, calipers, weight scraper, slide nut package, back cone spacer, light truck cone kit and short cone.

Premium Kit: Includes 4 passenger cones, wheel weight hammer, calipers, weight scraper, slide nut package, back cone spacer, light truck cone kit, short cone, Pin Plate System and Balancer Mate.

Order No.	Mfr.No.	Description
71682	8560759002	ProRide Basic Passenger Car Coverage Kit
71681	85607590	ProRide PL Basic Passenger Car Coverage Kit
71684	85607808	ProRide Extended Passenger Car Coverage Kit
71683	85607809	ProRide PL Extended Passenger Car Coverage Kit
71686	85607810	ProRide Premium Passenger & Light Truck Kit
71685	85607811	ProRide PL Premium Passenger & Light Truck Kit

Tire Balancers

COATS 1250-3D & 1250-3DV Wheel Balancers

- Laser guided operation provides pinpoint accuracy when applying Tape-A-Weights
- 1250-3D features LED display
- 1250-3DV features LCD display



Automatically positions the tire and wheel assembly at the correct weight position and holds the spindle aiding weight installation. Then, with the push of a button, the tire and wheel assembly is indexed to the next weight position. Commercial flat screen video monitor guides the technician through the balancing process. Static, dynamic, RV & four different alloy wheel modes with Direct Select weight placement. Automatic distance, diameter and width entry and auto indexing to weight placement. Warranty, 1-year parts, 6 months labor. *Both models feature fully automatic distance, diameter and width reading. 40 MM shaft and adapter kit required – see below.*

Order No.	Mfr.No.	Description	Ship Wt.
59383	1250-3DV	Balancer - 40 MM Shaft 220V, 1Ph.	680 lbs. - 308 kg
59384	1250-3DV	Balancer - 40 MM Shaft 220V, 3Ph.	680 lbs. - 308 kg
59286	1250-3D	Balancer - 40 MM Shaft 220V, 1Ph.	680 lbs. - 308 kg
59287	1250-3D	Balancer - 40 MM Shaft 220V, 3Ph.	680 lbs. - 308 kg

COATS 1250-2D Laser Guided Tire Balancer

- Laser guided operation provides pinpoint accuracy when applying Tape-A-Weights
- 28mm or 40mm shaft options



Commercial flat screen with keypad guides technician through the balancing process. Static, dynamic, RV & four different alloy wheel modes with Direct Select weight placement. Automatic offset and diameter measurements.

Note: Order 28mm Adapter Kits from chart below. Order 40mm Adapter Kits from bottom of page.

Order No.	Mfr. No.	Shaft Size	Description	Ship Wt.
59340	1250-2D	40mm	Wheel Balancer 220v 1Ph	625 lbs. - 283 kg
59382	1250-2D	40mm	Wheel Balancer 220v 3Ph	625 lbs. - 283 kg
59398	1250-2D	28mm	Wheel Balancer 220v 1Ph	625 lbs. - 283 kg
59399	1250-2D	28mm	Wheel Balancer 220v 3Ph	625 lbs. - 283 kg

28mm Shaft & Adapter Kits

Order No.	Shaft Size	Description
71672	28mm	Basic Adapter Kit for 11250-2D 28mm Shaft
71674	28mm	Extended Adapter Kit for 11250-2D 28mm Shaft
71676	28mm	Premium Adapter Kit for 11250-2D 28mm Shaft

COATS Adapter Kits for 1250-2D, 1250-3D & 1250-3DV Balancers

- 40mm Shaft
- Balancers are not shipped with adapters
- Premium kit offers the greatest coverage



Basic Kit: Coverage for most O.E. passenger cars and some light truck wheels. Small Cone, Medium Cone, Large Cone, Light Truck Back Cone, Calipers, Premium Wheel Weight Hammer, Hub Nut, Small Pressure Cup & Rubber Lip, Spring, Stub Shaft.

Extended Kit: Coverage for most O.E. passenger cars and most light truck wheels. Basic Kit plus: Short Cone, Light Truck Cone Kit, Faceplate Extension.

Premium Kit: Coverage for most O.E. and aftermarket car and light truck wheels. Extended Kit plus: Pin Plates with Balancer Mate.

Order No.	Mfr. No.	Description
71678	85009974	Basic Adapter Kit for 1250-3D & 1250-3DV
71679	85009976	Extended Adapter Kit for 1250-3D & 1250-3DV
71680	85009977	Premium Adapter Kit for 1250-3D & 1250-3DV

Specifications:

Mfr No.	Working Elec. Req.	Working Area	Rim Width	Rim Diameter	Max. Tire Diameter	Balancing Modes	Max. Tire Wt. lbs.	Ship Wt.
1250 3DV	220V, 1/3 Ph.	57" x 50"	2"-20"	8"-30"	40"	8	160	680 lbs. - 308 kg
1250 3D	220V, 1/3 Ph.	57" x 50"	2"-20"	8"-30"	40"	8	160	680 lbs. - 308 kg
1250 2D	220V, 1/3 Ph.	57" x 50"	2"-20"	Up to 20"	40"	8	160	625 lbs. - 283 kg

COATS 1000-D High Volume Wheel Balancer

- Stop-On-Top for speed & accuracy



"A" and "B" feature allows two technicians to use at once. Includes 8 balancing modes for static, dynamic, RV, four different alloy modes and the exclusive Match Mount program with individual readings for the tire and rim. Side shelves allow wheel weight storage at the balancer, saving time and increasing efficiency. Warranty, 1-year parts, 6 months labor.

Order No.	Mfr. No.	Description	Ship Wt.
59390	1000-D	Balancer - 28mm Shaft 220V., 1Ph.	586 lbs. - 266 kg
59391	1000-D	Balancer - 28mm Shaft, 220V, 3 Ph.	586 lbs. - 266 kg
59392	1000-D	Balancer - 40mm Shaft 220V, 1Ph.	586 lbs. - 266 kg
59393	1000-D	Balancer - 40mm Shaft, 220V, 3 Ph.	586 lbs. - 266 kg

COATS 1000 High Volume Wheel Balancer

All the features of the 1000-D balancer without the Stop-On-Top and auto entry.

Order No.	Mfr. No.	Description	Ship Wt.
59388	1000	Balancer - 28mm Shaft 220V., 1Ph.	586 lbs. - 266 kg
59389	1000	Balancer - 28mm Shaft, 220V, 3 Ph.	586 lbs. - 266 kg

COATS 775 Low Volume Wheel Balancer

- For small shops
- Motorcycle adaptable with 71171

10 Balancer modes including multiple static, dynamic, and alloy modes. Features self-calibration, tape-a-weight and hidden weight capabilities. Includes small, medium and large cones, light truck back cone, calipers, wheel weight hammer, hub nut, small pressure cup, rubber lip, spring, and stub shaft. Warranty, 1-year parts, 6 months labor.



Shown with optional 71171 adapter

Order No.	Mfr. No.	Description	Ship Wt.
59385	775	Economy Balancer, 40mm Shaft, 110V, 1 Ph.	
71171	85606376	Optional - Motorcycle Adapter Kit for 775 Balancer	

Specifications:

Mfr No.	Working Elec. Req.	Working Area	Rim Width	Rim Diameter	Max. Tire Diameter	Balancing Modes	Max. Tire Wt. lbs.	Ship Wt.
1175	220V, 1Ph.		2"-20"	Up to 30"	34"	10	150	264 lbs. - 120 kg
1000-D	220V, 1/3 Ph.	57" x 50"	2"-19.9"	Up to 40"		8	150	586 lbs. - 266 kg
875	110V, 1 Ph		2"-20"	Up to 30"	34" to 40"	10	130	213 lbs. - 97 kg
775	110V, 1 Ph		2"-20"	Up to 30"		10	100	198 lbs. - 90 kg

COATS 1175 High Volume Wheel Balancer

- For medium to high volume shops



Automatic distance and diameter entry. Audible sound indicates exact tape-a-weight placement. 10 Balancer modes including multiple static, dynamic, and alloy modes. Features auto start hood, self-calibration, tape-a-weight and hidden weight capabilities. Includes small, medium and large cones, light truck back cone, calipers, wheel weight hammer, hub nut, small pressure cup, rubber lip, spring, and stub shaft. Warranty, 1-year parts, 6 months labor.

Order No.	Mfr. No.	Description	Ship Wt.
59403	1175	High Volume Balancer, 40mm Shaft, 110V, 1 Ph.	264 lbs. - 120 kg

COATS 875 Medium Volume Wheel Balancer

- For low to medium volume shops



Automatic distance and diameter entry. 10 Balancer modes including multiple static, dynamic, and alloy modes. Features auto start hood, self-calibration, tape-a-weight and hidden weight capabilities. Includes small, medium and large cones, light truck back cone, calipers, wheel weight hammer, hub nut, small pressure cup, rubber lip, spring, and stub shaft. Warranty, 1-year parts, 6 months labor.

Order No.	Mfr. No.	Description	Ship Wt.
59386	875	Medium Volume Balancer, 40mm Shaft, 110V, 1 Ph.	237 lbs. - 107 kg

COATS 520 Wheel Lift

- Centers the wheel on the shaft

Use with any Coats wheel balancer. Lifts and centers tire and wheel assemblies weighing up to 175 lbs on heavy-duty bearings. Features a three position control valve, storage pegs for adapters and hub nut. *Specs.: Min. tire diameter 20.5"; max. tire diameter up to 33.5"; max. weight 175 lbs. @115 to 145 psi.*



Order No.	Mfr. No.	Description	Ship Wt.
51098	520	Wheel Lift	220 lbs. - 99 kg

COATS Balancer Cones & Adapters

Replacement Cones



For 28MM Shaft Balancers

Order No.	Mfr. No.	Description	Center Hole Range		Ship Wt.
			Min	Max	
71655	110410	Small Cone	1.75	2.25	2 lbs. - 1 kg
71656	110411	Medium Cone	2.25	3.00	3 lbs. - 1 kg
71657	110412	Large Cone	3.00	3.60	3 lbs. - 1 kg
71482	308095	Extra-Large Cone	3.375	5	5 lbs. - 2 kg
71176	113456	Set - (4) Cones & Spring			

For 40MM Shaft Balancers

Order No.	Mfr. No.	Description	Center Hole Range		Ship Wt.
			Min	Max	
71177	112098	Small Cone	1.75	2.25	2 lbs. - 1 kg
71178	112099	Medium Cone	2.25	3.00	3 lbs. - 1 kg
71179	112100	Large Cone	3.00	3.60	3 lbs. - 1 kg
71180	112101	Extra-Large Cone	3.375	5	5 lbs. - 2 kg

For 2" Shaft Balancers - 6401 & 6450

Order No.	Mfr. No.	Description	Center Hole Range		Ship Wt.
			Min	Max	
71181	308628	Small Cone	2.44	3.12	3 lbs. - 1 kg
71182	308629	Medium Cone	2.78	3.46	3 lbs. - 1 kg
71183	308630	Large Cone	2.98	5.06	4 lbs. - 2 kg
71184	308631	Extra-Large Cone	4.52	6.95	5 lbs. - 2 kg

1992 & Older Standard Cones

For 28MM Shaft Balancers

Order No.	Mfr. No.	Description	Center Hole Range		Ship Wt.
			Min	Max	
71480	308069	Miniature Cone	1.70	2.25	2 lbs. - 1 kg
71484	308096	Small Cone	2.25	2.62	2 lbs. - 1 kg
71486	308097	Medium Cone	2.62	3.00	3 lbs. - 1 kg
71490	308098	Large Cone	3.00	3.25	4 lbs. - 2 kg

"Tweener" Cones

For use with tire/wheel assemblies with shallow wheel center designs. Provides for more accurate mounting. Compatible with pin plate and fixed finger plate adapters. Set of 4 cones only. Sizes: 1.62" - 2.303", 2.05" - 2.76", 2.44" - 3.15" and 2.8" - 3.49".

Order No.	Mfr. No.	Description	Center Hole Range		Ship Wt.
			Min	Max	
71602	5000340	28MM Tweener Cone Set	1.62	3.49	9 lbs. - 4 kg
71601	113795	40MM Tweener Cone Set	1.62	3.49	9 lbs. - 4 kg

Offset Double-Sided Truck Wheel Adapters

Double-sided adapters require less storage space. Clearly marked with application information on each side helping the technician get the job done faster and correctly the first time. Includes Valve Index Balancing Procedure to assure wheel is accurately centered on the balancer and on the vehicle.

Order No.	Mfr. No.	Description
71407	113041C	28mm Plate Set
71408	113042	40mm Plate Set
71409	113043	2" Shaft (6401) Plate Set



Ford Double-Sided Plate

Order No.	Mfr. No.	Description
71670	113032	28mm 4.922" - 6.693"
71190	113033	40mm 4.922" - 6.693"
71193	113034	2" Shaft (6401) 4.922" - 6.693"

Chrysler/GM Double-Sided Plate

Order No.	Mfr. No.	Description
71189	113057	28mm 4.561" - 4.766"
71192	113058	40mm 4.561" - 4.766"
71194	113059	2" Shaft (6401) 4.561" - 4.766"

Ford 150 Ultra-Low Angle Cone

For 2004-2006 F150, 2003-2006 Expedition and Navigator wheels.

Order No.	Mfr. No.	Description
71196	1144441	For 28mm Shaft
71198	1141821	For 40mm Shaft

Short Cone

Necessary for required back cone mounting of "stepped" center hole alloy wheels on: Cadillac Seville, Oldsmobile Silhouette, Pontiac Grand Prix, Pontiac Trans Sport, and Chrysler "LH" chassis models.

Order No.	Mfr. No.	Description
71660	112420	28mm 2.65"-3.025"
71661	112421	40mm 2.65"-3.025"

Light Truck Back Cone

Order No.	Mfr. No.	Description
71185	111539	28mm 3.281"-4.05"

Tacoma Cone

Applications include Toyota Tacoma, Land Cruiser, Sequoia, and some Nissan light trucks. Eliminates the use of a faceplate extension (or "Viper" spacer) and a spacer cone when mounting wheels in certain light truck/SUV applications.

Order No.	Mfr. No.	Description
71186	500035201	28mm 3.281"-4.44"
71175	1136871	40mm 3.281"-4.44"

Improved Light Truck Cone

Order No.	Mfr. No.	Description
51139	113276	28mm Cone Kit 4.8" - 6.8"
71174	113279	28mm Cone Only 4.8" - 6.8"
71671	113060C	28mm Plate Only 8"
51141	113277	40mm Cone Kit 4.8" - 6.8"
71173	113280	40mm Cone Only 4.8" - 6.8"
71172	113061C	40mm Plate Only 8"

Standard Light Truck Cone

For light trucks up to one-ton

Order No.	Mfr. No.	Description
50647	309067	28mm Cone Kit 3.375"-5.88"
71600	309069	28mm Cone Only 3.375"-5.88"
71638	309068	28mm Plate Only

Baby Bud Cone

For 19.5" hub-centered wheels

Order No.	Mfr. No.	Description
71665	1111829C	28mm Cone Kit 8.52 - 8.89"
71187	111827	28mm Cone Only 8.52 - 8.89"
71188	111828	28mm Plate Only 10"
71666	111853C	40mm Cone Kit 8.52 - 8.89"
50066	109877	Cone Kit for 2" Shaft 8.52 - 8.89"

19.5" Fed Ex Adapter & Backing Plate

Order No.	Mfr. No.	Description
71442	112982	28mm 8.627"-8.7"
71443	112984	40mm 8.627"-8.7"

Backing Plate for Double-Sided Adapters

Used with Offset Truck Wheel Adapters and Improved Light Truck Front Cone Kit.

Order No.	Mfr. No.	Description
71671	113060C	28mm Range 8"
71172	113061C	40mm Range 8"
71195	113062	2" Shaft (6401) Range 8"



COATS Pin Style Adapters

- Eliminate balancing errors
- Choose the Plate System to fit your needs

Pin Plate System

Special Package
Includes Stand

- Covers over 90% of all passenger car & light truck applications
- Covers 98% of OEM applications
- For hub & lug centric wheels



Pin Plate System Includes: 4 Pin Plates with 1.125" I.D. listed below, Hole Gauge, Operations Video, Application Chart and Free Balancer Mate

Mfr. No.	Holes	Spacing
8113861	4, 5	100mm, 108mm, 110mm, 4.450", 5.50", 6.50"
8113159	5	110mm, 112mm, 115mm, 120mm, 130mm
8113160	5	100mm, 108mm, 4.25", 4.50", 4.75", 5.00"
8113161	6, 8	4.50", 5.50" 6.50"

Order No.	Mfr. No.	Shaft Size	Description	Ship Wt.
71382	8KPPBM28	1.125"	Pin Plate Set with Stand	97 lbs. - 44 kg

If used on an existing Coats balancer, must order a 7" replacement shaft.

71454	8113167	1.125"	7" Shaft for Coats Balancers
-------	---------	--------	------------------------------

Order No.	Mfr. No.	Shaft Size	Description	Ship Wt.
71384	8KPPBM40	40mm	Pin Plate Set with Stand	97 lbs. - 44 kg

Pin Plate Sets

- 4-Adapter system assures proper centering of most passenger & light truck wheels



Includes: Plates 1 through 4, Application Chart, Hole Gauge, Storage Panel, Video and Instructions.

Order No.	Mfr. No.	Mfr. Code	Shaft Size	Holes	Spacing	Ship Wt.
71387	8113465		1.125"	Plate Set - 1 Thru 4		125 lbs. - 57 kg
71388	8113153		40mm	Plate Set - 1 Thru 4		125 lbs. - 57 kg

Individual Plates

71460	8113831	1	1.125"	4 & 5	4x100mm, 4x180mm, 4x110mm, 4x4.50", 5x5.50", 5x6.50"	
71461	8113159	2	1.125"	5	5x110mm, 5x112mm, 5x115mm, 5x120mm, 5x130mm	
71462	8113160	3	1.125"	5	5x100mm, 5x108mm, 5x4.25", 5x4.50", 5x4.75", 5x5.00"	
71450	8113466	4	1.125"	6 & 8	8x170mm, 6x127mm, 6x135mm, 6x4.50", 6x5.50", 8x6.50"	
71464	8113162	1	40mm	4 & 5	4x100mm, 4x180mm, 4x110mm, 4x4.50", 5x5.50", 5x6.50"	
71465	8113163	2	40mm	5	5x110mm, 5x112mm, 5x115mm, 5x120mm, 5x130mm	
71466	8113164	3	40mm	5	5x100mm, 5x108mm, 5x4.25", 5x4.50", 5x4.75", 5x5.00"	
71452	8113840	4	40mm	6 & 8	8x170mm, 6x127mm, 6x135mm, 6x4.50", 6x5.50", 8x6.50"	
71468	8113113				Hole Gauge for Pin Plates	
71469	8113120				8 Pack of Pins, 24 x 80mm, Bullet Nose	
71470	8113121				8 Pack of Pins, 24 x 70.5mm, Funnel Nose-Long	
71471	8113122				5 Pack of Pins, 22 x 60mm, Funnel Nose-Short	

More than 60% of today's ride disturbance complaints can be eliminated by properly mounting the tire and wheel assembly on the wheel balancer.

Most OEM wheels today are hub centric and aftermarket wheels are often lug centric. Number one question, how do I mount them? Answer, same method for hub or lug centric – cone, wheel, and the Coats® Pin Plate or Fixed Finger Plate system and hub nut.

Fixed Finger Plate System

Special Package
Includes Stand

- Covers 84% of OEM applications
- Plate is always set-up & ready to go
- For hub & lug centric wheels

Fixed Finger Plates eliminate finding & relocating pins in the plate. Extremely helpful when balancing custom wheels with multiple bolt patterns. Fingers are held in place with fasteners for long-term accuracy. There is a secondary pattern on each plate for less popular wheels. Available in 1.125" (28mm) and 40mm I.D.

Fixed Finger Plate System Includes: 5 Fixed Finger Plates and 1 Pin Plate with 1.125" I.D. listed below, Hole Gauge, Application Chart and Free Balancer Mate

Mfr. No.	Holes	Spacing
8113206	4	100mm, 108mm
8113207	4	114.3mm, 108mm
8113208	5	100mm, 108mm
8113209	5	114.3mm, 108mm
8113210	5	115mm, 120.65mm
8113161	6, 8	4.50", 5.50" 6.50"



Order No.	Mfr. No.	Shaft Size	Description	Ship Wt.
71392	8KFFPBM28	1.125"	Fixed Finger Plate Set with Stand	110 lbs. - 50 kg

If used on an existing Coats balancer, must order a 7" replacement shaft.

71454	8113167	1.125"	7" Shaft for Coats Balancers
-------	---------	--------	------------------------------

Order No.	Mfr. No.	Shaft Size	Description	Ship Wt.
71393	8KFFPBM40	40mm	Fixed Finger Plate Set with Stand	110 lbs. - 50 kg

Fixed Finger Plates

Fingers are held in place with fasteners for long-term accuracy. There is a secondary pattern on each plate for less popular wheels.

Order No.	Mfr. No.	Mfr. Code	Shaft Size	Holes	Spacing
71491	8113206	1a	1.125"	4	100mm, 108mm
71492	8113207	2a	1.125"	4	114.3mm, 108mm
71493	8113208	3a	1.125"	5	100mm, 108mm
71494	8113209	4a	1.125"	5	114.3mm, 108mm
71495	8113210	5a	1.125"	5	115mm, 120.65mm
71496	8113211	6a	1.125"	5	112mm, 130mm
71497	8113212	7a	1.125"	5	120mm, 127mm
71498	8113213	1b	40mm	4	100mm, 108mm
71499	8113214	2b	40mm	4	114.3mm, 108mm
71500	8113215	3b	40mm	5	100mm, 108mm
71501	8113216	4b	40mm	5	114.3mm, 108mm
71502	8113217	5b	40mm	5	115mm, 120.65mm
71503	8113218	6b	40mm	5	112mm, 130mm
71504	8113219	7b	40mm	5	120mm, 127mm

COATS Balancer Mate

Organize and store adapters, wheel weights and tools. The mobile rack has double-sided panels, hooks for adapters and trays for weights and tools. Panels are labeled to identify placement for Pin Plates or Fixed Finger Plates.

Order No.	Mfr. No.	Description	Ship Wt.
71394	8113391	Balancer Mate	50 lbs. - 23 kg



Tire Balancing Accessories

COATS Replacement Accessories

- For 600, 650, 700, 850, 950, 1001, 1004, 1025, 1050 & 1250 models

Small Pressure Drums

Order No.	Mfr. No.	Description
71651	8110542	28mm— 4.625" Diameter
71769	8112106	40mm— 4.625" Diameter
71653	8110544	28mm— 5.75" Diameter



Extra-Large Pressure Drums

Order No.	Mfr. No.	Description
71770	8113308C	28mm— 8.375" Diameter
71767	8113309C	40mm— 8.375" Diameter



Hub Nuts

Replacement hub nut for 1.125" standard coarse thread shaft. Fits all Coats automotive wheel balancers.

Order No.	Mfr. No.	Description
71650	8110543	28mm Shaft Hub Nut
71427	8112103	40mm Shaft Hub Nut



No-Mar Rings

Prevents damaging the finish on wheels with a small diameter pilot hole and a raised center. For use with Hub Nuts

Order No.	Mfr. No.	Description
71416	8308105	No-Mar Ring for 28mm Hub Nut
71763	8112102	No-Mar Ring for 40mm Hub Nut



Replacement 1.125" Shaft

Coarse thread replacement shaft for balancers with standard hub nut. Fits all Coats automotive wheel balancers with a 1.125" shaft.

Order No.	Mfr. No.	Description
71420	308171	Standard Shaft
71454	113167	Replacement 7" Shaft



Spring For Back Cone Balancing

Order No.	Mfr. No.	Description
71658	308820	Spring for Back Cone Balancing



Caliper Assembly

Measures wheel width in inches. For use with all Coats automotive wheel balancing.

Order No.	Mfr. No.	Description
71445	309011	Caliper Assembly



Quick Chuck Balancer Adapter

- Fits all major brands of wheel balancers
- Eliminates many additional cone sets



Designed for mounting 19.5 light truck wheels on F350 and GMC chassis tow trucks and other light truck applications. It centers hub-centered wheels by uniformly clamping the center hole with three expanding chucks. In most applications no additional spacers are required. Range: 3.13" to 7.13". Includes 3-Jaw Chuck Adapter, Clamping Cup with Protector Ring, 3/8" Ratchet Key, and 5 year warranty. **Note:** For use with hub-centered wheels only, if the center hole is not true, the wheel will not be centered.

Order No.	Mfr. No.	Description	Shaft Size	Ship Wt.
51174	113330	Quick Chuck	40mm	21 lbs. - 10 kg

CENTOR Balancer Adapter Kits

- Centers & torques steel & aluminum wheels to the balancer just as on the vehicle



Avoid damaging and scratching alloy rims. Manufactured from O.E. approved high-quality steel. Kits include #1, #2, #3, #4 plates; (8) each studs "A", "B", (5) each stud "C"; storage stand and application chart.

Order No.	Mfr. No.	Description	Ship Wt.
51295	L200-400-01	40MM Shaft Flange Kit with Floor Stand	40 lbs. - 19 kg
51373	L200-400-25	40MM Shaft Flange Kit with Wall Stand	
51376	L200-400-09	40MM Shaft Flange Kit with No Stand	
51296	L200-380-01	38MM Shaft Flange Kit with Floor Stand	40 lbs. - 19 kg
51374	L200-380-25	38MM Shaft Flange Kit with Wall Stand	
51377	L200-380-09	38MM Shaft Flange Kit with No Stand	
51297	L200-280-01	(1.125) 28MM Shaft Flange Kit with Floor Stand	40 lbs. - 19 kg
51375	L200-280-25	(1.125) 28MM Shaft Flange Kit with Wall Stand	
51378	L200-280-09	(1.125) 28MM Shaft Flange Kit with No Stand	

COATS Speed Nut Kits & Accessories

For 600, 650, 700, 850, 950, 1001, 1004, 1025, 1050 & 1250 models

Includes speed nut, pressure drum, lip & spacer cap

Order No.	Mfr. No.	Description
71441	8113327	28mm Speed Nut Kit
71762	8113328	40mm Speed Nut Kit



Speed Nut Only

Order No.	Mfr. No.	Description
71761	8113344	28mm Speed Nut
71428	8113343	40mm Speed Nut



Replacement Parts for Speed Nuts

Order No.	Mfr. No.	Description
71765	8113345	Pressure Drum
71766	8113346	Rubber Lip
71764	8113347	Spacer Cap



COATS XR Series Hub Kits

- Includes hub nut, pressure drum, rubber ring, & no mar ring

Order No.	Mfr. No.	Description
71772	606472	XR Speed Nut Kit



Replacement Parts for Speed Nuts

Order No.	Mfr. No.	Description
71773	8500036701	Pressure Drum
71771	8500036901	Rubber Ring
71774	8500036801	No Mar Ring
71775	8500036601	Speed Nut Only



HAWEKA QuickNut Adapters



51120



51408



51417

COATS Balancers 700, 800, 825, 850, 925, 950, 1000, 1025, 1050, 1055 & 1250

With OEM 28mm Shaft

Order No.	Mfr. No.	Shaft Size / Type	Description
51120	HW124 937 003	28mm	ProGrip QuickNut Kit Repl. OEM Shaft & Nut
51417	HW124 937 150	28mm	28mm to 40mm Shaft Kit (Incl. QuickNut, Clamping Hood, 40mm Shaft, Spring & 4-Piece Cone Kit)
51400	HW143 283 003	28mm	ProGrip QuickNut for 28mm Aftermarket Repl. Shaft Only. Will Not Work on OEM Shaft

Previously Upgraded to OEM 40mm Shaft

Order No.	Mfr. No.	Shaft Size / Type	Description
51408	HW124 408 006	40mm	Steel ProGrip QuickNut (Incl. Clamping Hood)

Previously Upgraded to Haweka 40mm Shaft

Order No.	Mfr. No.	Shaft Size / Type	Description
51402	HW143 403 003	40mm	ProGrip QuickNut Kit*
51406	HW143 403 006	40mm	ProGrip QuickNut with Turning Knobs*
51411	HW140 403 033	40mm	Steel ProGrip QuickNut*

* Clamping Hoods Sold Separately

COATS Balancers 775, 875, 1175 & 7275HS

Order No.	Mfr. No.	Shaft Size / Type	Description
51408	HW124 408 006	40mm	Steel ProGrip QuickNut (Includes Clamping Hood)

COATS Balancers XR Series

Order No.	Mfr. No.	Shaft Size / Type	Description
51403	HW143 404 003	40mm OEM	ProGrip QuickNut Kit*
51407	HW143 404 006	40mm OEM	ProGrip QuickNut with Turning Knobs*
51410	HW140 404 033	40mm OEM	Steel ProGrip QuickNut*

* Clamping Hoods Sold Separately

COATS Balancers 6200HS

Order No.	Mfr. No.	Shaft Size / Type	Description
51419	HW143 285 006	28mm	ProGrip QuickNut with Turning Knobs*

* Clamping Hoods Sold Separately



CORGI Balancers All Models Pre-2007

Order No.	Mfr. No.	Shaft Size / Type	Description
51401	HW143 383 003	38mm	ProGrip QuickNut Kit*
51405	HW143 383 006	38mm	ProGrip QuickNut with Turning Knobs*

* Clamping Hoods Sold Separately

CORGI Balancers All Models 2007 & Later

Order No.	Mfr. No.	Shaft Size / Type	Description
51402	HW143 403 003	40mm	ProGrip QuickNut Kit*
51406	HW143 403 006	40mm	ProGrip QuickNut with Turning Knobs*
51411	HW140 403 033	40mm	Steel ProGrip QuickNut*

* Clamping Hoods Sold Separately

HOFMANN Balancers All Models

Order No.	Mfr. No.	Shaft Size / Type	Description
51403	HW143 404 003	40mm OEM	ProGrip QuickNut Kit*
51407	HW143 404 006	40mm OEM	ProGrip QuickNut with Turning Knobs*
51410	HW140 404 033	40mm OEM	Steel ProGrip QuickNut*

* Clamping Hoods Sold Separately

HUNTER Balancers 700 & DSP9500 1990-1992

Order No.	Mfr. No.	Shaft Size / Type	Description
51402	HW143 403 003	40mm	ProGrip QuickNut Kit*
51406	HW143 403 006	40mm	ProGrip QuickNut with Turning Knobs*
51411	HW140 403 033	40mm	Steel ProGrip QuickNut*

* Clamping Hoods Sold Separately

HUNTER Balancers All Other Models

Order No.	Mfr. No.	Shaft Size / Type	Description
51408	HW124 408 006	40mm	Steel ProGrip QuickNut (Includes Clamping Hood)

BOSCH Balancers All Models

Order No.	Mfr. No.	Shaft Size / Type	Description
51403	HW143 404 003	40mm OEM	ProGrip QuickNut Kit*
51407	HW143 404 006	40mm OEM	ProGrip QuickNut with Turning Knobs*
51410	HW140 404 033	40mm OEM	Steel ProGrip QuickNut*

* Clamping Hoods Sold Separately

Tire Balancers

HAWEKA Pro Expert System "Clad Solver Premium"



The system includes (3) Quick Plates, Quick Tips x 6, Duo Expert Kit, Toyota Precision collet, Ford Precision collet and wallboard.

Order No.	Mfr.No.	Description
51432	HWPRO 456 401	Pro Expert System

HOFMANN Geodyna 2350 Entry Level Wheel Balancer

Designed for single bay shops and quick lube facilities. Heavy-duty 40mm shaft. 10 Balancing modes including 5 alloy modes, two hidden weight "Pro-Match" tire/wheel matching, dynamic and static handles most wheel applications. Hidden Spoke Placement hides weights. Includes 1 5/8" to 4 1/2" automotive cone kit, quick nut, pressure cup, rim width gauge, calibration tool and storage pegs.



Order No.	Description	Ship Wt.
59889	Geodyna 2350 Wheel Balancer 115V, 1 Ph.	375 lbs. - 169 kg

HOFMANN Geodyna 2400 Entry-Level Wheel Balancer

Automatic rim diameter and distance entry. Long 40mm balancer shaft allows mounting of wider wheels. 10 Balancing modes including 5 alloy modes, 2 hidden weight programs, Pro-Match tire wheel matching, dynamic & static to handle most wheel applications. Hidden weight placement program. Includes 1 5/8" - 4 1/2" automotive cone kit, "ZipLock" quick nut, pressure cup with protective rubber cap, rim width gauge and storage pegs.



Order No.	Description	Ship Wt.
59888	Geodyna 2400 Wheel Balancer 115V, 1 Ph.	375 lbs. - 169 kg

HAWEKA Pro Collet Kit "Clad Solver"

- Low taper, double sided collets
- 52.5 - 122mm (2.07"-4.80") Coverage range
- No wheel hub interference



Order No.	Mfr.No.	Description
51425	HW150 400 110	40mm 9-Piece Low Taper Collet Kit
51426	HW150 360 110	36mm 9-Piece Low Taper Collet Kit
51427	HW150 280 110	28mm 9-Piece Low Taper Collet Kit

HOFMANN Geodyna Optima 3D Laser Technology



Laser technology automatically enters all data when the wheel guard is lowered without touching the wheel. Heavy-duty 40mm shaft. Non-contact measurement of radial and lateral run-out. 10 Balancing modes including 5 alloy modes, two hidden weight "Pro-Match" tire/wheel matching, dynamic and static to handle most wheel applications. Laser indicates hidden weight placement and wheel weight clamp positions stick-on weights. Automatic electro-mechanical wheel clamping. Flat screen displays all measured data. Optional Printer #59892 available

Order No.	Description	Ship Wt.
	Geodyna Optima 3-D Wheel Balancer 115V, 1 Ph.	
59891	Geodyna Optima 3-D Wheel Balancer 220V, 1 Ph.	400 lbs. - 180 kg

HOFMANN Rim Gauge



Order No.	Description
50456	Rim Gauge

Specifications:

Mfr. No.	Elec. Req.	Rim Width	Rim Diameter	Max. Tire Diameter	Shaft Size	Cycle Time/Sec.	Max. Tire Wt. lbs.	Accuracy oz./gm	Ship Wt.
Optima	115V, 1 Ph.	1"-20"	8"-30"	38"	40mm	6	150	0.05/1	400 lbs. - 180 kg
2350	110V, 1 Ph.	1"-20"	8"-30"	48"			150	0.05/1	300 lbs. - 138 kg
2400	115V, 1 Ph.	1"-20"	8"-30"	44"			150	0.05/1	375 lbs. - 169 kg

CORGHI EM7240 Wheel Balancer

- Automatic diameter & distance data entry
- 40MM shaft
- Entry level balancer



Features "Shift Plane" program for recalculating the position of adhesive weights and automatic braking at the end of the cycle. Displays weights in grams or ounces with seven ALU programs. Includes (3) cones, wheel weight tool, calipers, nut and hanging pegs. *Specs.: cycle time 7 seconds; max. tire diameter 44"; max. rim width 20"; max. wheel width 23-1/2"; max. wheel assembly weight 110 lbs.; 40mm shaft diameter; 115.v, 50/60 Hz; footprint 52" w x 44" d.*

Order No.	Mfr.No.	Description	Ship Wt.
51516	7240	Wheel Balancer - 40 MM Shaft 115V	340 lbs. - 154 kg

CORGHI EM7480 Wheel Balancer

- Automatic diameter & distance data entry
- 40MM shaft
- High volume balancer



Features a built-in radial run out gauge and 3 parameter automatic data entry. Displays weights in grams or ounces. Touch screen balancing program options. Includes (3) cones, wheel weight tool, calipers, nut and hanging pegs. *Specs.: cycle time 6 seconds; max. tire diameter 44"; max. rim width 20"; max. wheel width 23-1/2"; max. wheel assembly weight 165 lbs.; 40mm shaft diameter; 110.v, 50/60 Hz; footprint 52" w x 64" d.*

Order No.	Mfr.No.	Description	Ship Wt.
51515	7480	Wheel Balancer - 40 MM Shaft 115V	352 lbs. - 160 kg

Adhesive Weight Removal Tool



A high-impact plastic chisel designed to remove adhesive wheel weights quickly without damaging expensive rims.

Order No.	Description
50508	Adhesive Wheel Weight Removal Tool

@601 Economy Wheel Balancer

- For small shops



Automatic wheel spin and end cycle break. Features three Alu/Alu P, static, and dynamic modes. Includes speed nut wheel clamp, three cone kit, weight hammer, and calipers.

Specs.: Max. tire dia. 33"; max. rim width 17.5"; max tire weight 143 lbs.; 110v, 1 ph. Warranty, 6 months on parts, 90 days labor.

Order No.	Mfr. No.	Description	Ship Wt.
50054	@601	Economy Balancer, 36mm Shaft, 110V 1 Ph.	000 lbs. - 000 kg

CORGHI EM7280 Tire Balancer

- Handles tires up to 28"
- LCD monitor displays high resolution graphics
- Optional TT80 wheel lift available



Features dynamic balance on both sides of the rim, 7 ALU programs, motorcycle dynamic balance, split weight for motorcycle program, hidden weight, displays imbalance in gram or ounce and automatic braking at end of cycle. Includes (4) centering cones 1.65" to 5.39", wheel weight tool, wheel width calipers, 40mm threaded hub, quick release wing nut, weight for calibration, adapter sleeves for storage and ground fixing kit. *Specs.: balancing speed 90 to 130 rpm; average cycle time 7 seconds; 40mm shaft diameter; rim width range 1 1/2" to 20"; rim diameter 1" to 35"; rim diameter measurable with sensor 28"; max. wheel width 23.6"; max. wheel dia. 44"; max. wheel weight 165 lbs.; 220v, 1 ph.; footprint 51" w x 44" d x 61 h.*

Order No.	Mfr. No.	Description	Ship Wt.
51514	EM7280	Tire Balancer, 40mm Shaft, 220V 1 Ph.	000 lbs. - 000 kg

Wheel Weight Adhesive Removal Kit

- Removes wheel weight adhesive without damaging the rim



Includes tool with built-in regulator, (12) eraser pads, arbor, and spanner wrench. Replacement pads limited to 4,000 rpm. *Specs.: 1/2 hp, 4,000 rpm; min. hose size 3/8"; air inlet 1/4"; aver. air cons. 4 cfm; oper. air pressure 90 - 120 psi.*

Order No.	Description	Ship Wt.
17026	Wheel Weight Adhesive Removal Kit	9 lbs. - 4 kg
17027	Replacement Adhesive Removal Pad (Sold Each)	1 lbs. - 1 kg
17028	Replacement Arbor	1 lbs. - 1 kg

Tire Balancers

BOSCH Entry Level Wheel Balancers

- Compact balancers with LCD monitor or LED display
- 2D Entry for diameter & distance



These entry level balancers are ideal for passenger, motorcycle and light trucks with the proper adapters. The inner arm automatically records diameter and distance of inner weight locations. See specifications below.

Order No.	Description	Ship Wt.
57407	WBE4110 LED Display Wheel Balancer 110V, 1 Ph.	198 lbs. - 90 kg
57408	WBE4140 LCD Monitor Wheel Balancer 110V, 1 Ph.	198 lbs. - 90 kg

BOSCH LCD Monitor & Digital Wheel Balancers

- Ideal for medium to high volume shops
- 3D Entry arm for diameter, distance & width



Easyfix data recording arm measures rim diameter and distance and indicates the adhesive weight position on the inside of the rim. The split weight program separates weights to hide behind spokes for improved appearance. Features wheel positioning pedal and automatic lock for exact laser weight placement. See specifications below.

Order No.	Description	Ship Wt.
57409	WBE4230 LED Display Wheel Balancer 220V, 1 Ph.	477 lbs. - 216 kg
57410	WBE4430 LCD Monitor Wheel Balancer 220V, 1 Ph.	495 lbs. - 225 kg

BOSCH LCD Monitor & Digital Wheel Balancers

- Ideal for medium to high volume shops

Easyfix data recording arm measures rim diameter and distance and indicates the adhesive weight position on the inside of the rim. The split weight program separates weights to hide behind spokes for improved appearance. Features 11 passenger and 5 motorcycle wheel balancing programs, wheel positioning pedal and automatic lock for exact weight placement. See specifications below.

Order No.	Description	Ship Wt.
57413	WBE4200 LED Display Wheel Balancer 220V, 1 Ph.	477 lbs. - 216 kg
57414	WBE4400 19" TFT Monitor Wheel Balancer 220V, 1 Ph.	495 lbs. - 225 kg



NOTE: All balancers include 5 cone set, light truck spacer ring, split weight program, positioning pedal, 40mm shaft, quicknut and wheel positioning pedal, width caliper and distance gauge and operations manual.

Order No.	Mfr. No.	Display Type	Data Entry Type	Rim Width	Rim Diameter	Max. Wheel Diameter	Max. Tire Weight	Electric Power	Ship Wt.
57407	WBE 4110	Digital	2D	2" - 20"	8" - 26"	32 1/2"	143 Lbs.	110V	198 lbs. - 90 kg
57408	WBE 4140	17" Monitor	2D	2" - 20"	8" - 26"	32 1/2"	143 Lbs.	110V	198 lbs. - 90 kg
57413	WBE4200	Digital	2D	2" - 20"	6" - 40"; 10 - 26" Auto	47 1/4"	154 Lbs.	220V, 1 Ph.	230 lbs. - 104 kg
57414	WBE4400	19" Monitor	2D	2" - 20"	6" - 40"; 10 - 26" Auto	47 1/4"	154 Lbs.	220V, 1 Ph.	490 lbs. - 222 kg
57409	WBE 4230	Digital	3D	1" - 24"; 1 - 21" Auto	6" - 40"; 12 - 30" Auto	47 1/4"	154 Lbs.	220V, 1 Ph.	477 lbs. - 216 kg
57410	WBE 4430	19" Monitor	3D	1" - 24"; 1 - 21" Auto	6" - 40"; 12 - 30" Auto	47 1/4"	154 Lbs.	220V, 1 Ph.	495 lbs. - 225 kg

BOSCH Tire Changer & Balancer Combination

- TC 220S Entry level swing arm tire changer
- WBE 4100 Entry level digital wheel balancer



Basic low level swing arm tire changer handles standard tires with 10" - 20" external clamping, 12" - 23" internal clamping, maximum rim width 12", maximum wheel diameter 37 1/2", tire bead seater, 1 hp motor and requires 120v, 20A service. The entry level digital display balancer provides basic tire size coverage with manual data entry. It features a rim capacity width of 13", rim diameters of 8" - 26", maximum wheel diameter of 32 1/2", and allows a maximum wheel weight of 143 lbs. The balancer includes a 3-cone mounting set, quick mount nut and manual wheel weight positioning pedal.

Order No.	Description
57406	Easy Combo Tire Changer / Balancer Combination

TRU BALANCE Radial Run-Out Gauge

- Measures radial & lateral run-out
- Adjusts to zero point for accurate readings



Measures out of round tire condition and pinpoints the high and low spot. Determines the accurate centering of the tire and wheel mounting. Made in U.S.A. 1-Year warranty.

Order No.	Description	Ship Wt.
50069	Radial Run Out Gauge	9 lbs. - 4 kg

AMERMAC Tire Truer & Balancer

- Fast, accurate tire truer & wheel balancer



Designed to turn out a vibration free tire in 5 minutes. Handles tires up to 18" wide and passenger and truck tires through a 11:00-24.5. Includes Series 80 adapter kit for mounting foreign or domestic passenger and light truck tires. 110V, 60 cyc., 1 ph.

Order No.	Mfr. No.	Description	Ship Wt.
03477	711	Tire Truer	500 lbs. - 225 kg
Optional Adapters			
03247	Group C	Universal Truck Adapter for Budd Wheels	
03248	Group E	Truck Adapter for 20"-22" Dayton or Spoke Wheels	
Replacement Parts			
56191	P53	Blade	1 lbs. - 1 kg
56192	P47	Sharpening Stone	1 lbs. - 1 kg

Stud Plate Adapters

- All JBC & Hunter balancer shafts are 40mm



Mount tough-to-balance wheels as they mount on the vehicle with fixed bolt-circle adapters. Stud Plate must be installed to the wheel when flat on the floor, then mounted on the balancer.

Order No.	Mfr. No.	Shaft Size	Ship Wt.
8 x 6.5 - 8 Bolt For Ford, GM & Aftermarket Light Truck Wheels			
71201	113376	1.125	6 lbs. - 3 kg
71200	113381	40mm	6 lbs. - 3 kg
6 x 5.5 - 6 Bolt For Toyota Tacoma & 4-Runner 1999 & Up			
71202	113375	1.125	6 lbs. - 3 kg
71203	113374	40mm	6 lbs. - 3 kg
5 x 5.5 - 5 Bolt For Ford, GM & Aftermarket Light Truck Wheels			
71204	113377	1.125	6 lbs. - 3 kg
71205	113380	40mm	6 lbs. - 3 kg
8 x 170mm 8 Bolt For 1999+ Ford, GM & Aftermarket Light Truck Wheels			
71206	113382	1.125	6 lbs. - 3 kg
71207	113383	40mm	6 lbs. - 3 kg
5 x 135mm 5 Bolt For 1997+ Explorer & F150			
71209	113387	1.125	6 lbs. - 3 kg
71208	113379	40mm	6 lbs. - 3 kg

Bubble Wheel Balancer



Accurately balances all wheels when using regular weights. Sturdy, die cast. Simple to operate, easy-to-read circular level. Large divided base with convenient built-in weight trays.

Order No.	Mfr. No.	Description	Ship Wt.
50526	SE-161	Bubble Wheel Balancer	14 lbs. - 7 kg
50527	SE-108A	Replacement Bubble	1 lbs. - 1 kg

AMERMAC Spinner & Strobe Balancer



Handles passenger and truck tires including drive wheels. Use the 525 Spinner with the 501A Strobe Balancer for precision balancing of the wheel assembly. Flashing strobe indicator pin points exact placement of wheel weights. No wheel attachments needed. Ideal for correcting vibration problems.

Order No.	Mfr. No.	Description	Ship Wt.
03481	525-3	Spinner 7 1/2 HP, 220V, 3 Ph	250 lbs. - 113 kg
03479	525-1	Spinner 5 HP, 220V, 1 Ph	250 lbs. - 113 kg
03487	501A	Strobe Balancer 115V	18 lbs. - 8 kg
Replacement Parts			
03483		Pick-Up Unit without Base	6 lbs. - 3 kg
03485		Pick-Up Unit with Base	8 lbs. - 4 kg

COATS 6450 & 3D Heavy-Duty Wheel Balancers

- Dual Calibration Software (DCS) stores & runs independant calibrations for passenger & truck assemblies
- Powerful 1.5 hp direct drive motor cuts 20 seconds off an average 22.5" spin
- Tape-A-Weight laser-guided operation



Shown with 550 Scissors Wheel Lift

Uses the proven exclusive direct drive system – no belts, no pulleys, only one moving part. The system reaches balancing speed quickly, then coasts during measurements for a faster cycle time. After the first weight is applied, auto indexing automatically moves the wheel to the second weight position and holds until the second weight is applied. Eleven balancing modes. Includes two auto and two light truck cones.

6450-3D Model includes Auto Data Entry for all three parameters, auto indexing moves wheel to weight positions and Stop and Lock feature locks the spindle for accurate weight placement. *Specs.: Accuracy .01 oz.; rim width 20"; cycle time 18 seconds; round off 1/4 - 1/2 - 2 oz.; max. tire diameter 52"; max. tire weight 500 lbs; motor size 1.5 hp; footprint 72" w x 62" d.*

Truck Balancer Kit includes balancer, budd plate adapter, hub centered truck cone kit and the 550 scissors wheel lift.

Order No.	Mfr. No.	Description	Ship Wt. lbs.	kg.
51309	6450-3D	Truck Tire Balancer 220V, 1 Ph.	1100 lbs.	- 495 kg
51310	6450-3D	Truck Tire Balancer 220V, 3 Ph.	1100 lbs.	- 495 kg
51311	6450-3D	Truck Tire Balancer Kit 220V, 1 Ph.		
51312	6450-3D	Truck Tire Balancer Kit 220V 3 Ph.		

Optional Accessories

50176	143935	Lg. Budd Adapter 8, 10 Hole Stud Piloted Wheels	53 lbs.	- 24 kg
50066	109877	Hub Centered Wheel Adapter 220mm, 221mm, 8.73" Center Hole	50 lbs.	- 23 kg
50171	110785	20"-22.5" Dayton Adapter.	35 lbs.	- 16 kg
50172	110786	Opt. for 24.5 Rims Use with 50171	4 lbs.	- 2 kg
71070		Hub Pilate Plate 220mm/221mm		
71409	113043	Offset Plate for 19.5", 16" Hub Pilot	32 lbs.	- 15 kg

575 Scissors Wheel Lift

- Supports wheel assemblies up to 500 lbs.
- Attaches to the 6450-3D & 6450 balancers
- Air operated



Order No.	Mfr. No.	Description
51308	575	Scissors Wheel Lift

Specifications:

Mfr No.	Accuracy oz./ gm	Rim Width	Rim Diameter	Max. Tire Diameter	Max. Tire Wt. lbs.	Ship Wt.
6275		1½" to 20"	10" to 30"	51"	550	390 lbs. - 177 kg
980L	.05 oz. / 1gm	2" to 20"	8" to 30"	50"	500	690 lbs. - 311 kg
6450	.01 oz.	20"		52"	500	1,100 lbs. - 499 kg

HOFMANN Geodyna 980L

- Heavy-Duty truck tire balancer



Pneumatic wheel lift - no lifting. Includes truck centering cones for hub-piloted wheels & 4-star/5-star centering arms for stud piloted applications. 10 Balancing modes with automatic entry of rim distance and diameter to save time. Operator recalibration. Includes passenger & light truck cones for automotive use. Cycle time 7 seconds. Includes 1½ to 4½" automotive cone, 4¼" to 6¾" Light truck. cone, 8" to 9" Budd wheel cone, 220mm Budd wheel centering bushing, 8-10 lug 4/5-star centering arm, "ZipLock" quick nut, pressure cup with rubber scratch proof cap, rim width gauge & storage pegs

Order No.	Mfr. No.	Description	Ship Wt.
59876	980L	Geodyna Truck Balancer - 110/ 220v 1 Ph	690 lbs. - 311 kg

COATS 6275 Mobile Hand Spin Balancer

- For commercial & over-the-road truck tires
- Handles 10" to 30" wheels
- Handles tires up to 550 lbs.



Ideal for smaller, lower volume shops looking for an

inexpensive alternative to balance light duty and over-the road truck tires. Hand spin operation (no drive motor), with 40 mm shaft. Roll the balancer into position and raise it with the lift handle. Balancing cycle times from 8 to 20 seconds. Works off battery if needed. 40mm Shaft fits all 40mm adapters. Includes small cone 3.8" to 5.32", medium cone 4.88" to 7.0", and large cone 7.92 to 9.00" for Budd style wheels. Electric 110V AC main, 12V auto battery or 24V truck battery.

Order No.	Mfr. No.	Description	Ship Wt.
59268	6275	Mobile Hand Spin Balancer	390 lbs. - 177 kg

Passenger & Truck Wheel Weight Tools



Order No.	Mfr. No.	Description
00934	KD3358	Wheel Weight Tool
00933	113176	Replacement Head for 00934
50500	X-109	PDQ Tool
50504	MT-429	"Clip Claw" Tool
50502		Soft Head for Coated Weights
50506		Repl. Head for 50502 1 Each
50501		Repl. Hook for 50502 Pkg. Of 5
50154		Heavy-Duty Truck Weight Tool

Wheel Weight Storage Rack

- Includes 24 bins
- Stores up to 500 lbs. of weights



Keep wheel weights and related tools and accessories handy and easy to find. Storage rack accommodates up to 24 different sizes of wheel weights in heavy-duty polypropylene plastic bins. Stationary Bin Rack is made of heavy-duty steel and measures 36" l. x 14 1/8" w. x 53" h. Shipped un-assembled. Bins 10 7/8" l. x 11" w. x 5" h.

Order No.	Description	Ship Wt.
81307	Wheel Weight Storage Rack	54 lbs. - 24 kg

UWT Wheel Weight Tool Kit

- Removes 97% of all wheel weights

Eliminates scratched rims and pinched fingers. Includes cap, heel plate, T1952 and T1973 hooks.

Order No.	Description
50565	Wheel Weight Tool Kit



UWT 1200HP Wheel Weight Tool

- Removes 99% of all lead & non-lead wheel weights
- #5 Series head removes the majority of wheel weights & #7 series removes Asian O.E. & aftermarket FN weights

The protector cap cushions the blow and prevents scratching coated weights and rims. Use the heel plate for leverage to remove "clip only" weights. Includes #52 and #72 replaceable hooks and heel plate.

Order No.	Mfr. No.	Description
50611	UWT1200HP	Wheel Weight Hammer and Remover

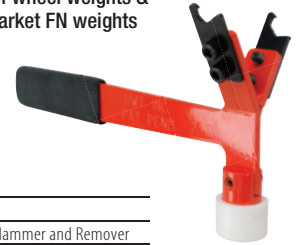

UWT 2200HP Wheel Weight Tool

- #5 Series head removes the majority of wheel weights & #7 series removes Asian O.E. & aftermarket FN weights

Removes 99% of all lead and non-lead wheel weights. Hooks can be "flipped" for extended use. Use the heel plate for leverage to remove "clip only" weights. Includes #53 and #73 replaceable hooks and heel plate.

Order No.	Mfr. No.	Description
50618	UWT2200HP	Wheel Weight Remover



Replacement Parts for 50611 & 50618

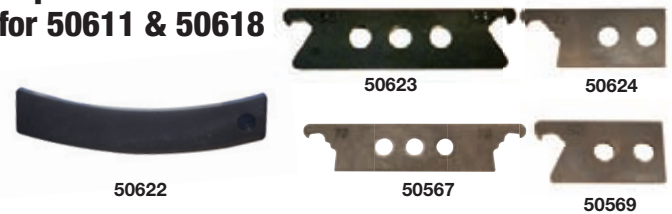

Replacement parts for UWT1200HP (50611) and UWT2200HP (50618)

Order No.	Mfr. No.	Description
50622	UWT9000-3	Polymer Heel Plate
50569	UWT9000-52	#5 Two Hole Replacement Hook
50623	UWT9000-53	#5 Three Hole Replacement Hook
50624	UWT9000-72	#7 Two Hole Replacement Hook
50567	UWT9000-73	#7 Three Hole Replacement Hook

AKRO-MILS Bench Rack Work Station Organizer

A free-standing work station or parts organizer. All-steel 27 3/4" x 21" x 8" bench stand complete with polypropylene AkroBins are available in three colors for coding. Specify bin color: blue (B), yellow (Y) or red (R) when ordering. (ex. 98610R)



Order No.	Includes	Inside Dimension of Bins	Ship Wt.
98610	24-#30210	4 3/4" l. x 3 3/8" w. x 2 1/4" h.	21 lbs. - 10 kg
98620	24-#30220	6 3/4" l. x 3 3/8" w. x 2 1/4" h.	23 lbs. - 11 kg
98630	12-#30230	10 3/4" l. x 4 3/8" w. x 4 3/4" h.	26 lbs. - 12 kg

HOFMANN Zinc Power Weights

- Manufactured to OEM specs
- Withstands 750 hours of salt spray testing
- Resists temperature fluctuations of -40° F to 485°F
- Made of premium zinc alloy



Hofmann Type 164 Series

- Universal weight for wide flange steel rims

Zinc Series	Size	Pcs/Box
HPW164005	5 GR	25
HPW164010	10 GR	25
HPW164015	15 GR	25
HPW164020	20 GR	25
HPW164025	25 GR	25
HPW164030	30 GR	25
HPW164035	35 GR	25
HPW164040	40 GR	25
HPW164045	45 GR	25
HPW164050	50 GR	25
HPW164055	55 GR	25
HPW164060	60 GR	25
HPW164065	65 GR	25
HPW164070	70 GR	25
HPW164075	75 GR	25
HPW164080	80 GR	25
HPW164085	85 GR	25
HPW164090	90 GR	25



Hofmann Type 274 Series Alloy

- 2-Piece zinc weight with B3 clip for BMW aluminum rims

Zinc Series	Size	Pcs/Box
61850	5 GR	25
61852	10 GR	25
61853	15 GR	25
61854	20 GR	25
61855	25 GR	25
61856	30 GR	25
61857	35 GR	25
61858	40 GR	25
61859	45 GR	25
61860	50 GR	25
61861	55 GR	25
61862	60 GR	25



Hofmann Type 160 Series

- Universal weight for slim flange steel rims

Zinc Series	Size	Pcs/Box
61240	5 GR	25
61241	10 GR	25
61242	15 GR	25
61243	20 GR	25
61244	25 GR	25
61245	30 GR	25
61246	35 GR	25
61247	40 GR	25
61248	45 GR	25
61382	50 GR	25
61385	55 GR	25
61387	60 GR	25



Hofmann Type 660 Series

- Universal weight for European aluminum rims

Zinc Series	Size	Pcs/Box
61782	5 GR	25
61783	10 GR	25
61784	15 GR	25
61785	20 GR	25
61786	25 GR	25
61787	30 GR	25
61788	35 GR	25
61789	40 GR	25
61790	45 GR	25
61791	50 GR	25
61792	55 GR	25
61793	60 GR	25



Hofmann Type 274 Series Steel

- 2-Piece zinc weight with B1 clip for BMW steel rims

Zinc Series	Size	Pcs/Box
HPW274005B1*	5 GR	25
HPW274010B1*	10 GR	25
HPW274015B1	15 GR	25
HPW274020B1	20 GR	25
HPW274025B1	25 GR	25
HPW274030B1	30 GR	25
HPW274035B1	35 GR	25
HPW274040B1	40 GR	25
HPW274045B1	45 GR	25
HPW274050B1	50 GR	25
HPW274055B1	55 GR	25
HPW274060B1	60 GR	25

* 5 and 10 gram weights are polypropylene. All others are zinc.



Hofmann Type 161 Series

- Universal weight for standard flange steel rims

Zinc Series	Size	Pcs/Box
HPW161005	5 GR	25
HPW161010	10 GR	25
HPW161015	15 GR	25
HPW161020	20 GR	25
HPW161025	25 GR	25
HPW161030	30 GR	25
HPW161035	35 GR	25
HPW161040	40 GR	25
HPW161045	45 GR	25
HPW161050	50 GR	25
HPW161055	55 GR	25
HPW161060	60 GR	25



Hofmann Type 661 Series

- Universal weight for Japanese aluminum rims

Zinc Series	Size	Pcs/Box
HPW661005	5 GR	25
HPW661010	10 GR	25
HPW661015	15 GR	25
HPW661020	20 GR	25
HPW661025	25 GR	25
HPW661030	30 GR	25
HPW661035	35 GR	25
HPW661040	40 GR	25
HPW661045	45 GR	25
HPW661050	50 GR	25
HPW661055	55 GR	25
HPW661060	60 GR	25



Hofmann Type 260 Series Alloy BMZ

- 2-Piece zinc weight with clip V3 for VW, Audi steel rims. Installation tool required

Zinc Series	Size	Pcs/Box
HPW260005V3*	5 GR	25
HPW260010V3*	10 GR	25
HPW260015V3	15 GR	25
HPW260020V3	20 GR	25
HPW260025V3	25 GR	25
HPW260030V3	30 GR	25
HPW260035V3	35 GR	25
HPW260040V3	40 GR	25
HPW260045V3	45 GR	25
HPW260050V3	50 GR	25
HPW260055V3	55 GR	25
HPW260060V3	60 GR	25

* 5 and 10 gram weights are polypropylene. All others are zinc.

HOFMANN Type 380 Adhesive Zinc Power Weights

- Performance & style for the enthusiasts
- 6 Bars of 60 gram adhesive weights in each box
- Available in 9 colors



Provide the end user with a rim matching color like chrome or black or with a brake caliper matching color like red, blue or yellow. The counter display helps generate interest and sales. High quality powder coating to OEM specs. Perforated adhesive tape eliminates cutting. The counter top display features 24 retail packs, (6) black, (4) chrome and red, (2) each of white, anthracite, blue, yellow and orange for a total of 144 bars of weight equalling 19 3/4 lbs.

Order No.	Mfr. Code	Description	Size
HPW380M1	380	Mixed Retail Color Retail Pack	60 Gram

Refill Packs Order As Required

Order No.	Mfr. Code	Description	Size
HPW380RKBK	380	Black Retail Pack	60 Gram
HPW380RKCH	380	Chrome Retail Pack	60 Gram
HPW380RKRD	380	Red Retail Pack	60 Gram
HPW380RKAN	380	Anthracite Retail Pack	60 Gram
HPW380RKBK	380	Blue Retail Pack	60 Gram
HPW380RKWH	380	White Retail Pack	60 Gram
HPW380RKYE	380	Yellow Retail Pack	60 Gram
HPW380RKOR	380	Orange Retail Pack	60 Gram

HOFMANN Zinc Specialty Adhesive Wheel Weights



Power Weights 360 Series/RUZ

- Narrow double grooved zinc

For Aston Martin, Audi, Ferrari, Jaguar, Land Rover, Maserati, Maybach, and Mercedes-Benz. Varying lengths by .59" wide. Weights of 20 grams and higher are single segments; 35 and higher are two segments; 50 grams and higher are three segments for ease of installation.

Zinc Series	Size	Pcs/Box
62183	5 GR	25
62184	10 GR	25
62185	15 GR	25
62186	20 GR	25
62187	25 GR	25
62188	30 GR	25
62189	35 GR	25
62190	40 GR	25
62191	45 GR	25
62192	50 GR	25
62193	55 GR	25
62194	60 GR	25



Power Weights 361 Series/CUZ

- Wide zinc adhesive

For Bentley, Bugatti, Lamborghini, Opel, Porsche, Saab, Seat, Smart, Vauxhall, Volvo, VW, Skoda and Tesla. Varying lengths by .75" wide. Weights of 10 grams and higher are single segments; 30 and higher are two segments; 40 grams and higher are four segments; 55 grams and higher are five for ease of installation.

Zinc Series	Size	Pcs/Box
62195	5 GR	25
62196	10 GR	25
62197	15 GR	25
62198	20 GR	25
62199	25 GR	25
62200	30 GR	25
62201	35 GR	25
62202	40 GR	25
62203	45 GR	25
62204	50 GR	25
62205	55 GR	25
62206	60 GR	25



Power Weights 390 Series

- Pliable narrow zinc adhesive weights

For Mini, BMW and Rolls Royce. Varying lengths by .59" wide.

Zinc Series	Size	Pcs/Box
61670	5 GR	25
61671	10 GR	25
61672	15 GR	25
61673	20 GR	25
61674	25 GR	25
61675	30 GR	25
61676	35 GR	25
61677	40 GR	25
61678	45 GR	25
61679	50 GR	25
61680	55 GR	25
61681	60 GR	25

HOFMANN Two-Piece Wheel Weights



MBZ/Power Weight 261 Series

- 2-Piece zinc with MA clip for Daimler aluminum rims. Installation tool required

Zinc Series	Size	Pcs/Box
62171*	5 GR	25
62172*	10 GR	25
62174	15 GR	25
62175	20 GR	25
62176	25 GR	25
62177	30 GR	25
62178	35 GR	25
62179	40 GR	25
62180	45 GR	25
62181	50 GR	25
62182	55 GR	25

* 5 and 10 gram weights are polypropylene. All others are zinc.



MBS/Power Weight 261 Series

- 2-Piece zinc weight with M1 clip for Daimler steel rims. Installation tool required

Zinc Series	Size	Pcs/Box
HPW261005M1*	5 GR	25
HPW261010M1*	10 GR	25
HPW261015M1	15 GR	25
HPW261020M1	20 GR	25
HPW261025M1	25 GR	25
HPW261030M1	30 GR	25
HPW261035M1	35 GR	25
HPW261040M1	40 GR	25
HPW261045M1	45 GR	25
HPW261050M1	50 GR	25
HPW261055M1	55 GR	25
HPW261060MA	60 GR	25

* 5 and 10 gram weights are polypropylene. All others are zinc.

Tools for Two-Piece Weights

- For applying balance weight clips without damage to the wheel.



61361



61362

Order No.	Mfr. No.	Description	Ship Wt.
61362	6414604	Tire Compressor	10 lbs. - 5 kg
To open the clip for 2-piece weights			
61361	6410500	Two-Piece Weight Tool	4 lbs. - 2 kg

PERFECT Lead, Zinc & Steel Weights for Alloy Wheels

- AW Style uncoated lead, AWN coated lead & AWZ coated zinc

Red

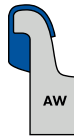

Domestic passenger cars and light trucks. GM, Ford and Chrysler.

Size Oz.	Pcs/Box	Lead AWN Series	Zinc AWZ Series Coated	Steel AWST Series	Lead AW Series
		Coated Order No.	Order No.	Order No.	Uncoated 50 Pcs/Box
.25	25	61017	62110		61000
.50	25	61018	62111	62920	61001
.75	25	61019	62112	62921	61002
1.00	25	61020	62113	62922	61003
1.25	25	61021	62114	62923	61004
1.50	25	61022	62115	62924	61005
1.75	25	61023	62116	62925	61006
2.00	25	61024	62117	62926	61007
2.25	25	61025	62118	62927	61008
2.50	25	61026	62119	62928	61009
2.75	25	61027	62120	62929	61010
3.00	25	61028	62121	62930	61011

- MC Style uncoated lead, MCN coated lead, MCZ coated zinc & MCST coated steel

Yellow

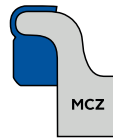

Domestic passenger cars and light trucks. GM, Ford and Chrysler.

Size Oz.	Pcs/Box	Lead MCN Series	Zinc MCZ Series Coated	Steel MCST Series	Lead MC Series
		Coated Order No.	Order No.	Order No.	Uncoated 50 Pcs/Box
.25	25	61050	62052	62824	61034
.50	25	61051	62053	62825	61035
.75	25	61052	62054	62826	61036
1.00	25	61053	62055	62827	61037
1.25	25	61054	62056	62828	61038
1.50	25	61055	62057	62829	61039
1.75	25	61056	62058	62830	61040
2.00	25	61057	62059	62831	61041
2.25	25	61058	62060	62832	61042
2.50	25	61059	62061	62833	61043
2.75	25	61060	62062	62834	61044
3.00	25	61061	62063	62835	61045
3.25	25	61745			
3.50	25	61746			
3.75	25	61747			
4.00	25	61748			

- EN Style coated lead, & ENZ coated zinc & ENST coated steel

Green

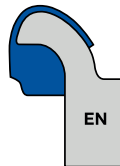

European passenger cars and light trucks

Size Gram	Pcs/Box	Lead EN Series	Zinc ENZ Series	Steel ENST Series
		Order No.	Order No.	Order No.
10	25	61092	62160	62885
15	25	61093	62161	62886
20	25	61094	62162	62887
25	25	61095	62163	62888
30	25	61096	62164	62889
35	25	61097	62165	62890
40	25	61098	62166	62891
45	25	61099	62167	62892
50	25	61100	62168	62893
55	25	61101	62169	62894
60	25	61102	62170	62895

- IAW style coated lead IAWZ coated zinc & IAWST coated steel

Blue



Japanese and European passenger cars and light trucks

Size Gram	Pcs/Box	Lead IAW Series	Zinc IAWZ Series Coated	Steel IAWST Series
		Order No.	Order No.	Order No.
5	25	61065	62080	
10	25	61066	62081	62874
15	25	61067	62082	62875
20	25	61068	62083	62876
25	25	61069	62084	62877
30	25	61070	62085	62878
35	25	61071	62086	62879
40	25	61072	62087	62880
45	25	61073	62088	62881
50	25	61074	62089	62882
55	25	61075	62090	62883
60	25	61076	62091	62884

- FN style coated steel, FNZ coated zinc & FNST coated steel

Orange



Japanese passenger cars and light trucks

Size Gram	Pcs/Box	Lead FN Series	Zinc FNZ Series	Steel FNST Series
		Order No.	Order No.	Order No.
5	25	61311		62836
7.5	25	61313		
10	25	61310	62093	62837
15	25	61312	62094	62838
20	25	61314	62095	62839
25	25	61316	62096	62840
30	25	61318	62097	62841
35	25	61320	62098	62842
40	25	61322	62099	62843
45	25	61324	62100	62844
50	25	61326	62101	62845
55	25	61328	62102	62846
60	25	61330	62103	62847
65	25	61327		
70	25	61329		

- LH Series coated lead & LHZ coated zinc & LHST Coated Steel

Purple



Domestic light trucks. GM, Ford & Chrysler

Size Oz.	Pcs/Box	Lead LH Series	Zinc LHZ Series	Steel LHST Series
		Order No.	Order No.	Order No.
.25	25	61363	62068	62931
.50	25	61364	62069	62932
.75	25	61365	62070	62933
1.00	25	61366	62071	62934
1.25	25	61367	62072	62935
1.50	25	61368	62073	62936
1.75	25	61369	62074	62937
2.00	25	61370	62075	62938
2.25	25	61371	62076	62939
2.50	25	61372	62077	62940
2.75	25	61373	62078	62941
3.00	25	61374	62079	62942

PERFECT Lead, Zinc & Steel Weights for Alloy Wheels

- TN Style coated lead, TZ coated zinc & TST coated steel

Grey



Domestic light trucks, GM, Ford Chrysler

Size Oz.	Pcs/Box	Lead TN Series	Zinc TZ Series	Steel TST Series
.25	25	61799		62812
.50	25	61800	62037	62813
.75	25	61801	62038	62814
1.00	25	61802	62039	62815
1.25	25	61803	62040	62816
1.50	25	61804	62041	62817
1.75	25	61805	62042	62818
2.00	25	61806	62043	62819
2.25	25	61807	62044	62820
2.50	25	61808	62045	62821
2.75	25	61809	62046	62822
3.00	25	61810	62047	62823
3.25	25	61811		
3.50	25	61812		
3.75	25	61813		
4.00	25	61814		
4.50	25	61815		
5.00	25	61816		

PERFECT Rim Gauge Tools

Convenient and economical gauges guide the technician to the correct weight application.

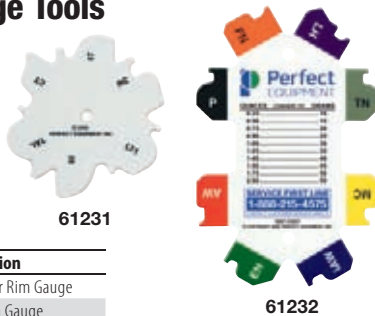

Order No.	Mfr. No.	Description
61232	RPG1	Passenger Rim Gauge
61231	RG2	Truck Rim Gauge

PERFECT Steel QuikStik Truck Adhesive Wheel Weights

- Steel alternative to 300360 (Myers 61113) lead weight
- Standard profile
- ½ Ounce increments, 6.00 ounces per strip



Designed for trucks and RVs

Order No.	Mfr. No.	Increment Width	No. Strips	Segment Wt.	Segments
61117	300360ST	½"	30	.50 Oz. Truck/RV	360

PERFECT Steel Economy Adhesive Weights

- Plated steel coating
- No cutting or measuring



Order No.	Mfr. Code	No. Strips	Segment Wt.	Qty. Box
62106	SST228PC	36	.25 Oz. Standard	288

PERFECT Steel QuikStik Adhesive Wheel Weights

- Low profile steel alternative to 200624 (Myers 61110) lead weight
- ¼ Ounce increments, 3.00 ounces per strip



Low profile for imports and sports cars where the brake caliper clearance knocks off standard thickness weights.

Order No.	Mfr. No.	Increment Width	No. Strips	Segment Wt.	Segments
61116	200624ST	¼"	52	.25 Oz. Low Profile	624

PERFECT Lead Quiktab Adhesive Wheel Weights



The Quiktab is an extension of the paper backing on the adhesive weight as an easy starter to peel the backing away. Weights are pre-cut and pre-taped. No cutting, no pre-contouring, and no waste.



Passenger Car Applications

Order No.	Mfr. Code	Size	No. Strips	Segment Wt.	Qty. Box
61108	100360	½" x 6"	30	.25 Oz. Standard	360
61029	100360S	½" x 6"	30	.25 Oz. Silver Coated	360
61109	100720	½" x 6"	60	.25 Oz. Standard	720
61110	200624	¾" x 6"	52	.25 Oz. Low Profile	624
61114	200624S	¾" x 6"	48	.25 Oz. Low Profile	576

Motorcycle Applications

No cutting, no pre-contouring, and no waste. Each box contains (30) 3 ounce strips segmented into (12) ¼ ounce increments. 360 segments per box.

Order No.	Mfr. No.	Color	Primary Application	Strips Per Box
61029	100360S	Silver	All	30
61029B	100360B	Black	All	30

Truck Applications

- Quiktab adhesive weights for light, medium & heavy-duty trucks



The 1 oz. CL6 is designed for light, medium and heavy-duty trucks. The 2 oz. CL12 is designed for medium and heavy-duty applications.

Order No.	Mfr. Code	Description	No. Strips	Segment Wt.	Segments
61113	300360	¾" x 6"	30	.50 Oz. Truck/RV	360
61225	CL6	6 Oz. Strips	30	1 Oz. Standard	180
61226	CL12	12 Oz. Strips	8	2 Oz. Standard	48

PERFECT Steel Quiktab Adhesive Wheel Weights



Non-Lead (Steel)

62104	SST300N	¾" x 4½"	25	.25 Oz. Standard Steel	300
62105	SSG060N	¾" x 4½"	25	5g Low Profile Steel	300
61115	SSM600N	1" x 6"	30	.25 Oz. Standard Steel	720

Wheel Weights

PERFECT "P" Series Wheel Weights

- P series coated lead, PZ coated zinc & PST coated steel
- Uncoated lead & uncoated zinc available
- Standard & bulk



For use on all standard passenger car 13" to 15" steel wheels.

Standard Coated				
		Lead P Series	Zinc PZ Series	Steel PST Series
Size Oz.	Pcs/Box	Order No.	Order No.	Order No.
.25	25	61430	62020	62800
.50	25	61431	62021	62801
.75	25	61432	62022	62802
1.00	25	61433	62023	62803
1.25	25	61444	62024	62804
1.50	25	61445	62025	62805
1.75	25	61446	62026	62806
2.00	25	61447	62027	62807
2.25	25	61448	62028	62808
2.50	25	61449	62029	62809
2.75	25	61450	62030	62810
3.00	25	61451	62031	62811

Standard Uncoated					
		Lead P Series	Zinc PZU Series		
Size Oz.	Pcs/Box	Order No.	Order No.	Pcs/Box	
.25	50	61290	62140	25	
.50	50	61291	62141	25	
.75	50	61292	62142	25	
1.00	50	61293	62143	25	
1.25	50	61294	62144	25	
1.50	50	61295	62145	25	
1.75	50	61296	62146	25	
2.00	50	61297	62147	25	
2.25	50	61298	62148	25	
2.50	50	61299	62149	25	
2.75	50	61300	62150	25	
3.00	50	61301	62151	25	
3.25	25	61302			
3.50	25	61303			
3.75	25	61304			
4.00	25	61305			
4.50	25	61306			
5.00	25	61307			
5.50	25	61308			
6.00	25	61309			

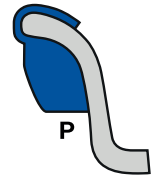

PERFECT Lead & Zinc Truck Tire Wheel Weights

LT1 Series



- LT1 uncoated lead & LT1Z coated zinc

All ¾ and 1-ton trucks with tube or tubeless wheels.

		Lead LT1 Series	Zinc LT1Z Series
Size Oz.	Pcs/Box	Order No.	Order No.
.50	25	61130	62850
1.00	25	61131	62851
1.50	25	61132	62852
2.00	25	61133	62853
2.50	25	61134	62854
3.00	25	61135	62855
3.50	25	61136	62856
4.00	25	61137	62857
4.50	25	61138	62858
5.00	25	61139	62859
6.00	25	61140	

I9 Series



A thin style weight for heavy-duty trucks where there may be interference with steering parts. Also for use on rims too thick for "I7" series weights. Basic rim sizes 7.50 and 8.

Lead I9 Series		
Size Oz.	Pcs/Box	Order No.
2.00	25	61215
3.00	25	61216
4.00	25	61217
6.00	25	61218
8.00	25	61219
10.00	25	61220
12.00	25	61221

I7 Series



- I7 uncoated lead & I7Z coated zinc

For medium and heavy-duty trucks. Used on the majority of trucks with tube type tires.

		Lead I7 Series	Zinc I7Z Series
Size Oz.	Pcs/Box	Order No.	Order No.
1.00	25	61173	62860
1.50	25		62861
2.00	25	61174	62862
2.50	25		62863
3.00	25	61175	62864
3.50	25		62865
4.00	25	61176	62866
5.00	25	61177	62867
6.00	25	61178	
8.00	25	61179	
10.00	25	61180	
12.00	25	61181	
14.00	25	61182	
16.00	25	61183	

RC Series

- Uncoated lead



Tubeless curved flange truck wheels like Firestone radial Commander, Budd, Firestone, Goodyear strip-steel wheels.

Lead RC Series		
Size Oz.	Pcs/Box	Order No.
2.00	25	61204
3.00	25	61205
4.00	25	61206
6.00	25	61207
8.00	25	61208
10.00	20	61209
12.00	20	61210

TAL Series



- TAL Style coated & uncoated lead & TALZ zinc coated

For all Alcoa and Accuride aluminum tubeless truck wheels from 1983 on.

		Lead TAL Coated	Lead TAL Uncoated	Zinc TALZ Series
Size Oz.	Pcs/Box	Order No.	Order No.	Order No.
1.00	25			62868
2.00	25	61284		62869
3.00	25	61280	61250	62870
4.00	25	61281	61251	62871
5.00	25			62872
6.00	25	61282	61252	62873
8.00	25	61283	61253	

CT Series

- Uncoated lead



For Firestone, Accuride, Budd or Goodyear tubeless rims with straight flanges. Rim widths of 6.76", 7.50", and 8.25"

Lead CT Series		
Size Oz.	Pcs/Box	Order No.
2.00	25	61190
3.00	25	61192
4.00	25	61193
6.00	25	61194
8.00	25	61195
10.00	20	61196
12.00	20	61197
14.00	10	61198
16.00	10	61199



61090, 62130



61089, 61091, 62133



61336

PERFECT Lead & Zinc Wheel Weight Assortments for Alloy Wheels

The ideal assortment for total alloy wheel coverage. It contains all seven alloy series including the new Chrysler "LH" series. Complete with rack, color-coded bins, labels, application header card, application catalog, rim gauge, Wheel Protectors® counter card and wheel weight hammer.

Lead Assortment

AW.25N-AW2.00N	161 pieces
MC.25N-MC2.00N	161 pieces
LH.25-LH2.00N	161 pieces
TO.25N-T2.00N	161 pieces
IAW10g-IAW40g	136 pieces
EN10g-EN40g	123 pieces
FN10g-FN40g	123 pieces

Zinc Assortment

P.25Z-P2.00Z	96 pieces
AW.25Z-AW2.00Z	96 pieces
MC.25Z-MC2.00Z	96 pieces
LH.25Z-LH2.00Z	96 pieces
TO.25Z-T2.00Z	96 pieces
IAW10Z-IAW40Z	84 pieces
EN10Z-EN40Z	84 pieces
FN10Z-FN40Z	84 pieces

Order No.	Mfr. No.	Description	Ship Wt.
61090	CWW150	Alloy Weight Assortment 1,026 Pieces	96 lbs. - 44 kg
62130	CWW150Z	Alloy Weight Assortment 732 Pieces	100 lbs. - 45 kg

PERFECT Non-Lead Wheel Weight Assortment for Passenger Car & Light Truck

- Environmentally-friendly

The most complete assortment of non-lead wheel weights available. Complete with color-coded bins, bin labels, rack, application header card, application catalog, wall chart, Wheel Protectors® counter card, and wheel weight hammer.

Non-Lead Assortment

P.25ST-P3.00ST	25 Pcs/Box
AW.25S-AW3.00Z	25 Pcs/Box
MC.25S-MC3.00ST	25 Pcs/Box
LH.25Z-LH3.00Z	25 Pcs/Box
IAW10ST-IAW60ST	25 Pcs/Box
EN10ST-EN60ST	25 Pcs/Box
FN10ST-FN60ST	25 Pcs/Box
T.25S-T3.00ST	25 Pcs/Box

Order No.	Mfr. No.	Description	Ship Wt.
61336	CWW075NL	Passenger & Light Truck Assortment 2,325 Pieces	385 lbs. - 175 kg

PERFECT Steel QuikStik Starter Kit

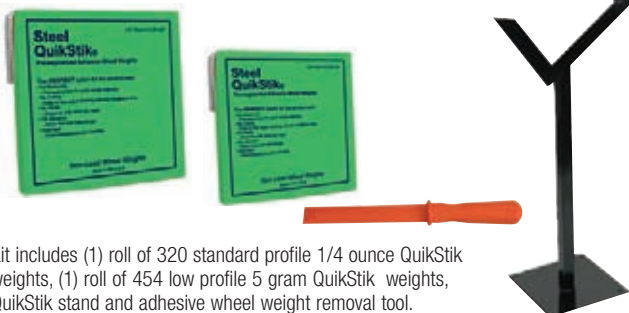

Kit includes (1) roll of 320 standard profile 1/4 ounce QuikStik weights, (1) roll of 454 low profile 5 gram QuikStik weights, QuikStik stand and adhesive wheel weight removal tool.

Order No.	Mfr. No.	Description
61843	SK2000	Steel QuikStik Starter Kit
61842	OS2000	Steel QuikStik Stand Only

PERFECT Lead & Zinc Wheel Weight Assortment for Passenger Car & Light Truck

The most complete assortment available. It contains six alloy series including the Chrysler "LH" series, passenger steel series, and the "TN" truck series. Complete with color-coded bins, bin labels, rack, application header card, application catalog, wall chart, Wheel Protectors® counter card, (2) car rim gauges, and wheel weight hammer.

Lead Assortment

P.25-P3.00	600 pieces
AW.25N-AW3.00N	300 pieces
MC.25N-MC3.00N	300 pieces
LH.25-LH3.00	300 pieces
IAW10g-IAW60g	275 pieces
EN10g-EN60g	275 pieces
FN10g-FN60g	275 pieces
T25-T3.00N	300 pieces

Zinc Assortment

P.25Z-P3.00Z	600 pieces
AW.25S-AW3.00Z	300 pieces
MC.25S-MC3.00Z	300 pieces
LH.25Z-LH3.00Z	300 pieces
IAW10Z-IAW60Z	275 pieces
EN10Z-EN60Z	275 pieces
FN10Z-FN60Z	275 pieces
T25Z-T3.00Z	300 pieces

Order No.	Mfr. No.	Description	Ship Wt.
61089	CWW075	Pass. & Light Truck Assortment 2,625 Pieces	360 lbs. - 162 kg
61343L	CWW075E	Rack Only with Bins	115 lbs. - 52 kg
62133	CWW075Z	Pass. & Light Truck Assortment 2,325 Pieces	360 lbs. - 162 kg
61343Z	CWW075E	Rack Only with Bins	115 lbs. - 52 kg

PERFECT Lead Wheel Weight Assortment

- Lower quantity of less popular sizes

Lead Assortment

P Series	25 ea. .25 oz. - 3 oz.
AWN	25 ea. .25 oz. - 2 oz., 12 ea. 2.25 oz. - 3 oz.
MCN	25 ea. .25 oz. - 2 oz., 12 ea. 2.25 oz. - 3 oz.
LH	25 ea. .25 oz. - 2 oz., 12 ea. 2.25 oz. - 3 oz.
IAW	25 ea. 10 - 45g, 12 ea. 50 - 60g
EN	25 ea. 10 - 45g, 12 ea. 50 - 60g
FN	25 ea. 10 - 45g, 12 ea. 50 - 60g
TN	25 ea. .25 oz. - 2 oz., 12 ea. 2.25 oz. - 3 oz.

Kit includes: color-coded bins, bin labels, rack, application header card, application catalog and wall chart, (2) rim gauges, Wheel Protectors® counter card, wheel weight hammer, and the following wheel weights.

Order No.	Mfr. No.	Description	Ship Wt.
61091	CWW074	Passenger & Light Truck Assortment 2,000 Pieces	330 lbs. - 149 kg

PERFECT Steel QuikStik Weights on a Roll

- Low environmental impact



Protects wheels from discoloration and rust. Conforms to rim contour easily. No cutting or measuring and the protective liner removes easily from the weight.

Order No.	Size	Segments Per Roll	Description
61840	.25 oz.	1,280	Standard QuikStik Roll, 20 Lbs. Per Roll
61841	5 gm	1,500	Low Profile QuikStik Roll, 16.5 Lbs. Per Roll

Steel Adhesive Wheel Weight Options

Rating	Mfg.	Myers No.	Weight Design	Style	Ounce Per Segment	Country of Origin	Tape	Salt Spray Test	
STANDARD									
*****	Perfect	62104	Trapezoid	Standard Profile	0.25	USA	QuikStik	1,000	
*****	Perfect	61115	Trapezoid	Standard Profile	0.25	USA	QuikStik	1,000	
****	Perfect	61116	Rectangle	Low Profile	0.25	USA	QuikStik	500	
****	Bada	55905	Square	Low Profile	0.25	China	US White	480	
	Generic	881/4B14	Square	Low Profile	0.25	China	China Blue	125	
ECONOMY									
**	Perfect	62106	Square	Low Profile	0.25	China	China Blue	75	
**	Bada	55908	Trapezoid	Standard Profile	0.25	USA	US White	75	
***	Generic	63001	Square	Low Profile	0.25	China	China White	125	
TRUCK									
****	Perfect	61117	Rectangle	Standard Profile	0.5	USA	QuikStik	500	
****	Bada	55193	Square	Low Profile	0.5	China	US White	480	
****	Bada	55194	Square	Low Profile	1.0	China	US White	480	
**	Generic	63005	Square	Low Profile	0.5	China	China White	75	
	Generic	67000	Square	Low Profile	1.0	China	China White	125	

Wheel Weight Designs



Trapezoid: The trapezoid shape centers the mass closer to the point of correction resulting in a higher first-time balance.



Rectangle: Using a Rectangle shape provides better center of mass.



Square

Wheel Weight Profiles



Standard: For use in most applications.

Low Profile: Used primarily on imports and sports cars where the brake caliper clearance knocks off the standard profile weights.

Wheel Weight Tapes

QuikStick: Perfect OEM wheel weight adhesive

QuikTab: Perfect adhesive paper extends to the side of the weight making the paper easy to remove

US White: Bada Premium adhesive produced in the US

China Blue: China Tape Formulations

China White: China Tape Formulations



QuikTab

Tape-On-Top feature keeps the weight strip rigid just like its lead predecessor, enabling easy, accurate one handed application.



Without Tape-On-Top

With Tape-On-Top

	Segments per Strip	Strips per Box	Segments per Box	Ounces per Strip	Ounces per Box	Comments
	12	25	300	3	75	OEM Equivalent, Coating & tape have highest quality aftermarket standards. High initial tack tape. QuikTab easy paper removal
	24	30	720	6	180	OEM Equivalent, Coating & tape have highest quality aftermarket standards. High initial tack tape. QuikTab easy paper removal
	12	52	624	3	156	Nano-Coating
	8	30	240	2	60	Powder coating with US Duratec tape
	12	48	576	3	144	Powder coating, black adhesive
	8	36	288	2	72	Zinc coating
	12	16	192	3	48	Zinc coating
	12	48	576	3	144	Zinc with powder coating
	12	30	360	6	180	Nano coating
	7	18	126	3.5	63	Tape On Top one hand application - Premium adhesive. Superior coating protection/finish. Same corrosion resistant coating used on BADA's steel clip weights. Center of mass is positioned closer to balance point of correction, Ideal geometry = higher first time balance.
	4	18	72	4	72	Tape On Top one hand application - Premium adhesive. Superior coating protection/finish. Same corrosion resistant coating used on BADA's steel clip weights. Center of mass is positioned closer to balance point of correction, Ideal geometry = higher first time balance.
	6	48	288	3	144	Zinc Coating
	4	36	124	4	144	Zinc Plated & powder coated

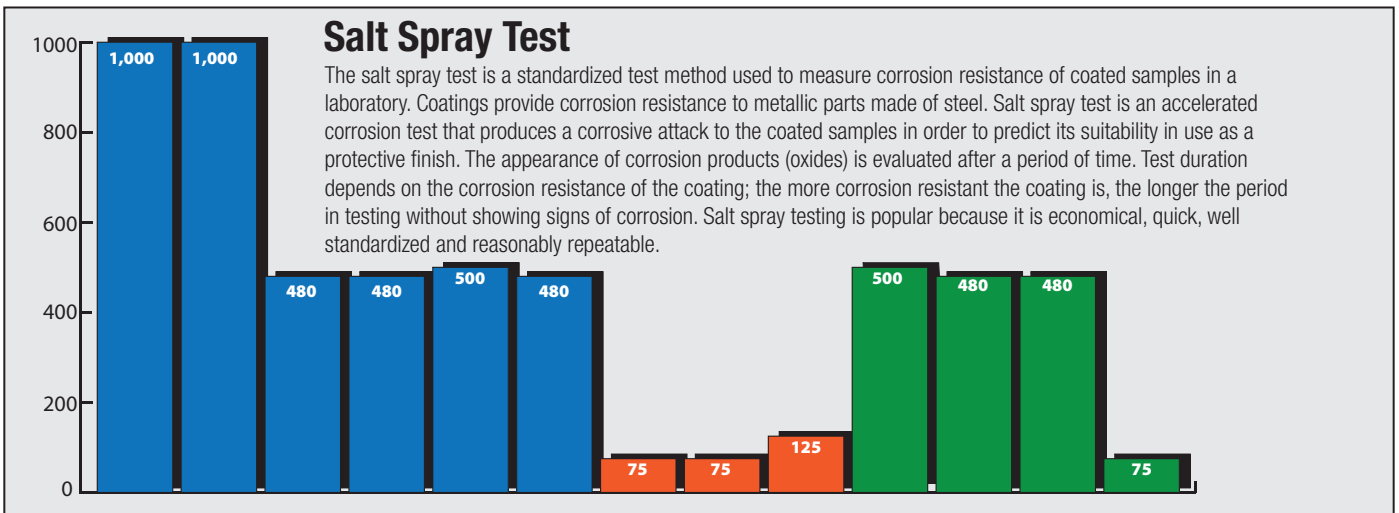

Adhesive Steel Truck Wheel Weights

- 1 Oz. segments
- 4 Segments per strip, 36 strips per box
- Zinc plated & powder coated



Easy peel backing



White adhesive tape. The weights are zinc plated and powder coated.

Order No.	Size	No. Strips	Segment Wt.	Segments Box
67000	¾" x 5 7/16"	36	1 Oz. Standard	144

Adhesive Steel Passenger Wheel Weights

- ¼ Oz. segments
- 12 Segments per strip, 48 strips per box
- Zinc plated & powder coated

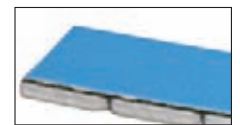

Blue paper, black adhesive



Low profile weights with blue adhesive tape. The weights are zinc plated and powder coated.

Order No.	Size	No. Strips	Segment Wt.	Segments Box
881/4B14	¾" x 7 3/4"	48	.25 Oz. Standard	576

BADA Lead Passenger Tape-A-Weights

- Slender profile for out of sight mounting
- Break-A-Way strips eliminate cutting & pre-contouring

Break-A-Way Weights



Order No.	Mfr. No.	Size	No. Pieces	Segment Wt.	Segments
55215	7025	1/2" x 12"	15	.25 oz. Standard	360
55208	7125	1/2" x 12"	30	.25 oz. Standard	720
55204	7026	3/4" x 6"	48	.25 oz. Low Profile	576
55212	7126	3/4" x 6"	348	.25 oz. Low Profile	4,176

Cut-A-Way Weights



Order No.	Mfr. No.	Size	No. Pieces	Segment Wt.	Segments
55200	9101	1/2" x 12"	30	.50 oz. Standard	360
55209	9101-65	1/2" x 12"	174	.50 oz. Standard	2,088
55211	9405-C	1/2" x 12"	12	.50 oz. Chrome	144
55201	9901	3/4" x 12"	24	.50 oz. Low Profile	288
55219	9901-65	3/4" x 12"	174	.50 oz. Low Profile	2,088

BADA Lead RV & Light Truck Tape-A-Weights

- Break-A-Way strips eliminate cutting & pre-contouring

Break-A-Way Weights



Order No.	Mfr. No.	Size	No. Pieces	Segment Wt.	Segments
55205	7127	3/4" x 12"	16	.50 oz. RV Lt. Truck	384

Cut-A-Way Weights

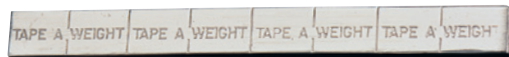

Order No.	Mfr. No.	Size	No. Pieces	Segment Wt.	Segments
55217	3101	1" x 12"	12	1 oz. RV Lt. Truck	216
55203	6001	3/4" x 12"	16	1 oz. RV Lt. Truck	192

BADA Lead SUV Tape-A-Weights

- Light truck & SUV applications



Order No.	Description
55229	1 oz. Lead Segments, 24 Strips Per Box
55230	2 oz. Lead Segments, 11 Strips Per Box

Adhesive Weight Removal Tool



A high-impact plastic chisel designed to remove adhesive wheel weights quickly without damaging expensive rims.

Order No.	Description
50508	Adhesive Wheel Weight Removal Tool

BADA Steel Tape-A-Weights

- Available on a roll or in a box



No lead, non-toxic, coated steel weights. Pull out the desired amount and tear. No cutting required. 176 ounces (11 lbs.) per roll in .25 ounce segments. Optional metal bracket designed to hang on the balancer.

Tape-A-Weight Strips in a box are .25 ounce segments, 2 oz. strips, 30 strips per box.

Order No.	Description
55901	STAW Tape-A-Weight on a Roll
55903	STAW Tape-A-Weight on a Roll with Holder
55902	Optional Holder for Roll
55905	STAW Tape-A-Weight Strips .25 oz., 60 oz. Per Box

BADA Steel Coated Tape-A-Weights

- 25 Pieces per box, 4 boxes per case



Order No.	Size	gram	Wt. Case/ lbs.
55035	5		1
55034	10		2
55033	15		3
55032	20		4
55031	25		6

Order No.	Size	gram	Wt. Case/ lbs.
55030	30		7
55029	35		8
55028	40		9
55027	45		10
55026	50		11

BADA Steel Truck Tape-A-Weights

- Low profile



55194

Order No.	Mfr. No.	Size	No. Pieces	Segment Wt.	Segments
55193	1050FE	3/4" x 5 1/2"	18	.50 oz. Low Profile	126
55194	11000FE	3/4" x 5"	18	1 oz. Low Profile	72

Wheel Weight Adhesive Removal Kit

- Removes wheel weight adhesive without damaging the rim



Includes tool with built-in regulator, (12) eraser pads, arbor, and spanner wrench. Replacement pads limited to 4,000 rpm. Specs.: 1/2 hp, 4,000 rpm; min. hose size 3/8"; air inlet 1/4"; aver. air cons. 4 cfm; oper. air pressure 90 - 120 psi.

Order No.	Description	Ship Wt.
17026	Wheel Weight Adhesive Removal Kit	9 lbs. - 4 kg
17027	Replacement Adhesive Removal Pad (Sold Each)	1 lbs. - 1 kg
17028	Replacement Arbor	1 lbs. - 1 kg

BADA Lead Wheel Weight Assortments for Alloy Wheels

- 1,125 Piece assortment



Fits all domestic and import alloy wheels with the correct coated weight. Includes bins and a bench/wall rack, bin labels, an application header card, wheel weight hammer, passenger rim gauge, counter card, gram to ounce conversion chart, an application guide, and the following wheel weights.

ALC.25-ALC2.00	200 pieces
ALCMC.25-ALCMC2.00	200 pieces
ALCTW.25-ALCTW2.00	200 pieces
ALCIW10g-ALCIW40g	175 pieces
ALCEN10g-ALCEN40g	175 pieces
ALCFN10g-ALCFN40g	175 pieces

Order No.	Mfr. No.	Description	Ship Wt.
55206	201125	Alloy Weight Assortment	150 lbs. - 68 kg

BADA Lead Wheel Weight Assortment

- 1,950 Piece assortment
- For passenger car & light truck



Includes: metal wheel weight storage rack, header card, color-coded channel cards, planogram, rim gauges, wall chart, tape-a-weight scraper, wheel weight hammer, and the following wheel weights.

T.25-T2.00	400 pieces
ALC.25-ALC2.00	200 pieces
ALCMC.25-ALCMC2.00	200 pieces
ALCLH.25-ALCLHC2.00	200 pieces
TTC.25-TTC2.00	200 pieces
ALCIW10g-ALCIW55g	250 pieces
ALCFN10g-ALCFN55g	250 pieces
ALCEN10g-ALCEN55g	250 pieces

Order No.	Mfr. No.	Description	Ship Wt.
55197	5201275	Passenger & Light Truck Assortment - Complete	240 lbs. - 108 kg
55198	5201205	Rack Only	55 lbs. - 25 kg

BADA Steel Wheel Weight Assortments for Alloy Wheels



Fits all domestic and import alloy wheels with the correct coated steel weight. Includes (40) bins, bench rack, bin labels, wheel weight hammer, rim gauge, application header card, and the wheel weights listed.

TFE.25-TFE2.00	25 Pcs/Box
ALFE.25-ALFE2.00	25 Pcs/Box
MCFE.25-MCFE2.00	25 Pcs/Box
PFE.25-PFE2.00	25 Pcs/Box
FNFE10g-FNFE45g	25 Pcs/Box

Order No.	Mfr. No.	Description	Ship Wt.
55196	5202125	Steel Weight Assortment	110 lbs. - 50 kg

BADA Steel Wheel Weight Assortment

- For passenger car & light truck



Includes: metal wheel weight storage rack, header card, color-coded channel cards, planogram, rim gauges, wall chart, application guide, weight order form, tape-a-weight scraper, wheel weight hammer, and the following wheel weights.

TFE.25-TFE2.00	25 Pcs/Box
ALFE.25-ALFE2.00	25 Pcs/Box
MCFE.25-MCFE2.00	25 Pcs/Box
PFE.25-PFE2.00	25 Pcs/Box
IWFE10g-IWFE55g	25 Pcs/Box
FNFE10g-FNFE55g	25 Pcs/Box
ENFE10g-ENFE55g	25 Pcs/Box

Order No.	Mfr. No.	Description	Ship Wt.
55195	5202075	Passenger & Light Truck Assortment Complete	240 lbs. - 108 kg

Alloy Wheel Gauge

- Hold the gauge to the lip of the wheel to select the proper wheel weight style
- Includes an ounce-to-gram conversion chart



Order No.	Mfr. No.	Description
55900	5200005	Alloy Wheel Gauge

BADA Lead & Steel Weights for Alloy Wheels

- ALC Style Coated & ALFE Steel

Red

Domestic passenger cars and light trucks. GM, Ford and Chrysler.



Standard			
Size Oz.	Pcs/Box	Lead ALC Series Order No.	Steel ALFE Series Order No.
.25	25	55507	55000
.50	25	55508	55001
.75	25	55509	55002
1.00	25	55510	55003
1.25	25	55511	55004
1.50	25	55512	55005
1.75	25	55513	55006
2.00	25	55514	55007
2.25	25	55517	55008
2.50	25	55515	55009
2.75	25	55518	55010
3.00	25	55516	55011

AL Style Lead Uncoated		
Size Oz.	Pcs/Box	Lead AL Series Order No.
.25	50	55213
.50	50	55214
.75	50	55221
1.00	50	55216
1.25	50	55223
1.50	50	55218
1.75	50	55225
2.00	50	55220
2.25	50	55226
2.50	50	55222
2.75	50	55227
3.00	50	55224

- ALCFN style coated lead & FNFE coated steel

Orange

Japanese passenger cars and light trucks



Standard			
Size Gram	Pcs/Box	Lead ALCFN Series Order No.	Steel FNFE Series Order No.
5	25	55599	
10	25	55600	55012
15	25	55601	55013
20	25	55602	55014
25	25	55603	55015
30	25	55604	55016
35	25	55605	55017
40	25	55606	55018
45	25	55607	55019
50	25	55608	55020
55	25	55609	55021
60	25	55610	55022

- ALCMC Style Coated lead & MCFE coated steel

Yellow

Domestic passenger cars and light trucks. GM, Ford and Chrysler.



Standard			
Size Oz.	Pcs/Box	Lead ALCMC Series Order No.	Steel MCFE Series Order No.
.25	25	55740	55059
.50	25	55741	55058
.75	25	55742	55057
1.00	25	55743	55056
1.25	25	55744	55055
1.50	25	55745	55054
1.75	25	55746	55053
2.00	25	55747	55052
2.25	25	55748	55051
2.50	25	55749	55050
2.75	25	55750	55049
3.00	25	55751	55048

Bulk		
Size Oz.	Pcs/Box	Lead ALCMC Series Order No.
.25	400	55177
.50	400	55178
.75	400	55179
1.00	400	55180
1.25	200	55181
1.50	200	55182
1.75	200	55183
2.00	200	55184
2.25	200	55185
2.50	200	55186
2.75	200	55187
3.00	200	55188

- ALCMC Style Lead Uncoated 50 per box

50 Per Box		
Size Oz.	Pcs/Box	Lead ALCMC Series Order No.
.25	50	55760
.50	50	55761
.75	50	55762
1.00	50	55763
1.25	50	55764
1.50	50	55765
1.75	50	55766
2.00	50	55767
2.25	50	55768
2.50	50	55769
2.75	50	55770
3.00	50	55771

- LH Series Lead & Steel Wheel Weights

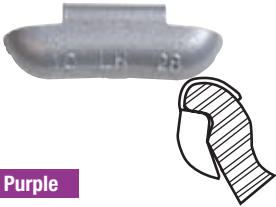

Purple

Newer Chrysler

Standard			
Size Oz.	Pcs/Box	Lead ALCLH Series Order No.	Steel LHFE Series Order No.
.25	25	55123	55440
.50	25	55124	55441
.75	25	55125	55442
1.00	25	55126	55443
1.25	25	55127	55444
1.50	25	55128	55445
1.75	25	55129	55446
2.00	25	55130	55447
2.25	25	55131	55448
2.50	25	55132	55449
2.75	25	55133	
3.00	25	55134	

- ALCEN Style Coated Lead & ENFE Steel



Green

Mercedes and older Japanese vehicles

Standard			
Size Gram	Pcs/Box	Lead ALCEN Series Order No.	Steel ENFE Series Order No.
10	25	55780	55150
15	25	55781	55151
20	25	55782	55152
25	25	55783	55153
30	25	55784	55154
35	25	55785	55155
40	25	55786	55156
45	25	55787	55157
50	25	55788	55158
55	25	55789	55159
60	25	55790	55160

- IAW Style Lead Coated & IWFE Steel Coated



Blue

Japanese and European passenger cars and light trucks

Standard			
Size Gram	Pcs/Box	Lead ALCIW Series Order No.	Steel IWFE Series Order No.
5	25	55529	
10	25	55530	55270
15	25	55531	55271
20	25	55532	55272
25	25	55547	55273
30	25	55533	55274
35	25	55534	55275
40	25	55548	55276
45	25	55535	55277
50	25	55536	55278
55	25	55537	55279
60	25	55538	55280

- TTC Style Coated Lead & TFE Coated Steel

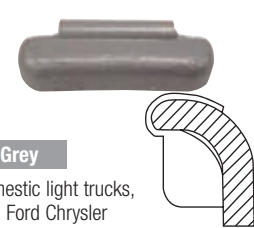

Grey

Domestic light trucks, GM, Ford Chrysler

Standard			
Size Oz.	Pcs/Box	Lead TTC Series Order No.	Steel TFE Series Order No.
.25	25	55354	55047
.50	25	55355	55046
.75	25	55356	55045
1.00	25	55357	55044
1.25	25	55358	55043
1.50	25	55359	55042
1.75	25	55360	55041
2.00	25	55361	55040
2.25	25	55362	55039
2.50	25	55363	55038
2.75	25	55364	55037
3.00	25	55365	55036

BADA TC Thinline

- T Style coated lead & coated steel



Passenger cars and light trucks

Standard			
Size Oz.	Pcs/Box	Lead TC Series	Steel PFE Series
.25	25	55250	55073
.50	25	55251	55072
.75	25	55252	55071
1.00	25	55253	55070
1.25	25	55254	55069
1.50	25	55255	55068
1.75	25	55256	55067
2.00	25	55257	55066
2.25	25	55258	55065
2.50	25	55259	55064
2.75	25	55260	55063
3.00	25	55261	55062
3.25	25	55262	55061
3.50	25	55263	55060
3.75	25	55264	
4.00	25	55265	
4.50	25	55266	
5.00	25	55267	
5.50	25	55268	
6.00	25	55269	

BADA Lead Two-Piece Wheel Weights

- MBC style coated lead for Mercedes Benz
- 4 Boxes per case



Lead MBC Series			Lead MBC Series		
Size Grams	Pcs/Box	Order No.	Size Grams	Pcs/Box	Order No.
5 GR.	25	55135	35 GR.	25	55141
10 GR.	25	55136	40 GR.	25	55142
15 GR.	25	55137	45 GR.	25	55143
20 GR.	25	55138	50 GR.	25	55144
25 GR.	25	55139	55 GR.	25	55148
30 GR.	25	55140	60 GR.	25	55146

Non-Lead Legislation in North America

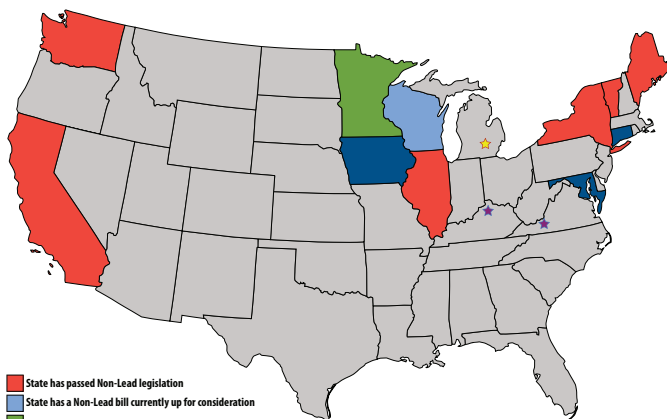

U.S. Air Force mandates Non-Lead on all bases
U.S. Postal Service mandates Non-Lead on all fleet vehicles

BADA Thinline

- T Style uncoated lead
- Standard & bulk



All import and domestic passenger cars, 1/2 ton trucks, mini-pickups, and vans with standard .125" flange

Standard			Bulk		
Size Oz.	Pcs/Box	Lead T Series	Size Oz.	Pcs/Box	Lead T Series
.25	50	55100	.25	800	55660
.50	50	55101	.50	800	55661
.75	50	55102	.75	800	55662
1.00	50	55103	1.00	400	55663
1.25	50	55104	1.25	400	55664
1.50	50	55105	1.50	400	55665
1.75	50	55106	1.75	200	55666
2.00	50	55107	2.00	200	55667
2.25	50	55108	2.25	200	55668
2.50	50	55109	2.50	200	55669
2.75	50	55110	2.75	200	55670
3.00	50	55111	3.00	100	55671
3.25	25	55120	3.25	100	55672
3.50	25	55112	3.50	100	55673
3.75	25	55121	3.75	100	55674
4.00	25	55113	4.00	100	55675
4.50	25	55114	4.50	100	55676
5.00	25	55115	5.00	100	55677
5.50	25	55116	5.50	100	55678
6.00	25	55117	6.00	100	55679

Wheel Weight Storage Rack

- Includes 24 bins
- Stores up to 500 lbs. of weights



Wheel Weights Not Included

Keep wheel weights and related tools and accessories handy and easy to find. Storage rack accommodates up to 24 different sizes of wheel weights in heavy-duty polypropylene plastic bins. Stationary Bin Rack is made of heavy-duty steel and measures 36" l. x 14 1/8" w. x 53" h. Shipped un-assembled. Bins 10 7/8" l. x 11" w. x 5" h.

Order No.	Description	Ship Wt.
81307	Wheel Weight Storage Rack	54 lbs. - 24 kg

AKRO-MILS Bench Rack Work Station Organizer

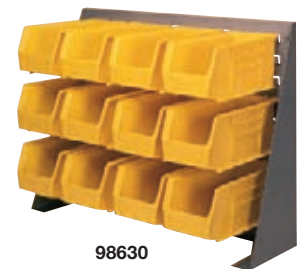

A free-standing work station or parts organizer. All-steel 27 3/4" x 21" x 8" bench stand complete with polypropylene AkroBins are available in three colors for coding. Specify bin color: blue (B), yellow (Y) or red (R) when ordering. (ex. 98610R)

Order No.	Includes	Inside Dimension of Bins	Ship Wt.
98610	24-#30210	4 3/4" l. x 3 7/8" w. x 2 1/8" h.	21 lbs. - 10 kg
98620	24-#30220	6 3/4" l. x 3 7/8" w. x 2 1/8" h.	23 lbs. - 11 kg
98630	12-#30230	10 3/4" l. x 4 3/8" w. x 4 3/4" h.	26 lbs. - 12 kg

BADA Lead & Steel Weights for Trucks & RVs

BTS Style



- BTS uncoated lead & BTSFE coated steel

All ¾ and 1-ton trucks with 13", 15" and 16" two piece rims; 16.5" x 6.00", 6.75", 8.25" and 9.75" tubeless wheels.

Size Oz.	Pcs/Box	Lead BTS Series	
		Order No.	Order No.
.50	25	55460	55331
1.00	25	55461	55332
1.50	25	55462	55333
2.00	25	55463	55334
2.50	25	55464	55335
3.00	25	55465	55336
3.50	25	55469	55337
4.00	25	55466	55338
5.00	25	55467	55339
6.00	25	55468	55340

BTST Style



- Uncoated lead

Budd DUO 16" x 5.50" split-ring wheels, RV's, .75 and 1-ton trucks with thick flange wheels that prohibit use of BTS weights.

Size Oz.	Pcs/Box	Lead BTST Series	
		Order No.	Order No.
2.00	25	55541	
3.00	25	55542	
4.00	25	55543	
5.00	25	55544	
6.00	25	55545	
8.00	25	55546	

BTRC Style



- Uncoated lead

Tubeless curved flange truck wheels like Firestone Radial Commander, Budd, Firestone, Goodyear strip-steel wheels.

Size Oz.	Pcs/Box	Lead BTRC Series	
		Order No.	Order No.
2.00	25	55499	
3.00	25	55500	
4.00	25	55501	
6.00	25	55502	
8.00	25	55503	
10.00	20	55504	
12.00	20	55505	
14.00	10	55580	

BTLT Style



- Uncoated lead

Used on "section" type straight flange, tubeless wheels; Goodyear Super Single; Budd 7.50" and 8.25" wheels with Firestone or Goodyear discs.

Size Oz.	Pcs/Box	BTLT Series	
		Order No.	Order No.
2.00	25	55520	
3.00	25	55521	
4.00	25	55522	
6.00	25	55523	
8.00	25	55524	
10.00	20	55525	
12.00	20	55526	
14.00	10	55527	
16.00	10	55528	

BTCAL Style

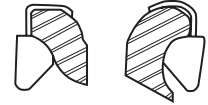

- BTCAL Style coated lead & BTCALFE coated steel

Used on both open side (inside flange) and disc side (lug nut-side flange) for Alcoa and Firestone aluminum truck wheels.

Size Oz.	Pcs/Box	Lead BTCAL Series	
		Order No.	Order No.
2.00	25	55689	55450
3.00	25	55690	55451
4.00	25	55691	55452
6.00	25	55692	55453
8.00	25	55693	55454

BTLM Style



- BTLM uncoated lead & BTLME coated steel

1½ to 2-ton medium-duty trucks and buses with tube type wheels; Firestone wheels R, DT and LB; Goodyear wheels L, LW and M.

Size Oz.	Pcs/Box	Lead BTLM Series	
		Order No.	Order No.
2.00	25	55481	55432
3.00	25	55482	55433
4.00	25	55483	55434
6.00	25	55485	55435
8.00	25	55486	55436
10.00	25	55487	
12.00	25	55488	
14.00	25	55489	
16.00	25	55490	

EQUAL Motorcycle Tire Balancing Formula

- Continuous balance for the life of the tire
- Improved comfort & handling

EQUAL powder adjusts across the footprint of the tire to correct dynamic imbalance and dampen vibrations created at the road surface. Provides a smoother ride, guaranteed!



Order No.	Description	Size Oz.	Qty. / Box
61438	Motorcycle Equal	1	30
61436	Motorcycle Equal	2	30
61439	Motorcycle Equal	3	30
50982	Equal Applicator IV		

EQUAL Yellow Identification Sleeve

A small yellow rubber identification sleeve for the tire valve signifying EQUAL in the tire.

Order No.	Size	Qty. Per Pack
61415	Equal I.D. Ring - Yellow	100

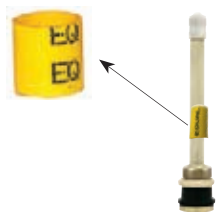

EQUAL Portable Applicator

- For on-the-vehicle installation

Use to install EQUAL in mounted tires. Connect applicator to air source, load with the specified package of balancing formula, remove the valve core, lock the chuck on the valve stem and open air valve.



Order No.	Description	Ship Wt.
50982	Portable Applicator	12 lbs. - 5 kg

XACTCleaner

- Will not harm wheels

Specially formulated to remove contaminants, leaving no residue. It does not contain harsh solvents and promotes adhesion without damaging the finish of the wheel.

Order No.	Description
61694	XACTBalance Wheel Cleaner 32 oz.
61695	XACTBalance Wheel Cleaner 5 gal..



EQUAL Truck Tire Balancing Formula

- Continuous balance....every tire, every wheel position, every time!
- No more vibration & uneven tread wear
- Fast installation with the drop-in bag

Equal is a dry balancing formula providing a continuous balance to the tire and wheel assembly. EQUAL powder adjusts across the tire footprint to correct dynamic imbalance and reduce vibrations created by the road surface. Continuously adjusts to changes in the road, the load, speed and tire wear. Fast and easy to install on or off the vehicle. Ideal for all types of truck tire and wheel assemblies, aluminum or steel, disc or spoke, tube and tubeless. Especially effective for difficult to balance aluminum rims. Simply take an unmounted tire, drop in the Equal bag and mount the tire. The bag breaks apart inside the tire for a clean application. Use the Portable Applicator for on-the-vehicle installation. Note: Consult the Application Chart for specific usage. (Single or dual wheels)



Note: Packed in 40 per case, includes 40 Filter Cores and 40 ID sleeves per case.

Order No.	For Tire Size	Use Package Size
61405	1200 R22.5	A
61403	10.00 R20 – 275/80 R24.5	B
61407	900 R20 – 245/75 R22.5	C
61409	800 R19.5 – 245/70 R19	D
61401	800 R17.5 – 245/75 R17.5	E
61411	215/85 R16 – 9.50 – R16.5	F

EQUAL Commercial Tire Application Chart

Tire Size	Wheel Position	
	Single	Dual
7.5 R18	C-8 oz.	C-8 Oz.
8 R19.5	D-6 oz.	C-8 Oz.
9 R19.5	D-6 oz.	C-8 Oz.
18 R19.5	B+E = 14 oz.	
225/70 R19t.5	D-6 oz.	C-8 Oz.
245/70 R19.5	D-6 oz.	C-8 Oz.
265/70 R19.5	D-6 oz.	C-8 Oz.
275/70 R19.5	C-8 oz.	B-10 Oz.
285/70 R19.5	C-8 oz.	B-10 Oz.
305/70 R19.5	B-10 oz.	A-12 Oz.
280/75 R19.5	C-8 oz.	B-10 Oz.
445/65 R19.5	B+E = 14 oz.	
525/65 R20.5	B+C = 18 oz.	
615/65 R20.5	B+B = 20 oz.	
7.5 R20	C-8 oz.	B-10 Oz.
8.25 R20	C-8 oz.	B-10 Oz.
9 R20	B-10 oz.	A-12 Oz.
10 R20	B-10 oz.	A-12 Oz.
11 R20	A-12 oz.	B+E = 14 Oz.
12 R20	A-12 oz.	A-12 Oz.
12.5 R20	A-12 oz.	B+E = 14 Oz.
13/80 R20	A-12 oz.	B+E = 14 Oz.
14/80 R20	A-12 oz.	B+E = 14 Oz.

Tire Size	Wheel Position	
	Single	Dual
14 R20	C+C = 16 Oz.	C+C = 16 Oz.
10 R22	A-12 Oz.	B+E = 14 Oz.
11 R22	A-12 Oz.	B+E = 14 Oz.
9 R22.5	C-8 Oz.	B-10 Oz.
10 R22.5	C-8 Oz.	B-10 Oz.
11 R22.5	B-10 Oz.	A-12 Oz.
12 R22.5	A-12 Oz.	B+E = 14 Oz.
275/50 R22.5	B-10 Oz.	A-12 Oz.
235/70 R22.5	D-6 Oz.	C-8 Oz.
255/70 R22.5	C-8 Oz.	B-10 Oz.
11/70 R22.5	C-8 Oz.	B-10 Oz.
265/70 R22.5	C-8 Oz.	B-10 Oz.
275/70 R22.5	B-10 Oz.	A-12 Oz.
305/70 R22.5	B-10 Oz.	A-12 Oz.
365/70 R22.5	A-12 Oz.	
315/70 R22.5	B-10 Oz.	A-12 Oz.
245/75 R22.5	C-8 Oz.	B-10 Oz.
265/75 R22.5	C-8 Oz.	B-10 Oz.
285/75 R22.5	B-10 Oz.	A-12 Oz.
295/75 R22.5	B-10 Oz.	A-12 Oz.
315/75 R22.5	B-10 Oz.	
345/75 R22.5	A-12 Oz.	
350/75 R22.5	B+E = 14 Oz.	

Tire Size	Wheel Position	
	Single	Dual
235/80 R22.5	D-6 Oz.	C-8 Oz.
255/80 R22.5	C-8 Oz.	B-10 Oz.
275/80 R22.5	B-10 Oz.	A-12 Oz.
295/80 R22.5	A-12 Oz.	B+E = 14 Oz.
315/80 R22.5	A-12 Oz.	
365/80 R22.5	A-12 Oz.	
385/65 R22.5	A-12 Oz.	
425/65 R22.5	B+E = 14 Oz.	
445/65 R22.5	C+C = 16 Oz.	
15 R22.5	A-12 Oz.	
16.5 R22.5	B+E = 14 Oz.	
18 R22.5	C+C = 16 Oz.	
11 R24	A-12 Oz.	B+E = 14 Oz.
12 R24	B+E = 14 Oz.	
14 R24	C+C = 16 Oz.	
285/75 R24.5	B-10 Oz.	A-12 Oz.
305/75 R24.5	B-10 Oz.	A-12 Oz.
315/75 R24.5	B-10 Oz.	A-12 Oz.
275/80 R24.5	B-10 Oz.	A-12 Oz.
295/80 R24.5	B-10 Oz.	A-12 Oz.
11 R24.5	B-10 Oz.	A-12 Oz.
12 R24.5	B+E = 14 Oz.	B+E = 14 Oz.

EQUAL Filtered Valve Core

- Eliminates the need for a filter extension

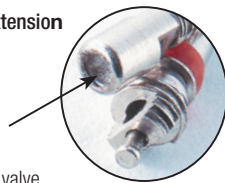

The stainless steel filter seats into the valve preventing dirt, or debris from reaching the valve core. Compatible with flow thru caps, valve stem extensions, pressure equalization devices and on-board central inflation systems. Fits valve stems that accommodate a long core.

Order No.	Description
21116	Filtered Valve Core Pkg of 20

EQUAL Valve Stem Filter

Use to prevent core leaks on valves which will not accept filtered valve core.



Order No.	Description
21114	Valve Stem Filter – Nickel Plated

ESCO Liquid Tire Balance

- Free flowing liquid tire balancer & lubricant



Liquid Tire Balance allows tires to run cooler reducing heat build up and extending tread life. The lube eliminates rust on rims and is tire changer friendly. Will not freeze. 22.5 and above tires uses a 32 ounce bottle except for these sizes; 235-85R16 tires 8 ounces; 385 floats 48 ounces; 425 floats 64 ounces and 445 floats 64 ounces.

Order No.	Mfr. No.	Description	Packaged	Ship Wt.
52664	20471	Liquid Truck Tire Balance	12 Bottles Per Case	31 lbs. - 14 kg

PATCH RUBBER Balance Pads



Install in the crown area for proper tire balance in passenger, truck and aircraft tires. A dual-curing, high-gravity balance pad available in precise, controlled weights of 1/2 to 10 ounces.

Order No.	Weight oz.	Weight gm.	Qty/Box	Order No.	Weight oz.	Weight gm.	Qty/Box
14601	1/2	14	25	14607	3 1/2	99	25
14600	3/4	21	25	14608	4	113	25
14602	1	28	25	14609	4 1/2	128	25
14603	1 1/2	43	25	14610	5	142	25
14604	2	57	25	14611	6	170	25
14605	2 1/2	71	25	14613	8	227	25
14606	3	85	25	14615	10	283	25

TSI Wheel Cleaners

- Cleans the bead and rim flange on steel & aluminum wheels
- Completely enclosed vacuum system prevents dirt & debris from being released into the shop
- Helps prevent bead leaks & provides a positive bead seating surface
- External adjustment handles maneuver the 6" wire brush to the proper position



84015



84016

Passenger and light truck specs.: UL approved; rim diameters 13" - 20"; rim widths up to 12"; 2 hp motor, 115v., 30 amp, 1 ph.; 48" w. x 32" d. x 48" h.

Truck specs.: UL approved; rim diameters 20" - 32"; rim widths up to 20"; 2 hp motor, 120v., 40 amp, 1 ph.; working area req. 108" l. x 60" w.

Order No.	Mfr. No.	Description	Ship Wt.
84015	WC-15	Passenger & Light Truck Wheel Cleaner	300 lbs. - 136 kg
84016	WC-30	Truck Wheel Cleaner	455 lbs. - 206 kg

V-Bond Absorbent Pads

- Grey pads for oil, water, & general use
- White pads for oil only
- Janitorial & shop supplies pages 229 - 232

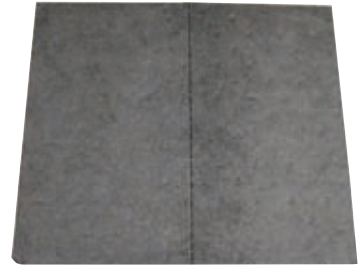

The large 17" x 19" x 3/8" pads are the economical solution for drips, leaks, and spills. Use for soaking up water and oil based fluids. Absorbs up to 32 ounces.

Order No.	Mfr. No.	Description	Per Case	Ship Wt.
11211	SEL 225519	Grey V-Bond Absorbent Pads	100	16 lbs. - 7 kg
11212	SEL 82001	White V-Bond Absorbent Pads	100	18 lbs. - 8 kg

SAFE T SORB Safety Absorbent

- 50 Lb. bag
- Janitorial & shop supplies pages 229 - 232



Quickly and easily soaks up spills that can cause accidents. Works on any concrete surface. Easy to use and transport.

Order No.	Mfr. No.	Description	Ship Wt.
11210	IMCZORBALL	SORB 50 lb. Bag	50 lbs. - 23 kg

GOJO Natural Orange Hand Cleaner

- More hand cleaners page 232



Deep scrubbing pumice removes grease, grime, tar, paint, etc. A good cleaning formula for general automotive repair facilities where a lotion-based product is preferred. Fortified with lanolin.

Order No.	Mfr. No.	Description	Ship Wt.
45024	0955	1-Gallon Orange Lotion with Pump	9 lbs. - 4 kg

MYERS Reusable Mechanics Gloves

- More gloves pages 242, 243, 244



Nitrile-coated palm protects hands. Machine washable, will not shrink. Air dry.

Order No.	Description	Size
45378	Mechanics Gloves	Large
45379	Mechanics Gloves	Extra Large

Protective Eyewear

- More protective eyewear page 236



Scratch resistant and lightweight for comfort. Snug fit minimizes discomfort.

Order No.	Description
82662	Protective Eyewear with Amber Lens
82663	Protective Eyewear with Blue Mirror Lens
82664	Protective Eyewear with Clear Lens

Lifts & Alignments

Myers Tire Supply is your lift & alignment headquarters. **FLEETLINE PROFESSIONAL**, **HEIN-WERNER**, **AMERICAN FORGE & FOUNDRY** & **OTC** jacks are standards of the industry. Custom lifting equipment for transmissions, forklifts, engines & flywheels are available. Myers distributes **ROTARY & CHALLENGER** in-ground, portable, two & four post lifts for general use. Alignment racks are available with lift capacities up to 108,000 pounds. **HOFMANN**, **TRU-LINE** & **TRU ALIGN** alignment systems are offered plus the complete line of **SPECIALTY ALIGNMENT** accessories.



Fleetline PROFESSIONAL

Portable Hydraulic Jacks

- Screw out extensions



Powerful, compact and portable. 12, 20 and 30-ton jacks have carrying handles for easy positioning. Two piece jack handle. Low profile models available.

Order No.	Mfr. No.	Capacity. Tons	Screw Extension	Height		Ship Wt.
				Low	High	
53360	AMH-5	5	2 3/4"	7 7/8"	15 3/8"	8 lbs. - 4 kg
53362	AMH-8	8	2 3/4"	7 7/8"	15 3/8"	12 lbs. - 5 kg
53358	AMH-12	12	3 1/8"	9 1/2"	18 1/2"	18 lbs. - 8 kg
53353	AMH-22	22	3 1/4"	10 3/8"	20 1/8"	32 lbs. - 15 kg
53366	AMH-35	35	—	11"	17 1/4"	45 lbs. - 21 kg
Low Profile Models						
53364	AMH-12S	12	3"	6 3/4"	13 3/8"	15 lbs. - 7 kg
53380	AMH-22S	22	1 1/2"	7 1/8"	12"	27 lbs. - 12 kg

* Maximum height with screw extended.

Note: 35-ton jack does not have an extension screw.

Hydraulic Jack Oil

Special additives to prevent foaming and rust formation. Assures proper valve action under varying temperatures.

Order No.	Mfr. No.	Size
56405	M3332	Quart
56406	M3334	1 Gallon



Economy Portable Hydraulic Jacks



Welded base and cylinder. Safety oil by-pass prevents over extension and damage to the cylinder.

Order No.	Mfr. No.	Capacity. Tons	Screw Extension	Height		Ship Wt.
				Low	High	
53582	AME12	12	3 1/8"	9 1/2"	18 1/2"	17 lbs. - 8 kg
53584	AME20	20	N/A	10 5/8"	16 7/8"	627 lbs. - 12 kg
Low Profile Models						
53583	AME12S	12	3"	6 3/4"	13 3/8"	615 lbs. - 7 kg
53585	AME20S	20	1 1/2"	7 1/8"	12"	620 lbs. - 9 kg

Hydraulic Rams



Used to push off rear beads on earthmover wheels.

Order No.	Mfr. No.	Capacity Tons	Stroke Inches	Ret. Height	Ship Wt.
52638	10301	10	2 1/8"	4 3/4"	5 lbs. - 3 kg
52640	10303	10	6 1/8"	9 3/4"	10 lbs. - 5 kg
52642	10305	10	10 1/8"	13 3/4"	14 lbs. - 6 kg
52644	10306	30	2 7/8"	4 9/8"	14 lbs. - 6 kg
52645	10309	25	6"	12 3/4"	28 lbs. - 13 kg

Jack Stands

Fleetline PROFESSIONAL

20 Ton Air/Manual Bottle Jack

- Operates manually or pneumatically
- 3-Piece long handle allows ease of pumping



Air/hydraulic bottle jack is faster than conventional hand operated hydraulic equipment. Air power permits one-handed operation and allows user to watch load more closely. Extension screw gives added height when necessary. Safety valve prevents overloading. Air hose swivels in any direction. *Specs.: capacity 20-tons; height low 10.4"; height high 20", lift 6.4"; screw 3.15", requires 90-120 psi.*

Order No.	Description	Ship Wt.
53537	20-Ton Air/Hydraulic Bottle Jack	40 lbs. - 18 kg

AMERICAN FORGE & FOUNDRY Air/Hydraulic Bottle Jacks

- 12 & 20-Ton capacity
- Heavy-Duty steel saddle for secure lifts



Machine hardened steel saddles. Center pump and ram for balance and easy positioning. *Specs.: 12-Ton: capacity 12-tons; height low 10 1/4"; height high 19 3/4"; lift 7". Specs 20-Ton: capacity 20-tons; height low 10 1/2"; height high 20"; lift 6 1/4".*

Order No.	Description	Ship Wt.
53526	12-Ton Air/Hydraulic Bottle Jack	30 lbs. - 14 kg
53527	20-Ton Air/Hydraulic Bottle Jack	38 lbs. - 18 kg

20 Ton Low Profile Air/Manual Bottle Jack

- Operates manually or pneumatically



Order No.	Air Pressure Required	Capacity Tons	Height		Ship Wt.
			Low	High	
53538	90 - 120 psi.	20	7"	12 3/4"	32 lbs. - 15 kg

OTC 12 Ton Support Stand



Stands sold individually.

Features a spun steel base that will not dig into sand or asphalt.

Order No.	Mfr. No.	Description	Height		Ship Wt.
			Low	High	
50434	17788	12-Ton Low Boy	19"	29 1/2"	33 lbs. - 15 kg

Fleetline PROFESSIONAL

12 Ton Jack Stands

The weight of the load prevents the ratchet from releasing while under load. Wide base for added stability. Saddle and ratchet bar are one piece, no welds, for additional strength under load. Sold in pairs only.



Order No.	Capacity Tons	Low Height	Max Height	Ship Wt.
53415	12	18 1/4"	28 7/8"	75 lbs. - 34 kg

AMERICAN FORGE & FOUNDRY Jack Stands

A must for maximum stability whenever lifting equipment is used. Notched saddle for use with unitized body vehicles. Ratchet prevents lowering when loaded. Designed to be used in pairs. Sold in pairs only.



Order No.	Mfr. No.	Capacity Tons	Height		Ship Wt.
			Low	High	
53473	SS3	3	11 1/2"	17"	16 lbs. - 8 kg
53497	SS6	6	15 1/2"	23 3/4"	42 lbs. - 19 kg

NORCO 22-Ton Low Profile Jack Stands

Pin-Type support column with four height positions. Solid 3/8" steel base provides stability. Sold in pairs only.



Order No.	Mfr. No.	Capacity Tons	Height		Ship Wt.
			Low	High	
53530	812221	22	12"	20"	70 lbs. - 32 kg

Forklift Jack Stands

5-Ton capacity is ideal to support forklifts. Adjustable to four height positions. Heavy-duty base stabilizes the load. Height low 13", height high 17".



Order No.	Description	Ship Wt.
53529	5-Ton Fork Lift Jack Stands - Sold In Pairs	36 lbs. - 17 kg

Hydraulic Forklift Jacks

- 8,800 & 15,000 Lb. Capacities
- 2-¼" Minimum height



52177

52637

Compact and lightweight, forklift jacks. Ideal for shops or van. Lifting height from 2¼" to 16¼". Features a removable handle and meets ANSI/CE standards.

Order No.	Mfr. No.	Description	Height		Ship Wt.
			Low	High	
52177	10435	8,800 lbs.	2¼"	16¼"	68 lbs. - 31 kg
52637	10437	15,000 lbs.	2¼"	16¼"	104 lbs. - 47 kg

BLACKHAWK 3-1/2 Ton Quick Load Service Jack

- Low profile allows easy access to lift points



Built-in by-pass protects jack from overloading. Features rear swivel casters for easy positioning. *Specs.: Capacity 3½ Ton, min. height 4", max. height 21½", chassis length 30 7/8".*

Order No.	Description	Ship Wt.
53432	3½-Ton Double Pumper Jack	109 lbs. - 49 kg

Jack Handle Protector



Protects vehicles from scratches or dents from falling jack handles. The durable synthetic rubber protector fits multiple jack manufacturers handles. Also fits the TNT tools.

Order No.	Mfr. No.	Description
52556	GHP-01	Jack Handle Protector

To set up a jack, make certain of the following:

- The base of the jack rests on a firm, level surface
- The jack is correctly centered
- The jack head bears against a level surface
- The lift force is applied evenly

Proper maintenance of jacks is essential for safety. All jacks must be lubricated regularly.

2-1/2 Ton Floor Jack

- Double plunger, 8 to 9 pumps to full height



Lifting arm reinforced with internal steel beam. Extra long handle for easier pumping and reach under vehicles. Universal 45° guarantees pumping at any position under load. Heavy-duty ball bearing rear casters. Extra wide front wheel. *Specs.: Saddle height low 4¼", high 19¼" chassis length 27½".*

Order No.	Description	Ship Wt.
53535	2½ Ton Floor Jack	105 lbs. - 48 kg

AMERICAN FORGE & FOUNDRY 2 Ton Low Rider Jack

- Double pumper for quick lifting
- 2-¾" High for low profile vehicles



Fast rise with double pump



Safety valve prevents overloading. Features rear swivel casters for easy positioning and a one-piece foam covered handle. Pinned steel saddle with rubber pad for vehicle protection. *Specs.: Capacity 2 Ton, min. height 2¾", max. height 20", power raise 19", chassis length 27", weight 99 lbs.*

Order No.	Description	Ship Wt.
53516	2-Ton Floor Jack	99 lbs. - 45 kg

AMERICAN FORGE & FOUNDRY 3-1/2 Ton Heavy-Duty Double Pumper Jack

- Double pumper for quick lifting



Fast rise with double pump



Safety valve prevents overloading. Features rear swivel casters for easy positioning and a one-piece foam covered handle. Pinned steel saddle with rubber pad for vehicle protection. *Specs.: Capacity 3½ Ton, min. height 4", max. height 19½", chassis length 29", weight 119 lbs.*

Order No.	Description	Ship Wt.
53517	3½-Ton Double Pumper Jack	119 lbs. - 54 kg

Service Jacks

HEIN-WERNER 2 Ton Service Jack

- Full swivel rear casters for easy positioning
- Pressure relief valve prevents overloading
- 2-Year warranty

Flanged side plates increase strength. In line pump provides efficient pumping operation. Sealed hydraulic pump for durability. Cast iron lift arm for heavy duty loads. *Specs.: Capacity 2 Ton, min. height 4½", max. height 20", power raise 15¾", chassis length 26¾", wheel to wheel width 11½", chassis height 6¾", saddle diameter 5¾", handle length 50", weight 96 lbs.*



Order No.	Mfr. No.	Description	Ship Wt.
53556	HW93642	2-Ton Service Jack	90 lbs. - 41 kg

HEIN-WERNER 3 Ton SUV Service Jack

- Longer chassis ideal for truck & SUVs
- 2-Year warranty

Heavy duty frame for rugged applications. U-joint release mechanism for precise load control. *Specs.: Capacity 3 Ton, min. height 5", max. height 23½", power raise 18½", chassis length 30¾", wheel to wheel width 11½", chassis height 7¼", saddle diameter 6¾", handle length 50", weight 110 lbs.*



Order No.	Mfr. No.	Description	Ship Wt.
53499	HW93652	3-Ton SUV Service Jack	110 lbs. - 50 kg

HEIN-WERNER 2 & 3 Ton Service Jack Replacement Parts



Order No.	Mfr. No.	Description
53532	HW890022666	Universal Joint
53531	HW231583	Swivel Caster (Each)
53533	HW890021666	Pump Assembly

HEIN-WERNER Hydraulic Service Jacks

- 4 & 10-Ton models

Adjustable three position handle with extra-long reach and wide-ribbed wheels for strength and stability. Features T-handle and dual pump piston. Includes auto overload valve, full swivel lifting cap, sealed hydraulic units and ball bearing casters.

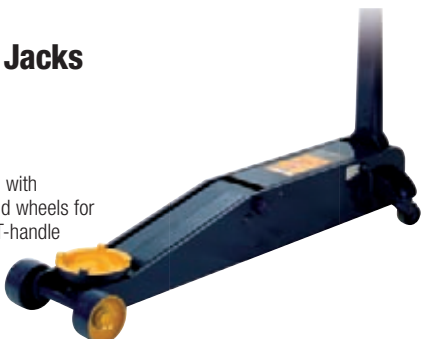

Order No.	Mfr. No.	Capacity Tons.	Saddle Low	Height High	Chassis Length	Ship Wt.
53436	HW93657	4	5"	25 ¾"	48 ¼"	219 lbs. - 99 kg
53448	HW93660	10	6 ¾"	25 ½"	53 ¾"	420 lbs. - 191 kg

Fleetline PROFESSIONAL Hydraulic Service Jack

- Extra-Wide wheels for easy rolling
- Handle release valve



Years of trouble-free lifting. Used in service stations, shops and garages. Welded steel construction with ball bearing rear casters for easy positioning. Safety valve prevents overloading.

Order No.	Capacity Tons.	Saddle Low	Height High	Chassis Length	Ship Wt.
53409	5	5 7/8"	24"	55 7/8"	242 lbs. - 109 kg
53411	10	6 3/8"	24"	61 1/4"	330 lbs. - 149 kg
53377	20	7 1/2"	24"	62"	506 lbs. - 228 kg

HEIN-WERNER Air/Manual Hydraulic Service Jacks

- 4 & 10-Ton models

Air/manual jack operates both manually and with air; patented "Speed Pak" eliminates handle pumping and reduces lifting time; jack operates under normal pressure (140 psi) for capacity load; load is held in place hydraulically. Features cast lift arm for extra strength, T-handle and dual pump piston. Air hose may be disconnected for other uses.



Order No.	Mfr. No.	Capacity Tons.	Saddle Low	Height High	Chassis Length	Ship Wt.
53434	HW93667	4	5"	25 ¾"	48 ¼"	233 lbs. - 106 kg
53449	HW93662	10	6 ¾"	25 ½"	53 ¾"	435 lbs. - 197 kg

SAFE T SORB Safety Absorbent

Quickly and easily soaks up spills that can cause accidents. Works on any concrete surface. Easy to use and transport.



Order No.	Mfr. No.	Description	Ship Wt.
11210	IMCZORBALL	SORB 50 lb. Bag	50 lbs. - 23 kg

Fleetline PROFESSIONAL

22 Ton Air/Hydraulic Jack

- Double spring return
- One-Piece handle
- 8-1/4" Low height



Double Spring Return



Includes Three Adapter Set and Holder

Includes additional three adapters and holder. Ideal for tire and wheel service on trucks, tractors, and OTR vehicles. Long 50" one piece handle locks in three positions for easy handling. 8" wheels for easy movement. Minimum height 8 1/4", maximum height 18 3/8", chassis length 20 1/2".

Order No.	Mfr. No.	Description	Ship Wt.
53391	AJ22C	22-Ton Air/Hydraulic Jack	98 lbs. - 44 kg

Replacement Adapters & Parts for Fleetline 22 Ton Air/Hydraulic Jack (53391)

53614 (A)



53615 (B)



53616 (C)



53617 (D)



53387



53388



53518

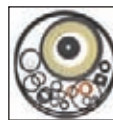

53519

Order No.	Mfr. No.	Description	Ship Wt.
53613	AJ-4	Extension Set - 4 Pc.	10 lbs. - 5 kg
53614	AJ-A	Ext. A, 3/4" High x 2 3/4" Dia.	2 lbs. - 1 kg
53615	AJ-B	Ext. B, 3/4" High x 2" Dia.	1 lbs. - 1 kg
53616	AJ-C	Ext. C, 2 3/8" High x 2" Dia.	3 lbs. - 2 kg
53617	AJ-D	Ext. D, 3 7/8" High x 2" Dia.	4 lbs. - 2 kg
53387	AJ22C-5-0	Handle Assembly Complete	
53388	1-3	Wheel	
53619	AJ22C-5-6	Lock Lever	
53518	AJ22C	Plastic Repair Kit	
53519	AJ22B/C	Metal Repair Kit	

AMERICAN FORGE & FOUNDRY

22-Ton Air/Hydraulic Jack

- Double spring return
- Extension kit uses rubber grommets eliminating clevis pins



Includes Three Adapter Set and Holder

Includes 3/4", 2-3/4" and 4" adapters and holder. In-Line filter and oiler protects and lubricates air motor. One-Piece handle locks in three positions. 7 3/4" Wheels for easy movement and positioning. Features a corrosion-resistant aluminum and nylon composite air motor and heat treated cylinder wall and "chromed" piston. Minimum height 8 3/4", maximum height 21 1/2".

Order No.	Description	Ship Wt.
53525	22-Ton Air/Hydraulic Jack	107 lbs. - 49 kg

NORCO

22-Ton Low Profile Jack Stands



Pin-Type support column with four height positions. Solid 3/8" steel base provides stability. Sold in pairs only.

Order No.	Mfr. No.	Capacity Tons	Height		Ship Wt.
			Low	High	
53530	81222i	22	12"	20"	16 8

Hydraulic Jack Oil

Special additives to prevent foaming and rust formation. Assures proper valve action under varying temperatures.

Order No.	Mfr. No.	Size
56405	M3332	Quart
56406	M3334	1 Gallon



Air / Hydraulic Jacks

HEIN-WERNER 20 Ton Air/Hydraulic Jack

Powerful, compact, portable design. Large 8" rubber wheels for easy maneuverability. Low height allows lifting from axles or suspension. Built-in overload valve.



Order No.	Mfr. No.	Capacity Tons	Height		Ship Wt.
			Low	High	
50367	HW93733	20	9½"	20"	97 lbs. - 44 kg

AME 22 Ton Air/Hydraulic Service Jack

- Single piece 49" handle

Includes 1", 2" and 4" extension saddles. *Specs.: Capacity 22-ton, min. height 9", stroke length 6"; air pressure req. 80 psi.*



Order No.	Mfr. No.	Description	Ship Wt.
85004	14140	22-Ton Service Jack	90 lbs. - 41 kg

OTC 5092 Air Under-Axle Jack

- 27.5-Ton capacity

Self-retracting, air-driven ram uses shop air. Handle locks in 4 positions from vertical to horizontal. Includes saddle and large adapter. Covered by the OTC Lifetime Marathon Warranty. *Specs.: capacity 27.5-tons; lifting range screw retracted 8¼" to 13⅞"; max. lift height with screw extended and large adapter 21¾" to 18"; cylinder stroke 4⅞" requires 90-175 psi.*



Order No.	Description	Ship Wt.
53487	Under Axle Jack	107 lbs. - 49 kg

GAITHER 35 Ton Air/ Hydraulic Jack

Specs.: Capacity: ram travel 4"; extended height 8"; chassis length: 22"



Order No.	Mfr. No.	Capacity Tons	Height		Ship Wt.
			Low	High	
89433	GT3531	35	7¼"	19½"	118 lbs. - 54 kg

OTC 1591A Air Lift Jack & Support Stand

- 10-Ton capacity

Use as a 10-ton air lift jack and also a support stand. Use in pairs for heavy-duty lifting jobs. Stroke 10⅞". Capacity 10-tons at 200 psi; max. height pinned in top hole with extension.



Order No.	Mfr. No.	Capacity Tons	Height		Ship Wt.
			Low	High	
53493	1591A	10	16⅞"	49½"	185 lbs. - 84 kg

30 LED Work Light

- Lithium-Ion battery holds charge longer with no memory effect
- Weatherproof body & switch
- 5-½ Hours use

Fleetline
PROFESSIONAL
by Myer Tire Supply



Allows freedom of movement and to work without worrying about tangled cords. 360° Rotating nylon swivel hook at the head. 30 LED super-bright, long-life LEDs provide forward directed pure white light. LEDs produce very little heat. 4-hour recharge time provides up to 5-1/2 hours of continuous operation. 7.2V rechargeable lithium battery. Includes LED charge indicator. Slim design allows access into tight areas.

Order No.	Description
84502	Cordless LED Inspection Light

ESCO Mammut Jacks

- 30 to 150 ton capacities
- Remote control & manual pump kits available
- Wide range of extensions available



All models are hydro-pneumatically operated and include a dual descent valve for greater control when bearing weight and automatic piston return. Each jack has a folding handle, wide pneumatic tires and hooks for transport.

Order No.	Mfr. No.	Capacity Tons	Height		Air Pressure Required PSI	Ship Wt.
			Low	High		
52665	91001	30 / 60	8 1/4"	17 5/8"	116-174	94 lbs. - 43 kg
52666	91000	25 / 50 / 80	13 3/8"	33 1/4"	116-174	138 lbs. - 63 kg
52667	91003	50 / 80	16 1/2"	33"	116-174	145 lbs. - 66 kg
52668	91004	100	28 1/2"	46"	116-174	324 lbs. - 147 kg
52669	91005	150	35 3/8"	57 3/4"	116-174	389 lbs. - 176 kg



Extension Holders

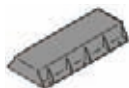

Block Holders



Locking Kits



Extensions

Order No.	Mfr. No.	Description
52670	91006	Remote Control
52671	91007	Manual Pump
52676	91017	Safety Block M/F 2"/7" for 91000, 91003, 91004
52681	91020	Safety Block M/F 2"/8 1/2" for 91005
52674	91015	Safety Block M/F 4"/7" for 91000, 91003, 91004
52678	91018	Safety Block M/F 4"/8 1/2" for 91005
52675	91016	Safety Block F/F 4"/7" for 91000, 91003, 91004
52679	91019	Safety Block F/F 4"/8 1/2" for 91005
52683	91023	3/8" Extension for 91001
52684	91024	2 1/4" Extension for 91001
52685	91025	2 1/4" Extension for 91001
52686	91026	5 7/8" Extension for 91000 & 91003
52687	91027	9 1/4" Extension for 91000 & 91003
52688	91028	11 1/4" Extension for 91000 & 91003
52689	91029	7 7/8" Extension for 91004 & 91005
52690	91030	9 1/4" Extension for 91004 & 91005
52691	91031	11 1/4" Extension for 91004 & 91005
52692	91032	Extension Holder L for 91000 & 91003
52697	91033	Extension Holder R for 91000 & 91003
52699	91034	Extension Holder L for 91004 & 91005
52625	91035	Extension Holder R for 91004 & 91005
52673	91012	Block Holder for 91005
52672	91011	Block Holder for 91000, 91003 & 91004
52682	91021	Locking Kit for 91005 Incl. (4) 91018 & 1 Each 91019, 91012, 91017
52677	91022	Locking Kit for 91000 91003, 91004 Incl. (3) 91015 & 1 Each 91016, 91011, 91017

OTC 1590 Truck & Trailer End Lift

- 10-Ton capacity
- Air operated



Features five-position automatic safety latches requiring manual release to lower the load. Two large swivel casters and pneumatic tires for ease of positioning, on rough ground or gravel. Adjustable saddle height and width. Heavy-duty piston includes a wear ring and seal for long life. 10-ton lifting capacity at 200 psi.

Order No.	Mfr. No.	Capacity Tons	Height		Ship Wt.
			Low	High	
50433	1590	10	13"	52"	650 lbs. - 293 kg

HEIN-WERNER Air Operated End Lifts



53568



50356

For light, medium or heavy loads. 2 1/2-ton model features 5 position, extra-wide saddle spread, multi-position lock to prevent load from lowering, spring loaded front casters, V-bar support for added stability. 10-Ton model has a wide base for stability and adjustable lifting arms to any position.

Order No.	Mfr. No.	Capacity Tons	Pickup Height		Ship Wt.
			Low	High	
50356	HW93696	2 1/2	10 1/4"	35 3/8"	200 lbs. - 91 kg
53568	HW93690	10	18 1/2"	50 1/2"	641 lbs. - 291 kg

OTC 5018 Low Clearance Truck Clutch & Flywheel Handler

- Handles 14" & 15-1/2" clutch assemblies weighing up to 250 lbs.

The specially designed unit raises the load from horizontal to vertical as the pump is cycled. 15" Minimum height allows access below the side faring. The centerline of the clutch is 38 1/4" high when raised. Features a 360° swivel head.



Order No.	Mfr. No.	Description	Ship Wt.
84154	5018	Truck Clutch & Flywheel Handler	125 lbs. - 56 kg

Transmission Jacks

OTC 5019A Low Lift Transmission Jack

- 2,200 Lb. capacity
- Tilt 20° back, 15° forward & 12° side to side



Gets under the truck without forcing the technician out of the way. Swivel pump handle is ideal for use in tight working spaces. Grab handles on each end make it easy to move and position. Includes adapter plate for Eaton, Fuller and RoadRanger transmissions of Class 7 and 8 trucks.

Order No.	Mfr. No.	Capacity Tons	Pickup Height		Ship Wt.
			Low	High	
53490	5019	1	8 1/4"	36 1/2"	330 lbs. - 149 kg
53492	540232	Optional Mounting Bracket for Mack T2000 Series Transmissions			21 lbs. - 10 kg

HEIN-WERNER 1 Ton Floor Style Transmission Jack

- 360° Swivel casters
- 2-Year warranty



Designed For Heavy Duty Transmissions Including: Spicer 50, 60, 5000, 6000 and split torque (SST) series; Mack T-2000 and Maxitorque series; Allison AT, MT, and HT Series; Clark 280, 282, 285, CL455 and CL550; Mercedes G3 and GV4 types; Volvo S & R models; Ivelco 31, 35, 46 and 2828 models. Wishbone design allows unit more mobility. Tubular steel frame. Includes load restraint chain. *Specs.: capacity 1-ton; height low 10"; height high 44"; chassis length 48"; chassis width 29 7/8"; forward tilt 40"; rear tilt 15°, sideways tilt L & R 10°.*

Order No.	Mfr. No.	Description	Ship Wt.
53435	HW93718	1-Ton Floor Style Transmission Jack	310 lbs. - 141 kg

Heavy-Duty Axle Stand



For supporting vehicle components. All steel construction. 23" wide tripod base for load stability. Maximum height 85 7/8", low height: 56 1/2"

Order No.	Capacity Tons	Ship Wt.
53417	2	40 lbs. - 18 kg

High Component Fleetline Stand

- 3/4"-Ton capacity



Lightweight for easy handling in close quarters. Quick adjust spin handle with thrust bearing eliminates wear and is easy to turn under load. Base diameter 12".

Order No.	Low Height	Max Height	Ship Wt.
53418	55 1/4"	81 1/2"	40 lbs. - 18 kg

Hydraulic Transmission Jacks

Fleetline
PROFESSIONAL

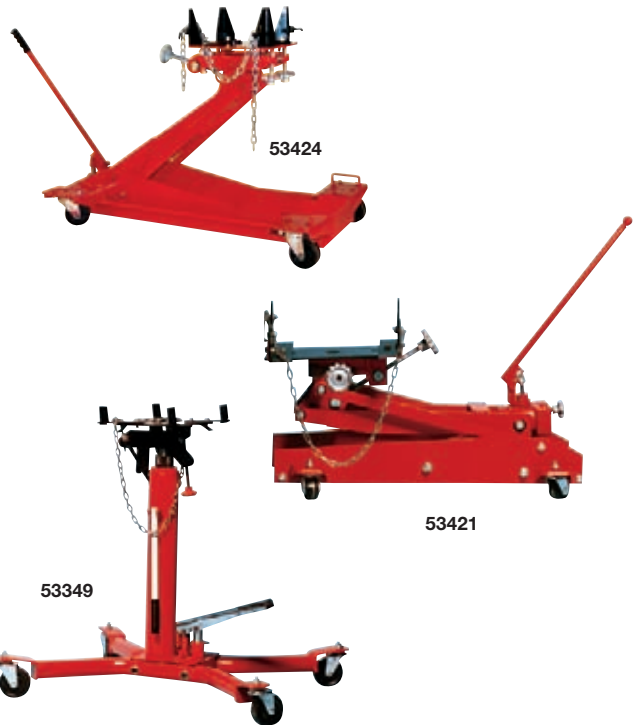

All models feature fully adjustable universal saddle with adjustable corner brackets and safety chain. Pump handle rotates 360° for all position operation. Safety by-pass system prevents damage to cylinder. Full swivel ball bearing caster wheels for easy positioning. Includes a safety overload preventing use beyond rated capacity. Flash chrome ram inhibits rust from entering the hydraulic system. 53349 features a two stage pump jack.

Order No.	Capacity Tons	Low Height	Max Height	Overall Length	Ship Wt.
53349	1/2	34"	70 1/2"	37 3/8"	165 lbs. - 74 kg
53421	1	9 1/2"	33 3/8"	33 1/2"	177 lbs. - 80 kg
53424	1 1/2	9"	37"	44 1/2"	375 lbs. - 170 kg

Engine Stands

Fleetline
PROFESSIONAL

- 1,250 Lb. capacity



Fully adjustable engine mounting head. 360° rotating head allows engine to be placed in desired working position. Heavy gauge steel mechanical tubing prevents excessive frame flex. Two 3" diameter rigid wheels in back and two 3" swivel caster wheels in front.

Order No.	Capacity lbs.	Length	Width	Height	Ship Wt.
53429	1,250	34 1/2"	34"	35 1/2"	76 lbs. - 34 kg

OTC 1580 Easy Roller

- 1,500 Lb. capacity per unit



A simple method of moving a disabled vehicle. Position them at each wheel of a vehicle weighing up to 6,000 lbs. Fits tread widths up to 12"

Order No.	Mfr. No.	Description	Ship Wt.
84164	1580	1,500 lb. Easy Roller	44 lbs. - 20 kg

(Sold individually, not as a set)

Tire Dolly

- 450 Lb. lifting capacity
- Designed specifically for use on super single & flotation tires
- Handles tire diameters 36" to 38"



14" Wide rollers accommodate even the largest super single tires. Made of heavy-duty tubular construction. Decreases the number of back injuries and workman's compensation claims associated with tire changing.

Order No.	Mfr. No.	Description	Ship Wt.
52238	3591	Tire Dolly	25 lbs. - 11 kg

Fleetline PROFESSIONAL

20-Ton Hydraulic Press

- Heavy-Duty return springs for fast ram retraction
- All welded steel construction
- Bottle jack included

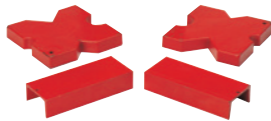

Self-contained power unit with built-in pressure gauge. Includes two Arbor Plates and two Bearing Separator Plates.

Order No.	Capacity	Stroke	Press Bed Width	Base Height	Width	Ship Wt
53425	20-Ton	5.7"	8 1/4"	59"	26 1/2"	290 lbs. - 132 kg

Ag Tire Wheel Dolly

- 3,306 Lb. capacity for agricultural & earthmover wheels



The top point wheel connection rod keeps the wheel in balance. A double acting hydraulic system with hands-free switch allows a controlled raising and lowering action. Features 6" large front wheels and 2" x 4" rear wheels. Handles tires from 45.3" to 84.7" in diameter and up to 41.3" deep.

Order No.	Mfr. No.	Description	Ship Wt.
52661	90538	Ag Tire Wheel Dolly	344 lbs. - 156 kg

Tire Dolly

- 500 Lb. capacity



Works on all tire sizes including super singles and small OTR tires. Rollers adjust to handle 6.5" to 22.5" tires. Durable steel construction.

Order No.	Mfr. No.	Description	Ship Wt.
52233	G471105	Tire Dolly	30 lbs. - 14 kg

Clever Lever

- Tire & wheel caddy



Pull and replace tires up to 300 lbs. easily. Heavy-duty high-tensile strength tubular steel. Kickstand keeps it out of the way when not in use. Made in the U.S.A.

Order No.	Mfr. No.	Description	Handles Tire Diameters	Ship Wt.
52230	MD22	Medium-Duty	24" To 36"	20 lbs. - 9 kg
52232	HD26	Heavy-Duty	36" To 48"	21 lbs. - 10 kg

Truck Wheel Dolly

- For use with all 22.5 & 24.5 tires



Aids in removing and replacing heavy tire assemblies. The 9 1/2" rollers accommodates low profile tires.

Order No.	Mfr. No.	Description	Ship Wt.
85019	71300	Truck Wheel Dolly	18 lbs. - 8 kg

KIENE Wheel Grabber Hub-Piloted Wheel Remover

- Removes seized hub-piloted wheels



Quickly removes seized hub-piloted wheels from steering, drive and trailer axles. Dealers servicing F450 and F550 trucks with dual wheels are having problems. A K1350 with steel chains and WW2154 socket will do the job. Works on steel or aluminum wheels.

Hook the pulling chains into the hand holes, attach the hooks to the Wheel Grabber, and center the hub socket on the wheel hub. Using an impact wrench on the forcing screw uniformly tightens the pulling chains until the seized wheel is free. 84453 Includes a choice of chains for steel wheels or aluminum wheels, and a choice of a hub socket, which fits drive, steer or trailer axles. To order, specify for steel or aluminum and which axle socket is required. If additional chains or sockets are needed, order as an option.

Order No.	Mfr. No.	Description	Ship Wt.
84453	K1350	Wheel Grabber Includes Choice of One Set of Chains, & Choice of a Hub Socket	140 lbs. - 63 kg
Chains			
84454	WW2101	Chain for Steel Wheels (Priced Each, 3 required)	15 lbs. - 7 kg
84455	WW2102	Chain for Aluminum Wheels (Priced Each, 3 required)	15 lbs. - 7 kg
Sockets			
Order No.	Mfr. No.	Description	Application
84456	WW2151	Drive Axle	Most Eaton & Meritor (Rockwell)
84458	WW2153	CR1798 Bus	Used on Steering Axles of Most Buses
84459	WW2154	Trailer	Most Stemco Hub Caps & CR1643 & CR1743
84460	WW2155	Freuhauf Trailer	Freuhauf Trailers
84461	WW2156	Pro Par Trailer	Pro Par Hub Caps

OTC 20 Ton Truck Ramps



T-handle and five-inch wheels make maneuvering into position easy.

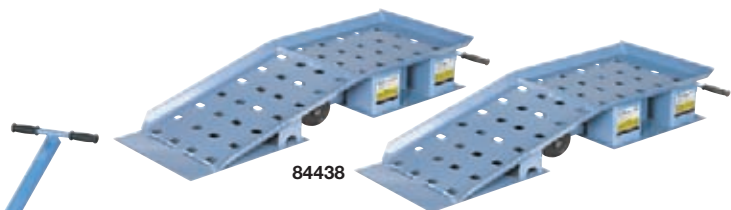

KIENE Clutch Caddy

- Helps prevent back injuries

One mechanic can roll a heavy clutch under the truck, raise, position, and install it. Allows the clutch to swivel 360°, giving it the flexibility to get around obstacles under extremely cramped conditions. Low enough (13") to roll under the truck. 39" raised height.



84442

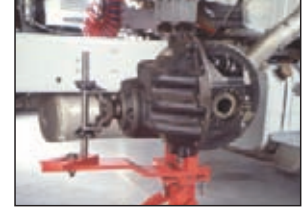

84448

Order No.	Mfr. No.	Description	Ship Wt.
84440	CC-2000	Clutch Caddy Includes Adapter for 14" & 15½" Clutches w/ 2" Shaft	121 lbs. - 55 kg

Optional Accessories For Clutch Caddy

- With the available adapters, the Clutch Caddy provides a unique lifting, holding & positioning device for a variety of heavy-duty tasks

Order No.	Mfr. No.	Description	Diameter	Pilot
84441	CC-2050	Splined Shaft Adapter	1¾"	1.180"
84443	CC-2052	Splined Shaft Adapter	1¾"	.983"
84444	CC-2053	Splined Shaft Adapter	1½"	.981"

Handles pot-type and flat flywheels used with 14" and 15½" clutches.

Order No.	Mfr. No.	Description
84442	CC-2051	Flywheel Adapter

Simplifies the removal and installation of heavy starters.

84446	CC-2055	Starter Motor Adapter
-------	---------	-----------------------

Eliminates manual lifting and lowering.

84448	CC-2057	Differential Adapter
-------	---------	----------------------

Remove auxiliary case without removing the entire transmission

84447	CC-2056	Auxiliary Case Adapter
-------	---------	------------------------

One-man method to change camelback springs

84450	CC-2059	Mack Camelback Spring Adapter
-------	---------	-------------------------------

Remove and install outboard and inboard brake drums

84449	CC-2058	Brake Drum Adapter
-------	---------	--------------------

Supports drive shaft under main carrier bearing or on the shaft itself

84445	CC-2054	Drive Shaft Adapter
-------	---------	---------------------

Clutch installation tool for shops with floor lifts

84451	CC-2060	Riser Dolly for Under Floor Lifts
-------	---------	-----------------------------------

Specs.:	Standard	Wide
Capacity Per Pair	20 Ton	20 Ton
Overall Length	51"	51"
Tread Width	10"	16"
Frame Height	9¼"	9¼"

Specs.:	Standard	Wide
Frame Width	13½"	18¼"
Frame Length	47"	47"
Wheel Diameter	5"	5"
Handle Length	33"	33"

33" Retractable T-handle and heavy-duty rubber wheels enhance mobility. Non-skid rubber matting prevents slippage. Covered by OTC lifetime marathon warranty.

Order No.	Mfr. No.	Description	Ship Wt.
84437	5268	Standard 20-Ton Truck Ramps (Pair)	230 lbs. - 104 kg
84438	5269	Wide 20-Ton Truck Ramps (Pair)	312 lbs. - 141 kg

Tweel™ Handler Tire & Wheel Handling System

- Pull off inside dual wheel with ease
- Super singles...no problem



Allows mechanics to remove, install, rotate and transport single tire and wheel assemblies with ease. Features a built-in ratcheting jack with 14 inches of vertical travel to eliminate stooping. Chassis is U-shaped allowing unhindered access to the tire in the cradle. No restraining chains are required. Three heavy-duty ball-bearing wheels mounted under ball bearing swivel casters make it highly maneuverable. High-quality structural steel tubing, with heavy-duty wheels and swivel casters, industrial strength ratcheting jack and foot-operated wheel lock.

Order No.	Mfr. No.	Description	Ship Wt.
52231	TW2000	Tweel Handler — Tire & Wheel Handler	120 lbs. - 54 kg

Wheel Dolly

- ¾-Ton capacity
- Adjustable height push bar



Fleetline
PROFESSIONAL

Easy one man operation to remove, replace and move dual wheels of any diameter weighing up to ¾-ton. 3" Rear swivel casters and 3 ½" rigid front wheels for easy positioning. 3-ton hydraulic bottle jack provides smooth and rapid lift.

Order No.	Cap. Tons	Description	Lift Range	Ship Wt.
53430	¾	Wheel Dolly	2 - 8 ¼"	108 lbs. - 49 kg

HEIN-WERNER Wheel Dolly

- ¾-Ton capacity



Handles dual wheels and large single wheels up to 52" in diameter. Carriage guides on 4 rollers for smooth vertical lift. Features load levelers to aid alignment.

Order No.	Mfr. No.	Cap. Tons	Lift Range	Ship Wt.
53455	HW93766	¾	4" - 9"	225 lbs. - 102 kg

REVOLUTION Motorcycle/ATV Lift

- 1,000 Lb. capacity
- 33" Rise



Foot pedal air control. Scissor-style drop tail lift features cycle jack, side extensions, adjustable wheel vice, and portable dolly. The lift has 5-locking positions and reversible side extensions providing storage space and greater access to ATVs. *Specs.: capacity 1,000 lbs.; lift range low 7 ¼", high 40 ¼"; platform width 24"; platform length 93"; requires 90 to 100 psi.*

Order No.	Mfr. No.	Description	Ship Wt.
59376	RXLDT	Motorcycle/ATV Lift	690 lbs. - 313 kg

BLACKHAWK Motorcycle Lift

- 1,500 Lb. capacity



Rubber padded platform prevents scratching. Foot pedal operated power units lift smoothly. Includes lock and tie down strap. *Specs.: Min. height 4 ½" max height 16 ½"*

Order No.	Description	Ship Wt.
53459	1500 lbs. Motorcycle lift	96 lbs. - 44 kg

Hydraulic Jack Oil

Special additives to prevent foaming and rust formation. Assures proper valve action under varying temperatures.

Order No.	Mfr. No.	Size
56405	M3332	Quart
56406	M3334	1 Gallon



REVOLUTION

2-Post Lift

- 10,000 Lb. capacity
- Three-Stage front arms allows positioning doors in front or behind columns to prevent damage
- Single point lock release



Overhead padded switch bar prevents vehicle damage. Top mounted pull design hydraulic cylinder. Re-setting safety locks in each column. Features two full-stroke cylinders with an overhead cable for equalization. Includes 1½", 3", and 6" extensions. *Specs.: Capacity 10,000 lbs, rise 77", height overall 12', width overall 11' 1", drive-thru clearance 8' 3", overhead switch height 11' 4¼", inside columns 9'¾", ceiling height required 12'½", 2 hp motor, 220v, 1 ph, 60 cycle.*

Order No.	Mfr. No.	Description	Ship Wt.
59039	RTP10	Two Post Lift	1,650 749

REVOLUTION

2-Post Lift

- 12,000 Lb. capacity for most passenger cars, vans & trucks



Overhead padded switch bar prevents vehicle damage. Top mounted pull design hydraulic cylinder. Re-setting safety locks in each column. Features two full-stroke cylinders with an overhead cable for equalization. Includes 4½" and 8½" truck extensions. *Specs.: Capacity 12,000 lbs, rise 82½" with adapters, width overall 12' 6", drive-thru clearance 9' 1½", overhead switch height 13' 4¾", inside columns 10' 3¼", 2 hp motor, 220v, 1 ph.*

Order No.	Mfr. No.	Description	Ship Wt.
59429	RTP12	Two Post Lift	1,615 727

REVOLUTION

2-Post Floor Plate Lift

- 9,000 Lb. capacity



Ideal for buildings with ceilings as low as 9' 5". Base plate style open top lift with chain over type hydraulic cylinders. *Specs.: Capacity 9,000 lbs, rise 72", height overall 9' 3¼", width overall 11' 6½", drive-thru clearance 8' 1¼", inside columns 9' 3", min. ceiling height 9' 5", 2 hp motor, 208/230v, 20 A.*

Order No.	Mfr. No.	Description	Ship Wt.
59372	RTP9	Two Post Floor Plate Lift	1,615 727

REVOLUTION

Commercial 4-Post Lift

- 14,000 Lb. capacity



A general service lift featuring a maximum 15' wheel base, 20" wide runways and jack in-rail kit, built-in anti-sway kit with standard drive-on ramps. *Specs.: Capacity 14,000 lbs, rise 6' 1¾", height overall 7' 4¾", overall width 11' 5¼", runway tread width 1' 8", runway height 7", width between runway 3' 7", 208/230v, 20A, 2 hp motor.*

Order No.	Mfr. No.	Description
59374	RFP14	Commercial Four Post Lift

REVOLUTION

Portable Mid-Rise Lift

- 6,000 Lb. Capacity



Space-saving scissor-style design with swing arms and pad adapters. Two cylinder designs provides a fast 30 second lift with multiple locking heights. *Specs.: Capacity 6,000 lbs, rise 4' 4", minimum height 5", length 7' 11", width 3' 5", 110v.*

Order No.	Mfr. No.	Description	Ship Wt.
59375	RMR6	Portable Mid-Rise Lift	1,000 454

ROTARY 2-Post Lifts

- Made in Madison IN
- Manual two-handed release locking system

Arm restraints make positioning of arms easy. They engage when the lift is raised and automatically disengage when the lift is fully lowered. Overhead padded switch bar prevents damage to the vehicle. The "double S" single-piece construction column design provides a channel for the bearings to travel maximizing the strength of the column and surface contact area of the bearing. High-pressure cylinders in each column provide maximum lifting force and smooth operation. Standard three-position flip-up adapters allow for quick and easy contact with pickup points on a variety of vehicles.

ROTARY 2-Post Symmetrical Lifts

- Columns are not rotated
- Vehicle load is centered between the columns maximizing lifting capacity
- Truck & van doors can open fully in front of lifting columns



59046 Shown

Mfr. Number	SPO10	SPO10-EH1	SPO10-EH2	SPO12-RA	SPO12-EH2	SPO15	SPO18
Order Number	59046R (Red) 59046B (Blue)	59052	59051	50386R (Red) 50386B (Blue)	59391	50374	50144
Lift Capacity (Lbs.)	10,000	10,000	10,000	12,000	12,000	15,000	18,000
Rise	78 ¼"	78 ¼"	78 ¼"	80¼"	80¼"	89 ½"	89 ½"
Height Overall	11' 8 ½"	12' 8 ½"	13' 8 ½"	13' 8"	14' 8"	15'-16'6"	15'-16'6"
Width Overall	11' 5 ½"	11' 5 ½"	11' 5 ½"	11' 5 ½"	11' 5 ½"	12' 11"	12' 11"
Drive Thru Clearance	102 ½"	102 ½"	102 ½"	102 ¾"	102 ¾"	105 ¾"	105 ¾"
Floor To Switch	11' 2 ¾"	11' 2 ¾"	11' 2 ¾"	13' 3 ¼"	13' 3 ¼"	Adjustable 14' 5"-15' 11"	Adjustable 14' 5"-15' 11"
Inside Columns	114 ½"	114 ½"	114 ½"	113 ¾"	113 ¾"	120"	120"
Speed of Rise (Sec.)	45	45	45	60	60	85	85
Motor	2 HP	2 HP	2 HP	2 HP	2 HP	2 HP	2 HP
Ceiling height Req.	12'	12' 9"	13' 9"	13' 9"	14' 9"	15' 1"-16' 7"	15' 1"-16' 7"
Shipping Weight	1,523			2,112		3,957	3,957
Power Requirements:	208V/230V	208V/230V	208V/230V	208V/230V	208V/230V	208V/230V	208V/230V

ROTARY 2-Post Asymmetrical Lifts

- Columns are rotated 30°
- Places the approximate center of gravity of the vehicle in line with the optimum load capability of the column
- Allows maximum door opening on passenger cars for improved access to vehicle interior & under the dash



3-Stage front arm



Description	Std.	Extended Hght	3-Stage Front Arm
Mfr. Number	SPOA10	SPOA10-EH2	SPOA10-RA
Order Number	59047R (Red) 59047B (Blue)	59049	59318R (Red) 59318B (Blue)
Lift Capacity (Lbs.)	10,000	10,000	10,000
Rise	78 ¼"	78 ¼"	73 ¾"
Height Overall	11' 8 ½"	13' 8 ½"	11' 8 ½"
Width Overall	11' 5 ½"	11' 5 ½"	10' 11 ½"
Drive Thru Clearance	95 ¼"	95 ¼"	95"
Floor To Switch	11' 2 ¾"	11' 2 ¾"	11' 2 ¾"
Inside Columns	107 ¼"	107 ¼"	107 ¼"
Speed of Rise (Sec.)	45	45	45
Motor	2 HP	2 HP	2 HP
Ceiling height Req.	12'	13' 9"	12'
Shipping Weight	1,523		1,523
Power Requirements:	208V/230V	208V/230V	208V/230V

ROTARY Shockwave Lifts

- Lifts & lowers faster
- 7,000 or 10,000 lb. capacities
- Spotline motion activated laser spots vehicles the first time
- Movable pads or 3 stage front arms / round adapters



Lifts and lowers faster with DC motor control system. **Note:** To order color specify "R" for red or "B" for blue after the 5-digit order number

Description	Std.	3-Stage Front Arm
Mfr. Number	SPOA82-MPSW	SPOA10-RASW
Order Number	50342	50343
Lift Capacity (Lbs.)	7,000	10,000
Rise	74"	73 7/8"
Height Overall	11' 8"	11' 8 1/2"
Width Overall	10' 11 3/8"	10' 11 1/2"
Drive Thru Clearance	89"	95"
Floor To Switch	11' 4"	11' 2 3/4"
Inside Columns	101 1/4"	107 1/4"
Speed of Rise (Sec.)	45	45
Motor	2 HP	2 HP
Ceiling height Req.	12'	12'
Shipping Weight		1,523
Power Requirements:	208V/230V	208V/230V

ROTARY VLXS7 & VLXS10 Fixed Pad Contact Lifts

- 7,000 & 10,000 Lb. capacities
- Wider drive over capability
- Lifts uni-body & frame contact undercarriages



Lift trucks and SUVs require a wider drive over capability. The 10,000 lb capacity lifts the heavier vehicles on the market. Both models feature a three-position wheel spotting dish for accurate spotting and dual lift cylinders to provide smooth power and a fast 40 second rise.

Low Rise Pad Lift ramp surfaces are covered with oil resistant, non-skid coating. Include 1 1/2" high rubber pad adapters. Pad dimensions: 18" x 16"

Mid-Rise Frame Contact Lifts have dual approach to allow vehicle loading from either direction. Locking latches set automatically in 4 positions. 3 Position, flip-up adapters rotate 360°.

Description	Frame Contact Air/Hydraulic	Frame Contact Elec./Hydraulic
Mfr. Number	VLXS7	VLXS10
Order Number	59319	59317
Lift Capacity (lbs.)	7,000	10,000
Rise	21 3/4"	21 3/4"
Locking Leg Height	13 3/8", 17 3/8", 21 3/8"	13 3/8", 17 3/8", 21 3/8"
Speed of Rise	40 Sec.	40 Sec.
Min. Collapsed Height	4"	4"
Forward Movement	13 1/2"	13 1/2"
Length Overall	90 1/2"	90 1/2"
Width Overall	70 3/4"	84 1/2"
Power Requirements	115v	115v

ROTARY 2-Post Lift Accessories

Extended Height Adapters

Required to lift 1988 or newer General Motors GMT400 pickup trucks. Includes (4) adapters, mounting rack and hardware.

Order No.	Mfr. No.	Description	Ship Wt.
50370	FJ6133	Overall Height 9"	36 lbs. - 17 kg



Auxiliary Adapters

Auxiliary adapters for use when raising certain vans or pick-ups. Includes adapters, mounting rack and hardware.

Includes 4 Adapters			
Order No.	Mfr. No.	Description	Ship Wt.
50361	FJ6115	Adds 9 3/8"	36 lbs. - 17 kg



Includes 2 Adapters (only 2 required for rear frame)

Order No.	Mfr. No.	Description	Ship Wt.
59315	FJ6195	Adds 12 3/8"	36 lbs. - 17 kg

Adapter Extensions

Provides additional lifting height. Fits models SPOA7-RA, SPOA9-RA, SL29RA, A8, A10, and S10 only. 53373 Kit includes (4) 3-1/2" and (4) 5" adapter extensions, mounting rack, and hardware. **Note:** Do not stack extensions.

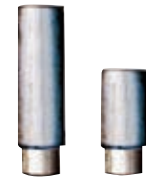

Order No.	Mfr. No.	Description
50373	FJ7880	3 1/2" & 5" Adapter Extension Kit

Spotting Dish

3-Position wheel spotting dish provides more accurate spotting of vehicles.

Order No.	Mfr. No.	Description
59111	FF729	Spotting Dish



ROTARY Polymer Pad Adapter Kit

- 3,000 Lb. capacity

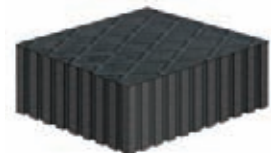

Kit includes four (4) FJ2428 adapters. Each adapter has a 3000 lbs. capacity and adds 3" in height with a rubber pad surfaces. Pad measures 4-3/4" x 6-5/16". The pad protects vehicles with factory-applied undercoating, for use with Versalifts.

Order No.	Mfr. No.	Description	Ship Wt.
50936	FJ2440	Polymer Pad Adapter Kit	4 lbs. - 2 kg

ROTARY Door Defender

Allows entering and exiting the vehicle without damaging the door. Includes (1) Door Defender, adhesive, decal, and instructions.



Order No.	Mfr. No.	Description	Ship Wt.
59045	N823	Door Defender	2 lbs. - 1 kg

ROTARY 4-Post Lifts

- 6" Higher rise provides more headroom & a more comfortable work area.
- Improved lock design features fewer parts & simplified design, for trouble-free operation.
- Non-Skid surface material is bonded to the runway in paint process
- Molded yoke caps keep debris away from yoke sleeves.
- Clearance holes allow the ramp chocks to clear yoke bolts resulting in less noise on vehicle driveover.

Closed Front, Four Post Service Racks



Open Front, Four Post Service Racks

Allows full undercar access for service. Single point release air-locks operate all column locks at once. Wheelbase capacity up to 206". Optional 7,000 pound rolling jack adds brake, tire and suspension work.

Open Front, Four Post Alignment Racks

The four-post alignment rack system easily accommodates all service business. Features an open-front crossmember allowing clear service access to the rear of the vehicle. Rolling jacks lift front, rear or all wheels off runways for brake, tire, alignment, and suspension work. Includes rolling jacks.

Open Front, Four Post Service Racks



Service Lift

Alignment Lift

Description	Service Lift			Alignment Lift			Standard	Long	Extra Long
	Long Open	X-Long Open	Standard Closed	Long Closed	X-Long Closed	Long Closed			
Mfr. Number	SMO14L	SMO14EL2	SM14S	SM14L	SM14EL2	AR14L	ARO14S	ARO14L	ARO14EL2
Order Number	50094	50089	50090	50091	50092	50083	50095	50097	50087
Lift Capacity (Lbs.)	14,000	14,000	14,000	14,000	14,000	14,000	14,000	14,000	14,000
Max. Wheelbase	192 1/2"	206 1/2"	158 1/2"	182 1/2"	206 1/2"	192 1/2"	158 1/2"	192 1/2"	212 1/2"
Max. 2 Wheel Align.	N/A	N/A	N/A	N/A	N/A	188"	153"	188"	208"
Max. 4 Wheel Align.	N/A	N/A	N/A	N/A	N/A	158"	142"	158"	158"
Rise	6' 1 3/4"	6' 1 3/4"	6' 1 3/4"	6' 1 3/4"	6' 1 3/4"	6' 1 3/4"	6' 1 3/4"	6' 1 3/4"	6' 1 3/4"
Length Overall	22'	23' 8"	18' 9"	20' 9"	20' 9"	21' 7"	19' 2"	22'	23' 8"
Width Overall	11' 7"	11' 7"	11' 1"	11' 1"	11' 1"	11' 1"	11' 7"	11' 7"	11' 7"
Inside of Columns	9' 9 1/2"	9' 9 1/2"	9' 9 1/2"	9' 9 1/2"	9' 9 1/2"	9' 9 1/2"	9' 9 1/2"	9' 9 1/2"	9' 9 1/2"
Between Columns	17' 1"	18' 3"	14' 3 7/8"	16' 3 7/8"	18' 3 7/8"	12' 1 7/8"	14' 3"	17' 1"	18' 3"
Height of Columns	7' 11 3/16"	7' 11 3/16"	6' 10 1/8"	6' 10 1/8"	6' 10 1/8"	6' 10 1/8"	7' 11 3/16"	7' 11 3/16"	7' 11 3/16"
Width of Runways	20"	20"	20"	20"	20"	20"	20"	20"	20"
Height of Runways	7"	7"	7"	7"	7"	7"	7"	7"	7"
Width Between Runways	43"	43"	43"	43"	43"	43"	43"	43"	43"
Bay Size	15' x 26'	15' x 28'	15' x 23'	15' x 24'	15' x 25'	15' x 26'	15' x 23'	15' x 26'	15' x 28'
Speed of Rise (Sec.)	65	65	55	55	55	65	65	65	65
Motor	2 hp	2 hp	2 hp	2 hp	2 hp	2 hp	2 hp	2 hp	2 hp
Shipping Weight (Lbs.)	2285	2396	2492	2631	2770	2770	3643	3774	3905
Power Requirements:	208V/230V	208V/230V	208V/230V	208V/230V	208V/230V	208V/230V	208V/230V	208V/230V	208V/230V

ROTARY Rolling Jacks for 4-Post Lifts



Rolling jacks lift front, rear or all wheels off runways for brake, tire, alignment and suspension work. When not in use, they roll away for unobstructed workspace between runways. Air over oil design for smooth operation. Optional internal airline coils allow two rolling jacks to operate simultaneously without changing air supply.

Order No.	Mfr. No.	Description
50380	RJ7000	7,000 lb. Rolling Jack (Each)
50077	RJ9000	9,000 lb. Rolling Jack (Each)
50112	FC5710	15,000 lb. Rolling Jack (Each)

ROTARY 4-Post Efficiency Package

The package includes two (2) Model SJ6000 Swing Air Jacks, an Internal Airline Kit (un-installed), and a model S100074 Bolt-On Alignment Package. This kit can be used with SMO series lifts and must be ordered with the four-post lift. Jacks have a capacity of 6,000 lbs. each and the Alignment Package allows for 4-wheel alignment performance.



Order No.	Mfr. No.	Description
50080	S100078	4-Post Efficiency Package

Vehicle Lifts

ROTARY Alignment Lift

- 12,000 Lb. capacity
- Handles wheel bases from 71 1/2" to 158" for 4-wheel alignments



Yspace provides 20% more work space below the lift and over 5 times more clear floor space under the runways. Hydraulic cylinder, locking mechanism and position sensor are mounted inside the runway protecting them from corrosion. Adjustable radius gauge pockets are 2" deep. *Specs.: Capacity 12,000 lbs; rise 68 3/8"; overall length 270", overall width 88", runway width 24"; runway height 11 3/8", width between runway 40", max. wheelbase 189 1/2"; max. 2 wheel align. 174 1/2"; min. 4 wheel align. 71 1/2"; 208/230v.*

Order No.	Mfr. No.	Description	Ship Wt.
50108	YA12-EL1	Alignment Lift	

ROTARY Heavy-Duty, Closed Center 4-Post Service Racks



Surface mounted, drive-on lift. Oil-resistant, non-skid coating runways and ramps. Includes air-operated single point release locking latches, spring-loaded to locking latches and filter lubricator regulator. Rolling jacks are optional.

Description	Standard	Extended Length	Standard
Mfr. Number	SM18	SM18EL2	SM30L
Order Number	59248	59341	59427
Lift Capacity (lbs.)	18,000	18,000	30,000
Max. Wheelbase	194"	230"	
Rise	5' 8"	5' 8"	5' 8"
Length Overall	22' 11 3/8"	25' 11 3/8"	
Width Overall	11' 5 3/4"	11' 5 3/4"	12' 4 13/16"
Inside of Columns	10' 1 1/2"	10' 1 1/2"	11'
Between Columns	17' 8"	20' 8"	
Height of Columns	6' 5 3/4"	6' 5 3/4"	
Width Between Runways	43" - 46"	43" - 46"	
Bay Size	16' x 27'	16' x 30'	
Speed of Rise (Sec.)	100	100	
Motor	2 HP	2 HP	2 HP
Power Requirements	208V/230V	208V/230V	208V/230V

Optional Internal Airlines for SM18 Racks

Order No.	Mfr. No.	Description
50112	FCS760	Internal Airlines for SM18 Racks

ROTARY Smartlift Inground Lifts

- Saves space - 9 SmartLifts fit in the space of 8 surface lifts
- No hard piping between the lift & its power source



Without columns, risk of vehicle damage is eliminated, shop appearance and employee workspace is improved. EasyAccess cylinder design does not require bleeding and can be removed for servicing while other components remain in place. All hose connections can be accessed from floor level. Removable non-skid cover plate with a leak resistant seal allows easy access to interior system. Fully contained polymer composite housing with SMARTGUARD Protection protects the entire unit from the environment. A flexible entry boot keeps moisture from seeping between the PVC chase and entry. Liquid Detection System (LDS) in the containment housing and on-screen alerts helps prevent accumulation of water.

Mfr. No.	SL210	SL210i	SL212
Order No.	59420	59073	59422
Rise*	81 1/4"	81 1/8"	84 1/4"
Width Overall	93 1/4"	93 1/4"	98 1/2"
Drive-thru/over clearance	84 1/4"	84 1/4"	88"
Reach (long arm min.)	25 3/8"	25 3/8"	
Reach (long arm max.)	42 3/8"	42 3/8"	
Reach (short arm min.)	22 1/8"	22 1/8"	
Reach (short arm max.)	36 5/8"	36 5/8"	
Reach (overall arm min.)	63 3/8"	63 3/4"	77"
Reach (overall arm max.)	95 3/8"	95 3/8"	110"
Min. Adapter Height	4 1/4"	4 1/4"	5 1/4"
Low Step Height	6 3/8"	6 3/8"	9 1/4"
High Step Height	10 1/4"	10 1/4"	13 3/4"
Capacity (overall)	10,000 lbs.	10,000 lbs.	12,000 lbs.
Capacity (per arm)	2,500 lbs.	2,500 lbs.	3,000 lbs.
Guide Plunger Diameter	8 1/2"	8 1/2"	8 1/2"
Motor	2 HP	2 HP	2 HP
Voltage Single Phase	208v-230v	208v-230v	208v-230v
Rise time to full stroke	45 seconds	55 seconds	54 seconds
Recom. Bay Size	11' X 24'	11' X 24'	12' X 26'

* Rise is measured with adapter in high step position.

** Plus runway height.

Optional 3 phase electrical available. 110v drop required for each bay.

Overall heights and widths reflect standard settings. Ceiling height required equals rise plus height of tallest vehicle.

ROTARY Mach 4 & 6 Mobile Column Lifts

- Battery operation eliminates cords
- Fast set-up
- Made in U.S.A.



4-Column Specs.: capacity 72,000 lbs.; rise 70"; lifting cycles 15-20 per charge; column width 45 1/2"; clearance from fork to column 10"; speed of rise 78 seconds; charging voltage 110v; tire dimensions 9" to 24".

6-Column Specs.: capacity 108,000 lbs.; rise 70"; lifting cycles 15-20 per charge; column width 45 1/2"; clearance from fork to column 10"; speed of rise 78 seconds; charging voltage 110v; tire dimensions 9" to 24".

Order No.	Mfr. No.	Description
59377	Mach 4	4 Column Mobile Lift
59369	Mach 6	6 Column Mobile Lift

CHALLENGER Heavy-Duty 2-Post Lifts

- 12,000, 15,000 & 18,000 lb capacities available
- Oversized steel pulley reduces stress on equalization system & provides increased durability
- Includes standard, medium & high extensions
- Single point air lock release system
- ALI/ETL Certified



Description	Two Post Lift	Two Post Lift	Two Post Lift
Mfr. Number	12000	15000	18000
Order Number	51206	51207	59135
Lift Capacity (Lbs.)	12,000	15,000	18,000
Rise	84 3/4"	85 1/2"	85 1/2"
Height Overall	13' 8"	14' 6"	14' 6"
Width Overall	11' 10"	12' 10 3/4"	12' 10 3/4"
Drive Thru Clearance	104 1/2"	106 3/4"	106 3/4"
Floor To Switch	13' 1"	13' 11"	13' 11"
Inside Columns	114 1/2"	120"	120"
Speed of Rise (Sec.)	60	80	80
Motor	2 HP	2 HP	3 HP
Ceiling height Req.	13' 9"	14' 7"	14' 7"
Power Requirements:	208V/230V 1 ph	208V/230V 1 ph	208V/230V 1 ph

CHALLENGER Economy 2-Post Lift

- Versymmetric technology lifts vehicles symmetrically & asymmetrically
- Double telescoping screw pads
- Single point lock release system
- ALI/ETL certified



Three stage front arms provide greater overall arm sweep for asymmetric and symmetric lifting in the same service bay. Features a padded overhead shutoff system and rubber door guards. **59431** Includes (4) standard screw pads, (4) 3" medium extensions, (2) 6" high extension, (2) organizer racks and set of 4 frame engaging truck adapters.

59444 Specs.: capacity 10,000 lbs.; rise 75 3/4"; height overall 11' 11 1/4"; width overall 10' 11 3/4"; drive thru clearance 98 3/8"; floor to switch 11' 5"; inside columns 110 1/4"; ceiling height required 12'; motor 2 hp; speed of rise 50 seconds, max. load per arm 2,500 lbs.

59431 Specs.: capacity 12,000 lbs.; rise 78 1/4"; height overall adj. 13' 10" or 14' 7"; width overall 11 7 3/4"; drive thru clearance 103"; floor to switch 13' 10" or 14' 7"; inside columns 115"; ceiling height required 13' 10" or 14' 7"; motor 2 hp; speed of rise 66 seconds, max. load per arm 3,000 lbs.

Order No.	Mfr. No.	Description
59444	E10	Economy Two Post Lift
59431	E12	Economy Two Post Lift

CHALLENGER 2-Post Lifts

- Versymmetric Technology lifts vehicles symmetrically & asymmetrically in the same bay
- Double telescoping screw pads
- Single point lock release system
- ALI/ETL Certified



The units feature double telescoping screw pads, rubber door guards, and a heavy-duty 5" diameter pulley with 5/16" cable and 48" carriage. Units have padded overhead shutoff system and 2' and 3' column extension options. **59440** CL10V3 features conventional power controls, Versymmetric Plus offset three stage front and three stage rear arms. **59442** Three stage front arms plus three stage rear arms for single sweep spotting. CL10V3-3 **59563** CL10V3DPC features Dual Pendant power controls, stack adapter kit and document caddy with Versymmetric Plus offset three stage front and three stage rear arms.

Description	Two Post Lift	Two Post Lift	Two Post Lift
Mfr. Number	CL10V3	CL10V3-3	CL10V3DPC
Order Number	59440	59442	59563
Lift Capacity (Lbs.)	10,000	10,000	10,000
Rise	74 3/4"	74 1/8"	74 3/4"
Height Overall	11' 8"	14' 8"	11' 8"
Adj. Width Overall	11' 6 1/2" - 11' 11"	11' 6 1/2" - 11' 11"	11' 6 1/2" - 11' 11"
Drive Thru Clearance	100" - 104 1/2"	100" - 104 1/2"	100" - 104 1/2"
Floor To Switch	11' 2 1/2"	14' 2 1/2"	11' 2 1/2"
Inside Columns	110" - 114 1/2"	110" - 114 1/2"	110" - 114 1/2"
Speed of Rise (Sec.)	48	48	48
Motor	2 HP	2 HP	2 HP
Ceiling height Req.	12'	14' 9"	12'
Power Req.:	208V/230V 1 ph	208V/230V 1 ph	208V/230V 1 ph

CHALLENGER Portable Mid-Rise Lift

- 6,000 Lb. capacity
- ALI/ETL certified



Features seven locking positions single push button power unit and sliding rotating arm design to handle pick up points on a wider range of vehicles. Specs.: capacity 6,000 lbs.; rise 52 3/8"; length overall 7' 10"; width overall 39 1/2"; min. collapsed 5 1/2"; min. pad height 8 3/8"; max. pad height 62 1/8"; 1 hp motor, 115 v; speed of rise 45 seconds; min. bay size 10' x 22'.

Order No.	Mfr. No.	Description
59437	MR6	Portable Mid-Rise Lift

Vehicle Lifts

CHALLENGER

4-Post General Service & Alignment Lifts

- 12,000 & 15,000 Lb. capacities
- Compatible with the industry's latest imaging alignment systems
- 80" Rear recessed free-floating slip plates offer a wide range of 4 wheel alignment capacities
- 14 Level locking positions for a variety of alignment & general duty services
- ALI/ETL Certified



AR4015EAO



4P12EFX

4105 Series features bracket strengthened base plate and top shroud reduces column deflection and is less sensitive to uneven floors. Large 9 1/2" heavy-duty pulleys and 1/2" cable diameter reduces the wear on the cable equalization system.

Alignment Rack models include (2) rolling jacks with internal airline system, flush mount stainless steel turning radius gauges, rear slip plates, multi-position work steps, and automatic wheel stops.

Description	Alignment Pkg.		Flat Deck		Alignment Pkg.		Flat Deck			
	Open	Open	Open	Open	Closed	Closed	Closed	Closed		
Mfr. Number	4P12EFX	4P12XFX	AR4015EAO	AR4015XAO	4015EFO	4015XFO	AR4015EAX	AR4015XAX	4015EFX	4015XFX
Order Number	59550	59551	59552	59553	59554	59555	59556	59557	59558	59559
Lift Capacity (Lbs.)	12,000	12,000	15,000	15,000	15,000	15,000	15,000	15,000	15,000	15,000
Max. Wheelbase	182½"	210"	182½"	210"	182½"	210"	182½"	210"	182½"	210"
Max. 2 Wheel Align.	N/A	N/A	166½"	194"	N/A	N/A	166½"	194"	N/A	N/A
Max. 4 Wheel Align.	N/A	N/A	88" - 158"	88" - 158"	N/A	N/A	88" - 158"	88" - 158"	N/A	N/A
Rise	78"	78"	78"	78"	78"	78"	78"	78"	78"	78"
Length Overall	20' 4½"	22' 8"	20'9"	23'	20'9"	23'	20' 4½"	22' 8"	20' 4½"	22' 8"
Width Overall (Front/Rear)	10' 10¾"	10' 10¾"	11'10"/11'2½"	11'10"/11'2½"	11'10"/11'2½"	11'10"/11'2½"	10'	10' 1"	10' 10"	10'
Inside of Columns (Front/Rear)	9' 8"	9' 8"	10'	10'	10'	10'	10'	10'	10'	10'
Between Columns	16' 3"	18' 6½"	16' 3"	18' 6½"	16' 3"	18' 6½"	16' 4"	18' 4¾"	14' 4"	18' 7½"
Height of Columns (Front/Rear)	90½"	90½"	99½"/93½"	99½"/93½"	99½"/93½"	99½"/93½"	90½"	90½"	90½"	90½"
Width of Runways	20"	20"	20"	20"	20"	20"	20"	20"	20"	20"
Height of Runways	7"	7"	7"	7"	7"	7"	7"	7"	7"	7"
Width Between Runways (Min./Max.)	40"/43"	40"/43"	43"	43"	43"	43"	40"/43"	40"/43"	40"/43"	40"/43"
Minimum Bay Size	12' x 24'	12' x 26'	12' x 24'	12' x 26'	12' x 24'	12' x 26'	12' x 24'	12' x 26'	12' x 24'	12' x 26'
Speed of Rise (Sec.)	70	70	85	85	85	85	85	85	85	85
Motor	2 hp	2 hp	2 hp	2 hp	2 hp	2 hp	2 hp	2 hp	2 hp	2 hp
Shipping Weight (Lbs.)			3,900	4,100	2,840	2,970	3,900	4,100	2,460	2,590
Power Requirements:	208V/230V	208V/230V	208V/230V	208V/230V	208V/230V	208V/230V	208V/230V	208V/230V	208V/230V	208V/230V

CHALLENGER Stack Adapters

- For Challenger 10,000 capacity inground car & truck lifts



Kit includes (4) 3" stack extensions, (2) 6" stack extensions and (2) organizer racks with hardware

Order No.	Mfr. No.	Description
59459	10315	Stack Adapters

CHALLENGER Rolling Jack

- 6,000 Lb. capacity



Features air/hydraulic operation for 4P12 series 4-post lifts. Allows easy access from underneath for brake and wheel service. Includes stackable height extensions with built-in storage rack and factory installed filter, lubricator and regulator.

Order No.	Mfr. No.	Description
59467	RJ6	Rolling Jack

HOFMANN 10K Scissor Alignment Lift

- 10,000 lb capacity
- 26" Runways provide alignment accuracy for cars & dual wheel trucks
- Includes integrated air kit for connecting optional roller jacks

Features front and rear open access and work steps on each side are adjustable to 8 positions. Features a triple safety system that includes air-actuated mechanical locks, velocity fuses and pressure sensing flow control valves. The low 9" design allows drive-on approach for low-profile vehicles. Durable 72" slip plates glide on over-sized roller balls. *Specs.: Capacity 10,000 lbs.; front accessibility open; max. 4 wheel alignment wheelbase 84 1/2" - 155"; max. 2 wheel alignment wheelbase 175"; general service max. wheelbase 189"; deck surface length 205 1/2"; overall width 92 1/2"; overall length 265 3/8"; min. lowered height approx. 9"; max. raised height 72"; elec. 230v, 1 ph., 60 Hz.; ship. wt. 4,630 lbs.*



Order No.	Mfr. No.	Description
59527	BLA10205H	10K Scissor Alignment Lift

HOFMANN 12K Scissor Alignment Lift

- 12,000 lb capacity
- "Pro-Style" 24" Runways provide easy drive-on for large vehicles
- Lifts straight up, no forward or back movement

Open front design provides easy access to alignment service and calibration areas. Four heavy duty lifting cylinders maintain constant level from floor to full lift height. Flush mounted rear slip plates include encapsulated bearings. *Specs.: Capacity 12,000 lbs.; open front design; max. 4 wheel alignment wheelbase 89" - 158"; max. 2 wheel alignment wheelbase 165"; general service max. wheelbase 179"; width between runways 40"; runway width 23"; overall width 90"; overall length 267 3/8"; max. raised height 70"; air req. 90 140 psi @ 5 - 10 cfm; ship. wt. 6,615 lbs.*



Order No.	Mfr. No.	Description
	EELR709A	12K Scissor Alignment Lift

HOFMANN 14K 4-Post Lifts

- 14,000 lb capacity
- Handles from 70" to 158" vehicle requirements
- 2 Wheel alignment up to 188" & general service wheelbases up to 205"

90" long read slip plates eliminate time consuming repositioning of front turn plates to accommodate shorter and longer vehicles during four wheel alignment adjustments. The 7" drive-on height allows for shorter approach ramps. "Super Glide" floating flush mounted rear slip plates eliminate repositioning turn plates.

EELR707A includes locking and lighted turntables and slip plates, runway lights, a filter-regulator-lubricator and pneumatically locking turntables and slip plates from the lift control position.

Specs.: Capacity 14,000 lbs.; front accessibility open; max. 4 wheel alignment wheelbase 70" to 158"; max. 2 wheel alignment wheelbase 188"; deck surface 220"; deck width 22"; distance between decks 40"; overall width 140 1/2"; overall length 269 1/2"; max. raised height 74"; max. lowered height 7"; lift time 70 seconds; elec. 230v, 1 ph.; ship. wt. 4,400 lbs.



Order No.	Mfr. No.	Description
59668	EELR705A	14K 4-Post Alignment Rack
	EELR707A	14K 4-Post Alignment Rack

HOFMANN Geoliner 670 Imaging Alignment System

- One of the most advanced alignment systems a shop can own
- Set-Up to readings in less than 2 minutes
- System is loaded with Premium Pro 32 software packaging



Includes animated adjustment aids providing on-screen visual aids for vehicle specific adjustments. *Specs.: wheel size 13" - 24"; tire diameter, unlimited; track width 48" - 96"; wheel base 79" - 180".*

Order No.	Mfr. No.	Description
59500F	EEWA715AL	670 Geoliner w/ Fixed Boom
59500M	EEWA715AL	670 Geoliner w/ Movable Boom
59500T	EEWA715AL	670 Geoliner w/ Tilt Boom

HOFMANN Geoliner 680 Imaging Alignment System

- One of the most advanced alignment systems a shop can own
- Set-Up to readings in less than 2 minutes
- System is loaded with Premium Pro 32 software packaging



Features EZ-Access (Wheels Off Alignment, software for modified vehicles, advanced vehicle dimensions, Pro-Ackerman, scrub radius, caster trail and SAI). *Specs.: wheel size 13" - 24"; tire diameter, unlimited; track width 48" - 96"; wheel base 79" - 180".*

Order No.	Mfr. No.	Description
59781F	EEWA714AL	680 Geoliner w/ Fixed Boom
59781M	EEWA714AL	680 Geoliner w/ Movable Boom
59781T	EEWA714AL	680 Geoliner w/ Tilt Boom

HOFMANN Geoliner 550 Imaging Alignment System

- Wireless communication with Bluetooth technology
- Cordless pods with Lithium Ion batteries
- Components made from lightweight magnesium
- Advanced technology to enter into the alignment business



Order No.	Mfr. No.	Description
59671	EEWA717AL	550 Geoliner w/ Flat Screen Monitor

HOFMANN Geoliner 650 Imaging Alignment System

- Wireless communication with Bluetooth technology
- Includes basic software package combining the benefits of camera technology & quality at an affordable price
- Components made from lightweight magnesium



Patented high definition cameras provide visual and directional assistance to the technician during the measuring procedure. Boosts shop productivity by doing more alignments in less time.

Order No.	Mfr. No.	Description
59780M	EEWA712AL	650 Geoliner w/ Movable Boom
59780T	EEWA712AL	650 Geoliner w/ Tilt Boom

HOFMANN Steering Wheel Holder



Order No.	Mfr. No.	Description
59766	55502	Steering Wheel Holder

HOFMANN AC4000 Touchless Alignment Wheel Clamps

- Secure clamping on the tire, not the rim
- Durable, lightweight magnesium construction

Clamping is accomplished with a single, fast action adjustment knob. No accessories are needed to handle the full range of tire sizes. Sold in sets of four. *Specs.: tire diameter, 19" - 39"; clamping force 37 lbs.; weight 7 lbs.; compatible alignment systems, Geoliner 670, Geoliner 680.*

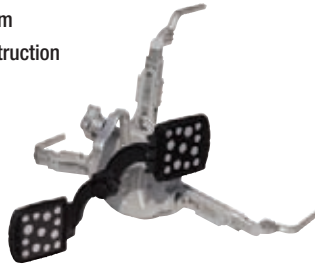

Order No.	Mfr. No.	Description
	AC4000	Touchless Alignment Wheel Clamps

TRU-LINE Laser Alignment System

- Completely portable, no rack required
- Live caster, accurate to 1/64"
- Measure caster, live caster, camber, SAI, toe, 2-wheel or 4-wheel alignments



48631

No cables or computers, runs on D cell batteries. Wheel clamps on inside or outside of rims 10" to 19 1/2". TL-12 Deluxe Kit includes laser guns, race ramps, front and rear stands, slip plates, turn tables, rear combination gauges, caster/camber gauge, calibration bar, 4 wheel clamps for rims up to 19 1/2", steering wheel holder, brake pedal depressor, training video and instruction manual.

TL-12 Passenger 4-Wheel Alignment System

Does not include race ramps, front and rear stands, slip plates, and turn tables.

TL-90 Dual 1-Ton Alignment Kit

- For larger trucks up to tractors

Aligns tractors and trailers. TL-12 Kit includes (2) TLT-28 truck wheel clamps, TLT-52 wheel centering targets, TLT-44 level compensator and digital level.

TL-550-8 Head Clamp Extensions

- For Hunter or Tru-Line

Adds up to 6" more in wheel diameter with the same precision. Kit includes (8) extension plates and (16) female adapters.

TLT-12 Bus & RV Alignment System

Aligns tractors and trailers. TLT-12 Kit includes (2) TLT-28 truck wheel clamps, TLT-52 wheel centering targets, TLT-44 level compensator and digital level.

TL-28 Wheel Clamps

Use with TL-12, TLT-12 to work on two vehicles side-by-side.

TLT-12 Truck Laser 4-Wheel Alignment System

- For heavy-duty trucks, trailers, buses, & RV

Aligns tractors and trailers. TLT-12 Kit includes laser guns, calibration bar, caster/camber gauge, (2) truck clamps for rims up to 27", wheel centering target, trailer king pin kit, level compensator, digital level, training video and instruction manual. Cannot be used on passenger cars.

Order No.	Mfr. No.	Description	Ship Wt.
48283	TL-12 Deluxe	Passenger 4-Wheel Alignment System	220 lbs. - 100 kg
48293	TL-12	Passenger 4-Wheel Alignment System	175 lbs. - 79 kg
48286	TL-90	Dual 1-Ton Alignment Kit	50 lbs. - 23 kg
48282	TL-550-8	Head Clamp Extension Kit	25 lbs. - 11 kg
48631	TLT-12	Heavy-Duty Truck & Trailer Alignment	155 lbs. - 75 kg
48284	TLT-12	Bus & RV Alignment System	165 lbs. - 74 kg
48688	TL-28	Bus & RV Alignment System	34 lbs. - 15 kg

TRU ALIGN Wheel Alignment System

- Align any diameter wheel
- Eliminates other adapters or extensions
- Works on all alignment systems, old or new

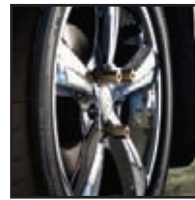

Remove 3 lug nuts & replace with extensions



Bolt the Plate to the face of the wheel



Attach aligner head to the plate

The head attaches to the plate not the wheel eliminating head-mounting problems caused by tire "rim guards" and damage to expensive wheels caused by mounting alignment heads directly to the wheel. Tru Align is much less expensive than buying a new alignment machine and allows technicians to do a better job at a fraction of the cost. System includes four wheel plates, extensions, studs, and thread gauge.

Order No.	Description	Ship Wt.
03113	Wheel Alignment System	55 lbs. - 25 kg

TRU ALIGN Replacement Parts

- All Tru Align replacement parts are sold & priced each

Order No.	Mfr. No.	Description
03109	TA012	3/8" x 1.5 Spacer
03028	TA002	13" Tru Align Plate



03109

Order No.	Mfr. No.	Description
03121	TA003	3/16" Adapter
03116	TA004	1/2" Adapter
03362	TA005	3/8" Adapter
03393	TA006	12 x 1.25 Adapter
03375	TA007	12 x 1.50 Adapter
03858	TA008	12 x 1.75 Adapter
03859	TA009	14 x 1.50 Adapter
03861	TA010	14 x 2.00 Adapter



03028

TRU ALIGN Cart & Case

- Organize & inventory parts
- Cart & case feature custom foam inserts & laminated parts layout sheet



03112



03111

Order No.	Description	Ship Wt.
03111	Tru-Align Cart 600 Lb. Capacity	100 lbs. - 45 kg
03112	Tru-Align Case	12 lbs. - 6 kg

Pro Super Hub-Shark

- Replace front wheel drive bearings in less than 25 minutes
- Pulls the hub on the car
- Pulls captured rotors

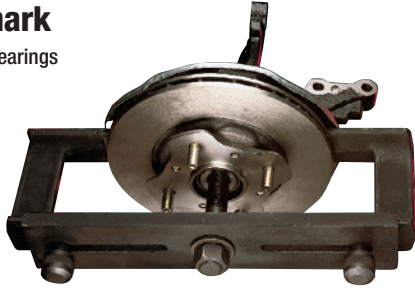

Replace front wheel bearings on front wheel drive vehicles in less than 25 minutes per wheel. Replacement is done with the steering knuckle on the car. Works on U.S. and foreign cars. No need to remove knuckle assembly and re-align the front end. Pulls the bearing race from the hub and pulls Ford tapered shaft through the hub. Use regular impact tools. Made in the U.S.A.

Order No.	Description	Ship Wt.
03321	Pro Super Hub-Shark	57 lbs. - 26 kg

Spade Sleeve Adapter Kit for Hunter Alignment Heads

- Used to grip standard aluminum wheels



Order No.	Description
71073	Spade Sleeve Adapter Kit (8 Per Kit)

Rim Guard Adapter Kit for Hunter Alignment Heads

- Grips tire & rim combinations having a rim guard wrapped closely to the wheel lip



Order No.	Description
71074	Rim Guard Adapter Kit (8 Per Kit)

Wheel Spreader

Simple and easy to use. Accurately spreads and holds the front wheels of the vehicle being tested with a toe gauge that does not require moving the vehicle. Length 42" minimum to 71" maximum, pressure 13 lbs.

Order No.	Mfr. No.	Description	Ship Wt.
72064	WA0918	Wheel Spreader	4 lbs. - 2 kg

Brake Pedal Depressor



Holds the foot brake simply and safely as required in all alignment procedures. Length 28"

Order No.	Mfr. No.	Description	Ship Wt.
72098	WA0928	Brake Pedal Depressor	2 lbs. - 1 kg

Steering Wheel Holder



Allows for greater accuracy in adjusting toe-in, toe-out and centering the steering wheel. Not to be used as a steering wheel lock.

Order No.	Mfr. No.	Description
72100	WA0938	Steering Wheel Holder

Replacement Stainless Steel Front Turn Plates

- Will not rust or pit from moisture and salt
- Sold in pairs

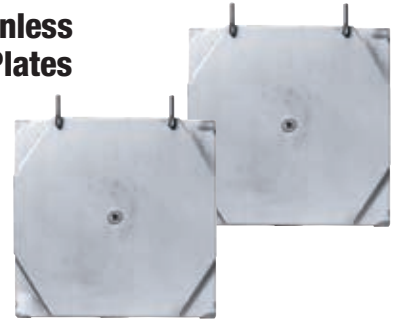

The plating, internal springs and lock pins are 304 stainless steel for long life. Tumbled Derlin, nylon-based bearings eliminate ridges for accurate readings. Capacity is 8,000 lbs., 4,000 lbs. per plate. Compatible with Hunter, JBC, Rotary, Forward, VBM and ALM. 14" x 14" x 1 1/2" Octagon top plate and square base. Older mechanical aligners require a pointer and scale, newer computer-based aligners do not. The pointer and scale cannot be added in the field.

Order No.	Mfr. No.	Description	Ship Wt.
71075	SS-14	Stainless Steel Turn Plates - Pair	86 lbs. - 39 kg
71076	SS-PS	Turn Plates w/ Pointer & Scale - Pair	86 lbs. - 39 kg
Repair Kit for 71075, 71076, & Hunter Turn Plates. One repair kit rebuilds a pair of turn plates. Includes 54 derlin bearings, 8 stainless steel springs, 4 lock pins, & 2 washers.			
71077	SS-RP	Repair Kit for 71075 & 71076	1 lbs. - 1 kg

Rear Wheel Slip Plate Set

- Use with scribe toe gauge



The steel slip plates allow unrestricted movement of the rear wheels, 1" forward, backward and side-to-side for a total of 2", to make easy and accurate adjustments by eliminating the friction between the tires and support system. Includes a tube of marine teflon lubricant. Size 17 1/4" x 11 1/2" x 3/8"; work area 13 1/4" x 10 1/2".

Order No.	Mfr. No.	Description	Ship Wt.
72069	WA1851	Rear Wheel Slip Plate Set	30 lbs. - 14 kg

Passenger & Truck Scribe Toe Gauges

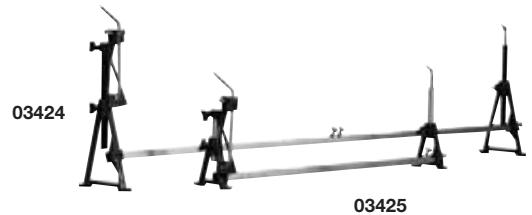

Large easy-to-read scale for accurate toe adjustments. Passenger gauge width extends 96", truck gauge extends 108" and checks toe and sets toe on trucks with tires up to 24.5. Pointer and scribe on truck model maybe lowered to handle most automotive applications. Includes built-in scribe.

Order No.	Mfr. No.	Description	Ship Wt.
03425	2635	Passenger Toe Gauge	20 lbs. - 9 kg
03424	2645	Truck Toe Gauge	30 lbs. - 14 kg

Passenger Scribe Toe Gauge



Easy-to-read scale for accurate toe adjustments. Passenger gauge width extends 96". 5" legs, 11" pointers. Includes scribe.

Order No.	Mfr. No.	Description	Ship Wt.
03094	WA0511	Passenger Toe Gauge	7 lbs. - 3 kg
03059		Replacement Bar	5 lbs. - 2 kg
72169	WA0516	Replacement Scribe	3 lbs. - 2 kg

Truck Toe Alignment Check Set

- Scribe-Type toe gauge
- For trucks, buses, RVs & other large vehicles



Pointer and scribe measures accurately and simply. One person operation without moving the vehicle. Designed to read toe by measuring the distance between marks previously scribed at the approximate center of the tire treads. The pointers are adjustable to hub height for greater accuracy. 8' long, 18 gauge welded steel tubing to prevent distortion. The measuring dial is calibrated in 1/32" and mm. Has 10" legs, 11" and 17" pointers. Includes scribe.

Order No.	Mfr. No.	Description	Ship Wt.
03062	WA515	Toe Gauge Truck	10 lbs. - 5 kg
03059		Replacement Bar	5 lbs. - 3 kg
72169	WA0516	Replacement Scribe	3 lbs. - 2 kg

Truck Front Slip Plate Set

- Use with scribe-type toe gauge



For use with the Truck Toe Alignment Check Set above. The steel slip plates allow unrestricted movement of the front wheels, 1 5/8" forward, backward and side-to-side for a total of 3 3/4", to make easy and accurate adjustments by eliminating the friction between the tires and support system. Includes a tube of marine teflon lubricant resistant to gas, solvent, water and salt. Overall size: 24" x 16" x 3/8". Work area: 17" x 14 3/4".

Order No.	Mfr. No.	Description	Ship Wt.
03063	WA1841	Slip Plate Pair	86 lbs. - 39 kg

Extra Heavy-Duty Turntable Set

- Easy to remove pins hold plates locked
- Non-Skid design minimizes sliding



Indicates accurate toe-out on turn angles of each wheel. Also allows the bottom of the wheel to move freely while the alignment adjustments are made. Full floating mechanism and enclosed ball bearings. Base is 20 1/4" x 15" x 2 1/8", top plate diameter 14", supports 10,000 lbs. per wheel, dial range 100, top plate motion 3".

Order No.	Mfr. No.	Description	Ship Wt.
03093	WA100	Extra Heavy-Duty Turntable Set	124 lbs. - 56 kg

NEXT DIMENSION Silicone Spray

- Heavy-Duty & non-staining
- Lubricates & protects
- Does not cause gumming

Order No.	Description	Case Qty	Fill	Container
11055	Silicone Spray	12	11 Oz.	16 Oz.



Tire Mating Square

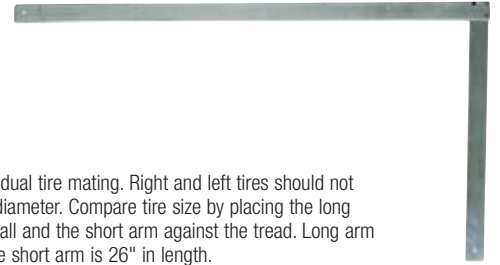

Checks for variance in dual tire mating. Right and left tires should not vary more than 1/2" in diameter. Compare tire size by placing the long arm against the side wall and the short arm against the tread. Long arm is 48" in length and the short arm is 26" in length.

Order No.	Mfr. No.	Description	Ship Wt.
03067	WA1844	Tire Mating Square	5 lbs. - 3 kg

Portable Dual Tire Mater

- Mates tires on vehicle (matches them up)



Checks dual tire mating and accurately measures diameter of truck and trailer tires. Four-wheel drive truck tires must be checked often to prevent "hot rear ends" caused by improper tire diameters. Right and left dual tires shouldn't exceed 1/2" in total diameter.

Order No.	Mfr. No.	Description	Ship Wt.
46722	TDM-200	Portable Dual Tire Mater	6 lbs. - 3 kg

Stationary Tire Meter

- Wall mounted
- Measures overall diameter of tires off vehicle



Used in conjunction with Portable Tire Mater installs permanently in tire shop. Measures overall diameter as tires are mounted and properly inflated. Mismatched tire found on vehicles with Portable Mater can be quickly mated to a proper diameter tire in stock. Eliminates guesswork and unnecessary wheel changes.

Order No.	Mfr. No.	Description	Ship Wt.
46720	TDM-100	Stationary Tire Meter	9 lbs. - 4 kg

Tire Caliper



Durable, lightweight aluminum. Measures overall diameter and cross section of tire at same time. 1/8" calibrations. Inches clearly marked bar length 53", arm 18". Measure passenger or truck tires. Match tire diameters before mounting.

Order No.	Mfr. No.	Description	Ship Wt.
46702	SE4-58E	Tire Caliper	5 lbs. - 3 kg

SPECIALTY EZ Cam XR Camber Kits For Domestic/Import 2-Bolt Struts (Pair)

- Designed for non-slotted struts
- Allows positive & negative camber changes up to approximately 1.75°, depending on vehicle, by replacing the upper OE strut/spindle bolt
- Built-in adjuster for the life of the vehicle by turning the head of the bolt
- Each kit contains 2 cam bolt assemblies, enough for both sides of the vehicle
- Estimated installation time ½ Hour

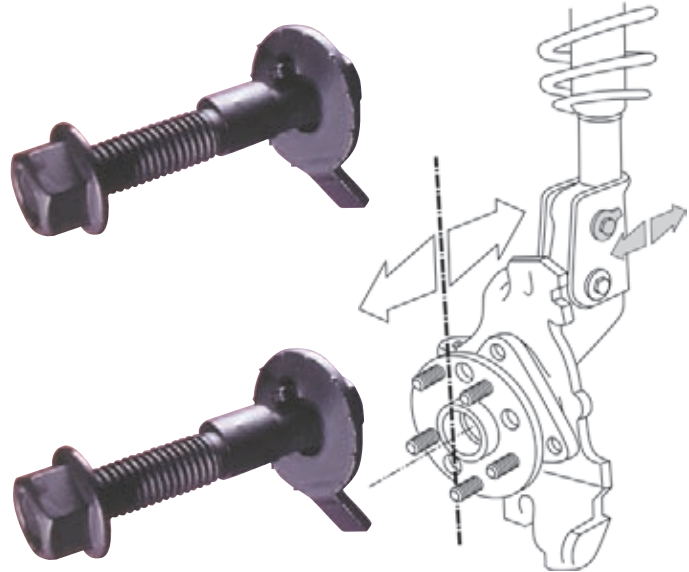

Note: Install handle in the direction of desired camber change; out for positive, in for negative

For replacement of 10mm bolts

APPLICATIONS: Alfa Romeo: 33, 75, 90, Alfetta, Arna, GTV, Ginlietta, SZ Spider, 145, 146, 155; Fiat: 127, 128, 147, Ducato (10, 13, 14, 18 & Maxi), Duna, Fiorino, Panorama, Aemio, Panda, Punto, Regatta, Tempra, Tipo, Uno, Barchetta, Bravo, Brava, Maria; Lancia: Delta, Pedra, Ypsilon.

Order No.	Mfr. No.	Description
73651	81240	10mm EZ Cam XR Camber Kits

For replacement of 12mm bolts

APPLICATIONS: Chevrolet: Malibu, Metro, Nova, Prizm, Spectrum, Sprint, Cadillac: Catera; Daihatsu: Charade, Daewoo: Leganza, Nubria; Dodge: Colt, Colt Vista, Neon; Eagle: Summit, Summit Station Wagon, Talon; Ford: 95 Aspire, Escort, EXP, Festiva, Fiesta, Probe, Tempo; Geo: Metro, Prizm, Spectrum, Storm, Tracker; Hyundai: Accent, Elantra, Excel, Scoupe; Infiniti: G20; Isuzu: Impulse, I-Mark, Stylus; Mazda: 323, 626, GLC, 929, MX3, MPV, MX6, Protege, RX7; Mercury: Capri, LN-7, Lynx, Topaz, Tracer, Villager; Mitsubishi: Cordia, Diamante, Eclipse, Expo, Galant, Mirage, Precis, Tredia; Nissan: 240SX, Altima, 2WD/4WD Access, Maxima, NX, Pulsar, Sentra, 2WD Stanza Wagon, Stanza, Quest; Plymouth: Colt, Colt Vista, Laser; Pontiac: Firefly; Porsche: 924, 944; Renault: Alliance, Encore, GTA; Saab: 9000; Saturn: L-Series; Suzuki: Grand Vitra, Swift, Vitra; Toyota: Celica, Corolla, FX16, MR2, Tercel Sedan, Tercel Wagon, Tercel Executive Wagon; Volkswagen: Cabriolet, Corrado, Golf, GTI, Jetta, Passat, Rabbit; Volvo: 40 Series; Yugo: GV series.

Order No.	Mfr. No.	Description
73652	81250	12mm EZ Cam XR Camber Kits

For replacement of 14mm bolts

APPLICATIONS: Chevrolet: Beretta, Cavalier, Corsica, Impala, Malibu, Monte Carlo, Prizm; Chrysler: Town & Country; Daewoo: Leganza, Nubria; Dodge: Caravan, Neon; Hyundai: Sonata; Infinity: I30; Mitsubishi: Eclipse, Galant; Nissan: Maxima, Stanza Wagon & 4WD; Plymouth: Voyager; Saturn: all models; Subaru: Impreza, Legacy, SVX; Toyota: Celica, Corolla, MR2, Paseo, Tercel, Tercel Wagon; Volvo: 850GLT.

Order No.	Mfr. No.	Description
73653	81260	14mm EZ Cam XR Camber Kits

SPECIALTY F150/250 (L/D) 2/4WD Camber/Caster Kit (4)



Use kit to change caster and/or camber on the new F150, F250 (L/D), Expedition and Navigator. Replace the existing upper control arm mounting bolts with these cam bolts for caster/camber changes up to 2.0°. One kit covers both sides of the vehicle. Estimated installation time - .5 hr/side. **APPLICATIONS:** Ford: 1997 - up F150, F250 (L/D), 1997 - up 2WD & 4WD Expedition; Lincoln: 1997 - up 2WD & 4WD Navigator.

Order No.	Mfr. No.	Description	Ship Wt.
73629	87385	F150/250 (LD) 2/4WD Caster/Camber Kits	3 lbs. -2 kg

For replacement of 15mm bolts

APPLICATIONS: Geo: Prizm; Lexus: ES250, ES300; Toyota: Avalon, Camry, Celica, Corolla, MR2, Paseo, Tercel.

Order No.	Mfr. No.	Description
73654	81270	15mm EZ Cam XR Camber Kits

For replacement of 16mm bolts

APPLICATIONS: Buick: Electra, LeSabre, Park Avenue, Reatta, Regal, Riviera, Skyhawk, Skylark/Somerset; Cadillac: Cimarron, Allante, Deville/Fleetwood, Eldorado, Seville, STS; Chevrolet: Beretta, Corsica, Cavalier, Camaro, Lumina Sedan, Monte Carlo; Chrysler: 300M, Concord, LHS, New Yorker; Dodge: Intrepid, Monaco; Eagle: Medallion, Premier, Vision; Ford: Fairmont, Granada, LTD, Mustang, Thunderbird; Lincoln: Continental, Mark VII; Mercury: Capri, Cougar, Marquis, Zephyr; Oldsmobile: Achieva, Aurora, Calais, Cutlass Supreme, Firenza, Toronado, Trofeo, 88, 98; Pontiac: Bonneville, J2000, Firebird, Grand AM, Grand Prix, Sunbird, Sunfire.

Order No.	Mfr. No.	Description
73655	81280	16mm EZ Cam XR Camber Kits

For replacement of 17mm bolts

APPLICATIONS: Lexus: ES250, ES300; Toyota: Avalon, Camry, Celica, Previa, Sienna.

Order No.	Mfr. No.	Description
73656	81290	17mm EZ Cam XR Camber Kits

SPECIALTY Explorer Camber/Caster Kit (4)

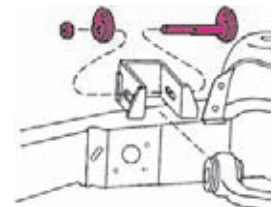

Set of 4 cams allows for quick installation without removing the upper control arm bolt. Change camber and caster up to ±1.75°. One kit covers both sides of the vehicle. Estimated installation time - .3 hr/side. **APPLICATIONS:** Ford: 1995 - up 2WD & 4WD Explorer, 1998 & up 2WD & 4WD Ranger; Mercury: 1995 - up 2WD & 4WD Mountaineer.; Mazda: 1998 2WD & 4WD B-Series Pickup.

Order No.	Mfr. No.	Description	Ship Wt.
72295	87310	Explorer Caster/Camber Kit	3 lbs. -2 kg

SPECIALTY Ford Adjustable Cam Nut Bracket

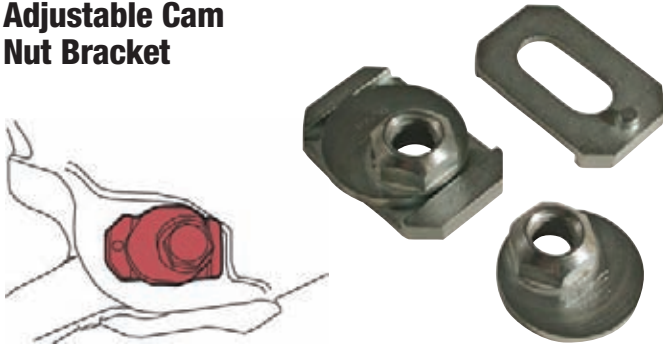

Allows easy camber and caster adjustments. No need to remove the OE bolt or stabilizer bar. One SKU covers a variety of vehicles. **APPLICATIONS:** 2004-2010 Ford F150; 2007-2010 Ford Expedition; 2006-2010 Lincoln Mark LT; 2007-2010 Lincoln Navigator.

Order No.	Mfr. No.	Description	Ship Wt.
72200	86250	Ford Adjustable Cam Nut Bracket	3 lbs. -2 kg

SPECIALTY Jeep & Dodge Offset Ball Joint

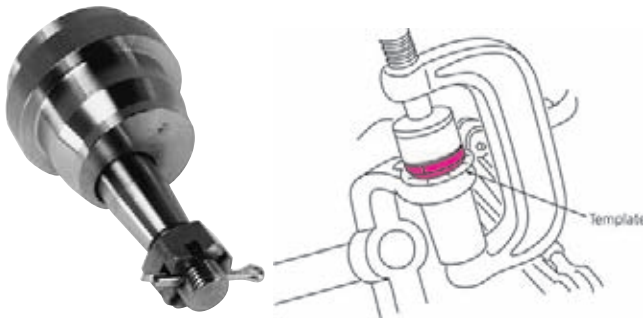

Caster and camber changes are now possible on some of the most popular sport utility vehicles and trucks. This offset ball joint replaces the O.E. upper ball joint providing up to 2° camber/caster change on several previously non-adjustable Jeep and Dodge vehicles. The ball joint comes with an installation template for accurate changes. Use Ball Joint Sleeves #23580 in conjunction with #7250 Bushing Press for quick and efficient removal and installation of all ball joints. One kit covers one side of the vehicle. Estimated installation time - .8 hr/side.

APPLICATIONS: Jeep: 1984 & up 2WD/4WD Cherokee, Comanche; 1987 & up Wrangler; 1990 & up Renegade; 1984 & up 2WD/4WD downsize Wagoneer; 1993 & up Grand Cherokee; Dodge: 1994 & up BR1500 4WD & BR2500 (L/D) Pickups.

Order No.	Mfr. No.	Description	Ship Wt.
72266	23510	.50° (1/2°) Positive or Negative	2 lbs. - 1 kg
72267	23520	1° (1°) Positive or Negative	2 lbs. - 1 kg
72268	23530	1.5° (1-1/2°) Positive or Negative	2 lbs. - 1 kg
72269	23540	2.00° (2°) Positive or Negative	2 lbs. - 1 kg

SPECIALTY Ford F250, F350 Sleeves

Ford changed the axle design in 2005 on their Heavy Duty trucks. These sleeves correct camber and caster on the new 4x4 F250 and F350 Super Duty truck. Front Adjustment range: Cam/Cas ±0.25° to ±2.25°. Installation time: 1/2 hr/side. Required: 1 per wheel. Use 0° sleeve to determine change.

APPLICATIONS: Ford 4WD: 2005 & Up F250, F350 Super Duty.

Order No.	Mfr. No.	Total Change
73598	23221	.25° (1/4°)
73597	23222	.50° (1/2°)
73596	23223	.75° (3/4°)
73595	23224	1.00° (1°)
74003	23225	1.25° (1-1/4°)
74004	23226	1.55° (1-1/2°)
74005	23227	1.75° (1-3/4°)
74006	23228	2.00° (2°)
74001	23211	2.25° (2-1/4°)
74002	23212	2.50° (2-1/2°)
73594	23229	0° (0°)



SPECIALTY Ford 2 & 4WD Camber/Caster Sleeve Set (9)

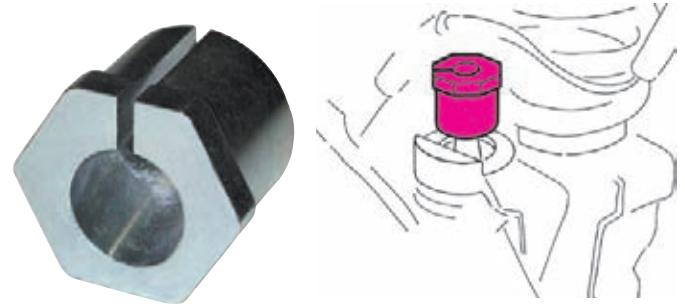

Widely used to adjust caster and/or camber on many Ford 2WD/4WD trucks. To install, loosen and remove upper ball joint pinch bolt. Remove top snap ring if one is present. Use #77880 or #88830 sleeve puller to remove the existing sleeve. To save time during alignment, use #23199 zero degree sleeve to determine initial readings, then install correct sleeve. Note: Sleeves adjust to a smaller degree on Ford 4WD light trucks. One sleeve covers one side of the vehicle. Estimated installation time - 1/2 hr/side. **APPLICATIONS:** Ford 2WD: 1987 & up F350, 1987-96 F150, F250 (L/D), 1989-90 Bronco II, 1992 & up E150, E250, E350. 1991-94 Explorer, 1989-97 Ranger, 1999 & up F250, F350 Super Duty ; Mazda 2WD: 1991-97 Navajo, Pickup; Ford 4WD: 1990 Bronco II, 1991-94 Explorer, 1990 - 97 Ranger; Mazda 4WD: 1991-97 Navajo, Pickup.

Set #23180 contains one each of: 23181, 23182, 23183, 23184, 23185, 23186, 23187, 23188, 23199.

Order No.	Mfr. No.	2WD Adj. Change	4WD Adj. Change
72456	23181	.25° (1/4°)	.20°
72457	23182	.50° (1/2°)	.40°
72458	23183	.75° (3/4°)	.60°
72459	23184	1.00° (1°)	.75°
72460	23185	1.25° (1-1/4°)	.90°
72461	23186	1.50° (1-1/2°)	1.10°
72462	23187	1.75° (1-3/4°)	1.25°
72463	23188	2.00° (2°)	1.40°
72817	23189	2.25° (2-1/4°)	1.60°
72816	23190	2.50° (2-1/2°)	1.80°
72921	23199	0.00° (0°)	0.00°

Order No.	Mfr. No.	Description	Ship Wt.
72157	23180	Ford/Mazda 2 & 4WD Camber/Caster Sleeve Set (9)	3 lbs. -2 kg

SPECIALTY Ford Explorer Camber/Caster Kit (4)



The new Ford Explorer has a torsion bar suspension with limited caster and no camber adjustment. This kit provides up to 2° positive or negative camber/caster adjustment. Replace the O.E. upper control arm mounting bolts with the #87500 cam bolts for fast and efficient adjustment now and in the future. One kit covers both sides of the vehicle. Estimated installation time - .5 hr/side passenger side, estimated installation time - .7 hr/side driver side. **APPLICATIONS:** Ford: 1995 - up 2WD & 4WD Explorer, 1998 & up 2WD & 4WD Ranger; Mercury: 1995 - up 2WD & 4WD Mountaineer; Mazda: 1998 2WD & 4WD B-Series Pickup.

Order No.	Mfr. No.	Description	Ship Wt.
72985	87500	Ford Explorer Caster/Camber Kit	3 lbs. -2 kg

SPECIALTY Forged Rear Camber Arm

- Celica, Focus, Mazda3, Volvo



For installers needing extended camber range. Includes OE style bushings. **APPLICATIONS:** Ford Focus 2000 and up, Mazda3 2000 and up, Mazda5 2006 and up, Volvo S40 2004 and up, Volvo V50 2004 and up.

Order No.	Mfr. No.	Description	Ship Wt.
74057	67420	Forged Rear Camber Arm	lbs. -kg

SPECIALTY Truck Axle Shims

- Available aluminum alloy or manganese bronze



Manganese Bronze



Aluminum Alloy

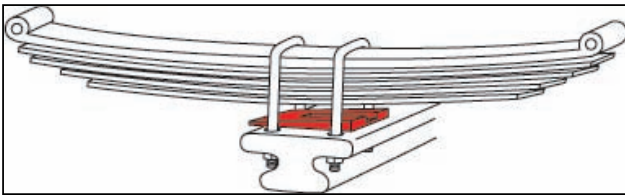

Aluminum Alloy		Manganese Bronze		Spring Width	Degree	Spr. Pad Length
Order No.	Mfr. No.	Order No.	Mfr. No.			
73282	10605			3 1/2"	1/2°	6 1/4"
72193	10612	72579	10614	3 1/2"	1°	6 1/4"
73284	10622	72598	10624	3 1/2"	1 1/2°	6 1/4"
73285	10632	72058	10634	3 1/2"	2°	6 1/4"
73286	10642	72191	10644	3 1/2"	2 1/2°	6 1/4"
73287	10652	72070	10654	3 1/2"	3°	6 1/4"
73288	10662			3 1/2"	3 1/2°	6 1/4"
73289	10672			3 1/2"	4°	6 1/4"
72072	10705	73230	10704	4"	1/2°	6 1/2"
72056	10712	72588	10714	4"	1°	6 1/2"
72597	10722	72028	10724	4"	1 1/2°	6 1/2"
72592	10732	72587	10734	4"	2°	6 1/2"
72071	10742	73234	10744	4"	2 1/2°	6 1/2"
72596	10752	72078	10754	4"	3°	6 1/2"
73296	10762	73236	10764	4"	3 1/2°	6 1/2"
72079	10772	73237	10774	4"	4°	6 1/2"
73298	10782			4"	5°	6 1/2"

SPECIALTY Tandem Truck Shims

- Fast, accurate way to align front or rear axles

I.H.C./Navistar Torque Arm Shim

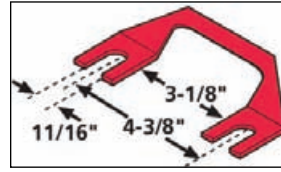

Changes thrust and toe when installed between the torque arm and the spring hanger.

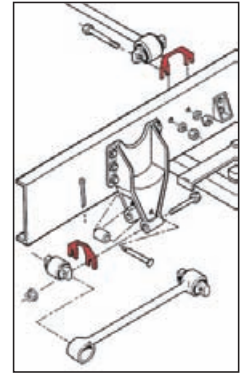

Order No.	Mfr. No.	Thickness	Qty./Box	Ship Wt.
72827	35040	1/32"	6	lbs. -kg
72826	35041	1/16"	6	
72830	35042	1/8"	6	

Single Slot Tandem Truck Shims

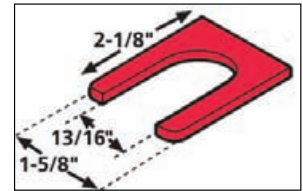

Universal shims are installed at the ends of torque rods to change toe and/or thrust angles. **APPLICATIONS:** Freightliner, Hendrickson and Navistar.

Order No.	Mfr. No.	Thickness	Qty./Box	Ship Wt.
72925	35060	1/32"	6	lbs. -kg
72926	35061	1/16"	6	
72942	35062	1/8"	6	

Navistar Shim for "Corporate" 6x4 Air Suspension

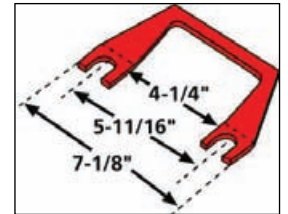

Shims center the axle with the frame rails when used on the lateral link. Also adjust thrust angle and toe by placing between the spring hammer and spring.

Order No.	Mfr. No.	Thickness	Qty./Box	Ship Wt.
74030	36020	1/32"	6	lbs. -kg
74031	36021	1/16"	6	
74032	36022	1/8"	6	

SPECIALTY Uni-Wedge Shims

- Heavy-Duty zinc alloy

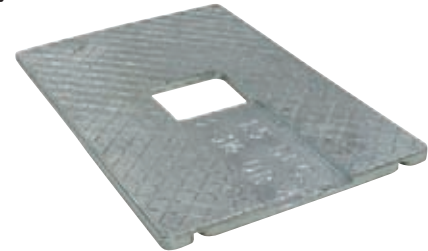

Changes castor positive or negative from 1/2° to 4°. **APPLICATIONS:** Any solid axle RWD or 4WD vehicle.

Order No.	Mfr. No.	Width	Degree Taper	Qty./Box
72957	89199	3" - 3 1/2" - 4"	1/2°	6
72958	89299	3" - 3 1/2" - 4"	1°	6
72959	89199	3" - 3 1/2" - 4"	1 1/2°	6
72960	89499	3" - 3 1/2" - 4"	2°	6
72961	89599	3" - 3 1/2" - 4"	2 1/2°	6
72961	89699	3" - 3 1/2" - 4"	3°	6

BRANICK 7400 Strut Spring Compressor

- Uniform spring compression



Double-start heavy-duty acme threads. Handles heavy coil spring shocks, extra long, narrow or angled springs & F-150 & Toyota RAV4 without additional adapters. Three-point lower hooks increment adjust for uniform spring compression; "common center" compression hooks fit between tightly wound coil springs. Optional bench mount or mobile cart.

Order No.	Description	Ship Wt.
59308	7400 Spring Compressor	100 lbs. -45 kg
59313	744 Optional Portable Cart	
59314	741 Optional Bench Mount	

PB BLASTER Nut Loosener

A powerful, penetrating lubricant that frees everything faster! Displaces moisture. Use on nuts and bolts, rusted joints, automatic chokes, to start wet engines and more. Just saturate troubled area and allow to stand for a few minutes.

Order No.	Description	Case Qty	Container
45217	Nut Loosener	12	11 Oz. Spray



T.O.M.C.A.T. Camber Adjustment Tool

- Makes camber adjustment a one man job
- Accurately adjusts camber to exact specifications

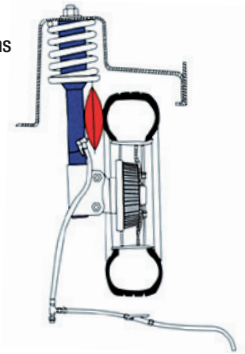

Works on many GM, Chrysler and other vehicles using two-bolt lower strut mounts and various rear wheel alignment specifications. The T.O.M.C.A.T. is a specially designed inflatable bladder that fits snugly between the top of the wheel and the strut. A small amount of air pressure allows the technician to easily and accurately control both positive and negative settings without assistance. Specially designed air bladder contains a hard plastic shield to prevent accidental punctures. Includes a 2', 300 psi rated air hose, a low pressure pop-off valve to prevent over inflating, and an air control valve for inflating and controlled deflating.

Order No.	Mfr. No.	Description	Ship Wt.
03003	TC614	Camber Adjustment Tool	3 lbs. -1 kg

Tandem Axle Spacing Caliper



Checks the space between the axles of tractors or trailers ensuring correct alignment and tracking. May also be used to measure the diameters of the tire so matching pairs and sets can be used in tandem. Easy to read scale measures up to 72" or 1830 mm covering the full range of tandem spacing.

Order No.	Mfr. No.	Description	Ship Wt.
03095	WA1891	Tandem Axle Caliper	6 lbs. -3 kg

Trailer Alignment Measuring System

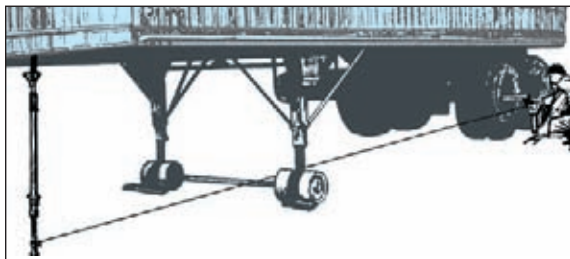

The king pin extension and universal axle extension provide a fast, accurate method of checking trailer axle alignment without removing the wheels. Axle extensions extend the axles beyond the wheel rim and tire so measurements can be made from the king pin center. Comparative measurements are made with a steel tape (not furnished) from the king pin extension to each axle extension.



King Pin Extension

Order No.	Mfr. No.	Description	Ship Wt.
03060	WA1889	King Pin Extension	6 lbs. - 3 kg

Aluminum Wheel Axle Extension Set of 2

- For use on steel & aluminum wheels
- For wheels up to 28"



Order No.	Mfr. No.	Description	Ship Wt.
03066	WA18901	Aluminum Wheel Axle Extension	8 lbs. -4 kg

Universal Axle Extensions Set Of 2

Order No.	Mfr. No.	Fits Wheel Sizes	Ship Wt.
03083	WA1888S	17 1/2"	4 lbs. - 2 kg
03085	WA1888M	19 1/2"	4 lbs. - 2 kg
03061	WA1888L	22 1/2"	4 lbs. - 2 kg



Steel Measuring Tape

Order No.	Mfr. No.	Description
46736	K-550	50' Steel Measuring Tape



TIGER TOOL Universal Joint Puller

- Removes sealed U-Joint cups without hammering or torching
- Use with a ¾" or 1" impact wrench

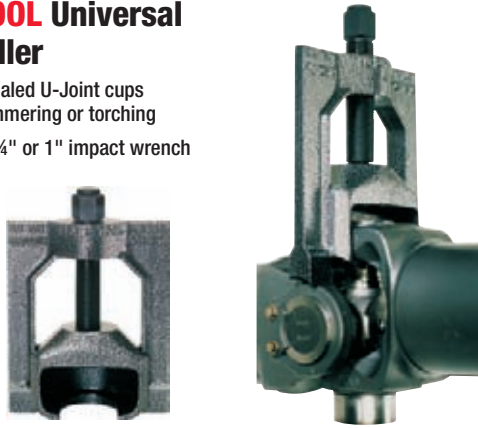

Tested and recommended by Dana Spicer Corporation. One piece unit requires no assembly, bolts, cables or adapters. The patented design provides the ultimate "brute strength" for disassembling drivelines. For Spicer drivelines 1610, 1710, 1760, 1810, 1880, Meritor (Rockwell) 16N, 17N, 18N, 1710, Spicer SPL 140, 170, 250, "Life Series", and Meritor RPL 20, 25 "Permalube" series.

Order No.	Mfr. No.	Description	Ship Wt.
03775	10102	Universal Joint Puller	14 lbs. -7 kg

Mack Truck King Pin Cap Tool Kit

- Removes & installs thrust bearing adjustment screws on 10,500, 12,000, 16,000, 18,000, & 20,000 lb. axles on Mack trucks



New cross design tool greatly reduces the camming action created by torque, making it easier to keep the tool fully engaged in the cap (adjusting screw) when removing and installing the cap. The Thread Chasers clear the cap threads on the axle casting so the threads are not damaged, saving the spindle assembly. The patented design, heat treating, and plating process extends the working life of the tool.

The kit contains: 17/8" Cap Removal Tool and Thread Chaser for 10,500 and 12,000 lb. axles and a 2 3/8" Cap Removal Tool and Thread Chaser for 16,000, 18,000 and 20,000 lb. axles.

Order No.	Mfr. No.	Description	Ship Wt.
07540	X10-KR84B	Mack Truck King Pin Cap Tool Kit	7 lbs. -5 kg

Replacement Items

07541	X10-KR17B	1 7/8" King Pin Screw Remover Tool
07542	X10-KR25B	2 3/8" King Pin Screw Remover Tool
07543	X10-TC17B	Thread Chaser for 10,500 & 12,000 Lb. Axles
07544	X10-TC25Z	Thread Chaser 16,000, 18,000 & 20,000 Lb. Axles

TIGER TOOL Yoke Puller

- Generates up to 25,000 lbs. of pulling power
- Use with a ½" impact wrench



Removes heavy-duty yokes on driveshafts, transmissions and rear-end differentials without damage to yokes or components. Machined from heat-treated and finished chrome-moly steel for maximum strength and wear. Fits full and half-round yokes on Spicer and Meritor 1610, 1710, 1760, 1810 series, Spicer SPL 140, 170, 250 series and Meritor (Rockwell) RPL 20 and 25 series.

Order No.	Mfr. No.	Description	Ship Wt.
03792	10803	Yoke Puller	18 lbs. -8 kg

V-Bond Absorbent Pads

- Grey pads for oil, water, & general use
- White pads for oil only
- Janitorial & shop supplies pages 228 - 232



The large 17" x 19" x ¾" pads are the economical solution for drips, leaks, and spills. Use for soaking up water and oil based fluids. Absorbs up to 32 ounces.

Order No.	Mfr. No.	Description	Per Case	Ship Wt.
11211	SEL 225519	Grey V-Bond Absorbent Pads	100	16 lbs. - 7 kg
11212	SEL 82001	White V-Bond Absorbent Pads	100	18 lbs. - 8 kg

SAFE T SORB Safety Absorbent

- 50 Lb. bag
- Janitorial & shop supplies pages 228 - 232



Quickly and easily soaks up spills that can cause accidents. Works on any concrete surface. Easy to use and transport.

Order No.	Mfr. No.	Description	Ship Wt.
11210	IMCZORBALL	SORB 50 lb. Bag	50 lbs. - 23 kg

GOJO Natural Orange Hand Cleaner

- More hand cleaners page 232



Deep scrubbing pumice removes grease, grime, tar, paint, etc. A good cleaning formula for general automotive repair facilities where a lotion-based product is preferred. Fortified with lanolin.

Order No.	Mfr. No.	Description	Ship Wt.
45024	0955	1-Gallon Orange Lotion with Pump	9 lbs. - 4 kg

MYERS Reusable Mechanics Gloves

- More gloves pages 242, 243, 244



Nitrile-coated palm protects hands. Machine washable, will not shrink. Air dry.

Order No.	Description	Size
45378	Mechanics Gloves	Large
45379	Mechanics Gloves	Extra Large

Protective Eyewear

- More protective eyewear page 236



Scratch resistant and lightweight for comfort. Snug fit minimizes discomfort.

Order No.	Description
82662	Protective Eyewear with Amber Lens
82663	Protective Eyewear with Blue Mirror Lens
82664	Protective Eyewear with Clear Lens

Service Equipment

Myers Tire Supply is your service equipment headquarters. Myers is a proud distributor of **AMMCO**, **HOFMANN** & **PRO-CUT** brake lathes. We stock brake bits & accessories plus brake washers, adapter kits & fluid evacuators. **ASSOCIATED** & **MIDTRONICS** battery service equipment is available through our Sales Offices & Distribution Centers. We carry a complete line of **ROBINAIR** A/C recovery/recycle/recharge stations. Underhood service products from **TRACERLINE**, **REDLINE** & **STANT** are in stock. **SLIP-N-GRIP** interior protection system includes seat protectors, wheel covers, tire bags & more. Oil & lube service equipment is available from **LINCOLN** & **OTC**. Check out the complete line of **MYERS** garage chemicals on pages 222 and 223. New to this catalog is the addition of **GOODYEAR** Wiper blades & display racks on page 224.



BACK BUDDY™ II Brake Drum Removal Cart

- Remove & roll out for easy servicing

Helps prevent injuries from awkward lifting and keep workers' compensation rates down. Roll under and bolt on to the heavy brake drum and hub assemblies, then roll the assembly out and lay it over for servicing. Reassembly is quick and precise because the tool angles for perfect hub alignment, eliminating seal damage and costly fixes. Ideal for brake jobs—no pain, no strain. Handles all hub and drum assemblies with the Universal Receiver and Adapter Sets. A change of adapters transforms it from an inboard hub/drum lifting device to an outboard drum or spoke-lifting device in seconds. Includes: 84401 10-hole inboard hub and drum assemblies adapter kit and 84402 10-hole outboard drums adapter set.

Order No.	Mfr. No.	Description	Ship Wt.
84400	350B	Back Buddy II	115 lbs. - 52 kg
84401		10-Hole Inboard Hub and Drum Assemblies Adapter Kit	4 lbs. - 2 kg
84102		10-Hole Outboard Drums Adapter Set	4 lbs. - 2 kg
Optional Adapter Sets Required for Following Hubs			
84403	MKA4	For 5 & 6 Spoke Hubs & Drums 20" & 22" Wheels (May Not Fit All Steering Axle Front Spoke Wheels)	8 lbs. - 4 kg
84404	MKA5	For 8 Hole - 275mm Bolt Circle & Stud Diameters 5/8" to 1 1/8"	8 lbs. - 4 kg
84405	MKA6	For 8 Hole - 275mm Bolt Circle Outboard Drums - Back Plate Thickness to 1/2"	8 lbs. - 4 kg
84406	MKA7	For 6 Hole - 8 3/4" Bolt Circle & Stud Diameters to 1 1/8"	8 lbs. - 4 kg
84407	MKA8	For 6 Hole 8 3/4" Bolt Circle Outboard Drums - Back Plate Thickness to 1/2"	8 lbs. - 4 kg
84410	MKHMV	Humvee/Hummer Geared Hubs	9 lbs. - 5 kg



Heavy-Duty ratchet



Handle folds down for storage

OTC 5017A Brake Drum Dolly



Remove, transport and install all 15" and 16 1/2" drums on Class 7 and 8 trucks and trailers without lifting. Features steel construction, 10" pneumatic tires and an adjustable handle.

Order No.	Mfr. No.	Description	Ship Wt.
84153	5017A	Brake Drum Dolly	48 lbs. - 22 kg

AMMCO 1450 Brake Washer

- Three-Stage filtration system
- Extra large catch basin
- Parts basket keeps things organized



Meets OSHA requirements in any brake service situation. Large capacity, 24" x 24" x 8" deep, catch basin with a parts basket keeps small parts together. Compact base allows more open floor space. Low pressure pneumatic pump has preset, tamper-proof air pressure regulator to control incoming air supply. Three stage filtration system includes large particle strainer, 20 micron sock style, primary filter and 5 micron secondary filter.

Order No.	Mfr. No.	Description	Ship Wt.
03570	1450	Deluxe Brake Washer	56 lbs. - 26 kg

AMMCO Brake Washer Accessories



03572
03573



03574



03579
03580



03575
03576

Order No.	Mfr. No.	Description	Package	Ship Wt.
03572	29700	Filter Sock	1	1 lbs. - 1 kg
03573	29700-6	Filter Sock	6	2 lbs. - 1 kg
03574	29702	Oil Absorbent Boom	1	1 lbs. - 1 kg
03575	29706	Cartridge Filter	1	1 lbs. - 1 kg
03576	29706-6	Cartridge Filter	6	2 lbs. - 1 kg
03579	297101	Cleaning Solution 1 Qt.	1	1 lbs. - 1 kg
03580	29710-6	Cleaning Solution 1 Qt.	6	6 lbs. - 3 kg

AMMCO Brake Lathe Enclosure

- Provides a safe, clean working environment
- Reduces shop noise

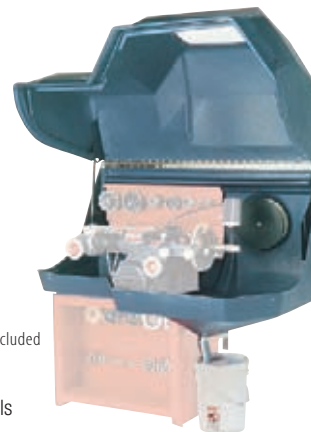

Lathe Not Included

A 110 cfm fan circulates the air and funnels heavy metal chips into a 5 gallon can for easy disposal. A separate air filter collects the micro dust. Large window allows monitoring of entire operation. Integrated tool board keeps all accessories at hand. The assembly takes no more room than a standard brake shop with the chip funnel and bucket installed. Made of durable polyethylene plastic for years of heavy-duty use. The 2801 Deluxe Model includes safety interlock system, to prevent an unattended lathe from operating with the cover open.

Order No.	Mfr. No.	Description	Ship Wt.
03368	2800	Standard Enclosure	281 lbs. - 125 kg
03369	2801	Deluxe Enclosure	290 lbs. - 127 kg

AMMCO 4100B Medium-Duty Drum/Disc Lathe

- Order the adapter kit to fit your needs – See Page 200
- 3 Spindle speeds
- Resurfaces both sides of the rotor at the same time

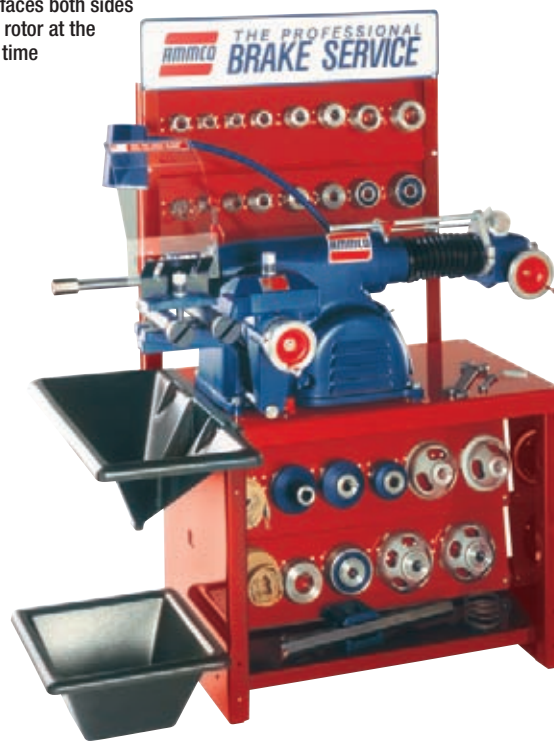

Machines drums and rotors on most passenger cars, light and medium-duty trucks and buses. Converts from drums to rotors in less than a minute. Lathe Includes: wrenches, silencer bands, boring bars, twin cutter, safety shield and work lamp. Order the adapter kit to fit your needs. See page 200. Specs.: Spindle speeds 60, 80, 115 rpm; rotor dia. up to 22" with 7900 twin cutter; rotor width up to 4" with 7900 twin cutter; drum dia. 6" to 28"; max. drum depth 9.875"; 115 VAC, 60 Hz, 1 ph, fused at 20A. Motor 1 hp.

Order No.	Mfr. No.	Description	Ship Wt.
03582	4100B	Brake Lathe Less Standard Adapters	480 lbs. - 216 kg
03452	2500	Optional Bench	132 lbs. - 73 kg
03469	6914-10	Brake Bits 10 Pack	1 lbs. - 1 kg
03379	7900	Optional Twin Cutter	45 lbs. - 21 kg

AMMCO 4000E Drum/Disc Lathe

- Order the adapter kit to fit your needs – See Page 200
- Resurfaces both sides of the rotor at the same time



Three spindle speeds. Shift on the fly for the speed that most fits the job. Machines drums and rotors on most passenger cars, light and medium-duty trucks and buses. Converts from drums to rotors in less than a minute. Lathe Includes wrenches, silencer bands, boring bars, twin cutter, safety shield and work lamp. Order the adapter kit to fit your needs. See page 200. *Specs.: spindle speeds 100, 150, 200 rpm; rotor dia. up to 14.5" with 906936 cross feed extension 19.5"; drum dia. 6" to 28"; max. drum depth 9.875"; max. rotor thickness 4"; 115V, 60 Hz, 1 ph, fused at 20A. Motor 1 hp.*

Order No.	Mfr. No.	Description	Ship Wt.
03126	4000E	Brake Lathe Less Standard Adapters	365 lbs. - 165 kg
03452	2500	Optional Bench	162 lbs. - 73 kg
03469	6914-10	Brake Bits 10 Pack	1 lbs. - 1 kg

AMMCO 4000B-SP Medium-Duty Drum/Disc Lathe

- Order the adapter kit to fit your needs— See Page 200
- Positive rake tool pits for precision turning



Machines drums and rotors on most passenger cars, light trucks and buses. Converts from drums to rotors in less than 30 seconds. Lathe Includes: wrenches, silencer bands, boring bars, twin cutter, safety shield and work lamp. Order the adapter kit to fit your needs. See page 200. *Specs.: Spindle speed 100 rpm; rotor dia. up to 14 1/2"; rotor width up to 1.875"; drum dia. 6" to 28"; max. drum depth 6.875"; 115 VAC, 60 Hz, 1 ph, fused at 20A. Motor 1 hp.*

Order No.	Mfr. No.	Description	Ship Wt.
03107	4000B-SP	Brake Lathe Less Standard Adapters	385 lbs. - 172 kg
03452	2500	Optional Bench	162 lbs. - 73 kg

AMMCO 4000B Drum/Disc Lathe

- Order the adapter kit to fit your needs – See Page 200
- Resurfaces both sides of the rotor at the same time
- Spindle speeds

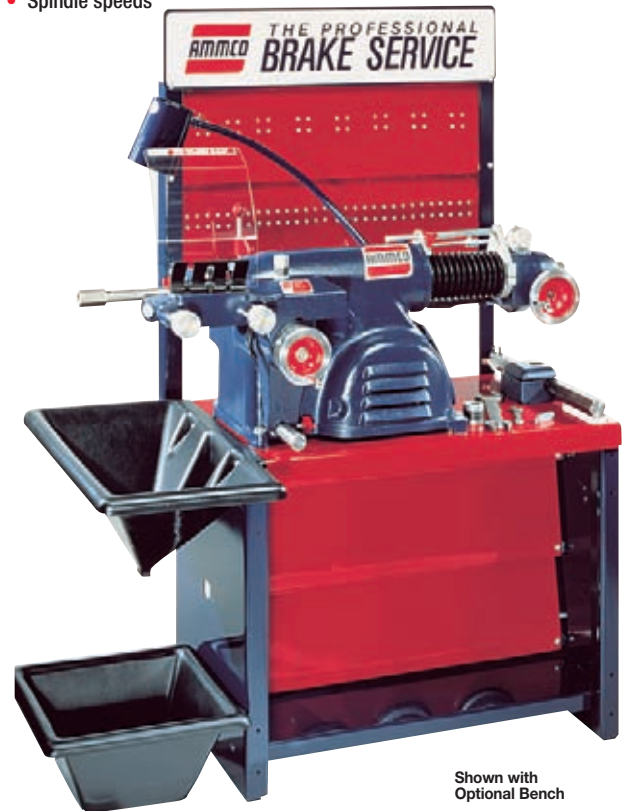

Rigid 44 lb. spindle for precision and durability. Converts from drums to rotors in less than 30 seconds. Lathe Includes: wrenches, silencer bands, boring bars, twin cutter, safety shield and work lamp. Order the adapter kit to fit your needs. See page 200. *Specs.: Spindle speeds 90, 115, 150 rpm; rotor dia. up to 13" with 6900 twin cutter, up to 17.4687" with 6900 and optl. 6936 cross feed extension, up to 22" with optl. 7900 twin cutter; rotor width up to 1.69" with 6900 twin cutter, up to 4" with optl. 7900 twin cutter; drum dia. 6" to 28"; max. drum depth 6.75"; 115 VAC, 60 Hz, 1 ph, fused at 20A. Motor 1 hp.*

Order No.	Mfr. No.	Description	Ship Wt.
03366	4000B	Brake Lathe Less Standard Adapters	365 lbs. - 165 kg
03452	2500	Optional Bench	162 lbs. - 73 kg
03469	6914-10	Brake Bits 10 Pack	1 lbs. - 1 kg

AMMCO 41412 Double Chuck

- Easier & faster for chuck-mounting hubless drums & rotors
- Fits any 1" arbor brake lathe



1" ID Double Chuck Adapter Set range 2.125" - 5.750" (53.98mm - 146.05mm), hubless rotors and drums through 1-ton vehicles, double chuck, 4 backing plates, chuck key, and instructions.

03495 Includes 9232 double taper adapter kit, 9233 truck double taper adapter kit, 3125 spacer, 9492 self-aligning, 9310 Adaptek, auto and light truck, 9313 Adaptek, truck through 1-ton. Includes Ammco Double Chuck simplifying rotor and drum machining.

Order No.	Mfr. No.	Description	Ship Wt.
03508	41412	Double-Chuck	33 lbs. - 15 kg
03495	900006E	Hub & Hubless Cars & Lt. Trk. Thru 1-Ton (Std. & Composite)	

AMMCO Brake Lathe Adapter Kits

- Must order with the lathes on page 198 & 199
- Order only the kit required for the application
- Order the 90003C adapter kit for the widest coverage

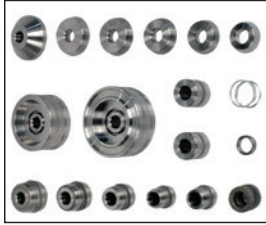

03370

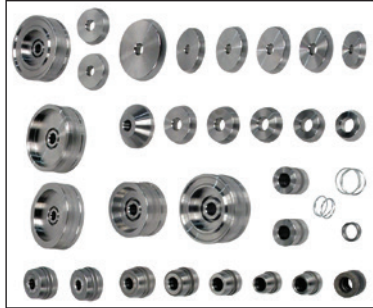

03374

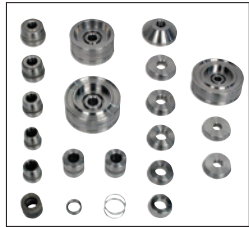

03372

Adapters allow superior micro finish on most drums and rotors, hub and hubless including composite. The self-centering and extra mass provide better results with less chatter. Use on many flywheels.

- A Kit 03370** Includes 9232 double taper adapter kit, 3125 spacer, 9492 self-aligning and 9311 Adaptek, auto
- B Kit 03372** Includes 9232 double taper adapter kit, 3125 spacer, 9492 self-aligning and 9310 Adaptek, auto and light truck through ½ ton.
- C Kit 03374** Includes 9232 double taper adapter kit, 9233 truck double taper adapter kit, 3125 spacer, 9492 self-aligning, 9310 Adaptek, auto and light truck, 9313 Adaptek, truck through 1 ton.
- D Kit 03357** Basic Kit shipped if no other kit is specified
- F Kit 03363** See full description below

Order No.	Mfr. No.	Description
03370	900001A	Hub & Hubless Cars (Std. & Composite)
03372	900002B	Hub & Hubless Cars & Lt. Trk. Thru ½-Ton (Std. & Composite)
03374	900003C	Hub & Hubless Cars & Lt. Trk. Thru 1-Ton (Std. & Composite)
03357	900004D	Hub & Hubless Cars & Lt. Trk. Thru ½-Ton (Std. Only)
03363	900007F	See Full Description Below

AMMCO "F" Brake Lathe Adapter Kit

- Offers the most complete coverage

Includes 9232 double taper adapter kit, 9233 truck double taper adapter kit, 3125 spacer, 9492 self-aligning, through 1 ton. Includes Ammco Double Chuck simplifying rotor and drum machining. The crossfeed extension increases rotor diameter capacity by up to 5". Also includes light truck adapters for splined rotors.



Order No.	Mfr. No.	Description
03363	900007F	F Brake Lathe Adapter Kit

Brake Cleaners See Page 223



AMMCO 9708 11/16" Arbor Set

- Fits models 3000, 4000, 4100, 7000 & 7700 lathes

For splined hubbed rotors and drums with center holes under 1" inside diameter. Set includes 11/16" arbor, arbor nut, self aligning washer set, 1/2" spacer, two 1" spacers and centering cone.

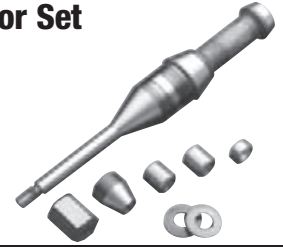

Order No.	Mfr. No.	Description	Ship Wt.
03458	9708	11/16" Arbor Set	8 lbs. - 4 kg

Quick Chuck Brake Lathe Adapter

- Eliminates multiple adapters
- 75% Less set-up time
- Fits any 1" arbor brake lathe

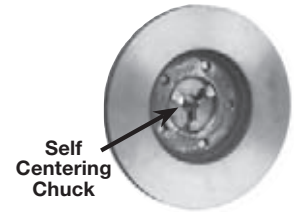

Self Centering Chuck

The adapter features expandable jaws for up to a 3 1/2" hole, a standard plate and key. The expanding, self-centering jaws to mount most foreign and domestic, hubless and composite rotors and drums. The adjustable jaws eliminate multiple fixed sized adapters. Self-Centering chuck locks the rotor/drum absolutely straight, reducing chatter allowing an accurate micro finish.



03302 Quick Chuck Adapter



03305



03306



03304



03279

Optional Large Jaws and Plate for ¾ and 1-ton pick up trucks. Fits hubless rotor and drums with centering holes from 3 3/4" to 5 3/4". Optional Small Plate is for use with small hubless rotors and drums. Optional Toyota Plate is for use on Toyota 4 WD hubless rotors. Use with optional Large Jaw Set.

Order No.	Mfr. No.	Description	Ship Wt.
03302	70040	Quick Chuck Adapter	16 lbs. - 8 kg
03304	70047	Optional Small Plate	4 lbs. - 2 kg
03305	70041	Optional Large Jaws	3 lbs. - 2 kg
03306	70046	Optional Large Plate	7 lbs. - 4 kg
03279	70054	Optional Toyota Plate	6 lbs. - 3 kg

AMMCO Truck Brake Lathe Adapter

- ¾ & 1-Ton lathe adapter

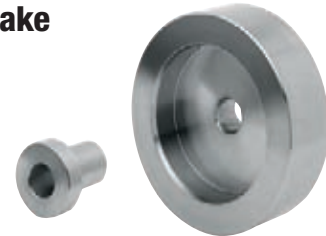

Mounts ¾ and 1-ton 4x4 Dodge and Chevy truck spline rotors on any 1" arbor brake lathe. The E.Z. Adapter allows spline rotors to be turned instead of replaced.

Order No.	Mfr. No.	Description	Ship Wt.
03307	940928	Truck Brake Lathe Adapter	15 lbs. - 8 kg

Replacement Swirl Grinder Pads

Replacement abrasive pads for the Ammco 8750 swirl grinder. Six, 120 grit abrasive pads per package.



Order No.	Mfr. No.	Description
03471	8756-6	Replacement Pads Pkg. 6

AMMCO Brake Shop Accessories



03390
03392

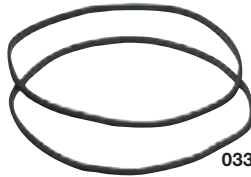

03399



03396



03397



03567

Order No.	Mfr. No.	Description	Per Pack
03390	5280	1¾" Drum Silencer Band (Extra-Long, Premium Grade Rubber Silencer Band for Auto Drums)	1
03392	5290	2¾" Drum Silencer Band (Extra-Long, Premium Grade Rubber Silencer Band for Wider Truck Drums)	1
03396	6920	Ventilated Rotor Silencer Band (Easily Wraps Around Ventilated Rotors to Dampen Machining Vibrations) Premium Grade Rubber w/ 7 Lead Weights.	1
03567	9800	Ventilated Rotor Spring Silencer Assembly – Greatly Increases Life Compared to Rubber Silencer Bands	1
03397	6921	6½" Solid Rotor Silencer Band (for Thin, Solid Rotors)	2
03399	6922	9" Solid Rotor Silencer Band (for Thin, Solid Rotors)	2

Brake Rotor Chatter Silencers

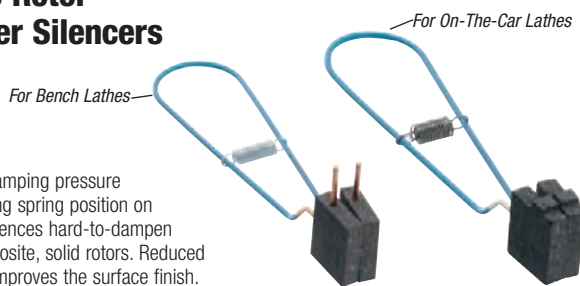

Adjusts clamping pressure by changing spring position on handle. Silences hard-to-dampen thin, composite, solid rotors. Reduced vibration improves the surface finish.

Order No.	Description
03160	Clamp Silencer – Bench Lathe
03257	Clamp Silencer – On-The-Car Lathe

Round Carbide Bits

- Cuts rotors 5 times faster
- One fast cut allows a higher rate of speed to turn rotors resulting in a smoother finish



03358



03359

Save time and money. Eliminates the need for a slow cut when machining rotors. Finish cut rotors in less than 2 minutes. The round cutting tips produce a superior finish and help eliminate costly reworks. Fits Ammco and most Hoffman lathes.

Order No.	Mfr. No.	Description	Per Pack
03358	CT1192	Round Bit w/ Tool Holder	2
03359	CT10	Round Replacement Bit	10
03276	MIS ^o	Screw for Round Bits	

Replacement Brake Bits

AMMCO

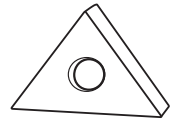

For Ammco 1000, 1001, 3000, 4000, 4100, 6900, 7000, and 7700 disc rotor lathes. 700, 705 and 710 On-The-Car lathes. Triangular carbide bit with twelve cutting edges by indexing the bit. Also fits RELS BC 500, BRC 550.

Order No.	Ref. No.	Description	Per Pack
03469	6914-10	For all Ammco Negative Rake	10
03470	6918-6	For Ammco 3850 Positive Rake	6

JBC (FMC)

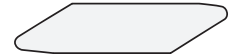

For JBC 600 and 601 lathes. Right and left hand tool holders. Triangular carbide bit with three cutting edges.

03164

Order No.	Ref. No.	Description	Per Pack
03141	JBC 90488	600, 601, 67	10
03164	JBC 92091	Drum Bit 800, 87	10
03168	VNE866561	RTR Bits	10

ACCU-TURN

For Accu-Turn disc/drum lathes. Positive rake triangular carbide bit with three cutting edges. The On-The-Car replacement brake bits are triangular carbide with twelve cutting edges by indexing the bit.

Order No.	Ref. No.	Description	Per Pack
03472	433796	Bits for Accu-Turn Disc Drum Lathes	10
03469	878051	Bits for Accu-Turn On-The-Car Lathe	10

HUNTER

For Hunter BL500, BL505, BL300 lathes. Triangular carbide bit with 12 cutting edges by indexing the bit.

Order No.	Ref. No.	Description	Per Pack
03696	221-580	Negative Rake .030	10
03697	221-640	Positive Rake .015	10
03698	221-538	Positive Rake .030	10
03699	221-626-3	For OCL 360 Lathe	10

KWIK-WAY, LINE-O-TRONICS, SNAP-ON & ROTUNDA

For Kwik-Way NDL, BCL, CBL, SDL, older model DL, 108-005-04 On-The-Car and 850 disc brake attachment. Triangular carbide bit with three cutting edges by rotating the bit.

Order No.	Ref. No.	Description	Per Pack
03597	109-1092-23	For 102 Combo Lathe & On-The-Car	10
03693	109-1092-32	For 104 Lightning Lathe	10

PRO-CUT

VGB, Procut & VGB On-The-car Lathe. Triangular carbide bit positive rake.

Order No.	Ref. No.	Description	Per Pack
03123	50742	Aftermarket Pro-Cut Silver	10
59613	50742	O.E. Pro-Cut Brake Bit	10

AMMCO Disc Rotor Silencer

- For solid rotors on models 3850, 4000, 4100 & 7000

Virtually eliminates ringing vibrations during machining. Adjustable and replaceable pads are made of tough friction material. The heavy wheel on which each pad snaps provides necessary mass to prevent vibration from developing.

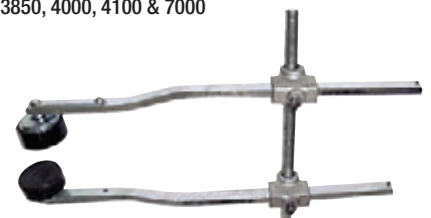

Order No.	Mfr. No.	Description	Ship Wt.
03398	7075	Disc Rotor Silencer	8 lbs. - 4 kg
03410	9183	Replacement Pads (Set Of 2)	1 lbs. - 1 kg

PRO-CUT On-the-Car Brake Lathe

- Onboard computer measures & compensates for lateral runout automatically
- One-Pass cut
- 1 HP motor delivers high start-up torque
- Heavy-Duty adapters set-up fast & are easy to identify
- 5 & 7 Adapter packages available



59614



59615

Five character LED displays run-out. Operating and efficiency data is captured and reviewed by a factory representative at 6 and 12 months to show profitability and possible service needs. Shows run-out in 1/10,000".

#59614 5-Adapter Package includes the Pro-Cut Lathe; 4-hole adapter; 5-hole adapter; GM/Dakota adapter; 4x4 adapter with 5, 6, 7, & 8 lug patterns fitting most trucks up to 1-ton; 2003/04 Ford Expedition & 2004 & later F150 adapter.

#59615 7-Adapter Package includes the above 5 adapters plus a heavy-duty Ford adapter & a Dual Wheel Pick Up adapter.

Order No.	Mfr. No.	Description
59614	9.2 DRO	Lathe w/ 5 adapter package
59615	9.2 DRO	Lathe w/7 adapter package
59608	50687	4-Hole Adapter Fits 4-Lug Except Certain Subaru's (See 59610)
59609	50688	5-hole adapter fits 5-lug vehicles. Most 5-lug cars, except full size & a few light trucks can be machined using this adapter
59604	50695	GM/Dakota adapter has 5-lug patterns for large cars & small 5-lug trucks & the 6-lug Dodge Dakota pattern
59610	50691	4x4 adapter 5, 6, 7, & 8-lug patterns fit most trucks up to 1-ton. On some vehicles the 30-791 spacer must be used with this adapter. Dual wheel trucks & larger Ford trucks require optional adapters (59607, 59606 below) Includes Subaru "4 on 140mm" pattern
59605	50694	2003 /2004 Ford Expedition, 2004 & later F150 adapter, specifically designed for the 2003 Ford Expedition. Pro-Cut cannot be used on this vehicle without this adapter.
59607	50683	Heavy-duty Ford adapter for machining many 8-lug Ford trucks & vans over 8,500 lbs. gross vehicle weight
59606	50935	Dual wheel pick up adapter for machining front rotors on dual wheel trucks. Dual wheel Fords require a cutting head extension.
59613	50742	50-472 Bits Pkg. Of 10
59602	50703	50-703 Disc Silencer
59603	50754	50-754 Thick Disc Silencer

MITYVAC Vacuum Brake Bleed Kit

- 1.9 Quart capacity
- Bleeds up to 2 quarts per minute

Variable control thumb throttle controls flow rate. Features a hanging hook, and large coarse threads reducing the chance of cross-threading. Automatic shutoff valve prevents overfilling. Includes clamp-on auto-refill kit for automatically refilling master cylinder, 6' bleed hose, 4' evacuation hose, (3) universal screw adapters, and user manual.



Order No.	Mfr. No.	Description	Ship Wt.
03684	MV6835	Vacuum Brake Bleed Kit	5 lbs. - 3 kg

HOFMANN 401 TrueCut Drum/ Disc Lathe

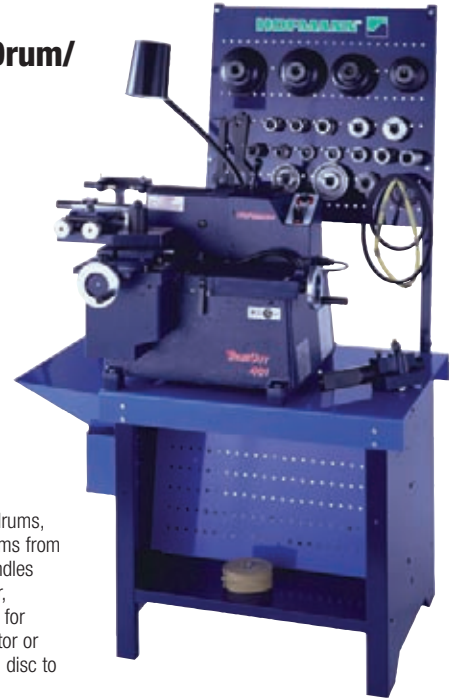

For auto & truck rotors, drums, & flywheels. Handles drums from 5" - 30" in diameter. Handles rotors up to 30" diameter, 3" width. 4 Arbor speeds for smallest sub-compact rotor or truck drum. Change from disc to drum tools in seconds.

Order No.	Mfr. No.	Description	Ship Wt.
59833	401	Combo Lathe	420 lbs. - 191 kg

VACULA Vacuum Brake Bleeder

- One-Person brake bleeder
- Safe for standard & ABS brake systems



Allows one person to remove old fluid from the system while refilling the cylinder with clean fluid. Features nickel-plated head component, 10' hose with universal adapter and the universal refiller that eliminates master cylinder adapters. Dual safety design prevents over-pressure in the canister. Safe for standard and ABS systems. Universal seal allows use with all types of brake fluids. *Specs.: working pressure 79 to 174 psi; max. air cons. 4.6 cfm @ 87 psi; 1/4" fpt, canister volume 2.6 qts.; hose length 8.8'; temp. range -4°F to 104°F.*

Order No.	Mfr. No.	Description	Ship Wt.
03147	DX2.5	Brake Bleeder with Auto Refiller Bottle	5 lbs. - 3 kg

Brake Cleaners See Page 223



STRIP DIP

- A 30 second test provides visual proof of fluid contamination
- For DOT 3, 4, 5 & 5.1 brake fluids



Measures the loss of corrosion inhibitors in brake fluid occurring over time. Dip the strip into the brake fluid reservoir and within 30 seconds the test portion of the strip changes color. If the color corresponds to the 75 high color purple to dark purple, the fluid is contaminated and the system should be flushed and replaced with new fluid.

Order No.	Description	Per Box
03000	Brake Fluid Test Strips	100

AMMCO Brake Drum Micrometers

Measures drums on or off the lathe. Checks out-of-roundness and diameter. For drum diameters to 16 $\frac{1}{4}$ " Scale graduation in .005 increments. Metric Brake Drum Micrometer is graduated by 0.1 mm and has a range of 152.4 to 406.575 mm.



Order No.	Mfr. No.	Description	Ship Wt.
03405	8500	Brake Drum Micrometer Standard	5 lbs. - 3 kg
03496	8500-50	Brake Drum Micrometer Metric	5 lbs. - 3 kg

Brake Drum Wear Limit Gauge



Mechanical gauge measures all brake drums. Range includes 6-22" and 150-560 mm. Measuring depth of 3 inches. Pointed anvils measure scores and bell mouth. Graduations of $\frac{1}{2}$ " and 1 mm.

Order No.	Mfr. No.	Description	Ship Wt.
03343	6478	Brake Drum Wear Limit Gauge	4 lbs. - 2 kg

Disc Brake Lining Wear Gauge

Measures brake lining remaining on bonded pads in fractions from $\frac{1}{16}$ " to $\frac{5}{8}$ " in $\frac{1}{32}$ " graduations without removing the caliper.



Order No.	Mfr. No.	Description
00476	2116	Disc Brake Lining Wear Gauge

Digital Brake Drum Gauges

- Use to meet inspection requirements of Federal Highway Administration Reg.49CFR part 396



Quickly and accurately measure brake drums on all cars and trucks. The pointed anvils allow for accurate measurement of scored drums. Digital read-out, powered by a standard SR44 battery. Complete with calibration gauge and adjusting tools.

Order No.	Mfr. No.	Measuring Std Metric	Arm Depth Std Metric	Ship Wt.
03428	6469A	6-14.350"	150-365 mm	3.250" 82 mm 2 lbs. - 1 kg
03429	6469SA	6-16.650"	150-425 mm	4.250" 108 mm 2 lbs. - 1 kg

Digital Rotor/ Ball Joint Gauge



Accurately measure rotor and ball joint wear. Inch and metric readout with measuring range of 0-5.000"/0-125 mm. Pointed anvils allow precise measurement of ball joint wear with 3.25" deep measuring arms. Easy-to-use and self-calibrating.

Order No.	Mfr. No.	Description	Ship Wt.
03344	6479A	Rotor/Ball Joint Gauge	2 lbs. - 1 kg

Digital Disc Rotor Micrometer

- Meets mandated motor vehicle inspection standards

Measures all highway vehicle brake rotor thicknesses, in inches or metric, from 0-2.25" and 0-58 mm. Throat depth of 3.25" (82 mm) and pointed anvil on one side to measure score depth.



Order No.	Mfr. No.	Description	Ship Wt.
03427	6459A	Digital Disc Rotor Micrometer	2 lbs. - 1 kg

Disc Rotor Ball Joint Gauge

Check ball joint wear and disc rotor run out, gear backlash, valve guide wear, camshaft wear. Range of 1" or 25 mm. Mounts directly on spindle, eliminating vibration problems and false readings.



Order No.	Mfr. No.	Description	Range	Ship Wt.
03337	6450	Rotor/Ball Joint Gauge	1"	4 lbs. - 2 kg
03338	6451	Metric Rotor/Ball Joint Gauge	25mm	4 lbs. - 2 kg

Brake Lining Gauge

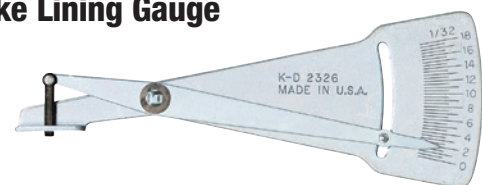

Measures the amount of lining remaining on riveted drum shoes and disc brake pads. Measures tire tread depth up to $\frac{9}{16}$ " in $\frac{1}{64}$ " graduations.

Order No.	Mfr. No.	Description
00617	2326	Brake Lining Gauge

Headlight Aligners

LIGHTRITE Headlight Restoration Kit

- Headlight Restoration & repair coating
- Improves driver night vision
- One time application - lifetime warranty



89314 Optional Hand Held UV Curing Wand

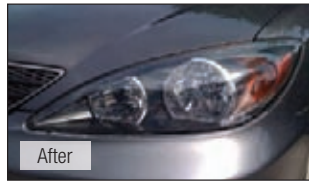
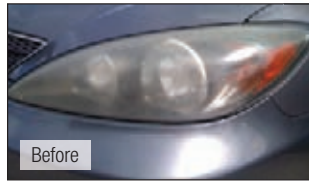

Exposure to the elements over time effects the polycarbonate lens making them cloudy and faded and reduces headlight effectiveness. LightRite has completed testing (SAE J2527 2004-02) at Q-Labs, the primary independent lab used by the automotive industry to test products for weathering. The test results prove the long term effectiveness of LightRite. The optional hand held UV cure light with a protective shade cures in 1 to 2 minutes per lens. Each kit includes an aerosol can /services 1 vehicle, (2) each sheets of 600 grit wet sandpaper, alcohol towelettes, & lint free towels, instruction sheet, warranty card, latex gloves and instructions.

Order No.	Mfr. No.	Description
89313	LRK-300	Headlight Restoration Kit
89314	LR-UV	Optional Hand Held UV Curing Wand

SYMTECH CVA 3EZ Headlight Aligner

- Mid-Level headlight aligner for all regulated states



Includes "visual assist" meter indicating when the meter reading reaches the highest level to complete the alignment. ISO color technology indicates where to center high intensity zone. Ideal for certified safety inspection centers needing to replace mechanical aligners.

Order No.	Mfr. No.	Description	Ship Wt.
03848	CVA 3EZ	Headlight Aligner	60 lbs. - 28 kg

HOPPY Vision 100 Headlight Aligner

- Aligns all types of headlamps & approved in all states.
- Three step aiming process



LCD scrolling display provides step-by-step instructions. Laser technology accurately aligns the aimer to the vehicle eliminating mirrors or visors. Photo sensor quickly locates the lamp center. Includes floor slope transit, charger, and alignment track.

Order No.	Mfr. No.	Description	Ship Wt.
03046	82005	Vision 100 Headlight Aligner	97 lbs. - 44 kg
03051	82057	Dust Cover	4 lbs. - 2 kg

SYMTECH HBA 5 Headlight Aligner

- Aligns all types of headlights
- Portable multi-bay usage
- Entry level headlight aligner for all regulated states



Measure and adjust for floor slope. Align the horizontal line in the mirror across any two common points on the front of the vehicle. Red arrows direct the technician in moving the optical head. A green light indicates perfect alignment. The light meter measures lamp intensity in kilo candles. Optional Tool Kit includes GM, Ford, and general headlight adjuster tools.

Order No.	Mfr. No.	Description	Ship Wt.
03020	HBA 5	Headlight Aligner	82 lbs. - 37 kg
03025	Tool Kit	Aiming Tools	1 lbs. - 1 kg

SYMTECH SCA 1 Headlight Aligner

- Entry level headlight aligner for all regulated states



ISO color technology indicates where to center high intensity zone. Ideal for certified safety inspection centers needing to replace mechanical aligners.

Order No.	Mfr. No.	Description	Ship Wt.
03847	SCA1	Headlight Aligner	50 lbs. - 23 kg

Super Mutt Deluxe

- Trailer tester for lights & air brakes
- Diagnostic one man testing operation
- Remote control allows air brake actuation at each axle
- Places a load on the electrical circuits to identify wiring problems



Operates air brakes by remote control up to 100' operating range. Repetitive brake activation finds developing problems and verifies leaking servo cans. Power lights individually or all at once via auto scan or remote control. Differentiates between wire and chassis ground failure and identifies open and cross-wired circuits. Includes (3) remote controls, 5' 7-way cable, chassis ground cable, external battery connector, 6' glad hands, 3A battery charger, face shield and rain cover. Specs.: power 12V DC, air input 120 psi; power input Group 31 or similar battery or external 12V power source; output 20 amps at 12V DC; connection type 7-way round pin; controls manual, remote and automatic.

Order No.	Description	Ship Wt.
03825	Super Mutt Deluxe	40 lbs. - 18 kg

MIDTRONICS MDX-P300 Battery & Electrical Tester

- Tests 12V batteries from 100 - 1400 CCA, including AGM & Gel.
- Integrated printer



Program shop information into the print-header. Displays voltage, measured CCA, battery, starting, and charging condition. Features voltmeter mode plus high and low voltage memory for starter/alternator testing. Recall last test on screen or print to built-in printer.

Order No.	Mfr. No.	Description
04349	MDX-P300	Battery & Electrical Tester

MIDTRONICS EXP-800 Battery & Electrical System Analyzer

- Tests 6V & 12V batteries and 12V & 24V charging systems from 100 – 3000 CCA
- Integrated printer & 4' cable set

Program shop information into the print-header plus optional coupon at the bottom of the print-out. The analyzer incorporates temperature measurement with deep-scan technology improving accuracy across a wider range of batteries. Displays voltage, measured CCA, battery, starting, and charging condition. Diode-ripple is included in the charging test and allows independent voltmeter mode. SD memory card allows record keeping, data transfer, and updates. Recall last test onscreen or print to built-in printer.



Order No.	Mfr. No.	Description
04350	EXP-800	Battery & Electrical System Analyzer

MIDTRONICS EXP-1000-HD-AMP Fleet Battery & Electrical Tester

- For heavy-duty & commercial fleet market
- Multiple battery routines & commercial battery algorithms for Group 31 & 4D to 8D batteries
- Separate truck & automotive test selections

Incorporates temperature measurement with deep-scan technology to improve accuracy. Displays voltage, measured CCA, battery, starting and charging condition and features a full digital multi-meter with scope and infrared temperature readings. Cable-drop test calculates the voltage drop across the negative and positive sides of any circuit and total circuit drop without running the engine. SD-memory card allows software updates. Includes heavy-duty clamps, amp clamp, DMM cable assembly, adapter, probe kit and case.



Order No.	Mfr. No.	Description
04354	EXP-1000-HD-Amp	Fleet Battery & Electrical Tester

OTC 3131 MinuteMan Plus Multi-Purpose Electrical System Checker

- Tests alternators, regulators & starters
- Tests all 12 volt batteries
- 100 – 1,500 cold cranking amp rating
- Performs accurate carbon pile testing electronically



Evaluates dead or charged batteries in one minute. No charging before testing. Direct-from-battery tachometer provides rpm readings without hookups to the ignition system. Includes ammeter/voltmeter capabilities. Internal battery makes it ideal for use on service trucks. Displays cranking amps and volts, indicates either "Good" or "Bad" starter. Includes roll-around cart.

Order No.	Mfr. No.	Description	Ship Wt.
04654	3131	Electrical Systems Tester with Cart	71 lbs. - 32 kg

ASSOCIATED 6033 Amp Load Tester

- Displays CCA minimum & maximum & current voltage



Kelvin connected digital meter displays battery voltage, maximum and minimum voltage reading and CCA of the battery. Load test time varies with the battery for a shorter testing time. Made in USA. 300A clamps, voltmeter 7-19 volts DC, load 125A. 1-year warranty.

Order No.	Mfr. No.	Description	Ship Wt.
03667	6033	Amp Load Tester	4 lbs. - 2 kg

MIDTRONICS GR8-1200 Battery & Electrical Diagnostic Unit

- Combines battery, electric testing & charging functions in one diagnostic station
- DMM function for advanced diagnostics & cable drop testing



Charge one battery while diagnosing batteries and electrical systems on other vehicles. The GR8-1200 provides intelligent, controlled and rapid charging combined with battery state-of-health analysis. The contoured rolling cart with detachable controller and integrated printer deliver maximum flexibility. Includes integrated printer, amp clamp and quick connect testing and charging cables.

Order No.	Mfr. No.	Description
04360	GR8-1200	Electrical Diagnostic Unit

ASSOCIATED 6012 Professional Fast Battery Charger

- 6/12 Volt

UL and CSA tested safe for indoor and outdoor use, "Safe In Any Weather". High cranking assist of 250 amps to better start vehicles and offers a UL continuous rating of 70/60 amps for peak performance. Features a timer and 400-amp fully insulated clamps on twin extruded DC leads, for tangle-free operation. *Specs.: UL cranking assist rating 250A; 6 1/2" D.C. Leads 6 1/2 AWG; clamp rating 400A; mfgs. boost rating 500A; UL continuous ratings 70/60 amp.*



Order No.	Mfr. No.	Description	Ship Wt.
03710	6012	Professional Fast Battery Charger	48 lbs. - 22 kg

ASSOCIATED US18 Fast Battery Charger

- 6/12 Volt charger for small shops
- Rated "Safe In Any Weather"

UL and CSA listed for indoor and outdoor use. Fan cooling prevents overheating. *Specs.: UL cranking assist rating 200 amp; clamp rating 400A; mfgs. boost rating 330A; UL continuous ratings 40 amp.*



Order No.	Mfr. No.	Description	Ship Wt.
03704	US18	Battery Charger	35 lbs. - 16 kg

ASSOCIATED 9425 Bench Battery Charger

- For AGM, Gel cell, sealed & standard flooded batteries including spiral cell, Orbital, or Optima batteries
- 20 Amp/25 Amp Peak

Electrical Stability System (ESS) technology makes it a stable power supply for extended service procedures. Nominal 13.7V DC output. Charges all types of 12V batteries.. Program for deep discharge recovery of flooded batteries. Diagnostics indicate weak or defective batteries. Made in USA. *Specs.: 20A DC output.*



Order No.	Mfr. No.	Description	Ship Wt.
03664	9425	Bench Battery Charger	21 lbs. - 10 kg

OTC Battery Replacement Reset Procedures Manual



All the essential information for battery service in one manual. Includes battery access and service locations, disconnection precautions, power window, locks and sunroof procedures, convenience accessory programming procedures, restraint and ABS system precautions, and engine & body control system resetting. Available in printed or CD formats

Order No.	Mfr. No.	Description
03702	3220	Battery Repl. Reset Procedures Manual Book
03703	3220CD	Battery Repl. Reset Procedures Manual CD Format

ASSOCIATED 6007A Battery Charger/Analyzer

- 40 Amp/130 Amp

Electrical Stability System (ESS) technology makes it a stable power supply for extended service procedures. Nominal 13.7V DC output. Charges all types of 12V batteries. UL tested "Safe In Any Weather". Program for deep discharge recovery of flooded batteries. Diagnostics indicate weak or defective batteries. Made in USA.

Specs.: 40A DC output.



Order No.	Mfr. No.	Description	Ship Wt.
03665	6007A	Battery Charger Analyzer	47 lbs. - 22 kg

ASSOCIATED 6021 Charger/Analyzer

- 50 Amp 6/12 volt charger
- All-In-One battery/starter/ alternator charger & tester

Combines a battery charger with a starter/ alternator tester. Tests alternator output and starter voltage draw. *Specs.: 50 amp charger; 200 amp crank assist; D.C. leads 6 1/2", 4 AWG; clamp rating 500A; UL indoor/outdoor approved.*



Order No.	Mfr. No.	Description	Ship Wt.
03714	6021	Charger/Analyzer	45 lbs. - 21 kg

ASSOCIATED 6042 Battery & Electrical System Tester

- Voltmeter reads to 99.9 volts DC
- Ammeter reads 999 amps

Diagnose electrical problems fast. Tests systems on 12, 12/24 and 24 volt vehicles. Interprets information received from the charging/starting system and displays it as usable diagnostic information on large, easy-to-read L.E.D. voltmeter and ammeter. Reads +/- amps for diagnosis of current leakage problems. Varnish sealed circuits. Circuits protected against reverse polarity hookup. *Specs.: Load - 1000 amp; Voltmeter - 0-32 DC; Leads - 8', 4 AWG; Clamps - 500A.*



Order No.	Mfr. No.	Description	Ship Wt.
03670	6042	Electrical System Checker	67 lbs. - 30 kg

ASSOCIATED 6044 Battery & Electrical System Tester

- Automatic BCI battery, alternator & starter test

Tests systems on 12, 12/24 and 24 volt vehicles. Easy-to-read LED voltmeter and ammeter. Microprocessor-based control board is protected from reverse connections. Automated 500 amp variable load. Optional stand and printer available.



Order No.	Mfr. No.	Description	Ship Wt.
03661	6044	Automated Electrical System Checker	48 lbs. - 22 kg
03663	6038C	Optional Cart	

ASSOCIATED 6006 Heavy-Duty Fast Battery Charger

- 6/12/24 Volt
- UL, cUL, &/or CSA listed for indoor & outdoor use

Cranking assist rating of 280 amps. Features AC and DC circuit overload protection. For standard and maintenance-free 6, 12, and 24 volt batteries with five charging positions. Equipped with a heavy-duty transformer. *Specs.: UL cranking assist rating 280A; 7' D.C. Leads 4 AWG clamp rating - 500A; mfgs. boost rating 600A; UL continuous ratings 75/65/30 amp.*



Order No.	Mfr. No.	Description	Ship Wt.
03669	6006	Heavy-Duty Fast Battery Charger	60 lbs. - 27 kg

ASSOCIATED 6002B Commercial Battery Charger

- 6/12/18/24 Volt
- Automatic timer

80 Amp continuous charge with 400 amp crank assist at 12 volts. Automatic reset for AC and DC circuit breakers. Charges 6, 12, 18, and 24 volt batteries. UL listed for indoor and outdoor use, "Safe In Any Weather" *Specs.: UL cranking assist rating 400A; D.C. leads 8', 4 AWG; clamp rating 500A; mfgs. boost rating 725A; UL continuous ratings 100/80/50/40 amp.*



Order No.	Mfr. No.	Description	Ship Wt.
03709	6002B	Heavy-Duty Commercial Battery Charger	70 lbs. - 32 kg

12/24 Volt Jump-Starter

- For truck service facilities
- Delivers 1400 CCA in 12 volt mode
- Delivers 800 CCA in 24 volt mode

The dual battery unit's large reserve capacity easily starts semi-trucks or dual battery equipment. Built-in charger and automatic reset circuit breaker on the AC input and DC output. 10' Jumper cables are 1/0 gauge cable. Easily switches from 12V to 24V by repositioning identifying "plug". Replaceable maintenance free sealed battery. Rugged polyethylene 1/4" case.



Order No.	Mfr. No.	Description	Ship Wt.
03733	1224	Truck Jump Starter	180 lbs. - 82 kg

Battery Water Jug

Made of rugged polyethylene. Over 2 qt. capacity. Ideal for dry charge batteries.



Order No.	Mfr. No.	Description	Ship Wt.
03707	75-030	Battery Water Jug	2 lbs. - 1 kg

Jump-N-Carry Pro 660

- 660 Amps of portable starting power
- 1,700 Peak amps
- 46", #4 Gauge cables



Works with any 12V starting system. 500 Discharge/ Recharge cycles based on 10 jump starts between recharging. Recharge the internal battery by plugging into any extension cord. Maintenance-free battery stores in any position without leakage. 660 amp battery grips fit side and top post batteries. Includes Lighter Plug Adapter with 30" cord to recharge the unit in the vehicle or starts a vehicle without opening the hood if a small boost is needed.

Order No.	Mfr. No.	Description	Ship Wt.
03736	PRO660	Jump-N-Carry	22 lbs. - 10 kg
03731	410105	Replacement Battery	16 lbs. - 8 kg

Jump-N-Carry 12/24

- 3,400/1,700 Peak amps
- 46", #2 Gauge cables



Use for any 12/24 volt starting system. The built-in charger for the internal battery can be plugged in for continuous recharging. Easily changes between 12 and 24 volt operation. One-year limited warranty.

Order No.	Mfr. No.	Description	Ship Wt.
03732	12/24	Jump-N-Carry	32 lbs. - 15 kg

OBDII Memory Saver Connector

Preserves vehicle codes and electronic presets while the battery is disconnected. Use in conjunction with a jump starter or 12V power supply. LED confirms a proper connection has been made to the OBDII port.



(Charger not included)

Order No.	Mfr. No.	Description
03729	ESA30	OBDII Memory Saver Connection

Terminal Clamp & Post Cleaner

Fits over battery post for cleaning and shaping. Terminal clamp brush fits inside clamp and removes corrosion.



Order No.	Mfr. No.	Description
03647	BT55	Clamp & Post Cleaner

Battery Carrier

Spring-action handle turns lifting power into battery gripping pressure. Works on all batteries, from motorcycle to boats. Grips battery just below the top lip for good balance.

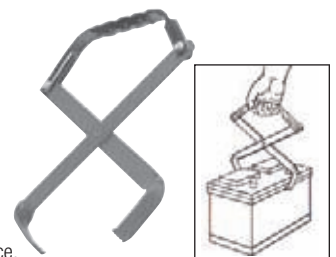

Order No.	Mfr. No.	Description	Ship Wt.
03701	57850	Battery Carrier	2 lbs. - 1 kg

ROBINAIR 34788 R-134a Recovery/Recycle/ Recharging Station

- Meets SAE J-2788 requirement of 95% of refrigerant recovered & recharge to ½ Oz.



Fully automatic function allows the technician to program and walk away without having to operate the panel valves. The vacuum leak test monitors the vacuum level after evacuation and signals possible leaks in the A/C system. Features automatic refrigerant refill, automatic air purge, automatic oil drain and on board oil injection. Includes on-board 30 lb. tank and 1.5 cfm vacuum pump. Optional refrigerant and oil database for North American market vehicles 1994 - 2012. Source tank not included. *Specs: Voltage: 115 volt, 60 Hz; refrigerant container onboard: 30 lb. (14 kg) vessel (source tank not included); operating range: 50 – 120° F (11– 49° C); pump-free air displacement: 1.5 c.f.m. (36 L/minute)*

Order No.	Mfr. No.	Description	Ship Wt.
02965	34788	Recovery/Recycling/Recharging Station	235 lbs. - 107 kg

ROBINAIR 34288 R-134a Recovery/Recycle/ Recharging Station

- Meets SAE J2788
- Semi-Automatic operation recover, evacuate & charge



The unit locates the pressure from the vehicle and proceeds if the pressures are acceptable. Select the refrigerant recharging mode from the low side or low side and high side. Automatic oil drain clearly shows the amount of oil to replace. Includes on-board 30 lb. tank and 1.5 cfm vacuum pump. Source tank not included. *Specs: Voltage: 115 volt, 60 Hz; refrigerant container onboard: 30 lb. (14 kg) vessel (source tank not included); operating range: 50 – 120° F (11– 49° C); pump-free air displacement: 1.5 c.f.m. (36 L/minute)*

Order No.	Mfr. No.	Description	Ship Wt.
02974	34288	Recovery/Recycling/Recharging Station	225 lbs. - 102 kg

ROBINAIR 17800B Multiple Refrigerant Recovery/Recycle/Recharging Station

- For R-12, R-134A, R-22, R-502 MP & HP blends



Float chamber auto-adjusts from liquid to vapor. Electronic scale makes it simple to recharge to specifications and weighs recovered refrigerant. Provides tank overflow protection. Cool-Tech 6 cfm vacuum pump has the capacity to evacuate system, readying for recharge.

Order No.	Mfr. No.	Description	Ship Wt.
02470	17800B	Recovery/Recycling/Recharging Station	360 lbs. - 163 kg

ROBINAIR 34988 Premium AC Recovery/Recycle/ Recharging Station

- Fully compliant with SAE J2788 standards
- Recover, vacuum, leak test, charge & walk away
- Automatic dye inject
- Automatic oil measure & inject



Recovers, recycles, evacuates, leak tests, and recharges R-134a quickly and accurately. Fully-Automatic, program to recover, vacuum, leak test, and charge with no operating panel valves. Gives the user the ability to use the machine to inject UV dye into a vehicle's A/C system. The machine automatically determines how much lubrication oil needs to be injected back into the A/C

system based on how much oil was taken out during recovery. Flushes the vehicle's A/C system with refrigerant, eliminating residual oil or other liquid. (Flushing adapters sold separately) Save and print before and after service. Vacuum leak test monitors level after evacuation. Automatic air purge eliminates damaging air without monitoring gauges or opening valves. Displays refrigerant use and monitors filter life and prompts when 1/3 remains. Optional refrigerant and oil database for North American market vehicles 1994 - 2012. *Specs: Voltage: 115 volt, 60 Hz; refrigerant container onboard: 30 lb. (14 kg) vessel (source tank not included); operating range: 50 – 120° F (11– 49° C); pump-free air displacement: 1.5 c.f.m. (36 L/minute)*

Order No.	Mfr. No.	Description	Ship. Wt.
02999	34988	Premium A/C Recovery/Recycling/Recharging Station	232 lbs. - 105 kg

ROBINAIR 34788H A/C Recover/Recycle/Recharge Machine for Hybrid & Non-Hybrid Vehicles

- One machine to safely service conventional & high voltage A/C systems
- Meets the new refrigerant recovery standards J-2788 for high voltage compressors



Menu selectable function gives the user the ability to clear any residual oil from the A/C recover, recycle and recharge machine's fluid circuit and hoses minimizing risk of oil cross contamination. Automatic air purge and recovery efficiency is 95%. Charge accuracy ± ½ oz. Higher accuracy for today's low volume A/C systems. Flushes the vehicle's A/C system with refrigerant eliminating residual oil. Optional A/C capacities database available. *Specs: Voltage: 115 volt, 60 Hz; refrigerant container onboard: 30 lb. (14 kg) vessel (source tank not included); operating range: 50 – 120° F (11– 49° C); pump-free air displacement: 1.5 c.f.m. (36 L/minute)*

Order No.	Mfr. No.	Description	Ship Wt.
02462	34788H	A/C Recover/Recycle/Recharge Station	255 lbs. - 116 kg

ROBINAIR 16910 Cool-Tech ID Plus

- Identifies refrigerant type & purges damaging air
- Tests R-12, R-134a, & R-22
- Gauge on the panel shows system pressure

Red light indicates failure and a green light passes refrigerant only if it is 98% pure. Features a display showing the actual percentage of R-12, R-134a, R-22 and air in the system or tank. The technician has the option of purging air if a significant concentration is found. Hydrocarbon alarm sounds if flammable substances are detected. An on-board printer port allows connection to a printer for a hard copy of test results.



Order No.	Mfr. No.	Description	Ship Wt.
02992	16910	Cool-Tech ID Plus	2 lbs. - 1 kg

ROBINAIR DiscovR R134a Refrigerant Identifier

- Best defense against unknown refrigerants

Protects expensive A/C recycling equipment and guards against costly repairs. Ensures only 95% "pure" enough R134a refrigerant is leaving and entering the vehicle.



Order No.	Mfr. No.	Description	Ship Wt.
02975	16009	DiscovR Refrigerant Identifier	3 lbs. - 1 kg

ROBINAIR Coolant & Battery Refractometer

- Scale range: 32° F to -60° F.

Used for measuring the freezing point of either propylene or ethylene glycol based cooling systems. Also use for checking the strength of electrolyte solution batteries.



Order No.	Mfr. No.	Description	Ship Wt.
02971	75240	Refractometer	5 lbs. - 3 kg

ROBINAIR Maintenance Kits

Keep recovery and recycling units at peak efficiency. Kits contain a Quick Change Filter-Dryer to be used on both R-12 and R-134A stations and a 16 oz. bottle of Premium High Vacuum Pump Oil.



Order No.	Mfr. No.	Description	Ship Wt.
02472	13172/42140	For 17700A, 17700-2K, 342000, 34234-2K, 34700, 34700-2K, 34788, 34800, 34288, 34800-2K & 34900 Series	3 lbs. - 1 kg
02894	13169/42130	For Early Models Using 34430 Filter-Dryer (17700A & 34700)	3 lbs. - 1 kg

ROBINAIR Filters



For maximum acid and moisture removal

Order No.	Mfr. No.	Description	Ship Wt.
02473	34724	Spin-On Filter for 7700-2K, 34134A, 34134-2K, 34200, 34234, 34300, 34300-2K, 34700, 34700-2K, 34800, 34800-2K, & 34900 Series	5 lbs. - 2 kg
02794	34430	For Older 17700A, 34134Z, 34450 & 34700 Series	5 lbs. - 2 kg

ROBINAIR 16600 Electronic Leak Detector

- For all CFC, HCFC, & HFC refrigerants
- True one-hand operation

The 16" gooseneck probe holds its position for easy operation. Features a sound alarm that increases as the tip nears higher concentrations and an easy-to-read LED display. Eliminates background contamination to pinpoint leaks. Four AA alkaline batteries (included) provide approximately 25 hours of testing.



Order No.	Mfr. No.	Description	Ship Wt.
02998	16600	Electronic Leak Detector	2 lbs. - 1 kg

ROBINAIR 45111 R134a Manifold Hose Kit

- Brass manifold with easy-to-grip handles

R12/R134a gauges with psi and F° temperature display. Rear R134a and 1/2" Acme fittings for holding hoses. 90° Manual couplers. Hoses are 72".



Order No.	Mfr. No.	Description	Ship Wt.
02795	45111	Side-Wheel Manifolds for Automotive Service	2 lbs. - 1 kg

ROBINAIR Service Couplers for Automotive 134a

Field service couplers connect to Enviro-Guard hoses allowing access to service ports on automotive R-134a A/C systems. Integrated safety sleeve to prevent refrigerant loss if the coupler is disconnected under pressure.

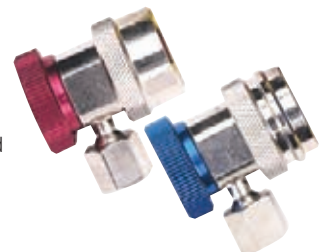

Order No.	Mfr. No.	Description	Ship Wt.
02480	18190A	Blue Actuator Low-Side Manual Coupler	
02482	18191A	Red Actuator High-Side Manual Coupler	

ROBINAIR Premium High Vacuum Pump Oil

Keeps pump operating at peak efficiency. Engineered to maintain maximum viscosity at high running temperatures and to improve cold weather starts.



Order No.	Mfr. No.	Description	Ship Wt.
02848	13203	Vacuum Pump Oil 1 Qt.	2 lbs. - 1 kg

ROBINAIR Vinyl Dust Covers

02474



02475



Protect your investment. Corded seams for durability.

Order No.	Mfr. No.	Description	Ship Wt.
02475	17492	For 17700-2K, 34134Z, 34200, 34711-2K, 34700Z, 34700-2K, AC375, AC375A, 17700Zt, 34788, 34288, 34988, 34788H	6 lbs. - 3 kg
02474	17490	For 34900, 34800-2K & 17800B Series	6 lbs. - 3 kg

NEXT DIMENSION A/C Refresher Service

- Professional strength cleaning
- Two-part bottom up & top down treatment



Dissolves and removes odor causing contaminants deep within the evaporator core and air intake. No dismantling of the A/C system is required. Refresher kit includes 18 ounce Foaming Evaporator Cleaner, 4 ounces A/C Intake Refresher and a plastic hose applicator with a wedge fitting. A case of (10) kits includes a stand up easel sell sheet, a tri-fold pamphlet explaining the service to customers and an instructional DVD.

Order No.	Description
11071	A/C Refresher Service Kit

ROBINAIR Coolant Test Strips

- Test freeze point & boil point
- Test coolant PH

Dip a strip in coolant and it shows the freeze point and the pH. 50 Test Strips per bottle. At 15 seconds after dipping strip, compare freeze point/boil point (end pad) to color chart on bottle. At 30 seconds after dipping strip, compare coolant pH to chart on bottle.



Order No.	Mfr. No.	Description
03288	75134	CoolTrak Coolant Test Strips - 50 Test Strips

BLOCK CHEK Coolant Test Strips

- Universal combustion leak tester
- Tests in seconds for blown head gaskets, cracked head or block, pulled bolts or studs & warped sealing surfaces



Works with almost any liquid-cooled, internal combustion engine or generator with a closed cooling system including gasoline, diesel, propane, natural gas and other alternative fuels. The large single chamber design provides greater accuracy and uses less test fluid. Block Chek can also be used to help diagnose unexplained engine overheating, loss of coolant without visible leaks, white smoke in the exhaust, intermittent check engine lights and poor or rough idling.

Order No.	Mfr. No.	Description
03892	BT-500	Block Chek

Combustion Leak Test Fluid

Fluid changes from Blue to Yellow in the presence of combustion gasses. Works with gasoline, diesel, natural gas, and propane powered engines. Can be used with Block-Chek or other brands of combustion leak testers. Bottle good for approx. 16 tests. Takes the guesswork out of diagnosing head gasket problems. No need to buy separate fluid for different fuel types

Order No.	Description
03893	Replacement Fluid for BT-500 Block Chek - 16 oz.

ROBINAIR 75700 CoolXChange

- 10 Minute cooling exchange
- Works on pressurized & non-pressurized cooling systems
- Two external coolant supply tanks allow on-board storage of two different coolant types



Offers everything needed to remove and replace coolant in a vehicle: drain and fill, and pressure test for leaks. No electricity is needed, requires 80 to 120 psi. No hoses to cut. No additional ventilation is required. The service procedure is performed with the engine off. Make the connections and the 75700 takes over. Impact-resistant cabinet will not scratch or dent vehicles. Graduations on tanks show the amount of new coolant on board. Includes adapter kit and 1 year warranty.

Order No.	Mfr. No.	Description	Ship Wt.
03254	75700	Coolant Exchange Unit	185 lbs. - 84 kg

T-TECH 500 PRO PLUS Transmission Fluid Exchange

- Provides virtually 100% fluid exchange
- Vehicle powered exchange
- Easy hook-up with 23 standard fittings & 12 special fitting kits
- Includes point-of-sale kit



The T-TECH TT500 includes everything needed for quick and easy ATF exchange. Most vehicles can be serviced in 15 minutes or less. The T-TECH exchange is powered by the vehicles transmission pump, eliminating the dangers of over-pressuring the system. For every quart pumped out by the vehicle, a quart of new fluid takes its place ensuring an accurate fill every time. The Auto-Alignment eliminates the need to verify fluid flow direction during initial connection – just hook-up and go. An Auto Bypass feature frees the technician for other tasks during the service. Includes 23 standard fittings, 12 special fitting kits, OEM Service Guide, POP Kit laminated manual and instructional DVD.

Order No.	Mfr. No.	Description	Ship Wt.
04485	TT500	Pro Plus Transmission Fluid Exchange	200 lbs. - 90 kg

VIPER Extreme Clean A/C Sealant Filter System

- Traps impurities & prevents them from entering A/C service equipment
- In-Line system with replaceable filters
- Use with any 134a A/C service center

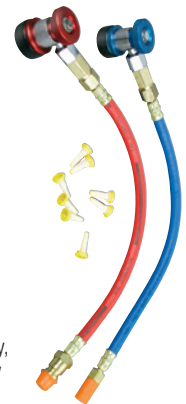

Extreme Clean prevents contaminants from entering the A/C service equipment and plugging solenoids and other small ports or flow areas causing the machine to operate improperly, or in some cases, stop the operation completely. Use with any 134a service center. Visually inspect the filters and replace if contaminated. Kit includes high and low side hoses and 10 filters.

Order No.	Description	Ship Wt.
02317	Extreme Clean Sealant Filter Kit	2 lbs. - 1 kg
02318	Replacement Filters - Package of 10	1 lbs. - 1 kg

REDLINE Smoke Pro Leak Detector

- Pinpoints leaks in sealed systems with standard shop air – no nitrogen required
- Uses common mineral oil (baby oil) – no annual oil change



Smoke Pro injects a low pressure vapor of smoke into sealed systems locating leaks in minutes instead of hours. Finds leaks in EVAP fuel vapor recovery, gaskets, hoses, catalytic converters, manifolds, head and taillight housings, EGR valves, hoses, brake boosters, door and window seals, oil, vacuum exhaust and more. Includes unit with pressure gauge and flow meter, instructional DVD, exhaust cone, EVAP port adapter, inspection light, bottle of mineral oil, and assorted caps and plugs.

Order No.	Mfr. No.	Description	Ship Wt.
03880	95-0001	Smoke Pro Leak Detector	12 lbs. - 6 kg

REDLINE Universal Filler Neck Connector

Connects to any filler neck creating an airtight seal. Connects to EVAP, gas tank, radiator, intake, crankcase and more. Press the connector on the filler neck and start. Works with any diagnostic leak detector on the market.



Order No.	Mfr. No.	Description
03881	95-0011	Universal Filler Neck Connector
03882	95-0017-12	Replacement Sealing Disks for 03881 Pkg. 12

STANT Cooling System Pressure Checker

- Tests up to 30 lb. cooling systems & pressure caps



Test high pressure cooling systems and pressure caps up to 30 lbs. The gauge includes cap testing pressure ranges of 17-19 lbs., 20 lbs., and 28-30 lbs. Large color coded dial is easy to read. Includes plastic carrying case with a 255-9 spacer to drop in 1" deep filler necks, 255-2 cap adapter for 3/4" deep caps, instructions and applications for all Stant adapters.

Order No.	Mfr. No.	Description	Ship Wt.
03648	12270	Cooling System Pressure Tester	5 lbs. - 3 kg
Optional Stant Adapters – Order As Required			
03650	A-450	STANT A-450 Truck Adapter Kit-2 Cap & Radiator Adapters, 7/8" Plug for 2 1/16" O.D. "B" Size Filler Neck	
03653	A-450-3	Kit Includes STANT A450-3 Rubber Gasket & "B" Size Filler Neck Adapter for GM-X Cars w/ 2.5 L & J Cars w/ 1.8L & 2.0L Engines	
03654	12015	Threaded Adapter to Fit Some White & GMC Trucks w/ Threaded Filler Necks. 2 1/2" Threaded Diameter	
03655	12016	Threaded Adapter for Late Model Audi, Porsche, & VW Systems w/ Threaded Filler Necks. M48 x 3 Threads	
03656	12017	Threaded Adapter for Use w/ TA-16 for Late Model Audi, Porsche, & VW Threaded Radiator Caps. M48 x 3 Threads	
03657	12018	Threaded Adapter for All Volvo, Saab & Late Model Renault Systems w/ Threaded Filter Neck on the Expansion Tank. M43.2 x 3 Threads	
03658	12019	Threaded Adapter for Early 80's BMW w/ Threaded Filler Neck on the Expansion Tank. M 52 x 4 Threads	
03659	12021	Cap Adapter Required to Test 45mm O.D. Radiator Caps	

SMARTFIT Universal Cooling Test Kit

- Fits every vehicle
- Eliminates the need to ever buy another adapter
- Includes the Universal Radiator Adapter Kit



Quickly and easily pressure test cooling systems in all vehicles. Works on all passenger and light truck vehicles. Manufactured from solid brass and anodized aluminum components. One year product warranty. Includes Universal Radiator Adapter Kit, pressure pump and storage case. 1 Year warranty.

Order No.	Description	Ship Wt.
03890	Universal Cooling System Test Kit	6 lbs. - 3 kg

SMARTFIT Universal Radiator Adapter Kit

- Four adapters covers all passenger & light truck vehicles
- Works with any Stant type pressure pump
- Eliminates the need to ever buy another adapter
- 1 Year warranty



Order No.	Description	Ship Wt.
03891	Universal Radiator Adapter Kit	3 lbs. - 2 kg

TRACERLINE Optimax Jr/ EZ-Ject Kit

- Most complete kit



EZ-Ject dye injector is the easiest, most accurate and most compact method of servicing a vehicle's A/C system with dye. Includes: high-intensity OPTIMAX Jr LED flashlight, EZ-Ject injector with universal A/C dye cartridge for servicing up to 14 vehicles, 1oz bottle Dye-Lite™ All-In-One dye for oil, fuel, ATF, PS and hydraulic leaks, services 2 vehicles, 1 oz bottle Dye-Lite™ coolant/auto body leak dye, services 1 vehicle, fluorescence-enhancing glasses, and plastic case.

Order No.	Mfr. No.	Description
03875	TP-8647	Optimax Jr/EZ-Jet Kit

Leak Detection

TRACERLINE EZ-Shot Kit

- A/C kit



Includes: OPTI-Lite flashlight, EZ-Shot A/C dye injector, R-134a hose and coupler with R-12 adapter/purge fitting, 8 oz BigEZ universal dye cartridge for all A/C systems, 8 oz bottle of Glo-Away dye cleaner, fluorescence-enhancing glasses, underhood labels, and plastic case.

Order No.	Mfr. No.	Description
03884	TP-8626	EZ-Shot Kit

TRACERLINE Optimax 3000 Cordless Leak Detection Flashlight

- Portable & rechargeable
- 15X Brighter than a regular LED light



Power is comparable to super-high intensity 150-watt lamps. Inspection range of up to 20 feet, 50,000 hour bulb life. Compatible with all standard leak detection dyes. Powered by rechargeable NiMH battery. Includes AC charger and fluorescence-enhancing glasses.

Order No.	Mfr. No.	Description
03769	TP-8690	Cordless Leak Detection Flashlight

TRACERLINE Optimax Jr. Leak Detection Flashlight

- Ideal for tight spaces



Power is comparable to high intensity 75-watt lamps. Inspection range of up to 6 feet, 100,000 hour bulb life. Compatible with all standard leak detection dyes. Powered by three included "AA" batteries. Includes fluorescence-enhancing glasses.

Order No.	Mfr. No.	Description
03887	TP-8640CS	Leak Detection Flashlight

TRACERLINE Blue Light Leak Detection Lamp

- 3 LED, 12v corded lamp



Comparable to high intensity 100-watt lamps. Inspection range of up to 8 feet, 100,000 hour bulb life. 14' Cord with alligator clips. Includes fluorescence-enhancing glasses.

Order No.	Mfr. No.	Description
03886	TP-1300	Blue Light Leak Detection Lamp

RAYTEK Infrared Non-Contact Thermometer



Target spot sizes D:S = 12:1 at focus point

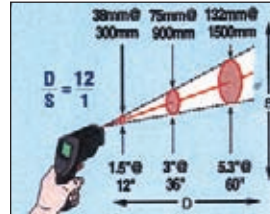

For automotive and truck diagnostic work on engines, air conditioning, brake inspection, and tire monitoring. Simply point, activate and read. Reads a 1 1/2" target at 12". The 8 point laser measures -25° to 950°F. Rubber casing protects the laser from rough handling. Accurate to +/- 1°. Includes 9V alkaline NiCad battery.

Order No.	Mfr. No.	Description
04097	ST20X	Infrared Thermometer

TRACERLINE BigEZ Universal A/C Dye Cartridges

BigEZ dye injector makes injecting dye into a pressurized A/C system easier and more accurate. Prefilled with solvent-free A/C dye, certified to meet SAE J2297 and calibrated for exact dosing. Also fits all caulking gun type injectors.



Order No.	Mfr. No.	Description	Services Per Bottle	Per Package
03706	TP-9770-0108	Universal A/C Dye	64	8 oz. Bottle
03716	TP-9770-0004	Universal A/C Dye	32	4 oz. Bottle

TRACERLINE BigEZ R134a PAG Dye Cartridges

The easiest and most accurate method of servicing a vehicle's A/C system with dye. Prefilled with solvent-free A/C dye, certified to meet SAE J2297 and calibrated for exact dosing. Also fits all caulking gun type injectors.



Order No.	Mfr. No.	Description	Services Per Bottle	Per Package
03868	TP-9760-0108	R134A PAG Dye	64	8 oz. Bottle
03717	TP-9760-0004	R134A PAG Dye	32	4 oz. Bottle

TRACERLINE Fluoro-Lite Bottled A/C Dye

- Solvent-free & certified to meet SAE J2297
- Universal - for all A/C systems



Order No.	Mfr. No.	Description	Services Per Bottle	Per Package
03773	TP-3840-0016	Fluoro-Lite A/C Bottled Dye	64	16 oz. Bottle
03762	TP-3840-0008	Fluoro-Lite A/C Bottled Dye	32	8 oz. Bottle
03832	TP-3840-0601	Fluoro-Lite A/C Bottled Dye	4	(6) 1 oz. Bottles
03765	TP-3840-12025	Fluoro-Lite A/C Bottled Dye	1	(12) 1/4 oz. Bottles

TRACERLINE Stick Capsules

- Universal - for all A/C systems



Order No.	Mfr. No.	Description	Services Per Bottle	Per Package
03744	TP-3870-0601	Stick Capsules	1	(6) .03 oz. Capsules

TRACERLINE Automotive Dyes

- Dye-Lite gasoline engine oil dye
- Dye-Lite automatic transmission & power steering dye
- Dye-Lite coolant/auto body dye
- Dye-Lite all-in-one dye



03745

03746



03797



03874

Order No.	Mfr. No.	Description	Services Per Bottle	Per Package
Dye-Lite Gasoline Engine Oil Dye				
03745	TP-3090-0601		1	(6) 1 oz. Bottles
Dye-Lite Automatic Transmission & Power Steering Dye				
03746	TP-3200-0601		1	(6) 1 oz. Bottles
Dye-Lite Coolant/Auto Body Dye				
03797	TP-3900-0008		8	8 oz. Bottle
03747	TP-3900-0601		1	(6) 1 oz. Bottles
Dye-Lite All-In-One Dye				
03874	TP-3400-0016		32	16 oz. Bottles
03750	TP-3400-0601		2	(6) 1 oz. Bottles

Fluorescence Enhancing Glasses

Eliminates blue light, so all leaks glow brighter. Makes leaks easy to spot. Protects user from ultraviolet light.



Order No.	Mfr. No.	Description
03842	TP-9940	Fluorescence Enhancing Glasses

30 LED Work Light

- Weatherproof body & switch
- 5-½ Hours use



Allows freedom of movement and to work without worrying about tangled cords. 360° Rotating nylon swivel hook at the head. 30 LED super-bright, long-life LEDs provide forward directed pure white light. LEDs produce very little heat. 4-hour recharge time provides up to 5-½ hours of continuous operation. 7.2V rechargeable lithium battery. Includes LED charge indicator. Slim design allows access into tight areas.

Order No.	Description
84502	Cordless LED Inspection Light

Fleetline
PROFESSIONAL
by Myers Tire Supply

Portable Exhaust Extraction System



Removes toxic exhaust fumes from repair facilities. High-output suction fan captures fumes and discharges them up to 30' away. Height position is controlled by a quick-release spring-loaded cam lock. ¾ HP fan produces 330 cfm air flow using 110v current. Rolls easily to position behind vehicles.

Order No.	Mfr. No.	Description	Ship Wt.
04585	EV-5100	Portable Exhaust Extraction System	100 lbs. - 45 kg

EUROVENT Exhaust Extraction System

- Eliminates multiple overhead drops
- Lightweight rails are easily connected
- Neoprene seal closes tight when the system is activated



Hose retracts when not in use.

The exhaust crab pulls easily along the rail and positions next to the vehicle for the extraction hose to connect to the tailpipe. The aluminum rail serves as the exhaust channel and a trolley. A neoprene seal in the rail closes tightly when the system is activated allowing exhaust removal from any position along the rail. Lightweight construction and the self-supporting shape is easy to install. The crab is available with 3" or 4" exhaust hoses. **Contact your Myers Sales Representative for details.**

Cordless LED Inspection Light

- 30 High intensity L.E.D.s
- 8 Hours of continuous use

Ergonomically designed handle for comfort and durability. 30 LEDs provide bright, non-glare light. No memory effect with an active life of approximately 8 hours. Includes swivel hanging hook, desk mount 110v charging station and low battery warning light.



Order No.	Description
45515	Cordless LED Inspection Light

Exhaust Service

Service Station Kits

- Kits work on both dual exhaust & single exhaust

Note: For single exhaust, remove the "Y" and connect two lengths of hose with splice connector.

Door ports not included, may be ordered separately.



84230 3" Kit Includes: (2) 4' x 3" Hose, 6' x 3" Hose, Y-connector, (2) straight tailpipe connectors and splice connector.

84232 2½" Kit Includes: (2) 4' x 2½" Hose, 6' x 2½" Hose, Y-connector, (2) straight tailpipe connectors and splice connector.

Order No.	Mfr. No.	Description	Ship Wt.
84232	DSS25	2½" Service Station Kit	13 lbs. - 6 kg
84230	DSS30	3" Service Station Kit	19 lbs. - 9 kg

Oversized Exhaust Adapter

- For Acura TL & MDX tailpipes

Solid rubber construction. Threaded for easy installation and removal. 3" x 11" opening. Fits 3" and 4" I.D. Crushproof hose. Assembly includes "Y" adapter, (2) 4' x 3" tubes and (2) F675 adapters.



Order No.	Mfr. No.	Description	Ship Wt.
84209	F675	Acura Exhaust Adapter	4 lbs. - 2 kg
84211	YA3675	Exhaust "Y" Assembly for Acura	18 lbs. - 8 kg

Tailpipe Adapters

- Designed for easy adapting to all sorts of vehicle tailpipes

A complete line of accessory items. Customer input and extensive testing have created the best products available. These items facilitate the ventilation of exhaust fumes, and prolong the life of the hose.



Order No.	Mfr. No.	Adapter Description	Tailpipe Style	Tailpipe Size	Hose (I.D.)	Ship Wt.
84206	F250	Straight with Hook & Chain	Single	Up To 2"	2", 2½", 3"	2 lbs. - 1 kg
84208	F300	Straight with Hook & Chain	Single	Up To 2½"	2½", 3", 3½"	2 lbs. - 1 kg
84218	F400	Straight with Hook & Chain	Single	Up To 3½"	3½", 4"	3 lbs. - 2 kg
84210	F475	Oval Adapter (3" x 6" Oval)	Twin Up To 2"	Oval 2½" x 5½"	3", 4"	2 lbs. - 1 kg
84212	F575	Oval Adapter (3½" x 8½" Oval)	Twin Up To 3"	Oval 3" x 8"	3", 4"	2 lbs. - 1 kg
84214	RA250	Bell with Snaps	All	All	2½", 3½"	2 lbs. - 1 kg
84216	RA300	Bell with Snaps	All	All	2", 3"	2 lbs. - 1 kg

Splice Connectors

- Joins two hoses



Order No.	Mfr. No.	Size	Ship Wt.
84234	SP-25	2½" Rubber	1 lbs. - 1 kg
84236	SP-30	3" Rubber	1 lbs. - 1 kg
84238	SP-40	4" Rubber	2 lbs. - 1 kg
84240	AC-30	3" Aluminum	2 lbs. - 1 kg

Door Ports

- Vents hose through the door



Order No.	Mfr. No.	Size	Ship Wt.
84222	DF25	2½" Rubber	2 lbs. - 1 kg
84220	ADF30	3" Aluminum	3 lbs. - 2 kg

Y-Connectors

- Joins three hoses



Order No.	Mfr. No.	Size	Ship Wt.
84224	RY25	2½" Rubber	1 lbs. - 1 kg
84226	RY30	3" Rubber	2 lbs. - 1 kg
84228	AY40	4" Aluminum	5 lbs. - 3 kg

Telescoping Overhead Kit

- For use with overhead system

Lightweight kit is fully extendible to a 17' length. Hoses can be shortened for low ceilings. Easy to install and shipped completely assembled. Unit weighs only 30 lbs. and locking snaps allow unit to be shut off.



Order No.	Mfr. No.	Description	Ship Wt.
84229	TE6000	Telescoping Overhead Kit	30 lbs. - 14 kg

Flarelock Replacement Hose

A flared end on each hose permits connection to two or more lengths of the same size hose.

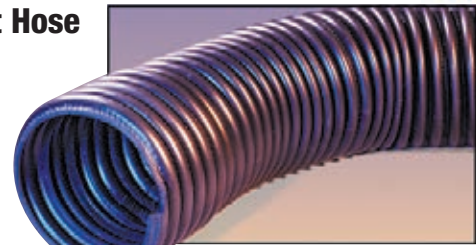

Order No.	Mfr. No.	Description	Use	Ship Wt.
84200	FLT250	2½" x 11 ft.	Compact Car	7 lbs. - 4 kg
84202	FLT300	3" x 11 ft.	Passenger Car	9 lbs. - 5 kg
84204	FLT400	4" x 11 ft.	Truck	16 lbs. - 8 kg

SLIP-N-GRIP Steering Wheel Covers

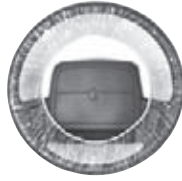

Reusable/disposable cover made of clear polyethylene with stretch elastic grip feature.

Order No.	Description	Quantity	Ship Wt.
60507	Car Steering Wheel Covers	250 Per Pkg.	5 lbs. - 2 kg
60506	Truck Steering Wheel Covers	250 Per Pkg.	8 lbs. - 4 kg

SLIP-N-GRIP Standard & Large Tire Bags



Standard size for passenger tires. Multi-use bags of clear polyethylene.

Large 33" x 6" x 44" size. For SUV tires or two small tires. Heavy-duty 1.5 mil white plastic.

Order No.	Description	Quantity	Ship Wt.
60503	Standard Tire Bags	Roll of 100	8 lbs. - 4 kg
60510	Large Heavy-Duty Tire Bags	Roll of 100	14 lbs. - 6 kg
60522	Extra Large Tire Storage Bags	Roll of 125	25 lbs. - 11 kg

SLIP-N-GRIP Dispenser System with Wall Mount Start-Up Package

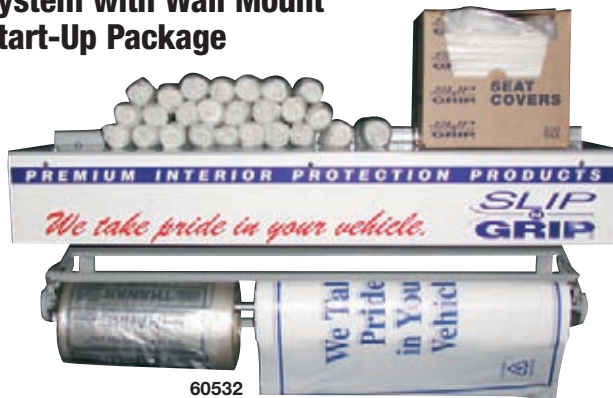

60532

Start-Up Package Includes: Wall Mount Dispenser System and a roll of 500 Plastic Floor Mats, a box of 250 Seat Covers, a roll of 500 Parts Bags, and 250 Car Steering Wheel Covers, plus your FREE Personalized sign.

Order No.	Description	Ship Wt.
60532	Wall Mount Start-Up Package	66 lbs. - 30 kg

SLIP-N-GRIP Auto Interior Protection

- Promote a professional image & save with the start-up package

Dispenser System with Start-Up Package

Includes: Dispenser System and one roll each of Seat Covers, Plastic Floor Mats, Parts Bags, Standard Tire Storage Bags, and one box of Auto Steering Wheel Covers plus your FREE Personalized sign. The heavy-duty steel rack, personalized with your name, shows your customers you care about their vehicle and are proud of your work.

The Dispenser Stand is constructed to allow easy product dispensing with spring-loaded retention arms preventing over-roll and includes a personalized sign.

Order No.	Description	Ship Wt.
60508	Dispenser System & Start-Up-Package	90 lbs. - 41 kg
60516	Dispenser Stand Only, Includes Personalized Sign	30 lbs. - 14 kg

SLIP-N-GRIP Seat Protectors

- Folded in a box for easy pull out



Unique two sided, double ply protectors clings to the seat while allowing technician to freely slide in and out.

Order No.	Description	Quantity	Ship Wt.
60530	Seat Protectors	Box of 250	14 lbs. - 7 kg
60500	Seat Protectors	Roll of 500	20 lbs. - 9 kg

SLIP-N-GRIP White Key Tags & Work Ticket Holders



White Key Tags can be used with pen or pencil.

Work Ticket Holders feature a clear plastic front and back with a nylon handle and brass gronnet.

Order No.	Description	Quantity	Ship Wt.
60517	White Key Tags	1,000 Per Box	1 lbs. - 1 kg
60518	Work Ticket Holders	25 Per Box	4 lbs. - 1 kg

SLIP-N-GRIP Floor Mats

Mats stay in place with the "clinging" feature. Rugged plastic won't tear or soak through. Coated paper floor mats resist water.



60531



60501

Order No.	Description	Quantity	Ship Wt.
60501	Plastic Floor Mats	Roll of 500	12 lbs. - 5 kg
60531	Coated Paper	Box of 500	44 lbs. - 20 kg

SLIP-N-GRIP Parts Bags

Heavy plastic bags for handling new or used parts. 11" w. x 17" h.



Order No.	Description	Quantity	Ship Wt.
60504	Parts Bag	Roll of 500	9 lbs. - 4 kg

FREE Personalized Sign

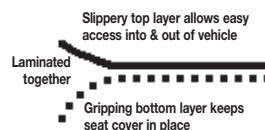

60508
Dispenser Rack with Start-Up Package

Service Reminder Stickers

- Easy-to-read size: 1½" x 2½"



45784 Dealer identification with logo



45783 Standard 4-Lines of dealer identification

Low tack adhesive vinyl service decals cling to glass or any smooth surface. White area for date or mileage information. Imprint and logo is standard black ink. If ordering the 45783 please provide: company name, street address, city, state, zip code, phone number. If ordering the 45784: email logo and information to: sales@myerstiresupply.com

Box Qty.: 3,000 stickers (3 Rolls of 1,000)

Order No.	Mfr. No.	Description	Quantity Per Box	Ship Wt.
45783	SC1000-3	Standard Stickers	3,000	5 lbs. - 2 kg
45784	SCL1000-3	Deluxe Stickers with Logo	3,000	5 lbs. - 2 kg

Drain Pans

- Tough polyethylene construction
- Black for oil & green for antifreeze



08016

Large handles and a 1" pour spout for rapid flow.

Order No.	Description	Size	Color	Ship Wt.
08016	Oil Drain Pan	4½ Gallon	Black	4 lbs. - 2 kg
08001	Radiator Drain Pan	4½ Gallon	Green	4 lbs. - 2 kg

Polyethylene Portable Oil Drains

- Available in 8 & 18 gallon capacities
- 18" Diameter funnel with strainer

Low center of gravity adds stability and makes them easy to roll, even over the roughest surfaces. Red translucent tank allows for easy viewing of oil level. Hand grips on top and bottom. 4" heavy-duty casters. Spout for evacuation.



04140
8 gallon



04139
18 gallon

Order No.	Mfr. No.	Description	Height Adjust	Ship Wt.
04140	JDI-8DCP	8-Gallon Oil Drain	48" to 67"	13 lbs. - 6 kg
04139	JDI-18DCP	18-Gallon Oil Drain	48" to 71"	19 lbs. - 9 kg

Oil Drain with Caster Base



04137

5-Gallon capacity metal oil drain features a large 14" funnel. Telescoping tube allows unit to adjust from 40" to 67" quickly and efficiently. Includes an easy-pour spout for emptying and swivel caster base. Ideal for smaller shops. Exclusive "lock-on" steel caster base will not detach, making moving easy.

Order No.	Mfr. No.	Description	Ship Wt.
04575	JDI-5DCK	Oil Drain with Caster Base	21 lbs. - 11 kg
04137	20174	Replacement 14" Funnel	2 lbs. - 1 kg

Portable Oil Drain

- 16-Gallon capacity
- Ball valve seals drain when not in use per EPA requirements
- Top mounted evacuation port



16-Gallon heavy-duty steel tank. Includes 16" deep-drawn, offset funnel with an expanded metal screen. Features a molded poly tool tray. Lift/lock tube quickly adjusts overall height from 50" to 70". Built-in sight glass shows fluid level. Heavy-duty caster base with (2) 6" fixed and (2) swivel casters.

Order No.	Mfr. No.	Description	Ship Wt.
04576	JDI-16-DCE	16-Gallon Portable Oil Drain	63 lbs. - 29 kg

Radiator Filler

Tough polyethylene won't damage automotive finishes. Impervious to oil, gasoline and antifreeze. Will withstand normal temperature extremes. 3 gallon capacity.



Order No.	Mfr. No.	Description	Ship Wt.
07993	75-025	Radiator Filler	1 lbs. - 1 kg

LINCOLN 16-Gallon Oil Drain

For use with 16 gallon, 120 lb. open-top drum. Float gauge in drum cover shows fluid level indicating when drum needs to be emptied. Includes rolling base, 17" square with 2½" wheels and telescopic drain bowl adjustable from 42¾" to 70". Optional 3610 Funnel Drain Pan rests on top of model 613 drain when a larger area is required. Diameter of 3610 bowl is 24½".



04555



Drum Not Included

Order No.	Mfr. No.	Description	Ship Wt.
04552	613	Waste Oil Drain	32 lbs. - 15 kg
04555	3610	Optional Large Drain Pan	2 lbs. - 1 kg

CREW CHIEF 22-Gallon Oil Change Station

- 16" Metal funnel
- Height adjusts 40" to 69"
- Padded push handlebars



Built-in filter drain easily holds 4 to 5 standard automotive filters.

Lift/lock drain tube for fast height adjustment. Features a 3" drain opening, a pop-up level indicator, a molded pocket for tools, and 10" rear wheels with 4" front swivel casters.



Order No.	Mfr. No.	Description	Ship Wt.
04141	JDI-22DCX	22-Gallon Oil Change Station	60 lbs. - 27 kg

BRANICK Smart-O Drain Plug Kits

- Features an O-Ring that expands up to 20% when it comes into contact with oil preventing leaks & costly mishaps due to oil loss
- Reduces the need for excess torquing for less risk of damaging oil pan's threads



52259

Smart-O kit contains a carrying case organizing 17 types of Smart-O drain plugs, a starter supply of 264 Smart-O drain plugs.

The Master Kit and Starter Kit include an application guide, P.O.P. poster, customer information and feedback forms in a counter top holder, and (4) videos to educate staff and customers.

Master Kit contains (50) each F1; (40) each F3, R1, R6; (20) each R3, R9; (10) each R20; (3) each R4, R22, S13; and (5) each R5, R11, R16, R21, R23, R24, S18.

Starter Kit includes (10) each F1, F3, R1, R6; (6) each R3; (4) each R9, R20 and (2) each R4, R5, R11, R16, R21, R22, R23, R24, S13, S18.

Reduced Inventory Kit includes (6) each F1; (5) each R1, R6; (4) each F3, R9; (3) each R3; (1) each R4, R5, R11, R16, R20, R21, R22, R23, R24, S13, S18 and carrying case for organizing. Does not include Point of Sale materials.

Order No.	Description
52136	Smart-O Master Kit - 264 Plugs
52258	Smart-O Starter Kit - 74 Plugs
52259	Smart-O Reduced Inventory Kit - 38 Plugs

Order No.	Mfr. No.	Order No.	Mfr. No.	Order No.	Mfr. No.
52240	F1	52246	R6	52252	R22
52241	F3	52247	R9	52253	R23
52242	R1	52248	R11	52254	R24
52243	R3	52249	R16	52255	S13
52244	R4	52250	R20	52256	S18
52245	R5	52251	R21		

LINCOLN 18-Gallon Economy Oil Drain

- 14" diameter steel funnel
- Height adjusts from 45" to 72"



Designed to be an affordable option to draining, transferring, and evacuating used oil quickly. The self-evacuating pressurized oil drain uses standard shop air. Dispensing hose doubles as sight gauge. Includes safety valve. 1-Year warranty.

Order No.	Mfr. No.	Description	Ship Wt.
04528	3601	18-Gallon Economy Oil Drain	65 lbs. - 29 kg

LINCOLN 20-Gallon Oil Drain

- Waste oil drain with power evacuation



The fixed air regulator allows the use of standard shop air during evacuation. Shop air transfers hazardous materials into the waste oil reservoir. Protected sight gauge for fluid level monitoring. Minimum height: 44", raises to 72". 18" Diameter by 5" deep bowl.

Order No.	Mfr. No.	Description	Ship Wt.
04530	3614	Waste Oil Drain w/ Power Evacuation	65 lbs. - 29 kg

25-Gallon Heavy-Duty Self-Evacuating Oil Drain

- 16" Diameter deep drawn "centered" funnel
- Height adjusts from 50" to 70"
- Auto-Check evacuation is easy & automatic



Easily and quickly empties using shop air. Poly-molded tool tray for convenient tool storage. Positive height adjustment makes funnel easy to position. 6' quick-disconnect discharge hose. Sight tube shows fluid level in the tank. Safety release valve and heavy-duty 4" casters. Specs.: 25-gallon capacity; 16" dia. steel funnel.; height. adj. 50" - 70"; 4" swivel wheels.

Order No.	Mfr. No.	Description	Ship Wt.
04138	JDI-25HDC	Heavy Duty Oil Drain	85 lbs. - 39 kg

LINCOLN 26-Gallon Oil Drain

- Pressurized evacuation drain



Polyethylene tank uses shop air during evacuation. Large tool tray and built-in oil filter drain. Large wheels and casters for easy movement. Includes sight gauge, pressure relief valve, fixed air regulator, evacuation hose with nozzle, and manual. Minimum height: 51 1/4" raises to 78 1/2"

Order No.	Mfr. No.	Description	Ship Wt.
04535	3624	Pressurized Evacuation Drain	74 lbs. - 34 kg

Low Profile Heavy-Duty Truck Oil Drain

- 17-Gallon capacity, only 9" high
- Screen covered reservoir & all steel construction
- Optional air evacuation kit



10" High
48" Long
25" Wide

For fast, efficient collection and transfer of used oil. Designed to meet the demands of the heavy-duty truck repair facility. 14-gauge steel construction with covered reservoir to prevent spillage and splash. 6" wheels and 38" T-handle for easy placement. 17-gallon reservoir.

Optional Air Evac Kit uses shop air to transfer fluid from reservoir to bulk storage. Kit Includes: Air regulator, safety pop-off valve, 10' evac hose with quick disconnect coupler, bushing and elbow for permanent mounting to oil storage tank.

Order No.	Mfr. No.	Description	Ship Wt.
04578	JDI-LP4	Heavy Duty Truck Oil Drain	137 lbs. - 62 kg
04579	JDI-EK	Optional Air Evacuation Kit	2 lbs. - 1 kg

Low Profile Heavy-Duty Truck Oil Drain with Electric Pump Evacuation

- 25-Gallon capacity with screen covered reservoir
- Steel construction
- 8" High



10" High
48" Long
25" Wide

Designed for large-volume vehicles. The 25-gallon reservoir is equipped with a 110V electric pump to transfer oil to a storage unit at 6 gallons per minute. Four internal baffles help prevent fluid splash when moving. 14-Gauge steel construction and a 10' quick-disconnect evacuation hose. 6" wheels and 38" T-handle for easy placement.

Order No.	Mfr. No.	Description	Ship Wt.
04118	JDI-LP5	Heavy Duty Truck Oil Drain with Electric Evacuation	150 lbs. - 68 kg

OTC 5077 Low Profile Oil Drain

- Handle drained oil without spilling a drop
- Includes electric transfer pump
- Only 7-1/2" high



Used oil is collected in the large 15-gallon reservoir. The 115v electric pump transfers the used oil at 5 gpm through the 8' fluid transfer hose. Can also be used for antifreeze. Large 4" diameter free-wheeling casters for use on uneven shop floors. Constructed of rugged and lightweight, one-piece urethane plastic.

Order No.	Mfr. No.	Description	Ship Wt.
04669	5077	Low Profile Truck Oil Drain	49 lbs. - 22 kg

Oil Filter Crushers

- Heavy-Duty aluminum cabinet
- Removes over 90% of residual oil reducing filter size by 75%
- Quiet



04582 Shown with 04110 Optional Stand



04580 Shown with 04110 Optional Stand

Powerful air-hydraulic pump uses shop air (90 psi) to compress filters quickly and safely. Semi-automatic, load and walk away. Operates only with door closed. Requires filter/regulator/lubricator (not included.)

Automotive Filter Crusher Specs.: 28 1/2" h. x 12 3/4" w. x 12 3/4" d.; filter length 7 1/2"; filter dia. 6"; crushing force 10-tons. Truck Filter Crusher Specs.: 40" h. x 12 3/4" w. x 12 3/4" d.; filter length 13"; filter dia. 6"; crushing force 15-tons.

Order No.	Mfr. No.	Description	Ship Wt.
04580	AFC100	Passenger Oil Filter Crusher	110 lbs. - 50 kg
04582	HDC150	Truck Oil Filter Crusher	200 lbs. - 90 kg
04586	FRL-1	Filter/Regulator/Lubricator (Required)	2 lbs. - 1 kg

Optional Filter Crusher Stands

- For AFC-100 & HDC-150



04110 Accommodates 16-gallon drum. Includes area for draining used filters. 28"w x 23"d x 38"h.

Order No.	Mfr. No.	Description	Ship Wt.
04110	FS-400	Optional Deluxe Stand	55 lbs. - 25 kg

Electric/Hydraulic Oil Filter Crusher

- 18,000 Lbs. of hydraulic force
- 7 to 20 second cycle time

Typical speed is more than twice that of a comparable air crusher. "Dead-man" hydraulic control stops crusher if handle is released. The optional factory-installed integral door switch (#84035) prevents operation if crusher door is open. Crushes any filter up to 5" diameter by 9" length. Mount to shop wall, or on the optional stand. The crusher can be plumbed to a 55-gallon or similar sized barrel for oil drainage convenience. 115 volt, 30 amp.



Shown with Optional Stand

Order No.	Mfr. No.	Description	Ship Wt.
84031	TC-6	Electric/Hydraulic Oil Filter Crusher	210 lbs. - 95 kg
84035		Optional Safety Switch for TC-6	1 lbs. - 1 kg
84033	5591	Optional Stand for TC-6	85 lbs. - 39 kg

Transmission Drain Pan Adapter

- Developed for long transmissions



High impact polyethylene adapts to any drain with 6" or larger diameter funnel. Developed especially for long transmissions like the E40D found in Ford F150s, F250s and F350s where traditional size drain pans can't catch all of the drainage during servicing. Large 38" long, 22" wide, 7" deep catch basin is 50% larger than most.

Order No.	Mfr. No.	Description	Ship Wt.
04577	JD-2436	Transmission Drain Pan Adapter	8 lbs. - 4 kg

Drain Funnel & Adapter



04136



04135

04136: 16" Diameter polypropylene funnel.

04135: 24" Wide drain reduces splash. Use for long transmission pans.

Order No.	Mfr. No.	Description	Ship Wt.
04136	10174	16" Drain Funnel	1 lbs. - 1 kg
04135	1416	24" Drain Pan Adapter	

WYPALL X80 Heavy-Duty Wipers

- Color - Blue
- 160 Wipes per box

Absorbs oil and water. Use for heavy-duty & part wiping, wiping metal shavings, prepping surfaces with solvents, cleaning rough surfaces.



Order No.	Mfr. No.	Description	Per Box	Ship Wt.
11200	KIM41041	Wypall X80 Wipers	160	7 lbs. - 3 kg

SAFE T SORB Safety Absorbent

- 50 Lb. Bag

Quickly and easily soaks up spills that can cause accidents. Works on any concrete surface. Easy to use and transport.



Order No.	Mfr. No.	Description	Ship Wt.
11210	IMCZORBALL	SORB 50 lb. Bag	50 lbs. - 23 kg

V-Bond Absorbent Pads

- Grey pads for oil, water, & general use
- White pads for oil only

The large 17" x 19" x 3/8" pads are the economical solution for drips, leaks, and spills. Use for soaking up water and oil based fluids. Absorbs up to 32 ounces.



Order No.	Mfr. No.	Description	Per Case	Ship Wt.
11211	SEL 225519	Grey V-Bond Absorbent Pads	100	16 lbs. - 7 kg
11212	SEL 82001	White V-Bond Absorbent Pads	100	18 lbs. - 8 kg

25-Gallon Gas Caddy Fuel Transfer & Storage Unit

- Drain "In Tank" fuel pumps
- Siphon or dispense
- OSHA compliant & FM approved
- Optional 2-way filter



04649 Recommended 2-way filter



Essential for any shop doing work requiring empty gas tanks. Two way pump for siphoning or dispensing. Great for hard to reach "in tank" fuel pumps. 25-gallon capacity. Complies with OSHA guidelines. Features fire screened vent and filler neck combination, ground wire and clamp, and fill level gauge. The dolly handle makes it easy to position anywhere in or outside the shop.

The optional two-way automatic fuel filter keeps fuel supply clean in both directions, siphoning or dispensing. Includes (2) 10 micron fuel filters, supply hose, and mounting hardware.

Order No.	Description	Ship Wt.
04648	25-Gallon Gas Caddy	88 lbs. - 40 kg
04651	Optional Standard Filter	2 lbs. - 1 kg
04649	Recommended Optional Two-Way Filter for 04648	

6-Gallon Evacuator

- Evacs 70% of capacity
- 7' Suction hose & 10' evacuation hose
- 7" Wheels for easy handling

Extract used oil and other fluids from any vehicle using the venturi-vacuum extracting system. Vacuum-charged unit is completely portable. Includes sight tube, easy-to-read vacuum gauge and five metal and flexible plastic suction probes. Also includes BMW and Volkswagen adapters. Easy-to-read vacuum gauge.



Order No.	Mfr. No.	Description	Ship Wt.
04572	JDI-6EV	6-Gallon Evacuator	45 lbs. - 21 kg

MITY VAC Fluid Evacuator

- Quick, clean extraction of engine oil, coolants, transmission fluid, brake fluid & gear oil

Includes evacuator, (2) dipstick tubes, (1) evacuation tube, tube adapters, and users manual. 1.9 Gallon reservoir capacity with automatic shut-off.



Order No.	Mfr. No.	Description	Ship Wt.
03700	MV7400	Manual Fluid Evacuator	8 lbs. - 4 kg

Lube Dispensers

LINCOLN Suction Gun



Holds up to 18 ounces of fluid. Flexible nozzle for transmission, differential or oil filter service. Precision follower fitted to the barrel. Impervious to oil, grease and water.

Order No.	Mfr. No.	Description	Ship Wt.
04515	615	Suction Gun	3 lbs. - 2 kg

Grease Guns



Order No.	Mfr. No.	Description	Maximum PSI	Ship Wt.
04554	30-475	Lever Grease Gun	10000	4 lbs. - 2 kg
04559	30-415	Pistol Grease Gun	6000	4 lbs. - 2 kg

LINCOLN High Pressure Control Valve

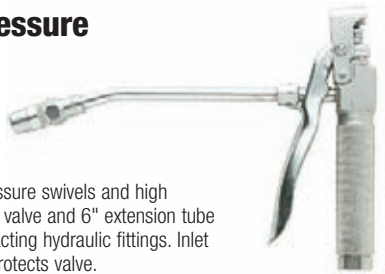

For use with standard high pressure swivels and high pressure hose. Includes control valve and 6" extension tube with hydraulic coupler for contacting hydraulic fittings. Inlet 1/4" fpt. Special guard bracket protects valve.

Order No.	Mfr. No.	Description	Ship Wt.
04550	740	High Pressure Control Valves	2 lbs. - 1 kg

LINCOLN Impact Fitting Cleaner



Flushes the lubricant passages of dried or separated grease and eliminates the need to disassemble joints or replace fittings. Includes steel drive cylinder, hardened piston, safety shield, high pressure hose, spare drive seals and model 5852 coupler.

Order No.	Mfr. No.	Description	Ship Wt.
04546	5805	Impact Fitting Cleaner	2 lbs. - 1 kg

LINCOLN Quick Connect Grease Injection Tool

- Prevents bent & broken needles



Provides a way to apply lubricant in close-fitting and difficult-to-reach areas. The flexible line keeps hands away from the needle when working with the coupler. Attaches to all 3 and 4-jaw grease couplers. Includes a threaded protective cap.

Order No.	Mfr. No.	Description	Ship Wt.
04547	5807	Quick Connect Grease Injection Tool	1 lbs. - 1 kg

LINCOLN Power Luber

- Eliminate hand grease guns
- Delivers a steady flow of grease Up to 6,000 psi
- 12 Volt rechargeable battery



Battery-powered, use wherever hand grease guns are used. A fully charged battery pumps 3 canisters of grease. Complete with 110 volt fast charger, 12 volt Ni-Cad rechargeable battery, 30" flex hose with spring guard, and a heavy-duty carrying case with room to hold 2 optional grease cartridges.

Order No.	Mfr. No.	Description	Ship Wt.
04537	1242	Power Lube Gun Kit with One Battery	18 lbs. - 9 kg
04538	1244	Power Lube Gun Kit with Two Batteries	19 lbs. - 9 kg
04539	1201	Replacement 12V Ni-Cad Battery	2 lbs. - 1 kg
04540	1230	Replacement 30" Whip Hose with Fittings	1 lbs. - 1 kg
04497		14.4 volt Cordless Grease Gun	

LINCOLN Professional PowerLuber

- Designed for heavy equipment, construction, fleet maintenance & agriculture
- Powerful 18 volt battery



Two-speed design delivers 10 Oz. per minute at medium pressure or a concentrated stream at high pressure, 7,500 psi working pressure. Stroke counter measures grease output. Recharges in less than one hour. Dispense up to 10 grease cartridges per charge. Includes PowerLuber, (1) or (2) 18V batteries, charger, and compact molded carrying case.

Order No.	Mfr. No.	Description	Ship Wt.
04495	1842	18V PowerLuber Kit with One Battery	16 lbs. - 7 kg
04496	1844	18V PowerLuber Kit with Two Batteries	16 lbs. - 7 kg

LINCOLN Lube Accessory Kit

- For use with all standard grease guns



Seven piece kit contains special quick-connect couplings; eliminates time required to un-thread and re-thread couplers. Heavy-duty storage case.

Order No.	Mfr. No.	Description	Ship Wt.
04544	58000	Lube Accessory Kit	5 lbs. - 3 kg

Replacement Adapters and Extensions included in the 58000 Kit:

04524	5859	90° Lube Tool	
04534	5855	Straight Extension	
04499	81795	Nozzle Assembly	
04545	5884	90° Coupler	
04533	83278	Rubber Tipped Nozzle	
04513	82784	Needle Nozzle	
04532	5849	360° Coupler	

LINCOLN 9917 Air Operated Grease Pump



Use with 120 lb. original refinery container. 50 to 1 pumping ratio. 20 cubic-inch displacement air motor requires no oiling during normal operation. Super-hard bushing and plunger resists abrasion – no packing to wear out. Double ballchecks in plunger for positive high pressure operation. Includes lubrigun, swivels, 7' hose and follower plate. Choice of hand truck Roll-A-Round or 4 Caster Roll-A-Round base.

Order No.	Mfr. No.	Description	Ship Wt.
04548	6917	Medium Duty Portable Grease Pump	
04500	9917	Lube Pump w/ 4 Caster Base	45 lbs. - 21 kg
04501	346P	Lube Pump w/ Hand Truck	46 lbs. - 21 kg
04567	75084	7' Grease Hose	
04560	81387	Universal Swivel	

LINCOLN 535 Manual Gear Lube Dispenser



¼ Pint graduations. Use with 120 lb. original refinery container. 15" drum cover with 17" square, 4 caster Roll-A-Round base. 5' hose, 25 ¾" pump tube length. Output: 1 pint per 7 strokes using SAE 90 Gear Lubricator at 70° F.

Order No.	Mfr. No.	Description	Ship Wt.
04551	535	Manual Gear Lube Dispenser	36 lbs. - 17 kg

LINCOLN 4480 Spigot Pump

- Use for dispensing motor oil, transmission fluid, gear oil, hydraulic oil, antifreeze & more
- Up to 4 gpm



Transfer and dispense low to medium viscosity fluids easily with the air-operated metallic positive displacement piston pump. Allows control of the flow rate for clean, direct transfer operations or for applications requiring precise volume dispensing. 2" Bung adjustable for 55 and 16 gallon drums, bench and portable tanks. *Specs.: pump tube length 34"; air pressure required 20 psi minimum, 120 psi max.; free delivery up to 4 gpm.*

Order No.	Mfr. No.	Description	Ship Wt.
04527	4480	Spigot Pump	10 lbs. - 5 kg

Rotary Barrel Pump

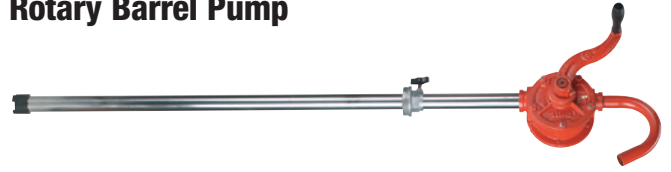

For transferring non-corrosive petroleum based fluids, of light to medium viscosity, at a rate of approximately 1-gallon per 18 revolutions with SAE 10 oil. Cast iron pump housing.

Order No.	Mfr. No.	Description	Ship Wt.
08002	55303	Rotary Barrel Pump	13 lbs. - 6 kg

Heavy-Duty Barrel Pump

- Also works with brake cleaner



Two-piece telescoping suction tube fits 30 to 55-gallon drums. Pump delivers ten ounces of fluid per stroke. Discharge spout thread fits all garden hose fittings. Includes a standard bung adapter, tough all-steel foot valve and piston valve.

Note: Gasoline is oil-based, however it is explosive and dangerous to pump.

Order No.	Mfr. No.	Description	Ship Wt.
08004	555123	Barrel Pump for Oil-Based Fluids	13 lbs. - 6 kg

MYERS Wheel & Tire Cleaner

- Keeps wheels looking "show room" new



Use as a brake dust remover. Spray on professional grade formula and power wash or use a soft cloth. Non-Acidic formula will not corrode coated weights. Four bottles per case. Includes two spray nozzles

Order No.	Description	Case Qty	Container
45161	Wheel & Tire Cleaner	4	16 Oz.

MYERS Tire Shine

- Professional grade formula dries crystal clear



Provides a glossy, wet look and a durable, long-lasting finish. Use on vinyl tops and trim. Four bottles per case. Includes two spray nozzles

Order No.	Description	Case Qty	Container
46525	Tire Shine	4	16 Oz.

V-Bond Absorbent Pads

- Grey pads for oil, water & general use
- White pads for oil only



The large 17" x 19" x ¾" pads are the economical solution for drips, leaks, and spills. Use for soaking up water and oil based fluids. Absorbs up to 32 ounces.

Order No.	Description	Per Case	Ship Wt.
11211	Grey V-Bond Absorbent Pads	100	16 lbs. - 7 kg
11212	White V-Bond Absorbent Pads	100	18 lbs. - 8 kg

MYERS

Engine Degreaser

- Heavy-Duty, easily removes thick grease, grime, oil & dirt
- Regular use helps engines run cooler & last longer
- VOC compliant & non-chlorinated



Professional-strength formula removes grease, oil, and dirt without using harsh chlorinated chemicals or ozone depleting chemicals. Fast acting, easy rinsing, and environmentally compliant meeting current California VOC requirements. Ideal for auto, truck, farm, marine, and more.

Order No.	Description	Case Qty	Fill	Container
11052	Engine Degreaser	12	16 Oz.	20 oz.

NEXT DIMENSION White Lithium Grease

- Lubricates & reduces friction
- Prevents rust & corrosion
- Will not harm the ozone



Heavy-duty, multi-purpose grease with PTFE provides superior lubrication. Reduces friction in all metal-to-metal applications, and will not run, wash off, or freeze. Ideal for use on cables, linkage, door hinges, striker plates and more. Contains PTFE for extra slipperiness.

Order No.	Description	Case Qty	Fill	Container
11054	White Lithium Grease	12	11 Oz.	16 Oz.

NEXT DIMENSION Silicone Spray

- Heavy-Duty & non-staining
- Lubricates & protects
- Does not cause gumming



Heavy-duty multi-purpose silicone lubricates, prevents squeaking, stops binding, waterproofs, and prevents rust and corrosion. Lubricates windows, doors, and locks. Protects rubber and window moldings. Weatherproofs ignition systems, and keeps battery terminals free of corrosion. Useful in shop, garage, and industrial applications.

Order No.	Description	Case Qty	Fill	Container
11055	Silicone Spray	12	11 Oz.	16 Oz.

NEXT DIMENSION Penetrant Lubricant

- Prevents corrosion & displaces moisture
- Penetrates & lubricates
- Fortified with PTFE



A unique blend of concentrated, fast-acting, powerful penetrating solvent quickly loosens rusted nuts, bolts, and frozen parts in seconds. 4 in 1 chemistry penetrates, lubricates, displaces moisture, and prevents corrosion. Ideal for shop, garage, and industrial applications.

Order No.	Description	Case Qty	Fill	Container
11053	Penetrant Lubricant	12	12 Oz.	16 Oz.

NEXT DIMENSION Glass Cleaner

- Superior performance
- Anti-Haze & anti-streak additives provide maximum clarity



Dissolves dirt, road film, grime and more. Safe for tinted windows. Foam spray clings to the surface and eliminates running.

Order No.	Description	Case Qty	Fill	Container
11067	Glass Cleaner	12	18 Oz.	19 Oz.

NEXT DIMENSION Carb & Choke Cleaner

- High pressure blast spray
- Dissolves carbon, gum, & varnish
- Eliminates stalling & rough idling



Formulated to remove dirt, gum, and varnish deposits on carburetors, heat valves, automatic chokes, throttle bodies, PCV valves, and linkages. Periodic use helps keep engines clean, fuel efficient, and trouble free. Contains no lead or silicone. Will not harm oxygen sensors, catalytic converters, or fuel injectors.

Order No.	Description	Case Qty	Fill	Container
11051	Carb & Choke Cleaner	12	15.5 Oz.	20 Oz.

NEXT DIMENSION Rust Breaker

- Removes the toughest "rust-frozen" bolts



Area sprayed is reduced down to -40° allowing the lubricant to penetrate micro-cracks caused by the freezing temperature. Compliant in all 50 states, no chlorinated solvents or ozone depleters.

Order No.	Description	Case Qty	Container
11062	Rust Breaker	12	9 Oz.

PB BLASTER Nut Loosener

A powerful, penetrating lubricant that frees everything faster! Displaces moisture. Use on nuts and bolts, rusted joints, automatic chokes, to start wet engines and more. Just saturate troubled area and allow to stand for a few minutes.



Order No.	Description	Case Qty	Container
45217	Nut Loosener	12	11 Oz. Spray
45218	Nut Loosener	4	1-Gallon

MYERS

Brake & Parts Cleaner

- Quiets & improves brake action
- California VOC compliant formula available



11050, 11065: Non-chlorinated formula quickly cleans and degreases. Dries instantly and leaves no residue. Available in two sizes. Not for sale in CA, LADCO or OTC compliant states.

11049, 11059, 11066: Non-chlorinated, low VOC formula easily removes brake fluid, grease and contaminants from linings, pads, drums, springs, and cylinders. Evaporates quickly and is available in three sizes. Not for sale in CA.

11070, 11072, 11073: Non-chlorinated, 50 state compliant formula. Cleans and evaporates quickly. Available in three sizes. This product can be sold in CA, LADCO, and OTC compliant states.

Order No.	Description	Size
11050	Brake & Parts Cleaner 14 oz. net wt.	20 oz
11065	Brake & Parts Cleaner	55 Gallon
11049	Brake & Parts Cleaner - OTC/VOC Compliant	20 oz.
11059	Brake & Parts Cleaner - OTC/VOC Compliant	5 Gallon
11066	Brake & Parts Cleaner - OTC/VOC Compliant	55 Gallon
11070	Brake & Parts Cleaner 50 State Compliant	20 oz.
11072	Brake & Parts Cleaner 50 State Compliant	5 Gallon
11073	Brake & Parts Cleaner 50 State Compliant	55 Gallon

MYERS

Super Purple Cleaner

- Powerful degreaser
- Save on the gallon size

Dissolves and easily removes grease, dirt, oil, and tar from auto parts, engines, tools, concrete, shop equipment, and more. Biodegradable water-based solution dilutes up to 1:20. Available in 1 quart and 1-gallon sizes.



Order No.	Description	Case Qty	Container
11077	Super Myers Purple Cleaner	4 (Sold Cases Only)	1 Qt.
11078	Super Myers Purple Cleaner	Sold Each	1-Gal.

EARTH SOAP Cleaner/Degreaser

- Ideal for dip tanks & metal parts washers
- VOC compliant in all 50 states

Can be used in heated parts washers up to 180° F. Solvent-free, non-flammable, non-corrosive and non-abrasive. Cleans grease, tar, bugs, road film and brake dust.



Order No.	Description	Size	Case Qty.	Ship Wt.
46528	Earth Soap	1 Gallon	6	9 lbs. - 4 kg

PENRAY

Non-Chlorinated Brake Cleaner

- California VOC compliant

Evaporates instantly with no residue, non-chlorinated. Dissolves and removes contaminants. 15.2 fluid ounces.

Order No.	Mfr. No.	Description
11081	4720	Brake Cleaner CA Approved 12 Per Case



PENRAY Non-Chlorinated Brake Cleaners

- Made in USA

11080, 11092: A non-chlorinated, quick drying degreaser. Leaves no residue. Net weight 14 ounces. Not for sale in CA.

11091: A high VOC content, non-chlorinated, quick drying degreaser. Leaves no residue. Net weight 12.5 ounces. Not for sale in CA or OTC compliant states.



Order No.	Mfr. No.	Description
11080	4620	14 Oz. Brake Cleaner 12 Per Case
11092	4655	55 Gallon Brake Cleaner
11091	4520	High VOC Brake Cleaner 12 Per Case

11080

11091

PENRAY Non-Flammable Brake Cleaner

- Does not contain silicones

A chlorinated, non-flammable formula that degreases instantly. Leaves no residue. Net weight 19 ounces. Not for sale in CA.

Order No.	Mfr. No.	Description
11093	4820	Non-Flammable Brake Cleaner 12 Per Case



TELECHEM Super-Blue Concentrated Windshield Washer Solvent

- Eliminates paying to ship water
- 2.5 Gallons in a 5-gallon pail. Fill with water to make the concentrate

Super-Blue removes the most stubborn road film, bugs, dirt and oils. Directions: 2.5 gallons of Super-Blue is shipped in a 5-gallon bucket. Fill the 5-gallon bucket with water as soon as it arrives. Use the pump to put one ounce in a gallon jug then fill with water. To make a 55-gallon drum add 55 ounces of Super-Blue.



Order No.	Description	Ship. Wt.
89209	Super-Blue Concentrated Windshield Washer Solvent with Pump	25 lbs. - 11 kg

GOODYEAR Wiper Display Racks

- Wiper blades not included with display racks. See below for suggested stocking levels



Pegboard not included



89477



89478

Order No.	Mfr. No.	Description
89477	DS2T	Facing Waterfall Wiper Display Rack with Graphics & 18 Hooks
89478	DSM3S	Mobile Wiper Display Rack with Stand, Graphics & 27 Hooks

Suggested stocking level

Order No.	Mfr. No.	Description	Size	Waterfall Display	Mobile Display
89249	765-14	Assurance	14"		4
89240	765-15	Assurance	15"		4
89246	765-16	Assurance	16"		4
89234	765-17	Assurance	17"		4
89220	765-18	Assurance	18"	4	4
89223	765-19	Assurance	19"	4	4
89216	765-20	Assurance	20"	4	8
89226	765-21	Assurance	21"	4	4
89215	765-22	Assurance	22"	4	4
89217	765-24	Assurance	24"	4	4
89221	765-26	Assurance	26"	4	4
89241	765-28	Assurance	28"	4	4

Order No.	Mfr. No.	Description	Size	Waterfall Display	Mobile Display
89257	728-15	Goodyear Wiper Blade	15"		5
89252	728-16	Goodyear Wiper Blade	16"	5	5
89247	728-17	Goodyear Wiper Blade	17"	5	5
89233	728-18	Goodyear Wiper Blade	18"	5	5
89239	728-19	Goodyear Wiper Blade	19"	5	5
89230	728-20	Goodyear Wiper Blade	20"	5	10
89238	728-21	Goodyear Wiper Blade	21"	5	5
89222	728-22	Goodyear Wiper Blade	22"	5	10
89236	728-24	Goodyear Wiper Blade	24"	5	5
89244	728-26	Goodyear Wiper Blade	26"	5	5
89393	728-28	Goodyear Wiper Blade	28"	5	5

GOODYEAR Racing Winter Wiper Blades

- Patented spoiler design provides maximum windshield pressure



Features stainless steel flexors and double paint coat. Available in sizes 16" through 28" for passenger and light truck.

Order No.	Mfr. No.	Description	Size
89470	758-16	Goodyear Racing, Winter	16"
89471	758-18	Goodyear Racing, Winter	18"
89472	758-19	Goodyear Racing, Winter	19"
89315	758-20	Goodyear Racing, Winter	20"
89473	758-21	Goodyear Racing, Winter	21"
89316	758-22	Goodyear Racing, Winter	22"
89474	758-24	Goodyear Racing, Winter	24"
89475	758-26	Goodyear Racing, Winter	26"
89476	758-28	Goodyear Racing, Winter	28"

GOODYEAR Application Charts

Order No.	Mfr. No.	Description
89479	90-A700	Wiper Blade Application Guide
89480	90-A700HD	Heavy-Duty Wiper Blade Application Guide

GOODYEAR Assurance Wiper Blades



- Rounded top ResponsEdge design helps repel ice & snow
- SilentArmor technology for quiet wiping action
- Heavy-Duty construction



Rounded top creates vortex



Silent wiping action

Premium flat or "beam" style wiper blades featuring SilentArmor Technology and ResponsEdgeTechnology for maximum, all-season, wiping power. Packaged with unique connectors to fit the latest OE designs and hook and side pin applications.

Order No.	Mfr. No.	Description	Size	Order No.	Mfr. No.	Description	Size
89249	765-14	Assurance Blade	14"	89216	765-20	Assurance Blade	20"
89240	765-15	Assurance Blade	15"	89226	765-21	Assurance Blade	21"
89246	765-16	Assurance Blade	16"	89215	765-22	Assurance Blade	22"
89234	765-17	Assurance Blade	17"	89217	765-24	Assurance Blade	24"
89220	765-18	Assurance Blade	18"	89221	765-26	Assurance Blade	26"
89223	765-19	Assurance Blade	19"	89241	765-28	Assurance Blade	28"

GOODYEAR Wiper Blades



- Stainless steel flexors & natural rubber compound
- SilentArmor technology for quiet wiping action



Premium wiper blades made in USA with double-painted, steel frame components and stainless steel flexors. Wiping element features unique, round-hinge profile and SilentArmor Technology for durability and quiet wiping action. Available in sizes 11" through 40" for passenger, light truck, commercial and RV applications.



Order No.	Mfr. No.	Description	Size	Order No.	Mfr. No.	Description	Size
89391	728-11	Goodyear Blade	11"	89239	728-19	Goodyear Blade	19"
89392	728-12	Goodyear Blade	12"	89230	728-20	Goodyear Blade	20"
89256	728-13	Goodyear Blade	13"	89238	728-21	Goodyear Blade	21"
89255	728-14	Goodyear Blade	14"	89222	728-22	Goodyear Blade	22"
89257	728-15	Goodyear Blade	15"	89236	728-24	Goodyear Blade	24"
89252	728-16	Goodyear Blade	16"	89244	728-26	Goodyear Blade	26"
89247	728-17	Goodyear Blade	17"	89393	728-28	Goodyear Blade	28"
89233	728-18	Goodyear Blade	18"				

20/20 Wiper Blades

- Riveted frame, stainless steel flexors, natural rubber
- Original equipment quality



Order No.	Mfr. No.	Description	Size	Order No.	Mfr. No.	Description	Size
89388	670-11	20/20 Blade	11"	89291	670-19	20/20 Blade	19"
89389	670-12	20/20 Blade	12"	89292	670-20	20/20 Blade	20"
89390	670-13	20/20 Blade	13"	89293	670-21	20/20 Blade	21"
89286	670-14	20/20 Blade	14"	89294	670-22	20/20 Blade	22"
89287	670-15	20/20 Blade	15"	89295	670-24	20/20 Blade	24"
89288	670-16	20/20 Blade	16"	89296	670-26	20/20 Blade	26"
89289	670-17	20/20 Blade	17"	89297	670-28	20/20 Blade	28"
89290	670-18	20/20 Blade	18"				

Shop Equipment & Supplies

Myers Tire Supply is your shop supply headquarters. Tire storage racks allow shops to work cleanly & efficiently. Myers offers a complete line of janitorial products for the tire dealer & fleet. Consolidating orders for cleaning & shop supplies saves time & money. Material handling & storage products from **AKRO-MILS** & **BUCKHORN** keep shops operating productively. Hand cleaning products from **GOJO** & a complete line of latex and nitrile mechanics gloves from **MICRO-FLEX** & **DURO GRIP** protect technician's hands. Cordless **FLEETLINE PROFESSIONAL** LED shop lights put light where it's needed without cords to clutter the work area.

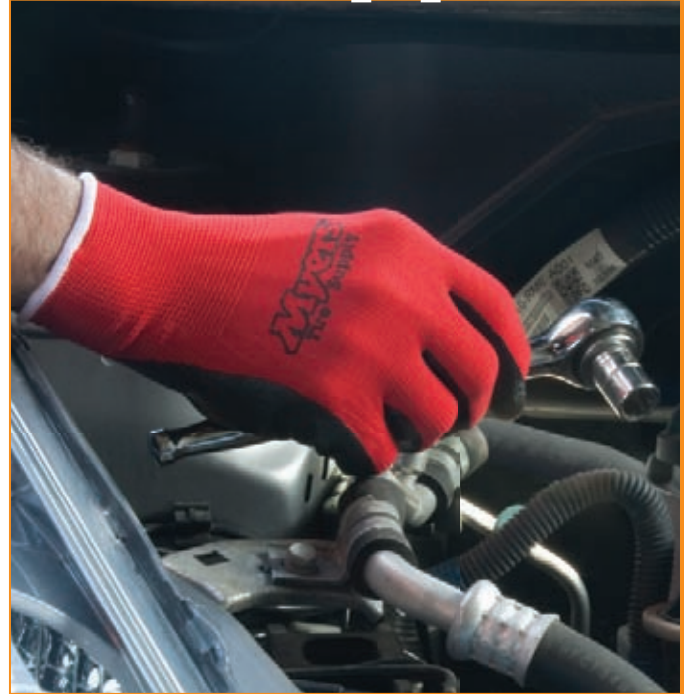

Slotted Angle Tire Racks

- Build racks to your exact requirements

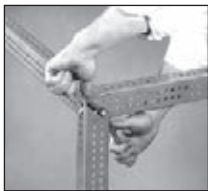

Assembles easily with nuts and bolts. No special parts or fittings needed. Sold in 10' or 12' lengths of slotted angle, ready to assemble. 14 gauge steel. One down-stroke of the cutter cuts angle square and accurate.

Order No.	Mfr. No.	Description	Ship Wt.
52137	DX225-80	Pkg. of 10 (27/16" x 1 1/8" x .080) 10' Lengths*	90 lbs. - 43 kg
52138	DX225-80A	Pkg. of 10 (27/16" x 1 1/8" x .080) 12' Lengths*	110 lbs. - 51 kg
52141	DX-1C	Pkg. of 75 - 3/8" Bolts for Above (Extra)	3 lbs. - 2 kg
52143	DX-1E	Cutter 2790 HKP Slotted	18 lbs. - 8 kg

* 75 Nuts and bolts included with each package.

Protective Eyewear



Scratch resistant and lightweight for comfort. Snug fit minimizes discomfort.

Order No.	Description
82662	Protective Eyewear with Amber Lens
82663	Protective Eyewear with Blue Mirror Lens
82664	Protective Eyewear with Clear Lens

Truck Tire Storage Racks

- Boltless snap together system



52222

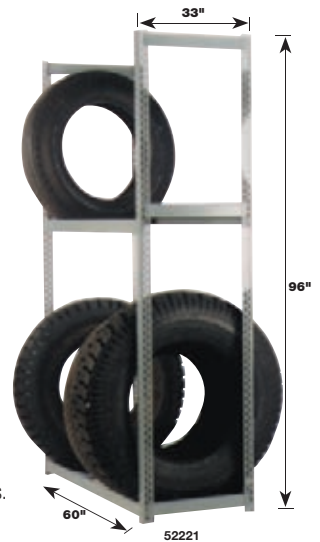

52221

Two tier systems assemble fast, with no sharp protrusions as in nut and bolt systems. Extruded rivets are welded into the base metal. Joints are strong and rigid.

Order No.	Mfr. No.	Description	Capacity	Ship Wt.
52221	2SEST5	Single Storage Rack	8-10 Tires	101 lbs. - 45 kg
52222	2DEST5	Double Storage Rack	16-20 Tires	206 lbs. - 93 kg

MYERS Reusable Mechanics Gloves

- More gloves page 242, 243, 244

Nitrile-coated palm protects hands against oil, grease and other shop grime. Rolled cuff and breathable fabric keeps hands cool in the heat and warm in the cold. Machine washable, will not shrink. Air dry.



Order No.	Description	Size
45378	Mechanics Gloves	Large
45379	Mechanics Gloves	Extra Large

Tire Racks

- Boltless, snap together

Starter Rack

Includes cross bars and two uprights.

Add-On Rack

Includes cross bars and one upright. Other side attaches to end of starter.

Simple locking system permits fast assembly. No protruding sharp hang-ups as in nut and bolt systems. The system uses extruded rivets welded into the base metal. To assemble, pass the heads through the holes in the upright framing and tap down into slats. Meets all weight and code requirements. Organize stock and make inventory checking easier.



Single Entry Starter Racks

Order No.	Mfr. Code	Tiers	Size Ft. L X D X H	Tire Capacity	Ship Wt.
52188	2SES	2	5 x 1 x 5	16	48 lbs. - 22 kg
52190	3SES	3	5 x 1 x 7	24	69 lbs. - 31 kg
52189	4SES	4	5 x 1 x 10	32	92 lbs. - 41 kg
52192	5SES	5	5 x 1 x 12	40	112 lbs. - 50 kg

Single Entry Add-On Racks

52198	2SEA	2	5 x 1 x 5	16	36 lbs. - 16 kg
52191	3SEA	3	5 x 1 x 7	24	52 lbs. - 23 kg
52199	4SEA	4	5 x 1 x 10	32	70 lbs. - 32 kg
52200	5SEA	5	5 x 1 x 12	40	85 lbs. - 38 kg

Double Entry Starter Racks

52201	2DES	2	5 x 3½ x 5	32	98 lbs. - 45 kg
52202	3DES	3	5 x 3½ x 7	48	137 lbs. - 62 kg
52203	4DES	4	5 x 3½ x 10	64	183 lbs. - 83 kg
52204	5DES	5	5 x 3½ x 12	80	227 lbs. - 103 kg

Double Entry Add-On Racks

52206	2DEA	2	5 x 3½ x 5	32	72 lbs. - 33 kg
52207	3DEA	3	5 x 3½ x 7	48	103 lbs. - 47 kg
52208	4DEA	4	5 x 3½ x 10	64	138 lbs. - 63 kg
52209	5DEA	5	5 x 3½ x 12	80	171 lbs. - 78 kg

Rubber Wheel Chock

Will not gouge tires or asphalt. One piece molded wheel chock is virtually indestructible. Sold each.



Order No.	Mfr. No.	Description	Size	Ship Wt.
37231	68-9	Rubber Wheel Chock	8" x 5 ¾" x 9"	10 lbs. - 5 kg

Tire Merchandiser

- Holds up to 30 tires & secures at single point



Optional 52176

Heavy-duty welded steel merchandiser. Moves easily on large 16 inch pneumatic tires. Has large square steel feet to protect asphalt. Locking bars and padlock to secure all three rows of tires at central position. 70" l. x 59" w. x 70" h.

Order No.	Mfr. No.	Description	Ship Wt.
52175	1804	Tire Merchandiser Only	120 lbs. - 54 kg
52176	1898	Optional Tote Jack Only	25 lbs. - 12 kg

Shipped knocked down, requires assembly

Tire Cart



The third locking caster allows the unit to be tilted back and maneuvered on three wheels for faster transport with less effort. Jaws open to 52", minimum jaw space 10". Heavy 1" axles. 300 Lb. capacity.

Order No.	Mfr. No.	Description	Ship Wt.
52077	TS-10	Tire Cart	85 lbs. - 39 kg

Portable Tire Rack

- Display 16 new or used tires



Save space while displaying tires. Made of 1¼" O.D. standard steel pipe for rugged use. Equipped with 5" hard rubber, swivel caster wheels. 76" overall height, 24" width, 58" tire storage length. Requires assembly.

Order No.	Mfr. No.	Description	Ship Wt.
52129	238HD	Portable Tire Rack	120 lbs. - 55 kg

E-Z Lift Conveyor Belt

- Use to move tires, wheels & batteries
- Four lengths from 12' to 20'

These floor-to-floor models move tires up steep inclines fast. The 18" wide belt has 4" curved cleats bolted on approximately 60" centers to fit tire contours. The 115V electric motor has a speed reducer mounted under the bottom end with a thermal overload protector. System includes belt conveyor, base plate, electric motor and one Up/Stop/Down switch mounted and wired at the bottom end.

Note: Maximum recommended degree of incline is 60°.

Optional Accessories:

52229 On/Off switch at the top.

52227 Up/Emergency Stop/Down control switches, one at the top and one at the bottom. This option gives the switches UL listing, as well as the most complete control of the system.

52228 Portable stand with locking casters to hold the conveyor belt at a specified height.

Order No.	Total Length Feet@55°	Floor / Floor Distance	Overhand	Vertical Distance	Ship Wt.
52223	12	8	2	10 Ft. High	290 lbs. - 131 kg
52224	15	10	2	12 Ft. High	330 lbs. - 149 kg
52225	17	12	2	14 Ft. High	360 lbs. - 162 kg
52226	20	14	2	16 Ft. High	390 lbs. - 178 kg
52229	Optional On/Off Switch at the Top				2 lbs. - 1 kg
52227	Optional Up/Emergency Stop/Down switches				3 lbs. - 2 kg
52228	Optional Portable Stand with Lock Casters				180 lbs. - 81 kg



BRANICK Tire Cart

- Moves entire stacks of tires easily



Built for years of trouble-free service. Handles 20" through 37" outside diameter tires. Features a gas spring to automatically close the arms and grip the tires. Pneumatic tires provide a smooth ride. Tubular frame backrest cradles and aligns uneven stacks. Arms close to 24", and open to 35".

Order No.	Mfr. No.	Description	Ship Wt.
52146	TC-550	Tire Cart	92 lbs. - 42 kg

Universal Clamp Tire Cart

- For rapid handling of tires



Eliminates time-consuming job of handling individual tires. Moves entire stacks of tires safely and easily. The clamp arms grip under bottom tire and adjust automatically to various sizes. Foot pedal opens and closes clamp arms which open to 30" and close to 24".

Order No.	Mfr. No.	Description	Ship Wt.
52147	U1-AT	Universal Clamp Tire Truck	98 lbs. - 45 kg

KEN-TOOL Tire Cart & Display

- Hauls tires by the stack
- Doubles as a horizontal or vertical display rack



Designed to haul tires and/or serve as a useful vertical or horizontal display rack. Excellent for use in retreading or tire shops for moving stacks of tires in process. Hauls 8-10 passenger tires. Rubber wheels roll smoothly over any surface. Shipped ready to use. 19½" width, 64" height.

Order No.	Mfr. No.	Description	Ship Wt.
52148	SE1-8C	Tire Cart & Display Truck	98 lbs. - 45 kg

BUCKHORN Collapsible Bulk Box



Bulk Box

- Ideal for storage
- Collapses in seconds for storage

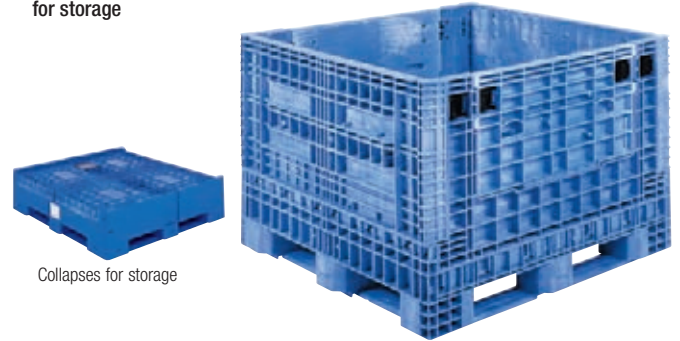

Collapses for storage

Store, load, and protect bulk storage items. Bulk Boxes are lightweight, impact resistant and maintenance-free HDPE plastic. Boxes feature an access door on each long side and can be stacked up to four high, with or without optional lid.

Order No.	Capacity lbs.	Description	Ship Wt.
84167	1,800	48" L. x 45" W x 34" H	114 lbs. - 51 kg
84169		Optional Lid for 84167 Bulk Box	

Drum Containment Pallet



Holds four 55-gallon drums and has 62-gallon secondary spill capacity. Pallet and grating resist corrosion and many chemicals. Natural translucent tub. Meets EPA requirements for secondary spill containment of hazardous chemicals.

Order No.	Mfr. No.	Description	Ship Wt.
84044	1645	4 Drum Containment Pallet	65 lbs. - 30 kg

Heavy-Duty Drum Truck & Barrel Cradle

- Handles 30 & 55-gallon drums



Heavy gauge welded steel construction to handle up to 1,200 lbs. 10" x 2½" and 6" x 2" mold-on rubber wheels. Weight distributed over four wheels for operator safety. Handle greater loads with ease. Climb curbs or load pallets.

Order No.	Mfr. No.	Description	Ship Wt.
84158	95-10-MR2	Drum Truck & Barrel Cradle	80 lbs. - 36 kg

Drum Plug Wrench



Opens all types of foreign and domestic male and female bung nuts or plugs. Offset handle protects operators knuckles in all positions.

Order No.	Mfr. No.	Description	Ship Wt.
84052	DPW	Drum Plug Wrench	4 lbs. - 2 kg

WYPALL X80 Heavy-Duty Wipers

- Color - Blue
- 160 Wipes per box



Absorbs oil and water. Use for heavy-duty & part wiping, wiping metal shavings, prepping surfaces with solvents, cleaning rough surfaces.

Order No.	Mfr. No.	Description	Per Box	Ship Wt.
11200	KIM41041	Wypall X80 Wipers	160	7 lbs. - 3 kg

WYPALL X60 Economical Wipers

- 180 Wipes per box



Extra tough light weight white wiper is reinforced for extra scrubbing and cleaning power.

Order No.	Mfr. No.	Description	Per Box	Ship Wt.
11201	KIM34015	Wypall X60 Wipers	180	7 lbs. - 3 kg

SAFE T SORB Safety Absorbent

- 50 Lb. bag



Quickly and easily soaks up spills that can cause accidents. Works on any concrete surface. Easy to use and transport.

Order No.	Mfr. No.	Description	Ship Wt.
11210	IMCZORBALL	SORB 50 lb. Bag	50 lbs. - 23 kg

V-Bond Absorbent Pads

- Grey pads for oil, water, & general use
- White pads for oil only



The large 17" x 19" x 3/8" pads are the economical solution for drips, leaks, and spills. Use for soaking up water and oil based fluids. Absorbs up to 32 ounces.

Order No.	Mfr. No.	Description	Per Case	Ship Wt.
11211	SEL 225519	Grey V-Bond Absorbent Pads	100	16 lbs. - 7 kg
11212	SEL 82001	White V-Bond Absorbent Pads	100	18 lbs. - 8 kg

Windshield Towels

Blue two-ply towels. Cost-effective absorbency for streak-free windshield cleaning.



Order No.	Mfr. No.	Description	Per Case	Ship Wt.
11220	SCA 192122	Paper Windshield Towels	2,240	25 lbs. - 11 kg

Rag-In-A-Box

- Economical, multi-purpose light duty wiper



10" x 13" low lint, white wiper. 200 Wipes per box.

Order No.	Mfr. No.	Description	Wipers/Box	Ship Wt.
11236	KIM75260	Rag-In-A-Box	200	4 lbs. - 2 kg

GOJO Heavy-Duty Scrubbing Wipes

- Cleans the toughest soil from hands without water
- Pre-moistened with heavy-duty cleaning solution



45017

Dual texture, use one side to scrub and the smooth side for quick absorption. Contains skin conditioners.

Order No.	Description	Wipes Per Bucket	Ship Wt.
45018	Scrubbing Wipes	72	3 lbs. - 1 kg
45017	Scrubbing Wipes	170	6 lbs. - 3 kg

WYPALL Shop Towels in a Bucket

- Use in the service truck



Weather and crush-resistant plastic bucket protects towels outdoors. Heavy-duty, cloth-like towels are solvent and residue-free. Use for oil and grease. 220 Towels per bucket, refills available.

Order No.	Description	Ship Wt.
11231	Shop Towels in a Bucket 1/Roll (220 Towels)	6 lbs. - 3 kg
11235	Refill Rolls - 220 Towels per roll - 2 Rolls per case	

GOJO Fast Wipes

- Fast removal of oil & Grease
- "Wet" hand towels



Boost productivity with portable cleaning at the work site. Removes irritating chemicals and soils while conditioning with vitamin E and aloe. 225 towels per bucket.

Order No.	Mfr. No.	Description	Ship Wt.
45023	6299	Fast Wipes	5 lbs. - 3 kg

GORAG Automatic Wiping System

- Replaces the waste of bundles & bulk packs
- Dispenses towels by motion or automatically when one is removed
- Reduces time wasted handling rags



Preset to deliver 8", 12" or 16" wipers. Delivers higher efficiency than cloth rags at a lower cost. Locked dispenser eliminates pilferage. One case of GoRags is equivalent to 2,250 8" x 12" rental shop rags. One roll is the equivalent of 250 10" x 12" shop rags.

Order No.	Mfr. No.	Description	Per Box	Ship Wt.
11204	59464	Automatic Dispenser without Towels	1	12 lbs. - 6 kg
11203	20067	Orange Absorbent, All-Purpose Wipes	6 Rolls	25 lbs. - 11 kg

MYERS Concentrate Green Cleaner

- Ideal for dip tanks & metal parts washers



Performs like a solvent cleaner. Use with pressure washers up to 180°. Safe for metals. One quart makes up to ten gallons of cleaning solution. Case of four quarts includes two sprayers.

Order No.	Description	Size	Case Qty.	Ship Wt.
46527	Green Cleaner	1 Qt	4	3 lbs. - 1 kg
46528	Green Cleaner	1-Gallon	6	9 lbs. - 4 kg

NEXT DIMENSION Glass Cleaner

- Anti-Haze & anti-streak additives provide maximum clarity



Professional strength glass cleaner uses foaming action to surround and dissolve dirt, road film, grime, tree sap, bugs, nicotine film and more. Foam spray clings to surfaces to eliminate running and provide maximum spray coverage. Safe to use on tinted windows.

Order No.	Mfr. No.	Description	Size	Ship Wt.
11067	0124-020PL	Glass Cleaner	19 Oz Spray	5 lbs. - 3 kg

Para Toss-In Urinal Blocks

- 12 Per box



4 oz. Cherry scented toss-in urinal block

Order No.	Mfr. No.	Description	Per Box	Ship Wt.
11303	06411	Para Toss-In Blocks	12	4 lbs. - 2 kg

Vinyl Deodorizing Urinal Screens

- 12 Per box



Cherry fragrance odor control lasts for up to 1,500 flushes. Helps eliminate odors and prevents clogging. Flexible to fit all urinals. Individually wrapped.

Order No.	Mfr. No.	Description	Per Box	Ship Wt.
11305	ROC430081	Vinyl Deodorizing Urinal Screen	12	2 lbs. - 1 kg

Urinal Screen with Para Block

- 12 Per box

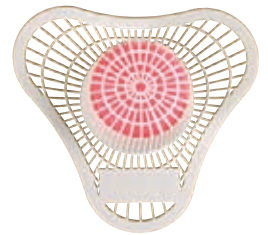

Screen with cherry scented block deodorizes for up to 30 days. Prevents drain clogging while deodorizing.

Order No.	Mfr. No.	Description	Per Box	Ship Wt.
11304	ROC430009	Urinal Screen w/4 Oz. Para Block	12	5 lbs. - 2 kg

Health Gards Toilet Seat Covers

- 1,000 Per box



Cost-effective covers are a hygienic alternative to the sloppy and expensive option of lining the seat with toilet paper or paper towels.

The dispenser (11308) is made of high impact white styrene and mounts anywhere. Sold each.

Order No.	Mfr. No.	Description	Per Box	Ship Wt.
11307	HG1000	Toilet Seat Covers	1000	6 lbs. - 3 kg
11308	HG12W	Toilet Seat Cover Dispenser	1	2 lbs. - 1 kg

Safety Sign

- 24" High



Lightweight and versatile. "Caution" warning messages imprinted in English. Folding design for convenient storage or transport. Sold each.

Order No.	Mfr. No.	Description	Ship Wt.
11358	6112-77	Safety Sign	3 lbs. - 2 kg

GEORGIA-PACIFIC Push Paddle Roll Towel Dispenser

Hygienic "elbow-push" dispenser. High capacity, contemporary design offers portion control to cut costs and provide consistent performance. Includes key for lock, mounting template. Mounting hardware not included



Order No.	Mfr. No.	Description	Per Box	Ship Wt.
11221	54338	Push Paddle Roll Towel Dispenser	Each	8 lbs. - 4 kg

Brown Roll Towels

High capacity economy natural hardwood roll towels offer reliable performance at a low cost. Designed to fit into a wide range of roll towel dispensers. 800' per roll, 7 7/8" wide.



Order No.	Mfr. No.	Description	Per Box	Ship Wt.
11222	FHP-263-01	Brown Roll Towels	6 Rolls	24 lbs. - 11 kg

Perforated Roll Towels

- Color - white

Popular 2-ply perforated roll towels offer reliable performance for everyday cleaning and wiping. 85 Sheets per roll, 8.8" x 11".



Order No.	Mfr. No.	Description	Per Box	Ship Wt.
11225	FHP-27385	White Perforated Roll Towels	30 Rolls	19 lbs. - 9 kg

Plastic Jumbo Toilet Paper Dispenser

Durable, high-capacity toilet paper dispenser for cost-saving performance. Dispenser features see-through grey front/grey back. Includes key for lock, mounting screws and template.

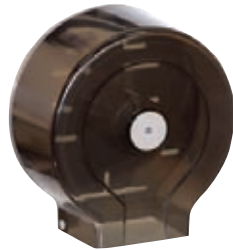

Order No.	Mfr. No.	Description	Per Box	Ship Wt.
11300	FHP-580-50	Jumbo Toilet Paper Dispenser	Each	2 lbs. - 1 kg

White Jumbo Toilet Paper

- Color - white

An affordable choice for high-traffic areas. The jumbo-sized roll delivers 1,000 feet of 2-ply tissue for reduced maintenance time and reduced risk of run-out during peak intervals.



Order No.	Mfr. No.	Description	Per Box	Ship Wt.
11309	137-28	2-Ply White Jumbo Toilet Paper	12	26 lbs. - 12 kg

Angel Soft Premium Embossed Toilet Paper

- Color - white

Premium 2-ply bath tissue, brand recognition, high capacity sheet count. 450 4" x 4" sheets per roll.



Order No.	Mfr. No.	Description	Per Box	Ship Wt.
11302	16840	2-Ply Embossed Toilet Paper	40	20 lbs. - 9 kg

Centerpull Towel Dispenser

Durable plastic construction holds up in high-traffic areas. Includes key for lock, mounting template. Mounting hardware not included.



Order No.	Mfr. No.	Description	Per Box	Ship Wt.
11223	540-50	Centerpull Towel Dispenser	Each	4 lbs. - 2 kg

Centerpull Towels

For use with the Centerpull towel dispenser. Centerpull towels are designed to reduce waste and cross-contamination while making dispensing quick and easy. 520 sheets per roll, 8 1/4" x 12".



Order No.	Mfr. No.	Description	Per Box	Ship Wt.
11224	44000/01	2-Ply White Centerpull Towels	6	24 lbs. - 11 kg

Combination C-Fold / Multifold Towel Dispenser

Georgia-Pacific metal towel dispenser holds up to 300 C-Fold for 600 multi-fold, providing a cost effective solution for washroom towel dispensing. Includes key for lock and mounting screws



Order No.	Mfr. No.	Description	Per Box	Ship Wt.
11226	566-01	C-Fold/Multi-Fold Towel Dispenser	Each	7 lbs. - 3 kg

Brown Multi-Fold Towels

Economical, EPA compliant, brown multifold towels for reliable performance at a low cost. 9.25" x 9.5". Folded width: 3 1/4" Use with 11226 above.



Order No.	Mfr. No.	Description	Per Box	Ship Wt.
11227	233-04	Brown Multi-Fold Towels	4,000	20 lbs. - 9 kg

White C-Fold Towels

Economy C-Fold towels for reliable performance at a low cost. 10 1/4" x 13 1/4" Folded width: 3 5/8" Use with 11226 above.



Order No.	Mfr. No.	Description	Per Box	Ship Wt.
11228	206-03	White C-Fold Towels	2,400	20 lbs. - 9 kg

Brown Single-Fold Towels

Economical, EPA compliant, brown singlefold towels for reliable performance at a low cost. 9 1/4" x 10 1/4". Folded width: 5 3/8".



Not for use with 11226 Dispenser.

Order No.	Mfr. No.	Description	Per Box	Ship Wt.
11229	235-04	Brown Single-Fold Towels	4,000	21 lbs. - 10 kg

Cotton Mop Head

- Handle not included



Excellent all-purpose mop for general cleaning. Universal headband fits both side-loading and clamp style handles.

Order No.	Mfr. No.	Description	Per Box	Ship Wt.
11350	WBM4601920	24 Oz. Cotton Head Mop	Each	2 lbs. - 1 kg

Wet Mop Handle

- Order with all-pro cotton mop head above



Hinged side gate allows mop to easily slide on and off handle. Contains antimicrobial product protection, inhibiting the growth of bacteria. Thumb wheel clamps the mop firmly in place. For 1" headband mops only. 60" Handle

Order No.	Mfr. No.	Description	Per Box	Ship Wt.
11351	ZEP161700	Wet Mop Handle	Each	2 lbs. - 1 kg

Dust Pan



Durable plastic provides long-lasting assistance in daily clean-up.

Order No.	Mfr. No.	Description	Per Box	Ship Wt.
11352	2005SCH	Dust Pan	Each	1 lbs. - 1 kg

Lobby Dust Pan



Stylish pan design. Durable rear wheels improve wear resistance. 36" high.

Order No.	Mfr. No.	Description	Per Box	Ship Wt.
11353	2531	Hinged Dust Pan	Each	2 lbs. - 1 kg

Lobby Broom

- 26" Handle length



11" Bristle, 100% corn fibers, for indoor use.

Order No.	Mfr. No.	Description	Per Box	Ship Wt.
11354	RBM6373	Dust Pan Broom	Each	3 lbs. - 2 kg

Indoor/Outdoor Broom

- 38" Handle length, 18" bristle



For rugged indoor/outdoor cleaning. 100% natural broom corn fibers for long life and effective pick up. Remove fine dirt from rough or smooth surfaces. Hand-selected, heavy-duty lacquered pine handles.

Order No.	Mfr. No.	Description	Per Box	Ship Wt.
11355	ZEP33034C	Indoor/Outdoor Broom	Each	3 lbs. - 2 kg

Cleaning Bucket with Casters



Plastic bucket and ringer will not rust. Non-marking casters will not scuff floor.

Order No.	Mfr. No.	Description	Ship Wt.
11357	7580-16	Bucket with Casters	20 lbs. - 9 kg

Safety Sign

- 24" High



Lightweight and versatile. "Caution" warning messages imprinted in English. Folding design for convenient storage or transport. Sold each.

Order No.	Mfr. No.	Description	Ship Wt.
11358	6112-77	Safety Sign	3 lbs. - 2 kg

24" Floor Squeegee



Black neoprene squeegee mounted in heavy metal channel. Shipped with adjustable 54", 58" and 60" aluminum handle with hand pads & ergonomic bend. Sold each.

Order No.	Mfr. No.	Description	Handle Length	Ship Wt.
81162	750-24	24" Floor Squeegee	60"	4 lbs. - 2 kg

24" Heavy-Duty Garage Broom

- Includes handle



Heavy bristles mounted in hardwood. Garage broom is oil, gasoline and abrasion resistant for tough sweeping jobs. Soft Bristle Broom cleans light dirt and dust. Ideal for show room floors. Shipped with 60" handle.

Order No.	Mfr. No.	Description	Handle Length	Ship Wt.
81160	627-24	24" Coarse Garage Broom	60"	4 lbs. - 2 kg
81159		Repl. Broom Head for 81160		
81154	617-24	24" Soft Bristle Garage Broom	60"	4 lbs. - 2 kg
81158		Repl. Broom Head for 81154		
81156	H-60DCM	60" Replacement Handle		1 lbs. - 1 kg

TIDE Heavy Duty Floor & All Purpose Cleaner

- Cleans floors, walls, pans, & laundry
- Can be used with chlorine bleach
- Non-Phosphate



Economical and versatile cleaner. Active cleaning agents make this a powerful cleanser. Cuts through tough grease and tracked-in dirt.

Order No.	Mfr. No.	Description	Per Box	Ship Wt.
11356	PGS8171	Tide Floor Cleaner	18# Box	20 lbs. - 10 kg

Hand Cleaners

Drink Cups

- 8 & 10 Ounce sizes
- 1,000 Cups per case



Economical styrofoam cups.

Order No.	Mfr. No.	Description	Size	Per Box	Ship Wt.
11496	DRT 8J8	Cups	8 Oz.	1,000	7 lbs. - 3 kg
11497	DRT10J10	Cups	10 Oz.	1,000	9 lbs. - 4 kg

GOJO Natural Orange Hand Cleaner

- Convenient pump top



Deep scrubbing pumice removes grease, grime, tar, paint, etc. A good cleaning formula for general automotive repair facilities where a lotion-based product is preferred. Fortified with lanolin.

Order No.	Mfr. No.	Description	Ship Wt.
45024	0955-02	1-Gallon Orange Lotion with Pump	9 lbs. - 4 kg

GOJO POWER GOLD Hand Cleaner

- 667 Hand washings per bottle



Power Gold with "crushables" is a heavy-duty hand cleaner. Removes tough contaminants such as oil, asphalt, and tar without damaging the skin. Two 2 liter per bottles per case.

Order No.	Mfr. No.	Description	Ship Wt.
45036	0988-04	Power Gold Pump (2) 1/2 Gallon Bottles	10 lbs. - 5 kg

Unit of measure is case of 2 bottles.

GOJO Foam Hand Soap

- For general & light duty
- Use in customer restroom

Ideal for public restrooms. Replaces small, liquid soap dispensers requiring frequent refills. The long-lasting refill enables 1,750 hand washes before changing. The dispenser mounts easily by sticking it on the wall. Start-Up kit includes dispenser and one refill.

Order No.	Description
45003	Foam Hand Soap Start-Up Kit
45004	3 Foam Hand Soap Refills



GOJO SUPRO MAX Hand Cleaner

- GoJo's #1 heavy-duty formula
- Reduce hand cleaner costs
- Start-Up kit includes dispenser & refill



Supro Max is a multi-purpose hand cleaner that removes tough, sticky soils like tar, brake fluid, and dirt mixed with oil or grease. Special conditioners leave the skin feeling smooth and help prevent skin irritation. Pleasant cherry fragrance available.

Order No.	Mfr. No.	Description	Ship Wt.
45022	7272-D2	Supro Max Start-Up Kit (Refill & Dispenser)	23 lbs. - 10 kg
45038	7272-04	Supro Max Refill (Sold Each)	5 lbs. - 2 kg
45046	7282-D2	Cherry Supro Max Start-Up Kit (Refill & Dispenser)	23 lbs. - 10 kg
45047	7282-04	Cherry Supro Max Refill (Sold Each)	5 lbs. - 2 kg

GOJO PRO 2000 Hand Cleaning System

- Lifetime guarantee
- Cherry Gel is newest heavy-duty formula
- Start-Up kit includes dispenser & refill



The new dispensing valve with every refill eliminates leaks and clogs. Adjustable portion control delivers the right amount of soap every time. Power Gold with Pumice lotion hand cleaner is formulated to remove lubricants, motor oils, asphalt, tar, sealants, anti-seize compounds or any kind of grease, sludge or slime. Skin conditioners, vitamin E and aloe help prevent skin irritation. Natural Orange with Pumice is a petroleum-free citrus formula with deep scrubbing pumice. Washes off completely leaving no oily residue. Formulated for light soil, general automotive. Cherry Gel with pumice cleans heavy dirt, grease, and oil.

Order No.	Mfr. No.	Description	Ship Wt.
45029	7295-04	Power Gold Refill	5 lbs. - 2 kg
45020	7255-D2	Natural Orange PRO2000 System Start-Up Kit	23 lbs. - 10 kg
45027	7255	Natural Orange Refill	5 lbs. - 2 kg
45049	7290-D2	Cherry Gel System Start-Up Kit	23 lbs. - 10 kg
45048	7290-04	Cherry Gel Refill	5 lbs. - 2 kg



Box-Top To Flat-Top Versatility

Quickly and easily convert the ProCart to a flat-top or a box-top cart with one hand. Hinged side gates flip up or down.

Generous Payload

Even under the 400 lbs. maximum payload, the ProCart easily maneuvers around tight corners and narrow aisles. Each shelf holds a maximum of 200 lbs.

Reinforced Construction

Built for years of rugged use, the ProCart is made of high-density polyethylene structural foam. The panels are dent-resistant, rust-proof, and never need painting.

Durable Wheels

The ProCart glides on durable, non-marking 5" ball bearing wheels. Toe touch, locking rear wheels stabilize the ProCart for loading or convert it to a portable workstation.

Dimensions: 35" h. x 45 l. x 24" w. Assembly requires phillips screwdriver and rubber mallet. 1 year limited warranty.

Order No.	Mfr No.	Description	Ship Wt.
84048	30936	ProCart Utility Cart	60 lbs. - 28 kg

Add Akro Bins to your cart for additional storage

1. Order a 9 rail hanging kit to suspend the bins.
2. Select the bin size and order the quantity indicated.
Specify red, yellow, or blue.

Order No.	Mfr No.	Description	Ship Wt.
84049	30906	Rail Kit for AkroBins	25 lbs. - 12 kg

AkroBins

Order No.	Description	Size	Quantity Needed	Ship Wt.
30220*	AkroBin®	7 3/8" x 4 1/8" x 3"	72	21 lbs. - 10 kg
30230*	AkroBin®	10 7/8" x 5 1/2" x 5"	36	27 lbs. - 13 kg
30235*	AkroBin®	10 7/8" x 11" x 5"	18	25 lbs. - 12 kg
30240*	AkroBin®	14 3/4" x 8 1/4" x 7"	12	21 lbs. - 10 kg

*Add Suffix R (Red), Y (Yellow), B (Blue) - Example 30230B



The 9-Rail Hanging Kit is required to hang AkroBins on your ProCart.

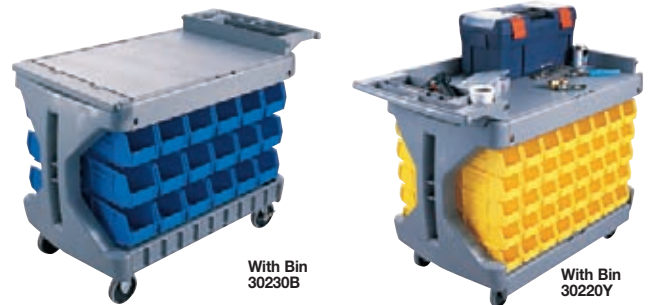

With Bin 30230B

With Bin 30220Y

AKRO-MILS Single Sided Bin Rack



Bin Rack designed to eliminate costly shelving. Use along walls, back side of shelving or end of aisles, etc. Bins suspend from racks and are easily removed, refilled and replaced. Heavy gauge all steel rack measures 53"h. x 36"l. x 14 1/4"d. Gray baked enamel finish - won't chip or rub off. 250 Lb. Load capacity. To order - specify order no., 1 each - 30008 rack, 48 each - 30230 bins (Red, blue, or yellow). Bin size 10 1/4"l. x 4 3/8"w. x 4 3/4"h.

Order No.	Description	Ship Wt.
30008	Single Sided Rack Only	56 lbs. - 25 kg
*30230	Bins (Red, Blue or Yellow)	48 lbs. - 22 kg

*Add Suffix R (Red), Y (Yellow), B (Blue) - Example 30230B

AKRO-MILS Roto-Shelf

Wheeled Storage

- Wheel weight storage
- Shop tools, supplies, storage

Tools and supplies not included.



A mobile storage rack that allows you to easily move tools or supplies anywhere in the shop. Six divided sections in each shelf allow for easy access and storage of up to 24 different products. Four circular shelves rotate on a central metal shaft. Shelves are made of tough industrial strength plastic. Shelves measure 19" inside diameter, distance between shelves 7 7/8", overall height 37 1/2".

Order No.	Mfr No.	Description	Ship Wt.
84101	02420	Roto-Shelf Storage Rack	32 lbs. - 15 kg



Polypropylene AkroBins®

- Use existing shelf space
- Store miscellaneous parts
- Stackable

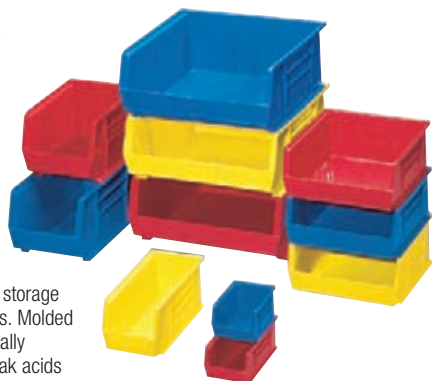

AkroBins help reduce and control inventories. Red, yellow and blue AkroBins give the option of color coding your storage system. Molded-in label holders. Molded heavy-duty polypropylene, virtually unbreakable, unaffected by weak acids and alkalis. Water, rust and corrosion-proof.

Order No.	Outside Dimensions (Inches)			Carton Qty	Ship Wt.
	L	W	H		
30210	4 3/4"	3 7/16"	2 13/16"	24	7 lbs. - 3 kg
30220	6 3/4"	3 7/16"	2 13/16"	24	8 lbs. - 4 kg
30230	10 1/4"	4 3/8"	4 3/4"	12	12 lbs. - 6 kg
30235	10 1/4"	10"	4 3/4"	6	9 lbs. - 4 kg
30239	10"	6 9/16"	6 3/4"	6	9 lbs. - 4 kg
30240	14"	6 9/16"	6 3/4"	12	22 lbs. - 10 kg
30250	14"	14 3/4"	6 3/4"	6	18 lbs. - 8 kg

*Add Suffix H (Red), Y (Yellow), B (Blue) - Example 30230B, 1 color per carton. Available in carton quantity only.



Hanging Panels for AkroBins®

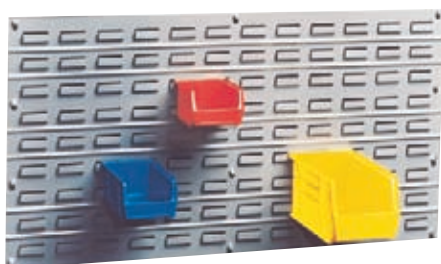

The louvered panel acts as a universal hanging surface for AkroBins and allows unlimited relocations of all bin sizes. These heavy-duty panels are made of 16-gauge cold-rolled steel with horizontal reinforcing ribs. Gray baked enamel.

Quantity of AkroBins That Fit Panels							
	30210	30220	30230	30235	30239	30240	30250
30618	16	16	9	-	-	-	-
30636	32	32	18	9	8	8	4

Order No.	Description	Panel Dimensions	Ship Wt.
30618	Small Hanging Panel	19" x 18"	7 lbs. - 3 kg
30636	Large Hanging Panel	19" x 35 3/4"	11 lbs. - 6 kg

Bench Rack Work Station Organizer

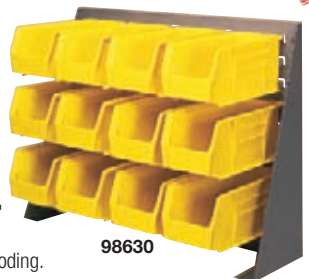

A free-standing work station or parts organizer. 16 gauge-steel 27 3/4" x 21" x 8" bench stand complete with polypropylene AkroBins are available in three colors for coding. Specify bin color: Blue, Yellow, or Red.

Order No.	Includes	Inside Dimensions of Bins (Inches)			Ship Wt.
		L	W	H	
98610	24- #30210 Bins	4 3/4"	3 7/16"	2 13/16"	21 lbs. - 10 kg
98620	24- #30220 Bins	6 3/4"	3 7/16"	2 13/16"	24 lbs. - 11 kg
98630	12- #30230 Bins	10 1/4"	4 3/8"	4 3/4"	26 lbs. - 12 kg
98600	Rack Only (27 3/4" x 21" x 8")				

*Add Suffix R (Red), Y (Yellow), B (Blue) - Example 30230B, 1 color per carton. Available in carton quantity only.



Portable Organizers

- Combination small & large parts storage
- Configures 12 to 62 compartments
- Ideal for TPMS sensors & repair kits



Product Not Included

Unique design won't allow parts and equipment to gravitate to other compartments when lids are shut. Separate lid compartment holds small items. The main compartment holds larger items. Organizers are blue with clear lids and black latches.

Order No.	Description
06118	Large Lid Organizer



15 Drawer Metal Cabinet

- Ideal cabinet for storing TPMS sensors & service kits



Cabinet dimensions: 11" high x 11" deep x 17" wide. Drawer size: 3.125" tall x 11" deep x 3.25" wide. Includes drawer dividers.

Order No.	Description
30007	15 Drawer Metal Cabinet



Shelf Bins

- Water, oil & grease proof
- Economically priced
- Designed to fit 36" wide shelving

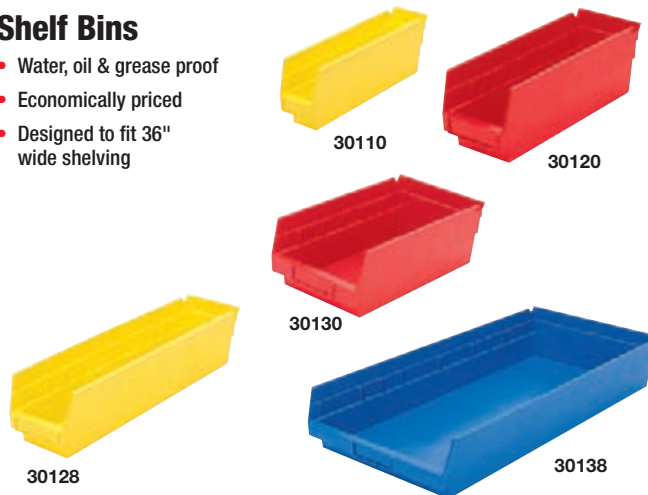

Seamless, molded polypropylene bins for 12" or 18" deep shelving. Handles include large label area. Permanently molded bright red, yellow, or blue colors. Outlasts corrugated bins.

Order No.	Dimensions (Inches)			Carton Qty	Ship Wt.
	L	W	H		
30110	11 5/8"	2 3/4"	4"	24	10 lbs. - 5 kg
30120	11 5/8"	4 1/8"	4"	24	11 lbs. - 5 kg
30128	17 5/8"	4 1/8"	4"	12	8 lbs. - 4 kg
30130	11 5/8"	6 5/8"	4"	12	9 lbs. - 4 kg
30138	17 5/8"	6 5/8"	4"	12	10 lbs. - 5 kg

Specify Blue, Yellow or Red when ordering 1 color per carton. Available in carton quantity only.

Heavy-Duty Work Benches

- Flared footprint maximize stability
- Heavy-Duty 12-gauge steel top

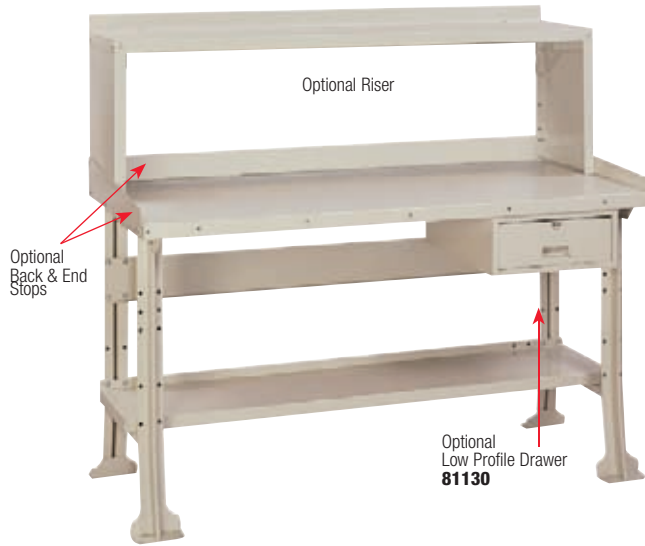

All benches feature stringer and shelf. Heavy channel steel flared legs provide sturdy base. Steel cross members welded between each upright add strength and rigidity. **Specify Color: Dove Gray or Putty.**

Order No.	Mfr. No.	Size	Top	Color	Ship Wt.
81318	2522	60" x 28"	12 Gauge Steel	Specify	125 lbs. - 57 kg
81320	2523	60" x 34"	12 Gauge Steel	Specify	139 lbs. - 64 kg
81322	2524	72" x 28"	12 Gauge Steel	Specify	141 lbs. - 64 kg
81324	2525	72" x 34"	12 Gauge Steel	Specify	160 lbs. - 73 kg

Back and End Stops
Extends 3" above top. Ends taper 1 1/2" at front.

81117	2602	60" x 28"	Specify	13 lbs. - 6 kg
81116	2603	60" x 34"	Specify	14 lbs. - 7 kg
81115	2604	72" x 28"	Specify	14 lbs. - 7 kg
81114	2605	72" x 34"	Specify	15 lbs. - 7 kg

Cabinet Desk



All the features of the Shop Desk plus a lockable bottom cabinet-type storage area. The cabinet door has a chrome-plated handle with built-in three point locking device. Cabinet inside is 32" w. x 28" d. **Specify Color: Dove Gray or Putty.**

Order No.	Mfr. No.	Description	W	D	H	Ship Wt.
81139	2251	Cabinet Desk	34 1/2"	30"	53"	156 lbs. - 71 kg

Cabinet

- Adjustable shelves



Modern styling with rounded front corners, chrome handles, built-in lock. All shelves adjustable. **Specify Color: Dove Gray or Putty.**

Order No.	Mfr. No.	Description	Ship Wt.
81118	1000	36" x 21" x 78"	164 lbs. - 74 kg
81119	1001	Same, Knocked Down	164 lbs. - 74 kg

Shop Desk



Writing surface, storage space, and lockable compartment for service writers, receiving clerk, and others. The bottom shelf is adjustable. Complete with pencil and paper compartments and sloping top. **Color: Dove Gray**

Order No.	Mfr. No.	Description	W	D	H	Ship Wt.
81308	2250	Shop Desk	34 1/2"	30"	53"	104 lbs. - 48 kg

Tool Stand Cabinet



Sturdy, small work surface and space to lock up tools, precision instruments or other valuables. Three shelves adjust every 2". Built-in lock. Chrome-plated handle. Top reverses for flat working surface. **Specify Color: Dove Gray or Putty.**

Order No.	Mfr. No.	Description	W	D	H	Ship Wt.
81010	3010	Tool Stand Cabinet	24 1/4"	15 1/4"	32 1/2"	84 lbs. - 38 kg
81144	NF3150	4 Casters for 3010 Only				1 lbs. - 1 kg

Cabinet Benches



The heavy steel top provides sturdy mounts for small grinders or vises. 12-gauge steel legs and frames support 14-gauge top and 18-gauge shelf. Features locking double doors, adjustable center shelf, and back end stops. Top may be inverted for flat surface. **Specify Color: Dove Gray, Putty, or Wedgwood Blue.**

Order No.	Mfr. No.	Description	W	D	H	Ship Wt.
81175	3000	Cabinet Bench	36"	24"	34"	107 lbs. - 49 kg
81145	3001	Mobile Bench Includes 3 1/2" Dyna-Tred Casters, 2 Swivel w/ Footbrakes, Tubular Steel Handle	36"	24"	37 1/2"	129 lbs. - 59 kg

Protective Eyewear



82664



82663



82662

Scratch resistant and lightweight for comfort. Snug fit minimizes discomfort. Stylish design helps ensure worker compliance.

Order No.	Description
82662	Protective Eyewear with Amber Lens
82663	Protective Eyewear with Blue Mirror Lens
82664	Protective Eyewear with Clear Lens

UVEX

- Adjustable - one size fits all
- Meets the requirements: ANSI Z87.1-1989, CSA Z94.3-1988



Easily adjusted for optimal fit and comfort. Impact resistant nylon frame. The lens can be quickly and economically replaced. The wide viewing area provides good visibility of the work area.

Order No.	Mfr. No.	Description
82665	3000Astrospec	Uvex
82667	UVS-535	Clear Replacement Lens
82668	S537	Amber Replacement Lens

Protective Eyewear

Wrap-around design with one-piece clear optical lens. Vented side shield-type temples. One size fits all. Meets or exceeds compliance with ANSI Z87.1 standards.



Order No.	Mfr. No.	Description
82599	CU9800	Protective Eyewear

Visitor's Spectacles

- Wear with or without personal glasses



Tough, light, comfortable. High quality plastic lenses, virtually indestructible in normal use.

Order No.	Mfr. No.	Description
82672	550-001	Visitor Spectacles

Soft Frame Goggles



82670



82671

Fits easily over glasses. Clear frame permits wide vision. Elastic headband.

DUST GOGGLES

Perforated top and sides for maximum ventilation.

CHEMICAL GOGGLES

Indirect ventilation. Splash proof, "stack-trap" vents for acid and splash conditions. ANSI Z.87.1 and CSA Z94.5

Order No.	Mfr. No.	Description
82670	AE202-C	Dust Goggle
82671	NW1012	Chemical Goggle

Deluxe Face Shield

- Window flips up



.040 gauge 8" clear window with flip up head gear & adjustable headband. Conforms to ANSI spec. ANSI Z87.1-1989.

Order No.	Mfr. No.	Description
45504	550-013	Face Shield
45505	GWA206-C	Replacement Window

Face Shield

- .040 Gauge window



Clear 8" window protects eyes, nose, mouth, face. Non-flammable. Feather light adjustable headband. Meets OSHA regulations.

Order No.	Mfr. No.	Description
45500	66300	Face Shield
45501	60007	Replacement Window

Hearing Protector

- For moderate or high noise levels
- Noise reduction rating 23 decibels



Scientifically designed to assure proper noise attenuation and to meet key requirements of industry and military. 360° Rotating headband. Compliance with ANSI S3.19-1974.

Order No.	Mfr. No.	Description
82687	550-021	Hearing Protector

Disposable Earplugs

- Noise reduction rating 29 decibels



Super soft non-deteriorating, non-irritating polyurethane foam construction. Slightly tapered to permit easy insertion into a wide range of ear canal sizes without loss of comfort or performance. Tested in accordance with ANSI S3.19-1974.

Order No.	Mfr. No.	Description
82689	NR28-00-05	Disposable Earplugs

Respiratory Protection



Dual cartridge half mask respirators, lightweight low profile design. Fully certified by NIOSH/MSHA.

Organic Vapor Meets TC 23 C 49

Order No.	Mfr. No.	Description	Ship Wt.
82616	550-033	Respirator	2 lbs. - 1 kg
82617	550-034	Replacement Cartridge Box of 2	1 lbs. - 1 kg

Paint, Lacquer, Enamel Vapor Meets TC-23C-75

82618	MT7731-L	Respirator	2 lbs. - 1 kg
82617	550-034	Replacement Cartridge Box of 2	1 lbs. - 1 kg
82619	550-036	Replacement Pre-Filter Box of 10	1 lbs. - 1 kg

Asbestos Meets TC-21C-152

82622	MT7780-L	Respirator	2 lbs. - 1 kg
82623	7580P100B	Replacement Cartridge Box of 2	1 lbs. - 1 kg

Disposable Dust/Mist Masks



Inexpensive, adjustable nose bridge, ribbed designs, molds to facial contours, large filter area. NIOSH and MSHA approved for coal, cadmium, lead, cotton dust, silica and more. Approved for a PEL not less than .05 mg/m³, OSHA up to 10 x PEL. NIOSH/MSHA TC-21C-132

Order No.	Mfg. No.	Std. Pkg.
45545	07048/8210	Sold Each

Disposable Filter Masks



Nuisance dust mask. Use for comfort only - not for lung protection. Provides relief against the irritating effects of such nuisance dusts as pollen, common house dust, salt and cut grass.

Order No.	Mfg. No.	Std. Pkg.
45546	1501	50

Hard Hats

- High-density polymer
- Exceeds OSHA requirements



High-ridge design in high-density, high-impact polyethylene. No seams, no projections inside. Nylon strap inner-webbing adjusts for sizes 6½ to 8.

Order No.	Mfr. No.	Description	Ship Wt.
82683B	410	Blue Hard Hat	1 lbs. - 1 kg
82683R	410	Red Hard Hat	1 lbs. - 1 kg
82683W	410	White Hard Hat	1 lbs. - 1 kg
82683Y	410	Yellow Hard Hat	1 lbs. - 1 kg
826830	410	Orange Hard Hat	1 lbs. - 1 kg

Back Support Belt

- Available in two sizes

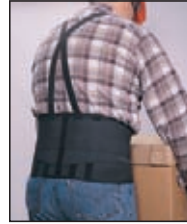

Double velcro closure with detachable straps. Four support stays. Net on back is lightweight and breathable. Adjustable over a wide range. Machine washable.

Order No.	Description	Ship Wt.
82684	Medium for Waist Sizes 28" - 34"	1 lbs. - 1 kg
82685	Large for Waist Sizes 35" - 41"	1 lbs. - 1 kg

Portable Tire Step

- Holds up to 400 lbs.



Ideal for secure footing while working on truck and bus engines. Slips over the front or rear tire for access to hard-to-reach places. Adjustable to most tire sizes. It folds flat for transport and storage. Lightweight steel construction.

Order No.	Mfr. No.	Description	Ship Wt.
84434	SU100A	Portable Tire Step	15 lbs. - 7 kg

Mechanic Seat



Features a rounded corner seat pad with comfortable 1¼" durable leatherette covered seat pad. Heavy-duty "U" spring leg. 15" x 15" x 12" high. Shipped un-assembled.

Order No.	Mfr. No.	Description	Ship Wt.
04007	SPP	Mechanic Seat	15 lbs. - 7 kg

Mechanics Creepers



Features 36" long hardwood frame with 1¼" side rails, 3" steel rollers and 5 cross members for strength and support.

Order No.	Mfr. No.	Description	Ship Wt.
04000	THC995	Mechanics Creeper	22 lbs. - 10 kg
04002	44	3" Repl. Casters for Above Creepers - Set of 4	4 lbs. - 2 kg

PORT-A-COOL Cooling Systems

- Ideal for cooling hot shops
- Cools anywhere using 115v & tap water
- Works where air conditioning is not practical

53640 Cyclone 3000 Specs: air delivery 3,000 cfm; total amps 5.6; cooling capacity 700 sq. ft.; 16-gallon tank.



53640



53642

53642 16" Filler Cart Specs: 3-speed, direct drive; air delivery 2,500 /3,280 /3,900 cfm; total amps 5.1; 1/2 hp; cooling capacity 900 sq. ft.; water reservoir 22-gallons; includes cart.



53648

53648 48" Unit Specs: 2-speed, belt drive; air delivery 11,000 /20,000 cfm; total amps 13.7; 1 hp; cooling capacity 4,000 sq. ft.

Lowers temperatures 15° to 25°. Features non-corrosive plastic fan blades and hub, non-corrosive plastic plumbing fittings, and non-corrosive plastic trough retainer to prevent rust. No assembly required. UL listed.

53640 Cyclone 3000 Specs: air delivery 3,000 cfm; total amps 5.6; cooling capacity 700 sq. ft.; 16-gallon tank.

53642 16" Filler Cart Specs: 3- speed, direct drive; air delivery 2,500 /3,280 /3,900 cfm; total amps 5.1; 1/2 hp; cooling capacity 900 sq. ft.; water reservoir 42-gallons; includes water level sight gauge and sump drain.

53644 24" Filler Cart Specs: variable speed, direct drive; air delivery 1,800 cfm; total amps 9.5; 1/3 hp; cooling capacity 1,000 sq. ft.; water reservoir 14-gallons.

53645 36" Unit Specs: single speed, belt drive; air delivery 9,600 cfm; total amps 9.5; 1/2 hp; cooling capacity 2,500 sq. ft.; water reservoir 20-gallons.

53646 36" Unit Specs: 3- speed belt drive; air delivery 4,800 /6,600 /9,600 cfm; total amps 9.5; 1/2 hp; cooling capacity 2,500 sq. ft.; water reservoir 20-gallons.

53647 36" Unit Specs: variable speed; air delivery 10,100 cfm; total amps 9.5; 1/2 hp; cooling capacity 2,6500 sq. ft.; water reservoir 20-gallons.

53648 48" Unit Specs: 2-speed, belt drive; air delivery 11,000 /20,000 cfm; total amps 13.7; 1 hp; cooling capacity 4,000 sq. ft.

Order No.	Mfr. No.	Description	Ship Wt.
53640	PAC2KCYC01	Cyclone 3000 Centrifugal Fan 2-Speed	100 lbs. - 45 kg
53642	PAC2K163SFC	16" 3-Speed Port A Cool	155 lbs. - 70 kg
53644	PAC2K24HPVS	24" Variable Speed Port A Cool	175 lbs. - 79 kg
53645	PAC2K615	36" Single Speed Port A Cool	235 lbs. - 107 kg
53646	PAC2K363S	36" 3- Speed Port A Cool	245 lbs. - 111 kg
53647	PAC2K36HPVS	36" Variable Speed Port A Cool	240 lbs. - 109 kg
53648	PAC2K482S	48" 2-Speed Port A Cool Port A Cool	405 lbs. - 184 kg

* Performance will vary depending on temperature, humidity, ceiling height, interior heat load, and other factors including the level of cooling desired.

WYPALL X80 Heavy-Duty Wipers

- Color - Blue
- 160 Wipes per box



Absorbs oil and water. Use for heavy-duty & part wiping, wiping metal shavings, prepping surfaces with solvents, cleaning rough surfaces.

Order No.	Mfr. No.	Description	Per Box	Ship Wt.
11200	KIM41041	Wypall X80 Wipers	160	7 lbs. - 3 kg

V-Bond Absorbent Pads

- Grey pads for oil, water & general use
- White pads for oil only



The large 17" x 19" x 3/8" pads are the economical solution for drips, leaks, and spills. Use for soaking up water and oil based fluids. Absorbs up to 32 ounces.

Order No.	Mfr. No.	Description	Per Case	Ship Wt.
11211	SEL 225519	Grey V-Bond Absorbent Pads	100	16 lbs. - 7 kg
11212	SEL 82001	White V-Bond Absorbent Pads	100	18 lbs. - 8 kg

Storage Cabinets for Flammable Liquids

- Yellow caution enamel
- Powder-Coat with "Flammable - Keep Fire Away" in red letters
- Meets OSHA/NFPA requirements
- Adjustable shelves



45573

Designed to meet National Fire Protection Association standards. Made of 18-gauge sheet iron, vented at top and bottom of sides. Door is raised 2 inches above bottom of cabinet. Cabinet has adjustable shelves and 4 adjustable leveling feet. Double wall 18 gauge steel and double doors with full length piano hinges. FM approved.

Order No.	Mfr. No.	Dimensions	Capacity	Ship Wt.
45574	1932	44"H x 43" W x 18"D	30-Gallon	240 lbs. - 109 kg
45573	1947	65"H x 43" W x 18"D	45-Gallon	270 lbs. - 122 kg

Solvent Dispensing Cans



For moistening swabs. Safe, economical and efficient. Tire casings, repair materials, etc., should be swabbed with rubber solvent to insure the cleanliness necessary for maximum adhesion. Construction of can reduces fire hazard to a minimum. Wastage from spilling is entirely eliminated. Easy to fill.

Order No.	Mfr. No.	Capacity	Ship Wt.
45579	B602	2 Qt.	4 lbs. - 2 kg
45587	B608	8 Qt.	8 lbs. - 4 kg
Plunger Type Dispensing Can			
45580	P701	1 Qt.	3 lbs. - 2 kg
45581	P702	2 Qt.	3 lbs. - 2 kg

Cement Dispensers



Keeps usable quantities of cement air tight and clean. Use different color cans for different type cements; a can with a black lid for one cement and a can with a blue lid for the other.

Order No.	Description
84025	1 Qt Aluminum Dispenser with Black Lid
84023	1 Qt Aluminum Dispenser with Blue Lid
Replacement Lid and Brush Assembly	
84029	Black Lid & Brush Only
84029B	Blue Lid & Brush Only

10-Gallon Poly Waste Can

- Meets OSHA & NFPA Code 30 Standards



One-piece molded design is leak proof. For indoor or outdoor use. Features a self-closing lid and hands-free foot lever. Use with or without liners. FM approved.

Order No.	Mfr. No.	Description	Capacity	Ship Wt.
45585	935-FL	Waste Can	10 Gallon	14 lbs. - 7 kg

SAFE T SORB Safety Absorbent

Quickly and easily soaks up spills that can cause accidents. Works on any concrete surface. Easy to use and transport.



Order No.	Mfr. No.	Description	Ship Wt.
11210	IMCZORBALL	SORB 50 lb. Bag	50 lbs. - 23 kg

Safety Can

- For flammable liquids
- Meets OSHA requirements



Eliminate fire hazards. Store flammable liquids in easy-to-pour 5-gallon Safety Can. Screen spout. Approved, inspected and numbered by Underwriters Laboratories.

Order No.	Mfr. No.	Description	Ship Wt.
45582	PE1061	5-Gallon Safety Can	7 lbs. - 4 kg

Air Vac

- Venturi vacuum system



Trigger control with an easy-to-clean bag.

Order No.	Mfr. No.	Description
82000	VAC-1	Air Vac

Wonder Air Vacuum



A complete air vacuum cleaner. Powered by compressed air, powerful suction picks up buffing dust and cleans tires. 6 ft. snake hose.

Order No.	Mfr. No.	Description	Ship Wt.
82435	W-100	Vacuum Complete	8 lbs. - 4 kg
Replacement Parts			
82436	W-100C	6 Foot Vinyl Covered Rubber Hose	3 lbs. - 2 kg
82437	W-100E	1" x 3" Tube for Joining 2 Hoses	1 lbs. - 1 kg
82438	W-100F	Brush	1 lbs. - 1 kg
82439	W-100H	Dust Bag	1 lbs. - 1 kg

Jet-Vac

- Removes water from tires in seconds

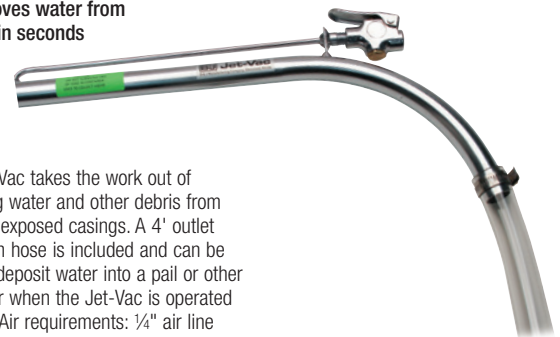

The Jet-Vac takes the work out of removing water and other debris from weather-exposed casings. A 4' outlet extension hose is included and can be used to deposit water into a pail or other container when the Jet-Vac is operated indoors. Air requirements: 1/4" air line with 100 psi.

Order No.	Mfr. No.	Description	Ship Wt.
82433	JVP	Jet-Vac Passenger	3 lbs. - 2 kg
82434	JVT	Jet-Vac Truck	6 lbs. - 3 kg

20" & 23" Tool Boxes with Storage Compartments

- High impact polypropylene
- Will not rust, chip or dent

5 1/2" x 4 3/4"
Small Part Storage

6 1/2" x 5 3/4"
Small Part Storage



Includes Tray



Removable small parts storage boxes

Order No.	Description
45588	20" Tool Box with Storage Compartments
45589	23" Tool Box with Storage Compartments

CHANNELLOCK Hand Tools

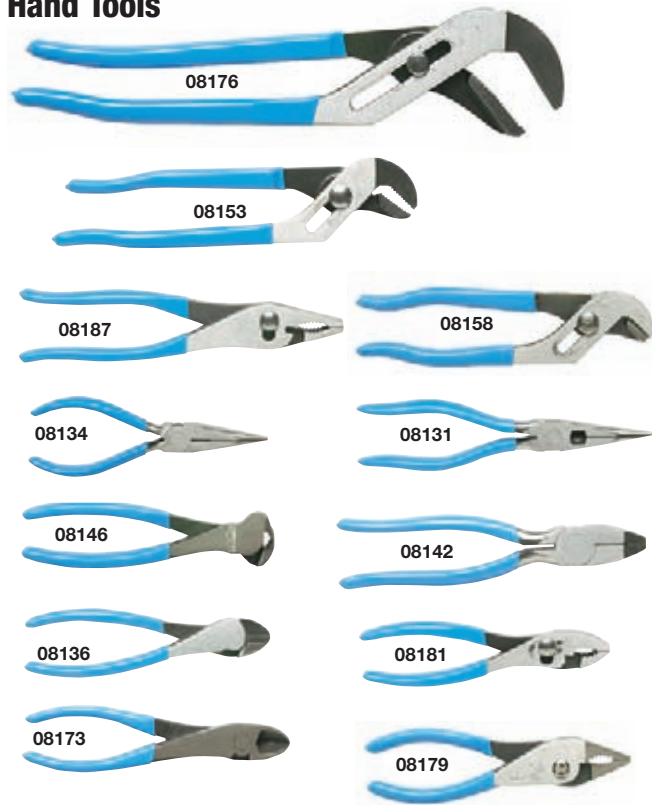

Order No.	Mfr. No.	Description	Ship Wt.
08176	460G	16" Tongue & Groove	3 lbs. - 2 kg
08153	420G	9 1/2" Tongue & Groove	1 lbs. - 1 kg
08158	426G	6 1/2" Tongue & Groove	1 lbs. - 1 kg
08142	348G	8 1/2" Rounded Nose Pliers	1 lbs. - 1 kg
08131	317G	7 1/2" Long Nose w/ Side Cutter	1 lbs. - 1 kg
08134	326G	6" Long Nose w/ Side Cutter	1 lbs. - 1 kg
08173	447G	7 3/4" Side Cutter	2 lbs. - 1 kg
08136	337G	7" Lap Joint Cutting Pliers	1 lbs. - 1 kg
08146	357G	7" End Cutter	1 lbs. - 1 kg
08181	526G	6" Slip Joint Plier Round Nose	1 lbs. - 1 kg
08179	516G	6" Slip Joint Plier Flat Nose	1 lbs. - 1 kg
08187	548G	8" Heavy-Duty Slip Joint	2 lbs. - 1 kg

Bench Grinder



Powerful, rugged. For grinding, sharpening, wire brushing and buffing operations. Ideal for all automotive service jobs. Fully enclosed motor is splash-proof and dust-proof. Lifetime lubricated motor shaft mounted on precision ball bearings for smooth, quiet operation. Includes 36 and 60 grit wheels, safety eyeshields, full guard covers, wheel guards, spark breakers and built-in water pot. 115V 1ph.

Order No.	Mfr. No.	HP	Wheel Dimensions			RPM	Ship Wt.
			Dia.	Arbor	Face		
02599	JBG-8A	1	8"	5/8"	1"	3,450	54 lbs. - 25 kg
02598	JBG-6A	1/2	6"	1/2"	3/4"	3,450	32 lbs. - 15 kg

Vises

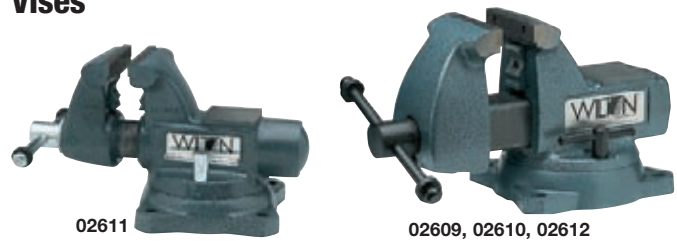

Heavy-duty, hardened steel, serrated jaw faces. Extra-large anvils. Extra-deep throats. Improved pipe jaws. 360° swivel locking bases. Box frame steel channel backbone. Model 1750 also features precision steel round slide bar and extra large 11 sq. in. anvil.

Order No.	Mfr. No.	Jaw Width	Throat Depth	Ship Wt.
02609	744	4"	3 7/16"	39 lbs. - 18 kg
02610	745	5"	3 3/4"	52 lbs. - 24 kg
02612	746	6"	4 1/8"	67 lbs. - 30 kg
02611	1750/1755	5 1/2"	3 3/4"	53 lbs. - 24 kg

Utility Vise



For general clamping applications. Built-in pipe jaws handles various pipe sizes. 180° swivel base with lockdown.

Order No.	Mfr. No.	Jaw Width	Throat Depth	Ship Wt.
02597	656HD	6 1/4"	4 3/16"	64 lbs. - 29 kg

10" Vise Grips



Order No.	Mfr. No.	Description
01046	10R	Vise Grip
01048	10CR	Vise Grip
01051	10WR	Vise Grip

30 LED Work Light

- Lithium-Ion battery holds charge longer with no memory effect
- Weatherproof body & switch
- 5-½ Hours use



Allows freedom of movement and to work without worrying about tangled cords. 360° Rotating nylon swivel hook at the head. 30 LED super-bright, long-life LEDs provide forward directed pure white light. LEDs produce very little heat. 4-Hour recharge time provides up to 5-1/2 hours of continuous operation. 7.2V Rechargeable lithium battery. Includes LED charge indicator. Slim design allows access into tight areas.

Order No.	Description
84502	Cordless LED Inspection Light

Adjustable Wrenches



Order No.	Mfr. No.	Description	Ship Wt.
07471	8004	4" Adjustable Wrench	1 lbs. - 1 kg
07472	8006	6" Adjustable Wrench	1 lbs. - 1 kg
07473	8008	8" Adjustable Wrench	1 lbs. - 1 kg
07474	8010	10" Adjustable Wrench	1 lbs. - 1 kg
07475	8012	12" Adjustable Wrench	2 lbs. - 1 kg
07476	8015	15" Adjustable Wrench	3 lbs. - 2 kg

LED Light with Retractable Reel

- 60 LED Light with 50' retractable reel
- ETL Listed & UL approved



High-quality, impact-resistant polypropylene reel case. Wall or swivel mounting allows it to be used anywhere in the shop. 60 Bulb LED light is rated up to 100,000 hours and is brighter than a conventional trouble light. Features a shatterproof plexiglass bulb cover and an adjustable cord stop.

Order No.	Description	Ship Wt.
45509	60 LED Light with Retractable Reel	13 lbs. - 6 kg

Advantages of LED Lights

Lifetime: LEDs can have a relatively long useful life up to 100,000 hours versus incandescent light bulbs at 1,000–2,000 hours.

Shock resistance: LEDs, being solid state components, are difficult to damage with external shock, unlike incandescent bulbs which are fragile.

Size: LEDs can be very small.

Efficiency: LEDs produce more light per watt than incandescent bulbs.

Cordless LED Inspection Light

- 30 High intensity LEDs
- 8 Hours of continuous use
- Professional Quality durable shock resistant rubber housing
- Includes 110V AC & 12/24 V DC chargers
- Lithium-Ion battery holds charge longer with no memory effect

Fleetline
PROFESSIONAL
By Myers Tire Supply



Ergonomically designed handle for comfort and durability. 30 LEDs provide bright, non-glare light. No memory effect with an active life of approximately 8 hours. Includes swivel hanging hook, desk mount 110v charging station and low battery warning light.

Order No.	Description
45515	Cordless LED Inspection Light

Compact Fluorescent Lights

- For tight places
- Equivalent to 80 watt incandescent



45570



45576
45577

Protected by a shatter proof clear outer housing and internal lamp support system. Energy efficient 13 watt twin tube bulb. Swivel end hook directs the light where you need it. Fully enclosed safety switch.

Order No.	Mfr. No.	Description	Ship Wt.
45576	12006	Compact Light with 25' Cord	3 lbs. - 2 kg
45577	12007	Compact Light with 50' Cord	5 lbs. - 3 kg
45570	103-50R	Compact Light with 40' Cord Reel	10 lbs. - 5 kg
45563	11006-17	Replacement Bulb	

Color: LEDs can emit light of an intended color without the use of the color filters that traditional lighting methods require. This is more efficient and can lower initial costs.

Cycling: LEDs are ideal for use in applications subject to frequent on-off cycling.

Cool light: In contrast to most light sources, LEDs radiate very little heat in the form of IR that can cause damage.

MICROFLEX Diamond Grip Latex

- Powder-Free
- Textured for enhanced wet & dry gripping



Fits the right or left hand, beaded cuff, powder-free interior, textured exterior. White, for single use only.

Order No.	Mfr. No.	Description	Size	Quantity Per Box
45368	MF-300	Diamond Grip	Small	100
45356	MF-300	Diamond Grip	Medium	100
45357	MF-300	Diamond Grip	Large	100
45358	MF-300	Diamond Grip	Extra-Large	100

Safegrip Latex

- Powder-free
- Thicker at the finger tips for protection & durability



Four times thicker than standard gloves. Fits the right or left hand, extended beaded cuff, powder free interior, textured exterior. Blue, for single use only.

Order No.	Mfr. No.	Description	Size	Quantity Per Box
45367	SG-375	SAFEGRIP	Small	50
45353	SG-375	SAFEGRIP	Medium	50
45354	SG-375	SAFEGRIP	Large	50
45355	SG-375	SAFEGRIP	Extra-Large	50

Supreno Nitrile

- Powder-free



Heavy-duty puncture resistant gloves are fully textured for a better grip. easy on and off poly coat. Fits the right or left hand, beaded cuff, powder free interior, textured exterior. Blue, for single use only.

Order No.	Mfr. No.	Description	Size	Quantity Per Box
45366	SU-690	SUPRENO	Small	100
45362	SU-690	SUPRENO	Medium	100
45363	SU-690	SUPRENO	Large	100
45364	SU-690	SUPRENO	Extra-Large	100

Nitrile Gloves

- 5 Mil thick, latex-free, powder-free
- Chemical resistant



Fully textured surface for secure grip, wet or dry. Resists solvents, gas, lubricants, and other chemicals. Stronger and more puncture resistant than regular latex gloves. 100% Non-Sterile nitrile polymer. Gloves fit right and left hands.

Order No.	Mfr. No.	Description	Size	Quantity Per Box
45350	5643	Nitrile Gloves	Medium	100
45351	5644	Nitrile Gloves	Large	100
45352	5645	Nitrile Gloves	Extra-Large	100

Micro One Latex

- Lightly powdered
- Thicker & longer for greater protection



Fits the right or left hand, beaded cuff, lightly powdered with absorbable cornstarch interior, non-texturized exterior. White, for single use only.

Order No.	Mfr. No.	Description	Size	Quantity Per Box
45365	MO-150	MICRO ONE	Small	100
45359	MO-150	MICRO ONE	Medium	100
45360	MO-150	MICRO ONE	Large	100
45361	MO-150	MICRO ONE	Extra-Large	100

DURA-GRIP Latex Gloves

Powder-free, 8 mil thick. Fully textured surface for secure grip, wet or dry. Contour fit. Gloves fit right and left hands. Ship. wt. 3 lbs.



Order No.	Mfr. No.	Description	Size	Quantity Per Box
45369	2243M	Latex Gloves	Medium	100
45370	2244L	Latex Gloves	Large	100
45371	2245XL	Latex Gloves	Extra-Large	100

Nitrile Plus Gloves

Powder-free, latex free, 8 mil thick. Fully textured surface. Extra long 12" cuff for greater protection over the wrist and arm. Gloves fit right and left hands. Ship. wt. 2 lbs.



Order No.	Mfr. No.	Description	Size	Quantity Per Box
45375	6643M	Nitrile Plus Gloves	Medium	50
45376	6644L	Nitrile Plus Gloves	Large	50
45377	6645XL	Nitrile Plus Gloves	Extra-Large	50

Latex Gloves

- Lightly powdered
- Economy - 5 mil thick
- Fully textured surface for secure grip, wet or dry



Protects mechanic's hands and provides great sensitivity. Quality, natural latex gloves. Sold in boxes of 100. Gloves fit right and left hands. Ship. Wt. 3 lbs.

Order No.	Mfr. No.	Description	Size	Quantity Per Box
45307	1143	Latex Gloves	Medium	100
45308	1144	Latex Gloves	Large	100
45309	1145	Latex Gloves	Extra-Large	100

Black Nitrile Mechanics Gloves



Chemical resistant to oil, grease and other common petroleum-based repair and maintenance products. Textured fingers for gripping power on wet or dry objects. Latex-free, powder-free.

Order No.	Mfr. No.	Size	Qty./Box	Ship. Wt.
45394	9943-M	Medium	100	2 lbs. - 1 kg
45395	9944-L	Large	100	2 lbs. - 1 kg
45396	9945-XL	X-Large	100	2 lbs. - 1 kg
45502	9943-XXL	XX-Large	100	2 lbs. - 1 kg

GOJO HiTactile Gloves

- Nitrile palm coating provides superior sensitivity & is slightly tacky for small parts gripping
- Breathable & reusable



Nitrile palm gloves are ideal for electrical, A/C, battery, brake, and engine repair. The palm coating repels liquids and oil. Wipe clean with a shop towel or wash at the sink like washing your hands. The reusable gloves are more economical than disposable gloves. The extended cuff provides a snug fit and additional wrist protection. The weave is breathable so hands stay cooler than in latex or nitrile gloves.

Order No.	Mfr. No.	Description	Size
45382	1431-12	HiTactile Gloves	Large
45383	1431-12	HiTactile Gloves	Extra-Large

GripRight HiTactile Medium Gloves



Order No.	Description	Size
45381	GripRight HiTactile Gloves	Medium

Reusable Mechanics Gloves

- Outstanding gripping power & superior flexibility



Nitrile-coated palm protects hands against oil, grease and other shop grime. Rolled cuff and breathable fabric keeps hands cool in the heat and warm in the cold. Machine washable, will not shrink. Air dry.

Order No.	Description	Size
45378	Mechanics Gloves	Large
45379	Mechanics Gloves	Extra-Large

Anti-Vibration Gloves

- 3MM shock absorbing "Gel" palm padding



Tough spandex top material and hidden seam design eliminates snagging. Flex Airprene knuckle and index finger protection system. Unique split palm design enhances fit. Snug fit design allows greater dexterity. Machine washable, air dry. Color - black.

Order No.	Mfr. No.	Description	Size
45343	143-09	Anti-Vibration Gloves	Medium
45344	143-10	Anti-Vibration Gloves	Large
45345	143-11	Anti-Vibration Gloves	Extra-Large

Insulated Gloves

- 3MM shock absorbing "Gel" palm padding



Full grain leather on the entire palm area insuring water resistance and durability. Flex Airprene knuckle and index finger protection system. Tough insulated spandex top material and hidden seam design eliminates snagging. Snug fit with insulated palm and fingers. Not machine washable. Color - black.

Order No.	Mfr. No.	Description	Size
45346	123-09	Insulated Gloves	Medium
45347	123-10	Insulated Gloves	Large
45348	123-11	Insulated Gloves	Extra-Large

RINGERS Tire Buddy Gloves



High abrasion-resistant palm and padding on the lower palm reduces fatigue. Rubberized fingers.

Order No.	Description
45397	Medium Tire Buddy Gloves
45398	Large Tire Buddy Gloves
45399	Extra-Large Tire Buddy Gloves

Lightning Gloves

- Unique formulation reduces excess chemicals
- Super strength & stretch
- Latex free



Powder free nitrile gloves protects mechanic's hands. Textured grip. Sold in boxes of 100. Gloves fit right and left hands. Ship. Wt. 3 lbs.

Order No.	Description
45295	Black Small
45296	Black Medium
45297	Black Large
45298	Black X-Large
45299	Black XX-Large

Order No.	Description
45287	Orange Small
45288	Orange Medium
45289	Orange Large
45290	Orange X-Large
45291	Orange XX-Large

Heat Insulated Gloves

Retreaders favorite cotton cloth glove. Protection for handling hot molds, mold parts etc. White with red trim. 24 oz.



Order No.	Mfr. No	Description
45300	PE6A	2" Cuff
45301	PE6G	5" Cuff

Green Hot Mill Gloves

Heavy-duty hot mill gloves. Flame-retardant.



Order No.	Mfr. No	Description
45302	SOUFGFBT-PK	2" Cuff
45303	SOUFGFG-P	5" Cuff

Grain Cowhide Driving Gloves

Shirred elastic wrist.



Order No.	Mfr. No	Description
45337	251	Grain Cowhide Gloves

Heavy-Duty Brown Jersey Gloves

Clute cut, brown jersey with knit wrist. 9 oz.



Order No.	Mfr. No	Description
45334	215	Jersey Knit Gloves

Leather Palm Gloves

Split cowhide. Waterproof Safe-T-Cuff. Elastic wrist strap. Leather palm, fingers with shield. Knuckle strap.



Order No.	Mfr. No	Description
45335	1505	2" Cuff
45339	PE-58	5" Gauntlet Cuff

Tire Painting Mitt

- Use with acid-proof glove

Not affected by solvents. Heavy synthetic fleece mitt with knit cuff. Use with 45333 Neoprene gloves to keep hands clean.



Order No.	Mfr. No	Description
46420	PE9-1XL	Tire Paint Mitt

Acid-Proof Gloves

Neoprene covered gloves with knit wrist for cleaning matrices, painting, etc.



Order No.	Mfr. No	Description
45333	PLNE47KW-L	Acid Proof Gloves

Cotton Gloves

Heavy-duty flannel with tough non-slip dots on palm and fingers. White knit wrist. 10 oz.



Order No.	Mfr. No	Description
45330	MX8800	Cotton Gloves

Steel Tapes

White clad 1/4" blade. Black on white with red foot figures.



46737



46736

Order No.	Mfr. No.	Description
46737	W-616	6' Tape
46723	W9212	12' Steel Tape
46736	C213C	50' Steel Tape

Circumference-Diameter Tape

Easy-to-read raised markings in natural steel over black background. Brown leather case. One side in feet; inches and 8ths. Other side diameter equivalents of circumference in diameter feet and inches. Length: 33 feet, claw hook.



Order No.	Mfr. No.	Description	Ship Wt.
46740	261PTH	33' Circumference Diameter Tape	1 lbs. - 1 kg
46747	261PTH-1	Refill	
46724	C106TPM	6.5m Metric Circumference Diameter Tape	

MYERS Truck Tire Dunker

- Easily lift & dunk
- Mounted truck tires
- Handles mounted tires up to 24.5 Duplex



Roll the tire on the ramp. Tire is lifted by actuating the foot valve. Swivel the cradle over the tank and lower. Rotate and inspect the tire in the water filled tank. Reverse the process to remove the tire. Tubes are checked just as easily.

Order No.	Mfr. No.	Description	Ship Wt.
56104	TS-24	Truck Tire Dunker.	575 lbs. - 259 kg

Passenger & RV Tire Dunker

- Rubber-coated metal arms
- Protect specialty wheels
- 360° Turn in water, for fast inspection



Find leaks in tires up to 38" in diameter. Positive air power up and down. Seamless polyethylene tank with a 1 1/2" bottom drain. Includes Caster and Ball Valve Drain Kits.

Order No.	Mfr. No.	Description	Ship Wt.
56105	39ED	Passenger & RV Tire Dunker	230 lbs. - 104 kg
56112	39P-3	Replacement 39" Tank; 24" Deep	34 lbs. - 15 kg

Tire Test Tanks

- Rugged heavy-duty polyethylene will not rust or dent
- Standard or wide models available

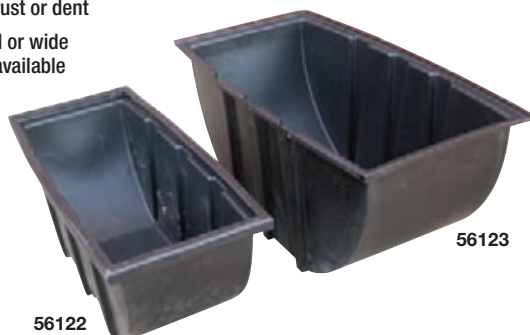

56122: Outside dimensions: 34 1/2" l. x 14 1/2" w. x 13 1/2" h.; inside dimensions: 31" l. x 10 1/4" w. x 12 1/2" h.

56123: Outside dimensions: 37 3/4" l. x 18" w. x 17 1/4" h.; inside dimensions: 35" l. x 15 1/4" w. x 17" h.

Order No.	Mfr. No.	Description	Ship Wt.
56122	HPN-85T	Tire Test Tank.	10 lbs. - 5 kg
56123	HPN-95T	Wide Tire Test Tank for Light Truck Tires	15 lbs. - 7 kg

Truck Tire Tube Dunker

- Positive air power both ways, no springs
- 360° Turn in water, for fast inspection
- Air cylinder submerges tube



Find even the smallest leaks in tubes up to 55" in diameter with the Myers Tube Dunker. Seamless polyethylene tank is accessible from all sides.

Order No.	Mfr. No.	Description	Ship Wt.
56107	55TMG	55" Dia.; 24" Deep	230 lbs. - 104 kg
Replacement Tanks			
56109	55T-3	Replacement 55" Tank; 24" Deep	54 lbs. - 25 kg

Nailhole Leak Detector

- Use for detecting air leaks, separations & final inspection after repairs
- Includes 13"-16" expandable rim

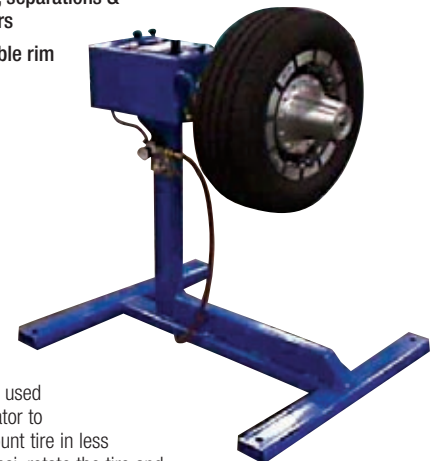

Quickly checks for punctures in used tires. Inflatable rim allows operator to mount, inflate, check and demount tire in less than 30 seconds. Inflate to 25 psi, rotate the tire and spray with leak detector to find leaks fast. Includes 31031 expandable rim 6-3/8" wide for 13"-16.5" tires, filter-regulator and auxiliary air tool connection. 31014 Features foot pedal operation. Requires 120 psi line pressure, 1/4" fpt. Additional expandable rims available, see below.

Order No.	Mfr. No.	PSI	Qty./Box	Ship. Wt.
31016		25	Nailhole Leak Detector	375 lbs. - 169 kg
31014	TTR	25	Rotating Nailhole Leak Detector	375 lbs. - 169 kg
31017	TT	35	High Pressure Nailhole Leak Detector	375 lbs. - 169 kg

Expandable Rims for Leak Detector

- Other sizes available, contact us

Expanding Rims Complete

Rim Order No.	Bead Size	Width
31533	12" - 14"	5"
31031 w/ Machine	13" - 16"	6 3/8"
31536	14" - 17"	7 7/8"
31033	17" - 20"	6 1/2"
31107	20" - 22.5"	8 3/4"
31108	20" - 22.5"	11 3/4"
31110	22" - 24.5"	8 3/4"
31540	22" - 24.5"	9"
31569	22" - 24.5"	13 3/8"



Tire Studs

Tire Studs

- Steel jacket



Precision made tire studs with carbide traction pins encased in a wear resistant jacket. The hole design of the jacket together with the tapered carbide pin help maintain a consistent pin protrusion for the life of the tire.

Sold in boxes of 1,000			
Order No.	Description	Hole Depth Inches	Ship Wt.
51722	#11 Tire Studs	1 ¹ / ₃₂	3 lbs. - 2 kg
51724	#12 Tire Studs	1 ² / ₃₂	4 lbs. - 3 kg
51725	#13 Tire Studs	1 ³ / ₃₂	5 lbs. - 3 kg
51726	#15 Tire Studs	1 ⁵ / ₃₂	5 lbs. - 3 kg
51727	#16 Tire Studs	1 ⁶ / ₃₂	5 lbs. - 3 kg
51728	#17 Tire Studs	1 ⁷ / ₃₂	6 lbs. - 3 kg
Sold in boxes of 500			
51729	#19 Tire Studs	1 ⁹ / ₃₂	7 lbs. - 4 kg
51730	#21 Tire Studs	2 ¹ / ₃₂	9 lbs. - 5 kg

Lightweight Steel Studs

Sold in boxes of 1,000			
Order No.	Description	Hole Depth Inches	Ship Wt.
51716	#12 Lightweight	1 ² / ₃₂	3 lbs. - 2 kg
51717	#13 Lightweight	1 ³ / ₃₂	4 lbs. - 2 kg

Lightweight Aluminum Studs

- Aluminum jacket weigh 50% less
- Reduces road damage

Sold in boxes of 1,000			
Order No.	Description	Hole Depth Inches	Ship Wt.
51718	#12 Lightweight	1 ² / ₃₂	3 lbs. - 1 kg
51719	#13 Lightweight	1 ³ / ₃₂	3 lbs. - 1 kg
51720	#15 Lightweight	1 ⁵ / ₃₂	3 lbs. - 1 kg
51721	#16 Lightweight	1 ⁶ / ₃₂	3 lbs. - 1 kg

Motorcycle Tire Studs

- Carbide-tipped studs provide maximum traction
- For the casual winter rider or extreme off-road racer



Order No.	Description	Size	Per Box
51783	Motorcycle Tire Stud	8 x 13 Rally	1,000
51784	Motorcycle Tire Stud	9 x 17 Rally	500
51785	Motorcycle Tire Stud	9 x 20 Rally	500
51786	Motorcycle Tire Stud	9 x 16 Moto Cross	500
51787	Motorcycle Tire Stud	9 x 18.5 Moto Cross	500
51788	Motorcycle Tire Stud	9 x 20 Moto Cross	500
51789	Motorcycle Tire Stud	9 x 22 Moto Cross	500
51790	Motorcycle Tire Stud	9 x 25 Moto Cross	500

Semi-Automatic Tire Stud Insertion Machine

- Consistent, accurate studding
- Reduces operator fatigue



Installs studs with a push rod to the proper depth without excessive downward pressure on the insertion tool. Used for single and most double-flanged studs. The tire mandrel features 4 ball transfer bearings to easily rotate the heaviest tires. Eight position working heights and swing away tool tray.

Order No.	Description	Ship Wt.
51714	Semi-Automatic Tire Studding Machine	140 lbs. - 63 kg

Stud Installation Work Station



Includes shelf for stud package, gun holder and support for tire stud feeder. Welded steel construction and stable T-shape support. *Base dimensions: 21" x 27", 5' 2" height.*

Order No.	Description	Ship Wt.
51705	K-5 Stud Stand	50 lbs. - 23 kg

Stud Feeder

A fully automatic feeder that provides positive stud orientation. Feeds up to 225 studs per minute. Handles (TSM) sizes #12, #13, #15, #16 and #17. 110V.

Order No.	Mfr. No.	Description
51706	KFP2-1	Stud Feeder
50999	0161	5' Replacement Feeder Hose



Feeder Boy

Holds up to 100 studs. Snap onto base and rotate by hand to release studs into gun chamber. Rugged plastic construction.

Order No.	Mfr. No.	Description	Ship Wt.
51709	4048	Standard Stud Feeder Boy	2 lbs. - 1 kg
51708	4048T	Truck Stud Feeder Boy	2 lbs. - 1 kg



Gun Not Included

Stud Guns

- For automatic feeding



Equipped for automatic feeding of studs to gun. Positive center feed eliminates wrong positioning of studs. Studs installed straight. Easy maintenance – no tools needed. No "push rod" yet fingers are automatically ejected from hole.

Order No.	Mfr. No.	Description	Handles Stud Sizes	Ship Wt.
51700	10	Standard Stud Gun	10-17	4 lbs. - 2 kg
51702	12	Truck Stud Gun	19-21	4 lbs. - 2 kg

Parts For #10 Standard Stud Gun

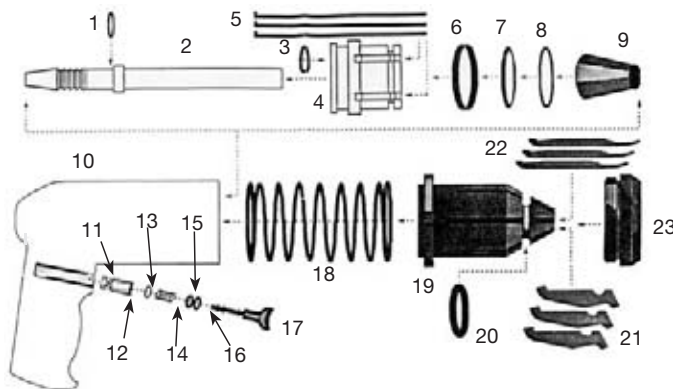

Order No.	Mfr. No.	Description
51733	0382	Repair Kit For #10 Stud Gun – See Below for Contents
51731	0385	Rebuild Kit For #10 Stud Gun – See Below for Contents

Myers No.	Drawing No.	Mfr. No.	Description	Quantity In 51733 Kit	Quantity In 51731 Kit
51767	1	0136	O-Ring	1	1
51748	2	0130-9	Feed Tube	1	1
51761	3	0383	Piston Cup – Small	1	1
51744	4	0129	Piston	1	1
51743	5	0126	Inserting Finger	6	3
51738	6	0092	Piston Cup – Large	1	1
51752	7	0135	Steel Ring	1	1
51736	8	0088	O-Ring	2	1
51749	9	0131	Tapered Sleeve	1	1
51779	10	0128	Handle	–	–
51773	11	0099	Trigger Sleeve	–	–
51741	12	0096	Trigger Pin	1	1
51737	13	0089	O-Ring	1	1
51739	14	0095	Trigger Spring	1	1
51765	15	0091	O-Ring	1	1
51764	16	0090	O-Ring	1	1
51742	17	0098	Trigger	1	1
51769	18	0134	Compression Spring	1	1
51750	19	0132-9	Head	–	–
51735	20	0087	O-Ring	2	1
51766	21	0127	Internal Finger	3	3
51734	22	0084	External Finger	3	3
51751	23	0133	Ring Nut	1	1

ST Saf-Tee Tire Siper

- For siping mounted tires
- Fast, three to four minutes per tire



Sipe any tire from 12" to 24.5" with appropriate adapters. Exclusive spiral cut creates "tie bars" at bottom of scalloped sipe to strengthen tread components. Siping does not affect the tire warranty of major tire manufacturers. Any type of tire can be siped as long as it has $\frac{1}{32}$ " of tread. Depth and width of sipe can be changed in seconds. Includes 12 cutting blades, four lead screws for siping depths of $\frac{1}{32}$ ", $\frac{7}{32}$ ", $\frac{1}{8}$ " and $\frac{1}{4}$ ", and a file.

Order No.	Mfr. No.	Description	Ship Wt.
42941	ST	Tire Siper w/ 1 kg hp, 110 kg V Motor, Adapters Sold Separately	275 lbs. - 124 kg
Recommended Adapters/Accessories			
42943	18.071	Replacement Blade for Siper – Heat Treated. Will Sipe 50 kg -75 kg Used, Up to 100 kg New Tires.	
42947		Universal Passenger Adapter for Mounted Tires from 12 kg " to 16 kg .5 kg "	10 lbs. - 5 kg
42938	33.901	10 kg Hole Budd Adapter for Mounted Truck Tires	17 lbs. - 8 kg
42939	1.959	Optional Ramp for Use with Truck Tires	36 kg lbs. - 16 kg

Additional adapters available. Specify type of wheel.

BRANICK Tire Cutter

- Gas or electric

Cuts through tires up to 50" diameter and 19" wide. The powerful hydraulic system cuts through steel belted tires in one revolution. Features a 25 gallon oil reservoir for cooler running during heavy use, two valve start insures hands free operation. 3- Gauge panel monitors valve input, cylinder pressure and orbit motor pressure. High strength cutting blade. 208/230/208/460, 60 cycle, 3 ph motor.



Order No.	Mfr. No.	Description	Ship Wt.
84017	HD/BTC	Electric Tire Cutter	2,655 lbs. - 1195 kg
84014	HD/BTC/G	Gas Tire Cutter 18 HP	2,655 lbs. - 1195 kg
70360	885-006	Replacement Blade	14 lbs. - 6 kg

Bead Notcher

- Eliminate liability on unwanted used tires
- Handles all passenger & truck tires
- Renders tires useless in seconds

Cuts a $\frac{1}{2}$ " notch through the beads of unwanted used tires. Tires cannot be mounted or resold. Roll the tire into the jaws and activate the hydraulic lever. Cuts the bead in seconds. Heat treated, tool steel jaws can be rotated and resharpened saving time and containing costs. 2 hp, 115/230V, 30 amp 1ph motor.



Order No.	Mfr. No.	Description	Ship Wt.
84010	TC-60	Bead Notcher	500 lbs. - 225 kg

Patch Rubber

Myers Tire Supply is your tire repair & retread materials headquarters. Founded in 1947, **PATCH RUBBER COMPANY** manufactures the most complete line of tire retreading & repair materials in the industry. From 1/8" Pilot Wire Patch Plugs to 72" EMR giant tire repair units **PATCH RUBBER** has the tire repair products customers need to run their business efficiently & successfully. Through Myers Tire Supply, **PATCH RUBBER** representatives conduct hands-on puncture & section repair training classes. The "Do It Right" classes follow industry-approved procedures & techniques to repair passenger, truck, & OTR tires.



Training materials and seminars are available from Patch Rubber Company.

Puncture Repair

The Do It Right! Program promotes four basic steps for repairing a punctured tire:

Inspect It!



Remove the tire from the wheel for proper inspection of the injury.

Drill It!



Drill the injury to remove any exposed cord.

Fill It!



Fill the injury with a stem or plug unit to seal out moisture and prevent contamination.

Seal It!



Seal the innerliner with a repair unit to prevent air loss.

"Do It Right" Training Classes



Attendees receive a "Certificate Of Participation" when the class is completed.

It is important that the technician performing industry-approved tire repairs for your business be properly trained. Patch Rubber Company's commitment to service involves providing both the specialized training needed to make industry-approved repairs and the materials necessary to reinforce proper repair approved procedures. Patch Rubber Company and Myers Tire Supply provide the training, tools and supplies required to correctly repair tires according to industry established guidelines.

Puncture Repair for Passenger Tires

Detailed instructions for puncture repairs up to 1/4" in radial and bias tires.

Puncture Repair for Truck Tires

Detailed instructions for puncture repairs up to 3/8" in radial and bias truck tires.

Section Repair for Bias & Radial Tires

Instructions for section repairs in bias or radial tires. Manual details repair procedures using a spotter and repairs during the retread cycle.

Section Repair for OTR Tires

A comprehensive OTR tire Section repair manual is available. Sections cover bias & radial tires using dual cure, heat cure, uncured and clothback units.



FREE On-Site Tire Repair Training

- Puncture & section repair classes available
- Repair speed rated tires
- FREE classes for passenger, truck & OTR tires
- Increase your profit by repairing punctures following RMA guidelines for permanent tire repairs
- Hands-on training, not just videos and lectures!
- Limit your liability by learning how to repair punctured tires to manufacturers' specifications
- Call today to schedule your free training 1-800-998-9897

“Do It Right” Tire Repair Kit

- Everything needed to make industry approved tire repairs to radial passenger & light truck tires



Kit includes (1) each of the following repair materials, Pilot Wire Patch Plugs 1/8", 18 per box (14040); Pilot Wire Patch Plugs 1/4", 18 per box (14041); 1 quart Bead Dressing (16118); 1 pint Repair Sealer (16170); 1/2 pint Fast Dry Cement (16451); 1 quart Cleaner Fluid (16471) and (1) each of the following tools and supplies, Pliers (01061); Akro ALC Container (39085); Blue Akro-Mils Shelf Bin (30130B); Low Speed Buffer/Reamer (31675); 1/2" Reversible Drill (31200M); stitcher (42614); knife (42500); brush (46000); Innerliner Scraper (42620); Adapter For 3/16" Burr (42375); 3/16" Extended Point Burr (42378); Long Pencil Point 1/8" Carbide Cutting Tool (42393); 1/8" Shaft Adapter with Set Screw (42497); Buffing Stone (42642); box of 12 white Paintstik (45121); Probe Awl (47024); Allen wrench (86766); and Safety Glasses (82664)

Order No.	Description	Ship Wt.
47108	Tire Repair Kit for Auto Dealerships	20 lbs. - 9 kg

Puncture Pac Truck Tire Repair Kit

- Put one in your service truck & one in the shop



A compact kit with all the required tools and patch supplies needed to make fast permanent puncture repairs to radial and bias ply passenger and truck tires. Kit includes following repair materials, (30) 2 3/16" All-Rubber Patch (14202); (20) "Bullseye" 10 Radial Patch (12117); (20) "Bullseye" 12 Radial Patch (12118); (20) 2" Reinforced Bias Patch (12021), (24) 3" Reinforced Bias Patch (12142); (1) box (40) 1/4" Plug Stem (14569); (1) box (25) 3/8" Plug Stem (14570); 1 Qt. Bead Dressing (16118); 1 Pt. Repair Sealer (16170); 1/2 Pt. Fast-Dry Cement (16451); 1 Qt. Cleaner Fluid (16471); (6) Pull-Thru Wires (14526), and (1) each of the following tools and supplies, Adapter for 3/16" Burr (42375); 3/16" Extended Point Burr (42378); 5/16" Extended Point Burr (42379); Adapter for 3/16" Burr (42376); Buffing Stone (42642); Adapter for Buffing Stone (42420); box of 12 white Paintstik (45121); Pliers (01061); brush (46000); Low Speed Buffer/Reamer (31675); Flexible Blade Knife (42500); Stitcher (42614); Innerliner Scraper (42620); Probe Awl (47024); Safety Glasses (82599); Allen wrench (86766); and Heavy-Duty Tool Box (45588); 1/2" Reversible Drill (31200M)

Order No.	Description	Ship Wt.
47107	Truck Tire Repair Kit	21 lbs. - 10 kg

Puncture Pac Passenger Tire Repair Kit



A compact kit with all the required tools and patch supplies needed to make fast permanent puncture repairs to radial passenger and light truck tires. Kit includes the following repair materials, 2 boxes (20) "Bullseye" 10 Radial Patch (12117); (1) box (50) UP2 Universal Patch 2 1/8" x 2 1/8" (14209); (1) box (40) 1/4" Plug Stem (14569); (6) Pull-Thru Wires (14526); 1 Qt. Bead Dressing (16118); 1 Pt. Repair Sealer (16170); 1/2 Pt. Fast-Dry Cement (16451); 1 Qt. Cleaner Fluid (16471), and (1) each of the following tools and supplies, 3/16" Extended Point Burr (42378); Adapter for 3/16" Burr (42375); Buffing Stone (42642); Adapter for Buffing Stone (42420); box of 12 white tire Crayons (45121); Pliers (01061); Low Speed Buffer/Reamer (31675); Flexible Blade Knife (42500); Stitcher (42614); Innerliner Scraper (42620); Brass Bristle Brush (46000); Probe Awl (47024); Safety Glasses (82599); Allen wrench (86766); and Heavy-Duty Tool Box (45588); 1/2" Reversible Drill (31200M)

Order No.	Description	Ship Wt.
47106	Passenger Tire Repair Kit	18 lbs. - 8 kg

Patch “Do It Right” Cabinet



(Tools and supplies sold separately)

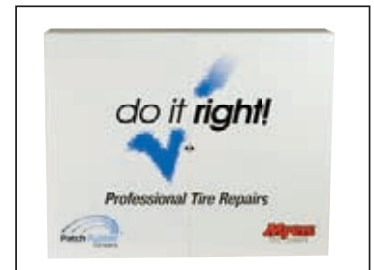

Organize and store all the tools and supplies required to perform professional repairs in passenger or truck tires. Heavy-duty, 24-gauge steel cabinet to hang on a wall or set on workbench. Magnetic locking double doors open to 60" wide. Includes built-in tool rack and small parts tray. 24" h. x 30" w. x 12" d. Supplies sold separately.

Order No.	Description
14219	Dispenser Cabinet

Tire Repair Tip:

- Always stitch tire repair units from the center outward to avoid trapping air. Trapping air under the repair unit may cause repair failure.

Patch Rubber Tire Puncture Repair

Plug Stems

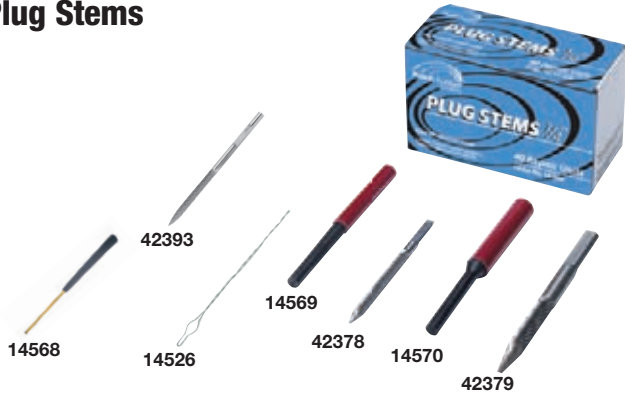

Use to fill injuries in conjunction with carbide cutters and/or plug cutters. Rubber cured plug covered with Dual Cure Cushion Gum for filling injuries. Apply with Fast-Dry Cement see page 253.

Order No.	Size Inches	Size mm	Qty. Box	Carbide Cutters*
14568	1/8	3	50	42393
14569	1/4	6	40	42378
14570	3/8	10	25	42379
14571	1/2	15	25	42373
14572	3/4	15	20	42164
14574	1	25	15	42367
14576	1 1/4	30	10	N/A
14526	Pulling Wire		1	

Bow Tie Inserts

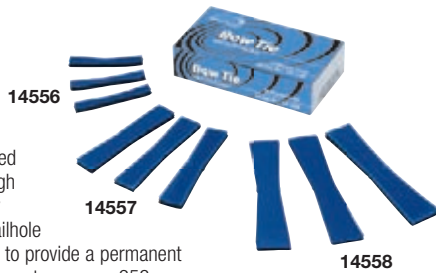

These inserts are manufactured with a specially formulated high tensile rubber and covered by Dual Cure Cushion Gum. A nailhole repair unit should be installed to provide a permanent repair. Apply with Fast-Dry Cement see page 253.

Order No.	Description	Size Inches	Size mm	Qty. Box
14556	Passenger Bow Tie	3/8 x 2 3/8	10 x 60	50
14557	Truck Bow Tie	3/8 x 3 1/8	15 x 80	20
14558	EW Bow Tie	3/4 x 4	20 x 100	20

Repair Inserts

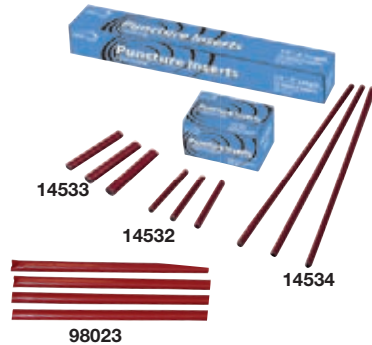

All inserts are composed of a core of cured rubber covered with Dual Cure Cushion Gum. The large diameter OTR EM Oval Inserts help eliminate "ganging" smaller inserts to repair punctures in OTR tires. A combination of compression and chemical vulcanization locks inserts into the injury. Apply with Fast-Dry Cement see page 253.

Order No.	Description	Mfr No.	Size Inches	Size mm	Qty Box
14532	Round Insert	R 2	1/4 x 2	6 x 50	20
14534	Round Insert	R 8	1/4 x 8	6 x 200	15
14533	Oval Insert	O 2	3/8 x 2	10 x 50	20
14535	Oval Insert	O 9	3/8 x 9	10 x 230	15
98023	OTR Insert	EM	1/2 x 8	15 x 200	10

Note: Plug Stems are for use in the crown area on passenger, light truck, and truck tires. They should always be used as part of a two-piece repair with a repair unit to seal the innerliner.

Pilot Wire Patch Plugs

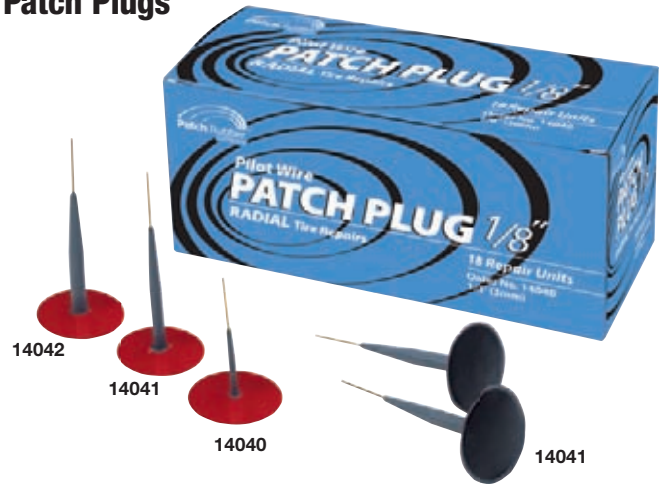

The combination patch plugs fills and seals the injury in one step. Use the 1/8" units to seal pinhole leaks, keeping the injury as small as possible. The 1/8" unit is also acceptable for the repair of Z-rated tires in the tread only. 1/4" units are the maximum puncture repair limit for passenger and light truck tires. Choose any of the Patch Plug repairs for truck tire punctures up to 3/8".

The wire tip, molded into the repair units, eliminates pull-thru wires and makes them easy to thread through the injury from inside the tire. The stem and repair unit are coated with Dual Cure Cushion Gum creating a permanent bond to the tire with increased adhesion compared to chemical cure repair units. Apply with Fast-Dry Cement see page 253.

The proper carbide cutter reams and standardizes the injury for the installation of the Pilot Wire Patch Plug (see chart).

Order No.	Size Inches	Size mm	Patch Dia. Inches	Patch Dia. mm	Qty. Box	Carbide Cutters*
14040	1/8	3	1 3/4	45	18	42393
14041	1/4	6	1 3/4	45	18	42378
14042	3/8	10	1 3/4	45	18	42379

Quilled Patch Plugs



Use for crown puncture repairs in bias and radial passenger and truck tires. The metal quill facilitates insertion and protects the plug from damage in steel belted tires.

Order No.	Mfr. Code	Stem Dia. Inches	Stem Dia. mm	Patch Dia. Inches	Patch Dia. mm	Qty. Box	Carbide Cutters
14508	QPP 2	1/4	6	2 1/4	55	25	42378
14509	QPP 3	5/16	8	2 1/4	55	25	42395
14510	QPP 4	3/8	10	1	100	10	42379
14511	QPP 5	1/2	15	4	100	10	42373

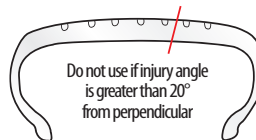

Note: Pilot Wire Patch Plugs are for use in the crown area on passenger, light truck, and truck tires if the angle of penetration is not more than 20° from the perpendicular. If the angle is greater than 20° use a separate plug stem and the appropriate repair unit.

Chemical Cure Tube Patches



Chemical Cure Repair Units are molded to a feather edge and feature a chemical curing base gum with the ultimate in green tack, along with extended poly backing for ease of removal and installation. Apply with Fast-Dry Cement see page 253.

Dispenser Box

Patch Pack

Order No.	Mfr. Code	Inches	Size mm	Qty. Box	Order No.	Mfr. Code	Qty. Pkg.
Round							
12000	PR 0	1 1/4	30	100	12040	PP 0	200
12001	PR 1	1 3/4	35	30	12041	PP 1	150
12002	PR 2	2	50	30	12042	PP 2	100
12003	PR 3	2 1/4	55	30	12043	PP 3	100
12016	PR 4	3	75	30	12044	PP 4	50
12018	PR 5	3 3/4	90	10	-	-	-
12019	PR 6	4 1/2	115	10	-	-	-
Oval							
12005	PR 7	1 3/4 x 3	35 x 75	30	-	-	-
12006	PR 7A	2 x 4 1/4	50 x 110	30	-	-	-
12008	PR 7C	3 1/2 x 6	90 x 150	10	-	-	-
12010	PR 7D	4 1/2 x 8	115 x 200	10	-	-	-
12012	PR 7E	5 1/2 x 10	140 x 255	10	-	-	-

Dual Cure Tube Patches



Dual Cure Repair Units feature a base gum that cures chemically or with heat. This soft, high-tack gum is less prone to problems associated with moisture, handling and cement drying time. Apply with Fast-Dry Cement see page 253.

Order No.	Mfr. Code	Description	Size		Qty. Box
			Inches	mm	
14201	SR	Small Round	1 3/4	40	40
14202	MR	Medium Round	2 3/4	55	30
14203	LR	Large Round	3	75	20
14204	SO	Small, Oval	1 3/4 x 2 1/4	35 x 55	30
14205	MO	Medium Oval	2 x 4	50 x 100	20
14225	PP SR	Small Round Patch Pack	1 3/4	40	150
14226	PP MR	Medium Round Patch Pack	2 3/4	55	125
14227	PP LR	Large Round Patch Pack	3	75	50

Round Repair Units



Non-directional round repair unit for puncture repairs in radial tires. Use with appropriate plug filler material, see page 250. Apply with Fast-Dry Cement see page 253.

Order No.	Mfr. Code	Inches	Size mm	Qty. Box
97935	RSR	1 3/4	45	30
97936	RMR	2 1/4	55	25
97937	RLR	3 1/4	80	15

Bullseye Repair Units



Bullseye Repair Units provide maximum reinforcement and adhesion making them the preferred patch for the "Do It Right!" industry-approved repair method. Use with appropriate plug filler material, see page 250. Apply with Fast-Dry Cement see page 253.

Order No.	Mfr. Code	Inches	Size mm	Qty. Box
12117	BUL DC 10	2 1/4 x 2 3/4	55 x 70	20
12118	BUL DC 12	2 3/4 x 4 1/4	65 x 110	10
12090	BUL DC 20	2 1/4 x 4 3/4	70 x 115	10
12091	BUL DC 22	2 7/8 x 5 1/2	75 x 140	10

Bias Repairs



Used for puncture repairs in bias ply passenger, light truck, and truck tires. Each unit features a large, reinforced platform providing added strength while maintaining maximum flexibility. Use with appropriate plug filler material, see page 250. Apply with Fast-Dry Cement see page 253.

Order No.	Mfr. Code	Inches	Size mm	Qty. Box
12021	CX 1	1 3/4	45	20
12022	CX 2	2 3/4	60	20
12023	CX 3	3 1/4	85	10
12024	CX 4	4 3/4	120	10

Universal Patch



Universally used for puncture injuries in every type of tire: passenger, light truck, truck, bias, radial, tubeless or tube-type. Special compound formulation makes a simplified repair for everything from pinholes to 3/8" punctures. Use with appropriate plug filler material, see page 250. Apply with Fast-Dry Cement see page 253.

Order No.	Mfr. Code	Inches	Size mm	Qty. Box	Order No.	Mfr. Code	Qty. Pkg.
14208	UP 1	1 7/8 x 1 7/8	50 x 50	100	-	-	-
14209	UP 2	2 1/4 x 2 1/4	55 x 55	50	14211	TB UP 2	200
14210	UP 3	2 3/4 x 2 3/4	65 x 65	50	14212	TB UP 3	150

Patch Rubber Emergency Tire Repairs

Radial Repairs



Specifically constructed for puncture repairs in radial tires. SM RAD and MD RAD feature a large, reinforced platform providing added strength while maintaining maximum flexibility. Use with appropriate plug filler material, see page 250. Apply with Fast-Dry Cement see page 253.

Order No.	Mfr. Code	Size Inches	mm	Qty. Box	Order No.	Mfr. Code	Qty. Pkg.
12211	SM RAD	1 3/4 x 3 1/16	45 x 80	20	12213	PP SM RAD	75
12212	MD RAD	2 1/16 x 4 1/4	50 x 110	10	12214	PP MD RAD	50

Plug Gun & Plugs



Features a manual Plug Gun which easily inserts an all rubber mushroom headed plug securely into the injury. Standard nozzle (15026) will accommodate both 5/16" and 3/8" diameter plugs. The (15027) nozzle is required for 7/16" plugs. Gun includes 5/16" and 7/16" nozzle.

Plug Gun		Plug	
Order No.	Description	Order No.	Size (inches)
15025	Manual Plug Gun	15033	5/16
15026	5/16 Repl. Nozzle	15032	3/8
15027	7/16 Repl. Nozzles	15034	7/16

Heavy-Duty String Repairs



Constructed of twisted cord permeated with butyl rubber. The high tensile cord assures no breakage during insertion while the soft and tacky butyl rubber seals the injury. Passenger and truck kits are available, complete with all required tools for repairing bias and radial tires.

Order No.	Description
15057	Passenger Repair Kit
Refill No.	15058 50 Passenger H.D. Strings
	15066 T-Handle with Needle Split Eye
	15067 Pass. Needle Split Eye
	15065 T-Handle with Spiral Cement Tool
15060	Truck Repair Kit
Refill No.	15061 25 Truck H.D. Strings
	15069 T-Handle with Needle Split Eye
	15070 Truck Needle Split Eye
	15065 T-Handle with Spiral Cement Tool

Mono-Fil Inserts

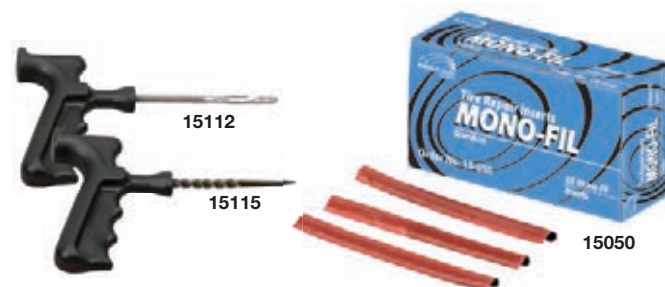

Mono-Fil Inserts utilize a nylon reinforced material with a Dual Cure Cushion Gum allowing the unit to be inserted without cutting or tearing and ensures a Dual Cure Vulcanization to create a solid bond with the tire. When used with an appropriate repair unit, a permanent repair is achieved. Apply with Fast-Dry Self-Vulcanizing Cement see page 253.

Order No.	Description	Size Inches	mm	Qty. Box
15049	Mini Mono-Fil	7/32	6	50
15050	Pass. Mono-Fil	1/4	6	50
15112	Split Eye Insert Tool	-	-	1
15115	Spiral Cement Tool	-	-	1

Black String Repairs



Black rubber coated strings are designed for puncture repairs in bias ply tires.

Order No.	Description	Qty. Box
15158	Black String	50
15111	Closed Eye Insert Tool	1

Repair Kits



Tools, cement and materials to perform emergency repairs on bicycle, auto, truck, and tractor tires. Also suitable for repairs to inner tubes, rubber sporting goods, rain gear, and other rubber goods.

Order No.	Description
15274	Bicycle Kit, 5 Repair Units, Cement & Scraper
15275	Motorists Kit, 4 Repair Units, Cement & Scraper
15276	Truck Kit, 22 Repair Units, Cement & Scraper
15277	Tractor Kit, 33 Repair Units, Cement & Scraper

WARNING: The repair materials on this page are for emergency temporary repairs only. The damaged tire should be taken to a repair facility and removed from the rim for inspection and a proper repair.

Fast-Dry Self-Vulcanizing Cement

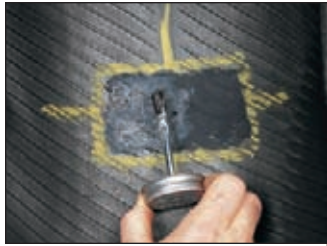

Developed to reduce drying time. Fast-Dry Self-Vulcanizing Cement eliminates the most common cause of failed repairs – lack of proper drying time. Flammable. Flash point -4°F. Shelf life 1 year.

Order No.	Size	Per Case	Ship Wt.
16451	½ Pt	12	7 lbs. - 3 kg
16450	1 Qt	6	11 lbs. - 5 kg
16452	1 Gal	4	32 lbs. - 14 kg

H.V. Chemical Cement

- Blue color aids application

Specially formulated for applications where a tackier cemented surface is required. Fast drying solvent reduces waiting time and repair failures due to wet cement. Use with Dual Cure or Heat Cure repair units. Blue color enables the repairman to see where cement has been applied. Contains no carcinogenic chlorinated solvents. Flammable. Flash point -4°F. Shelf life 1 year.



Order No.	Size	Per Case	Ship Wt.
16460	8 Oz	12	6 lbs. - 3 kg

Cleaner Fluid



Dissolves lubricants and contaminants prior to buffing. Also used to help remove excessive buffing dust prior to applying repair units. Its cleaning action maximizes adhesion. Available in an aerosol (non-flammable mixture) or spout type (flammable mixture – Flash point -4°F) can.

Order No.	Size	Per Case	Ship Wt.
Aerosol (Flammable)			
16483	10 Oz.	12	11 lbs. - 5 kg
Liquid (Flammable)			
16471	1 Qt.	6	12 lbs. - 5 kg
16472	1 Gal.	4	32 lbs. - 14 kg

Bead Sealer



Bead Sealer is a thick, high-solid content, black sealant. Brush on the beads of tubeless tires during mounting. Forms an air tight seal between the tire and rim reducing bead leaks. Quick, economical and profitable way to end comebacks from bead leaks. Flammable. Flash point 14°F. Shelf life 1 year.

Order No.	Description	Size	Per Case	Ship Wt.
16118	Bead Sealer	1 Qt.	6	12 lbs. - 5 kg
16119	Bead Sealer	1 Gal.	4	32 lbs. - 14 kg

Repair Sealer

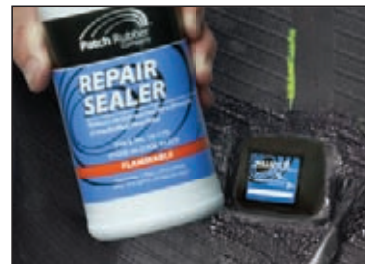

Used to restore the air impermeability of an overbuffed or damaged innerliner. Can be used in a service application or prior to the repair/retreading cycle. Flammable material. Flash point 14°F. Shelf life 1 year.

Order No.	Description	Size	Per Case	Ship Wt.
16170	Repair Sealer	1 Pt.	12	6 lbs. - 3 kg
16171	Repair Sealer	1 Gal.	4	32 lbs. - 15 kg

Citra-Clean Pre-Buff Cleaner Fluid

- Environmentally-friendly
- Use to clean innerliner prior to buffing

Made from orange peels to dissolve lubricants and contaminants prior to buffing. Its cleaning action maximizes adhesion. Spout type (flammable mixture – Flash point -4°F) quart can.



Order No.	Size	Per Case	Ship Wt.
16485	1 Qt	6	12 lbs. - 5 kg

Patch Rubber Radial & Bias Repair Units

Bullseye Radial Repair Units



Used to repair puncture and section injuries in passenger, light truck, heavy-duty truck and farm tractor radial tires. Bullseye Repair Units can be centered over the injury because of special cord reinforcement and ply construction. This special construction reduces the effects of flexing and reduces inventory requirements since they can be used for crown, shoulder and sidewall repairs. Specify Dual Cure or Heat Cure Units to maximize the tire repair performance of the repair system. Apply Dual Cure Units with Fast-Dry Cement (see page 253.) and Heat Cure Units with appropriate cement required for the repair system.



Bullseye Radial Passenger & Truck Repairs

Dual Cure

Heat Cure



Order No.	Mfr. Code	Order No.	Mfr. Code	Size		Qty. Box
				Inches	mm	
12117	BUL DC 10	12217	BUL HC 10	2 1/8 x 2 13/16	55 x 70	20
12118	BUL DC 12	12218	BUL HC 12	2 9/16 x 4 1/4	65 x 110	10
12119	BUL DC 14	12219	BUL HC 14	3 x 5 1/4	75 x 135	10
12090	BUL DC 20	12290	BUL HC 20	2 11/16 x 4 9/16	70 x 115	10
12091	BUL DC 22	12291	BUL HC 22	2 7/8 x 5 1/2	75 x 140	10
12092	BUL DC 24	12292	BUL HC 24	2 7/8 x 7 5/8	75 x 195	10
12089	BUL DC 26	12289	BUL HC 26	3 1/2 x 10	90 x 255	10
12093	BUL DC 40	12293	BUL HC 40	4 1/8 x 8 1/8	105 x 205	10
12094	BUL DC 42	12294	BUL HC 42	5 1/4 x 10 1/4	135 x 260	10
12095	BUL DC 44	12295	BUL HC 44	5 1/8 x 13	130 x 330	10

Bullseye Radial Tractor Repairs

Dual Cure



Order No.	Mfr. Code	Size		Qty. Box
		Inches	mm.	
12060	BUL DC 80	5 3/4 x 8	145 x 205	5
12061	BUL DC 82	7 3/8 x 9 7/8	190 x 250	5
12062	BUL DC 84	8 1/4 x 11 1/2	210 x 290	5
12063	BUL DC 86	9 3/4 x 13 3/4	250 x 350	5

Bullseye Reinforced Shoulder Repairs



NOTE: For repair of punctures up to 3/8" in commercial, tractor, grader and haul tires. Both ends of the repair unit must be anchored in non-flex zones.

Dual Cure

Order No.	Mfr. Code	Size		Qty. Box
		Inches	mm	
12118	BUL DC 12	2 9/16 x 4 1/4	65 x 110	10
12119	BUL DC 14	3 x 5 1/4	75 x 135	10
12090	BUL DC 20	2 11/16 x 4 9/16	70 x 115	10
12092	BUL DC 24	2 7/8 x 7 5/8	75 x 195	10
12101	BUL DC 37	5 x 7 1/2	125 x 190	10
12093	BUL DC 40	4 1/8 x 8 1/8	105 x 205	10
12095	BUL DC 44	5 1/8 x 13	130 x 330	10

Bullseye Radial Crown Truck Repairs

Dual Cure

Heat Cure



Order No.	Mfr. Code	Order No.	Mfr. Code	Size		Qty. Box
				Inches	mm	
12096	BUL DC 33	12296	BUL HC 33	4 x 5 3/8	100 x 130	
12097	BUL DC 35	12297	BUL HC 35	5 x 6 1/4	125 x 160	10
12101	BUL DC 37	12301	BUL HC 37	5 x 7 1/2	125 x 190	10

CX Bias Passenger & Truck Repairs

Used for puncture, reinforced and section repairs in passenger, light truck, heavy-duty truck and tractor bias ply, tube-type or tubeless tires. Made with full-ply construction, die cut and molded to a compact octagonal shape for strength and ease of installation. Specify Dual Cure or Heat Cure Units to maximize the tire repair performance. Apply Dual Cure Units with Fast-Dry Cement (see page 253.) and Heat Cure Units with appropriate cement required for the repair system.

Dual Cure

Heat Cure



Order No.	Mfr. Code	Order No.	Mfr. Code	Size			Qty. Box
				Inches	mm	Ply	
12142	CX DC 3-2	12542	CX HC 3-2	3	75	2	24
12143	CX DC 4-2	12543	CX HC 4-2	3 13/16	95	2	12
12145	CX DC 6-2	12545	CX HC 6-2	6	150	2	12
12146	CX DC 5-3	12546	CX HC 5-3	5	125	3	12
12147	CX DC 7-3	12547	CX HC 7-3	7 1/4	185	3	12
12148	CX DC 6-4	12548	CX HC 6-4	6	150	4	12
12150	CX DC 8-4	12550	CX HC 8-4	8 1/4	210	4	12
12151	CX DC 10-4			10	255	4	12
12153	CX DC 13-4			13	330	4	6
12154	CX DC 16-4			16	405	4	6
12155	CX DC 9-6			9	230	6	12
12156	CX DC 12-6			12	305	6	6
12157	CX DC 15-6			15	380	6	6
12158	CX DC 16-8			16	405	8	6
12159	CX DC 18-8			18	460	8	6



RFID Units

- Inside or outside of tire applications

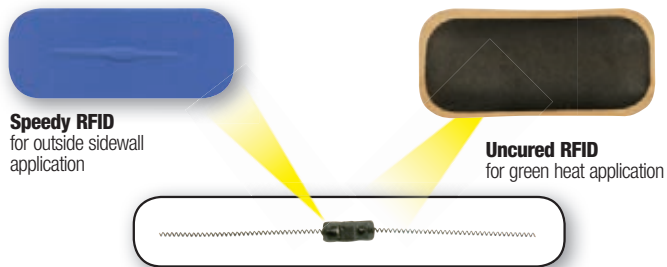

Record serial, manufacturer, and product numbers all in the same RFID. Ideal for commercial fleets, OEs, Government and aircraft. RFID reduces or eliminates the numerous labels applied to tires. Readers may be tethered to a PC, tethered to a PDA or PDA integrated. Speedy Tag for outside of tire application and cured unit for green/heat application. Many choices of readers and suppliers exist.

Order No.	Mfr. Code	Description	Qty. Box
98273	Gen 2	Gen 2 NXP Cured RFID	10
98267	Gen 2	Gen 2 NXP Speedy RFID	10

Identification Labels



Dual-curing, high-profile identification labels apply easily and permanently to any tire and most rubber products. Available in a variety of colors, shapes and sizes with custom imprints.

Order No.	Description	Qty. Box
12242	1 3/8 Color Label - Specify Color	500
98000	Custom ID Decal	

Sidewall Repair Identification Labels

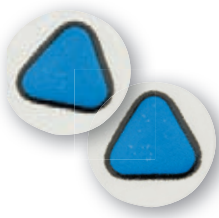

Blue triangle indicates a reinforced sidewall section repair has been made to the tire.

Order No.	Description	Qty. Box
12231	Blue Triangle	100

"Do It Right" Cabinet



(Tools and supplies sold separately)

Organize and store all the tools and supplies required to perform professional repairs in passenger or truck tires. Heavy-duty, 24-gauge steel cabinet to hang on a wall or set on workbench. Magnetic locking double doors open to 60" wide. Includes built-in tool rack and small parts tray. 24" h. x 30" w. x 12" d. Supplies sold separately.

Order No.	Description
14219	Dispenser Cabinet

Tire Track

- Permanently bonds to new or used tire casings
- Barcode is cut deeply into the rubber for permanent identification.
- Will not wear off



Tire-Track, is a sequential, permanent rubber bar code label designed for tire identification, tire management, tire tracking or tire inventory programs. The unit replaces tire branding and provides a barcode and eye readable number. It can also include an industry approved RFID sensor for tires. Applies to the outside sidewall using only chemical cement. The unit is a two-piece design featuring a Primer Gum. Contact us for specific questions.

Order No.	Description	Qty. Box
98979	CLV ID	250
98977	Primer Gum	500

Balance Pads



Install in the crown area for proper tire balance in passenger, truck and aircraft tires. A dual-curing, high-gravity balance pad available in precise, controlled weights of 1/2 to 10 ounces.

Order No.	Weight oz.	gr	Qty. Box
14601	1/2	14	25
14600	3/4	21	25
14602	1	28	25
14603	1 1/2	43	25
14604	2	57	25
14605	2 1/2	71	25
14606	3	85	25

Order No.	Weight oz.	gr	Qty. Box
14607	3 1/2	99	25
14608	4	113	25
14609	4 1/2	128	25
14610	5	142	25
14611	6	170	25
14613	8	227	25
14615	10	283	25

Oval Boots



Oval Boot feature a shape for quick and easy installation. Oval Boots are designed for temporary emergency repairs in truck and farm tires. Units made from cord-impregnated rubber provide a smooth, non-chaffing top surface. Apply with Black Repair Cement, see page 262.

Order No.	Mfr Code	Description	Size Inches	mm	Qty. Box
15251	1T	Oval Boot	4 x 5	100 x 125	50
15252	2T	Oval Boot	5 1/2 x 8	140 x 200	50
15253	3T	Oval Boot	7 x 10	180 x 255	50
15254	4T	Oval Boot	9 x 12	230 x 305	25
15255	5T	Oval Boot	10 x 14	255 x 355	25
15256	6T	Oval Boot	12 x 15	305 x 380	10

Patch Rubber OTR Repair Units

HEAT SHIELD

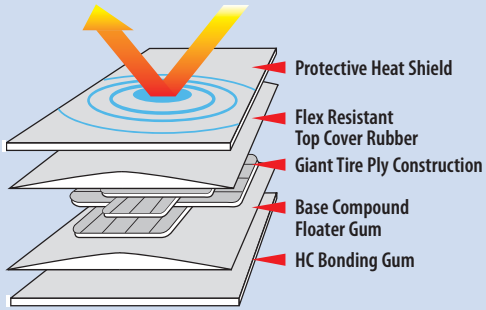

All Heat Cure Giant Tire Repair Units are covered with a special heat-resistant layer and marked by a Heat Shield Protected decal. This Heat Shield protects the entire repair unit from oxidation and heat degradation caused by the extreme operating temperatures common in giant tires.

Bullseye Radial OTR Repair Units



For section repairs in radial-ply off-the-road tires. These Bullseye Units feature an elongated stepdown between plies, together with additional top cover stock allowing the repair units to be centered over the injury and anchored in any flex area of the tire.

Bullseye Radial Repairs

Dual Cure		Heat Cure		Inches	Size mm	Qty. Box
Order No.	Mfr. Code	Order No.	Mfr. Code			
12070	BUL DC 46	12270	BUL HC 46	6 1/4 x 17 1/4	155 x 440	5
12071	BUL DC 50	12271	BUL HC 50	8 1/2 x 23	215 x 585	5
12072	BUL DC 52	12272	BUL HC 52	10 1/2 x 23 1/2	265 x 595	5
12073	BUL DC 56	12273	BUL HC 56	11 1/2 x 29 1/2	290 x 750	2
12074	BUL DC 60	12274	BUL HC 60	11 1/2 x 39 1/2	290 x 1005	2

Bullseye Radial Crown Repairs

Clothback		Heat Cure		Inches	Size mm	Qty. Box
Order No.	Mfr. Code	Order No.	Mfr. Code			
12069	BUL DC 45	12269	BUL HC 45	9 x 7 1/2	230 x 190	5
12075	BUL DC 55	12275	BUL HC 55	13 x 10	330 x 255	5
12076	BUL DC 65	12276	BUL HC 65	16 x 12	405 x 305	3
12077	BUL DC 75	12277	BUL HC 75	21 x 17	535 x 430	3

What are Aramid fibers?

A synthetic material that is stronger than its weight in steel. Due to its light weight, superior strength, and temperature resistance, Aramid fibers are used in products subjected to extreme environmental conditions. When infused with rubber in a tire repair unit, Aramid fibers create a lightweight, flexible extremely durable repair unit.

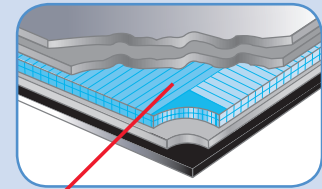

Reinforced with Aramid Fibers

STS Bullseye Radial OTR Repair Units

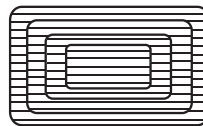

Advanced technology combines high strength with light weight to create a stronger, more flexible repair unit making them easier to install. The reinforcing Aramid fibers are stronger and lighter than nylon or steel reinforced units. The stronger STS units reduce the "bulge effect" in radial sidewall section repairs. Clothback products provide extended shelf-life and must be installed with 18-150 floater gum see pg. 261.

Bullseye Radial Repair Units

Clothback		Heat Cure		Inches	Size mm	Qty. Box
Order No.	Mfr. Code	Order No.	Mfr. Code			
13946	BUL CB 46 STS	13846	BUL HC 46 STS	5 x 16	125 x 405	5
13950	BUL CB 50 STS	13850	BUL HC 50 STS	7 x 21	180 x 535	5
13952	BUL CB 52 STS	13852	BUL HC 52 STS	9 x 21	230 x 535	5
13956	BUL CB 56 STS	13856	BUL HC 56 STS	9 x 28	230 x 710	2
13960	BUL CB 60 STS	13860	BUL HC 60 STS	10 x 38	255 x 965	2

Bullseye Radial Crown Repairs

Clothback		Heat Cure		Inches	Size mm	Qty. Box
Order No.	Mfr. Code	Order No.	Mfr. Code			
13945	BUL CB 45 STS	13845	BUL HC 45 STS	9 x 7 1/2	230 x 190	5
13955	BUL CB 55 STS	13855	BUL HC 55 STS	13 x 10	330 x 255	5
13965	BUL CB 65 STS	13865	BUL HC 65 STS	17 x 13 1/2	430 x 345	3
13975	BUL CB 75 STS	13875	BUL HC 75 STS	21 x 17	535 x 430	3
13985	BUL CB 85 STS	13885	BUL HC 85 STS	29 x 22 1/2	735 x 570	1

EMR Radial Repair Units

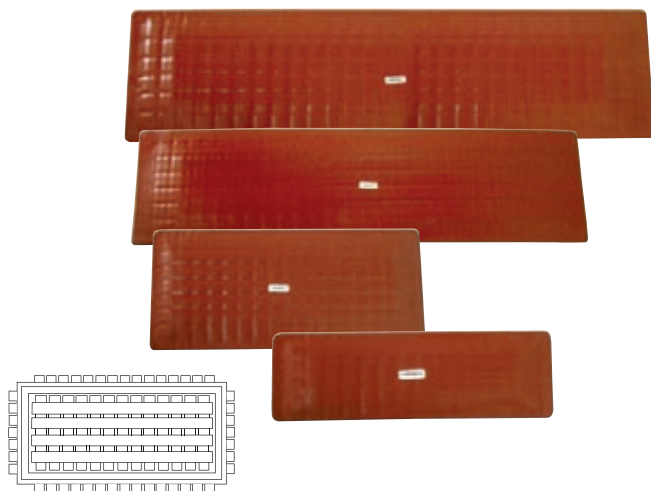

For section repairs in radial ply off-the-road tires. A combination of EM and radial tire construction techniques have created a specially-reinforced radial, off-the-road tire repair, which is extremely flexible and is equally suited for larger sidewall and shoulder injuries. Apply with Black Repair Cement see page 248.

Uncured

Order No.	Mfr. Code	Size		Qty. Box
		Inches	mm	
10295	EMR 15	5 x 16	125 x 405	5
10296	EMR 20	9 x 20	230 x 510	5
10297	EMR 27	10 x 27	255 x 685	5
10298	EMR 38	10 x 38	255 x 965	5

For non-flex to non-flex application.

Wide-Base EMR Repair Units

A larger version of the EMR Radial Repair units. These Wide-Base EMR repair units have more surface area for increased adhesion. A strong repair for severe repair service on haulage tire or other off-road tires. Apply with Black Repair Cement see page 248.

Uncured

Order No.	Mfr. Code	Size		Qty. Box
		Inches	mm	
10300	EMR 40 WB	17 1/2 x 40	445 x 1015	3
10301	EMR 20 WB	11 x 20	280 x 510	5
10302	EMR 27WB	13 1/2 x 27	345 x 685	5
10303	EMR 15 WB	7 x 15 1/2	180 x 395	5

For non-flex to non-flex application.

Bullseye Radial Tractor Repairs



For tread and sidewall section repairs in radial off-the-road tires. Bullseye Radial Tractor Repairs are constructed of one-directional fabric for reinforcement of the radial ply package. Special rubber compound gives maximum adhesion and resists over cures and the effects of radial tire flexing. Apply with Fast-Dry Cement see page 253.

Dual Cure

Order No.	Mfr. Code	Size		Qty. Box
		Inches	mm	
12060	BUL DC 80	5 3/4 x 8	145 x 205	5
12061	BUL DC 82	7 3/8 x 9 7/8	185 x 250	5
12062	BUL DC 84	8 1/4 x 11 1/2	210 x 290	5
12063	BUL DC 86	9 3/4 x 13 3/4	250 x 350	5

EMR-K Giant Tire Radial Repairs



Embedded Aramid cord platform limits or eliminates sidewall bulge

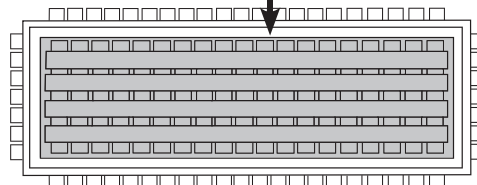

Radial haulage tires are the most abused tires in use today. The giant tires are subject to long hauls at high speeds in over-loaded conditions causing heat build-up and injuries.

The lengths of these new EMR-K Radial Repair units ensure both ends are "anchored" in Non-flex areas at the bead and the crown. The units are reinforced with Aramid fiber to limit or eliminate sidewall bulges that sometimes occur. The units may be cured in autoclaves and section molds. Heat pads for fixed and flexible Monarch Vulcanizing and Vulcan Vulcap systems are available.

Uncured

Order No.	Mfr. Code	Size		Qty. Box
		Inches	mm	
For 51" Radial Tires				
10250	EMR-K51	51 x 10	1295 x 255	3
10260	EMR-K 51WB	51 x 17 1/2	1295 x 445	5
For 57" Radial Tires				
10251	EMR-K 57	57 x 10	1450 x 255	5
10261	EMR-57KWB	57 x 17 1/2	1450 x 445	5
For 63" Radial Tires				
10252	EMR-K 63	63 x 10	1600 x 255	5
10262	EMR-K 63WB	63 x 17 1/2	1600 x 445	5

"Do It Right" Training Classes



do it right!



It is important that the technician performing industry-approved tire repairs for your business be properly trained. Patch Rubber Company's commitment to service involves providing both the specialized training needed to make industry-approved repairs and the materials necessary to reinforce proper repair approved procedures. Patch Rubber Company and Myers Tire Supply provide the training, tools and supplies required to correctly repair tires according to industry established guidelines.

Patch Rubber OTR Repair Units

EM Bias Repair Units

For reinforcement and section repairs in bias ply off-the-road tires. The EM Repair Units have plies made from strips of cord overlaid in an intricately-spaced design to form a "square lattice". This design allows the repair unit to flex with the tire.

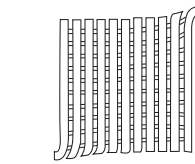

Uncured		Dual Cure		Heat Cure		Size		Qty. Box
Order No.	Mfr. Code	Order No.	Mfr. Code	Order No.	Mfr. Code	Inches	mm	
10304	EM 4	12304	EM DC 4	12404	EM HC 4	8 3/4	220	15
10306	EM 6	12306	EM DC 6	12406	EM HC 6	10 3/4	260	10
10308	EM 8	12308	EM DC 8	12408	EM HC 8	12 7/8	325	8
10310	EM 10	12310	EM DC 10	12410	EM HC 10	14 7/8	380	6
10312	EM 12	12312	EM DC 12	12412	EM HC 12	17 3/4	440	5
10314	EM 14	12314	EM DC 14	12414	EM HC 14	18 3/4	475	5
10316	EM 16	12316	EM DC 16	12416	EM HC 16	21	535	2
10318	EM 18	12318	EM DC 18	12418	EM HC 18	23 3/4	590	1
10320	EM DC 20	12320	EM DC 20	12420	EM HC 20	27 3/4	690	1

Uncured OTR Bias Repair Units

For reinforcement and section repairs in bias ply off-the-road tires, the OTR Repair Units have solid-ply construction, providing a large platform repair area in a smaller patch. Die-cut edges distribute the cord-end stresses across a radiused area, preventing lifting of the cord edges.

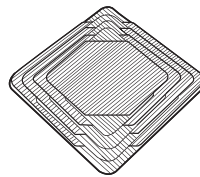

Order No.	Mfr. Code	Size		Qty. Box
		Inches	mm	
10340	OTR 4	6	150	10
10342	OTR 6	8	205	10
10344	OTR 8	10	255	10
10346	OTR 10	12	305	5
10348	OTR 12	14	355	5
10350	OTR 14	16	405	5
10352	OTR 16	18	460	2
10354	OTR 18	20	510	1
10356	OTR 20	24	610	1

Under Tread Repairs Bias Repairs



Compact repair units for reinforced and section repairs in truck and off-the-road tires. Constructed of specially-cut and fabricated plies, these units can be counter-sunk into the buffed casing in the crown area and cured during the retread process. Use in conjunction with bias ply repair units to make a sandwich repair.

Order No.	Mfr. Code	Size		Qty. Box
		Inches	mm	
10105	UT 6-4	6 x 4	150 x 100	25
10108	UT 8-4	8 x 4	200 x 100	20
10110	UT 10-6	10 x 6	255 x 150	10
10111	UT 12-8	12 x 8	305 x 205	5
10112	UT 14-10	14 x 10	355 x 255	5

Apply with Black Repair Cement, see pg 262

Self-Vulcanizing Cement

- Activates vulcanization to bond patch to the tire casing



Self-Vulcanizing cement dries quickly to speed repair process. Flammable, flash point -4° F. 1-year shelf life.

Order No.	Description	Size	Per Case	Ship Wt.
94391	Self-Vulcanizing Cement	8 oz.	12	1 lbs. - 1 kg

Rubber Solvent

- Dissolves lubricants & contaminants



Removes excess buffing dust. Provides clean surface for maximum adhesion. Flammable, flash point 0° F.

Order No.	Description	Size	Per Case	Ship Wt.
94392	Rubber Solvent	1 Qt.	6	2 lbs. - 1 kg

Tube Patches

- For any size tube repair



Chemically cures at room temperature. Use with Vulcatek Self-Vulcanizing Cement.

Order No.	Description	Size		Qty. Box
		Inch	mm	
Round Tube Patches				
94300	CVT 0	1 1/4	30	50
94301	CVT 1	1 3/8	35	50
94302	CVT 2	1 3/4	45	25
94303	CVT 3	2 1/4	55	25
94304	CVT 4	2 7/8	75	25
94305	CVT 5	3 3/16	80	10
Oval Tube Patches				
94306	CVT 02	1 1/16 x 1 1/32	25 x 30	50
94307	CVT 07	2 7/8 x 1 3/8	75 x 35	25
94308	CVT 08	4 5/32 x 1 3/4	105 x 45	25

Universal Patches

- For puncture repairs in every type of tire – bias or radial, tubeless or tube-type



Chemically cures at room temperature or with heat and pressure. Use with Vulcatek Self-Vulcanizing Cement and plug filler material.

Order No.	Description	Size		Qty. Box
		Inch	mm	
94211	CVUP 1	2	51	40
94212	CVUP 2	2 3/8	60	30
94213	CVUP 3	3 1/2	82	25

Bias Patches

- For repairs to bias ply passenger, light truck and truck tires



Full ply construction with a compact shape for strength and easy installation. Chemically cures at room temperature or with heat and pressure. Use with Vulcatek Self-Vulcanizing Cement and plug filler material.

Order No.	Description	Size		Qty. Box
		Inch	mm	
94221	CVB 32	3 3/16	90	25
94222	CVB 42	4 9/16	115	25
94223	CVB 52	5 3/4	145	10
94224	CVB 64	6	150	10
94225	CVB 106	10	255	5
94226	CVB 126	12	305	5

Repair Sealer

- Repairs damaged or overbuffed innerliner & seals repairs

Flammable, flash point 14° F. 1-year shelf life

Order No.	Description	Size	Per Case	Ship Wt.
94393	Repair Sealer	1 Pt.	12	1 lbs. - 1 kg



Radial Patches

- For repairs to radial ply passenger, light truck & truck tires



Suitable for crown, shoulder and sidewall repairs. Special cord and ply construction allows repair units to be centered over the injury. Chemically cures at room temperature or with heat and pressure. Use with Vulcatek Self-Vulcanizing Cement.

Order No.	Description	Size		Qty. Box
		Inch	mm	
94231	CVR 10	2 1/8 x 2 13/16	55 x 70	10
94232	CVR 12	2 3/8 x 4 1/8	60 x 105	10
94233	CVR 14	2 7/8 x 5	75 x 125	10
94234	CVR 20	2 7/8 x 4 3/4	75 x 105	10
94235	CVR 22	2 7/8 x 6	75 x 150	10
94236	CVR 24	2 7/8 x 8 1/8	75 x 205	10
94237	CVR 40	4 x 7 3/8	100 x 195	5
94238	CVR 42	5 x 10	125 x 255	5
94239	CVR 44	5 x 13	125 x 330	5

Pilot Wire Patch Plugs

- Use for puncture repairs in radial passenger & truck tires
- Combination patch & plug fills & seals in one step



Order No.	Inches	Size		Patch Dia.		Qty. Box
		mm	Inch	mm		
94340	1/8"	3	1 1/16	40	18	
94341	1/4"	6	1 3/8	50	18	
94342	3/8"	10	1 7/8	50	18	

Pilot Wire Plug Stems

- Use for puncture repairs in radial passenger & truck tires
- Rubber cured plug covered with Dual Cure Cushion Gum



Order No.	Description	Size		Qty. Box
		Inch	mm	
94251	1/8" Plug Stem	1/8	3	5
94253	1/4" Plug Stem	1/4	6	5
94255	3/8" Plug Stem	3/8	10	5

Bead Sealer

- Brush on beads of tubeless tires during mounting to form an airtight seal between tire & rim

Flammable, flash point 14° F. 1-year shelf life.

Order No.	Description	Size	Per Case	Ship Wt.
94394	Bead Sealer	1 Qt.	6	2 lbs. - 1 kg



Patch Rubber Precure Cushion

Skidder/Tractor Bias Repairs



These repair units feature a large ply platform to accommodate the large injuries commonly found in skidder and tractor section repairs, yet are lightweight and flexible in light ply tires. The multi-directional repair units may be applied parallel or perpendicular to the beads to properly repair any type of injury.

Dual Cure

Order No.	Mfr. Code	Size		Ply	Qty. Box
		Inches	mm		
12431	SKD DC 1	9 x 12	230 x 305	4	5
12432	SKD DC 2	11 x 15	280 x 380	4	5
12433	SKD DC 3	12 x 17	305 x 430	4	5
12434	SKD DC 4	13 x 19	330 x 485	4	5
12435	SKD-DC 5	9 x 12	230 x 305	6	5
12436	SKD DC 6	11 x 15	280 x 380	6	5
12437	SKD DC 7	12 x 17	305 x 430	6	5
12438	SKD DC 8	13 x 19	330 x 485	6	5
12451	HDSK DC 6	11 x 15	280 x 380	8	5
12452	HDSK DC 7	11 x 15	280 x 380	10	5
12453	HDSK DC 8	12 x 17	305 x 430	10	5
12454	HDSK DC 9	13 x 19	330 x 485	10	5

OTR Repair Inserts & Tools

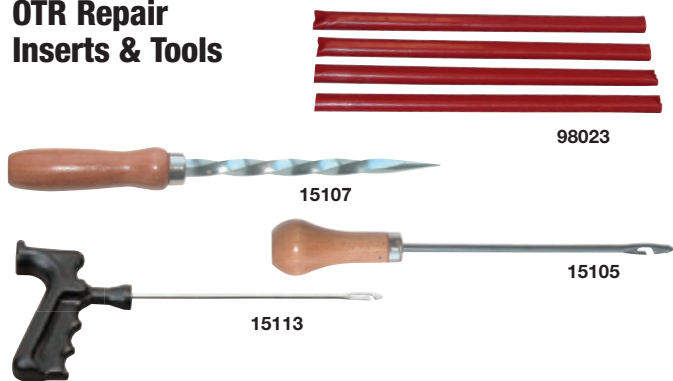

These new large diameter EM Oval Inserts help eliminate "ganging" smaller inserts to repair punctures in OTR tires. The inserts are composed of a core of cured rubber covered with Dual Cure Cushion Gum.

Dual Cure

Order No.	Mfr. No.	Description	Size		Qty. Box
			Inches	mm	
98023	EM	OTR Insert	½ x 8	15 x 205	10
15113		Open Eye OTR Insert Tool			
15105		OTR Insert Tool			
15107		OTR Spiral Cement Tool			

Quick Cure Tube Gum

RMA Cure Class 15A/20C

Reduce the time it takes to repair tubes, rubber products and vulcanize tube-replacement valves. Quick cure rate: 15 min/280° F, 20 min/260° F. Shelf life: 1 year. Use with Brush-Type Cement, see page 262.

Order No.	Width x Gauge	Ship Wt.
15151	9 x ¼ 230 x 1.5	5 lbs. - 2 kg

Precure Cushion Gum



RMA Cure Class 10A/15C

Use as an undertread bonding gum to vulcanize the precure tread to the casing. May be used as splicing gum and repair material for buzz-outs and exposed cords. Excellent heat and overcure resistant properties. Features uniform gauge tolerances and superior building tack. Stable curing compound for distortion-free tread appearance. Yield approximately 14 tires per box. Cure rate: 8 min/280° F, 15 min/260° F. Shelf life: 3 months. Use with Spray-Type Retread and Vulcanizing Cement, see page 262.

Order No.	Inches	Size	mm	Ship Wt.
18270	5 ½ x .060		145 x 1.5	35 lbs. - 16 kg
18272	6 ¼ x .060		160 x 1.5	35 lbs. - 16 kg
18274	6 ¾ x .060		170 x 1.5	35 lbs. - 16 kg
18271	7 x .060		180 x 1.5	35 lbs. - 16 kg
18273	7 ⅝ x .060		195 x 1.5	35 lbs. - 16 kg
18275	8 ¼ x .060		210 x 1.5	35 lbs. - 16 kg
18277	8 ¾ x .060		220 x 1.5	35 lbs. - 16 kg
18278	9 ¼ x .060		235 x 1.5	35 lbs. - 16 kg

Precure Cushion Strip



Cure rate: 8 min/280° F, 15 min/260° F. Shelf life: 3 months.

Order No.	Inches	Size	mm	Ship Wt.
18265	2 ⅝ x ¾		55 x 10	160 lbs. - 73 kg

Patch Fast Gum

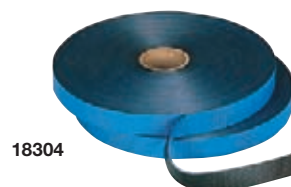

RMA Cure Class 10A/15C

Use for general purpose repairing to reduce cure time. Developed for fast curing at a wide range of temperatures. Has excellent resistance to overcure. Suitable for all types of repairs. Cure rate: 8 min/280° F, 15 min/260° F. Shelf life: 3 months.

Order No.	Inches	Size	mm	Ship Wt.
18304	1 x ¼		25 x 1.5	30 lbs. - 14 kg

Cushion Gum

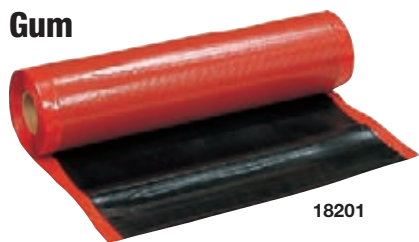

18201

RMA Cure Class 20A/35C

Fill buzz-outs over exposed cords, spot repairs, reinforce repairs and section repairs. Natural rubber compound with excellent tack and workability. Cure rate: 20 min/280° F, 35 min/260° F. Shelf life: 1 year. Use with Brush-Type Cement, see page 262.

Order No.	Size		Ship Wt.
	Inches	mm	
18202	18 x 1/4	460 x .4	10 lbs. - 5 kg
18198	2 x 1/2	50 x .8	30 lbs. - 14 kg
18199	3 x 1/2	75 x .8	30 lbs. - 14 kg
18191	4 x 1/2	100 x .8	25 lbs. - 12 kg
18193	6 x 1/2	150 x .8	25 lbs. - 12 kg
18201	18 x 1/2	460 x .8	10 lbs. - 5 kg
18196	4 x 1/16	100 x 1.5	25 lbs. - 12 kg
18197	6 x 1/16	150 x 1.5	25 lbs. - 12 kg
18200	18 x 1/16	460 x 1.5	10 lbs. - 5 kg

Tread Gum



18207

RMA Cure Class 20A/35C

Use to make repairs exposed to wear and/or weather conditions. Tough, abrasion-resistant compound with excellent finishing and wearing qualities. Cure rate: 20 min/280° F, 35 min/260° F. Shelf life: 1 year. Use with Brush-Type Cement, see page 262.

Order No.	Size		Ship Wt.
	Inches	mm	
18207	18 x 1/16	460 x 1.5	10 lbs. - 5 kg

All-Purpose Gum



15044

RMA Cure Class 20A/35C

Multi-purpose repair gum combines the properties of cushion and tread gums. Soft and pliable to enhance workability in all types of repairs. Cure rate: 20 min/280° F, 35 min/260° F. Shelf life: 1 year. Use with Brush-Type Cement, see page 262.

Order No.	Size		Ship Wt.
	Inches	mm	
15044	18 x 1/8	460 x .3	10 lbs. - 5 kg
15045	18 x 1/16	460 x 1.5	10 lbs. - 5 kg
15046	7 x 1/4	180 x 6	25 lbs. - 12 kg

Stripping Stock



18222

RMA Cure Class 20A/35C

Free-flowing stock for stripping edges of tread rubber to cover overbuff and improve sidewall appearance. Cure rate: 20 min/280° F, 35 min/260° F. Shelf life: 1 year. Use with Brush-Type Cement, see page 262.

Order No.	Size		Ship Wt.
	Inches	mm	
18222	1 x 1/16	25 x 1.5	25 lbs. - 12 kg
18223	2 x 1/16	50 x 1.5	25 lbs. - 12 kg
18225	3 x 1/16	75 x 1.5	25 lbs. - 12 kg

Butyl Innerliner Gum

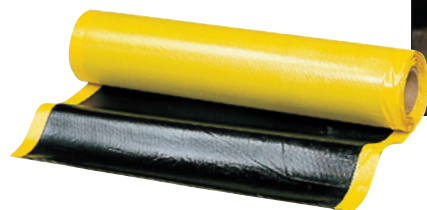

RMA Cure Class 20A/35C

Use in conjunction with an uncured repair unit as a cover stock to protect the finished repair from heat degradation and cracking caused by the extreme operating temperatures common in giant tires. Butyl Innerliner Gum assures air impermeability of the repair and can also be used to repair the damaged innerliner. Cure Rate: 20 min/280° F, 40 min/260° F. Shelf life: 6 months. Use with Brush-Type Cement, see page 262.

Order No.	Width x Gauge		Ship Wt.
	Inches	mm	
18156	18 x 1/16	460 x 1.5	10 lbs. - 5 kg

Floater Gum



All-natural gum specially compounded to use with EM patches. High flex-resistant quality floater gum acts as a shock absorber between the tire and EM patch. Shelf life: 1 year. Use with Black Brush Type Cement. Cure Rate: 20 min/280° F, 40 min/260° F. Shelf life: 6 months. Use with Brush-Type Cement, see page 262.

Order No.	Width x Gauge		Ship Wt.
	Inches	mm	
18150	18 x 1/8	460 x 3	10 lbs. - 5 kg

Chem-Gum

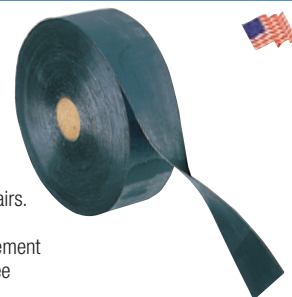

Chemical Cure

Use for field service repairs such as tread and shoulder snags, cuts in sidewalls and bead repairs. Compounded to cure chemically. Shelf life: 6 months. Apply with Fast Dry Self-Vulcanizing Cement to both sides of gum for proper vulcanization see page 253.

Order No.	Width x Gauge		Ship Wt.
	Inches	mm	
18317	9 x .045	230 x 1.1	10 lbs. - 5 kg

Repair Cords



15007

Use to build reinforced repairs to tires, conveyor belting and other types of fabric-reinforced rubber goods. High tensile-strength tire cord calendered with high-quality skim compound to a uniform gauge. Cure rate: 30 min/280° F, 50 min/260° F. Shelf life: 1 year. Use with Brush-Type Cement, see page 262.

Order No.	Description	Width x Gauge		Ship Wt.
		Inches	mm	
15007	Nylon	29 x 3/64	735 x 1.2	19 lbs. - 9 kg
15009	Polyester	29 x 3/64	735 x 1.2	19 lbs. - 9 kg
98006	Nylon Sq. Woven	28 x 3/64	710 x 1.2	15 lbs. - 7 kg
98001	Nylon H.D. Sq. Woven	28 x 1/16	710 x 1.5	15 lbs. - 7 kg
98007	Aramid Cord	28 x .045	710 x 1.1	15 lbs. - 7 kg
98008	Aramid Cord	56 x .045	1420 x 1.1	15 lbs. - 7 kg

Patch Rubber Cements

Black Repair Cement



16327

Use for buzz-outs, exposed fabric and with uncured gums. A fast-drying, penetrating, heat-curing cement. Use with repairs that are vulcanized with heat and pressure. (Section, reinforced and spot repairs.) Flammable. Flash point below 0° F. Shelf life: 1 year.

Order No.	Size	liter	Ship Wt.	Per Case
16325	1 Qt	1.0	12 5	6
16326	1 Gal	3.8	32 15	4
16327	5 Gal	18.9	39 18	1

V-10 Extruder Cement



16346

This widely-used retread cement is formulated for maximum green tack on hot extruded strip or die-sized rubber applications. Humidity and/or temperature does not affect green tack properties. Flammable. Flash point below 0° F. Shelf life: 1 year.

Order No.	Size	liter	Ship Wt.
16346	5 Gal	18.9	35 lbs. - 16 kg
16348	54 Gal	205	385 lbs. - 173 kg

Fiber Bond Cement



16350

A high solid content cement for hot and cold tread rubber application. Available in spray or brush type for retreading and repairing. Excellent adhesion and tack in all humidity conditions. Flammable. Flash point below 0° F. Shelf life: 1 year.

Order No.	Size	liter	Ship Wt.
16354	5 Gal. Spray Type	18.9	35 lbs. - 16 kg
16355	54 Gal. Spray Type	205	385 lbs. - 173 kg
16349	1 Gal Brush Type	3.8	8 lbs. - 4 kg
16350	5 Gal Brush Type	18.9	35 lbs. - 16 kg
16351	54 Gal Brush Type	205	418 lbs. - 188 kg

Rubber Solvent



16221

A high grade solvent used for thinning solvent based products. Flammable. Flash point below 0° F.

Order No.	Size	liter	Ship Wt.
16220	1 Gal	3.8	6 lbs. - 3 kg
16221	5 Gal	18.9	35 lbs. - 16 kg
16222	54 Gal	205	385 lbs. - 173 kg

Butyl Innerliner Sealer



16290



16291

This two part mixture, when brushed onto damaged innerliners, will cure at room temperature and renew the air retention properties of the innerliner. Heavy, viscous butyl cement to be mixed with activator. Once ingredients are mixed, sealer is usable for up to 3 hours. Flammable. Flash point below 0°F. Shelf life: 1 year.

Order No.	Item	Size	liter	Ship Wt.
16290	Sealer	1 Gal	3.8	9 lbs. - 4 kg
16239	Activator	50cc Tube	—	1 lbs. - 5 kg
16291	Sealer	5 Gal	18.9	40 lbs. - 18 kg
16240	Activator	250cc Can	—	2 lbs. - 1 kg

Water Base EF-10 Retread Cement



Performs like conventional retreading cements, contains no hazardous materials, and is Non-flammable. Color changes from light gray to flat black as cement dries, indicating when it is ready to continue the retread process. Compatible with all mold cure and preure retreading systems. Apply with high volume/low pressure spray equipment. Yields over 300 tires per pail.

Order No.	Item	Size	liter	Ship Wt.
16360	WB EF-10 Spray Type	5 Gal	18.9	43 lbs. - 20 kg
16370	WB Cleaning Solution	5 Gal	18.9	43 lbs. - 20 kg

Extruder Rope

- RMA Cure Class 10A/15C
- Recommended for final tread applications only



All Purpose Extruder Rope. A soft extrudable compound that eliminates air pockets, flows easily into contours and crevices of buzz-outs. Made with Fast Cure material. Consistent quality reduces gun maintenance problems. Cure rate 8 minutes at 280°F, 15 minutes at 260°F. Shelf life 3 months. Use with Black Brush Type Cement. *See below for export shipment. (Sold per lb.)

Order No.	Description	Width		Ship Wt.
		Inches	mm	
18122	Extruder Rope	3/8"	10	25 lbs. - 11 kg

Tread Rope

- RMA Cure Class 20A/35C
- Recommended for final tread applications only



Formulated to provide a finished repair with tread rubber qualities yet is still easily processed through the extruder gun. Cure rate 20 minutes at 280°F, 35 minutes at 260°F. Shelf life 1 year. Use with Black Brush Type Cement (16325).

Order No.	Description	Width		Ship Wt.
		Inches	mm	
18118	Tread Rope	3/8"	10	25 lbs. - 11 kg

Giant Tire Extruder Rope

- RMA Cure Class 12A/18C



A custom formulated extruder rope for OTR tire repairs. Giant Tire Extruder Rope bridges the gap between standard extruder rope and tread rope. One rope for both uses. Cure rate: 8 min/280°F, 15 min/260°F. Shelf life 6 months. Use with Black Brush Type Cement, see page 262.

Order No.	Description	Width		Ship Wt.
		Inches	mm	
18116	Giant Tire Extruder Rope	3/8"	10	30 lbs. - 14 kg

Clean Out Rope for Extruder Guns



CAUTION: Clean extruder guns thoroughly if unused for 20 minutes. Operation with cured rubber in the barrel may cause the extruder to bind resulting in severe damage.

Extruder clean out rope will not cure. It is used at the end of the shift to flush out all the regular extruder rope in the barrel. The next morning, after the extruder gun is heated to operating temperature, the operator feeds regular extruder rope and flushes through the gun until all the white material is ejected through the tip. A 5 lb. carton includes ten 10 ft. rolls of white extruder rope.

Order No.	Description	Ship Wt.
14994	Extruder Gun Clean Out Rope	6 lbs. - 3 kg

Black & Tan Rope Rubber

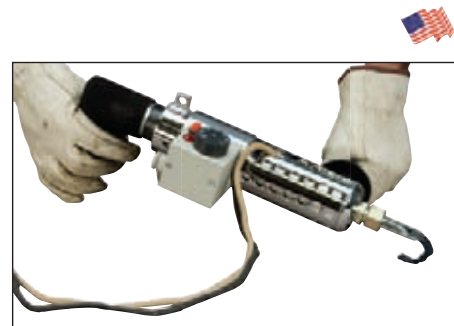

Feed Black and Tan Extruder Rope through an extruder gun to form a repair putty. Once it is properly mixed, the repair putty compound chemically cures at room temperature. Apply with Black Repair Cement (16325). Caution: Use Extruder Clean Out Rope (14994) to push out the mixed Black and Tan compound.

Order No.	Description	Width		Ship Wt.
		Inches	mm	
18120	Tan Extruder Rope	3/4	6	10 lbs. - 5 kg
18121	Black Extruder Rope	3/4	6	10 lbs. - 5 kg



FREE On-Site Tire Repair Training

- Puncture & section repair classes available
- Repair speed rated tires
- FREE classes for passenger, truck & OTR tires
- Increase your profit by repairing punctures following RMA guidelines for permanent tire repairs
- Hands-on training, not just videos and lectures!
- Limit your liability by learning how to repair punctured tires to manufacturers' specifications
- Call today to schedule your free training 1-800-998-9897

*ATTENTION: International Customers - FRT EXPORT

Most repair materials listed are either Fast Cure 10A/15C (3 month shelf life) or Regular Cure 20A/35C (1 year shelf life). Due to shelf life consideration for export shipments, The Patch Rubber Company provides our Fast Cure material in a special international cure rate (FRT 15A/20C). This FRT cure material will provide extended shelf life over Fast Cure material and still enable the end user to have reduced cure cycles when compared to regular cure materials. Minimum order 500 Lbs.

CAUTION: Clean unit thoroughly if unused for 20 minutes. Operation with cured rubber in the barrel may cause the repair extruder to bind and cause severe damage!

Mini Extruder Gun with Bosch Motor

- Cuts material waste
- Repair parts page 334



A lightweight extruder ideal for truck and OTR tire repairs. Fills injuries in a fraction of the time needed to hand stitch cushion gum into the injury. Adjustable thermostat 32° to 248°. Requires 90 to 100 psi. Available 110v or 220v.

Order No.	Description	Ship Wt.
15002	Mini Extruder 110V	9 lbs. - 4 kg
15022	Mini Extruder 220V	9 lbs. - 4 kg

Myers Repair Service Available on ALL Makes of Extruders

Extruder Gun

- Fill buzz-outs 5 times faster than hand stitching
- Cuts material wastes & eliminates trapped air
- I-R air motor
- High output 40 lbs./hr
- Repair parts page 333



Optional Tool Balancer 15004
6-1/2 to 13-1/2 lbs

Works like a caulking gun to fill skived areas with hot flowing repair rubber. Ideal for truck and OTR tire repairs. Eliminates hand stitching. The electrically heated gun barrel is controlled with a thermostat adjustable from 32°-248°F. The lightweight extruder is air-operated and requires 90-100 psi. Always use a patch to seal the innerliner. Available 110 or 220V.

Order No.	Description	Ship Wt.
14975	Extruder Gun 110V	9 lbs. - 4 kg
14976	Extruder Gun 220V	9 lbs. - 4 kg
15004	Optional Tool Balancer - 6.5 to 13.5 lbs.	4 lbs. - 2 kg
14998	110V Repl. Heat Element	
14981	220V Repl. Heat Element	
14999	Repl. Thermostat	

MYERS Nailhole Filler Extruder Gun

- Use from inside or outside the tire
- Adjustable thermostat
- Insulated heater stand warms barrel
- I-R Air motor
- Repair parts page 333



Use for filling nailholes before retreading. Extruded soft rubber flows into the nailhole and bonds to the carcass eliminating plugs. The electrically heated stand is controlled with a thermostat adjustable from 32°-248°F. Includes five nozzles. Requires 90-100 psi. Always use a patch to seal the innerliner. Available 110 or 220V.

Order No.	Description	Ship Wt.
14977	Myers Nailhole Extruder Gun 110V	12 lbs. - 5 kg
14978	Myers Nailhole Extruder Gun 220V	12 lbs. - 5 kg
14998	110V Repl. Heat Element	
14981	220V Repl. Heat Element	
14999	Repl. Thermostat	
15131	Myers Heater Box Only	
15132	Extruder Gun Only for Myers to Fit Heater Box	
15133	Extruder Gun Only for Bosch to Fit Heater Box	

TRIPLEMATIC Extruder Gun

- High output – 38 lb./hr.
- Repair parts page 333

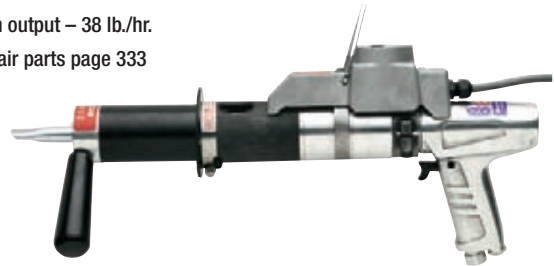

For heavy-duty, continuous use in the repair of the casings prior to retreading. Features a variable speed motor, an adjustable thermostat 150°-260°F, and hardened steel auger and barrel.

Order No.	Mfr. No.	Description	Ship Wt.
15128	HSG-48	Extruder 110V	12 lbs. - 5 kg
15130	HSG-48	Extruder 220 V	12 lbs. - 5 kg
15004	BL10	Tool Balancer	4 lbs. - 2 kg

OTR Extruder Gun

- Bosch air motor
- Delivers 61 lbs. per hour



Built for heavy-duty, continuous use in the repair of off-the-road tires. Allows the tire technician maximum speed and output in performing buzz-out and section repairs of truck and O.T.R. tires. Thermostat is adjustable to 248°F. Powerful air motor, air consumption 28 cfm.

Order No.	Mfr. No.	Description	Ship Wt.
48672	687	Extruder 110V/220V Specify Voltage	11 lbs. - 5 kg

Tire Seal

- Seals bead leaks, slow leaks & punctures up to 1/4" in diameter
- Use for ATV, bicycles & lawn & garden

16 Ounce bottle includes valve core tool and filler tube. Not recommended for passenger vehicles.

Order No.	Description	Per Case
46055	Tire Seal 16 Oz. Bottle	24



Tire Seal

- For truck & agricultural tires
- Seals punctures up to 1/4"
- Prevents tire & tube rot



54531



56222
Optional Hand Pump



46051

When a puncture occurs, thousands of tiny fibers and rubber particles suspended in a fluid base penetrate the injury quickly to seal the puncture from the inside out. The formula also conditions the innerliner to prevent dry rot and cracking which may cause chronic slow leaks. Will not corrode wheels or rims. One application lasts the life of the tire. Resists freezing to -30°C.

Order No.	Mfr. No.	Description	Size	Ship Wt.
46060		Tire Seal	1 Gal.	10 lbs. - 5 kg
46869		Pallet of 24 Tire Seal	1 Gal.	240 lbs. - 109 kg
46051		Tire Seal	5 Gal.	46 lbs. - 21 kg
46868		Pallet of 24 Tire Seal	5 Gal.	1,104 lbs. - 501 kg
46054		Tire Seal	55 Gal.	520 lbs. - 234 kg
46871		Pallet of 2 Tire Seal	55 Gal.	1,040 lbs. - 472 kg
56222	XM120	Hand Pump for 5-Gal.		7 lbs. - 4 kg
56247	ST-XMI	Hand Pump for 1-Gal.		2 lbs. - 1 kg
54531		Valve Core Remover & Filler		1 lbs. - 1 kg

Tire Seal Liqui-Fill Concentrate

- For liquid filled agricultural tires

For use in tires weighted with calcium chloride, water or antifreeze. Install with hand pump before or after ballast is pumped into the tire. Use one gallon of Liqui-Fill concentrate to 30-gallons of ballast liquid.

Order No.	Description	Ship Wt.
46052	Liqui-Fill Concentrate - 5 Gallon	50 lbs. - 23 kg

Total II Tire & Wheel Protection

- Prevents wheel/rim rust & corrosion
- Prevents innerliner degradation & dry rot
- Extends tire service life

Designed to prevent rust and corrosion on steel wheels and rims. Reduces bead damage during mounting and dismounting of tires. Prevents innerliner degradation and dry rot by lubricating the tire innerliner. Aids in tire dismounting. Biodegradable and environmentally safe. Not recommended for use on Aluminum Wheels. Four gallons per case.



Order No.	Mfr. No.	Description	Size
46067		Total II	1 Gal.
46068	TOT-II-640	Total II	5 Gal.
46860	24-TOT11640	Pallet of 24 Total II	5 Gal.
46085	TOT-II-6G	Total II	6 Gal.
46861	24-TOT116G	Pallet of 24 Total II	6 Gal.
46069	TOT-II-55G	Total II	55 Gal.
46862	2-TOT115G	Pallet of 2 Total II	55 Gal.

OTR Tire Seal

- Keep expensive OTR tires on the job

Specially formulated for off-the-road tires. Repairs up to 1/4" punctures on the vehicle. Helps cool the tire and seal bead leaks. Recommended for tube type and tubeless tires. Will not corrode rims or wheels. One application lasts the life of the tire.



46056

Order No.	Mfr. No.	Description	Size	Ship Wt.
46064	OTRIS-1	OTR Tire Seal	1 Gal.	10 lbs. - 5 kg
46872	24-STSTRCS4128	Pallet of 24 OTR Tire Seal	1 Gal.	240 lbs. - 109 kg
46056	OTRIS-5	OTR Tire Seal	5 Gal.	50 lbs. - 22 kg
46863	24-STOTR640	Pallet of 24 OTR Tire Seal	5 Gal.	1,200 lbs. - 544 kg
46057	OTRIS-55	OTR Tire Seal	55 Gal.	550 lbs. - 249 kg
46865	2-STOTR55G	Pallet of 2 OTR Tire Seal	55 Gal.	1,100 lbs. - 499 kg

Tire Life & Tire Life Bag

Casing protection for passenger, truck and OTR. Reduces the major causes of casing damage; underinflation, heat build up, liner oxidation, air migration into the cord body and the rusting of steel plies in radial tires. Put the Tire Life "Bag" in the tire before mounting. For use in all non-balanced 10-22.5 through 11-24.5 tubeless truck tires.



46678

46673

Order No.	Description	Size	Ship Wt.
46673	Tire Life Bag (48 Per Carton)	20 oz.	1 lbs. - 1 kg
46678	Tire Life	1 gal.	9 lbs. - 5 kg
46675	Tire Life	55 gal. Drum	500 lbs. - 227 kg

Tire Leak Detector

Spray-on leak detector shows smallest leaks with mass of bubbles. Diluted concentrate is used in Sure-Shot Sprayer or other pressure sprayer over entire tire. Use for tires, on or off vehicle. Dilute 3 tablespoons with 1 quart or 6 ounces with 1 gallon of water.



56435

46618

Order No.	Mfr. No.	Description	Ship Wt.
46617	TT-150	1-Qt. Plastic Bottle	3 lbs. - 1 kg
46618	TT-151	1-Gallon Plastic Jug	9 lbs. - 4 kg
46619	TT-152	5-Gallon Pail	40 lbs. - 13 kg
46620		55-Gallon Drum	
56435	HPN-52D	Sure Shot Sprayer 1 Qt.	3 lbs. - 1 kg

EcoSeal High Temperature Tire Sealant

- For waste haul & commercial applications

Water base sealant designed to seal leaks in tires up to 1/4" in the crown area of the tire. The high pH levels prevent corrosion and damage found on wheels used with some sealants even after extensive high heat and cooling cycles.



Order No.	Mfr. No.	Description	Ship Wt.
56224		EcoSeal 5-Gallon Pail	50 lbs. - 23 kg
56225		EcoSeal 55-Gallon Drum	500 lbs. - 227 kg
56226		EcoSeal 275-Gallon Tote	2,560 lbs. - 1,161 kg
56222		5-Gallon Hand Pump	7 lbs. - 3 kg
56227	ST-XM-55	55-Gallon Transfer Pump	7 lbs. - 3 kg

Puncture & Section Repair

Myers Tire Supply is your Puncture & Section Repair headquarters. Whatever tools, supplies, & equipment are needed to repair a tire, Myers is your single source! We have high & low speed buffers/skivers from **MTS PNEUMATIC**, **CP**, **IR**, & **DOTCO** plus adapters & quick change chucks. Our assortment of hand tools include awls, probes, insert tools, scrapers & a complete line of **DEXTER-RUSSELL** knives. **MARKAL**, **BRITE-MARK** & **MYERS TIRE SUPPLY** crayons are available in a multitude of colors. We stock high speed stones, solid carbide cutting tools, brushes & **L.R. OLIVER**, **B&J**, **RUBBERHOG**, **DUAL LIFE**, & **TEMCO** tire repair rasps. To cure the repair we offer **LINCOLN** & **WINNER** spotters & **VULCAN-VULCAP** & **MONAFLEX** curing systems.



Nailhole Leak Detector

- Use for detecting air leaks, separations & final inspection after repairs
- Includes 13"-16" expandable rim
- See page 302 for more expandable rims



Quickly checks for punctures in used tires. Inflatable rim allows operator to mount, inflate, check and demount tire in less than 30 seconds. Inflate to 25 psi, rotate the tire and spray with leak detector to find leaks fast. Includes **31031** expandable rim 6- $\frac{3}{8}$ " wide for 13"-16.5" tires, filter-regulator and auxiliary air tool connection. **31014** Features foot pedal operation. Requires 120 psi line pressure, $\frac{1}{4}$ " fpt. **Recommend:** Optional nickel plated piston and transfer tube.

Order No.	Mfr. No.	PSI	Qty./Box	Ship. Wt.
31016		25	Nailhole Leak Detector	375 lbs. - 169 kg
31014	TTR	25	Rotating Nailhole Leak Detector	375 lbs. - 169 kg
31017	TT	35	High Pressure Nailhole Leak Detector	375 lbs. - 169 kg

Tire Probing Awl



Special blunt duck bill tip will not damage cords while making repairs.

Order No.	Mfr. No.	Description	Blade Length
47016	TT-1140	Awl	3 $\frac{3}{4}$ "

Heavy-Duty Awl



Order No.	Mfr. No.	Description	Blade Length
47024	HD351	Heavy-Duty Awl	4 $\frac{1}{2}$ "

Pricking Awl

- With replaceable point



4" handle with chuck for changing points. Use to release trapped air from casing and to remove foreign objects from tire.

Order No.	Mfr. No.	Description	Blade Length
47000	K-80	Awl w/ Point	2 $\frac{1}{2}$ "
47001	K-80A	Replaceable Point	2 $\frac{1}{2}$ "

Heavy-Duty T-Handle Reamer

Heavy-duty aluminum T-handle. Use to release trapped air from casing and to remove foreign objects from tire. Includes Allen wrench.

Order No.	Description	Blade Length
15092	Reamer T-Handle	4"
15093	Replacement Reamer Needle	



Heavy-Duty T-Handle Spiral Probe Cement Tool

Heavy-duty aluminum awl. Use to release trapped air from casing and to remove foreign objects from tire. Includes Allen wrench.

Order No.	Description	Blade Length
15089	Spiral Probe T-Handle	4 1/2"
15090	Replacement Spiral Probe	

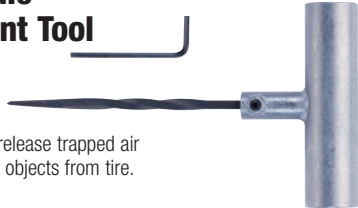

Pistol Grip Probe/Rasp Tool

Use to determine the extent and angle of puncture injuries as well as reaming injuries.

Order No.	Mfr. No.	Description	Blade Length
15114	77	Pistol Grip Probe Rasp Tool	3 1/2"



Pistol Grip Spiral Cement Tool

Designed to ream and apply cement to the walls of puncture injuries.

Order No.	Mfr. No.	Description	Blade Length
15115	78	Spiral Cement Tool	3 1/2"

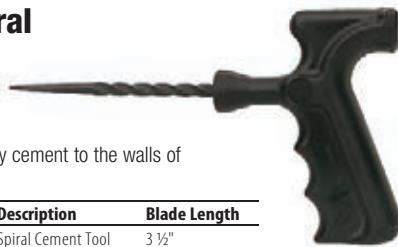

Tire Reamers

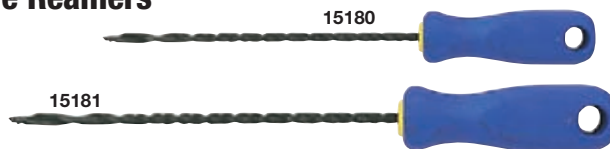

The tire repairman's most useful tool in preparing tires for repair.

Order No.	Description	Dia.	Blade Length
15180	Tire Reamer	3/16"	6 3/8"
15181	Tire Reamer	1/4"	9"

OTR Tools

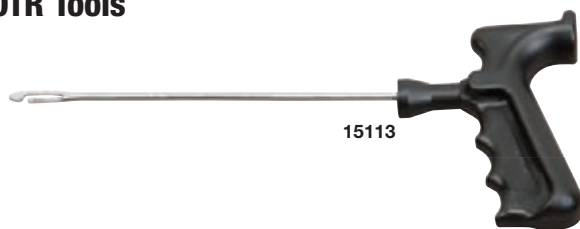

Order No.	Description	Blade Length
15113	Open Eye OTR Insert Tool	4 3/8"
15105	OTR Insert Tool	8"
15107	OTR Spiral Cement Tool	8"



Tire Repair Hand Tools

Open Eye Pistol Grip Tool

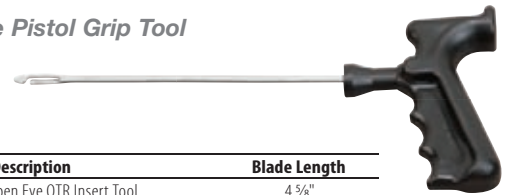

Order No.	Description	Blade Length
15113	Open Eye OTR Insert Tool	4 3/8"

Closed Eye Pistol Grip Tool

Closed eye pistol grip insert tool for installing string in tubeless tire nailhole repairs.

Order No.	Description	Blade Length
15111	Closed Eye Insert Tool	3"

Split Eye Pistol Grip Tool

Split eye pistol grip insert tool for installing all types of inserts (plugs) flat, round and oval in passenger and truck tires.

Order No.	Description	Blade Length
15112	Split Eye Insert Tool	3"

Solid T-Handle Split Eye Tool

- Passenger & truck

Split eye T-Handle insert tool for installing all types of inserts flat, round and oval in passenger or truck tires. Includes Allen wrench.

Order No.	Description
15066	Passenger T-Handle with Needle
15067	Replacement Passenger Needle Split Eye
15069	Truck T-Handle with Needle
15070	Replacement Truck Needle Split Eye

Heavy-Duty T-Handle Split Eye Tool

Heavy-duty aluminum split eye T-Handle insert tool. Includes Allen wrench.

Order No.	Description
15085	Split Eye Needle T-Handle
15086	Replacement Split Eye Needle

Tire Repair Hand Tools

Innerliner Scraper

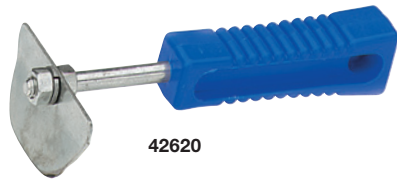

42620

For cleaning the innerliners for puncture and section repairs prior to buffing. Removes mounting lubricants, silicones etc. from the surface of the innerliner.

Order No.	Description	Length
42620	Innerliner Scraper	6"
97003	Economy Scraper	

Wire Cutting Drill Bit



For use in low speed grinder or drill motor. Cleans and contours puncture area.

Order No.	Mfr. No.	Description	Size Inches
42406	K370	Straight Shank Drill Bit	¼"

Pull Thru Wires



For installing Plug Stems in tire injuries.

Order No.	Description	Length
14526	Pull Thru Wires	7"

Tire & Rim Brush



Wire brush part 6" long. Handle, 14", curved for easier use.

Order No.	Mfr. No.	Description
46020	TT-1132	Tire & Rim Brush

Brass Bristle Tire Brush



Use to clean the buffed innerliner before cementing and applying the repair unit. 8 x 9 rows on 8½" x 2½" handle.

Order No.	Mfr. No.	Description
46000	TD58R	Brass Bristle Brush

Industrial Shears



Straight Handle

Bent Handle

Heavy-duty large size shears with steel blades.

Order No.	Mfr. No.	Description	Size	Cut	Ship Wt.
42549	K-23	Straight Handle	10"	5"	1 lbs. - 1 kg.
42550	K-24	R.H. Bent Handle	10"	5"	1 lbs. - 1 kg.
42548	K-24	L.H. Bent Handle	10"	5"	1 lbs. - 1 kg.
42521	K-24A	Bent Handle	12"	6"	2 lbs. - 1 kg.

Roughener-Stitcher



Order No.	Mfr. No.	Description
42616	K-22A	For Tubeless Tires & Inner Tubes

Ball Bearing Stitcher & Rollers



- Other sizes available, contact us

Order No.	Mfr. No.	Description
Flat Edge		
42615	K-21A	2" x ½"
Serrated Edge		
42611	K-19	1½" x ¼"
42612	K-20	2" x ¼"
42613	K-21	1½" x ½"
42614	K-56	2" x ¼"
42618	K-30	1½" x ¼"
42619	K-30	1½" x ¼"



Order No.	Mfr. No.	Description
42601	K-17	1½" x 1½" Flat
42602	K-18	2" x 2" Flat



Order No.	Mfr. No.	Description
42605	K-55D	2" x 2" Porcupine 7 Rows of Pins, 24 Per Row, ¼" Ext.

Poly Handle Ball Bearing Stitchers

- Heavy duty handle & smooth ball bearing motion



42591

42592

42593

42594

Order No.	Equivalent To	Description
42591	K-19	1½" x ¼" Serrated Edge
42592	K-20	2" x ¼" Serrated Edge
42593	K-56	2" x ¼" Serrated Edge
42594	K-30	1½" x ¼" Serrated Edge

Taper Point Knife



Order No.	Mfr. No.	Blade Size
42502	K-2	4"

Flexible Blade Skiving Knives



Order No.	Mfr. No.	Blade Size
42500	K-1	4"
42501	K-1A	4 7/8"

Square Point Knives



Order No.	Mfr. No.	Blade Size
42503	K-3	4" x 1"
42504	K-4	6" x 1"
42506	K-5	8" x 1 1/8"

Curved Square Point Knife



Order No.	Mfr. No.	Blade Size
42508	K-10A	10" x 1 1/4"

Hawk Bill Knife



Order No.	Mfr. No.	Blade Size
42515	K-31	3 1/8"

Hawk Bill Notch Ply Knife



Order No.	Mfr. No.	Blade Size
42516	K-32	2"

Curved Point Scalpel Knife



Order No.	Mfr. No.	Description
42539	2M	Handle Only 4 1/4"
42546	2K	Blade Pkg of 10

Extra Curve Sharp Point Knife



Order No.	Mfr. No.	Blade Size
42509	K-6	3 3/8"

Bail Cutting Knife



Order No.	Mfr. No.	Description	Blade Size
42535	39714HGC	Knife with Guard	14"

Single End Mill Knives



Single end handle

Order No.	Mfr. No.	Description
42519	12SE	Handle, Holds 9/16" Blade
42520	34SE	Handle, Holds 3/4" (20.5 mm) Blade

Mill Blade



Blades

Order No.	Mfr. No.	Description
42523	12 Bevel	6" x 9/16" (152.5 x 14.3 mm) Blade for 12SE Handle
42525	42 Bevel	9" x 3/4" (228.5 x 20.5 mm) Blade for 34SE Handle

Double End Mill Knife



Handle for K-11A Blade

Order No.	Mfr. No.	Description
42511	K-11	Double End Handle

Mill Blade



Blade for double-end handle K11.

Order No.	Mfr. No.	Description	Blade Size
42512	K-11A	Blade 32 Bevel	9" x 3/8"

Fast Trim Vent Knife



Trim vent excess and mold flow from a retreaded tire in 15 seconds. Guide on the handle positions multi-grooved blade. Removable blade trims approximately 3,000 tires.

Order No.	Mfr. No.	Description	Ship Wt.
42527	K-55M	Handle & Blade (K55MB)	2 lbs. - 1 kg.
42528	K-55MB	Hi-Alloy Blades 9 Grooves, 1 7/8" Wide	1 lbs. - 1 kg.
42536	2030	Hi-Alloy Blades 3" Wide	

Notched Blade Trim Knives



Curved End Blade



Straight End

Order No.	Mfr. No.	Description
42517	K-10	Curved End Knife, 1 1/8" Notch Blade 4" x 1"
42533	K-7	Straight Blade, Five 1/8" Notches, Blade 6" x 1 1/2"

Super Sharpener

Hand held knife sharpener for tool box or shop. Properly sharpened knives and scissors increase efficiency and extends tool life.



Order No.	Mfr. No.	Description
37113	80	Knife Sharpener

Sharpening Stone



Flat stone with medium finishing for tire knives. 8" x 2" x 3/4".

Order No.	Mfr. No.	Description
37126	K-14	Sharpening Stone

Jet Rasp Sharpener



Order No.	Mfr. No.	Description	Ship Wt.
37132	57	Jet Rasp Sharpener	2 lbs. - 1 kg.

Electric Knife Heaters

- With thermostat



Surfaces cut with a hot knife have better tack. Eliminate the danger of moisture-induced separations. Used in rubber factories. Operating temperature range 290° to 300°. 115V 60 cycle element or 230V element available. U.L. listed.

Order No.	Mfr. No.	Volt	Knife Size		Ship Wt.
			In.	cm	
37104	K-36T	115V	6"	15	6 lbs. - 3 kg.
37094	K-36T	230V	6"	15	6 lbs. - 3 kg.
37105	K-37T	115V	8"	20	7 lbs. - 3 kg.
37095	K-37T	230V	8"	20	7 lbs. - 3 kg.
37106	K-38T	115V	10"	25	8 lbs. - 4 kg.
37096	K-38T	230V	10"	25	8 lbs. - 4 kg.

Insulated Heater Knives



Easiest & fastest way to cut rubber – used with electric knife heaters. Handle completely insulated, with sunken rivets to eliminate burns.



Order No.	Mfr. No.	Description	Size
42543	K-6S	Insulated Heater Knife	6"
42544	K-8S	Insulated Heater Knife	8"

Tape Measures



46737



46736

Order No.	Mfr. No.	Description
46737	W-616	6' Tape, 1/4" Blade
46723	W9212	12' Steel Tape
46736	K550	50' Steel Tape with Ring

Circumference-Diameter Tape with Claw

Easy-to-read raised markings in natural steel over black background. Brown leather case. One side in feet; inches and 8ths. Other side diameter equivalents of circumference in diameter feet and inches.



Order No.	Mfr. No.	Description
46740	261PTH	33' Circumference Diameter Tape with Claw
46747	261PTH-1	Refill
46739	263PTH	50' Circumference Diameter Tape w/Claw
46724	C106TPM	6.5m Metric Circumference Diameter Tape with Claw

Serial Number Remover/Defacer



Deface or remove the serial number. Blade included.

Order No.	Mfr. No.	Description
42920	TTHB-1	Tool with Blade
42921	RRB-1	Replacement Blade
42924	OTR	OTR Tool
42925		Replacement Blade



MARKAL® Paintstik®

- Permanent paint
- 13 Colors



Permanent, waterproof and fadeproof. Marks on wet tires or tires covered with mold lubricant. Withstands vulcanizing and retreading temperatures. Also marks on wood, plastic, glass, etc. Nontoxic, contains no lead. 3/4" O.D. Sold 12 per box. Note: Myers Paintstiks have a marking range of -50° F to 150° F.

Order No.	Mfr. No.	Description	Order No.	Mfr. No.	Description
45121	TD-60	White	45128	TD-60G	Pink
45122	TD-60A	Black	45129	TD-60H	Brown
45123	TD-60B	Red	45130	TD-60I	Gray
45124	TD-60C	Blue	45131	TD-60Y	Yellow
45125	TD-60D	Green	45132	TD-60J	Gold
45126	TD-60E	Orange	45133	TD-60K	Silver
45127	TD-60F	Purple			

MARKAL® "M" Series Paintstik

- Marks at room temperature, withstands to 1,600°F.



Will not come off in oil or water. Packaged 12 per box.

Order No.	Mfr. No.	Description	Color
45070	81920	High Temperature Paintstik Marker	White
45071	81921	High Temperature Paintstik Marker	Yellow

PAINTSTIK® Holders

- Aluminum holder prevents waste from breakage



45134



45135

For use with 3/4" Paintstiks listed above.

Order No.	Mfr. No.	Description
45134	101	5" Holder - 3/4" I.D.
45135	102	6" Push Button Holder - 3/4" I.D.

MARKAL® Fugitive Yellow Marker



Marks disappear during the heat of the retread process leaving no crayon marks on the tire when finished. Sold 12 per box.

Order No.	Description
45106	Fugitive Yellow Marker

MYERS Tire Marking Crayons



Doesn't melt, soften or rub off in the pocket. Marks on tires, tubes, rubber and plastic products. 3 7/8" x 1/2". Sold 12 per box.

Order No.	Mfr. No.	Description
45100	TD-1Y	Yellow
45102	TD-1W	White
45136	108	5" Holder 1/2" I.D.

Crayon Holder



Crayon Holder for 1/2" O.D. crayons, Myers

Order No.	Mfr. No.	Description
45136	108	5" Holder 1/2" I.D.

BRITE-MARK 40



Valve-action paint marker. Fine point marks easily on any surface. Sold each.

Order No.	Mfr. No.	Description
45110	40006	Yellow Brite-Mark 40
45111	40008	White Brite-Mark 40

LISTO Marking Pencil

- Writes on anything, metal, rubber, wood & glass



Sold 12 per box.

Order No.	Description
45060	Listo Marking Pencil
45061	Listo Marking Pencil Refills - 72 Per Box

Innerliner Markers



Non-petroleum base. Marks innerliner of tires to be repaired. Sold 12 per box.

Order No.	Description
45050	White China Marker

Silver Tire Marking Pen



Waterproof, easy to read silver ink. Grey body with silver cap and pocket clip.

Order No.	Description
45144	.4mm Medium Point Silver Tire Marking Pen - Sold Each

Air Tool Maintenance *Maximum Performance*

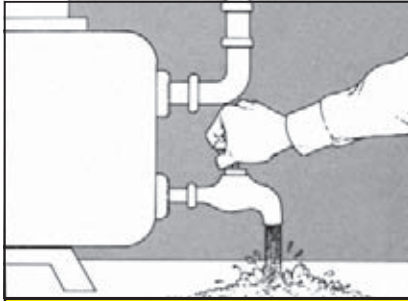

Drain Tank

• **Daily: Drain Tank & Air Line Filters.** Air under pressure condenses moisture in the bottom of the tank & throughout the air line system. Under average conditions of 75°F & 75% relative humidity, a compressor will take in about 18 gallons of water vapor a day! This moisture finds its way to your air tool, causing loss of power & premature tool failure.

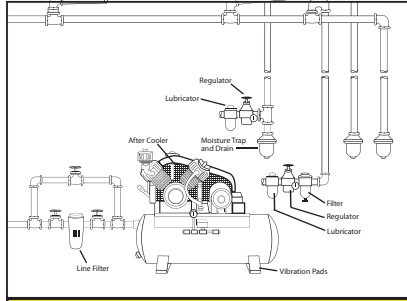

Install a Filter

• **Install a Filter - Regulator - Lubricator at each air tool outlet.** Some shop equipment requires only a filter-regulator unit. Check manufacturer's specifications. Shown above is a simple, dependable air system that will add life & efficiency to your air tools.



Check psi

• **Make Sure Your Compressor Is Up to the Job.** Impact tools usually require a minimum of 90 psi, maximum of 100 psi at the tool. Check manufacturer's recommendation. Check the air pressure at the tool while it's operating. An air leak you can hear is costing you money & your tools are losing power.



Warning Signs of Wear

• **Warning Signs of Wear.** Worn sockets or impact tool shanks drastically reduce tool life. When the beveled portions of the tip of the shank become worn, sockets don't fit correctly. A loose or sloppy fit quickly rounds the socket's opening. Old, rounded sockets on a new tool shank quickly damage the bevel for the same reason. Always purchase new sockets with a new wrench.



Oil Daily

• **Oil Daily.** The #1 contributing factor to air tool failure is lack of lubrication. Extend tool life. Squirt or drop an approved air tool oil (**45206**) directly into the tool whip hose or air inlet & run the tool for one or two seconds to disperse the oil in the tool. Oil tools at the beginning & end of the day.



Install a Whip Hose

• **Install a Whip Hose on Each Tool.** Never install a coupler directly to the air tool. Use a whip hose to reduce housing stress & add flexibility.



Keep Tools Clean

• **Keep Your Air Tools Clean.** A dirty tool results in power loss & shortened tool life. Inspect the air screens periodically. Use a protective tool cover to reduce damage caused by accidentally dropping & other abuse.



Don't Exceed Limit

• **Don't Exceed the Tool's Limit.** Use penetrating oil on rusted nuts. If an air tool does not loosen a bolt or nut in 3 to 5 seconds, stop. Use a penetrating lubricant (**11053**) & try again or if necessary, use a larger wrench.



Use a Conditioner

• **Use an Air Tool Conditioner.** Moisture evaporating in the tool while it's operating causes a calcium build-up. Air Tool Conditioner (**45201**) breaks the surface tension of the calcium & restores the tool to its normal power & speed. Use once per week or more often if the tool is used frequently.

IR Low Speed Buffer/Skiver Heavy-Duty

- 3,200 RPM
- For truck & earthmover tires
- Includes rear exhaust & whip hose



Optional
42415 Chuck

Lightweight, explosion-proof with geared head for powerful torque. Includes a rear exhaust hose to avoid contaminating the repair area. $\frac{3}{8}$ "-24 nf Spindle accommodates quick change chuck. *Specs.: $\frac{3}{4}$ hp; 3,200 rpm; min. air hose $\frac{3}{8}$ "; air inlet $\frac{1}{4}$ " fpt; average air cons. 7 cfm; operating air pressure 90 psi.*

Order No.	Mfr. No.	Description	Ship Wt.
31636	7LK	Heavy-Duty Buffer/Skiver	3 lbs. - 2 kg.
42415	TB-20C	Optional Quick Change Chuck	1 lbs. - 1 kg.
31649	MT-1	Replacement Exhaust Overhose	1 lbs. - 1 kg.
31640	7LTK1	Tune-Up Kit	1 lbs. - 1 kg.

DOTCO Low Speed Buffer

- 3,200 RPM
- Includes quick change chuck, 8' whip hose & 4' exhaust hose

Specs.: .3 hp; 3,200 rpm; min. air hose operating air pressure 90 psi. OSE $\frac{3}{8}$ "; air inlet $\frac{1}{4}$ " fpt;



Order No.	Mfr. No.	Description	Ship Wt.
31061	12L1092	Buffer with Chuck, Exhaust & Whip Hose	2 lbs. - 1 kg.
31064	45-2784	Repl. Whip Hose/Exhaust Kit for Composite Body	
31069	45-1931	Repl. Whip Hose/Exhaust Kit for Aluminum Body	

MYERS Lighted Low Speed Buffer

- 2,250 RPM
- Includes quick change chuck, rear exhaust & whip hose
- Air motor generates electricity & light for inside the tire



Replaceable lights increase visibility when working inside the tire. Use for innerliner preparation and reaming injuries before filling. *Specs.: .4 hp; 2,250 rpm; min. air hose $\frac{3}{8}$ "; air inlet $\frac{1}{4}$ " fpt; average air cons. 3 cfm; operating air pressure 90 psi.*

Order No.	Description	Ship Wt.
31663	Lighted Low Speed Buffer with Quick Change Chuck	3 lbs. - 2 kg.
31677	Replaceable Lights - Set of 3	

IR Low Speed Buffer

- 3,000 RPM
- Includes quick change chuck, 8' whip hose & 4' exhaust hose



Low speed buffer with $\frac{3}{8}$ " hex quick change chuck and rear exhaust hose. *Specs.: $\frac{1}{2}$ hp; 3,000 rpm; min. air hose $\frac{3}{8}$ "; air inlet $\frac{1}{4}$ " fpt; average air cons. 14 cfm; operating air pressure 90 psi.*

Order No.	Mfr. No.	Description	Ship Wt.
53221	IR327LS	Low Speed Buffer with Quick Change Chuck	3 lbs. - 2 kg.



Low Speed Buffer

- 2,600 RPM for innerliners, reaming & drilling
- Includes quick change chuck, rear exhaust & whip hose



Features a lever style throttle and a quick change chuck for fast rasp changing. 30" Rear exhaust hose directs air away from the repair area.

1-Year warranty. *Specs.: 2,600 rpm; average air consumption 4 cfm; .5 hp; air inlet $\frac{1}{4}$ "; minimum hose size $\frac{3}{8}$ "; air pressure required 90 psi*



Order No.	Description
31679	Low Speed Buffer

MYERS Low Speed Buffer

- 2,500 RPM for innerliners, reaming & drilling
- Includes quick change chuck, rear exhaust & whip hose
- Made in USA



Use for innerliner preparation and reaming injuries before filling. *Specs.: .5 hp; 2,500 rpm; min. air hose $\frac{3}{8}$ "; air inlet $\frac{1}{4}$ " fpt; average air cons. 4 cfm; operating air pressure 90 psi.*

Order No.	Description	Ship Wt.
31669	Low Speed Buffer with Quick Change Chuck	3 lbs. - 2 kg.

CP Low Speed Buffer Standard-Duty

- 2,500 RPM
- For innerliner buffing, reaming & drilling
- Includes rear exhaust & whip hose

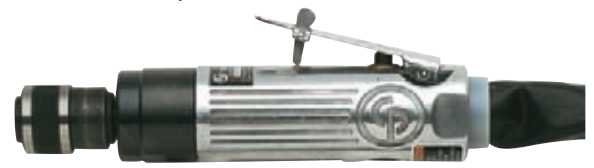

Economical, low speed buffer with $\frac{3}{8}$ " hex quick change chuck and rear exhaust hose. *Specs.: $\frac{1}{2}$ hp; 2,500 rpm; min. air hose $\frac{3}{8}$ "; air inlet $\frac{1}{4}$ " fpt; average air cons. 4 cfm; operating air pressure 90 psi.*



Order No.	Mfr. No.	Description	Ship Wt.
31675	CP873	Buffer with Quick Change Chuck	2 lbs. - 1 kg.
53413	EX KT	Replacement Rear Exhaust Kit	1 lbs. - 1 kg.

Buffer Specifications

- Low Speed 0 - 5,000 RPM - for buffing rubber
- High Speed 5,000 RPM & higher - for wire cord

Low Speed Buffers

Low Speed Buffer

- 4,000 RPM
- Includes quick change chuck, rear exhaust & whip hose
- For passenger, light truck tires & innerliners



Lever throttle geared head for powerful torque. Includes quick change chuck. *Specs.: .60 hp; 4000 rpm; wheel/disc capacity dia. 3"; min. air hose 3/8"; air inlet 1/4" fpt; average air cons. 7 cfm; operating air pressure 90 psi.*

Order No.	Mfr. No.	Description	Ship Wt.	
			lbs.	kg.
31672	5335	Low Speed Buffer/Skiver	3	1

DOTCO Low Speed Buffer

- 4,000 RPM
- Includes quick change chuck, 8' whip hose & 4' exhaust hose



Specs.: .3 hp; 4,000 rpm; min. air hose 3/8"; air inlet 1/4" fpt; operating air pressure 90 psi.

Order No.	Mfr. No.	Description	Ship Wt.
31063	15LF082	Grinder with Chuck, Exhaust & Whip Hose	2 lbs. - 1 kg.
31064	45-2784	Repl. Whip Hose/Exhaust Kit for Composite Body	
31069	45-1931	Repl. Whip Hose/Exhaust Kit for Aluminum Body	

IR Low Speed Buffer Medium-Duty

- 4,800 RPM
- Includes rear exhaust & whip hose



Optional 42415 Chuck

For passenger and light truck tires. 3/8"-24 nf spindle for a quick change chuck. *Specs.: .45 hp; 5,500 rpm with 4,800 rpm free speed; min. hose size 3/8"; air inlet 1/4" fpt; average air cons. 7 cfm; operating air pressure 90 psi.*

Order No.	Mfr. No.	Description	Ship Wt.
31648	5LJ	Low Speed Buffer/Skiver	2 lbs. - 1 kg.
42415	TB-20C	Optional Quick Change Chuck	1 lbs. - 1 kg.
31649	MT-1	Replacement Exhaust Overhose	1 lbs. - 1 kg.
31639	SLTK1	Tune-Up Kit	1 lbs. - 1 kg.

Replacement Exhaust Hoses

Order No.	Mfr. No.	Description
49014		1" Diameter Exhaust Hose 6' Long
49013		3/8" Diameter Exhaust Hose 6' Long
49011	IFC127211	Plastic Ring 1" Diameter



Whip Hoses



Length 24"

Order No.	Hose I.D.	MPT Ends	Order No.	Hose I.D.	MPT Ends
54150	1/4"	1/4"	54147	1/2"	1/4"
54145	3/8"	1/4"	54149	1/2"	3/8"
54146	3/8"	3/8"	54148	1/2"	1/2"

1/2" Reversible Air Drill

- With rear exhaust hose kit



Ideal for heavy drilling and plug cutting especially in truck tire treads. Reverse switch on side near trigger and auxiliary handle. *Specs.: include: 1/2" jacobs chuck; 1/2 hp motor; 500 rpm; avg. air consumption 4 cfm; air inlet 1/4"; min. hose size 3/8".*

Order No.	Mfr. No.	Description	Ship Wt.
31200M	527	1/2" Reversible Drill	3 lbs. - 2 kg.
53413		Rear Exhaust Kit	1 lbs. - 1 kg.

See page 278 for Carbide Cutting Tools

MYERS Combination Buffer/Reamer

- Variable speed up to 20,000 RPM
- Includes rear exhaust & whip hose & 3/8" Jacobs chuck
- Made in USA



Variable speed tool can be used as a buffer or high speed reamer. Rear directed exhaust hose, 3/8" Jacobs chuck. *Specs.: 20,000 rpm; .5 hp; min. air hose 3/8"; air inlet 1/4" fpt, average air cons. 4 cfm; operating air pressure 90 psi; 3/8"-24 spindle.*

Order No.	Mfr. No.	Description	Ship Wt.
31674	SLP-4038	Combination Buffer/Reamer	2 lbs. - 1 kg.
31676	SLP-9801	Repair Kit	1 lbs. - 1 kg.

Buffer Specifications

- Low Speed 0 - 5,000 RPM - for Buffing Rubber
- High Speed 5,000 RPM & Higher - for Wire Cord

Low Speed Buffer Comparison Chart						
Order No.	Free Sp. RPM	HP	Air Inlet	Min Air Hose	Average Air Cons.	Air Pres. Req.
31663	2,250	.4	1/4"	3/8"	3 cfm	90 PSI
31675	2,500	.5	1/4"	3/8"	4 cfm	90 PSI
31669	2,500	.5	1/4"	3/8"	4 cfm	90 PSI
31679	2,600	.5	1/4"	3/8"	4 cfm	90 PSI
53221	3,000	.5	1/4"	3/8"	14 cfm	90 PSI
31636	3,200	.75	1/4"	3/8"	7 cfm	90 PSI
31061	3,200	.3	1/4"	3/8"	4 cfm	90 PSI
31648	4,800	.45	1/4"	3/8"	7 cfm	90 PSI
31063	4,000	.3	1/4"	3/8"	4 cfm	90 PSI
31064	4,000	.3	1/4"	3/8"	4 cfm	90 PSI
31672	4,000	.60	1/4"	3/8"	7 cfm	90 PSI

High Speed Buffer Comparison Chart						
Order No.	Free Sp. RPM	HP	Air Inlet	Min Air Hose	Average Air Cons.	Air Pres. Req.
31673	20,000	.5	1/4"	3/8"	4 cfm	90 PSI
31674	20,000	.5	1/4"	3/8"	4 cfm	90 PSI
31668	20,000	.5	1/4"	3/8"	4 cfm	90 PSI
31666	20,000	.5	1/4"	3/8"	3 cfm	90 PSI
31667	22,000	.5	1/4"	3/8"	4 cfm	90 PSI
31060	30,000	.3	1/4"	1/4"	4 cfm	90 PSI
52981	30,000	.5	1/4"	3/8"	15 cfm	90 PSI
31642	20,000	.3	1/4"	3/8"	3 cfm	90 PSI

MYERS High Speed Buffer

- 20,000 RPM for trimming wire cord
- With quick change or Jacobs chuck
- Includes rear exhaust & whip hose
- Made in USA



For use with high speed grinding stones. Includes throttle lever. *Specs.: .5 hp; 20,000 rpm; min. air hose 3/8"; air inlet 1/4" fpt; average air cons. 4 cfm; operating air pressure 90 psi.*

Order No.	Description	Ship Wt.
31673	High Speed Buffer with Quick Change Chuck	3 lbs. - 2 kg.
31674	High Speed Buffer with Jacobs Chuck	3 lbs. - 2 kg.

MYERS High Speed Buffer

- 20,000 RPM for trimming wire cord
- 1/4" Collet
- Includes rear exhaust & whip hose
- Made in USA



For use with high speed grinding stones. Includes throttle lever, two wrenches, and 1/4" collet. Optional 1/8" collet available. *Specs.: .5 hp; 20,000 rpm; min. air hose 3/8"; air inlet 1/4" fpt; average air cons. 4 cfm; operating air pressure 90 psi.*

Order No.	Description	Ship Wt.
31668	High Speed Buffer with 1/4" Collet	2 lbs. - 1 kg.
31678	Optional 1/8" Collet	

MYERS Mini High Speed Buffer

- 20,000 RPM for trimming wire cord
- 1/4" Collet
- Includes rear exhaust & whip hose
- Made in USA



For use with high speed grinding stones Includes throttle lever, two wrenches, and 1/4" collet, optional 1/8" collet available. *Specs.: .3 hp; 20,000 rpm; min. air hose 3/8"; air inlet 1/4" fpt; average air cons. 3 cfm; operating air pressure 90 psi.*

Order No.	Description	Ship Wt.
31666	Mini High Speed Buffer with 1/4" Collet	1 lbs. - 1 kg.
31678	Optional 1/8" Collet	

Right Angle High Speed Buffer

- 20,000 RPM for trimming wire cord
- Includes rear exhaust & whip hose



Makes grinding of wire cord inside the tire easier. Lever throttle controls tool speed from 0 to 20,000 rpm. Rear exhaust and overhose avoids contamination to work area. *Specs.: 1/4" collet chuck, 20,000 rpm, min. hose size 3/8", air inlet 1/4" mpt, average air cons. 3 cfm, operating pressure 90 psi.*

Order No.	Mfr. No.	Description	Ship Wt.
31642	AP5201	Right Angle Grinder	3 lbs. - 2 kg.
31661	C-18	Optional 1/8" Collet	1 lbs. - 1 kg.

CP High Speed Buffer

- 22,000 RPM for trimming wire cord
- Includes rear exhaust & whip hose



Precision made for clean, quick grinding of wire cord. Lever throttle controls wide range of speeds. Rear exhaust and overhose helps avoid contamination of repair area. *Specs.: 1/2 hp, 22,000 rpm, minimum hose size 3/8", air inlet 1/4" mpt, average air consumption 4 cfm, operating pressure 90 psi.*

Order No.	Ref. No.	Description	Ship Wt.
31667	CP872	High Speed Grinder	11 lbs. - 5 kg.
31661	C-18	Optional 1/8" Collet	1 lbs. - 1 kg.

DOTCO High Speed Buffer

- 30,000 RPM for trimming wire cord
- Includes 4' exhaust & 8' whip hose



Includes 1/4" collet, 8' whip hose and 4' exhaust hose. *Specs.: .3 hp; 30,000 rpm; min. air hose 3/8"; air inlet 1/4" fpt; operating air pressure 90 psi.*

Order No.	Mfr. No.	Description	Ship Wt.
31060	12L1080-36	Buffer Complete	2 lbs. - 1 kg.
31064	45-2784	Repl. Whip Hose & Exhaust Hose Kit for Composite Body	1 lbs. - 1 kg.
31066	304	1/8" Collet	1 lbs. - 1 kg.
31069	45-1931	Repl. Whip Hose & Exhaust Hose Kit for Aluminum Body	1 lbs. - 1 kg.
31067	14-0807	Replacement 1/8" Collet Wrench	1 lbs. - 1 kg.
31068	14-0811	Replacement 1/16" Collet Wrench	1 lbs. - 1 kg.
31059	308	Replacement 1/4" Collet	1 lbs. - 1 kg.

IR High Speed Buffer

- 22,000 RPM
- Lever throttle
- Includes quick change chuck, 8' whip hose & 4' exhaust hose



Use with high speed stones and carbide cutting tools to trim steel cord. *Specs.: 1/2 hp; 22,000 rpm; min. air hose 3/8"; air inlet 1/4" fpt; average air cons. 15 cfm; operating air pressure 90 psi.*

Order No.	Mfr. No.	Description	Ship Wt.
52981	IR327	High Speed Buffer with Jacobs Chuck	3 lbs. - 2 kg.
54145		Optional 2' Whip Hose 3/8" I.D. with 1/4" MPT Ends	1 lbs. - 1 kg.
49014		Optional 1" Dia. Exhaust Hose	1 lbs. - 1 kg.

Air Tool Conditioner

- For all piston-type & rotary air tools

Moisture evaporating in the tool while it's operating causes a calcium build-up. Air Tool Conditioner breaks the surface tension of the calcium and restores the tool to its normal power and speed. Use once per week or more often if the tool is used frequently.

Order No.	Description	Size
45201	Air Tool Conditioner	12.2 oz. Can



Buffers / Skivers

URYU Heavy-Duty High Speed Passenger/Truck Buffer/Skiver

- 14,600 RPM for innerliners, tread & shoulder areas



Optional 42415 Chuck

Powerful tool for fast buffing/skiving. Muffled rear exhaust, lever throttle to control various speeds, and heavy-duty four bearing construction for long life. Tool has 3/8" - 24 nf spindle to accommodate quick change chuck. *Specs.:* 60 hp, 14,600 rpm, wheel capacity diameter 2 1/2", minimum air hose 3/8" air inlet 1/4" fpt, average air consumption 7 cfm, operating air pressure 90 psi.

Order No.	Mfr. No.	Description	Ship Wt.
31684	UG-65EBL	High Speed Buffer/Skiver	4 lbs. - 2 kg.
42204	K-354	Rasp - 3/4" W., 2" Dia. 36 Grit 3/8" A.H	1 lbs. - 1 kg.
42415	TB20C	Optional Quick Change Chuck	1 lbs. - 1 kg.

URYU OTR Buffer/Skiver Cup Cutter

- 7,200 RPM for OTR tires
- Includes side exhaust hose & rear whip hose

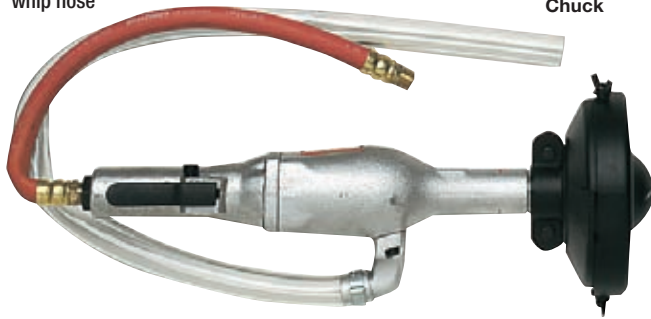

Optional 42424 Chuck

Powerful tool handles heavy jobs. Governor-controlled motor, lever throttle controls wide range of speeds, and muffled rear exhaust. Tool has 1/2"-13 nf spindle. *Specs.:* 1.2 hp, 7,200 rpm, wheel capacity diameter 5", minimum air hose 1/2", air inlet 3/8" fpt, average air consumption 11 cfm, operating air pressure 90 psi.

Order No.	Mfr. No.	Description	Ship Wt.
31688	UG-1250-LM	OTR Buffer/Skiver/Cup Cutter	9 lbs. - 4 kg.
42291	TCW-515	Tungsten Carbide Contour Wheel - 5" Dia., 1/2" A.H. 23 Grit (for Innerliner Buffing)	2 lbs. - 1 kg.
42493	TDW-5118	Tungsten Carbide Round-Faced Wheel - 5" Dia., 1/2" A.H., 16 Grit (for Skiving)	2 lbs. - 1 kg.
42424	MQC-2-13	1/2"-13 Optional Quick Change Chuck	1 lbs. - 1 kg.

IR Angle Grinder

- 5,000 RPM



Use for finishing sidewalls on OTR tire repairs. *Specs.:* max. free speed 5,000 rpm; pad dia. 7"; output 3/8" - 11 thread; , minimum air hose 3/8" air inlet 1/4" fpt, aver. air cons. 8 cfm; aver. air cons. @ load 29 cfm; ship. wt. 4 1/2 lbs.

Order No.	Mfr. No.	Description	Ship Wt.
52986	IR313A	Angle Grinder	6 lbs. - 3 kg.

Quick Change Chuck & Adapters



Use any of the adapters listed with the 42415 chuck. Rasps and other repair tool accessories mounted on the proper adapters make a quick and efficient system of performing professional repairs.

Order No.	Mfr. No.	Description
42415	TB-20C	Quick Change Chuck (3/8" - 24 FPT)
42424	MQC-2-13	Quick Change Chuck (1/2" - 13 FPT)
42365		3/16" - 18 Quick Change Chuck (3/16" - 18 FPT)
42420	TB-4	3/8" - 24 Adapter, 2 1/4" Long
42421	TB-4A	3/8" - 24 Adapter 1" Long Thread, 2 1/4" Length w/ 2 Washers, Nut for Mounting Tools w/ 3/8" Arbor Hole
42422	TB-4S	3/8" - 24 Short Adapter 1 3/8" Long
42497	TB-3AH	1/8" Shaft Adapter with Set Screw
42498	TB-3BH	1/4" Shaft Adapter with Set Screw
42375	2540	3/16" 3 Tang Shank Adapter with set screw
42376	2541	5/16" 3 Tang Shank Adapter with set screw
42370	CC	7/16" & 3/8" Shank Adapter w/set screw
42399	TB-4B	Quick Change Adapter with Spacer
42412		Double Adapter for Skiving Brush
42425L		1/2" Double Quick Change Adapter with Nut
49635		5/32" x 3/16" Set Screws for 42497, 42498, 42375, 42376 Adapters. 25 Per Bag

Jacobs Chucks & Adapters

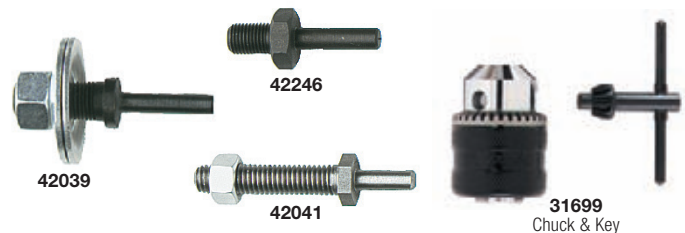

Order No.	Mfr. No.	Description
31699	30247	3/8" Chuck & Key (3/8"-24 Thread)
42039	TB-310-D	1/4" Shank to 1/2" SAE Male
42041	TB-320-D	1/4" Shank to 3/8" USS Male
42246	K-345	For 1/4" Drill to 3/8" USS Male
42413		1/4" Shank to 3/8" SAG Male (Not Shown)

Flexible Shaft Lubricant

For smooth running, cores need light lubrication about every 50 hours of operation.

Order No.	Mfr. No.	Description
45214	514-B	14 oz. Flexible Shaft Lubricant



Flexible Shaft & Drill Adapters



Adapters		
Order No.	Mfr. No.	Description
42045	TB-310-R	Special 1/2" (12.7mm) SAE F, 3/8" (9.1mm) USSM
42244	TB-313	For Sioux 3/8" - 16 USS F, 3/8" - 24M
42245	TB-314	Special 1/2" - 20 SAE F, 3/8" - 24M
Wheel Arbor With Flanges		
42047	TB-505-A	For Wyco 3/16" - 18 SAE F, 1/2" 20M
42049	TB-505-D	Bell 1/2" (12.7mm) SAE F, 3/8" (9.1mm) USSM
42243	TB-305R	For Wyco 3/16" - 18 SAE F, 3/8" 24M
Wheel Arbor Without Flanges, With Nuts		
42053	TB-5B	Special 1/2" (12.7mm), SAE F, 3/8" (9.1mm) USSM
42055	TB-5C	Special 1/2" (12.7mm), SAE F, 1/2" (12.7mm) SAEM
42057	TB-5D	Sioux 3/8" (9.1mm) USS F, 1/2" (12.7mm) SAEM
42365		For Wyco 3/16" - 18 FPT Quick Change

WYCO Flexible Shaft Buffers



Use grinding wheels, wire brushes, tire rasps, etc. for various grinding and buffing operations. Quick-change hand pieces snap on and off quickly and easily. All welded steel. Motors are capacitor type, constant speed, 115/ 230V, single phase, 60 cycle A.C. with toggle switch, and 7 ft., 3-wire cord and safety plug. Shipped knocked down in carton. Includes one hand piece, one set of wheel arbors and one set of wrenches.

Order No.	Mfr. No.	HP	Speed R.P.M.	Ship Wt.
31440	49-2	1/3	1725	60 lbs. - 27 kg.
31442	49-4	1/2	1725	65 lbs. - 30 kg.
31441	49-3	1/2	3450	55 lbs. - 25 kg.
31444	49-6	3/4	1725	75 lbs. - 34 kg.
31443	49-5	3/4	3450	65 lbs. - 30 kg.
31445	49-14	1	3450	85 lbs. - 38 kg.

WYCO Buffer Flexible Shaft Replacement Chart

• For Use with any Wyco Buffer

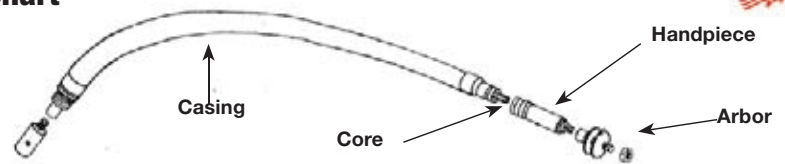

See above for flexible shaft adapters

Complete Flexible Shaft Assembly Includes core, casing and handpiece NO MOTOR COUPLING				Core Only			Casing Only		Handpiece Only		Optional Universal Motor Coupling Only		Optional Wyco Wheel Guards Only		
Order No.	Mfr. No.	Machine Mfr. No.	Length Feet	Order No.	Mfr. No.	End Type	Order No.	Mfr. No.	Order No.	Mfr. No.	Order No.	Shaft Size	Mfr. No.	Order No.	Mfr. No.
31449	10R Shaft	49-2	5	31463	C-10	Male	31470	K-10	31498	3500	31500C	3/8"	3400	31427	414
31450	2R Shaft	49-3	6	31464	C-2	Male	31471	K-2	31498	3500	31500C	3/8"	3400	31427	414
31450	2R Shaft	49-4	6	31464	C-2	Male	31471	K-2	31498	3500	31500C	3/8"	3400	31427	414
31451	30R Shaft	49-5	7	31465	C-30	Female	31472	K-30	31499	551	31501C	3/8"	550MP	31426	5576
31451	30R Shaft	49-6	7	31465	C-30	Female	31472	K-30	31499	551	31501C	3/8"	550MP	31426	5576
31455	4R Shaft	49-14	7	31456	C-4	Female	31457	K-4	31499	551	31501C	3/8"	550MP	31426	5576

Non-Wyco Buffer Flexible Shaft Replacement Chart

• For Any Standard Motor – Not for Wyco

See above for flexible shaft adapters

Complete Universal Flexible Shaft Assembly. Includes core, casing, handpiece and motor coupling				Core Only			Casing Only		Handpiece Only		Universal Motor Coupling Only		
Order No.	Shaft Complete w/Motor Coupling	Mfr. No.	Length Feet	Order No.	Mfr. No.	End Type	Order No.	Mfr. No.	Order No.	Mfr. No.	Order No.	Motor Shaft	Mfr. No.
31115B	1.) With 1/2" Coupling	01	5	31125	C-01	Male	31135	K-01	31124	251-N	N.A.	1/2"	2400
31115C	1.) With 3/8" Coupling	01	5	31125	C-01	Male	31135	K-01	31124	251-N	N.A.	3/8"	2400
N.A.	2.) With 1/2" Coupling	10	5	31463	C-10	Male	31470	K-10	31498	3500	31500B	1/2"	3400
N.A.	2.) With 3/8" Coupling	10	5	31463	C-10	Male	31470	K-10	31498	3500	31500C	3/8"	3400
31117B	3.) With 1/2" Coupling	02	5	31127	C-02	Male	31137	K-02	31498	3500	31500B	1/2"	3400
31117C	3.) With 3/8" Coupling	02	5	31127	C-02	Male	31137	K-02	31498	3500	31500C	3/8"	3400
31119B	3.) With 1/2" Coupling	2	6	31464	C-2	Male	31471	K-2	31498	3500	31500B	1/2"	3400
31119C	3.) With 3/8" Coupling	2	6	31464	C-2	Male	31471	K-2	31498	3500	31500C	3/8"	3400
31121C	4.) With 3/8" Coupling	30	7	31465	C-30	Female	31472	K-30	31499	551	31501C	3/8"	550MP
31121D	4.) With 3/4" Coupling	30	7	31465	C-30	Female	31472	K-30	31499	551	31501D	3/4"	550MP
N.A.	5.) With 3/8" Coupling	4	7	31456	C-4	Female	31457	K-4	31499	551	31501C	3/8"	550MP
N.A.	5.) With 3/4" Coupling	4	7	31456	C-4	Female	31457	K-4	31499	551	31501D	3/4"	550MP

NOTE: 1.) 31115B&C - Mfr. No. #01 Complete Shaft Assembly for use usually with Light Duty Buffers 2.) Mfr. No. #10 Complete Shaft assembly for use with 1/4hp & 1/4hp Motors 3.) 31117B&C & 31119B&C - Mfr. No. #02 and #2 Complete Shaft assemblies for use with 1/4hp Motors 4.) 31121 - Mfr. No. #30 Complete Shaft assembly for use with 3/4 hp Motors 5.) Mfr. No. #4 Complete Shaft assembly for use with 1 4hp & 1-1/2 4hp Motors

Wire Cutting Tools

Wire Cutting Solid Carbide Cutting Tools

- Use with proper eye protection see page 236



* Best results obtained using a 500 to 1,200 rpm maximum buffer. 42394** Made in China

Order No.	Description	Size	Shank Size	Length	Use Adapter
42396**	Pencil Point	1/8"	1/8"	1 1/2"	42497
42393**	Long Pencil Point	1/8"	1/8"	2 1/2"	42497
42394**	Value Long Pencil	1/8"	1/8"	2 1/2"	
42395**	Pencil Point	1/4"	1/4"	2"	42498
42378*	Extended Point	3/16"	3/16" 3 Tang	3"	42375
42372*	Extended Point	6mm	3/16" 3 Tang	76mm	42375
42379*	Extended Point	5/16"	3/16" 3 Tang	4"	42376
42373*	Extended Point	7/16"	3/16" 3 Tang	4"	42370
42369*	Extended Point	9mm	3/16" 3 Tang	100mm	42376

** Best results obtained using a 20,000 to 30,000 rpm maximum buffer

Order No.	Description	Size	Shank Size	Length	Use Adapter
42164*	Extended Point	1/2"	3/8"	5"	42370
42366*	Extended Point	3/4"	3/8"	6"	42370
42367*	Extended Point	1"	1/2"	6"	N/A
42381**	Short Point	3/8"	1/4"	2 3/4"	42498
42374**	Flat Head Router	1/8"	1/8"	1 1/2"	42497
42383**	Flat Router – Fine	1/4"	1/4"	2 1/2"	42498
42386**	Flat Router – Coarse	1/4"	1/4"	2 1/2"	42498
42382**	Round Ball	1/2"	1/4"	2 1/2"	42498
42377**	Round Ball	3/4"	1/4"	2 3/4"	42498

Wire Cord High Speed Grinding Stones

- Use with proper eye protection see page 236

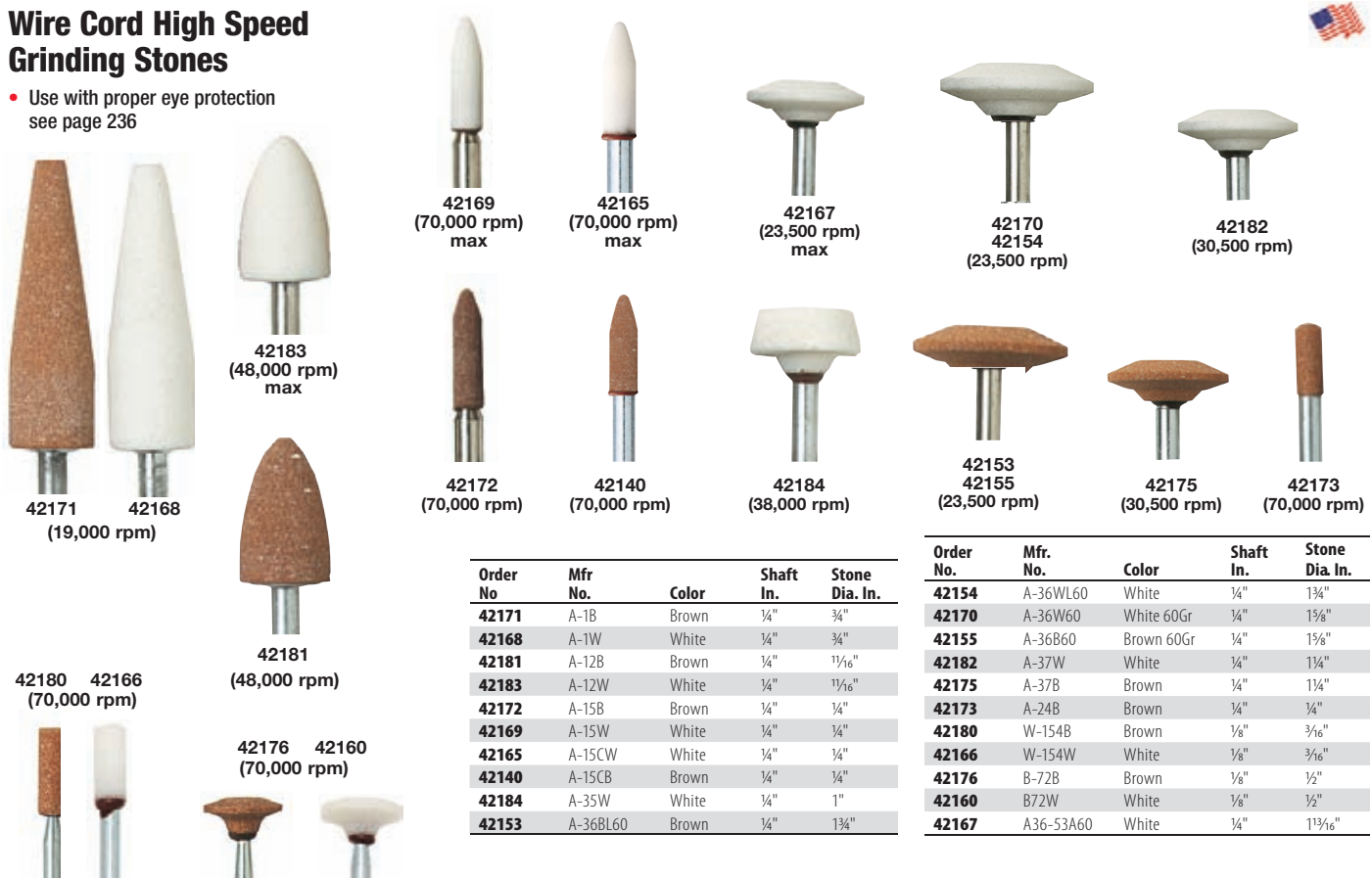

Order No.	Mfr No.	Color	Shaft In.	Stone Dia. In.
42171	A-1B	Brown	1/4"	3/4"
42168	A-1W	White	1/4"	3/4"
42181	A-12B	Brown	1/4"	1 1/16"
42183	A-12W	White	1/4"	1 1/16"
42172	A-15B	Brown	1/4"	1/4"
42169	A-15W	White	1/4"	1/4"
42165	A-15CW	White	1/4"	1/4"
42140	A-15CB	Brown	1/4"	1/4"
42184	A-35W	White	1/4"	1"
42153	A-36BL60	Brown	1/4"	1 3/4"

Order No.	Mfr. No.	Color	Shaft Dia. In.	Stone Dia. In.
42154	A-36WL60	White	1/4"	1 3/4"
42170	A-36W60	White 60Gr	1/4"	1 5/8"
42155	A-36B60	Brown 60Gr	1/4"	1 5/8"
42182	A-37W	White	1/4"	1 1/4"
42175	A-37B	Brown	1/4"	1 1/4"
42173	A-24B	Brown	1/4"	1/4"
42180	W-154B	Brown	1/8"	3/16"
42166	W-154W	White	1/8"	3/16"
42176	B-72B	Brown	1/8"	1/2"
42160	B72W	White	1/8"	1/2"
42167	A36-53A60	White	1/4"	1 13/16"

MYERS Tungsten Carbide Rasps

Myers specially coated tungsten carbide rasps are ideal for buffing, skiving, and finishing rubber, plastic, fiberglass, wood, or any non-metallic material. The tungsten carbide rasp cuts cleaner, quicker and at a lower cost. Use 36 grit and up for rubber finishing and cleaning and 16 grit for buffing, skiving, and cutting. *Save money. Myers Tungsten Carbide Rasps can be regritted. New tungsten carbide grit bonded to an old worn rasp provides a new rasp surface.*



LR OLIVER Rubberhog SSG Carbides

Rubberhog carbides have a coating of randomly spaced sharp uniform conical teeth made from a very hard tungsten carbide material. It is the combination of the sharpness of the teeth, with the uniform height and shape of the teeth, that gives the Rubberhog rasp a fast, cool, superior buff texture resulting in a longer rasp service life.

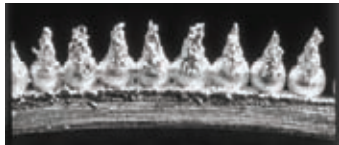

MCM	Description
120	Very Coarse
90	Coarse
70	Medium

SSG	Std. Grit
550	12
460	12
390	16
330	24
230	36
170	60
110	100

Comparison tooth size to standard carbide grit designation

MYERS Dualife Tungsten Carbide Rasps

The Myers Dualife rasp is an extended life tungsten carbide rasp for buffing and finishing tires. Dualife carbide rasps offers two to three times the life of a conventional carbide rasp.

- Sharper edges mean faster and cooler cutting, greatly improving durability
- Sharper carbide means cooler buffing and less chance for burning the buffed area
- Silver color identifies the rasp as the Myers longer life Dualife carbide rasp



B&J Jensen Tungsten Carbide Rasps

These rasps eliminate the need to handle cores.

The Jensen tungsten carbide product line is designed as a premium disposable carbide, always a new tool in use. The Jensen carbide is a disposable sharp-edged premium carbide offering long service with a consistent buff texture.



Arbor & Grit

Some of the tungsten carbide rasps may be ordered in varying arbor holes and grit specifications. By adding the proper letter after the 5 digit Myers Order Number. Specify the grit by adding the proper number after the arbor hole letter. For example 38211C3 is a 4" diameter; 3/8" arbor hole; 36 grit Cup Curved Rasp.

Arbor Hole	Grit
A = 3/8" AH	1 = 16 Grit
B = 1/2" AH	2 = 24 Grit
C = 5/8" AH	3 = 36 Grit
	4 = 46 Grit
	6 = 60 Grit

Note:

Use 36 grit and up for rubber finishing and cleaning
Use 16 grit for buffing, skiving, and cutting.

Flat Faced Rasps

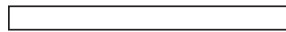

Vented & Non-Vented Contour Cup Rasp

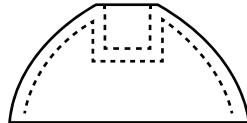

Vented Radiused Contour Cup Rasps

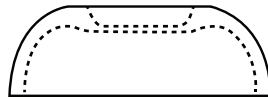

Radiused Faced Rasps

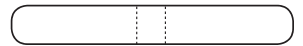

Non-Vented Radiused Cup Rasps

- Solid with heavy-duty machined core.
3/8"-24 threaded arbor hole

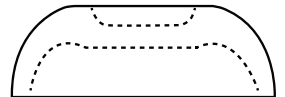

Vented & Non-Vented Curved Cup Rasps



RUBBERHOG Extreme Disc Wheel



Order No.	Mfr. No.	Diameter		Arbor Hole		Color	MCM
		In.	mm	In.	mm		
43315	SD412 x 120	4 1/2"	114.3	7/8"	22.2	Black	120
42819	SD412 x 90	4 1/2"	114.3	7/8"	22.2	Blue	90
42820	SD412 x 70	4 1/2"	114.3	7/8"	22.2	Teal	70

RUBBERHOG Extreme Dish Wheel

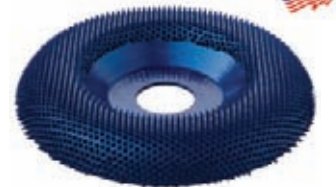

Order No.	Mfr. No.	Diameter		Arbor Hole		Color	MCM
		In.	mm	In.	mm		
42822	DW412 x 70	4 1/2"	114.3	7/8"	22.2	Teal	70
42821	DW412 x 90	4 1/2"	114.3	7/8"	22.2	Blue	90
42823	DW412 x 120	4 1/2"	114.3	7/8"	22.2	Black	120

RUBBERHOG Disc Wheel

- For angle head grinders



Order No.	Mfr. No.	Diameter		Arbor Hole		SSG
		In.	mm	In.	mm	
42816	SD4120390	4 1/2"	114	7/8"	22.2	390
43278	SD4120230	4 1/2"	114	7/8"	22.2	230
43279	SD4120550	4 1/2"	114	7/8"	22.2	550

RUBBERHOG Dish Wheel

- For angle head grinders



Order No.	Mfr. No.	Diameter		Arbor Hole		SSG
		In.	mm	In.	mm	
42757	DW4120390	4 1/2"	114	7/8"	22.2	390
42739	DW4120230	4 1/2"	114	7/8"	22.2	230
42783	DW4120550	4 1/2"	114	7/8"	22.2	550

Rasps

RUBBERHOG Flared Contour Wheels

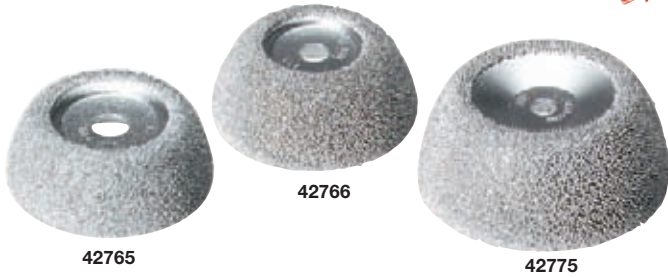

The working faces of the wheels are angled to the shaft making it easy to clear the hand piece for working inside and outside the casing. The wide and nearly flat working face radius produces the ideal texture over a wider contact area.

Order No.	Mfr. No.	Diameter		Width		Arbor Hole	SSG
		In.	mm	In.	mm		
42765	130-170	2"	51	3/4"	19	3/8"	170
42740	130-230	2"	51	3/4"	19	3/8"	230
42761	107	2 1/2"	64	1"	25	3/8"	170
42766	109	2 1/2"	64	1 1/8"	27	3/8"	230
42771	114	3"	76	1 1/4"	32	3/8"	230
42772	116	3"	76	1 1/4"	32	3/8"	390
42775	122	3 1/2"	89	1 1/2"	38	3/8"	390
42759	118	3 1/2"	89	1 1/2"	38	3/8"	170
42814	111	2 1/2"	64	1 1/8"	27	3/8"	390
42815	120	3 1/2"	89	1 1/2"	38	3/8"	230
OLIRG100	100	1 3/4"	44	3/4"	19	3/8"	230
OLI102	102	1 3/4"	44	3/4"	19	3/8"	170

RUBBERHOG Flared Contour Wheel Polyplugs



Units are made for flared contour wheels and are reusable. The polyplugs make the wheels run true, protect them from damage and provide better control.

Order No.	Mfr. No.	Diameter In.	Diameter mm	Arbor Hole
OL1150	150	1 3/4"	44	3/8"
42779	151	2"	51	3/8"
42760	152	2 1/2"	65	3/8"
42780	154	3"	76	3/8"
42781	156	3 1/2"	89	3/8"



RUBBERHOG Contour Wheel for Bandag Buffers



- Regrit service available



A precision contour wheel for sidewall buffing attachments.

Order No.	Mfr. No.	Diameter In.	Diameter mm	Width In.	Width mm	Arbor Hole	SSG
42768	129-P	4"	102	1 1/2"	38	3/4"	390

RUBBERHOG Donut Wheel for Matteuzzi Buffers



- Reducer bushings available
- Regrit service available



For Matteuzzi RAS90, RAS98E, RAS98E Ultra and other sidewall buffing attachments. Special bushings required, contact us.

Order No.	Mfr. No.	Diameter		Width		Arbor Hole	SSG
		In.	mm	In.	mm		
42774	708	6"	152	1"	25	1 1/2" (38mm)	390
	707-50	6"	152	1"	25	2" (50mm)	460
	708-50	6"	152	1"	25	2" (50mm)	390
42785	711	8"	203	1 1/4"	32	2 3/8" (60mm)	390

RUBBERHOG Round Faced Buzzout Wheel



For skiving and texturing of large exterior section repairs. 3/8" x 24 Standard thread arbor hole.

Order No.	Mfr. No.	Diameter		Width		SSG
		In.	mm	In.	mm	
OL1300	300	2"	51.8	1/4"	6.3	230
42776	302	2"	51.8	1/4"	6.3	390
OL1304	304	2"	51.8	3/8"	9.5	230
OL1306	306	2"	51.8	3/8"	9.5	390
OL1308	308	2"	51.8	1/2"	12.7	230
OL1310	310	2"	51.8	1/2"	12.7	390
OL1312	312	2"	51.8	3/4"	19	230
OL1314	314	2"	51.8	3/4"	19	390

RUBBERHOG Nailhole Reamers



For plug repairs on fabric tires only.



Order No.	Mfr. No.	Diameter		Length		Shank	SSG
		In.	mm	In.	mm		
42762	626	1/4"	6	3"	76	1/4"	230

RUBBERHOG Taper



For small section repairs of tread and sidewall.



Order No.	Mfr. No.	Diameter		Length		Shank	SSG
		In.	mm	In.	mm		
42763	611	5/8"	16	1"	25	1/4"	330
OLI613	613	7/8"	22.2	1 1/4"	31.7	1/4"	330

RUBBERHOG Rotor Saw



For small buzzout repairs of tread and sidewall.



Order No.	Mfr. No.	Diameter		Length		Shank	SSG
		In.	mm	In.	mm		
42777	619	1 3/8"	35	1 1/4"	32	1/4"	330

RUBBERHOG Balls



For skiving and texturing of small exterior section repairs.



Order No.	Mfr. No.	Diameter		Shank	SSG
		In.	mm		
42767	601	5/8"	16	1/4"	330
42764	603	7/8"	22	1/4"	330
42741	605	1 1/8"	28.5	1/4"	330

RUBBERHOG Black Contour Cup



For innerliner buffing. Standard tungsten carbide.



Order No.	Mfr. No.	Diameter		Width	Arbor Hole	Grit	
		In.	mm				
42770	130-B	2"	51	3/4"	19	3/8"	60

MYERS Dualife Tungsten Carbide Rasps



- Two to three times the life of conventional tungsten carbide rasps
- Improved durability for longer lasting cutting
- Sharper carbide means cooler buffing & less chance for burning the buffed area

Solid Curved Cup Rasps

3/8", 1/2" and 5/8" Arbor Holes (Specify)

Order No.	Mfr. No.	Diameter		Width		Arbor Hole	Grit*
		In.	mm	In.	mm		
38211A1	K375	4"	102	1 1/2"	38	3/8"	16
38213A4	K376	4"	102	1 1/2"	38	3/8"	46

* Other grit available upon request.



Vented Curved Cup Rasps

3/8", 1/2" and 5/8" Arbor Holes (Specify)

Order No.	Mfr. No.	Diameter		Width		Arbor Hole	Grit*
		In.	mm	In.	mm		
38416A1	TCW-315	3"	76	1 1/2"	38	3/8"	16
38417A3	TCW-3114	3"	76	1 1/4"	32	3/8"	36

* Other grit available upon request.



Non-Vented Radius Cup Rasps

3/8" x 24 Standard thread A.H.
Solid with heavy-duty machined core

Order No.	Mfr. No.	Diameter		Width		Arbor Hole	Grit*
		In.	mm	In.	mm		
38210	K360	3"	76	1"	25	3/8"	46

* Other grit available upon request.



Vented Radius Cup Rasps

Order No.	Mfr. No.	Diameter		Width		Arbor Hole	Grit*
		In.	mm	In.	mm		
38426A3		3"	76	1"	25	3/8"	36

* Other grit available upon request.



Vented Contour Cup Rasps

Vented
3/8" x 24 Standard thread arbor hole

Order No.	Diameter In.	Diameter mm	Length		Grit*
			In.	mm	
38185	2"	51	1"	25	16
38186	2"	51	1"	25	36

* Other grit available upon request.



MYERS Dualife Cone Rasps



3/8" x 24 Standard Thread

Order No.	Mfr. No.	Base Diameter		Length		Grit*
		In.	mm	In.	mm	
38690		3/4"	19	2"	51	36
38235	K331	3/4"	19	4"	102	16

* Other grit available upon request.

Specify Arbor Hole & Grit

Some of the above Dualife tungsten carbide rasps may be ordered in varying arbor holes and grit specifications. Specify arbor hole size by adding the proper letter after the 5 digit Myers Order Number. Specify the grit by adding the proper number after the arbor hole letter.

Arbor Hole	Grit
A = 3/8" AH	1 = 16 Grit
B = 1/2" AH	2 = 24 Grit
C = 5/8" AH	3 = 36 Grit
	4 = 46 Grit
	6 = 60 Grit

For example 38211C3 is a 4" diameter; 5/8" arbor hole; 36 grit Cup Curved Rasp.

MYERS Dualife Tungsten Carbide Rasps



Flat Faced & Radius Faced



Air-Cooled and Ventilated 3/8" x 24 Standard Thread

Order No.	Mfr. No.	Diameter		Width		Grit*
		In.	mm	In.	mm	
38480	22-03	2"	51	3/16"	5	36
38481	22-04	2"	51	3/16"	5	16
38482	22-05	2"	51	3/8"	10	36
38483	22-06	2"	51	3/8"	10	16
Radius Faced						
38484	22-07	2"	51	1/2"	13	36
38485	22-08	2"	51	1/2"	13	16
38486	22-09	2"	51	3/4"	10	36
38487	22-10	2"	51	3/4"	10	16
Radius Rasp - Solid, Not Ventilated						
38202	K352	2"	51	3/8"	10	36

MYERS Dualife Rods

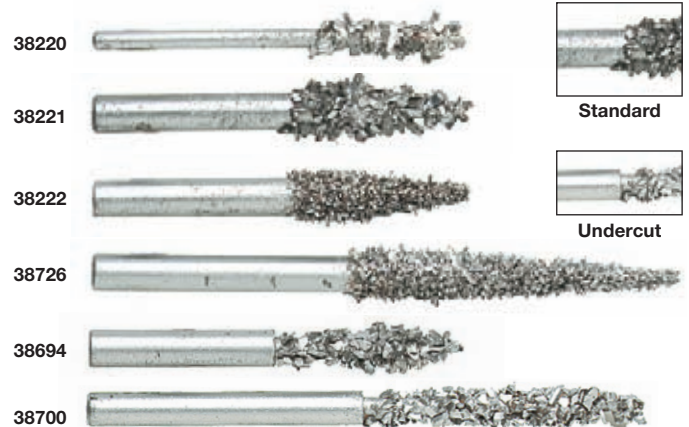

Order No.	Mfr. No.	Diameter		Width		Grit*
		In.	mm	In.	mm	
Standard						
38220	K344	1/8"	3	2 1/4"	57	16
38221	K343	1/4"	6	2 1/4"	57	16
38222	K343A	1/4"	6	2 1/4"	57	36
38726		1/4"	6	4"	102	36
Undercut for 1/4" Cutting Accuracy (1/4" Outside Diameter)						
38694		1/4"	6	2 1/2"	64	16
38700		1/4"	6	4"	102	16

MYERS Regritting Available

Don't discard your old tungsten carbide rasps. New tungsten carbide grit bonded to your old worn rasps gives them a "new" rasping surface. Specify grit. To order Regrits - place "R" in front of suffix. Example: 38211RA3 is a regrit. (K-375) with a 3/8 AH 36 grit. Contact your Myers salesperson for details.

Tungsten Carbide Rasps

MYERS Lightweight Tube & Innerliner Cup Rasps

- 3/8" arbor hole

Order No.	Diameter		Width		Grit
	In.	mm	In.	mm	
42489	2 1/2"	64	5/8"	16	36
31604	2"	51	1/2"	13	36

* Other grit available upon request.



MYERS Vented Radius Cup Rasps

- 3/8" arbor hole

Order No.	Diameter		Width		Grit
	In.	mm	In.	mm	
42426A3	3"	76.2	1"	25	36



MYERS Non-Vented Curved Cup Rasps

- 3/8" arbor hole

Order No.	Mfr. No.	Diameter		Width		Arbor Hole	Grit
		In.	mm	In.	mm		
42211A1	K-375	4"	101.6	1 1/2"	38.1	3/8"	16
42213A4	K-376	4"	101.6	1 1/2"	38.1	3/8"	46



MYERS Non-Vented Radius Cup Rasps

42210 machine core 3/8" x 24 SAE thread arbor hole

Order No.	Mfr. No.	Diameter		Width		Grit
		In.	mm	In.	mm	
42210	K-360	3"	76.2	1"	25.4	46



MYERS Contour Cup Rasps

Air-Cooled and ventilated or non-ventilated. Arbor hole 3/8"-24 SAE standard thread.

Order No.	Diameter In.	Diameter mm	Width		Grit	
			In.	mm		
42185	2"	51	1"	25	16	Vented
42186	2"	51	1"	25	36	Vented
42187	2"	51	1"	25	60	Vented
42190	2"	51	1"	25	16	Solid
42191	2"	51	1"	25	36	Solid
42189	2"	51	1"	25	60	Solid



MYERS Vented Flat Wheel Rasps

Other grit sizes and arbor holes available upon request.

Order No.	Mfr. No.	Diameter		Width		Arbor Hole	Grit
		In.	mm	In.	mm		
42440	TFW-310	3"	76	1"	25	*	Specify
42452	TFW-610	5"	152	1"	25	**	Specify
42453	TFW-615	6"	152	1 1/2"	38	**	Specify

* Specify arbor hole size 3/8" to 3/4" ** Specify arbor hole size 1/2" to 3/4"

MYERS Vented Curved Cup Rasps



Arbor Hole 3/8"-1/2"-3/4" specify. Other grit sizes and arbor holes available upon request.

Order No.	Mfr. No.	Diameter		Width		Arbor Hole	Grit
		In.	mm	In.	mm		
42414A1	TCW-310	3"	76	1"	25	3/8"	16
42414A3	TCW-310	3"	76	1"	25	3/8"	36
42417A3	TCW-3114	3"	76	1 1/4"	32	3/8"	36
42473A1	TCW-3114	3"	76	1 1/4"	32	3/8"	16
42416A1	TCW-315	3"	76	1 1/2"	38	3/8"	16
42416A2	TCW-315	3"	76	1 1/2"	38	3/8"	24
42416A3	TCW-315	3"	76	1 1/2"	38	3/8"	36
42416A4	TCW-315	3"	76	1 1/2"	38	3/8"	46
42416A6	TCW-315	3"	76	1 1/2"	38	3/8"	60
42431A1	TCW-415	4"	102	1 1/2"	38	3/8"	16
42419A3	TCW-415	4"	102	1 1/2"	38	3/8"	36
42431B1	TCW-415	4"	102	1 1/2"	38	1/2"	16
42419B3	TCW-415	4"	102	1 1/2"	38	1/2"	36
42491	TCW-515	5"	127	1 1/2"	38	7/8"	36
42291	TCW-515	5"	127	1 1/2"	38	1/2"	23
42292	TCW-615	6"	152	1 1/2"	38	*	36
42293	TCW-615	6"	152	1 1/2"	38	*	16

* Specify arbor hole size 1/2" to 3/4"

MYERS Vented Donut Curved Rasps



Arbor Hole 3/8"-1/2"-3/4" specify. Other grit sizes and arbor holes available upon request.

Order No.	Mfr. No.	Diameter		Width		Arbor Hole	Grit
		In.	mm	In.	mm		
42400A1	TDW-310	3"	76	1"	25	3/8"	16
42427A3	TDW-310	3"	76	1"	25	3/8"	36
42401A1	TDW-315	3"	76	1 1/2"	38	3/8"	16
42428A3	TDW-315	3"	76	1 1/2"	38	3/8"	36
42402A1	TDW-410	4"	102	1"	25	3/8"	16
42429A3	TDW-410	4"	102	1"	25	3/8"	36
42403A1	TDW-415	4"	102	1 1/2"	38	3/8"	16
42403B1	TDW-415	4"	102	1 1/2"	38	1/2"	16
42405	TDW-510	5"	127	1"	25	*	Specify
42407	TDW-515	5"	127	1 1/2"	38	*	Specify
42493	TDW-5118	5"	127	1 1/8"	28	*	Specify
42410	TDW-615	6"	152	1 1/2"	38	**	Specify

* Specify arbor hole size 3/8" to 3/4" ** Specify arbor hole size 1/2" to 3/4"

Note: We Recommend

Use 36 grit and up for rubber finishing & cleaning
Use 16 grit for buffing, skiving, & cutting.

MYERS 2" Rasps

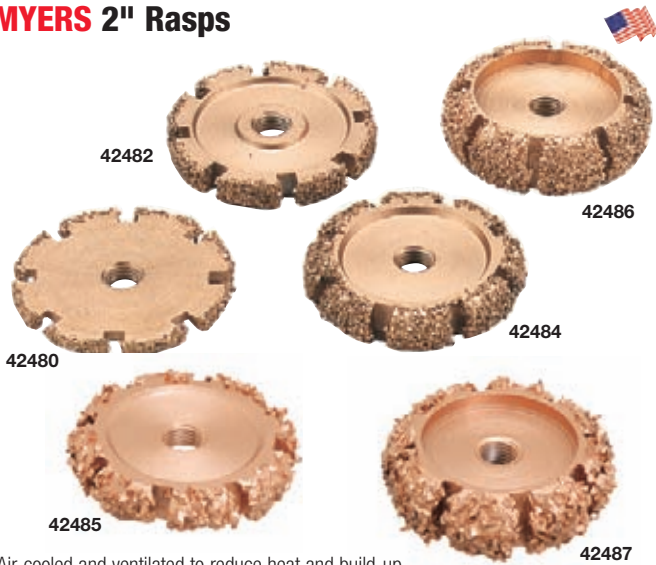

Air-cooled and ventilated to reduce heat and build-up.

Arbor Hole 3/8" – 24 SAE thread

Order No.	Mfr. No.	Diameter		Width		Grit
		In.	mm	In.	mm	
Flat Faced						
42480	22-03	2"	50.8	3/16"	4.7	36
42481	22-04	2"	50.8	3/16"	4.7	16
42482	22-05	2"	50.8	3/8"	9.5	36
42483	22-06	2"	50.8	3/8"	9.5	16
Radiused						
42484	22-07	2"	50.8	1/2"	12.7	36
42485	22-08	2"	50.8	1/2"	12.7	16
42486	22-09	2"	50.8	3/4"	19	36
42487	22-10	2"	50.8	3/4"	19	16

MYERS 4" & 6" Flat Face Rasps



Air-cooled and ventilated to reduce heat and build-up. Arbor hole 1/2"-24 SAE thread. Specify grit

Order No.	Mfr. No.	Diameter		Width		Grit
		In.	mm	In.	mm	
42443	T414	4"	102	1/4"	19	Specify
42444	T438	4"	102	3/8"	10	Specify
42445	T450	4"	102	1/2"	12.7	Specify
42446	T458	4"	102	5/8"	16	Specify
42447	T475	4"	102	3/4"	19	Specify
42448	T410	4"	102	1"	25.4	Specify
42717	UC650	6"	152.4	1/2"	12.7	16 Grit
42718	UC610	6"	152.4	1"	25.4	Specify

Regritting Available

Don't discard your old tungsten carbide rasps. New tungsten carbide grit bonded to your old worn rasps gives them a "new" rasping surface. Specify grit. To order Regrits - place "R" in front of suffix. Example: 38211RA3 is a regrit. (K-375) with a 3/8 AH 36 grit. Contact your Myers salesperson for details.

MYERS 1-1/2" Mini-Rasps



Reduce overbuff and spend less time buffing, filling and finishing an injury. Air-cooled and ventilated to reduce heat and build-up. Arbor hole 3/8"-24 SAE thread. Special grits available (Specify).

Order No.	Diameter		Width		Grit
	In.	mm	In.	mm	
Flat Faced					
42698	1 1/2"	38	1/8"	3	38
42699	1 1/2"	38	1/8"	3	36
42551	1 1/2"	38	3/16"	5	16
42553	1 1/2"	38	3/16"	5	36
42692	1 1/2"	38	1/2"	13	16
42693	1 1/2"	38	1/2"	13	36
Radiused					
42554	1 1/2"	38	5/8"	10	16
42556	1 1/2"	38	5/8"	10	36

MYERS Mega-Wheels

Fast buffing, long-lasting Dualife super grit

- Air cooled & ventilated to reduce heat
- Other grit & arbor hole sizes available on request
- All units regrittable with option to exchange same size with other grit & arbor hole sizes



Order Number	Mfr. No.	Diameter		Width		Arbor Hole	Grit
		in	mm	in	mm		
Flat Faced							
43280	33-03FFAC	3"	76	1/4"	4.8	3/8"SAE	36
43281	33-04FFAC	3"	76	1/4"	4.8	3/8"SAE	16
43282	33-05FFAC	3"	76	3/8"	9.5	3/8"SAE	36
43283	33-06FFAC	3"	76	3/8"	9.5	3/8"SAE	16
43288	44-03FFAC	4"	102	1/4"	4.8	3/8"SAE	36
43289	44-04FFAC	4"	102	1/4"	4.8	3/8"SAE	16
43290	44-05FFAC	4"	102	3/8"	9.5	3/8"SAE	36
43291	44-06FFAC	4"	102	3/8"	9.5	3/8"SAE	16
43294	66-03FFAC	6"	152	1/4"	4.8	3/8"SAE	36
43295	66-04FFAC	6"	152	1/4"	4.8	3/8"SAE	16
43296	66-05FFAC	6"	152	3/8"	9.5	1/2" AH	36
43297	66-06FFAC	6"	152	3/8"	9.5	1/2" AH	16
Round Face							
43284	33-07RFAC	3"	76	1/2"	12.7	3/8"SAE	36
43285	33-08RFAC	3"	76	1/2"	12.7	3/8"SAE	16
43286	33-09RFAC	3"	76	3/4"	9.5	3/8"SAE	36
43287	33-10RFAC	3"	76	3/4"	9.5	3/8"SAE	16
43292	44-07RFAC	4"	102	1/2"	12.7	3/8"SAE	36
43293	44-08RFAC	4"	102	1/2"	12.7	3/8"SAE	16
43298	66-07RFAC	6"	152	1/2"	12.7	1/2" AH	36
43299	66-08RFAC	6"	152	1/2"	12.7	1/2" AH	16

Tungsten Carbide Rasps

MYERS Air Cooled Buffing & Finishing Wheels

Available in 3" to 8" diameter, any width, 36 grit to 240 grit. Arbor hole 1/2", 3/8", and 3/4" std. When ordering specify diameter, width, arbor hole and grit.



Order No.	Diameter		Width	
	In.	mm	In.	mm
42705	3"	76	3/4"	6
42706	3"	76	3/8"	10
42707	3"	76	1/2"	13
42708	3"	76	3/4"	19
42709	3"	76	1"	25
42710	4"	102	3/8"	10
42711	4"	102	1/2"	13
42712	4"	102	5/8"	16
42713	4"	102	3/4"	19
42714	4"	102	1"	25

Order No.	Diameter		Width	
	In.	mm	In.	mm
42715	4"	102	1 1/2"	38
42716	6"	152	3/8"	10
42717	6"	152	1/2"	13
42718	6"	152	1"	25
42719	6"	152	1 1/2"	38
42720	8"	203	1/2"	13
42721	8"	203	5/8"	16
42722	8"	203	3/4"	19
42723	8"	203	1"	25
42724	8"	203	1 1/2"	38

MYERS Cone Rasps



Arbor Hole 3/8"-24 SAE thread.

Order No.	Mfr. No.	Base Diameter		Length		Grit
		In.	mm	In.	mm	
42690		3/4"	19	2"	51	36
42691		3/4"	19	2"	51	16
42234	K-332	3/4"	19	4"	102	36
42235	K-331	3/4"	19	4"	102	16
1 1/2" Bullnose Cone						
42253		3/4"	19	1 1/2"	38	36
42254		3/4"	19	1 1/2"	38	16

MYERS Rods



Order No.	Mfr. No.	Diameter		Width		Grit
		In.	mm	In.	mm	
42220	K-344	1/8"	3	2 1/4"	57	16
42221	K-343	1/4"	6	2 1/4"	57	16
42222	K-343A	1/4"	6	2 1/4"	57	36
Undercut for (1/4" Cutting Accuracy)						
42694		1/4"	6	2 1/2"	64	16
42695		1/4"	6	2 1/2"	64	36
42700		1/4"	6	4"	102	16
42701		1/4"	6	4"	102	36
Standard						
42725		1/4"	6	4"	102	16
42726		1/4"	6	4"	102	3

MYERS Flat Cup Rasps



Arbor hole 3/8"-24 SAE thread.

Order No.	Mfr. No.	Diameter		Width		Grit
		In.	mm	In.	mm	
42226	K-338	2"	51	1/2"	13	46
42227	K-337	2"	51	1/2"	13	16
42228	K-335	2"	51	1"	25	46
42229	K-334	2"	51	1"	25	16

MYERS Tapered Rasps

Arbor hole 3/8"-24 SAE thread.

Order No.	Mfr. No.	Diameter		Width		Grit
		In.	mm	In.	mm	
42215	K-358	2"	51	1"	25	16
42216	K-359	2"	51	1"	25	36

MYERS Ball Rasps



Order No.	Shaft Length		Shaft Diameter		Ball diameter		Grit
	In.	mm	In.	mm	In.	mm	
42696	2"	51	1/4"	6	3/4"	19	16
42697	2"	51	1/4"	6	3/4"	19	36

MYERS Wheel Rasps

Arbor Hole 3/8" - 24 SAE thread

Order No.	Mfr. No.	Diameter		Width		Grit*
		In.	mm	In.	mm	
42240	K-340	2 1/2"	64	5/16"	8	16

MYERS Angle Faced Rasps

3/4" (19mm) wide, 5/8" Arbor hole only

Order No.	Diameter		Arbor Hole	Grit
	In.	mm		
42490	4"	102	5/8"	23 Solid
42495	4"	102	5/8"	23 Ventilated

MYERS Flat Ventilated 7" Disc Rasps

Other grit sizes available upon request. Only 7/8" arbor hole available.

Order No.	Mfr. No.	Arbor Hole	Grit
42249	DSK-738	7/8"	16 Vented
42492	DSK-738	7/8"	24 Vented

Note: We Recommend

Use 36 grit and up for rubber finishing & cleaning
Use 16 grit for buffing, skiving, & cutting.

JENSEN Disposable Rasps

- Long-lasting, value-priced & designed to be disposable

JENSEN Flat-Faced Carbide Rasps

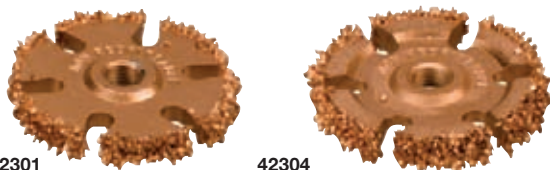

Arbor hole 3/8"-24 SAE thread.

Order No.	Mfr. No.	Diameter		Width		Grit
		In.	mm	In.	mm	
42303	21-098 (22-04)	2"	50.8	3/16"	4.7	16
42302	21-098 (22-03)	2"	50.8	3/16"	4.7	36
42301	21-099	2"	50.8	1/4"	6.4	16
42300	21-099	2"	50.8	1/4"	6.4	36
42304	21-100 (22-06)	2"	50.8	3/8"	9.5	16
42305	21-101 (22-05)	2"	50.8	3/8"	9.5	36

JENSEN Round-Faced Carbide Rasps



Arbor hole 3/8"-24 SAE thread.

Order No.	Mfr. No.	Diameter		Width		Grit
		In.	mm	In.	mm	
42306	21-102 (22-08)	2"	50.8	1/2"	12.7	16
42307	21-103 (22-07)	2"	50.8	1/2"	12.7	36
42308	21-104 (22-10)	2"	50.8	3/4"	19	16
42309	21-105 (22-09)	2"	50.8	3/4"	19	36
42310	21-106	2"	50.8	7/8"	22.2	16
42311	21-107	2"	50.8	7/8"	22.2	36

JENSEN Solid Contour Cup Rasps



Arbor hole 3/8"-24 SAE thread.

Order No.	Mfr. No.	Diameter		Width		Grit
		In.	mm	In.	mm	
42312	21-108	2"	50.8	1"	25.4	16
42313	21-109	2"	50.8	1"	25.4	36
42314	21-110	2"	50.8	1"	25.4	60

3" & 4" Vented Curved Cup Rasps



Order No.	Mfr. No.	Diameter		Width		Arbor Hole	Grit
		In.	mm	In.	mm		
42318	TCW310	3"	76.2	1"	25.4	3/8"	16
42319	TCW310	3"	76.2	1"	25.4	3/8"	36
42320	TCW310	3"	76.2	1"	25.4	3/8"	60
42321	TCW315	3"	76.2	1 1/2"	38.1	3/8"	16
42322	TCW315	3"	76.2	1 1/2"	38.1	3/8"	36
42323	TCW315	3"	76.2	1 1/2"	38.1	3/8"	60
42315	TCW415	4"	101.6	1 1/2"	38.1	3/8"	16
42316	TCW415	4"	101.6	1 1/2"	38.1	3/8"	36
42317	TCW415	4"	101.6	1 1/2"	38.1	3/8"	60
42324	TCW415	4"	101.6	1 1/2"	38.1	1/2"	16
42325	TCW415	4"	101.6	1 1/2"	38.1	1/2"	36
42326	TCW415	4"	101.6	1 1/2"	38.1	1/2"	60

TEMCO Tungsten Carbide Abrasive Sleeves

- For finishing rubber, plastic, any non-metallic material



Tungsten carbide particles permanently bonded to steel sleeves.

3" (76.2mm) diameter x 1" (25.4mm) wide 3" (76.2mm) diameter x 2" (50.8mm) wide 3" (76.2mm) diameter x 3" (76.2mm) wide

Order No.	Mfr. No.	Grit	Order No.	Mfr. No.	Grit	Order No.	Mfr. No.	Grit
42125	TB-400	24	42127		24	42132		16
42122	TB-400A	36	42128	TB-402A	36	42133		24
42123	TB-400B	60	42129	TB-402B	60	42134	TB-401A	36
42124	TB-400C	120	42130	TB-402C	120	42135	TB-401B	60
						42136	TB-401C	120

TEMCO Sanding Drums for Abrasive Sleeves



True-running uniform expansion molded rubber drums. Includes arbor for attaching to flexible shafts, electric drills, drill presses, open end buffers, etc. Squeezing action of flanges expands drum to fit tightly against abrasive sleeves. Sleeves cannot slip.

Order No.	Mfr. No.	Arbor Hole	Size
3" (76.2 mm) Diameter x 1" (25.4 mm) wide			
42101	TB-140	9/16"	18 SAE F
42102	TB-140A	1/2"	20 SAE F
42103	TB-140B	3/8"	16 USS F
42104	TB-140R		Repl. Rubber
3" (76.2 mm) Diameter x 2" (50.8 mm) wide			
42107	TB-340	9/16"	18 SAE F
42108	TB-340A	1/2"	20 SAE F
42109	TB-340B	3/8"	16 USS F
42110	TB-340R		Repl. Rubber
3" (76.2 mm) Diameter x 3" (76.2 mm) wide			
42113	TB-540	9/16"	18 SAE F
42114	TB-540A	1/2"	20 SAE F
42115	TB-540B	3/8"	16 USS F
42116	TB-540R		Repl. Rubber

Buffing Stone

2" diameter (50.8 mm) x 1 3/4" (44.5 mm) face, fits any low speed buffer or electric drill. 1/4" Shaft, 24 grit. 42498 Adapter required to use with a quick change chuck



Order No.	Mfr. No.	Description	Maximum RPM
42642	A-600-A	Buffing Stone	7,000
42498	TB-3BH	1/4" Shaft Adapter w/Set Screw	

Contour Buffing Stone

For use with a low speed buffer. 4" (102mm) diameter x 1 1/2" (38.1mm) face. Used for buffing tire injuries. Made of bonded silicone carbide. Beveled, medium hard, 24 grit.



Order No.	Mfr. No.	Arbor Hole	Maximum RPM
42644	5946	1/2"	4,200

Rotary Gougers

B&J Squiggly Rasps

- Fast rubber removal
- Less heat & scorching

For use on hand held buffers for buzzouts and rubber removal jobs. 45° Angle cutting surface creates the squiggly effect. Two specially formed steel plates hold it in place. 2" diameter with 3/8" arbor hole.



Order No.	Mfr. No.	Description
43513	20-103	10 Pack with 2 Plates
43514	20-104	24 Pack with 2 Plates
43515		Replacement Plates - Set of 2
42399		Quick Change Adapter with Spacer

B&J 5" Buffing Rasp

- Use for OTR repairs
- 5" Diameter

For hand-held buffers and grinders. Contact us for special applications.



Order No.	Mfr. No.	Description	Arbor Hole
43519	12003	R2 Regular Rasp Hub 2" Wide	1/2"
43520	12003-3	R2 Regular Rasp Hub 1-1/2" Wide	1/2"

Tack Rasps & Hubs for Flex Shafts & Drills

Small tack bands for buffing or grinding. Fits over small hubs for use on drills and flex shafts. Hub unit includes an expansion ring.



Order No.	Mfr. No.	Diameter		Width		A.H.	For Hub
		In.	mm	In.	mm		
43271	6	2 1/2"	64	1"	25		B-6
43273	8	1 1/2"	38	3/8"	16		B-8
43263A	B-6	2 1/2"	64	1"	25	3/8"	
43263B	B-6	2 1/2"	64	1"	25	1/2"	
43265A	B-8	1 1/2"	38	3/8"	16	3/8"	

R-5 & R-6 Rasps

For drills and flexible shafts buffers. Adapters to fit all sizes of female and male couplings are available. 1/2" Arbor only.



Order No.	Mfr. No.	Description	Arbor Hole
43500	R-5 Rasps w/ Spacers	1 3/4" Dia. x 1/2" w	1/2"
43501	R-6 Rasps w/ Spacers	3" Dia. x 3/8" w	1/2"
43502	R-5-R	Refills, 5 Per Set	
43504	R-6-R	Refills, 6 Per Set	

7" Tac-A-Disc

Hardened tacks mounted in a 7" diameter concave disc. 7/8" Arbor hole.



Order No.	Mfr. No.	Description	Arbor Hole
42267	7-C	Tac-A-Disc "C"	7/8"

Piranha Carbide Rasps

Ideal durable carbide rasp for removing large amounts of rubber. Stackable, just add washers between them and use a wider width carbide for big jobs. Not regreitable. Use the 42399 adapter with the spacer for a single Piranha.



Order No.	Mfr. No.	Description	Grit	Diameter	Width
42193	208-16	Piranha Rasp	16	2"	1/2"
42194	208-36	Piranha Rasp	36	2"	1/2"
42399		Quick Change Adapter with Spacer			

B&J Rotary Gougers

- Removes rubber fast & easy



The lightweight, low profile design gives improved control. Available in notched or un-notched styles. Thin wall sizes to fit all requirements. Notched gouger for use on fabric tires, un-notched on wire fabric. Sold in box quantity only.

Order No.	Mfr. No.	Diameter		Arbor	Notches	Per Box
		In.	mm			
31088	11-607	3/4"	19	3/8"	No	4
31083	11-604	1 1/4"	32	3/8"	No	3
31081A	11-610	2"	51	3/8"	No	2
31081B	11-610-1	2"	51	1/2"	No	2
31082A	11-612	2"	51	3/8"	Yes	2
31082B	11-612-1	2"	51	1/2"	Yes	2
Heavy-Duty Rotary Gouger						
31079	11-606	2"	51	1/2"	Yes	1
31092	11-605	2"	51	1/2"	No	1
Adapters						
31086	17-200	1/2" To 3/8" Reducer Bushing				
42421	TB-04A	3/8"-24 Thread Adapter				

B&J Threaded Rotary Gougers

3/8"-24 thread to be screwed onto an adapter. Use the nut supplied with the optional 42421 Adapter to keep the gouger toward the top of the threads.



Order No.	Mfr. No.	Diameter		Arbor	Notches	Per Box
		In.	mm			
31088	11-607	3/4"	19	3/8"-24 Thread	No	4
31087	11-603	1 1/4"	32	3/8"-24 Thread	No	3
31095	11-610-2	2"	51	3/8"-24 Thread	No	2
31096	11-612-2	2"	51	3/8"-24 Thread	Yes	2
42421	TB-04A	3/8"-24 Thread Adapter				

B&J Rotary Gouger Sharpener

Sharpen small or large rotary gougers. Press the spinning gouger between the angled stones. Replacement stones available.



Order No.	Mfr. No.	Description	Per Box
31089	11-626	Sharpener for 3/4" to 1 1/4"	
31090	11-636	Replacement Stone for 3/4" to 1 1/4"	2 Per Box
31084	11-625	Sharpener for 1 1/4" to 2"	
31085	11-635	Replacement Stone for 1 1/4" to 2"	6 Per Box

Texturing Brushes

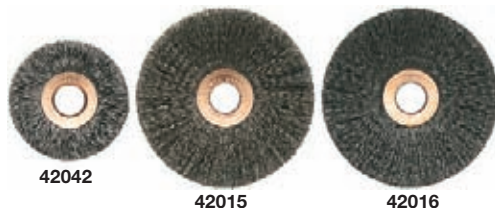

Wire brushes for texturing rubber surfaces and tire innerliners. For use in low speed grinders. Removable plastic insert for 1/2" arbor hole.

Order No.	Diameter		Width		Wire	Arbor Hole	
	In.	mm	In.	mm		In.	mm
42042	2"	50.8	1/4"	6	.0118	3/8"	10
42015	3"	76.2	1/4"	6	.008 Coarse	3/8"	10
42016	3"	76.2	1/4"	6	.006 Fine	3/8"	10

* Remove plastic insert for 1/2" arbor hole

Plastic Encapsulated Brushes

Minimizes bristle spreading, controls cut depth and bristle wear. Removable plastic insert for 1/2" arbor hole.



Order No.	Diameter		Width		Wire	Arbor Hole	
	In.	mm	In.	mm		In.	mm
42017	2"	50.8	1/4"	6	.006 Fine	3/8"	10
42022	3"	76.2	1/4"	6	.008	3/8"	10

* Remove plastic insert for 1/2" arbor hole

Rubber Encapsulated Wire Brushes

.006 wire., 1/4" face width

Order No.	Mfr. No.	Arbor Hole	
		In.	mm
42162	S897	3/8"	10
42163	S893	3/8"	10

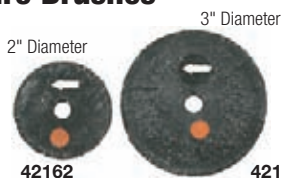

3" Tire Buffing Brush



Excellent for use in preparing buzz-outs. .0118 Wire.

Order No.	Mfr. No.	Diameter		Width		Arbor Hole	
		In.	mm	In.	mm	In.	mm
31601	5231	3"	76	1/4"	6	3/8"	10

3" Skiving Brush & Double Adapter

- Standard or encapsulated brushes
- Encapsulated brush lasts longer



Used for buzz outs to skive injured area after buffing. The stiff brush is designed to cut, not texture. The encapsulated brush wears more evenly and lasts longer. The double adapter allows the operator to reverse the sharp side of the brush without having to remove the nut and washer. Removable plastic insert for 1/2" arbor hole.

Order No.	Description	Arbor Hole	
		In.	mm
42028	76964 Brush	3/8"	10
42014	Wide Encapsulated Brush	3/8"	10
42013	Narrow Encapsulated Brush	3/8"	10
42412	Double Adapter		

4" Inner Tube Buffing Brush



Extra soft wire for buffing inner tubes. Fits bench grinder or flexible shaft buffer. .004 wire. 4" diameter, 1/2" arbor hole.

Order No.	Mfr. No.
42038	08-24

4" Tire Sidewall Brush



For preparing casings after surplus rubber is removed, and before camelback is applied. .0118 wire. 4" dia. x 1" width, 1/2" arbor hole.

Order No.	Mfr. No.
42024	1419

4" Twisted Wire Brush



For roughening and removing excess rubber. .020 Twisted wire. Removable plastic insert for 1/2" Arbor hole.

Order No.	Mfr. No.	Diameter		Width		Arbor Hole	
		In.	mm	In.	mm	In.	mm
42030	7810	4"	102	3/8"	10	3/8"	10

* Remove plastic insert 1/2" arbor hole

4" Twisted Wire Brush



For roughening and removing excess rubber. 5/8"-11 Threaded nut arbor hole.

Order No.	Mfr. No.	Diameter		Width	
		In.	mm	In.	mm
42009	5516-5	4"	102	3/8"	10

6" Twisted Wire Rim Buffing Brush



Approved by major rubber companies. Operates off flexible shaft buffers, bench grinders, or drill with speeds of 3,450 rpm or faster. .014 wire. For best results use 2 brushes side by side.

Order No.	Mfr. No.	Diameter		Width		Arbor Hole	
		In.	mm	In.	mm	In.	mm
42082	7814	6"	152	1/2"	13	1/2"	13

* Remove plastic insert 1/2" arbor hole

6" Rim Buffing Brush



Operates off flexible shaft buffers, bench grinders, or drill with speeds of 3,450 RPM or faster. .016 wire with 3/8"-11 threaded nut arbor hole.

Order No.	Diameter		Width	
	In.	mm	In.	mm
84009	6"	152	1/2"	13

Sidewall Buffer Brushes

Brass Sidewall Buffing Brushes



Replacement brush for the sidewall buffing attachment. 6" diameter brass brush, 1 3/4" wide.

Order No.	Description	Arbor Hole
42025	6" Brass Sidewall Brush	3"

Sidewall Buffing Brush For Bandag 8400 Series Buffers



For 8400 Series buffing attachment. 1 1/2" wide x 8" with a 2" arbor hole.

Order No.	Description
42035	8" Sidewall Brush

Wire Wheel Brushes



Patented carbon steel wire will not break off, separate, or heat up and scorch rubber or cord. All .010 wire. Brushes have 2 1/4" arbor hole and include 1/2" or 3/4" bushings except where noted.

Order No.	Mfr. No.	Diameter In.	Diameter mm	Arbor	Face Width	Description
42001B	412	4"	102	1/2"	1"	
42002B	432	4 1/4"	108	1/2"	1"	
42002D*	432	4 1/4"	108	3/4"	1"	For Use on Bandag sidewall buffers
42003B	632	6"	152	1/2"	1"	
42003M21**	632	6"	152	21mm	1"	For Use on Matteuzzi RAS 90 & 98E Ultra
42003M38***	632	6"	152	38mm	1"	For Use on Matteuzzi RAS 98E
42004C	832	8"	203	5/8"	1"	
42006J	1035	10"	254	2"	2 1/2"	

Steel Wheel Brush

- 5/8"-11 Threaded Nut
- Adapters available to reduce to 3/8"-24 thread. Contact us.



Use for cleaning rust and debris from passenger and truck steel wheels. 4" diameter, 5/8" 11 threaded arbor hole, 9,000 max. rpm.

Order No.	Mfr. No.	Description
42010	7076	Steel Wheel Brush

Stem Brushes



Use for preparing tire injury after drilling or grinding. Solid shaft will not unravel during use. Use with low speed tool.

Order No.	Description
42161	3/8" Stem Brush
42117	1/2" Stem Brush
42119	3/4" Stem Brush

Quick Change Chuck & Adapters



Use any of the adapters listed with the 42415 chuck.

Order No.	Mfr. No.	Description
42415	TB-20C	Quick Change Chuck (3/8" - 24 FPT)
42424	MQC-2-13	Quick Change Chuck (1/2" - 13 FPT)
42365		3/16" - 18 Quick Change Chuck (3/16" - 18 FPT)
42420	TB-4	3/8" - 24 Adapter, 2 1/4" Long
42421	TB-4A	3/8" - 24 Adapter 1" Long Thread, 2 1/4" Length with 2 Washers, Nut for Mounting Tools with 3/8" Arbor Hole
42422	TB-4S	3/8" - 24 Short Adapter 1 7/8" Long
42497	TB-3AH	1/8" Shaft Adapter with Set Screw
42498	TB-3BH	1/4" Shaft Adapter with Set Screw
42375	2540	3/16" 3 Tang Shank Adapter with set screw
42376	2541	5/16" 3 Tang Shank Adapter with set screw
42370	CC	7/16" And 3/8" Shank Adapter with set screw
42399	TB-4B	Quick Change Adapter with Spacer
42412		Double Adapter for Skiving Brush
42425L		1/2" Double Quick Change Adapter with Nut
49635		5/32" x 3/16" Set Screws for 42497, 42498, 42375, 42376 Adapters. 25 Per Bag

Jacobs Chucks & Adapters



Drill Adapters		
Order No.	Mfr. No.	Description
31699	30247	3/8" Chuck & Key (3/8"-24 Thread)
42039	TB-310-D	1/4" Shank to 1/2" SAE Male
42041	TB-320-D	1/4" Shank to 3/8" USS Male
42246	K-345	For 1/4" Drill to 3/8" USS Male

White Sidewall Buffing Stone



Vitrified white sidewall buffing wheel. Maximum operating speed 4,200 RPM.

Order No.	Grit	Diameter		Width		Arbor Hole	
		In.	mm	In.	mm	In.	mm
42656	46	4"	102	1 1/2"	38	1/2"	13

LINCOLN ERV Envelope Repair Spotter

Features a large 6" curing head with an air-driven silicone rubber piston pad providing even pressure during the cure cycle. Built-in timer turns off heat and air automatically. Throat depth 14½". Includes bench mount brackets. 220V Model available. See page 310 for #14340 Envelope Repair Kit.



Order No.	Description	Ship Wt.
36464	ERV Vulcanizer (110V)	60 lbs. - 27 kg.

LINCOLN 150 Heavy-Duty Electric Tube Plate Spotter

- 12" x 4-3/8" Curing surface

For large repairs on all sizes of inner tubes. Detachable plate for vulcanizing valve stems. Thermostatically controlled, high wattage element reaches curing temperature fast.



Order No.	Mfr. No.	Description	Ship Wt.
36500	150	Heavy-Duty Tube Plate Vulcanizer 120V	40 lbs. - 18 kg.
36392	150	Heavy-Duty Tube Plate Vulcanizer 240V	40 lbs. - 18 kg.
36507	T075	Truck Valve Stem Adapter	1 lbs. - 1 kg.
36510	T076	3 3/4" Base Air/Water Tractor Valve Stem Adapter	1 lbs. - 1 kg.
36509	T035	Replacement Heat Unit 120V	6 lbs. - 3 kg.
36518	T035	Replacement Heat Unit 240V	6 lbs. - 3 kg.

LINCOLN 200 Electric Tube Plate Spotter

- 4-3/8" x 6-3/8" Curing surface

Quick heating, snap type thermostat reaches and maintains curing temperature fast. Detachable flat plate for curing valve stems. Trigger action clamp for quick work adjustments.



Order No.	Mfr. No.	Description	Ship Wt.
36506	200	Tube Plate Vulcanizer 120V	27 lbs. - 13 kg.
36394	200	Tube Plate Vulcanizer 240V	27 lbs. - 13 kg.
36507	T075	Truck Valve Stem Adapter	1 lbs. - 1 kg.
36510	T076	3 3/4" Base Air/Water Tractor Valve Stem Adapter	1 lbs. - 1 kg.
36508	T036	Replacement Heat Unit 120V	4 lbs. - 2 kg.
36516	T036	Replacement Heat Unit 240V	4 lbs. - 2 kg.

LINCOLN 3100PL Portable Electric Truck Bead Spotter

- Application: truck tire bead repairs
- Maximum injury size 7"



Clamp-on the lightweight and portable vulcanizer, tighten the screw and it's ready to repair bead injuries up to 7". Features inside and outside heat units for fast, controlled curing; bead plates for 11:22.5 and 11:24.5 truck tires are included.

Order No.	Mfr. No.	Description	Ship Wt.
36315	3100PL	Bead Vulcanizer 120V	38 lbs. - 17 kg.
36316	3100PL	Bead Vulcanizer 240V	38 lbs. - 17 kg.
36268	T047	Replacement Outside Heat Unit 120V	
36267	T048	Replacement Inside Heat Unit 120V	

LINCOLN 300 Passenger Tire Spotter

- Throat depth 4"
- Throat height 8-1/4"
- 3-5/16" Curing surface
- Spotter plates see page 337



Thermostatically controlled heat unit reaches operating temperature quickly for fast cure rates. Unit can be bench mounted or used as a portable vulcanizer. Optional 36273 Plate package includes three 4" plates.

Order No.	Mfr. No.	Description	Ship Wt.
36400	300	Vulcanizer 120V without Plates	12 lbs. - 5 kg.
36281	300	Vulcanizer 240V without Plates	44 lbs. - 20 kg.
36273	T149	Optional Plate Pkg. for 300	2 lbs. - 1 kg.
36404	T038	Replacement Heat Unit 120V	2 lbs. - 1 kg.
36399	T038	Replacement Heat Unit 240V	2 lbs. - 1 kg.

LINCOLN LT Air/Electric Light Truck Tire Spotter

- Throat depth 8-1/4" (21 cm)
- Throat height 19" (48 cm)
- Maximum injury size 3-1/2"
- Spotter plates see page 337



Application: tread, shoulder, & sidewall repairs

Repair the tread, shoulder, and sidewall areas of passenger and light truck tires with one vulcanizer. Piston pad air head produces professional looking sidewall repairs. Tread and shoulder areas are solidly repaired with constant pressure provided by contour plates and a spring loaded compensating system. Heats from both sides of tire for maximum repair efficiency. 36269 Optional Stand supports tire on roller assembly for easy rotation. Horizontal vulcanizer makes alignment with repair easy and eliminates stress from repair area. Optional 36277 Contour Plate Set is required for new installations. Includes four, 4" plates. See page 337 for details.

Order No.	Mfr. No.	Description	Ship Wt.
36338	T016	LT Vulcanizer, 120V without Plates	44 lbs. - 20 kg.
36340	T016	LT Vulcanizer, 240V without Plates	44 lbs. - 20 kg.
36269	T031	Optional Stand for LT Vulcanizer	75 lbs. - 34 kg.
36277	T153	Optional Contour Plate Set for LT	4 lbs. - 2 kg.
36266	T023	Replacement Solid Heat Unit 120V	
36265	T055	Silicone Rubber Heat Pad (4" Dia.) 120V	
36417	T062	Silicone Rubber Air Seal (4" Dia.) 120V	
36264	T121	Detachable Electric Cord	

WINNER Bead Spotter

Repairs damaged beads in passenger and truck tires with inside and outside contour plates matching the tire size. Includes one set of plates for 11-22.5 and 11-24.5 tires. Other plate sizes are available for passenger and truck tires. Each inside and outside heater draws 485 watts on 100 V.A.C.



Shown on Optional Stand

Order No.	Mfr. No.	Description	Ship Wt.
36603	TT-15	Bead Vulcanizer 120V	140 lbs. - 63 kg.
36602	TT-15	Bead Vulcanizer 240V	140 lbs. - 63 kg.
36605	TT-15S	Optional Stand	75 lbs. - 34 kg.

LINCOLN 400B Electric Truck Tire Spotter

- Throat depth 6-1/4"
- Throat height 9-1/2"
- Spotter plates see page 337
- Application: shoulder, tread, sidewall repairs
- Maximum injury size 3-1/2"

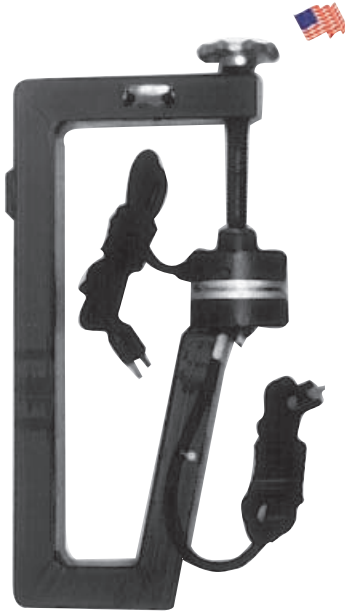

Allows repairs in tires up to 12.00 cross section. High performance heat units feature plate mounted, preset (European approved) thermostats. Heat-up time less than 5 minutes. Optional plate package includes eight plates. See page 337 for details.

Order No.	Mfr. No.	Description	Ship Wt.
36410	400B	Vulcanizer 120V w/o Plates	14 lbs. - 6 kg
36388	400B	Vulcanizer 240V w/o Plates	14 lbs. - 6 kg
36274	T150	Optional Plate Package for 400	8 lbs. - 3 kg
36413	T039	Replacement Heat Unit (Upper) 120V	2 lbs. - 1 kg
36404	T038	Replacement Heat Unit (Lower) 120V	2 lbs. - 1 kg
36415	T039	Replacement Heat Unit (Upper) 240V	2 lbs. - 1 kg
36399	T038	Replacement Heat Unit (Lower) 240V	2 lbs. - 1 kg

LINCOLN 2000TS Air/Electric Truck Tire Spotter

- Throat depth 11-1/2" (29cm)
- Throat height 24-1/2" (62cm)
- Spotter plates see page 337



Application: tread sidewall shoulder repairs
 Maximum injury size: 5-1/2"
 Size Range: Low profile truck tires to super single tires

The 6" flexible silicone rubber heat unit conforms to tire sidewall. Capable of repairs up to 5 1/2" on truck tires from low profile to super singles. Control panel has circuit breaker, air regulator, and current indicator lamp. Timer turns off heat, air flow and electricity for unattended shutdown. Indicator lamp shows when cure is complete. 16" Rollers for easy tire rotation. Optional nine piece Plate Package available. See page 337 for details.

Order No.	Mfr. No.	Description	Ship Wt.
36299	2000TS	Vulcanizer w/ Stand 120V without Plates	203 lbs. - 92 kg
36297	2000TS	Vulcanizer w/ Stand 240V without Plates	203 lbs. - 92 kg
36280	T156	Optional 9-Piece Plate Pkg. for 2000TS	32 lbs. - 15 kg
36263	T060	Replacement Solid Heat Unit 120V	
31624	T057	Silicone Rubber Heat Pad (6" Dia.) 120V	
36418	T063	Silicone Rubber Air Seal (6" Dia.) 120V	
36264	T121	Detachable Electric Cord	

LINCOLN MT Air/Electric Medium Truck Tire Spotter

- Throat depth 8-1/4" (21 cm)
- Throat height 19" (48 cm)
- Maximum injury size 5-1/2"
- Spotter plates see page 337



Shown with Optional Stand

Application: tread, shoulder, & sidewall repairs

Repair the tread, shoulder, and sidewall areas of medium sized (8:25 through 12:00) truck tires. Piston pad air head produces professional looking sidewall repairs. Tread and shoulder areas are solidly repaired with constant pressure provided by contour plates and a spring loaded compensating system. Heats from both sides of tire for maximum repair efficiency. 36269 Optional stand supports tire on roller assembly for easy rotation. Horizontal vulcanizer makes alignment with repair easy and eliminates stress from repair area. Optional 36279 Contour Plate Set is required for new installations. Includes 5 plates. See page 337 for details.

Order No.	Mfr. No.	Description	Ship Wt.
36342	T022	MT Vulcanizer, 120V w/o Plates	51 lbs. - 23 kg
36344	T022	MT Vulcanizer, 240V w/o Plates	51 lbs. - 23 kg
36269	T031	Optional Stand For MT Vulcanizer	75 lbs. - 34 kg
36279	T155	Optional Contour Plate Set for MT	15 lbs. - 7 kg
36263	T060	Replacement Solid Heat Unit 120V	
31624	T057	Silicone Rubber Heat Pad (6" Dia.) 120V	
36418	T063	Silicone Rubber Air Seal (6" Dia.) 120V	
36264	T121	Detachable Electric Cord	

LINCOLN 1000 Large Truck/Tractor Spotter

- Throat depth 14-1/2"
- Throat height 16"
- Spotter plates see page 337
- Application: tread, sidewall, shoulder repairs
- Maximum injury size 3-1/2"

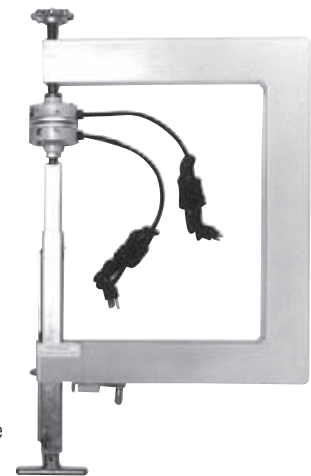

Spring loaded lower heat unit maintains continuous, even pressure during curing and eliminates retightening of heat units. Screw-driven upper heat unit for last minute adjustments. Use with pliable contour bags or plates. Optional Plate Package includes eleven plates and four bags. See page 337 for details.

Order No.	Mfr. No.	Description	Ship Wt.
36282	1000	Vulcanizer 120V without Plates	30 lbs. - 14 kg
36398	1000	Vulcanizer 240V without Plates	30 lbs. - 14 kg
36276	T152	Optional Plate Pkg for 1000	15 lbs. - 7 kg
36413	T039	Replacement Upper Heat Unit 120V	
36415	T039	Replacement Upper Heat Unit 240V	
36290	T044	Replacement Lower Heat Unit 120V	
36262	T044	Replacement Lower Heat Unit 240V	

LINCOLN 2500 Multi-Use Tire Spotter



- Agricultural, skidder & other OTR tire repairs
- Throat depth 18" (46cm)
- Throat height 32-½" (83cm)



Application: Tread, Sidewall Shoulder Repairs

Ideal size to handle tire repairs on light and medium construction equipment, tractors and logging, skidder and mining equipment. Handles tires from 20.5 x 25, OTR sizes up to 29.5 x 35 and skidder tires up to 30.5 x 32. Large 8" x 11" inside and 8" x 15" outside. Adjust-A-Plate contour plate system conforms heating surface to tire contours. Air-actuated bag applies over 5,000 lbs. of pressure evenly over the repair area. Five hour timer automatically shuts off heat unit when cycle is complete. Includes wheeled cart for maximum mobility. Shipped fully assembled.

Order No.	Mfr. No.	Description	Ship Wt.
36270	2500	Multi-Use Vulcanizer 120V	950 lbs. - 432 kg
36271	2500	Multi-Use Vulcanizer 240V	950 lbs. - 432 kg

LINCOLN GT2B Giant Tire Spotter



- Throat depth 14-½"
- Throat height 31-½"
- Application: tread & sidewall repairs maximum injury size 4-½"



For small spot repairs and plugs. Curing heads are 4¾" x 6¾". Spring loaded lower heat unit maintains continuous, even pressure throughout the curing process. Cure the plug with vulcanizer and apply a chemical patch. Includes two T096 Pliable Contour Bags.

Order No.	Mfr. No.	Description	Ship Wt.
36288	GT2B	Giant Tire Vulcanizer 120V	58 lbs. - 26 kg
36396	GT2B	Giant Tire Vulcanizer 240V	950 lbs. - 432 kg
36323	T096	Pliable Contour Bag (Long Strap)	2 lbs. - 1 kg
36405	T045	Upper Heat Unit 120V	4 lbs. - 2 kg
36406	T046	Lower Heat Unit 120V	4 lbs. - 2 kg

LINCOLN 1400 Air/Electric Tractor Tire Spotter



- Throat depth 14-½" (36.5 cm)
- Throat height 16" (40 cm)
- Spotter plates see page 337
- Application tread, sidewall shoulder repairs

PARTS LIST ON PAGE 335

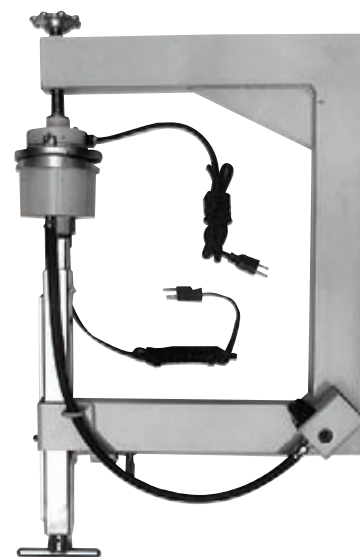

Maximum Injury Size 3½"

Deeper throat depth and height is ideal for large tractor and small off-the-road tires. The optional 1400 Plate Package includes eight plates and 2 bags. See page 337 for details.

Order No.	Mfr. No.	Description	Ship Wt.
36293	1400	Vulcanizer 120V without Plates	28 lbs. - 13 kg
36292	1400	Vulcanizer 240V without Plates	28 lbs. - 13 kg
36278	T154	Optional Plate Pkg. for 1400	12 lbs. - 6 kg
36413	T039	Replacement Upper Heat Unit 120V	
31623	T051	Silicone Rubber Heat Pad (4" Dia.) 120V	
36417	T062	Silicone Rubber Air Seal (4" Dia.) 120V	
36264	T121	Detachable Electric Cord	

LINCOLN OTR Tire Spotter



- Throat depth 26"
- Throat height 44"

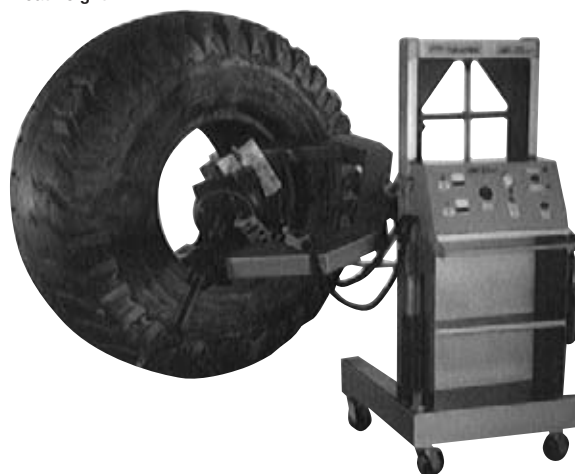

Requires only one operator. Accommodates tires from 20.5 x 25 to 45/65 x 45. Remote-control air cylinder raises and lowers vulcanizing unit. Thermostatically-controlled Adjust-A-Plates conform to tire contours. Air-actuator bag applies consistent pressure across repair area. Four swivel casters for easy rotation and maximum mobility. Twelve-hour timer shuts heat unit off when curing cycle is complete. Extension shafts supplied to accommodate various tire sidewall depths. Available in 120V - 15 amps. Contour plate size 12" x 15", 31 cm. x 38 cm., two curing heads, air pressure 125 psi, 9 bar. Shipped fully assembled.

Order No.	Mfr. No.	Description	Ship Wt.
36375	T030	OTR Tire Spotter 120V	2,000 lbs. - 909 kg

Monaflex Section Repair

WINNER "AS" Air Operated Tire Spotter

- For spot repairs inside & outside 14" through 11.00-24.5
- Steam units available

PARTS LIST ON PAGE 334



Cure spot repairs on all passenger and truck tires through 11.00-24.5. Swinging Pressure Screw and Heating Assembly applies air pressure and heat to the tire with it hanging in perpendicular position. Optional Tubeless Tire Kits consist of an inside mandrel to supply curing heat to the inside of tubeless tires.

Order No.	Mfr. No.	Description	Ship Wt.
36607	AS	Vulcanizer, Compl. w/ 10 Plates Passenger & Truck 120V	360 lbs. - 163 kg
36499	AS	Vulcanizer, Compl. w/ 10 Plates Passenger & Truck 240V	360 lbs. - 163 kg
36634	AS-T4	Vulcanizer & Stand w/ 4 Truck Plates Only 120V	320 lbs. - 145 kg
36608	AS-PTK-15	15" Pass. Tubeless Kit 120V	25 lbs. - 12 kg
36609	AS-PTK-14	14" Pass. Tubeless Kit 120V	25 lbs. - 12 kg
36610	AS-PTK-14	14" Pass. Tubeless Kit 120V	25 lbs. - 12 kg
36616*	AS-106	Pass. Sidewall Plate 5" x 9"	2 lbs. - 1 kg
36617*	AS-104	Pass. Shoulder Plate 5" x 9"	4 lbs. - 2 kg
36618*	AS-105	Pass. Thread Plate 5" x 9"	4 lbs. - 2 kg
36619*	AS-60R	Truck Sidewall Plate 6" x 9 1/2"	7 lbs. - 3 kg
36620*	AS-61R	Truck Shoulder Plate 6" x 9 1/2"	7 lbs. - 3 kg
36621*	AS-62R	Truck Tread Plate 6" x 9 1/2"	7 lbs. - 3 kg
36622*	AS57-R	Radial Pass. Sidewall Plate 5 1/2" x 9"	6 lbs. - 3 kg
36623*	AS58-R	Radial Pass. Shoulder Plate 5 1/2" x 9"	6 lbs. - 3 kg
36624*	AS59-R	Radial Pass. Tread Plate 5 1/2" x 9"	6 lbs. - 3 kg
36646*	AS41R	Truck Plate 6 1/4" x 8 3/4"	6 lbs. - 3 kg
36632	ASSR	Sidewall Repair Kit Truck 120V	11 lbs. - 5 kg
36633	ASSKID	Skid Repair Kit Truck 120V	11 lbs. - 5 kg

*These Contour Plates included with AS Vulcanizer Complete

MONAFLEX OTR Bead Repair System

- XLOTRS Extra large OTR bead repair system

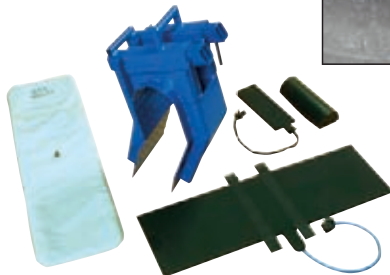

The heat pad and airbag are secured beneath a steel support allowing bead repairs in tire sizes from 4000-57 to 55.5 /85.63. The unit breaks down into two sections allowing easy transport and storage. The entire system can be assembled on the tire in under two minutes.

Order No.	Mfr. No.	Description
34707	TRRS (15)	Control Panel
34095	XLBRSH	Steel Frame
34602	XLBRS 4112H	Heat Pad
34603	XLBRS 13 x 4.75H	Heat Pad
34860	XLBRS 43.5 x 13A	Flat Air Bag
34096	XLBRS BB	Bead Block

MONAFLEX TRDD Truck Tire Section Repair

- 8.25-20 Through 12.00-24 range
- No heavy metal frame



The system uses inside and outside heat pads, strapping system and inflatable air bags for versatile truck tire section repair system. Timer switch actuates the power. Heat pad temperature is preset at 284° F. System consists of: control panel, bias heat pad, inside radial heat pad, curing pack, harness straps, and cylinder air bag. Custom Quotes Available: Submit smallest and largest tire sizes for repair.

Order No.	Mfr. No.	Description	Ship Wt.
34920	TRDD	Truck Section Repair 220V	120 lbs. - 54 kg

MONAFLEX OTR Sidewall Repair System

- OTRS Sidewall or XLOTRS extra large sidewall system



For the repair of sidewalls in radial and cross ply tires from 1400 x 24 through 29.5 - 29 plus skidder and terra tires. Complete assembly in two to three minutes. Cures repair unit and plug in one operation.

XLOTRS system was developed for the repair of sidewall injuries of size 4000-57 to 55.5/ 85.63. The unit breaks down into four sections for easy of transport and assembly by two tire repairmen.

34950 Complete OTRS Sidewall System

Order No.	Mfr. No.	Description	Order No.	Mfr. No.	Description
34707	TRRS (15)	Control Panel	34606	OSH2815HP	Heat Pad
34094	OSH	Housing	34840	OS2117A	Flat Air Bag
34065	M4832S	Heat Pad	34850	OS2517	A Flat Air Bag

34970 Complete XLOTRS Sidewall System

Order No.	Mfr. No.	Description	Order No.	Mfr. No.	Description
34707	MC	Control Panel		XLOTRS BB	Rubber Bead Block
34097	XLOTRS SW	Steel Frame	34880	M45.5 x 20	Outside Air Bag
34608	M45.5 x 20H	Outside Heat Pad	34870	M56 x 20	Inside Air Bag
34607	M5620H	Inside Heat Pad	34098	XLOTRS P	Repl. Pannier

VULCAN Lug Filler Bags

- Use to fill lugs & prevent cushion flow & damage to heat pads



Silica sand-filled tread lug filler bags are the best alternative to plaster of paris or aluminum foil.

The sand is very fine allowing them to take the shape of the tread void. Kit includes 20 bags of the following sizes: (4) 1.5" x 8", (2) 2" x 6", (4) 3" x 5", (4) 3" x 10", (4) 4" x 8" and (2) 3" x 14".

Order No.	Description
34757	Lug Filler Bags

MONAFLEX OTR Custom Components

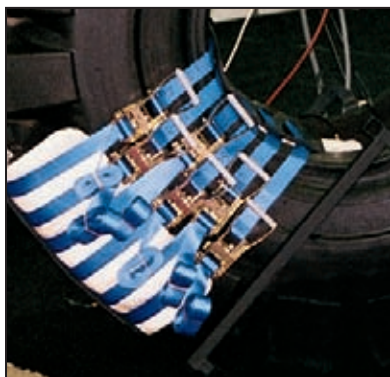

Custom Systems can be designed to accommodate specific tire size ranges. Control Panel and Harness are required. Order air bags and heat pads as required. See Component Chart below. MONAFLEX OTR Systems available 1300-24 through 55.5/80-63. For a quote call your Myers Professional.

Order No.	Mfr. No.	Description	Ship Wt.
34701	M100	OTR Control Panel – 220V	50 lbs. - 23 kg
34700	MC	OTR Control Panel – 220V	50 lbs. - 23 kg
34572	M45/6 /7(1HG)	OTR Harness (Set/6)	34 lbs. - 15 kg
34566	TROC/5XL	XL Straps (Set/5)	2 lbs. - 1 kg
34530*	TR2621EPC	Outside Curing Pack Only	30 lbs. - 14 kg
34540**	M4832EPC	Outside Curing Pack Only	30 lbs. - 14 kg

* Must order separate 36220 (M2621H) Heat Pad - See chart below
 ** Must order separate 36073 (M2626H) Heat Pad - See chart below

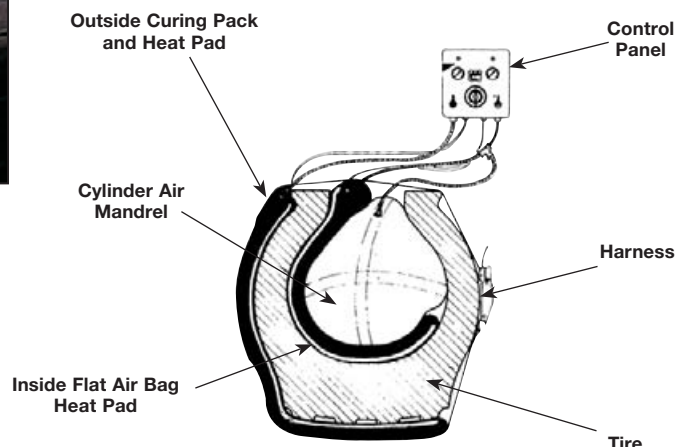

Component Chart

NOTE: The chart below is for guidance only. The final choice depends on: size of injury, number of plies injured, and size of patch recommended. Choose inside heat pad large enough to cover the patch. Because of variations in tire sizes and dimensions a smaller or larger air bag may be required. It may be necessary to measure the inside cross section of the tire to determine the correct fitting cylinder air bag and if a flat inside bag is required.

OTR Wide Base & Tractor Size	OTR Sizes	Cylinder Air Bag	Inside Flat Air Bag	Inside Heat Pad		Outside Heat Pad	Outside Curing Pack	Harness Complete
				Bias	Radial			
14.4-24 to 16.9-38	13.00 to 17.5	TR1315/20WA	–	M2519H	M3015	TR2621H	TR2621E	TROC-5XL
18.4-34 to 20.8-42	18.00 to 21.00	M1721/24WA	–	M2519H 2626H	M3015H	TR2621H	TR2621E	TROC-5XL
23.1-26 to 30.5-32	23.5 to 26.5	M1721/24WA	M4824WA	M2519H M2626H	M3015H	TR2621H	TR2621E	TROC-5XL
25/65-25	27.00 to 29.5-29	M1721/24WA	M4824WA or M5432WA	M2519H M2626H	M3015H M4220H	TR2621H	TR2621E	TROC-5XL
40/65-39, 45/65-45, 35/65-33	30.00 to 37.5	M2732/32WA	M5432WA	M2626H M3132H	M4220H M4224H	M2626H	M4832E	M4%/7 (1HG)
49.5/85-57 to 50/65-51	40.00	M3842/32WA	–	M3132H	M4220H M4224H M4824H M5224H		M4832E	M45 / 6 / 7 (1HG)

MONAFLEX Heat Pads, Air Bags, Harness Straps & Curing Packs

Note: Recommended air pressure 32 psi for Cylinder Bags & 28 psi for Flat Air Bags

Heat Pads – 220V

Order No.	Mfr. No.	Heated Area
34617	M1616H	16" x 16"
34614	TR2213H	19" x 12"
34612	TR2210H	19" x 9"
34618	M2519H	25" x 19"
34616	TR2621H	22 1/2" x 19"
34619	M2626H	26" x 26"
34620	M3132H	31" x 32"
34623	M3015H	30" x 15"
34621	M3636H	36" x 36"
34624	M4215H	41" x 15"
34625	M4220H	42" x 20"
34626	M4224H	42" x 24"
34628	M4824H	48" x 24"
34629	M5224H	52" x 24"

Cylinder Air Bags

Order No.	Mfr. No.
34150	*TR910/11W
34160	*TR911/13W
34360	M1220A
34170	*TR1315/15WA
34180	*TR1315/20WA
34370	M1518/24A
34440	*M1721/24WA
34190	*TR1921/20WA
34380	M2124A
34390	M2427/32A
34450	*M2427/32WA
34460	*M2732/32WA
34410	M3336/32A
34470	*M3336/32WA
34420	M3842/32A
34480	*M3842/32WA
34430	M4447/32A
34490	*M4447/32WA

* Window Style

Flat Air Bags

Order No.	Mfr. No.
34010	TR2210A
34120	TR2213A
34020	M2316A
34130	TR2621A
34210	M2820A
34140	TR3620A
34027	M3624A
34300	*M4824WA
34033	M4824A
34320	*M5432WA
34240	M5432A
34330	*M6732WA
34260	M6732A
34270	M7532A
34350	*M9032WA
34280	9032A

* Window Style

Harness Sets

Order No.	Mfr. No.
34562	TROC3 - 3 Straps 2.5 Meters Lg.
34563	TROC4 - 4 Straps 2.5 Meters Lg.
34564	TROC5 - 5 Straps 2.5 Meters Lg.
34566	TROC-5XL - 5 Straps 3.5 Meters Lg.
34569	M45/6 - 6 Straps 6 Meters Lg.
34571	M45/6/7 - 6 Straps 7 Meters Lg.
34572	M45/6/7/1HG - Used only with M4832 Curing Pack

Curing Packs: Outside Air Bags with Strap Guides Only

Order No.	Mfr. No.
34510	TR219EPC
34521	TR2213EPC
34530	TR2621EPC
34540	M4832EPC

Section Repair

VULCAN-VULCAP VRC OTR Tire Repair Clamp

- Range 18.00-25 through 36.00-51
- Optional extended arms increase size range to 45/65/45
- Optional lug filler bags available - see page 292



A portable OTR repair unit for tread, shoulder and sidewalls. Spotter heads raised and lowered by a manual hydraulic lift. Twin heat pads reduce distortion and have built-in thermostats to maintain constant curing temperature. Specify 115v or 230v; requires 70 to 80 psi.

Order No.	Mfr. No.	Description	Ship Wt.
34752	1002969	Vulcan OTR Clamp	800 lbs. - 364 kg

VULCAN-VULCAP Section Molds

Inflatable mandrel packages feature heat resistant rubber cores and outside high tensile nylon covers for maximum service life. Built-in thermostats in heat pads provide reliable temperature control.

RTV 12

- Range: truck 8.25 x 15 to 12.00 x 24

Truck mold includes air bag, outside heat pad, two bead filler pads, air differential control panel, and inflatable mandrel package.

Order No.	Mfr. No.	Description	Ship Wt.
36810	012000	RTV 12 Section Mold	250 lbs. - 113 kg

V14

- Range: truck - 8.25 x 20 - 12.00 x 24

Truck Mold includes built-in spreader, air bag, outside heat pad, two bead filler pads, air differential control panel and M2 inflatable mandrel package.

Order No.	Mfr. No.	Description	Ship Wt.
36762	202200	V14 Section Mold	745 lbs. - 335 kg

Options

36663	240700	M2.25 Low Profile Inflatable Mandrel Range: 255 /70R 22.5; 275 /80R, 22.5 /24.5; 255 /80R 22.5	16 lbs. - 8 kg
36664	203700	Low Profile Inflatable Mandrel Kit Use with M2 Pkg. for Extra Pressure on Shoulder & Sidewall Area	10 lbs. - 5 kg

MV20

- Range: truck - 14.00 x 24, 18.00 x 22.5; tractor - 13.6 x 24, 18.4 x 38; grader - 12.00 x 24, 17.5 x 25

MV20 Section Repair Mold 220V includes: air bag, two bead filler pads, side filler pad, outside heat pad, air differential control panel, and M4 Inflatable Mandrel package.

Order No.	Mfr. No.	Description	Ship Wt.
36661	20092	MV20 Repair Mold -- for Complete Tire Range, M3 Pkg as an Extra is Required	850 lbs. - 385 kg

M3 Inflatable Mandrel Package

- For Use With SM180, SM250, V20 & MV20
- Range: truck/tractor/grader - 13.00-16.9
- Call for Details

M5 Inflatable Mandrel Package

- For Use With MV30
- Range: tractor/em - 18.00-23.1
- Call for Details



MV30

- Range: 18.00 x 24 - 24.00/35

MV30 OTR Section Repair Mold 220V Single phase 20 amps. Includes: air bags, two bead filler pads, side filler pad, bottom filler pad, outside heat pad, air differential control panel and M6 inflatable mandrel. Package with expandomatic air bag 33" x 55". To cure from 23.5 to 29.5 with 36645 top clamp extension must be purchased. Both M5 and M6 package required for tire ranges listed.

Order No.	Mfr. No.	Description	Ship Wt.
36676	30092	MV30 Repair Mold	1,200 lbs. - 544 kg
Options			
36645	300700	Top Clamp Extension - Enables Machine to Handle Tire Sizes Up to 29.5 x 25 /29	20 lbs. - 9 kg

MV40A (Adjustable)

- Range: 27.00 x 49-37.5 x 33

MV40 OTR Section Repair mold 220V single phase 25 amps. Includes: air bags, two bead filler pads, side and bottom filler pads, outside heat pad, air differential control panel and M8 inflatable mandrel package with expandomatic air bag 37" x 66".

Order No.	Mfr. No.	Description	Ship Wt.
36647	40092	MV40A Repair Mold	1,400 lbs. - 635 kg

MV50A (Adjustable)

- Range: 36.00 x 51, 45/65/45

MV50A OTR Section repair Mold 220V single phase 25 amps. Includes: Air bags, two bead filler pads, side and bottom filler pads, outside heat pad, air differential control panel and M8 inflatable mandrel package with expandomatic air bag 37" x 80".

Order No.	Mfr. No.	Description	Ship Wt.
36625	50092	MV50A Repair Mold	1,750 lbs. - 795 kg

VULCAN-VULCAP Section Mold Replacement Components

Air Bags for Passenger & Truck Molds



Outside Air Bags

Order No.	Mfr. No.	Description	Ship Wt.
36691	901700	MPB Bag (12.5" x 30")	9 lbs. - 4 kg
36824	0120500	RTV Main Bag (40" x 12")	15 lbs. - 7 kg
36699	140920	MT Bag (22" x 43")	18 lbs. - 8 kg
36702	140410	MTB Bag (22" x 45")	23 lbs. - 11 kg
36957	201800	V14 Bag (21" x 40")	20 lbs. - 9 kg
36944	814100	V14 Spreader Bag (15" x 19.5")	8 lbs. - 4 kg
36705	816700	SM180 Main Bag (22" x 36.5")	20 lbs. - 9 kg
36708	816800	SM180 Side Bag (22" x 16")	13 lbs. - 6 kg
36648	814000	SM180 Spreader Bag (11.5" x 19.5")*	7 lbs. - 4 kg
36944	814100	SM180 Spreader Bag (15" x 19.5")	8 lbs. - 4 kg
36709	256240	SM250 Main Bag (22" x 43")	23 lbs. - 11 kg
36712	256500	SM250 Side Bag (22" x 19")	14 lbs. - 7 kg
36944	814100	SM250 Spreader Bag (15" x 19.5")	8 lbs. - 18 kg
36832	221600	V20 Air Bag (22.5" x 64")	33 lbs. - 15 kg
36944	814100	V20 Spreader Bag (15" x 19.5")	8 lbs. - 7 kg
36649	020400	MV20 Air Bag (65" x 20")	40 lbs. - 18 kg

Inside Flat Air Bags

36792	891100	Vulcamatic "A" Bag (20" x 30")	16 lbs. - 8 kg
36793	891200	Vulcamatic "B" Bag (20" x 40")	19 lbs. - 9 kg
36794	259300	Vulcamatic "C" Bag (20" x 50")	24 lbs. - 11 kg

*For SM180 Molds after serial #1500, use larger spreader bag #814100

Air Bags for Earthmover Molds

Outside Air Bags

Order No.	Mfr. No.	Description	Ship Wt.
36716	182900	V18 Bag (33" x 71")	74 lbs. - 34 kg
36717	214600	V21 Main Bag (33" x 58")	54 lbs. - 25 kg
36718	214500	V21 Side Bag (26" x 33")	25 lbs. - 12 kg
36650	300100	MV30 Main Bag (84.5" x 30")	65 lbs. - 30 kg
36717	214600	V310 Air Bag (Mold Requires 2) (33" x 58")	54 lbs. - 25 kg
36719	372200	V37.5 Main Bag (37" x 74")	73 lbs. - 33 kg
36720	372100	V37.5 Side Bag (37" x 36")	38 lbs. - 18 kg
36651	405100	MV40 Main Air Bag (81" x 35")	70 lbs. - 32 kg
36652	405000	Side Air Bag (44" x 35")	45 lbs. - 21 kg
36797	500100	V45 Main Bag (95" x 37")	95 lbs. - 43 kg
36798	500200	V45 Side Bag (48" x 37")	49 lbs. - 22 kg
36653	501400	MV50 Main Air Bag (103" x 40")	100 lbs. - 46 kg
36654	501300	MV50 Side Air Bag (50" x 40")	70 lbs. - 32 kg

Inside Flat Air Bags

36655	210300	Expandomatic Bag (33" x 55") V310/V21/MV30/V18	38 lbs. - 18 kg
36659	376100	Expandomatic Bag (37" x 45") V33/MV40	45 lbs. - 21 kg
36723	376300	Expandomatic Bag (37" x 56") V33/V37.5/V45/MV40/MV50	56 lbs. - 26 kg
36724	376000	Expandomatic Bag (37" x 66") V33/V37.5/V45/MV40/MV50	66 lbs. - 30 kg
36997	376600	Expandomatic Bag (37" x 80") V33/V37.5/V45/MV40/MV50	80 lbs. - 37 kg

Tire Talc (MICA)

Keeps casings, tubes, rims and patches from adhering to each other. Ideal for dusting curing tubes, air bags, etc.

Order No.	Mfr.No.	Description	Ship Wt.
46608	RM-23	1 lb. Can	1 lbs. - 1 kg
46610	RM-23X	50 lb. Bag	55 lbs. - 25 kg



myerstiresupply.com

Outside Heat Pads

Outside Heat Pads: Specify Voltage

Order No.	Mfr. No.	Description	Ship Wt.
36812	012600	RTV Outside Heat Pad	18 lbs. - 8 kg
36958	200500	V14 Heat Pad	30 lbs. - 14 kg
36739	856000	MT/MTB/SM180 Heat Pad	39 lbs. - 18 kg
36814	221500	V20 Heat Pad	45 lbs. - 20 kg
36744	251000	SM250 Heat Pad	54 lbs. - 25 kg

Earthmover: Specify Voltage

36742	214800	V18/V21 Heat Pad	90 lbs. - 41 kg
36743	372400	V33/V37.5 Heat Pad	150 lbs. - 68 kg
36713	300500	MV30 Heat Pad	90 lbs. - 41 kg
36714	405200	MV40 Heat Pad	150 lbs. - 68 kg
36715	502600	MV50 Heat Pad	185 lbs. - 84 kg

Inside Heat Pads

Inside Heat Pads

Order No.	Mfr. No.	Volt	Application	Overall Size	Ship Wt.
36734	904892	220	MPB "AAA"	9" x 9"	4 lbs. - 2 kg
36735	903791	110	MPB "AA"	12" x 12"	5 lbs. - 3 kg
36736	903792	220	MPB "A"	12" x 12"	5 lbs. - 3 kg
36946	204991	110	SM180/V14 "A"	16" x 19"	10 lbs. - 5 kg
36947	204992	220	SM180/V14 "A"	16" x 19"	10 lbs. - 5 kg
36790	856191	110	SM180 "B"	22" x 22"	18 lbs. - 8 kg
36799	856192	220	SM180 "B"	22" x 22"	18 lbs. - 8 kg
36800	259792	220*	SM250 "C"	33" x 23"	34 lbs. - 16 kg
36802	210192	220*	V21/V310/MV30	28" x 28"	41 lbs. - 19 kg
36730	376292	220*	V33/V37.5/MV40	32" x 32"	90 lbs. - 41 kg

*Not available in 110V

VULCAN-VULCAP Section Mold Inside Air Mandrels

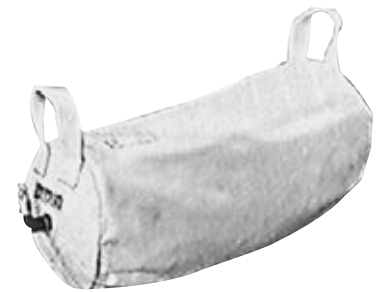

Order No.	For System	Description	Ship Wt.
36673	MO	920000 MO Mandrel	5 lbs. - 3 kg
36675	RTV	012800 RTV Mandrel	10 lbs. - 5 kg
36948	M2	201700 M2 Mandrel V-14	27 lbs. - 6 kg
36664	M2	Low Profile Flat Bag 203700 Kit V-14	10 lbs. - 5 kg
36663	M2.25	Low Profile 204700 M2.25 Mandrel	16 lbs. - 8 kg
36685	M3	253700 M3 Mandrel	18 lbs. - 9 kg
36687	M4	253200 M4 Mandrel	23 lbs. - 11 kg
36688	M5	216300 M5 Mandrel	32 lbs. - 15 kg
36689	M6	215900 M6 Mandrel	36 lbs. - 17 kg
36690	M8	370400 M8 Mandrel	62 lbs. - 29 kg

Heat Insulated Gloves

Retreaders favorite cotton cloth glove. Protection for handling hot molds, mold parts etc. White with red trim. 24 oz.

Order No.	Mfr. No	Description
45300	PE6A	2" Cuff
45301	PE6G	5" Cuff



Green Hot Mill Gloves

Heavy-duty hot mill gloves. Flame-retardant.

Order No.	Mfr. No	Description
45302	SOUGFBT-PK	2" Cuff
45303	SOUGFG-P	5" Cuff



Retreading

Myers Tire Supply is your retread headquarters. It was true when it was first said in 1933 and it's true today. From **BRANICK** spreaders, **ATEC & CRS** inspectors, **B&J** rasps & hubs, **GRACO** sprayers, **VULCAN-VULCAP** tread builders & stitchers, **SURESEAL** sealing rings, **ROBBINS** envelopes & curing tubes, **ELRICK** branders & **PARKER BOILERS**. Myers stocks the most complete line of retread tools, equipment & supplies in the industry.



Wonder Air Vacuum



Powered by compressed air, powerful suction picks up buffing dust and cleans tires. Cleans uncured tire treads before they're placed in matrix. 6' snake hose.

Order No.	Mfr. No.	Description	Ship Wt.
82435	W-100	Vacuum Complete	8 lbs. - 4 kg

Replacement Parts

82436	W-100C	6' Vinyl-Covered Rubber Hose	
82437	W-100E	1" x 3" Tube for Joining 2 Hoses	
82438	W-100F	Brush	
82439	W-100H	Dust Bag	
49006		Brass Valve	

Jet-Vac



Removes water and other debris from weather-exposed casings. The 4" outlet extension hose is used to deposit water into a pail or other container when the Jet-Vac is operated indoors. Air requirements: 1/4" air line with 100 p.s.i.

Order No.	Mfr. No.	Description	Ship Wt.
82433	JVP	Jet-Vac Pass	3 lbs. - 2 kg
82434	JVT	Jet-Vac Truck	6 lbs. - 3 kg

Truck Tire Spreader

- Spreads to 17"

Locks heavy-duty truck or passenger tire beads in any position. Use in pairs on large truck tires for best results. Excellent as inspection tool. Compact, easy to handle.

Order No.	Mfr. No.	Description	Ship Wt.
50927	T-54	Truck Tire Spreader	8 lbs. - 4 kg

Air Vac

- Venturi vacuum system



Trigger control with an easy-to-clean bag. Includes brush, angle tool and 9" extension.

Order No.	Mfr. No.	Description
82000	VAC-1	Air Vac

Portable Tire Spreader

- Passenger, truck, & small OTR



A powerful hand spreader ideal for service truck work or in the shop. Use a 1 1/4" socket to spread and release. Spreads from 1/2" to 13 1/2".

Order No.	Mfr. No.	Description	Ship Wt.
50929	GTS-01	Tire Spreader	7 lbs. - 3 kg

Speed Tire Spreader

A powerful hand spreader ideal for inspection work or used in pairs for holding beads apart when making section repairs. Includes locking pin to prevent spreader from unlocking during use and instruction sheet.



Order No.	Mfr. No.	Description	Ship Wt.
50926	M-1	Speed Tire Spreader	4 lbs. - 2 kg

Economy Tire Spreader

- For passenger, RV, & light truck tires



Spreads passenger, RV, and light truck tires up to 10". Features two ball bearing rollers and tire sidewall adjustments. Three height adjustments. The large base does not require bolting to the floor.

Order No.	Mfr. No.	Description	Ship Wt.
52156	EZM-50	Tire Spreader	31 lbs. - 14 kg

Floor Mount Tire Spreader

- For passenger, RV & light truck tires 13" to 20"



Features heavy-duty rollers with multiple height and width adjustments and tool tray.

Order No.	Mfr. No.	Description	Ship Wt.
85024	73080	Portable Tire Spreader	63 lbs. - 29 kg

BRANICK 5035 Passenger & Light Truck Tire Spreader

- Ideal for low profile & wide base tires
- Economy model. Does not include gas spring or rollers
- RMA compliant 200 foot candle CFL light



For tires 13" through 16.5". Adjustable spreader hooks adapt to varying sidewall heights and widths. Includes 60 watt light mounted on a flexible arm.

Order No.	Mfr. No.	Description	Ship Wt.
52139	5035	Economy Spreader	50 lbs. - 23 kg
52142		Optional Storage Cabinet 12" x 8" x 9 1/2"	
52144		Optional 3" Riser	

Solvent Dispensing Cans



For moistening swabs. Tire casings, repair materials, etc., should be swabbed with rubber solvent to insure the cleanliness necessary for maximum adhesion. Construction of can reduces fire hazard to a minimum. Wastage from spilling is entirely eliminated. Easy to fill.

Order No.	Mfr. No.	Capacity	Ship Wt.
45579	B602	2 Qt.	4 lbs. - 2 kg
45587	B608	8 Qt.	8 lbs. - 4 kg
Plunger-Type Dispensing Can			
45580	P701	1 Qt.	3 lbs. - 2 kg
45581	P702	2 Qt.	3 lbs. - 2 kg

BRANICK 5045 Passenger & Light Truck Tire Spreader

- Ideal for low profile & wide base tires
- Manual spreader with gas spring for controlled tension release
- RMA compliant 200 foot candle CFL light



Shown with optional riser & storage cabinet

For tires 13" through 16.5". Adjustable spreader with hooks adapt to varying sidewall heights and widths. Includes light mounted on a flexible arm and zinc-plated rollers. The optional 3" riser attaches to the spreader for an increased working height. The optional storage cabinet is 12" x 8" by 9.5" at the base and 6.5" wide at the top.

Order No.	Mfr. No.	Description	Ship Wt.
52140	5045	Professional Spreader	62 lbs. - 28 kg
52142		Optional Storage Cabinet	
52144		Optional Riser	

BRANICK 5120 Tire Spreader

- Air-Powered
- For passenger, light truck & truck tires up to 12.00-24
- Ideal for tire repair



Tool tray can be put on either side of the spreader. Includes flexible arm light fixture. Foot control valve keeps hands free. The wider platform offers a more stable work surface. Spreader hooks adjust with spring-loaded pins. Requires 75 psi.

Order No.	Mfr. No.	Description	Ship Wt.
52126	5120	Air Powered Tire Spreader	150 lbs. - 68 kg
70400	376-016	Replacement Lamp	3 lbs. - 2 kg

Tire Spreaders

BRANICK LR/EF Spreader



For inspecting, patching, buffing, or inserting tubes and flaps. Handles all passenger and truck tires from 13" through 24" rim diameter; tubeless truck from 16.5 through 24.5 rim diameter. Adjustable hooks are available for aircraft and small commercial tires. Pneumatic tire lift eliminates bending or lifting. Light assembly concentrates light on the inside of the tire.

Order No.	Mfr. No.	Description	Ship Wt.
50746	LR/EF	Tire Spreader	245 lbs. - 111 kg
70400	376-016	Replacement Lamp	3 lbs. - 2 kg

73100 Tire Spreader

- For passenger & light truck



Air operated tire spreader with an adjustable light and a wide platform for a stable work surface.

Order No.	Mfr. No.	Description	Ship Wt.
89218	73100	Tire Repair Station	180 lbs. - 82 kg

BRANICK 5500 Tire Repair Station

- For passenger, light truck & truck tires
- Economical work station for retreaders & section repair shops



Tool tray and spreader controls pivot for right or left handed operation. Foot controls are on both sides of the spreader. Tire ramp retracts when the platform is raised. A powerful 5 1/4" air cylinder lifts the platform. Maximum height is 33" to top of table. Requires 75 psi.

Order No.	Mfr. No.	Description	Ship Wt.
89218	73100	Tire Repair Station	180 lbs. - 82 kg

BRANICK AH/RI/R Adjustable Repair Inspector

- Reverse tire direction for inspection
- Spreads, revolves & inverts
- Lifts 12" to 34-1/2"

Lifting, spreading and inverting are controlled by a pivoting control panel for easy access to either side of the spreader. Foot valve operates the variable speed tire rotation. Air powered cylinder inverts bias tires for section repairs. Adjustable light for increased visibility inside the tire. Handles tires from 13" through 24.5"; up to 48" in overall diameter.



Order No.	Mfr. No.	Description	Ship Wt.
50759	AH/RI/R	Reversible Tire Spreader	592 lbs. - 269 kg

BRANICK EF Tire Spreader

Call for availability of reconditioned units



Parts list on page 332

Air operated tire lift handles all sizes of passenger, truck & bus tires 12" to 28" bead diameter and 4" to 11" cross section. Revolve tires for inspection. Anchoring to floor unnecessary. Convenient floor mounted foot controls.

Order No.	Mfr. No.	Description	Ship Wt.
50754	EF	Spreader	512 lbs. - 232 kg
50616	#541	Foot Control Kit Converts Older EF Spreaders from Hand to Foot Controls	

BRANICK Heavy-Duty EF/HD Tire Spreader

Call for availability of reconditioned units



Parts list on page 332

Air operated tire lift for all truck, bus and some airplane tires. Sizes thru 14.00 x 24" 20 ply. Revolves tires 360°. Convenient floor mounted foot controls.

Order No.	Mfr. No.	Description	Ship Wt.
50751	EF/HD	Spreader	800 lbs. - 363 kg

BRANICK S-FLL Tire Spreader



Built low for fast, easy handling of heavy tires. Tire support rollers are near floor so larger tires can be rolled onto spreader. One person operation, floor foot-valve control. Handles 16:00-24 tires.

Order No.	Mfr. No.	Description	Ship Wt.
50643	S-FLL	Tire Spreader	163 lbs. - 74 kg

HAWKINSON NDT III Tire Inspector

- Detector circuit finds more flaws than the NDT II
- Automatically stops at injury
- Inspect more than 100 tires in an 8-hour shift, reduce inspection time by 43%



Test light commercial, medium truck, bus and super single tires before buffing. The units stops automatically when an injury is detected. The adjustable table allows the operator to inspect tires at any height. The NDT III uses electrical impulses to detect nails, nailholes, cuts, tears and bad repairs not visible to the eye. Takes only 20 seconds per tire. Foot-activated tire lift automatically raises tire to the inspection level. Specify voltage.

Order No.	Mfr. No.	Description
57656	NDT III	Tire Inspector

HAWKINSON NDT II Tire Inspector

- Finds penetrations before they cause separations
- Automatically stops at injury
- More models available contact us

Parts list on page 336



Test radial and bias light commercial, medium truck, bus and super singles before buffing. The inspector is free-standing so tires can be inspected at anytime and the units stops automatically when an injury is detected. The NDT II uses electrical impulses to detect nails, nailholes, cuts, tears and bad repairs not visible to the eye. Takes only 32 seconds or less per tire. Foot-activated tire lift automatically raises tire to the inspection level. Specify voltage.

Order No.	Mfr. No.	Description	Ship Wt.
52150	NDT II	Tire Inspector	1,100 lbs. - 495 kg

Replacement Assemblies		
54456	NDT	Bead Rollers (Set of 2) 1 1/2" Dia. x 3 1/8" L.
54455	NDT	Spread Rollers (Set of 4) 1 1/4" Dia. x 3 1/4" L.
52158	H00-0724	Light Package

HAWKINSON NDT Probe Assemblies

- For Hawkinson NDT inspectors

Parts list on page 336

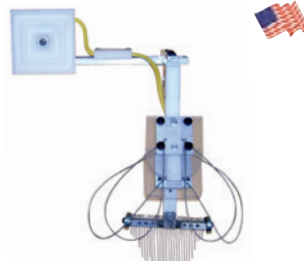

Order No.	Description
57648	14" Probe Assembly for 14" & 15" Bead Diameter Tires
57649	Light Truck Probe Assembly for 16" Thru 19.5 Bead Diameter Tires
57650	Medium Truck Probe Assembly for 20" Thru 24.5.5 Bead Diameter Tires
57651	315 Truck Probe Assembly for 315 / 80R22.5 Tires
57652	Wide Base Probe Assembly for Most Super Single Wide Base Tires
57653	X-1 Wide Base Probe Assembly for X-1 Tire Sizes 445 / 50R22.5 & 455 / 55R22.5

MYERS Hand Held Nailhole Leak Detector

- Quick & easy method to check tires for nailholes



Detect nailholes in any size tire. Tires must be free of all moisture. A foot switch activates the detector as it's passed over the innerliner. A humming noise and electrical glow will be signal a nailhole has been detected. Includes wall unit, foot switch and "T" handle detector probe.

Order No.	Description	Ship Wt.
46003	Hand Held Nailhole Wand-Type Leak Detector	20 lbs. - 9 kg

HAWKINSON Micro-NDT Tire Inspector

- Portable & manually operated
- Same proven technology as the NDT II



Detect nailholes in any size tire before they become a problem. Use with any tire spreader.

Order No.	Mfr. No.	Description
52163	Micro-NDT	Steel Only, Manual Stop Tire Inspector
52164	Micro-NDT	Steel & Fabric, Manual Stop Tire Inspector
57654	Micro-NDT	Steel Only, Auto Stop Tire Inspector
57655	Micro-NDT	Steel & Fabric, Auto Stop Tire Inspector

HAWKINSON NDT-2000 Tire Inspector

- Improved testing capability & flexibility
- Same proven technology as the NDT II



Test light commercial, medium truck, bus and super single tires before buffing. The units stops automatically when an injury is detected. The NDT-2000 uses electrical impulses to detect nails, nailholes, cuts, tears and bad repairs not visible to the eye. Takes only 32 seconds per tire. Foot-activated tire lift automatically raises tire to the inspection level. Specify voltage.

Order No.	Mfr. No.	Description
57657	NDT-2000	Tire Inspector

HAWKINSON NDT Replacement Chains & Wires

- Authentic replacements for Hawkinson NDT Probe Assemblies

Order No.	Mfr. No.	Description
54449	NDT	Chains (Set/32)
54448	NDT	B to B 19" Med. Truck Wire
54447	NDT	B to B 13" Light Truck Wire
54446	NDT	B to B 16" Combo Wire
54444	NDT	Metal Inserted Wire 19" Med.
54445	NDT	B to B 26 1/2" Wire Wide Base

ATEC Insta/Spect-I Inspection/Repair Station



Light Included

Use for repair, initial or final inspection. Two 4" lifting cylinders raise a 300 lb. tire at 125 psi. A separate 4" cylinder spreads tire beads. Automatically adjusts from 26" to 46" diameter x 20" cross section. Diameters can be modified for larger or smaller sizes. 4 HP air motor. Requires 125 psi, 1/2" air inlet.

Order No.	Description	Ship Wt.
45221	Model 9 Intal/Spect-I (Light Included)	750 lbs. - 338 kg

ATEC NDT Model 15 Inspector

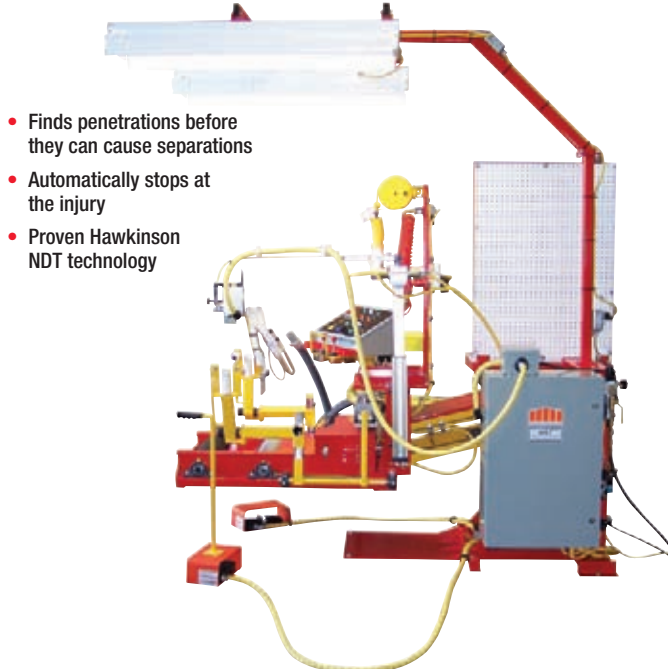

- Finds penetrations before they can cause separations
- Automatically stops at the injury
- Proven Hawkinson NDT technology

Roller height down 6 1/2", roller height up 47". Probe sizes, 14" through 15" bead diameters; 16" through 19.5" diameters; radial 255R22.5 through 12R24.5 and bias 900-20 through 1200-24. Includes medium truck probe assembly. Requires 145 psi, 120v, 50/ 60 Hz.

Order No.	Description	Ship Wt.
45227	Model 15 NDT Inspector	1,350 lbs. - 608 kg
45228	Optional Light Pkg. 110v., 15 amp	75 lbs. - 34 kg
45229	Optional Work Bench	500 lbs. - 225 kg

CRS Heavy-Duty Tire Buffers

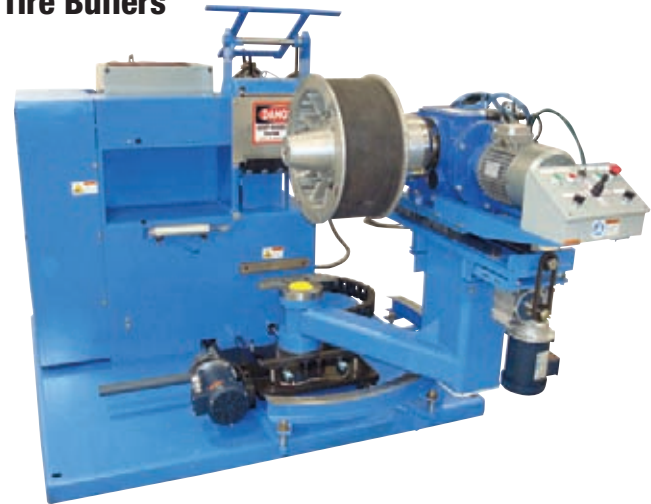

Features a standard 30, 40 or 50 hp drive motor one-to-one ratio templates, hubs, sidewall buffer, automatic traverse system and the precision dove-tail slide assembly. By using stock components and locally available maintenance items, the units allow for quick service and minimal down time. 150 psi required. Specify 220V or 440V 3 ph F.O.B. factory.

CB-40A and CB50A Heavy-Duty Truck Tire units: buff from 13" through 14.00 x 24.00 tires.

CB-50G Extra Heavy-Duty Truck and Grader: buffs from 15" through 20.5 x 25. See page 302 for expandable rim assemblies not included with buffers.

Order No.	Mfr. No.	Description	Ship Wt.
31051	CB-40A	Truck Tire Buffer	4,300 lbs. - 1,935 kg
31052	CB-50A	Truck Tire Buffer	4,400 lbs. - 1,996 kg
31053	CB-50G	Truck & Grader Buffer	4,500 lbs. - 2,041 kg
42409	TDW-610	Sidewall Buffing Carbide 6" x 1" Specify 3/8" A.H., 36 Grit	1 lbs. - 1 kg
31027	SW-2	Optional Sidewall Buffing Attachment	100 lbs. - 45 kg

CRS ATB Tire Buffers



- Fully automatic computer controlled buffers
- Store over 2,000 precure & mold cure buffing programs



Features a standard 40 or 50 hp drive motor one-to-one ratio templates, hubs, sidewall buffer, automatic traverse system, built-in belt detector, laser measurement and the precision dove-tail slide assembly. Communication ports allow off-site diagnostics, programming and software updates. By using stock components and locally available maintenance items, the units allow for quick service and minimal down time. Optional overhead sidewall buffer available. 150 psi required. Specify 220V or 440V 3 ph, F.O.B. factory.

Order No.	Mfr. No.	Description	Ship Wt.
31054	ATB40	Truck Tire Buffer	4,500 lbs. - 1,935 kg
31056	ATB50	Truck Tire Buffer	5,000 lbs. - 2,272 kg

Buffer Exhaust Hose

- Remove hazardous dust from tire buffing operations
- Other hose diameters & lengths available contact us



Available in 12' and 25' lengths, 8" in diameter. 8" hose clamps also available. Order as required.

Order No.	Description	Ship Wt.
31045	12' x 8" Diameter Buffer Exhaust Hose	17 lbs. - 8 kg
31046	25' x 8" Diameter Buffer Exhaust Hose	33 lbs. - 15 kg
31040	8" Hose Clamp	

Exhaust Blower

- Heavy-Duty 7.5 hp blower removes buffing dust efficiently
- Other sizes available, contact us



A heavy-duty, spark resistant dust removal blower widely used in the industry to collect and transport rubber buffing dust. Extra long life components for minimal up costs and reliable operation.

Order No.	Description
31038	7.5 HP Blower

Inflatable Hub Gauge



Use to check inflation pressure that is being maintained when tires are inflated on expandable hubs. Inflate an old bias casing and insert the gauge into the casing. If pressure is incorrect, adjust the regulator accordingly. Ideal pressure is 23 to 24 lbs.

Order No.	Mfr. No.	Description	Ship Wt.
56102	17400	Inflatable Hub Gauge	2 lbs. - 1 kg
56103	17402	Replacement Needle	1 lbs. - 1 kg

Buffing Templates



Use to check buffing templates on the buffer and are used with buffers having no templates. Complete set of 5 templates to check standard size buffing radius from 12-14, 16-18, 20-22, 24-26 and 28-30. Contact us for other sizes.

Order No.	Description	Ship Wt.
31011	Buffing Templates	2 lbs. - 1 kg

Buffing Hood Brushes



Assists in the collection of buffing dust by surrounding the buffing hood assembly. When the tire is in the buffing process, the brush is in contact with the tire deflecting the rubber dust back into the collection system.

Order No.	Description	Length	Bristle	Ship Wt.
94405	Tampico Hood Brush	6'	1½"	6 lbs. - 3 kg
94406	Tampico Hood Brush	6'	2"	6 lbs. - 3 kg
94407	Tampico Hood Brush	6'	3"	6 lbs. - 3 kg
94408	Black Nylon Hood Brush	6'	1½"	6 lbs. - 3 kg
94409	Black Nylon Hood Brush	6'	2"	6 lbs. - 3 kg
94410	Black Nylon Hood Brush	6'	3"	6 lbs. - 3 kg
94413	Tampico Hood Brush	1'	1½"	1 lbs. - 1 kg
94414	Tampico Hood Brush	1'	2"	1 lbs. - 1 kg
94415	Tampico Hood Brush	1'	3"	1 lbs. - 1 kg
94416	Black Nylon Hood Brush	1'	1½"	1 lbs. - 1 kg
94417	Black Nylon Hood Brush	1'	2"	1 lbs. - 1 kg
94418	Black Nylon Hood Brush	1'	3"	1 lbs. - 1 kg

Buffing Hood Brush Holders



Older style brush holders must be drilled in the brush for mounting to the buffer every time it needs replaced. New style brush holders only have to be drilled and installed once. The used brush can be slid out and a new one in.

Order No.	Description	Length	Ship Wt.
94411	Aluminum Brush Holder	6'	6 lbs. - 3 kg
94412	Aluminum Brush Holder	1'	1 lbs. - 1 kg

Expandable Rim Reconditioning Service Available

- Core trade-ins welcomed
- Reconditioned expandable hubs available
- One-Year limited warranty



Expandable Hubs

CRS Expandable Rim Assemblies & Replacement Belts

- More expandable rim sizes available, contact us



Use Myers Tire and Tube Mounting Compound (46632) to extend belt life.

Expandable Rims Complete

Replacement Belts

Order No.	Rim Size	Bead Width	Order No.
31533	12" - 14"	5"	31573
31534	13" - 16"	5"	31574
31031	13" - 16"	6 3/8"	31575
31537	13" - 16"	11 3/8"	31576
31538	14" - 17"	6"	31577
31536	14" - 17"	7 1/8"	31578
31539	14" - 17"	9 1/4"	31579
31565	14" - 17"	11 3/8"	31580
31033	17" - 20"	6 1/2"	31581
31566	17" - 20"	8 3/4"	31582
31563	18" - 20"	7 5/8"	31572
31508	17" - 20"	13 3/4"	31583
31035	20" - 22.5"	7 1/2"	31585
31107	20" - 22.5"	8 3/4"	31625
31055	20" - 22.5"	9"	31586
31108	20" - 22.5"	11 3/4"	31587
31037	22" - 24.5"	7 1/2"	31588
31110	22" - 24.5"	8 3/4"	31626
31540	22" - 24.5"	9"	31589
31569	22" - 24.5"	13 3/8"	31590
31057	23" - 25"	13 3/8"	31590
31058	23" - 25"	18 1/2"	31627

NATIONAL Expanding Hub Lubricant



Use to lubricate expandable hubs, pistons and stems.

Order No.	Mfr. No.	Description
31552	R733001	National Expanding Hub Lubricant 10 Oz.

Heavy-Duty Garter Spring for AZ Extruder

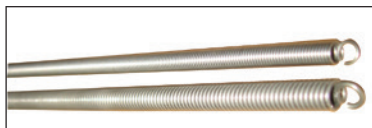

Heavy-duty .255 diameter spring holds the heavy brass stems in place on the AZ Extruder expandable hub.

Order No.	Description
31030	Heavy-Duty Garter Spring for AZ Extruder

Brass Hub Stems

- For use on AZ cushion gum extruder/tread builders



The brass hub stems are designed to withstand the higher pressure the extruder head puts on the tire in the expandable hub. Prevents leading edge wear and are guaranteed not to bend. Hubs require 12 locking stems. Sold in sets of 12.

Order No.	Description	Ship Wt.
31048	Brass Hub Stems	21 lbs. - 10 kg

Expandable Hub Rebuild Kit



Everything required to rebuild expandable hubs in the shop. Includes 8 Myers plain stems, 4 Myers locking stems, garter spring, O-Ring kit, (2) brass bushings, and a can of dry lubricant.

Order No.	Description	Ship Wt.
31599	Rebuild Kit for Expandable Hubs Includes Brass Bushings 31597, 31598	7 lbs. - 3 kg

Individual Expandable Hub Replacement Parts

Order No.	Description
31032	Myers Plain Stem - 8 Required - Sold Each
31034	Myers Locking Stem - 4 Required - Sold Each
31138	National Plain Stem Sold Each (8) Required
31139	National Locking Stem Sold Each (4) Required
31036	Garter Spring
31030	AZ Extruder Heavy-Duty Garter Spring
31596	Dry Lubricant for Expandable Hubs 11 Oz. Teflon
31595	O-Ring Kit for Expandable Hubs
31598	Brass Bushing for Main Shaft
5473225	112C Safety Valves Specify (Set at 25 psi) 1/4" MPT
31597	Brass Bushing for Piston (Front)

Expandable Hub Rebuild Kit for MRT Shops

- All locking stems stabilize the hub & tire assembly for a more accurate buff

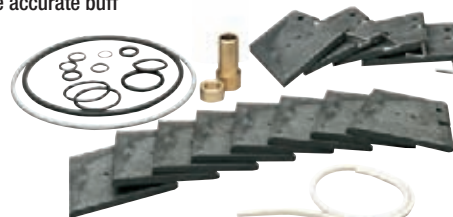

Rebuild expandable hubs in the shop. Includes (12) locking stems, garter spring, O-Ring kit, and (2) brass bushings.

Order No.	Description	Ship Wt.
31605	Rebuild Kit for Expandable Hubs w/ CRS All Locking Stems	7 lbs. - 3 kg

Expandable Hub Rebuild Kit for Bandag Shops

- Authentic National locking & plain stems & National lube



Rebuild expandable hubs in the shop. Includes (12) locking stems, garter spring, O-Ring kit, (2) brass bushings, and a can of National Expanding Hub Lubricant.

Order No.	Description	Ship Wt.
	Rebuild Kit for Expandable Hubs w/ Bandag All Locking Stems & National Spray Lube	7 lbs. - 3 kg
31138	National Plain Stems Sold Each (8) Required	
31139	National Locking Stems Sold Each (4) Required	

OTR Carbide Tipped Delugger Blades



Used on Lodi and Salisbury machinery. Delugger, Buffer 14 blades required per fill.

Order No.	Mfr. No.	Description	Ship Wt.
43949	47547	Carbide Tipped Blades	

OTR Delugger-Buffer Cup Cutter



- Contact us for other OTR cup cutters
- For use on Saico OTR buffers



Order No.	Mfr. No.	Description	Ship Wt.
31549	943	5" Diameter Repl. Cup Cutter	2 lbs. - 1 kg
31548	942	4" Diameter Repl. Cup Cutter	2 lbs. - 1 kg
31547	32A60	Sharpening Stone	2 lbs. - 1 kg

Detreader Cup Cutter



- For use on Akron detreader buffer only



Order No.	Mfr. No.	Description	Ship Wt.
31550	942	4" Serrated Cup Cutter	2 lbs. - 1 kg
31551	A46N	Sharpening Stone	1 lbs. - 1 kg

Circumference-Diameter Tape with Claw

Easy-to-read raised markings in natural steel over black background. Brown leather case. One side in feet; inches and 8ths. Other side diameter equivalents of circumference in diameter feet and inches. Length: 33' feet, claw hook.



Order No.	Mfr. No.	Description	Ship Wt.
46740	261PTH	33' Circumference Diameter Tape with Claw	2 lbs. - 1 kg
46747	261PTH-1	Refill	2 lbs. - 1 kg
46739	263PTH	50' Circumference Diameter Tape with Claw	2 lbs. - 1 kg
46724	C106TPM	6.5m Metric Circumference Diameter Tape with Claw	2 lbs. - 1 kg

R.M.A. Buffing Texture Pad



Various buffing textures are required for retreading and repair procedures. The rubber pad has the 6 standard textures molded into it. Includes R.M.A. bulletin #29.

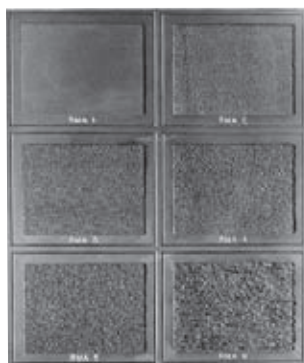

Order No.	Description
18400	RMA Buffing Texture Pad

Sharpening Stones for Buffers



Compatible for many Bandag buffers

Order No.	Description	Ship Wt.
42159	Sharpening Stones - Pair	2 lbs. - 1 kg

Replacement Cartridge for B&J Rasp Sharpener

For use with all B&J rasp sharpening attachments.

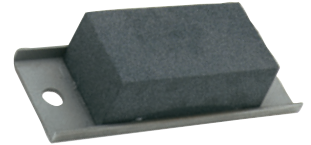

Order No.	Mfr. No.	Description
31078	19200	Replacement Cartridge

B&J R-115 Reg HD Mulching Rasp Hub



- Use for buffing scrap tires & turning buff scraps into black, bark-like ground cover mulch
- For best results use a mulching buffer



"Mulcher" buffer rasp hubs usually run at slower speeds and a slower tire revolving speed.

Order No.	Mfr. No.	Description	Ship Wt.
43898	12-800-3	R-115 Reg HD Rasp 8" Wide	25 lbs. - 11 kg
43899	12-800-4	R-115 Reg HD Rasp 10" Wide	26 lbs. - 12 kg
43900	12-800-5	R-115 Reg HD Rasp 12" Wide	27 lbs. - 12 kg
43518	11-210	Patriot M1 Mulching Blades Set of 30	

B&J OTR Detreader Buffing Blade



- Used on the outside row of a B&J R115 buffing rasp hub



Designed to work only with cross-cut type buffing heads. The "bent" detreader blade does the heavy cutting while the regular R115-20 blades texturize the buff surface. Primarily used in OTR applications.

Order No.	Mfr. No.	Description
43885	R-115-16	OTR Detreader Buffing Blade

Disposable Dust/Mist Masks

Inexpensive, adjustable nose bridge, ribbed designs, molds to facial contours, large filter area. NIOSH and MSHA approved for coal, cadmium, lead, cotton dust, silica and more. Approved for a PEL not less than .05 mg/m3, OSHA up to 10 x PEL. NIOSH/MSHA TC-21C-132



Order No.	Mfg. No.	Std. Pkg.
45545	07048/8210	Sold Each

Disposable Filter Masks

Nuisance dust mask. Use for comfort only - not for lung protection. Provides relief against the irritating effects of such nuisance dusts as pollen, common house dust, salt and cut grass.



Order No.	Mfg. No.	Std. Pkg.
45546	1501	50

Buffing Rasps

B&J Refill Buffing Blades

- For R2, R3, R4 & R115 rasp hubs

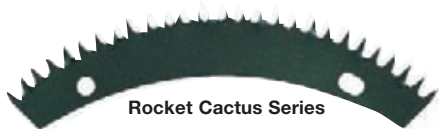

There are three types of B&J Rocket Refills or blades. Old-style Standard and Cactus, and the newer Jet series. The designs of the cutting teeth vary and are a matter of customer choice. We recommend the Jet series as they are generally the longest lasting, fastest and smoothest buffing blade. **Note:** All packaged 50 sets per case.

Order No.	Mfr. No.	Type	Per Set
43865	R-2	Standard	40
43868	R-3-24	Regular Jet	28
43863	R-4	Cactus	28
43808	R-4-20	Special Jet	28
43872	R-4-24	Regular Jet	28
43873	R-4-25	Special Jet	28
43874	R-4-16	Special Jet	28
43876	R-105-22	Regular Jet	35
43879	R-115-25	Special Jet	25
43911	R-115-25	Super Cool	25
43883	R-115-20	Special Jet	25
43909	R-115-20	Super Cool	25
43884	R-115-16	Special Jet	25
43518	M1	Patriot Mulching Blade	25
43956	R-115-20	Switch Blade	25

B&J Outer Support Spacers for Rocket R4 Rasp Hubs

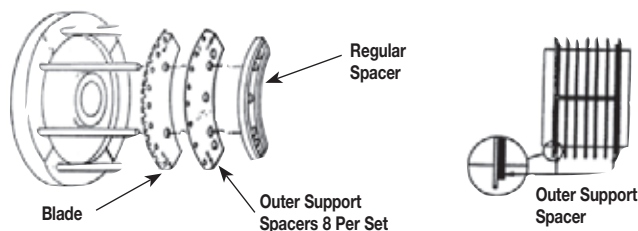

Order No.	Mfr. No.	Type	Per Set
43819	16-624	R4 Domestic	8

B&J Replacement Spacers for R3, R4 & R115 Rasp Hubs



I-Beam aluminum spacers available in $\frac{3}{16}$ ", $\frac{1}{4}$ ", and $\frac{3}{8}$ ". Note: For optimum performance replace spacers and pins as a set.

Order No.	Hub Type	Spacer Width
43850	R3	$\frac{3}{16}$ "
43851	R3	$\frac{1}{4}$ "
43852	R3	$\frac{3}{8}$ "
43853	R4	$\frac{3}{16}$ "
43854	R4	$\frac{1}{4}$ "

Order No.	Hub Type	Spacer Width
43855	R4	$\frac{3}{8}$ "
43856	R115	$\frac{3}{16}$ "
43857	R115	$\frac{1}{4}$ "
43858	R115	$\frac{3}{8}$ "

B&J Air-Cooled Spacers for R115 Rasp Hubs



Specially configured thin spacers allow air to flow between the buffing blades for longer service.

Order No.	Description
43823	R115 $\frac{3}{16}$ " Air-Cooled Spacer
43824	R115 $\frac{1}{4}$ " Air-Cooled Spacer

B&J Alu I-Beam Air-Cooled Spacers



- Air-Cooled spacers provide ventilation increasing rasp life
- For R115 rasp hubs
- Complete line available for all rasp hubs

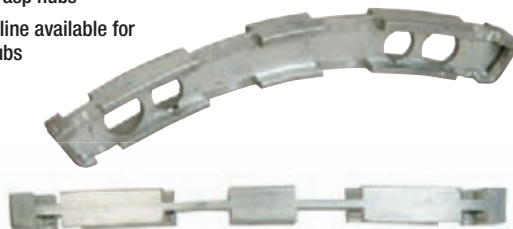

Order No.	Mfr. No.	Description	Pinhole
43818	111468	R115 Alum $\frac{3}{16}$ " I-Beam Air Spacer	8.7mm
43820	111469	R115 Alum $\frac{1}{4}$ " I-Beam Air Spacer	8.7mm
43797	111450	R4 Alum $\frac{3}{16}$ " I-Beam Air Spacer	8.7mm
43798	111451	R4 Alum $\frac{1}{4}$ " I-Beam Air Spacer	8.7mm
43799	111471	R115 CONVEX Alum $\frac{3}{16}$ " I-Beam Air Spacer	9.15mm
43800	111472	R115 CONVEX Alum $\frac{1}{4}$ " I-Beam Air Spacer	9.15mm

B&J Replacement Pins for Rasp Hubs



- Convex-Style hubs must be returned to the factory for convex pin replacement
- Other lengths available, contact us



Order No.	Dia.	Length
43934	$\frac{3}{16}$ "	2 1/2"
43935	$\frac{3}{16}$ "	3"
43936	$\frac{3}{16}$ "	3 1/8"
43937	$\frac{3}{16}$ "	3 1/4"
43938	$\frac{3}{16}$ "	3 3/8"
43939	$\frac{3}{16}$ "	3 1/2"
43940	$\frac{3}{16}$ "	3 3/4"
43941	$\frac{3}{16}$ "	4"

Order No.	Dia.	Length
43942	$\frac{3}{16}$ "	4 1/2"
43943	$\frac{3}{16}$ "	5"
43944	$\frac{3}{16}$ "	5 3/4"
43945	$\frac{3}{16}$ "	6"
43946	$\frac{3}{16}$ "	6 1/2"
43831	$\frac{3}{16}$ "	8"
43832	$\frac{3}{16}$ "	10"

Order No.	Dia.	Length
43833	$\frac{3}{16}$ "	12"
43813	$\frac{1}{4}$ "	3"
43812	$\frac{1}{4}$ "	3 3/8"
43897	$\frac{1}{4}$ "	3 3/4"
43814	$\frac{1}{4}$ "	4"
43811	$\frac{1}{4}$ "	6"
43815	$\frac{1}{4}$ "	8"

B&J Refill Buffing Blades for Eagle, Saturn & Duro-Max Rasp Hubs

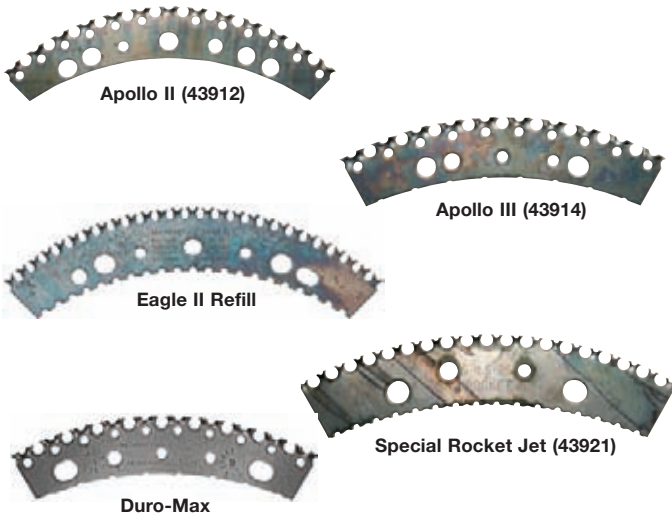

Rocket Saturn rasps are proven to be the fastest cutting, longest lasting rasps with the best texture for all tire buffing operations. Apollo refills have been tested under all conditions and used on all types of tire buffing equipment with outstanding results. Gemini II blade can be used in existing Saturn II or R4 hub assemblies.

Order No.	Description	Type	Blades Per Set
43912	Apollo II	Refill	28
43922	Apollo II	Detreader	8
43914	Apollo III	Refill	30
43920	S115-25	Refill	30
43921	S115-20	Refill	30
43928	Patriot II	Refill	28
43840	Gemini II	Refill	28
43839	Eagle II	Refill	28
43913	Duro-Max III	Refill	30

50 sets per case.

B&J Replacement Spacers for Eagle II Rasp Hubs



Order No.	Mfr. No.	Description	Spacer Width
43507	16-575	Eagle II Spacer	3/16"
43508	16-574	Eagle II	1/4"
43506	16-576	Eagle II Spacer (Standard) 24 Per Set	3/8"

B&J Outer Support Spacers for Saturn II Hubs

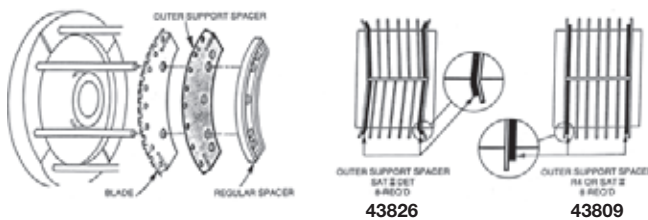

Rasp hubs on Bandag buffers ordered from factory include 43809 support spacers.

Order No.	Mfr. No.	Description	Per Set
43809	16630	For Use with Apollo II Blades (BANDAG O.E.M.)	8
43826	16626	For Use with Apollo II Detreader Blades	8

B&J Replacement Spacers for Saturn & Duro-Max Rasp Hubs



I-Beam aluminum spacers available in 3/16", 1/4" and 3/8".
Note: For optimum performance replace spacers and pins as a set.

Order No.	Hub Type	Spacer Width	Order No.	Hub Type	Spacer Width
43844	Saturn II	3/16"	43847	Saturn III, Duro-Max III	3/16"
43845	Saturn II	1/4"	43848	Saturn III, Duro-Max III	1/4"
43846	Saturn II	3/8"	43849	Saturn III, Duro-Max III	3/8"

B&J Alu I-Beam Air-Cooled Spacers



- Air-Cooled spacers provide ventilation increasing rasp life
- For Saturn II & III Rasp Hubs & Eagle II Rasp Hubs



Order No.	Mfr. No.	Description	Pinhole
43790	111462	SAT III Alum 3/8" I-Beam Air Spacer	8.7mm
43791	111463	SAT III Alum 1/4" I-Beam Air Spacer	8.7mm
43792	111456	SAT II Alum 3/8" I-Beam Air Spacer	8.7mm
43793	111457	SAT II Alum 1/4" I-Beam Air Spacer	8.7mm
43794	111480	Eagle II Alum 3/8" I-Beam Air Spacer	8.7mm
43795	111481	Eagle II Alum 1/4" I-Beam Air Spacer	8.7mm
43801	111465	SAT III CONVEX Alum 3/8" I-Beam Air Spacer	9.15mm
43802	111466	SAT III CONVEX Alum 1/4" I-Beam Air Spacer	9.15mm
43803	111474	Duro-Max III CONVEX Alum 3/8" I-Beam Air Spacer	9.15mm
43804	111475	Duro-Max III CONVEX Alum 1/4" I-Beam Air Spacer	9.15mm

B&J Air-Cooled Spacers for Saturn III Rasp Hubs



Specially configured thin spacers allow air to flow between the buffing blades for longer service.

Order No.	Description
43825	SAT III 1/4" Air-Cooled Spacer
43830	SAT III 3/8" Air-Cooled Spacer

B&J Replacement Pins for Rasp Hubs



- 5/16" Diameter pins for Eagle II, Duro-Max III & Saturn II & III Hubs

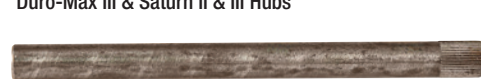

Specify length and rasp in which pins are to be used.

Order No.	Diameter	Length	Order No.	Diameter	Length
43934	5/16"	2 1/2"	43942	5/16"	4 1/2"
43935	5/16"	3"	43943	5/16"	5"
43936	5/16"	3 1/8"	43944	5/16"	5 3/4"
43937	5/16"	3 1/4"	43945	5/16"	6"
43938	5/16"	3 3/8"	43946	5/16"	6 1/2"
43939	5/16"	3 1/2"	43831	5/16"	8"
43940	5/16"	3 3/4"	43832	5/16"	10"
43941	5/16"	4"	43833	5/16"	12"

Buffing Hubs

B&J Convex Rasp Hub & Refill Blades for Mateuzzi Buffers



Convex rasp hub for use with Matteuzzi RAS98E and RAS90 buffers. Includes (45) 43857 1/4" spacers, and R115-20 or R115-25 refill buffing blades. Specify blade refill type. **Factory rasp hub rebuild service available.**

Order No.	Mfr. No.	Description	Ship Wt.
43901	12-809	R115 REG Convex Rasp Hub w/R115-20 or R115-25 Blades-Specify	18 lbs. - 8 kg
43883		R115-20 Refill Buffing Blades Set of 25	
43879		R115-25 Refill Buffing Blade Set of 25	
43857		R115 1/4" Spacers 45 Req	

B&J Rasp Hub & Refill Blades for MRT System



Designed for use in Michelin Retread Plants using the SIO RA2DC and RA2EC cross cut buffers. Includes (26) 43858 3/8" spacers, (8) 43856 3/16" spacers, (1) 3/8" HD spacer, and R115-20 or R115-25 refill buffing blades. Specify blade refill type. **Factory rasp hub rebuild service available.**

Order No.	Mfr. No.	Description	Ship Wt.
43827	12-843-1	R115NS HD Rasp Hub w/R115-20 or R115-25 Blades-Specify	18 lbs. - 8 kg
43883		R115-20 Refill Buffing Blades Set of 25	
43879		R115-25 Refill Buffing Blades Set of 25	
43856		R115 3/16" Spacers 8 Req-	
43858		R115 3/8" Spacers 26 Req-	

B&J Eagle II Rasp Hub & Refill Blades

- Compatible for use on Bandag buffers



Compatible for use with Bandag buffer models 8110, 8120, 8200, and 8400. Includes (24) 43506 3/8" Eagle-type spacers and 43839 Eagle II refill buffing blades. **Factory rasp hub rebuild service available.**

Order No.	Mfr. No.	Description	Ship Wt.
43505	12-900	Eagle II 8" Dia., 4" with, 1 1/2" A.H.	17 lbs. - 8 kg
43839		Eagle II Refill Buffing Blades Set of 28	
43506	16-576	Eagle II 3/8" Spacers 24 Req	

B&J Saturn II Rasp Hub & Refill Blades

- Includes 1 set 43922 Detreader blades
- Compatible for use on Bandag buffers

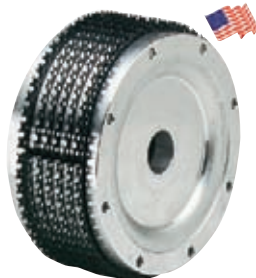

Designed for use with buffer models, 8110, 8120, 8200, and 8400. Includes (20) 43846 3/8" spacers, (4) 43844 3/16" spacers, (8) 43922 Detreader blades, and 43912 Apollo II refill buffing blades. **Factory rasp hub rebuild service available.**

Order No.	Mfr. No.	Description
43516	12-942	Replacement SATII Rasp Hub w/Apollo II or R-4 Blades-Specify
43517	12-921-1	OEM Sat II Hud w/Apollo II Blades & 43809 Support Spacers
43912		Apollo II Refill Buffing Blades Set of 28
43809		Saturn II Outer Support Spacer (Factory) 8 Req
43922		Replacement Detreader Blades 8 Req
43846		Saturn II 3/8" Spacers 20 Req
43844		Saturn II 3/16" Spacers 4 Req

B&J Duro-Max III Rasp Hub & Refill Blades for Mateuzzi Buffers



Convex rasp hub is designed for use with Matteuzzi RAS98E or RAS90 buffers. Includes (54) 43848 1/4" spacers and 43913 Duro-Max III refill buffing blades. **Factory rasp hub rebuild service available.**

Order No.	Mfr. No.	Description	Ship Wt.
43915	12-915	DURO MAX III Rasp Hub with DURO MAX III Blades	19 lbs. - 9 kg
43913		DURO MAX III Refill Buffing Blades Set of 30	
43848	16-909	Saturn III 1/4" Spacers 54 Req	

B&J Saturn III Rasp Hub & Refill Blades

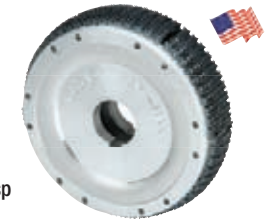

Convex rasp hub used on Marangoni Leonardo buffers. Includes (2) sets of Apollo III blades, (54) Saturn 1/4" spacers and (21) keyways. **Factory rasp hub rebuild service available.**

Order No.	Mfr. No.	Description	Ship Wt.
43947		Saturn III Rasp Hub	19 lbs. - 9 kg
43914		Apollo III Refill Buffing Blades	
43848		Saturn II 1/4" Spacers - 54 Required	

B&J Flat Rasp Hub & Refill Blades for Matteuzzi Buffers

- Flat rasp hub for use on Matteuzzi RAS98E Ultra Buffers



Order No.	Mfr. No.	Description	Ship Wt.
	12-809-3	R115 REG Flat Rasp Hub with R115-20 or 115-25 Blades. Specify	18 lbs. - 8 kg
43883		R115-20 Refill Buffing Blades Set of 25	
43879		R115-25 Refill Buffing Blades Set of 25	
43857		R115 1/4" Spacers 45 Required	

How To Order B&J Buffing Hubs

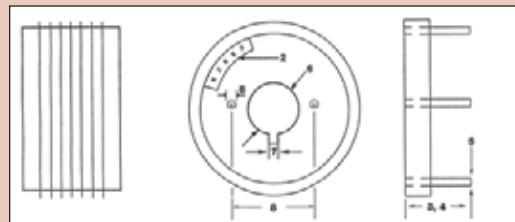

Specify

1. Buffer model number
2. Buffing hub type. See hub types below
3. Pins, straight or convex
4. Width - full length of pin & pin diameter
5. Arbor Hole
6. If required - Keyway size & number of keyways needed. (1 or 2)
7. If required - drive pin hole diameter & center-to-center hole dimension
8. Rasp blade type

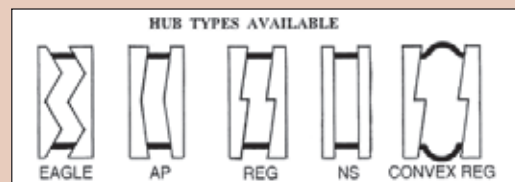

RUBBERHOG Contour Wheel

- Compatible for use on Bandag buffers



A contour wheel compatible for Bandag sidewall buffing attachments.

Order No.	Mfr. Code	Diameter	Width	Bore	SSG
42768	129-P	4"	1 1/2"	3/4"	390

RUBBERHOG Donut Wheel for Matteuzzi Buffers

- Reducer bushings available



For Matteuzzi RAS90, RAS98E, RAS98E Ultima and other sidewall buffing attachments. Special bushings required.

Order No.	Mfr. Code	Diameter	Width	Bore	SSG
42774	708	6"	1"	1 1/2"	390

Airless Sprayer for Patch Rubber Water Base Cement



A high production sprayer. Equipped with a reciprocating air motor, 5 gallon stainless steel tank and a filter regulator. Max. working pressure 110 psi.

Order No.	Mfr. No.	Description	Ship Wt.
56287	SPU	Sprayer Unit Complete	140 lbs. - 63 kg
56289	111884M	Filter Screen	1 lbs. - 1 kg
56291	112035M	Gasket	2 lbs. - 1 kg

GRACO MONARK Airless Hydra-Sprayer

- Prevents air contamination of cement
- 5-Gallon capacity



Lightweight, portable, quality airless spray unit. Supplies two spray guns under most operating conditions. Delivers 1/2 gal. per min. Operating pressure 20-120 psi. Includes agitator, 23:1 ratio pump, air regulator with gauge, air valve, tip clean out valve, instant-latch pail cover, 25' nylon spray hose, spray gun with swivel and .015" orifice. 5 gallon capacity.

Order No.	Mfr. No.	Description	Ship Wt.
56214	232-437	Monark Hydra-Spray	39 lbs. - 18 kg
56190	235-462	Repl. Spray Gun - No Tip	2 lbs. - 1 kg
56189	163-415	Repl. Tip Only for Spray Gun	1 lbs. - 1 kg
Optional Reverse-A-Clean Upgrade			
56188	237-859	Guard	
56213	221-415	Tip	

Tire Stippling Brushes

46011



Order No.	Mfr. No.	Description
46011	KTD-10	1 1/2" Diameter Brush
46013	KTD-14	2" Diameter Brush

Wire Wheel Brushes



Patented carbon steel wire will not break off, separate, or heat up and scorch rubber or cord. All .010 wire, 2 1/4" arbor hole.

Order No.	Mfr. Code	Dia.	Arbor Hole	Face Width	Description
42002D	432	4 1/4"	3/4"	1"	Compatible with Bandag Sidewall Buffers
42003M21**	632	6"	21mm	1"	For Use on Matteuzzi RAS90 & RAS98E Ultra
42003M38***	632	6"	38mm	1"	For Use on Matteuzzi RAS98E

Sidewall Buffing Brush

- Compatible for use on 8400 series Bandag buffers



Compatible for 8400 Bandag series buffing attachment. 1 1/2" wide x 8" with a 2" arbor hole.

Order No.	Description
42035	8" Sidewall Brush

Cement Dispensers



84025

84023

Keeps usable quantities of cement air tight and clean. Air tight screw cap with brush mounted in lid prevents contamination and evaporation. Bristles are 2" long. Use different color cans for different type cements, a can with a black lid for one cement and a can with a blue lid for the other.

Order No.	Description	Capacity
84025	Aluminum Dispenser with Black Lid	1 qt.
84023	Aluminum Dispenser with Blue Lid	
Replacement Lid and Brush Assembly		
84029	Black Lid & Brush Only	1 qt.
84029B	Blue Lid & Brush Only	

Spray Booths

- Call Myers Tire Supply for details

- Lighting**
- High efficiency Class 1, Division 2 fluorescent fixtures (tubes not included)
 - Lights are UL and CSA approved

- Filtration**
- Your choice of filtration media, pads or rolls

Multiple Configurations

- Flexible top or rear exhaust outlet - no additional parts required

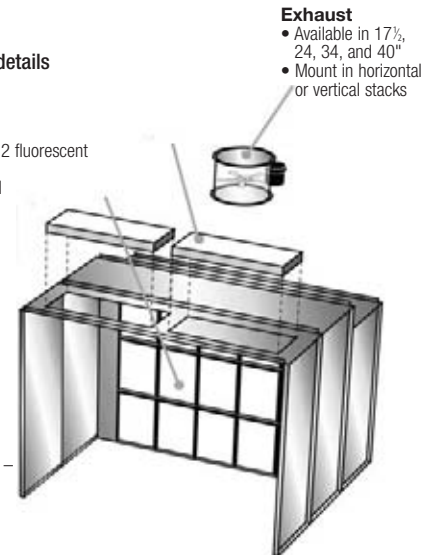

Cement spray booth for passenger and truck tires. Wide work area with power exhaust to prevent fume build-up and remove overspray. Includes explosion-proof motor, light and 24" diameter top stack. Inside dimensions: 6'W x 8'H x 6'D; outside dimensions 6'4"W x 8'2"H x 6'8"D. Recommended accessories include exhaust stack with automatic damper and connector ring fan to stack. Shipped un-assembled.

Staplers

VULCAN-VULCAP Tread Builder/ Stitcher

Build, stitch, and install envelopes, all on one piece of equipment. Automatic two stage stitching, rolls cushion gum at 30 psi and tread rubber at 90 psi. Forward-reverse foot control for tire building. Handles from 13" through 25" rim diameters. Requires 125 psi, 1/2" air line. 5 1/2' x 3' x 5' high. No electric power required. Includes expandable hub; 15" super single treadcutter; Hi-Lo stitch control; cushion gum support and drain filter. See page 302 for expandable rim assemblies not included with builders.



Order No.	Mfr. No.	Description	Ship Wt.
37022	TR106	Builder w/ Guillotine Cutter	700 lbs. - 315 kg
36977	1004404	Repl. Teflon Cutter Strip 13 1/2" Long	1 lbs. - 1 kg
36979	1060303	Repl. Teflon Cutter Strip 15" Long	1 lbs. - 1 kg
34773	1004502	13" Blade	2 lbs. - 1 kg
36594	1060302	15" Blade	

L.R. OLIVER Rotary Knife



For cutting precured tread. Carbide coated sides. Not regritable.

Order No.	Mfr. No.	Diameter	Arbor	Builder Application
42756	RH100-GE-138	6"	1 3/8"	Cahill R-23 & TR-36
42754	RH100-GEG-134	6"	1 3/4"	Salisbury & Oliver
42773	RH100-GE-200	6"	2"	Compatible with Bandag 5110 Builder, Matteuzzi RAS400, RAS401, RAS505, RAS201
Special 80 Grit				
42748	RH100-GEG-134-80	6"	1 3/4"	Salisbury & Oliver
42749	RH100-GE-138-80	6"	1 3/8"	Cahill R-23 & TR-36
42750	RH100-GE-200-80	6"	2"	Compatible with Bandag 5110 Builder, Matteuzzi RAS400, RAS401, RAS505, RAS201

Tungsten Carbide Tread Cutting Blades



For cutting precured tread. Carbide coated sides. Regritable.

Order No.	Fits	Diameter	Width	Arbor Hole	Grit
42702	Cahill R23 & TR36, Shaw Almex	6"	1/8"	1 3/4"	100
42703	Oliver/Salisbury/	6"	1/8"	1 3/4"	100
42704	Compatible with Bandag 5110 Builder, Matteuzzi, RAS400, RAS401, RAS505, RAS201	6"	1/8"	2"	100

DUO-FAST Stapler



Heavy-duty manual stapler.

Order No.	Mfr. No.	Description	Crown	Per Box	Ship Wt.
45748	CS5000	Heavy-Duty Stapler			3 lbs. - 1 kg
45758	ED5008C-06	1/4" Staples Length Fasco	1/2"	5,000	2 lbs. - 1 kg
45754	ED5010C-08M	5/16" Staples Length Fasco	1/2"	5,000	2 lbs. - 1 kg
45756	ED5012C-10	3/8" Staples Length Fasco	1/2"	5,000	2 lbs. - 1 kg
45757	ED5018C-14	5/8" Staples Length Fasco	1/2"	5,000	2 lbs. - 1 kg

Air Stapler

- 1/2" Crown (width)

Lightweight to meet the needs of the retreader. Small profile provides ease of handling with plenty of power. Bottom loading with rear exhaust. Operating pressure is 60 to 100 psi.



45755, 45763

FASCO Stapler & Staples (Duofast Type)

Order No.	Mfr. No.	Description	Crown	Per Box	Ship Wt.
45755	FIB50-16	Air Stapler			3 lbs. - 2 kg
45758	ED508C-06	1/4" Staples Length	1/2"	5,000	2 lbs. - 1 kg
45754	ED5010C-08	5/16" Staple Length	1/2"	5,000	2 lbs. - 1 kg
45756	ED5012C-10	3/8" Staple Length	1/2"	5,000	2 lbs. - 1 kg
45757	ED5018C-14	5/8" Staples Length	1/2"	5,000	2 lbs. - 1 kg

FASCO Stapler & Staples (Bostitch Type)

Order No.	Mfr. No.	Description	Crown	Per Box	Ship Wt.
45763	F1B84-16	Air Stapler			3 lbs. - 2 kg
45761	ESBNK4023-08	5/16" Staples Length	1/2"	10,000	3 lbs. - 2 kg
45759	ESBNK4023-10	3/8" Staples Length	1/2"	10,000	3 lbs. - 2 kg
45752	ESBNK4023-12	1/2" Staples Length	1/2"	10,000	3 lbs. - 2 kg
45753	ESBNK4023-14	5/8" Staples Length	1/2"	10,000	3 lbs. - 2 kg

DUO-FAST Authentic Stapler & Staples



45771

Order No.	Mfr. No.	Description	Crown	Per Box	Ship Wt.
45771	5020	Air Stapler			3 lbs. - 2 kg
45772	5012C	3/8" Staples Length	1/2"	5,000	2 lbs. - 1 kg
45773	5010C	5/16" Staple Length	1/2"	5,000	2 lbs. - 1 kg

BEA Authentic Stapler

Order No.	Mfr. No.	Description	Crown	Per Box	Ship Wt.
45768	BEA	Air Stapler			3 lbs. - 2 kg
45764	EH1808	Fasco 5/16" Staples Length	1/2"	10,000	3 lbs. - 2 kg

BLACK MAGIC Plastic Staples

- No staple removal, plastic staples melt during the retread process
- Eliminates cuts or abrasion marks from staple removal
- Use for tread splices, wick pads & tire tags



45901

45902
45903

Endorsed by major retread manufacturers. Black Magic 16 and 19 gauge composite polymer staples eliminate staples on the shop floor for a cleaner work area. Envelope life will be extended without the catching and abrasion caused by metal staples. The Omer air staplers are fast, light weight and rugged. Both models hold 70 staples and feature a trigger safety reducing the possibility of accidental firing. **NOTE:** Black Magic staples can only be used with recommended Omer air staplers. Stapler and staples are size specific. Order accordingly.

Order No.	Mfr. No.	Description	Crown	Per Box	Ship Wt.
45902	Omer 81P	Air Stapler for 45900 Staples			2 lbs. - 1 kg
45900	S/05-37TR	3/8" Staples Length 19 Gauge	1/2"	5,112	
45903	Omer 82P	Air Stapler for 45901 Staples			2 lbs. - 1 kg
45901	SH/05-55TR	5/16" Staples Length 16 Gauge	1/2"	4,200	

Air-Rid Cord

- Releases trapped air between buffed surface & tread rubber



Air-Rid Cord placed between buffed casing and tread rubber continuously releases air that may build up and cause mold blows or prevent firm bond of tread rubber. Length 100 yards.

Order No.	Mfr. No.	Description	Width
56456	AR-12	Full & Top Tread Commercial & Top Cap Truck Tires Thru 1100 x 20	12"
56458	AR-20	For Full Tread Truck Tires	20"

Pli-Vent

Vents air between the precure tread and the envelope. Use with conventional and precure retreading. Releases trapped air from casings of all retreads regardless of size, type or retreading process. Also used to vent air from section repairs and skives.



Order No.	Mfr. No.	Description
56450	RPV	100 Yd. Spool, 6" Wide

Buzzout Cord

The cord wicks air from buzzouts and section repairs in bias tires to reduce failures. 200 yards, two 100 yard rolls.



Order No.	Description	Per Roll
56478	Buzzout Cord	200 Yds. (2) 100 Yd. Spools

ROBBINS Wick Pad

- Fabric reinforced rubber

A molded rubber pad with grooves that wicks the air eliminating nylon wicking pads. Molded grooves wicks the air eliminating nylon wicking pads. No poly underneath. Can also be attached to the underside of an envelope using the valve to hold it in place

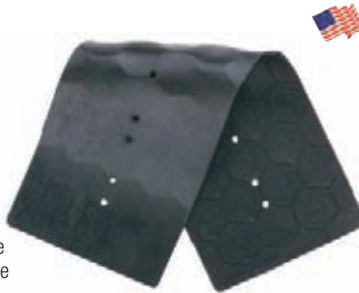

Order No.	Mfr. No.	Description
56060	2025	6" W x 19" L Wicking Pad

ROBBINS Rubber Wick Pad

- Designed for use with inside/outside envelope systems



More durable than cloth wick pads and can be used repeatedly. Does not require poly underneath.

Order No.	Mfr. No.	Description
56061	Size 1	Large Super Single Wick Pad 55½" x 6¾"
56062	Size 2	Medium Truck Wick Pad 48¾" x 6¾"
56063	Size 3	Light Truck Wick Pad 29" x 5"

Poly

- Perforated
- Available in standard, heavy-duty & high temperature



A heat-resistant polypropylene material used for wicking precure treads. Apply between tread and envelope. The choice as to which "poly" to use depends primarily on the temperature of the chamber and the width of the material.

Order No.	Description	Max. Temp.	Rolls Per Box	Feet Per Box	Ship Wt.
15010*	Standard Perf. 12"	280°	1	2,700'	13 lbs. - 6 kg
15028	HD Perf. 12" MTLT	280°	1	2,700'	14 lbs. - 6 kg
15029	HD Perf. 14" MTLT	280°	1	2,700'	16 lbs. - 7 kg
15030	HD Perf. 15" MTLT	280°	1	2,700'	17 lbs. - 8 kg
15031	HD Perf. 18" MTLT	280°	1	2,700'	20 lbs. - 9 kg
15048	HD Perf. 30"	280°	1	2,700'	50 lbs. - 34 kg
15020	High Temp. Perf. 12"	330°	1	4000'	19 lbs. - 9 kg
15038	High Temp. Perf. 14"	330°	1	4000'	22 lbs. - 10 kg
15021	High Temp. Perf. 16"	330°	1	4000'	25 lbs. - 11 kg
15039	High Temp. Perf. 18"	330°	1	4000'	28 lbs. - 13 kg

*15010 poly is sold by the pound, price quoted is based on weight per box.

Wicking Pad with Tabs

- Used with inside/outside envelope curing systems
- Overall length 44" including straps



An 8" x 12" stretch wicking pad with a 16½" long x 1½" wide tab sewn to each end. Sold in box quantity only.

Order No.	Description	Qty.	Ship Wt.
56486	8" x 12" Stretch Wicking Pads	24	2 lbs. - 1 kg

Wicking for Precure Treads

- 1-½" Green wicking
- Stretch pads



Order No.	Description	Qty.	Ship Wt.
56485	Green Wicking 1½"	180 Ft. Roll	4 lbs. - 2 kg
56477	Stretch Pads 8" x 12"	24 Per Box	3 lbs. - 2 kg
56481	Stretch Pads 8" x 15"	24 Per Box	4 lbs. - 2 kg
56482	Stretch Pads 8" x 20"	24 Per Box	5 lbs. - 3 kg
56484	Stretch Pads 8" x 48"	24 Per Box	9 lbs. - 4 kg
56470*	60"W x 75' Bulk Wick Material		9 lbs. - 4 kg

* Same material as stretch wick

Staple Pulling Tape

Tape is put over the splice and the staples go through it. Staples are removed by pulling off the tape.



Order No.	Color	Width	Length	Ship Wt.
56471	White	1"	300'	3 lbs. - 2 kg

Envelope Sealing Rings

Envelope Repair Kit

- For permanent repairs to damaged pre-cure envelopes



Repair ripped or hole-damaged curing envelopes and get the maximum amount of cures. The kit includes: 2 rolls of Envelope Repair Gum compounded with similar heat resistant material as envelopes, an 8 oz. can of Envelope Repair Adhesive, 1 quart of Cleaner Fluid and scraper.

ERV Envelope Repair Vulcanizer

Features a large 6" curing head with an air-driven silicone rubber piston pad providing even pressure during the cure cycle. Built-in timer turns off heat and air automatically. Throat depth 14 1/2". Includes bench mount brackets. Available in 110V and 220V.

Order No.	Description	Ship Wt.
14340	Envelope Repair Kit - Includes (2) Rolls of Repair Gum	6 lbs. - 3 kg
36464	ERV Vulcanizer (110V)	60 lbs. - 27 kg
Repair Kit Replacement Materials		
18140	1 Lb. Roll Envelope Repair Gum	2 lbs. - 1 kg
16180	8 Oz. Envelope Repair Adhesive	1 lbs. - 1 kg
16471	1 Qt. Cleaner Fluid	1 lbs. - 1 kg
42620	Innerliner Scraper	1 lbs. - 1 kg

ROBBINS Envelope Repair Kit

Everything needed to repair and extend the life of Robbins envelopes. Includes 2 lb. roll of specially formulated envelope cushion gum, cement and instructions



Order No.	Description
41597	Robbins Envelope Repair Kit
36464	ERV Vulcanizer (110V)

BRANICK Envelope Sealer Rings



Adjusting Screw and Clevis Retro-Fit Kits available. Contact your Myers sales representative.

Heavy-duty Acme threads on the adjusting bolt. Sliding shield on the outer ring body helps prevent pinched envelopes. Ring tabs are the exact length required, not too long to cause punctures.

Packaged and Sold in Pairs					
Order No.	Size	Ship Wt.	Order No.	Size	Ship Wt.
34206	14"	32 lbs. - 15 kg	34202	19.5"	34 lbs. - 16 kg
34207	15"	32 lbs. - 15 kg	34203	20"	34 lbs. - 16 kg
34200	16"	33 lbs. - 15 kg	34212	22"	34 lbs. - 16 kg
34208	16.5"	33 lbs. - 15 kg	34204	22.5"	34 lbs. - 16 kg
34209	17"	33 lbs. - 15 kg	34213	24"	34 lbs. - 16 kg
34201	17.5"	33 lbs. - 15 kg	34205	24.5"	34 lbs. - 16 kg

Curing Rim Road Type with Separate Flanges for Chamber Use

- Most types for passenger & truck tires with positive locking device
- Special order only



Available in passenger, truck, earthmover, and aircraft sizes. High Flange type available in limited sizes.

Order No.	Description
Call to Order	Specify Diameter & Width

Heat Resistant Rim Flaps

- Other sizes available, contact us



Made for pre-cure retreading to protect curing tubes from failure caused by contact with road rims. Flaps are highly resistant to heat and remain soft and pliable even after multiple cures.

Order No.	Mfr. No.	Description	Ship Wt.
15410	16 x 7.1	6.70-15 Thru 9/10/11-15 6.00-9.00-16, 8.00-10.00-16.5	3 lbs. - 1 kg
15411	20 x 8	8.25-20, 10.00-20 9.00-20, 12.00-20, 11.00-20	4 lbs. - 2 kg
15412	22 x 8	10.00-22, 10-22.5 11.00-22, 11-22.5 12.00-22, 12-22.5	6 lbs. - 3 kg
15413	24 x 8	11-24.5, 11.00-24, 12-24.5, 12.00-24, 13.00-24TG, 14.00-24TG	7 lbs. - 3 kg
15414	22.5 x 9	11-22.5	7 lbs. - 3 kg
15415	24.5 x 9	11-24.5	7 lbs. - 3 kg

SURESEAL Envelope Sealer Rings

- Eliminates metal-to-envelope contact
- Extends envelope life



Specially compounded rubber SureSeal envelope sealing rings eliminate metal to envelope contact lengthening envelope life and virtually eliminating tears. The design eliminates sealing ring adjustments. Simply lock and it seals. The conical design of the ring "adapts" to the variations in bead diameters. 22.5. Rings are sold in pairs only.

Order No.	Description	Ship Wt.
34220	XR-22.5 Metal Rings - Sold Per Pair - 2 Pair Per Box	35 lbs. - 16 kg
34221	SR-22.5/22 Rubber Rings - Sold Per Pair - 2 Pair Per Box	30 lbs. - 14 kg
34222	SR-19.5 Rubber Rings - Sold Per Pair - 2 Pair Per Box	30 lbs. - 14 kg
34224	XR-19.5 Metal Rings - Sold Per Pair - 2 Pair Per Box	30 lbs. - 14 kg
34223	SR-24.5 Rubber Rings - Sold Per Pair - 2 Pair Per Box	30 lbs. - 14 kg
34225	XR-24.5 Metal Rings - Sold Per Pair - 2 Pair Per Box	30 lbs. - 14 kg
31002	SR-17.5/17 Rubber Rings - Sold Per Pair - 2 Pair Per Box	
31003	XR-17.5 Metal Rings - Sold Per Pair - 2 Pair Per Box	
31004	SR-20 Rubber Rings - Sold Per Pair - 2 Pair Per Box	
31005	XR-20 Metal Rings - Sold Per Pair - 2 Pair Per Box	

Replacement parts for metal rings

Order No.	Description
34226	Spare Part Kit (2) Pull Pins, (2) Roll Pins, (8) Caps
34227	Pull Pin Pkg. of 5
34228	Vinyl Handle Pkg. of 10
34229	Handle Kit Assembly (1) Pull Pin, (1) Roll Pin, (3) Caps, Vinyl Handle & Handle Assembly



ROBBINS CMT Envelopes by Tire Size

Tire Size	No Valve Module Type Seals Sidewall to Sidewall		With Valve Road Rim Type Seals with Removable Flanges		With Valve Road Rim Type Seals with Extended Hi-Flange		With Valve Rimless System Seals on the Face of Bead	
	Envelope Size	Order No.	Envelope Size	Order No.	Envelope Size	Order No.	Envelope Size	Order No.
195/75R14	2715-16	39803	2715-16	39703	2713-18	39702	2710-21	39700
205/75R14	2715-16	39803	2715-16	39703	2711-20	39701	2913-22	39707
7.00R15	2916-19	39809	2916-19	39707	2913-22	39707	2910-25	39705
7.50R15	3216-22	39818	3216-22	39718	3213-24	39717	3211-27	39716
8.25R15	3517-23	39823	3515-25	39722	3513-27	39721	3511-29	39720
9.00R15 LT/LB	2915-20	39808	2913-22	39707	2911-24	39706	2910-25	39705
9.00T15 TR	3515-25	39822	3513-27	39721	3511-29	39720	N/A	-----
10.00R15 LT/LB	3218-19	39819	3216-22	39718	3213-24	39717	3211-27	39716
10.00R15TR	3816-28	39829	3816-28	39729	3812-31	39727	N/A	-----
31x15.5x15	3513-27	39821	3511-29	39720	N.A.	-----	N.A.	-----
215/70R15	2916-19	39809	2713-18	39702	2916-19	39709	2913-22	39707
215/75R15	2916-19	39809	2916-19	39709	2915-20	39708	2910-25	39705
225/75R15	2916-19	39809	2915-20	39708	2913-22	39707	2910-25	39705
235/75R15	2916-19	39809	2915-20	39708	2913-22	39707	2910-25	39705
255/75R15	3218-19	39819	3216-22	39718	3213-24	39717	3211-27	39716
6.00R16	2916-19	39809	2916-19	39709	2916-19	39709	2913-22	39707
6.50R16	2916-19	39809	2916-19	39709	2915-20	39708	2913-22	39707
7.00R16	3117-18	39813	3115-21	39712	3115-21	39712	3111-24	39710
7.50R16	3218-19	39819	3216-22	39718	3213-24	39717	3211-27	39716
8.25R16	3517-23	39823	3515-25	39722	3513-27	39721	3511-29	39720
9.00R16	3515-25	39822	3513-27	39721	3511-29	39720	3812-32	39727
215/75R16	2916-19	39809	2916-19	39709	2915-20	39708	2910-25	39705
215/85R16	3218-19	39819	3218-19	39719	3216-22	39718	3211-27	39716
225/75R16	2916-19	39809	2916-19	39709	2913-22	39707	2910-25	39705
235/85R16	3218-19	39819	3216-22	39718	3213-24	39717	3211-27	39716
245/75R16	3218-19	39819	3216-22	39718	3213-24	39717	3211-27	39716
265/75R16	3216-22	39818	3216-22	39718	3213-24	39717	3211-27	39716
225/70R16.5	2916-19	39809	2913-22	39707	2913-22	39707	2910-25	39705
10R16.5	3218-19	39819	3216-22	39718	3216-22	39718	3211-27	39716
12R16.5	3513-27	39821	3513-27	39721	3513-27	39721	3511-29	39720
8.00R16.5	2916-19	39809	2916-19	39709	2916-19	39709	2913-22	39707
8.75R16.5	2916-19	39809	2916-19	39709	2915-20	39708	2910-25	39705
9.50R16.5	3218-19	39819	3216-22	39718	3216-22	39718	3211-27	39716
750-17	3218-19	39819	3216-22	39718	3213-24	39717	3211-27	39716
8R17.5	3117-18	39813	3117-18	39713	3115-21	39712	3111-24	39710
9R17.5	3218-19	39819	3517-23	39723	3213-24	39717	3513-27	39721
10R17.5	3519-21	39825	3517-23	39723	3515-25	39722	3511-29	39720
11R17.5	3820-24	39831	3818-26	39730	3816-28	39729	3812-32	39727
215/75R17.5	2916-19	39809	3218-19	39719	2915-20	39708	3213-24	39717
225/75R17.5	3218-19	39819	3218-19	39719	3216-22	39718	3211-27	39716
235/75R17.5	3218-19	39819	3216-22	39718	3216-22	39718	3211-27	39716
245/70R17.5	3218-19	39819	3216-22	39718	3216-22	39718	3211-27	39716
8R19.5	3521-19	39826	3521-19	39726	3519-21	39725	3515-25	39722
9R19.5	3521-19	39826	3519-21	39725	3517-23	39723	3513-27	39721
15R19.5	4419-33	39856	4421-32	39758	4419-33	39756	4413-39	39751
16.5R19.5	4419-33	39856	4419-33	39756	4417-36	39754	*4814-44	39780
18R19.5	4419-33	39856	4415-38	39752	4415-38	39752	*4814-44	39780
225/70R19.5	3218-19	39819	3218-19	39719	3218-19	39719	3213-24	39717
235/70R19.5	3218-19	39819	3218-19	39719	3218-19	39719	3213-24	39717
245/65R19.5	3218-19	39819	3218-19	39719	3218-19	39719	3213-24	39717
245/70R19.5	3521-19	39826	3521-19	39726	3519-21	39725	3513-27	39721
265/70R19.5	3521-19	39826	3519-21	39725	3517-23	39723	3513-27	39721
285/70R19.5	3519-21	39825	3517-23	39723	3515-25	39722	3511-29	39720
305/70R19.5	3822-23	39832	3818-26	39730	3818-26	39730	3812-32	39727
445/65R19.5	4419-33	39856	4415-38	39752	4415-38	39752	4513-44	39761
6.50R20	3521-19	39826	3521-19	39726	3521-19	39726	3515-25	39722
7.00R20	3521-19	39826	3521-19	39726	3519-21	39725	3515-25	39722

*4814-44 Envelope Is A Robbins Accu-Fit Brand Envelope

All suggested envelope selections are to be used as a guide only. Variations in tire sizes, tire dimensions, precure tread designs, and precure tread thickness may require a smaller or larger envelope size. In some instances it may be necessary to measure the built tire to determine the correct envelope size. Capacities and specifications are subject to change without notice.

ROBBINS CMT Envelopes by Tire Size



Tire Size	No Valve Module Type Seals Sidewall to Sidewall		With Valve Road Rim Type Seals with Removable Flanges		With Valve Road Rim Type Seals with Extended Hi-Flange		With Valve Rimless System Seals on the Face of Bead	
	Envelope Size	Order No.	Envelope Size	Order No.	Envelope Size	Order No.	Envelope Size	Order No.
7.50R20	3822-23	39832	3822-23	39732	3822-23	39732	3816-28	39729
8.25R20	3822-23	39832	3820-24	39731	3818-26	39730	3812-32	39727
9.00R20	4022-25	39838	4020-26	39737	4018-27	39736	4012-34	39733
10.00R20	4220-28	39846	4221-29	39747	4219-30	39745	4213-37	39739
11.00R20	4218-30	39844	4420-31	39757	4217-34	39781	4415-38	39752
12.00R20	4422-29	39859	4418-34	39784	4416-35	39753	4413-39	39751
13/80R20	4223-27	39849	4219-30	39745	4217-34	39781	4213-37	39739
14.00R20	**55.5x17	39444	**55.5x14	39442	**55.5x10	39441	**58x13	39446
14/80R20	4422-29	39859	4419-33	39756	4419-33	39756	4413-39	39751
10.00R22	4422-29	39859	4422-29	39759	4420-31	39757	4416-35	39753
11.00R22	4422-29	39859	4420-31	39757	4418-34	39784	4415-38	39752
12.00R22	4422-29	39859	4421-32	39758	4419-33	39756	4413-39	39751
8R22.5	3521-19	39826	3822-23	39732	3519-21	39725	3818-26	39730
9R22.5	3822-23	39832	3822-23	39732	3822-23	39732	3814-29	39728
10R22.5	4022-25	39838	4022-25	39738	4022-25	39738	4014-32	39734
11R22.5	4223-27	39849	4223-27	39749	4223-27	39749	4217-34	39781
11R22.5 D.L.	4223-27	39849	4223-27	39749	4223-27	39749	4215-35	39741
12R22.5	4422-29	39859	4422-29	39759	4420-31	39757	4416-35	39753
12.75R22.5	4422-29	39859	4422-29	39759	4420-31	39757	4416-35	39753
15R22.5	4423-30	39860	4421-32	39758	4419-33	39756	4413-39	39751
16.5R22.5	4522-34	39866	4520-36	39765	4520-36	39765	4513-44	39761
18R22.5	4522-34	39866	4518-38	39764	4515-41	39762	4513-44	39761
235/80R22.5	3822-23	39832	3822-23	39732	3822-23	39732	3816-28	39729
245/75R22.5	3521-19	39826	3521-19	39726	3519-21	39725	3818-26	39730
255/70R22.5	3822-23	39832	3822-23	39732	3822-23	39732	3816-28	39729
265/70R22.5	3822-23	39832	3822-23	39732	3820-24	39731	3814-29	39728
265/75R22.5	3822-23	39832	3822-23	39732	3820-24	39731	3814-29	39728
275/70R22.5	3822-23	39832	3822-23	39732	3820-24	39731	3814-29	39728
275/80R22.5	4022-25	39838	4222-26	39748	4020-26	39737	4214-32	39740
295/75R22.5	4224-23	39850	4222-26	39748	4220-28	39746	4214-32	39740
295/80R22.5	4223-27	39849	4223-27	39749	4221-29	39747	4215-35	39741
305/70R22.5	4224-23	39850	4222-26	39748	4220-28	39746	4217-34	39781
305/75R22.5	4224-23	39850	4220-28	39746	4220-28	39746	4217-34	39781
305/85R22.5	4422-29	39859	4422-29	39759	4420-31	39757	4416-35	39753
315/80R22.5	4422-29	39859	4422-29	39759	4420-31	39757	4416-35	39753
315/80R22.5 Opt	4422-29	39859	4422-29	39759	4420-31	39757	4415-38	39752
385/65R22.5	4423-30	39860	4421-32	39758	4421-32	39758	4415-38	39752
385/65R22.5 DL	4423-30	39860	4421-32	39758	4421-32	39758	4415-38	39752
425/65R22.5	4423-30	39860	4520-36	39765	4520-36	39765	4515-41	39762
445/50R22.5	4423-30	39860	4421-32	39758	4419-33	39756	4415-38	39752
445/65R22.5	4522-34	39866	4518-38	39764	4518-38	39764	*4814-44	39780
455/55R22.5	4423-30	39860	4520-36	39765	4520-36	39765	4515-41	39762
11.00R24	4423-30	39860	4421-32	39758	4421-32	39758	4415-38	39752
12.00R24	4522-34	39866	4522-34	39766	4520-36	39765	4515-41	39762
12.00R24 D.L.	**55.5X17	39444	**55.5X17	39444	**55.5X17	39444	**55.5X15	39443
13.00R24	**55.5X17	39444	**55.5X17	39444	**55.5X17	39444	**55.5X14	39442
14.00R24	**55.5X17	39444	**55.5X17	39444	**55.5X17	39444	**63X13	39456
11R24.5	4422-29	39859	4422-29	39759	4422-29	39759	4418-34	39784
11R24.5 D.L.	4422-29	39859	4422-29	39759	4422-29	39759	4416-35	39753
12R24.5	4422-29	39859	4422-29	39759	4422-29	39759	4416-35	39753
275/80R24.5	4224-23	39850	4222-26	39748	4220-28	39746	4217-34	39781
285/75R24.5	4224-23	39850	4222-26	39748	4220-28	39746	4217-34	39781
295/80R24.5	4422-29	39859	4422-29	39759	4422-29	39759	4418-34	39784
305/75R24.5	4422-29	39859	4422-29	39759	4422-29	39759	4418-34	39784
305/75R24.5 D.L.	4223-27	39849	4223-27	39749	4223-27	39749	4418-34	39784

*4814-44 Envelope Is A Robbins Accu-Fit Brand Envelope **Hand-Built Envelopes

All suggested envelope selections are to be used as a guide only. Variations in tire sizes, tire dimensions, precure tread designs, and precure tread thickness may require a smaller or larger envelope size. In some instances it may be necessary to measure the built tire to determine the correct envelope size. Capacities and specifications are subject to change without notice.

ROBBINS CMT Outside Envelopes



Envelopes with Valves

Used in chamber systems with rims or sealing rings.

Envelopes without Valve

Used in module type Vulcan and Cox chambers.

Order No. W/Valve	Size	O.D.	I.D.	Width	B to B	Order No. No Valve
39780	*4814	48	14	N/A	44	39880
39766	4522	45	22	15"	34	39866
39765	4520	45	20	15"	36	39865
39764	4518	45	18	15"	38	39864
39763	4516	45	16	15"	40	39863
39762	4515	45	15	15"	41	39862
39761	4513	45	13	15"	44	39861
39760	4423	44	23	12"	30	39860
39758	4421	44	21	12"	32	39858
39756	4419	44	19	12"	34	39856
39754	4417	44	17	12"	36	39854
39752	4415	44	15	12"	38	39852
39751	4413	44	13	12"	39	39851
39759	4422	44	22	10"	29	39859
39757	4420	44	20	10"	31	39857
39784	4418	44	18	10"	34	39855
39753	4416	44	16	10"	35	39853
39749	4223	42	23	10"	27	39849
39747	4221	42	21	10"	29	39847
39745	4219	42	19	10"	30	39845
39781*	4217	42	17	10"	34	
39741	4215	42	15	10"	35	39841
39739	4213	42	13	10"	37	39839
39750	4224	42	24	8"	23	39850
39748	4222	42	22	8"	26	39848
39746	4220	42	20	8"	28	39846
39744	4218	42	18	8"	30	39844
39740	4214	42	14	8"	32	39840
39782	4023	40	23	8"	23	39882
39738	4022	40	22	8"	25	39838
39737	4020	40	20	8"	26	39837
39736	4018	40	18	8"	27	39836
39735	4016	40	16	8"	29	39835
39734	4014	40	14	8"	32	39834
39733	4012	40	12	8"	34	39833
39732	3822	38	22	8"	23	39832
39731	3820	38	20	8"	24	39831
39730	3818	38	18	8"	26	39830
39729	3816	38	16	8"	28	39829
39728	3814	38	14	8"	29	39828
39727	3812	38	12	8"	32	39827
39726	3521	35	21	8"	19	39826
39725	3519	35	19	8"	21	39825
39724	3518	35	18	8"	22	39824
39723	3517	35	17	8"	23	39823
39722	3515	35	15	8"	25	39822
39721	3513	35	13	8"	27	39821
39720	3511	35	11	8"	29	39820
39719	3218	32	18	8.5"	19	39819
39718	3216	32	16	8.5"	22	39818
39717	3213	32	13	8.5"	24	39817
39716	3211	32	11	8.5"	27	39816
39715	3119	31	19	6"	16	39815
39714	3118	31	18	6"	17	39814
39713	3117	31	17	6"	18	39813
39712	3115	31	15	6"	21	39812
39711	3113	31	13	6"	22	39811
39710	3111	31	11	6"	24	39810
39709	2916	29	16	7.5"	19	39809
39708	2915	29	15	7.5"	20	39808
39707	2913	29	13	7.5"	22	39807
39706	2911	29	11	7.5"	24	39806
39705	2910	29	10	7.5"	25	39805
39704	2716	27	16	5"	15	39804
39703	2715	27	15	5"	16	39803
39702	2713	27	13	5"	18	39802
39701	2711	27	11	5"	20	39801
39700	2710	27	10	5"	21	39800

ROBBINS OTR Envelopes



- For use with rim & tube curing systems & sealing ring curing systems. Hand-Built for OTR tires, can be custom-made to customer requirements
- Envelope prices do not include the valve

Envelopes 58" O.D. and smaller include one valve installed. Envelopes 58.5" to 65" O.D. include one valve installed and one extra valve in the box. Envelopes 65.5" to 99.5" O.D. include two valves in the box for end user to install. Envelopes 100" O.D. and larger include four valves in the box for end user to install. Use Myers Order No. 41472 for valve pricing. Note: these are custom orders. Delivery is approximately 2 to 3 weeks.

Myers No.	Envelope Size	Suggested Tire Size
39450	60x15	38x20.00-16
39452	60x20	14.00R20 MILITARY
39460	63x19	16.00R20 MILITARY
39741	72x20	48x25.00-20
39475	79x15	48x31.00-20
39443	55.5x15	L1400-20ML
39443	55.5x15	14.00-21ML
39443	55.5x15	13.00-21ML
39444	55.5x17	12.00-24ML
39443	**55.5x15	12.00-24ML
39444	55.5x17	13.00-24ML
39444	55.5x17	14.00-24
39444	55.5x17	L12.00-24ML
39450	60x15	L14.00-24ML
39444	55.5x17	12.00-25ML2
39456	**63x13	14.00-25ML
39450	60x15	14.00-25ML
39442	**55.5x14	13.00-24
39444	55.5x17	13.00-24
39441	**55.5x10	15.5-25
39443	55.5x15	15.5-25
39456	**63x13	14.00-24
39444	55.5x17	14.00-24
39456	**63x13	17.5-25
39450	60x15	17.5-25
39469	**72x15	16.00-24
39740	72x18	16.00-24
39740	**72x18	16.00-25
39471	72x20	16.00-25
39475	**79x15	18.00-25
39475	79x15	18.00-25
39470	**72x18	20.5-25
39741	72 x 20	20.5-25
39482	91x20	21.00-25
39431	**81x18	23.5-25
39478	81x20	23.5-25
39432	**91x18	26.5-25
39482	91x20	26.5-25
39433	**97x18	29.5-25
39487	97x20	29.5-25
39487	97x20	26.5-29
39433	**97x18	29.5-29
39487	97x20	29.5-29
39483	**91x25	18.00-33
39483	91x25	18.00-33
39491	106x30	27.00-33
39497	114x30	33.5-33
39491	109x30	35 ⁶ -33
39498	119x30	37.5x33
39489	**100x28	21.00-35
39489	100x28	21.00-35
39491	**106x30	24.00-35
39491	106x30	24.00-35
39491	106x30	29.5-35
39497	114x30	33.25-35
39499	124x30	37.25-35
39499	124x30	37.5-39
None	110x33	33.25-29
39496	**109x30	21.00-49
39496	109x30	21.00-49
39496	**109x30	24.00-49
39496	109x30	24.00-49
39498	**119x30	27.00-49
39498	119x30	27.00-49

** Recommended for use with sealing rings
Note: All suggested envelope selections are used as a guide only. Variations in tire sizes, tire dimensions, precure tread designs, and tread thickness may require a smaller or larger envelope size. In some instances it may be necessary to measure the built tire to determine the correct envelope size. All capacities and specifications are subject to change without notice.

ROBBINS MRT Outside Envelopes



- For MRT retread systems only, use with Robbins Accu-Fit Inside envelopes

Order No	Envelope Size	Tire Size
39259	4422	305/75R24.5 Deep
39249	4223	305/75R24.5
39250	4224	285/75R24.5
39250	4224	275/80R24.5
39259	4422	12R24.5
39259	4422	11R24.5
39260	4423	1200R24
39259	4422	11.00R24
39259	4422	455/55R22.5
39266	4522	445/65R22.5 (18R22.5)
39245	4219	445/50R22.5
39266	4522	425/65R22.5 (16R22.5)
39259	4422	385/65R22.5 (15R22.5)
39259	4422	315/80R22.5
39250	4224	305/85R22.5
39282	4023	305/75R22.5
39282	4023	305/70R22.5
39250	4224	295/80R22.5
39282	4023	295/75R22.5
39282	4023	275/80R22.5
39232	3822	275/70R22.5
39232	3822	265/75R22.5
39232	3822	255/80R22.5
39232	3822	255/70R22.5
39232	3822	245/75R22.5
39232	3822	235/80R22.5
39266	4522	18R22.5
39266	4522	16R22.5
39259	4422	15R22.5
39250	4224	12.75R22.5
39250	4224	12R22.5
39250	4224	11R22.5
39282	4023	10R22.5
39232	3822	9R22.5
39259	4422	11.00R22
39259	4422	10.00R22
39260	4423	365/80R20
39260	4423	14/80R20
39266	4522	14.00R20
39250	4224	13/80R20
39259	4422	12.00R20
39250	4224	11.00R20
39250	4224	10.00R20
39282	4023	9.00R20
39232	3822	8.25R20
39226	3521	305/70R19.5
39226	3521	285/70R19.5
39226	3521	265/70R19.5
39219	3218	245/70R19.5
39219	3218	225/70R19.5
39219	3218	8R19.5
39213	3117	245/70R17.5
39213	3117	215/75R17.5
39232	3822	11R17.5
39226	3521	10R17.5
39219	3218	9.5R17.5
39219	3218	9R17.5
39219	3218	7.50-17
39219	3218	245/75R16
39213	3117	235/85R16
39209	2916	225/75R16
39213	3117	215/85R16
39219	3218	7.50R16LT
39226	3521	10.00R15
39219	3218	8.25R15
39213	3117	7.50R15

Note: All suggested envelope selections are to be used as a guide only. Variations in tire sizes, tire dimensions, precure tread designs, and precure tread thickness may require a smaller or larger envelope size. In some instances it may be necessary to measure the built tire to determine the correct envelope size. All Capacities and specifications are subject to change without notice.

ROBBINS CMT Outside Envelopes



- For retread systems using Inside envelopes. Recommend using Robbins Accu-Fit inside envelopes

Order No	Envelope Size	Tire Size
39759	4422-29	305/75R24.5 Deep
39749	4223-27	305/75R24.5
39750	4224-23	285/75R24.5
39750	4224-23	275/80R24.5
39759	4422-29	12R24.5
39759	4422-29	11R24.5
39760	4423-30	1200R24
39759	4422-29	11.00R24
39759	4422-29	455/55R22.5
39766	4522-24	445/65R22.5 (18R22.5)
39745	4219-30	445/50R22.5
39766	4522-24	425/65R22.5 (16R22.5)
39759	4422-29	385/65R22.5 (15R22.5)
39759	4422-29	315/80R22.5
39750	4224-23	305/85R22.5
39782	4023-23	305/75R22.5
39782	4023-23	305/70R22.5
39750	4224-23	295/80R22.5
39782	4023-23	295/75R22.5
39782	4023-23	275/80R22.5
39732	3822-23	275/70R22.5
39732	3822-23	265/75R22.5
39732	3822-23	255/80R22.5
39732	3822-23	255/70R22.5
39732	3822-23	245/75R22.5
39732	3822-23	235/80R22.5
39766	4522-24	18R22.5
36766	4522-24	16R22.5
39759	4422-29	15R22.5
39750	4224-23	12.75R22.5
39750	4224-23	12R22.5
39750	4224-23	11R22.5
39782	4023-23	10R22.5
39732	3822-23	9R22.5
39759	4422-29	11.00R22
39759	4422-29	10.00R22
39760	4423-30	365/80R20
39760	4423-30	14/80R20
39766	4522-24	14.00R20
39750	4224-23	13/80R20
39759	4422-29	12.00R20
39750	4224-23	11.00R20
39750	4224-23	10.00R20
39782	4023-23	9.00R20
39732	3822-23	8.25R20
39726	3521-19	305/70R19.5
39726	3521-19	285/70R19.5
39726	3521-19	265/70R19.5
39719	3218-19	245/70R19.5
39719	3218-19	225/70R19.5
39719	3218-19	8R19.5
39713	3117-19	245/70R17.5
39713	3117-19	215/75R17.5
39732	3822-23	11R17.5
39726	3521-19	10R17.5
39719	3218-19	9.5R17.5
39719	3218-19	9R17.5
39719	3218-19	7.50-17
39719	3218-19	245/75R16
39713	3117-19	235/85R16
39709	2916-19	225/75R16
39713	3117-19	215/85R16
39719	3218-19	7.50R16LT
39726	3521-19	10.00R15
39719	3218-19	8.25R15
39713	3117-19	7.50R15

Note: All suggested envelope selections are to be used as a guide only. Variations in tire sizes, tire dimensions, precure tread designs, and precure tread thickness may require a smaller or larger envelope size. In some instances it may be necessary to measure the built tire to determine the correct envelope size. All Capacities and specifications are subject to change without notice.

ROBBINS Accu-Fit II Inside Envelopes



- Overlapping Envelopes Sealed
- by Vacuum – No Mechanical Clamps, Bands or Other
- Devices Needed

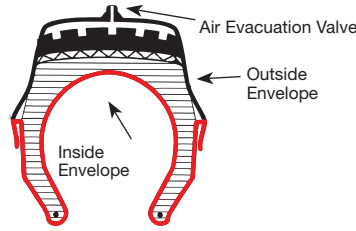

- Myers recommends using inside and outside envelope from same manufacturer.

Order No.	Envelope Size	Tire Size
41293	44x10-24.5	1200R24
41841	42x8-24.5	12R24.5, 11R24.5
41294	42x10-24.5	11R24.5
41582	40x8-24.5	305/75R24.5, 11R24.5
41203	38x8-24.5	285/75R24.5, 275/80R24.5
41295	44x12-22.5	445/55R22.5
41820	44x10-22.5	425/65R22.5, 16R22.5
41296	42x10-22.5	385/65R22.5, 1100R22, 455/55R22.5
41580	40x8-22.5	445/50R22.5, 315/80R22.5, 12.5R22.5, 10.00R22
41202	38x8-22.5	295/80R22.5, 295/75R22.5, 275/80R22.5, 11R22.5
41297	35x8-22.5	275/70R22.5, 265/70R22.5, 255/80R22.5,
41298	42x10-20	365/80R20
41299	40x8-20	335/80R20
41205	38x8-20	1000R20, 900R20
41300	35x8-20	825R20
41301	32x8-20	750-20
41085	42x10-19.5	445/65R19.5
41084	40x8-19.5	15R19.5
41080	35x8-19.5	305/70R19.5
41081	32x8-19.5	285/70R19.5, 265/70R19.5, 8R19.5
41083	29x7-19.5	245/70R19.5, 225/70R19.5, 8R19.5
41092	35x8-17.5	11R17.5, 10R17.5
41088	32x8-17.5	9R17.5, 10R17.5, 9.5R17.5
41087	29x7-17.5	245/70R17.5, 215/75R17.5, 7.50-17
41086	27x5-17.5	205-75R17.5
41093	32x8-16	12R16.5, 235/65R16
41090	29x7-16	245/75R16, 750R16, 235/85R16, 215/85R16
41089	27x5-16	225/75R16
39900	10x15 HB	10.00R15
39901	8.5x15 HB	8.25R15
39902	7.5x15 HB	7.50R15

Speed Tire Spreader

A powerful hand spreader ideal for inspection work or used in pairs for holding beads apart when making section repairs. Includes locking pin to prevent spreader from unlocking during use and instruction sheet.

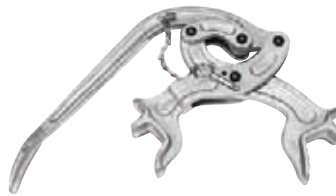

Order No.	Mfr. No.	Description	Ship Wt.
50926	M-1	Speed Tire Spreader	4 lbs. - 2 kg

ROBBINS Envelopes with Valve



- For industrial size tires
- For use with rim & curing tube curing system
- Customized sizes to fit industrial tire sizes available

Order No.	Envelope Size	Tire Size	Order No.	Envelope Size	Tire Size
39728	3814-29	10/11.00-15	41512*	252-15	7.50-10
39717	3213-24	8.25-15	41744*	252-15	7.50-10 No Valve
39709	2916-19	7.00-15	41794*	240-16	6.50-10 No Valve
39701	2711-20	7.00-12	41795*	240-16	6.50-10
41496**	270-22	7.00-12			

* Accu-Fit Type, ** For use with sealing rings

ROBBINS Precure Uni-Tubes



- For precure & mold cure retread systems
- .302 Valve cap thread



Order No.	Tube Size	Qty. Per Box	Ship Wt.
41540	UN-12" Medium	2	9 lbs. - 4 kg
41541	UN-13" Small	2	11 lbs. - 5 kg
41542	UN-13" Medium	2	9 lbs. - 4 kg
41544	UN-14" Small	2	11 lbs. - 5 kg
41545	UN-14" Medium	2	11 lbs. - 5 kg
41546	UN-14" Large	2	12 lbs. - 5 kg
41547	UN-14" Extra Large	2	14 lbs. - 6 kg
41548	UN-15" Small	2	12 lbs. - 5 kg
41551	UN-15" Medium	2	11 lbs. - 5 kg
41555	UN-15" Large	2	11 lbs. - 5 kg
41869	UN-700R15	2	10 lbs. - 5 kg
41870	UN-750R15/ 8.25-15	2	10 lbs. - 5 kg
41556	UN-1000R15, 1100R15	2	14 lbs. - 6 kg
41871	UN-700R16	2	12 lbs. - 5 kg
41872	UN-750R16	2	12 lbs. - 5 kg
41882	UN-10-16.5	2	12 lbs. - 5 kg
41679	7.00/7.50-17/18	2	
41972	UN-8R19.5, 9R-19.5, 245/70R19.5, 225/70R19.5, 245/70R19.5	2	11 lbs. - 5 kg
41595	UN-700R20, 750R20	2	12 lbs. - 5 kg
41873	UN-825R20	2	15 lbs. - 7 kg
41874	UN-900R20	2	15 lbs. - 7 kg
41875	UN-1000R20	2	16 lbs. - 7 kg
41878	UN-1100R20, 1200R20	2	20 lbs. - 9 kg
41876	UN-1000R22, 11R22.5, 12R22.5	2	19 lbs. - 9 kg
41564	UN-15R22.5, 16.5R22.5, 315/80R22.5	2	30 lbs. - 14 kg
41877	UN-1100R22	2	23 lbs. - 10 kg
41557	UN-245/75R22.5, 255/70R22.5	2	14 lbs. - 6 kg
41558	UN-265/75R 22.5, 275/80R22.5, 9R22.5, 10R22.5	2	17 lbs. - 8 kg
41559	UN-295/75R22.5	2	17 lbs. - 8 kg
41563	UN-285/75R24.5	2	19 lbs. - 9 kg
41879	UN-1100R24	2	27 lbs. - 12 kg
41880	UN-1200R24, 11R24.5, 12R24.5	2	23 lbs. - 10 kg
41881	UN-1300R24, 1400R24	2	31 lbs. - 14 kg
41627	13.00/14.00-20	1	54 lbs. - 25 kg
41881	13.00-24	1	52 lbs. - 24 kg

2 per Carton

Envelope Measurement Methods

Base envelope selection on the outside diameter & bead-to-bead measurement of the built retread unit.

- 1.) Identify the envelope sealing method
- 2.) Measure built retread tire diameter to estimated envelope O.D.
- 3.) Measure the built retread unit from sealing point to sealing point and add 2" to estimate envelope bead to bead.
- 4.) Compare the measurement to the bead-to-bead dimensions on the chart below for proper fit. Note: If the measurement falls between two bead-to-bead envelope sizes, use the larger size.

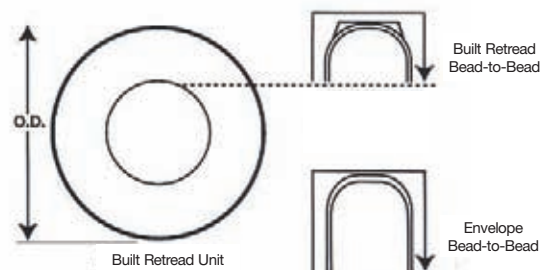

ROBBINS Envelope Lube



Spray on the inside of the envelope. Spraying while the envelope is hot helps it dry faster. Spray on as needed. The quart container is a convenient spray bottle. Ready to use, no dilution required. Available in 55-gallon drums.

Order No.	Mfr. No.	Size	Ship Wt.
41398	5611	1 Quart	3 lbs. - 2 kg
41399	5612	1 Gallon	9 lbs. - 4 kg
41397	5613	5 Gallons	44 lbs. - 20 kg

ATEC Envelope Release Lubricant



A water-based silicone release lubricant. New envelopes require 4 or 5 initial applications and again in approximately 6 cures. Re-apply when there are signs of sticking. Non-toxic and non-flammable.

Order No.	Mfr. No.	Description	Ship Wt.
45209	ERL-170	Envelope Release Lubricant	44 lbs. - 20 kg

SURE-SHOT Sprayer



Metal, one quart pressure sprayer for spraying mold lubricants. Holds up to 200 lbs. pressure. Shoots a wide-area mist spray or jet stream up to 20'. Fast, easy refilling with standard air chuck, hand pump, or CO2 cartridge.

Order No.	Mfr. No.	Description	Ship Wt.
56435	HPN-52D	1 Qt. Chrome Plated Brass Tank	3 lbs. - 1 kg
56436	HPN-1952	1 Qt. Enamelled Steel Tank	3 lbs. - 1 kg
56438	HPN-325	6" Extension Nozzle	1 lbs. - 1 kg
56439	K-10	Repair Kit for Sprayers: Complete (13 Parts)	2 lbs. - 1 kg
56440	A-5	Repair Kit for Sprayers: (8 Parts)	1 lbs. - 1 kg

B&J Precure Envelope Tester

- Tests for leaks in less than 20 seconds



Designed to exhaust trapped air between the envelope and precure tread on envelopes with valves, especially useful with envelope sealing rings. Recommended for Vulcan TB-52 (B manifold), Cedco, Salisbury and other chambers. A check valve is available to keep the vacuum drawn on already checked envelopes for a longer test, while other envelopes are being checked.

Order No.	Mfr. No.	Description	Ship Wt.
46001	33-400	Envelope Tester	25 lbs. - 11 kg
46002	33-405	Check Valve	1 lbs. - 1 kg

OLSON Envelope Expander

- Increase envelope life & reduce replacement cost
- Reduce the risk of hand or finger injuries
- Handles tire sizes - 7.50 x 16 thru 18 x 22.5 or 45" maximum tire diameter



50706
Shown with Optional
50738 Tire Lift

Fits and removes curing envelopes at the touch of a button. Slip the envelope onto the expansion fingers, and air operated cylinders stretch it onto the tire automatically. The 600 model is floor mounted and swings out of the way when not in use. Recommended for Branick band type spreaders or T-racks. The 750 model expander is for use with monorail systems. It mounts under the monorail and lets tires pass through center to continue down the line. The E-Z Lift is for use under the 50706 Enveloper, lifts the tire on and off the "J" hook and positions it for installing sealing rings. Requires 120 psi.

Upper Finger Stop Kit (50741) keeps the fingers in a true circle and spreads the envelope uniformly reducing the danger of tearing. For use on the #750 Monorail Enveloper.

Order No.	Mfr. No.	Description	Ship Wt.
50705	#600	Stationary Enveloper "E"	340 lbs. - 155 kg
50710	9610	Tire Lift for #600 Enveloper	
50706	#750	Monorail Enveloper "M"	300 lbs. - 135 kg
50738	#700	Tire Lift for 750 Enveloper	300 lbs. - 135 kg
50708		Repl. Rubber Hose Including Ends for Expanding Arms	1 lbs. - 1 kg
50709		Rubber Hose Only No Ends	1 lbs. - 1 kg
50675		50' Bulk Rubber Hose	3 lbs. - 1 kg
50741	#9032	Upper Finger Stop Kit	
50713		Replacement Air Cylinder	28 lbs. - 13 kg

Envelope Storage Carts

- Holds up to 800 lbs.
- Keeps envelopes off the floor & away from damage
- Five colors - sort envelopes by size



Manufactured of durable, high impact polyethylene with four ball bearing casters making it easy to move. Wide, rolled over edge will not snag envelopes when placing or removing. Cart size: 46" long x 34" wide x 32-1/2" high.

Order No.	Description	Ship Wt.
84610	Envelope Storage Cart - Blue	68 lbs. - 31 kg
84611	Envelope Storage Cart - Yellow	68 lbs. - 31 kg
84612	Envelope Storage Cart - Red	68 lbs. - 31 kg
84613	Envelope Storage Cart - Grey	68 lbs. - 31 kg
84614	Envelope Storage Cart - Green	68 lbs. - 31 kg

Tire Talc

Keeps casings, tubes, rims and patches from adhering to each other. Ideal for dusting curing tubes, air bags, etc.

Order No.	Mfr. No.	Description	Ship Wt.
46608	RM-23	1 Lb. Can	1 lbs. - 1 kg
46610	RM-23X	50 Lb. Bag	55 lbs. - 25 kg



Envelope Seal Couplers & Adapters



Effective when using a vacuum to test the seal of the envelope prior to loading the tires in the chamber. The adapter and coupler must be used together; it is not interchangeable with other systems.

Order No.	Mfr. No.	Description
41472	3245	Envelope Valve
41498	5079	Envelope Washer (Rubber)
41471	BH1-60Y-4FP	Coupler 1/4" FPT Sureseal
41486	VB75-013	Viton O-Ring for 41471 Sold Each (2) Req. Per Coupler - 10 per pack
41449	BH61-711	Adapter .482 Sureseal
54511	TW-12	Teflon O-Ring for 41449 (10 Pkg.)

Wide Base Envelope Valves



The wide 2 1/4" base helps the valve "bridge" the gap between wide tread voids on many aggressive designs. One-piece design eliminates the potential leak point of multi-piece valves.

Order No.	Mfr. No.	Description
41454	VDT-000	Wide Base .482 Threaded Valve

CIMS Date Code Tags



Retread identification tags for use on matrix, precure, and flexcure retread systems. Precure Combo Tags combine shop code and weekly date code onto one tag. "C" and "M" Series Date Code Sets. Full year sets contain 10 weekly Date Tags for 52 weeks. Precure Shop Code Tags can be used with all precure and flexcure systems, stamped with your shop code and/or optional code.

Order No.	Mfr. No.	Description	Size	Slot Center
45782	4260	Precure Combo Tags, Combines Shop & Weekly Date Codes	2 1/2" x 1/2"	-
45781	4215	Precure Shop Code Tags, Prestamped, Reusable	2" x 1/2"	-
45780	4206	"M" Style Date Code Set, Jan. thru Dec. - 1 Year.	1 3/8" x 3/8"	1 1/16"
45777	4208	"M" Style 1/2 Year Order after May 1st	1 3/8" x 3/8"	1 1/16"
45778	4200	"C" Style Date Code Set, June thru May - 1 Year	1 3/8" x 3/8"	1 5/16"
45779	4202	"C" Style Date Code Set, 1/2 Year Order After Dec. 1st	1 3/8" x 3/8"	1 5/16"

ROOVERS Aluminum Embossing Tape



Supplied in convenient pre-measured easy to load rolls. They are specially controlled for width, thickness and temper of material. Other sizes available, call for details.

Order No.	Mfr. No.	Tape Size Width	Gauge	Rolls Per Carton	Length Per Roll
45766	2643	1/2"	.015	10	120

Baird-Style Couplers & Adapters



Designed for use in the retread operation. Features patented teflon sealing system that uses 5 flat teflon washers. Couplers are for high temperature applications up to 550°F. and uses a locking pin system in place of balls for a tighter locking system to the adapter.

Order No.	Mfr. No.	Description
54372	874-6	Straight-Thru w/ 90° Side Exhaust Coupler
54376	874	90° Hose Inlet Coupler (Supply)
54378	1	Teflon Repl. Washers 5 Per Coupler Required
54370	814	.482 Envelope Adapter for 874-6 Coupler
54371	814S	Replacement Seal for 54370 (Bag of 100)
54463	812	.302 Valve Stem Adapter for 894 & 874 Couplers
54373	812S	Gasket For 54463 (Bag of 100)

1/4" Air Coupler & Adapters

- Inflate supply side of chamber (curing tube side)

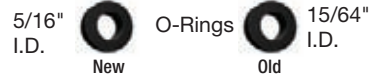

Order No.	Mfr. No.	Description
54473	1000	Coupler 1/4" fpt
54483	W-1000 "Old"	Repl. Washer Buna "M" to 200° 10 Per Pack Smaller I.D.
54484	3000-143 "Old"	Viton Hi-Temp Washer 10 Per Pack Smaller I.D.
54222	NEW Buna "M"	Repl. Washer Buna "M" to 200° 10 Per Pack Larger I.D.
54496	NEW "O" Viton Ring	Viton Hi-Temp Washer 10 Per Pack Larger I.D.

Order No.	Mfr. No.	Adapter Thread
54474	12	1/8" MPT
54475	10	1/4" MPT
54476	14	3/8" MPT
54477	11	1/4" FPT
54478	15	3/8" FPT
54479	E	.302F Valve Cap

1/4" Envelope Coupler & Adapters

- Exhaust side of chamber (envelope side)
- Compatible for use in Bandag chambers



Order No.	Mfr. No.	Description
54504	CST17BA	Exhaust Flow Thru Coupler
		Aflas Wide Hi-Temp O-Ring 10 Per Pack
		Aflas Thin Hi-Temp O-Ring 10 Per Pack

Order No.	Mfr. No.	Description
54510	1137	Envelope Adapter .482 Thread
54511	TW-12	Teflon O-Ring 10 Per Pack



Contact your local Myers Branch for complete information & specifications

Multi-Tire Curing Chambers

- 6 To 25 tire capacity & tire sizes up to 14.00-24

Chambers are available in either steam or electrically heated models. Features include: automatic controls to provide uniform temperature and pressure throughout the curing cycle; hydraulically operated quick-lock chamber door; top mounted inside track and tire hanger brackets. Chambers are fully insulated for optimum efficiency and economical operation.

Replacement Chamber Seals



34726



34777 34927



34778



34792

EDPM O-Rings are generally black in color and withstand temperatures in the 250° to 320°F range. Silicone O-Rings are generally red or pink in color and withstand temperatures to 500°.

Order No.	Application	Type	Diameter
Miscellaneous Horizontal Chambers			
34927	Michelin/Cure Tech	EPDM Seal	
34775	Salisbury 12, 15, 23, 25 Tire	EPDM O-Ring	½"
34776	Salisbury 12, 15, 23, 25 Tire	Silicone O-Ring	½"
34726	Alloy Craft 57"	EPDM Seal	
34777	Bandag 1973 & Newer, 11, 22, Tire	EPDM Seal	
34778	Bandag Pre-1973, 10, 20 Tire	EPDM Seal	
34792	Hercules/Cedco 12, 15, 22, 25 Tire	EPDM Seal	
See illustrations above			
Vulcan Chambers			
34731	TB-436	EPDM O-Ring	¾"
34760	TB-436	Silicone O-Ring	¾"
34725	TB-40, 45, 48	EPDM O-Ring	¾"
34761	TB-40, 45, 48	Silicone O-Ring	¾"
34729	TB-54, 52, 526, 606 & 706	EPDM O-Ring	¾"
34762	TB-54, 52, 526, 606 & 706	Silicone O-Ring	¾"
34728	TB-62	EPDM O-Ring	¾"
34763	TB-62	Silicone O-Ring	¾"
Longmile Vertical Chambers			
34775	All	EPDM O-Ring	½"
34776	All	Silicone O-Ring	½"
Oliver/Cox Chambers			
34780	P-41 Chamber	EPDM O-Ring	¾"
34781	T-50 Chamber	EPDM O-Ring	¾"
34782	T-55 Chamber	EPDM O-Ring	¾"
Heintz Chambers			
34787	MC-40, #A Heintz	Silicone O-Ring	¾"
34788	MC-46, #B Heintz	Silicone O-Ring	¾"
34789	MC-50, #C Heintz	Silicone O-Ring	¾"
¼" and 3/8" Silicone material sold by the foot for Temp-R-Tred, Lodi, Oliver, and Longmile Chambers			
34790	¼" Silicone Material Per Ft.		
34791	¾" Silicone Material Per Ft.		
O-Ring Lubricants			
34727	5.3 Oz. Silicone O-Ring Lubricant Tube DOW #111		
34717	8 Lb. Silicone O-Ring Lubricant Bucket DOW #111		
45215	Silicone Spray		

Curing Chamber Charts

- For Oliver, Goodyear, Salisbury, Hercules/Cedco, Cure Tech (Michelin) & other type chambers



Compatible for BANDAG

Order No.	Diameter	Application	Description	Qty. Per Box
PARTLOW Temperature Charts – 24 Hours				
34107	10" Dia.	50 – 250	A225F, #002-053-03	100
34108	10" Dia.	150 – 350	002-213-883	100
34113	10" Dia.	100 – 350	A335F, 002-060-03	100

Pen for Partlow Temperature Recorder

34116	Red Short Stem	605-004-03	Sold/Each
-------	----------------	------------	-----------

DICKSON Pressure Charts – 24 Hours

34100	8" Dia.	0 – 200	C456	60
34101	4" Dia.	40/0/50	C011	60
34102	4" Dia.	0-100	C010, DPC Chart	60
34112	4" Dia.	0 – 500	C028	60

Pens for Dickson Pressure And DPC Recorder

34104	Red	P-222, 700-022200	Pkg. 6
34105	Blue	P-226, 700-022600	Pkg. 6

Salisbury Type

DICKSON Temperature Charts – 24 Hours

34103	8" Dia.	0 – 500	C428	60
-------	---------	---------	------	----

Pen for Dickson Temperature Recorder

34105	Blue	P-226, 700-022600	Sold Pkg./6
-------	------	-------------------	-------------

DICKSON Pressure Charts – 24 Hours

34100	8" Dia.	0 – 200	C456	60
-------	---------	---------	------	----

Pens for Dickson Pressure Controller

34104	Red	P-222, 700-022200	Sold Pkg./6
34105	Blue	P-226, 700-022600	Sold Pkg./6

HERCULES/CEDCO Type

PARTLOW Temperature Charts – 24 Hours

34106	10" Dia.	0 – 400	#002-138-02	100
-------	----------	---------	-------------	-----

Pen for Partlow Temperature Recorder

34109	Red Long Stem	#605-004-02	Sold/Pkg. 5
-------	---------------	-------------	-------------

DICKSON Pressure Charts – 24 Hours

34100	8" Dia.	0 – 200	C456	60
-------	---------	---------	------	----

Pens for Dickson Pressure Controller

34104	Red	P-222, 700-022200	Sold/Pkg. 6
34105	Blue	P-226, 700-022600	Sold/Pkg. 6

Salisbury / Cedco (Wingfoot) Recorder

Honeywell Recorder Chart

34117	12" Dia.	80663-90/30755	100
		317-KC	

All items priced per box.

TIP: Be sure to check all hoses, couplers and connections for air leaks! See page 320 for order information on hose tester.

Precure Chamber Inflation & Exhaust Hoses

- 1/4" I.D hose with 1/4" mpt fittings



↑ Inside Spring

↑ Outside Guard

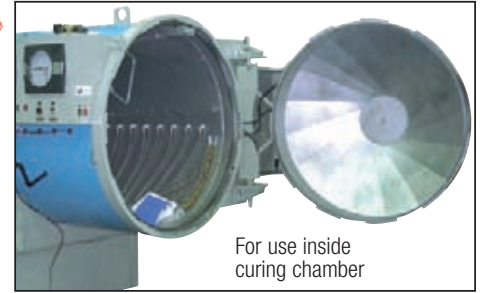

For use inside curing chamber

1/4" Inflation Hoses (Curing Tube Side)

Teflon hose with steel braided cover, are used inside the chamber for inflating the curing tube and on the envelope for evacuating the air between the tread and the envelope.



Without Inside Spring & No Outside Guard

Order No.	Length	Order No.	Length	Order No.	Length
48126	30"	48135	84"	48144	138"
48127	36"	48136	90"	48145	144"
48128	42"	48137	96"	48146	150"
48129	48"	48138	102"	48147	156"
48130	54"	48139	108"	48148	162"
48131	60"	48140	114"	48149	168"
48132	66"	48141	120"	48150	174"
48133	72"	48142	126"	48151	180"
48134	78"	48143	132"		

With Outside Guard Only No Inside Spring

Order No.	Length	Order No.	Length	Order No.	Length
48100	30"	48109	84"	48118	138"
48101	36"	48110	90"	48119	144"
48102	42"	48111	96"	48120	150"
48103	48"	48112	102"	48121	156"
48104	54"	48113	108"	48122	162"
48105	60"	48114	114"	48123	168"
48106	66"	48115	120"	48124	174"
48107	72"	48116	126"	48125	180"
48108	78"	48117	132"		

Bulk	
44211	3/4" Bulk Stainless Hose (Sold Per Foot) 100' Max. Length
49008	3/4" Inner Spring Only (Sold Per Foot) 25' Max. Length
49010	Outside Guard Only (Sold Per Foot) 25' Max. Length

1/4" Exhaust Hoses (Envelope Side)

The exhaust hose also includes an inner spring to keep the hose from collapsing.

With Inside Spring Only No Outside Guard

Order No.	Length	Order No.	Length	Order No.	Length
48152	30"	48161	84"	48170	138"
48153	36"	48162	90"	48171	144"
48154	42"	48163	96"	48172	150"
48155	48"	48164	102"	48173	156"
48156	54"	48165	108"	48174	162"
48157	60"	48166	114"	48175	168"
48158	66"	48167	120"	48176	174"
48159	72"	48168	126"	48177	180"
48160	78"	48169	132"		

With Inside Spring & Outside Guard

Order No.	Length	Order No.	Length	Order No.	Length
48178	30"	48187	84"	48196	138"
48179	36"	48188	90"	48197	144"
48180	42"	48189	96"	48198	150"
48181	48"	48190	102"	48199	156"
48182	54"	48191	108"	48200	162"
48183	60"	48192	114"	48201	168"
48184	66"	48193	120"	48202	174"
48185	72"	48194	126"	48203	180"
48186	78"	48195	132"		

1/4" Exhaust & inflation hoses may be custom ordered up to 300" long with spring guard to fit your requirements. Longer lengths available without spring guard. Call 800-998-9897

Teflon Steam Hose



3/8" MPT teflon hose with steel-braided cover and spring guard. Spring guard covers entire hose length.

Order No.	Length	Order No.	Length	Order No.	Length
44180	18"	44185	30"	44189	48"
44181	20"	44184	32"	44190	54"
44183	24"	44187	36"	44191	60"
44182	27"	44186	42"		

Bulk	
49009	3/8" I.D. Hose with Spring Guard (Sold Per Foot)
44217	3/8" I.D. Teflon Steel Braided Hose (Sold Per Foot)
54311	3/8" FTP to 1/4" MPT Reducer Bushing

Custom Steam Hose Available on Request

Any length of 3/8" MPT teflon hose with steel-braided cover and spring guard is available from your local Myers Sales Office..



**Call Today
800-998-9897**

MYERS Chamber Hose Tester

- Tests couplers & hoses preventing expensive leaks
- Attach "in-shop" adapter on one end & "envelope adapter" on the other



Step 1: Install the in-shop air line to the ball valve on the tester

Step 2: Install the chamber exhaust hose to the end of the tester where the envelope adapter has been attached. Be sure to close the 2-way or 3-way exhaust hose ball valve on the chamber exhaust hose line to be tested.

Step 3: Open the ball valve and pressurize the exhaust hose and check for and correct any leaks found in the hose or coupler. Close the ball valve and look for a drop in pressure on the gauge. If there is a drop in pressure, there's a leak. To locate a leak use the Myers 56435 Sure Shot Sprayer filled with Myers 46618 Leak Detector.

Order No.	Description
46817	Myers Chamber Hose Tester
56435	Sure Shot Sprayer
46618	Leak Detector 1-Gallon

Thermometer

- Dual range

4 1/2" dial can be read easily from a distance. Has 5 ft. flexible armored connecting tube, 1/2" union connected bulb. Temperature range of 100° to 350°F. (38° to 177°C.)

Order No.	Mfr. No.	Description
46815	V80341	Thermometer

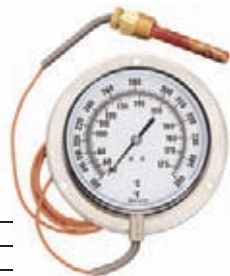

Liquid-Filled Gauge

- Other liquid-filled & vacuum gauges available, contact us

For use as replacement on curing chambers and other equipment. Face diameter 2 1/2"; 0-160 psi in 2 lb. increments; 1/4" mpt center back mount, accurate +/- 1.5%

Order No.	Mfr. No.	Description
49026	213.53	Liquid Filled Gauge



1/4" MPT Clock Gauges

- Other dry, liquid-filled & vacuum gauges available, contact us.

Use on air, steam or any other pressure medium which does not attack brass. Install siphon under gauge when used on steam.

Order No.	Mfr. No.	Dial Size	Lbs. Pressure
44645	*AS-7D	2"	0-300
44641	AS-7G	2 1/2"	0-60
44642	AS-7A	2 1/2"	0-160
44643	AS-7B	2 1/2"	0-200
44644	AS-7C	2 1/2"	0-300
44646	AS-7BB	3 1/2"	0-300
44647	AS-7E	4 1/2"	0-200

*With 1/4" MPT back connection.



44645



44642

MYERS Steam Coupler & Adapter for Press Type Matrices

- Interchangeable with Hansen

For Heintz, Ace, Bacon-American and Lodi steam matrix hook-up. Special quick connect/disconnect couplers. For steam and return lines. Double O-Rings in coupler provide positive seal and extra safety during coupling and uncoupling.



44533

44534

Order No.	Mfr. No.	Description
44533	A4S	3/8" Myers Coupler
44534	A4P	3/8" Myers Adapter
44535		1/2" Myers Coupler

Repair Kit for Myers Special Coupler & Adapters

44537	H68E-67K	Consists Of 1 Each Valve Spring, Snap Ring, O-Ring, Valve Assembly
44569	H10C-R	Repl. O-Ring for 44533 Coupler

HANSON Steam Coupler & Adapter for Press Type Matrix

Brass couplings for Heintz, Bacon-American, Lodi and others. Special seals to withstand special temperatures.



44566

44567

Order No.	Mfr. No.	Description
44566	H10C-S	3/8" Coupler (Bacon-American 41109, Heintz B3-HD-21Y, Lodi B3-H21)
44567	H10C-P	3/8" Plug (Bacon-American 41110, Heintz B3-HD-2Y)
44568	H10C-V	Repl. Valve Assy. BVA-3HKA-192
44569	H10C-R	Repl. Viton O-Ring, Black 10 Pkg

PARKER Steam Coupler & Adapters

Push in to connect, pull back to disconnect. Swivel action brass couplers and brass adapter. Leak-proof when attached.



44572

44573

Order No.	Mfr. No.	Description
44572	BH2-60W	1/4" Coupler
44573	BH2-61W	1/4" FPT Adapter
44574	1-54-310	1/4" MPT Adapter

Repair Kit

44577	2-015 (ES40-8)	Repl. O-Ring for 44572 (2 Req.)
-------	----------------	---------------------------------

Filter-Regulator-Lubricators

- See page 67 for complete listing of filters, regulators & lubricators



All combination units with manual drain filter, lubricator, and regulator are supplied with 0-300 lb. pressure gauge and 0 to 250 psi reduced pressure range. Furnished assembled. Available for 1/4", 3/8", 1/2", 3/4" and 1" lines.

Order No.	Mfr. No.	Size	Ship Wt.
54655	C628-02-FRL	1/4" Filter-Regulator-Lubricator	6 lbs. - 3 kg
54770	C628-03-FRL	3/8" Filter-Regulator-Lubricator	6 lbs. - 3 kg
54657	C628-04-FRL	1/2" Filter-Regulator-Lubricator	10 lbs. - 5 kg
54739	C628-06-FRL	3/4" Filter-Regulator-Lubricator	19 lbs. - 9 kg
54741	C628-08-FRL	1" Filter-Regulator-Lubricator	19 lbs. - 9 kg

ROBBINS PIV Push-In Valve Type Curing Tubes

- For mold cure retreading systems
- For tube-type Marangoni, Italmatic, Cisap & Cima curing presses
- Recommend using flap with the PIV type tube



Order No.	Tube Size	Ship Wt.
41850	12" Small	6 lbs. - 3 kg
41851	13" Small	7 lbs. - 3 kg
41852	13" Medium	9 lbs. - 4 kg
41845	13" Large	12 lbs. - 4 kg
41853	14" Small	9 lbs. - 4 kg
41854	14" Medium	11 lbs. - 5 kg
41855	14" Large	13 lbs. - 6 kg
41856	15" Small	9 lbs. - 4 kg
41857	15" Medium	13 lbs. - 6 kg
41858	15" Large	13 lbs. - 6 kg
41859	15" Extra Large	16 lbs. - 7 kg
41847	15" Super Large	17 lbs. - 8 kg

Order No.	Tube Size	Ship Wt.
41860	16" Medium	15 lbs. - 7 kg
41848	16" Large	18 lbs. - 8 kg
41861	700 /750-20	18 lbs. - 8 kg
41862	825-20	20 lbs. - 9 kg
41863	900-20	21 lbs. - 10 kg
41864	1000-20	26 lbs. - 12 kg
41865	1100-20	27 lbs. - 12 kg
41866	12 /1300-20	33 lbs. - 15 kg
41867	11 /12-22.5, 1000-22	27 lbs. - 12 kg
41868	11 /12-24.5, 1100-24	36 lbs. - 16 kg

ROBBINS PIV II Push-In Valve Type Curing Tubes

- For mold cure retreading systems
- Must use a flap
- For tube-type Marangoni, Italmatic, Cisap & Cima curing presses



Order No.	Tube Size	Ship Wt.
41280	14" Large	7 lbs. - 4 kg
41281	15" Large	7 lbs. - 4 kg
41282	16" Medium	8 lbs. - 4 kg
41283	16" Large	9 lbs. - 5 kg
41284	700 /750-20	10 lbs. - 5 kg
41285	825-20	10 lbs. - 5 kg
41286	900-20	11 lbs. - 6 kg
41287	1000-20	13 lbs. - 6 kg

Order No.	Tube Size	Ship Wt.
41288	1100-20	14 lbs. - 7 kg
41289	12/1300-20	16 lbs. - 8 kg
41290	11 /12-22.5, 1000-22	17 lbs. - 8 kg
41291	16.5-22.5, 856SR22.5	17 lbs. - 8 kg
41292	11 /12-24.5, 1100-24	18 lbs. - 9 kg

ROBBINS Euro-Tubes

- For mold cure retread systems
- Features cured-in valve – alternative to push-in valve type curing tubes
- For tube type Marangoni, Italmatic, Cisap & Cima curing presses



Order No.	Mfr. No.	Tire Size	Ship Wt.
41673	5368	900-20	25 lbs. - 12 kg
41801	5370	1000-20	27 lbs. - 13 kg
41674	5374	1000-22;1100-22.5	27 lbs. - 13 kg
41676	5378	15 /16.5-22.5	50 lbs. - 23 kg
41675	5380	11 /12R-24.5	31 lbs. - 14 kg

Rhein Chemie (Formerly Tire Curing Bladders)

- For bladder-type Marangoni, Italmatic, Cisap, Cima & SIO curing presses
- Contact us for the complete tire curing bladder product line



Order No.	Mfr. No.	Description	Ship Wt.
41120	6228	13"-15" x Small	11 lbs. - 5 kg
41122	7632	13"-15" x Large	11 lbs. - 5 kg
41130	6297	14" Medium	11 lbs. - 5 kg
41131	8911	14" Large	11 lbs. - 5 kg
41126	8376	20 /22/22.5	29 lbs. - 13 kg
41128	2895	20" Large	33 lbs. - 15 kg
41124	8177	22/22.5/24.5	34 lbs. - 15 kg

CONTINENTAL Bladders

- For bladder-type Marangoni, Italmatic, Cisap, Cima & SIO Curing presses
- Contact us for the complete Continental bladder product line



Order No.	Mfr. No.	Description	Ship Wt.
41100	RP 13 /3	560-13 To 7.00-14	8 lbs. - 4 kg
41102	RP 13 /5	650-13 To E 78-15 (185-15)	9 lbs. - 4 kg
41103	RP 13 /7	E 78-14 (185-14) To H 78-15 (205-15)	10 lbs. - 5 kg
41104	RP 13 /9	Large Passenger And Small Commercial Truck	12 lbs. - 6 kg
41107	RP20 /5	900-20 & Up	23 lbs. - 10 kg
41109	H 10	Aircraft Special Application	18 lbs. - 8 kg
41114	BN2	Aircraft Special Application	13 lbs. - 6 kg
41115	H 15 /5	Aircraft Special Application	19 lbs. - 9 kg
41116	B20 /7	Aircraft Special Application	32 lbs. - 14 kg
41119	B20 /5	Aircraft Special Application	32 lbs. - 14 kg

Push-In Valve

- For use with PIV curing tubes
- ¼" BSPT (British Pipe Thread)



Order No.	Description
21220	Push In Valve

Graphite Lubricating Stick



High heat lubricant used for lubricating matrix retainer ring. Easier insertion and removal. Prevents rust and corrosion. Individually tubed.

Order No.	Mfr. No.	Description
46663	TD-20	Graphite Lubricating Stick

Matrix Vent Drill Bits



For cleaning matrix vent holes

Order No.	Mfr. No.	Description
02439	THD-332	¾" x 4" Matrix Vent Drill Bits
02440	THD-564	¾" x 5" Matrix Vent Drill Bits



ROBBINS Double Dot Curing Tubes

- Collapsible rim type curing tubes for mold cure retreading systems
- .482 Valve Spud Thread

Note: Nomenclature of RMA sizes represents outside diameter (inches and 1/8") and recommended rim diameter.

Example: 206 x 35-15 tube dimension is 20 3/4" outside diameter, 35 is 3 5/8" width of tube and 15" rim diameter.



Order No.	RMA Size	Replacement No.	Ship Wt.
41049	181 x 35-12	62F-12.5	9 lbs. - 4 kg
41050	204 x 35-15	62F-15	9 lbs. - 4 kg
41051	214 x 41-16	63F-16	9 lbs. - 4 kg
41174	214 x 56-16	A78-13	10 lbs. - 6 kg
41052	221 x 45-16	65F-16	11 lbs. - 5 kg
41150	230 x 50-16	67F-16, 635-16	13 lbs. - 6 kg
41055	225 x 46-17	67F-17, 68F-17	13 lbs. - 6 kg
41151	237 x 54-17	685-17, 735-17, 233-62-17	13 lbs. - 6 kg
41030	240 x 52-17	704-17	18 lbs. - 8 kg
41163	240 x 64-17	F70-14, 235-65-17	16 lbs. - 7 kg
41192	240 x 80-17	F60-15	19 lbs. - 9 kg
41031	256 x 56-17	754-17	20 lbs. - 9 kg
41033	262 x 60-17	804-17	18 lbs. - 8 kg
41053	241 x 45-18	66F-18, 69F-18	17 lbs. - 8 kg
41166	256 x 66-18	G70-14-18, 243-67-18	19 lbs. - 9 kg
41003	250 x 42-18	76X	14 lbs. - 7 kg
41029	250 x 52-18	704-18	18 lbs. - 8 kg
41183	250 x 66-18	F78-14	19 lbs. - 9 kg
41032	254 x 57-18	754-18, 775-18	17 lbs. - 8 kg
41167	254 x 74-18	G70-15-18, G78-14, 257-75-18, 253-71-18	23 lbs. - 10 kg
41007	260 x 44-18	82X	16 lbs. - 7 kg
41034	260 x 60-18	804-18, 815-18	21 lbs. - 5 kg
41155	260 x 66-18	845-18	18 lbs. - 8 kg
41185	260 x 72-18	H78-14	19 lbs. - 9 kg
41156	264 x 72-18	885-18	23 lbs. - 11 kg
41035	266 x 63-18	854-18	22 lbs. - 10 kg
41157	271 x 75-18	915-18	23 lbs. - 11 kg
41036	272 x 62-18	904-18	16 lbs. - 7 kg
41158	275 x 80-18	905-18	22 lbs. - 10 kg
41002	280 x 52-18	73X, 74X	17 lbs. - 8 kg
41037	280 x 66-18	954-18	23 lbs. - 11 kg
41401	254 x 72-19	875-16.5	21 lbs. - 10 kg
41004	262 x 43-19	77X	14 lbs. - 7 kg
41402	264 x 76-19	950-16.5	24 lbs. - 11 kg
41008	270 x 41-19	80X, 83X	20 lbs. - 9 kg
41011	280 x 52-19	92X	20 lbs. - 9 kg
41406	280 x 101-19	1200-16.5	36 lbs. - 16 kg
41014	292 x 56-19	114X	21 lbs. - 10 kg
41009	282 x 52-20	84X	21 lbs. - 10 kg
41250	280 x 56-20	300X	20 lbs. - 9 kg
41015	290 x 56-20	116X	20 lbs. - 9 kg
41252	295 x 57-22	303X	22 lbs. - 10 kg
41254	306 x 60-22	307X	25 lbs. - 11 kg

Order No.	RMA Size	Replacement No.	Ship Wt.
41276	286 x 71-22	325X	25 lbs. - 11 kg
41375	336 x 73-25 1/4	320XXX	33 lbs. - 15 kg
41255	340 x 60-25 1/4	310X	25 lbs. - 11 kg
41256	352 x 66-25 1/4	320X	25 lbs. - 11 kg
41376	354 x 82-25 1/4	330XXX	45 lbs. - 21 kg
41258	364 x 76-25 1/4	330X	31 lbs. - 14 kg
41377	370 x 90-26 1/4	340XXX	42 lbs. - 18 kg
41261	380 x 76-26 1/4	340X, 340XL	37 lbs. - 17 kg
41249	380 x 76-26 1/4	340HDXL	44 lbs. - 20 kg
41263	394 x 84-26 1/4	225, 350X	45 lbs. - 20 kg
41273	380 x 90-28 1/4	11-22.5	40 lbs. - 18 kg
41378	390 x 90-28 1/4	342XXX	47 lbs. - 21 kg
41491	390 x 114-28 1/4	AC46-16	47 lbs. - 21 kg
41262	400 x 80-28 1/4	342X	45 lbs. - 26 kg
41264	414 x 84-28 1/4	352X	44 lbs. - 20 kg
41275	400 x 90-30 1/4	11-24.5	50 lbs. - 23 kg
41265	434 x 84-30 1/4	354X	55 lbs. - 25 kg
41266	422 x 100-30 1/4	364X	67 lbs. - 31 kg
41269	463 x 104-30 1/4	373X	73 lbs. - 33 kg
41478	370 x 80-31	440B	41 lbs. - 19 kg
41479	393 x 81-33	442B	43 lbs. - 20 kg
41481	404 x 85-33	452B	47 lbs. - 22 kg
41268	468 x 106-33	369X	60 lbs. - 28 kg
41270	470 x 120-33	374X	74 lbs. - 34 kg

Adapter Extension

- For full circle curing tubes

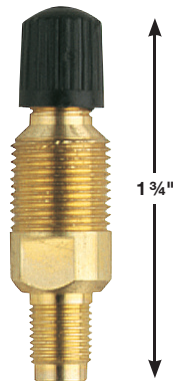

Order No.	Mfr. No.	Description
44440	888	Curing Valve Extension

STONER Spray Lube

- Dual range release



Provides for fast, easy removal from molds. Contains no Class I or Class II ozone depleting substances, no CFC or HCFC propellants, and no chlorinated solvents. Colorless and non-staining 12 Oz. aerosol.

Order No.	Mfr. No.	Description
45215	E218	Heavy-Duty Silicone Release

MYERS Mold Lubricant

- Available in 5-gallon pails, contact us



Concentrated, dilutes up to 40:1 with water and applied with spray or brush. Leaves no carbon deposit. Non-flammable, no unpleasant odor.

Order No.	Mfr. No.	Description	Ship Wt.
45211	D245	1 Gal. Mold Lubricant	10 lbs. - 5 kg

Tubeless Tire Tester



Reduce separation adjustments as much as 90%. Insert needle under surface cover near bead or casing. Air forced into cord body of tire makes any existing separations visible.

Order No.	Mfr. No.	Description
56154	SE6-58T	Tubeless Tire Tester
56156	SE6-58C	Replacement Needle 1/2"
56158	SE6-58D	Replacement Needle 3/4"

Multi-Station Digital Thermocouple

- Efficiently monitors
- Multiple thermocouples

Cost saving and compact combination for virtually instant temperature measurement and monitoring of up to five multiple thermocouples. Totally enclosed and fully wired. Male plugs are re-usable. Features separate battery compartment, low battery alert, peak hold with memory and steel case with cover. Specs.: -30° to 700°F temperature range, 1/2 Rd. second response; 1/2" liquid crystal display.



Order No.	Mfr. No.	Description	Ship Wt.
46846	ATK-TC	Type "K" Multi-Station Pyrometer	4 lbs. - 2 kg
46843	26-K	"K" Thermocouple Wire (Per Ft.) - Not Included	
46844	TPC-K	Male Plug - Not Included	

RAYTEK Infrared Non-Contact Thermometer

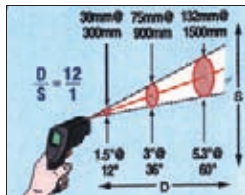

Target Spot Sizes D:S = 12:1 at Focus Point



For automotive and truck diagnostic work on engines, air conditioning, brake inspection, and tire monitoring. Simply point, activate and read. Reads a 1 1/2" target at 12". The 8 point laser measures -25° to 950°F. Rubber casing protects the laser from rough handling. Accurate to +/- 1°. Includes 9V alkaline NiCad battery.

Order No.	Mfr. No.	Description	Ship Wt.
04097	ST30	Infrared Thermometer	1 lbs. - 1 kg

High Heat Chamber Paint

Specially formulated high heat aluminum curing chamber paint. Use as a regular part of the chamber maintenance cycle. TIP: Approximately 2-gallons required for a 22-tire chamber. For best results use a brush.



Order No.	Description	Size	Ship Wt.
45170	High Heat Chamber Paint	1 Gal.	9 lbs. - 4 kg

MYERS Durometer "A" Type

A pocket size durometer with a large easy-to-read dial. Measures hardness by the deflection of a steel probe into the material showing possible process errors. Extremely accurate quality control instrument. Nickel plated brass case in suede-like pouch.



Order No.	Mfr. No.	Description	Ship Wt.
46728	DM	Durometer	1 lbs. - 1 kg

Digital Pyrometer



Offers a F° or C° option switch and a temperature range of 0° to +1,700°F / -18°C to +425°C, accurate to 1°. AV battery has a 1 year life. Features a low battery alert. A needle and surface probe are available, equipped with a flexible lead wire and plug to connect pyrometer. Kit includes Needle Probe, 20'K thermocouple wire, 2 male plugs and plastic case.

Order No.	Mfr. No.	Description	Ship Wt.
46839	E-Z	Pyrometer Kit Complete	2 lbs. - 1 kg

Replacement Parts

46859	EZKC	DP II Pyrometer Only
46855	FKTMSN-K2	Needle Probe 1-7/8" Long, .059 Dia.
46857	SS-12KM	Surface Probe
46843	TWK-02629FD2P	"K." Thermocouple Wire (Per Foot)
46844	TPC-K	Male Plug

Heat Insulated Gloves

Retraders favorite cotton cloth glove. Protection for handling hot molds, mold parts etc. White with red trim. 24 oz.



Order No.	Mfr. No	Description
45300	PE6A	2" Cuff
45301	PE6G	5" Cuff

Green Hot Mill Gloves

Heavy-duty hot mill gloves. Flame-retardant.



Order No.	Mfr. No	Description
45302	SOUGFBT-PK	2" Cuff
45303	SOUFGF-P	5" Cuff

Tire Paints

MYERS Black Tire Paint Water Base Concentrate

- No solvents
- No fire hazards

Non-flammable, non-toxic water base latex paint dries in 30 minutes to a pleasing jet black satin finish. Dilute 1 to 1 with water, or mix 1 part water to 4 parts paint for maximum shine. Spray, brush or swab. Covers crayon and chalk marks. Flash point exceeds 200°F.



Order No.	Size	Description	Ship Wt.
46432	1-Gal.	Black Tire Paint	12 lbs. - 6 kg
46434	5-Gal.	Black Tire Paint	45 lbs. - 21 kg
46435	50-Gal.	Black Tire Paint	495 lbs. - 223 kg

MYERS Black Tire Paint Water Base Ready-To-Use



46430

46431

Provides superior coverage and more tires per gallon. Ideal for high volume or smaller plants spraying or hand painting. Apply as is, with a brush, mitt, or spray, to a clean, dry surface. Works well with all types of automatic painters.

Order No.	Size	Description	Ship Wt.
46430	5-Gal.	Black Tire Paint	45 lbs. - 21 kg
46431	50-Gal.	Black Tire Paint	495 lbs. - 223 kg
46491	50-Gal. Fiber Drum	Black Tire Paint	495 lbs. - 223 kg

PATCH RUBBER Restore Tire Paint

- Returns tires to like new appearance
- Fast drying, matte finish
- Ready to use



Contains no solvents or carcinogens. Clean up with soap and water. Restore Tire Paint contains no hazardous volatile compounds. Open the can, agitate, and use. No mixing flammable solvents. Apply with a brush, mitt or sprayer. Restore Tire Paint is formulated to cover on the first coat and the matte finish makes tires look like new. Mix thoroughly before use and agitate during use.



Order No.	Size	Description	Ship Wt.
16365	5-Gal.	Restore Tire Paint	45 lbs. - 20 kg
16366	54-Gal.	Restore Tire Paint	510 lbs. - 231 kg

ATEC Final Touch Water Base Tire Paint

Formulated for the ATEC Model-11 tire inspection/paint machine. Micro size grade of pigment sprays without clogging tips. Premixed and no dilution is necessary. Non-flammable, non-hazardous, nontoxic and approved by the South Coast Air Quality of California. May be used with other sprayers.



Order No.	Mfr. No.	Description	Ship Wt.
45210	WB-10	Tire Paint - 55-Gallon	540 lbs. - 240 kg
45224	WB-10	Paint - 55-Gallon Fiber Drum	540 lbs. - 240 kg
45212	WB-10-5	Tire Paint - 5-Gallon	45 lbs. - 22 kg
45219	WB-10	Non-Skid Tire Paint - 55-Gallon	540 lbs. - 240 kg

MYERS "New Look" Water Base Black Tire Paint

Give retreads and repaired tires a semi-dull new tire look. "New Look" can be sprayed or brushed. Dries in 20 minutes at room temperature. Covers all chalk marks. Avoid freezing and extreme heat. **Note:** The 27.5 gallons of concentrate is delivered in a 55-gallon drum. Fill drum with water and stir thoroughly.



Order No.	Size	Description	Ship Wt.
46050	5-Gal.	New Look Tire Paint	45 lbs. - 22 kg
46049	55-Gal.	New Look Tire Paint	535 lbs. - 241 kg

MYERS Concentrated Black Tire Stain Solvent Base

- Provides a genuine factory finish

One coat brushed or sprayed on a tire gives it an original factory tire finish. One gallon makes 5 to 9 gallons of tire paint when diluted with gasoline or solvent. **Caution:** Combustible mixture. Observe label precautions. Flash point 105°.



Order No.	Size	Description	Ship Wt.
46400	1-Gallon	Black Tire Dressing	10 kg - 5 kg
46401	5-Gallon	Black Tire Dressing	45 kg - 21 kg
46403	55-Gallon	Black Tire Dressing	480 kg - 216 kg

MYERS Ready-to-Use Black Tire Stain Solvent Base

Permanent black dye to convert whitewalls to blackwalls. Will not scuff off. Apply with a brush, ready-to-use. Covers completely. Flash point 40°.



Order No.	Size	Description	Ship Wt.
46410	1-Gallon	Black Tire Stain	10 lbs. - 5 kg
46411	5-Gallon	Black Tire Stain	45 lbs. - 21 kg
46412	50-Gallon	Black Tire Stain	495 lbs. - 223 kg

Economy Tire Paint Sprayer

- Sprays water or solvent base paints

Designed for fast and easy spraying anywhere in the plant. Tank holds 2½ gallons of paint: solvent or water based. Includes pressure regulator, air and paint hoses, spray gun, and paint tank rated for 80 psi.



Order No.	Mfr. No.	Description	Ship Wt.
56090	TP-3	Myers Tire Painter	20 lbs. - 9 kg
56091		Replacement Gun	3 lbs. - 2 kg

Gloves



45333



46420

See page 244

RILLFIT VI-R Regrooving Tool

- The professionals choice for fast, controlled tire grooving



Parts list on 332

Designed for operating comfort and maximum grooving maneuverability. The Micro-Switch controlled cutting heads need only a slight amount of pressure to activate the heating element. Features an adjustable 4 step transformer corresponding to blade resistance value.

Order No.	Description	Ship Wt.
93233	Rillfit VI-R Regroover, 110V	11 lbs. - 5 kg
93234	Rillfit VI-R Regroover, 220V	11 lbs. - 5 kg

Round Blades				
Order No.	Mfr. Code	Cutting Width Inches	mm	Blades Per Pk.
93211	R-1	5/64"	2	20
93212	R-2	1/8"	3	20
93213	R-3	13/64"	5	20
93214	R-4	9/32"	7	20
93215	R-5	23/64"	9	20

Flat Blades				
Order No.	Mfr. Code	Cutting Width Inches	mm	Blades Per Pk.
93216	W-1	5/64"	2	20
93217	W-2	5/32"	4	20
93218	W-3	1/4"	6	20
93219	W-4	5/16"	8	20
93220	W-5	13/32"	10	20
93221	W-6	7/8"	22	20

IDEAL Tire Regroovers



Ideal Regroovers heat the rubber ahead of cutting blade. Blade is adjustable for depth. Includes No. TG-4 Head and 12 No. TG-4B Blades. Specify 110 or 220V, and 150 or 250 watt element.

Order No.	Mfr. No.	Description	Watt Element	Ship Wt.
42887	TG-115D	Straight Handle 110V	250	2 lbs. - 1 kg
42835	TG-125D	Pistol Grip 110V	250	2 lbs. - 1 kg
42878	TG-125D	Pistol Grip 220V	250	2 lbs. - 1 kg

Ideal Regroover Blades

Standard Round End				
Order No.	Mfr. No.	Grove In.	Blades Per Pkg.	
42859	TG-2B	3/32"	12	
42860	TG-3B	5/32"	12	
42861	TG-4B	7/32"	12	
42862	TG-5B	9/32"	12	

Large Square End				
Order No.	Mfr. No.	Grove In.	Blades Per Pkg.	
42863	TG-6B	3/8"	12	
42864	TG-8B	1/2"	12	
42865	TG-10B	5/8"	12	
42866	TG-12B	3/4"	12	

Standard Square End				
Order No.	Mfr. No.	Grove In.	Blades Per Pkg.	
42870	TG-3BS	5/32"	12	
42871	TG-4BS	7/32"	12	
42872	TG-5BS	9/32"	12	

Super Round End Blades				
Order No.	Mfr. No.	Grove In.	Blades Per Pkg.	
42880	TG-3BB	5/32"	12	
42881	TG-4BB	7/32"	12	
42882	TG-5BB	9/32"	12	

Super Square End Blades				
Order No.	Mfr. No.	Grove In.	Blades Per Pkg.	
42883	TG-6BB	3/8"	12	

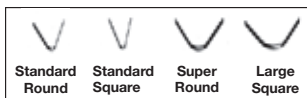

Ideal Groover Heads

Separate head required for each blade size.

Order No.	Mfr. No.	Grove In.
42842	TG-1H Head	1/16"
42843	TG-2H Head	3/32"
42844	TG-3H Head	5/32"
42845	TG-4H Head	7/32"
42846	TG-5H Head	9/32"
42847	TG-6H Head	3/8"
42848	TG-8H Head	1/2"
42849	TG-10H Head	5/8"
42850	TG-12H Head	3/4"

Groover Blades Sharpening File		
Order No.	Mfr. No.	Description
42898	TG-5	Small Round File
42899	TG-5A	Small Half Round File

MYERS G1000HL Regroover



- Made in the U.S.A
- Premium heavy-duty grooving blades



Designed for operating comfort and maximum grooving maneuverability. Features a stainless steel case and four power heat settings. A teflon guide block assures a smooth cutting action. Blades are changed quickly and easily. The "thicker" blade design is tapered for a wide top where strength is needed and a thinner bottom reducing cutting drag. Includes regroover and (2) each #4GF, #6GF, #8GF, and #10GF blades.

Order No.	Description	Ship Wt.
93230	Myers G1000 Regroover 110V	11 5
93232	Myers G1000 Regroover, 220V	11 5

Round Bottom Blades				
Order No.	Mfr. Code	Cutting Width Inches	Depth	Blades Per Pk.
48444	8 GR	1/4"	7/16"	12
48445	10 GR	5/16"	7/16"	12

Flat Bottom Blades				
Order No.	Mfr. Code	Cutting Width Inches	Depth	Blades Per Pk.
48438	4 GF	1/8"	7/16"	12
48439	6 GF	3/16"	7/16"	12
48440	8 GF	1/4"	7/16"	12
48441	10 GF	5/16"	7/16"	12
48442	12 GF	3/8"	7/16"	12
48443	14 GF	7/16"	7/16"	12
48515	16 GF	1/2"	7/16"	12

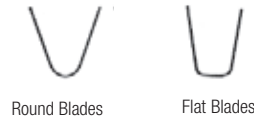

Note: Other blade sizes available up to 32/32" wide.

K-Z Regroover

- Universal cutting head
- Push-Type with fully automatic blade cutting
- 3-Step heat control



Blade holder is adjustable in 7 steps from 3/32" to 13/16" (2-28mm). The new method of blade insertion guarantees positive electrical contact and heat transfer. Air gap insulation between the two cutting head halves eliminates short circuits. Reinforced transformer has 3 heat control settings. Unbreakable plastic housing is fully insulated to meet regulations of the International Electro-Technical Commission.

Order No.	Mfr. No.	Description	Ship Wt.
42802	KZ-6	110V Regroover	5 lbs. - 2 kg
42686	KZ-6	220V Regroover	11 lbs. - 5 kg

For Passenger and Truck Tires V-Shaped Cutting Blades

Order No.	Mfr. No.	Cutting Width In.	Cutting Depth Up to In.	Blades Per Pk.
42825	KZ-101	3/32"-3/16"	5/16"	20
42826	KZ-102	3/16"-9/32"	5/16"	20
42827	KZ-103	9/32"-5/16"	7/16"	20
42828	KZ-104	5/16"-7/16"	9/16"	20
42829	KZ-105	7/16"-9/16"	5/8"	20
42837	KZ-106	5/8"-11/16"	5/8"	20

For Grader and EM Tires

42824	KZ-110	1 1/16"-13/16"	5/8"	20
-------	--------	----------------	------	----

Caution: Genuine KZ Blades must be used with the KZ Regroover

Tire Branders

ELRICK #32A Brander with 1" Numbering Disc



- Single slot for 1" letters



Support Handle gives more positive control, reduces fatigue and errors.



45699
45741

Slot holds three 1" replaceable numbers and letters.



Dial-The-Number Indicator shows number being branded.



45601

Parts list on page 330

Specially designed 1000W heating element reaches branding temperature faster (approx. 10 min.) and holds temperature. Hardwood handle. Special high heat conducting alloy number head and letter inserts for longer branding usage. Separate replaceable heating element, no need to replace number disc with element as with other branders. Built-in stand allows user to set hot tool almost anywhere. Both models feature a 1" numbering disc. The Branders include a 10' extension cord and a short handle for easier branding. Available in 110 and 240 volt. Specify voltage.

NOTE: Single Slot Brander holds up to three 1" characters.

Order No.	Mfr. No.	Description	Ship Wt.
45699	32A	Single Slot Brander 110V	11 lbs. - 5 kg
45741	32A	Single Slot Brander 240V	11 lbs. - 5 kg
45601		Timer	11 lbs. - 5 kg

ELRICK Stop Spacers & Blank Spaces



If the maximum allowed characters for the brander head are not used, a blank space "character" or stop spacer is needed to hold the characters in place.



Order No.	Description
45691	Stop Spacer for ¼" & ½" Brander Head
45664	Stop Spacer for 1" Brander Head
45712BLNK	¼" Blank Space
45717BLNK	½" Blank Space
45701BLNK	1" Blank Space for #32 Brander Only

ELRICK #16E Brander for ½", ¼" & ¾" Characters



Parts list on page 331

Built-in stand allows hot tool to be set almost anywhere. Brander head features a "T" slot for inserting up to (14) ¼", (12) ¾" or (7) ½" characters. Set screws in the head hold the maximum amount of characters without using a stop spacer. Characters can be inserted in a hot tool using pliers. Letters and numbers sold separately. 15" Long from head to start of cord. Replaceable heating element. Includes 12" cord. Available in 110V or 220 v.

Order No.	Mfr. No.	Description	Ship Wt.
45840	16E	Brander 110V	6 lbs. - 3 kg
45841	16E	Brander 220V	6 lbs. - 3 kg
45601		Timer	2 lbs. - 1 kg

Recommended for use with a 16 gauge extension cord

ELRICK Letter & Number Sets for Tire Branders



Actual Size ¼" ⅜" ½" 1"

Order No.	Letter Size	Description	Ship Wt.
45737	¼"	A Thru Z Set	2 lbs. - 1 kg
45726	⅜"	A Thru Z Set	2 lbs. - 1 kg
45735	½"	A Thru Z Set	2 lbs. - 1 kg
45733	1"	A Thru Z Set	3 lbs. - 2 kg
45731	¼"	0 Thru 9 Set	1 lbs. - 1 kg
45729	½"	0 Thru 9 Set	1 lbs. - 1 kg
45727	1"	0 Thru 9 Set	2 lbs. - 1 kg

Individual Letters & Numbers (Specify Each A-Z or 0-9) Example: 45712A

45712	¼"	A-Z, 0-9 (Specify)
45705	⅜"	A-Z, 0-9 (Specify)
45717	½"	A-Z, 0-9 (Specify)
45701	1"	A-Z, 0-9 (Specify)

ELRICK Custom Plates



- For all #16 & #32 branders



45747 Sample

Custom-made plate of your company trademark available for insert slot. Send design and sketch for quotation.

Order No.	Description
45740	½" Custom Branding Insert
45747	1" Custom Branding Insert for #32 Brander Only

MYERS REPAIR SERVICE AVAILABLE ON ALL BRANDERS

ELRICK #20 Brander Body for Interchangeable Plates

- ¼", 3/8" & ½", or 1" brander in one unit
- Custom brand or logo plates available
- Interchangeable plates sold separately below



Parts list on page 332

The #20 Brander body allows the use of ¼", 3/8" and ½" characters or 1" characters by attaching the desired plate to the brander body with 4 set screws. Order the ¼" and ½" or the 1" plates as required. 4 Set screws included for attaching the plates. Built-in stand allows hot tool to be set almost anywhere. 19" Long from head to start of cord. Includes 12" cord. Available in 110V or 220V.

Order No.	Mfr. No.	Description	Ship Wt.
45787	20	Brander 110V	7 lbs. - 3 kg
45788	20	Brander 220V	7 lbs. - 3 kg
45601		Optional Timer	

Recommended for use with a 16 gauge extension cord.

ELRICK Interchangeable 2" x 4-1/4" Plates for #20 Brander

- ¼", 3/8" & ½" Double slot, or 1" single slot brander plate
- Custom brand or logo plates available
- Includes screws for fastening to #20 brander



45789 Double Slot Holder for ¼", 3/8" or ½" Characters



45790 Single Slot Holder for 1" Characters



Example of 45791 Custom Character Plate



Example of 45792 Custom Design Logo Plate

45789 Double slot plate accommodates any combination of ¼", 3/8" or ½" characters. The plate holds up to 32, ¼" characters, 16 characters per row; 34, 3/8" characters, 17 characters per row and up to 18, ½" characters, 9 characters per row.*

45790 Single slot plate holds any combination of 1" characters, up to 7 characters total.*

45791 Custom Character Plate is permanently engraved plate with any combination of characters. Attaches to #20 brander with set-screws.

45792 Custom Design Plate is a permanently engraved plate of your company logo, trademark, or symbol. Attaches to #20 brander with set-screws.

* **NOTE:** When using less than the maximum number of characters a stop spacer must be used. See page 326 for complete listing of stop spacers.

Order No.	Description
45789	Double Slot Holder for ¼", 3/8" & ½" Characters
45790	Single Slot Holder for 1" Characters
45791	Custom Character Plate (Letters or Numbers)
45792	Custom Design Plate (Logo)

ATEC Insta/Spect-I Inspection/Painting Station



Use for repair, initial or final inspection. Two 4" lifting cylinders raise a 300 lb. tire at 125 psi. A separate 4" cylinder spreads tire beads. Options include an attached Tire Paint/Finishing machine and an airless pump with automatic spray guns. Automatically adjusts from 26" to 46" diameter x 20" cross section. Diameters can be modified for larger or smaller sizes. 4 HP air motor. Requires 125 psi, 1/2" air inlet.

Order No.	Description	Ship Wt.
45226	Model 11S Insta/Spect-1 with Light Package	750 lbs. - 338 kg

Sealing Ring Installation Stand

- Must specify monorail height when ordering



Sealing ring installation station is installed under the monorail. Raises to lift tire off the "J" hook and allows for the installation of sealing rings. **Note:** Specify monorail height before ordering.

Order No.	Description	Ship Wt.
36596	Sealing Ring Installation Stand	250 lbs. - 113 kg

Traveling Cable Lift Cylinder

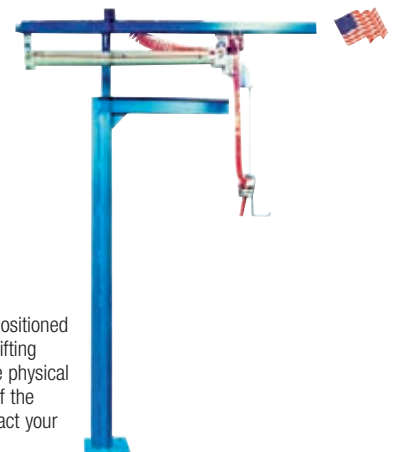

Complete with Support and Track: Positioned over buffers and builders, used for lifting tires on and off expanding rims. The physical effort of lifting heavy tires on and off the builder or buffer is eliminated. Contact your Myers Sales Rep for details.

Order No.	Description	Ship Wt.
36594	Traveling Cable Lift Cylinder, Includes Base, Post, Track with Wheels for 7" High Monorail	300 lbs. - 115 kg

Monorail Components

Monorail Track & Support

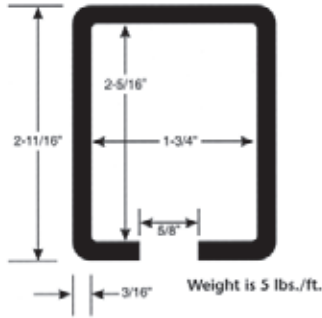

Track sold in 10' sections and configurations. Removable monorail section (36589) moves tires inside the curing chamber allowing the door to close.

Order No.	Description	Ship Wt.
36584	10' Straight Track	50 lbs. - 23 kg
36587	Track 45° Curve x 24" Radius with 8" Extension	35 lbs. - 16 kg
36586	Track 90° Curve x 24" Radius with 8" Extensions	35 lbs. - 16 kg
36589	Removable Chamber Door Monorail Lift Out Section	35 lbs. - 16 kg

Monorail Track Supports		
Order No.	Description	Ship Wt.
36581	Single Standard Monorail Support	125 lbs. - 57 kg
36580	Double Monorail Support	180 lbs. - 81 kg
36579	Triple Monorail Support	250 lbs. - 113 kg
36582	90° Corner Monorail Support	170 lbs. - 77 kg

"J" Hooks

This is an accessory to the monorail track. Made from 1" round bar stock this "J" hook fits better than older flat bar "J" hooks, making it more comfortable to handle and easier on beads of tires and envelopes. "J" hooks and trolley assemblies sold separately. Wide base "J" hook handles wide base tires easier.

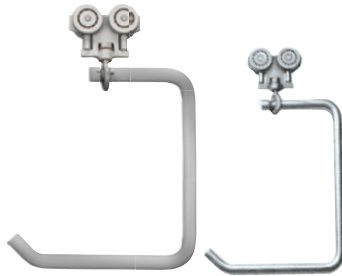

Order No.	Description	Ship Wt.
36571	Four Wheel Trolley Assembly Only with Eye Bolt	10 lbs. - 5 kg
36572	Two Wheel Trolley Assembly 3/8"-11 Thread Stud	7 lbs. - 3 kg
36590	"J" Hook Only - No Trolley Assembly 9" Hanging Area	7 lbs. - 3 kg
36600	Wide Base "J" Hook Only - No Trolley Assembly 16" Hanging Area	8 lbs. - 4 kg

3-Way Monorail "T" Switch



Allows the tire to be directed within the monorail system.

Order No.	Description	Ship Wt.
36575	3-Way Monorail Switch	50 lbs. - 23 kg

Tilt Table



Sealing Ring and Inside Envelope installation station installed under a monorail. Tire is lowered from the "J" hook on to the table where a sealing ring or inside envelope is installed on one side of the tire. Flip tire to the other side for the other sealing ring or tucking flap of the inside envelope under the outside envelope.

Order No.	Description	Ship Wt.
36595	Tilt Table	350 lbs. - 158 kg

Precure Vacuum Envelope Tester

Test duplicates the stress on envelopes during curing. Attach the coupler and an electric vacuum pump removes the air from under the envelope. A green light shows the envelope seal is good when the test is complete. 110v.



Order No.	Description	Ship Wt.
36597	Envelope Tester	85 lbs. - 31 kg

Steam Ball Valves



150 psi saturated steam on/off service. All wetted metallic components brass to resist corrosion. Solid Teflon seats and glass-filled Teflon stem seals. Chromium plated brass ball.

Order No.	Mfr. No.	Description	I.P.T. Size	Ship Wt.
44711	70-101	Steam Ball Valve	1/4"	1 lbs. - 1 kg
44713	70-102	Steam Ball Valve	3/8"	1 lbs. - 1 kg
44712	70-103	Steam Ball Valve	1/2"	1 lbs. - 1 kg
44714	70-104	Steam Ball Valve	3/4"	1 lbs. - 1 kg
44715	70-105	Steam Ball Valve	1"	2 lbs. - 1 kg
44716	70-106	Steam Ball Valve	1 1/4"	3 lbs. - 1 kg
44717	70-107	Steam Ball Valve	1 1/2"	4 lbs. - 2 kg
44718	70-108	Steam Ball Valve	2"	5 lbs. - 2 kg

SARCO Thermodynamic Steam Traps

- 10-600 PSI



3 Stainless steel parts-only one moving part. Self-adjusting trap for 10-600 psi for all loads without adjustment. Freeze-proof when installed with outlet down, free to drain.

Order No.	Mfr. No.	Description	Size
44590	AS-891	Steam Trap	3/8"
44591	AS-892	Steam Trap	1/2"
44592	AS-893	Steam Trap	3/4"

Replacement Slotted Discs

44587	56631	3/8"
44588	57443	1/2"
44589	56632	3/4"

Y-Strainers

Cast iron construction and designed for working pressure 250 lbs. psi at max. temp. 450° F.



Order No.	Mfr. No.	I.P.T. Size	Ship Wt.
44579	AS-YA	1/2"	1 lbs. - 1 kg
44580	AS-AT	3/8"	1 lbs. - 1 kg
44581	AS-YB	3/4"	2 lbs. - 1 kg

Check Valve

A perfectly sealed, leakproof, virtually maintenance free valve. Quick opening-positive closing-opens at 1 psi "bubble tight" against back pressure. Brass with 1/4" male connections. 0-250 psi



Order No.	Mfr. No.	Description
44616	2232B-2MM	Check Valve

ARMSTRONG Steam Traps

Side inlet steam traps. Series 800 and 880 max. psi 80 lbs. Series 881 max. psi 125 lbs. For draining low and medium pressure, Series 880 has a built-in strainer. (Specify pipe size.)



Order No.	Mfr. No.	Orifice	FTP In.	Ship Wt.
44593	AS-880	1/8"	1/2" or 3/4"	6 lbs. - 3 kg
44595	AS-800	1/8"	1/2" or 3/4"	5 lbs. - 2 kg
44594	AS-881	1/8"	1/2" or 3/4"	6 lbs. - 3 kg

Repair Kit and Replacement Parts

Order No.	Mfr. No.	Description
44635	PCA-881	Repair Kit
44578	A1433	Body Gasket

Steam Reducing Valves

For supply pressure up to 140 lbs., reduced pressure adjustable for 30-140 lbs. Set at 75 lbs. Other ranges available on special order. Female inlet and outlet.



Order No.	Mfr. No.	I.P.T. Size	Ship Wt.
44697	AS-152A	1/2"	6 lbs. - 3 kg
44698	AS-152B	3/4"	12 lbs. - 5 kg
44699	AS152C	1"	19 lbs. - 9 kg

*30-100 Set at 50

Repair Kits for Above Steam Reducing Valves

Includes diaphragm gasket, strainer, bottom plug gasket, stem disc and bushing assembly and diaphragm (set of 3).

Order No.	Mfr. No.	I.P.T. Size	Ship Wt.
44702	152A-RK	1/2"	1 lbs. - 1 kg
44704	152A-RK	3/4"	1 lbs. - 1 kg
44706	152A-RK	1" x 1 1/4"	2 lbs. - 1 kg
44708	152A-RK	1 1/2"	2 lbs. - 1 kg

Boiler Water Treatment

For calcium or magnesium carbonate hardness up to 5 grains per gallon; for excess oxygen and corrosion control. Do not use with food products.



Order No.	Mfr. No.	Description	Ship Wt.
44628	PB677	4-Gallon.	5 lbs. + 2 kg

PARKER Boilers

- 1-1/2 To 150 HP boilers available
- Return systems & blowdown tanks sized to your requirements
- Contact your local Myers Sales Office

Compact design and quality construction assures reliable, long life service in less space per hp than conventional designs with comparative heating surfaces. Easily accessible internal boiler drum, tubes and burners. Individual reversible tube sections. Less than 10 minutes required to generate 80 lbs. of steam from a cold start. Virtually explosion-free double welded boiler construction. Fully automatic controls. Low installation cost, economical operation, inexpensive to maintain, and easy to clean.



COMPAIR L-Series Lubricating Rotary Screw Air Compressors

- 30 to 150 HP models available
- 100, 125 & 190 Working psi available
- 195 CFM to 729 CFM available depending on hp & psi configuration
- Contact your local Myers sales office



Siphon for Steam Gauge

Straight pattern, 1/4" pipe, 4 3/8" long. Wrought steel for 475 lbs., 750° F.



Order No.	Mfr. No.	Description
44732	AS-S1	Siphon

Slic-Tite Pipe Thread Tape

High-density 1/2" x 300" roll



Order No.	Description
46157	Pipe Thread Tape

Parts Breakdown

ELRICK #16 & #16B Brander

- ½" Brander manufactured before Jan. 2005

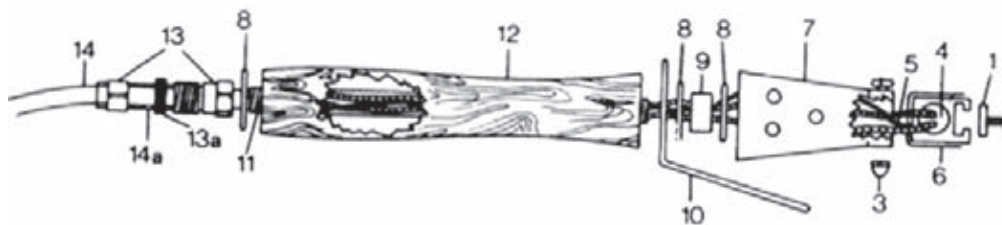

Picture No.	Order No.	Description	Qty. Req.
1	45691	Stop Spacer	2
4a	45695	120V Heating Element	1
4b	45667	220V Heating Element	1

Picture No.	Order No.	Description	Qty. Req.
6	45620	Insulator Gasket	1
8	45624	½" Washer	1
9	45626	Bushing	1
11	45628	Threaded Pipe	1
12	45694	Handle Grip	1

Picture No.	Order No.	Description	Qty. Req.
13	45630	Clamping Nut	1
14	45696	14" Cord	1
14a	45629	Nut	1

ELRICK #16C Brander

- ½" Brander manufactured after Jan. 2005

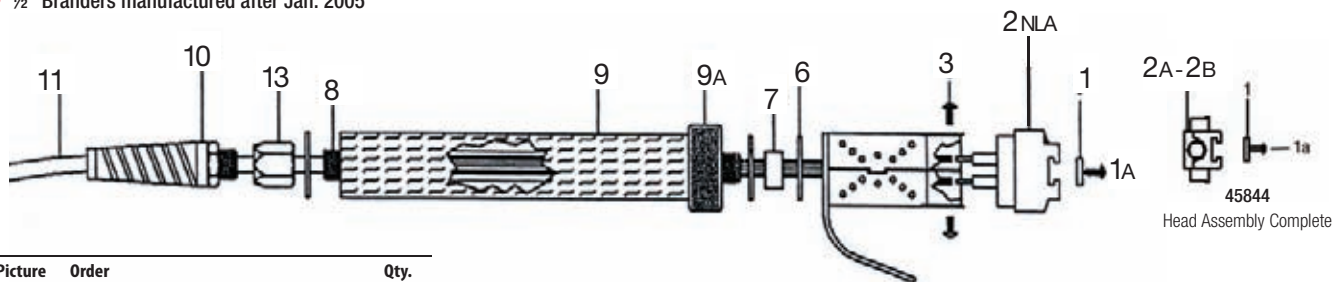

Picture No.	Order No.	Description	Qty. Req.
1	45793	Stop Spacer w/ Screw	2
1A	45794	Stop Screw Only	1
2A	45844	110V Head Assembly Complete (Incl. 2A, 2B, 2C, 2D & 3)	1
2B	45833	220V Head Assembly Complete (Incl. 2A, 2B, 2C, 2D & 3)	1
3	45796	Head Screws	

Picture No.	Order No.	Description	Qty. Req.
6	45797	1 ½" Washer	1
7	45798	Bushing	1
8	45799	Threaded Pipe	1
9	45800	Handle Grip	1
9A	45801	Handle Guard	1

Picture No.	Order No.	Description	Qty. Req.
10	45802	Strain Relief Assembly	1
11	45803	Electric Cord Assembly	1
13	45804	Coupling Nut	1

ELRICK #32A 1" Brander

- See page 326 for product details

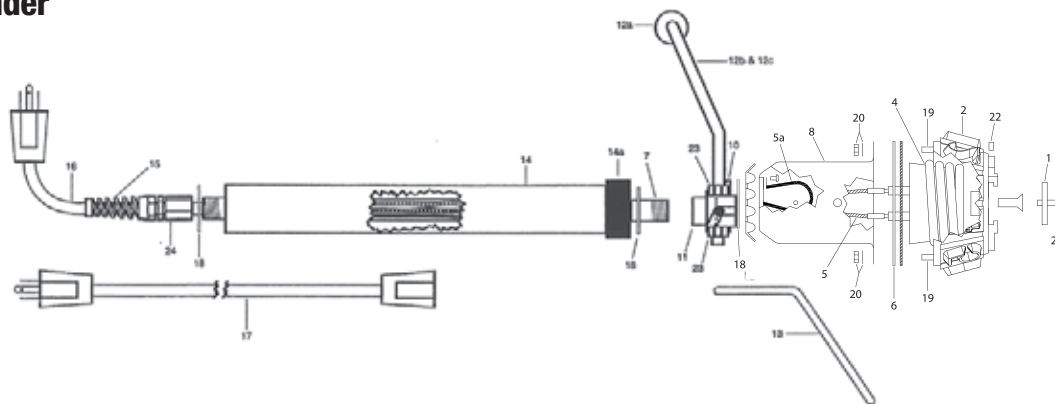

Picture No.	Order No.	Description	Qty. Req.
1	45664	Stop Spacer	1
2	45613	Branding Head (Incl Gasket & Nuts)	1
4A	45617	110V Heater Repl. Kit (Incl. Heater, Gasket, Nuts & Instructions*)	1
4B	45614	220V Heater Repl. Kit (Incl. Heater, Gasket, Nuts & Instructions*)	1
6	45623	Gasket	1
7	45625	Pipe	1
8	45675	Case Housing & Dial	1

Picture No.	Order No.	Description	Qty. Req.
10	45677	Indicator Bushing	1
11	45678	Inner Bushing	1
12	45679	Support Handle (Complete)	1
12a	45642	Wood Handle	1
12b	45644	Wire - Right	1
12c	45646	Wire - Left	1
13	45684	Wire Stand	1
14	45627	Wood Grip Handle	1
15	45629	Clamping Nut	1

Picture No.	Order No.	Description	Qty. Req.
16	45633	16" Cord	1
17	45637	10' Extension Cord	1
18	45688	1-½" Washer	1
19	45689	Head Stud	1
20	45639	Head Nut with Washer	1
21	45685	Screw/Stop Spacer	2
22	45640	Slot Screw	1
23	45654	Nut/Support Handle	2
24	45629	Coupling Nut	1

ELRICK #16D Brander

- ½" Brander manufactured after Jan. 2005

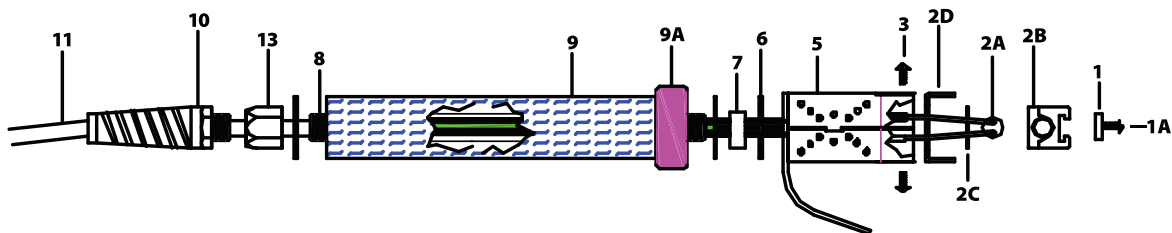

Picture No.	Order No.	Description	Qty. Req.
1	45793	Stop Spacer	2
1A	45794	Stop Screw	1
2	45844	110V Head Assembly Complete (Incl. 2A, 2B, 2C, 2D & 3)	1
2	45833	220V Head Assembly Complete (Incl. 2A, 2B, 2C, 2D & 3)	1
2A	45835	110V Heating Element	1
2A	45836	220V Heating Element	1
2B	45846	Branding Head Only	1

Picture No.	Order No.	Description	Qty. Req.
2C	45837	Head Gasket	1
2D	-	Head Bracket	1
3	45796	Head Screws	1
6	45797	1 ½" Washer	1
7	45798	Bushing	1
8	45799	Threaded Pipe	1

Picture No.	Order No.	Description	Qty. Req.
9	45800	Handle Grip	1
9A	45801	Handle Guard	1
10	45802	Strain Relief Assembly	1
11	45838	Electric Cord Assembly	1
13	45804	Coupling Nut	1

ELRICK #16E Brander

- See page 326 for product details

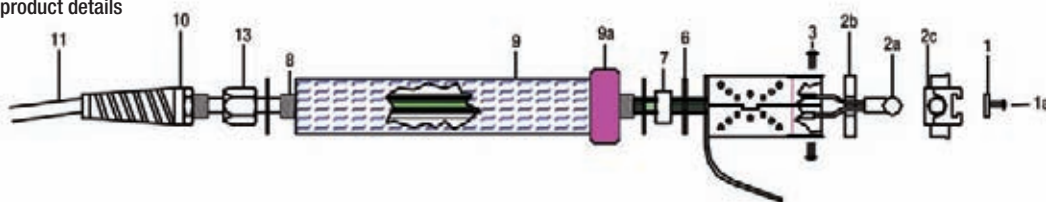

Picture No.	Order No.	Description	Qty. Req.
1	45793	Stop Spacer	2
1A	45794	Stop Screw	1
2	45844	110V Head Assembly Complete (Incl. 2A, 2B, 2C, 2D & 3)	1
2	45845	220V Head Assembly Complete (Incl. 2A, 2B, 2C, 2D & 3)	1
2A	45835	110V Heating Element	1
2A	45836	220V Heating Element	1

Picture No.	Order No.	Description	Qty. Req.
2B	45847	Deflector Guard	1
2B	45846	Branding Head Only	1
3	45796	Head Screws	1
6	45797	1 ½" Washer	1
7	45798	Bushing	1
8	45799	Threaded Pipe	1

Picture No.	Order No.	Description	Qty. Req.
9	45800	Handle Grip	1
9A	45801	Handle Guard	1
10	45802	Strain Relief Assembly	1
11	45838	Electric Cord Assembly	1
13	45804	Coupling Nut	1

ELRICK #32 1" Brander

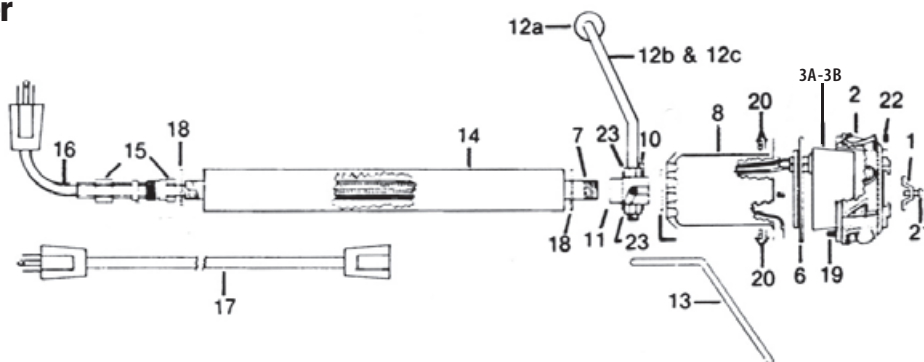

Picture No.	Order No.	Description	Qty. Req.
1	45664	Stop Spacer	1
2	45613	Branding Head (Incl. Gasket & Nuts)	1
3A	45617	110V Heater Repl. Kit (Incl. Heater, Gasket, Nuts & Instructions*)	1
3B	45614	220V Heater Repl. Kit	1
6	45623	Gasket	1
7	45625	Pipe	1
8	45675	Case Housing & Dial	1

Picture No.	Order No.	Description	Qty. Req.
10	45677	Indicator Bushing	1
11	45678	Inner Bushing	1
12	45679	Support Handle (Complete)	1
12a	45642	Wood Handle	1
12b	45644	Wire - Right	1
12c	45646	Wire - Left	1
13	45684	Wire Stand	1
14	45627	Wood Grip Handle	1
15	45629	Clamping Nut	1

Picture No.	Order No.	Description	Qty. Req.
16	45633	16" Cord	1
17	45637	10' Extension Cord	1
18	45688	1-½" Washer	1
19	45689	Head Stud	1
20	45639	Head Nut with Washer	1
21	45685	Screw/Stop Spacer	2
22	45640	Slot Screw	1
23	45654	Nut/Support Handle	1

Parts Breakdown

ELRICK #20 Brander

- See page 327 for product details

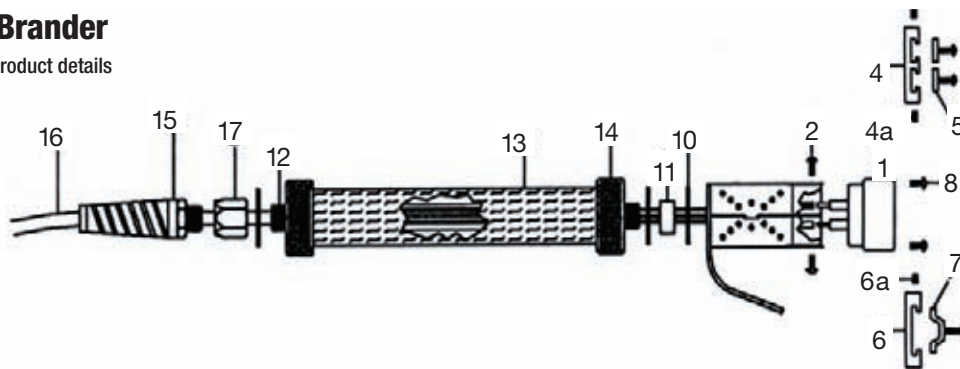

Picture No.	Order No.	Description	Qty. Req.
1A	45824	110V Element Head	1
1B	45806	2200V Element Head	1
2	45807	Head Fasteners	1
4	45789	Double Slot Plate	1
4A	45809	Double Slot Screw	1
5	45810	Double Slot Stop Spacers	2

Picture No.	Order No.	Description	Qty. Req.
6	45790	Single Slot Plate	1
6A	45812	Single Slot Screw	1
7	45813	Single Slot Stop Spacers	2
8	45814	Plate Fasteners	1
10	45815	½" Washer	1
11	45816	Bushing	1

Picture No.	Order No.	Description	Qty. Req.
12	45817	Threaded Pipe	1
13	45818	Handle Grip	1
14	45819	Handle Guard	1
15	45820	Strain Relief Assembly	1
16	45821	Electric Cord Assembly	1
17	45822	Coupling Nut	1

BRANICK EF & EF/HD Spreaders

- See page 298 for product details

For a complete list of parts, contact your local Myers Sales Professional.

Order No.	Mfr. No.	Description	Qty. Req.
70302	41.015	Piston Cup for EF Lift Cylinder	1
70342	41.295	Piston Cup for EF/HD Lift Cylinder	1
70338	190.014	Piston Cup for EF & EF/HD Diameter Arm Cylinder	1
70342	41.295	¾" ID Piston Cup for EF Spread Cylinder	1
70204	041.007	2" ID Piston Cup for EF Spread Cylinder	1
70338	190.014	Piston Cup For EF/HD Spread Cylinder	1
Call	190.003	#30 Air Valve 3-Way for Spread & Diameter Arm (Fast) Std.	2
Call	190.279	#48 Air Valve 3-Way for Tire Lift (Slow) Std.	1
Call	190.004	#60 Air Valve 3-Way for Tire Lift (Extra Slow) Older Models	1
70324	110.005	Spread Arm Spring for EF	2
70316	110.002	Spring for EF	2
70332	110.011	Bead Hook Spring for EF/HD	2



RILLFIT Regroover Models IV & VI

- See page 325 for product details

Order No.	Description	Rillfit IV	Rillfit VI	Qty. Req.
93222	Cable from Unit to Handle	X		1
93223	Electric Cord	X		1
93224	Clamping Jaws	X	X	Set
93225	Complete Blade Holder Assembly	X	X	1
93226	Allen Screws	X	X	2
93227	Allen Wrench	X	X	1
93228	Holding Blocks	X	X	2



For a complete list of parts, contact your local Myers Sales Professional.

MYERS Extruder Gun With IR Motor (14975 & 14976)

- See page 264 for product details
- All replacement parts require 1 each

Picture No	Order No.	Description
1*	52989	7803-A Air Drive Motor Only
1A**	49045	7803-A Air Drive Motor Less Chuck with Bushing
2	53140	Tool Cover
3	14987	Tang
4	14986	Square Joint
5	14996	Extruder Screw
6	14955	Clamp with Screw
7	14984	Handle
8	14954	Control Body
9	14953	Guard
10	14952	Head Cap
11	14960	Head Cap Screw
12	14983	Nozzle Adapter
13	14982	Shaped Nozzle

Picture No	Order No.	Description
14	14998	Heat Element 110 V.
15	14981	Heat Element 220 V.
16	14999	Thermostat
17	14974	Control Box
18	14959	Screw for Control Box
19	14958	Screw for Thermostat
20	14980	Knob
21	14964	Green Pilot Light
21A	14963	Red Pilot Light
22	14973	Fuse 4 Amp
23	14985	Fuse Holder/Locking
24	14988	¼" Lead Cord Fitting
25	14989	Cord & Plug
26	14844	Small ID Bushing-7803 Motor
26A	14843	Large ID Bushing-7803 Motor*

* For extruders purchased after June 2005 ** For extruders purchased before June 2005

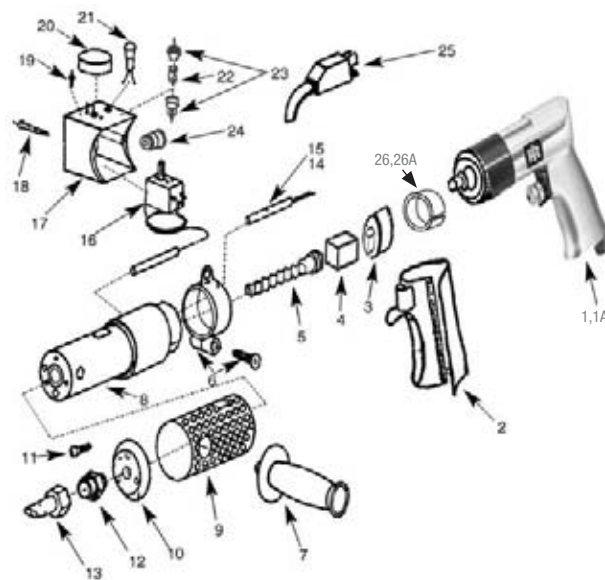

MYERS Nailhole Extruder Gun with IR Motor (14977 & 14978)

- See page 264 for product details
- All replacement parts require 1 each

Picture No	Order No.	Description
1	52989	Air Drive motor
2	53140	Tool Cover
3	14979	Extruder Screw
4	14972	Clamp with Screw
5	14971	Handle
6	14970	Control Body
7	14969	Nozzle Adapter
8	14968	Flat, 2mm, 3mm, 4mm, 5mm Dia. Nozzle Set
9	14967	Bottom Cover
10	14957	Grommets w/ screws
11	14998	Heat Element 110V
12	14981	Heat Element 220V

Picture No	Order No.	Description
13	14988	¼" Lead Cord Fitting
14	14966	Heater Body
15	14989	Cord & Plug
16	14965	Heat Box
17	14956	Screws For Heat Box
18	14964	Green Light
19	14980	Thermostat Knob
20	14963	Red Light
21	14962	On/Off Switch
22	14973	Glass Fuse 4 amp
23	14985	Fuse Holder/Locking Nut
24	14999	Thermostat
25	14961	Plastic Thermostat Ring

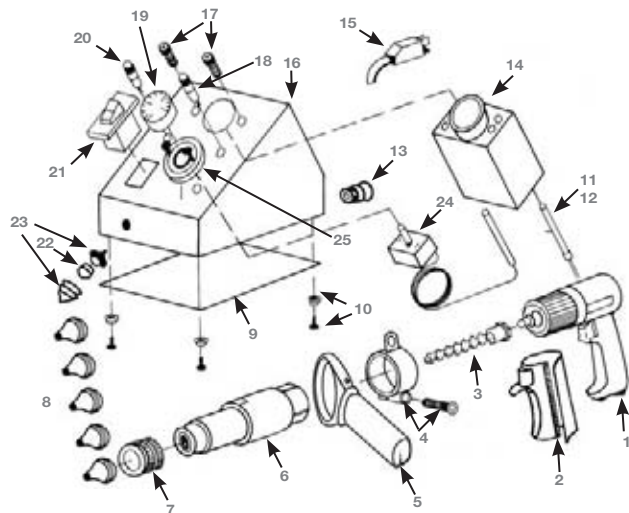

TRIPLEMATIC HSG-48 Extruder Gun

- See page 264 for product details
- All replacement parts require 1 each

Picture No	Mfr. No.	Description
7	6112005	Temp Control 120V
7	6112003	Temp Control 240V
25	0220011	Handle
27	6110080	Bushing 120V
27	6111080	Bushing 240V
28	6110045	Barrel
33	0320948	Cap
34	0410018	Nozzle

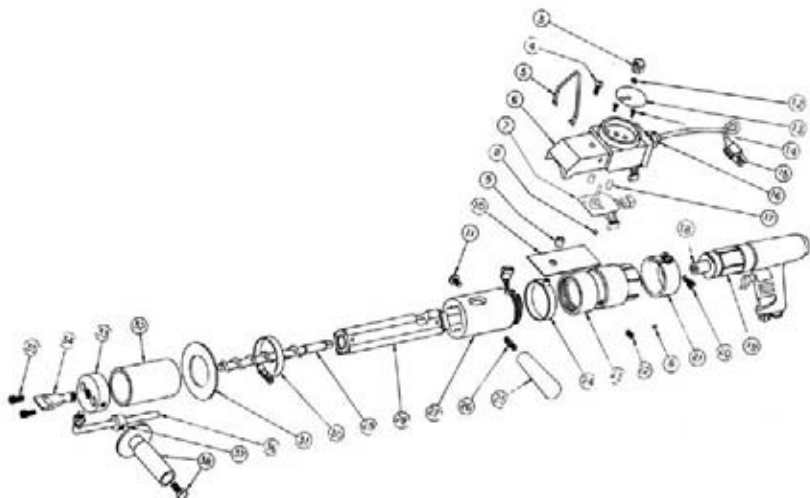

For a complete list of parts, contact your local Myers Sales Professional.

Parts Breakdown

Extruder Gun with Bosch Air Motor (15002)

- Note: Ingersoll-Rand Retro Kit available. Contact your local Myers Sales Professional
- See page 264 for product details

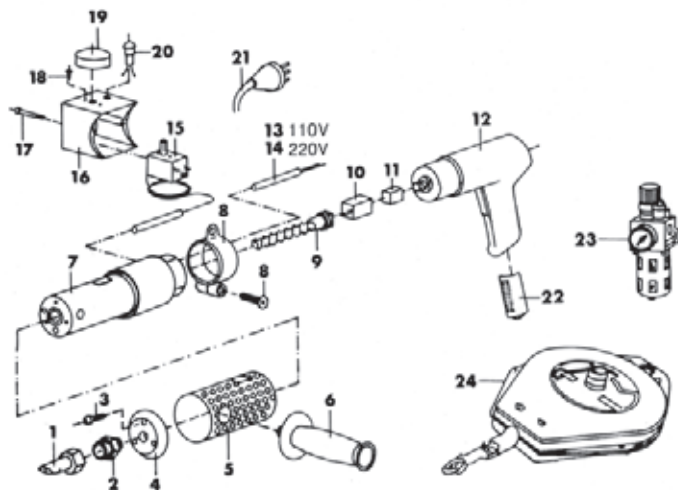

Picture No.	Order No.	Mfr. No.	Description	Qty. Req.
1	14847	68501	Shaped Nozzle	1
2	14846	68502	Nozzle Adapter	1
3	14960	68503	Screw/Head Cap	1
4	14944	68504	Head	1
5	14850	68505	Cooling Sleeve	1
6	14984	68506	Handle	1
7	14848	68507	Central Body	1
8	14849	68508	Clamp & Screw	1
9	14996	68509	Extruder Screw	1
10	14840	68510	Square Joint	1
11	14897	68511	Tang	1
12		68512	Bosch Drill	1
13	14950	68514	Heat Element 110V	1
14	14951	68513	Heat Element 220V	1
15	14999	68515	Thermostat	1
16	14873	68516	Control Box	1
17	14959	68517	Screw Control Box	1
18	14958	68518	Screw/Thermostat	1
19	14980	68519	Knob	1
20	14964	68520G	Green Pilot Light	1
20	14963	68520R	Red Pilot Light	1

Picture No.	Order No.	Mfr. No.	Description	Qty. Req.
22	14841	68522	Muffler	1
24	15004	68524	Retractable Reel	1
25		68525	Cord Fitting	1
27		68527	Terminal Block	1
29		68529	Front Bushing	1
30		68530	Back Bushing	1
N/A		68538	Clamp Screw	1
21	14989	685CA	Cord Assembly	1
N/A	14943		Retro-Fit Kit Converts Bosch to Ingersoll-Rand Air Motor	1

WINNER AS Spotter

- See page 292 for product details

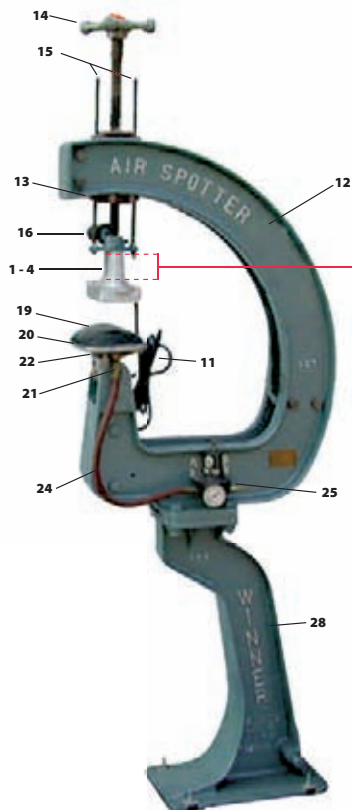

Note: Measure this distance
Either 2" or 4.5" to order
correct Part Number.
See numbers listed below.

Myers Part No.

36613 ASA115 Heater Assembly 2" - 115V
ASA230 Heater Assembly 2" - 230V

36611 ASA115/4.5 Heater Assembly 4-1/2" 115V
ASA230/4.5 Heater Assembly 4-1/2" 230V

Heater Assemblies & Heater Parts

Picture No.	Order No.	Mfr. No.	Description
1	36613	ASA115	Heater Assembly 2"-115V
2		ASA230	Heater Assembly 2"-230V
3	36611	ASA115 /4.5	Heater Assembly 4.5"-115V**
4		ASA230 /4.5	Heater Assembly 4.5"-230V**
N/A		AS13	Upper Housing Casting 2"
N/A		AS13/3.5	Upper Housing Casting 3.5"***
N/A		AS14	Lower Housing Casting
N/A	36612	ASB115	Element (Mica) 115V
N/A		ASB230	Element (Mica) 230V
N/A	36487	B200	Thermostat - 115 /230 V
11		CORD	Electrical Cord for Heater Assembly
12		ASX	Main "C" Frame
13		AS2	Swing Head Nut
14		AS4	Swing Head Pressure Screw
15		AS5	Swing Head Guide Rods (2-Req)
16		AS7	Heater Handle Assembly
N/A	36614	AS812	Heat Booster Pad 115V (5"x9"x1-1/2")
N/A		AS813	Transformer to Reduce 230V to 115V
19	36615	AS8	Air/Steam Bag (5"x9"x1-1/2")
20		AS18	Air Bag Backing Plate (Marked AS-4)
21		AS19	Brass Fitting Assembly
22		AS20	Backing Plate Hinge Pin
N/A		AS21	Backing Plate Locking Pin w/Chain
24		AS22	Air Line Hose Assembly
25		AS23	Air Regulator Assembly (Reg-Gauge-Bracket)
N/A		AS27	Quick Coupler 1/4"
28		AS29	Floor Stand - (AS-3)
N/A		AS31	Foot Pedal - (Marked AS-6)
N/A		AS33	Foot Pedal Double T-Rod - (2-Req.)
N/A		AS35	Foot Pedal T-Rod Bracket - (2-Req.)

LINCOLN 1400 Spotter

• See page 291 for product details

Order No.	Mfr. No.	Description
36413	T039	Upper Heat Unit, Swivel (110 Volt)
36415	T039	Upper Heat Unit, Swivel (220 Volt)
31623	T051	"Silicone Rubber Heat Pad (4" Dia.) with Elec. Conn (110 Volt)
36417	T062	Silicone Rubber Seal (4" Dia.)
	T065	Steel Air Cylinder w/Contoured Lip
LINT071	T071	Air Hose from Regulator to Cylinder
LINT115	T115	Hand-Wheel and Pressure Screw
LINT119	T119	Air Regulator (Preset to 60 P.S.I.)
LINT120	T120	Air Gauge for Regulator
36264	T121	Detachable Electrical Cord for T051
	T174	Nut for Part#T115
	T175	Compression Spring
LINT176	T176	Fiber Rod
	T183	Frame (w/Gusset)
	T184	Telescoping Pressure Screw

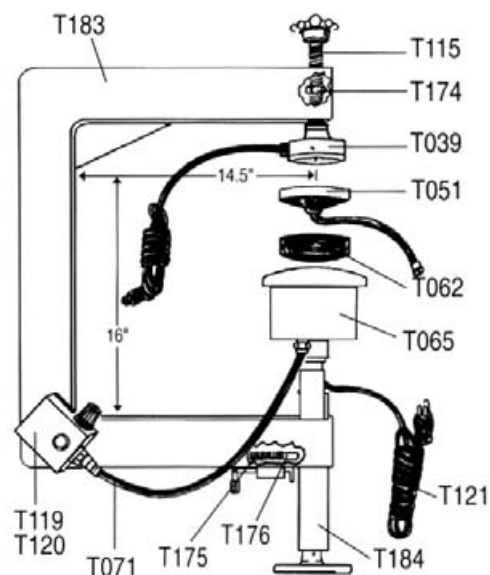

LINCOLN 2000 Spotter & Stand

Order No.	Mfr. No.	Description
31624	T057	Contoured Silicone Rubber Heat Pad (6"Dia.) w/Electrical Connection (110 Volt)
LINT057220	T057	Contoured Silicone Rubber Heat Pad (6"Dia.) w/Electrical Connection (220 Volt)
36263	T060	Solid Heat Units (110 Volt) (2 Req.)
LINT060220	T060	Solid Heat Units (220 Volt) (2 Req.)
36418	T063	6" Diameter Silicone Rubber Air Seal
LINT064	T064	Steel Air Cylinder w/Contoured Lip
36264	T121	Detachable Electrical Cord for T057
LINT192	T192	Detent pin
	T227	Plunger
LINT228	T228	Spring
	T229	Extension Shaft
	T239	Frame
	T240	Telescoping Assembly
	T277	Air Hose (with two fittings)
	T242	Stand Base Plate with Vertical Post
	T243	Roller Support Assembly (less rollers)
	T244	Rollers (2) 16" Long (2 Req.)
	T245	Front Legs (2 Req.)
	T246	Rear Leg with Tabs
	T247	Lower Vulcanizer Swivel Arm (with 1 nut & washer set)
	T248	Upper Vulcanizer Swivel Arm (with 1 nut & washer set)
	T249	Telescoping Vulcanizer Mounting Post
	T250	Vulcanizer Height-Adjusting Screw with Handle
	T251	Vulcanizer Mounting Bushings (2 Req.)
	T252	Locking Nut
	T253	Complete Assembly bolt & nut package (not shown)

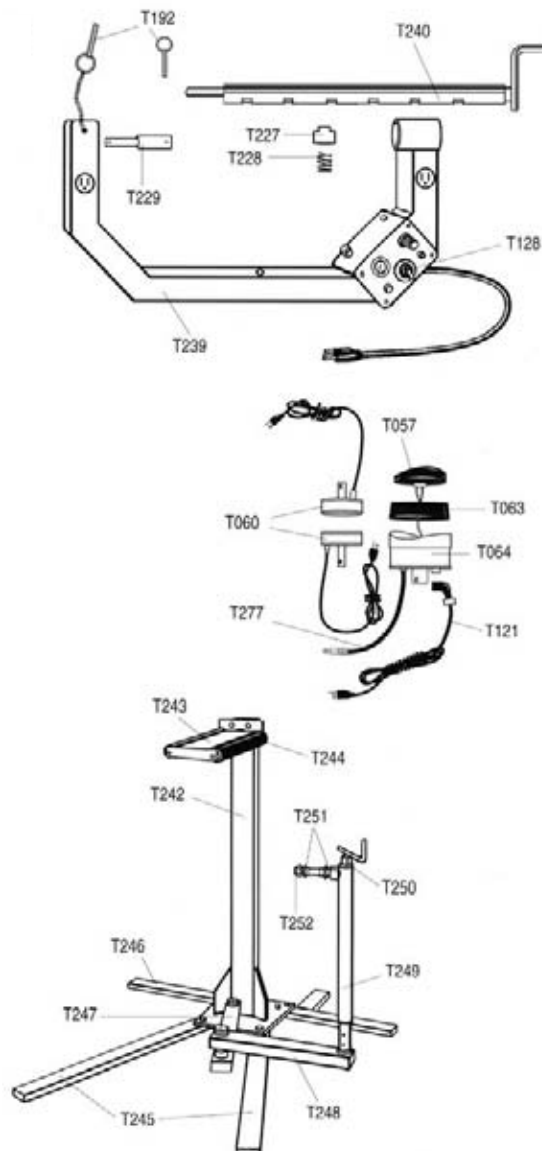

Parts Breakdown

HAWKINSON Medium Truck Probe Assembly

• See page 299 for product details

For a complete list of parts, contact your local Myers Sales Professional.

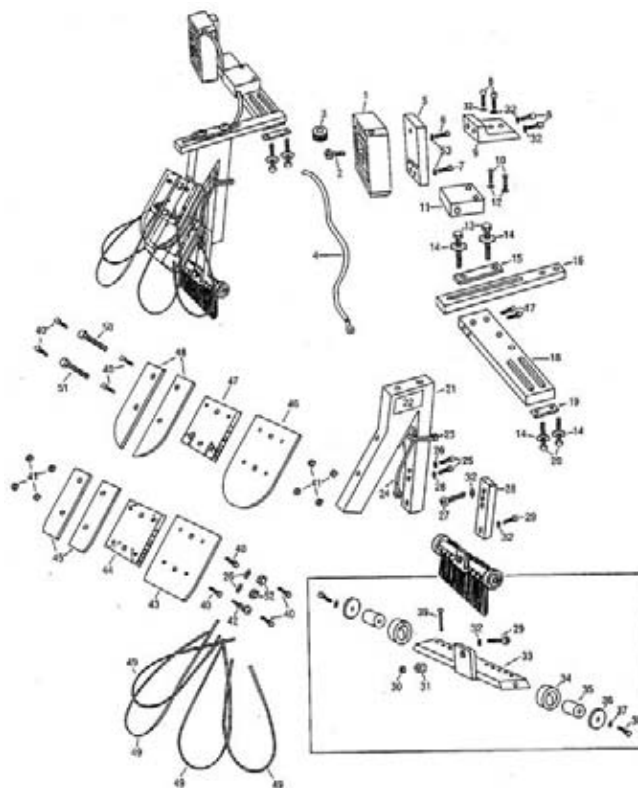

Picture No.	Order No.	Mfr. No.	Description
1	57600	H02-0024	HV SLAVE SQ.
2	57601	H50-0122	3/16 x 3/4 BHEAD
3	57602	H52-0024	3/16 WASHER
4	57647	H02-0058	PROBE WIRE
5	57603	H75-0004	HV SLAVE BACK
6	57604	H50-0086	10-32 x 3/4 BHEAD
7	57605	H50-0088	10-32 x 5/8 BHEAD
8	57606	H50-0071	1/4 x 3/4-28 SOCK
9	57607	H70-0080	ANGLE SUPPORT
10	57608	H50-0075	10-24 x 1 PHILH
11	57609	H11-0008	HV WIRE STANDOFF
12	57610	H51-0030	#10 INT LOCK WA
13	57611	H50-0100	3/8 x 1-1/2 BHEAD
14	57612	H52-0016	3/8 EXT LOCK WA
15	57613	H75-0002	3/8-DBL-WA-SGL
16	57614	H70-0083	BAR-SLOTTED-SGL
17	57615	H50-0037	1/4-28 x 2 SOCK
18	57616	H70-0081	BAR-SLOTTED-DBL
19	57617	H75-0001	3/8-DBL-WA-DBL
20	57618	H50-0104	3/8 x 1-3/4 BHEAD
21	57619	H11-0019	NDTII-K-HEAD
22	None	H80-0001	NDT - PROBE DECAL
23	57620	H53-0009	T5OROM4 TY-WRAP
24	57621	H02-0075	JUMPER WIRE #1
25	57622	H50-0045	1/4 x 1-1/2 SOCK
27	57623	H50-0056	1/4 x 1/2 PHILH
28	57624	H75-0011	K-HEAD BAR
29	57625	H50-0069	1/4X3/4 SHOLD
30	57626	H59-0010	10-24 HEX NUT
31	57627	H51-0010	10-24 FLEX L/N

Picture No.	Order No.	Mfr. No.	Description
32	57628	H51-0036	1/4 INT LOCK WA
33	57629	H03-0034	MED. TRK. CHAIN
34	57630	H20-0029	GEN-99R10 BEARING
35	57631	H20-0009	226935 1 BUSHING
36	57632	H51-0009	1/4 X 1 FENDER
37	57633	H52-0009	1/4 SPLIT LOCK
38	57634	H50-0040	1/4X1 BHEAD
39	54449	H40-0021	NDT-CHAIN
40	57635	H50-0085	10-32 CAP SCREW
41	57636	H51-0014	10-32 KEP NUT
42	57637	H50-0001	#10X3/4 SCREW
43	57638	H11-0026	INSP-PADDLE-MOD

Picture No.	Order No.	Mfr. No.	Description
44	57639	H75-0013	LOWER PADDLE
45	57640	H11-0009	INSP-1/2-PAD M
46	57641	H11-0010	INSP-PADDLE
47	57642	H75-0016	UPPER PADDLE
48	57643	H11-0027	INSP-1/2-PADDLE
49	54448	H42-0007	BT0B-19-WIRE
49-A	54444	None	H.D. Inserted BT0B-19-Wire
50	57644	H50-0051	1/4X1-3/4 HEX
51	57645	H50-0060	1/4X2 HEX HEAD BOLT
52	57646	H51-0029	1/4-20 HEX NUT

HAWKINSON NDTII Inspection Spreader

• See page 299 for product details

For a complete list of parts, contact your local Myers Sales Professional.

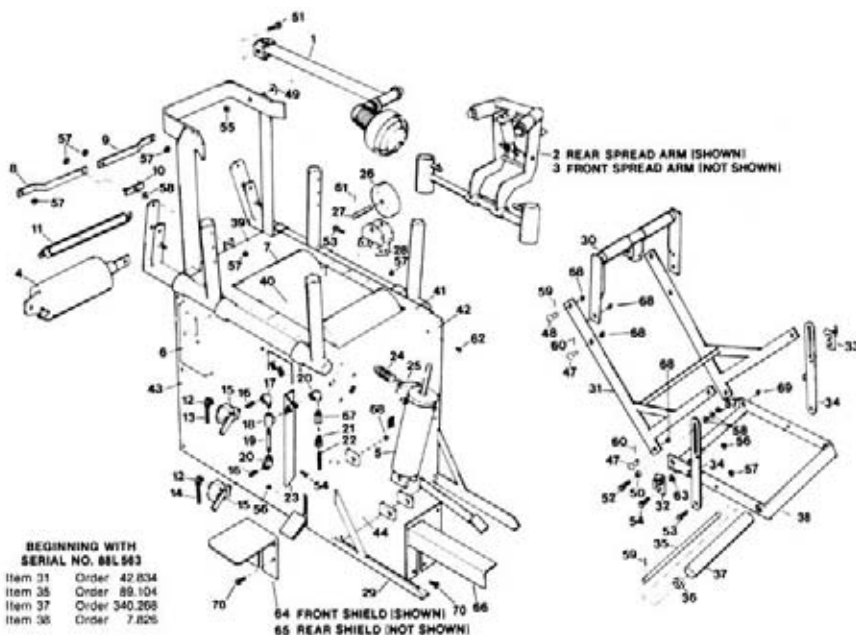

Picture No.	Order No.	Description	Qty. Req.
71	54455	Spread Rollers (Set of 4)	1
72	54456	Bead Rollers (Set of 2)	1

LINCOLN Vulcanizer Plates

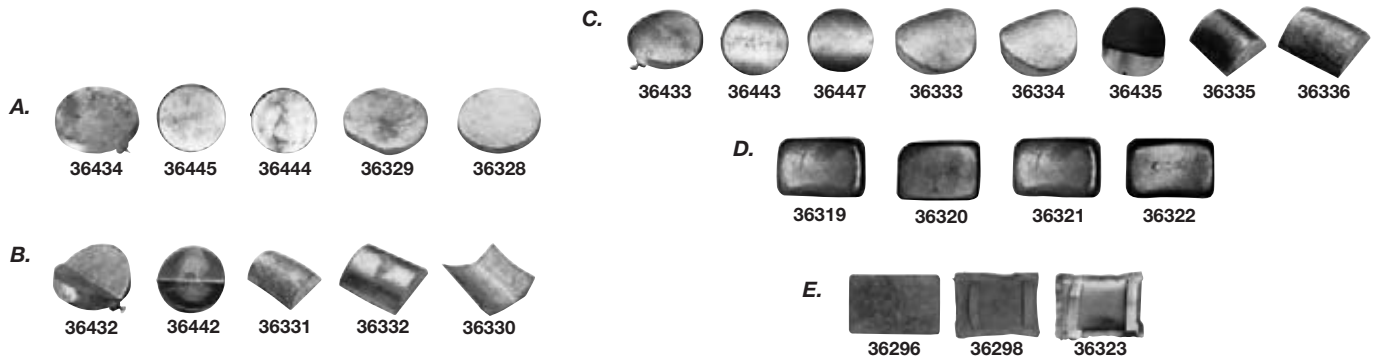

Vulcanizer Application

Vulcanizer	300	400	1000	1400	2000	LT	MT			
Plate Package	36273	36274	36276	36278	36280	36277	36279			
Order No	Ref. No.	Mfg. No.	Description	T149	T150	T152	T154	T156	T153	T155
A. Tread Area Truck Contour Plates										
36434	49	T080	4" Outside Tread Curing Plate	1	1	1	1		1	
36445	58A	T082	5" Inside Flat Radius Curing Plate		1	1	1			
36444	59	T085	5" Outside Tread Curing Plate		1	1				
36329	TPI	T130	Inside Tread Plate for All Tires					1		1
36328	TPO	T131	Outside Tread Plate for All Tires					1		1
B. Shoulder Area Truck Contour Plates										
36432	45	T078	4" Outside Shoulder Curing Plate	1	1	1	1		1	
36442	55	T081	5" Outside Shoulder Curing Plate		1	1	1			
36331	255SH	T132	Inside Shoulder Plate for 255 Low Profile					1		
36332	285SH	T133	Inside Shoulder Plate for 285 Low Profile					1		
36330	SHO	T134	Outside Shoulder Plate for All Tires					1		1
C. Sidewall Area Truck Contour Plates										
36433	48	T079	4" Inside Contour Curing Plate	1	1	1	1		1	
36443	58	T083	5" Inside Medium Radius Curing Plate		1	1	1			
36447	58S	T084	5" Inside Sharp Radius Curing Plate		1	1	1			
36333	68	T086	6" Inside Sidewall/Shoulder Plate For 11R					1		1
36334	68S	T087	6" Inside Sidewall/Shoulder Plate For Bias					1		1
36435	AS3-CP	T093	4" Cushioned Inside Plate						1	
36335	255SW	T135	Inside Sidewall Plate for 255 Low Profile					1		
36336	285SW	T136	Inside Sidewall Plate for 285 Low Profile					1		
D. Tractor Contour Plates										
36319	L1	T088	4" x 5 1/4" Left Outside Tractor Plate			1	1			
36320	L2	T089	4" x 5 1/4" Left Inside Tractor Plate			1				
36321	R1	T090	4" x 5 1/4" Right Outside Tractor Plate			1	1			
36322	R2	T091	4" x 5 1/4" Right Inside Tractor Plate			1				
E. Contour Bags										
36296	P1	T094	4 1/2" x 6 1/8" Flat Adapter Plate for B2 Bag			2	1			
36298	B2	T095	4" x 6" Pliable Contour Bag (Short Strap)			2	1			
36323	B3	T096	4" x 6" Pliable Contour Bag (Long Strap) for GT2B Spotter Only							

Index

Order	Page
00476.....	203
00617.....	203
00933.....	153
00934.....	153
01046.....	240
01048.....	240
01051.....	240
01201.....	91
01202.....	91
01203.....	91
01204.....	91
01205.....	91
01206.....	91
01207.....	91
01208.....	91
01287.....	85
01348.....	97
01349.....	97
01384.....	95
01400.....	98
01401.....	98
01402.....	98
01403.....	98
01404.....	98
01405.....	98
01406.....	98
01407.....	97
01407.....	98
01408.....	96
01434.....	95
01458.....	97
01459.....	96
01461.....	97
01462.....	97
01463.....	97
01468.....	92
01470.....	97
01472.....	97
01473.....	97
01474.....	88
01475.....	92
01476.....	92
01478.....	96
01479.....	92
01480.....	97
01482.....	97
01483.....	97
01485.....	92
01486.....	92
01488.....	92
01489.....	92
01491.....	92
01492.....	90
01492.....	90
01493.....	89
01494.....	88
01498.....	97
01499.....	97
01500.....	97
01501.....	97
01503.....	97
01504.....	97
01505.....	97
01506.....	97
01507.....	97
01508.....	97
01509.....	97
01510.....	97
01511.....	97
01512.....	97
01513.....	97
01540.....	97
01541.....	97
01547.....	97
01561.....	97
01562.....	98
01563.....	98
01564.....	98
01566.....	98
01567.....	98

01568.....	98
01569.....	98
01570.....	98
01571.....	98
01572.....	98
01573.....	98
01574.....	98
01575.....	98
01576.....	98
01577.....	98
01579.....	98
01580.....	98
01581.....	98
01582.....	98
01583.....	98
01584.....	98
01585.....	98
01586.....	98
01587.....	98
01588.....	98
01589.....	98
01590.....	98
01591.....	98
01592.....	98
01593.....	98
01601.....	95
01602.....	94
01603.....	95
01604.....	94
01606.....	86
01610.....	92
01654.....	95
01655.....	91
01660.....	91
01661.....	91
01662.....	91
01663.....	91
01664.....	91
01665.....	86
01667.....	86
01668.....	86
01670.....	86
01671.....	86
01672.....	86
01673.....	86
01674.....	86
01675.....	86
01676.....	90
01677.....	90
01678.....	90
01679.....	86
01680.....	86
0220011.....	333
02296.....	83
02301.....	83
02317.....	210
02318.....	210
02433.....	92
02435.....	92
02439.....	84
02440.....	84
02462.....	208
02470.....	208
02472.....	209
02473.....	209
02474.....	209
02475.....	209
02480.....	209
02482.....	209
02491.....	85
02496.....	97
02509.....	83
02512.....	83
02517.....	83
02519.....	83
02520.....	83
02521.....	83
02522.....	83
02523.....	83
02524.....	83

02526.....	83
02528.....	83
02542.....	92
02543.....	92
02544.....	92
02545.....	92
02546.....	92
02560.....	92
02562.....	91
02578.....	92
02579.....	92
02591.....	95
02596.....	83
02597.....	240
02598.....	240
02599.....	240
02600.....	83
02603.....	86
02604.....	83
02609.....	240
02610.....	240
02611.....	240
02612.....	240
02617.....	86
02618.....	86
02619.....	86
02620.....	86
02622.....	86
02623.....	86
02624.....	86
02625.....	86
02626.....	86
02627.....	86
02628.....	86
02629.....	86
02630.....	86
02631.....	86
02632.....	86
02633.....	83
02634.....	83
02635.....	83
02636.....	86
02637.....	86
02638.....	86
02649.....	86
02650.....	86
02651.....	86
02652.....	86
02653.....	86
02665.....	83
02667.....	83
02675.....	104
02676.....	104
02679.....	83
02680.....	90
02682.....	90
02683.....	90
02684.....	84
02686.....	84
02689.....	86
02692.....	90
02693.....	83
02694.....	99
02696.....	99
02697.....	99
02698.....	99
02699.....	99
02700.....	99
02701.....	99
02702.....	86
02703.....	90
02706.....	99
02707.....	99
02709.....	90
02710.....	90
02715.....	90
02716.....	85
02720.....	90
02721.....	90
02722.....	90

02727.....	90
02728.....	90
02729.....	90
02733.....	86
02734.....	86
02735.....	86
02736.....	86
02737.....	86
02738.....	86
02740.....	87
02741.....	86
02742.....	86
02743.....	86
02744.....	86
02748.....	86
02759.....	86
02760.....	86
02761.....	86
02762.....	86
02763.....	86
02764.....	86
02766.....	86
02767.....	86
02770.....	86
02771.....	86
02772.....	86
02773.....	86
02774.....	86
02775.....	100
02776.....	100
02777.....	100
02778.....	100
02779.....	100
02780.....	100
02781.....	100
02782.....	100
02783.....	100
02794.....	209
02795.....	209
02848.....	209
02894.....	209
02965.....	208
02971.....	209
02974.....	208
02975.....	209
02990.....	86
02992.....	209
02998.....	209
02999.....	208
03000.....	203
03003.....	195
03020.....	204
03025.....	204
03028.....	189
03046.....	204
03051.....	204
03059.....	190
03060.....	195
03061.....	195
03062.....	191
03063.....	191
03066.....	195
03067.....	191
03083.....	195
03085.....	195
03093.....	191
03094.....	190
03095.....	195
03107.....	199
03109.....	189
03111.....	189
03112.....	189
03113.....	189
03116.....	189
03121.....	189
03123.....	201
03126.....	199
03141.....	201
03147.....	202
03160.....	201

03164.....	201
03168.....	201
03247.....	151
03248.....	151
03254.....	210
03257.....	201
03276.....	201
03279.....	200
03288.....	210
03302.....	200
03304.....	200
03305.....	200
03306.....	200
03307.....	200
03321.....	190
03337.....	203
03338.....	203
03343.....	203
03344.....	203
03357.....	200
03358.....	201
03359.....	201
03362.....	189
03363.....	200
03363.....	200
03366.....	199
03368.....	198
03369.....	198
03370.....	200
03372.....	200
03374.....	200
03375.....	189
03379.....	198
03390.....	201
03392.....	201
03393.....	189
03396.....	201
03397.....	201
03398.....	201
03399.....	201
03405.....	203
03410.....	201
03424.....	190
03425.....	190
03427.....	203
03428.....	203
03429.....	203
03452.....	198
03452.....	199
03452.....	199
03452.....	199
03452.....	199
03458.....	200
03469.....	198
03470.....	201
03471.....	200
03472.....	201
03477.....	151
03479.....	151
03481.....	151
03483.....	151
03485.....	151
03487.....	151
03495.....	199
03496.....	203
03508.....	199
03567.....	201
03570.....	198
03572.....	198
03573.....	198
03574.....	198
03575.....	198
03576.....	198
03579.....	198
03580.....	198
03582.....	198
03597.....	201
03647.....	207
03648.....	211
03650.....	211
03653.....	211

03654.....	211
03655.....	211
03656.....	211
03657.....	211
03658.....	211
03659.....	211
03661.....	206
03663.....	206
03664.....	206
03665.....	206
03667.....	205
03669.....	207
03670.....	206
03684.....	202
03693.....	201
03696.....	201
03697.....	201
03698.....	201
03699.....	201
03700.....	219
03701.....	207
03702.....	206
03703.....	206
03704.....	206
03706.....	212
03707.....	207
03709.....	207
03710.....	206
03714.....	206
03716.....	212
03717.....	212
03729.....	207
03731.....	207
03732.....	207
03733.....	207
03736.....	207
03744.....	213
03745.....	213
03746.....	213
03747.....	213
03750.....	213
03762.....	212
03765.....	212
03769.....	212
03773.....	212
03775.....	196
03792.....	196
03795.....	100
03797.....	213
03832.....	212
03842.....	213
03847.....	204
03848.....	204
03858.....	189
03859.....	189
03861.....	189
03868.....	212
03874.....	213
03875.....	211
03880.....	211
03881.....	211
03882.....	211
03884.....	212
03886.....	212
03887.....	212
03890.....	211
03891.....	211
03892.....	210
03893.....	210
04000.....	237
04002.....	237
04007.....	237
04097.....	212
04110.....	218
04118.....	218
04135.....	219
04136.....	219
04137.....	216
04138.....	217
04139.....	216

04140.....	216
04141.....	216
04349.....	205
04350.....	205
04354.....	205
04360.....	205
04485.....	210
04495.....	220
04496.....	220
04497.....	220
04499.....	220
04500.....	221
04501.....	221
04513.....	220
04515.....	220
04524.....	220
04527.....	221
04528.....	217
04530.....	217
04532.....	220
04533.....	220
04534.....	220
04535.....	217
04537.....	220
04538.....	220
04539.....	220
04540.....	220
04544.....	220
04545.....	220
04546.....	

Order	Page		Page		Page		Page		Page				
04745	98	07414	97	10350	258	12022	251	12310	258	14534	250	14988	333
04746	98	07426	97	10352	258	12023	251	12312	258	14535	250	14989	333
04747	98	07469	97	10354	258	12024	251	12314	258	14556	250	14989	333
04750	98	07470	97	10356	258	12040	251	12316	258	14557	250	14994	263
04751	98	07471	241	11049	223	12041	251	12318	258	14558	250	14996	333
04752	98	07472	241	11050	223	12042	251	12320	258	14568	250	14996	334
04753	98	07473	241	11051	222	12043	251	12404	258	14569	250	14998	264
04754	98	07474	241	11052	222	12044	251	12406	258	14570	250	14999	264
04755	98	07475	241	11053	222	12060	254	12408	258	14571	250	15002	264
04756	98	07476	241	11054	222	12061	257	12410	258	14572	250	15004	264
04758	98	07477	97	11055	222	12062	257	12412	258	14574	250	15007	261
04759	98	07478	97	11059	223	12063	257	12414	258	14576	250	15009	261
04790	98	07479	97	11062	222	12069	256	12416	258	14600	168	15010	309
04815	98	07480	97	11065	223	12070	256	12418	258	14601	168	15020	309
04843	98	07481	97	11066	223	12071	256	12420	258	14602	168	15021	309
04844	98	07482	97	11067	222	12072	256	12431	260	14603	168	15022	264
04859	98	07483	97	11070	223	12073	256	12432	260	14604	168	15025	252
04884	98	07484	97	11071	210	12074	256	12433	260	14605	168	15026	252
04885	98	07485	97	11072	223	12075	256	12434	260	14606	168	15027	252
04918	91	07486	97	11073	223	12076	256	12435	260	14607	168	15028	309
04920	91	07493	97	11077	223	12077	256	12436	260	14608	168	15029	309
04921	91	07494	96	11078	223	12089	254	12437	260	14609	168	15030	309
04922	91	07506	89	11080	223	12090	251	12438	260	14610	168	15031	309
04924	91	07507	89	11081	223	12091	251	12451	260	14611	168	15032	252
04925	91	07508	89	11091	223	12092	254	12452	260	14613	168	15033	252
04927	91	07509	89	11092	223	12093	254	12453	260	14615	168	15034	252
04954	91	07510	88	11093	223	12094	254	12454	260	14840	334	15038	309
04955	91	07540	196	11200	219	12095	254	12542	254	14841	334	15039	309
04956	91	07541	196	11200	238	12096	254	12543	254	14843	333	15044	261
04959	101	07542	196	11201	228	12097	254	12545	254	14844	333	15045	261
04960	91	07543	196	11203	229	12101	254	12546	254	14846	334	15046	261
06118	234	07544	196	11204	229	12117	254	12547	254	14847	334	15048	309
06438	97	07993	216	11210	168	12118	251	12548	254	14848	334	15049	252
06462	97	08002	221	11211	168	12119	254	12550	254	14849	334	15050	252
06462	97	08004	221	11212	168	12142	254	13845	256	14850	334	15057	252
06469	97	08131	240	11220	228	12143	254	13846	256	14873	334	15058	252
07121	87	08134	240	11221	230	12145	254	13850	256	14897	334	15060	252
07127	90	08136	240	11222	230	12146	254	13852	256	14943	334	15061	252
07130	89	08142	240	11223	230	12147	254	13855	256	14944	334	15065	252
07150	87	08146	240	11224	230	12148	254	13856	256	14950	334	15066	252
07151	87	08153	240	11225	230	12150	254	13860	256	14951	334	15067	252
07152	87	08158	240	11226	230	12151	254	13865	256	14952	333	15069	252
07153	87	08173	240	11227	230	12153	254	13875	256	14953	333	15070	252
07154	87	08176	240	11228	230	12154	254	13885	256	14954	333	15085	267
07155	90	08179	240	11229	230	12155	254	13945	256	14955	333	15086	267
07156	87	08181	240	11231	228	12156	254	13946	256	14956	333	15089	267
07157	87	08187	240	11235	108	12157	254	13950	256	14957	333	15090	267
07159	90	10105	258	11236	228	12158	254	13952	256	14958	333	15092	267
07160	90	10108	258	11300	230	12159	254	13955	256	14958	334	15093	267
07164	87	10110	258	11302	230	12211	252	13956	256	14959	333	15105	260
07165	87	10111	258	11303	229	12212	252	13960	256	14959	334	15107	260
07166	87	10112	258	11304	229	12213	252	13965	256	14960	333	15111	252
07167	87	10250	257	11305	229	12214	252	13975	256	14961	333	15112	252
07168	87	10251	257	11307	229	12217	254	13985	256	14962	333	15113	260
07169	87	10252	257	11308	229	12218	254	14040	250	14963	333	15114	267
07174	88	10260	257	11309	230	12219	254	14041	250	14964	333	15115	252
07175	89	10261	257	11350	231	12231	255	14042	250	14965	333	15128	264
07179	87	10262	257	11351	231	12242	255	14201	251	14966	333	15130	264
07181	87	10295	257	11352	231	12269	256	14202	251	14967	333	15131	264
07182	88	10296	257	11353	231	12270	256	14203	251	14968	333	15132	264
07185	89	10297	257	11354	231	12271	256	14204	251	14969	333	15133	264
07186	87	10298	257	11355	231	12272	256	14205	251	14970	333	15151	260
07187	87	10300	257	11356	231	12273	256	14208	251	14971	333	15158	252
07191	89	10301	257	11357	231	12274	256	14209	251	14972	333	15180	267
07194	88	10302	257	11358	229	12275	256	14210	251	14973	333	15181	267
07195	88	10303	257	11496	232	12276	256	14211	251	14974	333	15251	255
07196	88	10304	258	11497	232	12277	256	14212	251	14975	264	15252	255
07199	88	10306	258	12000	251	12289	254	14219	249	14976	264	15253	255
07202	88	10308	258	12001	251	12290	254	14225	251	14977	264	15254	255
07203	88	10310	258	12002	251	12291	254	14226	251	14978	264	15255	255
07204	88	10312	258	12003	251	12292	254	14227	251	14979	333	15256	255
07375	97	10314	258	12005	251	12293	254	14340	310	14980	333	15274	252
07382	97	10316	258	12006	251	12294	254	14508	250	14981	264	15275	252
07386	97	10318	258	12008	251	12295	254	14509	250	14981	264	15276	252
07397	97	10320	258	12010	251	12296	254	14510	250	14982	333	15277	252
07398	97	10340	258	12012	251	12297	254	14511	250	14983	333	15410	310
07400	97	10342	258	12016	251	12301	254	14526	250	14984	333	15411	310
07404	97	10344	258	12018	251	12304	258	14526	268	14985	333	15412	310
07405	97	10346	258	12019	251	12306	258	14532	250	14985	333	15413	310
07410	97	10348	258	12021	251	12308	258	14533	250	14987	333	15414	310

Index

Order	Page
15415.....	310
16118.....	253
16119.....	253
16170.....	253
16171.....	253
16180.....	310
16220.....	262
16221.....	262
16222.....	262
16239.....	262
16240.....	262
16290.....	262
16291.....	262
16325.....	262
16326.....	262
16327.....	262
16346.....	262
16348.....	262
16349.....	262
16350.....	262
16351.....	262
16354.....	262
16355.....	262
16360.....	262
16365.....	324
16366.....	324
16370.....	262
16450.....	253
16451.....	253
16452.....	253
16460.....	253
16471.....	253
16472.....	253
16483.....	253
16485.....	253
17003.....	85
17010.....	85
17011.....	85
17012.....	85
17018.....	85
17019.....	85
17020.....	85
17021.....	85
17022.....	85
17023.....	85
17026.....	149
17027.....	149
17028.....	149
18116.....	263
18118.....	263
18120.....	263
18121.....	263
18122.....	263
18140.....	310
18150.....	261
18156.....	261
18191.....	261
18193.....	261
18196.....	261
18197.....	261
18198.....	261
18199.....	261
18200.....	261
18201.....	261
18202.....	261
18207.....	261
18222.....	261
18223.....	261
18225.....	261
18265.....	260
18270.....	260
18271.....	260
18272.....	260
18273.....	260
18274.....	260
18275.....	260
18277.....	260
18278.....	260
18304.....	260
18317.....	261

18400.....	303
20018.....	20
21001.....	20
21075.....	19
21095.....	23
21096.....	23
21097.....	23
21108.....	37
21114.....	167
21116.....	167
21220.....	321
21531.....	23
21534.....	60
21535.....	60
21546.....	33
21547.....	33
21556.....	34
21557.....	34
21567.....	30
21568.....	30
21579.....	19
21569.....	30
21572.....	19
21573.....	19
21574.....	19
21575.....	19
21583.....	26
21620.....	21
21621.....	21
21630.....	21
21631.....	21
21633.....	21
21634.....	21
22130.....	26
22176.....	26
22207.....	26
22229.....	31
22500.....	23
22501.....	23
22503.....	23
22504.....	23
22529.....	26
22591.....	34
22596.....	34
22601.....	36
22602.....	36
22603.....	36
22604.....	36
22609.....	34
22610.....	34
22612.....	34
22617.....	34
22618.....	34
22619.....	36
22620.....	36
22621.....	36
22625.....	34
22631.....	47
22632.....	47
22633.....	47
22634.....	47
22671.....	57
23123.....	32
23124.....	32
23125.....	32
23499.....	35
23502.....	35
23503.....	35
23504.....	35
23505.....	35
23506.....	35
23517.....	35
23518.....	35
23519.....	35
23525.....	35
23526.....	35
23527.....	35
24106.....	31
24117.....	27
24118.....	27

24116.....	31
24123.....	27
24124.....	27
24131.....	27
24166.....	28
24167.....	28
24172.....	29
24191.....	29
24192.....	29
24215.....	29
24216.....	29
24235.....	31
24243.....	31
24246.....	31
24252.....	31
24253.....	31
24260.....	37
24503.....	31
24505.....	30
24506.....	30
24507.....	30
24508.....	30
24509.....	30
24510.....	30
24511.....	30
25249.....	31
25407.....	26
25409.....	26
25500.....	38
25501.....	38
25502.....	38
25503.....	38
25504.....	38
25513.....	38
25517.....	37
25518.....	37
25519.....	37
26103.....	39
26102.....	42
26120.....	39
26127.....	37
26134.....	40
26138.....	42
26147.....	37
26143.....	42
26148.....	37
26151.....	42
26154.....	42
26155.....	42
26156.....	42
26157.....	42
26158.....	42
26159.....	41
26160.....	41
26162.....	41
26165.....	38
26172.....	38
26180.....	42
26181.....	42
26182.....	42
26187.....	39
26185.....	42
26189.....	39
26192.....	39
26193.....	41
26195.....	39
26194.....	41
26198.....	41
26199.....	41
26201.....	40
26205.....	40
26249.....	39
26224.....	37
26225.....	37
26226.....	37
26227.....	37
26239.....	37
26240.....	37
26513.....	38
26520.....	38

26649.....	37
27020.....	18
27021.....	26
27109.....	46
27119.....	46
27159.....	22
27163.....	46
27170.....	53
27225.....	51
27226.....	51
27227.....	51
27228.....	51
27229.....	51
27230.....	51
27231.....	51
27232.....	51
27233.....	51
27267.....	51
27273.....	52
27282.....	52
27314.....	51
27318.....	51
27341.....	46
30007.....	234
30008.....	233
30110.....	234
30120.....	234
30128.....	234
30130.....	234
30138.....	234
30210.....	234
30220.....	233
30230.....	233
30235.....	233
30239.....	234
30240.....	233
30250.....	234
30618.....	234
30636.....	234
31011.....	301
31014.....	245
31016.....	245
31017.....	245
31027.....	300
31030.....	302
31031.....	245
31032.....	302
31033.....	245
31034.....	302
31035.....	302
31036.....	302
31037.....	302
31038.....	301
31040.....	301
31045.....	301
31046.....	301
31048.....	302
31051.....	300
31052.....	300
31053.....	300
31054.....	300
31055.....	302
31056.....	300
31057.....	302
31058.....	302
31059.....	275
31060.....	274
31061.....	273
31063.....	274
31064.....	273
31066.....	275
31067.....	275
31068.....	275
31069.....	273
31078.....	303
31079.....	286
31081A.....	286
31081B.....	286
31082A.....	286
31082B.....	286

31083.....	286
31084.....	286
31085.....	286
31086.....	286
31087.....	286
31088.....	286
31089.....	286
31090.....	286
31092.....	286
31095.....	286
31096.....	286
31107.....	245
31108.....	245
31108.....	302
31110.....	245
31115B.....	277
31115C.....	277
31117B.....	277
31117C.....	277
31119B.....	277
31119C.....	277
31121C.....	277
31121D.....	277
31124.....	277
31125.....	277
31127.....	277
31135.....	277
31137.....	277
31138.....	302
31139.....	302
31200M.....	84
31426.....	277
31427.....	277
31440.....	277
31441.....	277
31442.....	277
31443.....	277
31444.....	277
31445.....	277
31449.....	277
31450.....	277
31451.....	277
31455.....	277
31456.....	277
31456.....	277
31457.....	277
31463.....	277
31464.....	277
31465.....	277
31470.....	277
31471.....	277
31472.....	277
31498.....	277
31499.....	277
31500B.....	277
31500B.....	277
31500C.....	277
31500C.....	277
31501C.....	277
31501D.....	277
31508.....	302
31533.....	245
31534.....	302
31536.....	245
31536.....	302
31537.....	302
31538.....	302
31539.....	302
31540.....	245
31547.....	303
31548.....	303
31549.....	303
31550.....	303
31551.....	303
31552.....	302
31563.....	302
31565.....	302
31566.....	302
31569.....	302
31572.....	302

31573.....	302
31574.....	302
31575.....	302
31576.....	302
31577.....	302
31578.....	302
31579.....	302
31580.....	302
31581.....	302
31582.....	302
31583.....	302
31585.....	302
31586.....	302
31587.....	302
31588.....	302
31589.....	302
31590.....	302
31595.....	302
31596.....	302
31597.....	302
31598.....	302
31599.....	302
31601.....	287
31604.....	282
31605.....	302
31623.....	291
31624.....	290
31625.....	302
31626.....	302
31627.....	302
31636.....	273
31639.....	274
31640.....	274
31642.....	273
31648.....	274
31649.....	274
31661.....	275
31663.....	274
31666.....	274
31667.....	274
31668.....	274
31669.....	273
31672.....	274
31673.....	274
31674.....	274
31675.....	273
31676.....	274
31677.....	273
31678.....	275
31679.....	274
31684.....	276
31688.....	276
31699.....	276
34010.....	293
34020.....	293
34027.....	293
34033.....	293
34065.....	292
34094.....	292
34095.....	292
34096.....	292
34097.....	292
34098.....	292
34100.....	318
34101.....	318
34102.....	318
34103.....	318
34104.....	318
34105.....	318
34106.....	318
34107.....	318
34108.....	318
34109.....	318
34112.....	318
34113.....	318
34116.....	318
34117.....	318
34120.....	293
34130.....	293
34140.....	293

34150.....	293
34160.....	293
34170.....	293
34180.....	293
34190.....	293
34200.....	310
34201.....	310
34202.....	310
34203.....	310
34204.....	310
34205.....	310
34206.....	310
34207.....	310
34208.....	310
34209.....	310
34210.....	293
34212.....	310
34213.....	310
34226.....	310
34227.....	310
34228.....	310
34229.....	310
34240.....	293
34260.....	293
34270.....	293
34280.....	293
34300.....	293
34320.....	293

Order	Page						
43851	304	44592	328	45210	324	45398	79
43852	304	44593	329	45211	322	45399	243
43853	304	44594	329	45212	324	45500	236
43854	304	44595	329	45214	276	45501	236
43855	304	44616	328	45215	318	45502	243
43856	304	44635	329	45217	105	45504	236
43857	304	44641	320	45218	105	45505	236
43858	304	44642	320	45219	324	45509	241
43863	304	44643	320	45221	300	45515	213
43865	304	44644	320	45224	324	45515	241
43868	304	44645	320	45226	327	45545	237
43872	304	44646	320	45227	300	45546	237
43873	304	44647	320	45228	300	45563	241
43874	304	44697	329	45229	300	45570	241
43876	304	44698	329	45287	244	45573	238
43879	304	44699	329	45288	244	45574	238
43883	304	44702	329	45289	244	45576	241
43884	304	44704	329	45290	244	45577	241
43885	303	44706	329	45291	244	45579	239
43897	304	44708	329	45295	244	45580	239
43909	304	44711	328	45296	244	45581	239
43911	304	44712	328	45297	244	45582	239
43912	305	44713	328	45298	244	45585	239
43913	305	44714	328	45299	244	45587	239
43914	305	44715	139	45300	244	45588	240
43920	305	44716	328	45301	244	45589	240
43921	305	44717	328	45302	244	45601	326
43922	305	44718	328	45303	244	45613	330
43928	305	44732	329	45307	243	45614	330
43934	304	45003	232	45308	243	45616	330
43935	304	45004	232	45309	243	45617	330
43936	304	45017	228	45330	244	45620	330
43937	304	45018	228	45333	244	45623	330
43938	304	45020	232	45334	108	45624	330
43939	304	45022	232	45335	244	45625	330
43940	304	45023	228	45337	244	45626	330
43941	304	45024	168	45339	244	45627	330
43942	304	45027	232	45343	243	45628	330
43943	304	45029	232	45344	243	45629	330
43944	304	45036	232	45345	243	45630	330
43945	304	45038	232	45346	243	45633	330
43946	304	45046	232	45346	79	45637	330
43949	303	45047	232	45347	243	45639	330
43956	304	45048	232	45348	243	45640	330
44180	319	45049	232	45350	242	45642	330
44181	319	45050	271	45351	242	45644	330
44182	319	45060	271	45352	242	45646	330
44183	319	45061	271	45353	242	45654	330
44184	319	45070	271	45354	242	45664	326
44185	319	45071	271	45355	242	45667	330
44186	319	45100	271	45356	242	45675	330
44187	319	45102	271	45357	242	45677	330
44189	319	45106	271	45358	242	45678	330
44190	319	45110	271	45359	242	45679	330
44191	319	45111	271	45360	242	45684	330
44211	319	45121	271	45361	242	45685	330
44217	319	45122	271	45362	242	45688	330
44440	322	45123	271	45363	242	45689	330
44533	320	45124	271	45364	242	45691	326
44534	320	45125	271	45365	242	45692	330
44535	320	45126	271	45366	242	45694	330
44537	320	45127	271	45367	242	45695	330
44566	320	45128	271	45368	242	45696	330
44567	320	45129	271	45369	242	45699	326
44568	320	45130	271	45370	242	45701	326
44569	320	45131	271	45371	242	45701BLNK	326
44569	320	45132	271	45375	242	45705	326
44572	320	45133	271	45376	242	45712	326
44573	320	45134	271	45377	242	45712BLNK	326
44574	320	45135	271	45378	100	45717	326
44577	320	45136	271	45379	100	45717BLNK	326
44578	329	45144	271	45381	243	45726	326
44579	328	45155	105	45382	243	45727	326
44580	328	45158	105	45383	243	45729	326
44581	328	45161	221	45394	243	45731	326
44587	328	45170	323	45395	243	45733	326
44588	328	45201	275	45396	243	45735	326
44589	328	45203	75	45397	243	45737	326
44590	328	45206	75	45397	79	45740	326
44591	328	45209	316	45398	243	45741	326
45747	326	46011	307	46653	117	45747	326
45748	308	46013	307	46654	117	45748	308
45752	308	46014	117	46657	116	45752	308
45753	308	46015	117	46658	117	45753	308
45754	308	46020	268	46659	116	45754	308
45755	308	46040	82	46660	117	45755	308
45756	308	46049	324	46661	117	45756	308
45757	308	46050	324	46663	321	45757	308
45758	308	46051	265	46673	265	45758	308
45759	308	46052	265	46675	265	45759	308
45761	308	46054	265	46678	265	45761	308
45763	308	46055	265	46702	191	45763	308
45764	308	46056	265	46720	191	45764	308
45766	317	46057	265	46722	191	45766	317
45768	308	46060	265	46723	244	45768	308
45771	308	46064	265	46723	244	45771	308
45772	308	46067	265	46723	270	45772	308
45773	308	46068	265	46724	244	45773	308
45777	317	46069	265	46728	323	45777	317
45778	317	46085	265	46736	244	45778	317
45779	317	46157	329	46737	244	45779	317
45780	317	46248	117	46739	270	45780	317
45781	317	46249	116	46740	244	45781	317
45782	317	46250	117	46747	244	45782	317
45783	216	46251	117	46815	320	45783	216
45784	216	46252	117	46817	320	45784	216
45787	327	46253	116	46839	323	45787	327
45788	327	46255	116	46843	323	45788	327
45789	327	46400	324	46844	323	45789	327
45790	327	46401	324	46846	323	45790	327
45791	327	46403	324	46855	323	45791	327
45792	327	46410	324	46857	323	45792	327
45793	330	46411	324	46859	323	45793	330
45794	330	46412	324	46860	265	45794	330
45796	330	46420	244	46861	265	45796	330
45797	330	46430	324	46862	265	45797	330
45798	330	46431	324	46863	265	45798	330
45799	330	46432	324	46865	265	45799	330
45800	330	46434	324	46868	265	45800	330
45801	330	46435	324	46869	265	45801	330
45802	330	46491	324	46871	265	45802	330
45803	330	46504	115	46872	265	45803	330
45804	330	46505	115	47000	266	45804	330
45805	330	46506	115	47001	266	45805	330
45806	332	46508	116	47016	266	45806	332
45807	332	46509	116	47024	266	45807	332
45809	332	46510	116	47106	249	45809	332
45810	332	46512	115	47107	249	45810	332
45812	332	46513	115	47108	249	45812	332
45813	332	46514	115	48100	319	45813	332
45814	332	46515	115	48101	319	45814	332
45815	332	46518	116	48102	319	45815	332
45816	332	46519	116	48103	319	45816	332
45817	332	46525	221	48104	319	45817	332
45818	332	46527	229	48105	319	45818	332
45819	332	46528	223	48106	319	45819	332
45820	332	46588	117	48107	319	45820	332
45821	332	46601	116	48108	319	45821	332
45822	332	46603	116	48109	319	45822	332
45824	332	46604	116	48110	319	45824	332
45833	330	46607	116	48111	319	458	

Index

Order.....Page

48132.....	319
48133.....	319
48134.....	319
48135.....	319
48136.....	319
48137.....	319
48138.....	319
48139.....	319
48140.....	319
48141.....	319
48142.....	319
48143.....	319
48144.....	319
48145.....	319
48146.....	319
48147.....	319
48148.....	319
48149.....	319
48150.....	319
48151.....	319
48152.....	319
48153.....	319
48154.....	319
48155.....	319
48156.....	319
48157.....	319
48158.....	319
48159.....	319
48160.....	319
48161.....	319
48162.....	319
48163.....	319
48164.....	319
48165.....	319
48166.....	319
48167.....	319
48168.....	319
48169.....	319
48170.....	319
48171.....	319
48172.....	319
48173.....	319
48174.....	319
48175.....	319
48176.....	319
48177.....	319
48178.....	319
48179.....	319
48180.....	319
48181.....	319
48182.....	319
48183.....	319
48184.....	319
48185.....	319
48186.....	319
48187.....	319
48188.....	319
48189.....	319
48190.....	319
48191.....	319
48192.....	319
48193.....	319
48194.....	319
48195.....	319
48196.....	319
48197.....	319
48198.....	319
48199.....	319
48200.....	319
48201.....	319
48202.....	319
48203.....	319
48204.....	189
48205.....	189
48206.....	189
48207.....	189
48208.....	189
48209.....	189
48210.....	189
48211.....	189
48212.....	189
48213.....	189
48214.....	189
48215.....	189
48216.....	189
48217.....	189
48218.....	189
48219.....	189
48220.....	189
48221.....	189
48222.....	189
48223.....	189
48224.....	189
48225.....	189
48226.....	189
48227.....	189
48228.....	189
48229.....	189
48230.....	189
48231.....	189
48232.....	189
48233.....	189
48234.....	189
48235.....	189
48236.....	189
48237.....	189
48238.....	189
48239.....	189
48240.....	189
48241.....	189
48242.....	189
48243.....	189
48244.....	189
48245.....	189
48246.....	189
48247.....	189
48248.....	189
48249.....	189
48250.....	189
48251.....	189
48252.....	189
48253.....	189
48254.....	189
48255.....	189
48256.....	189
48257.....	189
48258.....	189
48259.....	189
48260.....	189
48261.....	189
48262.....	189
48263.....	189
48264.....	189
48265.....	189
48266.....	189
48267.....	189
48268.....	189
48269.....	189
48270.....	189
48271.....	189
48272.....	189
48273.....	189
48274.....	189
48275.....	189
48276.....	189
48277.....	189
48278.....	189
48279.....	189
48280.....	189
48281.....	189
48282.....	189
48283.....	189
48284.....	189
48285.....	189
48286.....	189
48287.....	189
48288.....	189
48289.....	189
48290.....	189
48291.....	189
48292.....	189
48293.....	189
48294.....	189
48295.....	189
48296.....	189
48297.....	189
48298.....	189
48299.....	189
48300.....	189
48301.....	189
48302.....	189
48303.....	189
48304.....	189
48305.....	189
48306.....	189
48307.....	189
48308.....	189
48309.....	189
48310.....	189
48311.....	189
48312.....	189
48313.....	189
48314.....	189
48315.....	189
48316.....	189
48317.....	189
48318.....	189
48319.....	189
48320.....	189
48321.....	189
48322.....	189
48323.....	189
48324.....	189
48325.....	189
48326.....	189
48327.....	189
48328.....	189
48329.....	189
48330.....	189
48331.....	189
48332.....	189
48333.....	189
48334.....	189
48335.....	189
48336.....	189
48337.....	189
48338.....	189
48339.....	189
48340.....	189
48341.....	189
48342.....	189
48343.....	189
48344.....	189
48345.....	189
48346.....	189
48347.....	189
48348.....	189
48349.....	189
48350.....	189
48351.....	189
48352.....	189
48353.....	189
48354.....	189
48355.....	189
48356.....	189
48357.....	189
48358.....	189
48359.....	189
48360.....	189
48361.....	189
48362.....	189
48363.....	189
48364.....	189
48365.....	189
48366.....	189
48367.....	189
48368.....	189
48369.....	189
48370.....	189
48371.....	189
48372.....	189
48373.....	189
48374.....	189
48375.....	189
48376.....	189
48377.....	189
48378.....	189
48379.....	189
48380.....	189
48381.....	189
48382.....	189
48383.....	189
48384.....	189
48385.....	189
48386.....	189
48387.....	189
48388.....	189
48389.....	189
48390.....	189
48391.....	189
48392.....	189
48393.....	189
48394.....	189
48395.....	189
48396.....	189
48397.....	189
48398.....	189
48399.....	189
48400.....	189
48401.....	189
48402.....	189
48403.....	189
48404.....	189
48405.....	189
48406.....	189
48407.....	189
48408.....	189
48409.....	189
48410.....	189
48411.....	189
48412.....	189
48413.....	189
48414.....	189
48415.....	189
48416.....	189
48417.....	189
48418.....	189
48419.....	189
48420.....	189
48421.....	189
48422.....	189
48423.....	189
48424.....	189
48425.....	189
48426.....	189
48427.....	189
48428.....	189
48429.....	189
48430.....	189
48431.....	189
48432.....	189
48433.....	189
48434.....	189
48435.....	189
48436.....	189
48437.....	189
48438.....	189
48439.....	189
48440.....	189

48441.....	325
48442.....	325
48443.....	325
48444.....	325
48445.....	325
48515.....	325
48631.....	189
48672.....	264
48688.....	189
49006.....	296
49008.....	319
49009.....	319
49010.....	319
49011.....	274
49013.....	274
49014.....	274
49026.....	320
49045.....	333
49635.....	276
49038.....	126
50053.....	128
50054.....	149
50065.....	122
50066.....	144
50067.....	123
50068.....	123
50069.....	151
50070.....	132
50071.....	132
50075.....	122
50076.....	123
50077.....	183
50080.....	183
50081.....	131
50087.....	183
50089.....	183
50090.....	183
50091.....	183
50092.....	183
50094.....	183
50095.....	183
50097.....	183
50099.....	131
50100.....	131
50103.....	132
50108.....	184
50112.....	183
50116.....	123
50118.....	123
50132.....	122
50134.....	123
50135.....	122
50137.....	122
50140.....	123
50144.....	181
50151.....	123
50154.....	153
50171.....	152
50172.....	152
50176.....	152
50181.....	120
50189.....	126
50191.....	126
50200.....	121
50203.....	131
50204.....	131
50205.....	126
50207.....	128
50212.....	128
50215.....	126
50223.....	123
50224.....	123
50225.....	122
50228.....	123
50230.....	122
50230.....	123
50235.....	112
50308.....	128
50312.....	132
50342.....	182

50343.....	182
50346.....	132
50356.....	175
50361.....	182
50367.....	174
50370.....	182
50373.....	182
50374.....	181
50380.....	183
50386R.....	181
50386B.....	181
50433.....	175
50434.....	170
50456.....	148
50500.....	153
50501.....	153
50502.....	153
50504.....	153
50506.....	153
50508.....	149
50526.....	151
50527.....	151
50560.....	131
50560.....	131
50562.....	131
50565.....	153
50567.....	153
50569.....	153
50611.....	153
50616.....	298
50618.....	153
50622.....	153
50623.....	153
50624.....	153
50643.....	298
50647.....	144
50675.....	316
50705.....	316
50706.....	316
50708.....	316
50709.....	316
50710.....	316
50713.....	316
50738.....	316
50741.....	316
50746.....	298
50751.....	298
50754.....	298
50759.....	298
50892.....	135
50894.....	135
50904.....	138
50905.....	136
50906.....	136
50907.....	136
50908.....	138
50909.....	138
50926.....	297
50927.....	296
50928.....	139
50929.....	296
50930.....	139
50932.....	138
50933.....	138
50934.....	138
50936.....	182
50938.....	138
50940.....	138
50941.....	138
50942.....	138
50943.....	138
50947.....	138
50948.....	138
50950.....	139
50959.....	136
50961.....	139
50962.....	139
50963.....	139
50967.....	136
50971.....	138

50975.....	138
50976.....	138
50977.....	138
50982.....	166
50983.....	139
50984.....	139
50985.....	139
50986.....	139
50987.....	139
50989.....	139
50995.....	139
50996.....	139
50997.....	139
50998.....	139
50999.....	246
50XAF1.....	119
50XAF2.....	119
50XAF3.....	119
50XAH1.....	119
50XAH2.....	119
50XAH3.....	119
50XEF1.....	119
50XEF2.....	119
50XEF3.....	119
50XEH1.....	119
50XEH2.....	119
50XEH3.....	119
51000.....	118
51020.....	123
51021.....	123
51022.....	123
51023.....	123
51040.....	123
51044.....	126
51046.....	124
51057.....	120
51061.....	120
51075.....	126
51077.....	124
51082.....	128
51083.....	126
51087.....	128
51090.....	126
51095.....	128
51098.....	143
51099.....	131
51105.....	131
51117.....	118
51120.....	147
51137.....	132
51139.....	144
51141.....	144
51147.....	114
51148.....	114
51149.....	114
51174.....	146
51182.....	124
51184.....	124
51185.....	124
51196.....	124

Order	Page		Page		Page		Page
52394	91	52618	113	52714	108	53124	89
52396	107	52619	134	52715	108	53125	89
52397	107	52620	113	52717	109	53140	333
52398	111	52622	105	52721	109	53144	79
52400	134	52624	105	52722	109	53145	81
52425	135	52625	175	52723	108	53178	82
52427	134	52626	105	52724	108	53179	82
52429	134	52627	134	52725	108	53189	76
52430	134	52628	105	52726	108	53193	82
52432	134	52629	135	52727	108	53194	80
52433	135	52630	135	52728	109	53196	82
52435	135	52631	134	52729	109	53197	82
52437	133	52633	134	52730	109	53199	82
52438	112	52634	135	52732	108	53208	76
52440	99	52635	135	52733	108	53216	78
52441	133	52636	135	52737	109	53220	78
52442	133	52637	171	52742	108	53221	273
52450	133	52638	135	52745	109	53225	76
52451	133	52639	135	52748	107	53228	78
52459	135	52640	135	52748	109	53234	76
52460	135	52642	135	52749	109	53240	78
52462	136	52644	135	52754	109	53245	78
52464	137	52645	169	52804	105	53270	78
52472	133	52647	133	52808	105	53271	78
52482	135	52648	133	52810	105	53275	76
52483	135	52649	134	52819	106	53277	76
52484	135	52650	105	52820	106	53278	80
52486	133	52651	99	52821	106	53279	80
52487	113	52653	136	52866	107	53280	80
52488	113	52654	134	52869	140	53283	78
52489	113	52655	134	52870	140	53284	80
52494	136	52656	134	52876	114	53285	80
52500	107	52657	134	52877	114	53287	78
52501	107	52658	134	52878	140	53288	76
52502	107	52659	134	52907	111	53299	79
52503	107	52660	99	52915	140	53310	79
52505	107	52661	177	52916	140	53317	79
52506	107	52664	167	52919	140	53318	79
52507	107	52665	175	52921	140	53340	81
52508	107	52666	175	52923	140	53342	81
52512	113	52667	175	52925	140	53349	176
52514	113	52668	175	52927	140	53353	169
52521	107	52669	175	52961	82	53358	169
52522	107	52670	175	52962	76	53360	169
52523	107	52671	175	52963	76	53362	169
52524	107	52672	175	52965	81	53364	169
52525	107	52674	175	52966	81	53366	169
52526	107	52675	175	52967	81	53370	81
52530	107	52676	175	52975	76	53371	77
52531	107	52677	175	52981	274	53372	77
52532	107	52678	175	52986	276	53374	77
52533	107	52679	175	52988	84	53377	172
52536	107	52680	98	52989	84	53380	169
52540	110	52681	175	52995	78	53387	173
52544	107	52682	175	53015	85	53388	169
52545	112	52683	175	53017	85	53389	85
52549	114	52684	175	53025	85	53391	173
52550	112	52685	175	53031	80	53398	81
52551	112	52686	175	53033	80	53409	172
52552	112	52687	175	53038	80	53411	172
52553	112	52688	175	53042	80	53413	273
52554	112	52689	175	53046	78	53415	170
52556	171	52690	175	53055	85	53417	176
52557	112	52691	175	53056	80	53418	176
52558	112	52692	175	53057	80	53421	176
52559	112	52693	114	53058	80	53424	176
52560	112	52694	114	53059	81	53425	177
52565	112	52695	108	53060	77	53429	176
52570	112	52696	108	53061	77	53430	179
52593	113	52697	175	53062	77	53432	171
52594	113	52698	108	53071	81	53434	172
52595	113	52699	175	53078	83	53435	176
52596	113	52700	109	53081	82	53436	172
52597	114	52702	109	53083	82	53448	172
52598	113	52704	109	53094	81	53449	172
52601	113	52705	109	53100	79	53455	179
52602	113	52706	109	53103	78	53459	179
52610	113	52708	109	53104	78	53473	170
52614	113	52709	109	53120	89	53487	174
52616	113	52711	109	53121	89	53490	176
53492	176	53493	174	53497	170	53499	172
53499	172	53516	171	53517	171	53518	173
53519	173	53525	173	53526	170	53527	170
53529	170	53530	170	53531	172	53532	172
53533	172	53535	171	53537	170	53538	170
53556	172	53568	175	53582	169	53583	169
53584	169	53585	169	53613	173	53614	173
53615	173	53617	173	53640	238	53642	238
53644	238	53645	238	53646	238	53647	238
53648	238	53696	77	53697	77	53703	76
53705	80	54028	63	54029	63	54034	63
54035	63	54036	63	54037	63	54038	63
54102	64	54103	64	54110	64	54111	64
54116	64	54117	64	54125	64	54126	64
54133	64	54134	64	54135	64	54145	274
54146	274	54147	274	54148	274	54149	274
54150	274	54153	55	54154	55	54158	55
54159	63	54161	63	54200	63	54201	63
54208	63	54215	64	54216	64	54217	64
54218	64	54219	64	54220	64	54221	64
54222	317	54231	64	54232	64	54233	64
54241	64	54242	64	54243	64	54244	64
54245	64	54255	64	54256	64	54263	64
54264	64	54269	64	54270	64	54271	64
54291	64	54292	64	54294	64	54310	64
54311	319	54323	57	54324	57	54326	57
54327	57	54328	57	54329	57	54331	57
54332	57	54333	57	54334	57	54335	57
54336	57	54337	57	54338	57	54340	83
54343	57	54345	57	54353	57	54355	57
54360	57	54361	57	54366	57	54367	57
54368	57	54370	317	54371	317	54372	317
54373	317	54376	317	54378	317	54380	54
54400	65	54401	65	54403	65	54404	65
54405	65	54406	65	54407	65	54409	65
54410	65	54411	65	54413	65	54414	65
54415	63	54416	63	54417	63	54419	66
54420	66	54421	66	54422	66	54423	66
54424	66	54425	65	54426	65	54427	65
54428	65	54429	65	54431	65	54432	65
54433	66	54434	66	54435	66	54436	66
54437	66	54438	66	54439	66	54444	299
54445	299	54447	299	54448	299	54449	299
54453	55	54454	55	54455	299	54456	299
54459	65	54461	65	54462	65	54463	317
54468	299	54473	317	54474	317	54475	317
54476	317	54477	317	54478	317	54479	317
54480	317	54481	317	54482	317	54483	317
54484	317	54489	66	54496	317	54496	65
54504	317	54505	66	54508	66	54510	317
54511	317	54513	133	54531	265	54536	62
54537	62	54547	62	54578	62	54579	62
54582	62	54586	62	54590	64	54592	64
54594	64	54600	67	54601	67	54602	67
54603	67	54604	67	54605	67	54607	67
54608	67	54609	67	54610	67	54611	67
54612	67	54613	54	54615	139	54619	54
54623	67	54624	67	54628	67	54629	67
54630	67	54633	67	54634	67	54655	320
54667	67	54668	67	54689	67	54716	67
54717	67						

Order	Page		
57627	336	59090	70
57628	336	59091	70
57629	336	59095	71
57630	336	59105	58
57631	336	59109	58
57632	336	59110	58
57633	336	59111	182
57634	336	59125	58
57635	336	59126	58
57636	336	59127	58
57637	336	59128	58
57638	336	59130	58
57639	336	59131	60
57640	336	59135	185
57641	336	59137	58
57642	336	59138	60
57643	336	59154	71
57644	336	59155	71
57645	336	59156	71
57646	336	59157	71
57647	336	59229	121
57648	299	59230	121
57649	299	59248	184
57650	299	59258	118
57651	299	59262	122
57652	299	59267	120
57653	299	59268	152
57654	299	59270	121
57655	299	59271	121
57656	299	59272	121
57657	299	59273	120
58995	69	59286	142
58996	69	59287	142
58997	69	59288	118
58998	69	59289	118
59001	69	59290	118
59002	69	59291	118
59003	69	59308	195
59004	69	59309	58
59005	69	59312	58
59006	69	59313	195
59007	70	59314	195
59008	70	59315	182
59009	70	59317	182
59010	70	59318R	181
59011	70	59318B	181
59012	70	59319	182
59013	70	59340	142
59014	70	59341	184
59015	70	59342	120
59016	71	59343	120
59017	71	59346	59
59018	71	59347	59
59039	180	59348	59
59045	182	59349	59
59046	181	59350	59
59046	181	59351	59
59047R	181	59353	58
59047B	181	59354	58
59049	181	59355	58
59051	181	59357	60
59052	181	59358	60
59056	70	59360	59
59058	121	59361	59
59059	121	59362	59
59070	122	59364	58
59073	184	59365	60
59076	70	59367	59
59077	70	59368	59
59078	70	59369	184
59079	70	59372	180
59080	70	59374	180
59081	70	59375	180
59082	70	59376	179
59083	70	59377	184
59084	70	59379	120
59085	70	59382	142
59086	70	59383	142
59087	70	59384	142
59088	70	59385	143
59386	143	59401	122
59388	143	59402	121
59389	143	59403	143
59390	143	59404	141
59391	143	59405	141
59392	143	59420	184
59393	143	59422	184
59398	142	59427	184
59399	142	59431	185
59400	122	59437	185
59440	185	59444	185
59442	185	59459	186
59444	185	59467	186
59459	186	59500F	188
59467	186	59500M	188
59500F	188	59500T	188
59500M	188	59527	187
59500T	188	59537	59
59527	187	 	
59537	59	59539	61
 		59540	61
59539	61	59541	61
59540	61	59545	61
59541	61	59550	186
59545	61	59551	186
59550	186	59552	186
59551	186	59553	186
59552	186	59554	186
59553	186	59555	186
59554	186	 	
59555	186	59556	186
 		59557	186
59556	186	59558	186
59557	186	59559	186
59558	186	59563	185
59559	186	59570	59
59563	185	59575	60
59570	59	59576	60
59575	60	59578	59
59576	60	59579	59
59578	59	 	
59579	59	59580	69
 		59581	69
59580	69	59582	69
59581	69	59583	69
59582	69	59584	69
59583	69	59585	69
59584	69	59586	69
59585	69	59587	69
59586	69	59589	71
59587	69	59590	71
59589	71	 	
59590	71	59591	71
 		59592	71
59591	71	59593	71
59592	71	59594	71
59593	71	59595	71
59594	71	59596	71
59595	71	59597	71
59596	71	59598	71
59597	71	59599	61
59598	71	59602	202
59599	61	 	
59602	202	59603	202
 		59604	202
59603	202	59605	202
59604	202	59606	202
59605	202	59607	202
59606	202	59608	202
59607	202	59609	202
59608	202	59610	202
59609	202	59613	201
59610	202	59614	202
59613	201	 	
59614	202	59615	202
 		59668	187
59615	202	59671	188
59668	187	59697	72
59671	188	59698	72
59697	72	59699	72
59698	72	59711	129
59699	72	59766	188
59711	129	59780M	188
59766	188	59780T	188
59780M	188	 	
59780T	188	59781F	188
 		59781M	188
59781F	188	59781T	188
59781M	188	59833	202
59781T	188	59838	129
59833	202	59841	129
59838	129	59843	129
59841	129	59845	129
59843	129	59858	129
59845	129	59860	129
59858	129	 	
59860	129	59861	129
 		59862	129
59861	129	59863	129
59862	129	59864	129
59863	129	59865	129
59864	129	59876	152
59865	129	59888	148
59876	152	59889	148
59888	148	59891	148
59889	148	59897	60
59891	148	 	
59897	60	59898	60
 		59899	60
59898	60	59953	73
59899	60	59954	73
59953	73	59955	73
59954	73	59956	73
59955	73	59958	73
59956	73	59959	73
59958	73	59960	73
59959	73	59961	73
59960	73	 	
59961	73	59963	72
 		59965	72
59963	72	59966	72
59965	72	59967	72
59966	72	59968	72
59967	72	59969	72
59968	72	59970	72
59969	72	59971	72
59970	72	59972	72
59971	72	59973	72
59972	72	 	
59973	72	59974	72
 		59975	72
59974	72	59976	72
59975	72	59977	72
59976	72	59981	72
59977	72	59982	72
59981	72	59983	72
59982	72	59984	72
59983	72	59985	72
59984	72	59986	72
59985	72	 	
59986	72	59987	72
 		59988	72
59987	72	59992	73
59988	72	60500	215
59992	73	60501	215
60500	215	60503	215
60501	215	60504	215
60503	215	60506	215
60504	215	60507	215
60506	215	60508	215
60507	215	 	
60508	215	60510	215
 		60516	215
60510	215	60517	215
60516	215	60518	215
60517	215	60522	215
60518	215	60530	215
60522	215	60531	215
60530	215	60532	215
60531	215	61000	156
60532	215	61001	156
61000	156	 	
61001	156	61002	156
 		61003	156
61002	156	61004	156
61003	156	61005	156
61004	156	61006	156
61005	156	61007	156
61006	156	61008	156
61007	156	61009	156
61008	156	61010	156
61009	156	61011	156
61010	156	 	
61011	156	61017	156
 		61018	156
61017	156	61019	156
61018	156	61020	156
61019	156	61021	156
61020	156	61022	156
61021	156	61023	156
61022	156	61024	156
61023	156	61025	156
61024	156	61026	156
61025	156	 	
61026	156	61027	156
 		61028	156
61027	156	61029	157
61028	156	61029B	157
61029	157	61034	156
61029B	157	61035	156
61034	156	61036	156
61035	156	61037	156
61036	156	61038	156
61037	156	61039	156
61038	156	 	
61039	156	61040	156
 		61041	156
61040	156	61042	156
61041	156	61043	156
61042	156	61044	156
61043	156	61045	156
61044	156	61050	156
61045	156	61051	156
61050	156	61052	156
61051	156	61053	156
61052	156	 	
61053	156	61054	156
 		61055	156
61054	156	61056	156
61055	156	61057	156
61056	156	61058	156
61057	156	61059	156
61058	156	61060	156
61059	156	61061	156
61060	156	61065	156
61061	156	61066	156
61065	156	 	
61066	156	61067	156
 		61068	156
61067	156	61069	156
61068	156	61070	156
61069	156	61071	156
61070	156	61072	156
61071	156	61073	156
61072	1		

Index

Order	Page						
61679	155	62054	156	62166	156	62834	156
61680	155	62055	156	62167	156	62835	156
61681	155	62056	156	62168	156	62836	156
61694	166	62057	156	62169	156	62837	156
61695	166	62058	156	62170	156	62838	156
61745	156	62059	156	62171	155	62839	156
61746	156	62060	156	62172	155	62840	156
61747	156	62061	156	62174	155	62841	156
61748	156	62062	156	62175	155	62842	156
61782	154	62063	156	62176	155	62843	156
61783	154	62068	156	62177	155	62844	156
61784	154	62069	156	62178	155	62845	156
61785	154	62070	156	62179	155	62846	156
61786	154	62071	156	62180	155	62847	156
61787	154	62072	156	62181	155	62850	158
61788	154	62073	156	62182	155	62851	158
61789	154	62074	156	62183	155	62852	158
61790	154	62075	156	62184	155	62853	158
61791	154	62076	156	62185	155	62854	158
61792	154	62077	156	62186	155	62855	158
61793	154	62078	156	62187	155	62856	158
61799	157	62079	156	62188	155	62857	158
61800	157	62080	156	62189	155	62858	158
61801	157	62081	156	62190	155	62859	158
61802	157	62082	156	62191	155	62860	158
61803	157	62083	156	62192	155	62861	158
61804	157	62084	156	62193	155	62862	158
61805	157	62085	156	62194	155	62863	158
61806	157	62086	156	62195	155	62864	158
61807	157	62087	156	62196	155	62865	158
61808	157	62088	156	62197	155	62866	158
61809	157	62089	156	62198	155	62867	158
61810	157	62090	156	62199	155	62868	158
61811	157	62091	156	62200	155	62869	158
61812	157	62093	156	62201	155	62870	158
61813	157	62094	156	62202	155	62871	158
61814	157	62095	156	62203	155	62872	158
61815	157	62096	156	62204	155	62873	158
61816	157	62097	156	62205	155	62874	156
61840	159	62098	156	62206	155	62875	156
61841	159	62099	156	626001	104	62876	156
61842	159	62100	156	626701	104	62877	156
61843	159	62101	156	626801	104	62878	156
61850	154	62102	156	626901	104	62879	156
61852	154	62103	156	627001	104	62880	156
61853	154	62104	157	62800	158	62881	156
61854	154	62105	157	628001	104	62882	156
61855	154	62106	157	62801	158	62883	156
61856	154	62110	156	62802	158	62884	156
61857	154	62111	156	62803	158	62885	156
61858	154	62112	156	62804	158	62886	156
61859	154	62113	156	62805	158	62887	156
61860	154	62114	156	62806	158	62888	156
61861	154	62115	156	62807	158	62889	156
61862	154	62116	156	62808	158	62890	156
62020	158	62117	156	62809	158	62891	156
62021	158	62118	156	62810	158	62892	156
62022	158	62119	156	62811	158	62893	156
62023	158	62120	156	62812	157	62894	156
62024	158	62121	156	62813	157	62895	156
62025	158	62130	159	62814	157	629001	104
62026	158	62133	159	62815	157	62920	156
62027	158	62140	158	62816	157	62921	156
62028	158	62141	158	62817	157	62922	156
62029	158	62142	158	62818	157	62923	156
62030	158	62143	158	62819	157	62924	156
62031	158	62144	158	62820	157	62925	156
62037	157	62145	158	62821	157	62926	156
62038	157	62146	158	62822	157	62927	156
62039	157	62147	158	62823	157	62928	156
62040	157	62148	158	62824	156	62929	156
62041	157	62149	158	62825	156	62930	156
62042	157	62150	158	62826	156	62931	156
62043	157	62151	158	62827	156	62932	156
62044	157	62160	156	62828	156	62933	156
62045	157	62161	156	62829	156	62934	156
62046	157	62162	156	62830	156	62935	156
62047	157	62163	156	62831	156	62936	156
62052	156	62164	156	62832	156	62937	156
62053	156	62165	156	62833	156	62938	156
62939	156					71195	144
62940	156					71196	144
62941	156					71198	144
62942	156					71200	151
629501	104					71201	151
64008	101					71202	151
64009	101					71203	151
64010	101					71204	151
64011	101					71205	151
64012	101					71206	151
64013	101					71207	151
64014	101					71208	151
64015	101					71209	151
64016	101					71211	122
64017	101					71215	121
64018	101					71216	122
64019	101					71217	122
64020	101					71218	122
64021	101					71221	131
64022	101					71335	123
64023	101					71357	123
67000	161					71359	123
70000	120					71375	123
70204	332					71380	123
70302	332					71382	145
70316	332					71384	145
70324	332					71387	145
70332	332					71388	145
70338	332					71392	145
70338	332					71393	145
70342	332					71394	145
70342	332					71395	122
70360	247					71407	144
70400	297					71408	144
70400	298					71409	144
70XAF1	119					71409	152
70XAF2	119					71414	131
70XAF3	119					71416	146
70XAH1	119					71420	146
70XAH2	119					71422	122
70XAH3	119					71427	146
70XAH4	119					71428	146
70XEF1	119					71433	118
70XEF2	119					71440	131
70XEF3	119					71441	146
70XEHL	119					71442	144
70XEHL	119					71443	144
70XEHL	119					71445	146
71070	152					71447	122
71070	152					71450	145
71073	190					71452	145
71074	190					71454	145
71075	190					71457	122
71076	190					71459	122
71077	190					71460	145
71079	121					71461	145
71080	121					71462	145
71171	143					71464	145
71172	144					71465	145
71173	144					71466	145
71174	144					71468	145
71175	144					71469	145
71176	144					71470	145
71177	144					71471	145
71178	144					71480	144
71179	144					71482	144
71180	144					71484	144
71181	144					71486	144
71182	144					71490	144
71183	144					71491	145
71184	144					71492	145
71185	144					71493	145
71186	144					71494	145
71187	144					71495	145
71188	144					71496	145
71189	144					71497	145
71190	144					71498	145
71192	144					71499	145
71193	144					71500	145
71194	144					71501	145
71195	144					71502	145
71196	144					71503	145
71198	144					71504	145
71200	151					71600	144
71201	151					71601	144
71202	151					71602	144
71203	151					71638	144
71204	151					71650	146
71205	151					71651	146
71206	151					71653	146
71207	151					71655	144
71208	151					71656	144
71209	151					71657	144
71211	122					71658	146
71215	121					71660	144
71216	122					71661	144
71217	122					71663	121
71218	122					71665	144
71221	131					71666	144
71335	123					71670	144
71357	123					71671	144
71359	123					71672	142
71375	123					71674	142
71380	123					71676	142
71382	145					71678	142
71384	145					71679	142
71387	145					71680	142
71388	145					71681	141
71392	145					71682	141
71393	145					71683	141
71394	145						

METRIC CONVERSIONS

Approximate Conversions to Metric

Symbol	When You Know	Multiply By	To Find	Symbol
LENGTH				
in.	inches	25.4	millimeters	mm
in.	inches	2.5	centimeters	cm
yd.	yards	0.9	meters	m
mi.	miles	1.6	kilometers	km
AREA				
in ²	square inches	64.5	square millimeters	mm ²
in ²	square inches	6.45	square centimeters	cm ²
ft ²	square feet	.09	square meters	m ²
yd ²	square yards	.08	square meters	m ²
mi ²	square miles	2.6	square kilometers	km ²
	acres	0.4	hectares	ha
MASS				
oz.	ounces	28.	grams	g
lb.	pounds	0.45	kilograms	kg
S/T	short tons (2000 lbs)	0.9	tonnes (1000 kilograms)	M/T
VOLUME				
tsp.	teaspoons	5.0	milliliters	ml
fl. oz.	fluid ounces	29.6	milliliters	ml
pt.	pints	0.47	liters	l
qt.	quarts	0.95	liters	l
gal.	gallons	3.8	liters	l
in ³	cubic inch	16.4	cubic centimeters	cm ³
ft ³	cubic feet	0.03	cubic meters	m ³
yd ³	cubic yards	0.76	cubic meters	m ³
TEMPERATURE				
°F	Fahrenheit	$\frac{5}{9}$ (after subtracting 32)	Celsius	°C

Approximate Conversions from Metric

Symbol	When You Know	Multiply By	To Find	Symbol
LENGTH				
mm	millimeters	0.04	inches	in.
cm	centimeters	0.4	inches	in.
m	meters	1.1	yards	yd.
km	kilometers	0.6	miles	mi.
AREA				
mm ²	square millimeters	.016	square inches	in ²
cm ²	square centimeters	0.16	square inches	in ²
m ²	square meters	10.8	square feet	ft ²
m ²	square meters	1.2	square yards	yd ²
km ²	square kilometers	0.4	square miles	mi ²
ha	hectares	2.5	acres	
MASS				
g	grams	0.035	ounces	oz.
kg	kilograms	2.2	pounds	lb.
M/T	tonnes (1000 kilograms)	1.1	short tons (2000 lbs)	S/T
VOLUME				
ml	milliliters	0.034	fluid ounces	fl. oz.
l	liters	2.1	pints	pt.
l	liters	1.06	quarts	qt.
l	liters	.026	gallons	gal.
cm ³	cubic centimeters	0.06	cubic inch	in ³
m ³	cubic meters	35.3	cubic feet	ft ³
m ³	cubic meters	1.3	cubic yards	yd ³
TEMPERATURE				
°C	Celsius	$\frac{9}{5}$ (then add 32)	Fahrenheit	°F

DECIMAL EQUIVALENTS

Drill Equivalent	Drill Equivalent	Drill Equivalent	Drill Equivalent
1/16 .0625	5/16 .3125	9/16 .5625	13/16 .8125
5/64 .07812	21/64 .32812	37/64 .5781	53/64 .8281
3/32 .09375	11/32 .34375	19/32 .5937	27/32 .8437
7/64 .10937	23/64 .35937	39/64 .6093	55/64 .8593
1/8 .125	3/8 .375	5/8 .6250	7/8 .8750
9/64 .14062	25/64 .39062	41/64 .6406	57/64 .8906
5/32 .15625	13/32 .40625	21/32 .6562	29/32 .9062
11/64 .17187	27/64 .42187	43/64 .6718	59/64 .9218
3/16 .1875	7/16 .4375	11/16 .6975	15/16 .9375
13/64 .20312	29/64 .45312	45/64 .7031	61/64 .9531
7/32 .21875	15/32 .46875	25/32 .7187	31/32 .9687
15/64 .23437	31/64 .48437	47/64 .7343	63/64 .9843
1/4 .25	1/2 .5	3/4 .7500	1 1.0000
17/64 .26562	33/64 .5156	49/64 .7656	
9/32 .28125	17/32 .5312	25/32 .7812	
19/64 .29687	35/64 .5468	51/64 .7968	



4 Distribution Center Network ★

20 Myers Sales Offices ★

Over 160 Myers Representatives Nationwide ▲



Worldwide Distribution



©2013 All Rights Reserved • Printed In U.S.A.
©2013 Myers Tire Supply/ Myers Industries Inc.
Myers Tire Supply is a registered trademark of Myers Tire Supply Distribution, Inc.

800-998-9897 • myerstiresupply.com