

VILLAGE OF DOWNERS GROVE
Report for the Village Council Meeting
1/15/2019

SUBJECT:	SUBMITTED BY:
2019 Police Department Ruggedized Laptop Replacements	Dave Kenny Director, Information Technology

SYNOPSIS

A motion is requested to authorize the purchase of thirty-five (35) Dell 5420 rugged laptops along with docking stations and antennas from Insight Public Sector, Inc. of Tempe, Arizona in an amount of \$109,628.40.

STRATEGIC PLAN ALIGNMENT

The goals for 2017-2019 include *Exceptional Municipal Services*.

FISCAL IMPACT

The FY18 Equipment Replacement Fund (Page 4-37, Line 20) included \$135,000.00 for Police Department ruggedized laptop computer replacements but the purchase was postponed due to a delay in the project at the County level. The cash for this purchase is available in fund balance in the FY19 budget. If necessary, a budget amendment will be prepared for the 2019 expense budget.

RECOMMENDATION

Approval on the January 15, 2019 Consent Agenda.

BACKGROUND

As part of the IT Department's hardware lifecycle management plan, the 2019 work plan includes replacing thirty-five (35) Police Department ruggedized laptop bundles (laptop, docking station and antenna).

Organizations can avoid problems associated with inoperable or obsolete equipment by following a timely replacement schedule of aging hardware. Police Department ruggedized laptops were last replaced in 2013. The current devices have 32-bit processors and will not work with the impending CAD (computer aided dispatch) software upgrade, which requires 64-bit processors. The CAD upgrade is slated for June 2019.

The new CAD software is being developed as part of the county-wide DuJIS (DuPage Justice Information System) project, of which the Village is a participant. The Emergency Telephone System Board (ETSB) of DuPage County approved a contract back in 2016 to replace its Computer-Aided Dispatch Mobile Client, Field Based Reporting and Record Management Systems. Additionally, to assist member agencies, the County ETSB put out an RFP for hardware that will support the new CAD software.

Staff evaluated the equipment selected by the County for several months and has been satisfied with its performance. Furthermore, the cost of the hardware from the County RFP response is lower than the cost of ruggedized hardware devices that are listed on the statewide contract.

Staff recommends the purchase from Insight Public Sector, Inc. for a total cost of \$109,628.40.

Price Breakdown

Description	Unit Cost	Quantity	Extended Cost
Antenna	\$133.24	35	\$4,663.40
Dell Latitude 5420 Rugged Laptop	\$2,399.00	35	\$83,965.00
Docking Station	\$600.00	35	\$21,000.00
		Total:	\$109,628.40

ATTACHMENTS

Quotation

ETSB of DuPage County Contract and RFP Response

ETSB of DuPage County – Insight Public Sector, Inc. Contract Extension



INSIGHT PUBLIC SECTOR SLED
6820 S HARL AVE
TEMPE AZ 85283-4318
Tel: 800-467-4448

Page 1 of 2

SOLD-TO PARTY 10328359

VILLAGE OF DOWNERS GROVE
ACCOUNTS PAYABLE
801 BURLINGTON AVE
DOWNERS GROVE IL 60515-4782

SHIP-TO PARTY

VILLAGE OF DOWNERS GROVE
ACCOUNTS PAYABLE
801 BURLINGTON AVE
DOWNERS GROVE IL 60515-4782

Quotation	
Quotation Number	: 220774280
Document Date	: 02-JAN-2019
PO Number	:
PO Release	:
Sales Rep	: Bob Erwin
Email	: BERWIN@INSIGHT.COM
Telephone	: 4803667058

We deliver according to the following terms:

Payment Terms : Net 30 days
Ship Via : Insight Assigned Carrier/Ground
Terms of Delivery : FOB DESTINATION
Currency : USD

Material	Material Description	Quantity	Unit Price	Extended Price
3000032084472	DELL LATITUDE 5420 OPEN MARKET	35	2,399.00	83,965.00
A7916311-VODG	VODG-DOCKING STATION FOR DELL'S LATITUDE 14 RUGGED AND LATITUDE 12 & 14 RUGGED EXTREME NOTEBOOKS WITH POWER SUPPLY (ADVANCED PORT PLICATION) OPEN MARKET	35	600.00	21,000.00
A5481447-VODG	ANTENNA PLUS AP-CELL/LTE/WIFI - ANTENNA - NAVIGATION, CELLULAR, WI-FI - 3 DBI - OMNI-DIRECTIONAL - BLACK OPEN MARKET	35	133.24	4,663.40
			Product Subtotal	109,628.40
			TAX	0.00
			Total	109,628.40

Thank you for considering Insight. Please contact us with any questions or for additional information about Insight's complete IT solution offering.

Sincerely,

Bob Erwin
4803667058
BERWIN@INSIGHT.COM

Insight Global Finance has a wide variety of flexible financing options and technology refresh solutions. Contact your Insight representative for an innovative approach to maximizing your technology and developing a strategy to manage your financial options.

The U.S. government has imposed tariffs on technology-related goods. Many of Insight's OEM and distribution partners have notified Insight that these tariffs will result in frequent and significant price increases. Some of our major partners have already

**Quotation Number** 220774280**Document Date** 02-JAN-2019**Page** 2 of 2

provided Insight with cost increases, in some instances multiple times per day, while other providers are still assessing their situations. Due to the situation it is possible this quote may be subject to cost changes for Insight which will necessitate changes to the quoted pricing, or withdrawal of the quote.

This purchase is subject to Insight's online Terms of Sale unless you have a separate purchase agreement signed by both your company and Insight, in which case, that separate agreement will govern. Insight's online Terms of Sale can be found at: http://www.insight.com/en_US/help/terms-of-sale-products-ips.html

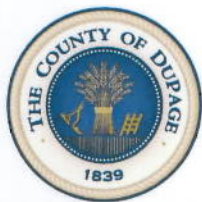

DuPage County Procurement Services Division

Bruce Flowers, Buyer
421 North County Farm Road, Room 3-400
Wheaton, Illinois 60187

(630) 407-6166

Bruce.Flowers@dupageco.org

CONTRACT #17-204-BF BETWEEN INSIGHT PUBLIC SECTOR, INC AND THE ETSB OF DUPAGE COUNTY

1.1.a Contract Introduction

THIS AGREEMENT is entered into this 16th day of November 2017, between the ETSB of DuPage County, Illinois a body corporate and politic, located at 421 North County Farm Road, Illinois, 60187-3978 (hereinafter referred to as the DUPAGE ETSB), and INSIGHT PUBLIC SECTOR Inc, located at 6820 S. Hart Ave., Tempe, AZ 85283 (hereinafter referred to as the VENDOR).

RECITALS

WHEREAS, the DUPAGE ETSB requires the goods and/or services specified in Bid #17-204-BF and

WHEREAS, the VENDOR is the vendor selected pursuant to the Bid process and is willing to perform under the terms of the Bid and this Contract.

NOW, THEREFORE, in consideration of the premises and mutual covenants contained herein, the parties agree that:

1.0 CONTRACT DOCUMENTS

- 1.1 This Contract includes all of the following component parts, all of which are fully incorporated herein and made a part of the obligations undertaken by the parties:
 - 1.1.a Contract Introduction
 - 1.1.b Bid Invitation
 - 1.1.c Project Information
 - 1.1.d Instructions to Offerors
 - 1.1.e General and Special Conditions and Terms
 - 1.1.f Special Conditions
 - 1.1.g Insurance/Bonding Requirements and Certificates
 - 1.1.h Bid Form (including Certification/Bid, Signature Affidavit including Bid Pricing)
 - 1.1.i Specifications (including any addenda, interpretations and approved exceptions)
 - 1.1.j Exhibits
 - 1.1.k Addenda
 - 1.1.l County Purchase Order
- 1.2 All documents are or will be on file in the office of the Procurement Services Division, DuPage Center, 421 North County Farm Road, Room 3-400, and Wheaton, Illinois 60187.

EMERGENCY TELEPHONE SYSTEM BOARD OF DU PAGE COUNTY, ILLINOIS

- 1.3 In the event of a conflict between any of the above documents, the documents control from top to bottom; i.e., "a" controls over "b" unless noted otherwise on this 1.1.a Contract Introduction.

2.0 DURATION OF THIS CONTRACT

- 2.1 Unless terminated as provided in the Bid Invitation, the term of this Contract shall be a one-year period beginning on December 1, 2017 and continuing through November 30, 2018.
- 2.2 The Contract term is subject to three (3) one-year renewals according to mutual acceptance of same pricing and terms from original bid.
- 2.3 In no event shall the term exceed four (4) years.

3.0 BID PRICES AND PAYMENT

- 3.1 The VENDOR shall provide the required goods and or services described in the Bid Specifications for the prices quoted on the Bid Form.
- 3.2 The County shall make payment pursuant to the Illinois Local Government Prompt Payment Act, except that no payment shall be approved where the Proposer has failed to comply with certified payroll requirements of the Illinois Prevailing Wage Act or Davis Bacon Act.
- 3.3 Pursuant to BID 17-204-BF, the DuPage ETSB negotiated a joint-purchasing program on behalf of itself and the various public safety member agencies to potentially purchase the goods sought. VENDOR's prices shall be made available to the individual agencies. All purchases made through this joint-purchasing program will be between the VENDOR and the individual agency. DuPage ETSB shall not make purchases on behalf of the individual agencies, unless by later mutually agreed upon amendment.

4.0 AMENDMENTS

- 4.1 This Contract may be amended by mutual agreement.
- 4.2 All amendments will conform to State of Illinois Statutes and County procedures for Change Orders.

5.0 CONTRACT ENFORCEMENT - ATTORNEY'S FEES

- 5.1 If the County is required to take legal action to enforce performance of any of the terms, provisions, covenants and conditions of this Contract, and by reason thereof, the County is required to use the services of an attorney, including the States Attorney, then the County shall be entitled to reasonable attorney's fees and all expenses and costs incurred by the County pertaining thereto and in enforcement of any remedy, including costs and fees relating to any appeal.

6.0 SEVERABILITY CLAUSE

- 6.1 If any section, paragraph, clause, phrase or portion of this Contract is for any reason determined by a court of competent jurisdiction to be invalid and unenforceable, such portion shall be deemed separate, distinct and an independent provision, and the court's determination shall not affect the validity or enforceability of the remaining portions of this Contract.

EMERGENCY TELEPHONE SYSTEM BOARD OF DU PAGE COUNTY, ILLINOIS

- 7.0 **GOVERNING LAW**
 - 7.1 This Contract shall be governed by the laws of the State of Illinois both as to interpretation and enforcement. Venue for all disputes will be exclusively in the circuit court for the Eighteenth Judicial Circuit in DuPage County, Illinois and that Illinois law will control.

- 8.0 **ENTIRE AGREEMENT**
 - 8.1 This Contract, including the documents listed in 1.0, contains the entire agreement between the parties.
 - 8.2 There are no covenants, promises, conditions, or understandings; either oral or written, other than those contained herein.

IN WITNESS WHEREOF, the parties set their hands and seals as of the date first written above.

INSIGHT PUBLIC SECTOR INC.

By: 
_____ AUTHORIZED SIGNATURE
David Cristal, Vice President / General Manager

_____ TITLE

ETSB OF DUPAGE COUNTY

By: _____
GARY GRASSO
BOARD CHAIRMAN



Insight Public Sector, Inc. Proposal Response

PREPARED FOR

Emergency Telephone System Board of DuPage County

ITB Mobile Data Terminals

October 27, 2017@ 2:30 PM

SUBMITTED BY:

Bob Erwin

Account Executive

t: 847.322.0898

e: berwin@insight.com



Cover Letter

October 27, 2017

Mr. Bruce Flowers, Buyer II
DuPage County Procurement Office
421 North County Farm Road, Room 3-400
Wheaton, IL 60187-3978
T: 630-407-6166
E: Bruce.flower@dupageco.org

RE: ITB #17-204-BF for Mobile Data Terminals (MDT) Police, Fire and Emergency Vehicles

Dear Mr. Flowers:

Insight Public Sector, Inc. (Insight) is pleased to participate in the Emergency Telephone System Board of DuPage County, ITB #17-204-BF for the acquisition of Mobile Data Terminals (MDT) for Police, Fire and Emergency Vehicles. Based on the scope of the requirements, Insight has prepared a response that represents a comprehensive effort at meeting the public safety needs of DuPage County.

For this engagement, Insight will partner with industry leader, Dell for the procurement of best-in-class laptops and tablets selected to meet DuPage County's configuration requirements.

Insight Public Sector is solely focused on the needs of local, state and federal governments as well as the educational institutions. With an industry-leading selection of products, a complete suite of IT services and a wide range of government contracts, Insight helps organizations streamline procurement, simplify deployment and maximize the value of the IT lifecycle.

Insight believes we are the right company for this contract and can become a beneficial and strategic partner with the Emergency Telephone System Board of DuPage County. Insight is a leading provider of IT products and services for the public sector. Our direct vendor relationships, along with sales revenues totaling \$5.5 billion in 2016, have helped us to build our infrastructure to meet large volume rollouts and have given us the versatility to tailor our services to our customers' individual needs. Our experienced sales team understands the public sector's needs and is focused on real-world solutions.

With 29 years in the IT industry, we offer unsurpassed commitment, management, and oversight in ensuring the success of meeting the defined deliverables. Every one of us at Insight is committed to delivering the highest level of technical expertise and service to the Public Safety agencies of DuPage County. Insight will ensure the technology-related services required will be provided in a seamless, efficient, and quality manner maintaining the highest customer satisfaction within the DuPage County mobile environment.

Insight ITB Response
Emergency Telephone System Board of DuPage County
Mobile Data Terminals (MDT) #P17-204-BF



We look forward to the opportunity to further present our Insight value and public sector solutions. Should the County or the Emergency Telephone System Board have any questions, concerns or requests for additional information, please do not hesitate to contact your Account Executive, Bob Erwin at 847.322.0898 / berwin@insight.com or Cheryl Jonagan at 480.409.6631 or IPSBidSupport@insight.com.

Sincerely,

A handwritten signature in blue ink, appearing to read "Ken Lamneck".

Ken Lamneck
President and CEO



TABLE OF CONTENTS

COVER LETTER 2

PROJECT INFORMATION..... 5

GENERAL CONDITIONS 7

SPECIAL CONDITIONS15

VENDOR QUALIFICATIONS:22

SPECIFICATIONS39

W-9 FORM52

REFERENCES53

BIDDERS SUBCONTRACTORS54

SAMPLE CONTRACT AGREEMENT56

ATTACHMENT 1 – WARRANTY INFORMATION59

ATTACHMENT 2 – ADVERTISING LITERATURE/SPEC. SHEETS60

Insight ITB Response
 Emergency Telephone System Board of DuPage County
 Mobile Data Terminals (MDT) #P17-204-BF



PROJECT INFORMATION

Invitation To Bid:	#17-204-BF	BID ISSUE DATE:	October 6, 2017
BID DESCRIPTION:	Mobile Data Terminals Police, Fire and Emergency Vehicles		
BID OPENING DATE:	October 27, 2017	PROPOSAL OPENING TIME:	2:30 pm
SUBMIT SUBMIT	1 ORIGINAL PLUS 1 Copy	BOND REQUIRED:	NO

FULL NAME OF BIDDER	Insight Public Sector, Inc.
BID CONTACT PERSON	Bob Erwin, Account Executive
TEL. # / EMAIL ADDRESS	(847) 322-0898 berwin@insight.com
COMPANY NAME	Insight Public Sector, Inc.

PROJECT NAME:	Mobile Data Terminals
USER DEPARTMENT:	EMERGENCY TELEPHONE SYSTEM BOARD (ETSB)

Insight ITB Response
 Emergency Telephone System Board of DuPage County
 Mobile Data Terminals (MDT) #P17-204-BF



EVENT:	LOCATION:	Date:	Time:
Deadline for Exceptions to Bid Language and Specification Inquiries.	Must be submitted in writing to: Bruce.flower@dupageco.org	October 13, 2017	2:30 pm
Response to Inquiries	Via E-mail	October 18, 2017	4:30 PM
Bidders Proposal Due	Procurement Services Room 3-400	October 27, 2017	2:30 PM

✓	SUBMITTAL CHECKLIST (BID PACKET SHOULD BE RETURNED IN ITS ENTIRETY)
✓	ORIGINAL BID WITH ONE BUSINESS CARD ATTACHED
✓	1 COPY WITH ONE BUSINESS CARD ATTACHED
✓	PROPOSAL PRICING (INCLUDING UNIT PRICES, WHERE REQUIRED
✓	ADDENDA NUMBER ACKNOWLEDGED, IF APPLICABLE
✓	REFERENCES
✓	PROPOSAL PRICING (INCLUDING UNIT PRICES, WHERE REQUIRED)
✓	CERTIFICATION/PROPOSAL SIGNATURE AFFIDAVIT PAGE, COMPLETED, WITH SEAL (IF CORPORATION) NOTARY PUBLIC AND AUTHORIZED SIGNATURE
✓	JOINT PURCHASING SECTION, COMPLETED
✓	WARRANTY INFORMATION
✓	COMPLETED VENDOR ETHICS DISCLOSURE FORM (SIGNED)
✓	COMPLETED IRS-Form W-9

GENERAL CONDITIONS

ADDENDUM AND SUPPLEMENT TO INVITATION TO BID (ITB):

If it becomes necessary or advisable to revise any part of this ITB or if additional data is necessary to enable the exact interpretation of provisions of this ITB, revisions will be provided in the form of an Addendum. If revisions are made after any mandatory Pre-Bid conference, the revisions will be provided only to those Contractors who will have attended the Pre-Bid conference.

Addendum information is available over the internet at www.DemandStar.com. Adobe Acrobat® Reader may be required to view this document. We strongly suggest that you check for any addendum a minimum of forty-eight (48) hours in advance of the bid deadline.

Response: Insight has read and understands.

APPLICABLE CODES AND ORDINANCES:

Contractor hereby certifies that all materials used conform to all articles and sections of all current applicable National Building Codes and other relevant construction-related codes. Workmanship and materials shall conform to all local applicable codes and ordinances.

Response: Insight certifies that all materials used for this project will conform to all articles and sections of all current applicable National Building Codes and other relevant construction-related codes. Further, we certify that all workmanship and materials will conform to all local applicable codes and ordinances.

CHANGES:

The ETSB of DuPage County reserves the right to make any desired change in the specifications after the same shall have been put under contract; but the change so made, with the price to be added or deducted from the contract price, therefore, shall be agreed upon in advance between ETSB of DuPage County and the successful Contractor.

Illinois law requires that changes in excess of \$10,000 or extensions greater than thirty (30) days must comply with the Criminal Code. The Procurement Services Division shall issue to the successful contractor a written change order to the original contract; such change orders shall be binding upon both parties thereto and shall in no way invalidate or make void the terms of the original contract not modified by such change.

Response: Insight has read and understands.

Insight ITB Response
Emergency Telephone System Board of DuPage County
Mobile Data Terminals (MDT) #P17-204-BF



COMMENCEMENT OF WORK:

The successful Contractor must not commence any billable work prior to the County's execution of the contract or until any required documents have been submitted. Work done prior to these circumstances shall be at the Contractor's risk.

Response: Insight has read and understands.

COMMUNICATIONS:

In an effort to create a more competitive and unbiased procurement process, the County desires to establish a single point of contact throughout the procurement process. From the issue date of this solicitation, until a contract has been awarded, all requests for clarification or additional information regarding this solicitation, or contact with the County personnel concerning this solicitation or the evaluation process, must be solely to the contact person listed on the cover page of this solicitation.

No contact regarding this document with other County employees or officers is permitted unless expressly authorized by the Buyer issuing the solicitation. A violation of this provision is cause for the County to reject the Bidder's proposal. If it is later discovered that a violation has occurred, the County may reject any proposal or terminate any contract awarded pursuant to this solicitation.

Questions will be answered within two (2) business days via email with a return reply acknowledging receipt of the email requested. Questions and answers in regard to the Scope of Work/Specifications will be shared with all bidders.

Response: Insight has read and understands.

CONFIDENTIAL INFORMATION AND COUNTY PROPERTY:

It is agreed that any and all specifications, drawings, or data furnished by ETSB of DuPage County shall (1) remain the ETSB of DuPage County's sole and exclusive property; (2) be considered and treated by Contractor as ETSB of DuPage County's confidential information, and not be copied, reproduced or duplicated in any manner or disclosed to any person or party, except as is necessary in the performance of this contract and (3) be returned upon request.

Response: Insight has read, understands and will comply.

CONTRACTOR PERFORMANCE:

The Instructions to Bidders, Bid Form, General Conditions, Special Conditions, Contract Specifications and Attached Exhibits, together with the approved purchase order shall be incorporated in and become terms of the Contract. All items shall be supplied in strict

Insight ITB Response
Emergency Telephone System Board of DuPage County
Mobile Data Terminals (MDT) #P17-204-BF



accordance with the specifications. The Contractor's performance under the terms of the Contract shall be to the satisfaction of the County. Failure to comply with any statutory requirements shall be deemed a performance breach.

Response: Insight has read and understands.

DISCIPLINE:

Nothing herein shall be construed to imply that the ETSB of DuPage County is retaining control over the operative details of the Contractor's work or the Subcontractor's employee's work. The Contractor is assuming all oversight, and the Contractor is ensuring compliance with safety guidelines.

Response: Insight has read and understands.

DRUG FREE WORKPLACE:

The Contractor (whether an individual or company) agrees to provide a drug free workplace as provided for in 30 ILCS 580/1 et seq.

Response: Insight has read, understands and will comply.

ENDORSEMENTS:

Contractor shall not use the name, seal or images of ETSB of DuPage County in any form of endorsement to any third-party without the County's written permission.

Response: Insight has read and understands.

F.O.B.:

All goods are to be shipped prepaid, F.O.B. delivered and installed. The total price quoted by the Bidder must be the total cost delivered to the location(s) stated. Bidder must not qualify his bid by stating a F.O.B. location other than such stated location(s). Shipments sent C.O.D. without ETSB of DuPage County's written consent will not be accepted and will at Contractor's risk and expense, be returned to Contractor.

Unauthorized shipments are subject to rejection and return at Contractor's expense.

Response: Insight has read and understands.

Insight ITB Response
Emergency Telephone System Board of DuPage County
Mobile Data Terminals (MDT) #P17-204-BF



FORCE MAJEURE:

The ETSB of DuPage County shall not hold Contractor liable for an extraordinary interruption of events, or damage of County property, by a natural cause that cannot be reasonably foreseen or prevented; i.e., droughts, floods, severe weather phenomena, et cetera.

Response: Insight has read and understands.

HOLDING OF PROPOSALS:

Bidder may withdraw the bid at any time prior to the time specified as the closing time for the receipt of bids. However, no Bidder shall withdraw or cancel the bid for a period of ninety (90) calendar days after said closing time for the receipt of bids. Unauthorized withdrawal may result in forfeiture of the bid bond, or if no bid bond is required, the withdrawing Bidder shall pay the sum of \$500.00 as liquidated damages for the County's loss in re-bidding.

Response: Insight has read and understands.

INDEMNITY:

The Contractor shall, at all times, to the extent permitted by law, fully indemnify, hold harmless, and defend the County and its officers, agents, and employees from and against any and all claims and demands, actions, causes of action, and cost and fees of any character whatsoever made by anyone whomsoever on account of or in any way growing out of the performance of this contract by the Contractor and its employees, or because of any act or omission, neglect or misconduct of the Contractor, its employees and agents or its subcontractors including, but not limited to, any claims that may be made by the employees themselves for injuries to their person or property or otherwise, and any claims that may be made by the employees themselves or by the Illinois Department of Labor for the Contractor's violation of the Illinois Prevailing Wage act (820 ILCS 130/1 et seq.).

Such indemnity shall not be limited by reason of the enumeration of any insurance coverage or bond herein provided.

Nothing contained herein shall be construed as prohibiting the County, its officers, agents, or its employees, from defending through the selection and use of their own agents, attorneys and experts, any claims, actions or suits brought against them.

The Contractor shall likewise be liable for the cost, fees and expenses incurred in the County's or the Contractor's defense of any such claims, actions, or suits.

Insight ITB Response
Emergency Telephone System Board of DuPage County
Mobile Data Terminals (MDT) #P17-204-BF



The Contractor shall be responsible for any damages incurred as a result of its errors, omissions or negligent acts and for any losses or costs to repair or remedy construction as a result of its errors, omissions or negligent acts.

The County does not waive its defenses or immunities under the Local Government and Governmental

Response: Insight has read and understands.

LAW GOVERNING:

The ITB and resulting contract shall be governed by the laws of Illinois. Bidder agrees to comply with all applicable State and Federal laws.

Response: Insight has read, understands and will comply.

LIENS, CLAIMS, AND ENCUMBRANCES:

Contractor warrants and represents that all the goods and materials ordered herein are free and clear of all liens, claims, or encumbrances of any kind.

Response: Insight has read, understands and complies.

LOBBYIST REGISTRATION:

Bidder shall comply with the provisions of Chapter 2, Article IX, Section 2-600, Lobbyist Registration of the Code of DuPage County, Illinois.

Response: Insight has read and understands.

SDS:

When applicable, Contractor shall furnish Safety Data Sheets for their products, in compliance with the Illinois Toxic Substance Disclosure to Employee Act and the "Right-to-Know" law, 820 ILCS 220/0.01 and 820 ILCS 225/0.1. Safety Data Sheets, upon award of Contract, shall be submitted to the County Procurement Services Division.

Response: Insight has read, understands and will comply.

MISCELLANEOUS REQUIREMENTS:

The County will not be responsible for any expenses incurred by the Contractor in preparing and submitting a Bid. All Bids shall provide a straightforward, concise delineation of your capabilities to satisfy the requirements of this request. Emphasis should be on completeness and clarity of content.

Response: Insight has read and understands.

Insight ITB Response
Emergency Telephone System Board of DuPage County
Mobile Data Terminals (MDT) #P17-204-BF



NON-DISCRIMINATING:

The Contractor, its employees and subcontractors, agree not to commit unlawful discrimination and agree to comply with applicable provisions of the Illinois Human Rights Act, the U.S. Civil Rights Act and Section 504 of the Federal Rehabilitation Act, and rules applicable to each.

Response: Insight has read, understands and will comply.

PATENTS:

Contractor undertakes and agrees to defend at Contractor's own expense all suits, actions, or proceedings in which the ETSB of DuPage County, its Officers, agents or employees are made defendants for actual or alleged infringement of any U.S. or foreign letters patent resulting from the use or sale of the items purchased hereunder. Contractor shall inform the ETSB of DuPage County whenever infringement will result from Contractor's adherence to specifications supplied by the ETSB of DuPage County or by an authorized County representative. Contractor further agrees to pay and discharge any and all judgments or decrees, which may be rendered in any such suit, action or proceedings against the ETSB of DuPage County, its Officers, agents or employees therein.

Response: Insight has read, understands and will comply.

PAYMENT:

Original invoices must be presented for payment in accordance with instructions contained on the Purchase Order including reference to Purchase Order number and submitted to the correct address for processing. The County shall pay all invoices pursuant to 50 ILCS 505, "Local Government Prompt Payment Act". Invoices containing charges for work subject to the Illinois Prevailing Wage Act (820 ILCS 130/) are required to be accompanied by the applicable Certified Transcript of Payroll form(s) for acceptance.

*Payment will not be made on invoices submitted later than six-months (180 days) after delivery of goods and **any statute of limitations to the contrary is hereby waived.***

Response: Insight has read, understands and will comply.

PROTEST:

No protest shall be based on a matter or issue which could have been raised as an exception prior to bid opening.

Any protest concerning the award of a contract shall be decided by the Procurement Officer. Protests shall be made in writing to the Procurement Services Division and shall be filed within three (3) business days of final approval and acceptance of the bid by the County Board. A

Insight ITB Response
Emergency Telephone System Board of DuPage County
Mobile Data Terminals (MDT) #P17-204-BF



protest is considered filed when received by the Procurement Services Division. The written protest shall include the name and address of the protestor, the ITB number, a statement of the specific reasons for the protest and supporting exhibits. The procurement Officer will respond to the written protest within seven (7) days. The Procurement Officer's decision relative to the protest shall be final.

Upon receipt of a protest the County may, but is not required to, delay its order under the awarded contract.

Response: Insight has read and understands.

RESERVATION OF RIGHTS:

The ETSB of DuPage County reserves the right to reject any or all bids failing to meet the County's specifications or requirements and to waive technicalities. If in the ETSB of DuPage County's opinion, the lowest bid is not the most responsible bid, considering value received for monies expended, the right is reserved to make awards as determined solely by the judgment of the ETSB of DuPage County.

In determining the lowest responsible bidder, the County shall take into consideration the qualities of the articles supplied, their conformity with the specifications, and their suitability to the requirements of the County and the delivery terms. Intangible factors, such as the Bidder's reputation and past performance, will also be weighed.

The Bidder's failure to meet the mandatory requirements of the ITB will result in the disqualification of the bid from further consideration.

The County further reserves the right to reject all bids and obtain goods or services through intergovernmental or cooperative agreements, or to issue a new and revised ITB.

Submission of a bid confers no rights on the Contractor to a selection or to a subsequent contract. All decisions on compliance, evaluation, terms and conditions shall be made solely at the County's discretion and shall be made in the best interest of the County.

Response: Insight has read and understands.

TAX:

The ETSB of DuPage County does not pay Federal Excise Tax or Illinois Sales Tax. The tax exemption number is E9997-4551-07. A copy of the exemption letter is available upon written request.

Response: Insight has read and understands.

Insight ITB Response
Emergency Telephone System Board of DuPage County
Mobile Data Terminals (MDT) #P17-204-BF



TERMINATION, CANCELLATION AND DAMAGES:

This contract may be terminated upon mutual agreement of both parties.

The County may terminate based on the Contractor's breach or default. Unless the breach or default creates an emergency situation, as determined in the County's sole discretion, the Contractor shall be given notice and a five (5) day opportunity to correct before the termination becomes effective.

If the County terminates this Contract because of the Contractor's breach or default, the County shall have the right to purchase items or services elsewhere and to charge the Contractor with any additional cost incurred, including but not limited to the cost of cover, incidental and consequential damages and the cost of re-bidding. The County may offset these additional costs against any sums otherwise due to the Contractor under this bid or any unrelated contract.

If the ETSB of DuPage County fails to appropriate funds to enable continued payment of multi-year Contracts the County may cancel, without termination charges, provided Contractor received at least thirty (30) days prior written notice of termination.

Response: Insight has read and understands.

TRANSFER OF OWNERSHIP OR ASSIGNMENT:

The terms and conditions of this contract shall be binding upon and shall enure to the benefit of the parties hereto and their respective successors and assigns. Prior to any sales or assignments the ETSB of DuPage County must be notified and approve the same in writing.

Response: Insight has read and understands.

VENUE:

By submitting a response, bidder agrees that venue for all disputes arising out of the solicitation process, including but not limited to judicial review of any protest decision, will be exclusively in the circuit court for the Eighteenth Judicial Circuit in DuPage County, Illinois and that Illinois law will control.

Response: Insight has read and understands.

Warranty Information:

Complete warranty information detailing period and coverage must be submitted.

Response: Please see Attachment 1 for warranty information as required.

Insight ITB Response
Emergency Telephone System Board of DuPage County
Mobile Data Terminals (MDT) #P17-204-BF



SPECIAL CONDITIONS

ACCURACY DISCLAIMER:

The Contractor shall thoroughly acquaint himself with the sites for the proposed bid to fully understand the facilities, difficulties and restrictions attending to the execution of the bid. The Contractor will be allowed no additional compensation for his failure to be so informed.

Response: Insight has read, understands and will comply.

COMPLIANCE WITH ILLINOIS STATE LAW:

By submitting a response, offeror certifies that it has obtained all required authorizations, certifications, and/or licenses required by law to perform the work described herein and transact business within the State of Illinois. This includes, but is not limited to, in the case of a foreign business corporation, limited liability company, limited partnership, or limited liability partnership, authorization from the Illinois Secretary of State to transact business within the State of Illinois.

To determine if you are a Corporation / LLC in with a "Certificate in Good Standing", please visit the Illinois Secretary of State website: <https://www.ilsos.gov/corporatellc/CorporateLlcController>. Input your company name and under the Corporation File Detail Report, your Status should be "Active" to be approved for doing business with DuPage County. If it is not, please contact the Secretary of State office to activate.

Response: Insight has read, understands and has complied.

DELIVERY REQUIREMENTS:

All purchases must be delivered to the receiving dock, (address), or as otherwise specified by Buyer. All deliveries shall be made Monday through Friday between the hours of 8:30 a.m. and 3:00 p.m.

Response: Insight has read, understands and will comply.

DEMONSTRATION:

Pre-demonstration of unit may be required to determine suitability for our needs.

Response: Insight has read, understands and will comply.

EXTENDED WARRANTY OPTIONS:

Attach additional information, if available, to your bid submittal.

Insight ITB Response
Emergency Telephone System Board of DuPage County
Mobile Data Terminals (MDT) #P17-204-BF



Response: DuPage County can add selected support options to basic support. Options include Keep Your Hard Drive (KYHD) and Accidental Damage. An overview of basic support packages and extension options are provided below.

Next Business Day On Site

A Next Business Day service is provided as a minimum standard on all Dell Client equipment and selected Enterprise Equipment. This basic support provides telephone support during business hours and a next business day on-site (NBD) hardware repair service.

Dell's Next Business Day On-Site Service (NBD) places a Dell-certified engineer at the customer's location the following business day, after completion of telephone-based troubleshooting when a Dell technician accepts and logs a system fault call before 17:00 Monday-Friday, subject to parts availability.

Basic Support Extension option - Keep Your Hard Drive

Keep Your Hard Drive (KYHD) is a support service designed to give peace of mind to customers with sensitive, confidential and / or irreplaceable data stored on computer hard drives.

If, after completion of Dell's standard on-site diagnostic procedures, it is determined that the system has a faulty hard drive, the KYHD Service allows DuPage County to retain the faulty hard drive after it has been removed from the system by the Dell technician.

Keeping the hard drive means that DuPage County can either destroy the data on the hard drive according to your own security policy or attempt to retrieve the data on the faulty drive using a specialist data retrieval company, without the time pressure of trying to do this before the product is repaired. KYHD is also available as an option for ProSupport customers.

Please see Attachment 1 for detailed information on Dell's extended Warranty options including the Pro-Support Plus option.

INSPECTIONS:

Contractors are encouraged to inspect the ETSB of DuPage County equipment prior to bidding. The Contractor shall be responsible for all goods rejected by ETSB of DuPage County and returned to Contractor. The Contractor will initiate damage claims against carrier and/or manufacturers in the event of County DuPage non-acceptance. The Contractor shall replace or adjust the cost of all rejected items.

Response: Insight has read, understands and will comply.

Insight ITB Response
 Emergency Telephone System Board of DuPage County
 Mobile Data Terminals (MDT) #P17-204-BF



JOINT PURCHASING:

OTHER TAXING BODIES: Based on County Board Resolution IR-084-76.

Would your firm be willing to extend your bid to other taxing bodies in DuPage County such as school districts, townships, cities and villages, etc.? The approximate quantity usage is unknown.

YES _____ NO _____

State any other requirements that they would have to meet beyond that of our Bid invitation and specification.

NOTE: The ETSB of DuPage County would not be involved in purchasing by any other taxing body other than to receive a copy of their purchase order that would reference the ETSB of DuPage County contract number. The invoicing and payments would be entirely between the other taxing bodies and the Contractor. If the ETSB of DuPage County accepts this bid, the procedure to handle joint purchases would be developed by the ETSB of DuPage County with the Contractor and distributed to the taxing bodies by the ETSB of DuPage County.

Response: Insight has read and understands.

NON-EXCLUSIVITY:

Nothing herein is intended nor shall be construed as creating any exclusive arrangement with Vendor.

Response: Insight has read and understands.

LITERATURE:

Contractor must supply with their bid the latest printed specifications and advertising literature on the equipment they propose to furnish.

Response: Insight has read, understands and has complied.

MANUALS:

Contractor shall supply one (1) parts book, one (1) service and repair manuals and one (1) operator's manual with unit at time of delivery.

Response: Insight has read, understands and will comply.

Insight ITB Response
Emergency Telephone System Board of DuPage County
Mobile Data Terminals (MDT) #P17-204-BF



PRE-AWARD:

Bidder may be required to attend a pre-award meeting for clarifications, demonstrations, presentations; this meeting will be set with the Bidder prior to award of the contract.

Response: Insight has read, understands and will comply.

PAYMENTS:

Separate invoices shall be required for each ETSB of DuPage County Department participating in the purchase.

Response: Insight has read, understands and will comply.

Partial Payment

The Contractor may from time to time present to the ETSB of DuPage County a request for partial payment based on certification of work completed. All requests shall be accompanied by a release of lien or claims for that portion of the work completed. A ten percent (10%) security retention will be made on each partial payment and will become due at the point of final acceptance by the ETSB of DuPage County.

Response: Insight has read and understands.

Final Payment

From the final payment shall be retained all monies expended by the ETSB of DuPage County according to the terms of this contract and there under chargeable to the Contractor. Payment of the final sum and acceptance thereof by the Contractor shall release the ETSB of DuPage County from all claims and liabilities to the Contractor in connection with this contract. The final payment shall not become due until the Contractor shall deliver to the Owner a complete release of all claims or liens arising out of this Contract, or receipts in full in lieu thereof and, if required in either case, an affidavit that insofar as he has knowledge or information, release and receipts include all the labor and materials for which a lien of claim could be filed. If any claim or lien remains unsatisfied after all payments are made, the Contractor shall refund to the Owner all monies that the latter may be compelled to pay in discharging such a lien, including all costs and reasonable attorney's fee.

Response: Insight has read and understands.

PERMITS, FEES, AND NOTICES:

The Awarded Proposer shall secure and pay for all Building Permits and Governmental Fees, licenses, and inspection necessary for the proper execution and completion of the work which are legally

Insight ITB Response
Emergency Telephone System Board of DuPage County
Mobile Data Terminals (MDT) #P17-204-BF



required, file all notices, comply with all laws, rules, regulations and lawful orders bearing on the performance of the work.

Response: Insight has read, understands and will comply.

PRICING:

*Prices shall remain firm for a **one (1) year period** from contract award. Notice of any price increase, from a manufacturer only, shall be submitted to the County thirty (30) days in advance, along with proof of the corresponding price increase from your supplier. Price increases are subject to review and approval prior to acceptance.*

Response: Insight will hold pricing firm for these exact part numbers for a 4-year period of time. However, should part numbers change as items go end of life, Reseller will work with DuPage County to come to a mutually agreeable price.

PROPERTY FURNISHED TO CONTRACTOR BY ETSB OF DUPAGE COUNTY:

All property furnished to the Contractor by the ETSB of DuPage County or specifically paid for by the ETSB of DuPage County, for use in the performance of this contract, shall be and remain the property of the ETSB of DuPage County, shall be subject to removal upon the ETSB of DuPage County's instruction, shall be used only in filling orders from the ETSB of DuPage County, shall be held at the Contractor's risk, shall be kept insured by the Contractor at the Contractor's expense while in its custody or control in an amount equal to the replacement cost thereof, with loss payable to the ETSB of DuPage County, and upon recall by ETSB of DuPage County shall be packaged at Contractor's expense for shipment to ETSB of DuPage County in accordance with ETSB of DuPage County's instructions. Copies of policies or certificates of such insurance will be furnished to ETSB of DuPage County on demand.

It is agreed that any and all specifications, drawings, or data furnished by ETSB of DuPage County shall (1) remain the ETSB of DuPage County's sole and exclusive property; (2) be considered and treated by Contractor as ETSB of DuPage County's confidential information, and not be copied, reproduced or duplicated in any manner or disclosed to any person or party, except as is necessary in the performance of this order/contract and (3) be returned upon request.

Response: Insight has read, understands and will comply.

Insight ITB Response
Emergency Telephone System Board of DuPage County
Mobile Data Terminals (MDT) #P17-204-BF



QUANTITIES:

The ETSB of DuPage County reserves the right to increase or decrease the quantities shown herein at any time during the life of the contract to correspond to the actual needs of the ETSB of DuPage County.

*All quantities shown are **ESTIMATES ONLY** of anticipated volume for the one-year period from date of actual Purchase Order. Quantities represent total usage and not order lot quantities. Orders will be placed on an "AS-NEEDED" basis, with quantities specified at time of order placement.*

Response: Insight has read and understands.

RENEWAL & EXTENSION:

*The contract may be subject to three (3) additional twelve (12) month renewal periods provided there is no change in the terms, conditions, specifications, and prices and provided that such renewals are mutually agreed to by both parties. **In no event shall the term plus renewals exceed four (4) years.***

Response: Insight has read and understands.

SPLIT BIDS:

Contractors may bid on one or more categories. The ETSB of DuPage County reserves the right to award by total bid, by single item or by any combination of items, in accordance with our language in the Bid Document relating to Contractor selection (or rejection) in the best interest of the ETSB of DuPage County.

Response: Insight has read and understands.

SUBCONTRACTORS:

All subcontractors shall be identified on the form contained herein. Contractor shall require that the subcontractor comply with all Prevailing Wage Act requirements. The ETSB of DuPage County reserves the right to reject any or all subcontractors.

Response: Insight has read and understands.

TERMINATION:

Except as otherwise set forth in this AGREEMENT, either party shall have the right to terminate this AGREEMENT for any cause or without cause thirty (30) days after having served written notice upon the other party, except in the event of Vendor's insolvency, bankruptcy or receivership, in which case termination shall be effective immediately upon receipt of notice.

Insight ITB Response
Emergency Telephone System Board of DuPage County
Mobile Data Terminals (MDT) #P17-204-BF



Upon such termination, the liabilities of the parties to this AGREEMENT shall cease, but they shall not be relieved of the duty to perform their obligations up to the date of termination, or to pay for deliverables tendered prior to termination. There shall be no termination expenses.

Upon termination of this AGREEMENT, all data, work products, reports and documents produced, because of this AGREEMENT shall become the property of the COUNTY. Further, Vendor shall provide all deliverables within fourteen (14) days of termination in accordance with the other provisions of this AGREEMENT.

Response: Insight has read, understands and will comply.

THIRD PARTY AGREEMENT:

The County shall not enter into a third party rental agreement and reserves the right to disqualify a vendor so bidding.

Response: Insight has read and understands.

TRAINING:

The Contractor will be responsible for all key operators training required for the operation of proposed equipment at our site. All training shall be at no additional cost to the ETSB of DuPage County.

Future training for employees shall be available either on-site or Contractor's location. Contractor will also provide training for new employees and/or equipment, in a timely manner.

Response: Insight has read, understands, and will coordinate the appropriate vendors when training needs arise.

VENDOR QUALIFICATIONS:

Vendor will provide a general history, description and status of their Company.

Response: Insight has provided an overview of the company's history, description and status below.

About Insight

Insight Enterprises, Inc. (our parent company) is a leading technology provider of hardware, software and service solutions to business and government customers in the United States, Canada, Europe, and Asia-Pacific. Insight Enterprises, Inc. became a publicly traded company in 1995, selling its stock on the NASDAQ under the ticker symbol NSIT. Insight Enterprises, Inc. is ranked number 473 on Fortune Magazine's 2017 "Fortune 500" list. It is interesting to note that 416 of the global Fortune 500 companies are our customers.

Insight is a leading worldwide technology provider of integrated solutions to business and government clients. Through our extensive hardware, software and services offerings and efficient supply chain combined with highly skilled technology specialists and engineers, we provide integrated information technology ("IT") solutions to our clients' most compelling problems, helping them run their businesses smarter. Our ability to assess, design, deploy and manage IT solutions creates meaningful connections with our clients, enabling them to better manage and secure their IT environments. We are a single source for our clients' diverse IT needs; simplifying their businesses and helping them control their IT costs.

Our Purpose, Value, & Strategy

Our purpose is to make meaningful connections that help businesses run smarter. Our value is our ability to guide, advise, implement and manage IT solutions for our clients, and our strategy is to deliver relevant IT solutions to our clients on a scalable support and delivery platform. With the continual emergence of new technologies in the IT industry, we believe businesses continue to seek technology providers to supply value-added advice to help them identify and deploy complex IT solutions. Insight has a unique position in the market by providing enhanced value to our clients.

Insight at a Glance

- Founded in 1988, headquartered in Tempe, Arizona
- \$5.5 billion in revenues in 2016
- Leading global software reseller with extensive License Management Services
- Software lifecycle support for a majority of Global Fortune 500 companies
- More than 5,900 employees worldwide with operations in North America, Europe, and Asia-Pacific regions



- Serves 70,000 Enterprise, SMB, and Public Sector clients in 200+ countries
- More than 5,000 partnerships with hardware and software manufacturers and publishers
- SAS 70 Certified NOC
- On-hand, virtual and customer-owned inventory of \$3.3 billion
- Distribution Center moves 26,000 – 30,000 pieces a day
- Custom Configuration Lab formats 2,000 customer systems a day
- Over one million seats of cloud services have been provided

Partnerships

- Microsoft Gold Certified Partner
- VMware Premier Partner
- Cisco Gold Certified Partner
- EMC Premier Partner
- Microsoft Cloud Deployment & Azure Circle Partner
- HP Elite Partner
- IBM Premier Business Partner
- Lenovo Solution Partner

Insight and our family of companies - BlueMetal and Datalink - provide **end-to-end technology services** to help you to engage customers, enable your workforce, optimize your infrastructure and boost operational excellence.

With a **single source** for all of your IT needs, we align the latest technologies with your customer, workforce and infrastructure goals.

Insight is committed to your success. With a holistic approach to IT, we'll ensure nothing slips through the cracks as you work toward your business goals:

Insight's 5,100 partnerships with hardware, software and cloud providers mean we know these technologies inside and out – and how to align them with your goals.

Plan	Build	Manage
A solid foundation is vital. We assess, design and create a road map of your goals to help jump-start your transformation.	Our team executes on your goals by developing, configuring and/or migrating the technologies that help you succeed.	To help you stay effective after the rollout, we provide ongoing support and will optimize and maintain your new technology.

Stay Relevant

All thriving organizations have one thing in common: *They ask the right questions about their business, answer them honestly and pivot accordingly.* We've identified four key areas that are needed to stay relevant:

1. *How are you using technology to better engage your customers?* **Customer Engagement.** We'll show you how the digital world is transforming business – and how we will help you lead the charge through our strategy and IT services.
2. *How are you empowering employees to stay productive and satisfied?* **Workforce Enablement.** See how technology is impacting your workforce, and how we will help you make the most of it to help your business run smarter.
3. *Is your infrastructure enabling innovation, scale and efficiencies for your business?* **Infrastructure Optimization.** See how technology is impacting your infrastructure for better or for worse – and how Insight will help your business make the most of it to run smarter.
4. *Are you operating your infrastructure effectively while supporting your end users?* **Operational Excellence.** See how IT is affecting your business – and how our strategy and technology services can help you boost operational excellence with an agile infrastructure and more empowered users.

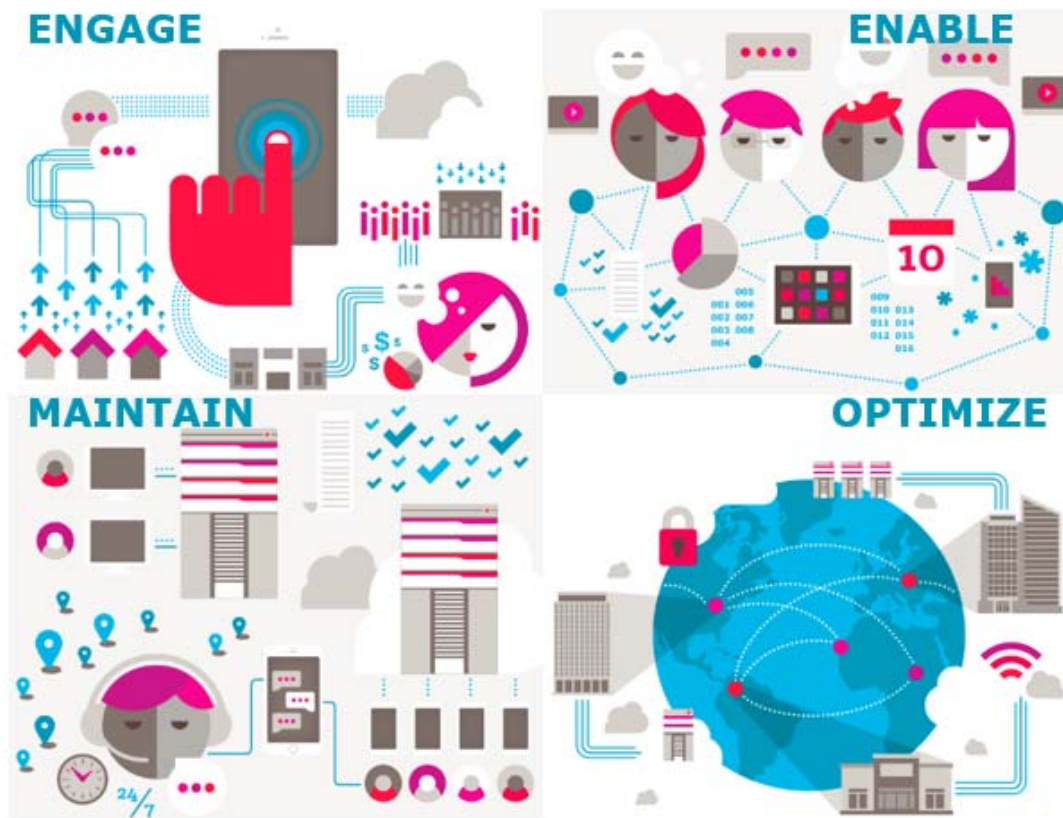

Insight ITB Response
 Emergency Telephone System Board of DuPage County
 Mobile Data Terminals (MDT) #P17-204-BF



Insight and our family of companies, including BlueMetal and Datalink, provide **end-to-end technology services** to help you engage customers, enable your workforce, optimize your infrastructure and boost operational excellence.



- Intelligent Customer Applications
- Modern Business
- Real-Time Business
- Hybrid Cloud
- Modern Workplace
- Branch Infrastructure
- Cloud
- Security
- Next-generation technology
- IT operations

In 2016, BlueMetal was named the Microsoft Internet of Things (IoT) Worldwide Partner of the Year for its commitment to driving digital transformation through a world of connected people, processes and technologies.



Datalink is a recognized leader in next-generation data center solutions. Together, our collective position as a market-leading Intelligent Technology Solutions™ provider is strengthened, with global scale and deep technical talent, focused on delivering comprehensive solutions to you.

Insight represents the **single source** for all your IT needs, aligning the latest technologies with your customer, workforce and infrastructure goals. With our **holistic approach to IT**, we ensure nothing slips through the cracks as you work toward your business goals.

Workforce Enablement

Enabling the next generation of workers through more connected technologies.

See how technology is impacting your workforce, and how we will help you make the most of it to help your business run smarter.

- **Workforce Applications** - From custom app development to collaboration, Workforce Applications, a BlueMetal solution, delivers a flexible, modernized approach that contains costs and helps you automate, collaborate and stay productive.
- **Modern Workplace.** We'll help you take control of your organization with workforce solutions. Infrastructure Optimization – Attaining a more modernized infrastructure that helps you focus on customer and workforce goals. See how technology is impacting your infrastructure for better or for worse—and how Insight will help your business make the most of it to run smarter.

Insight ITB Response
 Emergency Telephone System Board of DuPage County
 Mobile Data Terminals (MDT) #P17-204-BF



- **Unified Branch Infrastructure** - Whether on premises or in the cloud, our Unified Branch infrastructure solutions helps you scale cost-effectively, manage connectivity, and empower both your workforce and your customers.
- **Hybrid Cloud** - With our application-centric approach, we will help you understand your existing environment and how it is interconnected.
- **Intelligent Network** - From assessment to design and execution, our services and partnerships with the most trusted names in IT give your organization more capacity and availability than ever before.
- **Real-Time Business** - We will help you embrace the latest technologies with Real-Time Business, a BlueMetal solution. Through machine learning, advanced analytics and smart devices, you will power the future of your business.
- **Operational Excellence** – Enabling IT to support your business, so you can focus on what you do best.



See how IT is affecting your business—and how our strategy and technology services can help you boost operational excellence with an agile infrastructure and more empowered users.

- **Infrastructure Management** – We take on day-to-day operations, from application management, infrastructure monitoring, security and administration to swift troubleshooting—so you can spend more time growing and less time maintaining.
- **Lifecycle Services** - Insight's Lifecycle Services help you spend more time driving business growth while we handle everything else—from planning and deployment to overall IT asset management and ongoing support.
- **Workplace Services** - With next-generation solutions, best practices and true thought leadership, we help you cut costs and drive growth by simplifying and enhancing every moving part of your business.



End-to-End Lifecycle Solutions for Asset Management

We've simplified IT asset management with our end-to-end IT lifecycle solutions that help your organization maximize efficiency.

Insight's Lifecycle Services help you spend more time driving business growth while we handle everything else- from planning and deployment to overall IT asset management and ongoing support.

Start Fresh. Supported by a focused maturity model, we conduct robust assessments that give you deeper insight into how well you're delivering services and outline your unique goals. We'll help you create a more focused plan for driving efficiencies, ensuring a rapid quality deployment and containing costs. Our detailed assessments are supported by:

- Vendor and product road maps
- Market intelligence
- Executive briefings
- Planning and design sessions

Simplify Acquisition. Acquiring your new technology is a multistep process. Let us act as your single source of expertise, from procurement to financing and leasing and more. We'll help you optimize resources, keep your technology current and meet the demands of a rapidly shifting technology landscape.

Self-Service. Insight's secure, self-service e-commerce portal helps you save time, reduce soft costs and streamline purchases to drive business impact faster. Your account on insight.com lets you control everything from procurement to reporting, ongoing software management and even the cloud.

Reliable Partner. We handle everything from start to finish, to help you drive real business benefits.

Your investment in the hardware and software that support your business is just the beginning of the IT lifecycle. But managing how all of it gets set up, distributed, maintained, upgraded and remarketed for the next lifecycle is a lot to juggle.

Rapid implementation

Speed time to use, detect faulty assets and improve end-user experience with preconfiguration, just-in-time shipments and managed deployment.

Simplified maintenance

Reduce your organization's costs and stay in the know with best-in-class extended warranty services, remote network operations support and more.

Mindful asset disposition

Maximize the economic return on marketable equipment, protect sensitive data and reduce compliance risks with our asset disposition program.

Insight's Workplace Services

Insight's Workplace Services are solutions that provide the care and support your end users require from a source you can trust. From service desk to asset disposal, redeployment and remarketing, we provide the tools you need to keep your endpoints up and running flawlessly.

Together, we'll gain a better understanding of the challenges you face and apply our robust capabilities to help your business run smarter.

- **Success starts with Insight.** We have access to more resources and key industry relationships than any other outsourcing service provider.

4,000+	22	5,100+
Consulting & services delivery professionals	Countries with insight operations	Hardware, software & cloud partners

- **Create your Workplace of the Future.** With next-generation solutions, best practices and true thought leadership, we help you cut costs and drive growth by simplifying and enhancing every moving part of your business.
- **Future Forward Workforce.** At Insight, we have the expertise that you need to power your future-forward workforce. Advance your technology with services and resources while receiving unwavering support – preparing you for tomorrow and beyond.
- **Multitude of Benefits.** With Insight's breadth of solutions, you can expect a multitude of benefits to your business.

Self-service & automation	Enterprise mobility management	Continuous improvement & governance
Reduce downtime and manage costs with automation and self-service capabilities like password reset and new-hire onboarding.	Enhance user experience and manage large-scale secure mobile deployments without the need for additional staff.	Achieve business value and maturity with knowledge management, data analytics and continuous improvement road mapping.

- **End-to-End Support.** We combine traditional end-user services – sourcing, integration, service desk, on-site support and disposition – with governance and transformation. So your business objectives are met and you gain knowledge management, data analytics, self-service and continuous improvement road maps.

- **Flexible Solutions.** With flexible solutions and one partner to skillfully support your entire IT lifecycle, we'll help you reduce support costs, achieve program governance and create a more mature and capable infrastructure.
- **Save Money.** Based on our estimates, clients internally supporting IT could save up to 30%, and those with traditional outsourcing could save an average of 15%. No matter the environment, we have a forward-thinking solution that cuts costs and drives outcomes.
- **Asset Disposition.** Maximize your economic return on your IT assets, while ensuring data security and EPA compliance with our remarketing, redeployment and disposition service.
- **Save Money. Secure Data. Go Green.** Our best-in-class asset disposition program maximizes your economic return on equipment and protects data, as well as the environment – so you can save more, focus on your business and have peace of mind.
- **Trusted Partner.** Working with reputable IT asset disposition vendor Sipi Asset Recovery, we put your technology through a tried and true, rigorous review to determine the best route for your end-of-life assets – from remarketing to redeployment to disposition.
- **Certificate of Erasure.** With a Department of Defense (DOD) 5220.22M hard drive wipe, Insight renders the data on your legacy drive completely erased, providing a certificate of erasure so you can be sure your assets are protected.
 - Better visibility into your environment
 - Centralized traceability
 - Easier reporting and documentation

Asset program makes every day Earth Day. Insight helps companies repurpose used technology safely, all while determining the best opportunities to maximize the marketability of the assets.

Customized Online Reporting. Through a personalized disposition portal, information guiding your entire asset disposal process stays safe and in one central hub – from serial numbers to shipment records, certificates of destruction and more. That means:

Certificate of Recycling. Protecting the environment is important to organizations and customers alike. From the glass in your monitor to the copper in your power supply, we will send salvageable items to recycling vendors and provide you with a Certificate of Recycling.

Proven Methods. Reduce risk and ease management by leveraging a single point of contact with a successful track record and proven methods.

Strong remarketing

Through a network of buyers, remarketable equipment can be sold based on highest rate of return, giving you trade-in dollars.

Enterprise mobility management

Manage all redeployment activities, including end of lease and returning assets to your environment for continued use.

Confident disposition

Ensure EPA compliance with a disposal process that's sensitive to environmental regulations and the latest EPA mandates.

End-User Support Services

Get flexible, scalable and certified technical resources for deployment, installs, moves, adds and changes, and desk-side support.

Focus on Business. Streamline your deployments and minimize end-user and business disruptions while saving money with Insight's wide range of technical capabilities. Management and governance are provided through the Insight command center 24/7 to ensure you're seeing year-over-year improvements.

Extend your Team. Obtaining and retaining the necessary talent to maintain your operations can drain precious resources, hindering your ability to focus on innovating. Our technicians provide specialized support to free your internal teams, helping you achieve low turnover and a more engaged workforce through:

- Original Equipment Manufacturer (OEM) – certified support
- Dedicated on-site or dispatched resources
- Installs, moves, adds, changes and deskside services

Governance

Full-time program managers provide dedicated oversight of all activities to ensure service levels are met.

Specialized support

Get dedicated or on-demand technical resource support for campus and remote locations to meet your unique needs.

Fast troubleshooting

Keep moving with an OEM-authorized depot for warranty services, advanced exchange programs and repair.

Why Dell Products?

Dell has over 30 years of experience of manufacturing and installing computer products as well as providing numerous services. Dell is a leading global information technology company that offers its customers a broad range of I.T solutions and equipment. Dell is focused on providing technology solutions that are efficient, accessible and easy to manage. They have operations and conduct business in three geographic regions:

- The Americas region, based in Round Rock, Texas, covers the US, Canada and Latin America
- The EMEA region, based in Bracknell, England, covers Europe, the Middle East and Africa

- The APJ region, based in Singapore, covers the Asian countries of the Pacific Rim, Australia, New Zealand and India

They have also invested in high-growth countries such as Brazil, Russia, India and China.

Preferred Supplier

Virtually every Fortune 100 company does business with Dell, as they are the preferred desktop and laptop provider of enterprises in the US. Their products help medical professionals improve patient care, and their education-specific technology solutions have made them the top provider of laptops and desktops to schools in several geographies around the world.

Further, Dell is dedicated to protecting our environment and committed to green technology. Their goal is to become energy efficient and an environmental leader. They have developed a global recovery and recycling supply chain on six continents to recycle the parts and materials they collect. They are also the first and only computer company offering free computer recycling to consumers worldwide.

Dell Ruggedized Computers



With the industry's most secure, most manageable rugged products, you can focus on what matters most. Latitude Rugged delivers peace of mind with:

- **Real-world durability** — Dell goes above and beyond the standards to verify reliability in the real-world situations you face every day.
- **Go-anywhere productivity** — Get your job done no matter what with stunning performance, reliable connectivity and outdoor-readable displays.
- **Business-class control** — With all of the manageability and security you've come to expect from Dell, be confident you are in control of your technology.



Demanding workplaces require professional tools. Dell's unique rugged solutions allow you to stay focused on your work in any environment.

- Outdoor-readable screens with anti-reflective treatment and glove-touch capability
- Sealed, customizable RGB backlit keyboards on all notebooks and available for the tablet

- Webcams with physical privacy shutters
- Powerful and efficient Intel® processors
- Intel 802.11ac Wi-Fi with optional mobile broadband and dedicated GPS
- Common docking across Latitude Rugged notebooks and specialized docking for the tablet; all with durable pogo-pin interface
- Independently-certified to MIL-STD-810G tests and IEC ingress protection standards
- Confident security with Dell Data Protection | Encryption and TPM



Dell's rugged Tablet and laptop Options

We are offering DuPage County two standard laptops and Tablets, as well as two rugged models, one Laptop and one Tablet.

1. New Latitude 12 Rugged Extreme 7414

The Latitude 12 Rugged Extreme:

- This is the first ruggedized device of its kind to feature a flip-hinge display that seamlessly switches between notebook and tablet.
- Third-party certification of our products to meet military standard (MIL-STD) requirements.
- Built with a rigid magnesium alloy backbone and shock-absorbent ultra-polymer materials.
- All entry points are sealed by compression gaskets and a dual-knife-edge design that's certified for IP65 protection from sand, dust and liquid.
- Rugged Extreme is built to last in extreme temperatures with fourth-generation QuadCool™ thermal management.
- Great visibility outdoors - The Direct-View outdoor-readable display is designed to reduce reflections, preserve contrast and conserve battery life.
- Backlit keyboard with stealth
- With an optional customizable RGB backlight, you can switch between red, green, blue and white lighting, allowing the keyboard to remain visible but unobtrusive. A stealth key lets you stay undercover, turning off all lights and sounds with a single touch.
- Resistive multi-touch screen - you can work with or without gloves using the resistive multi-touch screen that responds to finger pressure with fluid response.



- This 12" 2-in-1 notebook is ideal for tight spaces or situations that require a convenient and portable device.
- Wireless connectivity options: Stay connected out in the field with 802.11ac Wi-Fi and a dedicated GPS.
- Long battery life: With up to 9.1 hours of battery life* from the standard 4-cell battery, you can keep plugging away without having to plug in. Get extended battery life in the field with optional hot-swap bridge battery and optional spare battery charger.
- Universal docking: Easily switch between vehicles and workspaces with universal docking solutions from Dell, Havis and PMT that are compatible with all Latitude Rugged notebooks.

2. Latitude 5414 Rugged

The Dell Latitude 5414 Rugged is independently tested and certified to military standards, including drops up to 3 feet as well as an IP52 certification for protection from the ingress of dust and water. Features include:

- Privacy shutter on the integrated webcam, sealed RGB backlit keyboard, and universal docks for your desk and vehicle.
- Expansive 14" outdoor-readable display with up to FHD resolution and optional glove-capable multi-touch.
- Powerful and efficient 6th generation Intel® processors and up to 16 hours of battery life.



3. New Latitude Rugged 7212 Extreme

The latest 12" rugged Tablet is built to:

- A crisp, bright, 11.6" FHD resolution outdoorviewable display lets you work in direct sunlight while the glove-capable touchscreen remains responsive even if you have to wear protective gear. All day productivity is easy with optional dual hot-swap batteries for endless power.
- Less is more in our latest iteration of our flagship rugged tablet which is 27% lighter and starts at just 2.8lbs (1.27kg). Upgraded with powerful 7th Generation Intel Core Processors and boasting up to 1TB of fast, reliable, and high performance solid state storage, this fully-rugged tablet can tackle the most demanding rugged tasks.
- Have peace of mind and trust that your missioncritical rugged tablet is well-protected with coverage options such as Dell's signature Pro Support Plus.



- With premium support service featuring 24/7 access to the most experienced technicians, downtime is a thing of the past.
- Security matters even more in the field. With Dell Data Protection on your rugged tablet, you can rest easy knowing you have comprehensive encryption, advanced authentication, and leading-edge malware protection built right in.
- Universal docking: Easily switch between vehicles and workspaces with universal docking solutions from Dell, Havis and PMT that are compatible with all Latitude Rugged notebooks.

Dell's Non-ruggedized Tablet and laptop Options

We are offering DuPage County two standard laptops and Tablets, as well as the ruggedized models.

1. Dell Latitude 5280

The Dell Latitude 5280 is:

- Powered by the latest Intel® processors, NVIDIA graphics and a range of storage options from HDD to PCIe NVMe to ignite your workforce productivity.
- Comes with multiple battery options and handy peripherals like the Dell Power Companion for additional battery life. Also enjoy best-in-class serviceability with a bottom access door for ease of accessibility.
- New features to the series include optional Windows Hello and an infrared camera which facilitates logon using facial recognition.
- Docking is now also a breeze with multiple options including DisplayPort™ over USB Type C, Thunderbolt3™ and Dell Wireless dock.
- Security is assured by multi-factor authentication options, including touchfinger print reader, contacted FIPS 201 Smart Card Reader, contactless smart card reader with Control Vault 2™ FIPS 140-2 Level 3 certification.



2. Dell Latitude 5289

Insight is also offering the Dell Latitude 5289 which comes with the following features:

- Seamlessly transition between multiple work modes including laptop, tablet, stand and tent modes.
- The latest 7th Generation Intel® Core I processors, PCIe NVMe flash storage.
- A natural writing experience with the optional active pen, using Wacom technology.
- Varying biometric and card readers, NFC with Control Vault 2™ and FIPS 140-2 Level 3 certification.



Please see Attachment 2 for Spec sheets on the devices offered to DuPage County.

Havis Docking Station Product Information

1. Havis DS-DELL-402

The Havis Docking Station for the Dell Latitude 14 Rugged and Latitude 12 & 14 Rugged Extreme Notebooks brings you the best computing solution for all your business needs. The DS-DELL-400 Series Docking Station offers computer charging, security, and connection to peripherals in medical, enterprise, and in-vehicle workplaces. Maximize your productivity with this rugged yet lightweight dock, which has been built with theft deterrence, longevity and stability in mind.

The Dell Latitude 12 Rugged Extreme is the industry's first fully rugged "flip-hinge" convertible notebook that easily transforms into a tablet whenever and wherever needed. The Dell Latitude 14 Rugged Extreme notebook is built for performance in the most demanding conditions.

Havis DS-DELL-402 Features

- Adjustable to secure the Latitude 14 Rugged notebook, Latitude 12 Rugged Extreme convertible notebook, and the Latitude 14 Rugged Extreme notebook.
- Constant connectivity is maintained with a guided, floating docking connector.
- Docking station was engineered with fully functional front- and rear-facing connectors.
- Mounting bracket and integrated cable strain relief allows for ease of installation and faster rollouts.
- Theft deterrence is accomplished through Havis' rugged locking system and front hooks, which keep your Latitude Rugged Extreme Notebook safe and secure.
- Strain relief for connectors prevents loose connections and accidental disconnects.
- Scalable connectivity provides a flexible solution.
- Havis offers a full line of accessories to complete any solution.



2. Havis DS-DELL-602-2



The Havis Docking Station for the Dell Latitude 12 Rugged Tablet brings you the best computing solution for all your business needs. The DS-DELL-600 Series Docking Station offers computer charging, security, and connection to peripherals in enterprise, warehouse and other in-vehicle workplaces. Maximize your productivity with this rugged yet lightweight dock, which has been built with theft deterrence, longevity and stability in mind.

Havis DS-DLL-602-2 Features

- Docking station with dual pass-through antenna for Dell's Latitude 12 rugged tablet with power supply
- Includes Lind power supply with customized cord length and connector tip

- Low profile design maximizes available space inside of vehicle
- Full port replication and integrated strain relieving provide simple, safe, and secure connectivity to essential peripherals, as well as convenient and efficient cable management
- Rounded corners and edges are ideal for your safety in accidents and airbag deployment, in addition to daily use and operation of docking station
- Designed to fit all Havis and VESA 75 hole pattern mounting equipment, as well as most competitors
- Lock and key supplied for peace of mind theft deterrence

Havis Rugged Communications Hub

Havis DS-DA-602

Maximize data productivity when device uptime counts with the highest quality solution on the market. Introducing the newest rugged USB/ethernet hub by Havis. Expanding connectivity requirements is now easily attained with this 4 port, fully powered USB 2.0 hub featuring an ethernet port. Economical expansion of peripherals such as in-vehicle video, GPS, scanners, card readers and printers is no problem for the Rugged Hub II. This ground breaking product provides the ideal solution for use in unfavorable conditions where ruggedness and reliability is a necessity.



Havis Universal Laptop Mounts



The Havis series of Universal Laptop Mounts represents the next generation of ruggedized mounts for any laptop that does not have the need for port replication. With a new lightweight design featuring composite materials and a lightweight and strong aluminum structure, the Universal Laptop Mount provides the most flexible and durable universal tray available for mobile computing applications.

- Engineered with lightweight aluminum and composite materials to maximize strength while minimizing weight.
- Attractive footprint and design provide for improved ergonomics in universal tray application.
- Easy to use latch mechanism.
- Barrel lock provides security and theft-deterrence.
- Easily configured by the user for the best ergonomic fit with most laptop computers and manufacturers.

Antennas

AP-4G Antenna

The AP-4G Antenna is the all-in-one, low profile Cellular/LTE, WiFi and GPS combination external antenna. Everything is in one housing reducing the need for multiple antennas and holes being drilled. The AP-4G Antenna offers:

- Better Cellular/LTE and WiFi Reception
- Bigger Wireless Footprint
- Faster Data Speeds
- Long Product Life — Low Profile Design
- One Simple Installation



BACKGROUND

DuPage County, DuPage ETSB and the public safety agencies of DuPage County are in the process of replacing their Computer Aided Dispatch (CAD) system, Field Based Reporting (FBR) system, and Records Management (RMS) system. To support this new environment, many of the agencies will be required to modernize their mobile data terminals (MDT). It is the intent of the DuPage ETSB to negotiate a joint-purchasing program on behalf of these agencies. These agencies include both police departments and fire departments.

All purchases made through this joint-purchasing program will be between the awarded vendor and the individual agency. The DuPage County will not be responsible for the cost of the purchase or any related cost. The DuPage County makes no guarantees as to the actual number of MDTs or accessories that will be purchased through this program, nor will they, or any DuPage County agency, accept any penalties from the vendor regarding the number of MDTs purchased. No agency is required to purchase from this joint-purchasing program.

The following is the result of a survey of ETSB agencies when asked about anticipated mobile purchases. For the purposes of this document, MDT will include ruggedized mobile laptop, standard laptop, or a tablet that can be fit for a vehicle docking station.

Response: Insight has read and understands.

Current number of mobile units that are operational today including police and fire: 1061 UNITS

FUTURE MDT EQUIPMENT NEEDS for Vehicles	FY18	FY19	FY20	FY21
Ruggedized Laptop	168	25	26	21
Standard Laptop	70	56	49	49
Tablet (Regular & Ruggedized)	38	4	10	30

SPECIFICATIONS

MINIMUM REQUIREMENT FOR MOBILE (Laptop or Tablet; Ruggedized or Non-ruggedized):

MINIMUM REQUIREMENT FOR MOBILE	
• Processor	• i5 or equal or greater processor (Not ARM)
• Memory	• 8GB RAM or greater
• Hard Drive	• 256 GB Solid SATA
• Operating System	• Windows 10 Pro, 64bit
• Monitor\Screen	<ul style="list-style-type: none"> ○ 11 in. minimum for laptop: ○ 10 in minimum for tablets
• Resolution:	<ul style="list-style-type: none"> ○ 1024x768 required ○ 1920x1080 preferred
• Touchscreen	<ul style="list-style-type: none"> ○ be able to capture electronic signatures ○ Optimized for outdoor use
• Wireless	• 802.11ac or better
• WWAN	<ul style="list-style-type: none"> ○ Supports all major carriers ○ If needed, carrier can be specified at time of order
• GPS	• Capable of supporting NMEA Standard
• NIC	• 1 GB
• USB	<ul style="list-style-type: none"> ○ Minimum 4 (3.0) ports ○ combination of internal and the external hub
• Webcam	• 720HD – minimum
• Bluetooth	• 4.0 or better
• Warranty Minimum	• 3 year Onsite NBD (next business day) with accidental damage protection

<i>OPTIONS</i>	
<ul style="list-style-type: none"> • <i>Backlit keyboard</i> 	<ul style="list-style-type: none"> • <i>GPS external vehicle mounted antenna with wiring harness</i>
<ul style="list-style-type: none"> • <i>Optical drive</i> 	<ul style="list-style-type: none"> • <i>Centronics Port</i>
<ul style="list-style-type: none"> • <i>Biometric Fingerprint reader or UID\Smart Card reader</i> 	<ul style="list-style-type: none"> • <i>Antivirus solution</i>
<ul style="list-style-type: none"> • <i>GPS receiver – Standard NMEA output</i> 	<ul style="list-style-type: none"> • <i>Docking station – compatible with proposed vehicle mount and wiring</i>

WARRANTY/ SERVICE DESCRIPTION:

Describe in detail the warranty and maintenance program and how each of the following would be addressed:

- *How would repairs be handled?*

Response: With ProSupport, there is NBD onsite repair for failed parts after remote diagnostics have been completed with one of our N. American engineers. If it is an accidental damage claim, it is NBD onsite as well with ProSupport. Please note that accidental damage has a 1 incident per 12 month maximum. ProSupport can be contacted 24/7, via email, chat, or by telephone. The Support team will conduct remote diagnostics before a tech and/or part is dispatched.

- *Time required for replacement of equipment?*

Response: With ProSupport, there is NBD onsite repair for failed parts after remote diagnostics have been completed. If it is an accidental damage claim it is NBD onsite as well with ProSupport. If the part is on backorder, NBD will take place onsite once when the part becomes available. If the accidental damage is extensive and the technician determines it cannot be repaired, then the unit will be sent to a repair depot. The turn-around for another system or repair is 7-10 business days.

- *Any issues with a minimum for a 3-year warranty?*

Response: Insight's pricing includes 3-Year Accidental Damage. Some models also include Dell's 3-Year Pro-support.

Insight ITB Response
 Emergency Telephone System Board of DuPage County
 Mobile Data Terminals (MDT) #P17-204-BF



Response: Insight's offer to DuPage County includes the following models:

Ruggedized Laptop

Dell Latitude 7414 Rugged Extreme Notebook

- Latitude 14 Rugged Extreme 7414
- Intel Core i5-6300U Processor (Dual Core, 3M Cache, 2.40 GHz)
- Win 10 Pro 64 English, French, Spanish
- Microsoft(R) Office 30 Days Trial
- 8GB (1x8GB) 2133MHz DDR4 Memory
- 256GB Solid State Drive
- Heatsink for Integrated Graphics
- Intel Integrated HD Graphics 520
- 35.6cm (14.0") HD (1366x768) Touch Display with
- Microphone Camera with Privacy Shutter
- Regulatory Label, W/GS, No Rubber coating
- Sealed Internal RGB Backlit English Keyboard
- Intel Dual-Band Wireless-AC 8260 Driver
- Intel Dual Band Wireless 8260 (802.11ac) W/ Bluetooth
- DW5808E Gobi5000 4G/LTE Wireless WAN Card for AT&T
- 6-cell (65Wh) Lithium Ion Battery With ExpressCharge
- 65W AC Adapter, 3-pin
- No Fingerprint Reader Palmrest
- No Optical Drive
- No FGA
- Waves Maxx Audio Royalty
- Dedicated u-blox NEO-M8Q-0-01 GPS Card
- ProSupport: Next Business Day Onsite, 3 Years
- ProSupport: 7x24 Technical Support, 3 Years
- Accidental Damage Service, 3 year

Dell Latitude 5414 Rugged Laptop

- Latitude 14 Semi-Rugged 5414
- Intel Core i5-6300U Processor, Security, (Dual Core, 3M Cache, 2.40 GHz)
- Win 10 Pro 64 English, French, Spanish
- 8GB (1x8GB) 2133MHz DDR4 Memory
- 256GB Solid State Drive
- TPM Enabled
- Intel Integrated HD Graphics 520
- 14.0" FHD(1920 x 1080) Outdoor-readable, Touch, with Camera with Privacy Shutter and Microphone
- Sealed Internal RGB Backlit English Keyboard
- Qualcomm QCA61x4A 802.11ac Dual Band(2x2) Wireless Adapter+ Bluetooth 4.1 Driver
- Qualcomm QCA61x4A 802.11ac Dual Band (2x2) Wireless Adapter+ Bluetooth 4.1
- DW5808E Gobi5000 4G/LTE Wireless WAN Card for AT&T (Windows 10)
- 6-cell (65Wh) Lithium Ion Battery With ExpressCharge
- 65W AC Adapter, 3-pin
- US Power Cord
- Optical Drive Airbay
- Waves Maxx Audio
- No PCMCIA Card or ExpressCard Reader
- Docking connector for Rugged Docking Station only
- Dedicated u-blox NEO-M8Q-0-01 GPS Card
- ProSupport: Next Business Day Onsite, 3 Years

Insight ITB Response
 Emergency Telephone System Board of DuPage County
 Mobile Data Terminals (MDT) #P17-204-BF



- ProSupport: 7X24 Technical Support, 3 Years
- Accidental Damage Service, 3 year

Standard Laptop

Dell Latitude 5280 Series

- Dell Latitude 5280
- 7th Generation Intel Core i7-7600U (Dual Core, 2.80Gz, 4MB cache)
- Win 10 Pro 64 English, French, Spanish
- Microsoft(R) Office 30 Days Trial
- Intel(R) Core(TM) i7-7600U Processor Base, Integrated HD Graphics 620
- 8G (1 X 8G) DDR4 Memory
- M.2 256GB SATA Class 20 Solid State Drive
- M.2 SSD SATA Hard Drive Bracket
- 31.8cm Touch Corning Gorilla Glass FHD (1920 x1080) with HD Camera, WWAN Capable
- Internal US English Qwerty Backlit Keyboard
- Qualcomm QCA61x4A 802.11ac Dual Band(2x2) Wireless Adapter+ Bluetooth 4.1 Driver
- Qualcomm QCA61x4A 802.11ac Dual Band (2x2) Wireless Adapter+ Bluetooth 4.1
- Qualcomm Snapdragon X7 LTE-A (DW5811e) AT&T
- Primary 4-cell 68W/HR Battery
- 65W AC Adapter, 3-pin
- No Smart Card Reader and No Fingerprint Reader Palmrest
- Intel Rapid Storage Technology
- Dell Latitude E5280 Flex 4
- Waves Maxx Audio
- Onsite/In-Home Service After Remote Diagnosis, 1 Year
- Onsite/In-Home Service After Remote Diagnosis, 2 Year
- Extended Accidental Damage Service, 3 year

Tablet

Dell Latitude 7212 Rugged Extreme Tablet

- Dell Latitude 7212
 - 7th Generation Intel Core i5-7300U
 - Win 10 Pro 64 English
 - Intel Core i5-7300U with u-blox NEO-M8 GPS card and 8GB Memory
 - 8GB 1866MHz LPDDR3
 - 256GB M.2 2280 SSD
 - Qualcomm QCA61x4A 802.11ac Dual Band(2x2) Wireless Adapter+ Bluetooth 4.1 Driver
 - Qualcomm QCA61x4A 802.11ac Dual Band(2x2) Wireless Adapter+ Bluetooth 4.1
 - Qualcomm Snapdragon X7 LTE-A for Win 10 (DW5811 Gobi5000) for ATT, for Windows 8.1/10
 - 5MP HD Webcam / 8MP Rear Camera with Flash and Dual Microphone for Win 8.1/10
 - Dual Microphones
 - WLAN/WWAN Chassis 11.6 FHD (1920X1080) Outdoor-Readable Glove-Capable Touchscreen w/Gorilla Glass
 - 2-cell 34wH) Lithium Ion Primary Battery
 - 45 Watt AC Adapter
 - No Secondary Battery
 - Micro Serial Port
 - No Smart Card Reader
 - No Fingerprint Reader
 - Connector for I/O Expansion
 - No Removable CD/DVD Drive
 - Waves Maxx Audio Royalty
-

Insight ITB Response
 Emergency Telephone System Board of DuPage County
 Mobile Data Terminals (MDT) #P17-204-BF



- E5 Power Cord (US)
- Active Pen for the Latitude 12 Rugged Tablet
- ProSupport: Next Business Day Onsite, 3 Years
- ProSupport: 7x24 Technical Support, 3 Years
- Accidental Damage Service, 3 year

Dell Latitude 5289 2-in-1 Convertible Business Laptop

- Dell Latitude 5289 – Non-Rugged Tablet
- 7th Generation Intel Core i5-7300U (Dual Core, 2.60GHz, 3MB Cache)
- Win 10 Pro 64 English, French, Spanish
- Microsoft Office 30 Days Trial
- Intel Core I5-7300U VPro CPU, UMA Graphic, 8G memory
- Intel vPro Technology Advanced Management Features
- Intel Sensor Solution
- 256GB M.2 2280 SSD
- 12.5" FHD (1920 X 1080) Touch Corning Gorilla Glass LCD with Mic/Camera, WWAN/WLAN Capable
- Palmrest with Non-security, 82key
- Internal US English Qwerty Backlit Keyboard
- Intel Dual-Band Wireless-AC 8265 Driver
- Intel Dual-Band Wireless-AC 8265 Wireless Card (2x2)
- Qualcomm Snapdragon X7 LTE-A (DW5811e) AT&T
- Primary 3-cell 45W/HR Battery
- E5 45W Type C (PCR Material), Liteon
- No FGA
- US Power Cord
- Waves Maxx Audio
- Dell Latitude 5289 Flex 5
- Dell Active Pen - PN557W
- Onsite/In-Home Service After Remote Diagnosis, 1 Year
- Onsite/In-Home Service After Remote Diagnosis, 2 Year
- Extended Accidental Damage Service, 3 year

Type of Equipment	Manufacturer	Part Number	Per Unit Cost
Ruggedized Laptop	Dell Latitude 7414 Rugged Extreme Notebook	3000018816857	\$3,068.55
Ruggedized Laptop	Dell Latitude 5414 Rugged Laptop	3000018824039	\$1,993.77
Standard Laptop	Dell Latitude 5280 Series	3000018816968	\$1,298.70
Ruggedized Tablet	Dell Latitude Rugged 7212 Extreme	3000018816762	\$1,965.90
Standard Tablet	Dell Latitude 5289 2-in-1 Convertible Business Laptop	3000018817249	\$1,139.36

Insight ITB Response
 Emergency Telephone System Board of DuPage County
 Mobile Data Terminals (MDT) #P17-204-BF



BUNDLED OPTION – MDT AND DOCKING STATIONS		
Manufacturer/Component	Specifications	Unit Cost
Dell Latitude 7414 Regged Extreme Notebook with Havis DS-DELL-402-3 Advanced Port Replication with Triple High-Gain Antenna – Docking Station	Please see Product Spec Sheets for more information.	\$3,778.33
Dell Latitude 5414 Rugged Laptop with Havis DS-DELL-402-3 Advanced Port Replication with Triple High-Gain Antenna – Docking Station	Please see Product Spec Sheets for more information.	\$2,703.55
Dell Latitude 5280 Series with Havis UT-101 Tray w/ UT-102 mounting brackets and Havis DS-DA-602 Vehicle HUB	Please see Product Spec Sheets for more information.	\$1,650.49
Dell Latitude Rugged 7212 Extreme with Havis Docking Station 600 Series DS-DELL-602-2 with Dual Pass-Through Antenna and Power Supply	Please see Product Spec Sheets for more information.	\$2,466.92
Dell Latitude 5289 2-in-1 Convertible Business Laptop with Havis UT-101 Tray w/ UT-102 mounting brackets and Havis DS-DA-602 Vehicle HUB	Please see Product Spec Sheets for more information.	\$1,491.15
<i>Bundled Total Cost</i>		\$12,091.44

OPTIONAL COMPONENTS		
Manufacturer/Component	Specifications	Unit Cost
Backlit keyboard	Included in all Models	\$0.00
Optical drive	Dell External USB Slim DVD+/-RW Optical Drive	\$36.80
Biometric Fingerprint reader or UID\Smart Card reader	7212 - Fingerprint Reader 7212 - SmarCard 5280 – SmartCard 7414 – Fingerprint Reader 7414 – PCMCIA Card 7414 – Express Card Reader	\$50 add-on Included \$20 add-on \$95 add-on \$12 add-on Included
GPS receiver – standard NMEA output	Included in Rugged Models	\$0.00
GPS external vehicle mounted antenna with wiring harness	AP-Tablet-Cell/LTE/WiFi Antenna Antenna Plus AP for 7212 CELL/LTE/WIFI - Antenna - navigation, cellular for 7414 -Black	\$113.53 \$133.24

Insight ITB Response
 Emergency Telephone System Board of DuPage County
 Mobile Data Terminals (MDT) #P17-204-BF



OPTIONAL COMPONENTS		
Manufacturer/Component	Specifications	Unit Cost
	CELL/LTE/WIFI - Antenna - navigation, cellular for 7414 - White	\$131.85
Optional GPS Add-on for Latitude 5280 / 5289	GPS 18x USB	\$70.83
Centronics Port	Dell Legacy Adapter LD17	\$51.37
Antivirus solution	Sophos Endpoint Protection Standard – Cloud Management	\$19.94
Active Stylist Pen Option	7212 – Included	\$0
	5414 – Included	\$0
	7414 – Optional Passive Pen	\$12.56
	5289 – Included	\$0
	5280 – Optional Passive Pen	\$12.78
Docking station – compatible with proposed vehicle mount and wiring	Havis DS-DELL 602-2	\$519.73
	Havis DS-DELL-402-3	\$736.29
	WD15 Desk Dock for 5280 / 5289 (optional)	\$125.96
	Havis UT-101 Tray w/ UT-102 Mounting Brackets for Models 5280 / 5289	\$242.71
	DS-DA-602 Vehicle HUB: Models 5280/5289	\$131.53
12-32 VDC 180W Dell M6400 with Bare-Wire Input	Required if used WD15 Dock with Vehicle for Power - A9947961-DCSO. Insight recommends using the Havis DS-DA-602 for Vehicle Hub with the 5280 / 5289 Models instead of the WD15.	\$202.22
Insight's Gold Service Level Standard Labs Imaging / Asset Tagging / POST Test, QA	Service Includes: Imaging / Asset Tagging / POST Test, QA. See Appendix for additional information on Insight's Lab Services	\$21.00 / unit

Insight ITB Response
 Emergency Telephone System Board of DuPage County
 Mobile Data Terminals (MDT) #P17-204-BF



CORRESPONDENCE TO CONTRACTOR:		REMIT TO CONTRACTOR:	
NAME	Bob Erwin	NAME	Insight Public Sector
CONTACT	Account Executive	CONTACT	Jim Trevino
ADDRESS	2250 West Pinehurst Blvd	ADDRESS	6820 S Harl Ave
CITY ST ZIP	Addison, IL 60101	CITY ST ZIP	Tempe AZ 85283
TX	847.322.0898	TX	480.333.3102
FX	480.760.9488	FX	480.760.7043
EMAIL	berwin@insight.com	EMAIL	ach@insight.com
COUNTY BILL TO INFORMATION:		COUNTY SHIP TO INFORMATION:	
DuPage County ETSB 421 North County Farm Road Wheaton, IL 60187 TX: (630)-550-7743		DuPage County ETSB 421 North County Farm Road Wheaton, IL 60187 TX: (630)-550-7743	

Full Name of Bidder	Insight Public Sector, Inc.
Main Business Address	6820 South Harl Ave.
City, State, Zip Code	Tempe, AZ 85283
Telephone Number	847-322-0898
Fax Number	480-760-9488
Bid Contact Person	Bob Erwin
Email Address	berwin@insight.com

Insight ITB Response
 Emergency Telephone System Board of DuPage County
 Mobile Data Terminals (MDT) #P17-204-BF



TO: The DuPage County Procurement Services

The undersigned certifies that he is:

the Owner/Sole a Member authorized an Officer of the a Member of the Proprietor to sign on behalf of the Corporation Joint Venture Partnership

Herein after called the Proposer and that the all of the Partners of the Partnership, Officers of the Corporation or Member of the Limited Liability are as follows:

Kenneth Lamneck, President and CEO IPS Dave Cristal, Vice President & GM IPS Sales

(President, CEO or Member)

(Vice-President, Partner or Member)

Michael Walker, General Counsel and Secretary Helen K. Johnson, Treasurer

(Secretary, Partner, or Member)

(Treasurer, Partner, or Member)

Further, the undersigned declares that the only person or parties interested in this bid as principals are those named herein; that this bid is made without collusion with any other person, firm or corporation; that he has fully examined the proposed forms of agreement and the contract specifications for the above designated purchase, all of which are on file in the office of the Procurement Officer, DuPage County, 421 North County Farm Road, Wheaton, Illinois 60187, and all other documents referred to or mentioned in the contract documents, specifications and attached exhibits, including Addenda No. _____, _____, _____ and _____ issued thereto;

Further, the undersigned proposes and agrees, if this bid is accepted, to provide all necessary machinery, tools, apparatus, and other means of construction, including transportation services necessary to furnish all the materials and equipment specified or referred to in the contract documents in the manner and time therein prescribed.

Further, the undersigned certifies and warrants that he is duly authorized to execute this certification/affidavit on behalf of the Bidder and in accordance with the Partnership Agreement or by-laws of the Corporation, and the laws of the State of Illinois and that this Certification is binding upon the Bidder and is true and accurate.

Further, the undersigned certifies that the Bidder is not barred from bidding on this contract as a result of a violation of either 720 Illinois Compiled Statutes 5/33 E-3 or 5/33 E-4, bid rigging or bid-rotating, or as a result of a violation of 820 ILCS 130/1 et seq., the Illinois Prevailing Wage Act.

Insight ITB Response
Emergency Telephone System Board of DuPage County
Mobile Data Terminals (MDT) #P17-204-BF



The undersigned certifies that he has examined and carefully prepared this bid and has checked the same in detail before submitting this bid, and that the statements contained herein are true and correct.

If a Corporation, the undersigned, further certifies that the recitals and resolutions attached hereto and made a part hereof were properly adopted by the Board of Directors of the Corporation at a meeting of said Board of Directors duly called and held and have not been repealed nor modified, and that the same remain in full force and effect. (Bidder may be requested to provide a copy of the corporate resolution granting the individual executing the contract documents authority to do so.)

Further, the Bidder certifies that he has provided equipment, supplies, or services comparable to the items specified in this contract to the parties listed in the reference section below and authorizes the County to verify references of business and credit at its option.

Response: Insight has read, understands and will comply.

Insight ITB Response
Emergency Telephone System Board of DuPage County
Mobile Data Terminals (MDT) #P17-204-BF



BID AWARD CRITERIA:

This bid will be awarded to the lowest responsive, responsible bidder meeting specifications based upon the total lump sum bid amount. Contractors may bid on one or more categories. The County reserves the right to award by total bid, by single item or by any combination of items, in accordance with our language in the Bid Document relating to Contractor selection (or rejection) in the best interest of the ETSB of DuPage County. Where unit prices are requested, the quantities stated are approximate only but will be used to determine bid award.

Response: Insight has read and understands.

VENDOR AGREES TO HOLD BID PRICING FOR EQUIPMENT LISTED ABOVE FOR 1 YEAR FROM DATE SIGNED BELOW:

PROPOSAL MUST BE SIGNED AND NOTARIZED (WITH SEAL) FOR CONSIDERATION





(Signature and Title)

John Carnahan, SVP Global Business Development

Subscribed and sworn to before me this 23 day of October AD, 2017

(Notary Public)

My Commission Expires: 6/25/2021



VENDOR ETHICS DISCLOSURE

The Vendor Ethics Disclosure Statement can be found on the next page and on the County's Internet site under Contractor Forms in the Procurement section. The most current version of the form should always be utilized. There is also another form for additional pages; all pages are Adobe fillable forms.

Continuing Disclosure: It is the contractor/vendor's responsibility to update contribution information on an ongoing basis during the life of the contract. The vendor is required to submit an updated Ethics Disclosure Statement to the user department any time contributions are made to the Chairman or County Board Members subsequent to the most recent authorized contract action.

Failure to Comply: Failure to provide the requested information will at minimum delay awarding of the contract and could result in the selected vendor being disqualified as non-responsive and non-responsible.

Providing fraudulent information on the Vendor Ethics Disclosure Statement may result in a Class 3 Felony.

Contribution: A gift, subscription, dues, loan, advance, or deposit of money or anything of value, including services, knowingly received in connection with the nomination for election or election of any person to County office.

Multi-year contracts: Those contracts with a duration greater than 12 months require annual updates, to be filed by the vendor with the user department, and forwarded to Procurement. The reporting period should be the current and previous calendar years.

Prohibited Source: Any person or entity who (i) is seeking official action by the Chairman, County Board member or in the case of an employee, by the employee or by the Chairman or County Board member, or another employee directing that employee; (ii) does business or seeks to do business with the Chairman, County Board member, or employee (iii) conducts activities regulated by the Chairman, County Board member, or employee (iv) has interests that may be substantially affected by the performance or non-performance of the official duties of the Chairman, County Board member, or employee (v) is registered or required to be registered with the Secretary of State under the Lobbyist Registration Act or the DuPage County Lobbyist Registration Act, except that an entity not otherwise a prohibited source does not become a prohibited source merely because a registered lobbyist is one of its member or serves on its board of directors (vi) is a Political Action Committee to which a prohibited source has been contributed.

Insight ITB Response
 Emergency Telephone System Board of DuPage County
 Mobile Data Terminals (MDT) #P17-204-BF



REQUIRED VENDOR ETHICS DISCLOSURE STATEMENT



Required Vendor Ethics Disclosure Statement

Failure to complete and return this form may result in delay or cancellation of the County's Contractual Obligation.

Date: Jul 21, 2017

Bid/Contract/PO #: _____

Company Name: Insight Public Sector, Inc.	Company Contact: Bob Erwin
Contact Phone: 847-322-0898	Contact Email: bob.erwin@insight.com

The DuPage County Procurement Ordinance requires the following written disclosures prior to award:

- Every contractor, union, or vendor that is seeking or has previously obtained a contract, change orders to one (1) or more contracts, or two (2) or more individual contracts with the county resulting in an aggregate amount at or in excess of \$25,000, shall provide to Procurement Services Division a written disclosure of all political campaign contributions made by such contractor, union, or vendor within the current and previous calendar year to any incumbent county board member, county board chairman, or countywide elected official whose office the contract to be awarded will benefit. The contractor, union or vendor shall update such disclosure annually during the term of a multi-year contract and prior to any change order or renewal requiring approval by the county board. For purposes of this disclosure requirement, "contractor or vendor" includes owners, officers, managers, lobbyists, agents, consultants, bond counsel and underwriters counsel, subcontractors and corporate entities under the control of the contracting person, and political action committees to which the contracting person has made contributions.

NONE (check here) - If no contributions have been made

Recipient	Donor	Description (e.g. cash, type of item, in-kind services, etc.)	Amount/Value	Date Made

- All contractors and vendors who have obtained or are seeking contracts with the county shall disclose the names and contact information of their lobbyists, agents and representatives and all individuals who are or will be having contact with county officers or employees in relation to the contractor bid and shall update such disclosure with any changes that may occur.

NONE (check here) - If no contacts have been made

Lobbyists, Agents and Representatives and all individuals who are or will be having contact with county officers or employees in relation to the contract or bid	Telephone	Email

A contractor or vendor that knowingly violates these disclosure requirements is subject to penalties which may include, but are not limited to, the immediate cancellation of the contract and possible disbarment from future county contracts.

Continuing disclosure is required, and I agree to update this disclosure form as follows:

- If information changes, within five (5) days of change, or prior to county action, whichever is sooner
- 30 days prior to the optional renewal of any contract
- Annual disclosure for multi-year contracts on the anniversary of said contract
- With any request for change order except those issued by the county for administrative adjustments

The full text for the county's ethics and procurement policies and ordinances are available at:
<http://www.dupageco.org/CountyBoard/Policies/>

I hereby acknowledge that I have received, have read, and understand these requirements.

Authorized Signature *Erica Falchetti*
 Printed Name Erica Falchetti
 Title Capture Manager
 Date Jul 21, 2017

Attach additional sheets if necessary. Sign each sheet and number each page. Page 1 of 1 (total number of pages)

Insight ITB Response
 Emergency Telephone System Board of DuPage County
 Mobile Data Terminals (MDT) #P17-204-BF



W-9 Form

Form **W-9**
 (Rev. December 2014)
 Department of the Treasury
 Internal Revenue Service

Request for Taxpayer Identification Number and Certification

Give Form to the requester. Do not send to the IRS.

Print or type
See Specific Instructions on page 2.

1 Name (as shown on your income tax return). Name is required on this line; do not leave this line blank.
Insight Public Sector, Inc

2 Business name/disregarded entity name, if different from above

3 Check appropriate box for federal tax classification; check only **one** of the following seven boxes:
 Individual/sole proprietor or single-member LLC
 C Corporation S Corporation Partnership Trust/estate
 Limited liability company. Enter the tax classification (C=C corporation, S=S corporation, P=partnership) ▶ _____
Note. For a single-member LLC that is disregarded, do not check LLC; check the appropriate box in the line above for the tax classification of the single-member owner.
 Other (see instructions) ▶ _____

4 Exemptions (codes apply only to certain entities, not individuals; see instructions on page 3):
 Exempt payee code (if any) _____
 Exemption from FATCA reporting code (if any) _____
(Applies to accounts maintained outside the U.S.)

5 Address (number, street, and apt. or suite no.)
6820 S. Harl Ave

6 City, state, and ZIP code
Tempe, AZ 85283

7 List account number(s) here (optional)

Requester's name and address (optional)

Part I Taxpayer Identification Number (TIN)

Enter your TIN in the appropriate box. The TIN provided must match the name given on line 1 to avoid backup withholding. For individuals, this is generally your social security number (SSN). However, for a resident alien, sole proprietor, or disregarded entity, see the Part I instructions on page 3. For other entities, it is your employer identification number (EIN). If you do not have a number, see *How to get a TIN* on page 3.

Note. If the account is in more than one name, see the instructions for line 1 and the chart on page 4 for guidelines on whose number to enter.

Social security number	<table style="width: 100%; border-collapse: collapse;"> <tr> <td style="width: 25%; border: 1px solid black; height: 20px;"></td> <td style="width: 5%; border: 1px solid black; text-align: center;">-</td> <td style="width: 25%; border: 1px solid black; height: 20px;"></td> <td style="width: 5%; border: 1px solid black; text-align: center;">-</td> <td style="width: 40%; border: 1px solid black; height: 20px;"></td> </tr> </table>		-		-																
	-		-																		
OR	<table style="width: 100%; border-collapse: collapse;"> <tr> <td colspan="10" style="text-align: center;">Employer identification number</td> </tr> <tr> <td style="border: 1px solid black; text-align: center;">3</td> <td style="border: 1px solid black; text-align: center;">6</td> <td style="border: 1px solid black; text-align: center;">-</td> <td style="border: 1px solid black; text-align: center;">3</td> <td style="border: 1px solid black; text-align: center;">9</td> <td style="border: 1px solid black; text-align: center;">4</td> <td style="border: 1px solid black; text-align: center;">9</td> <td style="border: 1px solid black; text-align: center;">0</td> <td style="border: 1px solid black; text-align: center;">0</td> <td style="border: 1px solid black; text-align: center;">0</td> </tr> </table>	Employer identification number										3	6	-	3	9	4	9	0	0	0
Employer identification number																					
3	6	-	3	9	4	9	0	0	0												

Part II Certification

Under penalties of perjury, I certify that:

- The number shown on this form is my correct taxpayer identification number (or I am waiting for a number to be issued to me); and
- I am not subject to backup withholding because: (a) I am exempt from backup withholding, or (b) I have not been notified by the Internal Revenue Service (IRS) that I am subject to backup withholding as a result of a failure to report all interest or dividends, or (c) the IRS has notified me that I am no longer subject to backup withholding; and
- I am a U.S. citizen or other U.S. person (defined below); and
- The FATCA code(s) entered on this form (if any) indicating that I am exempt from FATCA reporting is correct.

Certification instructions. You must cross out item 2 above if you have been notified by the IRS that you are currently subject to backup withholding because you have failed to report all interest and dividends on your tax return. For real estate transactions, item 2 does not apply. For mortgage interest paid, acquisition or abandonment of secured property, cancellation of debt, contributions to an individual retirement arrangement (IRA), and generally, payments other than interest and dividends, you are not required to sign the certification, but you must provide your correct TIN. See the instructions on page 3.

Sign Here Signature of U.S. person ▶ *George Rivera* Date ▶ *1-1-17*

General Instructions

Section references are to the Internal Revenue Code unless otherwise noted.

Future developments. Information about developments affecting Form W-9 (such as legislation enacted after we release it) is at www.irs.gov/fw9.

Purpose of Form

An individual or entity (Form W-9 requester) who is required to file an information return with the IRS must obtain your correct taxpayer identification number (TIN) which may be your social security number (SSN), individual taxpayer identification number (ITIN), adoption taxpayer identification number (ATIN), or employer identification number (EIN), to report on an information return the amount paid to you, or other amount reportable on an information return. Examples of information returns include, but are not limited to, the following:

- Form 1099-INT (interest earned or paid)
- Form 1099-DIV (dividends, including those from stocks or mutual funds)
- Form 1099-MISC (various types of income, prizes, awards, or gross proceeds)
- Form 1099-B (stock or mutual fund sales and certain other transactions by brokers)
- Form 1099-S (proceeds from real estate transactions)
- Form 1099-K (merchant card and third party network transactions)

- Form 1098 (home mortgage interest), 1098-E (student loan interest), 1098-T (tuition)
- Form 1099-C (canceled debt)
- Form 1099-A (acquisition or abandonment of secured property)

Use Form W-9 only if you are a U.S. person (including a resident alien), to provide your correct TIN.

If you do not return Form W-9 to the requester with a TIN, you might be subject to backup withholding. See What is backup withholding? on page 2.

By signing the filled-out form, you:

- Certify that the TIN you are giving is correct (or you are waiting for a number to be issued).
- Certify that you are not subject to backup withholding, or
- Claim exemption from backup withholding if you are a U.S. exempt payee. If applicable, you are also certifying that as a U.S. person, your allocable share of any partnership income from a U.S. trade or business is not subject to the withholding tax on foreign partners' share of effectively connected income, and
- Certify that FATCA code(s) entered on this form (if any) indicating that you are exempt from the FATCA reporting, is correct. See *What is FATCA reporting?* on page 2 for further information.

Cat. No. 10231X
Form **W-9** (Rev. 12-2014)

Insight ITB Response
 Emergency Telephone System Board of DuPage County
 Mobile Data Terminals (MDT) #P17-204-BF



References

The bidder must list three (3) references, listing firm name, address, telephone number and contact person to whom they have provided similar equipment, material or services for a period of not less than six (6) months. Additional references may be required.

COMPANY NAME:	Wheeling Police Department
ADDRESS:	1 Community Blvd.
	Wheeling IL 60090
CONTACT PERSON:	Jacek Trzebunia, IT Tech
TELEPHONE NUMBER:	(847) 459-2990

COMPANY NAME:	City of Lake Forest
ADDRESS:	220 E Deerpath
	Lake Forest IL 60045
	gabanskij@cityoflakeforest.com
CONTACT PERSON:	Joe Gabanski, IT Director
TELEPHONE NUMBER:	(847) 810-3591

COMPANY NAME:	Florida Highway Patrol
ADDRESS:	2900 Apalachee Parkway
	Tallahassee, FL 32399
	JamesCrosby@flhsmv.gov
CONTACT PERSON:	Sgt James Crosby
TELEPHONE NUMBER:	(386) 785-4014

COMPANY NAME:	Los Angeles Police
ADDRESS:	100 West 1st St.
	Los Angeles, CA 90012
	dan.gonzalez@lapd.lacity.org
CONTACT PERSON:	Lt Dan Gonzalez
TELEPHONE NUMBER:	(213) 842-4064

Insight ITB Response
 Emergency Telephone System Board of DuPage County
 Mobile Data Terminals (MDT) #P17-204-BF



BIDDERS SUBCONTRACTORS

FULL NAME OF BIDDER:	Insight Public Sector, Inc.
CONTACT PERSON:	Bob Erwin

SUBCONTRACTORS:

A. Will you employ subcontractors? _____ X _____
 (YES) (NO)

B. If "YES", identify with each firm's name, address, telephone number and work to be subcontracted:

COMPANY NAME:	
ADDRESS:	
CONTACT PERSON:	
TELEPHONE NUMBER:	
WORK TO BE PROVIDED:	

The Contractor will not change or use subcontractors not identified in this bid without prior written approval from the ETSB of DuPage County.

Insight ITB Response
Emergency Telephone System Board of DuPage County
Mobile Data Terminals (MDT) #P17-204-BF



A request for a change in subcontractors shall be made in writing and will include a description of any savings that may be realized in the execution of this contract, and must be passed on to the ETSB of DuPage County.

***FAILURE TO PROVIDE SUBCONTRACTORS MAY BE
JUST CAUSE FOR REJECTION OF BIDDER'S
PROPOSAL.***

SAMPLE CONTRACT AGREEMENT

CONTRACT #XXXXXXX BETWEEN [CONTRACTOR]
 AND THE ETSB OF DUPAGE COUNTY

THIS AGREEMENT is entered into this _____ day of _____, 20____, between the ETSB of DuPage County, Illinois a body corporate and politic, located at 421 North County Farm Road, Illinois, 60187-3978 (hereinafter referred to as the COUNTY), and _____, licensed to do business in the State of Illinois, located at _____, _____, _____ (hereinafter referred to as the CONTRACTOR)

RECITALS

WHEREAS, the COUNTY requires the goods and/or services specified in Bid #XX-XXX-XX for its Department of _____, located at the DuPage County Center, 421 North County Farm Road, Wheaton, Illinois 60187; and

WHEREAS, the CONTRACTOR is the vendor selected pursuant to the bid process and is willing to perform under the terms of the Bid and this Contract.

NOW, THEREFORE, in consideration of the premises and mutual covenants contained herein, the parties agree that:

1.0 CONTRACT DOCUMENTS

1.1 This Contract includes all of the following component parts, all of which are fully incorporated herein and made a part of the obligations undertaken by the parties:

- 1.1 a Bid Invitation
- 1.1.b Project Information
- 1.1.c Instructions to Bidders
- 1.1.d General Conditions
- 1.1.e Special Conditions
- 1.1.f Insurance/Bonding Requirements and Certificates
- 1.1.g Bid Form (including Certification/Proposal, Signature Affidavit including Proposal Pricing)
- 1.1.h Specifications (including any addenda, interpretations and approved exceptions)
- 1.1.i Exhibits
- 1.1.j County Purchase Order

1.2 All documents are or will be on file in the office of the Procurement Services Division, DuPage Center, 421 North County Farm Road, Room 3-400, and Wheaton, Illinois 60187.

1.3 In the event of a conflict between any of the above documents, the documents control from top to bottom; i.e., "a" controls over "b".

2.0 DURATION OF THIS CONTRACT

2.1 Unless terminated as provided in the Bid Invitation, the term of this Contract shall be a ___year period beginning on, 20__ and continuing through _____, 20__.

2.2 The Contract term is subject to renewal according to the Bid Invitation specifications.

2.3 In no event shall the term plus renewals exceed three (3) years.

3.0 BID PRICES AND PAYMENT

3.1 The Contractor shall provide the required goods and or services described in the Proposal Specifications for the prices quoted on the Proposal Form.

3.2 The County shall make payment pursuant to the Illinois Local Government Prompt Payment Act, except that no payment shall be approved where the Proposer has failed to comply with certified payroll requirements of the Illinois Prevailing Wage Act or Davis Bacon Act.

4.0 AMENDMENTS

4.1 This Contract may be amended by mutual agreement.

4.2 All amendments will conform to State of Illinois Statutes and County procedures for Change Orders.

5.0 CONTRACT ENFORCEMENT - ATTORNEY'S FEES

5.1 If the County is required to take legal action to enforce performance of any of the terms, provisions, covenants and conditions of this Contract, and by reason thereof, the County is required to use the services of an attorney, including the States Attorney, then the County shall be entitled to reasonable attorney's fees and all expenses and costs incurred by the County pertaining thereto and in enforcement of any remedy, including costs and fees relating to any appeal.

6.0 SEVERABILITY CLAUSE

6.1 If any section, paragraph, clause, phrase or portion of this Contract is for any reason determined by a court of competent jurisdiction to be invalid and unenforceable, such portion shall be deemed separate, distinct and an independent provision, and the court's determination shall not affect the validity or enforceability of the remaining portions of this Contract.

Insight ITB Response
Emergency Telephone System Board of DuPage County
Mobile Data Terminals (MDT) #P17-204-BF



7.0 GOVERNING LAW

7.1 This Contract shall be governed by the laws of the State of Illinois both as to interpretation and enforcement. Venue for all disputes will be exclusively in the circuit court for the Eighteenth Judicial Circuit in DuPage County, Illinois and that Illinois law will control.

8.0 ENTIRE AGREEMENT

8.1 This Contract, including the documents listed in 1.0, contains the entire agreement between the parties.

8.2 There are no covenants, promises, conditions, or understandings; either oral or written, other than those contained herein.

IN WITNESS WHEREOF, the parties set their hands and seals as of the date first written above.

ETSB of DuPage County

[Contractor]

By: _____
GARY GRASSO
ETSB Chairman

By: _____
AUTHORIZED SIGNATURE

TITLE

SAMPLE

Insight ITB Response
Emergency Telephone System Board of DuPage County
Mobile Data Terminals (MDT) #P17-204-BF



Attachment 1 – Warranty Information

Services and Ongoing Warranty Support

In line with our build-to-order model, Dell's support services are tied to each system, letting you design a complete program that fits your organization's unique technology and operational needs. Such a program means you select and pay for only those services that you determine are business critical, thereby minimizing your IT infrastructure's Total Cost of Ownership (TCO).

Dell offers DuPage County a single point of accountability for all of your service and support needs. Whether an issue can be quickly resolved by a Dell technician over the phone or it is more complex and requires the dispatch of a technician, Dell retains ownership of every service and support issue until each issue is resolved.

To provide best in class service and support, Dell uses "Virtual Integration;" seamlessly joining industry leading partners to create customer value faster and more effectively than any single company could create alone. Through this model we have access to over 70,000 field technicians around the world to provide on-site service in over 170 countries.

Another reason for Dell's success and our superior level of customer satisfaction is our ability to harness the power of information. We gather and track information on a per-system, per component basis. System service tags allow technicians to access original factory installed configurations, service call history, and warranty information. Having this information immediately available enables Dell to proactively identify and resolve product issues much more efficiently than our competitors.

Maximum Base Warranty Term Extensions

The following chart clarifies the maximum number of years a base warranty term extension for consumer and commercial products.

Brand	Inspiron		XPS		Vostro		Alienware			Latitude		OptiPlex		Precision		Latitude Rugged	Chromebook	Venue	Latitude	XPS	Wyse	IoT	SurfacePro
Maximum Term Extension	NB	DT	NB	DT	NB	DT	NB	DT	Console	NB	DT	MWS	FWS	NB	NB	Tablet	Tablet	Tablet	Client	Client	Gateway/ Embedded Box PC	Client	
	4	4	4	4	4	4	5	5	4	5	5	5	5	5	4	3	3	3	5	5	5	4	

Basic Hardware Support

DuPage County can add selected support options to basic support. Options include Keep Your Hard Drive (KYHD) and Accidental Damage. An overview of basic support packages and extension options are provided below.

Next Business Day on Site

A Next Business Day service is provided as a minimum standard on all Dell Client equipment and selected Enterprise Equipment. This basic support provides telephone support during business hours and a next business day on-site (NBD) hardware repair service.

Dell's Next Business Day On-Site Service (NBD) places a Dell-certified engineer at the customer's location the following business day, after completion of telephone-based troubleshooting when a Dell technician accepts and logs a system fault call before 17:00 Monday-Friday, subject to parts availability.

Basic Support Extension option - Keep Your Hard Drive

Keep Your Hard Drive (KYHD) is a support service designed to give peace of mind to customers with sensitive, confidential and/ or irreplaceable data stored on computer hard drives.

If, after completion of Dell’s standard on-site diagnostic procedures, it is determined that the system has a faulty hard drive, the KYHD Service allows DuPage County to retain the faulty hard drive after it has been removed from the system by the Dell technician.

Keeping the hard drive means that DuPage County can either destroy the data on the hard drive according to your own security policy or attempt to retrieve the data on the faulty drive using a specialist data retrieval company, without the time pressure of trying to do this before the product is repaired.

KYHD is also available as an option for ProSupport customers.

Basic Support Extension option - Accidental Damage

Dell’s Accidental Damage service provides comprehensive coverage of your Client system against Accidental Damage and/or Theft — providing replacement or Next Business Day (NBD) repair in the event of an unforeseen incident.

Accidental Damage is also an available option for ProSupport customers.

ProSupport Suite for PCs and Tablets

Trends and challenges in end user hardware management

Five big trends are impacting the management of end user hardware today. From an IT administrator’s perspective, cloud, the internet of things and big data especially have a big impact on end user hardware that can lead to significant challenges when managing support for PCs and tablets.

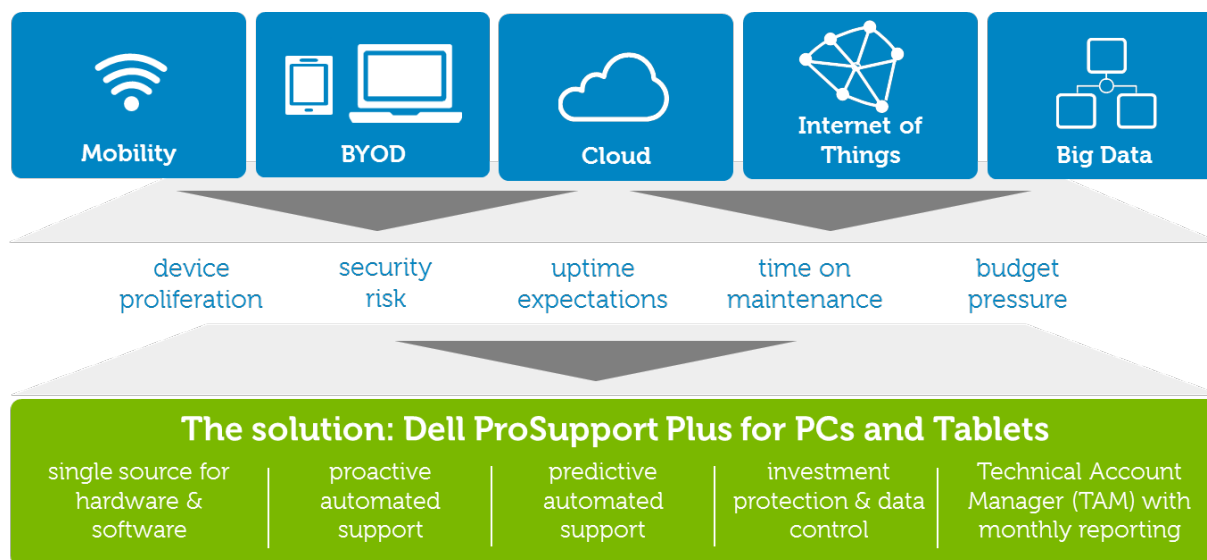

Figure 1: PCs and tablets market landscape

These challenges include device proliferation, security risk, uptime expectations, time required for maintenance, and budget pressure. Your organization is now being asked to support a variety of devices and platforms in the workplace, making it difficult to provide effective and efficient service in a more complex environment.

Allocating resources to strategic planning and initiatives is critical to long term success, but most IT departments spend 80% of their time on routine maintenance and support instead of innovation — a fact that hasn't changed in years.¹

80% of IT time spent on routine operations & support	20% of IT time spent on Innovation
<ul style="list-style-type: none"> • Handling routine support and maintenance • Rolling out the next refresh • Managing end point security 	<ul style="list-style-type: none"> • Progressing the project backlog • Advancing the IT vision • Collaborating with business partners

The more we rely on technology every day, everywhere — from complex, mission critical data center systems to office PCs and mobile devices — the more you need the right support. Dell provides the complete support solutions you need and you can shift the right amount of support to the experts at Dell — freeing you to conquer the next innovation for your organization.

Complete support for evolving businesses

Dell ProSupport Suite offer varied support options — including ProSupport, ProSupport Plus and ProSupport Flex — for your business needs and delivers experts, insights and ease.

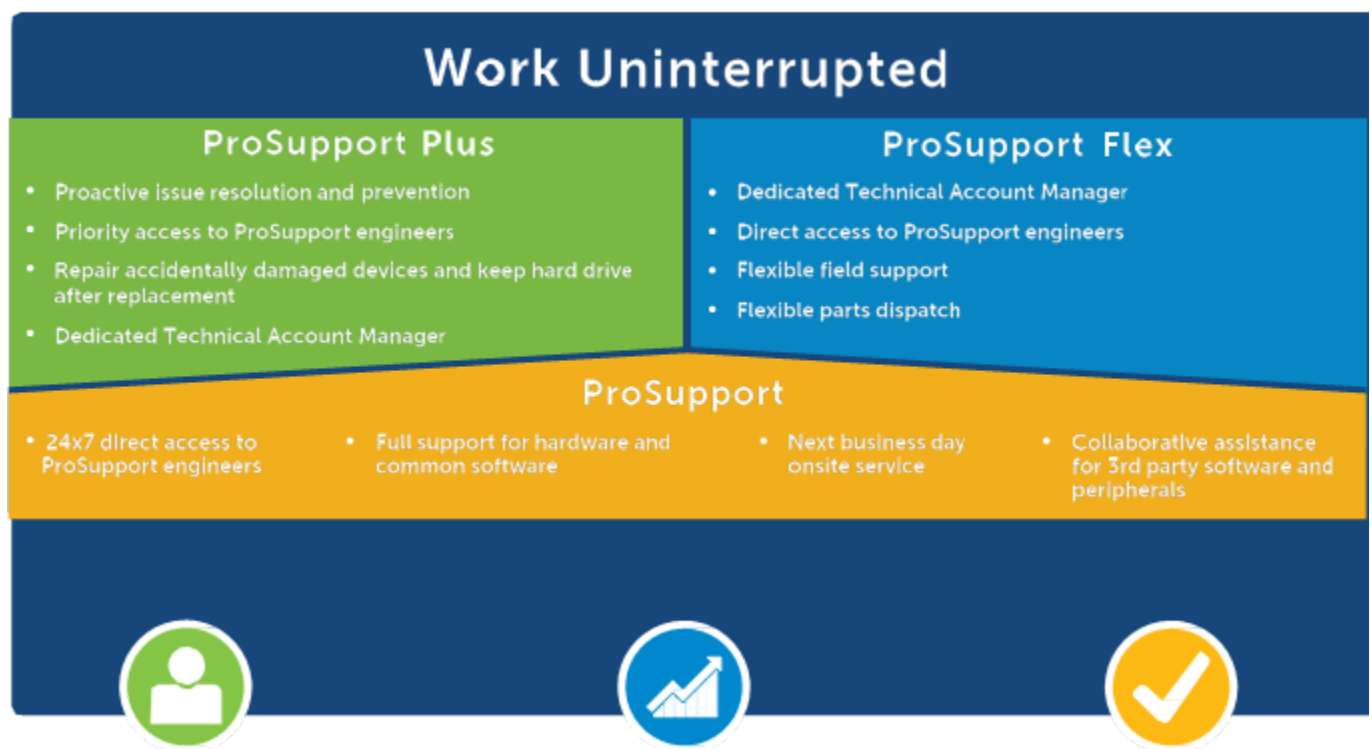

- **Experts:** Focus on business outcomes while Dell experts reduce complexity
 - 24,000+ support engineers in over 160 countries with broad and deep expertise
 - 8,700+ certifications in industry-leading hardware, software and solutions

¹ Source: IDC Converged and Integrated Systems End-User Survey, N = 300 (2012), N = 308 (2013), N=301 (2014)

- Access to consistent, single-source expertise for hardware and software
- **Insights:** Improve performance and stability with deep insights and intelligent data
 - Predictive analysis for issue prevention and optimization enabled by SupportAssist²
 - Personalized relationship with a dedicated Technical Account Manager with deep knowledge of your business and environment³
 - Monthly support history and contract renewal reporting⁴
- **Ease:** Increase productivity by shifting tasks to Dell's always accessible support teams
 - 24x7x365 phone support in 55 languages with next business day onsite service⁴
 - Collaborative support agreements with over 195 3rd party vendors
 - Automated case creation with notification
 - Easy, self-service online portal, mobile application and APIs with TechDirect to manage support requests and dispatch parts

Traditional support vs. Dell ProSupport Plus proactive and predictive automated support

The following figure shows the comparison between the traditional support process and ProSupport Plus process.

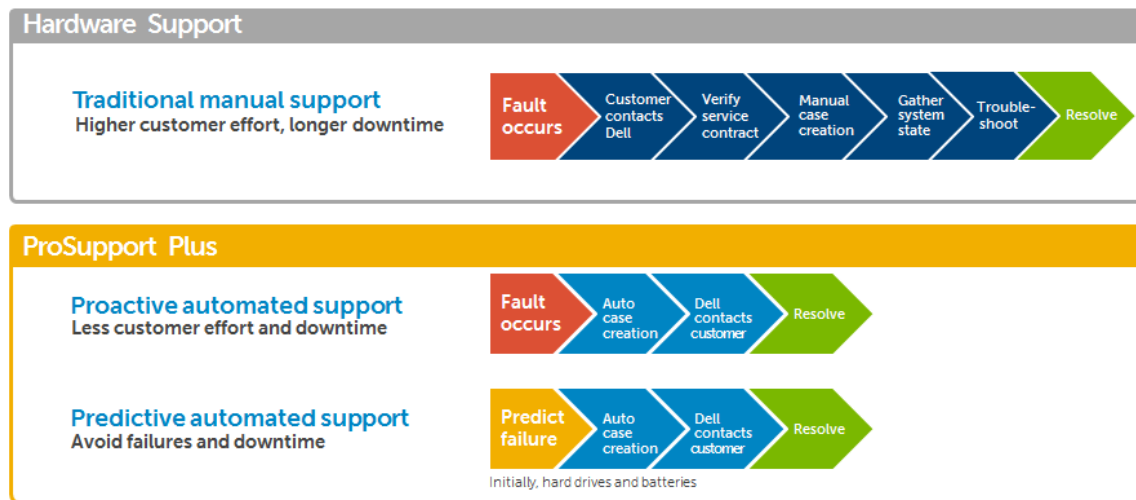

With the traditional support model, when a failure occurs in the environment, IT contacts their technical support who spends time on the phone to verify the name and contact information on the service tag and then create a case. Then, the technical support asks for a lot of information on the state of their system in order to narrow down the focus for troubleshooting. Then, technical support does the troubleshooting and then finally helps IT resolve the issue.

² SupportAssist is only available on Windows 8 and 8.1 based mobile products, yet not available on Windows RT, Android or Google Chrome. Predictive support is available for hard drive and batteries.

³ PC and tablet Technical Account Manager is available for customers with 1,000 or more ProSupport Plus Systems.

⁴ PC and tablet Technical Account Manager is available for customers with 1,000 or more ProSupport Plus Systems.

This process is entirely reactive. It is up to the customer or, in the case of larger environment, possibly the end-user submitting a ticket into their IT staff, to contact technical support. It is a multi-step process and during that entire process, the end-user could be experiencing downtime.

With ProSupport Plus and SupportAssist, the support process is completely different and can happen two different ways:

- **Proactive automated support.** Because of the monitoring via SupportAssist, when a fault does occur, it will trigger case creation with Dell technical support and notifies the customer. Then, Dell starts the conversation with the customer, which is a huge difference from the traditional support process.

In addition to starting the conversation and automatically creating the case, Dell has gathered all the system information and hence knows what the problem is. In most cases, Dell only contacts the customer to verify the shipping address to ensure the parts are sent to the correct address. All of this leads to streamlined process with fewer steps and a much faster time to resolution. Furthermore, through the part dispatch process, some scenarios are completely automated without having to talk to a Dell technician.

- **Predictive automated support.** This scenario gives the customer an even better experience through Dell's predictive capabilities. Dell contacts the customer before the fault even occurs. Dell actually predicts the failure and then follows the same steps of creating the case and contacting our customer to confirm the shipping address. For instance, Dell will call them to let the customer know their hard drive is about to fail, remind the customer to back-up their data, confirm their contact information and then send the parts before they even knew there would be an issue.

Service Description

Accidental Damage Service

Introduction

Dell is pleased to provide Dell Accidental Damage Service (the "**Service(s)**") in accordance with this Service Description ("**Service Description**"). Your quote, order form or other mutually-agreed upon form of invoice or order acknowledgment (as applicable, the "**Order Form**") will include the name of the service(s) and available service options that you purchased. For additional assistance or to request a copy of your service contract(s), contact Dell Technical Support or your sales representative.

The Scope of Your Service Agreement

For your one-time payment to Dell as specified on your invoice or other order confirmation (the "**Total Price**") for each product ("**Supported Product**," as defined below) plus any applicable sales or similar taxes, Dell will provide the Service in accordance with this Agreement for the term of Service specified on such invoice, or other order confirmation.

You must pay a separate Total Price for each Supported Product you wish to be covered by this Agreement. For example, a printer purchased with a notebook system is not covered by the notebook system's service contract. Instead, the printer and the notebook will each need their own service contract. When the Service is purchased for a desktop system, both the desktop and the monitor purchased with the desktop will be covered under the service contract. With regard to each Supported Product covered by this Agreement the following general terms, conditions and exclusions shall apply:

During the term of this Agreement and subject to the limitations in this Agreement, we will repair the Supported Product as necessary to correct any damage to the Supported Product which occurs during the usual and customary usage of the Supported Product and is caused by either accidental damage from handling (including drops and spills) or an electrical surge.

Only parts built in or on the base unit of the Supported Product, including parts or accessories that are required for regular operation of the base unit and shipped at point of sale, such as internal memory, built-in LCD, internal components/switches, built-in buttons, drawers, lids or panels, remote controls, or cables are covered.

This Agreement does not cover externally-attached computers, peripherals, or other devices that may work in conjunction with the Supported Product, and this Agreement does not cover components, cases, television or monitor wall mounts, wiring, or items classified as "accessories" or "consumables" and not built in or on the base unit of the Supported Product, such as batteries that are out of warranty, light bulbs, disposable/replaceable print/ink cartridges, print or photo paper, memory disks, memory cards, SIM cards, disposable memory devices, wire connections, carrying cases, stylus pens, docking stations, external modems, external speakers, game devices, game disks, secondary monitors, external mouse for notebooks, external keyboard for notebooks, or other input/output devices, any other components not internal to the Supported Product for which you purchased Service, or other parts/components requiring regular user maintenance.

If we repair your Supported Product, you understand and agree that we may replace original parts with new or used parts from the original manufacturer, or an equivalent part from a different manufacturer. Replacement parts will be functionally equivalent to the original parts. In our discretion, we may designate an affiliated company or contract with a third party to complete repairs on the Supported Product.

If we decide that it is necessary to replace the Supported Product rather than repair it, you will receive a Supported Product equivalent to or better than the Supported Product you originally purchased from us, as



determined by us in our sole and reasonable discretion.

For any incident that Dell determines is eligible for Service under this Agreement (a "Qualified Incident"), Service coverage is limited to one Qualified Incident per Supported Product per 12 month period commencing from the start date of the term of Service. The ability to submit an incident does not accumulate or carry over to any subsequent 12 month period. However, each Qualified Incident will be applied to the 12 month period during which it is reported, even if such incident is resolved during a subsequent period. Once the Qualified Incident limit is reached, Customer may request repair of the Supported Product for an additional charge.

This is not a contract of insurance. Please read this Agreement carefully, and please note that Dell reserves the right to change or modify any of the terms and conditions set forth in this Agreement at any time. Dell also reserves the right to determine whether and when any such changes apply to both existing and future Customers.

Service Response Level. When you request Service, you must allow Dell to evaluate the Supported Product to determine whether the product qualifies for Service. Dell's technical support agent will inform you of the options available to you to ship your Supported Product to Dell for evaluation and repair. As long as you follow our directions, as specified in the "Cooperate with Technician" section below, Dell will pay all shipping charges for return of the Supported Product to Dell's service facility. In some instances, Dell may make other evaluation and repair methods available to you as part of the Service.

Hardware Only. This Agreement is for hardware only. This Service does not cover software. This software exclusion includes but is not limited to: 1) any defects in or damage (including without limitation virus-inflicted damage) to software preloaded on, purchased with or otherwise loaded on the Supported Product and 2) any software loaded through Custom Factory Integration. In addition, this Service does not cover any other items added through Custom Factory Integration. We will exercise reasonable efforts to, but this Agreement does not guarantee that we will, repair or replace non-software Custom Factory Integration items that may otherwise be excluded components.

Service Limitations. This Agreement does not cover and we are not obligated to repair or replace:

- Any damage to or defect in the Supported Product that is cosmetic. Under this Agreement, we are not obligated to repair wear and tear on the Supported Product and other superficial items, such as scratches and dents that do not materially impair your use of the Supported Product.
- Any Supported Product that anyone other than Dell or a person we designate has tried to repair. We will not provide Service for any product defect that results after repairs to the Supported Product made or attempted by you or any other person not authorized by Dell to repair the Supported Product.
- Any Supported Product that suffers damage in connection with or as a result of incorrect or inadequate Customer Installation. "Customer Installation" shall include any of the following performed by the Customer or any third party on behalf of the customer: (1) unpacking or moving the Supported Product (2) installation or mounting of a Supported Product to a wall or other structure (or removal of the same following installation) and (3) affixing of brackets or other weight bearing devices designed for mounting or attachment to a wall or other structure (or removal of the same). Customer Installation does not include installation services purchased from Dell.
- Any Supported Product that is lost or stolen. To receive repair or replacement of a Supported Product, you must return the damaged Supported Product to us in its entirety.
- Any Supported Product that is damaged by fire from an external source or that is intentionally damaged or damaged by misuse, abuse, failure to follow instructions provided with the Supported Product, or use of the Supported Product in an incorrect environment. If we find evidence of intentional damage, misuse, abuse, failure to follow instructions provided with the Supported Product, or use of the Supported Product in an incorrect environment, we are not obligated to repair or replace the Supported Product.
- Any recovery or transfer of data stored on the Supported Product. You are solely responsible for all data stored on the Supported Product, and it is your responsibility to complete a backup of all existing data,



software, and programs on affected products before receiving services (including telephone support) or shipping products back to Dell. In addition, you are responsible for removing any confidential, proprietary, or personal information and any removable media such as SIM cards, memory cards, CDs, or PC cards. We do not provide you any data recovery services under this Agreement. However, if Dell determines that replacement of a storage device or hard drive is necessary, we will reload, at no charge to you, the then-current version of major application and operating system software you originally purchased from us, including any installed Custom Factory Integration applications. We do not, however, represent or warrant and this Agreement does not obligate us to ensure that any installed Custom Factory Integration applications will be compatible with the replacement Supported Product.

- Preventive maintenance. It is not necessary that you perform any preventive maintenance on the Supported Product to obtain repair or replacement of a Supported Product covered by this Agreement.
- Except as specifically provided herein, any other damages that do not arise from defects in materials or workmanship or ordinary and customary usage of the covered Supported Product.
- Any damages arising from acts of God such as, but not limited to, lightning, flooding, tornado, earthquakes, and hurricanes.

Failure rates of your Supported Products and all components within are constantly monitored. For customers with a history of high incident rates, Dell reserves the right to require such customers to work with Dell to reduce the number of incidents and/or deny requests to continue to purchase this Service.

Additional Limitations for Service Purchased After the Purchase of the Supported Product. Where allowed by law, this Service may also be available for purchase after the date that Customer purchased a product. In those instances, the following conditions and limitations apply:

- Requests for service for the supported product cannot be presented until 30 days after the Service's purchase date, as indicated on customer's invoice, information page or other order confirmation; provided however, that the 30-day waiting period will not apply to customers who extend their service period prior to the expiration of the preceding service term
- Customer is responsible for ensuring that the Supported Product is in normal operating condition at the time Service is purchased. Under no circumstances will Dell be responsible for Service for any damage or defect that existed prior to the Customer's purchase of the Service.
- Dell reserves the right to inspect the Supported Product to confirm that it is in normal operating condition. Dell may, for an additional charge, offer Customer repair options to return the underlying product to normal operating condition.
- If, upon inspection, Dell determines in its sole discretion that the damage or defect for the Supported Product existed before the Service was purchased, then the request for Service will be denied.

Geographic Limitations & Relocation. This Service will be delivered to the site(s) indicated on the Customer's invoice, or other order confirmation. Dell is not obligated to provide Service for any Supported Product located outside of the country or site(s) indicated on Customer's invoice or other order confirmation. Service options, including service levels, technical support hours and onsite response times will vary by geography and certain options may not be available in Customer's location. Dell's obligation to provide Service for a relocated Supported Product is subject to local Service availability and may be subject to additional fees as well as inspection and recertification of the relocated Supported Product at Dell's then current time and materials consulting rates. Support outside of the country in which Customer purchased this Service may be available on a commercially reasonable efforts basis (e.g., not available in all countries, not available on all parts, not available to all Customers). In addition, out of country support will not include any whole unit replacements. Please contact a Dell technical support analyst for additional details.

Authority to Grant Access. Customer represents and warrants that it has obtained permission for both Customer and Dell to access and use the Supported Products, the data located thereon and all hardware and software components included therein, for the purpose of providing these Services. If Customer does not already have



that permission, it is Customer's responsibility to obtain it, at Customer's expense, before Customer asks Dell to perform these Services.

On-site Obligations. Where Services require on-site performance, Customer will provide (at no cost to Dell) free, safe and sufficient access to Customer's facilities and the Supported Products, including ample working space, electricity, and a local telephone line. A monitor or display, a mouse (or pointing device), and a keyboard must also be provided (at no cost to Dell), if the system does not already include these items.

Maintain Software and Serviced Releases. Customer will maintain software and Supported Products at Dell-specified minimum release levels or configurations as specified on PowerLink for Dell | EMC Storage or EqualLogic™, or as specified on www.support.dell.com for additional Supported Products. Customer must also ensure installation of remedial replacement parts, patches, software updates or subsequent releases as directed by Dell in order to keep the Supported Products eligible for this Service.

Data Backup; Removing Confidential Data. Customer will complete a backup of all existing data, software and programs on all affected systems prior to and during the delivery of this Service. Customer should make regular backup copies of the data stored on all affected systems as a precaution against possible failures, alterations, or loss of data. In addition, Customer is responsible for removing any confidential, proprietary, or personal information and any removable media such as SIM cards, CDs, or PC Cards regardless of whether an on-site technician is also providing assistance. **DELL WILL HAVE NO LIABILITY FOR:**

- **ANY OF YOUR CONFIDENTIAL, PROPRIETARY OR PERSONAL INFORMATION;**
- **LOST OR CORRUPTED DATA, PROGRAMS OR SOFTWARE;**
- **DAMAGED OR LOST REMOVABLE MEDIA;**
- **DATA OR VOICE CHARGES INCURRED AS A RESULT OF FAILING TO REMOVE ALL SIM CARDS OR OTHER REMOVABLE MEDIA INSIDE SUPPORTED PRODUCTS THAT ARE RETURNED TO DELL;**
- **THE LOSS OF USE OF A SYSTEM OR NETWORK;**
- **AND/OR FOR ANY ACTS OR OMISSIONS, INCLUDING NEGLIGENCE, BY DELL OR A THIRD-PARTY SERVICE PROVIDER.**

Dell will not be responsible for the restoration or reinstallation of any programs or data. When returning a Supported Product or part thereof, Customer will only include the Supported Product or part which has been requested by the phone technician.

Third Party Warranties. These Services may require Dell to access hardware or software that is not manufactured by Dell. Some manufacturers' warranties may become void if Dell or anyone else other than the manufacturer works on the hardware or software. Customer will ensure that Dell's performance of Services will not affect such warranties or, if it does, that the effect will be acceptable to Customer. Dell does not take responsibility for third party warranties or for any effect that the Services may have on those warranties.

How to Contact Dell If Your Require Service

Self-Dispatch Support Programs:

For customers enrolled in the Tech Direct Program, Qualified Incidents may be handled by Certified Customer technicians through the submission of a service request to the self-dispatch website or telephone queue for your region. Depending on the nature or extent of the damage, the issue may require that the Supported Product be sent to a Dell-designated repair center.

Chat and E-mail Support

Dell technical support service may be contacted through instant online chat or e-mail available at www.support.dell.com

Telephone-Based Support:



For telephone support requests, contact your Dell support center to speak to a technical support analyst. When you call, diagnosis or troubleshooting under your Dell Limited Hardware Warranty (see www.Dell.com/Warranty), or other underlying warranty or service contract (see www.Dell.com/ServiceContracts) may be required prior to receiving Service under this Agreement. The hours of support shall not include holidays. Please contact your Dell sales or support analyst for additional details. Dell is not liable for any failure or delay in performance due to any cause beyond its control.

General customer responsibilities

Cooperate with Technician. You must cooperate with the technician to ensure that the Supported Product is properly serviced. When you call, a Dell technician will both ask for the Service Tag number located on your Supported Product and verify your purchase of the Service.

The technician will then ask you a series of questions to assess the extent and cause of damage to the Supported Product. These diagnostic and troubleshooting steps may require more than one call or an extended session, and you may be asked to access the inside of your Supported Product where safe to do so.

If your issue is covered by this Service and that issue is not resolved remotely, then, at our discretion following completion of remote diagnosis or troubleshooting, the technician may send you a replacement part for you to install on the Supported Product.

In some cases, where we can determine over the telephone that a replacement Supported Product will be necessary, we may in our discretion, ship you a replacement Supported Product immediately. However, if you fail to return the damaged Supported Product to us, you agree that you are responsible for the retail price of the replacement Supported Product.

When returning a Supported Product for replacement, unless otherwise directed by your Dell tech support agent, do not include parts not sent to you for replacement (such as battery, battery pack cover, SIM card, memory card, etc.). Dell will not be responsible for any data or voice charges incurred as a result of Customer's failure to remove all SIM cards inside Products returned to Dell. In addition, when returning your Product for replacement, do not send external parts (such as cords, cables, controls, or lens caps).

Payment. Service is only available with the purchase of a Dell product for which Dell currently offers Dell Accidental Damage Service, but it is not necessary that you purchase the Service to buy a Supported Product from us. Our invoice or other order confirmation issued to you for the Supported Product will indicate whether you purchased Dell Accidental Damage Service, and will serve as your receipt. We will provide you a copy of the invoice or other order confirmation and this Agreement within ten (10) days after your purchase of a Supported Product with Service. In addition, the Supported Product will be tagged with a serial number that will indicate your purchase of the Service (the "**Service Tag**").

Limitation of Liability. NEITHER DELL MARKETING L.P. (NOR DELL CANADA INC. FOR CANADIAN PURCHASES) NOR ITS AFFILIATES, PARTNERS, OFFICERS, DIRECTORS, EMPLOYEES OR AGENTS ARE LIABLE TO YOU, OR ANY SUBSEQUENT OWNER OR OTHER USER OF THE SUPPORTED PRODUCT, FOR ANY INCIDENTAL OR CONSEQUENTIAL DAMAGES, INCLUDING, BUT NOT LIMITED TO, LIABILITY OR DAMAGES FOR THE SUPPORTED PRODUCT NOT BEING AVAILABLE FOR USE, LOSS OR CORRUPTION OF DATA OR SOFTWARE, PERSONAL INJURY, DEATH, ANY LOSS DUE TO SUPPORTED PRODUCT FAILURE, OR ANY AND ALL INCIDENTAL, INDIRECT, SPECIAL OR CONSEQUENTIAL DAMAGES ARISING OUT OF OR IN CONNECTION WITH THE USE OR PERFORMANCE OF THE SUPPORTED PRODUCT, EVEN IF YOU HAVE BEEN ADVISED OF THE POSSIBILITY OF SUCH DAMAGES. BY ENTERING INTO THIS AGREEMENT, YOU EXPRESSLY WAIVE ANY CLAIMS DESCRIBED IN THIS PARAGRAPH. YOU AGREE AND UNDERSTAND THAT WE WILL NOT BE RESPONSIBLE FOR ANY AMOUNT OF DAMAGES ABOVE THE AGGREGATE DOLLAR AMOUNT PAID BY YOU FOR THE PURCHASE OF THE SUPPORTED PRODUCT COVERED BY THIS AGREEMENT. SOME STATES AND JURISDICTIONS DO NOT ALLOW THE EXCLUSION OR LIMITATION OF INCIDENTAL OR CONSEQUENTIAL DAMAGES, SO SOME OR ALL OF THE ABOVE LIMITATION OR EXCLUSION MAY NOT APPLY TO YOU.



Dell Services Terms & Conditions

This Service Description is entered between you, the customer ("you" or "Customer"), and the Dell entity identified on your invoice for the purchase of this Service. This Service is provided subject to and governed by Customer's separate signed master services agreement with Dell that explicitly authorizes the sale of this Service. In the absence of such agreement, depending on Customer's location, this Service is provided subject to and governed by either Dell's Commercial Terms of Sale or the agreement referenced in the table below (as applicable, the "Agreement"). Please see the table below which lists the URL applicable to your Customer location where your Agreement can be located. The parties acknowledge having read and agree to be bound by such online terms.

Customer Location	Terms & Conditions Applicable to Your Purchase of Dell Services	
	Customers Purchasing Dell Services Directly From Dell	Customers Purchasing Dell Services Through an Authorized Dell Reseller
United States	www.dell.com/CTS	www.dell.com/CTS
Canada	www.dell.ca/terms (English) www.dell.ca/conditions (French-Canadian)	www.dell.ca/terms (English) www.dell.ca/conditions (French-Canadian)
Latin America & Caribbean	Local www.dell.com country-specific website or www.dell.com/servicedescriptions/global .*	Local www.dell.com country-specific website or www.dell.com/servicedescriptions/global .*
Asia-Pacific-Japan	Local www.dell.com country-specific website or www.dell.com/servicedescriptions/global .*	Service Descriptions and other Dell service documents which you may receive from your seller shall not constitute an agreement between you and Dell but shall serve only to describe the content of Service you are purchasing from your seller, your obligations as a recipient of the Service and the boundaries and limitations of such Service. As a consequence hereof any reference to "Customer" in this Service Description and in any other Dell service document shall in this context be understood as a reference to you whereas any reference to Dell shall only be understood as a reference to Dell as a service provider providing the Service on behalf of your seller. You will not have a direct contractual relationship with Dell with regards to the Service described herein. For the avoidance of doubt any payment terms or other contractual terms which are by their nature solely relevant between a buyer and a seller directly shall not be applicable to you and will be as agreed between you and your seller.
Europe, Middle East, & Africa	Local www.dell.com country-specific website or www.dell.com/servicedescriptions/global .* In addition, customers located in France, Germany and the UK can select the applicable URL below: France: www.dell.fr/ConditionsGeneralesdeVente Germany: www.dell.de/Geschaeftsbedingungen UK: www.dell.co.uk/terms	Service Descriptions and other Dell service documents which you may receive from your seller shall not constitute an agreement between you and Dell but shall serve only to describe the content of Service you are purchasing from your seller, your obligations as a recipient of the Service and the boundaries and limitations of such Service. As a consequence hereof any reference to "Customer" in this Service Description and in any other Dell service document shall in this context be understood as a reference to you whereas any reference to Dell shall only be understood as a reference to Dell as a service provider providing the Service on behalf of your seller. You will not have a direct contractual relationship with Dell with regards to the Service described herein. For the avoidance of doubt any payment terms or other contractual terms which are by their nature solely relevant between a buyer and a seller directly shall not be applicable to you and will be as agreed between you and your seller.

* Customers may access their local www.dell.com website by simply accessing www.dell.com from a computer connected to the Internet within their locality or by choosing among the options at Dell's "Choose a Region/Country" website available at <http://www.dell.com/content/public/choosecountry.aspx?c=us&l=en&s=gen>.



Customer further agrees that by renewing, modifying, extending or continuing to utilize the Service beyond the initial term, the Service will be subject to the then-current Service Description available for review at www.dell.com/servicedescriptions/global.

To the extent that any terms of this Service Description conflict with any terms of the Agreement, the terms of this Service Description will prevail, but only to the extent of the specific conflict, and will not be read or deemed to replace any other terms in the Agreement which are not specifically contradicted by this Service Description.

By placing your order for the Services, receiving delivery of the Services, utilizing the Services or associated software or by clicking/checking the "I Agree" button or box or similar on the Dell.com website in connection with your purchase or within a Dell software or Internet interface, you agree to be bound by this Service Description and the agreements incorporated by reference herein. If you are entering this Service Description on behalf of a company or other legal entity, you represent that you have authority to bind such entity to this Service Description, in which case "you" or "Customer" shall refer to such entity. In addition to receiving this Service Description, Customers in certain countries may also be required to execute a signed Order Form.



General Terms

Supported Products. This Service is available on supported products which includes select Dell OptiPlex™, Latitude™, Venue™, Inspiron™, Precision™, Vostro™, XPS™, Alienware™, Chromebooks™, and Dell Wyse™ products which are purchased in a standard configuration, as well as select Microsoft™ Surface Pro™ tablets ("**Supported Products**"). Supported Products are added regularly, so please contact your sales representative for the most up-to-date list of Services that are available on your Dell or non-Dell products. Each Supported Product is tagged with a serial number (the "**Service Tag**"). A separate service agreement must be purchased by Customer for each Supported Product. For example, a printer purchased with a laptop system is not covered by the laptop system's service contract; the printer and the laptop will each need their own service contract. Please refer to the Service Tag on your Supported Product when contacting Dell for this Service.

Term and Renewal. The service type, term and the Supported Product you have purchased is recorded on the Customer invoice or on the information page included with your copy of this Agreement; provided that the term of Service purchased may not exceed the length of Customer's underlying Dell limited hardware warranty, or service contract for the Supported Product. Prior to the expiration of your service contract and subject to the limitations set forth in this Agreement, you may extend your service period based on available options then in effect for your Supported Product.

Claims of Confidentiality or Proprietary Rights. You agree that any information or data disclosed or sent to Dell, over the telephone, electronically or otherwise, is not confidential or proprietary to you.

Transferability. Subject to the limitations set forth in this Agreement, Customer may transfer this Service to a third party who purchases Customer's entire Supported Product before the expiration of the then-current service term; provided that Customer is the original purchaser of the Supported Product and this Service, or Customer purchased the Supported Product and this Service from its original owner (or a previous transferee) and complied with all the transfer procedures available at www.support.dell.com. Additional terms, conditions and fees may apply to any such transfer. Please note that if Customer or Customer's transferee moves the Supported Product to a geographic location in which this Service is not available (or is not available at the same price), Customer or Customer's transferee may not have coverage or may incur an additional charge to maintain the same categories of support coverage at the new location. If Customer or Customer's transferee chooses not to pay such additional charge, the Service may be automatically changed to categories of support which are available at such price or a lesser price in such new location with no refund available.

Assignment. Dell may assign this Service and/or Service Description to qualified third party service providers.

Cancellation by You. For US Customers Only - This Agreement is dated as of the invoice date or other start date noted on your invoice. You may cancel this Agreement within thirty (30) days of your receipt of this Agreement by sending written notice to us at:

Dell Marketing L.P.
One Dell Way
Round Rock, Texas 78682
Attn: Service and Support Department

Except as provided in paragraph 5.i. for customers in certain states or jurisdictions, where applicable, if you cancel this Agreement within thirty (30) days of your receipt of it, we will send you a full refund less the cost of claims, if any, made under this Agreement. For example, if no claim has been made under this Agreement and you cancel this Agreement within 30 days of your receipt of it, this Agreement shall be void and we shall send you a full refund of the purchase price of this Agreement. You may not cancel this Agreement after thirty (30) days of your receipt of this Agreement, except as provided in paragraph 5.i. for customers in certain states or jurisdictions.

Cancellation by Dell. We may cancel this Agreement if you fail to pay us the Total Price for the Service in accordance with our invoice terms, make a misrepresentation to us or our agents, or otherwise breach your obligations under this Agreement. If we cancel this Agreement, we will send you written notice of



cancellation at the address indicated in our records. The notice will include the reason for cancellation and the effective date of cancellation, which will not be less than ten (10) days from the date we send notice of cancellation to you, except as provided in paragraph 5.i. for customers in certain states or jurisdictions.

Service must be cancelled separately for each Supported Product.

Entire Agreement. This Agreement is the entire agreement between you and Dell with respect to its subject matter and none of Dell's employees or agents may orally vary the terms and conditions of this Agreement.

Additional Remedies. This Agreement affords you specific legal rights. You may have additional legal rights that vary from jurisdiction to jurisdiction, including those listed below. This Agreement is not a warranty. The Supported Product you purchase from us may also come with a limited hardware warranty from Dell or third party manufacturers of Supported Products we distribute. Please consult the applicable limited warranty statements for your rights and remedies under those limited warranties. (For the Dell Limited Hardware Warranty please see www.Dell.com/Warranty).

Dispute Resolution. Customer and Dell will attempt to resolve any claim, dispute, or controversy (whether in contract, tort, or otherwise) arising out of or relating to this Agreement, Dell's advertising, or any related purchase (a "Dispute") through face-to-face negotiation with persons fully authorized to resolve the Dispute or through mediation utilizing a mutually agreeable mediator, rather than through litigation. The existence or results of any negotiation or mediation will be treated as confidential. Notwithstanding the foregoing, either party will have the right to obtain from a court of competent jurisdiction a temporary restraining order, preliminary injunction, or other equitable relief to preserve the status quo, prevent irreparable harm, avoid the expiration of any applicable limitations period, or preserve a superior position with respect to other creditors, although the merits of the underlying Dispute will be resolved in accordance with this paragraph. In the event the parties are unable to resolve the Dispute within 30 days of notice of the Dispute to the other party, the parties shall be free to pursue all remedies available at law or equity.

Force Majeure. Neither party shall be liable to the other party for any failure to perform any of its obligations (except payment obligations) under this Agreement during any period in which such performance is delayed by circumstances beyond its reasonable control including, but not limited to, acts of God, fire, flood, war, embargo, strike, riot, or the intervention of any governmental authority (a "Force Majeure"). In such event, however, the delayed party must promptly provide the other party with written notice of the Force Majeure. The delayed party's time for performance will be excused for the duration of the Force Majeure, but if the Force Majeure event lasts longer than thirty (30) days, the other party may immediately terminate this Agreement by giving written notice to the delayed party.

State-Specific Provisions. The terms stated in this paragraph are specific to warranties and services purchased for a separate charge in certain states. If you are not a permanent resident of the state identified in each paragraph below at the time you purchase the service for a separate charge, then you are not eligible for these rights and/or remedies. We are not obligated to provide the service under these terms except in the states specified below.

- **Hawaii Customers.** If you cancel this Agreement pursuant to the procedures for cancellation set forth in this Agreement and we fail to refund the purchase price of this Agreement to you within forty-five (45) days after your cancellation, we are obligated to pay you a penalty of 10% per month of the amount of the refund due and owing to you. Your right to cancel this Agreement only applies to the original owner of the Agreement and may not be transferred to subsequent owners of the Agreement. The obligations of Dell under this Agreement are backed by the full faith and credit of Dell.
- **New York Customers.** If you cancel this Agreement pursuant to the procedures for cancellation set forth in this Agreement and we fail to refund the purchase price of this Agreement to you within thirty (30) days after your cancellation, we are obligated to pay you a 10% penalty per month of the amount of the refund due and owing to you. The obligations of Dell under this Agreement are backed by the full faith and credit of Dell. In addition to the services specified under this Agreement, Dell will provide repair and replacement services as to defects in materials or



workmanship, or wear and tear, to the extent provided in Dell's Limited Hardware Warranty (see www.Dell.com/Warranty), including any warranty extensions, the provisions of which Limited Hardware Warranty are incorporated by reference herein. Dell's Limited Hardware Warranty may be included with the purchase and in the price of the covered hardware. Such incorporation by reference shall not enlarge or diminish your rights or Dell's obligations under the Limited Hardware Warranty, provided, however, the duration of this Agreement shall not extend beyond the duration of the Limited Hardware Warranty (including any warranty extensions). In the event of a conflict between the provisions of this Agreement and the Limited Hardware Warranty, the provisions of this Agreement shall control.

- **Montana Customers.** Obligations of the provider under this service contract are backed by the full faith and credit of the provider.
- **Oregon Customers.** The obligations of Dell Marketing L.P. under this Agreement are backed by the full faith and credit of Dell Inc. The contact information for both Dell Marketing L.P. and Dell Inc. is One Dell Way, Round Rock, TX 78682, Attn: Service and Support Department, (800) 624-9897.
- **Utah Customers.** Obligations of Dell under this service contract are guaranteed under a service contract reimbursement insurance policy. Should Dell fail to pay or provide service on any claim within 60 days after proof of loss has been filed, Customer is entitled to make a claim directly against the Insurance Company. Coverage afforded under this Agreement is not guaranteed by the Property and Casualty Guaranty Association. This service contract is subject to limited regulation by the Utah Insurance Department. To file a complaint, contact the Utah Insurance Department. Section 5.E. is amended as follows: Dell can cancel the Agreement during the first sixty (60) days of the initial annual term by mailing to Customer a notice of cancellation at least thirty (30) days prior to the effective date of cancellation except that Dell can also cancel the Agreement during such time period for nonpayment of premium by mailing Customer a notice of cancellation at least ten (10) days prior to the effective date of cancellation. After sixty (60) days have elapsed, Dell may cancel the Agreement by mailing a cancellation notice to Customer at least ten (10) days prior to the cancellation date for cancellations due to nonpayment of premium, and thirty (30) days prior to cancellation date for any of the following reasons: (a) material misrepresentation, (b) substantial change in the risk assumed, unless Dell should reasonably have foreseen the change or contemplated the risk when entering into the Agreement, (c) substantial breaches of contractual duties, conditions, or warranties. The notice of cancellation must be in writing to Customer at Customer's last known address and contain all of the following: (1) the order number for Customer's purchase of this Agreement, (2) the date of notice, (3) the effective date of the cancellation and, (4) a detailed explanation of the reason for cancellation.
- **Wisconsin Customers.** **This warranty is subject to limited regulation by the Office of the Commissioner of Insurance.** Dell Inc. shall be considered the obligor on the service obligations hereunder.

State-Specific Provisions for Customers that Purchase Select Microsoft™ Surface Pro™ Tablets

The terms stated in this paragraph are specific to warranties and services purchased for a separate charge in certain states for Microsoft™ Surface Pro 3™ tablets. If you are not a permanent resident of the state identified in each paragraph below at the time you purchase the service for a separate charge, then you are not eligible for these rights and/or remedies. We are not obligated to provide the service under these terms except in the states specified below.

- **Maine Customers.** The obligations of Dell under this service contract are backed by the full faith and credit of Dell and are not guaranteed under a service contract reimbursement policy. If you cancel this Agreement within twenty (20) days after we sent the Agreement to you or within ten (10) days of delivery if the Agreement was provided to you at the time of sale and you have not made a claim under this Agreement, then this Agreement is void and Dell shall refund to the Agreement holder, or credit the account of the Agreement holder for the full purchase price of the Agreement and any sales



tax refund required by state law. The right to void this Agreement is not transferrable and applies only to the original purchaser of the Agreement, and only if no claim has been made prior to its return to Dell. A ten (10) percent penalty per month will be added to the amount of the refund due and owing to you that is not paid or credited within forty-five (45) days after your cancellation. After the applicable twenty (20) or ten (10) day period has lapsed, or if a claim has been made under the Agreement during that time period, you may cancel the Agreement and we will refund to you 100% of the unearned pro rata provider fee, less any claims paid. An administrative fee not to exceed 10% of the provider fee may apply. If Dell cancels the Agreement under Section [insert] for a reason other than non-payment of the provider fee, Dell will refund to you 100% of the unearned pro rata provider fee, less any claims paid. An administrative fee not to exceed 10% of the provider fee may apply upon cancellation by Dell.

- **Maryland Customers.** If you return the service contract within twenty (20) days of the date the contract was mailed to you, or the date the contract was delivered to you if it was delivered at the time of sale, and if no claim has been made under the contract, the service contract will be void and Dell will refund to you, or credit your account, the full purchase price of the service contract. If we fail to refund the purchase price of the service contract to you within forty-five (45) days after your cancellation, we are obligated to pay you a penalty equal to ten (10) percent of the value of the consideration paid for the service contract for each month that the refund is not paid or credited. Your right to void this service contract is not transferrable and applies only to the original purchaser of the service contract, and only if no claim has been made prior to cancellation.
- **Massachusetts Customers.** If you return the service contract within (a) twenty (20) days of the date the contract was mailed to you, or (b) ten (10) days of the date the contract was delivered to you, if it was delivered at the time of sale, and if no claim has been made under the contract, the service contract will be void and Dell will refund to you, or credit your account, the full purchase price of the service contract. A ten (10) percent penalty per month will be added to a refund that is not paid or credited within forty-five (45) days after return of the service contract to Dell. Your right to cancel this service contract applies only to the original owner of the contract and only if no claim has been made prior to its return to Dell.
- **New York Customers.** If you return the service contract within (a) twenty (20) days of the date the contract was mailed to you, or (b) ten (10) days of the date the contract was delivered to you, if it was delivered at the time of sale, and if no claim has been made under the contract, the service contract will be void and Dell will refund to you, or credit your account, the full purchase price of the service contract.

For more information about any of our service offerings, please contact your Dell representative or visit dell.com/services

Availability varies by country. To learn more, customers and Dell Channel Partners should contact your sales representative for more information.

© 2015 Dell Inc. All rights reserved. Trademarks and trade names may be used in this document to refer to either the entities claiming the marks and names or their products.



Service Description

Dell ProSupport

Introduction

Dell is pleased to provide Dell ProSupport, which includes ProSupport Powered by Co-Pilot for applicable systems¹, (the “**Service(s)**”) in accordance with this Service Description (“**Service Description**”). Your quote, order form or other mutually-agreed upon form of invoice or order acknowledgment (as applicable, the “**Order Form**”) will include the name of the service(s) and available service options that you purchased. For additional assistance or to request a copy of your service contract(s), contact Dell Technical Support or your sales representative.

The Scope of This Service

The features of your service include:

- Telephone access 24 hours each day, 7 days each week (including holidays)² to Dell’s global expert center staffed by senior-level analysts for troubleshooting assistance of hardware and select Dell OEM software issues.
- On-site dispatch of technician and/or service parts to Customer’s business location (as necessary and according to level of service purchased) for repairs and resolution necessary to remedy a Qualified Incident (as defined below). Refer to **Exhibit A** for more details on severity levels and onsite service options.
- For products that are not serviceable at a Customer’s location, please refer to **Exhibit B** for details on service response options for systems that are non-field serviceable.
- Remote troubleshooting assistance for common support issues, when available and with Customer’s consent, in which Dell technicians connect directly to your system over a secure internet connection to expedite troubleshooting.
- Client operating system and application “Getting Started” assistance associated with common Dell OEM end-user applications such as Norton AntiVirus™ software, Microsoft® Office software suite, Intuit® QuickBooks® accounting software, Adobe® Photoshop® software and Adobe Acrobat® software. In addition, select OEM server operating systems, such as Microsoft Windows Server, and hypervisors, such as Microsoft Hyper-V®, VMware ESX®, and Citrix XenServer® are also supported. Please see Dell’s Comprehensive Software Support list for other supported software titles or contact your technical support analyst for details.

What’s Included in “Getting Started” assistance	What’s NOT Included in “Getting Started” assistance
Support of select Dell OEM operating systems, hypervisors and end-user applications;	Support for software not validated and tested by Dell for your system;
Basic “How To” or feature definition questions;	Step-by-step installation, reinstallation, or configuration assistance;
Hot-fix and patch assistance.	Performance assistance or administrative assistance.

¹ Statements referring to ProSupport throughout this Service Description should be read to refer to ProSupport Powered by Co-Pilot unless otherwise noted herein.

² Availability varies by country. Customers and Dell Channel Partners should contact your sales representative for more information.



- Getting-started advice or set-up assistance associated with simple network³ connectivity for select desktop, notebook, smartphones, cloud client computing hardware and tablets.
- Access to online support forums 24 hours each day, 7 days each week.
- Access to Global Command Centers, which help manage critical situations in Customer environments, monitor all on-site "mission critical" labor dispatches and provide proactive crisis management coordination and communication during events such as natural disasters.
- Access to Dell SupportAssist used for monitoring, alerting, and data gathering for the systems entitled under the ProSupport contract. See <http://Dell.Com/SupportAssist> for more information.
- Case management to help track resolution and escalation of Qualified Incidents.
- Escalation management to provide a single point of contact for incident management, escalation, and status of incidents within the scope of this Service.
- All local services are provided by Dell authorized service provider
- **Dell International Services Program.** This program provides service and support options when travelling with select Dell products outside of your home country and for a period of less than six (6) months. Additional terms and conditions apply; please contact Dell Technical Support for more details.

Hardware Coverage Limitations:

Dell's Limited Hardware Warranty will apply to the Supported Product, and is available for review at www.Dell.com/Warranty for U.S. and Canadian customers. Outside of the United States and Canada, the terms and conditions describing the warranty applicable to the Supported Product may be available at the regional Dell.com website that corresponds to the geographic location where the Supported Product was purchased, or such other geographic location to which the Supported Product was relocated in accordance with Section 4.F. or 4.G. of the Additional Terms & Conditions Applicable to Support & Warranty-Related Services section below. Hardware coverage limitations may apply and premium service offerings may be available to extend these hardware limitations as part of the premium service or for an additional fee. These coverage limitations are set forth on www.Dell.com/Warranty, and are applicable to Supported Products in all geographic locations, unless any specific limitation is prohibited under local law applicable where the Supported Product is located at the time that service is requested by Customer. A Supported Product or a component of a Supported Product that carries a limited lifetime warranty will be serviced by Dell according to this Service Description for the duration of your Dell ProSupportservice contract. After your Dell ProSupport service contract period expires, subsequent Qualified Incidents related to a Supported Product or component with a limited lifetime warranty will be serviced pursuant to the Dell Basic Hardware Service contract available at www.Dell.com/ServiceContracts/global.

Dell's Limited Hardware Warranty and/or the warranty applicable to your Supported Product(s) outside the U.S. and Canada, and the Services do not cover commercial hardware products that use, or in which have been installed, products or components that have not been provided by Dell. Your Dell Limited Hardware Warranty and/or the warranty applicable to your Supported Product(s) outside the U.S. and Canada and corresponding entitlement to the Services may be voided if third party products that were not provided by Dell are installed in your Dell system.

How to Contact Dell if You Require Service

Self-Dispatch Support Programs:

For Customers enrolled in Warranty Parts Direct, Fast-Track Dispatch, Technician Direct (TechDirect) Program, or Dell Online Self Dispatch (DOSD), Qualified Incidents may be handled by certified Customer technicians through the submission of a service request to the self-dispatch website or telephone queue for your region.

³ Simple network assistance is limited to a single client system covered by ProSupport, connecting to a single router port or wireless access point, and does not include connectivity to secondary devices, systems, or domains.



Online, Chat, and Email Support:

Dell ProSupport website, chat, and email support available at www.Support.Dell.com.

[Dell SC Storage Systems](#): For non-urgent support, you may email the Dell SC storage support center at Dell_Online_Storage@dell.com.

Telephone Support Requests:

Available 24 hours each day, 7 days each week (including holidays). Availability may differ outside of the United States and is limited to commercially reasonable efforts. Please contact your sales representative or technical support analyst for specific details for your location.

Step One: Call for Assistance

- For telephone support requests, contact your Regional Dell ProSupport support center to speak to a technical support analyst. Regional telephone numbers can be found at www.Dell.com/ProSupport/RegionalContacts.
- Call from a location which includes physical access to the Supported Product.
- Provide the Service Tag (as defined below) and other information as requested by the analyst. The analyst will verify Customer's Supported Product, applicable Service and response levels and confirm any expiration of Services.

Step Two: Assist with Telephone-based Troubleshooting

- When requested, identify error messages received and when they occur; what activities preceded the error message; and what steps you have already taken to attempt to solve the problem.
- The analyst will work with you through a series of troubleshooting steps to help diagnose the issue.
- If an on-site dispatch of a service technician is necessary, the analyst will provide additional instructions.

Dell KACE Support

- Visit the Dell Software Support Portal, www.software.dell.com/support to find answers to your questions and issues, or call the support center using the numbers listed here, <https://support.software.dell.com/essentials/contact-technical-support>.

Service Parts

Regardless of the service response level purchased, some component parts are specifically designed for easy Customer removal and replacement: such parts are designated as Customer Replaceable Units ("CRU"). If during the diagnosis, the Dell analyst determines that a Qualified Incident can be resolved with a CRU designated part, Dell will ship the CRU designated part(s) directly to the Customer. CRU parts fall into two categories:

Optional CRU Parts. These parts are designed to be replaced by the Customer. Depending on the type of service that was purchased with the Supported Product, Dell may provide an on-site technician to replace the parts. Contact a technical support analyst for more details regarding which Optional CRU part(s) and which service response levels qualify for on-site installation at no additional fee.

Mandatory CRU Parts. Dell does not automatically provide an on-site technician for the installation of Mandatory CRU parts. Contact a technical support analyst for more details regarding which Mandatory CRU parts and which service response levels qualify for on-site installation at no additional fee.

The freight method used to ship the CRU part is based on the level of service purchased by the Customer.

- Service parts for customers with "Next Business Day" or Advanced Exchange response times will be shipped via a next-business day freight method, unless otherwise noted by the technician.
- Service parts for customers with "Return for Repair" service options will be shipped via ground freight service.

Once a Dell analyst has determined whether it is necessary to replace a part or return the system, you will be informed of the next steps to take. Depending on the service level that was purchased, the following On-site or Return for Repair procedures apply.

Dell SupportAssist

Dell SupportAssist is a software application that when installed, will monitor your system and collect information to assist in providing technical support. In the event an issue is detected, the information collected can be sent to Dell to provide you with an enhanced, personalized and efficient support experience.

Used with ProSupport, SupportAssist will provide the following features and capabilities:

- Monitoring of systems for issues impacting normal operation and performance.
- Automatic creation of Dell Technical Support requests in the event of issue detection.
- Automatic uploading of diagnostics and other data that allows efficient diagnosis of issues.

By installing SupportAssist, you allow Dell to save your contact information (e.g. name, phone number, and/or email address) which would be used to provide technical support for your Supported System(s). By enabling the Log Collection features Dell may use the information gathered for providing recommendations to improve your IT infrastructure.

Note: Removal or de-activation of SupportAssist or opting out of log collections options will impair Dell's ability to provide customers with the certain features of the Services as described in this Service Description, as well as other services that require access to the information collected by SupportAssist to function properly.

Additional Resources

To learn more about Dell SupportAssist and see the latest list of supported Dell products please visit the Dell SupportAssist website at: <http://Dell.Com/SupportAssist>.

Collaborative Assistance

If a problem arises with certain third-party products and software commonly utilized in conjunction with Customer's Supported Product, Dell will serve as a single point of contact, as set forth herein, until the problems are isolated and escalated to the third-party product vendor. Specifically, Dell will contact the third-party vendor and create a "problem incident" or "trouble ticket" on behalf of Customer, providing the necessary problem documentation. Once a vendor is engaged, Dell will monitor the problem resolution process and obtain status and resolution plans from the vendor until the vendor resolves the problem by either providing a resolution, steps towards a resolution, workaround, configuration changes, or escalation of a bug report. Upon the Customer's request, Dell will initiate management escalation procedures within Dell and/or the vendor organization.

To be eligible for Collaborative assistance, Customer must have the appropriate active support agreements and entitlement with the respective third-party vendor. Once isolated and reported, the third-party vendor provides technical support and resolution for Customer's problem. **DELL WILL NOT BE RESPONSIBLE FOR THE PERFORMANCE OF OTHER VENDORS' PRODUCTS OR SERVICES.**

View current Collaborative assistance partners [here](#). Please note that supported third-party products may change at any time without notice to Customers.

Comprehensive Software Support

Dell ProSupport includes Dell Comprehensive Software Support for select Dell OEM end-user applications, operating systems, hypervisors and firmware on Supported Products (the "**Covered Software Products**") over the telephone, or by transmission of software and other information through electronic means, or by shipping software



and/or other information to Customer. Covered Software Products include pre-installed end-user client applications such as Norton AntiVirus™ software, Microsoft® Office software suite, Intuit® QuickBooks® accounting software, Adobe® Photoshop® software and Adobe Acrobat® software. Certain OEM server operating systems and hypervisors, such as Microsoft Hyper-V®, VMware ESX®, and Citrix XenServer® are also supported. Please contact a Dell technical support analyst for an up-to-date list of Covered Software Products.

View current Comprehensive Software Support partners [here](#). Please note that supported third-party products may change at any time without notice to Customers.

Limits on Dell Comprehensive Software Support. Dell does not warrant that any particular software-related question will be resolved or that the Covered Software Product will produce any particular result. Situations giving rise to Customer's questions must be reproducible on a single system (*i.e.*, one central processing unit with its workstation and other peripherals). Dell may conclude that a software issue is sufficiently complex or that Customer's Supported Product is of a nature that precludes effective analysis of the question through telephone support. Customer understands and accepts that resolutions of certain issues giving rise to Customer's service request may not be available from the publisher of the relevant software title. Customer accepts that in such situations where no resolution is available from the publisher of the relevant software title, Dell's obligation to provide support to the Customer will be fully satisfied.

Additional Terms and Conditions for Certain Supported Products

Dell Storage Software Updates

EqualLogic:

Dell ProSupport for select Dell EqualLogic Supported Products, including the Dell EqualLogic PS Series, includes both maintenance software updates and the introduction of new features to firmware and core software such as SAN HQ, Auto Snapshot Manager and the Host Integration Toolkit (for the service period indicated on the invoice).

Compellent:

Dell ProSupport Powered by Copilot for select Dell Compellent Products includes both maintenance software updates and the introduction of new features, as applicable, to the storage firmware (Storage Center) and core software such as Enterprise Manager Foundation, Enterprise Manager Reporter, Dynamic Capacity, Data Instant Replay, and Dynamic Controllers (for the service period indicated on the invoice). Compellent Core software support base covers the first eight (8) drives of the Customer's Dell Compellent SC TM Supported Products. Each additional drives of the Customer's Dell Compellent SC TM Supported Product will require an additional purchase of an Expansion Software Support contract.

Dell Technical Support team will also provide maintenance software updates for optional Compellent value-add software products provided that the corresponding software support service is purchased for each of the Compellent value-add software products. The Compellent value-add software products include Remote Instant Replay, Data Progression, Fast Track, Live Volume, Live Volume + RIRA, Virtual Ports, Replay Manager Management Suite, and Enterprise Manager Chargeback.

Dell | EMC:

Dell ProSupport includes the following software updates for core Dell | EMC software such as Navisphere® Manager, Navisphere Manager Express (AX series only), Access Logix™ (CX series only), PowerPath®, and SnapView Express (AX series only) (for the service period indicated on the invoice).

Patches and Bug Fixes. Dell or EMC, as applicable, will periodically release patches and bug fixes to the applicable Storage Software for purposes of maintaining operating system compatibility and/or database compatibility; and any error corrections, workarounds and/or patches needed to maintain conformance to the Supported Product's documentation.



New Versions. New versions or releases of the applicable Storage Software are generally made available by Dell or EMC, as applicable, at no additional charge to licensees for Storage Software that is installed on a Supported Product covered by a Dell or EMC, as applicable, limited warranty or an annual service or maintenance contract. New Versions generally consist of releases that contain patches and bug fixes, changes that reflect an expansion or extension of existing features, and changes that include substantial new features, functions, or capabilities.

May Require Additional Purchase. Dell or EMC, as applicable, Storage Software Updates may require the purchase of a separate Dell or EMC On-site Installation or Proactive Maintenance Service as directed by Dell in order to keep the Supported Product(s) eligible for this Service.

Renewal. Customer may be entitled to renew for additional periods and/or purchase additional Dell or EMC Storage Software Updates depending on the available options then in effect and in accordance with Dell's then-current rates, terms and conditions by submitting a purchase order to Dell. Dell may change its rates, terms, and conditions for providing support at any time.

Dell ProSupport on Networking Products

Dell ProSupport, which is available on Dell PowerConnect and Dell Force10 products, may also include remote support in the following areas:

- Power on device and management of Internet Protocol (IP) address to enable the user for self-configuration
- Configuration Problem Assistance which includes explanation of networking features, answering questions
- about functionality, troubleshooting configuration issues, and answer syntax questions
- Best Practice Recommendations as defined by Industry and Dell published best practice documentation
- Installation and activation of licenses
- Troubleshoot and diagnose performance degradation based on prior established documented performance, including dropped packets.
- Performance troubleshooting assistance on single switch issues or where the devices is not performing to a Dell published specification
- Best effort interoperability with non-Dell specific devices
- Dell will periodically release patches and bug fixes to the applicable Software for purposes of maintaining operating system compatibility; and any error corrections, workarounds and/or patches needed to maintain conformance to the Supported Product's documentation.
- New versions or releases of the applicable Software are generally made available by Dell at no additional charge to licensees for Software that is installed on a Supported Product covered by a Dell annual support or maintenance contract. New Versions generally consist of releases that contain patches and bug fixes, changes that reflect an expansion or extension of existing features, and changes that include substantial new features, functions or capabilities.

Dell ProSupport on Dell Edge Gateway and Embedded PC Products

Dell ProSupport, which is available on Dell Edge Gateway and Embedded PC products, provides comprehensive support of factory-installed OEM image of your operating system, pursuant to the Comprehensive Software Support terms above. Dell will not provide Comprehensive Software Support for custom images, 3rd party software, or infrastructure configuration. Dell cannot provide remote diagnosis or troubleshooting without customer assistance. **Customers are expected to provide the following:**

- You must have product in front of you. This will allow tech support to remote diagnose the failure and dispatch parts and labor if needed.



- You must provide product in safe environment for servicing. Dell onsite technicians will not be responsible for mounting and dismounting product
- You must provide monitor, mouse, and keyboard to onsite technician in order to troubleshoot product onsite
- You must provide power to product.

What IS included in ProSupport on Dell Edge Gateway and Embedded PC products	What IS NOT included in ProSupport on Dell Edge Gateway and Embedded PC products
Comprehensive support of factory OEM image of operating system	Comprehensive support for custom image, 3 rd party software, or infrastructure configuration. Remote diagnosis or troubleshooting without customer assistance.
Comprehensive support of entitled hardware	Comprehensive support for connectivity of non-entitled hardware or software.
Collaborative support as identified by the collaborative support list	Collaborative support for titles not on the collaborative support list

Additional Terms and Conditions Applicable to End Users who Purchase their Supported Product from an OEM

An "OEM" is a reseller who sells the Supported Products in a capacity as an original equipment manufacturer that is purchasing Dell Products and Services from the Dell OEM Solutions (or its successor) business group for an OEM project. An OEM typically embeds or bundles such Dell Products in or with OEM Customer's proprietary hardware, software or other intellectual property, resulting in a specialized system or solution with industry or task-specific functionality (such system or solution an "OEM Solution") and resells such OEM Solution under OEM's own brand. With respect to OEMs, the term "Supported Products" includes Dell Supported Products that are provided without Dell branding (*i.e.* unbranded OEM-ready system), and "End-User" means you, or any entity purchasing an OEM Solution for its own end-use and not for reselling, distributing or sub-licensing to others. It is OEM's responsibility to provide first level troubleshooting to the End User. An appropriate best-effort initial diagnosis should be performed by OEM before the call goes to Dell. This OEM maintains responsibility for providing the initial troubleshooting even when its End-User engages Dell to request service, and if an End User contacts Dell for service without contacting their OEM, Dell will ask the End User to contact their OEM to receive first level troubleshooting before contacting Dell.

Excluded Services

- Performance or administrative assistance.
- Activities such as installation, de-installation, relocation, preventative maintenance, training assistance, remote administration, or any activities or services not expressly described in this Service Description.
- Supply items, media replacement, operating supplies, cosmetic accessories or parts such as batteries, frames, and cover or support thereon.
- Direct third party product support or collaborative assistance of versions not currently supported by the manufacturer, vendor, or partner.
- Support to the hardware or/and software pre-installed or post-installed by OEM, unless it is covered by a separate service contract purchased from Dell.
- Support for equipment damaged by act of nature (such as, but not limited to, lightning, flooding, tornado, earthquakes, and hurricanes), misuse, accident, abuse of Supported Product or components (such as, but not limited to, use of incorrect line voltages, use of incorrect fuses, use of incompatible devices or accessories, improper or insufficient ventilation, or failure to follow operating instructions), modification, unsuitable physical or operating environment, improper maintenance by Customer (or Customer's agent),



moving the Supported Product in a manner inconsistent with its design, removal or alteration of equipment or parts identification labels, or failure caused by a product for which Dell is not responsible.

- Spyware/virus removal.
- Data backup services.
- Advanced wireless, networking or remote installation, set-up, optimization and configuration of applications beyond those described in this Service Description.
- Scripting, programming, database design/implementation, web development or recompiled kernels.
- Repair of damage or defects in supported Products which are purely cosmetic and do not affect device functionality.
- Repairs necessitated by software problems, or as a result of alteration, adjustment, or repair by anyone other than Dell, Dell's Authorized Reseller or Service Provider or by customers utilizing Customer Self Replaceable (CSR) parts.



General Customer Responsibilities

Authority to Grant Access. Customer represents and warrants that it has obtained permission for both Customer and Dell to access and use the Supported Products, the data located thereon and all hardware and software components included therein, for the purpose of providing these Services. If Customer does not already have that permission, it is Customer's responsibility to obtain it, at Customer's expense, before Customer asks Dell to perform these Services.

Cooperate with Phone Analyst and On-site Technician. Customer will cooperate with and follow the instructions given by any Dell phone analyst or on-site technicians. Experience shows that most system problems and errors can be corrected over the phone as a result of close cooperation between the user and the analyst or technician.

On-site Obligations. Where Services require on-site performance, Customer will provide (at no cost to Dell) free, safe and sufficient access to Customer's facilities and the Supported Products, including ample working space, electricity, and a local telephone line. A monitor or display, a mouse (or pointing device), and a keyboard must also be provided (at no cost to Dell), if the system does not already include these items.

Maintain Software and Serviced Releases. Customer will maintain software and Supported Products at Dell-specified minimum release levels or configurations as specified on PowerLink for Dell | EMC Storage or EqualLogic™, or as specified on www.support.dell.com for additional Supported Products. Customer must also ensure installation of remedial replacement parts, patches, software updates or subsequent releases as directed by Dell in order to keep the Supported Products eligible for this Service.

Data Backup; Removing Confidential Data. Customer will complete a backup of all existing data, software and programs on all affected systems prior to and during the delivery of this Service. Customer should make regular backup copies of the data stored on all affected systems as a precaution against possible failures, alterations, or loss of data. In addition, Customer is responsible for removing any confidential, proprietary, or personal information and any removable media such as SIM cards, CDs, or PC Cards regardless of whether an on-site technician is also providing assistance. **DELL WILL HAVE NO LIABILITY FOR:**

- **ANY OF YOUR CONFIDENTIAL, PROPRIETARY OR PERSONAL INFORMATION;**
- **LOST OR CORRUPTED DATA, PROGRAMS OR SOFTWARE;**
- **DAMAGED OR LOST REMOVABLE MEDIA;**
- **DATA OR VOICE CHARGES INCURRED AS A RESULT OF FAILING TO REMOVE ALL SIM CARDS OR OTHER REMOVABLE MEDIA INSIDE SUPPORTED PRODUCTS THAT ARE RETURNED TO DELL;**
- **THE LOSS OF USE OF A SYSTEM OR NETWORK;**
- **AND/OR FOR ANY ACTS OR OMISSIONS, INCLUDING NEGLIGENCE, BY DELL OR A THIRD-PARTY SERVICE PROVIDER.**

Dell will not be responsible for the restoration or reinstallation of any programs or data. When returning a Supported Product or part thereof, Customer will only include the Supported Product or part which has been requested by the phone technician.

Third Party Warranties. These Services may require Dell to access hardware or software that is not manufactured by Dell. Some manufacturers' warranties may become void if Dell or anyone else other than the manufacturer works on the hardware or software. Customer will ensure that Dell's performance of Services will not affect such warranties or, if it does, that the effect will be acceptable to Customer. Dell does not take responsibility for third party warranties or for any effect that the Services may have on those warranties.



Dell Services Terms & Conditions

This Service Description is entered between you, the customer (“you” or “Customer”), and the Dell entity identified on your invoice for the purchase of this Service. This Service is provided subject to and governed by Customer’s separate signed master services agreement with Dell that explicitly authorizes the sale of this Service. In the absence of such agreement, depending on Customer’s location, this Service is provided subject to and governed by either Dell’s Commercial Terms of Sale or the agreement referenced in the table below (as applicable, the “Agreement”). Please see the table below which lists the URL applicable to your Customer location where your Agreement can be located. The parties acknowledge having read and agree to be bound by such online terms.

Customer Location	Terms & Conditions Applicable to Your Purchase of Dell Services	
	Customers Purchasing Dell Services Directly From Dell	Customers Purchasing Dell Services Through an Authorized Dell Reseller
United States	www.dell.com/CTS	www.dell.com/CTS
Canada	www.dell.ca/terms (English) www.dell.ca/conditions (French-Canadian)	www.dell.ca/terms (English) www.dell.ca/conditions (French-Canadian)
Latin America & Caribbean Countries	Local www.dell.com country-specific website or www.dell.com/servicedescriptions/global .*	Local www.dell.com country-specific website or www.dell.com/servicedescriptions/global .*
Asia-Pacific-Japan	Local www.dell.com country-specific website or www.dell.com/servicedescriptions/global .*	Service Descriptions and other Dell service documents which you may receive from your seller shall not constitute an agreement between you and Dell but shall serve only to describe the content of Service you are purchasing from your seller, your obligations as a recipient of the Service and the boundaries and limitations of such Service. As a consequence hereof any reference to “Customer” in this Service Description and in any other Dell service document shall in this context be understood as a reference to you whereas any reference to Dell shall only be understood as a reference to Dell as a service provider providing the Service on behalf of your seller. You will not have a direct contractual relationship with Dell with regards to the Service described herein. For the avoidance of doubt any payment terms or other contractual terms which are by their nature solely relevant between a buyer and a seller directly shall not be applicable to you and will be as agreed between you and your seller.
Europe, Middle East, & Africa (EMEA)	Local www.dell.com country-specific website or www.dell.com/servicedescriptions/global .* In addition, customers located in France, Germany and the UK can select the applicable URL below: France: www.dell.fr/ConditionsGeneralesdeVente Germany: www.dell.de/Geschaeftsbedingungen UK: www.dell.co.uk/terms	Service Descriptions and other Dell service documents which you may receive from your seller shall not constitute an agreement between you and Dell but shall serve only to describe the content of Service you are purchasing from your seller, your obligations as a recipient of the Service and the boundaries and limitations of such Service. As a consequence hereof any reference to “Customer” in this Service Description and in any other Dell service document shall in this context be understood as a reference to you whereas any reference to Dell shall only be understood as a reference to Dell as a service provider providing the Service on behalf of your seller. You will not have a direct contractual relationship with Dell with regards to the Service described herein. For the avoidance of doubt any payment terms or other contractual terms which are by their nature solely relevant between a buyer and a seller directly shall not be applicable to you and will be as agreed between you and your seller.

* Customers may access their local www.dell.com website by simply accessing www.dell.com from a computer connected to the Internet within their locality or by choosing among the options at Dell’s “Choose a Region/Country” website available at <http://www.dell.com/content/public/choosecountry.aspx?c=us&l=en&s=gen>.



Customer further agrees that by renewing, modifying, extending or continuing to utilize the Service beyond the initial term, the Service will be subject to the then-current Service Description available for review at www.dell.com/servicedescriptions/global.

To the extent that any terms of this Service Description conflict with any terms of the Agreement, the terms of this Service Description will prevail, but only to the extent of the specific conflict, and will not be read or deemed to replace any other terms in the Agreement which are not specifically contradicted by this Service Description.

By placing your order for the Services, receiving delivery of the Services, utilizing the Services or associated software or by clicking/checking the "I Agree" button or box or similar on the Dell.com website in connection with your purchase or within a Dell software or Internet interface, you agree to be bound by this Service Description and the agreements incorporated by reference herein. If you are entering this Service Description on behalf of a company or other legal entity, you represent that you have authority to bind such entity to this Service Description, in which case "you" or "Customer" shall refer to such entity. In addition to receiving this Service Description, Customers in certain countries may also be required to execute a signed Order Form.



Additional Terms & Conditions Applicable to Support & Warranty-Related Services

1. Supported Products

This Service is available on supported products which includes select Dell OptiPlex™, Latitude™, Venue™, Inspiron™, Precision™, Vostro™, XPS™, Gateway Edge, Embedded PCs PowerEdge™, PowerEdge SC™, PowerVault™, PowerConnect™, Dell EqualLogic™, Dell Storage SC™, Dell | EMC Storage Systems™, Dell Wyse™ and Dell printers, monitors and smartphones which are purchased in a standard configuration, as well as select Microsoft™ Surface Pro™ tablets ("**Supported Products**"). Supported Products are added regularly, so please contact your sales representative for the most up-to-date list of Services that are available on your Dell or non-Dell products. Each Supported Product is tagged with a serial number (the "**Service Tag**"). A separate service agreement must be purchased by Customer for each Supported Product. For example, a printer purchased with a laptop system is not covered by the laptop system's service contract; the printer and the laptop will each need their own service contract. Please refer to the Service Tag on your Supported Product when contacting Dell for this Service.

2. Support Services

A. Limited Hardware Warranty; Hardware Coverage Limitations. Support-related services may include technical support options (telephone, Internet, etc.) and service parts and related labor services to repair or replace defect(s) in workmanship pursuant to and occurring within the limited warranty period applicable to Customer's Supported Product(s) (a "**Qualified Incident**"). Dell's Limited Hardware Warranty for US. And Canadian customers is available for review at <http://www.Dell.com/Warranty> or posted outside of the United States at your regional Dell.com website.* The Microsoft Surface Pro Warranty (available at: <http://www.microsoft.com/surface/warranty>) covers Surface Pro Supported Products for the first year of Customer's service Term (as defined below), and is fulfilled by Dell pursuant to the terms and conditions of this Service Description. Customer acknowledges that the risk of hardware failures may increase as the age of Customer's Supported Product increases.

Hardware coverage limitations may apply and service offerings may be available to extend these hardware limitations for an additional fee. Please see www.Dell.com/Warranty or your regional Dell.com website for warranty information or contact a Dell technical support analyst for more details.

B. Whole Unit Replacement; Failure to Return. If Dell determines that a component of the defective Supported Product is one that is easily disconnected and reconnected (such as a keyboard or monitor), or if the analyst determines that the Supported Product is one that should be replaced as a whole unit, Dell reserves the right to send Customer a whole replacement unit. If Dell delivers a replacement unit to Customer, Customer must relinquish the defective system or component thereof to Dell, unless Customer has purchased "Keep Your Hard Drive" for the affected system, in which case Customer may retain the respective hard drive(s). If Customer does not relinquish the defective system or component to Dell as required above, or if the defective unit is not returned within ten (10) days in accordance with written instructions provided with the replacement unit (in the event the replacement unit was not delivered in person by a Dell technician), Customer agrees to pay Dell for the replacement unit upon receipt of invoice. If Customer fails to pay such invoice within ten (10) days after receipt, in addition to any other legal rights and remedies available to Dell, Dell may terminate this Service Description upon notice.

C. Parts Stocked; Mission Critical Parts. Dell currently stocks parts in various locations throughout the world. Selected parts may not be stocked in the location closest to Customer's site. If a part that is needed to repair the Supported Product is not available from a Dell facility near Customer's location and must be transferred from another facility, it will be shipped as soon as is practical and commercially reasonable. 2-Hour and 4-Hour parts locations stock mission critical parts of Supported Products, as determined by Dell. A mission critical part is one which upon failure may prevent the Supported Product from performing its basic functions. Parts deemed non-critical include, but are not limited to: software, floppy drives, media drives, modems, speakers, sound cards, zip drives, monitors, keyboards, and mice. These parts may be shipped using overnight delivery. In order to receive 2-Hour or 4-Hour parts, Customer must have purchased a corresponding service contract that supports mission critical parts delivery and the Supported Product must be located within the supported coverage area, as determined by Dell.



- D. Service Parts Ownership.** All Dell service parts removed from the Supported Product and returned to Dell become the property of Dell. Customer must pay Dell at the then-current retail price for any service part removed from the Supported Product which are retained by Customer (except for hard drives from Supported Products covered by "Keep Your Hard Drive" service) if Customer has received replacement parts from Dell. Dell uses and Customer expressly authorizes the use of new and reconditioned parts made by various manufacturers in performing warranty repairs.

3. Term of Service.

This Service Description commences on the date listed on your Order Form and continues through the term ("**Term**") indicated on the Order Form. As applicable, the number of systems, licenses, installations, deployments, managed end points or end-users for which Customer has purchased any one or more Services, the rate or price, and the applicable Term for each Service is indicated on Customer's Order Form. Unless otherwise agreed in writing between Dell and Customer, purchases of Services under this Service Description must be solely for Customer's own internal use and not for resale or service bureau purposes.

4. Important Additional Information

- A. Rescheduling.** Once this Service has been scheduled, any changes to the schedule must occur at least 8 calendar days prior to the scheduled date. If Customer reschedules this service within 7 days or less prior to the scheduled date, there will be a rescheduling fee not to exceed 25% of the price for the Services. Any rescheduling of the Service will be confirmed by Customer at least 8 days prior to commencement of the Service.
- B. Commercially Reasonable Limits to Scope of Service.** Dell may refuse to provide Service if, in its opinion, providing the Service creates an unreasonable risk to Dell or Dell's Service providers or if any requested service is beyond the scope of Service. Dell is not liable for any failure or delay in performance due to any cause beyond its control, including Customer's failure to comply with its obligations under this Service Description. Service extends only to uses for which the Supported Product was designed.
- C. Optional Services.** Optional services (including point-of-need support, installation, consulting, managed, professional, support or training services) may be available for purchase from Dell and will vary by Customer location. Optional services may require a separate agreement with Dell. In the absence of such agreement, optional services are provided pursuant to this Service Description.
- D. Assignment.** Dell may assign this Service and/or Service Description to qualified third party service providers.
- E. Cancellation.** Dell may cancel this Service at any time during the Term for any of the following reasons:
- Customer fails to pay the total price for this Service in accordance with the invoice terms;
 - Customer is abusive, threatening, or refuses to cooperate with the assisting analyst or on-site technician; or
 - Customer fails to abide by all of the terms and conditions set forth in this Service Description.

If Dell cancels this Service, Dell will send Customer written notice of cancellation at the address indicated on Customer's invoice. The notice will include the reason for cancellation and the effective date of cancellation, which will be not less than ten (10) days from the date Dell sends notice of cancellation to Customer, unless local law requires other cancellation provisions that may not be varied by agreement. If Dell cancels this Service pursuant to this paragraph, Customer shall not be entitled to any refund of fees paid or due to Dell.

- F. Geographic Limitations and Relocation.** This Service will be delivered to the site(s) indicated on the Customer's invoice. This Service is not available at all locations. If your Supported Product is not located in the geographic location that matches the location reflected in Dell's service records for your Supported Product, of if configuration details have been changed and not reported back to Dell, then Dell must first re-qualify your Supported Product for the support entitlement you purchased before applicable response times for the Supported Product can be reinstated. Service options, including service levels, technical support hours, and on-site response times will vary by geography and configuration, and certain options may not be available for purchase in Customer's location, so please contact your sales representative for these details. Dell's obligation



to supply the Services to relocated Supported Products is subject to various factors, including without limitations, local Service availability, additional fees, and inspection and recertification of the relocated Supported Products at Dell's then-current time and materials consulting rates. For EMEA customers, unless stated otherwise in this Service Description or the Agreement, on-site service is available up to a distance of 150 kilometers from nearest Dell Logistics location (PUJO or Pick-Up/Drop-off location). Please contact your sales representative for more information about availability of on-site service in EMEA.

- G. Transfer of Service.** Subject to the limitations set forth in this Service Description, Customer may transfer this Service to a third party who purchases Customer's entire Supported Product before the expiration of the then-current Term, provided Customer is the original purchaser of the Supported Product and this Service or Customer purchased the Supported Product and this Service from its original owner (or a previous transferee) and complied with all the transfer procedures available at www.support.dell.com. A transfer fee may apply. Please note that if Customer or Customer's transferee moves the Supported Product to a geographic location in which this Service is not available (or is not available at the same price), Customer or Customer's transferee may not have coverage or may incur an additional charge to maintain the same categories of support coverage at the new location. If Customer or Customer's transferee chooses not to pay such additional charge, the Service may be automatically changed to categories of support which are available at such price or a lesser price in such new location with no refund available.

© 2016 Dell Inc. All rights reserved. Trademarks and trade names may be used in this document to refer to either the entities claiming the marks and names or their products. Dell's terms and conditions of sale apply and can be located using the chart on the following page. A printed hardcopy of Dell's terms and conditions of sale is also available upon request.



Exhibit A

Severity Levels

Severity levels will be assigned to Qualified Incidents according to the table(s) below. "Severity 1" status is contingent on Customer purchasing optional "Mission Critical" enhanced services with Dell ProSupport.

Severity Levels and Dell Response for Products Purchased with Optional "Mission Critical" Service

Severity	Condition	Dell Response	Customer Role
1	Complete loss of critical business function, requiring immediate response.	Emergency dispatch in parallel with immediate telephone troubleshooting; quick Escalation Manager intervention.	Provide twenty-four (24) hours/day by seven (7) days/week appropriate staff/resources in support of issue resolution. Site-based senior management should be informed and engaged.
2	High impact, but imminent workaround or resolution available; twenty-four (24) hours/day by seven (7) days/week Customer resource allocation not available to aid Dell in its response.	Immediate telephone troubleshooting; Escalation Manager intervention if remote diagnosis has not been determined within 90 minutes of contact. Parts/labor dispatch when necessary <i>after</i> telephone troubleshooting and diagnosis.	Provide appropriate staff and resources to sustain continuous communication and work efforts. Site-based senior management informed and engaged.

Severity Levels and Dell Response for Products Purchased WITHOUT "Mission Critical" Service

Severity	Condition	Dell Response	Customer Role
2	High impact, but imminent workaround or resolution available; twenty-four (24) hours/day by seven (7) days/week Customer resource allocation not available to aid Dell in its response.	Immediate phone troubleshooting; Escalation Manager intervention if remote diagnosis has not been determined within ninety (90) minutes of contact. Parts/labor dispatch <i>after</i> telephone troubleshooting and diagnosis.	Provide appropriate staff and resources to sustain continuous communication and work efforts. Site-based senior management informed and engaged.
3	Minimal business impact.	Troubleshooting by telephone, parts/labor dispatched telephone troubleshooting and diagnosis.	Provide point-of-contact information for case and respond to Dell requests within twenty-four (24) hours.



On-site Service Options

On-site response options vary depending on the type of service purchased and whether optional "Mission Critical" enhanced service was purchased with Dell ProSupport. If you purchased ProSupport with an on-site support service response level, your invoice indicates the applicable on-site service response level, which corresponds to the tables below. Provided all applicable terms and conditions set forth in this Service Description have been fulfilled, Dell will dispatch a service technician to the Customer's business location for a Qualified Incident as necessary and pursuant to the Severity level and applicable on-site response table below.

If Customer or Customer's authorized representative is not at the location when the service technician arrives, the service technician cannot service the Supported Product. The technician will leave a card to let Customer know he or she was there or attempt to contact Customer by telephone or email. Customer may be charged an additional charge for a follow-up service call.

Dell ProSupport On-site Response WITH Mission Critical Enhanced Service

This Service when purchased in conjunction with "Mission Critical" enhanced service provides faster response times. Dell may initiate a critical situation ("**Crit Sit**") process for severity level one (1) issues and issue emergency dispatches when required.⁴

On-site Response Levels Available for Purchase with Mission Critical Enhanced Service

Type of On-site Response	On-site Response Time ⁵	Restrictions/Special Terms
2-Hour On-site Response with 6-Hour Repair Service	Technician typically arrives on-site within 2 hours after completion of telephone-based troubleshooting and often repairs the hardware within 6 hours of dispatch.	<ul style="list-style-type: none"> Available 7 days each week, 24 hours each day - including holidays. Available within defined 2 hour response locations. Available on select models of Supported Products. 2 Hour parts locations stock mission critical components, as determined by Dell, of Supported Products. Non-mission critical parts may be shipped using overnight delivery. Emergency dispatch in parallel with troubleshooting available for issues assigned a Mission Critical Severity Level 1 status.
4-Hour On-site Response	Technician typically arrives on-site within 4 hours after completion of telephone-based troubleshooting.	<ul style="list-style-type: none"> Available 7 days each week, 24 hours each day - including holidays. Available within defined 4 hour response locations. Available on select models of Supported Products. 4 Hour parts locations stock mission critical components, as determined by Dell, of Supported Products. Non-mission critical parts may be shipped using overnight delivery. Emergency dispatch in parallel with troubleshooting available for issues assigned a Mission Critical Severity Level 1 status.

⁴ **Emergency Dispatch for Mission Critical Severity Level 1 issues:** Supported Products with Dell ProSupport, Dell ProSupport Mission Critical and ProSupport Powered by Copilot Mission Critical service contract with two (2) hour or four (4) hour on-site response will have an on-site technician dispatched, if necessary, in parallel with phone-based troubleshooting. Following completion of problem determination, a Dell analyst will determine if the issue requires parts to be dispatched.

⁵ Not all response times are available in all countries and locations. Contact your sales representative for more information.



Type of On-site Response	On-site Response Time ⁵	Restrictions/Special Terms
8-Hour On-site Response	Technician typically arrives on-site within 8 hours after completion of phone-based troubleshooting.	<ul style="list-style-type: none"> Available 7 days each week, 24 hours each day - including holidays. Available within defined 8 hour response locations. Available only on select models of Supported Products. Non-mission critical parts may be shipped using overnight delivery. Emergency dispatch in parallel with troubleshooting available for issues assigned a Mission Critical Severity Level 1 status.
Outside Continental United States ("OCONUS") Customers	Following telephone-based troubleshooting, parts can be dispatched. On-site arrival times will depend on OCONUS Customer location and part-availability.	<ul style="list-style-type: none"> Limited to Dell-approved (US only) OCONUS Customers. Availability limited to select systems and locations. See http://content.dell.com/us/en/fedgov/fed-solutions-oconus.aspx?~ck=bt for details. Federal Customers should consult OCONUS Service Locations in Customer's applicable separately-signed services agreement with Dell.

Dell ProSupport On-site Response WITHOUT Mission Critical Enhanced Service

Standard On-site Response Levels Available for Purchase

Type of On-site Response	On-site Response Time ⁴	Restrictions/Special Terms
4-Hour On-site Response	Technician typically arrives on-site within 4 hours after completion of telephone-based troubleshooting.	<ul style="list-style-type: none"> Available 7 days each week, twenty-four (24) hours each day - <i>including</i> holidays. Available only within defined 4 hour response locations. Available only on select models of Supported Products. 4 Hour parts locations stock mission critical components, as determined by Dell, of Supported Products. Non-mission critical parts may be shipped using overnight delivery.
Next Business Day On-site Response	Following telephone-based troubleshooting and diagnosis, a technician can usually be dispatched to arrive on-site the next business day.	<ul style="list-style-type: none"> Available 5 days each week, 10 hours each day - <i>excluding</i> holidays. Calls need to be received before latest local ship time⁵, you will be advised of this during your call or contact your dell representative for country specific details Available only on select models of Supported Products.
Outside Continental United States ("OCONUS") Customers	Following telephone-based troubleshooting, parts can be dispatched. On-site arrival times will depend on OCONUS Customer location and part-availability.	<ul style="list-style-type: none"> Limited to Dell-approved (US only) OCONUS Customers. Availability limited to select systems and locations. See http://content.dell.com/us/en/fedgov/fed-solutions-oconus.aspx?~ck=bt for details. Federal Customers should consult OCONUS Service Locations in Customer's applicable separately-signed services agreement with Dell.



For All Other On-site Response Service Options:

Following completion of remote troubleshooting, diagnosis, and problem determination, a Dell analyst will determine if the Qualified Incident requires an on-site service technician and/or parts to be dispatched or if the issue can be resolved remotely.



Exhibit B

Non Field Serviceable Units

Return for Repair Service after Telephone–Based Troubleshooting. If, after remote diagnosis and troubleshooting, Dell determines that Customer's Supported Product requires Mail-In Service as described in the table below. Customer must immediately package the Supported Product and either mail or schedule carrier pickup on the same day, or the next available day to maintain Customer's entitlement, and any delay by Customer in packaging and returning or arranging for return of the Supported Product will result in delayed response times.

Upon repair or replacement of the Supported Product, Dell will deliver the Supported Product to the carrier for return shipping to Customer. If non-Dell options added to Customer's Supported Product are found to be the cause of the reported problem, a service charge may be applied and repair and return times may be delayed. Dell reserves the right to send Customer a whole replacement for the Supported Product or a replacement for portions of the Supported Product rather than repairing and returning the Supported Product that Customer sent for repair. Customer is obligated to pay at the then-current standard Dell price for any service parts removed from Customer's Supported Product and not properly returned to Dell by Customer. Failure to timely pay for service parts not properly returned to Dell by Customer may result in suspension of Customer's service under this Agreement in accordance with Section 2.D of the Additional Terms and Conditions Applicable to Support & Warranty-Related Services above. In the event that customer's Supported Product is located in an area not currently serviced by a major common carrier or with limited service by one or more major common carriers, Dell's normal repair service will be delayed. The Return for Repair Service Options listed in the table below are not available in all countries and locations. Review your Order Form to confirm the Return for Repair Service Option that you purchased. Contact your sales representative for more information.

Other Non-Field Serviceable Response Options:

Service Response Level	Additional Options (if applicable)	Details
Return for Repair Service Options	Mail-in Service (MIS)	Mail-in Service is initiated by calling Dell technical support as outlined above. During diagnosis, the Dell Technician will determine if the issue requires that the Supported Product be sent to a Dell-designated repair center to support a Qualified Incident. Typical cycle time, including shipping to and from the repair center, is 10 business days from the date Customer ships the Support Product to Dell.
	Carry-In Service (CIS)	Carry-In Service is a "drop-off" service initiated by calling Dell technical support as outlined above. During the telephone-based troubleshooting process, the Dell Technician will diagnose whether a hardware fault is the issue: If so, then the Customer will be asked to deliver the Supported Product to a Dell-designated repair center or shipping location (at the Customer's cost). Standard service hours are local business hours, available 5 days per week, excluding local national holidays. Repairs of Qualified Incidents will be performed in accordance with the response time identified on Customer's Order Form. Once the Supported Product has been repaired, Dell will contact Customer to make arrangements to retrieve it. Repair service level agreements may vary by country and city.



Service Response Level	Additional Options (if applicable)	Details
Return for Repair Service Options	Partner Led Carry-In Service (CIS) ⁶	Carry-In Service is a “drop-off” service initiated by either calling or bringing the Supported Product to a Dell-designated repair center or shipping location (at the Customer’s cost). Standard service hours are local business hours, available 5 days per week, excluding local national holidays. Repairs of Qualified Incidents will be performed in accordance with the response time identified on Customer’s Order Form. Once the Supported Product has been repaired, The Dell Authorized Service Provider will contact Customer to make arrangements to retrieve it. Repair service level agreements may vary by country and city.
	Collect and Return Service	Collect and Return Service is initiated by calling Dell technical support as outlined above. If a Qualified Incident in the Supported Product is diagnosed and cannot be resolved through telephone-based troubleshooting with the Dell Technician, a Dell representative will collect your Supported Product and take it to a Dell-designated repair center. This service method includes labor and the repair or replacement of parts in the main system unit, including monitor, keyboard, and mouse, if not ordered separately.
	Partner Led Collect and Return Service (CAR) ⁷	Collect and Return Service is initiated by calling your Dell Authorized Service Provider. If a Qualified Incident in the Supported Product is diagnosed and cannot be resolved through telephone-based troubleshooting, your Dell Authorized Service Provider will collect your Supported Product and take it to a Dell-designated repair center. Standard service hours are local business hours, available 5 days per week, excluding local national holidays. Repairs of Qualified Incidents will be performed in accordance with the response time identified on Customer’s Order Form. Once the Supported Product has been repaired, The Dell Authorized Service Provider will contact Customer to make arrangements to return it. This service method includes labor and the repair or replacement of parts in the main system unit, including monitor, keyboard, and mouse, if not ordered separately. Repair service level agreements may vary by country and city.
	Terms and conditions applicable to all Non-Field Serviceable Response Options.	Repairs of Qualified Incidents will be performed in accordance to the response time identified on Customer’s Order Form. Once the Supported Product has been repaired, it will be returned to the Customer. Shipping Procedures: During diagnosis, the Dell Technician will provide instructions on how to return the product to the Dell-designated repair center. The Supported Product must be shipped to the address provided by the Dell Technician and prominently labeled with the “Return Authorization Number”. The Return Authorization Number will be provided by the Dell Technician. To expedite repair or replacement, enclose a brief description of the issue in writing. Package the product being returned in its original packaging. If the original packaging is not available, the Dell Technician may assist by providing packaging; however a fee may apply for this service. Shipping Precautions: Customer should not send manuals, confidential, proprietary or personal information, or removable media such as floppy disks, DVDs, PC Cards, etc. Dell is not responsible for lost or corrupted data, damaged or lost media, or Customer’s confidential, proprietary or personal information.

⁶ Partner Led Carry-In Service (CIS) is performed by Dell Authorized Service Providers.

⁷ Partner Led Collect and Return Service (CAR) is performed by Dell Authorized Service Providers.



Service Response Level	Additional Options (if applicable)	Details
Parts-Only Service	N/A	For Customers with Parts-Only Service, Dell will enable Customer to request replacement parts to support a Qualified Incident(s). Dell may provide whole unit exchanges rather than the exchange of individual parts, in which case Dell includes a prepaid shipping container with each replacement part for Customer to use to return the original defective part to Dell. Parts-Only Service includes limited telephone support to qualify the failing component – the telephone support does not include telephone-based trouble-shooting or other types of remote assistance.
Advanced Exchange Service	N/A	For Customers with Advanced Exchange Service, Dell may ship a replacement product to the Customer's business location to support a Qualified Incident. The replacement product will be shipped via ground shipping if possible, but will be shipped in a manner consistent with Customer's overall service response level. In some instances, at Dell's discretion, an on-site service technician may also be dispatched to replace/ install the replacement product. Upon receipt of the replacement product, Customer must return the defective Supported Product to Dell by taking the defective Supported System to the designated return carrier location within 3 business days. If Dell determines that Customer's Supported Product cannot be returned at a carrier location and Customer must return the Supported Product via a mail-in return method, then Customer shall use the packaging, shipping instructions, and a pre-paid shipping waybill will ordinarily be dispatched to Customer's site with the replacement product. Upon receipt of the replacement product, Customer will immediately package the Supported Product and either mail or schedule carrier pickup on the same day, or the next available day. Should the Customer fail to return the defective item, a fee may be charged.



ProSupport Plus

Complete support with minimal effort



Benefits:

- + Resolve issues quickly with ProSupport engineers
- + Increase productivity with proactive automated support
- + Avoid downtime with failure prevention
- + Protect your investment with coverage for accidents
- + Secure your data with hard drive retention

Experts

- Priority access to ProSupport engineers
- Dedicated Technical Account Manager⁴
- Collaborative support

Insights

- Proactive issue detection
- Predictive failure prevention
- Monthly history and contract reporting⁴

Ease

- Automated case creation with notification
- Repair for drops, spills and surges
- Retain hard drive after replacement

PC and tablet support services

Feature comparison

	Base Warranty	ProSupport	ProSupport Plus
Technical support access	Business hours	24x7	24x7
Hardware repair service delivery ¹	Varies	Onsite	Onsite
Self-service case management and parts dispatch through TechDirect	✓	✓	✓
Direct access to in-region ProSupport engineers		✓	Priority Access
Single resource for software and hardware expertise		✓	✓
Command center monitoring and crisis management		✓	✓
Software support with collaborative 3rd party assistance		✓	✓
Case Management API for helpdesk integration		✓	✓
Automated issue detection, notification and case creation by SupportAssist ²		✓	✓
Predictive issue detection for failure prevention by SupportAssist ²			✓
Accidental damage repair for drops, spills and surges			✓
Retention of hard drive after replacement ³			✓
Dedicated Technical Account Manager ⁴			✓
Monthly support history and contract reporting ⁴			✓

1 Onsite service not available on Chromebook 11 A35 and Venue 7, 8, and 8 Pro tablets

2 SupportAssist is only available on Windows 7, 8 8.1 and 10. Not available on Windows RT, Android or Google Chrome.

3 Hard drive retention is not available on Chromebook or Venue tablets, except the Venue 11 Pro

4 Available for customers with 1000 or more ProSupport Plus systems.

5 Based on Mar 2016 Principled Technologies test report, "Dell SupportAssist Provided Proactive Support for Hard Drive Failure", commissioned by Dell. Testing conducted in the United States. Actual results will vary. Full report: <http://facts.pt/Cr3tEy>



ProSupport Plus with SupportAssist significantly reduced time to resolve a failed hard drive⁵ with:

- Up to 91% less time to resolution
- Up to 72% fewer steps in the support process

ProSupport Plus for PCs and tablets is the only complete support service that combines priority access to expert support, accidental damage repair, and proactive monitoring for automatic issue prevention and resolution. It helps ensure PCs and tablets are running smoothly so customers can focus on what's important.

Learn More

Dell.com/ProSupportPlus and
Dell.com/SupportAssist to get started

Integration Labs and Asset Lifecycle Services

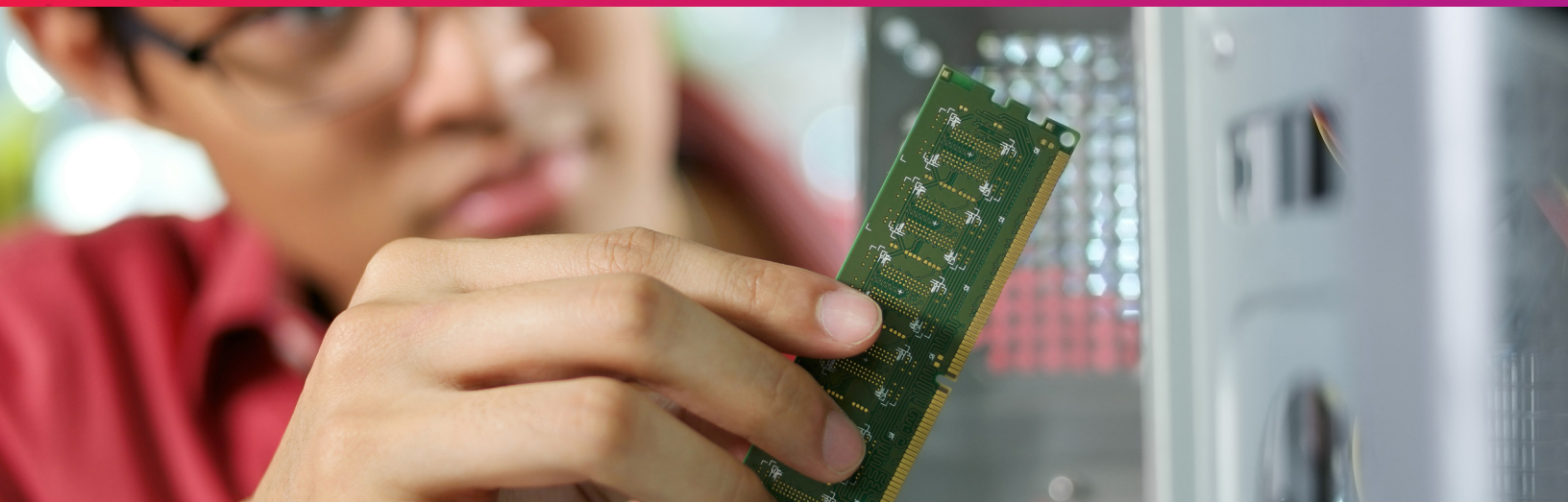

Why Insight for labs and asset lifecycle services?

With more resources and key industry relationships than any other outsourcing service provider, Insight helps you transform your workforce and focus on your goals.

Our flexible solutions and scalable capacity make deployment easy. From the edge of your IT to the core, we process your equipment in a centralized, secure and vendor-neutral ISO 9001:2015-certified technical lab environment. Here are some of the things we bring to the table:

- 27 years of industry experience
- 1,400+ consulting and service delivery professionals
- 200+ countries and territories served
- 3,600+ hardware and software partners

How labs and asset lifecycle services will help your business

After a rollout, you're tasked with ensuring your technology keeps the workplace up and running. And setting the stage the right way is key.

Not only will the staff in our dedicated labs configure your assets to your exact specifications, but we'll also support you at every phase of your IT asset lifecycle — from etching and imaging to disposition and remarketing. This helps you:

- Reduce maintenance costs.
- Accelerate time to use for new hardware.
- Eliminate Dead On Arrivals (DOAs).
- Streamline with a single source for entire IT lifecycle.
- Improve the end-user experience.

Insight is your expert connection to the IT solutions that help your business run smarter.

Integration labs and asset lifecycle services

Service	Description	Features
Imaging and staging	Drive cost savings by using our least-cost-touch methodology for device imaging and predeployment staging.	<ul style="list-style-type: none"> • Device imaging for Windows®, Mac OS® or Chrome • Asset tagging and application (4 format choices or client-supplied) • Kitting and consolidated packaging • Shipped to meet deployment schedule
Device customization	Reduce or eliminate on-site setup steps and create a seamless, zero-touch deployment experience for end users.	<ul style="list-style-type: none"> • Post-imaging customization to end-user level • Rack/stack activity • Application loads (manual or via hosted deployment server) • Laser etching (custom text or logo) • Custom labeling options
Asset centralization	For environments with 500+ devices, this program drives reduced maintenance costs by keeping working assets in use and increasing end-user satisfaction.	<ul style="list-style-type: none"> • Retrieval and refurbishment • Advanced exchange (configured replacement device arrives next business day) • Redeployment (available for same-day outbound shipment) • Warranty repairs and lease-end processing
Special project lab	This is a customized solution for short-term, project-based staging of data center and networking equipment.	<ul style="list-style-type: none"> • Badge-restricted access to secure cage • Dedicated workspace for client/partner resources • Space, power, HVAC & 24/7 security included • Technical resources available via time and materials
Standards automation	Use our expertise for the creation and maintenance of Windows® and Mac OS® end-user device images.	<ul style="list-style-type: none"> • Image creation and scheduled maintenance • Application packaging and sequencing • Data migration tools
Asset disposition and remarketing	Maximize economic return on remarketable equipment and achieve environmentally safe breakdown and recycling of end-of-life assets.	<ul style="list-style-type: none"> • Secure chain of custody • Department of Defense-level drive erasure • Certificates of erasure and destruction

Insight ITB Response
Emergency Telephone System Board of DuPage County
Mobile Data Terminals (MDT) #P17-204-BF



Attachment 2 – Advertising Literature/Spec. Sheets

Dell recommends Windows®



Latitude 14 Rugged Extreme Nerves of steel.



Rugged for the real world

Life happens in the real world, where your notebook may be exposed to hazards such as accidental drops, vibration, water, dust and extreme temperatures. The Dell Latitude 14 Rugged Extreme was built for the worst with the most durable materials available including impact-resistant ultra polymers and sturdy magnesium alloy.

Protect your data from the elements with sealed doors and compression gasketing while enabling performance at high temperature with fourth-generation QuadCool™ thermal management.

Latitude Rugged Extreme notebooks are independently tested¹ to military standards including drops up to 6 feet, as well as ingress protection, emissions and hazardous materials certifications by an accredited third-party testing facility.

Productivity anywhere

You can't quit when the going gets rough. You don't slow down and neither will your Rugged Extreme notebook with powerful and efficient 6th generation Intel® processors, speedy solid state storage and optional discrete graphics. With up to 14 hours of battery life² and an optional hot-swap bridge battery, you have power for your entire shift.

Collaborate effectively and stay connected with a suite of wireless³ capabilities including optional mobile broadband and dedicated GPS.

With an expansive 14" Direct-View outdoor-readable display, you'll see everything clearly from bright sunlight to low light conditions and standard resistive touch means you can keep your gloves on.

Latitude Rugged means innovation everywhere you look. A customizable RGB backlit keyboard enables you to work comfortably in all lighting environments while stealth mode allows you to go incognito with a simple keypress.

Business-class control

Dell provides absolute peace of mind with the easiest rugged products to own. Stay in control with the most secure, manageable rugged notebooks, featuring industry-leading endpoint security solutions that include comprehensive encryption, advanced authentication and leading-edge malware protection.

Simplify system management with remote management capability and available Intel® vPro™ technology for efficient out-of-band management.

Safeguard your data with an array of protections including a Trusted Platform Module (TPM)⁹ 2.0, Dell Data Protection | Encryption⁷ and ControlVault™ advanced authentication.

Dell Rugged notebooks are backed by a wide array of Dell service and support options that can be custom-tailored to your unique needs.

Specifications

Feature	Technical specification
Name / model	Latitude 14 Rugged Extreme / 7414
Processors	6 th generation Intel® Core™ i3, i5 and i7 dual-core processors
Operating systems	Windows® 10 Pro/Home (64-bit), Windows® 8.1 Pro (64-bit), Windows® 8.1 (64-bit), Genuine Windows® 7 Professional (64/32-bit); Linux Ubuntu 14.04
Memory ⁶	2 DIMM slots supporting up to 32GB 2133MHz DDR4
Graphics ⁷	Intel HD Graphics 520; Optional AMD Radeon™ R7 M360 discrete graphics
Display	14.0" HD (1366 x 768) 16:9 Direct-View outdoor-readable display with resistive touchscreen
Storage ⁸	128GB, 256GB, 512GB or 1TB mobility solid state drives; Optional 256GB, 512GB SED SSD
Multimedia	High-quality speaker, integrated noise-reducing array microphones, stereo headphone/microphone combo jack, Optional integrated FHD video web camera with privacy shutter
Battery	6-cell (65 Whr) or 9-cell (97 Whr) lithium-ion batteries; Optional 6-cell (58 Whr) or 9-cell (87 Whr) long life cycle lithium-ion batteries with 3 year warranty; Optional hot-swap bridge battery
Power	65W or 90W AC adapters; Optional 90W auto/air DC adapter
Connectivity	10/100/1000 gigabit Ethernet and triple RF-passthrough (GPS, mobile broadband and Wi-Fi) Wireless LAN: Intel® Dual Band Wireless-AC 8260 (802.11ac, dual band, 2x2, up to 867 Mbps) with Bluetooth® 4.2 + vPro™ Mobile broadband^{4,9}: Optional Dell Wireless 5808E multi-mode Gobi™ 5000 4G LTE card (US and Canada only: AT&T, Verizon, Sprint, Rogers, Telus); Optional Dell Wireless 5809E multi-mode Gobi™ 5000 4G LTE card (Europe, Asia Pacific) GPS: Optional dedicated u-blox NEO-M8 GPS card
Ports, slots and peripherals	Ports: USB 3.0 (3), USB 2.0 (1), native RS-232 serial ports (2), RJ-45 gigabit Ethernet network connectors (2), stereo headphone/microphone combo jack, pogo-pin docking connector, VGA, HDMI Slots: Memory card reader; ExpressCard 54 mm or PCMCIA; M.2 slots (2 internal); Optional DVD+/-RW Optional docking and peripherals: Rugged desk dock, third-party vehicle docking ⁹ , Quick-Disconnect shoulder strap
Security	Steel-reinforced cable lock slot, SmartCard reader, contactless SmartCard reader, optional fingerprint reader, TPM 2.0 ⁹ , ControlVault™ advanced authentication, Dell Security Tools, Dell Data Protection Encryption, NIST SP800-147 secure platform, Dell Backup and Recovery
Dimensions and weight ¹⁰	Dimensions: Starting at 14.0" x 9.7" x 2.03" (356 x 247 x 52 mm); 14.4" x 11.5" x 2.4" (366 x 293 x 61 mm) maximum Weight: Starting at 7.79 lbs. (3.54 kg) with 6-cell battery and no optical drive
Input	Rugged RGB backlit keyboard; Optional rubberized RGB backlit keyboard (English only); Resistive touchpad, Resistive single-point gloved-capable touch screen
Management	Intel vPro™ technology's advanced management features on i5/i7 configurations
Regulatory and environmental	Regulatory model: P45G Regulatory type: P45G002 Energy Star 6.0, EPEAT MIL-STD-810G testing¹: Transit drop (72",60",48"; single unit; 78 drops), operating drop (36"), blowing rain, blowing dust, blowing sand, vibration, functional shock, humidity, salt fog (with rubberized keyboard), altitude, explosive atmosphere, solar radiation, thermal extremes, thermal shock, freeze/thaw, tactical standby to operational Operating thermal range: -20°F to 145°F (-29°C to 63°C); Non-operating range: -60°F to 160°F (-51°C to 71°C) IEC 60529 ingress protection¹: IP65 (dust-tight, protected against pressurized water) Hazardous locations: ANSI/ISA.12.12.01 certification capable ¹ (Class I, Division 2, Groups A, B, C,D) Electromagnetic interference: MIL-STD-461F certified ¹

1 Based on testing and certification to MIL-STD-810G, IEC 60529 (IP65), MIL-STD-461F, and ANSI/ISA.12.12.01 standards, performed and reported independently by accredited testing companies. ANSI/ISA.12.12.01 must be specified at time of order for certification. Contact your sales representative for more information.

2 Based on testing using the Mobile Mark 2012 Productivity battery life benchmark test. For more information about this benchmark test, visit www.bapco.com. Test results should be used only to compare one product with another and are not a guarantee you will experience the same battery life. Battery life may be significantly less than the test results and varies depending on your product's configuration, software, usage, operating conditions, power management settings and other factors. Maximum battery life will decrease with time and use.

3 Where wireless access is available. Additional access charges apply in some locations.

4 Subject to service provider's broadband subscription and coverage area; additional charges apply.

5 Contact your sales representative for feature availability.

6 A 64-bit operating system is required to support 4GB or more of system memory.

7 Significant system memory may be used to support graphics, depending on system memory size and other factors.

8 GB means 1 billion bytes and TB equals 1 trillion bytes; actual capacity varies with preloaded material and operating environment and will be less.

9 Regional availability may vary for some offerings. Vehicle docking and other peripherals may be offered by third-party providers.

10 Weights vary depending on configuration and manufacturing variability.



Dell recommends Windows®



Latitude 14 Rugged Works as hard as you do.



Get durable performance wherever work takes you with the Latitude 14 Rugged powered by Intel® Core™ processors. Built from the same rock-solid DNA as our Latitude Rugged Extreme, trust the security, manageability and reliability that never settles for “good enough.”

Rugged for the real world

Work confidently with best-in-class protection from dust, water and the elements and conquer any job, anytime, anywhere.

Protect your data while enabling performance at high temperature with fourth-generation QuadCool™ thermal management.

The Latitude 14 Rugged notebook is independently tested and certified¹ to military standards including drops up to 3 feet as well as an IP52 certification for protection from the ingress of dust and water.

Productivity anywhere

Conquer your most challenging work environments with essential rugged features, like a privacy shutter on the integrated webcam, sealed RGB backlit keyboard, and universal docks for your desk and vehicle .

You'll see everything clearly in everything from darkness to bright sunlight with an expansive 14" outdoor-readable display with up to FHD resolution and optional glove-capable multi-touch.

You don't slow down and neither will your Latitude Rugged notebook with powerful and efficient 6th generation Intel® processors, optional solid state storage and optional discrete graphics. With up to 16 hours of battery life² and an optional hot-swap bridge battery, you can work confidently through your entire shift.

Collaborate effectively and stay connected with a suite of wireless³ capabilities including optional mobile broadband⁴ and dedicated GPS.

Business-class control

Dell provides absolute peace of mind with the easiest rugged products to own. Stay in control with the most secure, manageable rugged notebooks, featuring industry-leading endpoint security solutions that include comprehensive encryption, advanced authentication and leading-edge malware protection.

Simplify system management with remote management capability and available Intel® vPro™ technology for efficient out-of-band management.

Safeguard your data with an array of protections including Trusted Platform Module (TPM)⁷ 2.0, Dell Data Protection | Encryption⁷ and ControlVault™ advanced authentication.

Dell Rugged notebooks are backed by a wide array of Dell service and support options that can be custom-tailored to your unique needs.

Specifications

Feature	Technical specification
Name / model	Dell Latitude 14 Rugged / 5414
Processors	6 th generation Intel® Core™ i3, i5 and i7 dual-core processors
Operating systems	Windows® 10 Pro/Home (64-bit), Windows® 8.1 Pro (64-bit), Windows® 8.1 (64-bit), Genuine Windows® 7 Professional (64/32-bit); Linux Ubuntu 14.04
Memory ⁶	2 DIMM slots supporting up to 32GB 2133MHz DDR4
Graphics ⁷	Intel HD Graphics 520; Optional AMD Radeon™ R7 M360 discrete graphics
Display	14.0" HD (1366 x 768) 16:9 display; Optional 14.0" FHD (1920 x 1080) 16:9 1000 nit Direct-View outdoor-readable display with optional glove-capable touchscreen
Storage ⁸	128GB, 256GB, 512GB or 1TB mobility solid state drives or 500GB 5400RPM hard disk drive; Optional 500GB FIPS SATA HD, 256GB, 512GB SED SSD
Multimedia	High-quality speaker, integrated noise-reducing array microphones, stereo headphone/microphone combo jack, Optional integrated HD video web camera with privacy shutter
Battery	6-cell (65 Whr) or 9-cell (97 Whr) lithium-ion batteries; Optional 6-cell (58 Whr) or 9-cell (87 Whr) long life cycle lithium-ion batteries with 3 year warranty; Optional hot-swap bridge battery
Power	65W or 90W AC adapters; Optional 90W auto/air DC adapter
Connectivity	10/100/1000 gigabit Ethernet and triple RF-passthrough (GPS, mobile broadband and Wi-Fi) Wireless LAN: Dell Wireless™ 1802 802.11AGN Dual-Band Wi-Fi + BT 4.0 Wireless Card (2x2); Intel® Dual Band Wireless-AC 8260 (802.11ac, dual band, 2x2, up to 867 Mbps) with Bluetooth® 4.2 + vPro™ Mobile broadband ^{4,9} : Optional Dell Wireless 5808E multi-mode Gobi™ 5000 4G LTE card (US and Canada only: AT&T, Verizon, Sprint, Rogers, Telus); Optional Dell Wireless 5809E multi-mode Gobi™ 5000 4G LTE card (Europe, Asia Pacific) GPS: Optional dedicated u-blox NEO-M8 GPS card
Ports, slots and peripherals	Ports: USB 3.0 (3), USB 2.0 (1), native RS-232 serial ports (1), RJ-45 gigabit Ethernet network connectors (1), optional second native RS-232 serial ports and second RJ-45 gigabit Ethernet network connector or Fischer USB , stereo headphone/microphone combo jack, optional pogo-pin docking connector, VGA, HDMI Slots: Memory card reader; Optional ExpressCard 54 mm or PCMCIA; M.2 slots (2 internal); Optional DVD+/-RW Optional docking and peripherals: Rugged DisplayPort notebook desk dock, third-party vehicle docking ⁹ , shoulder strap
Security	Steel-reinforced cable lock slot, optional security package (SmartCard reader, contactless SmartCard reader, fingerprint reader), TPM 2.0 ⁹ , ControlVault™ advanced authentication, Dell Security Tools, Dell Data Protection Encryption, NIST SP800-147 secure platform, Dell Backup and Recovery
Dimensions and weight ¹⁰	Dimensions: Starting at 13.66" x 9.57" x 1.73" (347 x 243 x 44.4 mm); 13.8" x 11.2" x 1.98" (351 x 284 x 50.2 mm) maximum Weight: Starting at 6.3 lbs. (2.86 kg) with 6-cell battery and no optical drive
Input	Rugged RGB backlit keyboard; Optional rubberized RGB backlit keyboard (English only); Capacitive touchpad, Capacitive ten-point gloved-capable multi-touch screen
Management	Intel vPro™ technology's advanced management features on i5/i7 configurations
Regulatory and environmental	Regulatory model: P46G Regulatory type: P46G002 Energy Star 6.0, EPEAT MIL-STD-810G testing ¹ : Transit drop (36"), blowing dust, vibration, functional shock, humidity, altitude, thermal extremes Operating thermal range: -20°F to 140°F (-29°C to 60°C); Non-operating range: -60°F to 160°F (-51°C to 71°C) IEC 60529 ingress protection ¹ : IP52 (dust-protected, protected against dripping water when tilted up to 15°)

1 Based on testing and certification to MIL-STD-810G, IEC 60529 standards, performed and reported independently by accredited testing companies.

2 Based on testing using the Mobile Mark 2012 Productivity battery life benchmark test. For more information about this benchmark test, visit www.bapco.com. Test results should be used only to compare one product with another and are not a guarantee you will experience the same battery life. Battery life may be significantly less than the test results and varies depending on your product's configuration, software, usage, operating conditions, power management settings and other factors. Maximum battery life will decrease with time and use.

3 Where wireless access is available. Additional access charges apply in some locations.

4 Subject to service provider's broadband subscription and coverage area; additional charges apply.

5 Contact your sales representative for feature availability.

6 A 64-bit operating system is required to support 4GB or more of system memory.

7 Significant system memory may be used to support graphics, depending on system memory size and other factors.

8 GB means 1 billion bytes and TB equals 1 trillion bytes; actual capacity varies with preloaded material and operating environment and will be less.

9 Regional availability may vary for some offerings. Vehicle docking and other peripherals may be offered by third-party providers.

10 Weights vary depending on configuration and manufacturing variability.





Latitude 7212 Rugged Extreme Tablet

Intelligently tough

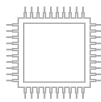

Lighter and more powerful

Less is more in our latest iteration of our flagship rugged tablet which is 27% lighter and starts at just 2.8lbs (1.27kg). Upgraded with powerful 7th Generation Intel Core Processors and boasting up to 1TB of fast, reliable, and high performance solid state storage, this fully-rugged tablet can tackle the most demanding rugged tasks.



Work wherever the job takes you

A crisp, bright, 11.6" FHD resolution outdoor-viewable display lets you work in direct sunlight while the glove-capable touchscreen remains responsive even if you have to wear protective gear. All day productivity is easy with optional dual hot-swap batteries for endless power.



Award winning service

Have peace of mind and trust that your mission-critical rugged tablet is well-protected with coverage options such as Dell's signature Pro Support Plus. With premium support service featuring 24/7 access to the most experienced technicians, downtime is a thing of the past.



Security Knows No Boundaries

Security matters even more in the field. With Dell Data Protection on your rugged tablet, you can rest easy knowing you have comprehensive encryption, advanced authentication, and leading-edge malware protection built right in. It doesn't get any simpler.

Features & Technical Specifications



Feature	Latitude 7212 Rugged Extreme Tablet
Model Number¹	7212
Processor Options¹	7 th Generation Intel Core i3, i5, i7 Dual-Core Processors 6 th Generation Intel Core i5 Dual-Core Processor
Operating System¹	Microsoft Windows 10 Pro 64 Bit Microsoft Windows 10 Pro with Windows 7 Professional Downgrade (64 bit)
Memory Options^{1,2,3}	8GB 1866MHz LPDDR3 Memory 16GB 1866MHz LPDDR3 Memory
Chipset¹	Integrated with the Processor
Intel Responsiveness Technologies^{1,7}	Intel [®] Rapid Storage Technology
Graphics^{1,13}	Intel [®] Integrated HD Graphics
Display¹	11.6" FHD (1920x1080) 16:9 Direct-View outdoor-readable display with gloved multi-touch AG/AR/AS/Polarizer and Gorilla Glass
Storage Options^{1,3}	128GB SATA Class 20 Solid State Drive 256GB SATA Class 20 Solid State Opal 2.0 SED Drive 256GB SATA Class 20 Solid State Drive 256GB PCIe NVMe Class 40 Solid State Opal 2.0 SED Drive 512GB SATA Class 20 Solid State Opal 2.0 SED Drive 512GB SATA Class 20 Solid State Drive 512GB PCIe NVMe Class 40 Solid State Drive 1TB SATA Class 20 Solid State Drive 1TB PCIe NVMe Class 40 Solid State Drive
Security¹	TPM 2.0, ControlVault™ advanced authentication, Dell Security Tools, Dell Data Protection Encryption, Contactless SmartCard reader, optional fingerprint reader and SmartCard reader NIST SP800-147 secure platform, Dell Backup and Recovery
Docking¹	Rugged Tablet Desk Dock Rugged Tablet Vehicle Dock Dell Business Dock
Optical Drive Options	External Options Only
Multimedia¹	Optional integrated front and rear cameras with built-in privacy shutter
Battery Options^{1,5}	2-cell (34Wh) Lithium Ion Primary Battery 2-cell (34Wh) Lithium Ion Secondary Battery 2-cell (26Wh) Lithium Ion Primary Battery 2-cell (26Wh) Lithium Ion Secondary Battery
Power Options¹	45W 4.5mm AC Adapter (3-prong) 45W Type-C AC Adapter (3-prong) Dell Power Companion (Type-C)
Connectivity options^{1,14}	Dual RF-passthrough (Wi-Fi and mobile broadband), Near field communication (NFC) Wireless LAN Options: Intel [®] Dual Band Wireless-AC 8265 with Bluetooth [®] 4.2 + vPro™ Mobile broadband Intel [®] Dual Band Wireless-AC 8265 + No Bluetooth 4.2 Wireless Card Qualcomm QCA61x4A 802.11ac Dual Band (2x2) Wireless Adapter+ Bluetooth 4.1 Optional Mobile Broadband Options:^{8, 10} Qualcomm [®] Snapdragon™ X7 LTE-A for Win 10 (DW5811e Gobi5000) for Worldwide (Windows 7 and 10 options) Qualcomm [®] Snapdragon™ X7 LTE-A for Win 10 (DW5811e Gobi5000) for AT&T (Windows 7 and 10 options) Qualcomm [®] Snapdragon™ X7 LTE-A for Win 10 (DW5811e Gobi5000) for Verizon (Windows 7 and 10 options) Qualcomm [®] Snapdragon™ X7 LTE-A for Win 10 (DW5811e Gobi5000) for Sprint (Windows 7 and 10 options) Dell Wireless 5816e multi-mode Gobi™ 5000 4G LTE WAN Card (Japan/ANZ only) GPS:Dedicated u-blox NEO-M8 GPS card
Ports, Slots & Chassis¹	USB 3.0 Type A USB 3.1 Type C Gen 1, supports power and display Universal Audio Jack Contactless SmartCard reader Optional Micro serial RS-232 Optional Contacted SmartCard Reader and touch Fingerprint Reader Kensington Lock slot

Dimensions & Weight ^{1,15}	Dimensions: (WxDxH) 12.3" x 8.0" x 0.96" (312 x 203 x 24 mm) Weight: Starting at 2.82 lbs. (1.3 kg) with single 2-cell battery
Regulatory and Environmental Compliance ¹	MIL-STD-810G testing: Transit drop (48"/1.22m; single unit; 26 drops), operating drop (36"/0.91m), blowing rain, blowing dust, blowing sand, vibration, functional shock, humidity, salt fog, altitude, explosive atmosphere, thermal extremes, thermal shock, freeze/thaw, tactical standby to operational Operating thermal range: -20°F to 145°F (-29°C to 63°C); Non-operating: -60°F to 160°F (-51°C to 71°C) IEC 60529 ingress protection ¹⁸ : IP-65 (dust-tight, protected against pressurized water) Hazardous locations: ANSI/ISA.12.12.01 certification capable (Class I, Division 2, Groups A, B, C,D), CAN/CSA C22.2 Electromagnetic interference: MIL-STD-461F certified
Input ¹	Rugged RGB Backlit Keyboard Cover
Systems Management ¹	Intel vPro™ technology's advanced management features on i5/i7 configurations
Warranty and Service ¹	Limited Hardware Warranty ⁴ Standard 1 year Mail-in Service after Remote Diagnosis ¹¹ optional 3, 4 and 5 year hardware warranty extensions and 3-5 year Dell ProSupport contracts available ¹²
Peripheral Ecosystem ¹	Maximize the performance of your Latitude 12 Rugged Tablet with Dell recommended essential accessories. Includes Dell Desktop Dock for the Rugged Tablet, Dell Dock WD15, Dell Power Companions, Kickstand and Rugged RGB Backlit Keyboard cover, Shoulder Strap, Soft and Rigid Handle options, Chest Harness, Cross Strap, Active Pen, Backpack Modules, Dell 24" & 27" Monitors, and Dell Wireless Keyboard and Mouse.

¹ Offering may vary by country and by configuration

² 64-bit operating system is required to support 4GB or more of system memory.

³ GB means 1 billion bytes and TB equals 1 trillion bytes; actual capacity varies with preloaded material and operating environment and will be less.

⁴ Limited Hardware Warranty: For copy of Limited Hardware Warranty, write Dell USA LP, Attn: Warranties, One Dell Way, Round Rock, TX 78682 or see www.dell.com/warranty

⁵ Battery support is dependent upon graphics support. Check technical guides for detailed support

⁶ COMPUTRACE Not a Dell offer. Certain conditions apply. For full details, see terms and conditions at www.absolute.com/en/about/legal/agreements.

⁷ Intel Rapid Storage Technology requires a HDD, mSATA, or an SSD, as primary storage device and Windows OS required

⁸ Wireless antenna available only at time of system purchase

⁹

¹⁰ Mobile Broadband Subject to service provider's broadband subscription and coverage area; additional charges apply.

¹¹ Onsite Service after Remote Diagnosis: Remote Diagnosis is determination by online/phone technician of cause of issue; may involve customer access to inside of system and multiple or extended sessions. If issue is covered by Limited Hardware Warranty (www.dell.com/warranty) and not resolved remotely, technician and/or part will be dispatched, usually within 1 business day following completion of Remote Diagnosis. Availability varies. Other conditions apply.

¹² Dell Services: Availability and terms of Dell Services vary by region. For more information, visit www.dell.com/servicedescriptions.

¹³ GB means 1 billion bytes and TB equals 1 trillion bytes; significant system memory may be used to support graphics, depending on system memory size and other factors.

¹⁴ Miracast Wireless Technology: Requires a compatible media adapter (sold separately) and an HDMI-enabled display.

¹⁵ Weights vary depending on configuration and manufacturing variability.

¹⁶ Intel 7th Gen Core 15W (U) CPUs support 2133MHz memory, Intel 7th Gen Core 35W (H) supports 2400MHz Memory

¹⁷ US only. WW availability in 2017

¹⁸ Based on testing and certification to MIL-STD-810G, IEC 60529 standards, performed and reported independently by accredited testing companies.

Essential Accessories

Latitude 7212 Rugged Extreme Tablet

At-the-Desk



Rugged Tablet Dock



Keyboard Cover with Kickstand



Dell Rugged Battery Charger

On-The-Go



Rugged Shoulder Strap



Dell Rugged Extreme Handle



Extended IO Module



Introducing the world's most secure laptops designed for ultimate productivity and flexibility.

LATITUDE 5000 SERIES LAPTOPS 5280 | 5480 | 5580

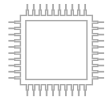

Scalable performance

Experience scalability in performance and flexibility all in one series of commercial laptops. Powered by the latest Intel® processors, NVIDIA graphics and a range of storage options from HDD to PCIe NVMe to ignite your workforce productivity.



Serviceable and long battery life

Choose how to power through your day with multiple battery options and handy peripherals like the Dell Power Companion for additional battery life. Also enjoy best-in-class serviceability with a bottom access door making component accessibility a snap.



Easy access and connectivity

New features to the series include optional Windows Hello and an infrared camera which facilitates logon using facial recognition. Docking is now also a breeze with multiple options including DisplayPort™ over USB Type C, Thunderbolt3™ and Dell Wireless dock.



World's most secure

Relax knowing that this series of laptops is the world's most secure featuring optional multi-factor authentication including touch finger print reader, contacted FIPS 201 Smart Card Reader, contactless smart card reader with Control Vault 2™ FIPS 140-2 Level 3 certification.

Features & Technical Specifications

	KabyLake 12 U
Model Number¹	Latitude 5280
Processor Options¹	7th Gen Intel® Core Processors up to i7, U Dual Core
Operating System¹	Microsoft® Windows 10 Pro 64 bit Microsoft® Windows 10 Home 64 bit Ubuntu 16.04 LTS 64-bit NeoKylin 6.0 64 bit
Memory Options^{1,2,3}	DDR4 2133 MHz; 2 slots supporting up to 32GB
Chipset¹	Integrated with the Processor
Intel Responsiveness Technologies^{1,7}	Intel® Rapid Storage Technology
Graphics^{1,13}	Intel® HD Graphics 620
Display¹	12.5" HD (1366 x 768) Anti-glare (16:9) WLED, 200 nits, Carbon Fiber Reinforced Polymer LCD Back 12.5" FHD WVA (1920 x 1080) Anti-glare (16:9) WLED, 300 nits, Carbon Fiber Reinforced Polymer LCD Back 12.5" FHD WVA Anti-Reflective Touch with Corning® Gorilla® Glass 4 (1920 x 1080), Anti-Finger Print, (16:9), 360 nits, Carbon Fiber Reinforced Polymer LCD Back
Storage Options^{1,3}	HDD: up to 1TB, Hybrid, OPAL SED options SSD M.2 2280 SATA: up to 512GB, OPAL SED options SSD M.2 2280 PCIe/NVMe: up to 512GB, OPAL SED options SSD M.2 2242 64GB Cache (in WWAN slot) Dell Fast Response Free Fall Sensor and HDD Isolation (standard feature)
Security¹	TPM 2.0 FIPS 140-2 Certified, TCG Certified Optional Hardware Authentication Bundle 1: FIPS 201 Contacted Smart Card with Control Vault 2.0 Advanced Authentication with FIPS 140-2 Level 3 Certification Optional Hardware Authentication Bundle 2: Touch Fingerprint Reader, FIPS 201 Contacted Smart Card, Contactless Smart Card, NFC, Control Vault 2.0 Advanced Authentication with FIPS 140-2 Level 3 Certification Dell Client Command Suite Optional Dell Data Security and Management Software Dell Endpoint Security Suite Enterprise Dell Data Guardian Dell Encryption (Enterprise or Personal Edition) Dell Threat Defense Dell Protected Workspace MozyPro® or MozyEnterprise® RSA NetWitness® Endpoint ¹⁷ VMware Airwatch® ¹⁷ RSA SecurID Access ¹⁷ Absolute Data & Device Security
Docking¹	Dell Dock WD15 (optional, sold separately) Dell Wireless Dock WLD15 (Optional, sold separately, requires optional installed Intel® Tri-Band Wireless-AC 18265 WiGig + Wi-Fi + BT4.2 ⁸)
Optical Drive Options	External Options Only
Multimedia¹	High Quality Speakers Headset/mic combo jack Noise reducing array microphones Optional HD, IR or no camera Skype For Business Certified
Battery Options¹	42 WHr Prismatic, ExpressCharge™ capable 51 WHr Polymer, ExpressCharge™ capable 68 WHr Polymer, ExpressCharge™ capable 68 WHr Long Life Cycle Polymer (Spring 2017)

Power Options¹	65W adapter, 7.4mm barrel 65W BFR/PVC Halogen Free adapter, 7.4mm barrel
Connectivity options^{1,14,18}	10/100/1000 Ethernet Wireless LAN Options: Qualcomm QCA61x4A 802.11ac Dual Band (2x2) Wireless Adapter+ Bluetooth 4.1 Intel® Dual-Band Wireless-AC 8265 Wi-Fi + BT 4.2 Wireless Card (2x2). Bluetooth Optional Optional Mobile Broadband Options:^{8,10} Qualcomm® Snapdragon™ X7 LTE-A (DW5811e) (EMEA/APJ/ROW) Qualcomm® Snapdragon™ X7 LTE-A (DW5811e) for AT&T, Verizon & Sprint, US Qualcomm® Snapdragon™ X7 HSPA+ (DW5811e) (China/Indonesia/India) Dell Wireless™ Telit Intel Ln-930 AP LTE CAT4 (DW5814e for Japan) Optional WiGig Option:⁸ Intel® Tri-Band Wireless-AC 18265 WiGig + Wi-Fi + BT4.2 Wireless Card
Ports, Slots & Chassis¹	2 USB 3.1 Gen 1 (one with PowerShare), HDMI, VGA RJ-45, external uSIM card tray option uSD 4.0 Memory card reader Headset/mic combo jack Optional Contacted SmartCard Reader and touch Fingerprint Reader Display Port over USB Type-C™ Noble Wedge Lock slot
Dimensions & Weight^{1,15}	Width: 12.0" / 305.1mm Height (front): 0.8" / 21.4mm Depth: 8.3" / 211.3mm Starting weight: 2.99 lbs. / 1.36 kg (42Whr battery, M.2 SSD, non touch FHD LCD, UMA)
Regulatory and Environmental Compliance¹	Regulatory Model: P72S Regulatory Type: P72S001 ENERGY STAR 6.1 ¹ EPEAT Gold Registered. For specific country participation and rating, please see www.epeat.net BFR/PVC free ⁹ TAA configurations available
Input¹	Single Pointing non-backlit Keyboard Single Pointing backlit Keyboard Multi-touch Touchpad
Systems Management¹	Intel® vPro™ Technology (iAMT 11.6) (optional, requires Intel Wi-Fi® Link WLAN and a vPro compatible processor), Dell Client Command Suite available (dell.com/command), Factory Installed Dell Client Command Update, Dell Command Power Manager
Warranty and Service¹	Limited Hardware Warranty ⁴ Standard 1 year Mail-in Service after Remote Diagnosis ¹¹ optional 2, 3, 4 and 5 year hardware warranty extensions and 3-5 year Dell ProSupport contracts available ¹²
Peripheral Ecosystem¹	Purpose built ecosystem to enable productivity on the go or at the desk. Includes Dell Dock, Dell Wireless Dock, Dell Power Companions, Dell Professional Briefcases, Dell 24" & 27" Monitors and Dell Wireless Keyboard and Mouse

Features & Technical Specifications

	KabyLake 14 U	KabyLake 14 H
Model Number¹	Latitude 5480	
Processor Options¹	7th Gen Intel® Core Processors up to i7, U Dual Core	7th Gen Intel® Core Processors up to i7, H Quad Core
Operating System¹	Microsoft® Windows® 10 Home Microsoft® Windows® 10 Pro 64 bit Ubuntu 16.04 LTS 64-bit NeoKylin 6.0 64 bit	
Memory Options^{1,2,3}	DDR4 2133 MHz; 2 slots supporting up to 32GB	DDR4 2400 MHz; 2 slots supporting up to 32GB
Chipset¹	Integrated in the processor	CM238
Intel Responsiveness Technologies^{1,7}	Intel® Rapid Storage Technology	
Graphics^{1,13}	Intel® HD Graphics 620 NVIDIA® GeForce 930MX 64 Bit	Intel® HD Graphics 630 NVIDIA® GeForce 930MX 64 Bit
Display¹	14.0" HD (1366 x 768) Anti-glare (16:9) WLED, 200 nits, Carbon Fiber Reinforced Polymer LCD Back 14.0" FHD WVA (1920 x 1080) Anti-glare (16:9) WLED, 220 nits, Carbon Fiber Reinforced Polymer LCD Back 14.0" FHD WVA (1920 x 1080) On-cell Touch Display with Truelife, 220 nits, Carbon Fiber Reinforced Polymer LCD Back	
Storage Options^{1,3}	HDD: up to 1TB, Hybrid, OPAL SED options SSD M.2 2280 SATA: up to 512GB, OPAL SED options SSD M.2 2280 PCIe/NVMe: up to 512GB, OPAL SED options SSD M.2 64GB Cache (in WWAN slot) Dell Fast Response Free Fall Sensor and HDD Isolation (standard feature)	
Security¹	TPM 2.0 FIPS 140-2 Certified, TCG Certified Optional Hardware Authentication Bundle 1: FIPS 201 Contacted Smart Card with Control Vault 2.0 Advanced Authentication with FIPS 140-2 Level 3 Certification Optional Hardware Authentication Bundle 2: Touch Fingerprint Reader, FIPS 201 Contacted Smart Card, Contactless Smart Card, NFC, Control Vault 2.0 Advanced Authentication with FIPS 140-2 Level 3 Certification Optional Hardware Authentication Bundle 4: Touch Fingerprint Reader, Control Vault 2.0 Advanced Authentication with FIPS 140-2 Level 3 Certification Dell Client Command Suite Optional Dell Data Security and Management Software Dell Endpoint Security Suite Enterprise Dell Data Guardian Dell Encryption (Enterprise or Personal Edition) Dell Threat Defense Dell Protected Workspace MozyPro® or MozyEnterprise® RSA NetWitness® Endpoint ¹⁷ VMware Airwatch® ¹⁷ RSA SecurID Access ¹⁷ Absolute Data & Device Security	
Docking¹	Dell Dock WD15 (optional, sold separately) Dell Wireless Dock WLD15 (Optional, sold separately, requires optional installed Intel® Tri-Band Wireless-AC 18265 WiGig + Wi-Fi + BT4.2 ⁸) Dell Thunderbolt™ Dock TB 16 (optional, sold separately)	
Optical Drive Options	External Options Only	
Multimedia¹	High Quality Speakers Headset/mic combo jack Noise reducing array microphones Optional HD, IR or no camera Skype For Business Certified	

Battery Options¹	42 WHr Prismatic, ExpressCharge™ capable (UMA Only) 51 WHr Polymer, ExpressCharge™ capable 68 WHr Polymer, ExpressCharge™ capable 68 WHr Long Life Cycle Polymer (Spring 2017)	51 WHr Polymer, ExpressCharge™ capable (UMA Only) 68 WHr Polymer, ExpressCharge™ capable 68 WHr Long Life Cycle Polymer (Spring 2017)
Power Options¹	65W adapter, 7.4mm barrel 65W BFR/PVC Halogen Free adapter, 7.4mm barrel	65W adapter, 7.4mm barrel 65W BFR/PVC Halogen Free adapter, 7.4mm barrel 90W adapter, 7.4mm barrel
Connectivity options^{1,14,18}	10/100/1000 Ethernet Wireless LAN Options: Qualcomm QCA61x4A 802.11ac Dual Band (2x2) Wireless Adapter+ Bluetooth 4.1 Intel® Dual-Band Wireless-AC 8265 Wi-Fi + BT 4.2 Wireless Card (2x2). Bluetooth Optional Optional Mobile Broadband Options:^{8,10} Qualcomm® Snapdragon™ X7 LTE-A (DW5811e) (EMEA/APJ/ROW) Qualcomm® Snapdragon™ X7 LTE-A (DW5811e) for AT&T, Verizon & Sprint, US Qualcomm® Snapdragon™ X7 HSPA+ (DW5811e) (China/Indonesia/India) Dell Wireless™ Teliit Intel Ln-930 AP LTE CAT4 (DW5814e for Japan) Optional WiGig Option:⁸ Intel® Tri-Band Wireless-AC 18265 WiGig + Wi-Fi + BT4.1 Wireless Card	
Ports, Slots & Chassis¹	3 USB 3.1 Gen 1 (one with PowerShare), HDMI, VGA RJ-45, external uSIM card tray option SD 4.0 Memory card reader Headset/mic combo jack Optional Contacted SmartCard Reader and touch Fingerprint Reader Display Port over USB Type C™	Display Port over USB Type C™ with optional Thunderbolt™ 3
Dimensions & Weight^{1,15}	Noble Wedge Lock slot Width: 13.1" / 333.4mm Height (front): 0.9" / 22.45mm Depth: 9.0" / 228.9mm Starting weight: 3.52 lbs. / 1.60 kg	Width: 13.1" / 333.4mm Height (front): 0.9" / 22.45mm Depth: 9.0" / 228.9mm Starting weight: 3.63 lbs. / 1.65 kg
Regulatory and Environmental Compliance¹	(42Whr battery, M.2 SSD, non touch FHD LCD, UMA) Regulatory Model: P72G Regulatory Type: P72G001 ENERGY STAR 6.1 ¹ EPEAT Gold Registered. For specific country participation and rating, please see www.epeat.net BFR/PVC free ⁹ TAA configurations available	(51Whr battery, M.2 SSD, non touch, FHD LCD, UMA)
Input¹	Single Pointing non-backlit Keyboard Dual Pointing backlit Keyboard Multi-touch Touchpad	
Systems Management¹	Intel® vPro™ Technology (iAMT 11.6) (optional, requires Intel WiFi® Link WLAN and a vPro compatible processor), Dell Client Command Suite available (dell.com/command), Factory Installed Dell Client Command Update, Dell Command Power Manager	
Warranty and Service¹	Limited Hardware Warranty ⁴ Standard 1 year Mail-in Service after Remote Diagnosis ¹¹ optional 2, 3, 4 and 5 year hardware warranty extensions and 3-5 year Dell ProSupport contracts available ¹²	
Peripheral Ecosystem¹	Purpose built ecosystem to enable productivity on the go or at the desk. Includes Dell Dock, Dell Wireless Dock, Dell Power Companions, Dell Professional Briefcases, Dell 24" & 27" Monitors and Dell Wireless Keyboard and Mouse	

Features & Technical Specifications

	KabyLake 15 U	KabyLake 15 H
Model Number¹	Latitude 5580	
Processor Options¹	7th Gen Intel® Core Processors up to i7, U Dual Core	7th Gen Intel® Core Processors up to i7, H Quad Core
Operating System¹	Microsoft® Windows 10 Pro 64 bit Microsoft® Windows 10 Home 64 bit Ubuntu 16.04 LTS 64-bit NeoKylin 6.0 64 bit	
Memory Options^{1,2,3}	DDR4 2133 MHz; 2 slots supporting up to 32GB	DDR4 2400 MHz; 2 slots supporting up to 32GB
Chipset¹	Integrated with the processor	CM238
Intel Responsiveness Technologies^{1,7}	Intel® Rapid Storage Technology	
Graphics^{1,13}	Intel® HD Graphics 620 NVIDIA® GeForce 930MX 64 Bit	Intel® HD Graphics 630 NVIDIA® GeForce 930MX 64 Bit
Display¹	15.6" HD (1366 x 768) Anti-glare (16:9) WLED, 200 nits, Carbon Fiber Reinforced Polymer LCD Back 15.6" FHD WVA (1920 x 1080) Anti-glare (16:9) WLED, 220 nits, Carbon Fiber Reinforced Polymer LCD Back 15.6" FHD WVA (1920 x 1080) On-cell Touch Display with Truelife, 220 nits, Carbon Fiber Reinforced Polymer LCD Back	
Storage Options^{1,3}	HDD: up to 1TB, Hybrid, OPAL SED options SSD M.2 2280 SATA: up to 512GB, OPAL SED options SSD M.2 2280 PCIe/NVMe: up to 512GB, OPAL SED options SSD M.2 64GB Cache (in WWAN slot) Dell Fast Response Free Fall Sensor and HDD Isolation (standard feature)	
Security¹	TPM 2.0 FIPS 140-2 Certified, TCG Certified Optional Hardware Authentication Bundle 1: FIPS 201 Contacted Smart Card with Control Vault 2.0 Advanced Authentication with FIPS 140-2 Level 3 Certification Optional Hardware Authentication Bundle 2: Touch Fingerprint Reader, FIPS 201 Contacted Smart Card, Contactless Smart Card, NFC, Control Vault 2.0 Advanced Authentication with FIPS 140-2 Level 3 Certification Optional Hardware Authentication Bundle 3: Touch FIPS 201 Fingerprint Reader, FIPS 201 Contacted Smart Card, Contactless Smart Card, NFC, Control Vault 2.0 Advanced Authentication with FIPS 140-2 Level 3 Certification (15" only) Dell Client Command Suite Optional Dell Data Security and Management Software Dell Endpoint Security Suite Enterprise Dell Data Guardian Dell Encryption (Enterprise or Personal Edition) Dell Threat Defense Dell Protected Workspace MozyPro® or MozyEnterprise® RSA NetWitness® Endpoint ¹⁷ VMware Airwatch® ¹⁷ RSA SecurID Access ¹⁷ Absolute Data & Device Security	
Docking¹	Dell Dock WD15 (optional, sold separately) Dell Wireless Dock WLD15 (Optional, sold separately, requires optional installed Intel® Tri-Band Wireless-AC 18265 WiGig + Wi-Fi + BT4.2 ⁸) Dell Thunderbolt™ Dock TB 16 (optional, sold separately)	
Optical Drive Options	External Options Only	
Multimedia¹	High Quality Speakers Headset/mic combo jack Noise reducing array microphones Optional HD, IR or no camera Skype For Business Certified	

Battery Options¹	42 WHr Prismatic, ExpressCharge™ capable (UMA Only) 51 WHr Polymer, ExpressCharge™ capable 68 WHr Polymer, ExpressCharge™ capable 68 WHr Long Life Cycle Polymer (Spring 2017)	51 WHr Polymer, ExpressCharge™ capable (UMA only) 68 WHr Polymer, ExpressCharge™ capable 68 WHr Long Life Cycle Polymer (Spring 2017) 92 WHr Polymer, ExpressCharge™ capable
Power Options¹	65W adapter, 7.4mm barrel 65W BFR/PVC Halogen Free adapter, 7.4mm barrel	65W adapter, 7.4mm barrel 65W BFR/PVC Halogen Free adapter, 7.4mm barrel 90W adapter, 7.4mm barrel
Connectivity options^{1,14,18}	10/100/1000 Ethernet Wireless LAN Options: Qualcomm QCA61x4A 802.11ac Dual Band (2x2) Wireless Adapter+ Bluetooth 4.1 Intel® Dual-Band Wireless-AC 8265 Wi-Fi + BT 4.2 Wireless Card (2x2). Bluetooth Optional Optional Mobile Broadband Options:^{8,10} Qualcomm® Snapdragon™ X7 LTE-A (DW5811e) (EMEA/APJ/ROW) Qualcomm® Snapdragon™ X7 LTE-A (DW5811e) for AT&T, Verizon & Sprint, US Qualcomm® Snapdragon™ X7 HSPA+ (DW5811e) (China/Indonesia/India) Dell Wireless™ Telit Intel Ln-930 AP LTE CAT4 (DW5814e for Japan) Optional WiGig Option:⁸ Intel® Tri-Band Wireless-AC 18265 WiGig + Wi-Fi + BT4.1 Wireless Card	
Ports, Slots & Chassis¹	3 USB 3.1 Gen 1 (one with PowerShare), HDMI, VGA RJ-45, external uSIM card tray option SD 4.0 Memory card reader Headset/mic combo jack Optional Contacted SmartCard Reader and touch Fingerprint Reader Display Port over USB Type C™	Display Port over USB Type C™ with optional Thunderbolt™ 3
Dimensions & Weight^{1,15}	Noble Wedge Lock slot Width: 14.8" / 376.0mm Height (front): 0.9" / 23.25mm Depth: 9.9" / 250.7mm Starting weight: 4.14 lbs. / 1.88 kg	Width: 14.8" / 376.0mm Height (front): 1.0" / 24.3mm Depth: 9.9" / 250.7mm Starting weight: 4.27 lbs. / 1.94 kg
Regulatory and Environmental Compliance¹	(42Whr battery, M.2 SSD, non touch FHD LCD, UMA) Regulatory Model: P60F Regulatory Type: P60F001 ENERGY STAR 6.1 ¹ EPEAT Gold Registered. For specific country participation and rating, please see www.epeat.net BFR/PVC free ⁹ TAA configurations available	(51Whr battery, M.2 SSD, non touch, FHD LCD, UMA)
Input¹	Dual Pointing non-backlit Keyboard Dual Pointing backlit Keyboard Multi-touch Touchpad	
Systems Management¹	Intel® vPro™ Technology (iAMT 11.6) (optional, requires Intel WiFi® Link WLAN and a vPro compatible processor), Dell Client Command Suite available (dell.com/command), Factory Installed Dell Client Command Update, Dell Command Power Manager	
Warranty and Service¹	Limited Hardware Warranty ⁴ Standard 1 year Mail-in Service after Remote Diagnosis ¹¹ optional 2, 3, 4 and 5 year hardware warranty extensions and 3-5 year Dell ProSupport contracts available ¹²	
Peripheral Ecosystem¹	Purpose built ecosystem to enable productivity on the go or at the desk. Includes Dell Dock, Dell Wireless Dock, Dell Power Companions, Dell Professional Briefcases, Dell 24" & 27" Monitors and Dell Wireless Keyboard and Mouse	

Features & Technical Specifications

	Skylake 14 U	Skylake14 H
Model Number¹	Latitude 5480	
Processor Options¹	6th Gen Intel® Core i5 and i7 Processors, U Dual Core	6th Gen intel® Core i5 Processors, H Quad Core
Operating System¹	Microsoft® Windows 10 Pro 64 bit Microsoft® Windows 10 Home 64 bit Microsoft® Windows® 7 Professional 32/64 bit, (available through downgrade rights from Windows® 10 Pro License) Microsoft® Windows® 8.1 Professional 64 bit, (available through downgrade rights from Windows® 10 Pro License only through Dell Configuration Services)	
Memory Options^{1,2,3}	DDR4 2133 MHz; 2 slots supporting up to 32GB	DDR4 2400 MHz; 2 slots supporting up to 32GB
Chipset¹	Integrated with the Processor	CM236
Intel Responsiveness Technologies^{1,7}	Intel® Rapid Storage Technology	
Graphics^{1,13}	Intel® HD Graphics 520 NVIDIA® GeForce 930MX 64 Bit	Intel® HD Graphics 530 NVIDIA® GeForce 930MX 64 Bit
Display¹	14.0" HD (1366 x 768) Anti-glare (16:9) WLED, 200 nits, Carbon Fiber Reinforced Polymer LCD Back 14.0" FHD WVA (1920 x 1080) Anti-glare (16:9) WLED, 220 nits, Carbon Fiber Reinforced Polymer LCD Back 14.0" FHD WVA (1920 x 1080) On-cell Touch Display with Truelife, 220 nits, Carbon Fiber Reinforced Polymer LCD Back	
Storage Options^{1,3}	HDD: up to 1TB, Hybrid, OPAL SED options SSD M.2 2280 SATA: up to 512GB, OPAL SED options SSD M.2 2280 PCIe/NVMe: up to 512GB, OPAL SED options SSD M.2 64GB Cache (in WWAN slot) Dell Fast Response Free Fall Sensor and HDD Isolation (standard feature)	
Security¹	TPM 2.0 FIPS 140-2 Certified, TCG Certified Optional Hardware Authentication Bundle 1: FIPS 201 Contacted Smart Card with Control Vault 2.0 Advanced Authentication with FIPS 140-2 Level 3 Certification Optional Hardware Authentication Bundle 2: Touch Fingerprint Reader, FIPS 201 Contacted Smart Card, Contactless Smart Card, NFC, Control Vault 2.0 Advanced Authentication with FIPS 140-2 Level 3 Certification Optional Hardware Authentication Bundle 4: Touch Fingerprint Reader, Control Vault 2.0 Advanced Authentication with FIPS 140-2 Level 3 Certification Dell Client Command Suite Optional Dell Data Security and Management Software Dell Endpoint Security Suite Enterprise Dell Data Guardian Dell Encryption (Enterprise or Personal Edition) Dell Threat Defense Dell Protected Workspace MozyPro® or MozyEnterprise® RSA NetWitness® Endpoint ¹⁷ VMware Airwatch® ¹⁷ RSA SecurID Access ¹⁷ Absolute Data & Device Security	
Docking¹	Dell Dock WD15 (optional, sold separately) Dell Wireless Dock WLD15 (Optional, sold separately, requires optional installed Intel® Tri-Band Wireless-AC 18265 WiGig + Wi-Fi + BT4.2 ⁸) Dell Thunderbolt™ Dock TB 16 (optional, sold separately)	
Optical Drive Options	External Options Only	

Multimedia¹	High Quality Speakers Headset/mic combo jack Noise reducing array microphones Optional HD, IR or no camera Skype For Business Certified	
Battery Options¹	42 WHr Prismatic, ExpressCharge™ capable (UMA Only) 51 WHr Polymer, ExpressCharge™ capable 68 WHr Polymer, ExpressCharge™ capable 68 WHr Long Life Cycle Polymer (Spring 2017)	51 WHr Polymer, ExpressCharge™ capable (UMA Only) 68 WHr Polymer, ExpressCharge™ capable 68 WHr Long Life Cycle Polymer (Spring 2017)
Power Options¹	65W adapter, 7.4mm barrel 65W BFR/PVC Halogen Free adapter, 7.4mm barrel	65W adapter, 7.4mm barrel 65W BFR/PVC Halogen Free adapter, 7.4mm barrel 90W adapter, 7.4mm barrel
Connectivity options^{1,14,18}	10/100/1000 Ethernet Wireless LAN Options: Qualcomm QCA61x4A 802.11ac Dual Band (2x2) Wireless Adapter+ Bluetooth 4.1 Intel® Dual-Band Wireless-AC 8265 Wi-Fi + BT 4.2 Wireless Card (2x2). Bluetooth Optional Optional Mobile Broadband Options:^{8,10} Qualcomm® Snapdragon™ X7 LTE-A (DW5811e) (EMEA/APJ/ROW) Qualcomm® Snapdragon™ X7 LTE-A (DW5811e) for AT&T, Verizon & Sprint, US Qualcomm® Snapdragon™ X7 HSPA+ (DW5811e) (China/Indonesia/India) Dell Wireless™ Telit Intel Ln-930 AP LTE CAT4 (DW5814e for Japan) Optional WiGig Option:⁸ Intel® Tri-Band Wireless-AC 18265 WiGig + Wi-Fi + BT4.1 Wireless Card	
Ports, Slots & Chassis¹	3 USB 3.1 Gen 1 (one with PowerShare), HDMI, VGA RJ-45, external uSIM card tray option SD 4.0 Memory card reader Headset/mic combo jack Optional Contacted SmartCard Reader and touch Fingerprint Reader Display Port over USB Type C™	Display Port over USB Type C™ with optional Thunderbolt™ 3
Dimensions & Weight^{1,15}	Noble Wedge Lock slot Width: 13.1" / 333.4mm Height (front): 0.9" / 22.45mm Depth: 9.0" / 228.9mm Starting weight: 3.52 lbs. / 1.60 kg	Width: 13.1" / 333.4mm Height (front): 0.9" / 22.45mm Depth: 9.0" / 228.9mm Starting weight: 3.63 lbs. / 1.65 kg
Regulatory and Environmental Compliance¹	(42Whr battery, M.2 SSD, non touch FHD LCD, UMA) Regulatory Model: P72G Regulatory Type: P72G001 ENERGY STAR 6.1 ¹ EPEAT Gold Registered. For specific country participation and rating, please see www.epeat.net BFR/PVC free ⁹ TAA configurations available	(51Whr battery, M.2 SSD, non touch, FHD LCD, UMA)
Input¹	Single Pointing non-backlit Keyboard Dual Pointing backlit Keyboard Multi-touch Touchpad	
Systems Management¹	Intel® vPro™ Technology (iAMT 11.6) (optional, requires Intel WiFi® Link WLAN and a vPro compatible processor), Dell Client Command Suite available (dell.com/command), Factory Installed Dell Client Command Update, Dell Command Power Manager	
Warranty and Service¹	Limited Hardware Warranty ⁴ Standard 1 year Mail-in Service after Remote Diagnosis ¹¹ optional 2, 3, 4 and 5 year hardware warranty extensions and 3-5 year Dell ProSupport contracts available ¹²	
Peripheral Ecosystem¹	Purpose built ecosystem to enable productivity on the go or at the desk. Includes Dell Dock, Dell Wireless Dock, Dell Power Companions, Dell Professional Briefcases, Dell 24" & 27" Monitors and Dell Wireless Keyboard and Mouse	

Features & Technical Specifications

	Skylake 15 U	Skylake15 H
Model Number¹	Latitude 5580	
Processor Options¹	6th Gen Intel® Core i5 Processors, U Dual Core	6th Gen intel® Core i5 Processors, H Quad Core
Operating System¹	Microsoft® Windows 10 Pro 64 bit Microsoft® Windows 10 Home 64 bit Microsoft® Windows® 7 Professional 32/64 bit, (available through downgrade rights from Windows® 10 Pro License) Microsoft® Windows® 8.1 Professional 64 bit, (available through downgrade rights from Windows® 10 Pro License only through Dell Configuration Services) Ubuntu 16.04 LTS 64-bit NeoKylin 6.0 64 bit	
Memory Options^{1,2,3}	DDR4 2133 MHz; 2 slots supporting up to 32GB	DDR4 2400 MHz; 2 slots supporting up to 32GB
Chipset¹	Integrated in the processor	CM236
Intel Responsiveness Technologies^{1,7}	Intel® Rapid Storage Technology	
Graphics^{1,13}	Intel® HD Graphics 520 NVIDIA® GeForce 930MX 64 Bit	Intel® HD Graphics 530 NVIDIA® GeForce 940MX 64 Bit
Display¹	15.6" HD (1366 x 768) Anti-glare (16:9) WLED, 200 nits, Carbon Fiber Reinforced Polymer LCD Back 15.6" FHD WVA (1920 x 1080) Anti-glare (16:9) WLED, 220 nits, Carbon Fiber Reinforced Polymer LCD Back 15.6" FHD WVA (1920 x 1080) On-cell Touch Display with Truelife, 220 nits, Carbon Fiber Reinforced Polymer LCD Back	
Storage Options^{1,3}	HDD: up to 1TB, Hybrid, OPAL SED options SSD M.2 2280 SATA: up to 512GB, OPAL SED options SSD M.2 2280 PCIe/NVMe: up to 512GB, OPAL SED options SSD M.2 64GB Cache (in WWAN slot) Dell Fast Response Free Fall Sensor and HDD Isolation (standard feature)	
Security¹	TPM 2.0 FIPS 140-2 Certified, TCG Certified Optional Hardware Authentication Bundle 1: FIPS 201 Contacted Smart Card with Control Vault 2.0 Advanced Authentication with FIPS 140-2 Level 3 Certification Optional Hardware Authentication Bundle 2: Touch Fingerprint Reader, FIPS 201 Contacted Smart Card, Contactless Smart Card, NFC, Control Vault 2.0 Advanced Authentication with FIPS 140-2 Level 3 Certification Optional Hardware Authentication Bundle 3: Touch FIPS 201 Fingerprint Reader, FIPS 201 Contacted Smart Card, Contactless Smart Card, NFC, Control Vault 2.0 Advanced Authentication with FIPS 140-2 Level 3 Certification (15" only) Dell Client Command Suite Optional Dell Data Security and Management Software Dell Endpoint Security Suite Enterprise Dell Data Guardian Dell Encryption (Enterprise or Personal Edition) Dell Threat Defense Dell Protected Workspace MozyPro® or MozyEnterprise® RSA NetWitness® Endpoint ¹⁷ VMware Airwatch® ¹⁷ RSA SecurID Access ¹⁷ Absolute Data & Device Security	
Docking¹	Dell Dock WD15 (optional, sold separately) Dell Wireless Dock WLD15 (Optional, sold separately, requires optional installed Intel® Tri-Band Wireless-AC 18265 WiGig + Wi-Fi + BT4.2 ⁸) Dell Thunderbolt™ Dock TB 16 (optional, sold separately)	
Optical Drive Options	External Options Only	

Multimedia¹	High Quality Speakers Headset/mic combo jack Noise reducing array microphones Optional HD, IR or no camera Skype For Business Certified	
Battery Options¹	42 WHr Prismatic, ExpressCharge™ capable (UMA Only) 51 WHr Polymer, ExpressCharge™ capable 68 WHr Polymer, ExpressCharge™ capable 68 WHr Long Life Cycle Polymer (Spring 2017)	51 WHr Polymer, ExpressCharge™ capable (UMA only) 68 WHr Polymer, ExpressCharge™ capable 68 WHr Long Life Cycle Polymer (Spring 2017) 92 WHr Polymer, ExpressCharge™ capable
Power Options¹	65W adapter, 7.4mm barrel 65W BFR/PVC Halogen Free adapter, 7.4mm barrel	65W adapter, 7.4mm barrel 65W BFR/PVC Halogen Free adapter, 7.4mm barrel 90W adapter, 7.4mm barrel
Connectivity options^{1,14,18}	10/100/1000 Ethernet Wireless LAN Options: Qualcomm QCA61x4A 802.11ac Dual Band (2x2) Wireless Adapter+ Bluetooth 4.1 Intel® Dual-Band Wireless-AC 8265 Wi-Fi + BT 4.2 Wireless Card (2x2). Bluetooth Optional Optional Mobile Broadband Options:^{8,10} Qualcomm® Snapdragon™ X7 LTE-A (DW5811e) (EMEA/APJ/ROW) Qualcomm® Snapdragon™ X7 LTE-A (DW5811e) for AT&T, Verizon & Sprint, US Qualcomm® Snapdragon™ X7 HSPA+ (DW5811e) (China/Indonesia/India) Dell Wireless™ Telit Intel Ln-930 AP LTE CAT4 (DW5814e for Japan) Optional WiGig Option:⁸ Intel® Tri-Band Wireless-AC 18265 WiGig + Wi-Fi + BT4.1 Wireless Card	
Ports, Slots & Chassis¹	3 USB 3.1 Gen 1 (one with PowerShare), HDMI, VGA RJ-45, external uSIM card tray option SD 4.0 Memory card reader Headset/mic combo jack Optional Contacted SmartCard Reader and touch Fingerprint Reader Display Port over USB Type C™	Display Port over USB Type C™ with optional Thunderbolt™ 3
Dimensions & Weight^{1,15}	Noble Wedge Lock slot Width: 14.8" / 376.0mm Height (front): 0.9" / 23.25mm Depth: 9.9" / 250.7mm Starting weight: 4.14 lbs. / 1.88 kg	Width: 14.8" / 376.0mm Height (front): 1.0" / 24.3mm Depth: 9.9" / 250.7mm Starting weight: 4.27 lbs. / 1.94 kg
Regulatory and Environmental Compliance¹	(42Whr battery, M.2 SSD, non touch FHD LCD, UMA) Regulatory Model: P60F Regulatory Type: P60F001 ENERGY STAR 6.1 ¹ EPEAT Gold Registered. For specific country participation and rating, please see www.epeat.net BFR/PVC free ⁹ TAA configurations available	(51Whr battery, M.2 SSD, non touch, FHD LCD, UMA)
Input¹	Dual Pointing non-backlit Keyboard Dual Pointing backlit Keyboard Multi-touch Touchpad	
Systems Management¹	Intel® vPro™ Technology (iAMT 11.6) (optional, requires Intel WiFi® Link WLAN and a vPro compatible processor), Dell Client Command Suite available (dell.com/command), Factory Installed Dell Client Command Update, Dell Command Power Manager	
Warranty and Service¹	Limited Hardware Warranty ⁴ Standard 1 year Mail-in Service after Remote Diagnosis ¹¹ optional 2, 3, 4 and 5 year hardware warranty extensions and 3-5 year Dell ProSupport contracts available ¹²	
Peripheral Ecosystem¹	Purpose built ecosystem to enable productivity on the go or at the desk. Includes Dell Dock, Dell Wireless Dock, Dell Power Companions, Dell Professional Briefcases, Dell 24" & 27" Monitors and Dell Wireless Keyboard and Mouse	

¹ Offering may vary by country and by configuration

² A 64-bit operating system is required to support 4GB or more of system memory.

³ GB means 1 billion bytes and TB equals 1 trillion bytes; actual capacity varies with preloaded material and operating environment and will be less.

⁴ Limited Hardware Warranty: For copy of Limited Hardware Warranty, write Dell USA LP, Attn: Warranties, One Dell Way, Round Rock, TX 78682 or see www.dell.com/warranty

⁵ Battery support is dependent upon graphics support. Check technical guides for detailed support

⁶ COMPUTRACE Not a Dell offer. Certain conditions apply. For full details, see terms and conditions at www.absolute.com/en/about/legal/agreements.

⁷ Intel Rapid Storage Technology requires a HDD, mSATA, or an SSD, as primary storage device and Windows OS required

⁸ Wireless antenna available only at time of system purchase

⁹ Dell Latitude 5000 Series are brominated flame retardant free (BFR-free) and polyvinyl chloride free (PVC-free); meeting the definition of BFR-/PVC free as set forth in the iNEMI Position Statement on the 'Definition of Low-Halogen Electronics (BFR-/CFR-/PVC-free)'. Plastic parts contain less than 1,000 ppm (0.1%) of bromine (if the Br source is from BFRs) and less than 1,000 ppm (0.1%) of chlorine (if the Cl source is from CFRs or PVC or PVC copolymers). All printed circuit board (PCB) and substrate laminates contain bromine/chlorine total less than 1,500 ppm (0.15%) with a maximum chlorine of 900 ppm (0.09%) and maximum bromine being 900 ppm (0.09%).

¹⁰ Mobile Broadband Subject to service provider's broadband subscription and coverage area; additional charges apply.

¹¹ Onsite Service after Remote Diagnosis: Remote Diagnosis is determination by online/phone technician of cause of issue; may involve customer access to inside of system and multiple or extended sessions. If issue is covered by Limited Hardware Warranty (www.dell.com/warranty) and not resolved remotely, technician and/or part will be dispatched, usually within 1 business day following completion of Remote Diagnosis. Availability varies. Other conditions apply.

¹² Dell Services: Availability and terms of Dell Services vary by region. For more information, visit www.dell.com/servicedescriptions.

¹³ GB means 1 billion bytes and TB equals 1 trillion bytes; significant system memory may be used to support graphics, depending on system memory size and other factors.

¹⁴ Miracast Wireless Technology: Requires a compatible media adapter (sold separately) and an HDMI-enabled display.

¹⁵ Weights vary depending on configuration and manufacturing variability.

¹⁶ Intel 7th Gen Core 15W (U) CPUs support 2133MHz memory, Intel 7th Gen Core 35W (H) supports 2400MHz Memory

¹⁷ US only. WW availability in 2017

¹⁸ Intel 8265ac / 18265ac card support BT4.2 but is limited to BT4.1 by Windows OS

Essential Accessories



LATITUDE 5000 SERIES LAPTOPS 5280 | 5480 | 5580

At The Desk



Dell Dock – WD15 IE



Dell Wireless Keyboard and Mouse | KM636



Dell 24 Monitor | P2417H

On-The-Go



Dell Adapter – USB-C to DisplayPort
Dell Premier Slim Backpack 14.



Dell Professional Backpack 15



Dell Portable Power Companion (18000 mAh)
- PW7015L



Work how you want with the world's most secure convertible laptop

LATITUDE 5289 2-in-1



Multiple work modes

Seamlessly transition between multiple work modes including laptop, tablet, stand and tent modes.

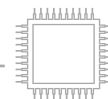

Mobile performance

With the latest 7th Generation Intel® Core i processors, PCIe NVMe flash storage.



Writing is natural again

Enjoy a natural writing experience with the optional active pen using Wacom technology for an natural writing experience.



Security at its best

Features may include varying biometric and card readers, NFC with Control Vault 2™ and FIPS 140-2 Level 3 certification.

Features & Technical Specifications

Model Number	Latitude 5289 2-in-1
Processor Options¹	7th Generation Intel® Core™ i3-7100U Processor (up to 2.4GHz, 3M cache, 15W) 7th Generation Intel® Core™ i5-7200U Processor (up to 3.1GHz, 3M cache, 15W) 7th Generation Intel® Core™ i5-7300U Processor (up to 3.5GHz, 3M cache, 15W), vPro 7th Generation Intel® Core™ i7-7600U Processor (up to 3.9GHz, 4M cache, 15W), vPro
Operating System¹	Microsoft® Windows 10 Pro 64 Microsoft® Windows 10 Home 64 bit
Memory Options^{1,2,3}	LPDDR3 SDRAM 1866MHz; Up to 16GB (on board)
Chipset¹	Integrated with the Processor
Intel Responsiveness Technologies^{1,7}	Intel® Rapid Storage Technology
Graphics^{1,13}	Intel® Integrated HD Graphics 620
Display¹	12.5" 16:9 1920x1080 Touch with Corning® Gorilla Glass® 4, Active Pen Support, Anti-reflective and Anti-Smudge, 255 nits
Storage¹	M.2 Up to 360GB SATA Solid State Drive M.2 Up to 1TB PCIe NVMe Solid State Drive M.2 Up to 512 GB PCIe NVMe Self Encrypting Solid State Drive M.2 Up to 256GB Secondary PCIe Solid State Drive (in WWAN slot)
Security¹	TPM 2.0 FIPS 140-2 Certified, TCG Certified Optional Hardware Authentication Bundle 1: Contacted Smart Card, Control Vault 2.0 Advanced Authentication with FIPS 140-2 Level 3 Certification Optional Hardware Authentication Bundle 2: Touch Fingerprint Reader, FIPS 201 Contacted Smart Card, Contactless Smart Card/NFC5, Control Vault 2.0 Advanced Authentication with FIPS 140-2 Level 3 Certification Optional Face IR camera (Windows Hello compliant) Dell Client Command Suite Optional Dell Data Security and Management Software Dell Endpoint Security Suite Enterprise Dell Data Guardian Dell Threat Defense Dell Protected Workspace Dell Data Protection Secure Lifecycle MozyPro®, or MozyEnterprise® RSA NetWitness® Endpoint VMware Airwatch® Absolute Data & Device Security RSA SecurID Access
Docking¹	Dell Dock - WD15 (optional, sold separately) Dell Dock with Monitor Stand - DS1000 (optional, sold separately) Dell Wireless Dock WLD15 (Optional, sold separately, requires optional installed Intel® Tri-Band Wireless-AC 18265 WiGig + Wi-Fi + BT4.2 ⁸)
Optical Drive Options	External Options Only
Multimedia¹	Microsoft Skype for Business Certified HD 6.5 mm RGB Integrated Camera (User-Facing fixed focus) with LED Stereo Speaker with MaxxAudio Pro 4 x Noise reducing integrated array microphones Headset/Mic combo jack

Battery Options¹	45 WHr ⁶ Polymer, ExpressCharge™ capable 60 WHr ⁶ Polymer, ExpressCharge™ capable 60 WHr ⁶ Polymer Long Life Cycle (Summer 2017)
Power Options¹	45W adapter, USB Type-C (3' AC/6' DC) 65W adapter, USB Type-C (3' AC/6' DC) 90W adapter, USB Type-C (3' AC/6' DC)
Connectivity Options^{1,14}	Microsoft Modern Standby compliant WiFi Display (Miracast) ¹⁴ Wireless LAN Options⁸: Qualcomm QCA61x4A 802.11ac Dual Band (2x2) Wireless Adapter+ Bluetooth 4.1 Intel® Dual-Band Wireless-AC 8265 Wi-Fi + BT 4.2 Wireless Card (2x2). Bluetooth Optional Optional Mobile Broadband Options^{8,10} Qualcomm® Snapdragon™ X7 LTE-A (DW5811e) for AT&T, Verizon & Sprint (US) Qualcomm® Snapdragon™ X7 LTE-A (DW5811e) (EMEA/APJ/ROW) Qualcomm® Snapdragon™ X7 HSPA+ (DW5811e) (China/Indonesia/India) Qualcomm Snapdragon X7 LTE-A (DW5816e for APJ) - Summer 2017 Optional WiGig Option⁸ Intel® Tri-Band Wireless-AC 18265 WiGig + Wi-Fi + BT4.2 Wireless Card
Ports, Slots & Chassis¹	2 x USB 3.1 Gen 1 (with Power Share) 2 x Display Port over USB Type-C™ HDMI 1.4 uSIM card slot (WWAN only) uSD 4.0 Memory card reader Noble Wedge Lock slot Power Button Volume Up/Down Rocker
Keyboard	ISO/GS compliant, Backlit, Single Pointing, Dual-Button Touchpad with 1.65 mm key travel
Pen	Dell Active Pen PN557W (optional, sold separately)
Dimensions & Weight^{1,15}	Width: 12" / 304.8mm Height: 0.47"- 0.73" / 12.03-18.45mm (Front to Back) Depth 8.26" / 210mm Starting weight: 2.97lb / 1.34kg (with 45Whr 3-cell Battery)
Regulatory and Environmental Compliance¹	Regulatory Model: T02H Regulatory Type: T02H001 ENERGY STAR 6.11 EPEAT Gold Registered. For specific country participation and rating, please see www.epeat.net Hg-Free/Arsenic-Free BFR/PVC free (not including PSU) ⁹ TAA compliant
Input¹	10-Finger Touch Display Integrated Array Microphones (4) Headset/Mic combo jack Integrated ISO Keyboard Active Pen PN557W (Optional, sold separately)
Sensors	Gyroscope, eCompass/Magnetometer, Accelerometer/FFS, GPS (via WWAN Card only), Ambient Light Sensor
Systems Management¹	Intel® vPro™ (AMT 11.0) Technology's advanced management features (optional, requires Intel WiFi® Link WLAN and a vPro compatible processor), Dell Client Command Suite available (dell.com/command), Factory Installed Dell Client Command Update, Factory Installed Dell Command Power Manager

Warranty and Service¹

Limited Hardware Warranty⁴, Standard 1 year Mail-in Service after Remote Diagnosis¹¹, optional 3, 4 and 5 year hardware warranty extensions and 3-5 year Dell ProSupport contracts available¹²

Peripheral Ecosystem¹

Powerful accessories designed and tested for Latitude 5289 2-in-1 enable seamless productivity for Corridor Warriors and On-the-Go Professionals, wherever work takes them. Includes Dell Active Pen (PN557W), Dell Hybrid Adapter + Power Bank - USB-C, Dell Adapter – USB-C to HDMI/VGA/ Ethernet/USB 3.1 Gen 1 - DA200, Dell Wireless Keyboard and Mouse - KM636, Dell Premier Slim Backpack 14 and Dell Premier Slim Briefcase 14, Dell Pro Stereo Wireless Headset (Skype for Business) UC650 (summer 2017)

¹ Offering may vary by country and by configuration

² A 64-bit operating system is required to support 4GB or more of system memory.

³ GB means 1 billion bytes and TB equals 1 trillion bytes; actual capacity varies with preloaded material and operating environment and will be less.

⁴ Limited Hardware Warranty: For copy of Limited Hardware Warranty, write Dell USA LP, Attn: Warranties, One Dell Way, Round Rock, TX 78682 or see www.dell.com/warranty

⁵ Tap to Pay will not be supported. Tap to Login is only supported with USH SKU

⁶ The stated Watt Hour (WWhr) is not an indication of battery life

⁷ Intel Rapid Storage Technology requires a HDD, mSATA or an SSD, as primary storage device. See OS requirements

⁸ Wireless antenna and module available only at time of system purchase; Intel 8265ac / 18265ac card support BT4.2 but is limited to BT4.1 by Windows OS

⁹ Dell Latitude 5000 Series 2-in-1 are brominated flame retardant free (BFR-free) and polyvinyl chloride free (PVC-free); meeting the definition of BFR-PVC-free as set forth in the iNEMI Position Statement on the 'Definition of Low-Halogen Electronics (BFR-/CFR-/PVC-free)'. Plastic parts contain less than 1,000 ppm (0.1%) of bromine (if the Br source is from BFRs) and less than 1,000 ppm (0.1%) of chlorine (if the Cl source is from CFRs or PVC or PVC copolymers). All printed circuit board (PCB) and substrate laminates contain bromine/chlorine total less than 1,500 ppm (0.15%) with a maximum chlorine of 900 ppm (0.09%) and maximum bromine being 900 ppm (0.09%).

¹⁰ Mobile Broadband Subject to service provider's broadband subscription and coverage area; additional charges apply.

¹¹ Onsite Service after Remote Diagnosis: Remote Diagnosis is determination by online/phone technician of cause of issue; may involve customer access to inside of system and multiple or extended sessions. If issue is covered by Limited Hardware Warranty (www.dell.com/warranty) and not resolved remotely, technician and/or part will be dispatched, usually within 1 business day following completion of Remote Diagnosis. Availability varies. Other conditions apply.

¹² Dell Services: Availability and terms of Dell Services vary by region. For more information, visit www.dell.com/servicesdescriptions.

¹³ GB means 1 billion bytes and TB equals 1 trillion bytes; significant system memory may be used to support graphics, depending on system memory size and other factors.

¹⁴ Miracast Wireless Technology: Requires a compatible media adapter (sold separately) and an HDMI-enabled display.

¹⁵ Weights vary depending on configuration and manufacturing variability.

Essential Accessories

LATITUDE 5289 2-in-1

Purpose built and powerful accessories **designed** and **tested** for Latitude enables seamless productivity for Corridor Warriors and On-the-Go Professionals, wherever work takes them.

At The Desk



Dell Dock – WD15



Dell Wireless Keyboard
and Mouse - KM636



Dell UltraSharp 24
InfinityEdge Monitor –
U2417H

On-The-Go



Dell Active Pen –
PN557W



Dell Premier Slim
Backpack 14



Dell Hybrid Adapter +
Power Bank - PH45W17-CA



Havis Docking Station for Dell Latitude Rugged Extreme

DS-DELL-400 Series

The Havis Docking Station for the Dell Latitude 14 Rugged and Latitude 12 & 14 Rugged Extreme Notebooks brings you the best computing solution for all your business needs. The DS-DELL-400 Series Docking Station offers computer charging, security, and connection to peripherals in medical, enterprise, and in-vehicle workplaces. Maximize your productivity with this rugged yet lightweight dock, which has been built with theft deterrence, longevity and stability in mind.



- Adjustable to secure the Latitude 14 Rugged notebook, Latitude 12 Rugged Extreme convertible notebook, and the Latitude 14 Rugged Extreme notebook.
- Constant connectivity is maintained with a guided, floating docking connector.
- Docking station was engineered with fully functional front- and rear-facing connectors.
- Mounting bracket and integrated cable strain relief allows for ease of installation and faster rollouts.
- Theft deterrence is accomplished through Havis' rugged locking system and front hooks, which keep your Latitude Rugged Extreme Notebook safe and secure.
- Strain relief for connectors prevents loose connections and accidental disconnects.
- Scalable connectivity provides a flexible solution.
- Havis offers a full line of accessories to complete any solution.



Havis Docking Station for Dell Latitude Rugged Extreme



Front- and rear-facing port replication protects cable connections while integrated strain relief protects from accidental disconnects

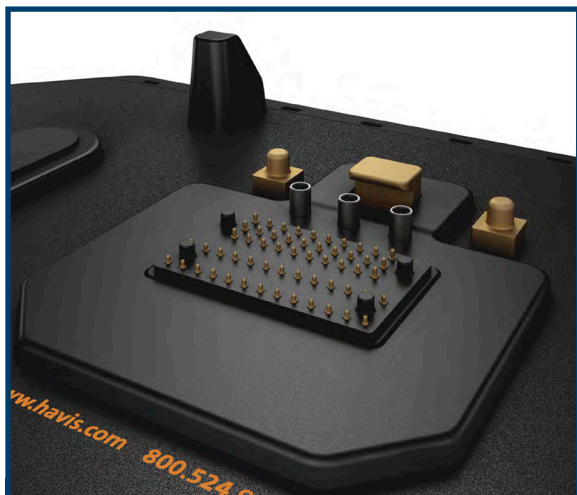

Floating Docking Connector and brass mounting pins protect against damage.

Full Port Replication

- Best-in-class circuit and power system supports fully powered USB 3.0
- USB: Fully-Powered USB 3.0 (3)
- USB: Fully-Powered USB 2.0, front accessible (1)
- Ethernet: RJ45 (1)
- Serial DB9 (2)
- Video: VGA (1)
- Video: HDMI (1)
- Speaker & Mic: Stereo (1 each, front-facing)
- Power Input: 19.5 V DC
(Part # DS-DELL-401/401-3/402/402-3/405/405-3/406/406-3)
- Power Input: 10-17 V DC
(Part# DS-DELL-404/404-3/407/407-3)
- Antenna Connection: Triple Hi-Gain *(Optional)*

Specifications

- Height:** 10.8" (27.6 cm)
- Width:** 12.4" (31.5 cm)
- Depth:** 2.7" (6.9 cm)
- Weight:** 5.25 lbs (2.38 kg)

Certifications & Testing

- Vibration Testing: MIL-STD 810G 514.5
- Impact Test: Crash Simulation per SAE J1455
(Forward/Rearward/Side Impact Directions)
- Cycle Test: Latch tested to 30,000 cycles
- Environmental Testing: Hot/Cold Operation and Storage
- CE, FCC
- RoHS

Part Number	USB 2.0	USB 3.0	Ethernet	Serial	VGA	HDMI	Speaker /Mic	Bundled Power Supply	Internal Power Supply	Dock Input Power	Antenna Connection <i>(Triple Hi-Gain)</i>
DS-DELL-401	1	3	1	2	1	1	Yes	No	No	19.5 V DC*	None <i>DS-DELL-401-3</i>
DS-DELL-402	1	3	1	2	1	1	Yes	Yes	No	19.5 V DC	None <i>DS-DELL-402-3</i>
DS-DELL-403**	0	0	0	0	0	0	0	No	No	n/a	None
DS-DELL-404	1	3	1	2	1	1	Yes	No	Yes	10-17 V DC	None <i>DS-DELL-404-3</i>
DS-DELL-405	1	3	1	0	0	0	Yes	No	No	19.5 V DC*	None <i>DS-DELL-405-3</i>
DS-DELL-406	1	3	1	0	0	0	Yes	Yes	No	19.5 V DC	None <i>DS-DELL-406-3</i>
DS-DELL-407	1	3	1	0	0	0	Yes	No	Yes	10-17 V DC	None <i>DS-DELL-407-3</i>

* Requires an external Dell authorized DC power supply

** Cradle only option (no electronics)



Havis Docking Solution for Dell Latitude 12 Rugged Tablet

DS-DELL-600 Series Dell Latitude 12 Rugged Tablet

With the release of the Windows based Latitude 12 Rugged Tablet from Dell, Havis brings you the best computing solution for all your business needs.

The DS-DELL-600 Series Docking Station will offer tablet charging, security, and connection to peripherals in enterprise, warehouse, and other in-vehicle work environments.

Maximize your productivity with this lightweight and strong design that is built with theft deterrence, longevity and stability in mind.



Specifications

Height: 14.1" (35.8 cm)

Width: 13.7" (34.8 cm)

Depth: 3.0" (7.5 cm)

Weight: 4.7 lbs. (2.1 kg)



Full Port Replication

- Best-in-class circuit and power system supports fully powered USB 3.0
- USB: Fully-Powered USB 3.0 (2)
- USB: Fully-Powered USB 2.0, front accessible (1)
- Ethernet: RJ45 (1)
- Serial: RS232 (2)
- Video: VGA (1)
- Video: DisplayPort (1)
- Power Input: 19.5 V DC (Part # DS-DELL-601*, DS-DELL-602)
- Power Input: 10-17 V DC (Part# DS-DELL-604)
- Antenna: Dual Pass-Through (Optional)

Part Number	USB 2.0 (front)	USB 3.0	Ethernet	Serial	VGA	DisplayPort	Bundled Power Supply	Internal Power Supply	Dock Input Power	Antenna Connection (Optional Dual Hi-Gain)
DS-DELL-601	1	2	1	2	1	1	No	No	19.5 V DC*	None DS-DELL-601-2
DS-DELL-602	1	2	1	2	1	1	Yes	No	19.5 V DC	None DS-DELL-602-2
DS-DELL-603**	0	0	0	0	0	0	No	No	n/a	None DS-DELL-603-2
DS-DELL-604	1	2	1	2	1	1	No	Yes	10-17 V DC	None DS-DELL-604-2

* Requires an external Dell authorized DC power supply

** Cradle only option (no electronics)

Havis Rugged Communications Hub

The latest in ruggedized communications

Part # DS-DA-602

Maximize data productivity when device uptime counts with the highest quality solution on the market. Introducing the newest rugged USB/ethernet hub by Havis. Expanding connectivity requirements is now easily attained with this 4 port, fully powered USB 2.0 hub featuring an ethernet port. Economical expansion of peripherals such as in-vehicle video, GPS, scanners, card readers and printers is no problem for the Rugged Hub II. This ground breaking product provides the ideal solution for use in unfavorable conditions where ruggedness and reliability is a necessity, such as Mobile Workplaces, Manufacturing Plants, Construction, Shipping/Loading Docks, and Agricultural Industries.



LED Functionality

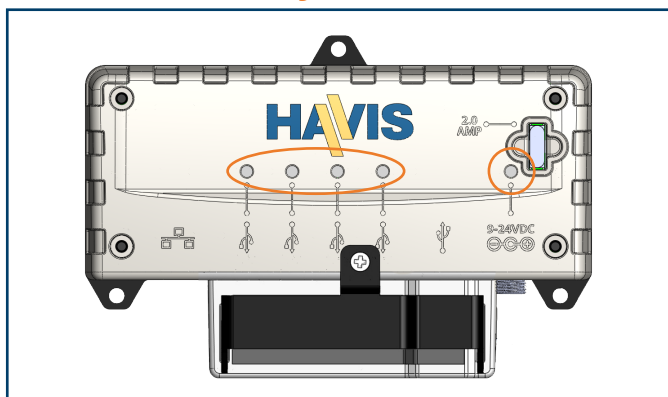

LED	Color	Status
USB Indicators (4)	Green	Port is available
	Off	Port has an over current
Power Indicator	Red	Input Power is between 9V - 24V
	Off	Voltage less than 9, or more than 24

Port Replication

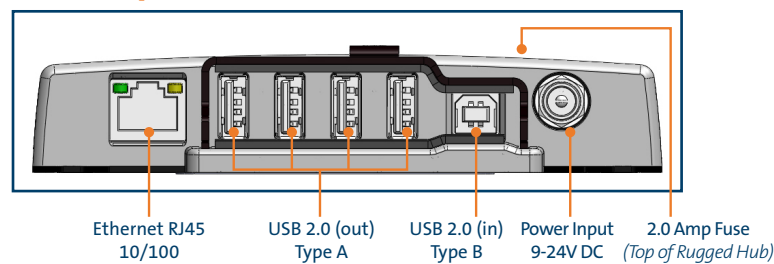

Specifications

Power Supply Input	9-24V DC-In
Dimensions (W x D x H)	5.1" (12.9 cm) x 3.3" (8.4 cm) x 1.0" (2.5 cm)
Weight	0.6 lbs (0.3 kg)
Operating Environment	-20° C to 65° C (-4° F to 149° F)
Storage Environment	-30° C to 70° C (-22° F to 158° F)

Industrial Uses

- Manufacturing Plants
- Shipping/Loading Docks
- Waste Management Facilities
- Construction Industry
- Agricultural Industry

Certifications

- MIL-STD-810G
- FCC, CE, RoHS

Havis Universal Laptop Mounts



- Engineered with lightweight aluminum and composite materials to maximize strength while minimizing weight.
- Includes two sets of Hold-Down Lugs to maximize compatible laptops
- Attractive footprint and design provide for improved ergonomics in universal tray application.
- Easy to use latch mechanism
- Barrel lock provides security and theft-deterrence
- Easily configured by the user for the best ergonomic fit with most laptop computers and manufacturers.

The Havis series of Universal Laptop Mounts represents the next generation of ruggedized mounts for any laptop that does not have the need for port replication. With a new lightweight design featuring composite materials and a lightweight and strong aluminum structure, the Universal Laptop Mount provides the most flexible and durable universal tray available for mobile computing applications. The Universal Laptop Mount, in conjunction with Havis supplied mounts and motion accessories, continue the tradition of Havis designing the most ergonomically correct and safe solution for your equipment while minimizing the risk of injury and maximizing productivity. This combination of comfort, quality and safety in a truly universal device are what make the Havis Universal Laptop Mount the clear choice.



Top: The bottom of Universal Laptop Mount features mounting holes for Power Supplies and Rugged Communications Hub, as well as Cable Strain Relief Holes and Equipment Mounting Holes.

Bottom: Side Hold-down Lugs are easily adjustable to accommodate availability to ports.

Havis Universal Laptop Mounts

UT-101

Specifications (UT-101)

Width: 13.2 - 15.1" (33.3 - 38.3 cm)

Depth: 11.2 - 12.2" (28.4 - 30.9 cm)

Height: 2.2 - 2.5" (5.5 - 6.4 cm)

Weight: 4.2 lbs (1.9 kg)



Compatible Computer Dimensions (Part # UT-101)

Width: 11.43 - 14.23" (29.03 - 36.15 cm)

Depth: 9.27 - 11.02" (23.55 - 27.99 cm)

Height: 0.66 - 1.86" (1.7 - 4.7 cm)

Standard Lugs: 0.66 - 1.26" (1.7 - 3.2 cm)

Tall Lugs: 1.26 - 1.86" (3.2 - 4.7 cm)

Laptop Compatibility

The UT-101 is compatible with most of the laptops currently on the market, including Panasonic, DELL, Lenovo, IBM, Hewlett-Packard and Toshiba.

UT-102

Specifications (UT-102)

Width: 13.2 - 14.5" (33.5 - 36.8 cm)

Depth: 11.2 - 12.2" (28.4 - 30.9 cm)

Height: 2.5" - 2.8" (6.3 - 7.0 cm)

Weight: 4.2 lbs (1.9 kg)



Compatible Computer Dimensions (Part # UT-102)

Width: 9.55 - 11.34" (24.25 - 28.80 cm)

Depth: 7.67 - 9.42" (19.48 - 23.92 cm)

Height: 0.63 - 1.50" (1.60 - 3.81 cm)

Laptop Compatibility

This UT-102 is compatible with laptops featuring a smaller footprint, including Panasonic T Series, Panasonic W Series, Panasonic CF-19, and HP 2703P notebook computers.

Related Products



In-vehicle Power Supplies

- In-vehicle power supplies that are compatible with a wide variety of laptop models.

Rugged Communications Hub (Part # DS-DA-601)

- Rugged USB/Ethernet Hub makes adding peripherals to your mobile electronics easy and safe.

Havis Chargeguard (Part # CG-X)

- Self-contained unit that provides intelligent circuit protection for a vehicle's power system and is regulated on a programmable timer.

Screen Stiffener (Part # SS-UT-X)

- Secure your laptop screen to prevent excess wear and reduce vibration while in use.
- **USB Powered Keyboard Light (Part # DS-DA-102).** Soft red LED light illuminates the laptop keyboard for night viewing. Attaches to the Screen Stiffener.

Dell power supply mount (Part # LPS-201)

- Two brackets designed to mount the Dell 65W Power Supply to the bottom of the Universal Laptop Mount



AP-4G ANTENNA

Cellular/LTE, WiFi & GPS Antenna for the DELL Rugged Extreme 12, Rugged Extreme 14 and Rugged 14 Laptops



Available colors: Black or White

The AP-4G Antenna is the all-in-one, low profile Cellular/LTE, WiFi and GPS combination external antenna. Everything is in one housing reducing the need for multiple antennas and holes being drilled.

Key Benefits:

Better Cellular/LTE and WiFi Reception

By using the AP-4G-Antenna, the wireless signal is optimized, getting the signal outside of the vehicle.



The AP-4G Antenna Connects to the Dell Rugged Extreme 12, Rugged Extreme 14 & Rugged 14 Laptops with a Tri-Passthrough docking station.

Bigger Wireless Footprint

AP-4G-Antenna provides up to 25% more wireless coverage, depending on the geography you travel in.

Faster Data Speeds

Better reception translates to faster speeds. The data gets through the first time, correctly. WiFi speeds are especially sensitive to signal strength.

Long Product Life — Low Profile Design

The AP-4G-Antenna is very durable and stands only 2.22 inches high. It withstands all of the natural elements, car washes, and being swept by tree branches.

One Simple Installation

The AP-4G-Antenna has all of the antennas in the one housing. This means you only have one hole to drill and one installation effort.

Product	Cell/LTE Antenna	WiFi Antenna	GPS Antenna
A5481447 (Black)	✓	✓	✓
A5280775 (White)	✓	✓	✓



Airgain, Inc.

8350 E. Evans Road, Suite D-2, Scottsdale, AZ 85260
 Phone: 480.657.7354 | Fax: 480.657.0204 | AP-orders@airgain.com

Copyright 2017 Airgain, Inc. : Version 6c (07/18/17)



AP-4G ANTENNA

Electrical Specifications

Frequencies:

Cellular/LTE = 698-2700 MHz
 (includes Band 14 LTE)
 WiFi = 2.4 & 5 GHz (802.11 a,b,g,n, ac)
 GPS = 1575.42 MHz - 1602 MHz

VSWR: 1.5:1 or less at resonant point

Gain: 698-890 MHz: 3 dBi;
 1710-2700 MHz: 4 dBi

Radiation Pattern:

OMNI Directional
 Hemispherical (GPS)

Polarization:

Vertical

Mechanical Specifications

Radome:

Glass Filled Polypropylene

Cable Length:

15 feet (4.5 m) (Adhesive and Bolt Mount)
 10 feet (3 m) (Magnet Mount)
 Optional cable length to 35 feet

Connectors:

The AP-4G Antenna comes with 3 TNC connectors to connect to the docking station.

Environmental Specifications

RoHS Compliant

Temperature: - 40 °C to 85 °C (- 40 °F to +185 °F)
 operating and storage

Humidity: (non-condensing) - 5% to 95%
 operating and storage

Military Spec MIL-STD 810 conformance to thermal,
 mechanical shock, and humidity.

GPS Antenna Specifications

Frequency Range 1575.42 MHz - 1602 MHz
 Gain 28 dB min.
 Polarization R.H.C.P.
 (Right Hand Circular Polarization)
 Noise Figure 2.0 max.
 Aerial Ratio 3 dB max.
 Bandwidth 2 MHz min.
 VSWR 2.0 max.
 Output Impedance 50 Ohms
 Voltage 2.7-5.6 Volts
 Current 10 mA ± 0.8 mA

Dimensions

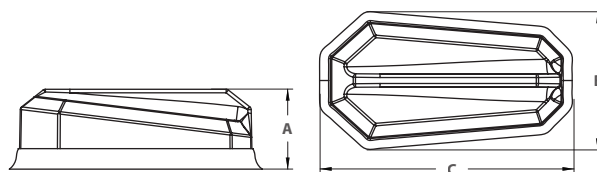

A	B	C
2.220" (56.4 mm)	3.831" (97.3 mm)	7.000" (177.8 mm)

Built-in Metal Ground Plane

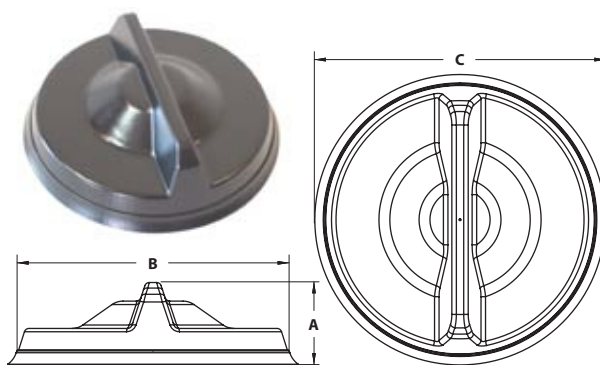

A	B	C
2.183" (55.5 mm)	7.074" (179.7 mm)	7.650" (194.3 mm)

Mounting Styles

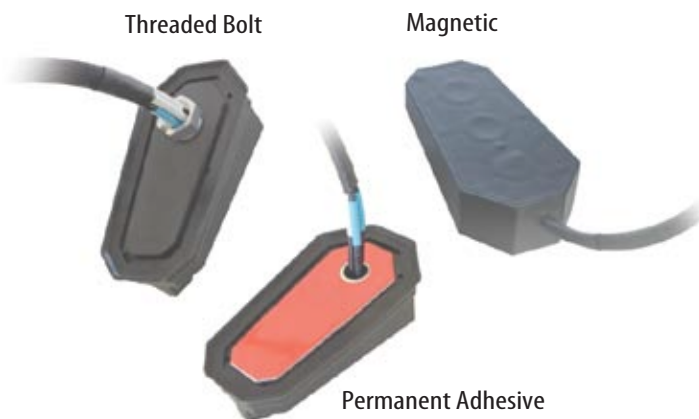



DuPage County Procurement Services Division

421 North County Farm Road, Room 3-400
Wheaton, Illinois 60187-3978

Phone: (630) 407-6184

Email: dthompson@dupageco.org

November 29, 2018

Insight Public Sector
Mr. Bob Erwin
6820 S. Harl Avenue
Tempe, AZ 85283
berwin@insight.com

Dear Mr. Erwin,

Attached please find our *OPTION TO RENEW CONTRACT* form for Mobile Data Terminals per Bid 17-204-BF for DuPage County ETSB, W-9 form and Required Vendor Ethics Disclosure Statement for your company's signature. After processing, a signed copy will be returned to your company along with the new contract purchase order.

We wish to encourage your continued participation in DuPage County's procurement process, as this will continue to ensure the County taxpayers that they are receiving the maximum value for their tax dollars.

Best Regards,

Debby Thompson

Debby Thompson, CPPB
DuPage County Buyer
DuPage County Procurement Services
421 N. County Farm Road
Wheaton, IL 60187
dthompson@dupageco.org
(630) 407-6184





**COUNTY OF DU PAGE, ILLINOIS
OPTION TO RENEW CONTRACT**

This agreement, made and entered into by the County of DuPage, Department of Finance, Procurement Services Division, 421 North County Farm Road, Wheaton, Illinois, 60187, hereinafter called the "County" and Insight Public Sector, 6820 S. Harl Avenue, Tempe, AZ 85283 hereinafter called the "Contractor", witnesseth;

The County and the Contractor have previously entered into a Contract, pursuant to Bid 17-204-BF which became effective November 30, 2017 and which expired December 31, 2017. The contract is subject to an option to renew for a FIRST twelve (12) month period.

The parties now agree to renew said agreement, upon the same terms as previously agreed to, as specified in the original contract.

The contract renewal becomes effective November 30, 2018 and which expired December 31, 2019, contingent upon Parent Committee approval.

INSIGHT PUBLIC SECTION

COUNTY OF DU PAGE, ILLINOIS

SIGNATURE DATE

SIGNATURE DATE

PRINTED NAME

Debra Thompson, CPPB
DuPage County Buyer

PRINTED TITLE



Quote: Q-00110518

Date: 11/9/2018

DuPage County ETSB
136 N COUNTY FARM RD
WHEATON, IL 60187

Part #	3000030671015
210-AQPY	Dell Latitude 5420 Rugged, CTO
379-BDHB	8th Gen Intel Core i5-8350U Processor (Quad Core, 6M Cache, 1.7GHz, 15W, vPro)
619-AHKH	Win 10 Pro 64 English
338-BPVK	Integrated Intel UHD 620 Graphics on i5-8350U
370-AEMN	8GB, 2x4GB, 2400MHz DDR4 Non-ECC
400-BBTW	M.2 256GB PCIe NVMe Class 40 Solid State Drive
391-BDVP	14" FHD WVA (1920 x 1080) Embedded Touch, Outdoor-Readable Screen, Camera with Privacy Shutter & Microphone
580-ABYR	Sealed Internal RGB Backlit English Keyboard
555-BEPD	Qualcomm QCA61x4A 802.11ac Dual Band (2x2) Wireless Adapter+ Bluetooth 4.1 Driver
555-BCMWW	Qualcomm QCA61x4A 802.11ac Dual Band (2x2) Wireless Adapter+ Bluetooth 4.1
556-BBZI	Qualcomm Snapdragon X20 (DW5821e) ATT
451-BCHG	3 Cell 51Whr ExpressCharge Capable Battery
492-BCNQ	90 Watt AC Adapter
346-BEVG	Dell Top Case and Palmrest without Security
325-BDEH	Dummy Airbay Cover
340-AJPV	TPM Enabled
387-BBNJ	Energy Star Certified
319-BBFM	IR Camera
808-6784	ProSupport: Next Business Day Onsite, 3 Years
808-6805	Dell Limited Hardware Warranty Initial Year
808-6809	ProSupport: 7X24 Technical Support, 3 Years
973-9199	Accidental Damage Service, 3 year

Units	Price
1	\$2,399.00
1	
1	
1	
1	
1	
1	
1	
1	
1	
1	
1	
1	
1	
1	
1	
1	
1	
1	
1	

*The prices shown above are effective for 30 Days from date of quote.
Items are subject to availability.*

Subtotal	\$2,399.00
Sales Tax	\$ -
Freight	\$ -
Total	\$2,399.00

Quote Provided By:
Bob Erwin
Account Executive
Insight Public Sector
847-322-0898
berwin@insight.com