



Workwear | Professional footwear 2021

Extract from main catalog

## Contact and support



**DPV Elektronik-Service GmbH**  
Herregrundstr. 1  
75031 Eppingen  
Germany

**Phone:** +49 (0)7262 9163-0  
**Fax:** +49 (0)7262 9163-90  
**E-Mail:** sales@dpv-elektronik.eu  
**Internet:** www.dpv-elektronik.eu



### Sales Germany

- Team North Zip codes 0, 1, 2, 3, 4, 5 +49 (0)7262 9163-182  
TeamNord@dpv-elektronik.de
- Team South Zip codes 6, 7, 8, 9 +49 (0)7262 9163-185  
TeamSued@dpv-elektronik.de

### Sales Europe

- Europe / international +49 (0)7262 9163-200  
export@dpv-elektronik.eu

### Sales Switzerland

- Compumet AG +41 (0)61 836 10 50  
info@compumet.ch

### Customer service and quality assurance

+49 (0)7262 9163-500  
service@dpv-elektronik.eu



### Quality management according to ISO 9001

An efficient quality management system certified according to ISO 9001:2015 ensures the compliance of our high quality level.

## General terms and conditions of sale, delivery and payment (excerpt\*\*)



### Conditions of delivery and payment

DPV Elektronik-Service GmbH exclusively delivers for the commercial sector! No selling to private individuals!

#### \*Flat-rate shipping costs per order

- Germany: 5.90 €
- Belgium, Denmark, France, Luxembourg, Netherlands, Austria, Poland: 10.00 €
- Great Britain, Italy, Sweden, Ireland, Norway, Spain, Portugal, Czech Republic, Hungary, Finland: 15.00 €
- Others: depending on order. Please contact us.

The flat-rate shipping costs are only valid for deliveries sent as standard package!

Volume-dependent deliveries, deliveries by forwarder and dangerous goods are excluded!

**Delivery: unpaid ex warehouse including packaging  
Delivery outside the EU only on request!**

#### Minimum order value:

- Within Germany: no minimum order value
- Within the EU: 50 €

**Orders outside the EU only on request!**

\*\*Complete terms and conditions:

<https://www.dpv-elektronik.de/info/conditions-of-use.html>

All technical data and prices were correct at the time of printing. All prices are available on [www.dpv-elektronik.eu](http://www.dpv-elektronik.eu).

This catalog was created by a DTP system and with utmost care.

We reserve the right to errors, price changes and technical modifications.

Any reproduction from our catalog requires our approval. Copyright© by DPV Elektronik-Service GmbH, 75031 Eppingen, Germany.

Version: DPV BERUF EN 2021



# Celebrate with us:



30 years of products, solutions and services for your ESD safety



[www.dpv-elektronik.de/30Jahre](http://www.dpv-elektronik.de/30Jahre)

## Simply order in our online shop: [www.dpv-elektronik.eu](http://www.dpv-elektronik.eu)

Become a registered customer



Your advantage as a registered customer:

- **Prices:** After logging in you see your personal prices **immediately**, at any time and **up-to-date**.
- **Datasheets and user manuals for download**
- **Practical shoe filter and different configurators**
- **Direct inquiry function:** You can make your inquiries **directly** via the product page.

## Product search: quickly and easily from the print catalog to the online product

Whether you are using the computer, tablet or smartphone –the product search helps you to find the product also in the online shop

### dpvlink

Simply enter the **dpvlink** in the search field and find directly the wished product.



Online shop - computer

### Etikett ESD (Rolle)



ESD-Warschilder, selbstkl. Papier  
Symbol (Rolle = 1000 Stück)

**dpvlink 1090**

| Artikel  | Abmessungen LxB | Anzahl   | Typ   |
|----------|-----------------|----------|-------|
| 2855.001 | 5 x 5,0 mm      | 1000 Stk | Rolle |
| 2855.002 | 12,5 x 12,5 mm  | 1000 Stk | Rolle |
| 2855.003 | 50 x 50 mm      | 1000 Stk | Rolle |
| 2855.004 | 25 x 25 mm      | 1000 Stk | Rolle |

Print catalog



### QR-Code

Use the smartphone or tablet to scan the **QR code** and you are directly led to the product.

Online shop – smartphone



# Your system partner for electronics manufacturing for 30 years

## ESD protection from the beginning



1998 - New building Herregrundstrasse, Eppingen



Head office in Herregrundstrasse, Eppingen

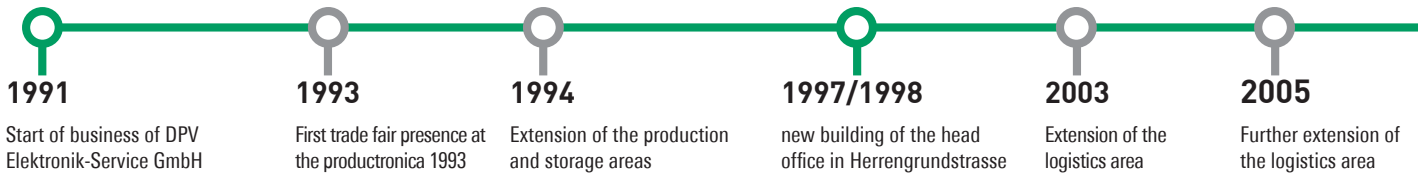

### DPV Elektronik-Service GmbH

DPV Elektronik-Service GmbH celebrates the 30th anniversary in 2021.

We have been your reliable partner for ESD protection and production equipment for 30 years.



In January 1991, DPV Elektronik-Service GmbH started its business activity with the focus on the production and distribution of manufacturing equipment for the electronics industry. Having a product range of yet more than 1,000 articles, we already supplied our customers all over the world at that time.

The demand of our customers has steadily risen and we have been able to extend our product range continuously to more than 30,000 articles until today.

### International fairs

Already in 1993, we presented our products on an international trade fair, the productronica, for the first time and have been regularly present on different trade fairs since that time.

### The head office

As a result of the increasing demand and the enlargement of the product range the previous business rooms became too small despite several extensions.

A further extension was impossible. We planned a new building and could move to Herregrundstrasse in Eppingen in 1998. The new site offered also enough space for future extensions.

### Our subsidiary Compumet AG

Expanding our international business activity we took over Compumet AG located in Rheinfelden, Switzerland, in 2006.

Our subsidiary Compumet AG follows and supplies our clients in Switzerland and Liechtenstein.

### Logistics center Tiefental – site 2

Despite continuous extensions the production and storage areas soon became too small. In 2017, 3 kilometers from the head office in the industrial area Tiefental, in cooperation with the Fraunhofer Institut, a highly automated logistics center with laboratory and offices was built allowing us to supply you as our customer even better, faster and more efficiently.

### Training courses and further training – ESD protection from the beginning

The employees' knowledge plays an important role in the ESD protection. In our trainings and workshops we impart the knowledge that is important for the ESD safety, from the basics to the practical application.

### Services in the field of ESD protection and auditing

We are pleased to advise you imparting our experiences and knowledge concerning ESD safety. We provide support to perform an analysis, make a plan, organize ESD trainings and implement the ESD control program.

A regular control and auditing of the ESD protective measures ensure their functionality.

Our qualified auditors verify the application of the protective measures implemented in compliance with the ESD control program.

### Innovative solutions

Quality, longevity and functionality in the industrial environment characterize our products and are important to us. An experience of 30 years in the field of ESD protection allows us developing, in cooperation with our customers, new innovative products and improving existing ones.

Many of our products can often be adapted to special customer requirements even in smaller quantities.





# Our comprehensive product range

## Brands and products especially for the electronics industry



### Environmental protection and sustainability

Environmental protection and sustainability are important issues for us.

- Since 2012 a photovoltaic system installed on the roof of the head office in Eppingen has been satisfied more than 50% of our own power consumption
- Our server rooms and offices are air-conditioned by an absorption refrigeration system using the waste heat of a block-type thermal power station. With this we satisfy 40% of our energy consumption for the air conditioning
- Recyclable packaging materials are used for shipping

### Quality management according to ISO 9001:2015

Quality is important to us – we are a company certified by DEKRA according to ISO 9001. We continuously verify the quality of our products in our laboratory.





# EPA® - Innovative solutions for the ESD safety

## EPAwear® ESD workwear

Dissipative EPAwear® ESD workwear for the protection against electrostatic charge

ESD safety according to DIN EN 61340-5-1 

- Breathable and hard-wearing fabrics for best wearing comfort
- Dimensionally stable work coats in 3 versions
- Particularly soft and supple fabric of the PremiumSmooth shirts
- Hard-wearing and durable

Further information is available under [www.dpv-elektronik.de/kleidung](http://www.dpv-elektronik.de/kleidung) or from page 89



EPAwear

## EPAglove® ESD gloves

The EPAglove® ESD gloves protect your products against the consequences of electrostatic discharge.

Comply with the ESD standard DIN EN 61340-5-1 

- Fulfill strict requirements concerning the electrostatic discharge capability
- Breathable mixed textile fabrics for different applications
- Perfect fit with seamless design for an excellent sense of touch
- PU-coated fingertips or palms (depending on model)

Further information is available online or from page 120

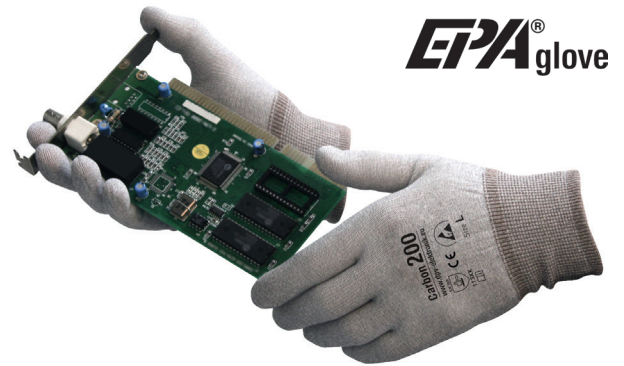

EPAglove

## EPAclean® ESD cleaning

The cleaning products of the EPAclean® series ensure that floors and surfaces in the EPA stay clean and functional and keep their ESD protective properties.

- Ready-to-use cleaners for a quick and uncomplicated cleaning of ESD surfaces
- Concentrates for a daily maintenance cleaning of ESD floors
- Concentrates for an intensive basic cleaning of ESD floors

Further information is available online or on page 128



EPAclean

## EPAchair® ESD work swivel chairs

Comply with the ESD standard DIN EN 61340-5-1 

- Large selection of chairs, standing aids and stools
- High sitting comfort for your employees working in the laboratory, office or production
- High quality level and long life
- Diverse adjustment options for your individual sitting comfort

Further information is available online or from page 129



EPAchair



**EPA® stands for products especially developed for the EPA protective zone. The focus is on ESD safety, quality and functionality.**

### EPApro® personnel grounding test system

EPApro® is a modern, networkable personnel grounding test system with optional EPA zone access control for measurement, analysis and sustainable documentation of the data.

Complies with the requirements of DIN EN 61340-5-1, ANSI ESD S20.20 and GDPR

- Integrated multi RFID reader
- Central administration of the devices and data in one database
- Comprehensive export and import functions
- REST API interface for the data connection to an external system

Further information is available under [www.dpv-elektronik.de/EPApro](http://www.dpv-elektronik.de/EPApro) or from page 132

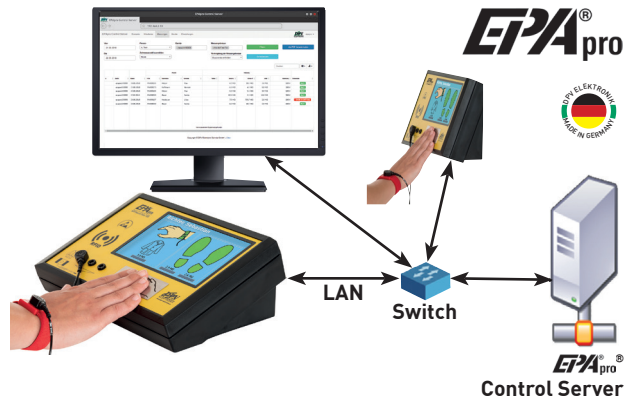

### EPApack® ESD packaging

ESD-sensitive components and assemblies are safely protected against electrostatic influences in shielding, DRY-SHIELD bags and packaging of the EPApack® series.

Electrostatic shielding <15nJ (Energy Test)

- Shielding, metallized ESD protective bags DPV-1000
- DRY-SHIELD protective bag DPV-2000 with additional moisture and visual protection

Further information is available online



### EPAstore® ESD storage solutions

The products of the series EPAstore® provide ESD safety when storing and transporting components and assemblies.

Comply with the ESD standard DIN EN 61340-5-1

- Optimal and ESD-protected storage of your products
- Individual packaging solutions: configurable via our online shop
- 200 different standard solutions – suitable for your Euro and KLT containers
- Available in three different, permanently conductive materials and thicknesses

Further information is available online

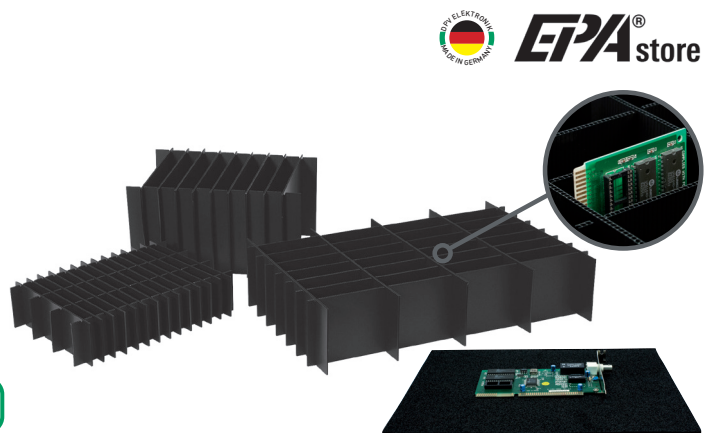

### EPAmove® ESD transport trolleys

The functional transport trolleys of the EPAmove® series ensure the ESD-safe transport inside your production.

Comply with the ESD standard DIN EN 61340-5-1

- ESD transport trolley type 700 Maxi FLEX – with standard or individual dimensions
- Shelf trolleys – safe transport on 3 shelves
- ESD transport trolleys in different versions

Further information is available online





## ESD Protective measures

Wherever people move or material is moved, electrostatic charge is generated. Electronic modules with increasingly smaller structures may be damaged or destroyed by electrostatic discharge. As it is not possible to feel electrostatic charge or to measure it with a multimeter, it is not easy to recognize the risks for components and modules.

Example for the effects of electrostatic discharge:

- 3000 Volt Persons can feel discharge (e.g. on door handles)
- 100 Volt may be sufficient to delete information on a magnetic data medium
- 50 Volt Sparks may ignite explosive gases
- 30 Volt may damage or destroy electronic components
- 20 Volt may damage LEDs and lead to their failure after some time.
- 5 Volt are sufficient to damage reader heads of hard disks during fabrication

The components damaged by electrostatic discharge may lead to a failure or a shorter service life of the concerned modules.

In order to prevent electrostatic discharge of persons and material, ESD protective measures are required. The target is to avoid discharge and to discharge slowly charged material by means of grounding.

Areas which serve to allow the safe handling of electronic modules are called ESD protection zones or EPA (Electrostatic Protected Area). These areas are especially marked.

Independently of the equipment of the ESD protection zone, additional measures have to be observed:

- ESDS may only be processed in electrostatic discharge protected areas (EPA)
- Ensure a personnel grounding with wrist straps and footwear grounding
- Wear dissipative clothes covering other garments
- Avoid electrostatically chargeable materials like conventional PE, PVC, polystyrene, etc.
- Avoid electrostatic fields > 5000 V/m
- Only use marked ESD packaging and transport containers
- Deploy only ESD trained personal in EPA protection zones

## Example of an ESD protection zone EPA (Electrostatic protected area)



- |                                 |                                    |                            |                         |
|---------------------------------|------------------------------------|----------------------------|-------------------------|
| 1. Floor marking                | 7. Ionizing equipment              | 13. Personnel test station | 19. Heel straps / shoes |
| 2. Floor coverings              | 8. Cleaner for floor covering      | 14. Warning signs          | 20. Clothes             |
| 3. Wastepaper basket            | 9. Cleaner for table covering      | 15. Warning labels         | 21. Film bags           |
| 4. Test and measuring equipment | 10. Shelf coverings                | 16. Permanent monitoring   | 22. Grounding cables    |
| 5. Table coverings              | 11. Ring folder / document holders | 17. Shipping boxes         | 23. Chairs              |
| 6. Grounding boxes              | 12. Containers                     | 18. Wrist straps           | 24. PCB holders         |



# Systems against electrostatics



## ESD occupational and safety footwear

|                                    |    |
|------------------------------------|----|
| Overview of safety classes         | 10 |
| Find your shoe quickly and easily! | 10 |
| DPV Komfort                        | 11 |
| Birkenstock                        | 16 |
| ABEBA                              | 18 |
| JALAS                              | 34 |
| SIEVI                              | 40 |
| LUPOS                              | 46 |
| ELTEN                              | 48 |
| STEITZ SECURA                      | 56 |
| ATLAS                              | 59 |
| FTG Safety shoes                   | 64 |
| UVEX                               | 67 |
| BATA                               | 70 |
| BAAK                               | 73 |
| LEMAITRE                           | 78 |
| U-POWER                            | 80 |



## Orthopedic insoles

|                    |    |
|--------------------|----|
| Orthopedic insoles | 81 |
|--------------------|----|



## ESD socks

|           |    |
|-----------|----|
| ESD socks | 81 |
|-----------|----|



## Care products

|                    |    |
|--------------------|----|
| Shoe care products | 82 |
|--------------------|----|



## Heel grounders and overshoes

|                              |    |
|------------------------------|----|
| Heel grounders and overshoes | 83 |
| Overshoes                    | 85 |



## Sole cleaning

|                         |    |
|-------------------------|----|
| Tacky mats              | 87 |
| Industrial sole cleaner | 88 |

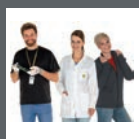

## Workwear

|                    |     |
|--------------------|-----|
| Work coat EPAwear® | 89  |
| Work coat EPAwear® | 90  |
| DPV Workwear       | 95  |
| Workwear           | 100 |
| ID card holders    | 120 |



## ESD gloves

|                            |     |
|----------------------------|-----|
| Gloves series LEO textiles | 120 |
| Textile gloves CARBON      | 122 |
| Textile gloves COPPER      | 122 |
| Textile gloves CUT         | 123 |
| Polyester gloves           | 124 |
| Gloves series TEGERA       | 124 |
| Disposable gloves          | 126 |
| Finger cots                | 126 |



## Hygiene solutions

|                                      |     |
|--------------------------------------|-----|
| Hygienic equipment                   | 126 |
| Medical masks                        | 127 |
| Disinfection / disinfectant cleaners | 127 |
| EPAClean®                            | 128 |

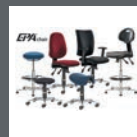

## DPV Swivel chairs

|                       |     |
|-----------------------|-----|
| Swivel chairs CLASSIC | 129 |
|-----------------------|-----|



## Measurement and test equipment

|                               |     |
|-------------------------------|-----|
| EPApro® Personnel Tester 1000 | 132 |
| Turnstiles                    | 135 |
| Personnel test stations       | 137 |

## Overview of safety classes

Professional and safety shoes have to withstand the requirements in different working areas every day. The standards EN ISO 20347 for professional footwear and EN ISO 20345 for safety footwear are to assure homogenous safety standards. The selection of the appropriate shoes is made on the basis of the risks for the relevant application. You will receive information about this subject from the security officers in your company and the relevant trade associations.

### EN ISO 20347 for professional footwear

The standard EN ISO 20347 defines the basic and additional requirements for professional footwear that are not subject to mechanical risks (by impact or pressure). Professional footwear according to EN ISO 20347 is normally produced without toe cap.

**OB** All basic requirements

**O1** In addition to OB: closed heel, antistatic, energy absorption capacity in the heel

**O2** In addition to O1: water penetrability, water absorption

### EN ISO 20345 for safety shoes

Safety shoes are produced according to the standard EN ISO 20345 and offer the wearer the highest possible protection. The processed protective toe caps are certified for high stress caused by an impact or pressure effect of 200 Joule.

**SB** All basic requirements

**S1** Additionally to SB: closed heel, antistatic, energy absorption capacity in the heel, fuel resistance

**S1P** In addition to S1P: midsole with penetration protection

**S2** In addition to S1: water penetrability, water absorption

**S3** In addition to S2: midsole with penetration protection, profiled outsole

Further technical information is available on page 145

## Find your shoe quickly and easily!

- Find the appropriate shoe quickly with our **shoe filter** in our **online shop**
- **simple search** in the complete product range of professional and safety shoes
- **many filter criteria** for optimal selection

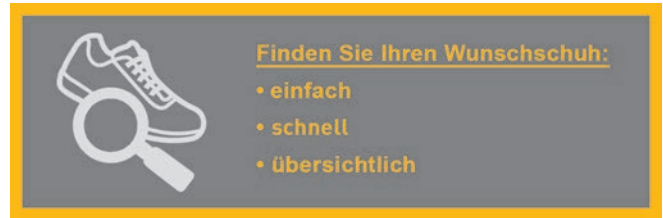

Use our online shoe filter - with just a few clicks to the appropriate shoe!

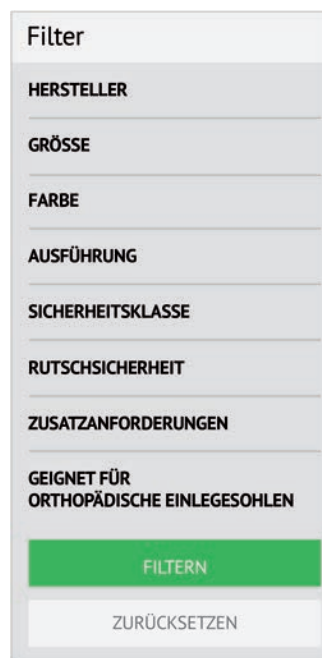

Filter according to the requirements for your shoe:

- Manufacturer and brand
- Size
- Color
- Models (shoe shape)
- Safety class
- Slip resistance
- Additional requirements (e.g. penetration protection or insulation)
- Suitability for orthopedic insoles

You will find more information about the requirements directly in the filter.

Filter now and find the appropriate shoe...

# DPV-komfort

## für besten Tragekomfort

Antistatic DPV occupational shoes offer best wearing comfort in your daily work.

The use of high-quality natural materials guarantees highest quality and environmental compatibility. All materials are free of CFCs and PCP.

The upper is made of selected types of leather. All leathers are completely dyed and treated to ensure that the natural breathability of the leather is retained.

The leathers used fulfill the strict German regulations relating to the ingredients and tannins for leather.

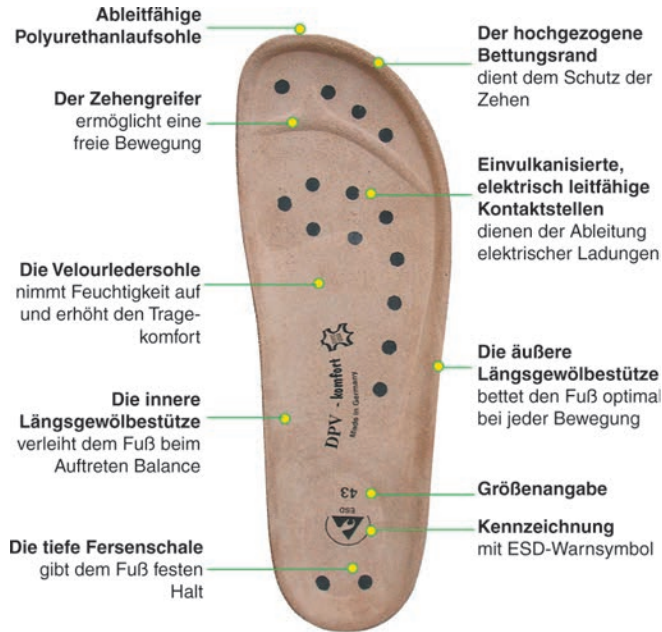

Article number in catalog: 2505.011.51

### Slippers, sandals

#### Slipper STYLE DPV-komfort



Slipper, adjustable buckle at the instep; air cushion cork footbed. DIN EN ISO 20347.



**dpvlink 22591** 

| Article       | Color                  | Upper                   | Size  |
|---------------|------------------------|-------------------------|-------|
| 2505.026.K961 | marine / metallic blue | nubuck / patent leather | 36-42 |
| 2505.026.K966 | black / croco          | nubuck / leather        | 36-42 |
| 2505.026.K968 | stone grey / sand      | nubuck / leather        | 36-42 |

#### Slipper NEW-FORM DPV-komfort



Slipper with two buckles and T-strap; cork sole / air cushion; DIN EN ISO 20347.



**dpvlink 19642** 

| Article       | Color          | Upper   | Size  |
|---------------|----------------|---------|-------|
| 2505.027.K975 | marga / grey   | leather | 36-42 |
| 2505.027.K959 | marga / marine | leather | 36-42 |
| 2505.027.K956 | marga / black  | leather | 36-42 |
| 2505.027.K925 | flower white   | leather | 36-42 |

#### Women's slipper with three buckles DPV-komfort



Women's slipper with three buckles; air cushion cork footbed; DIN EN ISO 20347.



**dpvlink 13042** 

| Article       | Color           | Upper          | Size  |
|---------------|-----------------|----------------|-------|
| 2505.021.K982 | copper metallic | patent leather | 36-42 |
| 2505.021.K975 | marga / grey    | nubuck         | 36-42 |
| 2505.021.K956 | marga / black   | nubuck         | 36-42 |



## Women's slipper with wedge heel DPV-komfort



Women's slipper, three buckles with wedge heel, nubuck; air cushion cork footbed; DIN EN ISO 20347.



dpvlink 16751



| Article       | Color  | Upper  | Size  |
|---------------|--------|--------|-------|
| 2505.025.K717 | purple | nubuck | 36-42 |
| 2505.025.K56  | black  | nubuck | 36-42 |

## Slipper DPV-komfort



Women's / men's slipper with velcro fastener; air cushion cork footbed; DIN EN ISO 20347.

.K56

metallfrei



.K719

.K59

.51

.00



dpvlink 9723



| Article       | Color     | Upper   | Size  |
|---------------|-----------|---------|-------|
| 2505.030.K56  | black     | nubuck  | 36-41 |
| 2505.030.K719 | turquoise | nubuck  | 36-41 |
| 2505.030.K59  | marine    | nubuck  | 36-41 |
| 2505.030.51   | navy      | nubuck  | 36-41 |
| 2505.030-1.51 | navy      | nubuck  | 42-48 |
| 2505.030.00   | white     | leather | 36-41 |

## Woman's slipper with velcro fastener DPV-komfort



Women's slipper, adjustable velcro fastener, nubuck, metal-free, wedge heel, air cushion cork footbed; DIN EN ISO 20347.

metallfrei



dpvlink 16748



| Article       | Color  | Upper  | Size  |
|---------------|--------|--------|-------|
| 2505.122.K717 | purple | nubuck | 35-42 |
| 2505.122.K56  | black  | nubuck | 35-42 |
| 2505.122.K59  | marine | nubuck | 35-42 |

## Women's sandal DPV-komfort



Women's sandal with velcro fastener; nubuck; metal-free; air cushion cork footbed; DIN EN ISO 20347.

.K719

metallfrei



.K756

.K59

.K714

.K718



dpvlink 7211



| Article       | Color     | Upper  | Size  |
|---------------|-----------|--------|-------|
| 2505.126.K719 | turquoise | nubuck | 35-41 |
| 2505.126.K56  | black     | nubuck | 35-41 |
| 2505.126.K59  | marine    | nubuck | 35-41 |
| 2505.126.K714 | camel     | nubuck | 35-41 |
| 2505.126.K718 | pink      | nubuck | 35-41 |

## Women's slipper DPV-komfort



Women's slipper with wedge heel, two buckles; air cushion cork footbed; DIN EN ISO 20347.



dpvlink 012



| Article       | Color  | Upper   | Size  |
|---------------|--------|---------|-------|
| 2505.012.00   | white  | leather | 36-42 |
| 2505.012.16   | black  | leather | 36-42 |
| 2505.012.51   | navy   | nubuck  | 36-42 |
| 2505.012.K717 | purple | nubuck  | 36-42 |

## Slipper DPV-komfort

Women's / men's slipper with two buckles; air cushion cork footbed; DIN EN ISO 20347.



### dpvlink 005

| Article       | Color      | Upper   | Size  |
|---------------|------------|---------|-------|
| 2505.011.51   | navy       | nubuck  | 35-41 |
| 2505.011-1.51 | navy       | nubuck  | 42-48 |
| 2505.011.K722 | berry      | nubuck  | 35-41 |
| 2505.011.K725 | stone grey | nubuck  | 35-41 |
| 2505.011.00   | white      | leather | 35-41 |
| 2505.011-1.00 | white      | leather | 42-48 |
| 2505.011.11   | blue       | leather | 35-41 |
| 2505.011-1.11 | blue       | leather | 42-48 |
| 2505.011.16   | black      | leather | 35-41 |
| 2505.011-1.16 | black      | leather | 42-48 |

## Sandal with heel strap DPV-komfort

Women's and men's sandal with heel strap, two buckles; air cushion cork footbed. DIN EN ISO 20347.



### dpvlink 018

| Article       | Color | Upper   | Size  |
|---------------|-------|---------|-------|
| 2505.101.00   | white | leather | 35-41 |
| 2505.101-1.00 | white | leather | 42-48 |
| 2505.101.11   | blue  | leather | 35-41 |
| 2505.101-1.11 | blue  | leather | 42-48 |
| 2505.101.16   | black | leather | 35-41 |
| 2505.101-1.16 | black | leather | 42-48 |
| 2505.101.51   | navy  | nubuck  | 35-41 |
| 2505.101-1.51 | navy  | nubuck  | 42-48 |

## Men's slipper / sandal DPV-komfort

Men's slipper / sandal, upper nubuck, adjustable velcro fastener and sturdy PU outsole; exchangeable air cushion cork footbed comfort. DIN EN ISO 20347.



### dpvlink 002

| Article       | Color   | Upper  | Size  |
|---------------|---------|--------|-------|
| 2505.075-1.57 | asphalt | nubuck | 40-46 |
| 2505.175-1.57 | asphalt | nubuck | 40-46 |

## Men's slipper / sandal DPV-komfort

Men's slipper / sandal, upper nubuck, with sturdy PU outsole and exchangeable air cushion cork footbed. DIN EN ISO 20347.



### dpvlink 163

| Article       | Color | Upper  | Size  |
|---------------|-------|--------|-------|
| 2505.065-1.51 | navy  | nubuck | 40-46 |
| 2505.166-1.51 | navy  | nubuck | 40-46 |

## Insole for shoes DPV-komfort

Replaceable ESD insole, for men's slipper/sandal DPV-komfort



### dpvlink 7231

| Article  | Size                                  |
|----------|---------------------------------------|
| 2505.079 | Insole for shoes DPV-komfort<br>40-46 |

Clogs

Women's clog AIR DPV-komfort



Women's clogs with perforation, foldable heel strap, air cushion cork footbed. DIN EN ISO 20347.



dpvlink 13047

| Article       | Color      | Upper  | Size  |
|---------------|------------|--------|-------|
| 2505.271.K722 | berry      | nubuck | 36-42 |
| 2505.271.K718 | pink       | nubuck | 36-42 |
| 2505.271.K719 | turquoise  | nubuck | 36-42 |
| 2505.271.K725 | stone grey | nubuck | 36-42 |
| 2505.271.K717 | purple     | nubuck | 36-42 |
| 2505.271.K713 | apple      | nubuck | 36-42 |
| 2505.271.K56  | black      | nubuck | 36-42 |
| 2505.271.K59  | marine     | nubuck | 36-42 |
| 2505.271.K716 | khaki      | nubuck | 36-42 |



Men's clog AIR DPV-komfort



Men's clog with perforation, folding heel strap; air cushion cork footbed. DIN EN ISO 20347.



dpvlink 16854

| Article         | Color      | Upper  | Size  |
|-----------------|------------|--------|-------|
| 2505.271-1.K725 | stone grey | nubuck | 43-48 |
| 2505.271-1.K56  | black      | nubuck | 43-48 |
| 2505.271-1.51   | navy       | nubuck | 43-48 |
| 2505.271-1.K716 | khaki      | nubuck | 43-48 |



Clog BASIC DPV-komfort



Clog Basic with foldable heel strap; air cushion cork footbed. DIN EN ISO 20347.



dpvlink 22586

| Article         | Color      | Upper  | Size  |
|-----------------|------------|--------|-------|
| 2505.281.K722   | berry      | nubuck | 36-42 |
| 2505.281.K725   | stone grey | nubuck | 36-42 |
| 2505.281-1.K725 | stone grey | nubuck | 43-48 |
| 2505.281.51     | navy       | nubuck | 36-42 |



Women's clog NEW CUT DPV-komfort



Stylish women's clog with instep strap; air cushion cork footbed; cowhide upper leather. DIN EN ISO 20347.



dpvlink 15624

| Article       | Color           | Upper   | Size  |
|---------------|-----------------|---------|-------|
| 2505.275.K56  | black           | nubuck  | 35-42 |
| 2505.275.K722 | berry           | nubuck  | 35-42 |
| 2505.275.51   | navy            | nubuck  | 35-42 |
| 2505.275.K952 | marine / flower | leather | 35-42 |



Women's clog COLOR DPV-komfort



Women's clog with instep strap; air cushion cork footbed; full-grain leather. DIN EN ISO 20347.



dpvlink 7219

| Article       | Color  | Upper  | Size  |
|---------------|--------|--------|-------|
| 2505.201.K717 | purple | nubuck | 35-42 |
| 2505.201.K56  | black  | nubuck | 35-42 |
| 2505.201.K714 | camel  | nubuck | 35-42 |
| 2505.201.K713 | apple  | nubuck | 35-42 |
| 2505.201.K59  | marine | nubuck | 35-42 |





## Clog DPV-komfort



Women's / Men's clog with perforation; air cushion cork footbed and cowhide upper leather. DIN EN ISO 20347.



### dpvlink 055



| Article       | Color | Upper   | Size  |
|---------------|-------|---------|-------|
| 2505.211.00   | white | leather | 35-41 |
| 2505.211-1.00 | white | leather | 42-48 |
| 2505.211.11   | blue  | leather | 35-41 |
| 2505.211-1.11 | blue  | leather | 42-48 |
| 2505.211.16   | black | leather | 35-41 |
| 2505.211-1.16 | black | leather | 42-48 |
| 2505.211.51   | navy  | nubuck  | 35-41 |
| 2505.211-1.51 | navy  | nubuck  | 42-48 |

## Clog DPV-komfort



Women's / Men's clog with instep strap; full-grain leather and air cushion cork footbed. DIN EN ISO 20347.



### dpvlink 033



| Article       | Color | Upper   | Size  |
|---------------|-------|---------|-------|
| 2505.201.00   | white | leather | 35-41 |
| 2505.201-1.00 | white | leather | 42-48 |
| 2505.201.11   | blue  | leather | 35-41 |
| 2505.201-1.11 | blue  | leather | 42-48 |
| 2505.201.16   | black | leather | 35-41 |
| 2505.201-1.16 | black | leather | 42-48 |
| 2505.201.51   | navy  | nubuck  | 35-41 |
| 2505.201-1.51 | navy  | nubuck  | 42-48 |

## Clog with heel strap DPV-komfort



Women's / Men's clog with heel strap; air cushion cork footbed; cowhide upper leather. DIN EN ISO 20347.



### dpvlink 068



| Article       | Color | Upper   | Size  |
|---------------|-------|---------|-------|
| 2505.251.00   | white | leather | 35-41 |
| 2505.251-1.00 | white | leather | 42-48 |
| 2505.251.11   | blue  | leather | 35-41 |
| 2505.251-1.11 | blue  | leather | 42-48 |
| 2505.251.16   | black | leather | 35-41 |
| 2505.251-1.16 | black | leather | 42-48 |
| 2505.251.51   | navy  | nubuck  | 35-41 |
| 2505.251-1.51 | navy  | nubuck  | 42-48 |

## Clog with heel strap DPV-komfort



Women's / Men's clog with heel strap; perforation; cowhide upper leather; air cushion cork footbed. DIN EN ISO 20347.



### dpvlink 079



| Article       | Color | Upper   | Size  |
|---------------|-------|---------|-------|
| 2505.261.00   | white | leather | 35-41 |
| 2505.261-1.00 | white | leather | 42-48 |
| 2505.261.11   | blue  | leather | 35-41 |
| 2505.261-1.11 | blue  | leather | 42-48 |
| 2505.261.16   | black | leather | 35-41 |
| 2505.261-1.16 | black | leather | 42-48 |
| 2505.261.51   | navy  | nubuck  | 35-41 |
| 2505.261-1.51 | navy  | nubuck  | 42-48 |

# BIRKENSTOCK

## PROFESSIONAL



**BIRKENSTOCK** ESD shoes dissipate electrostatic charges through embedding and outsole. The original **BIRKENSTOCK** footbed as well as the entire outsole are completely conductive, since only materials are used that guarantee a bleeder resistance of  $10^5$  to  $10^6$  Ohm. The breathable upper material Birko-flor ensures improved wearing comfort.

In compliance with the ESD standard DIN EN 61340-5-1

Optimale Paßform durch zwei Weiten



für normale kräftige Füße



für schmale schlanke Füße

BEST PROTECTION AGAINST DISCHARGE DUE TO TÜV-CERTIFIED SANDALS AND CLOGS

01 The anatomic shape offers enough space for toes and foot, supports the balance and contributes to healthy feet.

02 An integrated antistatic agent provides permanent discharge of electrostatic charge.

03 Distinctive footbed shapes fit to the natural shape of the sole.

04 The shock-absorbing cork core imitates exactly the sole shape.

05 The deep heel cup keeps the foot firmly in the footbed and supports the natural posture.



- **Latex heel pad:** has shock-absorbing effect when placing the foot
- **Cover made of suede leather:** adapts softly to the sole
- **Footbed core of Alpro® foam:** millions of microscopic air bubbles offer best absorption

### Slippers, sandals

#### Bilbao ESD Birko-Flor



Slipper Bilbao ESD; with two buckles and soft footbed; outsole slip-resistant, oil- and grease-resistant, non-marking; footbed made of strongly cushioning Alpro foam, very flexible, elastic heel pad; upper material Birko-Flor [BF]. DIN EN ISO 20347.



dpvlink 17504

| Article                      | Color | Width  | Size  |
|------------------------------|-------|--------|-------|
| <b>Bilbao ESD Birko-Flor</b> |       |        |       |
| 520840                       | black | normal | 39-46 |
| 520848                       | black | slim   | 36-42 |



#### Kano ESD Birko-Flor



Sandal Kano ESD; with two buckles and soft footbed; outsole slip-resistant oil- and grease-resistant, non-marking; footbed made of strongly cushioning Alpro foam, very flexible, elastic heel pad; upper material Birko-Flor [BF]. DIN EN ISO 20347.



dpvlink 17507

| Article                    | Color | Width  | Size  |
|----------------------------|-------|--------|-------|
| <b>Kano ESD Birko-Flor</b> |       |        |       |
| 500580                     | black | normal | 39-46 |
| 500588                     | black | slim   | 36-42 |



#### Milano ESD Birko-Flor



Sandal Milano ESD, with two buckles and heel strap; original BIRKENSTOCK footbed with completely conductive bedding; upper material Birko-Flor [BF]. DIN EN ISO 20347.



dpvlink 17544

| Article                      | Color | Width  | Size  |
|------------------------------|-------|--------|-------|
| <b>Milano ESD Birko-Flor</b> |       |        |       |
| 634790                       | black | normal | 35-46 |
| 634790-1                     | black | normal | 47-48 |
| 634798                       | black | slim   | 35-46 |
| 634798-1                     | black | slim   | 47-48 |
| 634880                       | white | normal | 35-46 |
| 634880-1                     | white | normal | 47-48 |
| 634888                       | white | slim   | 35-46 |
| 634888-1                     | white | slim   | 47-48 |





## Arizona ESD Birko-Flor



Slipper Arizona ESD, with two buckles; BIRKENSTOCK footbed with completely conductive bedding, upper material Birko-Flor [BF]. DIN EN ISO 20347.



**dpvlink 17527**

| Article                       | Color | Width  | Size  |
|-------------------------------|-------|--------|-------|
| <b>Arizona ESD Birko-Flor</b> |       |        |       |
| 089410                        | white | normal | 36-46 |
| 089410-1                      | white | normal | 47-48 |
| 089418                        | white | slim   | 35-46 |
| 089418-1                      | white | slim   | 47-48 |
| 089420                        | black | normal | 35-46 |
| 089420-1                      | black | normal | 47-48 |
| 089428                        | black | slim   | 35-46 |
| 089428-1                      | black | slim   | 47-48 |
| 089430                        | blue  | normal | 35-46 |
| 089430-1                      | blue  | normal | 47-48 |
| 089438                        | blue  | slim   | 35-46 |
| 089438-1                      | blue  | slim   | 47-48 |



## Arizona ESD Birko-Flor



Slipper Arizona ESD, with two buckles; original BIRKENSTOCK footbed with completely conductive bedding; upper material Birko-Flor [BF]. DIN EN ISO 20347.



Lieferbar ab Sommer

**dpvlink 24885**

| Article                       | Color              | Width | Size  |
|-------------------------------|--------------------|-------|-------|
| <b>Arizona ESD Birko-Flor</b> |                    |       |       |
| 1021400                       | turquoise / flower | slim  | 35-43 |
| 1021411                       | rose / flower      | slim  | 35-43 |



## Kay ESD Birko-Flor



Clog ESD, instep strap with buckle, foldable heel strap; BIRKENSTOCK footbed with completely conductive bedding, upper material Birko-Flor [BF]. DIN EN ISO 20347.



Lieferbar ab Sommer

**dpvlink 24888**

| Article                   | Color              | Width | Size  |
|---------------------------|--------------------|-------|-------|
| <b>Kay ESD Birko-Flor</b> |                    |       |       |
| 1020876                   | turquoise / flower | slim  | 35-43 |
| 1020945                   | rose / flower      | slim  | 35-43 |



## Boston ESD leather



Clog Boston ESD, instep strap with buckle; original BIRKENSTOCK footbed with completely conductive bedding; upper material genuine leather, breathable. DIN EN ISO 20347.



**dpvlink 17557**

| Article                   | Color | Width  | Size  |
|---------------------------|-------|--------|-------|
| <b>Boston ESD leather</b> |       |        |       |
| 061380                    | blue  | normal | 39-46 |
| 061388                    | blue  | slim   | 36-42 |
| 061370                    | white | normal | 39-46 |
| 061378                    | white | slim   | 36-42 |
| 061360                    | black | normal | 39-46 |
| 061368                    | black | slim   | 36-42 |
| 061360-1                  | black | normal | 47-48 |
| 061370-1                  | white | normal | 47-48 |
| 061380-1                  | blue  | normal | 47-48 |



## Tokio ESD leather



Clog Tokio ESD, instep strap with buckle; heel strap; original BIRKENSTOCK footbed with completely conductive bedding; upper material genuine leather, breathable. DIN EN ISO 20347.



**dpvlink 17564**

| Article                  | Color | Width  | Size  |
|--------------------------|-------|--------|-------|
| <b>Tokio ESD leather</b> |       |        |       |
| 061410                   | white | normal | 39-46 |
| 061418                   | white | slim   | 36-42 |
| 061390                   | blue  | normal | 39-46 |
| 061398                   | blue  | slim   | 36-42 |
| 061400                   | black | normal | 39-46 |
| 061408                   | black | slim   | 36-42 |
| 061390-1                 | blue  | normal | 47-48 |
| 061400-1                 | black | normal | 47-48 |
| 061410-1                 | white | normal | 47-48 |



Linz ESD leather



Clog Linz ESD, closed heel area / velcro fastener; original BIRKENSTOCK footbed with completely conductive bedding; upper material leather, breathable. DIN EN ISO 20347.



dpvlink 17576

| Article                 | Color | Width  | Size  |
|-------------------------|-------|--------|-------|
| <b>Linz ESD leather</b> |       |        |       |
| 583150                  | white | normal | 39-46 |
| 583158                  | white | slim   | 36-42 |
| 583160                  | black | normal | 39-46 |
| 583168                  | black | slim   | 36-42 |



Occupational and safety footwear

Sneaker Q0 / QS 500 ESD



Sneaker Q0 500 ESD O2; original BIRKENSTOCK footbed with completely conductive bedding, exchangeable; upper leather; nitrile/caoutchouc outsole, oil- and fuel-resistant, slip-resistant (SRC)

Variant safety shoe QS 500 ESD S3 additionally with steel toe cap; scratch-resistant tip protection; penetration protection (metal-free)



dpvlink 21174

| Article                        | Color | Size  | Category | Protective toe cap |
|--------------------------------|-------|-------|----------|--------------------|
| <b>Sneaker Q0 / QS 500 ESD</b> |       |       |          |                    |
| 1011365                        | black | 35-46 | O2       |                    |
| 1011365-1                      | black | 47-48 | O2       |                    |
| 1011366                        | white | 35-46 | O2       |                    |
| 1011366-1                      | white | 47-48 | O2       |                    |
| 1011363                        | black | 35-46 | S3       | steel              |
| 1011363-1                      | black | 47-48 | S3       | steel              |
| 1011364                        | white | 35-46 | S3       | steel              |
| 1011364-1                      | white | 47-48 | S3       | steel              |



ABEBA®  
Berufs- und Sicherheitsschuhe

ABEBA ESD protective work footwear reconciling ideal protection with best wearing comfort and a healthy foot climate.  
In compliance with the ESD standard DIN EN 61340-5-1



- SRC slip-resistance:** according to EN ISO 20347:2012
- TPU outsole:** abrasion-resistant
- resistant:** to animal fats, oil and fuel
- flex zones:** for walking comfort

- ESD-geprüfte Schuhe**  
nach EN 61340
- Berufsschuhe OB**  
nach EN ISO 20347
- Berufsschuhe O1**  
nach EN ISO 20347
- Berufsschuhe O2**  
nach EN ISO 20347
- Sicherheitsschuhe SB**  
nach EN ISO 20345
- Sicherheitsschuhe S1**  
nach EN ISO 20345
- Sicherheitsschuhe S1P**  
nach EN ISO 20345
- Sicherheitsschuhe S2**  
nach EN ISO 20345
- Sicherheitsschuhe S3**  
nach EN ISO 20345
- Zehenschutzkappe aus Stahl**
- Zehenschutzkappe aus Kunststoff**
- Zehenschutzkappe aus Aluminium**
- Metallfrei**
- Washbar bei 30°C**  
(Reinigung mit Wasser ohne Zusätze)
- Washbar bei 60°C**  
(Reinigung mit Wasser ohne Zusätze)
- Hazard Analysis Critical Control Points**
- Atmungsaktiv**  
(Atmungsaktives Innenfutter)
- Einlegesohle auswechselbar**
- Sohlenerhöhung möglich**
- Besonders gute Dämpfung**
- geeignet für orthopädische Einlegesohlen nach DGUV**
- Zertifiziert für orthopädische Einlage ORTHOstat**
- geeignet für orthopädische Einlegesohlen Secosol®**
- Sanitized® behandelt (geruchs- und bakterienhemmend)**

## Clogs

### Slipper / sandal NATURE



Slipper with two adjustable instep strap with velcro fastener; upper leather; cork footbed; metal-free; no lining; leather-covered; oil and benzine-resistant, acid- and alkali-resistant special rubber outsole, slip-resistant (SRC).

### NATURE



dpvlink 1003

| Article                        | Color | Size  | Category | Form    |
|--------------------------------|-------|-------|----------|---------|
| <b>Slipper / sandal NATURE</b> |       |       |          |         |
| AB-4080                        | white | 34-48 | OB       | slipper |
| AB-4085                        | black | 34-48 | OB       | slipper |
| AB-4090                        | white | 34-48 | OB       | sandal  |

### Slipper / Sandal NATURE



Slipper / sandal with two adjustable instep straps; upper nubuck leather; metal-free, no lining; cork footbed; leather covered; oil- and benzine-resistant, acid- and alkali-resistant outsole of special rubber, slip-resistant (SRC).

### NATURE



dpvlink 15893

| Article                        | Color | Size  | Category | Form    |
|--------------------------------|-------|-------|----------|---------|
| <b>Slipper / Sandal NATURE</b> |       |       |          |         |
| AB-4086                        | blue  | 34-48 | OB       | slipper |
| AB-4096                        | blue  | 34-48 | OB       | sandal  |

### Women's slipper Reflexor



Women's slipper; upper and lining leather; hand-sewn seam; extremely light PU outsole, fuel-resistant; fixed Reflexor® footbed, slip-resistant.

### Reflexor



dpvlink 14360

| Article                         | Color | Size  |
|---------------------------------|-------|-------|
| <b>Women's slipper Reflexor</b> |       |       |
| AB-31094                        | white | 36-42 |
| AB-31092                        | black | 36-42 |

### Women's slipper Reflexor



Women's slipper with three adjustable instep straps with velcro fastener; upper smooth leather and leather lining; hand-sewn seam; exchangeable insole; extremely light PU outsole, fuel-resistant, slip-resistant (SRC).

### Reflexor



dpvlink 964

| Article                         | Color | Size  | Category |
|---------------------------------|-------|-------|----------|
| <b>Women's slipper Reflexor</b> |       |       |          |
| AB-36902                        | white | 36-42 | OB       |
| AB-36912                        | black | 36-42 | OB       |

### Clog with heel strap x-light



Clog with adjustable and foldable heel strap. Elastic band over instep; upper smooth leather; lining with silver ions: sanitized treated; exchangeable insole; oil- and benzine-resistant PU outsole, slip-resistant (SRC).

### x-light



dpvlink 22608

| Article                             | Color | Size  | Category |
|-------------------------------------|-------|-------|----------|
| <b>Clog with heel strap x-light</b> |       |       |          |
| AB-7131141                          | white | 35-48 | OB       |
| AB-7131142                          | black | 35-48 | OB       |

### Clog with heel strap DYNAMIC



Clog with fixed heel strap; upper knitted textile; water-repellent; breathable lining; shock-absorbing, exchangeable insole; oil- and fuel-resistant TPU outsole, slip-resistant (SRC).

### DYNAMIC



dpvlink 22850

| Article                             | Color              | Size  | Category |
|-------------------------------------|--------------------|-------|----------|
| <b>Clog with heel strap DYNAMIC</b> |                    |       |          |
| AB-37326                            | light blue / white | 35-48 | OB       |
| AB-37327                            | red / white        | 35-48 | OB       |
| AB-37328                            | anthracite / white | 35-48 | OB       |
| AB-37329                            | white              | 35-48 | OB       |

**Clog with heel strap DYNAMIC**



Clog with adjustable, foldable heel strap; upper material smooth leather; moisture-absorbing lining; shock-absorbing, exchangeable insole with heel cup; functional joint stabilizer; oil- and benzine-resistant outsole, ABEBA special profile, slip-resistant (SRC).



**DYNAMIC**



dpvlink 16640



| Article                             | Color         | Size  | Category |
|-------------------------------------|---------------|-------|----------|
| <b>Clog with heel strap DYNAMIC</b> |               |       |          |
| AB-37310                            | white         | 35-48 | OB       |
| AB-37312                            | white / blue  | 35-48 | OB       |
| AB-37313                            | white / red   | 35-48 | OB       |
| AB-37315                            | black / brown | 35-48 | OB       |

**Clog with heel strap DYNAMIC**



Clog with cushioning in the instep; adjustable fixed heel strap; upper material A-micro (microfiber); **breathable textile insert**; HACCP compatible; moisture-absorbing lining; shock-absorbing, exchangeable insole with heel cup; functional joint stabilizer; oil- and benzine-resistant outsole, ABEBA special profile, slip-resistant (SRC).



**DYNAMIC**



dpvlink 16635



| Article                             | Color          | Size  | Category |
|-------------------------------------|----------------|-------|----------|
| <b>Clog with heel strap DYNAMIC</b> |                |       |          |
| AB-37341                            | black / blue   | 35-48 | OB       |
| AB-37342                            | black / red    | 35-48 | OB       |
| AB-37343                            | black / yellow | 35-48 | OB       |
| AB-37345                            | white / black  | 35-48 | OB       |

**Clog with heel strap DYNAMIC**



Clog with cushioning in the instep; adjustable fixed heel strap; upper material A-micro (microfiber); HACCP compatible; moisture-absorbent lining; shock-absorbing, exchangeable insole with heel cup; functional joint stabilizer; oil- and benzine-resistant outsole, ABEBA special profile, slip-resistant (SRC).



**DYNAMIC**



dpvlink 16629



| Article                             | Color          | Size  | Category |
|-------------------------------------|----------------|-------|----------|
| <b>Clog with heel strap DYNAMIC</b> |                |       |          |
| AB-37331                            | black / blue   | 35-48 | OB       |
| AB-37332                            | black / red    | 35-48 | OB       |
| AB-37333                            | black / yellow | 35-48 | OB       |
| AB-37335                            | white / black  | 35-48 | OB       |

**Clog with heel strap DYNAMIC**



Clog with adjustable, fixed heel strap; upper material A-micro (microfiber); HACCP compatible; moisture-absorbing lining; shock-absorbing, exchangeable insole with heel cup; functional joint stabilizer; oil- and benzine-resistant outsole, ABEBA special profile, slip-resistant (SRC).



**DYNAMIC**



dpvlink 16647



| Article                             | Color        | Size  | Category |
|-------------------------------------|--------------|-------|----------|
| <b>Clog with heel strap DYNAMIC</b> |              |       |          |
| AB-37360                            | white        | 35-48 | OB       |
| AB-37361                            | black        | 35-48 | OB       |
| AB-37363                            | grey / red   | 35-48 | OB       |
| AB-37365                            | grey / black | 35-48 | OB       |

## Clog with heel strap easy

Clog with adjustable fixed heel strap; upper material smooth leather; perforated; shock-absorbing, exchangeable insole with heel cup; oil- and benzine-resistant outsole, ABEBA special profile, slip-resistant (SRC).



dpvlink 16655



| Article                          | Color | Size  | Category |
|----------------------------------|-------|-------|----------|
| <b>Clog with heel strap easy</b> |       |       |          |
| AB-37630                         | white | 35-48 | OB       |
| AB-37631                         | black | 35-48 | OB       |

## Clog with heel strap the ORIGINAL

Clog with top layer microfiber; adjustable foldable heel strap: upper material A-micro (microfiber); slip-resistant TPU outsole; sanitized treated; TPU outsole, slip-resistant (SRC).



the ORIGINAL 



dpvlink 17413



| Article                                  | Color | Size  | Category | Upper                   |
|--|-------|-------|----------|-------------------------|
| <b>Clog with heel strap the ORIGINAL</b> |       |       |          |                         |
| AB-37520                                 | white | 36-42 | OB       | microfiber / perforated |
| AB-37521                                 | white | 36-42 | OB       | microfiber              |
| AB-37530                                 | black | 36-42 | OB       | microfiber / perforated |
| AB-37531                                 | black | 36-42 | OB       | microfiber              |

## Women's clog with wedge heel high ORIGINAL

Women's clog with wedge heel (45mm); adjustable and foldable heel strap; upper smooth leather, perforated; top layer leather; oil- and benzine-resistant, PU outsole, slip-resistant (SRC).



dpvlink 15884



| Article   | Color | Size  | Category |
|---|-------|-------|----------|
| <b>Women's clog with wedge heel high ORIGINAL</b> |       |       |          |
| AB-5009   | black | 36-42 | OB       |
| AB-5008   | white | 36-42 | OB       |

## Clog with heel strap rubber

Clog with adjustable and foldable heel strap. Upper smooth leather; perforated; top layer leather; oil- and benzine-resistant, acid- and alkali-resistant rubber outsole, slip-resistant (SRA).



dpvlink 137



| Article                            | Color | Size  | Category |
|------------------------------------|-------|-------|----------|
| <b>Clog with heel strap rubber</b> |       |       |          |
| AB-5300                            | white | 36-47 | OB       |
| AB-5310                            | black | 36-47 | OB       |

## Women's clog with wedge heel high ORIGINAL

Women's clog with wedge heel (45mm); suitable for **very slim** feet; adjustable and foldable heel strap; upper smooth leather; top layer leather; oil- and benzine-resistant PU outsole, slip-resistant (SRC).



dpvlink 973



| Article   | Color | Size  | Category | Upper                |
|---|-------|-------|----------|----------------------|
| <b>Women's clog with wedge heel high ORIGINAL</b> |       |       |          |                      |
| AB-5001   | white | 36-42 | OB       | leather / perforated |
| AB-5004   | white | 36-42 | OB       | leather              |

## Clog with heel strap Arrow

Clog with top layer microfiber; adjustable foldable heel strap: upper material A-micro (microfiber), perforated; sanitized treated; wear-resistant PU outsole, slip-resistant (SRA).



Arrow



dpvlink 17419



| Article                           | Color | Size  | Category |
|-----------------------------------|-------|-------|----------|
| <b>Clog with heel strap Arrow</b> |       |       |          |
| AB-38330                          | black | 35-47 | OB       |
| AB-38332                          | black | 48-51 | OB       |

**Clog with heel strap Arrow**



Clog with fixed heel strap with velcro fastener. Upper smooth leather, perforated; elastic band over instep; lining leather; shock-absorbing PU midsole; abrasion-resistant, oil- and benzine-resistant PU compact outsole, slip-resistant (SRC).



**Arrow**



dpvlink 161

| Article                           | Color | Size  | Category |
|-----------------------------------|-------|-------|----------|
| <b>Clog with heel strap Arrow</b> |       |       |          |
| AB-38600                          | white | 36-47 | OB       |
| AB-38602                          | white | 48-51 | OB       |



**Clog with heel strap Arrow**



Clog with adjustable and foldable heel strap. Upper smooth leather; lining leather; top layer leather; shock-absorbing PU midsole; abrasion-resistant, oil- and benzine-resistant PU outsole, slip-resistant (SRA).



**Arrow**



dpvlink 976

| Article                           | Color | Size  | Category | Upper                |
|-----------------------------------|-------|-------|----------|----------------------|
| <b>Clog with heel strap Arrow</b> |       |       |          |                      |
| AB-38200                          | white | 36-47 | OB       | leather              |
| AB-38202                          | white | 48-51 | OB       | leather              |
| AB-38210                          | black | 36-47 | OB       | leather              |
| AB-38212                          | black | 48-51 | OB       | leather              |
| AB-35600                          | white | 36-47 | OB       | leather / perforated |
| AB-35602                          | white | 48-51 | OB       | leather / perforated |



**Clog with heel strap NATURE**



Clog with fixed heel strap with adjustable instep strap; upper leather; no lining; cork footbed, leather-covered; oil- and benzine-resistant, acid- and alkali-resistant special rubber outsole, slip-resistant (SRC).



**NATURE**



dpvlink 983

| Article                            | Color  | Size  | Category | Upper                |
|------------------------------------|--------|-------|----------|----------------------|
| <b>Clog with heel strap NATURE</b> |        |       |          |                      |
| AB-4055                            | black  | 34-48 | OB       | leather              |
| AB-4040                            | white  | 34-48 | OB       | leather              |
| AB-4045                            | marine | 34-48 | OB       | leather / perforated |
| AB-4050                            | white  | 34-48 | OB       | leather / perforated |



**Women's clog Reflexor**



Women's clog with fixed heel strap; elastic band over instep; upper and lining leather; hand-sewn seam; fixed Reflexor® massage footbed; extremely light PU outsole, slip-resistant, fuel-resistant.



**Reflexor**



dpvlink 14444

| Article                      | Color         | Size  |
|------------------------------|---------------|-------|
| <b>Women's clog Reflexor</b> |               |       |
| AB-31064                     | black / white | 36-42 |



**Women's clog with heel strap Reflexor**



Women's clog with adjustable and foldable heel strap, elastic band over instep; upper smooth leather, lining microfiber; hand-sewn seam; exchangeable insole; extremely light PU outsole, fuel-resistant, slip-resistant (SRC):



**Reflexor**



dpvlink 967

| Article                                      | Color | Size  | Category |
|--|-------|-------|----------|
| <b>Women's clog with heel strap Reflexor</b> |       |       |          |
| AB-36903                                     | white | 36-42 | OB       |
| AB-36913                                     | black | 36-42 | OB       |



## Women's shoes XXL width

### Women's slipper XXL



Women's slipper with two adjustable instep straps (velcro fastener); upper smooth leather; lining microfiber, hand-sewn seam; exchangeable insole; extremely light PU outsole, slip resistant (SRB).



### Reflexor



dpvlink 14414



| Article                    | Color | Size  | Category |
|----------------------------|-------|-------|----------|
| <b>Women's slipper XXL</b> |       |       |          |
| AB-36809                   | white | 36-43 | OB       |
| AB-36819                   | black | 36-43 | OB       |

#### Women's slipper XXL

|          |       |       |    |
|----------|-------|-------|----|
| AB-36809 | white | 36-43 | OB |
| AB-36819 | black | 36-43 | OB |

### Women's sandal XXL



Women's sandal with adjustable heel strap; elastic band over instep; upper smooth leather, lining microfiber; hand-sewn seam; exchangeable insole; extremely light PU outsole, fuel-resistant, slip-resistant (SRB).



### Reflexor



dpvlink 14417



| Article                   | Color | Size  | Category | Upper   |
|---------------------------|-------|-------|----------|---------|
| <b>Women's sandal XXL</b> |       |       |          |         |
| AB-36872                  | black | 36-43 | OB       | nubuck  |
| AB-36874                  | white | 36-43 | OB       | leather |

#### Women's sandal XXL

|          |       |       |    |         |
|----------|-------|-------|----|---------|
| AB-36872 | black | 36-43 | OB | nubuck  |
| AB-36874 | white | 36-43 | OB | leather |

### Women's clog XXL



Women's clog with adjustable and foldable heel strap; elastic band over instep; upper smooth leather, lining microfiber; hand-sewn seam; exchangeable insole; extremely light PU outsole, fuel-resistant, slip-resistant (SRB).



### Reflexor



dpvlink 14420



| Article                 | Color | Size  | Category |
|-------------------------|-------|-------|----------|
| <b>Women's clog XXL</b> |       |       |          |
| AB-36813                | black | 36-43 | OB       |

#### Women's clog XXL

|          |       |       |    |
|----------|-------|-------|----|
| AB-36813 | black | 36-43 | OB |
|----------|-------|-------|----|

## Occupational and safety footwear

### Loafer dynamic flow



Loafer. Upper knitted textile (breathable); closure with double rubber band, elastic entry; exchangeable insole; oil- and fuel-resistant TPU outsole, slip-resistant (SRC).

### DYNAMIC flow



dpvlink 24572



| Article                    | Color              | Size  | Category |
|----------------------------|--------------------|-------|----------|
| <b>Loafer dynamic flow</b> |                    |       |          |
| AB-37374                   | red / white        | 35-48 | 01       |
| AB-37375                   | anthracite / white | 35-48 | 01       |
| AB-37376                   | black / light blue | 35-48 | 01       |

#### Loafer dynamic flow

|          |                    |       |    |
|----------|--------------------|-------|----|
| AB-37374 | red / white        | 35-48 | 01 |
| AB-37375 | anthracite / white | 35-48 | 01 |
| AB-37376 | black / light blue | 35-48 | 01 |

### Low shoe dynamic flow



Lace-up shoe. Upper microfiber; lining with silver ions; exchangeable insole; oil- and fuel-resistant TPU outsole, slip-resistant (SRC).



### DYNAMIC flow



dpvlink 24580



| Article                      | Color | Size  | Category |
|------------------------------|-------|-------|----------|
| <b>Low shoe dynamic flow</b> |       |       |          |
| AB-37370                     | white | 35-43 | 01       |

#### Low shoe dynamic flow

|          |       |       |    |
|----------|-------|-------|----|
| AB-37370 | white | 35-43 | 01 |
|----------|-------|-------|----|

Safety shoe



Lace-up shoe. Upper knitted textile (breathable); lining with silver ions (moisture-absorbing); protective coating in toe area; midsole Soft-PU; exchangeable insole; oil- and fuel-resistant TPU outsole with flex zones, slip-resistant (SRC).

Variant safety shoe S1, S2 and S3 additionally with steel toe cap



dpvlink 21251

| Article            | Color      | Size  | Category | Protective toe cap |
|--------------------|------------|-------|----------|--------------------|
| <b>Safety shoe</b> |            |       |          |                    |
| AB-36774           | orange     | 35-48 | 01       |                    |
| AB-36772           | white      | 35-48 | 02       |                    |
| AB-36773           | blue       | 35-48 | 01       |                    |
| AB-36775           | anthracite | 35-48 | 01       |                    |
| AB-36776           | black      | 35-48 | 02       |                    |
| AB-31774           | orange     | 35-48 | S1       | steel              |
| AB-31772           | white      | 35-48 | S2       | steel              |
| AB-31773           | blue       | 35-48 | S1       | steel              |
| AB-31775           | anthracite | 35-48 | S1       | steel              |
| AB-31676           | black      | 35-48 | S3       | steel              |

Safety shoe



Safety shoe with lacing. Upper material functional leather with honeycomb design (water-repellent and scratch-resistant); lining with silver ions (moisture-absorbing); dimensionally stable, cushioned shaft edge and counter; PU midsole; exchangeable insole; oil- and fuel-resistant TPU outsole with flex zones, slip-resistant (SRC).

Variant safety shoe S1 and S2 additionally with steel toe cap



dpvlink 16713

| Article            | Color  | Size  | Category | Protective toe cap |
|--------------------|--------|-------|----------|--------------------|
| <b>Safety shoe</b> |        |       |          |                    |
| AB-36761           | black  | 35-48 | 02       |                    |
| AB-36760           | white  | 35-48 | 01       |                    |
| AB-31761           | black  | 35-48 | S2       | steel              |
| AB-31762           | blue   | 35-48 | S1       | steel              |
| AB-31760           | white  | 35-48 | S1       | steel              |
| AB-31763           | marine | 35-48 | S1       | steel              |

Safety shoe



Lace-up shoe. Upper textile (breathable); lining with silver ions (moisture-absorbing); puncture-resistant midsole (metal-free); exchangeable insole; oil- and fuel-resistant TPU outsole with flex zones, slip-resistant (SRC).

Variant safety shoe S3 additionally with steel toe cap and metal-free penetration protection



dpvlink 21249

| Article            | Color | Size  | Category | Protective toe cap |
|--------------------|-------|-------|----------|--------------------|
| <b>Safety shoe</b> |       |       |          |                    |
| AB-36728           | black | 35-48 | 02       |                    |
| AB-36729           | white | 35-48 | 02       |                    |
| AB-31628           | black | 35-48 | S3       | steel              |
| AB-31629           | white | 35-48 | S3       | steel              |

Safety shoe



Lace-up shoe. Upper material smooth leather/suede; breathable textile inserts; reflector stripes; lining with silver ions; cushioned shaft edge and counter; functional joint stabilizer; Soft-PU midsole; exchangeable insole; oil- and fuel-resistant TPU outsole with flex zones, slip-resistant (SRC).

Variant safety shoe S1 additionally with steel toe cap



dpvlink 16704

| Article            | Color | Size  | Category | Protective toe cap |
|--------------------|-------|-------|----------|--------------------|
| <b>Safety shoe</b> |       |       |          |                    |
| AB-36721           | black | 35-48 | 01       |                    |
| AB-31721           | black | 35-48 | S1       | steel              |

Safety sandal



Sandal with velcro fastener; microfiber; moisture-absorbing and breathable microfiber lining; sanitized treatment, Soft-PU midsole; exchangeable insole; oil- and fuel-resistant TPU outsole with flex zones, slip-resistant (SRC).



dpvlink 18472

| Article              | Color | Size  | Category | Protective toe cap |
|----------------------|-------|-------|----------|--------------------|
| <b>Safety sandal</b> |       |       |          |                    |
| AB-36795             | white | 35-48 | 01       |                    |
| AB-31795             | white | 35-48 | S1       | steel              |



## Loafer



Loafer with upper material A-micro (microfiber); lining with silver ions; elastic in the instep; sanitized treatment, Soft-PU midsole; exchangeable insole; oil- and fuel-resistant TPU outsole with flex zones, slip-resistant (SRC).



dpvlink 18469

| Article       | Color | Size  | Category |
|---------------|-------|-------|----------|
| <b>Loafer</b> |       |       |          |
| AB-36740      | white | 35-48 | 02       |
| AB-36741      | black | 35-48 | 02       |



## Loafer air cushion



Men's loafer. Upper smooth leather; exchangeable insole; extremely light, oil- and benzene-resistant PU air cushion outsole, slip-resistant (SRA).



dpvlink 1030

| Article                   | Color | Size  | Category |
|---------------------------|-------|-------|----------|
| <b>Loafer air cushion</b> |       |       |          |
| AB-32700                  | white | 39-47 | 02       |
| AB-32710                  | black | 39-47 | 02       |



## Low shoe air cushion



Lace-up shoe. Upper smooth leather, lining leather; exchangeable insole; extremely light, oil- and benzene-resistant PU air cushion outsole; slip-resistant (SRA).



dpvlink 1026

| Article                     | Color | Size  | Category |
|-----------------------------|-------|-------|----------|
| <b>Low shoe air cushion</b> |       |       |          |
| AB-32600                    | white | 35-47 | 02       |
| AB-32610                    | black | 39-47 | 02       |



## Lace-up shoe



Lace-up shoe. Upper leather, lining with silver ions, exchangeable insole; extremely light, oil- and benzene-resistant PU air cushion outsole, slip-resistant (SRA).



dpvlink 15905

| Article             | Color | Size  | Category |
|---------------------|-------|-------|----------|
| <b>Lace-up shoe</b> |       |       |          |
| AB-32650            | black | 35-47 | 02       |



## Loafer air cushion



Loafer; upper smooth leather, perforated; exchangeable insole; extremely light, oil- and benzene-resistant PU air cushion outsole, slip-resistant (SRA).



dpvlink 1034

| Article                   | Color | Size  | Category |
|---------------------------|-------|-------|----------|
| <b>Loafer air cushion</b> |       |       |          |
| AB-32310                  | black | 39-47 | 01       |
| AB-32300                  | white | 35-47 | 01       |



## Low shoe CRAWLER



Safety shoe with lacing, suede / smooth leather. Breathable lining with silver ions; scratch-resistant coating in toe and heel area; absorbing PU midsole; steel toe cap; dimensionally stable shaft edge padding and counter; shock-absorbing exchangeable insole; TPU outsole with continuous water groove; ABEBA special profile, antistatic, slip-resistant (SRC).



dpvlink 17946

| Article                 | Color        | Size  | Category | Protective toe cap | Form     |
|-------------------------|--------------|-------|----------|--------------------|----------|
| <b>Low shoe CRAWLER</b> |              |       |          |                    |          |
| AB-34621                | black / blue | 36-48 | S2       | steel              | low shoe |



Low shoe CRAWLER



Safety shoe; lining with silver ions; cushioning PU midsole; aluminum toe cap; dimensionally stable shaft edge padding and counter; shock-absorbing exchangeable insole; TPU outsole with continuous water channel; ABEBA special profile, antistatic, slip-resistant (SRC).



CRAWLER



dpwlink 17346



| Article                 | Color        | Size  | Category | Protective toe cap |
|-------------------------|--------------|-------|----------|--------------------|
| <b>Low shoe CRAWLER</b> |              |       |          |                    |
| AB-34581                | black / blue | 36-48 | S1       | aluminum           |

Clog CRAWLER



Safety clog with adjustable instep strap and fix heel strap. Microfiber, breathable lining with silver ions; aluminum toe cap; foamed PU midsole; shock-absorbing exchangeable insole; TPU outsole with continuous water groove; ABEBA special profile, antistatic, slip-resistant (SRC).



CRAWLER



dpwlink 18463



| Article             | Color | Size  | Category | Protective toe cap |
|---------------------|-------|-------|----------|--------------------|
| <b>Clog CRAWLER</b> |       |       |          |                    |
| AB-34555            | white | 36-48 | SB       | aluminum           |
| AB-34556            | black | 36-48 | SB       | aluminum           |

Clog Classic



Safety clog with adjustable instep and fixed heel strap; Upper and top layer leather, lining grained leather; steel toe cap; extremely light, shock-absorbing, oil- and benzene-resistant mono PU outsole, slip-resistant (SRC).



Classic



dpwlink 322



| Article             | Color | Size  | Category | Protective toe cap |
|---------------------|-------|-------|----------|--------------------|
| <b>Clog Classic</b> |       |       |          |                    |
| AB-31000            | white | 36-46 | SB       |                    |
| AB-31010            | black | 36-46 | SB       |                    |

Clog Classic



Safety clog with adjustable instep and fixed heel strap; upper A-micro, steel toe cap; extremely light, shock-absorbing, oil- and benzene-resistant mono PU outsole, slip-resistant (SRC).



Classic



dpwlink 15929



| Article             | Color | Size  | Category |
|---------------------|-------|-------|----------|
| <b>Clog Classic</b> |       |       |          |
| AB-31011            | black | 36-46 | SB       |
| AB-31001            | white | 36-46 | SB       |

Low shoe x-light



Safety lace-up shoe with breathable air mesh textile inserts; reflective stripes; upper smooth leather, lining with silver ions; steel toe cap; exchangeable insole; extremely light, oil- and benzene-resistant PU outsole, shock-absorbing, slip-resistant (SRC).



x-light



dpwlink 23722



| Article                 | Color       | Size  | Category |
|-------------------------|-------------|-------|----------|
| <b>Low shoe x-light</b> |             |       |          |
| AB-7131056              | black / red | 35-48 | S1       |

Safety shoe x-light



Lace-up shoe with breathable air mesh textile inserts; upper smooth leather, lining with silver ions; exchangeable insole; extremely light, oil- and benzene-resistant PU outsole, shock-absorbing, slip-resistant (SRC).

Variant safety shoe S1 additionally with steel toe cap



x-light



dpwlink 23724



| Article                    | Color | Size  | Category | Protective toe cap |
|----------------------------|-------|-------|----------|--------------------|
| <b>Safety shoe x-light</b> |       |       |          |                    |
| AB-7131158                 | white | 35-48 | 01       |                    |
| AB-7131058                 | white | 35-48 | S1       | steel              |

## Clog x-light



Safety clog with adjustable and foldable heel strap. Elastic band over instep; upper smooth leather; lining with silver ions; steel toe cap; sanitized treated; exchangeable insole; extremely light, shock-absorbing, oil- and benzine-resistant PU outsole, slip-resistant (SRC).



dpvlink 22620

| Article             | Color | Size  | Category |
|---------------------|-------|-------|----------|
| <b>Clog x-light</b> |       |       |          |
| AB-7131041          | white | 35-48 | SB       |
| AB-7131042          | black | 35-48 | SB       |



## Clog x-light



Safety clog with velcro fastener. Upper smooth leather; lining with silver ions; steel toe cap; sanitized treated; exchangeable insole; extremely light, shock-absorbing, oil- and benzine-resistant PU outsole, slip-resistant (SRC).



dpvlink 22623

| Article             | Color | Size  | Category |
|---------------------|-------|-------|----------|
| <b>Clog x-light</b> |       |       |          |
| AB-7131030          | white | 35-48 | SB       |
| AB-7131035          | black | 35-48 | SB       |



## Sandal x-light



Sandal with breathable air-mesh textile inserts. Double velcro fastener; upper smooth leather; lining with silver ions; sanitized treated; exchangeable insole; extremely light, oil- and benzine-resistant PU outsole, slip-resistant (SRC).

Variant safety shoe S1 additionally with steel toe cap



dpvlink 22626

| Article               | Color | Size  | Category | Protective toe cap |
|-----------------------|-------|-------|----------|--------------------|
| <b>Sandal x-light</b> |       |       |          |                    |
| AB-7131136            | black | 35-48 | 01       |                    |
| AB-7131131            | white | 35-48 | 01       |                    |
| AB-7131036            | black | 35-48 | S1       | steel              |
| AB-7131031            | white | 35-48 | S1       | steel              |



## Loafer x-light



Safety loafer with elastic over instep. Upper smooth leather; lining with silver ions; sanitized treated; exchangeable insole; extremely light, oil- and benzine-resistant PU outsole, slip-resistant (SRC).

Variant safety shoe S2 additionally with steel toe cap



dpvlink 22629

| Article               | Color | Size  | Category | Protective toe cap |
|-----------------------|-------|-------|----------|--------------------|
| <b>Loafer x-light</b> |       |       |          |                    |
| AB-7131137            | black | 35-48 | O2       |                    |
| AB-7131132            | white | 35-48 | O2       |                    |
| AB-7131037            | black | 35-48 | S2       | steel              |
| AB-7131032            | white | 35-48 | S2       | steel              |



## Loafer x-light



Loafer, instep area with elastic band; upper microfiber, breathable, lining with silver ions; exchangeable insole; extremely lightweight oil- and fuel-resistant PU outsole, shock-absorbing, slip-resistant (SRC).



dpvlink 22730

| Article               | Color | Size  | Category |
|-----------------------|-------|-------|----------|
| <b>Loafer x-light</b> |       |       |          |
| AB-7131128            | white | 35-48 | O2       |
| AB-7131129            | black | 35-48 | O2       |



## Lace-up shoe x-light



Lace-up shoe; upper microfiber; breathable lining with silver ions; steel toe cap; reflective stripes; exchangeable insole; PU outsole, slip-resistant (SRC).

Variant safety shoe S1 and S3 additionally with steel toe cap



dpvlink 24652

| Article                     | Color          | Size  | Category | Protective toe cap |
|-----------------------------|----------------|-------|----------|--------------------|
| <b>Lace-up shoe x-light</b> |                |       |          |                    |
| AB-7131150                  | black / orange | 35-48 | O1       |                    |
| AB-7131050                  | black / orange | 35-48 | S1       | steel              |
| AB-7131827                  | black          | 35-48 | S3       | steel              |



Low shoe x-light



Lace-up shoe with reflective stripes. Upper smooth leather; lining with silver ions; sanitized treated; exchangeable insole; extremely light, oil- and benzine-resistant PU outsole, slip-resistant (SRC).

Variant safety shoe S2 additionally with steel toe cap



x-light



dpvlink 22636

| Article                 | Color | Size  | Category | Protective toe cap |
|-------------------------|-------|-------|----------|--------------------|
| <b>Low shoe x-light</b> |       |       |          |                    |
| AB-7131133              | white | 35-48 | O2       |                    |
| AB-7131138              | black | 35-48 | O2       |                    |
| AB-7131033              | white | 35-48 | S2       | steel              |
| AB-7131038              | black | 35-48 | S2       | steel              |

Low shoe x-light



Safety shoe with metal-free penetration protection; upper smooth leather; lining with silver ions; steel toe cap; sanitized treated; exchangeable insole; extremely light, oil- and benzine-resistant PU outsole, shock-absorbing, slip-resistant (SRC).



x-light



dpvlink 22639

| Article                 | Color | Size  | Category |
|-------------------------|-------|-------|----------|
| <b>Low shoe x-light</b> |       |       |          |
| AB-7131874              | black | 35-48 | S3       |

Low shoe x-light



Lace-up shoe. Upper microfiber, breathable, lining with silver ions; exchangeable insole; extremely light, oil- and benzine-resistant PU outsole, slip-resistant (SRC).

Variant safety shoe S2 additionally with steel toe cap



x-light



dpvlink 22743

| Article                 | Color | Size  | Category | Protective toe cap |
|-------------------------|-------|-------|----------|--------------------|
| <b>Low shoe x-light</b> |       |       |          |                    |
| AB-7131127              | black | 35-48 | O2       |                    |
| AB-7131126              | white | 35-48 | O2       |                    |
| AB-7131026              | white | 35-48 | S2       | steel              |
| AB-7131027              | black | 35-48 | S2       | steel              |

Safety loafer x-light



Safety loafer, instep area with elastic band: upper microfiber, breathable, lining with silver ions; steel toe cap; extremely lightweight oil- and fuel-resistant PU outsole, slip-resistant, shock-absorbing; exchangeable insole. EN ISO 20345:2012, S2, SRC



x-light



dpvlink 22740

| Article                      | Color | Size  | Category |
|------------------------------|-------|-------|----------|
| <b>Safety loafer x-light</b> |       |       |          |
| AB-7131028                   | white | 35-48 | S2       |
| AB-7131029                   | black | 35-48 | S2       |

Low shoe x-light



Safety shoe with two velcro fasteners. Overcap with scratch-resistant coating; upper smooth leather; lining with silver ions; steel toe cap; exchangeable insole; extremely light oil- and fuel-resistant TPU outsole, shock-absorbing, slip-resistant (SRC).



x-light



dpvlink 23736

| Article                 | Color | Size  | Category |
|-------------------------|-------|-------|----------|
| <b>Low shoe x-light</b> |       |       |          |
| AB-7131047              | white | 35-48 | S2       |

Safety shoe ANATOM TEC



Safety shoe. Upper Cordura® textile, water-repellent; lining with silver ions (moisture-absorbent); steel toe cap; metal-free penetration protection; exchangeable insole; PU/PU outsole; reflector stripes; slip-resistant (SRC).



anatom



dpvlink 24107

| Article                       | Color         | Size  | Category |
|-------------------------------|---------------|-------|----------|
| <b>Safety shoe ANATOM TEC</b> |               |       |          |
| AB-32252                      | blue / black  | 36-48 | S1P      |
| AB-32251                      | green / black | 36-52 | S3       |
| AB-32238                      | red / black   | 36-48 | S3       |



## Safety sandal ANATOM TEC



Safety sandal with velcro fastener. Upper Cordura® textile, water-repellent; lining with silver ions (moisture-absorbent); steel toe cap; metal-free penetration protection; exchangeable insole; PU/PU outsole; reflector stripes; slip-resistant (SRC).



dpvlink 24103

| Article                         | Color         | Size  | Category |
|---------------------------------|---------------|-------|----------|
| <b>Safety sandal ANATOM TEC</b> |               |       |          |
| AB-32282                        | blue / black  | 36-48 | S1P      |
| AB-32283                        | green / black | 36-52 | S1P      |



## Sandal ANATOM



Safety sandal with double velcro fastener; reflector stripes. Upper breathable A-micro, washable at 30°C; moisture-absorbing, antibacterial special lining with silver threads; steel toe cap; exchangeable insole; two-layer PU outsole with protection from ankle twisting, flexzone, shock absorption, asymmetric heel and torsion waist made of TPU, slip-resistant (SRC).



dpvlink 13785

| Article              | Color | Size  | Category |
|----------------------|-------|-------|----------|
| <b>Sandal ANATOM</b> |       |       |          |
| AB-2616              | white | 36-48 | S1       |
| AB-2616-1            | white | 49-50 | S1       |



## Safety shoe ANATOM TEC



Safety shoe. Upper Cordura® textile, water-repellent; lining with silver ions (moisture-absorbent); steel toe cap; metal-free penetration protection; exchangeable insole; PU/PU outsole; reflector stripes; slip-resistant (SRC).



dpvlink 24110

| Article                       | Color          | Size  | Category |
|-------------------------------|----------------|-------|----------|
| <b>Safety shoe ANATOM TEC</b> |                |       |          |
| AB-32257                      | orange / black | 36-48 | S3       |



## Sandal ANATOM



Safety sandal with adjustable instep, reflector stripes. Upper suede/textile; steel toe cap; exchangeable insole; two-layer PU outsole with protection from ankle twisting, flexzone, shock absorption, asymmetric heel and torsion waist made of TPU, slip-resistant (SRC).



dpvlink 8766

| Article              | Color | Size  | Category |
|----------------------|-------|-------|----------|
| <b>Sandal ANATOM</b> |       |       |          |
| AB-32189             | black | 36-48 | S1       |
| AB-32189-1           | black | 49-52 | S1       |



## Clog ANATOM



Safety clog with adjustable instep, fixed adjustable heel strap. Upper breathable A-micro, washable at 30°C; antibacterial lining with silver ions; steel toe cap; exchangeable insole; two-layer PU outsole with protection from ankle twisting; flexzone, shock absorption, asymmetric heel and torsion waist made of TPU, slip-resistant (SRC)



dpvlink 8754

| Article            | Color | Size  | Category |
|--------------------|-------|-------|----------|
| <b>Clog ANATOM</b> |       |       |          |
| AB-32120           | white | 36-48 | SB       |
| AB-32120-1         | white | 49-52 | SB       |
| AB-32125           | black | 36-48 | SB       |
| AB-32125-1         | black | 49-52 | SB       |



## Low shoe ANATOM



Safety lace-up shoe with scratch-resistant coating in the instep. Upper nubuck leather/textile; moisture-absorbing and antibacterial special lining; steel toe cap; exchangeable insole; two-layer PU outsole with protection from ankle twisting, flexzone, shock absorption, asymmetric heel and torsion waist made of TPU, slip-resistant (SRC).



dpvlink 8757

| Article                | Color  | Size  | Category |
|------------------------|--------|-------|----------|
| <b>Low shoe ANATOM</b> |        |       |          |
| AB-32147               | marine | 36-48 | S1       |
| AB-32147-1             | marine | 49-50 | S1       |
| AB-32247               | marine | 36-48 | S1P      |



**Sandal ANATOM**



Safety sandal with metal-free penetration-resistant midsole; adjustable instep; upper suede/textile, reflector stripes; steel toe cap; exchangeable insole; two-layer PU outsole with protection from ankle twisting, flexzone, shock-absorption; asymmetric heel and torsion waist made of TPU, slip-resistant (SRC).



anatom



dpvlink 14423

| Article              | Color | Size  | Category |
|----------------------|-------|-------|----------|
| <b>Sandal ANATOM</b> |       |       |          |
| AB-32289             | black | 36-50 | S1P      |

**Sandal StaticControl**



Safety sandal with scratch-resistant carbon coating, reflector stripes, double velcro fastener; upper leather, breathable air mesh textile inserts; plastic toe cap; exchangeable insole; oil- and benzine-resistant special rubber outsole with flexzone, cross profile, lamellar profile and torsion waist, slip-resistant (SRA).



Static Control



dpvlink 850

| Article                     | Color | Size  | Category |
|-----------------------------|-------|-------|----------|
| <b>Sandal StaticControl</b> |       |       |          |
| AB-1275                     | black | 36-47 | S1       |

**Sandal StaticControl**



Safety sandal with double velcro fasteners; upper suede; plastic toe cap; exchangeable insole; oil- and benzine-resistant special rubber outsole with flexzone, cross profile, lamellar profile and torsion waist, slip-resistant (SRA).



Static Control



dpvlink 7546

| Article                     | Color      | Size  | Category |
|-----------------------------|------------|-------|----------|
| <b>Sandal StaticControl</b> |            |       |          |
| AB-31378                    | anthracite | 36-47 | S1       |

**Manager shoe**



Manager shoe; upper made of calf leather; breathable and moisture-absorbing micro-fiber lining, top layer leather; leather outsole with ESD compatible inserts.



MANAGER



dpvlink 10039

| Article             | Color | Size  |
|---------------------|-------|-------|
| <b>Manager shoe</b> |       |       |
| AB-3110             | black | 39-46 |

**Manager shoe**



Manager shoe; upper made of calf leather; breathable and moisture-absorbing micro-fiber lining, top layer leather; leather outsole with ESD compatible inserts.



MANAGER



dpvlink 10042

| Article             | Color | Size  |
|---------------------|-------|-------|
| <b>Manager shoe</b> |       |       |
| AB-3120             | black | 39-46 |
| AB-3121             | brown | 39-46 |

**Men's lace-up shoe BusinessMen**



Safety lace-up shoe. Upper leather; lining microfiber; steel toe cap; oil- and benzine-resistant rubber outsole, slip-resistant (SRA).



BUSINESS MEN



S2



dpvlink 13801

| Article                               | Color | Size  | Category |
|---------------------------------------|-------|-------|----------|
| <b>Men's lace-up shoe BusinessMen</b> |       |       |          |
| AB-33240                              | black | 36-48 | S2       |

## Men's lace-up shoe BusinessMen

Safety lace-up shoe. Upper leather; lining microfiber; steel toe cap; oil- and benzine-resistant rubber outsole, slip-resistant (SRA).



**BUSINESS  
MEN**



[dpvlink 10062](#)



| Article                               | Color | Size  | Category |
|---------------------------------------|-------|-------|----------|
| <b>Men's lace-up shoe BusinessMen</b> |       |       |          |
| AB-3230                               | black | 36-48 | S2       |

## Men's lace-up shoe BusinessMen

Men's lace-up shoe. Upper cowhide, breathable and moisture-absorbing microfiber lining; leather top layer; abrasion-resistant, oil- and benzine-resistant TPU outsole, slip-resistant (SRA).



**BUSINESS  
MEN**



[dpvlink 14370](#)



| Article                               | Color | Size  | Category |
|---------------------------------------|-------|-------|----------|
| <b>Men's lace-up shoe BusinessMen</b> |       |       |          |
| AB-32430                              | black | 40-47 | 01       |

## Men's lace-up shoe BusinessMen

Men's lace-up shoe. Upper cowhide, breathable and moisture-absorbing microfiber lining, leather top layer; abrasion-resistant, oil- and benzine-resistant TPU outsole, slip-resistant (SRA).



**BUSINESS  
MEN**



[dpvlink 14374](#)



| Article                               | Color | Size  | Category |
|---------------------------------------|-------|-------|----------|
| <b>Men's lace-up shoe BusinessMen</b> |       |       |          |
| AB-32450                              | black | 40-47 | 01       |

## Men's lace-up shoe BusinessMen

Men's lace-up shoe. Upper cowhide, breathable and moisture-absorbing microfiber lining, leather top layer; California style; abrasion-resistant, oil- and benzine-resistant TPU outsole, slip-resistant (SRA).



**BUSINESS  
MEN**



[dpvlink 1053](#)



| Article                               | Color | Size  | Category |
|---------------------------------------|-------|-------|----------|
| <b>Men's lace-up shoe BusinessMen</b> |       |       |          |
| AB-32922                              | black | 39-47 | OB       |

## Women's manager shoe

Women's manager shoe; upper finest leather, breathable and moisture-absorbing microfiber lining; moderate 60 mm heel.



**BUSINESS  
LADY**



[dpvlink 13788](#)



| Article                     | Color | Size  |
|-----------------------------|-------|-------|
| <b>Women's manager shoe</b> |       |       |
| AB-3940                     | black | 36-42 |
| AB-3990                     | black | 36-42 |

## Women's manager shoe

Women's manager shoe; upper finest leather, breathable and moisture-absorbing microfiber lining; moderate 60 mm heel.



**BUSINESS  
LADY**



[dpvlink 13786](#)



| Article                     | Color | Size  |
|-----------------------------|-------|-------|
| <b>Women's manager shoe</b> |       |       |
| AB-3980                     | black | 36-42 |

Women's lace-up shoe Reflexor



Women's lace-up shoe. Upper smooth leather and lining microfiber; hand-sewn seam; extremely light PU outsole, slip-resistant, fuel-resistant; exchangeable insole. 01, SRC; EN ISO 20347:2007



Reflexor



dpvlink 287



| Article                              | Color | Size  | Category |
|--------------------------------------|-------|-------|----------|
| <b>Women's lace-up shoe Reflexor</b> |       |       |          |
| AB-36900                             | white | 36-42 | 01       |
| AB-36910                             | black | 36-42 | 01       |

Men's lace-up shoe Reflexor



Men's lace-up shoe. Upper smooth leather, lining microfiber; hand-sewn seam; extremely light PU outsole, slip resistant; fuel-resistant, exchangeable insole. 01, SRC; EN ISO 20347:2007



Reflexor



dpvlink 6720



| Article                            | Color | Size  | Category |
|------------------------------------|-------|-------|----------|
| <b>Men's lace-up shoe Reflexor</b> |       |       |          |
| AB-35700                           | white | 40-46 | 01       |
| AB-35710                           | black | 40-46 | 01       |

Special shoes

Special clog



Special clog made of autoclavable, sterilizable special material with foldable heel strap; comfortable fit; **autoclavable at 135° C**, washable at 60° C, outsole slip-resistant outsole (SRC).



dpvlink 10057



| Article             | Color  | Size  | Category |
|---------------------|--------|-------|----------|
| <b>Special clog</b> |        |       |          |
| AB-39600            | white  | 35-46 | OB       |
| AB-39630            | orange | 36-46 | OB       |
| AB-39620            | green  | 35-46 | OB       |
| AB-39610            | blue   | 35-46 | OB       |

Cleanroom loafer



Cleanroom loafer with integrated footbed. Upper A-micro, breathable; elastic band over instep; decontaminable up to 30 times; washable up to 60°C; extremely light, oil- and benzine-resistant PU air cushion outsole, slip-resistant (SRA).



cushion



dpvlink 8771



| Article                 | Color | Size  | Category |
|-------------------------|-------|-------|----------|
| <b>Cleanroom loafer</b> |       |       |          |
| AB-32370                | white | 35-47 | 01       |



## Cleanroom boots

Cleanroom boots. Upper microfiber; washable at 30°C (material must be checked, because it can lose its function); oil- and benzine-resistant PU outsole, slip-resistant (SRA).

Minimum order quantity required!



OB

**dpvlink 14481**

| Article                | Color | Size  | Category |
|------------------------|-------|-------|----------|
| <b>Cleanroom boots</b> |       |       |          |
| AB-3620                | white | 35-47 | OB       |

## Cleanroom shoe with gaiter

Cleanroom shoe with gaiter. Upper leather, perforated; gaiter cleanroom textile as requested; oil- and benzine-resistant PU outsole, slip-resistant (SRA).

Minimum order quantity required !



**dpvlink 14483**

| Article                           | Color | Size  |
|-----------------------------------|-------|-------|
| <b>Cleanroom shoe with gaiter</b> |       |       |
| AB-1144                           | white | 35-48 |

## Insoles

### Insole für models Reflexor®

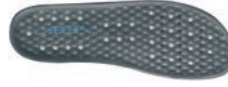

- air bubble insole
- stimulation of the foot reflexzones
- stimulates blood-circulation
- orthopedic cushioning



- leather-covered
- comfortable
- flat and smooth

**dpvlink 16006**

| Article                            | Type               | Size  |
|------------------------------------|--------------------|-------|
| <b>Insole für models Reflexor®</b> |                    |       |
| AB-3565                            | Massage Active     | 36-42 |
| AB-3566                            | Massage Active     | 40-46 |
| AB-3572                            | Massage Active XXL | 36-43 |
| AB-3567                            | Comfort white      | 36-42 |
| AB-3569                            | Comfort white      | 40-46 |
| AB-3568                            | Comfort anthracite | 36-42 |
| AB-3570                            | Comfort anthracite | 40-46 |

### Insole for models StaticControl



- Instant shock absorption
- Even pressure distribution over the whole surface
- Air circulation under the entire foot surface
- Support of the forefoot

**dpvlink 16002**

| Article                                | Type                   | Size  |
|--|------------------------|-------|
| <b>Insole for models StaticControl</b> |                        |       |
| AB-3553                                | acc Wave StaticControl | 36-47 |

### ESD Active Comfort insole



- ESD Active Comfort insole
- anti-odor activated carbon
- additional support of the metatarsus
- antibacterial
- moisture-release outward
- very lightweight

**dpvlink 22746**

| Article                          | Type                                       | Size  |
|----------------------------------|--|-------|
| <b>ESD Active Comfort insole</b> |  |       |
| AB-351920                        | for Crawler Aluminium / Steel safety shoes | 36-48 |
| AB-352710                        | for Easy safety shoes                      | 35-48 |
| AB-352320                        | for closed Anatom shoes                    | 36-52 |
| AB-352510                        | for uni6 occupational shoes                | 35-48 |
| AB-352520                        | for uni6 safety shoes                      | 35-48 |
| AB-352610                        | for Dynamic safety shoes                   | 35-48 |
| AB-351710                        | for open x-light professional shoes        | 35-48 |
| AB-351610                        | for closed x-light professional shoes      | 35-48 |
| AB-351720                        | for open x-light safety shoes              | 35-48 |
| AB-351620                        | for closed x-light safety shoes            | 35-48 |

### ESD Active MedFit insole for Dynamic flow models



**dpvlink 24582**

| Article   | Type                                | Size  |
|---|-------------------------------------|-------|
| <b>ESD Active MedFit insole for Dynamic flow models</b> |                                     |       |
| AB-352630   | for Dynamic flow professional shoes | 35-48 |



ESD series by **Jalas** - occupational footwear of premium comfort, quality and manufacturing. The shoes have an ergonomic structure, are comfortable to wear and easy-care. Made in Finland.

In compliance with the ESD standard DIN EN 61340-5-1



- ESD-sicher**
- Berufsschuhe 01**  
nach EN ISO 20347
- Sicherheitsschuhe SB**  
nach EN ISO 20345
- Sicherheitsschuhe S1P**  
nach EN ISO 20345
- Sicherheitsschuhe S3**  
nach EN ISO 20345
- Aluminium-Schutzkappe**  
(Leichter als Stahlkappen)
- Ergo**  
(verhindert Rücken- u. Fusschmerzen)
- Boa®-System**  
Schuh mit Boa-Verschlusssystem
- Stabilisator**  
(Schutz vor Verdrehen, Umknicken)
- Geräumige Passform**
- Stahlkappe**
- Wasserabweisend**
- Geeignet für Orthopädische Einlegesohlen nach DGUV**
- Waschbar bei 40°**
- Berufsschuhe OB**  
nach EN ISO 20347
- Berufsschuhe 02**  
nach EN ISO 20347
- Sicherheitsschuhe S1**  
nach EN ISO 20345
- Sicherheitsschuhe S2**  
nach EN ISO 20345
- Antistatisch**  
(verhindert statische Aufladungen)
- Komposit-Schutzkappe**  
(metallfreies Kompositmaterial)
- Geox**  
(Schuhsohle mit Geox-Membrane)
- Ölbeständig**  
(gegen Öl u. Lösungsmittel beständig)
- C2-Innensohle**  
(temp. regulierende Innensohle)
- PU-Überkappe**
- Zehenkappenverschleisschutz**
- Hitzebeständige Sohle**
- PTC-Durchtrittschutz**

Clogs

Sandal CARE



Sandale CARE with velcro fastener; adjustable heel and instep straps; exchangeable FX2 Pro insole with shock-absorbing zone made of Poron® XRD®; oil-resistant PU outsole, antistatic. EN ISO 20347 01 SRC



dpvlink 13497

| Article            | Color | Size  |
|--------------------|-------|-------|
| <b>Sandal CARE</b> |       |       |
| JA-5042            | black | 36-47 |



Clog with heel strap SARITA



Clog made of comfortable microfiber; fixed, adjustable heel strap; exchangeable FX2 Pro insole with shock-absorbing zone made of Poron® XRD®; oil-resistant EVA/rubber outsole, antistatic. EN ISO 20347 0B SRC



dpvlink 15527

| Article                            | Color          | Size  |
|------------------------------------|----------------|-------|
| <b>Clog with heel strap SARITA</b> |                |       |
| JA-2942                            | black / silver | 34-42 |



Safety shoes

Men's loafer VIP



Elegant men's loafer made of leather; exchangeable FX2 Pro insole with shock-absorbing zone made of Poron® XRD®; oil-resistant PU outsole, antistatic. EN ISO 20347 02 SRA



dpvlink 10110

| Article                 | Color | Size  | Category | Form     |
|-------------------------|-------|-------|----------|----------|
| <b>Men's loafer VIP</b> |       |       |          |          |
| JA-2112                 | black | 39-47 | 02       | low shoe |
| JA-2102                 | black | 39-47 | 02       | Loafer   |
| JA-2142                 | brown | 39-47 | 02       | low shoe |



## Low shoe SPOC BLACK / RED

Sporty low shoe; upper textile; polyester lining; FX2 PRO SpOc insole with shock-absorbing zone made of Poron® XRD®; EVA/rubber outsole, slip-resistant. EN ISO 20347 01 SRC



dpvlink 21364

| Article                          | Color | Size  | Category |
|----------------------------------|-------|-------|----------|
| <b>Low shoe SPOC BLACK / RED</b> |       |       |          |
| JA-5302                          | black | 35-48 | 01       |
| JA-5322                          | red   | 35-48 | 01       |



## Low shoe SPOC Boa®

Light low shoe with quick closure BOA®; upper textile; polyester lining; FX2 PRO SpOc insole with shock-absorbing zone made of Poron® XRD®; EVA/rubber outsole, slip-resistant. EN ISO 20347 01 SRC



dpvlink 23435

| Article                   | Color          | Size  | Category |
|---------------------------|----------------|-------|----------|
| <b>Low shoe SPOC Boa®</b> |                |       |          |
| JA-5362                   | black / orange | 35-48 | 01       |
| JA-5372                   | black          | 35-48 | 01       |



## Low shoe SPOC

Sporty low shoe; upper leather; polyester lining; FX2 PRO SpOc insole with shock-absorbing zone made of Poron® XRD®; oil-resistant EVA/rubber outsole, antistatic. EN ISO 20347 02 SRC



dpvlink 21361

| Article              | Color | Size  | Category |
|----------------------|-------|-------|----------|
| <b>Low shoe SPOC</b> |       |       |          |
| JA-5342              | black | 35-48 | 02       |
| JA-5352              | black | 35-48 | 02       |



## RESPIRO

The safety shoes of the Jalas **Respiro** series are equipped with a unique, three-layered IQ TEX® laminate. The especially **breathable upper surface** and **ventilated shock absorption material** in the insole keep your feet dry. The temperature in the shoe is regulated. So there will be no sweat or unpleasant odors.

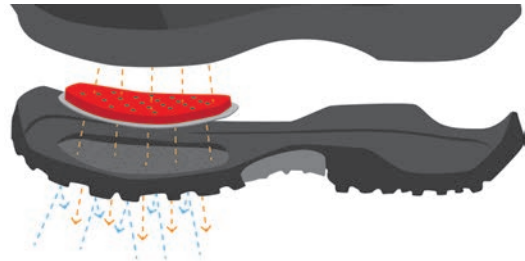

### Material in dry conditions

- Plenty of space between the super-absorbent polymer particles
- Dry air can get much easier from outside to the foot
- Warm and humid air can be transported much faster from the foot

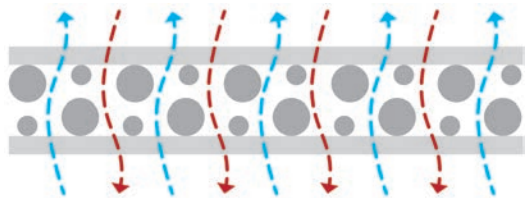

### Material in wet conditions

- The super-absorbent polymer particles swell
- The laminate remains its dimensions, as the room is limited by adhesives
- The material becomes quickly waterproof, as the super-absorbent polymers press against each other tightly
- When the material is dry again, the ultra high air permeability will be restored completely

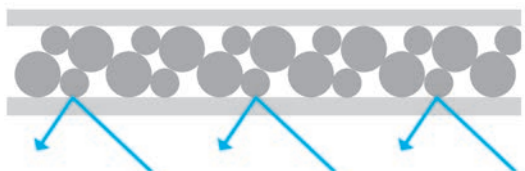

## Safety sandal 3800R RESPIRO

Breathable safety sandal; upper microfiber; ultra-high air permeability, ventilation holes, padded shaft edges; exchangeable FX2 Supreme insole with shock-absorbing zone made of Poron® XRD®; oil-resistant TPU outsole, antistatic. EN ISO 20345 S1 SRC



**RESPIRO**



dpvlink 20142

| Article                            | Color        | Size  | Category |
|------------------------------------|--------------|-------|----------|
| <b>Safety sandal 3800R RESPIRO</b> |              |       |          |
| JA-3800R                           | black / blue | 36-47 | S1       |



**Safety sandal 3820R RESPIRO**



Sporty safety sandal; upper nubuck/textile; ultra-high air permeability; aluminum toe cap; exchangeable FX2 Supreme insole insole with shock-absorbing zone made of Poron® XRD®; oil-resistant TPU outsole, antistatic. EN ISO 20345 S1 SRB



**RESPIRO**



dpvlink 20146

| Article                            | Color        | Size  | Category |
|------------------------------------|--------------|-------|----------|
| <b>Safety sandal 3820R RESPIRO</b> |              |       |          |
| JA-3820R                           | black / blue | 36-47 | S1       |

**Safety shoe 3700R RESPIRO**



Sporty safety shoe; upper PU-coated leather/textile; ultra-high air permeability; aluminum toe cap; exchangeable FX2 Supreme insole insole with shock-absorbing zone made of Poron® XRD®; oil-resistant TPU outsole, antistatic. EN ISO 20345 S2 SRB



**RESPIRO**



dpvlink 20144

| Article                          | Color        | Size  | Category |
|----------------------------------|--------------|-------|----------|
| <b>Safety shoe 3700R RESPIRO</b> |              |       |          |
| JA-3700R                         | black / blue | 36-47 | S2       |

**Safety sandal 3510R RESPIRO**



Sporty safety shoe; upper PU-coated leather/textile; ultra-high air permeability; aluminum toe cap; exchangeable FX2 Supreme insole insole with shock-absorbing zone made of Poron® XRD®; oil-resistant TPU outsole, antistatic. EN ISO 20345 S1 SRB



**RESPIRO**



dpvlink 20148

| Article                            | Color | Size  | Category |
|------------------------------------|-------|-------|----------|
| <b>Safety sandal 3510R RESPIRO</b> |       |       |          |
| JA-3510R                           | white | 36-47 | S1       |

**Safety shoe ZENIT EVO**



Safety shoe, textile upper; seamlessly finished; polyester/polyamide lining; aluminium toe cap; insole with double shock-absorbing zones made of Poron XRD. EN ISO 20345 S1 / S1P SRC



dpvlink 21354

| Article                      | Color        | Size  | Category | Closure        |
|------------------------------|--------------|-------|----------|----------------|
| <b>Safety shoe ZENIT EVO</b> |              |       |          |                |
| JA-7100                      | black / red  | 35-48 | S1       | lace fastening |
| JA-7128                      | grey / black | 35-48 | S1P      | lace fastening |

**Safety shoe ZENIT EVO Boa®**



Safety shoe, textile upper; with Boa® quick-release fastener; seamlessly finished; polyester/polyamide lining; aluminium toe cap; flexible, ultra-thin penetration protection; insole with double shock-absorbing zones made of Poron XRD. EN ISO 20345 S1P SRC



dpvlink 21358

| Article                           | Color        | Size  | Category | Closure                       |
|-----------------------------------|--------------|-------|----------|-------------------------------|
| <b>Safety shoe ZENIT EVO Boa®</b> |              |       |          |                               |
| JA-7118                           | grey / black | 35-48 | S1P      | Boa® / quick-release fastener |
| JA-7108                           | black / red  | 35-48 | S1P      | Boa® / quick-release fastener |

**Safety sandal 1605 E-Sport**



Safety sandal, upper PU-coated leather with velcro fastener; upper PU-coated leather; aluminium toe cap; metal-free penetration protection; shock-absorbing insole, oil-resistant PU outsole; antistatic. EN ISO 20345 S1P SRC



dpvlink 18481

| Article                           | Color        | Size  | Category |
|-----------------------------------|--------------|-------|----------|
| <b>Safety sandal 1605 E-Sport</b> |              |       |          |
| JA-1605                           | black / grey | 36-47 | S1P      |

## Safety shoe 1615 E-Sport

ESD safety shoe; upper PU-coated leather; aluminium toe cap; metal-free penetration protection; shock-absorbing insole, oil-resistant PU outsole; antistatic. EN ISO 20345 S3 SRC



dpvlink 18482

| Article | Color       | Size  | Category |
|---------|-------------|-------|----------|
| JA-1615 | black / red | 36-47 | S3       |

## Safety shoe BLACK

Classic safety shoe; upper leather; aluminum toe cap; metal-free penetration protection; exchangeable FX2 Pro insole with shock-absorbing zone made of Poron® XRD®; oil-resistant rubber outsole, antistatic. EN ISO 20345 S3 SRB



dpvlink 20150

| Article | Color | Size  | Category |
|---------|-------|-------|----------|
| JA-1335 | black | 36-47 | S3       |

## Safety shoe EXALTER

Safety shoe with polyamide lining; aluminum toe cap; insole with double shock absorption zone of Poron XRD. EN ISO 20345 S1 / S1P / S3 SRC



dpvlink 17875

| Article                    | Color         | Size  | Category |
|----------------------------|---------------|-------|----------|
| <b>Safety shoe EXALTER</b> |               |       |          |
| JA-9500                    | black / green | 36-47 | S1       |
| JA-9520                    | black / red   | 36-47 | S1       |
| JA-9518                    | black         | 36-47 | S1P      |
| JA-9508                    | black / green | 36-47 | S3       |
| JA-9528                    | black / red   | 36-47 | S3       |
| JA-9568                    | black         | 36-47 | S3       |

## Safety shoe EXALTER Boa®

Comfortable safety shoe with quick-release fastener BOA®; upper microfiber/textile; polyester lining; aluminum toe cap; metal-free penetration protection; FX3 Supreme insole with double shock-absorbing zones made of Poron® XRD®; EVA/rubber outsole, slip-resistant.

JA-9925 and JA-9945 EN ISO 20345 S1P SRC

JA-9965 and JA-9985 additionally water-repellent EN ISO 20345 S3 SRC



dpvlink 23448

| Article                         | Color         | Size  | Category | Closure                       |
|---------------------------------|---------------|-------|----------|-------------------------------|
| <b>Safety shoe EXALTER Boa®</b> |               |       |          |                               |
| JA-9925                         | black / green | 34-47 | S1P      | Boa® / quick-release fastener |
| JA-9965                         | black / red   | 34-47 | S3       | Boa® / quick-release fastener |
| JA-9945                         | black / green | 34-47 | S1P      | Boa® / quick-release fastener |
| JA-9985                         | black / red   | 34-47 | S3       | Boa® / quick-release fastener |

## Safety shoe ZENIT - EASYROLL

Safety shoe with innovative shock absorption system; BOA closure system; aluminum toe cap; ProNose overcap; FX2 supreme insole with shock absorption zones made of Poron XRD and merino wool interlayer; shock-absorbent RPU outsole with stabilizer waist; slip resistant. EN ISO 20345 S1P S3 SRC



dpvlink 18071

| Article                             | Color       | Size  | Category | Form     |
|-------------------------------------|-------------|-------|----------|----------|
| <b>Safety shoe ZENIT - EASYROLL</b> |             |       |          |          |
| JA-1708                             | black / red | 36-47 | S1P      | sandal   |
| JA-1738                             | black / red | 36-47 | S3       | low shoe |

**Safety shoe FORTY-FIVE**



Comfortable safety shoe; upper leather; aluminum toe cap; metal-free penetration protection; exchangeable FX2 Pro insole with shock-absorbing zone made of Poron® XRD®; oil-resistant RPU outsole, antistatic. EN ISO 20345 S3 SRC



dpvlink 17479

| Article                       | Color          | Size  | Category | Form     |
|-------------------------------|----------------|-------|----------|----------|
| <b>Safety shoe FORTY-FIVE</b> |                |       |          |          |
| JA-3045                       | black / yellow | 36-47 | S3       | low shoe |
| JA-3055                       | black / yellow | 36-47 | S3       | boot     |

**Safety sandal BIO**



Safety sandal with with velcro fastener; upper microfiber/textile; composite toe cap; metal-free penetration protection; ProNose toe cap wear protection; exchangeable TX2 Pro insole with shock-absorbing zone made of Poron® XRD®; oil-resistant PU outsole, antistatic. EN ISO 20345 S1P SRC



dpvlink 16087

| Article                  | Color | Size  | Category |
|--------------------------|-------|-------|----------|
| <b>Safety sandal BIO</b> |       |       |          |
| JA-6418                  | black | 36-47 | S1P      |

**Safety shoe EKO**



Comfortable safety shoe; upper microfiber/textile; composite toe cap; metal-free penetration protection; ProNose toe cap wear protection; exchangeable TX2 Pro insole with shock-absorbing zone made of Poron® XRD®; oil-resistant PU outsole, antistatic. EN ISO 20345 S3 SRC



dpvlink 13494

| Article                | Color | Size  | Category |
|------------------------|-------|-------|----------|
| <b>Safety shoe EKO</b> |       |       |          |
| JA-6468                | black | 36-47 | S3       |

**Safety boots NATURE**



Safety boot; upper microfiber/textile; composite toe cap; metal-free penetration protection; ProNose toe cap wear protection; exchangeable FX2 Pro insole with shock-absorbing zone made of Poron® XRD®; oil-resistant PU outsole, antistatic. EN ISO 20345 S3 SRC



dpvlink 13740

| Article                    | Color | Size  | Category |
|----------------------------|-------|-------|----------|
| <b>Safety boots NATURE</b> |       |       |          |
| JA-6498                    | black | 36-47 | S3       |

**Safety sandal Pro 3100**



Light safety sandal with velcro fastener; upper PU-coated leather; aluminum toe cap; exchangeable FX2 Pro insole with shock-absorbing zone made of Poron® XRD®; oil-resistant TPU outsole, antistatic. EN ISO 20345 S1 SRB



dpvlink 16283

| Article                       | Color          | Size  | Category |
|-------------------------------|----------------|-------|----------|
| <b>Safety sandal Pro 3100</b> |                |       |          |
| JA-3100                       | black / yellow | 36-47 | S1       |

**Safety shoe Pro 3110**



Light safety shoe; upper leather/textile; aluminum toe cap; exchangeable FX2 Pro insole with shock-absorbing zone made of Poron® XRD®; oil-resistant rubber outsole, antistatic. EN ISO 20345 S2 SRB



dpvlink 16278

| Article                     | Color          | Size  | Category |
|-----------------------------|----------------|-------|----------|
| <b>Safety shoe Pro 3110</b> |                |       |          |
| JA-3110                     | black / yellow | 36-47 | S2       |

## Safety sandal ZENIT 3020

Safety sandal with velcro fastener; padded leg edge of Memory Foam; aluminum toe cap; exchangeable FX2 Supreme insole with shock-absorbing zone made of Poron® XRD®; oil-resistant RPU outsole, antistatic. EN ISO 20345 S1 SRC



**dpvlink 14515**

| Article                         | Color       | Size  | Category |
|---------------------------------|-------------|-------|----------|
| <b>Safety sandal ZENIT 3020</b> |             |       |          |
| JA-3020                         | black / red | 36-47 | S1       |

## Safety shoe ZENIT 3030

Safety shoe; upper nubuck/textile; padded leg edge of Memory Foam; aluminum toe cap; exchangeable FX2 Supreme insole with shock-absorbing zone made of Poron® XRD®; oil-resistant RPU outsole, antistatic. EN ISO 20345 S2 SRC



**dpvlink 14516**

| Article                       | Color       | Size  | Category |
|-------------------------------|-------------|-------|----------|
| <b>Safety shoe ZENIT 3030</b> |             |       |          |
| JA-3030                       | black / red | 36-47 | S2       |



# ESD

## Insoles

### FX2 Supreme/FX2 Pro -insole ESD

suitable for all J alas shoes and safety shoes



- breathable
- maximal shock-absorption due to Poron XRD under forefoot and heel
- support of high arches and skew feet
- ESD compliant 

**dpvlink 15575**

| Article | Type         | Size  |
|---------|--------------|-------|
| JA-8202 | FX 2 Supreme | 35-50 |
| JA-8102 | FX2 Pro      | 35-48 |

### Anatomic insole ESD

suitable for all J alas safety shoes



- double shock absorption zone of Poron® XRD™
- distinct heel cup
- perforated forefoot
- ESD-compliant 

**dpvlink 16947**

| Article                    | Type            | Size  | Color  |
|----------------------------|-----------------|-------|--------|
| <b>Anatomic insole ESD</b> |                 |       |        |
| JA-8709H                   | for high arch   | 34-50 | blue   |
| JA-8710M                   | for normal arch | 34-50 | green  |
| JA-8711L                   | for low arch    | 34-50 | orange |

### FX3 Supreme insole ESD

suitable for all J alas safety shoes



- very comfortable
- optimized shock absorption
- breathable
- ESD compliant 

**dpvlink 24966**

| Article | Type         | Size  |
|---------|--------------|-------|
| JA-8303 | FX 3 Supreme | 34-47 |



Sievi is the leading manufacturer of safety and occupational footwear in Northern Europe. The Sievi brand, a mark of quality, offers unsurpassed work safety, fit and wearing comfort. Sievi is always working with the latest technology, materials and features to develop the best footwear for work.

In compliance with the ESD standard DIN EN 61340-5-1 ⚠



- ESD-geprüfte Schuhe nach EN 61340-5-1**
- 01** Berufsschuhe 01 nach EN ISO 20347
- 02** Berufsschuhe 02 nach EN ISO 20347
- 03** Berufsschuhe 03 nach EN ISO 20347
- S1** Sicherheitsschuhe S1 nach EN ISO 20345
- S2** Sicherheitsschuhe S2 nach EN ISO 20345
- Antistatisch**
- FlexStep®-Absatz-Stossdämpfung**
- Geeignet für heiße Arbeitsumgebung bis +300 Grad**
- Metallfrei**
- DUAL-Einlegesohle**
- Laufsohle aus PU**
- Laufsohle aus PU/TPU**
- Nageldurchtrittschutz aus Komposit-Textil**
- Zehenschutz aus Komposit**
- Schuh mit Boa®-Verschluss-system**
- Geeignet für Orthopädische Einlegesohlen nach DGUV**
- OB** Berufsschuhe OB nach EN ISO 20347
- 02** Berufsschuhe 02 nach EN ISO 20347
- SB** Sicherheitsschuhe SB nach EN ISO 20345
- S1P** Sicherheitsschuhe S1P nach EN ISO 20345
- S3** Sicherheitsschuhe S3 nach EN ISO 20345
- Öl- und Chemikalienbeständig**
- Wasserabstossend**
- Nageldurchtrittschutz**
- XL-Leisten**
- Sievi ALU-Einlegesohle mit isolierender Aluminiumschicht gegen Kälte**
- Laufsohle aus PU/PU**
- Laufsohle aus PU/Gummi**
- Zehenschutz aus Aluminium**
- Zehenschutz aus Stahl**
- Elastisches Fersenelement in der Sohle für maximale Stossdämpfung und bequemen Sitz bei jedem Schritt, aus TPU Infinergy®**
- Geeignet für eine komplette orthopädische Zurichtung nach DGUV**

- Mikrofaser**
- 3D-dry-Futter** (leitet Feuchtigkeit vom Fuss)
- SieviBalance** (sicherer Schritt und mehr Trittfestigkeit)

- DryStep-Einlegesohlen** (lässt Feuchtigkeit entweichen)
- Mikrofaser Sohlenmaterial** (ausgezeichnete Stossdämpfung und Elastizität auch bei Frost)

Slippers, sandals

Sandal Ion Black 2



Comfortable sandal with velcro fastener; upper nubuck; 3D-dry® lining; exchangeable and machine washable (at 40°C) DryStep® insole; shock-absorbing FlexStep® PU outsole, oil- and chemical-resistant, antistatic. EN ISO 20347 OB A E FO



- OB**

**dpwlink 21148**

| Article  | Color                       | Size  | Category |
|----------|-----------------------------|-------|----------|
| SI-12156 | Sandal Ion Black 2<br>black | 36-42 | OB       |

Slipper Art 2 / Rom 2



Comfortable slipper with instep strap adjustable by velcro fastener, partly with adjustable heel strap, upper nubuck; 3D-dry® lining; exchangeable and machine washable (at 40°C) DryStep® insole; shock-absorbing FlexStep® PU outsole, oil- and chemical-resistant, antistatic. EN ISO 20347 OB A E FO



- OB**

**dpwlink 21150**

| Article  | Color                          | Size  | Category | Form    |
|----------|--------------------------------|-------|----------|---------|
| SI-12146 | Slipper Art 2 / Rom 2<br>black | 39-47 | OB       | slipper |
| SI-12157 | Slipper Art 2 / Rom 2<br>black | 39-47 | OB       | sandal  |



## Sandal Active

Comfortable sandal with heel and instep straps adjustable by velcro fastener; upper microfiber (washable); 3D-dry® lining; shock-absorbing FlexStep®-PU outsole, oil- and chemical-resistant, antistatic. EN ISO 20347 OB A E FO



dpvlink 21156

| Article  | Color                | Size  | Category |  |
|----------|----------------------|-------|----------|---|
|          | <b>Sandal Active</b> |       |          |   |
| SI-12225 | black                | 35-47 | OB       |   |

## Clog File

Clog File black of resistant PU leather; Clog File White upper of microfiber withstanding frequent washing; adjustable heel strap with elastic, higher heel; exchangeable Sievi comfort insole; shock-absorbing FlexStep® PU outsole, oil- and chemical-resistant, antistatic. EN ISO 20347:OB SRC A E FO



dpvlink 17183

| Article   | Color            | Size  | Category |  |
|-----------|------------------|-------|----------|---|
|           | <b>Clog File</b> |       |          |   |
| SI-12327M | black            | 35-47 | OB       |   |
| SI-12327W | white            | 35-47 | OB       |   |

## Clog Emilia

Clog with adjustable heel strap; upper microfiber; breathable microfiber lining; shock-absorbing FlexStep® outsole, PU outsole oil- and chemical-resistant, antistatic. EN ISO 20347 OB A E FO SRC



dpvlink 24815

| Article  | Color              | Size  | Category |  |
|----------|--------------------|-------|----------|---|
|          | <b>Clog Emilia</b> |       |          |   |
| SI-12026 | black              | 35-43 | OB       |   |

## Safety shoes

### Safety clog Riff

Stylish safety clog with heel strap, upper cowhide; steel toe cap; shock-absorbing FlexStep® PU outsole, oil- and chemical-resistant, antistatic. EN ISO 20345 SB A E FO



dpvlink 15470

| Article   | Color                   | Size  | Category |  |
|-----------|-------------------------|-------|----------|---|
|           | <b>Safety clog Riff</b> |       |          |   |
| SI-52933M | black                   | 35-47 | SB       |   |
| SI-52933W | white                   | 35-47 | SB       |   |

### Professional shoe Mia / Ava

Low shoe; upper leather; breathable microfiber lining; shock-absorbing FlexStep® outsole, PU outsole oil- and chemical-resistant, antistatic. EN ISO 20347 01 02 FO SRC



dpvlink 24817

| Article  | Color                              | Size  | Category | Closure         |  |
|----------|------------------------------------|-------|----------|-----------------|---|
|          | <b>Professional shoe Mia / Ava</b> |       |          |                 |   |
| SI-12027 | black                              | 35-43 | 01       | velcro fastener |   |
| SI-12025 | black                              | 35-43 | 02       | lace fastening  |   |

### Men's loafer Key

Men's loafer, upper leather; exchangeable Sievi comfort insole; shock-absorbing FlexStep® PU outsole, oil- and chemical-resistant, antistatic; EN ISO 20347 02 SRC FO



dpvlink 17208

| Article  | Color                   | Size  | Category |  |
|----------|-------------------------|-------|----------|---|
|          | <b>Men's loafer Key</b> |       |          |   |
| SI-12109 | black                   | 39-48 | 02       |   |

### Men's lace-up shoe Street



Stylish men's lace-up shoe with colorful applications, upper leather; shock-absorbing FlexStep outsole; very comfortable to wear due felt insole oil- and chemical-resistant, antistatic; EN ISO 20347 : 02 SRC FO



dpvlink 19492

| Article  | Color                                      | Size  | Category |
|----------|--|-------|----------|
| SI-12194 | Men's lace-up shoe Street<br>black / brown | 39-48 | 02       |



### Men's shoe Mark



Men's shoe, upper cowhide; exchangeable Sievi comfort insole; shock-absorbing FlexStep® PU outsole; oil- and chemical-resistant, antistatic.



dpvlink 15460

| Article  | Color                    | Size  |
|----------|--------------------------|-------|
| SI-12010 | Men's shoe Mark<br>black | 40-48 |



### Safety shoe Terrain



Modern safety shoe; upper nubuck; aluminium toe cap; steel penetration protection; 3D-dry® lining; elastic Sievi FlexEnergy element for maximal shock absorption; exchangeable Dual-Comfort insole, two-layer ActionPro outsole with shock-absorbing FlexStep® interlayer, oil- and chemical-resistant, antistatic. EN ISO 20345 S3



FLEX ENERGY 3D-dry

dpvlink 22436

| Article  | Color                        | Size  | Category | Form     |
|----------|------------------------------|-------|----------|----------|
| SI-52357 | Safety shoe Terrain<br>brown | 39-47 | S3       | low shoe |



### Safety shoe Rival



Sporty safety shoe; upper PU coated leather; aluminum toe cap; 3D-dry lining; exchangeable Sievi Comfort insole, suitable for orthopedic insoles; shock-absorbing FlexStep® PU outsole, oil- and chemical-resistant, antistatic; EN ISO 20345 S2 SRC



dpvlink 17222

| Article  | Color                             | Size  | Category |
|----------|-----------------------------------|-------|----------|
| SI-52190 | Safety shoe Rival<br>black / grey | 36-47 | S2       |



### Safety shoe Racer Free Roller



Safety shoe; upper PU-coated leather/textile; breathable network structure; BOA® quick closure; aluminum toe cap; steel penetration protection; 3D-dry lining; elastic FlexEnergy element for maximal shock absorption; exchangeable Sievi Dual Comfort insole; double-layer ActionPro outsole with shock-absorbing FlexStep® interlayer, oil- and chemical-resistant, antistatic. EN ISO 20345 S1P



FLEX ENERGY 3D-dry

dpvlink 22434

| Article  | Color   | Size  | Category |
|----------|---|-------|----------|
| SI-52363 | Safety shoe Racer Free Roller<br>black / yellow | 34-47 | S1P      |



### Safety shoe Racer



Sporty safety shoe; upper PU-coated leather/textile; aluminum toe cap; 3D-dry lining; elastic FlexEnergy element for maximal shock absorption; exchangeable Sievi Dual Comfort insole; double-layer ActionPro outsole with shock-absorbing FlexStep® interlayer, oil- and chemical-resistant, antistatic. EN ISO 20345



FLEX ENERGY 3D-dry

dpvlink 21043

| Article  | Color                               | Size  | Category | Closure        |
|----------|-------------------------------------|-------|----------|----------------|
| SI-52343 | Safety shoe Racer<br>black / orange | 34-48 | S3       | Boa®           |
| SI-52342 | Safety shoe Racer<br>black / orange | 35-48 | S2       | lace fastening |



## Low shoe Fly



Sporty low shoe with breathable textile upper; 3D-dry lining; exchangeable Sievi Comfort insole; shock-absorbing FlexStep®-PU outsole, oil- and chemical-resistant, antistatic. EN ISO 20347 O2 SRC FO



dpvlink 22442

| Article             | Color         | Size  | Category | Closure                       |
|---------------------|---------------|-------|----------|-------------------------------|
| <b>Low shoe Fly</b> |               |       |          |                               |
| SI-12192            | black / white | 35-47 | O2       | lace fastening                |
| SI-12192R           | red           | 35-47 | O2       | lace fastening                |
| SI-12190            | blue          | 35-47 | O2       | Boa® / quick-release fastener |
| SI-12196            | black         | 35-47 | O2       | lace fastening                |

## Safety shoe SieviAir R3 / R5H / R4 NEU

Safety shoes, upper microfiber; aluminum toe cap, steel penetration protection; 3D-dry lining; exchangeable Sievi Dual-Comfort insole; very shock-absorbent FlexEnergy midsole; breathable SieviAir® PU outsole, oil- and chemical-resistant, antistatic; EN ISO 20345:S1P S3 SRC



dpvlink 23313

| Article                                   | Color         | Size  | Category | Form     |
|---|---------------|-------|----------|----------|
| <b>Safety shoe SieviAir R3 / R5H / R4</b> |               |       |          |          |
| SI-52385                                  | black / green | 35-48 | S1P      | sandal   |
| SI-52375                                  | black / green | 35-48 | S3       | low shoe |
| SI-52371                                  | black / green | 35-48 | S1P      | boot     |

## Safety shoe SieviAir R1 / R2

Safety shoe, upper microfiber; aluminum toe cap; 3D-dry lining; exchangeable Sievi Dual-Comfort insole; shock-absorbent FlexEnergy midsole; breathable SieviAir® PU outsole, oil- and chemical-resistant, antistatic; EN ISO 20345:S1 SRC



dpvlink 23310

| Article                             | Color         | Size  | Category | Form     |
|-------------------------------------|---------------|-------|----------|----------|
| <b>Safety shoe SieviAir R1 / R2</b> |               |       |          |          |
| SI-52374                            | black / green | 34-48 | S1       | sandal   |
| SI-52378                            | black / green | 35-48 | S1       | low shoe |

## Safety shoe Roller+

Safety shoe with BOA® quick-release closure system; plastic toe cap, upper leather, partly microfiber, 3D-dry lining; steel penetration protection; PU/TPU outsole, Roller XL+ S3 with PU outsole, with shock-absorbent FlexStep® mid-layer, oil- and chemical-resistant, antistatic; EN ISO 20345 S3 SRC



dpvlink 17197

| Article                    | Color          | Size  | Category | Form     | Width |
|----------------------------|----------------|-------|----------|----------|-------|
| <b>Safety shoe Roller+</b> |                |       |          |          |       |
| SI-52156-113               | black / yellow | 39-47 | S3       | low shoe | 10    |
| SI-52156-153               | black / orange | 39-47 | S3       | low shoe | 12    |
| SI-52184                   | black / pink   | 35-42 | S3       | low shoe | 10    |
| SI-52157                   | black / orange | 39-47 | S3       | boot     | 12    |
| SI-52185                   | black / yellow | 36-42 | S3       | boot     | 10    |

### Safety shoe Viper 1+



Safety shoe, upper microfiber (breathable, water-repellent); composite toe cap; 3D-dry lining; exchangeable Sievi Dual comfort insole; two-layered PU/TPU outsole with shock-absorbing FlexStep® mid-layer, oil- and chemical-resistant, antistatic; EN ISO 20345:S1 SRC

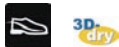

dpvlink 18497

| Article  | Color         | Size  | Category |
|----------|---------------|-------|----------|
| SI-52124 | black / green | 35-47 | S1       |

### Safety shoe Viper 2+ / Viper Roller+



Safety shoe, upper leather; composite toe cap; puncture-resistant sole; 3D-dry lining; exchangeable Dual insole; two-layered PU/TPU outsole with shock-absorbing FlexStep® mid-layer, oil- and chemical-resistant, antistatic; EN ISO 20345:S3 SRC



dpvlink 18499

| Article  | Color         | Size  | Category | Closure        |
|----------|---------------|-------|----------|----------------|
| SI-52125 | black / green | 35-47 | S3       | Boa®           |
| SI-52137 | black / green | 35-47 | S3       | lace fastening |

### Safety sandal Relax S1



Classic safety sandal with velcro fastener, closed heel cap; 3D-dry lining; exchangeable Sievi comfort insole; shock-absorbing FlexStep® PU outsole, oil- and chemical-resistant, antistatic. EN ISO 20345: S1 SRC



dpvlink 14311

| Article     | Color | Size  | Category | Width |
|-------------|-------|-------|----------|-------|
| SI-52236    | black | 35-39 | S1       | 10    |
| SI-52236-XL | black | 39-47 | S1       | 12    |

### Safety sandal SieviAir Roller



Safety sandal with BOA® quick-release fastener, plastic toe cap, sole with penetration protection, upper polished nubuck; 3D-dry lining; exchangeable Sievi Dual comfort insole; shock-absorbing FlexStep® outsole, oil- and chemical-resistant, antistatic; EN ISO 20345: S1 / S1P SRC



dpvlink 20063

| Article                              | Color             | Size  | Category | Width |
|--------------------------------------|-------------------|-------|----------|-------|
| <b>Safety sandal SieviAir Roller</b> |                   |       |          |       |
| SI-52524                             | black / turquoise | 36-38 | S1       | 10    |
| SI-52524-XL                          | black / turquoise | 39-47 | S1       | 12    |
| SI-52523                             | black / orange    | 36-38 | S1P      | 10    |
| SI-52523-XL                          | black / orange    | 39-47 | S1P      | 12    |

### Safety sandal SieviAir Galaxy



Safety sandal with composite toe cap, upper microfiber; shoe tips with brushed PU coated leather; 3D-dry lining; exchangeable Sievi Dual comfort insole; shock-absorbing FlexStep® outsole, oil- and chemical-resistant, antistatic; EN ISO 20345 S1 SRC



dpvlink 19488

| Article                              | Color          | Size  | Category | Form     | Width |
|--------------------------------------|----------------|-------|----------|----------|-------|
| <b>Safety sandal SieviAir Galaxy</b> |                |       |          |          |       |
| SI-52520                             | black / orange | 36-38 | S1       | sandal   | 10    |
| SI-52520-XL                          | black / orange | 39-47 | S1       | sandal   | 12    |
| SI-52704                             | black / orange | 36-38 | S1       | low shoe | 10    |
| SI-52704-XL                          | black / orange | 39-47 | S1       | low shoe | 12    |

### Safety sandal Promo 1



Safety sandal; upper coated cowhide; aluminum heel cap; 3D-dry-lining; exchangeable Sievi comfort insole; shock-absorbing FlexStep® PU outsole, oil- and chemical-resistant, antistatic. EN ISO 20345 S1



dpvlink 13003

| Article                      | Color         | Size  | Category |
|------------------------------|---------------|-------|----------|
| <b>Safety sandal Promo 1</b> |               |       |          |
| SI-52162M                    | black / green | 36-47 | S1       |

## Safety shoe Elixir XL

Safety shoe; upper leather; metal-free; closed heel; plastic toe cap; 3D-dry lining; exchangeable Sievi Dual comfort insole; PU outsole with shock-absorbing FlexStep® mid-layer, oil- and chemical-resistant, antistatic; EN ISO 20345:S3 SRC



**dpvlink 20066** 

| Article                      | Color                  | Size  | Category | Form     | Width |
|------------------------------|------------------------|-------|----------|----------|-------|
| <b>Safety shoe Elixir XL</b> |                        |       |          |          |       |
| SI-52772-XL                  | anthracite / turquoise | 39-47 | S3       | low shoe | 12    |
| SI-52774-XL                  | anthracite / turquoise | 39-47 | S3       | boot     | 12    |

## Safety shoe Auto S2

Classic safety lace-up shoe; upper wear-resistant and water-repellent PU leather, aluminium toe cap; exchangeable, anatomically shaped insole; suitable for insoles; shock-absorbing FlexStep® outsole, oil- and chemical-resistant. EN ISO 20345 S2 SRC



**dpvlink 21159** 

| Article                    | Color | Size  | Category |
|----------------------------|-------|-------|----------|
| <b>Safety shoe Auto S2</b> |       |       |          |
| SI-52204                   | black | 35-47 | S2       |

## Safety shoe Planar Sweet / 1 / 2

Safety shoe of the new generation, very robuste outsole for a good grip even on slippery surfaces, 3D-dry lining and shock-absorbing, removable Dual insoles provide maximum comfort. EN ISO 20345 S3 SRC



**dpvlink 19430** 

| Article                                 | Color         | Size  | Category | Form     |
|---|---------------|-------|----------|----------|
| <b>Safety shoe Planar Sweet / 1 / 2</b> |               |       |          |          |
| SI-52175                                | blue / rose   | 35-42 | S3       | low shoe |
| SI-52173                                | black / white | 35-48 | S3       | low shoe |
| SI-52135                                | black / white | 35-48 | S3       | boot     |

## Insoles

### DryStep insole



suitable for Sievi sandals Ion Black 2, Art 2, Rom 2

- transfers moisture from the foot down to the lower layer of the insole and keeps your feet dry
- machine washable at 40°C

**dpvlink 15569** 

| Article | Type | Size |
|---------|------|------|
|---------|------|------|

|          |   |       |
|----------|---|-------|
| SI-99610 | <b>DryStep insole</b><br>suitable for Sievi sandals Ion Black 2, Art 2, Rom 2 | 35-46 |
|----------|---|-------|

### Comfort insoles



suitable for all Sievi shoes with exchangeable insole

- breathable
- machine washable at 40°C

**dpvlink 15566** 

| Article | Type | Size |
|---------|------|------|
|---------|------|------|

|             |  |       |
|-------------|--|-------|
| SI-99520    | <b>Comfort insoles</b><br>Comfort standard | 35-48 |
| SI-99522-XL | Comfort XL                                 | 39-50 |

### Dual Comfort insole

suitable for all Sievi shoes with exchangeable insole



- shock-absorbing PORON® cushioning in the heel
- soft upper material
- breathable and moisture-absorbing mid-layer
- light, shock-absorbing EVA bottom layer

**dpvlink 15567** 

| Article | Type | Size |
|---------|------|------|
|---------|------|------|

|             |   |       |
|-------------|---|-------|
| SI-99525    | <b>Dual Comfort insole</b><br>Dual Comfort standard | 35-48 |
| SI-99527-XL | Dual Comfort XL                                     | 39-50 |

### Dual Comfort Plus insole

suitable for all Sievi shoes with exchangeable insole



- Sievi Balance arch support
- shock-absorbing PORON® cushioning in the heel
- soft upper material
- breathable and moisture-absorbing mid-layer
- light and shock-absorbing EVA bottom layer

**dpvlink 15568** 

| Article | Type | Size |
|---------|------|------|
|---------|------|------|

|             |   |       |
|-------------|---|-------|
| SI-99530    | <b>Dual Comfort Plus insole</b><br>Dual Comfort Plus +Neutral Arch+ | 35-48 |
| SI-99532-XL | Dual Comfort Plus XL +Neutral Arch+                                 | 39-48 |
| SI-99534    | Dual Comfort Plus +High Arch+                                       | 35-48 |
| SI-99536-XL | Dual Comfort Plus XL +High Arch+                                    | 39-48 |

# LUPOS

The king is back

## PRODUCTS FOR EVERY NEED

LUPOS® offers a collection of safety shoes classified by the requirements. The characteristics that come together in the shoes are the robustness and the technology of the materials.

Besides the models of pull-up leather and suede, Lupos uses PUTEK PLUS offering lots of advantages. PUTEK PLUS is a highly durable and abrasion-resistant yarn with is directly integrated in the fabric. This yarn ensures the manufacture of ultra-lightweight and very breathable products.

Anti-slip and anti-perforation system; innovative and extremely comfortable sole guarantees a well-being throughout the whole day.



The materials used, the profound adaptation studies, the cutting-edge technology have allowed to implement a series of products that are synonyms for guarantee, efficiency and durability, ensuring lasting well-being.

Thanks to the lightness of the materials these shoes are ideal for every sector of work and for any activity for free time and cannot only be worn in different work environments, but also in the most extreme situations.

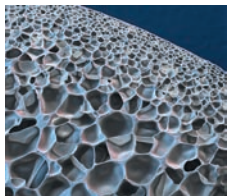

### Lightness and flexibility in a single product.

Infinergy® developed by BASF is the first expanded thermoplastic polyurethane. It returns you positive energy. A concentration of technology that turns the traditional cushioning into a dynamic cushioning. The resulting energy when the foot hits the ground is stored and is directly returned during the walking process, thus supporting you when walking. Even when

exposed to permanent stress it provides excellent long-term strength. In contrast to other conventional foams, Infinerogy® remains highly elastic, even at temperature ranges from +40°C to -20°C.



**ESD-geprüfte Schuhe**  
nach EN 61340



**Sicherheitsschuhe S1P**  
nach EN ISO 20345



**Sicherheitsschuhe S3**  
nach EN ISO 20345



**Berufsschuhe O1**  
nach EN ISO 20347



**Berufsschuhe O2**  
nach EN ISO 20347



**Zehenkappe CAP LIGHT® Aluminium**

Gelochte 200J Sicherheitskappe aus Aluminium



**Dämpfungssystem Infinerogy®**  
Hervorragende Dämpfeigenschaften durch Zwischensohle aus Infinerogy®. Dauerhaft gelenkschonend



**Besteht aus Cordura®**

Sehr reissfestes, abriebfestes Nylon



**Secosol®**  
geeignet für orthopädische Einlegesohlen  
Secosol®

## Safety shoes

### Safety shoe Marra / Fibra



Safety shoe; upper soft pull-up leather; with integrated band; thin, perforated aluminum toe cap; metal-free penetration protection; breathable, absorbent lining; Memory+Gel ESD insole; Infinerogy® midsole; PU outsole; oil-, acid and fuel-resistant; slip-resistant; antistatic. EN ISO 20345:2011 S3 SRC



dpvlink 23342



| Article                          | Color | Size  | Category | Form     |
|----------------------------------|-------|-------|----------|----------|
| <b>Safety shoe Marra / Fibra</b> |       |       |          |          |
| LU-20044                         | black | 35-48 | S3       | low shoe |
| LU-10044                         | black | 38-48 | S3       | boot     |

### Safety sandal Jake / Logan



Safety shoe; upper soft pull-up leather or suede; with integrated band; thin, perforated aluminum toe cap; metal-free penetration protection; very breathable, absorbent lining; Memory+Gel ESD insole; Infinerogy® midsole; PU outsole with a slightly increased heel; oil-, acid and fuel-resistant; slip-resistant; antistatic. EN ISO 20345:2011 S1P SRC



dpvlink 23345



| Article                           | Color | Size  | Category | Upper   |
|-----------------------------------|-------|-------|----------|---------|
| <b>Safety sandal Jake / Logan</b> |       |       |          |         |
| LU-30076                          | black | 38-48 | S1P      | leather |
| LU-30066                          | grey  | 35-48 | S1P      | suede   |

### Safety shoe Park / Bank



Safety shoe; upper suede; with integrated band; thin, perforated aluminum toe cap; metal-free penetration protection; very breathable, absorbent lining; Memory+Gel ESD insole; Infinerogy® midsole; PU outsole with a slightly increased heel; oil-, acid and fuel-resistant; slip-resistant; antistatic. EN ISO 20345:2011 S1P SRC



dpvlink 23488



| Article                        | Color | Size  | Category | Form     |
|--------------------------------|-------|-------|----------|----------|
| <b>Safety shoe Park / Bank</b> |       |       |          |          |
| LU-20056                       | grey  | 35-48 | S1P      | low shoe |
| LU-10056                       | grey  | 35-48 | S1P      | boot     |

## Shoe Entics / Nach



Safety shoe; upper Putek® PLUS; with integrated band; very breathable, absorbent lining; Memory ESD insole; Infinergy® midsole; PU outsole; oil-, acid and fuel-resistant; slip-resistant (SRC).

Variant safety shoe S3 additionally with aluminum toe cap and metal-free penetration protection



dpvlink 23489



| Article                   | Color | Size  | Category | Protective toe cap | Form     |
|---------------------------|-------|-------|----------|--------------------|----------|
| <b>Shoe Entics / Nach</b> |       |       |          |                    |          |
| LU-20477                  | black | 38-48 | O2       |                    | low shoe |
| LU-20174                  | black | 35-48 | S3       | aluminum           | low shoe |
| LU-10174                  | black | 35-48 | S3       | aluminum           | boot     |

## Shoe Dex / Juice / Lucas



Safety shoe; upper very breathable nylon with suede; with integrated band; very breathable, absorbent lining; Memory+Gel ESD insole; Infinergy® midsole; PU outsole with a slightly increased heel; oil-, acid and fuel-resistant; slip-resistant (SRC).

Variant safety shoe S1P additionally with aluminum toe cap



dpvlink 23513



| Article                         | Color       | Size  | Category | Form     |
|---------------------------------|-------------|-------|----------|----------|
| <b>Shoe Dex / Juice / Lucas</b> |             |       |          |          |
| LU-20277                        | black / red | 38-47 | O2       | low shoe |
| LU-20367                        | black       | 38-47 | O1       | low shoe |
| LU-20366                        | black       | 38-47 | S1P      | low shoe |
| LU-20266                        | black / red | 38-47 | S1P      | low shoe |

## Safety shoe Emis / Lil



Safety shoe; upper microfiber; with integrated band; thin, perforated aluminum toe cap; metal-free penetration protection; very breathable, absorbent lining; Memory+Gel ESD insole; Infinergy® midsole; PU outsole with a slightly increased heel; oil-, acid and fuel-resistant; slip-resistant; antistatic. 100% vegan

Emis LU-20166 EN ISO 20345:2011 S1P SRC

Lil LU-20374 EN ISO 20345:2011 S3 CI SRC



dpvlink 23516



| Article                       | Color        | Size  | Category | Form     |
|-------------------------------|--------------|-------|----------|----------|
| <b>Safety shoe Emis / Lil</b> |              |       |          |          |
| LU-20166                      | white / grey | 35-47 | S1P      | low shoe |
| LU-20374                      | white / blue | 35-47 | S3       | low shoe |

## Shoe Sylvia / Kendrick / Vince



Safety shoe; upper Putek® PLUS; with integrated band; very breathable, absorbent lining; Memory+Gel ESD insole; Infinergy® midsole; PU outsole with a slightly increased heel; oil-, acid and fuel-resistant; 100% vegan; slip-resistant (SRC).

Variant safety shoe S3 additionally with aluminum toe cap



dpvlink 23519



| Article                               | Color          | Size  | Category | Protective toe cap |
|---------------------------------------|----------------|-------|----------|--------------------|
| <b>Shoe Sylvia / Kendrick / Vince</b> |                |       |          |                    |
| LU-20387                              | black / rose   | 35-42 | O2       |                    |
| LU-20384                              | black / rose   | 35-42 | S3       | aluminum           |
| LU-20394                              | black / orange | 38-47 | S3       | aluminum           |
| LU-20404                              | black / green  | 38-47 | S3       | aluminum           |

## Safety shoe Logan DUO / Entics DUO / Nach DUO



Safety shoe; with integrated band; thin, perforated aluminum toe cap; metal-free penetration protection; very breathable, absorbent lining; Memory+Gel ESD insole; Infinergy® midsole; PU/PU midsole with Elastopan by BASF with anti-fatigue insert; PU outsole with a slightly increased heel; oil-, acid and fuel-resistant; slip-resistant; antistatic.

Logan DUO LU-30476: upper suede; EN ISO 20345:2011 S1P CI SRC

Entics DUO LU-20474 and Nach DUO LU-10474: upper Putek® PLUS; EN ISO 20345:2011 S3 CI SRC



dpvlink 23524



| Article  | Color        | Size  | Category | Form     | Closure         |
|--|--------------|-------|----------|----------|-----------------|
| <b>Safety shoe Logan DUO / Entics DUO / Nach DUO</b> |              |       |          |          |                 |
| LU-30476   | grey         | 35-48 | S1P      | sandal   | velcro fastener |
| LU-20474   | black / grey | 35-48 | S3       | low shoe | lace fastening  |
| LU-10474   | black / grey | 35-48 | S3       | boot     | lace fastening  |



Alle mit diesem Symbol markierten Schuhmodelle sind für Secosol® geeignet. Weitere Informationen finden Sie unter [dpvlink 20191](#)

Safety shoe Distance / Metallic / Sonic 

Safety shoe; upper soft pull-up leather; with integrated band; thin, perforated aluminum toe cap; metal-free penetration protection; very breathable, absorbent lining; Memory ESD insole; Infinergy® midsole; PU outsole with a slightly increased heel; oil-, acid and fuel-resistant; slip-resistant; antistatic.  
Distance LU-30146 EN ISO 20345:2011 S1P SRC  
Metallic LU-20084 and Sonic LU-10084 EN ISO 20345:2011 S3 SRC



dpvlink 23490



| Article  | Color       | Size  | Category | Form     | Closure         |
|--|-------------|-------|----------|----------|-----------------|
| <b>Safety shoe Distance / Metallic / Sonic</b> |             |       |          |          |                 |
| LU-30146                                       | black / red | 38-48 | S1P      | sandal   | velcro fastener |
| LU-20084                                       | black / red | 35-48 | S3       | low shoe | lace fastening  |
| LU-10084                                       | black / red | 38-48 | S3       | boot     | lace fastening  |

Safety shoe Premium 

Safety shoe; upper nylon with suede; with integrated band; thin, perforated aluminum toe cap; metal-free penetration protection; very breathable, absorbent lining; Memory ESD insole; Infinergy® midsole; PU outsole with a slightly increased heel; oil-, acid and fuel-resistant; slip-resistant; antistatic. EN ISO 20345:2011 S1P SRC



dpvlink 23491



| Article                    | Color         | Size  | Category | Form     |
|----------------------------|---------------|-------|----------|----------|
| <b>Safety shoe Premium</b> |               |       |          |          |
| LU-20126                   | black / green | 38-48 | S1P      | low shoe |

Safety shoe Lunar 

Safety shoe; upper soft pull-up leather with Cordura elements; with integrated band; thin, perforated aluminum toe cap; metal-free penetration protection; very breathable, absorbent lining; Memory ESD insole; Infinergy® midsole; PU outsole with a slightly increased heel; oil-, acid and fuel-resistant; slip-resistant; antistatic. EN ISO 20345:2011 S3 SRC



dpvlink 23492



| Article                  | Color        | Size  | Category | Form     |
|--------------------------|--------------|-------|----------|----------|
| <b>Safety shoe Lunar</b> |              |       |          |          |
| LU-20104                 | black / grey | 38-48 | S3       | low shoe |

# ELTEN

Take a walk on the safe side

ELTEN safety shoes always give the wearer a genuine feeling of safety. For good reason. ELTEN safety shoes are not only made without compromise to the highest levels of quality, they are also designed to fulfill specifications, which partly go far beyond the current standards requirements.

Millions of people all over the world wear ELTEN safety shoes at work. Their trust is an obligation for us to continuously improve the performance of our safety shoes in the future, to reduce occupational hazards with every new model and to make working places safer every day.

In compliance with the ESD standard DIN EN 61340-5-1 



Infinergy® developed by BASF is the first expanded thermoplastic polyurethane (TPU E) in the world. Thanks to the enormous resilience of Infinergy®, the so-called rebound effect, the sole returns the wearer most of the energy consumed while walking. So, the wearer must spend less strength.

BASF's Infinergy® is thus the ideal material for safety shoes used in areas with hard floors. The new series WELLMAXX is a real innovation in the field of foot protection, because the elastic material has only been used with running shoes in the sport sector before. The footwear is lightweight and of high durability at the same time. The sole remains highly elastic without hardening even at temperatures of minus 20°C.

-  **ESD-geprüfte Schuhe**  
nach EN 61340
-  **Berufsschuhe OB**  
nach EN ISO 20347
-  **Berufsschuhe O1**  
nach EN ISO 20347
-  **Berufsschuhe O2**  
nach EN ISO 20347
-  **Sicherheitsschuhe S1**  
nach EN ISO 20345
-  **Sicherheitsschuhe S1P**  
nach EN ISO 20345
-  **Sicherheitsschuhe S2**  
nach EN ISO 20345
-  **Sicherheitsschuhe S3**  
nach EN ISO 20345
-  **Durchtrittshemmung**  
verhindert das Eindringen von Fremdkörpern durch die Sohle
-  **Reflektierende Materialien**  
erhöhen die Sicherheit bei Dämmerlicht und Dunkelheit
-  **Rutschhemmung SRC**  
Der Schuh ist nach der höchsten Anforderung an die Rutschhemmung zertifiziert (SRC)
-  **Dämpfungssystem Infinergy®**  
Hervorragende Dämpfungseigenschaften durch Zwischensohle aus Infinergy®. Dauerhaft gelenkschonend
-  **Boa®-System**  
Schuh mit Boa-Verschlusssystem
-  **GORE-TEX® Laminat**  
Wasserabweisendes, aber dennoch atmungsaktives Material
-  **Orthopädischer Fußschutz**  
nach DGUV Regel 112-191
-  **geeignet für orthopädische Einlegesohlen Secosol®**



## Clogs

### Occupational clog MICHEL / MIA

Clog; upper microfiber; heel strap for an individual adaption to the foot; instep area adjustable with velcro fastener; breathable textile lining; metal- and leather-free equipment; exchangeable insole C-FIT ESD; MONO-PU outsole C-FIT, oil- and chemical-resistant; slip-resistant, EN ISO 20347 O2 SRC



dpvlink 22543



| Article                               | Color | Size  |       |
|---------------------------------------|-------|-------|-------|
| <b>Occupational clog MICHEL / MIA</b> |       |       |       |
| EL-972430                             | black | 40-48 | men   |
| EL-972440                             | white | 40-48 | men   |
| EL-974430                             | black | 35-42 | women |
| EL-974440                             | white | 35-42 | women |

## Occupational and safety footwear

### Occupational shoe OFFICER GTX

Occupational shoe; upper cowhide; extra large fit; exchangeable insole BUSINESS ESD; MONO-PU outsole BUSINESS, oil- and chemical-resistant; slip-resistant, EN ISO 20347 O2 SRC



dpvlink 22556



| Article                              | Color | Size  |  |
|--------------------------------------|-------|-------|--|
| <b>Occupational shoe OFFICER GTX</b> |       |       |  |
| EL-972312                            | black | 40-48 |  |

### Sneaker MAROON

Sporty sneaker; upper cowhide; leather lining; padded flap; steel toe cap; exchangeable insole ESD PRO; TPU/PU outsole L10, oil- and chemical-resistant; slip-resistant SRC



dpvlink 22564



| Article               | Color | Size  | Category | Protective toe cap |
|-----------------------|-------|-------|----------|--------------------|
| <b>Sneaker MAROON</b> |       |       |          |                    |
| EL-72110              | brown | 37-47 | S2       | steel              |

## WELLMA ELTEN Wellmaxx - ergonomic outsole

### MAXIMAL EFFECTIVITY

With every step Infinergy® absorbs enormous amounts of energy and keeps your feet healthy.

### MAXIMAL WELLNESS

Your feet remain fitter with Infinergy® and tire less quickly.

### MAXIMAL DURABILITY

Infinergy® stays durably elastic and always bounces back into its original shape.

### MAXIMAL BOUNCE

Infinergy® returns a lot more energy and drive to you than conventional materials.

### MAXIMAL PROTECTION OF THE JOINTS

The outstanding cushioning characteristics of Infinergy® steadily prevent the joints from damage.

### MAXIMAL TEMPERATURE RESISTANCE

Infinergy® keeps it full functionality in a wide range from -20 to +40 degrees Celsius.

### Safety shoe SENEX XXT

Comfortable safety shoe; upper: water-repellent microfiber/water-repellent textile CORDURA®; closed and padded flap; breathable textile lining; plastic toe cap; metal-free penetration protection; exchangeable ESD insole PRO black; PU/PU outsole WELLMAXX TRAINERS with sole core of Infinergy® by BASF for optimal cushioning; oil- and chemical-resistant, antistatic; slip-resistant. EN ISO 20345 S3 SRC



WELLMA 



dpvlink 23151



| Article   | Color       | Size  | Category | Closure        |
|-----------|-------------|-------|----------|----------------|
| EL-729731 | black / red | 36-48 | S3       | lace fastening |
| EL-729831 | black / red | 36-48 | S3       | Boa®           |

### Safety shoe NEWTON

Modern safety shoe; upper water-repellent textile/water-repellent nubuck; breathable textile lining; steel toe cap; exchangeable ESD insole PRO grey; PU/PU outsole WELLMAXX L10 with sole core of Infinergy® by BASF for optimal cushioning; oil- and chemical-resistant, antistatic; slip-resistant. EN ISO 20345 S2 SRC



WELLMA 



dpvlink 23178



| Article                   | Color        | Size  | Category | Form     |
|---------------------------|--------------|-------|----------|----------|
| <b>Safety shoe NEWTON</b> |              |       |          |          |
| EL-729910                 | black / grey | 36-48 | S2       | low shoe |
| EL-769910                 | black / grey | 36-48 | S2       | boot     |



## Safety shoe NEWTON



Modern safety shoe; upper water-repellent textile/water-repellent nubuck; breathable textile lining; steel toe cap; exchangeable ESD insole PRO grey; PU/PU outsole WELLMAXX L10 with sole core of Infinergy® by BASF for optimal cushioning; oil- and chemical-resistant, antistatic; slip-resistant. EN ISO 20345 S2 SRC



dpvlink 23175

| Article                   | Color | Size  | Category | Form     |
|---------------------------|-------|-------|----------|----------|
| <b>Safety shoe NEWTON</b> |       |       |          |          |
| EL-729905                 | blue  | 36-48 | S2       | low shoe |
| EL-769905                 | blue  | 36-48 | S2       | boot     |



## Safety shoe BREEZER XX10



Safety shoe with sporty design; upper nubuck; padded flap; breathable textile lining; steel toe cap; exchangeable ESD insole PRO black; PU/PU outsole WELLMAXX L10 with sole core of Infinergy® by BASF for optimal cushioning; oil- and chemical-resistant, antistatic; slip-resistant. EN ISO 20345 S1 SRC



dpvlink 23173

| Article                         | Color       | Size  | Category |
|---------------------------------|-------------|-------|----------|
| <b>Safety shoe BREEZER XX10</b> |             |       |          |
| EL-729925                       | black / red | 36-48 | S1       |



## Safety shoe SENSATION XXT



Modern safety shoe; upper hydrophobized textile with jeans look/hydrophobized nubuck; padded flap; breathable textile lining Bioactive; plastic toe cap; ESD insole Pro grey; PU/PU outsole WELLMAXX TRAINERS with sole core of Infinergy® by BASF for optimal cushioning; oil- and chemical-resistant, antistatic; slip-resistant. EN ISO 20345 S2 SRC



dpvlink 22500

| Article                          | Color | Size  | Category | Form     |
|----------------------------------|-------|-------|----------|----------|
| <b>Safety shoe SENSATION XXT</b> |       |       |          |          |
| EL-729720                        | jeans | 36-48 | S2       | low shoe |
| EL-769720                        | jeans | 36-48 | S2       | boot     |



## Safety shoe LAKERS XXT



Sporty and lightweight safety shoe; upper mesh/microfiber; metal- and leather-free; padded flap; breathable textile lining; plastic toe cap; metal-free penetration protection; exchangeable ESD insole PRO black; PU/PU outsole WELLMAXX TRAINERS with sole core of Infinergy® by BASF for optimal cushioning; oil- and chemical-resistant, antistatic; slip-resistant. EN ISO 20345 S1P SRC



dpvlink 22497

| Article                       | Color       | Size  | Category | Form     |
|-------------------------------|-------------|-------|----------|----------|
| <b>Safety shoe LAKERS XXT</b> |             |       |          |          |
| EL-729711                     | black / red | 36-48 | S1P      | low shoe |
| EL-769711                     | black / red | 36-48 | S1P      | boot     |



## Safety sandal SCOTT XXT



Comfortable safety sandal; upper mesh/microfiber; padded flap; breathable textile lining; plastic toe cap; metal-free penetration protection; exchangeable ESD insole PRO black; PU/PU outsole WELLMAXX TRAINERS with sole core of Infinergy® by BASF for optimal cushioning; oil- and chemical-resistant, antistatic; slip-resistant. EN ISO 20345 S1P SRC



dpvlink 22503

| Article                        | Color | Size  | Category |
|--------------------------------|-------|-------|----------|
| <b>Safety sandal SCOTT XXT</b> |       |       |          |
| EL-719731                      | black | 36-48 | S1P      |



## Safety shoe IMPULSE XXT



Comfortable and airy safety shoe; upper microfiber; breathable textile lining; plastic toe cap; exchangeable ESD insole PRO black; PU/PU outsole WELLMAXX TRAINERS with sole core of Infinergy® by BASF for optimal cushioning; oil- and chemical-resistant, antistatic; slip-resistant. EN ISO 20345 S1 SRC



dpvlink 23181

| Article                        | Color        | Size  | Category | Form     |
|--------------------------------|--------------|-------|----------|----------|
| <b>Safety shoe IMPULSE XXT</b> |              |       |          |          |
| EL-719755                      | black / blue | 36-48 | S1       | sandal   |
| EL-729755                      | black / blue | 36-48 | S1       | low shoe |



## Safety shoe NED / NOEL



Sporty safety shoe; padded flap; breathable textile lining; steel toe cap; exchangeable ESD insole PRO black; PU/PU outsole WELLMAXX L10 with sole core of Infinergy® by BASF for optimal cushioning; oil- and chemical-resistant, antistatic; slip-resistant. EN ISO 20345 S2 SRC



WELLMA:XXX



dpvlink 23189

| Article                       | Color         | Size  | Category | Upper      |
|-------------------------------|---------------|-------|----------|------------|
| <b>Safety shoe NED / NOEL</b> |               |       |          |            |
| EL-729915                     | black         | 36-48 | S2       | leather    |
| EL-729920                     | black / white | 36-48 | S2       | microfiber |



## Safety shoe LELAND blue



Breathable safety shoe; upper textile/microfiber; padded flap; breathable textile lining; steel toe cap; metal-free penetration protection; exchangeable ESD insole SPORTIVE black; TPU/PU outsole MAXXIMO with sole core of Infinergy® by BASF for optimal cushioning; oil- and chemical-resistant, antistatic; slip-resistant. EN ISO 20345 S1P SRC



WELLMA:XXX



dpvlink 23194

| Article                        | Color        | Size  | Category | Form     |
|--------------------------------|--------------|-------|----------|----------|
| <b>Safety shoe LELAND blue</b> |              |       |          |          |
| EL-729601                      | black / blue | 40-48 | S1P      | low shoe |



## Safety sandal ETHAN Easy



Safety sandal; microfiber, padded flap; plastic toe cap; non-metallic penetration protection; breathable textile lining; exchangeable ESD insole PRO black; TPU/PU outsole; optimal cushioning; outsole: oil- and chemical-resistant, antistatic; slip-resistant, EN ISO 20345 S1 SRC



WELLMA:XXX



dpvlink 21126

| Article                         | Color | Size  | Category | Form   |
|---------------------------------|-------|-------|----------|--------|
| <b>Safety sandal ETHAN Easy</b> |       |       |          |        |
| EL-719460                       | black | 40-48 | S1       | sandal |



## Safety shoe LANCE



Modern safety shoe; upper textile/microfiber; padded flap; breathable textile lining; steel toe cap; metal-free penetration protection; exchangeable ESD insole SPORTIVE black; TPU/PU outsole MAXXIMO with sole core of Infinergy® by BASF for optimal cushioning; oil- and chemical-resistant, antistatic; slip-resistant. EN ISO 20345 S1P SRC



WELLMA:XXX



dpvlink 24271

| Article                  | Color | Size  | Category | Form     |
|--------------------------|-------|-------|----------|----------|
| <b>Safety shoe LANCE</b> |       |       |          |          |
| EL-729695                | grey  | 40-48 | S1       | low shoe |
| EL-729691                | black | 40-48 | S1P      | low shoe |



## Safety shoe LELAND GTX



Modern safety shoe; upper water-repellent textile/water-repellent microfiber; padded flap; GORE-TEX® Special Comfort Footwear lining; steel toe cap; metal-free penetration protection; exchangeable ESD insole SPORTIVE black; TPU/PU outsole MAXXIMO with sole core of Infinergy® by BASF for optimal cushioning; oil- and chemical-resistant, antistatic; slip-resistant. EN ISO 20345 S3 SRC



WELLMA:XXX



dpvlink 23196

| Article                       | Color        | Size  | Category | Form     |
|-------------------------------|--------------|-------|----------|----------|
| <b>Safety shoe LELAND GTX</b> |              |       |          |          |
| EL-729581                     | black / grey | 40-48 | S3       | low shoe |
| EL-729591                     | black / lime | 40-48 | S3       | low shoe |



## Safety shoe LONNY



Sporty safety shoe; upper mesh/microfiber; leather-free equipment; padded flap; breathable textile lining; steel toe cap; metal-free penetration protection; exchangeable insole SPORTIVE ESD black; TPU/PU outsole MAXXIMO with sole core of Infinergy® by BASF for optimal cushioning; oil- and chemical-resistant, antistatic; slip-resistant. EN ISO 20345 SRC



WELLMA:XXX



dpvlink 22509

| Article                  | Color        | Size  | Category | Form     |
|--------------------------|--------------|-------|----------|----------|
| <b>Safety shoe LONNY</b> |              |       |          |          |
| EL-719521                | black / red  | 35-48 | S1P      | sandal   |
| EL-729521                | black / red  | 35-48 | S1P      | low shoe |
| EL-729525                | black / blue | 35-48 | S1       | low shoe |



## Low shoe MADDOX

**ELTEN** 

Sporty safety shoe; upper water-repellent textile/water-repellent microfiber/water-repellent nubuck; padded flap; breathable lining; leather-free; exchangeable ESD insole SPORTIVE black; TPU/PU outsole MAXXIMO with sole core of Infinergy® by BASF for optimal cushioning; oil- and chemical-resistant, antistatic; slip-resistant.

Model MADDOX Black Leather (EL-929563) with upper water-repellent nubuck

Variant safety shoe S3 additionally with steel toe cap and metal-free penetration protection



**WELLMA** 

**dpvlink 23199** 

| Article                | Color        | Size  | Category | Protective toe cap |
|------------------------|--------------|-------|----------|--------------------|
| <b>Low shoe MADDOX</b> |              |       |          |                    |
| EL-929652              | black / red  | 36-49 | O2       |                    |
| EL-929563              | black        | 36-49 | O2       |                    |
| EL-729461              | black / grey | 35-48 | S3       | steel              |
| EL-729561              | black / red  | 40-48 | S3       | steel              |

## Low shoe MADDOX / MADDIE

**ELTEN** 

Sporty professional shoe; padded flap; breathable textile lining; exchangeable ESD insole SPORTIVE ESD; TPU/PU outsole with sole core of Infinergy® by BASF for optimal cushioning; outsole: oil- and chemical-resistant, antistatic; slip-resistant.

Variant safety shoe S1P additionally with steel toe cap and metal-free penetration protection



**WELLMA** 

**dpvlink 21128** 

| Article                         | Color       | Size  | Category | Upper                | Form     | Protective toe cap |
|---------------------------------|-------------|-------|----------|----------------------|----------|--------------------|
| <b>Low shoe MADDOX / MADDIE</b> |             |       |          |                      |          |                    |
| EL-949502                       | grey / blue | 36-42 | O1       | microfiber / textile | low shoe |                    |
| EL-729551                       | grey / blue | 40-48 | S1P      | microfiber / textile | low shoe | steel              |
| EL-749531                       | grey / blue | 35-42 | S1P      | microfiber / textile | sandal   | steel              |
| EL-749501                       | grey / blue | 35-42 | S1P      | microfiber / textile | low shoe | steel              |
| EL-729571                       | blue        | 35-48 | S1P      | suede / textile      | low shoe | steel              |

## Safety shoe MARTEN / MARTY

**NEU ELTEN** 

Safety shoe; upper seamless mesh; padded flap; steel toe cap; breathable textile lining; leather-free; exchangeable insole; TPU/PU outsole WELLMAXX SPORTS with sole core of Infinergy® by BASF for optimal cushioning; slip-resistant, EN ISO 20345 S1P / S3

Model MARTEN Low (EL-728121) with upper microfiber/mesh

Modell Marty Low (EL-728181) with upper water-repellent textile Cordura®



**WELLMA** 

**dpvlink 24975** 

| Article                           | Color        | Size  | Category | Closure        |
|-----------------------------------|--------------|-------|----------|----------------|
| <b>Safety shoe MARTEN / MARTY</b> |              |       |          |                |
| EL-728121                         | blue         | 35-48 | S1P      | lace fastening |
| EL-728181                         | black / blue | 40-48 | S3       | lace fastening |

## Safety shoe LARKIN

**NEU ELTEN** 

Sporty safety shoe; upper seamless mesh; padded flap; steel toe cap; breathable textile lining; leather-free; exchangeable insole; TPU/PU outsole WELLMAXX SPORTS with sole core of Infinergy® by BASF for optimal cushioning; slip-resistant, EN ISO 20345 S1 / S1P



**WELLMA** 

**dpvlink 24971** 

| Article                   | Color        | Size  | Category | Closure        |
|---------------------------|--------------|-------|----------|----------------|
| <b>Safety shoe LARKIN</b> |              |       |          |                |
| EL-728101                 | blue         | 35-48 | S1P      | lace fastening |
| EL-728110                 | black / blue | 35-48 | S1       | lace fastening |
| EL-728111                 | black / grey | 35-48 | S1P      | lace fastening |

## Safety shoe LANDON

**ELTEN** 

Stylish safety shoe; upper microfiber/textile; padded flap; breathable textile lining; steel toe cap; metal-free penetration protection; exchangeable ESD insole SPORTIVE black; TPU/PU outsole MAXXIMO with sole core of Infinergy® by BASF for optimal cushioning; oil- and chemical-resistant, antistatic; slip-resistant. EN ISO 20345 S1 SRC



**WELLMA** 

**dpvlink 23192** 

| Article                   | Color | Size  | Category |
|---------------------------|-------|-------|----------|
| <b>Safety shoe LANDON</b> |       |       |          |
| EL-729505                 | grey  | 40-48 | S1       |

## Safety shoe VINTAGE



Safety shoe: cowhide waxy in vintage design, padded flap; steel toe cap; textile lining Bioactive; non-metallic penetration protection; exchangeable ESD insole PRO Lady grey; TPU/PU outsole; optimal cushioning; outsole: oil- and chemical-resistant, antistatic; slip-resistance, EN ISO 20345 S3 SRC



dpvlink 19064



| Article                    | Color | Size  | Category | Form    |
|----------------------------|-------|-------|----------|---------|
| <b>Safety shoe VINTAGE</b> |       |       |          |         |
| EL-74101                   | grey  | 35-42 | S3       | sneaker |
| EL-721071                  | grey  | 37-48 | S3       | sneaker |
| EL-74201                   | grey  | 35-42 | S3       | boot    |

## Safety shoe SENSATION



Safety shoe: hydrophobized textile in jeans optics and hydrophobized nubuck, padded flap; steel toe cap; textile lining Bioactive; exchangeable ESD insole PRO grey; TPU/PU outsole; optimal cushioning; outsole: oil- and chemical-resistant, antistatic; slip-resistance, EN ISO 20345 S2 SRC



dpvlink 19058



| Article                      | Color | Size  | Category | Form    |
|------------------------------|-------|-------|----------|---------|
| <b>Safety shoe SENSATION</b> |       |       |          |         |
| EL-72106                     | black | 37-47 | S2       | sneaker |
| EL-74106                     | black | 35-42 | S2       | sneaker |
| EL-76106                     | black | 37-47 | S2       | boot    |

## Safety shoe BREEZER



Safety shoe: nubuck; neon-yellow reflective material, padded flap; steel toe cap; breathable textile lining; exchangeable ESD insole PRO black; TPU/PU outsole; optimal cushioning; outsole: oil- and chemical-resistant, antistatic; slip-resistance, EN ISO 20345 S1P SRC



dpvlink 19066



| Article                    | Color         | Size  | Category | Form    |
|----------------------------|---------------|-------|----------|---------|
| <b>Safety shoe BREEZER</b> |               |       |          |         |
| EL-74121                   | black / neon  | 35-42 | S1P      | sneaker |
| EL-72109                   | grey / yellow | 37-47 | S1       | sneaker |

## Safety shoe MAVERICK / LAKERS



Safety shoe; upper microfiber with mesh element; padded flap; leather-free equipment; plastic toe cap; metal-free penetration protection; breathable textile lining; exchangeable ESD insole PRO black; PU/PU outsole FUN; outsole: oil- and chemical-resistant, antistatic; slip-resistant, EN ISO 20345 S1P SRC



dpvlink 21447



| Article                              | Color | Size  | Category | Protective toe cap |
|--------------------------------------|-------|-------|----------|--------------------|
| <b>Safety shoe MAVERICK / LAKERS</b> |       |       |          |                    |
| EL-723351                            | blue  | 38-48 | S1P      | steel              |
| EL-724451                            | black | 35-49 | S1P      | plastic            |

## Safety shoe JOURNEY



Safety shoe, padded flap; steel toe cap; partially metal-free penetration protection; breathable textile lining; exchangeable ESD insole SPORTIVE; TPU/PU outsole; optimal cushioning; outsole: oil- and chemical-resistant, antistatic; slip-resistant. EN ISO 20345 SRC



dpvlink 21132



| Article                    | Color        | Size  | Category |
|----------------------------|--------------|-------|----------|
| <b>Safety shoe JOURNEY</b> |              |       |          |
| EL-729630                  | grey         | 40-48 | S1       |
| EL-729621                  | black / blue | 40-48 | S1P      |

## Safety shoe MILA



Sporty safety shoe: padded flap; steel toe cap; partially metal-free penetration protection; breathable textile lining; exchangeable ESD insole Ladies ESD grey; PU/PU outsole NOVA; optimal cushioning; outsole: oil- and chemical-resistant, antistatic; slip-resistant, EN ISO 20345 SRC



dpvlink 22535



| Article                 | Color            | Size  | Category | Form     |
|-------------------------|------------------|-------|----------|----------|
| <b>Safety shoe MILA</b> |                  |       |          |          |
| EL-74710                | grey / turquoise | 35-42 | S1       | sandal   |
| EL-74720                | grey / turquoise | 35-42 | S1       | low shoe |

Safety shoe MAJA Easy



Safety shoe: microfiber/textile; padded flap; steel toe cap; breathable textile lining; ESD insole; PU/PU outsole; optimal cushioning; outsole: oil- and chemical-resistant, antistatic; slip-resistance, EN ISO 20345 S1 SRC



dpvlink 20177



| Article                      | Color        | Size  | Category |
|------------------------------|--------------|-------|----------|
| <b>Safety shoe MAJA Easy</b> |              |       |          |
| EL-74770                     | black / grey | 35-42 | S1       |

Safety shoe IMPULSE Aqua



Modern safety shoe: microfiber; padded flap; steel toe cap; breathable textile lining; leather-free equipment; exchangeable ESD insole Ladies black; metal-free penetration protection; PU/PU outsole NOVA; optimal cushioning; outsole: oil- and chemical-resistant, antistatic; slip-resistance, EN ISO 20345 S1P SRC



dpvlink 20188



| Article                         | Color             | Size  | Category | Closure                |
|---------------------------------|-------------------|-------|----------|------------------------|
| <b>Safety shoe IMPULSE Aqua</b> |                   |       |          |                        |
| EL-74801                        | black / turquoise | 35-42 | S1P      | velcro fastener        |
| EL-74811                        | black / turquoise | 35-42 | S1P      | quick-release fastener |
| EL-74831                        | black / turquoise | 35-42 | S1P      | Boa®                   |

Safety shoe IMPULSE Grey



Lightweight safety shoe; upper microfiber; padded flap; metal- and leather-free; plastic toe cap; breathable textile lining; exchangeable semi-orthopedic insole ESD; TPU/PU outsole BIOMEX DYNAMICS; oil- and chemical-resistant, antistatic; slip-resistant. EN ISO 20345 S1 SRC



dpvlink 22515



| Article                         | Color        | Size  | Category | Form     |
|---------------------------------|--------------|-------|----------|----------|
| <b>Safety shoe IMPULSE Grey</b> |              |       |          |          |
| EL-72245                        | black / grey | 36-47 | S1       | low shoe |
| EL-71245                        | black / grey | 36-47 | S1       | sandal   |

Safety shoe IMPULSE Green



Lightweight safety shoe; upper microfiber; padded flap; metal-free penetration protection; plastic toe cap; breathable textile lining; exchangeable semi-orthopedic insole ESD; TPU/PU outsole BIOMEX DYNAMICS; oil- and chemical-resistant, antistatic; slip-resistant. EN ISO 20345 S1P SRC



dpvlink 22519



| Article                          | Color         | Size  | Category | Form     |
|----------------------------------|---------------|-------|----------|----------|
| <b>Safety shoe IMPULSE Green</b> |               |       |          |          |
| EL-712551                        | black / green | 36-47 | S1P      | sandal   |
| EL-722551                        | black / green | 36-47 | S1P      | low shoe |
| EL-762551                        | black / green | 36-47 | S1P      | boot     |

Safety shoe AMBITION BOA



Safety shoe with BOA® closure system: hydrophobized nubuck/textile; closed, padded flap; steel toe cap; breathable textile lining; semi-orthopedic ESD insole DIMENSION PRO; metal-free penetration protection; TPU/PU outsole; optimal cushioning; outsole: oil- and chemical-resistant, antistatic; slip-resistance, EN ISO 20345 S2 SRC



dpvlink 19068



| Article                         | Color             | Size  | Category | Closure                |
|---------------------------------|-------------------|-------|----------|------------------------|
| <b>Safety shoe IMPULSE Aqua</b> |                   |       |          |                        |
| EL-74801                        | black / turquoise | 35-42 | S1P      | velcro fastener        |
| EL-74811                        | black / turquoise | 35-42 | S1P      | quick-release fastener |
| EL-74831                        | black / turquoise | 35-42 | S1P      | Boa®                   |



dpvlink 19068



| Article                         | Color          | Size  | Category |
|---------------------------------|----------------|-------|----------|
| <b>Safety shoe AMBITION BOA</b> |                |       |          |
| EL-72752                        | black / yellow | 36-48 | S2       |

Safety shoe MOTION AIR



Safety shoe: mesh material/microfiber, padded flap; plastic toe cap; textile lining Bioactive; ESD insole PRO black; TPU/PU outsole; optimal cushioning; outsole: oil- and chemical-resistant, antistatic; slip-resistance, EN ISO 20345 S1 SRC



dpvlink 19076



| Article                       | Color       | Size  | Category |
|-------------------------------|-------------|-------|----------|
| <b>Safety shoe MOTION AIR</b> |             |       |          |
| EL-72170                      | black / red | 38-47 | S1       |



dpvlink 19076



| Article                       | Color       | Size  | Category |
|-------------------------------|-------------|-------|----------|
| <b>Safety shoe MOTION AIR</b> |             |       |          |
| EL-72170                      | black / red | 38-47 | S1       |

## Safety shoe MOTION

Safety shoe: hydrophobized microfiber/CORDURA®; metal-free; closed padded flap; plastic toe cap; breathable textile lining; ESD insole PRO grey; TPU/PU outsole; optimal cushioning; outsole: oil- and chemical-resistant, antistatic; slip-resistance, EN ISO 20345 S2 SRC



[dpvlink 19078](#)

| Article                   | Color        | Size  | Category |
|---------------------------|--------------|-------|----------|
| <b>Safety shoe MOTION</b> |              |       |          |
| EL-72182                  | black / grey | 38-47 | S2       |



## Safety shoe EASY

Safety shoe: mesh material/textile; padded flap; steel toe cap; breathable textile lining; ESD insole PRO grey; TPU/PU outsole; optimal cushioning; outsole: oil- and chemical-resistant, antistatic; slip-resistance, EN ISO 20345 S1 SRC



[dpvlink 19074](#)

| Article                 | Color        | Size  | Category |
|-------------------------|--------------|-------|----------|
| <b>Safety shoe EASY</b> |              |       |          |
| EL-72178                | black / blue | 39-48 | S1       |



## Safety shoe SENEX / SCOTT

Safety shoe: microfiber/textile; metal-free; padded flap; plastic toe cap; breathable textile lining; ESD insole PRO black; TPU/PU outsole; optimal cushioning; outsole: oil- and chemical-resistant, antistatic; slip-resistance, EN ISO 20345 S1 SRC



[dpvlink 20179](#)

| Article                          | Color       | Size  | Category | Closure         |
|----------------------------------|-------------|-------|----------|-----------------|
| <b>Safety shoe SENEX / SCOTT</b> |             |       |          |                 |
| EL-71872                         | black / red | 35-48 | S1       | velcro fastener |
| EL-72872                         | black / red | 35-48 | S2       | lace fastening  |



Alle mit diesem Symbol markierten Schuhmodelle sind für Secosol® geeignet.  
Weitere Informationen finden Sie unter [dpvlink 20191](#)

## Safety shoe DIRECTOR XXB

Smart safety shoe with business look; upper microfiber; padded flap; breathable textile lining; steel toe cap; exchangeable ESD insole SPORTIVE grey; PU/PU outsole WELLMAXX BUSINESS with sole core of Infinergy® by BASF for optimal cushioning; oil- and chemical-resistant, antistatic; slip-resistant. EN ISO 20345 S1 SRC

**WELLMAXX**



[dpvlink 23185](#)

| Article                         | Color | Size  | Category |
|---------------------------------|-------|-------|----------|
| <b>Safety shoe DIRECTOR XXB</b> |       |       |          |
| EL-729592                       | grey  | 40-48 | S1       |
| EL-729594                       | blue  | 40-48 | S1       |
| EL-729593                       | black | 40-48 | S1       |



## Safety shoe OFFICER / ADVISER / OFFICER LADY

Safety shoe in elegant business design; cowhide; padded flap; steel toe cap; leather lining; ESD insole; MONO-PU outsole; optimal cushioning; outsole: oil- and chemical-resistant, antistatic; slip-resistance, EN ISO 20345 S2 SRC



[dpvlink 19088](#)

| Article   | Color | Size  | Category |
|---|-------|-------|----------|
| <b>Safety shoe OFFICER / ADVISER / OFFICER LADY</b> |       |       |          |
| EL-71307  | black | 40-48 | men      |
| EL-71306  | black | 40-48 | men      |
| EL-74304  | black | 36-42 | women    |



## Insoles

### ESD PRO - insole



- ESD compliant
- anatomically shaped footbed
- dimensionally stable and permanently flexible
- odor-absorbing due to active carbon absorber
- high moisture absorption and release
- unisex and women's model

[dpvlink 19195](#)

| Article                 | Type                | Size  |
|-------------------------|---------------------|-------|
| <b>ESD PRO - insole</b> |                     |       |
| EL-204054               | ESD PRO             | 35-52 |
| EL-204056               | ESD PRO LADY insole | 35-42 |





**STEITZ SECURA**  
SICHERHEITSSCHUHE

**HIGH-TECH FOR YOUR FEET**

Our shoes have reduced leverage as well as multi-zone and heel absorption. That is the foundation. Added to this are special features for various occupations. Because every job presents different requirements for safety shoes. That is why we have such a great variety of models: safety shoes for all-round use, heavy-duty models with optional mid-foot protection and protection against electrostatic discharge, special shoes for foundrymen and welders, our firefighter collection, the women's line specially designed for women's feet and much more.

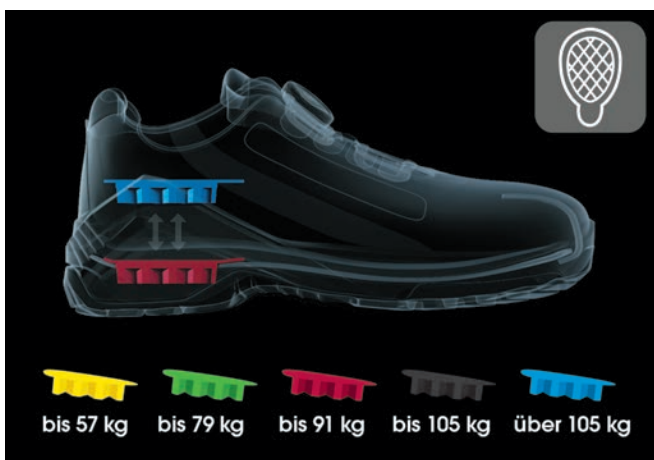

**SECURA VARIO® SYSTEM**

BACK PROTECTION THANKS TO INDIVIDUAL HEEL SHOCK ABSORPTION

Customized shock absorption: the replaceable, weight- and pressure-dependent heel shock absorption system ensures cushioning adapted to the individual needs of the wearer. The pressure load in the shoe is reduced to a natural extent and provides targeted relief to the back. At the same time, it helps to relieve the back in a targeted way and to significantly reduce fatigue.



**CLIMATE COMFORT**

NOT TOO COLD, NOT TOO WARM, JUST RIGHT

A perfect climate for your feet: With the climate comfort concept, we make sure that you will feel comfortable in your shoes for many hours. We only use climate- and skin-friendly materials to provide a pleasant-to-wear sensation. We use Gore-Tex as an effective climate-membrane. Inside the shoe you will find the heart of the STEITZ climate comfort concept, the leather insole. The sole made of genuine, vegetable-tanned leather with skin-friendly pH-value adapts individually to the foot. It also stores humidity that is carried away from the foot through our insoles. This prevents heat build-up and unpleasant sweating inside the shoe.



**VARIO MULTIFLEX®**

GET THE FEEL OF BAREFOOT WALKING

Many safety shoes influence the natural movement of the foot and limit its flexibility. The resulting leverage forces cause knee pain and back problems and can result in twisted ankles. That won't happen with us! Through intelligent adjustments to the shoe, we reduce undesired leverage forces: for example, by modifying the geometry of the outsole or reducing the sole thickness. One result of the VARIO Multiflex® technology is the multi-flexible sole.

-  **ESD-geprüfte Schuhe**  
nach EN 61340
-  **Sicherheitsschuhe S1**  
nach EN ISO 20345
-  **Sicherheitsschuhe S2**  
nach EN ISO 20345
-  **Aluminium-Zehenschutzkappe**
-  **Zehenschutzkappe, metallfrei**  
aus Verbundstoffen
-  **SECURA VARIO® System**  
belastungsangepasste Fersendämpfung
-  **4 verschiedene Weiten je Schuhlänge**
-  **VARIO MULTIFLEX®**  
hebelarmreduzierte Schuhkonstruktion für ein barrierefreies Laufverhalten
-  **Echtleder-Brandsohle**  
Einzigartige schuhklimatische Eigenschaften
-  **Baumustergeprüft**  
nach DGUV Regel 112-191
-  **geeignet für orthopädische Einlegesohlen Secosol®**



## Safety shoes

### Safety sneaker CP 43

Safety shoe; textile with high-frequency impression; composite toe cap; reinforced TPU tip protection; breathable functional lining; seamless; exchangeable comfort insole ERGO-SOFT ESD with shock-absorption, good moisture absorption; outsole TPU Competition ESD; TPU heel edging; metal-free; EN ISO 20345:2011 S2 SRC



[dpvlink 23741](#)

| Article                     | Color         | Size  | Category | Closure        |
|-----------------------------|---------------|-------|----------|----------------|
| <b>Safety sneaker CP 43</b> |               |       |          |                |
| SZ-CP4360                   | red / black   | 36-47 | S2       | lace fastening |
| SZ-CP4300                   | black / white | 36-47 | S2       | lace fastening |
| SZ-CP4380                   | black / green | 36-47 | S2       | lace fastening |

### Safety shoe SK 50/60

Safety shoe; breathable functional textile combined with hexagon-optics; shaft appliqué, aluminum toe cap; breathable functional lining; leather-free, suitable for all-ergy sufferers; exchangeable comfort insole ERGO-SOFT ESD with shock-absorption, excellent moisture absorption; outsole: TPU Skater ESD; EN ISO 20345:2011 S2 SRC



[dpvlink 22664](#)

| Article                     | Color        | Size  | Category |
|-----------------------------|--------------|-------|----------|
| <b>Safety shoe SK 50/60</b> |              |       |          |
| SZ-SK50                     | black / blue | 35-47 | S2       |
| SZ-SK60                     | black / red  | 35-47 | S2       |



Alle mit diesem Symbol markierten Schuhmodelle sind für Secosol® geeignet. Weitere Informationen finden Sie unter [dpvlink 20191](#)

### Safety sneaker CP 41

Safety shoe; ultra-light microfiber; mesh element; composite toe cap; TPU tip protection; breathable functional lining; exchangeable comfort insole ERGO-SOFT ESD with shock-absorption, excellent moisture absorption; suitable for orthopedic insoles; outsole TPU Competition ESD; TPU heel edging; EN ISO 20345:2011 S1 SRC



[dpvlink 23746](#)

| Article                     | Color       | Size  | Category | Closure         |
|-----------------------------|-------------|-------|----------|-----------------|
| <b>Safety sneaker CP 41</b> |             |       |          |                 |
| SZ-CP4000                   | black / red | 36-47 | S1       | velcro fastener |
| SZ-CP4100                   | black / red | 36-47 | S1       | lace fastening  |
| SZ-CP4100B                  | black / red | 36-47 | S1       | Boa®            |

### Safety shoe SK 40

Safety shoe; breathable functional textile with mesh fabric; aluminum toe cap; breathable functional lining; exchangeable comfort insole ERGO-SOFT ESD with shock-absorption, excellent moisture absorption; outsole: TPU Skater ESD; EN ISO 20345:2011 S1 SRC



[dpvlink 22667](#)

| Article                  | Color             | Size  | Category |
|--------------------------|-------------------|-------|----------|
| <b>Safety shoe SK 40</b> |                   |       |          |
| SZ-SK40                  | anthracite / blue | 35-47 | S1       |

### Safety shoe VD Pro

Safety shoe; ultra-light microfiber combined with perforated design for optimal ventilation; velcro fastener; shaft appliqué; aluminum toe cap; breathable functional lining; leather-insole; exchangeable comfort insole ERGO-SOFT ESD with shock-absorption, excellent moisture absorption; outsole: TPU Athletic ESD; EN ISO 20345:2011 S1 SRC



[dpvlink 22646](#)

| Article                   | Color        | Size  | Category | Closure         |
|---------------------------|--------------|-------|----------|-----------------|
| <b>Safety shoe VD Pro</b> |              |       |          |                 |
| SZ-VD1060                 | black / red  | 36-47 | S1       | velcro fastener |
| SZ-VD1010                 | black / grey | 36-47 | S1       | velcro fastener |
| SZ-VD1000                 | black / blue | 36-47 | S1       | velcro fastener |

Safety shoe VD Pro



Safety shoe; ultra-light microfiber combined with perforations; aluminum toe cap; breathable functional lining; leather insole; exchangeable comfort insole ERGO-SOFT ESD with shock-absorption; excellent moisture absorption; outsole: TPU Athletic ESD; EN ISO 20345:2011 S1 SRC



dpwlink 22645

| Article                   | Color        | Size  | Category |
|---------------------------|--------------|-------|----------|
| <b>Safety shoe VD Pro</b> |              |       |          |
| SZ-VD1400                 | black / blue | 36-47 | S1       |
| SZ-VD1410                 | black / grey | 36-47 | S1       |
| SZ-VD1460                 | black / red  | 36-47 | S1       |

Safety shoe VD Pro 1100



Safety shoe; ultra-light microfiber, with large perforations; dust flap; tip protection; shaft appliqué; aluminum toe cap; breathable functional lining; leather insole; exchangeable comfort insole ERGO-SOFT ESD with shock-absorption, excellent moisture absorption; outsole: TPU Athletic ESD; EN ISO 20345:2011 S1 SRC



dpwlink 22656

| Article                        | Color        | Size  | Category |
|--------------------------------|--------------|-------|----------|
| <b>Safety shoe VD Pro 1100</b> |              |       |          |
| SZ-VD1100                      | black / blue | 36-47 | S1       |

Safety shoe Julia / Laura / Lisa



Safety shoe; ultra-light microfiber combined with large ventilation structure; aluminum toe cap; breathable functional lining; genuine leather insole; exchangeable comfort insole ERGO-SOFT ESD with shock-absorption, excellent moisture absorption; outsole: TPU Woman Sport ESD; EN ISO 20345:2011 S1 SRC



dpwlink 23752

| Article                                 | Color       | Size  | Category | Closure         |
|---|-------------|-------|----------|-----------------|
| <b>Safety shoe Julia / Laura / Lisa</b> |             |       |          |                 |
| SZ-W120                                 | rose / grey | 35-42 | S1       | elastic         |
| SZ-W100                                 | rose / grey | 35-42 | S1       | velcro fastener |
| SZ-W130                                 | rose / grey | 35-42 | S1       | lace fastening  |

Safety shoe Frieda/Carla/Ella



Safety shoe; ultra-light microfiber combined with large ventilation structure; aluminum toe cap; breathable functional lining; genuine leather insole, exchangeable comfort insole ERGO-SOFT ESD with shock-absorption, good moisture absorption; suitable for orthopedic insoles; outsole: TPU Woman Sport ESD; EN ISO 20345:2011 S1 SRC



dpwlink 23756

| Article                              | Color        | Size  | Category | Closure         |
|--------------------------------------|--------------|-------|----------|-----------------|
| <b>Safety shoe Frieda/Carla/Ella</b> |              |       |          |                 |
| SZ-W125                              | blue / white | 35-42 | S1       | elastic         |
| SZ-W105                              | blue / white | 35-42 | S1       | velcro fastener |
| SZ-W135                              | blue / white | 35-42 | S1       | lace fastening  |

Safety shoe Audrey / Sophia



Women's safety shoe; breathable functional textile; aluminum toe cap; breathable functional lining; leather insole; exchangeable comfort insole ERGO-SOFT ESD with shock-absorption; excellent moisture absorption; outsole: TPU women Sport ESD; EN ISO 20345:2011 S2 SRC



dpwlink 22669

| Article                            | Color         | Size  | Category |
|------------------------------------|---------------|-------|----------|
| <b>Safety shoe Audrey / Sophia</b> |               |       |          |
| SZ-WG58                            | white         | 35-42 | S2       |
| SZ-WG78                            | black / beige | 35-42 | S2       |

Safety shoe Ginger



Women's safety shoe; breathable functional textile with and hexagon-optics; leg appliqué, aluminum toe cap; breathable functional lining; leather insole; exchangeable comfort insole ERGO-SOFT ESD with shock-absorption, excellent moisture absorption; outsole: TPU Women Sport ESD; EN ISO 20345:2011 S2 SRC



dpwlink 22673

| Article                   | Color | Size  | Category |
|---------------------------|-------|-------|----------|
| <b>Safety shoe Ginger</b> |       |       |          |
| SZ-WG80                   | black | 35-42 | S2       |



**Quality made by ATLAS®** already starts when choosing the materials. Whether high-quality natural leather, aluminum toe cap or new, breathable functional lining - ATLAS® always has high standards in order to meet your expectations.

For all areas where electrostatically susceptible components are worked on, ATLAS® offers a collection of modern ESD safety shoes. Because anyone who handles high-tech products needs a special equipment protecting the product. These special models are antistatic in the range between  $1 \times 10^5$  and  $3.5 \times 10^7$  Ohm. This prevents the wearer from building up an electrostatic charge that may severely damage or even destroy very highly sensitive electronic components in case of an insufficient dissipation.

In compliance with the ESD standard DIN EN 61340-5-1



**ESD-geprüfte Schuhe**  
nach EN 61340



**Sicherheitsschuhe S1P**  
nach EN ISO 20345



**Sicherheitsschuhe S3**  
nach EN ISO 20345



**XP® Zwischensohle:**  
leichte, durchtritthemmende Zwischensohle ohne Stahl



**alu-tec® Technologie:**  
Leichtgewicht mit Aluminiumkappe



**Boa®-System**  
Schuh mit Boa-Verschlusssystem



**Weiten W10 / W12**  
Schuh erhältlich in Weite 10 (breit) und 12 (extra)



**DGVV-Regel 112-191**  
geeignet für orthopädische Einlegesohlen und Zurichtung nach DGVV



**Sicherheitsschuhe S1**  
nach EN ISO 20345



**Sicherheitsschuhe S2**  
nach EN ISO 20345



**dämpfende MPU® Komfort-Zwischensohle**  
für schonendes, ermüdungsfreies Laufen



**feuchtigkeitsregulierend**  
für einen trockenen Fuss



**clima-stream®:**  
Atmungsaktiver Schuh, passt sich Umgebungstemperatur an



**Serie: SportLine 3.0**  
Schuh erhältlich in Weite 13 (spezial) und 14 (spezial)



**Weiten W13 / W14**  
Schuh erhältlich in Weite 13 (spezial) und 14 (spezial)



**Secosol®**  
geeignet für orthopädische Einlegesohlen Secosol®

## Safety shoes

### Safety shoe Flash 1000 / 1005 / 1300 / 1305 / 1600 / 1605



Safety shoe; upper mesh material, tip protection; alu-tec® aluminium toe cap; integrated climate zone; aktiv-X functional lining; exchangeable insole; MPU® INNOFLEX SYSTEM® sole; 3D shock-absorption for insoles, ESD equipment; outsole: oil-, acid- and fuel-resistant, antistatic; slip-resistant.



dpvlink 21071

| Article  | Color | Size  | Category | Form     | Closure         |
|--|-------|-------|----------|----------|-----------------|
| <b>Safety shoe Flash 1000 / 1005 / 1300 / 1305 / 1600 / 1605</b> |       |       |          |          |                 |
| AT-1600ESD   | black | 36-48 | S1       | sandal   | velcro fastener |
| AT-1600-1ESD   | black | 49    | S1       | sandal   | velcro fastener |
| AT-1605ESD   | black | 36-48 | S1P      | sandal   | velcro fastener |
| AT-1605-1ESD   | black | 49    | S1P      | sandal   | velcro fastener |
| AT-1000ESD   | blue  | 36-48 | S1       | low shoe | lace fastening  |
| AT-1000-1ESD   | blue  | 49    | S1       | low shoe | lace fastening  |
| AT-1005ESD   | blue  | 36-48 | S1P      | low shoe | lace fastening  |
| AT-1005-1ESD   | blue  | 49    | S1P      | low shoe | lace fastening  |
| AT-1300ESD   | black | 36-48 | S1       | low shoe | lace fastening  |
| AT-1300-1ESD   | black | 49    | S1       | low shoe | lace fastening  |
| AT-1305ESD   | black | 36-48 | S1P      | low shoe | lace fastening  |
| AT-1305-1ESD   | black | 49    | S1P      | low shoe | lace fastening  |



### Safety shoe Flash 2000 / 2005 / 3200 / 3205



Safety shoe; upper mesh material, neon reflective stripes, carbon-fiber reinforced tip protection; alu-tec® aluminium toe cap; integrated climate zone; aktiv-X functional lining; exchangeable insole; MPU® INNOFLEX SYSTEM® sole; 3D shock-absorption for insoles, ESD equipment; outsole: oil-, acid- and fuel-resistant, antistatic; slip-resistant.



dpvlink 21067

| Article  | Color | Size  | Category | Closure                       |
|--|-------|-------|----------|-------------------------------|
| <b>Safety shoe Flash 2000 / 2005 / 3200 / 3205</b> |       |       |          |                               |
| AT-2000ESD   | black | 36-48 | S1       | lace fastening                |
| AT-2000-1ESD                                       | black | 49    | S1       | lace fastening                |
| AT-2005ESD   | black | 36-48 | S1P      | lace fastening                |
| AT-2005-1ESD                                       | black | 49    | S1P      | lace fastening                |
| AT-3200ESD   | black | 36-48 | S1       | Boa® / quick-release fastener |
| AT-3200-1ESD                                       | black | 49    | S1       | Boa® / quick-release fastener |
| AT-3205ESD   | black | 36-48 | S1P      | Boa® / quick-release fastener |
| AT-3205-1ESD                                       | black | 49    | S1P      | Boa® / quick-release fastener |



## Safety shoe Flash 2600 / 2605 XP®



Safety shoe; upper mesh material, neon reflective stripes, carbon-fiber reinforced tip protection; alu-tec® aluminium toe cap; integrated climate zone; aktiv-X functional lining; exchangeable insole; MPU® INNOFLEX SYSTEM® sole; 3D shock-absorption for insoles, ESD equipment; outsole: oil-, acid- and fuel-resistant, antistatic; slip-resistant.



dpvlink 21069



| Article                                  | Color         | Size  | Category |
|--|---------------|-------|----------|
| <b>Safety shoe Flash 2600 / 2605 XP®</b> |               |       |          |
| AT-2600ESD                               | black / green | 36-48 | S1       |
| AT-2600-1ESD.49                          | black / green | 49    | S1       |
| AT-2605ESD                               | black / green | 36-48 | S1P      |
| AT-2605-1ESD.49                          | black / green | 49    | S1P      |

## Safety shoe Flash 4000 / 4005 / 4600 / 4605



Safety shoe; SPORTLINE upper material, carbon-fiber reinforced tip protection; alu-tec® aluminium toe cap; integrated climate zone; aktiv-X functional lining; exchangeable insole; MPU® INNOFLEX SYSTEM® sole; 3D cushioning system for insoles, ESD features; reflective neon stripes; outsole: oil- acid and benzene-resistant, antistatic; slip-resistant.



dpvlink 21018



| Article  | Color        | Size  | Category | Form     | Closure         |
|--|--------------|-------|----------|----------|-----------------|
| <b>Safety shoe Flash 4000 / 4005 / 4600 / 4605</b> |              |       |          |          |                 |
| AT-4600ESD   | blue / green | 36-48 | S1       | sandal   | velcro fastener |
| AT-4600-1ESD                                       | blue / green | 49    | S1       | sandal   | velcro fastener |
| AT-4605ESD   | blue / green | 36-48 | S1P      | sandal   | velcro fastener |
| AT-4605-1ESD                                       | blue / green | 49    | S1P      | sandal   | velcro fastener |
| AT-4000ESD   | blue / green | 36-48 | S1       | low shoe | lace fastening  |
| AT-4000-1ESD                                       | blue / green | 49    | S1       | low shoe | lace fastening  |
| AT-4005ESD   | blue / green | 36-48 | S1P      | low shoe | lace fastening  |
| AT-4005-1ESD                                       | blue / green | 49    | S1P      | low shoe | lace fastening  |



Alle mit diesem Symbol markierten Schuhmodelle sind für Secosol® geeignet. Weitere Informationen finden Sie unter [dpvlink 20191](#)

## Safety sandal SL26 2.0 / SL46 2.0



Safety sandal; carbon fiber reinforced tip protection; alu-tec® aluminium toe cap; clima-stream® functional lining; velcro fastener; exchangeable ESD insole; MPU® INNOFLEX SYSTEM® sole; optimal damping behavior; suitable for orthopedic insoles; outsole: oil- and chemical-resistant, antistatic; slip-resistant. EN ISO 20345 S1 SRC



dpvlink 17905



| Article                                  | Color         | Size  | Category |
|--|---------------|-------|----------|
| <b>Safety sandal SL26 2.0 / SL46 2.0</b> |               |       |          |
| AT-SL26ESD                               | black / green | 36-48 | S1       |
| AT-SL26-1ESD                             | black / green | 49    | S1       |
| AT-SL46ESD                               | black / blue  | 36-48 | S1       |
| AT-SL46-1ESD                             | black / blue  | 49    | S1       |

## Safety shoe SL20 / SL920 2.0 GREEN



Safety shoe; perforated SPORTLINE upper; carbon fiber reinforced tip protection; alu-tec® aluminium toe cap; clima-stream® functional lining; exchangeable ESD insole; 3D cushioning system; suitable for orthopedic insoles; MPU® INNOFLEX SYSTEM® sole; outsole: oil- and chemical-resistant, antistatic; slip-resistant. EN ISO 20345 S1 SRC



dpvlink 17903



| Article                                   | Color         | Size  | Category | Closure                       |
|---|---------------|-------|----------|-------------------------------|
| <b>Safety shoe SL20 / SL920 2.0 GREEN</b> |               |       |          |                               |
| AT-SL20ESD                                | black / green | 36-48 | S1       | lace fastening                |
| AT-SL20-1ESD                              | black / green | 49    | S1       | lace fastening                |
| AT-SL920ESD                               | black / green | 36-48 | S1       | Boa® / quick-release fastener |
| AT-SL920-1ESD                             | black / green | 49    | S1       | Boa® / quick-release fastener |

## Safety shoe SL9405 2.0 XP® BOA®



Safety shoe with Boa® closure system; perforated SPORTLINE upper; aktiv-X functional lining; XP® metal-free penetration protection; carbon-fiber reinforced tip protection; alu-tec® aluminum toe cap; MPU® INNOFLEX SYSTEM® sole; 3D cushioning system; suitable for orthopedic insoles; outsole: oil- and chemical-resistant, antistatic; slip-resistant. EN ISO 20345 S1P SRC



dpvlink 21609

| Article                                | Color        | Size  | Category |
|--|--------------|-------|----------|
| <b>Safety shoe SL9405 2.0 XP® BOA®</b> |              |       |          |
| AT-SL9405ESD                           | black / blue | 36-48 | S1P      |
| AT-SL9405-1ESD.49                      | black / blue | 49    | S1P      |

## Safety shoe SL40 / SL82 2.0 BLUE



Safety shoe; perforated SPORTLINE upper material; carbon fiber reinforced tip protection; alu-tec® aluminum toe cap; clima-stream® functional lining; exchangeable ESD insole; MPU® INNOFLEX SYSTEM® sole; 3D cushioning system; suitable for orthopedic insoles, ESD equipment; outsole: oil- and chemical-resistant, antistatic; slip-resistance according to EN ISO 20345 S1 SRC



dpvlink 17907

| Article                                 | Color        | Size  | Category | Form     |
|---|--------------|-------|----------|----------|
| <b>Safety shoe SL40 / SL82 2.0 BLUE</b> |              |       |          |          |
| AT-SL40ESD                              | black / blue | 36-48 | S1       | low shoe |
| AT-SL40-1ESD                            | black / blue | 49    | S1       | low shoe |
| AT-SL82ESD                              | black / blue | 36-48 | S1       | boot     |

## Safety shoe SL60 / SL80 2.0 BLUE



Safety shoe; SOFT nubuck; carbon fiber reinforced MPU tip protection; alu-tec® aluminum toe cap; aktiv-X functional lining; exchangeable ESD insole; MPU® INNOFLEX SYSTEM® sole; 3D cushioning system; suitable for orthopedic insoles, ESD equipment; outsole: oil- and chemical-resistant, antistatic; slip-resistance according to EN ISO 20345 S2 SRC



dpvlink 19044

| Article                                 | Color        | Size  | Category | Form     |
|---|--------------|-------|----------|----------|
| <b>Safety shoe SL60 / SL80 2.0 BLUE</b> |              |       |          |          |
| AT-SL60ESD                              | black / blue | 36-48 | S2       | low shoe |
| AT-SL60-1ESD                            | black / blue | 49    | S2       | low shoe |
| AT-SL80ESD                              | black / blue | 36-48 | S2       | boot     |

## Safety sandal SL36 2.0 RED



Safety sandal; SPROTLINE upper; carbon fiber reinforced tip protection; alu-tec® aluminum toe cap; clima-stream® functional lining; aktiv-X functional lining; velcro fastener; exchangeable ESD insole; MPU® INNOFLEX SYSTEM® sole; 3D absorption system; suitable for orthopedic insoles; outsole: oil- and chemical-resistant, antistatic; slip-resistance according to EN ISO 20345 : S1 SRC



dpvlink 19199

| Article                           | Color       | Size  | Category |
|-----------------------------------|-------------|-------|----------|
| <b>Safety sandal SL36 2.0 RED</b> |             |       |          |
| AT-SL36ESD                        | black / red | 36-48 | S1       |
| AT-SL36-1ESD                      | black / red | 49    | S1       |

## Safety shoe SL30 2.0/SL32 2.0 RED



Safety shoe; perforated SPORTLINE upper; carbon fiber reinforced tip protection; alu-tec® aluminum toe cap; clima-stream® functional lining; aktiv-X functional lining; exchangeable ESD insole; MPU® INNOFLEX SYSTEM® sole; 3D absorption system; suitable for orthopedic insoles; outsole: oil- and chemical-resistant, antistatic; slip-resistance according to EN ISO 20345 S1 SRC



dpvlink 19201

| Article                                  | Color       | Size  | Category | Form     |
|--|-------------|-------|----------|----------|
| <b>Safety shoe SL30 2.0/SL32 2.0 RED</b> |             |       |          |          |
| AT-SL30ESD                               | black / red | 36-48 | S1       | low shoe |
| AT-SL30-1ESD                             | black / red | 49    | S1       | low shoe |
| AT-SL32ESD                               | black / red | 36-48 | S1       | boot     |

## Safety sneaker GX100/GX200



Safety shoe; upper mesh material with integrated climate zone; steel toe cap; aktiv-X functional lining; lacing; exchangeable insole; MPU® Light sole technology; 3D damping system for insoles; outsole: oil-, acid- and fuel-resistant, antistatic; slip-resistant according to EN ISO 20345 S1 SRC



dpvlink 22605

| Article                           | Color        | Size  | Category |
|-----------------------------------|--------------|-------|----------|
| <b>Safety sneaker GX100/GX200</b> |              |       |          |
| AT-GX100ESD                       | blue / rose  | 35-43 | S1       |
| AT-GX200ESD                       | black / rose | 35-43 | S1       |

**Safety shoe GX130/GX132/GX133/GX134 Women**

Safety shoe; SPORTLINE upper material; steel toe cap, clima-stream® concept; aktiv-X functional lining; lacing; exchangeable insole; MPU® Light sole technology; 3D damping system for insoles; outsole: oil-, acid- and fuel-resistant, antistatic; slip-resistant according to EN ISO 20345 S1 SRC



dpvlink 20102

| Article  | Color             | Size  | Category |
|--|-------------------|-------|----------|
| <b>Safety shoe GX130/GX132/GX133/GX134 Women</b> |                   |       |          |
| AT-GX130ESD                                      | black / blue      | 35-43 | S1       |
| AT-GX132ESD                                      | black / green     | 35-43 | S1       |
| AT-GX133ESD                                      | black / red       | 35-43 | S1       |
| AT-GX134ESD                                      | anthracite / blue | 35-43 | S1       |

**Safety shoe GX350 Black**

Safety shoe; SPORTLINE upper material; clima-stream® concept; aktiv-X functional lining; Velcro fastener; exchangeable insole; MPU® Light sole technology; 3D damping system for insoles; outsole: oil-, acid- and fuel-resistant, antistatic; slip-resistant according to EN ISO 20345 S1 SRC



dpvlink 20118

| Article                        | Color        | Size  | Category |
|--------------------------------|--------------|-------|----------|
| <b>Safety shoe GX350 Black</b> |              |       |          |
| AT-GX350ESD                    | black / blue | 35-43 | S1       |

**Safety clog GX 390 black**

Safety clog; upper SOFT nubuck; steel toe cap; clima-stream® functional lining; comfort insole; MPU® Light sole technology; antistatic; outsole: oil- and chemical-resistant, antistatic; slip-resistant according to EN ISO 20345 SB SRC



dpvlink 19598

| Article                         | Color        | Size  | Category |
|---------------------------------|--------------|-------|----------|
| <b>Safety clog GX 390 black</b> |              |       |          |
| AT-GX390ESD                     | black / blue | 35-43 | SB       |

**Safety sandal TX360 S1 ESD**

Safety sandal; SPORTLINE upper material; carbon-fiber reinforced MPU toe protection; clima-stream® concept; aktiv-X functional lining; Velcro fastener; exchangeable insole; MPU® Innoflex System sole technology; 3D damping system for insoles, ESD equipment; outsole: oil-, acid- and fuel-resistant, antistatic; slip-resistant according to EN ISO 20345 S1 SRC



dpvlink 20109

| Article                           | Color        | Size  | Category |
|-----------------------------------|--------------|-------|----------|
| <b>Safety sandal TX360 S1 ESD</b> |              |       |          |
| AT-TX360ESD                       | black / blue | 36-48 | S1       |
| AT-TX360-1ESD                     | black / blue | 49-50 | S1       |

**Safety shoe CF2**

Safety shoe; upper microfiber; safety reflective stripes; carbon-fiber reinforced MPU toe protection; steel toe cap, clima-stream® concept; aktiv-X functional lining; 3D shock absorption; exchangeable insoles, suitable for insoles, ESD equipment; MPU® Innoflex System sole technology; outsole: oil-, acid- and fuel-resistant, antistatic; EN ISO 20345 S1 SRC



dpvlink 21073

| Article                | Color | Size  | Category |
|------------------------|-------|-------|----------|
| <b>Safety shoe CF2</b> |       |       |          |
| AT-CF2ESD              | black | 36-48 | S1       |
| AT-CF2-1ESD            | black | 49    | S1       |

**Safety sneaker A422 women**

Safety sneaker; upper material: SPORTLINE microfiber; aktiv-X functional lining; exchangeable ESD insole; 3D cushioning system, suitable for the insole equipment, ESD equipment, Sneaker sole technology; outsole oil- and chemical-resistant, antistatic; EN ISO 20345 S1



dpvlink 22604

| Article                          | Color | Size  | Category |
|----------------------------------|-------|-------|----------|
| <b>Safety sneaker A422 women</b> |       |       |          |
| AT-A422ESD                       | grey  | 36-43 | S1       |

## Safety sneaker A240/A420



Safety sneaker; upper material: SPROTLINE microfiber, partially perforated; steel toe cap; aktiv-X functional lining; exchangeable ESD insole; 3D cushioning system, suitable for the insole equipment, ESD equipment, Sneaker sole technology; outsole oil- and chemical-resistant, antistatic; EN ISO 20345 S1



dpvlink 16922

| Article                         | Color         | Size  | Category |
|---------------------------------|---------------|-------|----------|
| <b>Safety sneaker A240/A420</b> |               |       |          |
| AT-A240ESD                      | black / green | 36-48 | S1       |
| AT-A240-1ESD                    | black / green | 49    | S1       |
| AT-A420ESD                      | black / blue  | 36-49 | S1       |



## Safety sneaker A100/A515



Safety sneaker; upper material: soft full-grain leather; steel toe cap; metal-free penetration protection; aktiv-X functional lining; exchangeable ESD insole; 3D cushioning system, suitable for the insole equipment, ESD equipment, Sneaker sole technology; outsole oil- and chemical-resistant, antistatic; EN ISO 20345



dpvlink 20114

| Article                         | Color | Size  | Category | Form    |
|---------------------------------|-------|-------|----------|---------|
| <b>Safety sneaker A100/A515</b> |       |       |          |         |
| AT-A100ESD                      | brown | 36-48 | S2       | sneaker |
| AT-A515ESD                      | brown | 36-48 | S3       | boot    |



## Safety sneaker A280/A585



Safety sneaker; upper material: soft full-grain leather; steel toe cap; metal-free penetration protection; aktiv-X functional lining; exchangeable ESD insole; 3D cushioning system, suitable for the insole equipment, ESD equipment, Sneaker sole technology; outsole oil- and chemical-resistant, antistatic; AT-585ESD in addition with XP metal-free penetration protection. EN ISO 20345 S2 / S3



dpvlink 20112

| Article                         | Color | Size  | Category | Form    |
|---------------------------------|-------|-------|----------|---------|
| <b>Safety sneaker A280/A585</b> |       |       |          |         |
| AT-A280ESD                      | black | 36-48 | S2       | sneaker |
| AT-A280-1ESD                    | black | 49    | S2       | sneaker |
| AT-A585ESD                      | black | 36-48 | S3       | boot    |



## Safety shoe CX540 Office Boot / CX340 Office / CX 320



Safety shoe; upper material: soft full-grain calf leather, steel toe cap, aktiv-X functional lining; lacing; exchangeable insole; MPU Light sole technology; 3D damping system for insoles, ESD equipment; outsole: oil-, acid- and fuel-resistant, antistatic; slip-resistant according to EN ISO 20345 S2 SRC



dpvlink 20122

| Article  | Color | Size  | Category | Form     |
|--|-------|-------|----------|----------|
| <b>Safety shoe CX540 Office Boot / CX340 Office / CX 320</b> |       |       |          |          |
| AT-CX340ESD  | black | 39-48 | S2       | low shoe |
| AT-CX540ESD  | black | 39-47 | S2       | boot     |
| AT-CX320ESD  | black | 39-47 | S2       | low shoe |



## Safety shoe CX 200 Office women



Women's safety shoe; upper leather, comfortable women's last, comfort heel 3 cm; exchangeable insole with heel cushioning; MPU Office sole technology; outsole oil- and chemical-resistant, antistatic; EN ISO 20345:S2



dpvlink 16921

| Article                                | Color | Size  | Category |
|--|-------|-------|----------|
| <b>Safety shoe CX 200 Office women</b> |       |       |          |
| AT-CX200ESD                            | black | 36-43 | S2       |



## Safety shoe CX



Safety shoe; upper breathable microfiber, steel toe cap, aktive-X functional lining, exchangeable insole, suitable for insoles, ESD equipment, MPU sole technology; oil-, acid- and fuel-resistant, antistatic; EN ISO 20345 S1 SRC



dpvlink 21076

| Article               | Color | Size  | Category |
|-----------------------|-------|-------|----------|
| <b>Safety shoe CX</b> |       |       |          |
| AT-CX50ESD            | black | 39-48 | S1 men   |
| AT-CX56ESD            | grey  | 39-48 | S1 men   |
| AT-CX40ESD            | black | 36-43 | S1 women |
| AT-CX46ESD            | grey  | 36-43 | S1 women |



## Insoles

### ESD Clima Comfort insole



- suitable for all Atlas shoes
- ESD-compliant

dpvlink 21672



| Article                         | Color | Size  |
|---------------------------------|-------|-------|
| <b>ESD Clima Comfort insole</b> |       |       |
| AT-92000                        | green | 36-48 |

### ERGO-MED® insoles



Running and walking take on a genuine feeling of well being: the exclusive Ergo-Med® insoles offer relaxation for your feet.

**Available in three different thicknesses** - the insoles support the longitudinal arch area and adapt optimally to suit your feet, therefore assuring comfortable padding. Outstanding cushioning and uniform weight distribution provide tangible relieve for sensitive pain and pressure points. They are antistatic and can therefore also be worn in ESD shoes.

**Relaxation you can feel: step by step.**

**Certified for all ATLAS® safety shoes in accordance with EN ISO 20345**

- Ergo-Med® blue - developed for the normal classic foot
- Ergo-Med® green - developed for the flatfoot
- Ergo-Med® red - developed for the hollow foot

dpvlink 17407



| Article                  | Color | Size  |
|--------------------------|-------|-------|
| <b>ERGO-MED® insoles</b> |       |       |
| AT-99000                 | blue  | 36-49 |
| AT-99100                 | green | 36-49 |
| AT-99200                 | red   | 36-49 |



The long experience gained in more than 60 years of production, combined with a constant research in innovative technologies and materials, allows **FTG an unparalleled development and production.**

FTG is able to satisfy **highest requirements**, covering the most varied environments of use.

A modern production site equipped with a system of the latest generation turns FTG into a reliable business partner capable of producing a wide range of safety shoes to satisfy all needs.

**Our values guarantee safety.**



In compliance with the ESD standard DIN EN 61340-5-1

We have designed our models in such away that they are very lightweight. Experiments and innovations in manufacturing allow us to produce the most lightweight footwear in the safety sector.

- |   |   |
|---|---|
| <b>ESD-geprüfte Schuhe</b><br>nach EN 61340                             | <b>Sicherheitsschuhe S1P</b><br>nach EN ISO 20345 |
| <b>Sicherheitsschuhe S3</b><br>nach EN ISO 20345                        | <b>Extrem leichter Schuh</b>                      |
| <b>Nichtmetallische Kappe</b>   | <b>Zehenschutz</b>                                |
| <b>Nichtmetallische Zwischensohle</b>                                   | <b>Weite 12</b>                                   |
| <b>Sohle mit Überkappe</b>  | <b>Schuhwerk ohne Nähte</b>                       |
| <b>Schuhe ohne Metalleinsätze</b>                                       | <b>Washbar bei 30°</b>                            |
| <b>Nicht im Trockner trocknen</b>                                       | <b>Reflektierende Einsätze</b>                    |
| <b>Hitzebeständiges Obermaterial</b>                                    | <b>Innovatives und modernes Design</b>            |
| <b>Nichtmetallische Kappe</b>   | <b>Schuh zertifiziert nach DGVU 112-191</b>       |
| <b>Secosol®</b><br>geeignet für orthopädische Einlegesohlen<br>Secosol® |   |





## Safety shoes

### Safety shoe Black



Light safety shoe, to put on like a sock, only one seam on the heel; upper SAFETY-KNIT (special, very tear-resistant fabric); plastic toe cap; metal-free penetration protection; exchangeable SPORT-LITE insole, anatomic, antibacterial; PU outsole; suitable for orthopedic insoles; oil-, acid- and benzene-resistant; slip-resistant; antistatic. EN ISO 20345:2011 S3 SRC

**Fitting:** due to the special design the shoes cut larger - in case of intermediate sizes always take the smaller size



**dpvlink 23992**

| Article                  | Color | Size  | Category | Upper       | Form     |
|--------------------------|-------|-------|----------|-------------|----------|
| <b>Safety shoe Black</b> |       |       |          |             |          |
| FT-1062                  | black | 35-47 | S3       | Safety-Knit | low shoe |
| FT-1063                  | black | 35-47 | S3       | Safety-Knit | boot     |

### Safety shoe Judo / Rugby / Kayak



Safety shoe; upper microfiber or microfiber with mesh; very thin plastic toe cap; metal-free penetration protection; SPORT-LITE insole, anatomic, antibacterial; exchangeable insole; PU outsole; suitable for orthopedic insoles; oil-, acid- and fuel-resistant; slip-resistant; antistatic.

Judo FT-1010 and Rugby FT-1015 EN ISO 20345:2011 S1P  
Kayak FT- 1018 EN ISO 20345:2011 S3



**dpvlink 23424**

| Article                                 | Color                   | Size  | Category | Upper             | Form     |
|---|-------------------------|-------|----------|-------------------|----------|
| <b>Safety shoe Judo / Rugby / Kayak</b> |                         |       |          |                   |          |
| FT-1010                                 | anthracite / black      | 35-47 | S1P      | microfiber / mesh | low shoe |
| FT-1015                                 | anthracite / green      | 35-47 | S1P      | microfiber        | low shoe |
| FT-1018                                 | anthracite / light grey | 35-47 | S3       | microfiber        | low shoe |



Alle mit diesem Symbol markierten Schuhmodelle sind für Secosol® geeignet.  
Weitere Informationen finden Sie unter **dpvlink 20191**

### Safety shoe Frisbee / Surf



Safety shoe; upper mesh with padded leg edge; very thin plastic toe cap; metal-free penetration protection; SPORT-LITE insole, anatomic, antibacterial; exchangeable insole; PU outsole; suitable for orthopedic insoles; oil-, acid- and fuel-resistant; slip-resistant; antistatic. EN ISO 20345:2011 S1P SRC



**dpvlink 23350**

| Article                           | Color | Size  | Category | Upper | Closure         |
|-----------------------------------|-------|-------|----------|-------|-----------------|
| <b>Safety shoe Frisbee / Surf</b> |       |       |          |       |                 |
| FT-1024                           | black | 35-47 | S1P      | mesh  | lace fastening  |
| FT-1025                           | black | 35-47 | S1P      | mesh  | velcro fastener |

### Safety shoe Sixty



Safety shoe; upper extremely durable 3D polyester/nylon mixture; very thin plastic toe cap; metal-free penetration protection; SPORT-LITE insole, anatomic, antibacterial; exchangeable insole; PU outsole; suitable for orthopedic insoles; oil-, acid- and fuel-resistant; slip-resistant; antistatic. EN ISO 20345:2011 S3 SRC



**dpvlink 23422**

| Article                  | Color         | Size  | Category | Upper             | Form     |
|--------------------------|---------------|-------|----------|-------------------|----------|
| <b>Safety shoe Sixty</b> |               |       |          |                   |          |
| FT-1060                  | black / azure | 35-47 | S3       | polyester / nylon | low shoe |
| FT-1061                  | black / azure | 35-47 | S3       | polyester / nylon | boot     |

### Safety shoe Basket



Safety shoe; upper microfiber with padded leg edge; very thin plastic toe cap; metal-free penetration protection; SPORT-LITE insole, anatomic, antibacterial; exchangeable insole; PU/PU outsole; suitable for orthopedic insoles; oil-, acid- and fuel-resistant; slip-resistant; antistatic. EN ISO 20345:2011 S3



**dpvlink 23419**

| Article                   | Color | Size  | Category | Closure                 | Form     |
|---------------------------|-------|-------|----------|-------------------------|----------|
| <b>Safety shoe Basket</b> |       |       |          |                         |          |
| FT-1050                   | grey  | 35-48 | S3       | lace fastening          | low shoe |
| FT-1051                   | grey  | 38-48 | S3       | lace fastening / zipper | boot     |

## Safety shoe Golf / Squash



Safety shoe; upper textile with padded leg edge; very thin plastic toe cap; metal-free penetration protection; SPORT-LITE insole, anatomic, antibacterial; exchangeable insole; PU/PU outsole; suitable for orthopedic insoles; oil-, acid- and fuel-resistant; slip-resistant; antistatic. EN ISO 20345:2011 S1P



dpvlink 23423

| Article                          | Color | Size  | Category | Upper   | Form     |
|----------------------------------|-------|-------|----------|---------|----------|
| <b>Safety shoe Golf / Squash</b> |       |       |          |         |          |
| FT-1041                          | grey  | 35-48 | S1P      | textile | low shoe |



## Safety shoe Estoril / Mugello



Safety shoe; upper microfiber with padded leg edge; composite toe cap; metal-free penetration protection; SPORT-LITE insole, anatomic, antibacterial; exchangeable insole; PU/PU outsole; suitable for orthopedic insoles; oil-, acid- and fuel-resistant; slip-resistant; antistatic. EN ISO 20345:2011 S1P



dpvlink 23421

| Article                              | Color       | Size  | Category | Upper                | Form     |
|--------------------------------------|-------------|-------|----------|----------------------|----------|
| <b>Safety shoe Estoril / Mugello</b> |             |       |          |                      |          |
| FT-6061                              | black / red | 38-47 | S1P      | microfiber / mesh    | low shoe |
| FT-6060                              | black / red | 38-47 | S1P      | microfiber / textile | low shoe |



## Safety shoe Douglas / Gladiator



Safety shoe; upper nubuck with padded leg edge; composite toe cap; metal-free penetration protection; Atomic insole, antibacterial; exchangeable insole; PU/PU outsole with overcap; suitable for orthopedic insoles; oil-, acid- and fuel-resistant; slip-resistant; antistatic. EN ISO 20345:2011 S3 SRC



dpvlink 23420

| Article                                | Color       | Size  | Category | Upper  | Form     |
|--|-------------|-------|----------|--------|----------|
| <b>Safety shoe Douglas / Gladiator</b> |             |       |          |        |          |
| FT-8220                                | black / red | 36-48 | S3       | nubuck | low shoe |
| FT-8221                                | black / red | 36-48 | S3       | nubuck | boot     |



## Safety shoe Junkers / Firebrand



Safety shoe; upper microfiber with padded leg edge, composite toe cap; metal-free penetration protection; Atomic insole, antibacterial; exchangeable insole; microfiber /PU outsole with overcap; suitable for orthopedic insoles; oil-, acid- and fuel-resistant; slip-resistant; antistatic. EN ISO 20345:2011 S3



dpvlink 23425

| Article                                | Color        | Size  | Category | Upper      | Form     |
|--|--------------|-------|----------|------------|----------|
| <b>Safety shoe Junkers / Firebrand</b> |              |       |          |            |          |
| FT-8210                                | black / blue | 38-48 | S3       | microfiber | low shoe |
| FT-8211                                | black / blue | 38-48 | S3       | microfiber | boot     |



## Insoles

### Insole Sport Lite FTG



- for models of the **Sport Line and Ducati Racing Line**
- removable, preformed ESD insoles
- washable up to 30°C
- antibacterial
- high comfort and energy consumption



dpvlink 23347

| Article                      | Type   | Width  | Size  |
|------------------------------|--|--------|-------|
| <b>Insole Sport Lite FTG</b> |  |        |       |
| FT-0976                      | ESD insole for Sport Lite and Ducati Racing Line | normal | 36-48 |



### Insole Atomic FTG



- for models of the **Professional Line**
- removable, preformed ESD insoles
- washable up to 30°C
- antibacterial
- high comfort and energy consumption



dpvlink 23487

| Article                  | Type                                    | Width  | Size  |
|--------------------------|---|--------|-------|
| <b>Insole Atomic FTG</b> |   |        |       |
| FT-0977                  | ESD insole Atomic for Professional Line | normal | 36-48 |



# uvex

Nothing is more important than the safety of people in their day-to-day work! This is why uvex is constantly developing their products based on pioneering technologies. The objective: combining protection, wearing comfort and relief in every product in the best possible way.

In compliance with the ESD standard DIN EN 61340-5-1 



**climazone** uvex climazone is an innovative head-to-toe climate control system. uvex has combined its expertise in research and product development using intelligent materials and processing technologies to develop a unique range of climate-optimizing safety products, such as climate-optimizing safety footwear.

Hot or cold feet, discomfort caused by heavy perspiration - a perfect climate regulation is demanded especially in safety footwear:

- perceived comfort with uvex climazone
- regulation of the individual body climate
- working with a remaining well-being
- longer lasting performance
- optimal wearing comfort in every situation

The uvex comfortable climate insole provides all-over cushioning of the foot and ensures comfort in high-strain zones. It is breathable and is made of moisture-absorbing materials. The cushioning zones support the natural walking movement. The upper is skin-friendly and pleasant.



The uvex xenova® system is a performant, completely metal-free safety system to protect the foot inside a safety shoe. The uvex xenova® duo toe cap fits perfectly without any pressure points. The cap is fully lined with soft, comfortable padding ensuring increased wearer comfort when kneeling and during impacts.



**ESD-geprüfte Schuhe**  
nach EN 61340



**Sicherheitsschuhe S1**  
nach EN ISO 20345



**Sicherheitsschuhe S2**  
nach EN ISO 20345



**Spezielle lackneutrale Sohlenmaterialien,**  
welche die Lackbenetzung von Oberflächen nicht beeinträchtigen (von der Automobilindustrie geprüft und freigegeben)



**Sicherheitsschuhe mit Damenleisten**  
(Größen 35 bis 40 mit reinen Damenleisten gefertigt)



**Zertifiziert für orthopädische Anpassungen**  
(nach DGUV 112-191/ÖNORM Z 1259)



**Berufsschuhe 01**  
nach EN ISO 20347



**Sicherheitsschuhe S1P**  
nach EN ISO 20345



**Sicherheitsschuhe S3**  
nach EN ISO 20345



**Sicherheitsschuhe mit Herrenleisten**  
(Größen 41 bis 52 mit reinen Herrenleisten gefertigt)



**Komplett metallfreie xenova® Zehenschutzkappe**

## Occupational and safety footwear

### Professional shoe ESD 1 Sport nc **NEU uvex**

Professional shoe; upper textile; exchangeable, shock-absorbing comfort insole; suitable for orthopedic insoles; PU/PU outsole; slip-resistant. EN ISO 20347:2012 01 SRC FO



dpvlink 24238

| Article                                 | Color | Size  | Category | Upper   | Form     |
|---|-------|-------|----------|---------|----------|
| <b>Professional shoe ESD 1 Sport nc</b> |       |       |          |         |          |
| UX-65938                                | black | 35-52 | 01       | textile | low shoe |
| UX-65958                                | black | 35-52 | 01       | textile | low shoe |



### Safety shoe ESD 1 Sport **NEU uvex**

Safety shoe; upper textile; xenova® plastic toe cap; metal-free penetration protection; exchangeable, shock-absorbing comfort insole; suitable for orthopedic insoles; PU/PU outsole; slip-resistant. EN ISO 20345:2011 S1 SRC



dpvlink 24227

| Article                        | Color | Size  | Category | Upper   | Form     |
|--------------------------------|-------|-------|----------|---------|----------|
| <b>Safety shoe ESD 1 Sport</b> |       |       |          |         |          |
| UX-65902                       | black | 35-52 | S1P      | textile | low shoe |



### Safety shoe ESD 1 ladies **NEU uvex**

Safety shoe; upper micro suede; perforated; large xenova® plastic toe cap; exchangeable, shock-absorbing comfort insole; suitable for orthopedic insoles; PU/PU outsole; slip-resistant. EN ISO 20345:2011 S1 SRC



dpvlink 24290

| Article                         | Color       | Size  | Category | Closure         | Form     |
|---------------------------------|-------------|-------|----------|-----------------|----------|
| <b>Safety shoe ESD 1 ladies</b> |             |       |          |                 |          |
| UX-85608                        | grey / pink | 35-43 | S1       | velcro fastener | sandal   |
| UX-85618                        | grey / pink | 35-43 | S1       | lace fastening  | low shoe |



Safety shoe ESD 1 Sport



Safety shoe; upper textile; xenova® plastic toe cap; exchangeable, shock-absorbing comfort insole; suitable for orthopedic insoles; PU/PU outsole; slip-resistant. EN ISO 20345:2011 S1 SRC



dpvlink 24229



| Article                        | Color | Size  | Category | Upper   | Form     |
|--------------------------------|-------|-------|----------|---------|----------|
| <b>Safety shoe ESD 1 Sport</b> |       |       |          |         |          |
| UX-65978                       | pink  | 35-43 | S1       | textile | low shoe |
| UX-65998                       | blue  | 35-52 | S1       | textile | low shoe |
| UX-65988                       | black | 35-52 | S1       | textile | low shoe |

Safety shoe ESD 1



Safety shoe; upper micro suede; perforated; xenova® plastic toe cap; exchangeable, shock-absorbing comfort insole; suitable for orthopedic insoles; PU/PU outsole; slip-resistant. EN ISO 20345:2011 S1 SRC



dpvlink 24233



| Article                  | Color        | Size  | Category | Closure                | Form     |
|--------------------------|--------------|-------|----------|------------------------|----------|
| <b>Safety shoe ESD 1</b> |              |       |          |                        |          |
| UX-85428                 | black / lime | 35-52 | S1       | velcro fastener        | sandal   |
| UX-85438                 | black / lime | 35-52 | S1       | quick-release fastener | low shoe |
| UX-65658                 | black / lime | 35-52 | S1       | Boa®                   | low shoe |

Safety shoe ESD 1 G2



Safety shoe with quick-release fastener; upper micro suede (perforated); Distance mesh lining; large xenova® plastic toe cap; exchangeable, shock-absorbing comfort insole; suitable for orthopedic insoles; TPU outsole; very slip-resistant. UX-68467 and UX-68438: EN ISO 20345:2011 S1 SRC UX-68372: EN ISO 20345:2011 S1P SRC



dpvlink 24866



| Article                     | Color          | Size  | Category |
|-----------------------------|----------------|-------|----------|
| <b>Safety shoe ESD 1 G2</b> |                |       |          |
| UX-68372                    | black / red    | 35-52 | S1P      |
| UX-68438                    | black / yellow | 35-52 | S1       |
| UX-68468                    | black / orange | 35-52 | S1       |

Safety sandal ESD 1 G2



Safety sandal; upper micro suede; perforated; with velcro fastener; large xenova® plastic toe cap; exchangeable, shock-absorbing comfort insole; suitable for orthopedic insoles; PU/PU outsole; very slip-resistant. UX-68428 and UX-68488: EN ISO 20345:2011 S1 SRC UX-68362: EN ISO 20345:2011 S1P SRC



dpvlink 24241



| Article                       | Color          | Size  | Category |
|-------------------------------|----------------|-------|----------|
| <b>Safety sandal ESD 1 G2</b> |                |       |          |
| UX-68428                      | black / yellow | 35-52 | S1       |
| UX-68488                      | black / orange | 35-52 | S1       |
| UX-68362                      | black / red    | 35-52 | S1P      |

## Safety shoe ESD 1 G2

Safety shoe; upper textile (water-repellent); xenova® plastic toe cap; metal-free penetration protection; exchangeable, shock-absorbing comfort insole; suitable for orthopedic insoles; TPU outsole; very slip-resistant. EN ISO 20345:2011 S1 SRC



dpvlink 24871

| Article                     | Color        | Size  | Category |
|-----------------------------|--------------|-------|----------|
| <b>Safety shoe ESD 1 G2</b> |              |       |          |
| UX-68342                    | black / blue | 35-52 | S1P      |



## Safety shoe ESD 2 trend black/blue

Safety shoe; upper micro suede; steel toe cap; exchangeable, shock-absorbing comfort insole; suitable for orthopedic insoles; PU/PU outsole; very slip-resistant. EN ISO 20345:2011 S1 SRC



dpvlink 24280

| Article                                   | Color        | Size  | Category | Closure         | Form     |
|---|--------------|-------|----------|-----------------|----------|
| <b>Safety shoe ESD 2 trend black/blue</b> |              |       |          |                 |          |
| UX-69362                                  | black / blue | 38-52 | S1P      | velcro fastener | sandal   |
| UX-69378                                  | black / blue | 38-52 | S1       | lace fastening  | low shoe |



## Safety shoe ESD 2 xenova

Safety shoe; upper micro suede; perforated; reflective appliqué; xenova® plastic toe cap; exchangeable, shock-absorbing comfort insole; suitable for orthopedic insoles; PU/PU outsole; slip-resistant. EN ISO 20345:2011 S1 SRC



dpvlink 24264

| Article                         | Color        | Size  | Category | Closure         | Form     |
|---------------------------------|--------------|-------|----------|-----------------|----------|
| <b>Safety shoe ESD 2 xenova</b> |              |       |          |                 |          |
| UX-95538                        | black / blue | 38-52 | S1       | velcro fastener | sandal   |
| UX-95548                        | black / blue | 38-52 | S1       | lace fastening  | low shoe |



## Safety shoe ESD 2 trend black/red

Safety shoe; upper micro suede; steel toe cap; exchangeable, shock-absorbing comfort insole; suitable for orthopedic insoles; PU/PU outsole; very slip-resistant. EN ISO 20345:2011 S1P SRC



dpvlink 24281

| Article                                  | Color       | Size  | Category | Closure         | Form     |
|--|-------------|-------|----------|-----------------|----------|
| <b>Safety shoe ESD 2 trend black/red</b> |             |       |          |                 |          |
| UX-69062                                 | black / red | 38-52 | S1P      | velcro fastener | sandal   |
| UX-69078                                 | black / red | 38-52 | S1       | lace fastening  | low shoe |



## Safety shoe ESD 2 xenova, green

Safety shoe; upper micro suede; perforated; reflective appliqué; xenova® plastic toe cap; exchangeable, shock-absorbing comfort insole; suitable for orthopedic insoles; PU/PU outsole; slip-resistant. EN ISO 20345:2011 S1 SRC



dpvlink 24267

| Article                                | Color         | Size  | Category | Closure         | Form     |
|--|---------------|-------|----------|-----------------|----------|
| <b>Safety shoe ESD 2 xenova, green</b> |               |       |          |                 |          |
| UX-95598                               | black / green | 38-52 | S1       | velcro fastener | sandal   |
| UX-95608                               | black / green | 38-52 | S1       | lace fastening  | low shoe |



## Safety shoe ESD 2 trend black/grey

Safety shoe; upper micro suede; steel toe cap; exchangeable, shock-absorbing comfort insole; suitable for orthopedic insoles; PU/PU outsole; very slip-resistant. EN ISO 20345:2011 S1P SRC



dpvlink 24282

| Article                                   | Color        | Size  | Category | Closure         | Form     |
|---|--------------|-------|----------|-----------------|----------|
| <b>Safety shoe ESD 2 trend black/grey</b> |              |       |          |                 |          |
| UX-69462                                  | black / grey | 38-52 | S1P      | velcro fastener | sandal   |
| UX-69478                                  | black / grey | 38-52 | S1       | lace fastening  | low shoe |



Safety shoe ESD 1 Business



Safety shoe; upper micro suede; wide plastic toe cap; exchangeable, shock-absorbing comfort insole; suitable for orthopedic insoles; PU outsole; oil- and benzine-resistant; very slip-resistant. EN ISO 20345:2011 S2 SRC



dpvlink 24244

| Article                           | Color | Size  | Category | Upper       | Form     |
|-----------------------------------|-------|-------|----------|-------------|----------|
| <b>Safety shoe ESD 1 Business</b> |       |       |          |             |          |
| UX-84698                          | grey  | 39-52 | S2       | micro suede | low shoe |



Safety shoe / safety boot ESD 1 Business blue



Safety shoe; upper micro suede; steel toe cap; metal-free penetration protection; exchangeable, shock-absorbing comfort insole; suitable for orthopedic insoles; PU outsole; oil- and benzine-resistant; very slip-resistant. EN ISO 20345:2011 S3 SRC



dpvlink 24246

| Article  | Color | Size  | Category | Closure        | Form     |
|--|-------|-------|----------|----------------|----------|
| <b>Safety shoe / safety boot ESD 1 Business blue</b> |       |       |          |                |          |
| UX-84282   | blue  | 39-52 | S3       | lace fastening | low shoe |
| UX-84272   | blue  | 39-52 | S3       | lace fastening | boot     |
| UX-84262   | blue  | 39-52 | S3       | elastic        | boot     |



**BATA INDUSTRIALS**  
THE SAFETY SHOE

Safety shoes produced by Bata Industrials have an excellent fit, an innovative design and offer best safety properties for your work.

Bata Industrials is constantly researching for innovative solutions with new features and materials.



Safety shoes no longer have to be boring! The Radiance collection is designed with an eye for style and a mind for safety. With its sporty look and wide range of features to deliver maximum protection and all day comfort, each shoe model is a perfect mixture of design, safety and comfort with typical 3B-Motion technology: Bata's Boosting Base in it. This technology gives your feet an enormous power boost with every step you take

- ESD-geprüfte Schuhe**  
nach EN 61340
- Sicherheitsschuhe S1**  
nach EN ISO 20345
- Sicherheitsschuhe S2**  
nach EN ISO 20345
- Komplett metallfrei**
- Durchtrittssichere Stahl-Zwischensohle**
- Aluminium-Zehenschutzkappe 200J**
- Äusserer TPU-Schuhkappenschutz**
- Anti-Rutsch Sohle**
- Vegan**  
komplett lederfrei
- Geruchshemmend (Odor Control)**
- Zertifiziert für orthopädische Einlagen / Zurichtungen möglich (nach DGUV 112-191)**
- Antistatisch**  
(verhindert statische Aufladungen)
- Sicherheitsschuhe S1P**  
nach EN ISO 20345
- Sicherheitsschuhe S3**  
nach EN ISO 20345
- Durchtrittssichere Kunststoff-Zwischensohle**
- Stahl-Zehenschutzkappe 200J**
- Kunststoff-Zehenschutzkappe 200J**
- Besonders leichter Sicherheitsschuh**
- Schuh mit Cool Comfort® Innenfutter aus Textil**
- Schuh mit einem modularen, ergonomischen Konzept - Walkline® Technologie Inside EVO**
- Mit BOA® Verschlusssystem**

## Safety shoes

### Safety sandal Falcon ESD

**NEU**  

Modern safety sandal with velcro fastener; upper suede; steel toe cap; lining mesh fabric; exchangeable ESD insole; antistatic; PU/PU outsole; EN ISO 20345 S1 SRC



dpvlink 24116



| Article                         | Color        | Size  | Category |
|---------------------------------|--------------|-------|----------|
| <b>Safety sandal Falcon ESD</b> |              |       |          |
| BT-60449                        | black / blue | 35-49 | S1       |

### Safety shoe FIT / VIM / SPARK ESD Radiance

Safety shoe; upper textile with TPU overcap; **Radiance series**; plastic toe cap and penetration protection; metal-free; breathable lining; Vibram® outsole of EVA and rubber; antistatic, slip-resistant



dpvlink 23812



| Article   | Color        | Size  | Category |
|---|--------------|-------|----------|
| <b>Safety shoe FIT / VIM / SPARK ESD Radiance</b> |              |       |          |
| BT-66419  | grey / black | 35-47 | S1P      |
| BT-66420  | black / blue | 35-47 | S1P      |
| BT-66426  | black / red  | 35-47 | S1P      |

### Safety shoe VIGOR / VIBE ESD Radiance

**NEU**  

Safety shoe; upper nylon; aluminum toe cap; FlexGuard® plastic midsole (penetration protection); mesh lining with Odor Control; exchangeable Premium Fit insole; antistatic; PU/TPU outsole



dpvlink 24949



| Article                                      | Color          | Size  | Category | Closure                       |
|--|----------------|-------|----------|-------------------------------|
| <b>Safety shoe VIGOR / VIBE ESD Radiance</b> |                |       |          |                               |
| BT-66633                                     | black / yellow | 35-47 | S1P      | Boa® / quick-release fastener |
| BT-36634                                     | black / red    | 35-47 | S3       | Boa® / quick-release fastener |

### Safety shoe SUMM TWO / ONE ESD

**NEU**  

Safety shoe; upper nylon; aluminium toe cap; FlexGuard® plastic midsole (penetration protection); mesh lining with Odor Control; exchangeable Premium Fit insole; antistatic; PU/TPU outsole; EN ISO 20345 S3 SRC



dpvlink 24781



| Article                               | Color        | Size  | Category | Form     |
|---------------------------------------|--------------|-------|----------|----------|
| <b>Safety shoe SUMM TWO / ONE ESD</b> |              |       |          |          |
| BT-63592                              | black / blue | 38-48 | S3       | low shoe |
| BT-63591                              | black / blue | 38-48 | S3       | boot     |

### Safety shoe SUMM SEVEN ESD

**NEU**  

Safety shoe; upper Putek® textile with BOA® closure; aluminium toe cap; FlexGuard® plastic midsole (penetration protection); mesh lining with Odor Control; exchangeable Premium Fit insole; antistatic; PU/TPU outsole; EN ISO 20345 S3 SRC



dpvlink 24782



| Article                           | Color        | Size  | Category |
|-----------------------------------|--------------|-------|----------|
| <b>Safety shoe SUMM SEVEN ESD</b> |              |       |          |
| BT-63597                          | black / grey | 38-48 | S3       |

### Safety shoe LEGEND / TURN ESD FWD

Safety shoe; upper mesh/TPU overcap; thermoplastic toe cap; FlexGuard® plastic midsole (puncture-resistant); Bata Cool Comfort® lining; exchangeable ESD insole; antistatic; PU/PU outsole; EN ISO 20345 S1P SRC



dpvlink 21325



| Article                                  | Color      | Size  | Category | Closure        |
|--|------------|-------|----------|----------------|
| <b>Safety shoe LEGEND / TURN ESD FWD</b> |            |       |          |                |
| BT-LEGEND-ESD                            | grey       | 38-48 | S1P      | Boa®           |
| BT-TURN-ESD                              | grey / red | 38-48 | S1P      | lace fastening |

Safety shoe SURF / RAFT ESD FWD



Safety shoe; upper mesh/TPU overcap; thermoplastic toe cap; FlexGuard® plastic midsole (puncture-resistant); Bata Cool Comfort® / OutDry® lining; exchangeable ESD insole; antistatic; PU/PU outsole; EN ISO 20345 S3 SRC



dpvlink 21322

| Article                                | Color        | Size  | Category | Form     |
|--|--------------|-------|----------|----------|
| <b>Safety shoe SURF / RAFT ESD FWD</b> |              |       |          |          |
| BT-SURF-ESD                            | black / grey | 38-48 | S3       | low shoe |
| BT-RAFT-ESD                            | black / grey | 38-48 | S3       | boot     |



Safety shoe LOGIK/ZIP ESD NOVA



Safety shoe; upper material microfiber with steel toe cap; **NOVA series**; FlexGuard® plastic penetration protection; Bata Cool Comfort® lining; QuattroTech® outsole (TPU); antistatic; EN ISO 20345:2011 S1P SRC HI



dpvlink 21054

| Article                               | Color        | Size  | Category |
|---------------------------------------|--------------|-------|----------|
| <b>Safety shoe LOGIK/ZIP ESD NOVA</b> |              |       |          |
| BT-LOGIK-ESD                          | black / blue | 38-48 | S1P      |
| BT-ZIP-ESD                            | black / red  | 38-48 | S1P      |



Safety shoe GOAL / SCORE ESD FWD



Safety shoe; upper microfiber/TPU overcap; thermoplastic toe cap; FlexGuard® plastic midsole (puncture-resistant); Bata Cool Comfort® lining; exchangeable ESD insole; antistatic; PU/PU outsole; EN ISO 20345 S3 SRC



dpvlink 21319

| Article                                 | Color | Size  | Category | Form     |
|---|-------|-------|----------|----------|
| <b>Safety shoe GOAL / SCORE ESD FWD</b> |       |       |          |          |
| BT-GOAL-ESD                             | black | 38-48 | S3       | low shoe |
| BT-SCORE-ESD                            | black | 38-48 | S3       | boot     |



Safety shoe CRYPTO ESD NOVA



Safety shoe; upper material microfiber with steel toe cap; **NOVA series**; FlexGuard® plastic penetration protection; Bata Cool Comfort® lining; QuattroTech® outsole (TPU); antistatic.



dpvlink 21057

| Article                            | Color        | Size  | Category |
|------------------------------------|--------------|-------|----------|
| <b>Safety shoe CRYPTO ESD NOVA</b> |              |       |          |
| BT-CRYPTO-ESD                      | black / grey | 38-48 | S1P      |



Safety shoe BICKZ 736 ESD



Modern safety shoe; upper nubuck; plastic toe cap; FlexGuard® plastic penetration protection; Bata Bickz Cool System® lining; exchangeable ESD insole; antistatic; rubber outsole; EN ISO 20345 S1P SRC



dpvlink 22527

| Article                          | Color | Size  | Category |
|----------------------------------|-------|-------|----------|
| <b>Safety shoe BICKZ 736 ESD</b> |       |       |          |
| BT-Bickz736ESD                   | black | 36-48 | S1P      |



Safety shoe ACT124 WALKLINE



Safety shoe; upper nubuck; ACT 124 with mesh nylon fabric element; steel toe cap; exchangeable ESD insole; antistatic. EN ISO 20345 S1 SRC



dpvlink 17381

| Article                            | Color | Size  | Category | Form     |
|------------------------------------|-------|-------|----------|----------|
| <b>Safety shoe ACT124 WALKLINE</b> |       |       |          |          |
| BT-ACT124ESD                       | black | 38-49 | S1       | low shoe |







## Fußgerechte Sicherheit

**BAAK** - ESD safety shoes with sporty and modern design and high-quality processing. Newest sole technology with excellent and all-over shock absorption. Comfortable to wear due to shock-absorbing and antibacterial insoles with particularly good moisture absorption and release. Comfort due to easy-care materials and non-marking outsoles.

In compliance with the ESD standard DIN EN 61340-5-1 



## Das BAAK® go&relax System

### The revolution of the safety shoe

Our innovative system has especially been developed for people wearing safety shoes for many hours a day. For this customer group a natural and functional foot load distribution is particularly important - low-fatigue walking over the whole working day.

### BAAK® go&relax can\*

- reduce the risk of arthrosis of the knee
- improve the posture of the body
- influence the back muscles and contribute to a reduction of the symptoms

Wearing conventional safety shoes the feet are bent in an unnatural way when walking due straight protective toe caps. In addition, rigid outsoles limit the movement of the metatarsophalangeal joints. The two external toes are not included in the rolling movement. This can lead to an incorrect loading of foot muscles, tendons and ligaments. And to grave consequences for foot dynamic and body statics.

\*Due to „bottom up“ strategy (from bottom to top) – study available at [www.baak.de](http://www.baak.de)

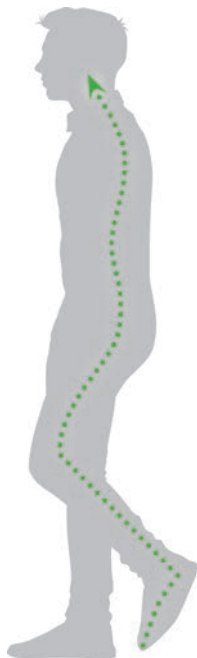

Einfach besser laufen.

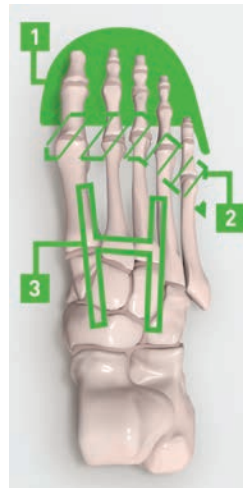

### Triple feature

Due to these three functional elements the BAAK® go&relax system for safety shoes includes all five toes in the rolling movement. The load during walking is so optimally distributed to all included muscles and joints. BAAK® go&relax consists of a unique component combination for a natural bending. And thus ensures healthy feet relieving the whole musculoskeletal system.



Fußgerecht statt gerade



Herkömmliche Schutzkappe

### 1. Asymmetric toe cap

The BAAK® flex cap provides a functional bending of bending of the metatarsophalangeal joints and thus a "more relaxed" walking.



Flexzone im Ballenbereich der Laufsohle



Natürliche Abknicklinie

### 2. Biomechanically optimized flex zone

The appropriate BAAK® flex zone in the outsole permits in addition the natural and functional bending of all metatarsophalangeal joints.

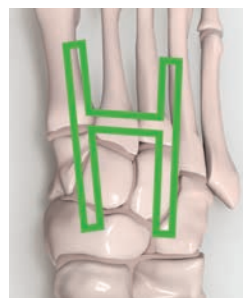

### 3. Biomechanical H coupling element

The BAAK® H coupling element integrated in the outsole provides an elastic connection of forefoot and rear foot, supports the appropriate bending of the toes and assures stability and control.



### Healthy feet

Healthy feet relieve the whole musculoskeletal system.



All Baak shoes sold by DPV are certified, according to DGUV 112-191, for the orthopedic insoles Basic AS and Comfort AS by the company Springer.



**ESD-geprüfte Schuhe**  
nach EN 61340



**Sicherheitsschuhe S1P**  
nach EN ISO 20345



**Hohe Rutschhemmung SRC**  
der höchsten Kategorie nach DIN EN 13287  
- Test bestanden, sowohl SRA als auch SRB



**Metallfrei**  
100% metallfreier Sicherheitsschuh



**Baak® go & relax-System**  
Flexkappe und Flexzone zum fussgerechten Abknicken



**Multiweiten-System**  
Modelle mit anpassbarer Weite



**DGVV Regel 112-191**  
Modelle zertifiziert für orthopädische Einlagen



**Sicherheitsschuhe S1**  
nach EN ISO 20345



**Sicherheitsschuhe S3**  
nach EN ISO 20345



**Vegan**  
komplett lederfrei/vegan



**Ultraleicht**  
Extrem leichter Sicherheitsschuh



**Knie- und Rückenfreundlich:**  
Wissenschaftlich evaluiert



**Boa®-System**  
Schuh mit Boa-Verschlussystem

## Safety shoes

### Safety shoe Captain Jogi / Captain John / Captain Jens

Safety shoe with BOA® quick fastener; made of microfiber and nylon; nano fiberlass flexible cap; textile penetration protection; Baak Lightstep insole; suitable for orthopedic insoles; LIEVA (liquid injected EVA) / nitrile outsole; ultra-light; all-over cushioning; very breathable; slip-resistant. EN ISO 20345:2011 S1P SRC



BA-5080 Captain Jogi



BA-5082 Captain John



dpvlink 21002

| Article   | Color              | Size  | Category |
|---|--------------------|-------|----------|
| <b>Safety shoe Captain Jogi / Captain John / Captain Jens</b> |                    |       |          |
| BA-5080   | black / grey       | 39-48 | S1P      |
| BA-5082   | black / anthracite | 39-48 | S1P      |
| BA-5081   | black              | 39-48 | S1P      |



### Safety shoe Conner / Clark



Safety shoe made of breathable textile material; nano fiberglass flexible cap; Baak Lightstep insole; suitable for orthopedic insoles; LIEVA (liquid injected EVA) / nitrile outsole; ultra-light; all-over cushioning; very breathable; metal- and leather-free, slip-resistant. EN ISO 20345:2011 S1 SRC



BA-5001 Conner



BA-5002 Clark



dpvlink 20996

| Article                           | Color        | Size  | Category |
|-----------------------------------|--------------|-------|----------|
| <b>Safety shoe Conner / Clark</b> |              |       |          |
| BA-5001                           | grey / black | 39-48 | S1       |
| BA-5002                           | grey / black | 39-48 | S1       |



### Safety shoe Herby / Harry



Safety shoe of microfiber with mesh textile insert; aluminum toe cap; Baak Lightstep insole; suitable for orthopedic insoles; PU/PU outsole; very breathable; non-marking, slip-resistant. EN ISO 20345:2011 S1 SRC



dpvlink 21005

| Article                          | Color        | Size  | Category | Closure                |
|----------------------------------|--------------|-------|----------|------------------------|
| <b>Safety shoe Herby / Harry</b> |              |       |          |                        |
| BA-7008                          | black / blue | 36-47 | S1       | quick-release fastener |
| BA-7228                          | black / blue | 36-47 | S1       | velcro fastener        |



### Safety sandal Henry



Safety sandal with two velcro fasteners; upper cowhide suede with reflective appliqué; steel toe cap; metal-free penetration protection; Baak ESD Softstep insole; suitable for the supply with insoles; PU/PU outsole, slip-resistant (non-marking). EN ISO 20345:2011 S1P SRC



BAK INDUSTRIAL



dpvlink 21170

| Article                    | Color        | Size  | Category |
|----------------------------|--------------|-------|----------|
| <b>Safety sandal Henry</b> |              |       |          |
| BA-8424                    | black / grey | 37-48 | S1P      |



## Safety shoe Hardy/Henk



Safety shoe made of abrasion-resistant microfiber with textile elements; perforated; soft padded shaft edge; aluminium toe cap; flexible insole with penetration protection; Baak ESD Softstep insole; suitable for orthopedic insoles; PU outsole with PU midsole; antibacterial, fungicidal, robust; slip-resistant. EN ISO 20345 S1P SRC Sizes 36-47 in width 11; size 48 in width 13



BA-7227 Hardy



BA-7007 Henk



dpvlink 19547

| Article                       | Color        | Size  | Category | Closure                |
|-------------------------------|--------------|-------|----------|------------------------|
| <b>Safety shoe Hardy/Henk</b> |              |       |          |                        |
| BA-7227                       | black / grey | 36-48 | S1P      | velcro fastener        |
| BA-7007                       | black / grey | 36-48 | S1P      | quick-release fastener |

- Special sizes 49 + 50 and other width on request -

## Safety shoe Hugo



Safety shoe; upper suede with reflective appliqué; steel toe cap; metal-free penetration protection; Baak ESD Softstep insole; suitable for the supply with insoles; PU/PU outsole, slip-resistant (non-marking). EN ISO 20345:2011 S1P SRC



dpvlink 21172

| Article                 | Color        | Size  | Category |
|-------------------------|--------------|-------|----------|
| <b>Safety shoe Hugo</b> |              |       |          |
| BA-8724                 | black / grey | 35-48 | S1P      |

## Safety shoe Svea



Sporty safety shoe; upper nylon material with decorative TPU appliqué (abrasion-resistant and water-repellent); steel toe cap; metal-free penetration protection; Baak ESD Softstep insole; suitable for orthopedic insoles, EVA/nitrile outsole, slip-resistant (non-marking). EN ISO 20345:2011 S3 SRC



dpvlink 23548

| Article                 | Color             | Size  | Category |
|-------------------------|-------------------|-------|----------|
| <b>Safety shoe Svea</b> |                   |       |          |
| BA-3218                 | black / turquoise | 34-42 | S3       |

## Women's safety sandal Sue 2



Safety sandal of wear-resistant microfiber, with quick fastener; padded collar; steel toe cap; Baak ESD Softstep insole; PU midsole; PU/PU outsole; breathable, fungicide; slip-resistant. EN ISO 20345 S1 SRC



dpvlink 21707

| Article                            | Color       | Size  | Category |
|------------------------------------|-------------|-------|----------|
| <b>Women's safety sandal Sue 2</b> |             |       |          |
| BA-32112                           | black / red | 35-42 | S1       |

## Safety shoe Sonja / Steve



Modern safety shoe; with nylon inserts; steel toe cap; textile penetration protection; Baak Softstep insole; antibacterial; fungicidal; suitable for orthopedic insoles; EVA/nitrile outsole, slip-resistant. EN ISO 20345:2011 S1P SRC

Model Sonja (BA-3219) with upper microfiber with leather optics  
Model Steve (BA-5519) with upper cowhide suede



dpvlink 24219

| Article                          | Color     | Size  | Category | Width |       |
|----------------------------------|-----------|-------|----------|-------|-------|
| <b>Safety shoe Sonja / Steve</b> |           |       |          |       |       |
| BA-3219                          | grey      | 35-42 | S1P      | 10    | women |
| BA-5519                          | dark grey | 38-48 | S1P      | 11    | men   |

## Safety shoe Stan / boot Stanley



Safety shoe of breathable, water-resistant nylon with TPU appliqué; composite toe cap; Baak Lightstep insole; antibacterial; fungicidal; suitable for orthopedic insoles; EVA/nitrile outsole; full-surface shock absorption; very breathable; metal-free, slip-resistant. EN ISO 20345:2011 S3 SRC



dpvlink 24216

| Article                                | Color | Size  | Category | Form     |
|--|-------|-------|----------|----------|
| <b>Safety shoe Stan / boot Stanley</b> |       |       |          |          |
| BA-5518                                | black | 38-48 | S3       | low shoe |
| BA-5618                                | black | 38-48 | S3       | boot     |

## Safety shoe Sam



Modern safety shoe; upper water-resistant nylon; composite toe cap; metal-free penetration protection; Baak ESD Softstep insole, antibacterial, fungicidal, suitable for orthopedic insoles; EVA/nitrile outsole, slip-resistant (non-marking). EN ISO 20345:2011 S3 SRC



dpvlink 24770

| Article                | Color | Size  | Category |
|------------------------|-------|-------|----------|
| <b>Safety shoe Sam</b> |       |       |          |
| BA-5520                | black | 35-48 | S3       |

## Safety shoe Rui



Modern safety shoe; upper water-resistant microfiber with TPU appliqué; wide composite toe cap; sized width; textile penetration protection; Baak Softstep insole; antibacterial; fungicidal; suitable for orthopedic insoles; EVA/nitrile outsole, slip-resistant (non-marking). EN ISO 20345:2011 S3 SRC  
Sizes 36-40 with width 10.5; sizes 41-48 with width 12



dpvlink 24224

| Article                | Color | Size  | Category | Width     |
|------------------------|-------|-------|----------|-----------|
| <b>Safety shoe Rui</b> |       |       |          |           |
| BA-73181               | black | 36-48 | S3       | 10.5 - 12 |

## Safety shoe Rob2 / Robert2



Safety shoe, upper robust nubuck; water-repellent; climate-regulating lining; metal- and leather-free; composite toe cap; flexible insole; Baak ESD Softstep insole; suitable for orthopedic insoles; all-over cushioning due to EVA midsole; nitrile outsole; robust; slip-resistant; non-marking. EN ISO 20345 S3 SRC



BA-73442 Rob2



BA-73742 Robert2



dpvlink 19537

| Article                           | Color        | Size  | Category | Form     |
|-----------------------------------|--------------|-------|----------|----------|
| <b>Safety shoe Rob2 / Robert2</b> |              |       |          |          |
| BA-73442                          | black / grey | 36-48 | S3       | low shoe |
| BA-73742                          | black / grey | 36-48 | S3       | boot     |

- Special sizes 49 + 50 for Rob2 on request -

## Safety shoe Red / Reeny



Safety shoe made of abrasion-resistant microfiber with textile elements; perforated; soft padded shaft edge; metal- and leather-free; composite toe cap; flexible insole with penetration protection; Baak ESD Softstep insole; suitable for orthopedic insoles; all-over cushioning due to EVA midsole; nitrile outsole; antibacterial; fungicidal; robust; slip-resistant; non-marking. EN ISO 20345 S1P SRC



dpvlink 19541

| Article                        | Color         | Size  | Category |
|--------------------------------|---------------|-------|----------|
| <b>Safety shoe Red / Reeny</b> |               |       |          |
| BA-71502                       | black / red   | 36-48 | S1P      |
| BA-71522                       | black / green | 36-48 | S1P      |

## Safety shoe Rick2 / Ron2



Safety shoe; upper abrasion-resistant microfiber with textile elements; metal- and leather-free; composite toe cap; flexible insole; Baak ESD Softstep insole; suitable for orthopedic insoles; all-over cushioning due to EVA midsole; nitrile outsole; robust; slip-resistant. EN ISO 20345 S1P SRC



BA-71462 Rick2



BA-71472 Ron2



dpvlink 19532

| Article                         | Color         | Size  | Category |
|---------------------------------|---------------|-------|----------|
| <b>Safety shoe Rick2 / Ron2</b> |               |       |          |
| BA-71462                        | blue / yellow | 36-48 | S1P      |
| BA-71472                        | black / grey  | 36-48 | S1P      |

## Safety shoe Paul



Safety shoe made of calf suede with reflective applications; steel toe cap; textile penetration protection; Baak ESD Softstep insole; suitable for orthopedic insoles; PU-midsole; PU outsole with flexline for easy rolling movement; abrasion-resistant, robust; slip-resistant (non-marking). EN ISO 20345:2011 S1P SRC



dpvlink 18286

| Article                 | Color       | Size  | Category |
|-------------------------|-------------|-------|----------|
| <b>Safety shoe Paul</b> |             |       |          |
| BA-7003                 | blue / grey | 38-48 | S1P      |

- Special sizes 49 + 50 on request -

## Safety sandal Rene2 / Rico2



Safety sandal made of abrasion-resistant microfiber with textile elements; soft padded shaft edge; velcro fastener and elastic; metal- and leather-free; composite toe cap; flexible insole; Baak ESD Softstep insole; suitable for orthopedic insoles; antibacterial; fungicide; all-over cushioning due to EVA midsole; nitrile outsole; robust; slip-resistant. EN ISO 20345 S1P SRC



BA-74112 Rico2



dpvlink 19531

| Article                            | Color         | Size  | Category |
|------------------------------------|---------------|-------|----------|
| <b>Safety sandal Rene2 / Rico2</b> |               |       |          |
| BA-72112                           | blue / yellow | 36-48 | S1P      |
| BA-74112                           | black / grey  | 36-48 | S1P      |

## Safety sandal Pit



Safety sandal made of calf suede; quick fastener; separate laces; reflective applications; steel toe cap; textile penetration protection; Baak ESD Softstep insole; suitable for orthopedic insoles; PU-midsole; PU outsole with flexline; abrasion-resistant, robust, slip-resistant. EN ISO 20345:2011 S1P SRC

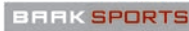

dpvlink 18489

| Article                  | Color       | Size  | Category |
|--------------------------|-------------|-------|----------|
| <b>Safety sandal Pit</b> |             |       |          |
| BA-7013                  | blue / grey | 38-48 | S1P      |

## Safety shoe Peter / boot Philipp



Safety shoe made of hydrophobic calf nubuck with reflecting appliques; steel toe cap; textile penetration protection; exchangeable insole; Baak ESD Softstep insole; suitable for orthopedic insoles; PU-midsole; PU outsole with flexline for an easy roll; abrasion-resistant, robust, slip-resistant (non-marking). EN ISO 20345:2011 S3 SRC



dpvlink 18288

| Article                                 | Color        | Size  | Category | Form     |
|---|--------------|-------|----------|----------|
| <b>Safety shoe Peter / boot Philipp</b> |              |       |          |          |
| BA-7204                                 | black / grey | 38-48 | S3       | low shoe |
| BA-7304                                 | black / grey | 38-48 | S3       | boot     |

## Insoles

### Insole Softstep ESD 4660



suitable for all BAAK Woman Premium ESD models

- Soft cushioning, shock-absorbing insole of PU foam
- breathable with excellent moisture absorption and release
- foot moisture is quickly transported away from the foot
- antibacterial and fungicidal due to silver ions

dpvlink 18302

| Article                         | Type           | Size  |
|---------------------------------|----------------|-------|
| <b>Insole Softstep ESD 4660</b> |                |       |
| BA-4660                         | for BAAK Woman | 35-42 |

### Insole ESD Softstep 4661



suitable for BAAK Sports, BAAK Sports Light, BAAK Sports exclusive, BAAK Industrial except with width XW

- Soft cushioning, shock-absorbing insole of PU foam
- breathable with excellent moisture absorption and release
- foot moisture is quickly transported away from the foot
- antibacterial and fungicidal due to silver ions

dpvlink 18304

| Article                         | Type  | Size  |
|---------------------------------|---|-------|
| <b>Insole ESD Softstep 4661</b> |   |       |
| BA-4661                         | for series Sports, Sports Light, Sports exclusive, Industrial | 36-50 |

### Insole ESD Ortho-Step 4663



suitable for BAAK Unity with size control

- Soft cushioning, shock-absorbing insole of PU foam
- breathable with very good moisture absorption and release
- foot moisture is quickly transported from the foot
- antibacterial and fungicide due to silver ions

dpvlink 19664

| Article                           | Type                  | Size  |
|-----------------------------------|-----------------------|-------|
| <b>Insole ESD Ortho-Step 4663</b> |                       |       |
| BA-4663                           | for series BAAK Unity | 38-48 |



# LEMAITRE

meisterhafte Sicherheitsschuhe

Lemaitre creates extraordinary sole structures, designs and fits and more than 30 years of experience are put in every shoe.

Diversity, individuality and uncompromising technology are a must. LEMAITRE patents contribute to most different solutions and keep product innovations at hand that are considered to be spectacular and trendsetting. Competence and experience provide a complete product range of safety shoes for qualitative "foot work" valid according to EN standards.

Wearing LEMAITRE safety shoes the boundaries between work and leisure become blurred.



Ihr LOGO

You want to emphasize the company affiliation of your employees? Have the models RILEY LOW S3 ESD and Bolt S3 ESD additionally equipped with your company logo, and that from 1 pair! Just contact us!

### BOLT S3 ESD logo

Due to its black microfiber and the attractive lacing this shoe Bolt S3 ESD can be identified as a safety equipment only at second glance.

fied as a safety equipment only at second glance.

### RILEY LOW S3 ESD logo

The safety shoe Riley low S3 ESD made of black microfiber is a pure lace-up shoe with an additional elastic band. When leaving out the upper loop, it can be used as a comfortable loafer.



**ESD-geprüfte Schuhe**  
nach EN 61340



**Sicherheitsschuhe S1**  
nach EN ISO 20345



**Sicherheitsschuhe S1P**  
nach EN ISO 20345



**Sicherheitsschuhe S3**  
nach EN ISO 20345



**Rutschhemmende Sohle SRC**  
für keramische Fliesen (SRA) sowie Stahl-  
berflächen (SRB) nach EN ISO 20345



**Durchtrittssichere Zwischen-  
sohle aus Kunststoff «Fibre-  
LS»**



**200-Joules-Zehenkappe aus  
Aluminium**



**200-Joules-Zehenkappe aus  
Stahl**



**Passform: Normal**



**Passform: Weit**



**100% Vegan**



**Springer-Einlagen**  
nach DGUV Regel 112-191 / ÖNorm Z 1259

## Safety shoes

### Safety shoe Riley Low

LEMAITRE

Safety shoe; upper microfiber seamless, reflecting appliqués, aluminum toe cap; metal-free penetration protection; mesh lining; PU outsole; suitable for orthopedic insoles (DGUV 112-191); oil-, acid- and fuel-resistant; slip-resistant; antistatic. EN ISO 20345:2011 S3 SRC



dpvlink 23841

| Article                      | Color       | Size  | Category | Closure        |
|------------------------------|-------------|-------|----------|----------------|
| <b>Safety shoe Riley Low</b> |             |       |          |                |
| LE-8061                      | black / red | 36-49 | S3       | lace fastening |



### Safety shoe Bolt

LEMAITRE

Safety shoe; upper microfiber; steel toe cap; metal-free penetration protection; abrasion-resistant lining; PU outsole; suitable for orthopedic insoles (DGUV 112-191); antistatic; oil-, acid- and fuel-resistant; slip-resistant. EN ISO 20345:2011 S3 SRC



dpvlink 23543

| Article                 | Color | Size  | Category | Closure        |
|-------------------------|-------|-------|----------|----------------|
| <b>Safety shoe Bolt</b> |       |       |          |                |
| LE-8095                 | black | 36-48 | S3       | lace fastening |



### Safety shoes Riley Fresh / Riley High

LEMAITRE

Safety shoe; upper microfiber seamless, reflecting appliqués, aluminum toe cap; metal-free penetration protection; mesh lining; PU outsole; suitable for orthopedic insoles (DGUV 112-191); oil-, acid- and fuel-resistant; slip-resistant; antistatic.

Riley Fresh LE-8060 EN ISO 20345:2011 S1P SRC

Riley High LE-8062 EN ISO 20345:2011 S3 SRC



dpvlink 23536

| Article                                      | Color       | Size  | Category | Form   | Closure         |
|--|-------------|-------|----------|--------|-----------------|
| <b>Safety shoes Riley Fresh / Riley High</b> |             |       |          |        |                 |
| LE-8060                                      | black / red | 36-49 | S1P      | sandal | velcro fastener |
| LE-8062                                      | black / red | 36-49 | S3       | boot   | lace fastening  |





## Safety shoes Space Red / Space Blue LEMAITRE

Safety shoe; upper textile with suede; aluminum toe cap; metal-free penetration protection; abrasion-resistant textile lining; PU outsole; suitable for orthopedic insoles (DGUV 112-191); oil-, acid- and fuel-resistant; slip-resistant; antistatic. EN ISO 20345:2011 S3 SRC



dpvlink 23540

| Article                                    | Color        | Size  | Category | Form     |
|--|--------------|-------|----------|----------|
| <b>Safety shoes Space Red / Space Blue</b> |              |       |          |          |
| LE-1980                                    | black / red  | 38-48 | S3       | low shoe |
| LE-1985                                    | black / blue | 38-48 | S3       | low shoe |



## Safety shoes Super X Fresh / Super X Low / Super X High LEMAITRE

Safety shoe; upper buffalo nubuck, reflecting appliqués, steel toe cap; metal-free penetration protection; mesh lining; PU outsole; suitable for orthopedic insoles (DGUV 112-191); oil-, acid- and fuel-resistant; slip-resistant; antistatic.

Super X Fresh LE-1260 EN ISO 20345:2011 S1P SRC

Super X Low LE-1261 and Super X High LE-1262 EN ISO 20345:2011 S3 SRC



dpvlink 23340

| Article  | Color       | Size  | Category | Form     | Closure         |
|--|-------------|-------|----------|----------|-----------------|
| <b>Safety shoes Super X Fresh / Super X Low / Super X High</b> |             |       |          |          |                 |
| LE-1260  | black / red | 35-48 | S1P      | sandal   | velcro fastener |
| LE-1261  | black / red | 35-48 | S3       | low shoe | lace fastening  |
| LE-1262  | black / red | 35-48 | S3       | boot     | lace fastening  |



## Safety shoe Roy LEMAITRE

Safety shoe; upper microfiber with perforations; aluminum toe cap; abrasion-resistant textile lining; PU outsole; oil-, acid- and fuel-resistant; slip-resistant; antistatic. EN ISO 20345:2011 S1 SRC



dpvlink 23545

| Article                | Color       | Size  | Category | Closure        |
|------------------------|-------------|-------|----------|----------------|
| <b>Safety shoe Roy</b> |             |       |          |                |
| LE-8067                | black / red | 36-49 | S1       | lace fastening |



## Safety shoe Paul / Harrison / Ringo NEU LEMAITRE

Safety shoe; upper microfiber/PUATEK®; aluminum toe cap; metal-free penetration protection; breathable 3D mesh lining; shock protection on the foot tip; PU outsole; oil-, acid- and fuel-resistant; slip-resistant; antistatic. EN ISO 20345:2011 S3 SRC

Model **Ringo** (LE-8076) with upper PUATEK® (robust, flexible and extremely light microfiber)

Model **Harrison** (LE-8078) with comfortable UTURN® Smart Lacing System (quick-release fastener for perfect support)



dpvlink 24800

| Article                                    | Color          | Size  | Category | Closure        | Upper      |
|--|----------------|-------|----------|----------------|------------|
| <b>Safety shoe Paul / Harrison / Ringo</b> |                |       |          |                |            |
| LE-8075                                    | black / blue   | 35-49 | S3       | lace fastening | microfiber |
| LE-8076                                    | black / green  | 35-49 | S3       | lace fastening | Putek®     |
| LE-8078                                    | black / yellow | 35-49 | S3       | UTURN®         | microfiber |



## Safety shoe Ohmex / Faye NEU LEMAITRE

Safety shoe; upper microfiber with perforations; aluminum toe cap; abrasion-resistant textile lining; PU outsole; oil-, acid- and fuel-resistant; slip-resistant; antistatic. EN ISO 20345:2011 S1 SRC

Model **Ohmex** (LE-8080) additionally with sporty, flexible TPU tip protection extending the shelf life with kneeling work and external impacts.



dpvlink 24801

| Article                         | Color | Size  | Category | Closure        |
|---------------------------------|-------|-------|----------|----------------|
| <b>Safety shoe Ohmex / Faye</b> |       |       |          |                |
| LE-8080                         | black | 36-48 | S1P      | lace fastening |
| LE-8081                         | grey  | 36-43 | S1P      | lace fastening |



## Safety shoe Veggie NEU LEMAITRE

Vegan safety shoe; upper microfiber (highly abrasion-resistant); aluminum toe cap; breathable AirMesh lining; PU outsole; oil- acid and fuel-resistant; slip-resistant; antistatic. EN ISO 20345:2011 S3 SRC



dpvlink 24802

| Article                   | Color | Size  | Category | Closure        |
|---------------------------|-------|-------|----------|----------------|
| <b>Safety shoe Veggie</b> |       |       |          |                |
| LE-1988                   | black | 38-48 | S3       | lace fastening |



# U-POWER

Don't worry... be happy!

The continuous research and development of U-POWER surprises with an innovative insole. The best technologies are combined providing an experience of absolute comfort for each and every one! The insole consists of two elements:

An anatomic structure of Elastopan of BASF with extremely good viscoelastic properties

- distributes the body weight evenly across the foot

An element consisting of a revolutionary Elastopan mixture of BASF

- ensures anti-fatigue properties
- absorbs and reduces physical stress caused by standing activity over a longer time

This results in an immediate well-being when wearing the shoe for the very first time which reflects a reduced fatigue during every workday.

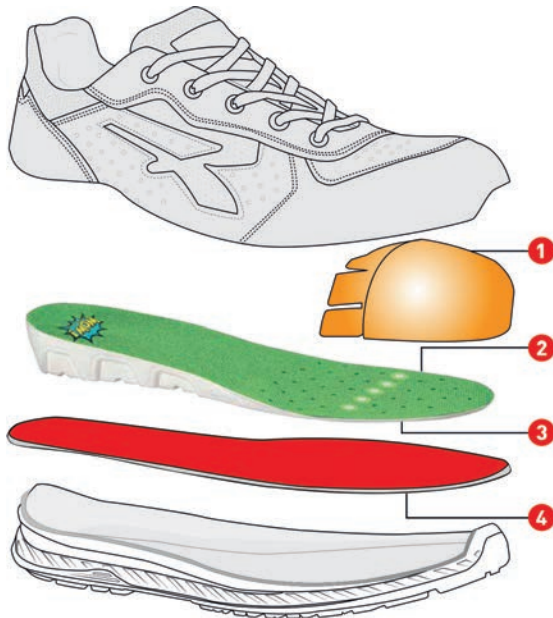

- AirToe**  
protective toe cap 200J
- WOW & BASF**  
Anatomic, soft insole for optimal support and perfect shock absorption combined with an anti-fatigue element and ventilation channels
- Seamless**  
New seamless antistatic technology for an increased comfort. No pressure spots and no rubbing on the sole of the foot
- Save & FLEX plus**  
"No metal" insole with penetration protection. 100% protection of the foot surface

## Safety shoes

### Safety shoe Denver / Vortex / Tokyo

Safety shoe; upper perforated suede, breathable mesh elements; perforated composite toe cap; metal-free penetration protection; breathable microfiber lining; insole with anti-fatigue insert; PU midsole; abrasion-resistant PU/PU outsole; oil-resistant; slip-resistant; antistatic. EN ISO 20345:2011 S1P SRC



dpvlink 24821

| Article                                    | Color          | Size  | Category | Form            |
|--|----------------|-------|----------|-----------------|
| <b>Safety shoe Denver / Vortex / Tokyo</b> |                |       |          |                 |
| UP-21086                                   | grey / green   | 35-48 | S1P      | low shoe unisex |
| UP-20666                                   | black / yellow | 35-47 | S1P      | low shoe unisex |
| UP-21076                                   | grey / pink    | 35-42 | S1P      | low shoe women  |



### Safety shoe Marsiglia / Nairobi / Demon

Safety shoe; upper perforated suede, breathable nylon elements; perforated composite toe cap; metal-free penetration protection; breathable microfiber lining; insole with anti-fatigue insert; PU midsole; abrasion-resistant PU/PU outsole; oil-resistant; slip-resistant; antistatic. EN ISO 20345:2011 S1P SRC



dpvlink 24825

| Article  | Color          | Size  | Category | Form     |
|--|----------------|-------|----------|----------|
| <b>Safety shoe Marsiglia / Nairobi / Demon</b> |                |       |          |          |
| UP-21106                                       | black / yellow | 35-48 | S1P      | low shoe |
| UP-21096                                       | black / orange | 35-48 | S1P      | low shoe |
| UP-20066                                       | grey / red     | 38-47 | S1P      | low shoe |



### Safety shoe Shanghai

Safety shoe; upper abrasion-resistant microfiber, breathable nylon elements; perforated composite toe cap; metal-free penetration protection; breathable microfiber lining; insole with anti-fatigue insert; PU midsole; abrasion-resistant PU/PU outsole; oil-resistant; slip-resistant; antistatic. EN ISO 20345:2011 S1P SRC



dpvlink 24829

| Article                     | Color        | Size  | Category | Form     |
|-----------------------------|--------------|-------|----------|----------|
| <b>Safety shoe Shanghai</b> |              |       |          |          |
| UP-21226                    | black / grey | 35-48 | S1P      | low shoe |





## Orthopedic insoles

### Orthopedic insoles

You wear certified shoes and need an orthopedic insole adapted to your personnel requirements? You will find the right insole with our range of orthopedic insoles - available for all shoes with Secosol® icon purchased from us

ORTHOstat® according to EN ISO 20347:2012 or EN ISO 20345:2011 or Secosol® Complete - tested for type examination and certified according to DGUV 112-191



An insole like no other!  
Secosol® Complete – the answer for your foot problem. With our innovative insole system for safety shoes manufactured with modern CAD/CAM methods your feet get exactly the support and correction they need. Individually adapted to your foot, Secosol® Complete insoles facilitate painless walking and standing in order to prevent damage in the locomotor system. Particularly for the use in safety shoes, insoles have to fulfill the highest requirements regarding orthopedic function and also comfort. The Secosol® Complete insole respects the existing type examination standards and is type-tested for more than 1,400 different models of various manufacturers. Therefore trust in our know-how and the competence of our experienced employees. Secosol® Complete. Developed for your foot.  
For further information please visit [www.hartmann-os.com](http://www.hartmann-os.com)

### ORTHOstat®

Orthopädische Einlage nach ESD-Sicherheitsstandard.

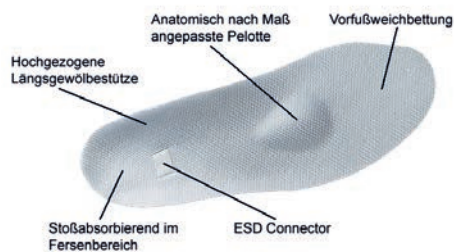

ORTHOstat® is ABEBA's individual orthopedic insole according to EN ISO 20345:2011 and 20347:2012.

Anatomically shaped treading surface for the heel, support of the longitudinal and transverse arches, anatomically customized pad, cushioning of the metatarsal heads, especially light and dimensionally stable, skin-friendly, safety shoe remains certified.

### Secosol® Complete or ORTHOstat® - as easy as this:

1. Choose a shoe with the ORTHOstat® or Secosol® Complete icon
2. Demand the foam for your footprint
3. For further information see [dpvlink 20191](#)

#### dpvlink 20191

| Article         | Type               |
|-----------------|--------------------|
| DPV-3550.Schaum | Foam for footprint |



## ESD socks

### ESD socks Basic



86% cotton, 12% polyester, 1% elastane, 1% Bekinox®

- anatomically shaped footbed
- skin-friendly materials
- highly elastic, non-constricting cuffs
- washable up to 30°C
- available sizes 36-38, 39-41, 42-43, 44-45, 46-47

#### dpvlink 22632

| Article                | Color | Size  |
|------------------------|-------|-------|
| <b>ESD socks Basic</b> |       |       |
| EL-900019              | black | 35-50 |



### ESD socks Perfect Fit



44% cotton, 37% Coolmax®, 15% polyamide, 3% elastane, 1% Bekinox®

- anatomically shaped footbed
- skin-friendly materials
- climate-regulating COOLMAX® yarn
- highly elastic, non-constricting cuffs
- reinforced heel, toe and sole
- washable up to 30°C
- available sizes 36-38, 39-42, 43-46, 47-50

#### dpvlink 22635

| Article                      | Color        | Size  |
|------------------------------|--------------|-------|
| <b>ESD socks Perfect Fit</b> |              |       |
| EL-900020                    | black / grey | 35-50 |



### ESD socks 8201 LIGHT



50% modal, 36% nylon, 12% polyester, 1% elasthan, 1% carbon fiber

- very good fit, fine
- breathable and odor-inhibiting
- protection against wet feet and abrasions
- washable up to 40°C
- available sizes 36-38, 39-41, 42-43, 44-45, 46-47

#### dpvlink 19672

| Article                     | Color | Size  |
|-----------------------------|-------|-------|
| <b>ESD socks 8201 LIGHT</b> |       |       |
| JA-8201                     | black | 36-47 |



### ESD Line socks



90% polyester, 7% elastane, 3% silver treads

- Perfectly fitting and flexible socks
- conductive fibers in the heel and toe
- washable up to 40°C
- with ESD logo

#### dpvlink 14258

| Article               | Color        | Size  |
|-----------------------|--------------|-------|
| <b>ESD Line socks</b> |              |       |
| 2720.4260.S           | white / grey | 36-38 |
| 2720.4260.M           | white / grey | 39-40 |
| 2720.4260.L           | white / grey | 41-42 |
| 2720.4260.XL          | white / grey | 43-45 |
| 2720.4260.XXL         | white / grey | 46-48 |



All Season COTTON ESD socks



All Season COTTON ESD socks  
 49% cotton , 22% polyamide, 17% polyester, 9% acryl, 2% elastane, 1% Bekinox® (metal fibers)

- adapts to the temperature of the foot
- absorbs up to 80% moisture
- strong
- washable up to 40°C
- available sizes  
35-38, 39-42, 43-46, 47-50

dpvlink 19623

| Article                            | Color | Size  |
|------------------------------------|-------|-------|
| <b>All Season COTTON ESD socks</b> |       |       |
| BT-11300                           | grey  | 35-50 |



ESD socks



ESD socks Bata Cool series - professional

39% polyamide, 39% polyester PRO-COOL®, 20% cotton, 1% elastane, 1% Bekinox®

- anti-bacterial
- high quality
- washable up to 40°C
- dissipative
- sizes available  
35-38, 39-42, 43-46, 47-50

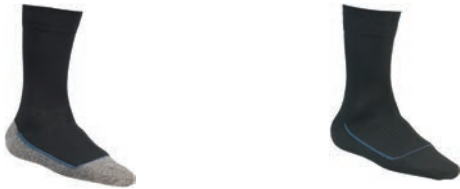

dpvlink 17395

| Article          | Color        | Size  |
|------------------|--------------|-------|
| <b>ESD socks</b> |              |       |
| BT-10101         | black        | 35-50 |
| BT-10100         | black / grey | 35-50 |



ESD socks



66% cotton, 31% polyamide, 2% elasthan, 1% carbon fiber

- comfortable ESD socks
- nearly seamless, no rubbing against the skin
- durable, dimensionally stable
- toe and heel area slightly padded
- color: graphite/grey
- washable up to 40°C
- available in the sizes  
36-39, 40-42, 43-46

dpvlink 24787

| Article          | Color           | Size  |
|------------------|-----------------|-------|
| <b>ESD socks</b> |                 |       |
| SI-99360         | graphite / grey | 36-46 |



ESD sneaker socks



40% polyamide, 42% Microlon polyamide, 14% polypropylen, 2% elasthan, 2% carbon fiber

- comfortable ESD sneaker socks
- angle-high, soft socks
- toe and heel area slightly padded
- durable
- color: graphite/grey
- washable up to 40°C

available in the sizes 36-39, 40-42, 43-46

dpvlink 24789

| Article                  | Color           | Size  |
|--------------------------|-----------------|-------|
| <b>ESD sneaker socks</b> |                 |       |
| SI-99372                 | graphite / grey | 36-46 |



Care products

Fresh shoe deo spray



Fresh shoe deo spray with long-term effect

- colorless
- long-lasting fragrance
- eco-friendly pump dispenser

dpvlink 23170

| Article    | Type  |
|------------|---|
| 2500.B1505 | <b>Shoe-Fresh Bama</b><br>100 ml spray bottle   |
| 2500.B1508 | <b>Trainer Fresh Bama</b><br>Antibacterial effect - eliminates 99.9% of bacteria<br>100 ml spray bottle |



Express shine sponge Bama



BAMA express shine sponge for fast care of smooth leather shoes - shiny shoes without polishing

- specially for smooth leather
- protects and gives intensive shine
- colorless
- content: 5 ml

dpvlink 23298

| Article    | Type                                   |
|------------|--|
| 2500.B1603 | <b>Express shine sponge Bama, 5 ml</b> |



Fine wax care Bama



BAMA Fine wax care for the intensive care of smooth leather shoes

- ideal for all types of smooth leather
- cares and protects sensitive and high-quality leather
- gives shine
- colorless
- content: 250 ml

dpvlink 23300

| Article    | Type                              |
|------------|-----------------------------------|
| 2500.B1608 | <b>Fine Wax care Bama, 250 ml</b> |



Cleansing and caring foam Bama



BAMA Cleansing and caring foam cleans and cares effectively all materials

- effective care and cleaning for all materials
- tested and recommended for breathable membranes
- removes also snow and salt stains
- colorless
- content: 300 ml

dpvlink 23302

| Article    | Type  |
|------------|---|
| 2500.B1612 | <b>Cleansing and caring foam Bama, 300 ml</b> |





## Active Universal care Bama



BAMA Active universal care cares, protects and refreshes the colors of the materials and can be used on shoes, jackets and bags

- suitable for all materials like e.g. smooth, suede and patent leather as well as synthetic materials, textile and material combinations
- tested and recommended for breathable membranes
- colorless
- content: 300 ml

dpvlink 23304

Article Type

2500.B1613 Active Universal care Bama, 300 ml



## Impregnating spray Bama



BAMA Universal impregnating spray protects the material from moisture and dirt

- suitable for all materials like e.g. smooth, suede and patent leather as well as synthetic materials, textile and material combinations
- tested and recommended for breathable membranes
- colorless
- content: 400 ml

dpvlink 23306

Article Type

2500.B1620 Impregnating spray Bama, 400 ml



## Protector 3x3 WOLY



Highly effective impregnation spray, suitable for all textiles, smooth and rough leather

- colorless
- repels oil and dirt
- recommended for shoes and textiles with climatic membrane

dpvlink 18059

Article Type

2500.W1530 Protector WOLY, 250 ml



## High-Tech-Lotion WOLY



Profitable care emulsion, especially made for high-tech materials like smooth leather, reptile and patent leather.

- color-untensifying, provides gloss and a comfortable grip
- fruity fresh fragrance
- suitable for all colors
- protects the material against environmental influences

dpvlink 20342

Article Type

2500.W1489.N High-Tech-Lotion WOLY, 75 ml



## Heel grounders and overshoes

### Disposable heel grounder



Conductive polyester strap, self-adhesive, for visitors with normal outdoor shoes or boots, yellow/black.

In compliance with the ESD standard DIN EN 61340-5-1

dpvlink 121

| Article      | Type                         | L [mm] |
|--------------|------------------------------|--------|
| 2560.894     | Pack with 100 heel grounders | 300    |
| 2560.894.600 | Pack with 100 heel grounders | 600    |



### Wall-mounted container for disposable heel grounders



Screw-on wall mount made of plastic for always handy disposable heel grounders



dpvlink 5862

Article Type

|                |   |
|----------------|---|
| 2560.894.H     | Wall-mounted container for disposable heel grounders 300 mm |
| 2560.894.H-600 | Wall-mounted container for disposable heel grounders 600 mm |



## Permanent heel grounder for visitors



Permanent heel grounder with clip closure for visitors with exchangeable contact strips, with snap fastener. 1 MOhm safety resistance. ⚠️



**dpvlink 110**

| Article         | Type  |
|-----------------|---|
| 2560.893.R.blue | <b>Permanent heel grounder</b> with snaps for contact stripes, clip closure |
| 2560.893.R.red  | <b>Permanent heel grounder</b> with snaps for contact stripes, clip closure |



## Contact strips



- replacement contact strips ESD
- textile and carbon
- snap 10 mm

In compliance with the ESD standard DIN EN 61340-5-1 ⚠️

**dpvlink 5863**

| Article        | Type  |
|----------------|---|
| 2560.893.R.050 | <b>Contact stripes VPE = 50 pieces</b><br>Length 50 cm  |
| 2560.893.R.100 | <b>Contact stripes VPE = 25 pieces</b><br>Length 100 cm |



## Permanent heel grounder with velcro fastener



Permanent heel strap for men and women with velcro fastener. Usable for outdoor shoes with flat heel. 1 MOhm safety resistance. ⚠️



**dpvlink 104**

| Article  | Closure  | Color      |
|----------|--|------------|
| 2560.890 | <b>Permanent heel grounder with velcro fastener</b><br>velcro fastener | red / blue |



## Permanent heel grounder D-ring



Permanent heel grounder, D-ring with velcro fastener and large contact surface in the heel area; 1 MOhm safety resistance. ⚠️



**dpvlink 12945**

| Article      | Closure  | Color       |
|--------------|--|-------------|
| 2560.890.HGS | <b>Permanent heel grounder D-ring</b><br>velcro fastener | red / black |



## Permanent heel grounder with clip closure



Permanent heel strap for men and women with clip closure, usable for outdoor shoes with flat heel. 1 MOhm/1.5 MOhm safety resistance. ⚠️



**dpvlink 13877**

| Article  | Closure      | Color          |
|--|--------------|----------------|
| <b>Permanent heel grounder with clip closure</b> |              |                |
| 2560.890.2                                       | Clip closure | blue / black   |
| 2560.890.2R                                      | Clip closure | red / black    |
| 2560.890.3G                                      | Clip closure | yellow / black |
| 2560.890.3G-90                                   | Clip closure | yellow / black |



## Women's permanent toe grounder



Permanent toe grounder for outdoor shoes with high heel. 1 MOhm / 1.5 MOhm safety resistance. ⚠️



**dpvlink 107**

| Article                               | Closure         | Color          |
|---------------------------------------|-----------------|----------------|
| <b>Women's permanent toe grounder</b> |                 |                |
| 2560.891                              | Standard        | black / grey   |
| 2560.891.2R                           | velcro fastener | red            |
| 2560.891.3G                           | Clip closure    | black / yellow |



## Permanent sole grounder women / men



Permanent sole grounder with velcro fastener and large contact surface in heel and ball area.

1 MOhm safety resistance. ⚠️



**dpvlink 19027**

| Article                                    | Type                  | Size  |
|--|-----------------------|-------|
| <b>Permanent sole grounder women / men</b> |                       |       |
| 2560.SG1.S                                 | Size S - small        | 34-37 |
| 2560.SG1.M                                 | Size M - medium       | 38-41 |
| 2560.SG1.L                                 | Size L - large        | 42-45 |
| 2560.SG1.XL                                | Size XL - extra large | 46-50 |



## Mobile dispenser for overshoes CANMAT S-50 and S-100

The mobile dispensers for overshoes CANMAT S-50 and S-100 were developed especially for visitors of ESD protected zones and cleanroom areas. There is no more troublesome bending down - long waiting periods of visitor groups can thus be avoided. Both CANMAT dispensers can be placed quickly and easily, everywhere.



CANMAT S-100



CANMAT S-50

- Ideal for large groups
- Easy filling
- Visible filling level
- High capacity
- Quick and easy handling



### Handling:

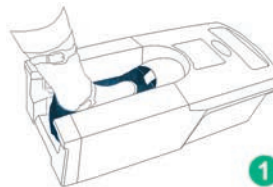

1

Put your foot on the metal plate of the CANMAT S-50 / S-100.

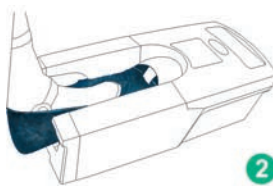

2

Draw your foot back while an overshoe is being fitted on over your shoe.

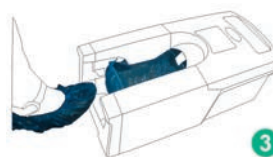

3

Draw your foot back until the clips have released and the overshoe has been completely put over your shoe. Then put the black grounding strap of the overshoe into your shoe - ready!

Overshoes for CANMAT **S-50 and S-100** - see article number 2560.860.S110

PU/Magazine = 80 pieces, only complete PUs available

In compliance with ESD standard DIN EN 61340-5-1 

[dpvlink 14716](#)



| Article       | Type  |
|---------------|---|
| 2560.860.S050 | <b>Mobile Dispenser CANMAT S-50</b><br>Capacity: 100 pieces<br>Dimensions: 690 x 320 x 230mm (LxWxH)<br>Weight: 8.6 kg  |
| 2560.860.S100 | <b>Mobile Dispenser CANMAT S-100</b><br>Capacity: 200 pieces<br>Dimensions: 740 x 310 x 900 mm (LxWxH)<br>Weight: 18 kg |

## Disposable overshoes ESD for CANMAT S-50 and S-100



Disposable overshoes ESD with contact strap

- for CANMAT S-50 or CANMAT S-100
- **slip- and water-resistant**
- white
- one size fits all 35-48
- PU magazine = 80 pieces



In compliance with the ESD standard DIN EN 61340-5-1 

[dpvlink 23857](#)



| Article       | Type   |
|---------------|--|
| 2560.860.S110 | Disposable overshoes ESD for CANMAT S-50 and S-100 |

**Further overshoes, also as non-ESD version, available on request.**

## Disposable overshoes



- Disposable overshoe for outdoor shoes
- with contact strap
- Eco 300 PU = 120 pieces / bag (60 pairs)
- Premium 400 PU = 100 pieces / bag (50 pairs)

In compliance with ESD standard DIN EN 61340-5-1



### dpvlink 118

| Article       | Type        | Size  | Color      |
|---------------|-------------|-------|------------|
| 2560.830.1.60 | Eco 300     | 35-48 | light blue |
| 2560.835.1.50 | Premium 400 | 35-47 | light blue |



## Reusable overshoe type PCR-125

- Reusable overshoe for outdoor shoes
- outsole made of conductive rubber material
- **anti-slip profile**
- contact strap with conductive carbon coating (exchangeable)
- PU = 1 pair

In compliance with ESD standard DIN EN 61340-5-1



### dpvlink 21219

| Article       | Type                                  | Size  | Color |
|---------------|---------------------------------------|-------|-------|
| 2760.PCR125.1 | Reusable overshoe type PCR-125 size 1 | 35-39 | white |
| 2760.PCR125.2 | Reusable overshoe type PCR-125 size 2 | 40-43 | white |
| 2760.PCR125.3 | Reusable overshoe type PCR-125 size 3 | 44-48 | white |



## Replaceable contact strap for reusable overshoes type PB 120 and type PCR-125

### dpvlink 8290

| Article       | Type                                     |
|---------------|--|
| 2760.PB120.40 | Replaceable contact strap PU= 100 pieces |



## Overshoes



- Cleanroom overshoe
- ankle-high
- elastic band
- upper integrity 1750 antibacterial
- synthetic leather outsole

In compliance with the ESD standard DIN EN 61340-5-1



### dpvlink 10145

| Article         | Type             | Size  | Color      |
|-----------------|------------------|-------|------------|
| 1000.3900.36-37 | Overshoes size 1 | 36-37 | white      |
| 1000.3900.38-39 | Overshoes size 2 | 38-39 | white      |
| 1000.3900.40-43 | Overshoes size 3 | 40-43 | white      |
| 1000.3900.44-46 | Overshoes size 4 | 44-46 | white      |
| 1000.3900.47-48 | Overshoes size 5 | 47-48 | white      |
| 1000.3910.36-37 | Overshoes size 1 | 36-37 | light blue |
| 1000.3910.38-39 | Overshoes size 2 | 38-39 | light blue |
| 1000.3910.40-43 | Overshoes size 3 | 40-43 | light blue |
| 1000.3910.44-46 | Overshoes size 4 | 44-46 | light blue |
| 1000.3910.47-48 | Overshoes size 5 | 47-48 | light blue |



## Reusable overshoe Type PB-120

- Reusable overshoe for outdoor shoes
- upper material of 98% polyester and 2% conductive yard
- outsole made of conductive rubber material
- contact strap with conductive carbon coating (exchangeable)
- PU = 5 pairs/bag

In compliance with ESD standard DIN EN 61340-5-1



### dpvlink 8286

| Article      | Type                                 | Size  | Color |
|--------------|--------------------------------------|-------|-------|
| 2760.PB120.1 | Reusable overshoe type PB-120 size 1 | 35-39 | white |
| 2760.PB120.2 | Reusable overshoe Type PB-120 size 2 | 40-43 | white |
| 2760.PB120.3 | Reusable overshoe Type PB-120 size 3 | 44-48 | white |



### Overshoes



- Grounding system for outdoor shoes
- upper polyamide
- washable by hand up to 30°C
- synthetic rubber outsole
- conductive contact strap with internal snap

In compliance with ESD standard DIN EN 61340-5-1 



**dpvlink 113**

| Article  | Type      | Size  | Color |
|----------|-----------|-------|-------|
| 2560.801 | Overshoes | 36-42 | white |
| 2560.802 | Overshoes | 42-48 | white |



### Contact strips



- replacement contact strips ESD
- textile and carbon
- snap 10 mm

In compliance with the ESD standard DIN EN 61340-5-1 

**dpvlink 5863**

| Article        | Type   |
|----------------|--|
| 2560.893.R.050 | <b>Contact strips VPE = 50 pieces</b><br>Length 50 cm  |
| 2560.893.R.100 | <b>Contact strips VPE = 25 pieces</b><br>Length 100 cm |



# ESD

### Sole cleaning

### Tacky mats

In controlled ESD areas and cleanrooms, the use of **tacky mats** or **adhesive mats** has proven its worth as an ideal tool for cleaning shoe soles and cart wheels. Whether they are used in the semiconductor, pharmaceutical or also in electronic industries, adhesive mats are an **useful barrier against dust**.



You have the choice between disposable peel-off mats or permanently tacky mats. Both types have such an **adhesive force** that only dust and other particles stick on the mat.

### Tacky mats permanent



Permanently tacky mat; cleanable only with warm water, mat regains its adhesive properties after drying.

**dpvlink 442**

| Article    | W [mm] | L [mm] | Thickness [mm] |
|------------|--------|--------|----------------|
| 1000.105.3 | 1200   | 600    | 3              |
| 1000.106.3 | 1000   | 1000   | 3              |
| 1000.105.5 | 1200   | 600    | 6              |
| 1000.106.5 | 1000   | 1000   | 6              |



### Foil tacky mats 30 layers

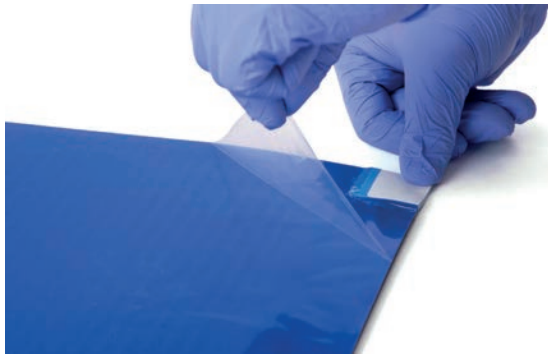

Foil tacky mats with high adhesive force, 30 layers, in case of decreasing adhesive force, just remove the dirty foil, the new foil is immediately ready for use.  
PU = 1 carton = 4 mats

**dpvlink 437**

| Article         | W [mm] | L [mm] | Color               |
|-----------------|--------|--------|---------------------|
| 1000.030.1      | 1140   | 460    | white / transparent |
| 1000.030.3      | 1140   | 610    | white / transparent |
| 1000.030.1.blau | 1140   | 460    | blue                |
| 1000.030.3.blau | 1140   | 610    | blue                |



### Accessories for foil tacky mats

**NEU**



#### Frame for mat size 1140 x 610 mm

- rubber frame to edge foil tacky mats
- sloping edges
- cut-out inner part
- easy insertion of the mats
- ideal for sliding
- height 2 to 5 mm
- edge width 70 mm
- color dark grey

**dpvlink 23849**

| Article      | Accessories for foil tacky mats      |
|--------------|--------------------------------------|
| 1000.030.3.R | Frame for foil stacky mat 1000.030.3 |



### Industrial sole cleaner

#### SOLAMAT 90

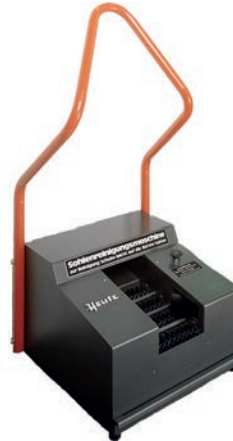

Four counter-rotating wheel brushes clean the soles from underneath. Two lateral disk brushes clean the edges of the soles. The brushed-off dirt falls into a large drawer at the bottom of the device. This drawer can be removed and cleaned easily.

#### Technical data:

|                         |  |
|-------------------------|--|
| Drive:                  | round belt drive                                     |
| Colors:                 | Standard agate grey RAL 7038 / ESD graphite RAL 7022 |
| Dimensions (W x D x H): | 460 x 560 x 1140 mm                                  |
| Brushes:                | 4 nylon wheel brushes ESD / 2 nylon disk brushes     |
| Weight:                 | 43 kg  |
| Aperture priority:      | 1 min  |
| Power supply:           | 230 V (optionally 110 V)                             |

**dpvlink 7737**

| Article      | Type                  |
|--------------|-----------------------|
| 2599.090.ESD | <b>SOLAMAT 90 ESD</b> |



#### SOLAMAT 100/ 200



Four wheel brushes clean the soles, while the two lateral disk brushes clean the edges of the shoes. The uppers are cleaned by a third brush. The brushed-off dirt falls into a large drawer that can be cleaned easily. A round belt drive ensures a powerful brushing while running smoothly at the same time.

#### SOLAMAT 200:

Like the SOLAMAT 100 it is equipped with an additional exhaust and filtering system placed inside the upper part of the case. Dust and aerosols are sucked into the upper part by means of under-inflation and they are collected by a filter. Cleaned air exits via a grid at the rear side of the case.

#### Technical data:

|                         |  |
|-------------------------|--|
| Colors:                 | Standard agate-grey RAL 7038 / ESD graphite RAL 7022   |
| Dimensions (W x D x H): | 460 x 600 x 1100 mm  |
| Brushes:                | 4 nylon wheel brushes ESD / 2 nylon disk brushes / 1 horsehair top brush   |
| Weight:                 | 65 kg  |
| Power supply:           | 50 Hz, 0,18KW, 230 V, 1.6A, IP 54<br>(Option 110 V - without additional charge)<br>650 U/min (for brush gear, placed underneath) |

**dpvlink 15587**

| Article      | Type                   |
|--------------|------------------------|
| 2599.100.ESD | <b>SOLAMAT 100 ESD</b> |
| 2599.200.ESD | <b>SOLAMAT 200 ESD</b> |





Work coat EPAwear®

**EPAwear® work coats - highest quality for optimal ESD protection in electronics manufacturing**

EPAwear® work coats of the WhiteLine plus, GreyLine plus and BlueLine plus series have specially been designed for the requirements in electronics manufacturing



- ESD safety according to DIN EN 61340-5-1
- high-quality processing
- double seams for stability and continuous conductivity
- covered snap fastener
- conductive mixed cotton fabric 150 g/m<sup>2</sup> (67% polyester, 31% cotton, 2% conductive yarn)
- fabrics fulfill Öko-Tex 100 Standard

- very comfortable to wear
- breathable and lightweight
- hard-wearing and durable
- easy-care and crease-free
- machine washable up to 60°C
- 3 models:
  - 3/4 design with long sleeves, 1/2 design with long sleeves, 1/2 design with short sleeves



**Inscription according to your wishes**

- patched logo
- embroidered logo
- direct embroidery
- direct printing



**Quality is important to us!**

Made in Europe - we attach importance to high quality of manufacture and use high-quality fabrics. The used fabrics have been tested over many years and ensure optimal characteristics even after frequent washing. They are machine washable up to 60°C, colorfast, easy to care and crease-resistant. Double seams ensure longer life and

continuous conductivity even after prolonged used. The used materials comply with the Öko-Tex 100 standard.

Further information is available under **dpvlink 8567**



**dpvlink** - Produkte schnell finden!

www.dpv-elektronik.eu

z.B.: **dpvlink 21010** → **dpvlink 21010**

Work coat WhiteLine plus

Work coat WhiteLine plus WL-185



- very comfortable to wear
- hard-wearing and durable
- breathable and lightweight
- optimal ESD protection

The unisex work coat WhiteLine plus 185 is available in 3 designs:



3/4 design, long sleeves



1/2 design, long sleeves



1/2 design, short sleeves



All models with 2 side pockets, breast pocket with woven ESD symbol, white pocket piping, lapel collar and continuously covered snap fastener.

Mixed fabric, weight 150 g/m<sup>2</sup>  
67% polyester, 31% cotton and 2% conductive yarn  
Machine washable up to 60°C

In compliance with ESD standard DIN EN 61340-5-1

Available sizes: XS, S, M, L, XL, XXL, 3XL, 4XL

dpvlink 23765

| Article                                | Type       | Sleeve length | Size   |
|--|------------|---------------|--------|
| <b>Work coat WhiteLine plus WL-185</b> |            |               |        |
| 2710.WL185-P                           | 3/4 design | long sleeves  | XS-4XL |
| 2711.WL185-P                           | 1/2 design | long sleeves  | XS-4XL |
| 2712.WL185-P                           | 1/2 design | short sleeves | XS-4XL |



Work coat WhiteLine plus WL-180



- very comfortable to wear
- hard-wearing and durable
- breathable and lightweight
- optimal ESD protection

The unisex work coat WhiteLine plus 180 is available in 3 designs:



3/4 design, long sleeves



1/2 design, long sleeves



1/2 design, short sleeves



All models with 2 side pockets, breast pocket with woven ESD symbol, dark blue pocket piping, lapel collar and continuously covered snap fastener.

Mixed fabric, weight 150 g/m<sup>2</sup>  
67% polyester, 31% cotton and 2% conductive yarn  
Machine washable up to 60°C

In compliance with ESD standard DIN EN 61340-5-1

Available sizes: XS, S, M, L, XL, XXL, 3XL, 4XL

dpvlink 23771

| Article                                | Type       | Sleeve length | Size   |
|--|------------|---------------|--------|
| <b>Work coat WhiteLine plus WL-180</b> |            |               |        |
| 2710.WL180-P                           | 3/4 design | long sleeves  | XS-4XL |
| 2711.WL180-P                           | 1/2 design | long sleeves  | XS-4XL |
| 2712.WL180-P                           | 1/2 design | short sleeves | XS-4XL |



### Work coat WhiteLine plus WL-181



- very comfortable to wear
- hard-wearing and durable
- breathable and lightweight
- optimal ESD protection

The unisex work coat WhiteLine plus 181 is available in 3 designs:

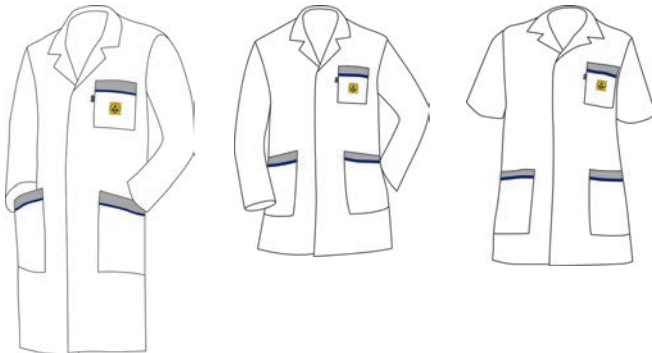

3/4 design, long sleeves

1/2 design, long sleeves

1/2 design, short sleeves



All models with 2 side pockets, breast pocket with woven ESD symbol, dark blue pocket piping, grey edging, lapel collar and continuously covered snap fastener.

Mixed fabric, weight 150 g/m<sup>2</sup>  
67% polyester, 31% cotton and 2% conductive yarn  
Machine washable up to 60°C

In compliance with ESD standard DIN EN 61340-5-1 

Available sizes: XS, S, M, L, XL, XXL, 3XL, 4XL

**dpvlink 23772**

| Article                                | Type       | Sleeve length | Size   |
|--|------------|---------------|--------|
| <b>Work coat WhiteLine plus WL-181</b> |            |               |        |
| 2710.WL181-P                           | 3/4 design | long sleeves  | XS-3XL |
| 2711.WL181-P                           | 1/2 design | long sleeves  | XS-4XL |
| 2712.WL181-P                           | 1/2 design | short sleeves | XS-4XL |



### Work coat WhiteLine plus WL-182



- very comfortable to wear
- hard-wearing and durable
- breathable and lightweight
- optimal ESD protection

The unisex work coat WhiteLine plus 182 is available in 3 designs:

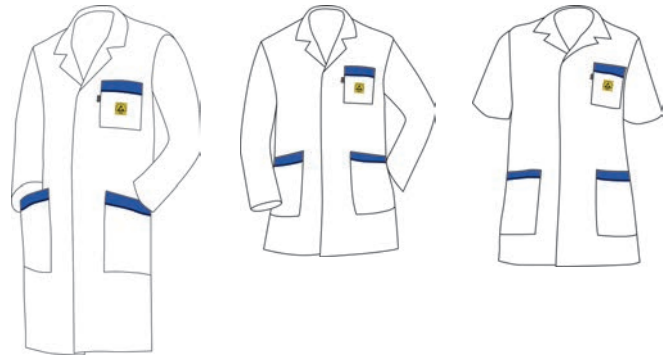

3/4 design, long sleeves

1/2 design, long sleeves

1/2 design, short sleeves



All models with 2 side pockets, breast pocket with woven ESD symbol, dark blue pocket piping, blue edging, lapel collar and continuously covered snap fastener.

Mixed fabric, weight 150 g/m<sup>2</sup>  
67% polyester, 31% cotton and 2% conductive yarn  
Machine washable up to 60°C

In compliance with ESD standard DIN EN 61340-5-1 

Available sizes: XS, S, M, L, XL, XXL, 3XL, 4XL

**dpvlink 23773**

| Article                                | Type       | Sleeve length | Size   |
|--|------------|---------------|--------|
| <b>Work coat WhiteLine plus WL-182</b> |            |               |        |
| 2710.WL182-P                           | 3/4 design | long sleeves  | XS-3XL |
| 2711.WL182-P                           | 1/2 design | long sleeves  | XS-4XL |
| 2712.WL182-P                           | 1/2 design | short sleeves | XS-4XL |



Work coat WhiteLine plus Woman

Work coat WhiteLine plus Woman  
WLW-175



The WhiteLine women's coat always makes you look good by its figure-hugging cut; for a perfect wearing comfort due to a high-quality finish and maximum mobility.

- very comfortable to wear
- hard-wearing and durable
- breathable and lightweight
- optimal ESD protection

The women's work coat WhiteLine plus Woman 175 is available in 3 designs:

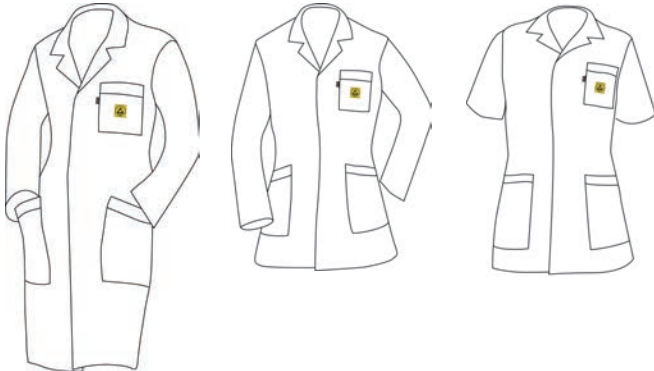

3/4 design, long sleeves

1/2 design, long sleeves

1/2 design, short sleeves

All models with 2 side pockets, breast pocket with woven ESD symbol, white pocket piping, lapel collar and continuously covered snap fastener.



Mixed fabric, weight 150 g/m<sup>2</sup>  
67% polyester, 31% cotton and 2% conductive yarn  
Machine washable up to 60°C

In compliance with ESD standard DIN EN 61340-5-1

Available sizes: XS, S, M, L, XL, XXL, 3XL

dpmlink 24196



| Article                                       | Type       | Sleeve length | Size   |
|---|------------|---------------|--------|
| <b>Work coat WhiteLine plus Woman WLW-175</b> |            |               |        |
| 2710.WLW175-P                                 | 3/4 design | long sleeves  | XS-3XL |
| 2711.WLW175-P                                 | 1/2 design | long sleeves  | XS-3XL |
| 2712.WLW175-P                                 | 1/2 design | short sleeves | XS-3XL |

Work coat GreyLine plus

Work coat GreyLine plus GL-185



- very comfortable to wear
- hard-wearing and durable
- breathable and lightweight
- optimal ESD protection

The unisex work coat GreyLine plus 185 is available in 3 designs:

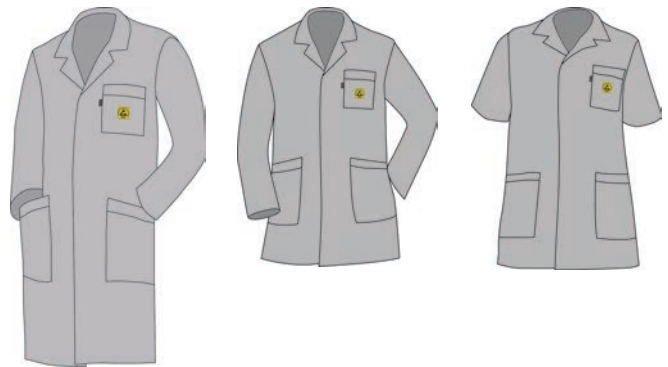

3/4 design, long sleeves

1/2 design, long sleeves

1/2 design, short sleeves



All models with 2 side pockets, breast pocket with woven ESD symbol, grey pocket piping, lapel collar and continuously covered snap fastener.

Mixed fabric, weight 150 g/m<sup>2</sup>  
67% polyester, 31% cotton and 2% conductive yarn  
Machine washable up to 60°C

In compliance with ESD standard DIN EN 61340-5-1

Available sizes: XS, S, M, L, XL, XXL, 3XL, 4XL

dpmlink 24833



| Article                               | Type       | Sleeve length | Size   |
|---------------------------------------|------------|---------------|--------|
| <b>Work coat GreyLine plus GL-185</b> |            |               |        |
| 2720.GL185-P                          | 3/4 design | long sleeves  | XS-4XL |
| 2721.GL185-P                          | 1/2 design | long sleeves  | XS-4XL |
| 2722.GL185-P                          | 1/2 design | short sleeves | XS-4XL |

Work coat GreyLine plus GL-180



- very comfortable to wear
- hard-wearing and durable
- breathable and lightweight
- optimal ESD protection

The unisex work coat GreyLine plus 180 is available in 3 designs:

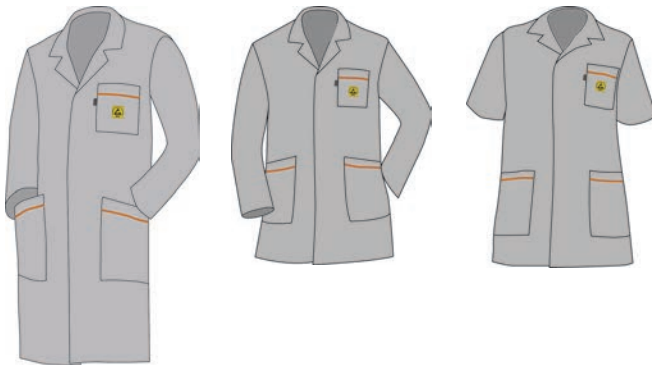

3/4 design, long sleeves

1/2 design, long sleeves

1/2 design, short sleeves



All models with 2 side pockets, breast pocket with woven ESD symbol, orange pocket piping, lapel collar and continuously covered snap fastener.

Mixed fabric, weight 150 g/m<sup>2</sup>  
67% polyester, 31% cotton and 3% conductive yarn  
Machine washable up to 60°C

In compliance with ESD standard DIN EN 61340-5-1 

Available sizes: XS, S, M, L, XL, XXL, 3XL, 4XL

**dpvlink 24834**

| Article                               | Type       | Sleeve length | Size   |
|---------------------------------------|------------|---------------|--------|
| <b>Work coat GreyLine plus GL-180</b> |            |               |        |
| 2720.GL180-P                          | 3/4 design | long sleeves  | XS-3XL |
| 2721.GL180-P                          | 1/2 design | long sleeves  | XS-3XL |
| 2722.GL180-P                          | 1/2 design | short sleeves | S-3XL  |



Work coat GreyLine plus GL-186



- very comfortable to wear
- hard-wearing and durable
- breathable and lightweight
- optimal ESD protection

The unisex work coat GreyLine plus 186 is available in 3 designs:

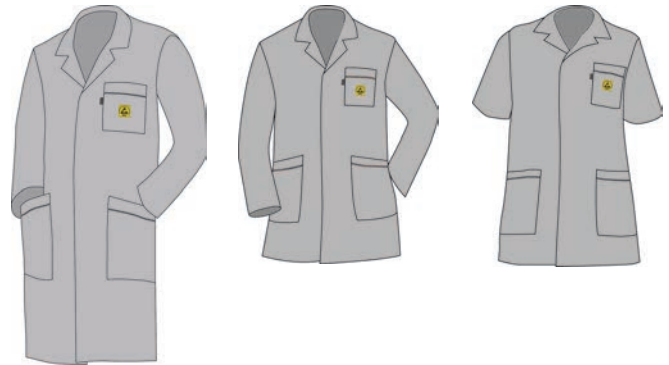

3/4 design, long sleeves

1/2 design, long sleeves

1/2 design, short sleeves



All models with 2 side pockets, breast pocket with woven ESD symbol, dark grey pocket piping, lapel collar and continuously covered snap fastener.

Mixed fabric, weight 150 g/m<sup>2</sup>  
67% polyester, 31% cotton and 3% conductive yarn  
Machine washable up to 60°C

In compliance with ESD standard DIN EN 61340-5-1 

Available sizes: XS, S, M, L, XL, XXL, 3XL

**dpvlink 24836**

| Article                               | Type       | Sleeve length | Size   |
|---------------------------------------|------------|---------------|--------|
| <b>Work coat GreyLine plus GL-186</b> |            |               |        |
| 2720.GL186-P                          | 3/4 design | long sleeves  | XS-3XL |
| 2721.GL186-P                          | 1/2 design | long sleeves  | XS-3XL |
| 2722.GL186-P                          | 1/2 design | short sleeves | XS-3XL |



Work coat BlueLine plus

Work coat BlueLine plus BL-180



- very comfortable to wear
- hard-wearing and durable
- breathable and lightweight
- optimal ESD protection

The unisex work coat BlueLine plus 180 is available in 3 designs:



3/4 design, long sleeves



1/2 design, long sleeves



1/2 design, short sleeves



All models with 2 side pockets, breast pocket with woven ESD symbol, dark blue pocket piping, lapel collar and continuously covered snap fastener.

Mixed fabric, weight 150 g/m<sup>2</sup>  
67% polyester, 31% cotton and 3% conductive yarn  
Machine washable up to 60°C

In compliance with ESD standard DIN EN 61340-5-1

Available sizes: XS, S, M, L, XL, XXL, 3XL, 4XL

dpwink 24837

| Article                               | Type       | Sleeve length | Size   |
|---------------------------------------|------------|---------------|--------|
| <b>Work coat BlueLine plus BL-180</b> |            |               |        |
| 2730.BL180-P                          | 3/4 design | long sleeves  | XS-4XL |
| 2731.BL180-P                          | 1/2 design | long sleeves  | XS-4XL |
| 2732.BL180-P                          | 1/2 design | short sleeves | XS-4XL |



DPV Quality label

The dissipative work coats of the WhiteLine plus, GreyLine plus and BlueLine plus collections offer a reliable protection against electrostatic charge according to DIN EN 61340-5-1: 2008-07 and are comfortable to wear. The high-quality, breathable and specially finished mixed fabric consists of 67% polyester, 31% cotton and 2% conductive yarn. Machine washable up to 60°C.



Safety and quality

The DPV label guarantees highest safety and quality. The fabrics are manufactured in Europe and processed only in Germany. The dissipative EPAwear® work coats offer a reliable protection against electrostatic charge according to DIN EN 61340-5-1: 2008-07. A prudent warehousing and foresighted purchase allow us to offer high-quality products at fair prices. Top conditions for high standard!

Fabric quality and processing

Even after frequent washing, the clothes retain their original shape, are tear-resistant and dissipative. The clothes are sewn with conductive yarn. The formation of knots is avoided. Even in case of a constant use a long durability of the material is possible.

Wearing properties

The proportion of cotton offers a particularly pleasant wearing comfort, the polyester makes the clothes largely wrinkle-resistant. The conductive yarn prevents static charges of the clothing.

Oeko-Tex standard 100 class III.

The materials are tested by means of internationally binding catalogs according to Eco-Tex® 100. This is based on scientific parameters, and is updated to the current state of the legislation and scientific research annually.

The criteria in details are:

- legally prohibited substances such as carcinogenic dyes
- legally regulated substances such as formaldehyde, softeners, heavy metals or pentachlorophenol
- still legally regulated or prohibited substances that, according to the latest knowledge, are however harmful to health, such as pesticides, allergenic dyes or organic tin compounds
- parameters such as color fastness and a skin-friendly pH value that help the health care of the consumer

Further information can be found on [www.oeko-tex.com](http://www.oeko-tex.com)

Work coat GreyLine

Work coat GreyLine GL-180



The women's and men's coat GreyLine 180 is available in 3 designs:



3/4 design, long sleeves

1/2 design, long sleeves

1/2 design, short sleeves

All models with 2 side pockets, breast pocket with woven ESD symbol, orange pocket piping, lapel collar and continuously covered snap fastener.



Mixed fabric (weight 180 g / m<sup>2</sup>):  
65% polyester, 32% cotton and 3% conductive yarn  
Machine washable up to 60°C

In compliance with the ESD standard DIN EN 61340-5-1 

Available sizes: XS, S, M, L, XL, XXL, 3XL

**dpvlink 8365**

| Article                          | Type       | Sleeve length | Size   |
|----------------------------------|------------|---------------|--------|
| <b>Work coat GreyLine GL-180</b> |            |               |        |
| 2720.GL180                       | 3/4 design | long sleeves  | XS-3XL |
| 2721.GL180                       | 1/2 design | long sleeves  | XS-3XL |
| 2722.GL180                       | 1/2 design | short sleeves | S-3XL  |



Work coat GreyLine GL-181



The women's and men's coat GreyLine 181 is available in 3 designs:

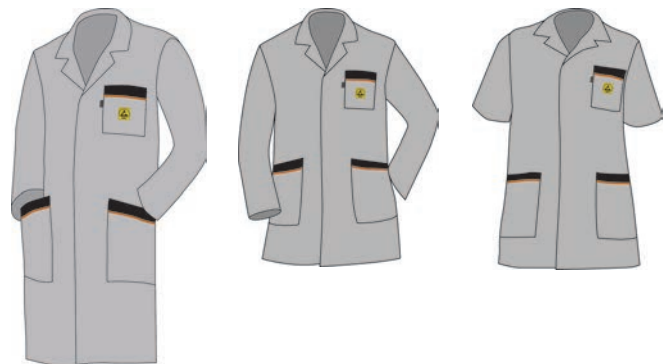

3/4 design, long sleeves

1/2 design, long sleeves

1/2 design, short sleeves

All versions with 2 side pockets, breast pocket with woven ESD symbol, orange pocket piping, black edging, lapel collar and continuously covered snap fastener.



Mixed fabric (weight 180 g/m<sup>2</sup>):  
65% polyester, 32% cotton and 3% conductive yarn  
Machine washable up to 60°C

In compliance with the ESD standard DIN EN 61340-5-1 

Available sizes: XS, S, M, L, XL, XXL, 3XL

**dpvlink 8366**

| Article                          | Type       | Sleeve length | Size   |
|----------------------------------|------------|---------------|--------|
| <b>Work coat GreyLine GL-181</b> |            |               |        |
| 2720.GL181                       | 3/4 design | long sleeves  | XS-3XL |
| 2721.GL181                       | 1/2 design | long sleeves  | XS-3XL |
| 2722.GL181                       | 1/2 design | short sleeves | S-3XL  |



Work coat BlueLine

Work coat BlueLine BL 180



The women's and men's coat BlueLine 180 is available in 3 designs:



3/4 design, long sleeves

1/2 design, long sleeves

1/2 design, short sleeves

All models with 2 side pockets, breast pocket with woven ESD symbol, dark blue pocket piping, lapel collar and continuously covered snap fastener.



Mixed fabric (weight 180 g/m<sup>2</sup>):  
65% polyester, 32% cotton and 3% conductive yarn  
Machine washable up to 60°C

In compliance with the ESD standard DIN EN 61340-5-1 ⚠

Available sizes: XS, S, M, L, XL, XXL, 3XL, 4XL

| Article                          | Type       | Sleeve length | Size   |
|----------------------------------|------------|---------------|--------|
| <b>Work coat BlueLine BL 180</b> |            |               |        |
| 2730.BL180                       | 3/4 design | long sleeves  | XS-4XL |
| 2731.BL180                       | 1/2 design | long sleeves  | S-4XL  |
| 2732.BL180                       | 1/2 design | short sleeves | XS-4XL |

Work coat BlueLine BL-181



The women's and men's coat BlueLine 181 is available in 3 designs:



3/4 design, long sleeves

1/2 design, long sleeves

1/2 design, short sleeves

All models with 2 side pockets, breast pocket with woven ESD symbol, orange pocket piping, lapel collar and continuously covered snap fastener.



Mixed fabric (weight 180g/ m<sup>2</sup>):  
65% polyester, 32% cotton and 3% conductive yarn  
Machine washable up to 60°C

In compliance with the ESD standard DIN EN 61340-5-1 ⚠

Available sizes: XS, S, M, L, XL, XXL, 3XL

| Article                          | Type       | Sleeve length | Size   |
|----------------------------------|------------|---------------|--------|
| <b>Work coat BlueLine BL-181</b> |            |               |        |
| 2730.BL181                       | 3/4 design | long sleeves  | XS-3XL |
| 2731.BL181                       | 1/2 design | long sleeves  | S-3XL  |
| 2732.BL181                       | 1/2 design | short sleeves | S-3XL  |



Work coat BlueLine BL-182



The women's and men's coat BlueLine 182 is available in 3 designs:



3/4 design, long sleeves

1/2 design, long sleeves

1/2 design, short sleeves

All models with 2 side pockets, breast pocket with woven ESD symbol, dark blue pocket piping, grey edging, lapel collar and continuously covered snap fastener.



Mixed fabric (weight 180 g/m<sup>2</sup>):  
65% polyester, 32% cotton and 3% conductive yarn  
Machine washable up to 60°C

In compliance with the ESD standard DIN EN 61340-5-1 

Available sizes: XS, S, M, L, XL, XXL, 3XL

**dpvlink 8385**

| Article                          | Type       | Sleeve length | Size   |
|----------------------------------|------------|---------------|--------|
| <b>Work coat BlueLine BL-182</b> |            |               |        |
| 2730.BL182                       | 3/4 design | long sleeves  | XS-3XL |
| 2731.BL182                       | 1/2 design | long sleeves  | S-3XL  |
| 2732.BL182                       | 1/2 design | short sleeves | S-3XL  |



Work coat BlueLineWoman BLW 175



The figure-hugging women's work coat BlueLine Woman 175 is available in 3 designs:



3/4 design, long sleeves

1/2 design, long sleeves

1/2 design, short sleeves

All models with 2 side pockets, breast pocket with woven ESD symbol, dark blue pocket piping, lapel collar and continuously covered snap fastener.

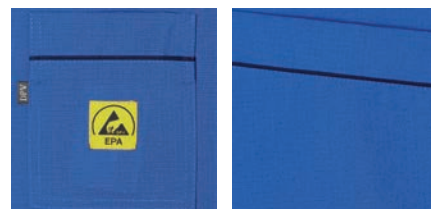

Mixed fabric (weight 180 g/m<sup>2</sup>):  
65% Polyester, 32% cotton and 3% conductive yarn  
Machine washable up to 60°C

In compliance with the ESD standard DIN EN 61340-5-1 

Available sizes: XS, S, M, L, XL, XXL, 3XL

**dpvlink 13059**

| Article                                | Type       | Sleeve length | Size   |
|--|------------|---------------|--------|
| <b>Work coat BlueLineWoman BLW 175</b> |            |               |        |
| 2730.BLW175                            | 3/4 design | long sleeves  | XS-3XL |
| 2731.BLW175                            | 1/2 design | long sleeves  | XS-3XL |
| 2732.BLW175                            | 1/2 design | short sleeves | XS-4XL |



Work coat MyLine

Work coat MyLine



You haven't found your coat in the desired color combination yet? In this case, the MyLine collection offers you the opportunity to give the clothes your personal touch. The three colors of the collections WhiteLine, GreyLine and BlueLine can be combined with a colored piping selectable from the color palette below.

The coats are also available in three different versions:

- 3/4 design, long sleeves
- 1/2 design, long sleeves
- 1/2 design, short sleeves

The high-quality, breathable and specially treated mixed fabric consists of 65% polyester, 32% cotton and 3% conductive Resistat® fibers. Machine washable up to 60°C. Weight 180 g/m<sup>2</sup>.

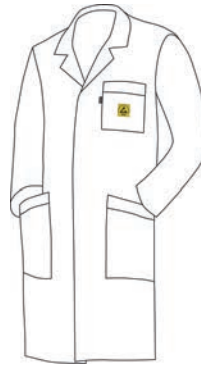

3/4 design, long sleeves



1/2 design, long sleeves



1/2 design, short sleeves

Standard color code for the piping

When ordering, please specify like this: *Example:* 2721.MyLine.K711.S



- Weitere Biesenfarben auf Anfrage -

dpvlink 13034



| Article                 | Type       | Sleeve length | Color | Size   |
|-------------------------|------------|---------------|-------|--------|
| <b>Work coat MyLine</b> |            |               |       |        |
| 2710.MyLine             | 3/4 design | long sleeves  | white | XS-3XL |
| 2711.MyLine             | 1/2 design | long sleeves  | white | XS-3XL |
| 2712.MyLine             | 1/2 design | short sleeves | white | XS-3XL |
| 2720.MyLine             | 3/4 design | long sleeves  | grey  | XS-3XL |
| 2721.MyLine             | 1/2 design | long sleeves  | grey  | XS-3XL |
| 2722.MyLine             | 1/2 design | short sleeves | grey  | XS-3XL |
| 2730.MyLine             | 3/4 design | long sleeves  | blue  | XS-3XL |
| 2731.MyLine             | 1/2 design | long sleeves  | blue  | XS-3XL |
| 2732.MyLine             | 1/2 design | short sleeves | blue  | XS-3XL |

++ All MyLine work coats are custom-made products and therefore excluded from return. ++

## Company logos / Emblem service



We affix your company logo on all work clothes at a reasonable price.



- Patched logo**  
 By the efficient treatment patched logos are at present the most cost-effective way to affix advertising on your clothing. The adhesive layer creates a very high composite with the clothing.
- Embroidered logo**  
 Embroidered logos give the clothing an exclusive look, even in small quantities. They are suited for industrial cleaning, being washable up to 95°C.
- Direct embroidery**  
 Embroideries on clothes give the impression of exclusiveness. It is rather unsuitable for small quantities. Washable at 95°C it is suitable for industrial cleaning.
- Direct printing**  
 With the textile printing each color is printed by the respective screen directly on the textile and fixed afterwards while drying. This method is ideal for larger quantities of textiles, it is also characterized by a high resistance to washing and easier ironing.

Embroidered emblems or direct stitcheries are mainly used for simple logotypes. We recommend patched emblems for complex logos or images. Direct printing is recommended for larger quantities. For an individual offer we only need your company logo in a common graphics format (jpg, tif, eps, bmp,...) and, if possible, the color codes. Before each order you will obtain a galley proof of the logo.

Send us a template and we will submit you an offer.

## Embroidered label / patch with name



ca. 90 x 20 mm, stitched on a textile surface with edging, patch for cotton and mixed fabric. Color according to arrangement.

dpvlink 8567

Article



**Embroidered label / patch with name**

Embroidered label / patch with name

2691.5.Namen



## Personnel grounding test system EPApro®

The modern personnel grounding test system EPApro® combines a user-friendly hardware and a forward-looking software solution allowing for testing the ESD safety equipment and documenting the data in compliance with the standards. Interfaces and control outputs permit the integration into the existing infrastructure of your company.

### EPApro® ESD-Personnel-Tester 1000



The EPApro® ESD Personnel Tester 1000 allows testing the personal ESD protective equipment.

The results are documented in compliance with the standards and saved in a database.

dpvlink 21010



- quick measurement <2 seconds
- connectable via LAN/WLAN
- intuitive operation with a large TFT touch panel
- GDPR-compliant data storage
- Paperless documentation
- Integrated Multi-RFID reader
- Potential-free switch outputs for activating of access control systems
- Menu-guided calibration mode
- etc.

### EPApro® Control Server



Software solution for a central administration of measured data, devices and employees across locations.

It is not necessary to install client software. The interface can be operated from all devices by means of a web browser (PCs, notebooks, tablets, smartphones etc.)

dpvlink 21904



- simple import of employee master and data
- GDPR-compliant data storage
- REST-API interface for a data exchange with other programs
- Employee groups with access rights
- Networking across locations and central administration of several EPApro® 1000 devices
- Safe data storage in a SQL data base
- Direct and uncomplicated report function
- etc.

For further information is available under dpvlink 21010.

Work coat ECO-180

The conductive coat ECO-180 protects you against electrostatic charge and the top finish offers you a pleasant wearing comfort. The work coat consists of 68% polyester, 30% cotton and 2% carbon fiber. Machine washable up to 60°C.

In compliance with the ESD standard DIN EN 61340-5-1 

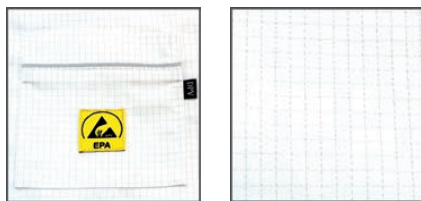

Work coat ECO-180



Short coat with long sleeves, **white**, with 2 lateral pockets, breast pocket with woven ESD warning symbol, light grey pocket piping (breast pocket), lapel collar and completely covered snap fastener.

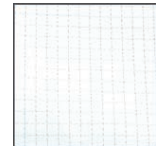

Short coat with long sleeves, **grey**, with 2 lateral pockets, breast pocket with woven ESD warning symbol, dark grey pocket piping (breast pocket), lapel collar and completely covered snap fastener.



Short coat with long sleeves, **light blue**, with 2 lateral pockets, breast pocket with woven ESD warning symbol, light grey pocket piping (breast pocket), lapel collar and completely covered snap fastener.



Material: 68% polyester, 30% cotton and 2% carbon fibers; 5 mm grid

In compliance with the ESD standard DIN EN 61340-5-1 

Available sizes: XS, S, M, L, XL, XXL, 3XL, 4XL, 5XL

**dpvlink 19660**

| Article     | Type       | Sleeve length | Color      | Size   |
|-------------|------------|---------------|------------|--------|
| 2701.ECO180 | 1/2 design | long sleeves  | white      | XS-5XL |
| 2702.ECO180 | 1/2 design | long sleeves  | grey       | XS-5XL |
| 2703.ECO180 | 1/2 design | long sleeves  | light blue | XS-5XL |



further designs on request

### Work coat AM-161 plus

The dissipative work coat AM-161 plus offers a reliable protection against electrostatic charge and is comfortable to wear. The high-quality, light (weight 160g/m<sup>2</sup>), breathable and specially finished mixed fabric consists of 63% polyester, 35% cotton and 2% conductive yarn. Machine washable up to 60°C.

Entspricht der ESD-Norm DIN EN 61340-5-1 



1/2 design, short sleeves



3/4 design, long sleeves



Our clothes have especially been developed for the requirements in electronics manufacturing. All products marked with this sign are tested and certified by the Sächsischen Textilforschungsinstitut e.V (stfi) according to EN 61340-5-1.

### Work coat AM-161 plus standard



Long sleeves, 3/4 design, with 2 side pockets, breast pocket with woven ESD symbol, continuously covered snap fastener.

In compliance with the ESD standard DIN EN 61340-5-1 

Available sizes: XS, S, M, L, XL, XXL, 3XL, 4XL, 5XL

**dpvlink 16344**



| Article                               | Color | Size   |
|---------------------------------------|-------|--------|
| <b>Work coat AM-161 plus standard</b> |       |        |
| 2610.AM161                            | white | XS-5XL |
| 2630.AM161                            | blue  | XS-5XL |

### Work coat AM-161 plus with short sleeves



Short sleeves, 1/2 design (short coat), with 2 side pockets, breast pocket with woven ESD symbol, continuously covered snap fastener. The model in white/blue has a collar and a breast pocket of contrasting blue.

In compliance with the ESD standard DIN EN 61340-5-1 

Available sizes: S, M, L, XL, XXL, 3XL, 4XL

**dpvlink 16348**



| Article   | Color        | Size  |
|---|--------------|-------|
| <b>Work coat AM-161 plus with short sleeves</b> |              |       |
| 2640.AM161-K                                    | white / blue | S-4XL |
| 2641.AM161-K                                    | white        | S-4XL |
| 2642.AM161-K                                    | blue         | S-4XL |

Work coat AM-140

The dissipative coat AM-140 offers a reliable protection against electrostatic charge and is comfortable to wear. The high-quality, light, breathable and specially finished mixed fabric consists of 63% polyester, 34% cotton and 3% conductive yarn. Machine washable up to 60°C. Weight 140 g/m<sup>2</sup>.



3/4 design, long sleeves



3/4 design, short sleeves

Work coat AM 140 with long sleeves



Long sleeves, 3/4 design with 2 side pockets, breast pocket with woven ESD symbol, continuously covered snap fastener.

In compliance with the ESD standard DIN EN 61340-5-1 

Available sizes: XS, S, M, L, XL, XXL, 3XL, 4XL

**dpvlink 5812**



| Article                                   | Color | Size   |
|---|-------|--------|
| <b>Work coat AM 140 with long sleeves</b> |       |        |
| 2610.AM140                                | white | XS-4XL |
| 2630.AM140                                | blue  | XS-4XL |

Work coat AM140-K short sleeves



Short sleeves, 3/4 design with 2 side pockets, breast pocket with woven ESD symbol, continuously covered snap fastener.

In compliance with the ESD standard DIN EN 61340-5-1 

Available sizes: XS, S, M, L, XL, XXL, 3XL

**dpvlink 1374**



| Article                                | Color | Size   |
|--|-------|--------|
| <b>Work coat AM140-K short sleeves</b> |       |        |
| 2610.AM140-K                           | white | XS-3XL |
| 2630.AM140-K                           | blue  | S-3XL  |

**Work coat AM-120**

The dissipative coat AM-120 offers a reliable protection against electrostatic charge and is comfortable to wear. The high-quality, very light polyester fabric is made of 98% polyester and 2% conductive yarn. Machine washable up to 40°C. Weight 120 g/m<sup>2</sup>.

**Work coat AM-120**



Long sleeves, 3/4 design with 2 side pockets, conductive 4 mm grid, polyester fabric (98% polyester, 2% carbonized yarn), breast pocket with woven ESD symbol, continuously covered snap fastener. Machine washable up to 40°C, weight 120 g/m<sup>2</sup>. Suitable for clean production areas.

In compliance with the ESD standard DIN EN 61340-5-1 

Available sizes: S, M, L, XL, XXL, 3XL

**dpvlink 8294**

| Article                 | Color | Size  |
|-------------------------|-------|-------|
| <b>Work coat AM-120</b> |       |       |
| 2760.AM120              | white | S-3XL |



**Reusable cap Type HB 120**



- Reusable cap
- color white
- material: 98% polyester, 2% carbonized yarn
- suitable for clean production areas
- cleanroom class 100 (ISO 5)
- PU = 10 pieces

In compliance with the ESD standard DIN EN 61340-5-1 

**dpvlink 8291**

| Article    | Type                     | Color |
|------------|--------------------------|-------|
| 2760.HB120 | Reusable cap Type HB-120 | white |



You find suitable **reusable overshoes type PB-120** made of the same material under **dpvlink 8286**.

**Work coat AM-110 extra lightweight**

**Work coat AM-110 extra lightweight**



Long sleeves, 3/4 design, with 2 side pockets, conductive 4-mm grid, dissipative cotton mixed fabric (50% polyester, 47% cotton, 3% carbonized yarn), breast pocket with embroidered ESD logo, snap fastener, machine washable up to 60°C, weight 110g/m<sup>2</sup>. Suitable for clean production areas.

In compliance with the ESD standard DIN EN 61340-5-1 

Available sizes: XS, S, M, L, XL, XXL, 3XL, 4XL, 5XL

**dpvlink 21215**

| Article                                   | Color | Size   |
|---|-------|--------|
| <b>Work coat AM-110 extra lightweight</b> |       |        |
| 2760.AM110                                | white | XS-3XL |
| 2760.AM110-1.4XL                          | white | 4XL    |
| 2760.AM110-1.5XL                          | white | 5XL    |



Workwear GreyLine 180

ESD overalls GreyLine



- Overalls with elastic suspenders
- rear overall pocket with zipper
- zipped fly
- 2 pouch pockets
- fly in contrasting light grey
- double folding ruler pocket
- stretch insert

In compliance with ESD standard DIN EN 61340-5-1 ⚠

Material: 65% polyester, 33% cotton, 2% carbon fibers

Available sizes: 42, 44, 46, 48, 50, 52, 54, 56, 58, 60, 62, 64, 90, 94, 98, 102, 106, 110

You cannot find the suitable image clothing for your company in our product range? Please, don't hesitate to contact us. Special manufacture and other colors are possible.

Individual manufacture is possible for 250 pieces and more.



dpvlink 21412

| Article                      | Color                 | Fabric weight g/qm | Size   |
|------------------------------|-----------------------|--------------------|--------|
| <b>ESD overalls GreyLine</b> |                       |                    |        |
| 2780.GL813                   | graphite / light grey | 180                | 42-64  |
| 2780.GL813-1                 | graphite / light grey | 180                | 90-110 |

Individual manufacture of at least 250 units possible

ESD blouson GreyLine



- 2 breast pockets
- 2 pockets
- one inside pocket
- pocket for mobile phone
- blouson with turn down collar
- rear and front yoke in light grey
- yellow contrast stripe between rear and front yoke
- pleat in the back for better movement
- width-adjustable snaps

In compliance with the ESD standard DIN EN 61340-5-1 ⚠

Material: 65% polyester, 33% cotton, 2% carbon fibers

Available sizes: 42, 44, 46, 48, 50, 52, 54, 56, 58, 60, 62, 64

dpvlink 21406

| Article                     | Color      | Fabric weight g/qm | Size  |
|-----------------------------|------------|--------------------|-------|
| <b>ESD blouson GreyLine</b> |            |                    |       |
| 2780.GL824                  | light grey | 180                | 42-64 |

ESD work trousers GreyLine



- 2 pouch pockets
- fly in contrasting color
- leg gathers width-adjustable by snap
- fly with zipper
- reinforced back pocket
- double folding ruler pocket
- width-adjustable snaps

In compliance with the ESD standard DIN EN 61340-5-1 ⚠

Material: 65% polyester, 33% cotton, 2% carbon fibers

Available sizes: 42, 44, 46, 48, 50, 52, 54, 56, 58, 60, 62, 64, 90, 94, 98, 102, 106, 108, 110

dpvlink 21408

| Article                           | Color                 | Fabric weight g/qm | Size   |
|-----------------------------------|-----------------------|--------------------|--------|
| <b>ESD work trousers GreyLine</b> |                       |                    |        |
| 2780.GL803                        | graphite / light grey | 180                | 42-64  |
| 2780.GL803-1                      | graphite / light grey | 180                | 90-110 |

ESD men's work coat GreyLine



- work coat with lapel collar
- stitched back strap
- 2 sloped side pockets
- breast pocket
- integrated inside pocket
- integrated pocket for mobile phone
- yellow contrast stripe between rear and front yoke
- pleat in the back for better movement
- width-adjustable snaps

In compliance with the ESD standard DIN EN 61340-5-1 ⚠

Material: 65% polyester, 33% cotton, 2% carbon fibers

Available sizes: 42, 44, 46, 48, 50, 52, 54, 56, 58, 60, 62, 64

dpvlink 21410

| Article                             | Color      | Fabric weight g/qm | Size  |
|-------------------------------------|------------|--------------------|-------|
| <b>ESD men's work coat GreyLine</b> |            |                    |       |
| 2780.GL834                          | light grey | 180                | 42-64 |



EPAwear® workwear

The dissipative workwear protects from electrostatic charge and is therefore an important part of the ESD protective measures in electronics manufacturing. The breathable and hard-wearing fabrics offer best wearing comfort, long durability and good care properties.

In our comprehensive product range you find unisex and women's versions of the following fabrics:



**PremiumSmooth**

Due to a special weaving procedure the functional material perfectly combines high-quality cotton with moisture-absorbent micro-polyester. The cotton inside is soft, supple and assures a feeling of well-being on the skin. The breathable and moisture-absorbent micro-polyester on the outside provides optimal thermoregulation.

This particular combination promotes a pleasant-to-wear sensation and has a very positive effect on the durability. Due to the conductive fibers integrated in the material the clothes have excellent dissipation values. All garments are marked with an ESD symbol and machine washable at 30°C.



**CoolMax® ALL SEASON**

The high-tech material with freshPRO technology supports the right balance between body and room temperature.

The soft and lightweight fabric perfectly adapts to changing temperatures and is pleasant and comfortable to wear - including the reliable protection against electrostatic charge due to the integrated conductive yarn. All garments are marked with an ESD symbol and machine washable at 30°C.

**Cotton mixed fabric**

The light and breathable material is skin-friendly and comfortable to wear. The integrated yarn ensures a reliable protection from charge.

All garments are marked with an ESD symbol and machine washable at 40°C.



### T-Shirt Uni



T-Shirt Uni, electrostatically dissipative, breathable, with integrated conductive fibers, sleeve with ESD logo, machine washable up to 40°C.

Cotton mixed fabric: 97% cotton, 3% conductive yarn, weight 150 g/m<sup>2</sup>

In compliance with the ESD standard DIN EN 61340-5-1 ⚠



dpvlink 14315

| Article            | Style            | Color      | Size   |
|--------------------|------------------|------------|--------|
| <b>T-Shirt Uni</b> |                  |            |        |
| 2658.T010          | T-Shirt          | white      | XS-3XL |
| 2658.T210          | T-Shirt          | dark blue  | XS-4XL |
| 2658.T210-V        | T-Shirt / V-neck | dark blue  | XS-3XL |
| 2658.T910          | T-Shirt          | royal blue | XS-4XL |
| 2658.T610          | T-Shirt          | black      | XS-4XL |
| 2658.T610-V        | T-Shirt / V-neck | black      | XS-5XL |



### T-Shirt Uni High Quality



T-shirt Uni, electrostatically dissipative, breathable, with conductive inwoven fibers, sleeves with ESD logo, machine washable up to 40°C. High-quality TOP product with excellent wearing comfort.

Cotton mixed fabric: 97% cotton, 3% conductive yarn, weight 195g/m<sup>2</sup>

In compliance with the ESD standard DIN EN 61340-5-1 ⚠



Gewicht 195 g/m<sup>2</sup>



dpvlink 17640

| Article                         | Color     | Size   |
|---------------------------------|-----------|--------|
| <b>T-Shirt Uni High Quality</b> |           |        |
| 2658.TQ211                      | dark blue | XS-4XL |
| 2658.TQ611                      | black     | XS-4XL |



### T-shirt



T-Shirt, electrostatically dissipative, breathable, with conductive yarn, sleeve with ESD logo, machine washable up to 40°C.

Cotton mixed fabric: 97% cotton, 3% conductive yarn, weight 150 g/m<sup>2</sup>

In compliance with the ESD standard DIN EN 61340-5-1 ⚠



dpvlink 6742

| Article        | Color            | Size   |
|----------------|------------------|--------|
| <b>T-shirt</b> |                  |        |
| 2655.T         | grey / dark blue | XS-3XL |
| 2657.T         | blue / dark blue | XS-4XL |



### Lady Shirt



Women's T-Shirt or tank top fitted with V neck, electrostatically dissipative. Breathable, with conductive carbon fibers, ESD logo on sleeve or seam, machine washable up to 40°C.

Cotton mixed fabric: 97% cotton, 3% conductive yarn (carbon), weight 150g/m<sup>2</sup>

In compliance with the ESD standard DIN EN 61340-5-1 ⚠



dpvlink 19845

| Article           | Style             | Color     | Size   |
|-------------------|-------------------|-----------|--------|
| <b>Lady Shirt</b> |                   |           |        |
| 2658.TT215        | Tank Top / V-neck | dark blue | XS-4XL |
| 2658.TT615        | Tank Top / V-neck | black     | XS-4XL |
| 2658.TL210        | T-Shirt / V-neck  | dark blue | XS-4XL |
| 2658.TL610        | T-Shirt / V-neck  | black     | XS-4XL |



### Polo Shirt Lady



Polo Shirt Lady, electrostatically dissipative, collar with button placket, breathable, conductive fibers, sleeve with ESD logo, machine washable up to 40°C.

Cotton mixed fabric: 96% cotton, 4% conductive yarn, weight 150 g/m<sup>2</sup>

In compliance with the ESD standard DIN EN 61340-5-1 



Tapered cut (close-fitting), short sleeves with slight gathers on the transition to the shoulder, collar with button placket (5 buttons), rounded waistband with lateral insert



**dpvlink 14477**

| Article                | Color     | Size   |
|------------------------|-----------|--------|
| <b>Polo Shirt Lady</b> |           |        |
| 2658.PL010             | white     | XS-3XL |
| 2658.PL717             | purple    | XS-3XL |
| 2658.PL210             | dark blue | XS-4XL |
| 2658.PL610             | black     | XS-4XL |



### Polo Shirt Uni



Polo Shirt UNI, electrostatically dissipative. Collar with button placket, breathable, with conductive yarn, sleeve with ESD logo, machine washable up to 40°C.

Cotton mixed fabric: 96% cotton, 4% conductive yarn, weight 210 g/m<sup>2</sup>

In compliance with the ESD standard DIN EN 61340-5-1 



**dpvlink 14319**

| Article               | Color           | Size   |
|-----------------------|-----------------|--------|
| <b>Polo Shirt Uni</b> |                 |        |
| 2670.P010             | white           | XS-4XL |
| 2670.P210             | dark blue       | XS-4XL |
| 2670.P610             | black           | XS-4XL |
| 2670.P910             | cornflower blue | XS-4XL |



### Polo Shirt



Polo-Shirt, electrostatically dissipative, collar with button placket, breathable, with conductive fibers, sleeve with ESD logo, machine washable up to 40°C.

Mixed fabric: 50% cotton, 47% polyester, 3% conductive yarn, weight 210g/m<sup>2</sup>

Entspricht der ESD-Norm DIN EN 61340-5-1 

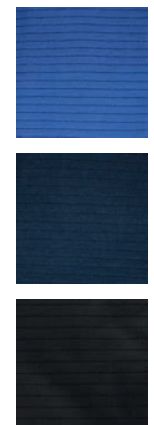

**dpvlink 16382**

| Article           | Color      | Size   |
|-------------------|------------|--------|
| <b>Polo Shirt</b> |            |        |
| 2628.P915         | royal blue | XS-4XL |
| 2628.P215         | dark blue  | XS-4XL |
| 2628.P615         | black      | XS-5XL |



### Polo Shirt



Polo Shirt, electrostatically dissipative. Collar with button placket, breathable, conductive yarn, breast pocket with ESD logo, machine washable up to 40°C.

- Grey with contrasting dark blue collar, breast pocket and sleeves
- Blue with contrasting black collar, breast pocket and sleeves

Mixed fabric: 50% cotton, 47% polyester, 3% conductive yarn, weight 210 g/m<sup>2</sup>

In compliance with the ESD standard DIN EN 61340-5-1 



**dpvlink 154**

| Article           | Color            | Size   |
|-------------------|------------------|--------|
| <b>Polo Shirt</b> |                  |        |
| 2625.P            | grey / dark blue | XS-4XL |
| 2627.P            | blue / black     | XS-4XL |



### Polo shirt long sleeves



Polo shirt with long sleeves, dissipative. Collar with button placket, breathable, with conductive yarn, breast pocket with ESD symbol, machine washable up to 40°C

- blue with contrasting black collar, breast pocket and sleeves
- grey with contrasting dark blue collar, breast pocket and sleeves
- black with black collar, breast pocket and sleeves

Mixed fabric: 50% cotton, 47% polyester, 3% conductive yarn, weight 210 g/m<sup>2</sup>

In compliance with the ESD standard DIN EN 61340-5-1 



**dpvlink 5885**

| Article                        | Color            | Size   |
|--------------------------------|------------------|--------|
| <b>Polo shirt long sleeves</b> |                  |        |
| 2645.P                         | grey / dark blue | XS-4XL |
| 2647.P                         | blue / black     | XS-4XL |
| 2647.P615                      | black            | XS-4XL |



### Sweatshirt



Sweatshirt, electrostatically dissipative. Round neck, breathable, comfortable to wear, unisex design, 1/2 design, ESD symbol on the sleeve, machine washable up to 40°C

Mixed fabric: 48% polyester, 48% cotton, 4% conductive yarn, weight 280 g/m<sup>2</sup>

In compliance with the ESD standard DIN EN 61340-5-1 

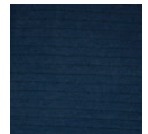

**dpvlink 16239**

| Article           | Color      | Size    |
|-------------------|------------|---------|
| <b>Sweatshirt</b> |            |         |
| 2671.S210         | dark blue  | XXS-4XL |
| 2671.S610         | black      | XXS-4XL |
| 2671.S910         | royal blue | XXS-4XL |



### Sweat jacket



Sweat jacket with covered zipper. Electrostatically dissipative, breathable, comfortable to wear, unisex model, 1/2 design, ESD symbol on the sleeve, 2 pockets, machine washable up to 40°C.

Mixed fabric: 48% polyester, 48% cotton, 4% conductive yarn, weight 280 g/m<sup>2</sup>

In compliance with the ESD standard DIN EN 61340-5-1 

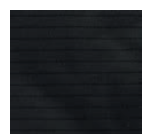
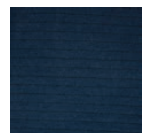

**dpvlink 16243**

| Article             | Color      | Size    |
|---------------------|------------|---------|
| <b>Sweat jacket</b> |            |         |
| 2671.SJ210          | dark blue  | XXS-4XL |
| 2671.SJ610          | black      | XXS-4XL |
| 2671.SJ910          | royal blue | XXS-4XL |



### Sweatshirt Premium



Sweatshirt Premium, electrostatically dissipative. Round neck, breathable, comfortable to wear, unisex design, 1/2 design, ESD symbol on the sleeve, machine washable up to 40°C.

Mixed fabric 240 g/m<sup>2</sup> (46% polyester, 50% cotton, 4% carbonized yarn)

In compliance with the ESD standard DIN EN 61340-5-1 



**dpvlink 21346**

| Article                   | Color     | Size    |
|---------------------------|-----------|---------|
| <b>Sweatshirt Premium</b> |           |         |
| 2672.S215                 | dark blue | 2XS-5XL |
| 2672.S615                 | black     | 2XS-5XL |



### Sweat jacket Premium



Sweat jacket Premium, electrostatically dissipative. Zipper, breathable, comfortable to wear, unisex design, 1/2 design, ESD symbol on the sleeve, 2 pockets, machine washable up to 40°C.

Mixed fabric 240 g/m<sup>2</sup> (46% polyester, 50% cotton, 4% carbonized yarn)

In compliance with the ESD standard DIN EN 61340-5-1 



**dpvlink 21349**

| Article                     | Color     | Size    |
|-----------------------------|-----------|---------|
| <b>Sweat jacket Premium</b> |           |         |
| 2672.SJ215                  | dark blue | 2XS-5XL |
| 2672.SJ615                  | black     | 2XS-5XL |



### Sweatshirt



Electrostatically dissipative mixed fabric (43% polyester, 50% cotton, 7% conductive yarn), light, breathable, comfortable to wear, fabric with conductive fibers, unisex model, 1/2 design, ESD symbol on the left upper arm, machine washable up to 40°C, weight 270 g/m<sup>2</sup>

In compliance with the ESD standard DIN EN 61340-5-1 



**dpvlink 10272**

| Article           | Color | Size  |
|-------------------|-------|-------|
| <b>Sweatshirt</b> |       |       |
| 2671.SS.B         | blue  | S-3XL |



### Sweat jacket



Sweat jacket, electrostatically dissipative mixed fabric (43% polyester, 50% cotton, 7% conductive yarn), continuous zipper, conductive cuffs, comfortable to wear, light, breathable, unisex model, 1/2 design, ESD symbol on the left upper arm, machine washable up to 40°C, weight 290 g/m<sup>2</sup>

In compliance with the ESD standard DIN EN 61340-5-1 



**dpvlink 20092**

| Article             | Color | Size    |
|---------------------|-------|---------|
| <b>Sweat jacket</b> |       |         |
| 2670.SJ.BL          | black | XS-3XL  |
| 2670.SJ.BL-1        | black | 4XL-5XL |
| 2671.SJ.B           | blue  | XS-3XL  |
| 2671.SJ.B-1         | blue  | 4XL-5XL |



Coolmax® ALL SEASON



**COOLMAX®**  
ALL SEASON TECHNOLOGY

Coolmax® ALL SEASON with freshPRO technology is a multifunctional high-tech fabric combining several characteristics. It offers its wearer a perfect wearing comfort adapted to the respective degree of temperature and activity.

- perfectly adapted to changing climatic conditions
- pleasant and comfortable to wear
- easy to care and machine washable
- dissipative

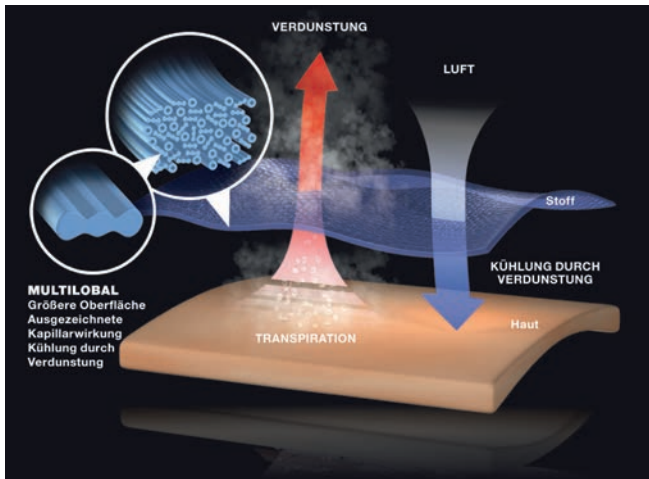

Higher temperatures and increased activity produce a comfortable evaporative cooling.

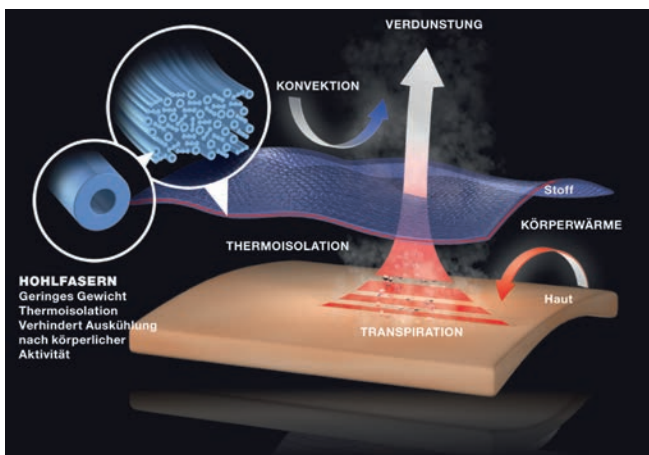

Lower temperatures and activity produce a protective thermal-insulating effect.

T-Shirt / Polo shirt Coolmax® ALL SEASON **DPV ELEKTRONIK**

T-Shirt Coolmax® ALL SEASON with high electrostatic dissipation, weight 160 g/m<sup>2</sup> for ESD protected work areas, soft, light and breathable, comfortable to wear.

Mixed fabric: 96% Coolmax® ALL SEASON, 4% conductive yarn

In compliance with the ESD standard DIN EN 61340-5-1 ⚠



- keeps the skin cool and preserves the well-being
- moisture is transported away from the body
- dry wear climate
- easy-care, machine washable
- dissipative

**COOLMAX®**  
ALL SEASON TECHNOLOGY



dpvlink 16371



| Article   | Style                      | Color      | Size   |
|---|----------------------------|------------|--------|
| <b>T-Shirt / Polo shirt Coolmax® ALL SEASON</b> |                            |            |        |
| 2680.T6517                                      | T-Shirt                    | anthracite | XS-4XL |
| 2680.T6512                                      | T-Shirt                    | dark blue  | XS-4XL |
| 2680.T6516                                      | T-Shirt                    | black      | XS-4XL |
| 2680.P6525                                      | Polo shirt / short sleeves | red        | XS-4XL |
| 2680.P6527                                      | Polo shirt / short sleeves | anthracite | XS-4XL |
| 2680.P6522                                      | Polo shirt / short sleeves | dark blue  | XS-4XL |
| 2680.P6526                                      | Polo shirt / short sleeves | black      | XS-4XL |
| 2680.P6537                                      | Polo shirt / long sleeves  | anthracite | XS-4XL |
| 2680.P6532                                      | Polo shirt / long sleeves  | dark blue  | XS-4XL |
| 2680.P6536                                      | Polo shirt / long sleeves  | black      | XS-4XL |

**Polo-Shirt Lady Coolmax® ALL SEASON** 

Figure-hugging women's polo shirt Coolmax® ALL SEASON very dissipative, short sleeves, weight 160g/m<sup>2</sup>, for ESD-protected areas, soft, lightweight and breathable, comfortable to wear.

Mixed fabric: 96% Coolmax® ALL SEASON, 4% conductive yarn

In compliance with the ESD standard DIN EN 61340-5-1 



- keeps cool and saves well-being
- directs moisture away from the body
- dry wearing comfort
- easy to care and machine-washable
- dissipative



**dpvlink 19498**

| Article                                    | Color      | Size   |
|--|------------|--------|
| <b>Polo-Shirt Lady Coolmax® ALL SEASON</b> |            |        |
| 2680.P5525                                 | red        | XS-2XL |
| 2680.P5527                                 | anthracite | XS-2XL |
| 2680.P5522                                 | dark blue  | XS-4XL |
| 2680.P5526                                 | black      | XS-2XL |



**Sweatshirt / sweat jacket Coolmax® ALL SEASON** 

Sweatshirt / sweat jacket Coolmax® ALL SEASON very dissipative, weight 230 g/m<sup>2</sup> for ESD protected work areas, soft, light and breathable, comfortable to wear.

Mixed fabric: 84% Coolmax® ALL SEASON, 10% conductive yarn, 6% Lycra

In compliance with the ESD standard DIN EN 61340-5-1 



- keeps cool and saves well-being
- directs moisture away from the body
- dry wearing comfort
- easy to care and machine-washable
- dissipative

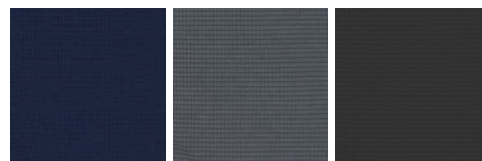

**dpvlink 16377**

| Article  | Style                                 | Color      | Size   |
|--|---------------------------------------|------------|--------|
| <b>Sweatshirt / sweat jacket Coolmax® ALL SEASON</b> |                                       |            |        |
| 2685.S6557   | Sweatshirt / V-neck                   | anthracite | XS-4XL |
| 2685.S6552   | Sweatshirt / V-neck                   | dark blue  | XS-4XL |
| 2685.S6567   | Sweatshirt / lapel collar with zipper | anthracite | XS-4XL |
| 2685.S6562   | Sweatshirt / lapel collar with zipper | dark blue  | XS-4XL |
| 2685.SJ6577  | Sweat jacket                          | anthracite | XS-4XL |
| 2685.SJ6572  | Sweat jacket                          | dark blue  | XS-4XL |
| 2685.SJ6576  | Sweat jacket                          | black      | XS-4XL |



**Women's sweat jacket Coolmax® ALL SEASON** 

**dpvlink 22323**

| Article   | Style        | Color      | Size   |
|---|--------------|------------|--------|
| <b>Women's sweat jacket Coolmax® ALL SEASON</b> |              |            |        |
| 2685.SJ5577                                     | Sweat jacket | anthracite | XS-2XL |
| 2685.SJ5572                                     | Sweat jacket | dark blue  | XS-2XL |
| 2685.SJ5576                                     | Sweat jacket | black      | XS-2XL |



PremiumSmooth

PremiumSmooth is a NEWLY developed functional textile. Its high-quality inside **adapts softly** to the skin - ensuring therefore an extremely comfortable wearing. The **breathable and moisture-absorbing** micro polyester on the exterior ensures optimal thermal regulation. The result of the EPAwear® PremiumSmooth shirts stands for itself: Smooth comfort combined with **optimal ESD protection**.



T-Shirt / Polo shirt PremiumSmooth

- high electrostatic dissipation
- weight 180g/m<sup>2</sup>
- for ESD protected working areas
- soft, light and breathable
- very comfortable to wear

PremiumSmooth functional fabric:

47% cotton inside  
46% micro polyester outside  
7% conductive fibers

Available in the 2 standard colors black and dark blue.

Your requested color is possible when ordering at least 300 pieces.

With the new innovative PremiumSmooth textile, the new generation of Polo and T-Shirts offers everything a TOP product needs:

- TOP industrial quality
- extremely durable textile
- **extremely comfortable wearing**
- breathable fabric
- pleasant wearing
- wellbeing on the skin
- excellent dissipation values
- Active cold and heat regulation
- timeless cut
- machine washable up to 30°C



Polo-Shirt Lady PremiumSmooth



Polo shirt PremiumSmooth with high electrostatic dissipation, Premium Smooth fabric (47% cotton inside / 47% micro polyester outside / 7% conductive fibers), weight 180g/m<sup>2</sup>, soft, light and breathable, very comfortable to wear.

In compliance with the ESD standard DIN EN 61340-5-1



dpvlink 17851

| Article                              | Color     | Size   |
|--------------------------------------|-----------|--------|
| <b>Polo-Shirt Lady PremiumSmooth</b> |           |        |
| 2675.PL7542                          | dark blue | XS-3XL |
| 2675.PL7546                          | black     | XS-3XL |



Polo-Shirt PremiumSmooth



Polo shirt PremiumSmooth with high electrostatic dissipation, Premium Smooth fabric (47% cotton inside / 47% micro polyester outside / 7% conductive fibers), weight 180g/m<sup>2</sup>; soft, light and breathable, very comfortable to wear.

In compliance with the ESD standard DIN EN 61340-5-1



dpvlink 17850

| Article                         | Color      | Size  |
|---------------------------------|------------|-------|
| <b>Polo-Shirt PremiumSmooth</b> |            |       |
| 2675.P7532                      | dark blue  | S-4XL |
| 2675.P7537                      | anthracite | S-4XL |
| 2675.P7536                      | black      | S-4XL |





### T-Shirt Lady PremiumSmooth



T-shirt Lady PremiumSmooth with high electrostatic dissipation, Premium Smooth fabric (47% cotton inside / 47% micro polyester outside / 7% conductive fibers), weight 180g/m<sup>2</sup>, with stylish V-neck; soft, light and breathable, very comfortable to wear.

In compliance with the ESD standard DIN EN 61340-5-1 

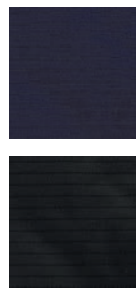

**dpvlink 17853**

| Article                           | Color     | Size   |
|-----------------------------------|-----------|--------|
| <b>T-Shirt Lady PremiumSmooth</b> |           |        |
| 2675.TL7422                       | dark blue | XS-3XL |
| 2675.TL7426                       | black     | XS-3XL |



### T-Shirt PremiumSmooth



T-shirt PremiumSmooth with high electrostatic dissipation, PremiumSmooth fabric (47% cotton inside / 47% micro polyester outside / 7% conductive fibers), weight 180g/m<sup>2</sup>; soft, light and breathable, very comfortable to wear.

In compliance with the ESD standard DIN EN 61340-5-1 

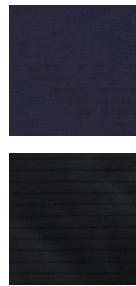

**dpvlink 17852**

| Article                      | Color     | Size  |
|------------------------------|-----------|-------|
| <b>T-Shirt PremiumSmooth</b> |           |       |
| 2675.T7412                   | dark blue | S-4XL |
| 2675.T7416                   | black     | S-4XL |



### Other workwear

#### ESD Winter vest type 1600



Vest without sleeves, dissipative material (31% polyester, 66% cotton, 3% conductive yarn): unisex version; inside completely with quilted lining, drawstring at hem, panel seams with insertion pockets, 1 breast pocket with zipper, stand-up collar, EPA logo on bottom hem; machine washable up to 40°C.

In compliance with the ESD standard DIN EN 61340-5-1 

(standard only fulfilled in connection with further ESD-compliant clothing)



**dpvlink 21228**

| Article                          | Color    | Size   |
|----------------------------------|----------|--------|
| <b>ESD Winter vest type 1600</b> |          |        |
| DPV-1600                         | graphite | XS-3XL |



#### ESD Winter jacket



ESD winter jacket, material (62% polyester, 34% cotton, 4% conductive yarn) electrostatically dissipative, warming fleece lining; water-repellent, unisex version, EPA logo on the left breast, machine washable up to 40°C.

In compliance with the ESD standard DIN EN 61340-5-1 



**dpvlink 19465**

| Article                  | Color | Size   |
|--------------------------|-------|--------|
| <b>ESD Winter jacket</b> |       |        |
| DPV-1066                 | black | XS-2XL |



**Sizes 3XL to 5XL on request**

### ESD Winter vest type 1000



Men's winter vest without sleeves, upper material dissipative (98% polyester, 2% conductive yarn) water-repellent, lining of warming cotton fleece, unisex, EPA logo on the left breast, machine washable up to 40°C.

In compliance with the ESD standard DIN EN 61340-5-1 (standard only fulfilled in connection with further ESD-compliant clothing)



**dpvlink 19463**

| Article  | Color     | Size   |
|----------|-----------|--------|
| DPV-1000 | dark blue | XS-2XL |

**Sizes 3XL to 5XL on request**



### ESD Winter jacket



Men's winter jacket with long sleeves, upper material dissipative (98% polyester, 2% conductive yarn); warming fleece lining; unisex; EPA-logo on the left breast, machine washable up to 40°C. In compliance with the ESD standard DIN EN 61340-5-1



**dpvlink 19652**

| Article  | Color     | Size   |
|----------|-----------|--------|
| DPV-1010 | dark blue | XS-2XL |

**Sizes 3XL to 6XL on request**



### ESD Softshell jacket in signal color



ESD softshell jacket; material (98% polyester, 2% conductive yarn) electrostatically dissipative; breathable; internal layer Softshell; unisex version; EPA-logo on the left breast, machine washable up to 40°C. In compliance with the ESD standard DIN EN 61340-5-1

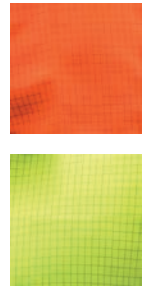

**dpvlink 19656**

| Article                                     | Color       | Size   |
|---|-------------|--------|
| <b>ESD Softshell jacket in signal color</b> |             |        |
| DPV-1031                                    | orange      | XS-2XL |
| DPV-1030                                    | neon yellow | XS-2XL |

**Sizes 3XL to 5XL on request**



### ESD Reflective vest



ESD warning vest; material (98% polyester, 2% conductive yarn) electrostatically dissipative, fluorescent with reflecting stripes, unisex version, EPA logo on the left breast, machine washable up to 40°C. In compliance with the ESD standard DIN EN 61340-5-1

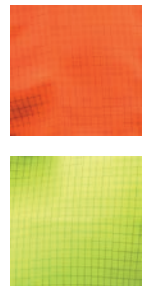

**dpvlink 19397**

| Article                    | Color  | Size   |
|----------------------------|--------|--------|
| <b>ESD Reflective vest</b> |        |        |
| DPV-1026                   | yellow | XS-2XL |
| DPV-1027                   | orange | XS-2XL |

**Sizes 3XL to 5XL on request**



### ESD sweatshirt / sweat jacket



Electrostatically dissipative sweatshirt and sweat jacket; mixed fabric (48% polyester, 48% cotton, 4% conductive yarn), lime-green with collar and cuffs in contrasting black, unisex version, EPA-logo on the left upper arm, weight 300 g/m<sup>2</sup>, machine washable up to 40°C.

In compliance with the ESD standard DIN EN 61340-5-1 



dpvlink 24934

| Article                              | Style        | Color      | Size   |
|--------------------------------------|--------------|------------|--------|
| <b>ESD sweatshirt / sweat jacket</b> |              |            |        |
| DPV-1200                             | Sweatshirt   | lime-green | XS-4XL |
| DPV-1250                             | Sweat jacket | lime-green | XS-4XL |



# ESD

### Trousers ESD BlackLine



The functional ESD working trousers have many pockets for tools. So everything is always within reach. At the same time the trousers are very comfortable to wear due to the laterally elastic Flexbelt® seam.



#### ESD trousers BlackLine

- electrostatically dissipative
- ESD logo
- weight 180 g/m<sup>2</sup>
- color black
- sizes 40 - 62
- Flexbelt® waistband very elastic and comfortable to wear
- belt loops

In compliance with the ESD standard DIN EN 61340-5-1

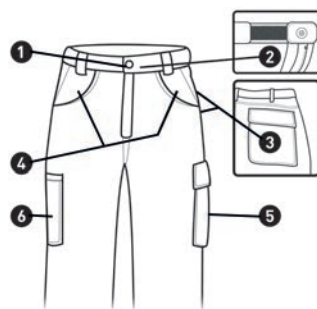

#### Highlights

1. Covered waistband fastener inside
2. Flexbelt® waistband for high wearing comfort
3. 2x back pockets with flap and velcro fastener
4. 2x large pockets
5. Large thigh pocket with flap and velcro fastener
6. Ruler pocket

Material: 65% polyester, 33% cotton, 2% carbon

Available sizes: 40/42, 44/46, 48/50, 52/54, 56/58, 60/62

dpvlink 23201

| Article                       | Color | Size  | Type  | Fabric weight g/qm |
|-------------------------------|-------|-------|-------|--------------------|
| <b>Trousers ESD BlackLine</b> |       |       |       |                    |
| 2770.BK151                    | black | 40-62 | short | 180                |
| 2770.BK150                    | black | 40-62 | long  | 180                |



### ESD Cap



ESD cap; material (48% polyester, 48% cotton, 4% conductive yarn) electrostatically dissipative, unisex version; one size fits all; EPA labeling at the front, machine washable up to 40°C. In compliance with the ESD standard DIN EN 61340-5-1. Available in light blue with 210 g/m<sup>2</sup> or in dark blue with 210 g/m<sup>2</sup> or with 280 g/m<sup>2</sup>.



dpvlink 21079

| Article        | Color      | Fabric weight g/qm |
|----------------|------------|--------------------|
| <b>ESD Cap</b> |            |                    |
| DPV-1082       | light blue | 210                |
| DPV-1081       | dark blue  | 210                |
| DPV-1080       | dark blue  | 280                |



### ESD Loop scarf



ESD loop scarf; electrostatically dissipative



- material
  - 96% cotton
  - 4% conductive yarn
- unisex version
- one size fits all
- available in dark blue and black
- machine washable up to 40°C
- In compliance with the ESD standard DIN EN 61340-5-1

dpvlink 22695

| Article               | Color     | Fabric weight g/qm |
|-----------------------|-----------|--------------------|
| <b>ESD Loop scarf</b> |           |                    |
| DPV-1085              | dark blue | 150                |
| DPV-1085.B            | black     | 150                |



### ESD Scarf



ESD scarf; electrostatically dissipative



- material
  - 96% cotton
  - 4% conductive yarn
- unisex version
- one size fits all
- available in dark blue and black
- dimensions 185 x 30 cm
- machine washable up to 40°C
- In compliance with the ESD standard DIN EN 61340-5-1

dpvlink 22930

| Article          | Color     | Fabric weight g/qm |
|------------------|-----------|--------------------|
| <b>ESD Scarf</b> |           |                    |
| DPV-1086         | dark blue | 150                |
| DPV-1086.B       | black     | 150                |



## Cleanroom clothing

### Cleanroom overalls



DPV cleanroom overalls suitable for cleanrooms and ESD-safe Material: 110 g/m<sup>2</sup> (98 % polyester and 2% conductive fibers)



- lapel collar
- covered zipper
- raglan sleeves
- knitted cuffs on arms
- adjustable snaps on legs
- adjustable buttonhole elastic in waist
- snap counterpart for hood
- clip band dispositive for name labeling
- name tape
- thigh pocket with flap on the right
- antistatic
- usable up to cleanroom class ISO 4 (class 10)

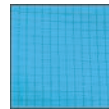

On request also available in light blue.

dpvlink 21424

| Article                   | Color      | Size  |
|---------------------------|------------|-------|
| <b>Cleanroom overalls</b> |            |       |
| 1010.RR-101               | white      | S-XXL |
| 1010.RR-201               | light blue | S-XXL |



Sizes 3XL to 5XL on request

### Cleanroom all-around protection hood



- Zipper in front
- with shoulder cover
- adjustment possible with buckle on the back
- large head harness
- snap fixture for mask
- ear insert
- antistatic
- usable up to cleanroom class ISO 4 (class 10)

dpvlink 21432

| Article     | Color      | Size  |
|-------------|------------|-------|
| 1010.RR-107 | white      | S-XXL |
| 1010.RR-207 | light blue | S-XXL |



### Cleanroom mask



- for buttoning in the all-around protection hood
- antistatic
- usable up to cleanroom class ISO 4 (class 10)

dpvlink 21444

| Article     | Color      | Size     |
|-------------|------------|----------|
| 1010.RR-108 | white      | one size |
| 1010.RR-208 | light blue | one size |



## Cleanroom coat



DPV cleanroom coat suitable for cleanrooms and ESD-safe  
Material: 110 g/m<sup>2</sup> (98 % polyester and 2% conductive fibers)

- lapel collar
- snaps in front
- raglan sleeves
- clip band fixture for name labeling
- name tape
- knitted cuffs on arms
- 1 breast pocket
- 2 hip pockets
- antistatic
- usable up to cleanroom class ISO 4 (class 10)



On request also available in light blue.

**dpvlink 21428**

| Article               | Color      | Size  |
|-----------------------|------------|-------|
| <b>Cleanroom coat</b> |            |       |
| 1010.RR-102           | white      | S-XXL |
| 1010.RR-202           | light blue | S-XXL |

Sizes 3XL to 5XL on request

## Cleanroom overboot



- high version
- plastic outsole
- with zipper
- clip fastener over instep for optimal fit
- antistatic
- usable up to cleanroom class ISO 4 (class 10)

**dpvlink 21441**

| Article     | Color      | Size  |
|-------------|------------|-------|
| 1010.RR-112 | white      | S-XXL |
| 1010.RR-212 | light blue | S-XXL |

## Cleanroom overshoe



- angle-high
- plastic outsole
- elastic
- antistatic
- usable up to cleanroom class ISO 4 (class 10)

**dpvlink 21438**

| Article                   | Color      | Size  |
|---------------------------|------------|-------|
| <b>Cleanroom overshoe</b> |            |       |
| 1010.RR-114               | white      | S-XXL |
| 1010.RR-214               | light blue | S-XXL |

## Tyvek® Protective clothing

Tyvek® is a special and versatile material. It is durable, but also extremely light and soft. Permeable to air and water vapor, Tyvek® fabric provides an excellent barrier as well against water-based chemicals and aerosols as to particles and fibers. It is low-linting and antistatic. Due to the combination of these special characteristics Tyvek® products are ideal for a wide range of applications and prevent contamination of products and processes by people in the pharmaceutical, food or electronics industry.



**Protection:** Good barrier to particles due to its structure of extremely fine filaments and a good protection against fine liquid mist and water-based chemicals in low concentration.

**Durability:** The Tyvek® fabric is extremely durable, tear- and abrasion-resistant. Tyvek® overalls remain intact even under difficult conditions, in case of movements such as those described in the standards for chemical protective clothing.

**Comfort:** Tyvek® is a breathable fabric. It is permeable to air and water vapor. At the same time it is very soft, light and flexible and feels comfortable on the skin.

## Disposable overall Tyvek® Classic Xpert CHF5



Protection against numerous inorganic chemicals in low concentration and particles > 1 µm. TYVEK® is permeable to air and vapor. Not containing any halogen compounds, it can be disposed without further residues that harm the environment or health.

- The ergonomic three-part hood offers the head a better mobility without impeding the field of vision.
- TYVEK® zipper with cover for an improved protection.
- Elastic cuffs on arm and legs end provide a better, tight fitting.

**Seams:** External seams offer a higher protection against the penetration of solid and liquid particles into the overall.

**dpvlink 8325**

| Article  | Color | Size  | Shipping Unit |
|----------|-------|-------|---------------|
| 2790.205 | white | S-3XL | 25            |
| 2790.206 | green | S-XXL | 100           |
| 2790.207 | blue  | S-XXL | 100           |

### Disposable overall Tyvek® CCF5



Protection against numerous inorganic chemicals in low concentration and contamination by radioactive particles. Containing no halogen compounds, it can be disposed without further residues that harm the environment or health.

- Overall with collar.
- TYVEK® zipper with zip cover provide a high tightness.
- Elastic cuffs on the arm and legs end offer a better and tight closure.
- Glued elastic waistband for a reliable fit of the overall and optimal comfort.

**Seams:** Internal seams reduce the risk of an contamination by the suit preventing the particles from the inside of the overall to the outside.

dpvlink 8324

| Article  | Color | Size  | Shipping Unit |
|----------|-------|-------|---------------|
| 2790.201 | white | S-XXL | 100           |



### Disposable coat Tyvek® PL30



Tyvek® disposable coat with 5 snaps, collar and 3 pockets.

- Material:** Tyvek® 1431 N, 41 g/m<sup>2</sup>, antistatic  
**Description:** Laboratory coat with snap fastener and pockets

dpvlink 8318

| Article  | Color | Size  | Shipping Unit |
|----------|-------|-------|---------------|
| 2790.100 | white | M-XXL | 10            |



### Disposable coat Tyvek® PL30NP



Tyvek® disposable coat without pockets with 5 snaps, collar.

- Material:** Tyvek® 1431 N, 41 g/m<sup>2</sup>, antistatic  
**Description:** Laboratory coat with snap fastener without pockets

dpvlink 8320

| Article  | Color | Size  | Shipping Unit |
|----------|-------|-------|---------------|
| 2790.105 | white | M-XXL | 10            |



### Disposable coat Tyvek® PL309



Tyvek® disposable coat with zipper, 2 pockets and collar. Elastic band on the arm end.

- Material:** Tyvek® 1431 N, 41 g/m<sup>2</sup>, antistatic  
**Description:** Laboratory coat with zipper and pockets

dpvlink 8322

| Article  | Color | Size  | Shipping Unit |
|----------|-------|-------|---------------|
| 2790.110 | white | S-XXL | 10            |



### Disposable cover Tyvek® PH30LO

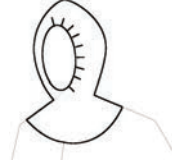

Tyvek® disposable hood with collar, neck and face edging with elastic band, color: white.

- Material:** Tyvek® 1431 N, 41 g/m<sup>2</sup>, antistatic  
**Description:** Hood with overlock seam.

dpvlink 8337

| Article  | Color | Shipping Unit |
|----------|-------|---------------|
| 2790.305 | white | 100           |



### Disposable skirt Tyvek® PA30LO



Tyvek® disposable skirt, color: white

- Material:** Tyvek® 1431 N, 41 g/m<sup>2</sup>, antistatic.  
**Description:** Skirt with chest protector and 2 bands to tie together on the back, length 108 cm.

dpvlink 8339

| Article  | Color | Shipping Unit |
|----------|-------|---------------|
| 2790.300 | white | 100           |



### Disposable gauntlets Tyvek® PS32LA



Tyvek® disposable gauntlets, 50 cm, points of seam at the upper blue elastic, removable for short arms, color: white

- Material:** Tyvek® 1431 N, 41 g/m<sup>2</sup>, antistatic.  
**Description:** Arm gauntlets with elastic at both ends, 50 cm long. For men and women. Points of seam at the upper blue elastic; removable for short arms.

dpvlink 8341

| Article  | Color | Shipping Unit |
|----------|-------|---------------|
| 2790.309 | white | 200           |



### Disposable overshoe Tyvek® POB0



Tyvek® disposable overshoe, high design with elastic on ankles and calf; color: white

- Material:** Tyvek® 1431 N, 41 g/m<sup>2</sup>, antistatic.  
**Description:** Overshoe high, 48 cm high, 42 cm long, with strip for fastening over the calf. (2790.316 with slip-resistant outsole)

dpvlink 8335

| Article  | Color | Size     | Style                             | Shipping Unit |
|----------|-------|----------|-----------------------------------|---------------|
| 2790.315 | white | one size | Overshoe                          | 200           |
| 2790.316 | white | one size | Overshoe / slip-resistant outsole | 200           |



**Disposable overshoe Tyvek® POSO** 



Tyvek® disposable overshoe, low design, color: white  
**Material:** Tyvek® 1431 N, 41 g/m<sup>2</sup>, antistatic.  
**Description:** overshoe with elastic on the ankle. Length: 40 cm.

**dpvlink 8330**

| Article  | Color | Size     | Shipping Unit |
|----------|-------|----------|---------------|
| 2790.310 | white | one size | 400           |



**Disposable overshoe Tyvek® POSA, slip-resistant** 



Tyvek® disposable overshoe with reinforced, slip-resistant outsole, low design, color: white  
**Material:** Tyvek® 1431 N, 41 g/m<sup>2</sup>, antistatic.  
**Description:** Overshoe with slip-resistant outsole and elastic on the ankle. Length: 40 cm.

**dpvlink 8332**

| Article  | Color | suitable for shoe sizes | Shipping Unit |
|----------|-------|-------------------------|---------------|
| 2790.311 | white | 36-42                   | 200           |
| 2790.312 | white | 42-46                   | 200           |



**Tyvek® is a registered trademark of DuPont or one of its affiliate companies.**

**Disposable clothes**

**Disposable cap / mask**



**Disposable bouffant cap**

- white non-woven
- size 1 = Ø 53 cm
- size 2 = Ø 60 cm

PU = box with 1000 pieces

**dpvlink 8435**

| Article  | Style | Color | Size | PU         |
|----------|-------|-------|------|------------|
| 2795.153 | Cover | white | 1    | 1000 piece |
| 2795.160 | Cover | white | 2    | 1000 piece |



**Disposable mask / hygienic mask**

**NEU**



**Hygienic disposable mask**

- with ear band
- 100% polypropylene
- hydrophobic non-woven fabric
- 3 layers
- 12.5 cm metal stripe for optimal fit
- one size fits all
- made in Europe

PU = box with 50 pieces



**dpvlink 24453**

| Article  | Style | Color | Size     | PU       |
|----------|-------|-------|----------|----------|
| 2795.200 | mask  | white | one size | 50 piece |



**Disposable mask medical mask type II R**

**NEU**

**Medical disposable mask type II**

Protects the wearer and the people in the surroundings



- 100% polypropylene non-woven fabric
- with meltblown filter layer
- 3 layers
- bacterial filter performance (BFE) ≥ 98%
- metal stripe for optimal fit
- one size fits all
- medical mask with CE marking
- **self-protection / protection of others**
- made in Europe
- complies with the standard EN 14683+AC:2019

PU = box with 50 pieces

**dpvlink 24899**

| Article       | Style | Color | Size     | PU       |
|---------------|-------|-------|----------|----------|
| 2795.200.MM.R | mask  | white | one size | 50 piece |



**Disposable mask medical mask type II**

**NEU**

**Medical disposable mask type II**



- 100% polypropylene non-woven fabric
- with meltblown filter layer
- 3 layers
- bacterial filter performance (BFE) ≥ 98%
- metal stripe for optimal fit
- one size fits all
- made in Europe
- complies with the standard EN 14683+AC:2019

PU = box with 50 pieces



**dpvlink 24454**

| Article     | Style | Color | Size     | PU       |
|-------------|-------|-------|----------|----------|
| 2795.200.MM | mask  | white | one size | 50 piece |



**Disposable nitrile gloves ESD** 



- antistatic 
- powder-free and silicone-free
- textured gripping surface
- 100% nitrile
- available sizes: S (7), M (8), L (9), XL (10)

**dpvlink 23094**

| Article   | Size | L [mm] | Thickness [mm] | PU              |
|-----------|------|--------|----------------|-----------------|
| 2750.7550 | S-XL | 240    | 0,10           | 100 piececarton |
| 2750.7565 | S-XL | 300    | 0,15           | 50 piece carton |



ID card holders

ID card holder Premium



- transparent/clear
- dissipative
- high-quality and flexible material
- insertion pocket with zipper
- upper edging in contrasting yellow
- ESD symbol
- fastening: metal clip

In compliance with the ESD standard DIN EN 61340-5-1

dpvlink 16247

| Article    | Version          | W [mm] | H [mm] |
|------------|------------------|--------|--------|
| 5221.35016 | Portrait format  | 68     | 107    |
| 5221.35017 | landscape format | 102    | 86     |



ID card holder, transparent dissipative



- clear/ transparent
- ESD symbol
- clip closure
- dissipative

In compliance with the ESD standard DIN EN 61340-5-1

dpvlink 398

| Article         | Version          | W [mm] | H [mm] | Thickness [mm] |
|-----------------|------------------|--------|--------|----------------|
| 5221.31.IDP.150 | landscape format | 95     | 65     | 0.15           |
| 5221.31.IDP     | landscape format | 95     | 65     | 0,25           |
| 5221.31.2       | Portrait format  | 56     | 89     |                |



ID card holder credit card size



- credit card size
- conductive plastic
- clip closure
- portable in portrait and landscape format

In compliance with the ESD standard DIN EN 61340-5-1

dpvlink 5814

| Article | Type                                |
|---------|-------------------------------------|
| 5221.21 | Card holder credit card size, black |



ESD lanyard



ESD lanyard

- with safety closure
- carabiner
- ESD imprint
- for all ID card holders
- dissipative/yellow

In compliance with the ESD standard DIN EN 61340-5-1



Safety closure (opens when pulling hard)

dpvlink 7884

| Article  | Type        |
|----------|-------------|
| 5221.323 | ESD Lanyard |



ESD gloves



ESD gloves are used to dissipate static electricity. This is necessary because susceptible electronics can be damaged or even destroyed by static discharge if the mounting is made without ESD protection.

ESD gloves must fulfill strict requirements with regard to the electrostatic dissipation.

Gloves series LEO textiles

The gloves of the LEO series are ideal for all dry areas in electronics production. The seamlessly finished textile mixed fabric of the gloves is breathable and combines a perfect fit with a comfortable wearing. Due to the knitted antistatic agent the gloves of type LEO have very good dissipation values. The antistatic agent is not resistant to water and cleanser.

ESD glove LEO 100 / 200



Gloves made of textile mixed fabric, not washable, very good dissipation values, seamlessly finished, perfect fit, comfortable to wear.

In compliance with the ESD standard DIN EN 61340-5-1

Available sizes: S, M, L, XL, XXL (model LEO 200 also available in XS)



dpvlink 8343

| Article       | Type  | Size   | Color |
|---------------|---|--------|-------|
| 2070.3100     | ESD glove LEO 100   | S-XXL  | white |
| 2070.3200     | ESD glove LEO 200   | XS-XXL | grey  |
| 2070.3100.SET | ESD glove LEO 100, set mixed sizes, 1 pair each size S-XXL  |        | white |
| 2070.3200.SET | ESD glove LEO 200, set mixed sizes, 1 pair each size XS-XXL |        | grey  |





### ESD glove LEO 105 / 205



Gloves made of textile mixed fabric, not washable, very good dissipation values due to knitted antistatic agents, seamlessly finished, perfect fit, comfortable to wear

- PU coated fingertips

In compliance with the ESD standard DIN EN 61340-5-1 

Available sizes: XS, S, M, L, XL, XXL



**dpvlink 8404**

| Article       | Type  | Size   | Color |
|---------------|---|--------|-------|
| 2070.3105     | ESD glove LEO 105   | XS-XXL | white |
| 2070.3205     | ESD glove LEO 205   | XS-XXL | grey  |
| 2070.3105.SET | ESD glove LEO 105, set mixed sizes, 1 pair each size XS-XXL |        | white |
| 2070.3205.SET | ESD glove LEO 205, set mixed sizes, 1 pair each size XS-XXL |        | grey  |



### ESD glove LEO 110 / 210



Gloves made of textile mixed fabric, not washable, very good dissipation values due to knitted antistatic agent, seamlessly finished, perfect fit, comfortable to wear.

- PU coated palm and fingertips

In compliance with the ESD standard DIN EN 61340-5-1 

Available sizes: S, M, L, XL, XXL (model LEO 210 also available in XS)



**dpvlink 8406**

| Article       | Type  | Size   | Color |
|---------------|---|--------|-------|
| 2070.3110     | ESD glove LEO 110   | S-XXL  | white |
| 2070.3210     | ESD glove LEO 210   | XS-XXL | grey  |
| 2070.3110.SET | ESD glove LEO 110, set mixed sizes, 1 pair each size S-XXL  |        | white |
| 2070.3210.SET | ESD glove LEO 210, set mixed sizes, 1 pair each size XS-XXL |        | grey  |



### ESD gloves LEO 125 PLUS



Flexible gloves of very fine nylon fabric, not washable, very high dissipation values due to knitted antistatic agent, seamlessly processed, perfect fit, comfortable wearing, with coated PU fingertips.

In compliance with the ESD standard DIN EN 61340-5-1 

available sizes: XS, S, M, L, XL, XXL



**dpvlink 17858**

| Article       | Type   | Size   | Color |
|---------------|--|--------|-------|
| 2070.3125     | ESD glove LEO 125+   | XS-XXL | white |
| 2070.3125.SET | ESD glove LEO 125+, set mixed sizes, 1 pair each size XS-XXL |        | white |



### ESD gloves LEO 130 PLUS



Flexible gloves of very fine nylon fabric, not washable, very high dissipation values due to knitted antistatic agent, seamlessly processed, perfect fit, comfortable wearing, PU coated palm and fingertips.

In compliance with the ESD standard DIN EN 61340-5-1 

available sizes: XS, S, M, L, XL, XXL



**dpvlink 17864**

| Article       | Type   | Size   | Color |
|---------------|--|--------|-------|
| 2070.3130     | ESD glove LEO 130+   | XS-XXL | white |
| 2070.3130.SET | ESD glove LEO 130+, set mixed sizes, 1 pair each size XS-XXL |        | white |



Textile gloves CARBON

ESD glove Carbon 200 STANDARD



Gloves made of textile mixed fabric with carbon fiber, breathable, dissipative, seamlessly finished, perfect fit, comfortable to wear.

In compliance with the ESD standard DIN EN 61340-5-1

Available sizes: S, M, L, XL, XXL



dpvlink 16324

| Article       | Type  | Size  | Conductive fiber |
|---------------|---|-------|------------------|
| 2070.4200     | ESD glove Carbon 200 STANDARD   | S-XXL | Carbon           |
| 2070.4200.SET | ESD glove Carbon 200 STANDARD, set mixed sizes, 1 pair each size XS-XXL |       | Carbon           |

ESD glove Carbon 205 AMPERE



Gloves made of mixed textile fabric with carbon fibers, breathable, dissipative, seamlessly finished, perfect fit, comfortable to wear.

- PU coated fingertips

In compliance with the ESD standard DIN EN 61340-5-1

Available sizes: XS, S, M, L, XL, XXL



dpvlink 16325

| Article       | Type  | Size   | Conductive fiber |
|---------------|---|--------|------------------|
| 2070.4205     | ESD glove Carbon 205 AMPERE   | XS-XXL | Carbon           |
| 2070.4205.SET | ESD glove Carbon 205 AMPERE, set mixed sizes, 1 pair each size XS-XXL |        | Carbon           |

ESD glove Carbon 210 VOLT



Gloves made of textile mixed fabric (75% nylon, 25% carbon), breathable back of the hand, dissipative, seamlessly finished, perfect fit, comfortable to wear.

- PU-coated palm and fingertips

In compliance with the ESD standard DIN EN 61340-5-1

Available sizes: XS, S, M, L, XL, XXL



dpvlink 19486

| Article       | Type  | Size   | Conductive fiber |
|---------------|---|--------|------------------|
| 2070.4210     | ESD glove Carbon 210 VOLT   | XS-XXL | Carbon           |
| 2070.4210.SET | ESD glove Carbon 210 VOLT, set mixed sizes, 1 pair each size XS-XXL |        | Carbon           |

Textile gloves COPPER

The gloves COPPER made of textile mixed fabric with woven conductive copper fibers offer a very good, durable dissipation. All gloves are seamlessly finished and combine perfect fit with comfortable wearing.

In compliance with the ESD standard DIN EN 61340-5-1

ESD glove Copper 100 STANDARD



Gloves made of textile mixed fabric with copper fibers, breathable, dissipative, seamlessly finished, perfect fit, comfortable to wear.

In compliance with the ESD standard DIN EN 61340-5-1

Available sizes: S, M, L, XL, XXL



dpvlink 411

| Article       | Type   | Size  | Conductive fiber |
|---------------|--|-------|------------------|
| 2070.3355     | ESD glove Copper 100 STANDARD  | S-XXL | Copper           |
| 2070.3355.SET | ESD glove Copper 100 STANDARD, set mixed sizes, 1 pair each size S-XXL |       | Copper           |

### ESD glove Copper 105 AMPERE



Gloves made of textile mixed fabric with copper fibers, breathable, dissipative, seamlessly finished, perfect fit, comfortable to wear

- PU coated fingertips

In compliance with the ESD standard DIN EN 61340-5-1 

Available sizes: S, M, L, XL, XXL



**dpvlink 415** 

| Article       | Type   | Size  | Conductive fiber |
|---------------|--|-------|------------------|
| 2070.4105     | ESD glove Copper 105 AMPERE  | S-XXL | Copper           |
| 2070.4105.SET | ESD glove Copper 105 AMPERE, set mixed sizes, 1 pair each size S-XXL |       | Copper           |

### ESD glove Copper 110 VOLT



Gloves made of textile mixed fabric with copper fibers, breathable, dissipative, seamlessly finished, perfect fit, comfortable to wear

- PU coated palm and fingertips

In compliance with the ESD standard DIN EN 61340-5-1 

Available sizes: S, M, L, XL, XXL



**dpvlink 417** 

| Article       | Type   | Size  | Conductive fiber |
|---------------|--|-------|------------------|
| 2070.4110     | ESD glove Copper 110 VOLT  | S-XXL | Copper           |
| 2070.4110.SET | ESD glove Copper 110 VOLT, set mixed sizes, 1 pair each size S-XXL |       | Copper           |

### ESD glove Copper 115 MICRODOTS



Gloves made of textile mixed fabric with copper fibers, breathable, dissipative, seamlessly finished, perfect fit, comfortable to wear

- palm with PVC micro dots

In compliance with the ESD standard DIN EN 61340-5-1 

Available sizes: S, M, L, XL, XXL



**dpvlink 413** 

| Article       | Type  | Size  | Conductive fiber |
|---------------|---|-------|------------------|
| 2070.4115     | ESD glove Copper 115 MICRODOTS  | S-XXL | Copper           |
| 2070.4115.SET | ESD glove Copper 115 MICRODOTS, set mixed sizes, 1 pair each size S-XXL |       | Copper           |

### Textile gloves CUT

#### Cut protection glove CUT-505



Gloves of textile mixed fabric with carbon fibers (Chineema 400D, nylon 75D, Spandex 40D), back of the hand breathable, dissipative, seamless, comfortable to wear

- PU-coated palm and fingertips
- cut resistance class 5

In compliance with the ESD standard DIN EN 61340-5-1 

Available sizes: S, M, L, XL, XXL



**dpvlink 19674** 

| Article   | Type                                  | Size  | Conductive fiber |
|-----------|---------------------------------------|-------|------------------|
| 2070.4505 | Cut protection glove ESD Type CUT-505 | S-XXL | Carbon           |

Polyester gloves

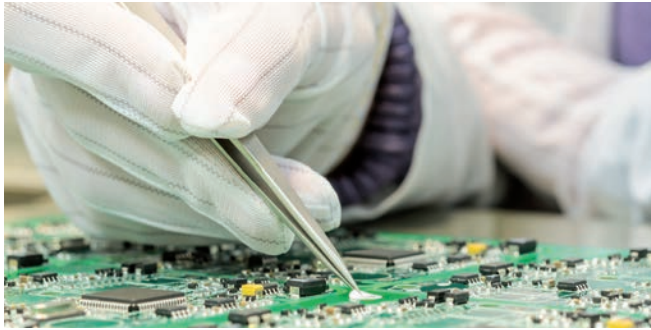

The gloves made of polyester with woven, conductive carbon fibers have good dissipation values and are suitable for the use in cleanrooms.

ESD glove YUKO



ESD gloves YUKO made of polyester with conductive carbon fiber

- lint-free
- dissipative

In compliance with the ESD standard DIN EN 61340-5-1 ⚠

Available sizes: S, M, L, XL



dpvlink 425

| Article       | Type   | Size |
|---------------|--|------|
| 2071.5201     | ESD glove YUKO Eco   | S-XL |
| 2071.5201.SET | ESD glove YUKO Eco, set mixed sizes, 1 pair each size S-XL |      |

ESD gloves MEGUMI



ESD gloves MEGUMI made of polyester with conductive carbon fiber

- PU coated palm (antistatic)
- lint-free
- dissipative

In compliance with the ESD standard DIN EN 61340-5-1 ⚠

Available sizes: S, M, L, XL



dpvlink 22641

| Article       | Type   | Size |
|---------------|--|------|
| 2071.5233     | ESD gloves MEGUMI Eco  | S-XL |
| 2071.5233.SET | ESD glove MEGUMI Eco, set mixed sizes, 1 pair each size S-XL |      |

ESD glove MIKA



ESD gloves MIKA made of polyester with conductive carbon fiber

- lint-free
- dissipative
- palm with plastic dots (antistatic)

In compliance with the ESD standard DIN EN 61340-5-1 ⚠

Available sizes: S, M, L, XL



dpvlink 421

| Article       | Type  | Size |
|---------------|---|------|
| 2071.5241     | ESD glove MIKA Eco  | S-XL |
| 2071.5242     | ESD glove MIKA Eco II with cuffs  | S-XL |
| 2071.5241.SET | ESD glove MIKA Eco, set mixed sizes, 1 pair each size S-XXL               |      |
| 2071.5242.SET | ESD glove MIKA Eco II avec cuffs, set mixed sizes, 1 pair each size S-XXL |      |

Gloves series TEGERA

ESD glove TEGERA 30



ESD glove TEGERA 30 made of goatskin with nylon back

- high-quality materials
- dissipative
- reinforced index finger
- better fit due to elastic band

In compliance with the ESD standard DIN EN 61340-5-1 ⚠

Available sizes: 5, 6, 7, 8, 9, 10, 11



dpvlink 12925

| Article       | Type                | Size | Color        |
|---------------|---------------------|------|--------------|
| 2070.TEGERA30 | ESD glove TEGERA 30 | 5-11 | blue / white |

### ESD glove TEGERA 9101

ESD glove TEGERA 9101 made of Microthan/nylon/carbon fiber

- high-quality materials
- dissipative
- chrome- and silicone-free
- better fit due to elastic band

In compliance with the ESD standard DIN EN 61340-5-1 

Available sizes: 5, 6, 7, 8, 9, 10



**dpvlink 12927**

| Article         | Type                  | Size | Color         |
|-----------------|-----------------------|------|---------------|
| 2070.TEGERA9101 | ESD glove TEGERA 9101 | 5-10 | black / white |



### ESD glove TEGERA 805

ESD glove TEGERA 805 made of 90% nylon, 10% carbon fibers

- breathable
- high-quality materials
- fulfills IEC 61340-5-1
- comfortable
- suitable for dry and clean areas

In compliance with the ESD standard DIN EN 61340-5-1 

Available sizes: 6, 7, 8, 9, 10, 11



**dpvlink 19593**

| Article        | Type                 | Size | Color |
|----------------|----------------------|------|-------|
| 2070.TEGERA805 | ESD glove TEGERA 805 | 6-11 | grey  |



### ESD glove TEGERA 810

ESD glove TEGERA 810 made of 80% nylon, 10% polyurethane, 10% carbon fibers

- PU-coated fingertips
- high-quality materials
- fulfills IEC 61340-5-1
- suitable for the use in dry areas and cleanrooms

In compliance with the ESD standard DIN EN 61340-5-1 

Available sizes: 5, 6, 7, 8, 9, 10, 11



**dpvlink 19591**

| Article        | Type                 | Size | Color |
|----------------|----------------------|------|-------|
| 2070.TEGERA810 | ESD glove TEGERA 810 | 5-11 | grey  |



### ESD glove TEGERA 811

ESD glove TEGERA 811 made of 60% nylon, 30%, polyurethane, 10% carbon fibers

- PU-coated palm
- comfortable
- fulfills IEC 61340-5-1
- robust
- suitable for dry areas and cleanroom

In compliance with the ESD standard DIN EN 61340-5-1 

Available sizes: 6, 7, 8, 9, 10



**dpvlink 19589**

| Article        | Type                 | Size | Color        |
|----------------|----------------------|------|--------------|
| 2070.TEGERA811 | ESD glove TEGERA 811 | 6-10 | grey / white |



Disposable gloves

Disposable nitrile gloves ESD



- antistatic
- powder-free and silicone-free
- textured gripping surface
- 100% nitrile
- available sizes: S (7), M (8), L (9), XL (10)

dpvlink 23094

| Article   | Size | L [mm] | Thickness [mm] | PU              |
|-----------|------|--------|----------------|-----------------|
| 2750.7550 | S-XL | 240    | 0,10           | 100 piececarton |
| 2750.7565 | S-XL | 300    | 0,15           | 50 piece carton |



ESD disposable vinyl gloves



- antistatic
- long design
- suitable for ISO 5
- PU = 1.000 pcs per box
- Available sizes: S, M, L, XL

dpvlink 427

| Article  | Type        | Size |
|----------|-------------|------|
| 2750.000 | Vinyl glove | S-XL |



Underneath half-finger glove



- light nylon fabric
- suitable for wearing underneath vinyl gloves
- unlimited sensivity of the fingertips
- one size fits all

dpvlink 429

| Article   | Type                         | Size              |
|-----------|------------------------------|-------------------|
| 2071.9913 | Underneath half-finger glove | One size fits all |



Finger cots

Finger cots, antistatic



Finger cots are important when handling sensitive components. They assure the protection of the products against static discharge and avoid finger prints.

antistatic  
PU = 1440 pcs

dpvlink 435

| Article  | Type                       | Size | Color |
|----------|----------------------------|------|-------|
| 2750.100 | Finger cots latex          | S-XL | rose  |
| 2750.105 | Finger cots nitrile        | S-XL | white |
| 2750.101 | Finger cots latex textured | S-XL | rose  |



Finger cots, conductive



Finger cots are important when handling sensitive components. They assure the protection of the products against static discharge and avoid finger prints.

conductive  
PU = 1440 pcs.

dpvlink 433

| Article  | Type        | Material             | Size | Color |
|----------|-------------|----------------------|------|-------|
| 2750.110 | Finger cots | natural rubber latex | S-XL | black |



Hygiene solutions

Transparent hygiene panel ESD with dissipative coating

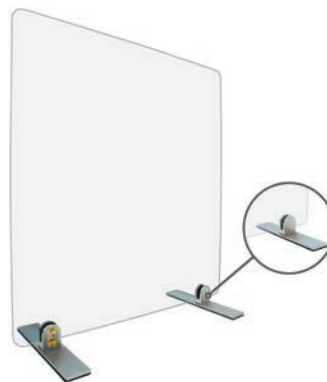

ESD hygiene panel with feet for mounting on workstations. Effective separation of workspaces.

- ESD hygiene panel transparent
- PC 120 ESD polycarbonate with dissipative coating
- rounded corners
- with grounding connection (10 mm snap)
- high impact resistance
- suitable for cleanrooms
- with 2 feet
- quick and easy mounting

In compliance with the ESD standard DIN EN 61340-5-1

dpvlink 23946

| Article   | W [mm] | H [mm] | Thickness [mm] |
|-----------|--------|--------|----------------|
| 5231.HSW1 | 600    | 650    | 4              |
| 5231.HSW2 | 600    | 1000   | 5              |



Special sizes available on request

**Medical masks**

**Disposable mask medical mask type II R** **NEU**

**Medical disposable mask type II**

Protects the wearer and the people in the surroundings



- 100% polypropylene non-woven fabric
- with meltblown filter layer
- 3 layers
- bacterial filter performance (BFE) ≥ 98%
- metal stripe for optimal fit
- one size fits all
- medical mask with CE marking
- **self-protection / protection of others**
- made in Europe
- complies with the standard EN 14683+AC:2019

PU = box with 50 pieces

**dpvlink 24899** 

| Article       | Style | Color | Size     | PU       |
|---------------|-------|-------|----------|----------|
| 2795.200.MM.R | mask  | white | one size | 50 piece |

**Disposable mask medical mask type II** **NEU**



**Medical disposable mask type II**

- 100% polypropylene non-woven fabric
- with meltblown filter layer
- 3 layers
- bacterial filter performance (BFE) ≥ 98%
- metal stripe for optimal fit
- one size fits all
- made in Europe
- complies with the standard EN 14683+AC:2019

PU = box with 50 pieces



**dpvlink 24454** 

| Article     | Style | Color | Size     | PU       |
|-------------|-------|-------|----------|----------|
| 2795.200.MM | mask  | white | one size | 50 piece |

**Disposable mask / hygienic mask** **NEU**



**Hygienic disposable mask**

- with ear band
- 100% polypropylene
- hydrophobic non-woven fabric
- 3 layers
- 12.5 cm metal stripe for optimal fit
- one size fits all
- made in Europe

PU = box with 50 pieces



**dpvlink 24453** 

| Article  | Style | Color | Size     | PU       |
|----------|-------|-------|----------|----------|
| 2795.200 | mask  | white | one size | 50 piece |

**Disinfection / disinfectant cleaners**

**SaniSchutz Hand sanitizer** **NEU**

Hand sanitizer against envelope viruses.



- for a hygienic hand disinfection on washed, dry hands
- excellent immediate effect
- excellent tolerance even with long-term application
- higher skin moisture in case of multiple use
- consumption approx. 3 ml per application

**dpvlink 23917** 

| Article      | Type   |
|--------------|--|
| 2900.605.100 | <b>SaniSchutz Hand sanitizer</b><br>100 ml bottle    |
| 2900.605.5   | <b>SaniSchutz Hand sanitizer</b><br>5 liter canister |

**SaniSchutz Surface disinfectant** **NEU**

Ready-made surface disinfectant with virucidal, bactericidal and fungicidal effect.



- ready-made solution for wipe disinfection
- suitable for dissipative surfaces
- suitable for non-porous, hard, washable (water-resistant) surfaces and things
- good cleaning effect at a comparatively low pH value
- available as spray bottle (500 ml) or canister (10 liters)
- consumption approx. 500 ml for 10 m<sup>2</sup>

**dpvlink 23920** 

| Article      | Type  |
|--------------|---|
| 2900.610.500 | <b>SaniSchutz Surface disinfectant</b><br>500 ml spray bottle |
| 2900.610.10  | <b>SaniSchutz Surface disinfectant</b><br>10 liter canister   |

EPAclean®



Quick and simple cleaning for conductive surfaces in ESD areas. Clean reliably your work place and table coverings as well as floorings and other surfaces. The high-quality of the new

EPAclean cleaning series professional is ready-to-use and available as spray bottle and refill canister. When used for maintenance cleaning the EPAclean concentrate ESD Floor Cleaner professional is very economical. If a basic cleaning is necessary, the ESD Basic cleaner professional concentrate produces excellent results.

ESD Cleaner professional



EPAclean® ESD Cleaner professional for the quick and easy cleaning of ESD surfaces



- ready-to-use cleaner
- binds loose dust and fine dirt in a hygienic way
- cleans without streaking and does not build up layers
- spray nozzle allows damp-wiping due to a controlled and well-measured dispersion of the cleaner
- prevents overdosage and swelling effects caused by excessive moisture
- surface dries completely and is usable within a very short period of time

dpvlink 22449

| Article   | Type  |
|-----------|---|
| 2920.2001 | EPAclean® ESD Cleaner Professional 1l aerosol       |
| 2920.2005 | EPAclean® ESD Cleaner Professional 5 liter canister |



ESD Floor Cleaner professional



EPAclean® ESD Floor Cleaner professional suitable for the maintenance cleaning of ESD floors

- excellent dirt-binding characteristics, even with greasy residues
- no leaching of the surface
- no formation of grey haze
- cleaning without stripes
- concentrate
- dilution ratio 1:200

dpvlink 22452

| Article     | Type   |
|-------------|--|
| 2920.2010.K | EPAclean® ESD Floor Cleaner Professional 10 liter canister |



ESD Basic Cleaner professional



EPAclean® ESD Basic Cleaner professional for the gentle and effective basic cleaning of ESD floors

- for the removal of waxes, wash products, care coatings as well as adhesive residues and building dirt during the final cleaning after construction work with a given PU treatment at the factory
- high dissolving power and of gentle low alkalinity
- all-purpose basic cleaner for all elastic floorings
- concentrate
- dilution ratio 1:10

dpvlink 22454

| Article     | Type   |
|-------------|--|
| 2920.2050.K | EPAclean® ESD Basic cleaner Professional 5l canister |



ESD Swivel chairs EPAchair®



EPAchair® ESD work swivel chairs ensure ergonomics and ESD safety at the workstation. Carefully selected material and components guarantee a high quality. Different models, options, upholstery and colors enable an optimal integration in the respective work environments. You can choose between different models, starting from the climbing aid to the ergonomic work swivel chair. All models of the EPAchair® series are ESD-compliant according to DIN EN 61340-5-1

⚡



All models of the der EPAchair® ESD work swivel chairs are produced in Germany



Highlights EPAchair® swivel chairs



1. Adjustable seat tilt
2. Different ESD upholstery covers
  - ESD Dralon fabric
  - ESD SKAI synthetic leather
  - conductive PU solid material
3. Adjustable seat depth
4. Dissipative seat outer shell
5. Made in Germany
6. Weight up to 130 kg
7. Dissipative safety double castors or glides
8. ESD-compliant according to DIN EN 61340-5-1 ⚡
9. Adjustable seat height
10. Multifunctional armrest (optional)
11. Dissipative back outer shell



All information about the ESD swivel chairs EPAchair® is clearly summarized in the current leaflet available

- as online catalog
- as download





**Fabric dralon® ESD**

available in:

- black
- anthracite
- blue
- medium blue
- bordeaux

**Advantages**

- soft and comfortable
- breathable
- washable

**Synthetic leather skai® ESD**

available in:

- black

**Advantages**

- soft and comfortable
- washable
- insensitive to oil
- hard-wearing

All upholstery types comply with the ESD standard DIN EN 61340-5-1 

 **ESD-sicher**  
Entspricht ESD-Norm DIN EN 61340-5-1

 **Sitzhöhenverstellung**  
modellabhängig mit Gasfeder auf bis zu 83 cm

 **Sitztiefe verstellbar**

 **Sitzneigeverstellung**  
Fördert eine ergonomische Haltung

 **Rückenlehnerhöhung**  
Rückenlehne in der Höhe entsprechend der Körpergröße anpassbar

 **Permanentkontaktrückenlehne**  
Ermöglicht den dauerhaften Kontakt zwischen Lehne und Rücken

 **Gewichtsregulierung**  
Individuell auf das Körpergewicht einstellbarer Rückenlehnen-Gegendruck für eine dynamische Sitzhaltung

 **Asynchronmechanik**  
Neigungswinkel von Rückenlehne und Sitzfläche können unabhängig voneinander angepasst werden

 **Verfügbar mit leitfähigem Bezug aus Stoff dralon® ESD**  
Entspricht ESD-Norm DIN EN 61340-5-1

 **Verfügbar mit leitfähigem Bezug aus Kunstleder skai® ESD**  
Entspricht ESD-Norm DIN EN 61340-5-1

 **Leitfähiges Polster aus Polyurethan**  
Entspricht ESD-Norm DIN EN 61340-5-1

 **Made in Germany**  
Alle EPAchair® ESD-Drehstühle werden in Deutschland hergestellt

ESD Swivel chair Comfort 5000



- Stepless seat height adjustment by safety gas spring, seat height approx. 46 -59 cm
- **Seat adjustable in tilt and depth**
- Seat surface 50 x 45 cm
- Backrest adjustable in height (steplessly) and tilt
- Backrest height approx. 55 cm
- Individual asynchronous adjustment of seat and backrest
- Permanent contact backrest
- Functions adjustable to the body weight
- Polished aluminum base
- In compliance with the ESD standard DIN EN 61340-5-1 
  - conductive upholstery
  - dissipative safety double castors
  - **dissipative back outer shell**
  - **dissipative seat outer shell**



Stoff schwarz .100-ESD    Stoff blau .220-ESD    Stoff mittelblau .225-ESD    Stoff bordeauxrot .250-ESD



**dpvlink 20722**

Article 023.5000    Type **ESD Swivel chair Comfort 5000**



Accessories DPV Comfort 5000



**dpvlink 20933**

Article 023.2474-ESD    **Multifunction armrest ESD**  
for swivel chair DPV Comfort 5000  
Plastic black (set = 2 pieces)



ESD Swivel chair CLASSIC Comfort



- Stepless seat height adjustment by safety gas spring, seat height approx. 43 - 55 cm / 57 - 83 cm
- Seat adjustable in tilt and depth
- Seat surface 57 x 44 cm / 50 x 45 cm
- Backrest adjustable in height (steplessly) and tilt
- Backrest height approx. 40 cm / 50 cm
- Individual asynchronous adjustment of seat and backrest
- Permanent contact backrest
- Functions adjustable to the body weight
- Polished aluminum base
- In compliance with the ESD standard DIN EN 61340-5-1 ⚡
  - conductive upholstery
  - dissipative safety double castors
  - **dissipative back outer shell**
  - **dissipative seat outer shell**

Model Comfort-plus with seat depth adjustment and larger seat surface



dpvlink 14583

Article Type



023.2600 **ESD Swivel chair CLASSIC Comfort**  
 Seat height: 43-55 cm  
 Backrest height approx. 40 cm  
 dissipative safety double castors for hard surfaces

dpvlink 14583

Article Type



023.2603 **ESD Swivel chair CLASSIC Comfort**  
 Seat height: approx. 43 - 55 cm  
 Backrest height approx. 50cm  
 dissipative safety double castors for hard surfaces



023.2604 **ESD Swivel chair CLASSIC Comfort-plus**  
 Seat height: approx. 46 - 59 cm  
 Seat surface 50 x 45 cm  
 Backrest height approx. 50 cm  
 seat depth adjustment  
 dissipative safety double castors for hard surfaces



023.2620 **ESD Swivel chair CLASSIC Comfort**  
 High chair with seat height: approx. 57-83 cm  
 Backrest approx. 40 cm  
 Height-adjustable foot ring  
 dissipative glides

Accessories CLASSIC



dpvlink 14896

Article



023.2462-ESD **Multifunctional armrest ESD** for swivel chair CLASSIC Comfort plastic black (set = 2 pieces)



023.2463-ESD **Multifunctional armrest ESD** for swivel chair CLASSIC Comfort-plus plastic black (set = 2 pieces)



023.2490-ESD **ESD castors soft for hard floors**  
 Set = 5 pieces



023.2495-ESD **ESD castors hard for soft floors**  
 Set = 5 pieces



023.2499-ESD **ESD glides**  
 Set = 5 pieces



023.2480 **Extended gas spring (extra charge)**  
 Extension  
 seat height 51-68 cm with series Classic  
 seat height 55-73 cm with Classic Comfort-plus and DPV Comfort 5000  
 lift approx. 200 mm

ESD Swivel chair CLASSIC Ergonomic



- Ergonomically shaped, disk-friendly seat surface
- Stepless seat height adjustment by safety gas spring, seat height approx. 43 -55 cm
- Seat adjustable in tilt
- Seat surface 47 x 44 cm
- Backrest adjustable in height (stepwise) and tilt
- Backrest height approx. 40 cm / 50 cm
- Individual asynchronous adjustment of seat and backrest
- Permanent contact backrest
- Functions adjustable to the body weight
- Polished aluminum base
- In compliance with the ESD standard DIN EN 61340-5-1 
  - conductive upholstery
  - dissipative safety double castors
  - **dissipative back outer shell**
  - **dissipative seat outer shell**



| dpvlink 14582 |  |
|---------------|--|
| Article       | Type   |
| 023.2700      | <b>ESD Swivel chair CLASSIC Ergonomic</b><br>backrest approx. 40 cm<br>dissipative safety double castors for hard surfaces |
| 023.2703      | <b>ESD Swivel chair CLASSIC Ergonomic</b><br>backrest approx. 50 cm<br>dissipative safety double castors for hard surfaces |

Accessories CLASSIC Ergonomic



**dpvlink 20932**

Article  
023.2461-ESD **Multifunctional armrest ESD**  
for swivel chair CLASSIC Ergonomic  
plastic black (set = 2 pieces)

ESD Swivel chair CLASSIC Economy



- Stepless seat height adjustment by safety gas spring, seat height approx. 43 -55 cm
- Seat surface 46 x 44 cm
- Backrest adjustable in height (stepless) and tilt
- Backrest height approx. 40 cm
- Polished aluminum base
- In compliance with the ESD standard DIN EN 61340-5-1 
  - conductive upholstery
  - dissipative safety double castors
  - **dissipative back outer shell**
  - **dissipative seat outer shell**



| dpvlink 14581 |  |
|---------------|--|
| Article       | Type   |
| 023.2500      | <b>ESD Swivel chair CLASSIC Economy</b><br>dissipative safety double castors for hard surfaces |

Accessories CLASSIC Economy



**dpvlink 20931**

Article  
023.2460-ESD **Multifunctional armrest ESD**  
for swivel chair CLASSIC Economy  
plastic black (set = 2 pieces)

Measurement and test equipment

EPApro® Personnel Tester 1000

EPApro® Personnel Tester 1000



EPApro® 1000 is a modern and compact tester for the testing of personnel grounding and fulfills the latest requirements of DIN EN ISO 61340-5-1, ANSI ESD S20.20 and GDPR (General Data Protection Regulation). Programmable switch outputs allow for the use as access control system.

The integrated Multi-RFID reader enables the personal identification with present RFID cards or chips. EPApro® allows to record the measurements conforming to standards and in compliance with GDPR.

It is possible to connect several EPApro® Personnel Testers 1000 with the optionally available EPApro® Control Server via the company network and to manage the EPApro® devices from a central point. The data are stored centrally in the server database.



Properties:

- 7" HD color touch screen display
- Graphic user interface with intuitive operation
- Multicore processor-controlled
- Personal identification with integrated Multi-RFID reader (all common standards, existing ID cards can be used further on)
- configurable measuring functions
- Hands-Free mode
- Quick **measurement in less than 2 seconds**
- Password-protected access for administrators and managers
- Privacy mode adjustable (recording and display without names, GDPR-compliant)
- Reduced personal measuring voltage adjustable for individual persons
- Time synchronization via network
- password-protected access for administrators and managers
- Privacy mode adjustable (recording and display without names, GDPR-compliant)
- Reduced personal measuring voltage adjustable for individual persons
- can be networked via WLAN (optionally via USB WLAN adapter)
- „Stand Alone“ operation or connectable via the EPApro® Control Server
- Standard testing according to IEC / DIN EN 61340-5-1 and ANSI ESD S20.20
- Recording and display of the measurements in the device (5000 measurements)
- Measurement and logging of temperature and humidity per measurement
- adjustable languages German and English
- 2 configurable switching outputs e.g. for access control systems
- Menu-guided calibration function with logging  
- no sending of the device for calibration necessary
- **Made in Germany**



In connection with the optionally available EPApro® Control Server (see also EPApro® Control Server)

- EPApro® 1000 devices remotely configurable with EPApro® Control Server from a central point
- Networking, also across locations via VPN
- Networking of EPApro® devices and management of the data in a central database
- comprehensive export and import functions
- Printing of reports
- Filtering of displayed data
- REST-API interface for the data connection to third-party systems
- UTC time synchronization
- In case of network failure or maintenance work on the server the measuring data are buffered in the EPApro® devices and synchronized with reavailability of the EPApro® Control Server

Scope of delivery:

- EPApro® Personnel Tester 1000 (table-top or wall-mounted device)
- Power supply unit
- integrated Multi-RFID reader
- Footwear electrode
- Operating manual German
- Factory's calibration certificate

For accessories see [dpv/link 21905](#):

- Striking **divider** for a reliable measurement
- **ID cards** blank white, printable
- EPApro® **calibration unit** for a recommended calibration every two years

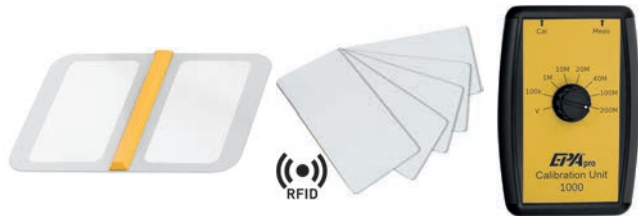

WLAN adapter for EPApro®

The EPApro® can be connected to a network via LAN or optionally via WLAN. WLAN adapter, USB, transmission up to 150 Mbit/s for EPApro® devices.

Upgrade the EPApro® Personnel Tester with a pedestal oder use it in connection with an access control system (e.g. a turnstile) and apply the Hands-free mode.

Possible applications:



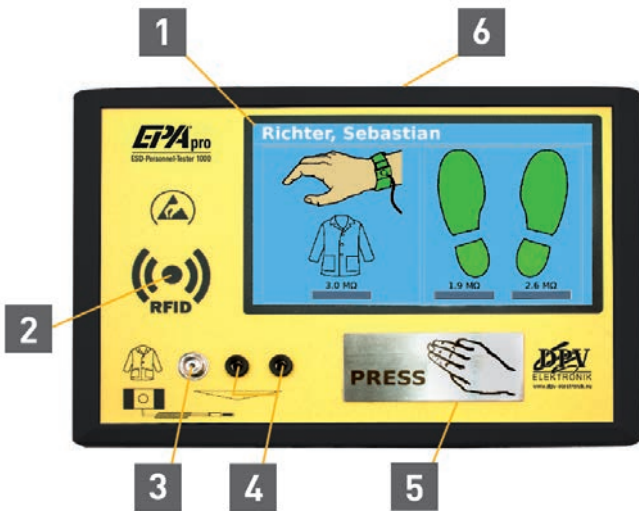

1. 7" HD color touch screen display
2. integrated Multi-RFID reader
3. Connection snap 10 mm
4. 2 x banana sockets  
other connectors possible with adapter
5. Contact plate
6. further connectors at rear of the device:  
power supply, 2 x USB, Ethernet, switching output 2 x PhotoMOS Relais (24V / 2A) configurable e.g. for door opener, temperature and humidity sensor, calibration connection, connection for footwear electrode L+ R

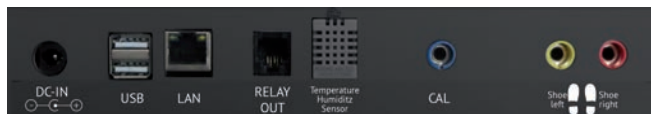

### Technical data

|                               |   |
|-------------------------------|---|
| Voltage                       | 100 - 230 V / AC                                      |
| Power                         | approx. 6 W (9V / DC)                                 |
| Operation conditions          | +10 to + 40°C / up to 75% relative humidity           |
| Storage conditions            | +10 to + 60°C / up to 75% relative humidity           |
| Display test result           | 7" HD color touch screen display                      |
| Tolerance T/H sensor          | ±2°C / ±5% r.h.                                       |
| Testing time                  | < 2 seconds   |
| Test voltage                  | selectable: 30V, 50V, 100V                            |
| Dimensions                    | 265 x 180 x 100 mm                                    |
| Weight                        | 1 kg  |
| Footwear electrode dimensions | 500 x 350 x 8 mm                                      |
| Footwear electrode weight     | 2.6 kg  |
| Version                       | wall-mounted or table-top unit (for turnstiles, etc.) |

### Measurements:

- quick measurements < 2 seconds of wriststraps, work coats and shoes
- simultaneous measurement of wriststraps and shoes
- Hands-Free measurement (measurement by stepping on the footwear electrode)
- test voltage, measuring mode and thresholds configurables
- several special functions e.g. "1 test per day"

Test voltage 100V / 50V / 30V DC - tolerance ±5%

| Measurement   | Measuring range<br>Upper thresholds | Measuring range<br>Lower thresholds |
|---|-------------------------------------|-------------------------------------|
| Wriststrap / coats  | 1 MΩ - 200 MOhm                     | none / 100 KΩ / 750 KOhm            |
| Footwear worn against metal plate<br>(value per shoe)       | 1 MΩ - 200 MOhm                     | none / 100 KΩ / 750 KOhm            |
| Footwear measurement as<br>"series connection" (Hands-free) | 1 MΩ - 200 MOhm                     | none / 100 KΩ / 750 KOhm            |

### Evaluation example:

| Datum              | Name/ID                 | Series | Schuh links | schuh recht | HGB/Kittel | Temp.   | Feucht. | Ergebn |
|--------------------|-------------------------|--------|-------------|-------------|------------|---------|---------|--------|
| 2017-06-26 / 14:03 | 11 - Mertens, Kurt      |        | 4.2 MΩ      | 7.0 MΩ      | 2.6 MΩ     | 27.6 °C | 43.5 %  | PASS   |
| 2017-06-26 / 14:03 | 12 - Kramer, Hubert     |        | 4.1 MΩ      | 6.8 MΩ      | 2.6 MΩ     | 27.6 °C | 43.5 %  | PASS   |
| 2017-06-26 / 14:03 | 23 - Richter, Sebastian |        | 4.2 MΩ      | 6.6 MΩ      | 2.6 MΩ     | 27.5 °C | 43.4 %  | PASS   |
| 2017-06-26 / 14:03 | 11 - Mertens, Kurt      |        | 10.5 MΩ     | 21.7 MΩ     | 3.8 MΩ     | 27.5 °C | 43.4 %  | PASS   |
| 2017-06-26 / 14:03 | 23 - Richter, Sebastian |        | 3.2 MΩ      | 2.5 MΩ      |            | 27.4 °C | 44.0 %  | FAIL   |
| 2017-06-26 / 14:02 | 12 - Kramer, Hubert     |        | 4.4 MΩ      | 5.7 MΩ      | 2.5 MΩ     | 27.4 °C | 44.0 %  | PASS   |
| 2017-06-26 / 14:02 | 23 - Richter, Sebastian |        | 4.3 MΩ      | 5.0 MΩ      | 2.7 MΩ     | 27.4 °C | 44.0 %  | PASS   |
| 2017-06-26 / 14:02 | 11 - Mertens, Kurt      |        |             | 94.4 MΩ     | 2.8 MΩ     | 27.4 °C | 44.1 %  | PASS   |

## EPApro® Personnel Tester 1000

DPV  
ELEKTRONIK

dpvlink 21010



Article Type  
EPApro.1000 **EPApro® Personnel Tester 1000 table-top device**  
For installation on tables or pedestals

- color touch screen display
- integrated Multi-RFID reader
- footwear electrode

EPApro.1000.2W **EPApro® Personnel Tester 1000 wall-mounted device**  
For mounting on walls

- color touch screen display
- integrated Multi-RFID reader
- footwear electrode

## EPApro® Personnel Tester 1000 accessories

DPV  
ELEKTRONIK

dpvlink 21905



Article Type  
EPApro.1001.ID.HF **ID card High Frequency**  
PU = 5 pieces, printable

EPApro.1001.ID.LF **ID card Low Frequency**  
PU = 5 pieces, printable

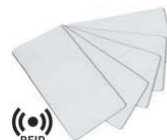

EPApro.1001.TS **Divider for footwear electrode**  
for screwing



EPApro.1001.CU **EPApro® calibration unit 1000**  
including calibration certificate



EPApro.1001.WL1 **EPApro® WLAN Adapter**  
connection via USB  
150 Mbit/s



EPApro.1001.ZPM **Test mat for EPApro®**  
Footwear electrode  
separately available

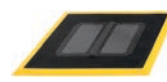

EPApro.1001.ZSF.SET **Pedestal set for EPApro®**  
consisting of:  
pedestal  
holder for EPApro®  
floor mat  
  
EPApro® ESD Personnel  
Tester separately available



further accessory on request

**EPApro® Control Server**



The EPApro® Control Server software enables to manage the measuring data, devices and employees with the EPApro® ESD Personnel testers 1000 connected via the company network.

The data are stored and saved in compliance with GDPR. A privacy mode allows the recording and display of the measurements without names. Import/export and report functions are integrated.

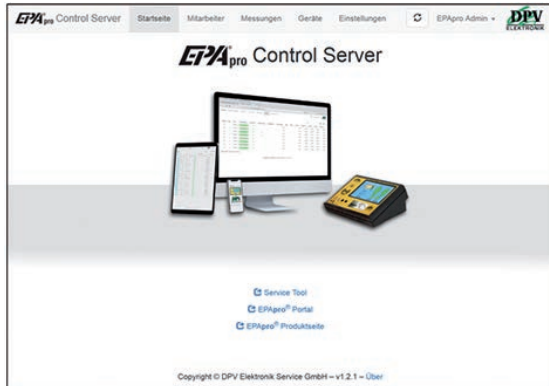

On the EPApro® Control Server all data are stored centrally in a SQL database and the EPApro® devices are synchronized with the parameters on the server. The EPApro® Control Server enables to configure the EPApro® devices from a central point. The access via an internet browser is possible from any computer in the company network.

The rights of the user for the access to an EPApro® 1000 device can be limited in the user profile. In case the EPApro® devices are connected to access control systems, it is possible to control the access to individual manufacturing areas.

For a simpler administration users can be assigned to one or several groups. Groups can be structured hierarchically making it possible to display user and department structures. EPApro® Control Server users obtain access rights to these groups. A department head can e.g. manage and see the employees of his department, a team leader only the employees and measurement reports of his team. So, data can only be managed and seen by authorized persons in compliance with the GDPR.

The EPApro® Control Server software is installed as VM (Virtual Machine) and no further client software needs to be installed.

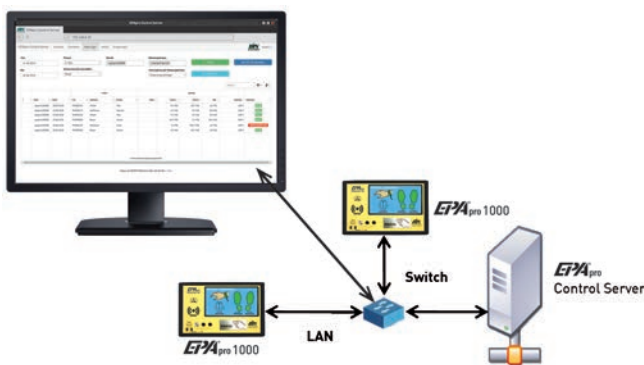

**Advantages:**

- Central data storage on a safe server
- No installation of client software required
- enables central data saving/encoded backups
- Networking with other locations in the company network via Ethernet/VPN
- All EPApro® devices can be managed and configured from a central point
- Central employee database (SQL)
- Central measuring value database (SQL)
- Central management of access authorizations of the employees for individual EPApro® devices 1000
- Communication via encoded data transmission

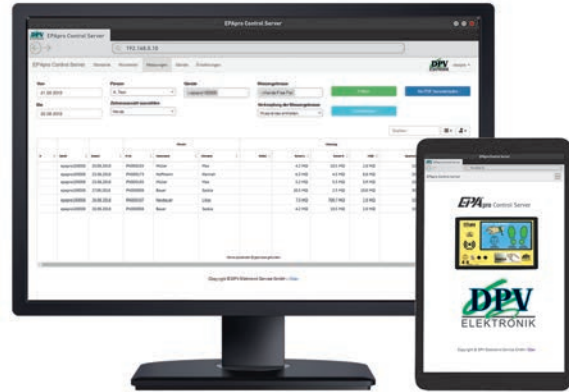

- installation via a Virtual Machine (VM) on a company server
- in case of a network failure or maintenance the measuring data are buffered on the EPApro® 1000 devices and synchronized with the reavailability of the EPApro® Control Server
- easy maintenance of the software via the EPApro® portal
- user management with group function e.g. teams and departments, EPA, laboratory etc.
- rights for the user management can be set via groups
- simple maintenance of the software
- password protection for users
- management of the rights with roles such as manager, administrators, department head

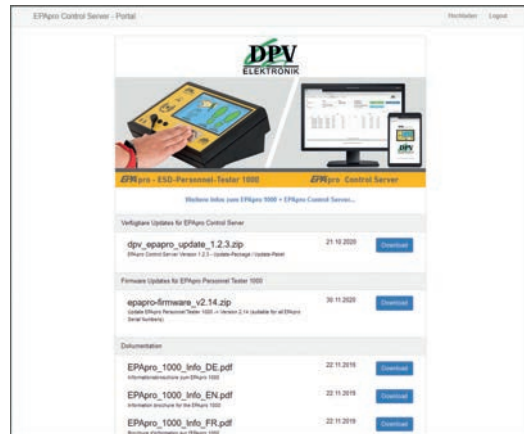

- report functions/audit report as PDF file
- ensures conformity GDPR
- possibility to delete the measurement report automatically after a selectable retention period
- comprehensive import/export functions e.g. with Excel
- key-protected data interface (REST) for automatic connection of external software
- software multilingual (DE/EN/FR)

**Licensing:**

An EPApro® Control Server license is once required. For the connection of the EPApro® 1000 devices an EPApro® device license key is needed for each EPApro® 1000.

| Article          | Type  |
|------------------|---|
| EPApro.1000.LI-1 | <b>EPApro® Control Server license</b><br>1 license to manage the EPApro® Control Server |
| EPApro.1000.LI-2 | <b>EPApro® Personnel Tester device license</b><br>1 license for device management       |

dpvlink 21904



Turnstiles

EPApro® with access control systems



An access control system assures that only authorized persons are authorized to access to limited areas like an EPA protected zones or manufacturing areas.

For the ESD safety it is important that existing personal ESD protective equipment like shoes and / or wriststraps is functional.



In combination with the modern EPApro® personal grounding test system it is possible check and document the function of the personal ESD protective equipment when accessing an EPA protected zone.



The integrated Multi-RFID reader for personal identification retrieves the stored access rights.

The programmable potential-free switch outputs of the EPApro® ESD Personnel Tester 1000 allow activating a door opener or an access control system.

The special functions of the EPApro® ESD Personnel Tester 1000 enable to configure the access in such a way that e.g. a measurement of the personal ESD protective equipment takes place only once a day.

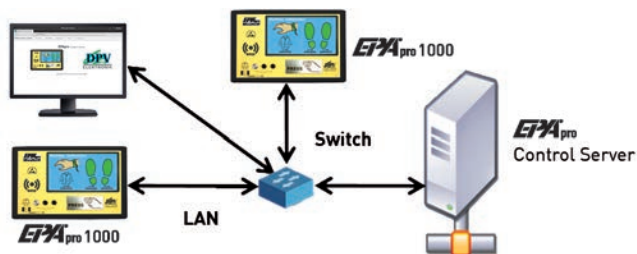

The EPApro® Control Server Software allows for the company-wide networking and a central configuration and administration of the EPApro® ESD Personnel Tester 1000. The logged measured data are centrally stored on the server.

Further information about EPApro® ESD Personnel Tester 1000 is available under [dpvlink 21010](#)

Barrier system COMPACT

Very small and robust construction is suitable for high-frequency entrances. The motorized turnstile Compact has a weather-proof, powder-coated housing with integrated height-adjustable pedestal.



Properties:

- especially compact construction
- 2-arm or 3-arm version
- maintenance-free mechanism
- entrance side can be changed
- high transit flow-rate
- secure traffic separation
- noiseless operation
- height-adjustable
- durable quality
- delivered completely assembled
- suitable for outdoor use



excl. lane divider and base plate

Technical data:

|                        |  |
|------------------------|--|
| Operating voltage:     | 230 V / 50-60 Hz   |
| Power consumption:     | Max. 50 Wh   |
| Storage temperature:   | -40°C to +50°C   |
| Operating temperature: | -20°C to +50°C   |
| Width/passage:         | 305 mm/577 mm  |
| Length:                | 350 mm   |
| Height:                | 1,000 - 1,365 mm   |
| Weight:                | 45 kg  |
| Material:              | steel, powder-coated<br>CrNi steel V2A,<br>material 1.4301 |
| Interfaces:            | potential-free contacts                                    |



Card readers can be attached to the housing by means of a reader bracket. **Optionally available with integrated personnel test station PGT 120.**

The durable quality guarantees a high transit flow-rate. With the one- or two-way operation the turnstile can be used as entrance as well as exit.

[dpvlink 20079](#)



| Article      | Type   |
|--------------|--|
| 6COM.2.AEB-H | <b>Turnstile Compact 2-arm</b><br>Galvanized and plastic-laminated steel                           |
| 6COM.3.AEB-H | <b>Turnstile Compact 3-arm</b><br>Galvanized and plastic-laminated steel                           |
| 6COM.3.AEW   | <b>Turnstile Compact 3-arm including integrated PGT 120</b><br>galvanized and plastic-coated steel |

**Barrier system MODUL CROSS**



With the stainless steel housing the motorized turnstile as 2-arm or 3-arm version is very robust and also suitable for outdoor use.

**Technical data:**

|                        |                                       |
|------------------------|---------------------------------------|
| Operating voltage:     | 230 V / 50-60 Hz                      |
| Consumption:           | 50 Wh                                 |
| Storage temperature:   | -40°C to +50°C                        |
| Operating temperature: | -15°C to +40°C                        |
| Width/passage:         | 275 mm/550 mm                         |
| Length:                | 1,225 mm                              |
| Height:                | 1,025 mm                              |
| Weight:                | 70 kg                                 |
| Material:              | CrNi steel V2A, material 1.4301       |
| Interfaces:            | potential-free contacts, RS485, RS232 |

**Properties:**

- compact construction
- 2-arm or 3-arm version
- maintenance-free mechanism
- entrance side can be changed
- high transit flow-rate
- secure traffic separation
- noiseless operation
- height-adjustable
- durable quality
- delivered completely assembled
- suitable for outdoor use
- easy to service due to tiltable lid



A high transit flow-rate and a maintenance-free mechanism allow for a long useful life. Card readers can be optionally integrated into the housing.

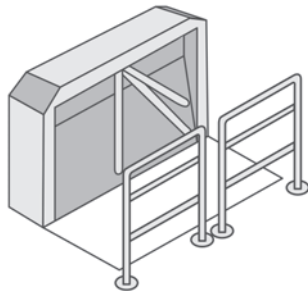

**Drawing:**  
example setup MODUL CROSS

dpvlink 20086

| Article    | Type                                  |
|------------|---------------------------------------|
| 6MCR.2.AEC | Turnstile MODUL CROSS 2-arm motorized |
| 6MCR.3.AEC | Turnstile MODUL CROSS 3-arm motorized |



**Barrier system IKARUS HOLM 1000**



The waist-high motorized swing gate Ikarus Holm is especially suitable for passages that have to be passed with baggage, wheelchairs or bulky goods. Due to its simple design Ikarus Holm fits well in every architecture.

**Properties:**

- waist-high motorized swing gate
- double entrance possible
- smooth running
- maintenance-free mechanism
- entrance side can be changed
- high transit flow-rate
- noiseless operation
- height-adjustable
- durable quality
- delivered completely assembled
- architecture-friendly transparency



**Technical data:**

|                        |                                 |
|------------------------|---------------------------------|
| Power supply:          | 24 V                            |
| Consumption:           | 50 Wh                           |
| Storage temperature:   | -40°C to +50°C                  |
| Operating temperature: | -10°C to +50°C                  |
| Width/passage:         | 900 mm/950 mm                   |
| Length:                | 1,954 mm                        |
| Height:                | 1,000 mm                        |
| Weight:                | 35 kg                           |
| Material:              | CrNi steel V2A, material 1.4301 |
| Interfaces:            | potential-free contacts         |



Also suitable as paired double entrances or for one-/two-way operation. We will be pleased to help you with the implementation of your requirements.

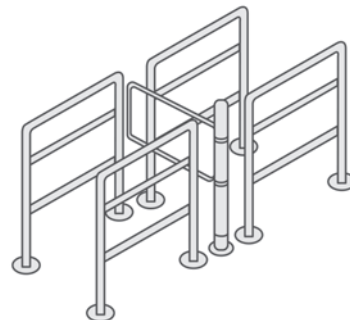

**Drawing:**  
example setup IKARUS HOLM

dpvlink 20082

| Article      | Type                          |
|--------------|-------------------------------|
| 6IKH.1.AEC   | Single swing gate IKARUS HOLM |
| 6IKH.1.AEC.2 | Double swing gate IKARUS HOLM |





## PGT 120 Personnel grounding tester

The personnel grounding tester PGT 120 is a wrist strap and footwear tester used for the access control of ESD protected areas.



- The test result is indicated with visual and acoustic signals. An additional floating relay contact provides the possibility to activate e.g. a door opener or a turnstile for access control.
- Power is supplied via an integrated battery or a power supply unit.
- The separate measuring circuits allow the simultaneous testing of wrist strap, left and right shoe.
- Separate measurement of the contact resistance of the left and right shoe
- In combination with an access control system (e.g. turnstiles), the footwear measurement can be performed in the so-called "hands-free mode" without pressing a button
- Test voltage 30 V, 50 V or 100 volt (default setting)
- The lower limit values can be deactivated.
- Can be used as desktop and wall-mounted device (wall mounting requires an additional wall mounting plate)
- Limit values adjustable via DIP switches



dpvlink 10131

| Article     | Type                               |
|-------------|------------------------------------|
| 7100.PGT120 | Personnel grounding tester PGT 120 |



## Calibration unit for PGT 120



Calibration unit contains resistances with limit values for the on-site verification of the PGT 120 personnel grounding tester ⚠

dpvlink 10133

| Article           | Type  |
|-------------------|---|
| 7100.PGT120.CU    | Calibration unit for PGT 120 with 8 Dip switches  |
| 7100.PGT120.CU.12 | Calibration unit for PGT 120 with 12 dip switches |



## METRISO® 3000 measurement kit



### METRISO® 3000 measurement kit,

consisting of the digital high ohmmeter Metriso® 3000, a pluggable temperature and humidity sensor, USB interface, PC software for Windows®, 2 measuring electrode, 1 hand electrode, measuring cables, user manual (German/English/French), factory calibration certificate and a conductive carrying case with dissipative pink foam according to DIN EN 61340-4-1.



- suitable for measuring of point-to-point resistances and bleeder resistances
- Integrated data memory allows the logging of 50,000 measured values that can be read out via a USB interface to the PC
- Logging software "ETC" facilitates the creation and recording of complete test protocols
- with pluggable sensor for measuring temperature and humidity
- The application of the bar code scanner allows an automatic identification of the measuring points before the measurement

### Technical data:

|                               |  |
|-------------------------------|--|
| Measuring voltage/ ohm range: | 1mA ≤ I ≤ 1.3 mA   |
| measuring current:            | high ohmic range: direct current 10, 100 und 500 V               |
| Measuring range:              | low ohmic range: 0 up to 10kOhm                                  |
|                               | high ohmic range: 1 kOhm bis 1.2 TOhm                            |
| Operation mode:               | battery mode   |
| Electrode:                    | 2 x model 850 with conductive rubber 1 x hand electrode model 45 |



1. USB port
2. interface for temperature/humidity sensor and bar-code scanner
3. 2 sockets for testing the reference resistance 10 MΩ

dpvlink 16556

| Article         | Type   |
|-----------------|--|
| 7100.3000.G     | METRISO® 3000 measurement device                 |
| 7100.3000.MK    | METRISO® 3000 - measurement kit German, complete |
| 7100.3000.SC.D2 | Barcode scanner for 2D and 1D codes              |



### Glove garment electrode

The electrode is designed to measure the bleeder resistance of fingercots and worn gloves according to ANSI / ESD TR53-01-15



- insulating plastic frame with 4 mm banana jack
- contact electrode of stainless steel
- dimensions: 130 x 80 x 40 mm (H x W x D)
- weight: 460 g



dpvlink 19944

| Article | Type   |
|---------|--|
| 7220.15 | Glove garment electrode according to ANSI/ESD TR53-01-15 |



### Clamping electrode



- for the measurement of point-to-point resistances on ESD clothes
- contact surface of stainless steel 50 x 25 mm
- with clamping effect for a good contacting
- connection: 1 banana jack
- corresponds to IEC 61340-4-9



dpvlink 17700

| Article    | Type                             |
|------------|----------------------------------|
| 7220.CL.49 | Clamping electrode PU = 2 pieces |



### Backrest probe



For bleeder resistance measurements of backrests of ESD chairs with conductive contact rubber with silver particles  $R < 5$  ohms.

- Total resistance per electrode  $R < 100$  ohm
- Diameter 63.5 mm
- Insulated handle
- Connection 4 mm banana plug socket

dpvlink 19739

| Article  | Type           |
|----------|----------------|
| 7220.900 | Backrest probe |



### Hand electrode model 450



Hand electrode made of stainless steel  $\varnothing 25$  mm, 75 mm long for measurement of "system resistance person / shoes / ground" and walking test according to DIN EN 61340-4-5 ⚠

dpvlink 8491

| Article  | Type                     |
|----------|--------------------------|
| 7220.450 | Hand electrode model 450 |



### Measuring electrodes

Measuring electrodes for the measurement of the bleeder and surface resistances according to DIN IEC 61340-4-1, DIN EN 61340-2-3 and ⚠  
Connection type: 4 mm sockets

dpvlink 4699

| Article | Type |
|---------|------|
|---------|------|



7220.870

#### Probe model 870

- diameter 63.5 mm / 2.27 kg
- for the measurement of point-to-point and bleeder resistances
- conductive rubber with silver particles ( $R < 100$  Ohm)
- banana plug socket under the insulated handle
- DIN IEC 61340-5-1, 61340-4-1 and 61340-2-3



7220.850

#### Measuring electrode ETS model 850

Cylindrical measuring electrode 850 with handle  $\varnothing 63.5$  mm  
Weight 2.25 kg, conductive contact rubber ( $R < 200$  ohm), Total resistance of the electrode  $R < 150$  ohm  
Scope of delivery: 1 piece



7220.870.V.SET

#### Extension three-part (for probe 870)

for probe 870, for the measurement on floor systems with insulated handle



### EFM®51 Walking Test Kit



EFM®51 with conductive base and measuring head MK 51. By attaching the measuring head MK 51 EFM can be used for the verification measurement of the body voltage (walking test)\* according to IEC 61340-4-5. The measuring head MK 51 is specially calibrated to the EFM®51. The positive and negative "PEAK" value of the measured body voltage is displayed

**Scope of delivery:**

- EFM®51 with measuring head MK 51
- Conductive case
- Conductive base
- Measuring lead and hand electrode

**dpvlink 19761**

| Article       | Type                    |
|---------------|-------------------------|
| 7100.EFM51.WT | EFM®51 Walking Test Kit |



### EFM®51 Verification Kit



Mobile, handy electric field meter with digital display for the measurement of electrostatic fields and charges

- By means of the measuring head MK 51 included in the verification kit it is possible to use the EFM®51 for verifying the measurement of the body voltage (walking test) according to IEC 61340-4-5
- The also included Charged Plate kit allows the measurement of the effectiveness of ionizers and their offset voltages

**Scope of delivery:**

- EFM®51 - CPS (Charged Plate Set)
- EFM®51 - Walking Test Kit
- factory calibration certificate
- conductive carrying case

**dpvlink 21679**

| Article       | Type                    |
|---------------|-------------------------|
| 7100.EFM51.VK | EFM®51 Verification Kit |



### WT 5000.A Walking test kit

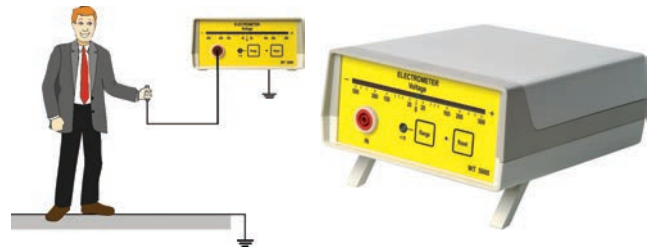

The walking test kit is used mainly to measure the body voltage and their graphical presentation.

The A/D converter can present the measurement data of body voltage "online" on the PC or laptop and as a graphic. 

**Technical data:**

**Electrometer WT 5000 (available also as a single instrument):**

|                       |  |
|-----------------------|--|
| Measuring range:      | ± 5,000 Volts  |
| Measurement accuracy: | 5% of the measured value   |
| Input resistance:     | > 10 <sup>14</sup> ohm   |
| Input capacity:       | < 5 pF   |
| Display:              | logarithmic LED display ± 500 V switchable to ± 5000 V, peak hold function |
| Output                | Analog ± 5V DC for each area   |
| Operating mode:       | Batteries (charger included)   |

**A/D converter:**

|                          |                             |
|--------------------------|-----------------------------|
| Input resistance:        | 1 MOhm                      |
| Interface                | USB 2.0 / USB 1.1 (08.2008) |
| Input voltage:           | ± 5 Volts DC                |
| Resolution:              | 12 Bit                      |
| Max. sampling frequency: | 15 kHz                      |
| Power supply:            | via USB interface           |
| Measuring software:      | for WINDOWS®                |

**Scope of delivery:**

- Electrometer WT5000
- A/D converter
- measuring software Digilloscope (CD-ROM)
- rechargeable batteries
- Hand electrode
- measuring cables and connectors
- Conductive carrying case
- User manual
- Factory calibration certificate

**dpvlink 4695**

| Article       | Type  |
|---------------|---|
| 7100.WT5000.B | WT 5000 walking test kit incl. A/D converter with USB interface |

|                |  |
|----------------|--|
| 7100.WT5000.KA | Calibration incl. certificate for later review, instrument must be sent in |
|----------------|--|



- A**
- ABEBA Professional footwear ..... 18-33
  - Access control ..... 132-137
  - Access control system ..... 132-134
  - Analog-to-digital converter ..... 139
  - ATLAS Professional footwear ..... 59-64
- B**
- BAAK Professional footwear ..... 74-78
  - Backrest electrode ..... 138
  - Barcode scanner ..... 137
  - Barrier system ..... 135
  - BATA Professional footwear ..... 70-72
  - BIRKENSTOCK Professional footwear ..... 16-18
  - Bleeder resistance measurement ..... 137
  - BlueLine work coats ..... 96-97
  - BlueLineWoman work coat ..... 97
  - Bouffant cap ..... 119
  - Business / Manager shoe ..... 30-31, 34, 42, 55, 63
- C**
- Calibration units ----> measuring and testing devices ..... 137
  - Canmat ..... 85-86
  - Cap, reusable ..... 103
  - Caps ..... 113-116
  - Care product shoes ..... 82-83
  - Cargo trousers ..... 113-116
  - Chair - Armrests ..... 130
  - Chair - backrest adjustable ..... 130-131
  - Chair - base aluminium ..... 130-131
  - Chair - ESD castors ..... 130
  - Chair - ESD glides ..... 130
  - Chair - gas spring (extended) ..... 130
  - Chair cover - fabric ..... 130-131
  - Chair cover - synthetic leather ..... 130-131
  - Chair with backrest ..... 130-131
  - Chair with castors ..... 130-131
  - Chair with glides ..... 130
  - Chairs ..... 138
  - Clamping electrode ..... 138
  - Cleaning - shoes ..... 87-88
  - Cleaning, antistatic ..... 128
  - Cleanroom ..... 116-117
  - Clogs ..... 11-16, 19-23, 26, 29, 32, 34
  - Clogs ----> Safety clogs ..... 41, 62
  - Clothes ..... 89-120
  - Clothes with collar ..... 95-103, 107-108, 111-114, 118
  - Clothes with pockets ..... 95-103, 108, 114, 118
  - Clothes, long sleeves ..... 95-103, 108, 111, 113-114
  - Clothes, short sleeves ..... 95-99, 101-102, 106-108, 110-114
  - Coat design - 3/4 long, short sleeves ..... 102
  - Coat design - short, short sleeves ..... 95-98, 101
  - Coat version - 3/4 long, long sleeves ..... 95-98, 100, 102-103
  - Coat version - short, long sleeves ..... 95-98, 101
  - Compact ..... 135
  - Contact heat resistant ..... 125
  - Contact stripes ..... 83-87
  - Contact strips ..... 83-87
  - Cut protection glove ..... 123
- D**
- Dispenser, for overshoes ..... 85
  - Disposable clothes ..... 117-119
  - Disposable cuffs ..... 118
  - Disposable finger cots ..... 126
  - Disposable gloves ..... 126
  - Disposable heel strap ..... 83-87
  - Disposable heel straps ..... 83-87
  - Disposable hood ..... 118
  - Disposable overshoes ..... 83-87
  - Disposable skirt ..... 118
- E**
- Documentation / Archiving ..... 137
  - DPV swivel chairs ..... 129-131
  - DPV workwear ..... 95-99
  - DPV- komfort ..... 11-16, 129
- E**
- Electric field meter ..... 139
  - Electrode ..... 138
  - Electrode, backrest ..... 138
  - Electrode, manual ..... 138-139
  - ELTEN professional footwear ..... 48-55
  - Embroidery ..... 99
  - EPA ..... 85
  - EPA Electrostatic Protected Area ..... 132-134
  - EPAChair ..... 129-131
  - EPAclean ..... 128
  - EPAglove ..... 120-123
  - EPApro 1000 ..... 132-136
  - EPApro Control Server ..... 132-134
  - EPAwear ..... 90-95, 100, 106, 112-113
  - ESD clothes ..... 95-119
  - ESD gloves ..... 120-126
  - ESD shoes ..... 10-80
  - ESD socks ..... 81-82
  - ESD Workwear ..... 89-120
- F**
- Finger cots ..... 126
  - Foil tacky mats ..... 88
  - Footbeds ..... 33, 39, 45, 55, 64, 77-78
  - FTG professional footwear ..... 64-66
- G**
- Gaiter ..... 33
  - Gloves - CARBON ..... 122
  - Gloves - COOPER ..... 122-123
  - Gloves - LEO ..... 120-121
  - Gloves - Palms coated ..... 121-123, 125
  - Gloves - polyester ..... 124
  - Gloves - TEGERA ..... 124-125
  - Gloves - textile ..... 122-123
  - Gloves - textile CUT ..... 123
  - Gloves EPAglove ..... 120-123
  - GreyLine work coats ..... 95
  - GreyLineWoman work coats ..... 96
- H**
- Half-finger gloves ..... 126
- I**
- ID card cover ..... 120
  - Ikarus Holm ..... 136
  - Impregnation spray ..... 83
  - Industrial sole cleaner ..... 88
  - Insulated ..... 138
- J**
- Jackets, winder ..... 113-116
  - JALAS Professional footwear ..... 34-39
- L**
- Lanyards ..... 120
  - LEMAITRE professional footwear ..... 78-79
  - Loafer ..... 25, 32, 34, 41
  - LUPOS professional footwear ..... 46-48
- M**
- Manual electrode ..... 138-139
  - Mask ..... 119
  - Measuring case ..... 137
  - Meters and testers ..... 132-136
  - Metriso 3000 ..... 137
  - Modul Cross ..... 136
  - MyLine workcoats ..... 98-99
- O**
- Orthopedic insoles ..... 81
  - Orthostat ..... 81
  - Overalls ..... 99, 104
  - Overshoes ..... 83-87
  - Overshoes, reusable ..... 85-87
- P**
- Patch ..... 99
  - Permanent heel straps ..... 83-87
  - Permanent sole grounders ..... 84
  - Permanent toe straps ..... 83-87
  - Personnel test station ..... 132-134
  - PGT 120 Personal test station ..... 137
  - Point-to-point resistance measurement ..... 137
  - Polo shirts ..... 106-113
  - PremiumSmooth ..... 112-113
  - Professional footwear ..... 10-80
  - Professional footwear - ABEBA ..... 18-33
  - Professional footwear - ATLAS ..... 59-64
  - Professional footwear - BAAK ..... 74-78
  - Professional footwear - BATA ..... 70-72
  - Professional footwear - BIRKENSTOCK ..... 16-18
  - Professional footwear - DPV komfort ..... 11-16
  - Professional footwear - ELTEN ..... 48-55
  - Professional footwear - JALAS ..... 34-39
  - Professional footwear - SIEVI ..... 40-45
  - Professional footwear - STEITZ SECURA ..... 56-58
  - Professional footwear FTG ..... 64-66
  - PU foam ..... 121-123, 125
- R**
- Reflective vest ..... 113-116
- S**
- Safety boots ..... 38, 61, 72, 75-77
  - Safety shoes ..... 23-32, 34-39, 41-55, 59-66, 71-72, 74-80
  - Safety sneaker ..... 63
  - Sandals ..... 11-14, 16-18, 23, 40-41
  - Secosol ..... 81
  - Shoe care product ..... 82-83
  - Shoe care products ..... 82-83
  - Shoe tester ..... 137
  - SIEVI professional footwear ..... 40-45
  - Slippers ..... 11-18, 23, 40-41
  - Socks ESD ..... 81-82
  - Softshell jacket ..... 113-116
  - SOLAMAT ..... 88
  - Sole cleaner, mechanic ..... 88
  - Sole cleaning ..... 87-88
  - Special footwear ..... 32-33
  - STEITZ SECURA Professional workwear ..... 56-58
  - Suitcase ..... 139
  - Sweat jacket ..... 106-111, 115
  - Sweatshirts ..... 106-111, 115
  - Swivel chairs series CLASSIC ..... 129-131
- T**
- T-shirt ..... 106-113
  - Tacky mats / foils ..... 87-88
  - Tank top ..... 106
  - Testing device ..... 137
  - Thermo-Cool ..... 110-111
  - Toe strap, women ..... 83-87
  - Trousers ..... 99, 104
  - Turnstile ..... 132-136
  - Turnstiles ..... 132-136
  - Tyvek ..... 117-119
- V**
- Vests ..... 113-116
- W**
- Walking - Test kit ..... 139
  - Wall bracket ..... 137
  - Wedge heel ..... 12, 21
  - Winter clothes ..... 113-116
  - Winter jackets ..... 113-116
  - Women's work coat ..... 96-97
  - Work coats ..... 90-103
  - Work coats BlueLine ..... 96-97
  - Work coats GreyLine ..... 95

Work coats MyLine ..... 98-99  
Work shoes ..... 10-80  
Workstation swivel chairs ..... 129-131  
Workwear ..... 89-120

# Alpha-Nummerischer Index

|                 |     |                 |     |                 |        |               |     |                  |          |                   |     |
|-----------------|-----|-----------------|-----|-----------------|--------|---------------|-----|------------------|----------|-------------------|-----|
| 023.2460-ESD    | 131 | 2070.3210       | 121 | 2505.201.K714   | 14     | 2658.T610     | 106 | 2722.GL186-P     | 93       | 6IKH.1.AEC.2      | 136 |
| 023.2461-ESD    | 131 | 2070.3210.SET   | 121 | 2505.201.K717   | 14     | 2658.T610-V   | 106 | 2722.MyLine      | 98       | 6MCR.2.AEC        | 136 |
| 023.2462-ESD    | 130 | 2070.3355       | 122 | 2505.211-1.00   | 15     | 2658.T910     | 106 | 2730.BL180       | 96       | 6MCR.3.AEC        | 136 |
| 023.2463-ESD    | 130 | 2070.3355.SET   | 122 | 2505.211-1.11   | 15     | 2658.TL210    | 106 | 2730.BL180-P     | 94       | 7100.3000.G       | 137 |
| 023.2474-ESD    | 129 | 2070.4105       | 123 | 2505.211-1.16   | 15     | 2658.TL610    | 106 | 2730.BL181       | 96       | 7100.3000.MK      | 137 |
| 023.2480        | 130 | 2070.4105.SET   | 123 | 2505.211-1.51   | 15     | 2658.TQ211    | 106 | 2730.BL182       | 97       | 7100.3000.SC.D2   | 137 |
| 023.2490-ESD    | 130 | 2070.4110       | 123 | 2505.211.00     | 15     | 2658.TQ611    | 106 | 2730.BLW175      | 97       | 7100.EFM51.VK     | 139 |
| 023.2495-ESD    | 130 | 2070.4110.SET   | 123 | 2505.211.11     | 15     | 2658.TT215    | 106 | 2730.MyLine      | 98       | 7100.EFM51.WT     | 139 |
| 023.2499-ESD    | 130 | 2070.4115       | 123 | 2505.211.16     | 15     | 2658.TT615    | 106 | 2731.BL180       | 96       | 7100.PGT120       | 137 |
| 023.2500        | 131 | 2070.4115.SET   | 123 | 2505.211.51     | 15     | 2670.P010     | 107 | 2731.BL180-P     | 94       | 7100.PGT120.CU    | 137 |
| 023.2600        | 130 | 2070.4200       | 122 | 2505.251-1.00   | 15     | 2670.P210     | 107 | 2731.BL181       | 96       | 7100.PGT120.CU.12 | 137 |
| 023.2603        | 130 | 2070.4200.SET   | 122 | 2505.251-1.11   | 15     | 2670.P610     | 107 | 2731.BL182       | 97       | 7100.WT5000.B     | 139 |
| 023.2604        | 130 | 2070.4205       | 122 | 2505.251-1.16   | 15     | 2670.P910     | 107 | 2731.BLW175      | 97       | 7100.WT5000.KA    | 139 |
| 023.2620        | 130 | 2070.4205.SET   | 122 | 2505.251-1.51   | 15     | 2670.SJ.BL    | 109 | 2731.MyLine      | 98       | 7220.15           | 138 |
| 023.2700        | 131 | 2070.4210       | 122 | 2505.251.00     | 15     | 2670.SJ.BL-1  | 109 | 2732.BL180       | 96       | 7220.450          | 138 |
| 023.2703        | 131 | 2070.4210.SET   | 122 | 2505.251.11     | 15     | 2671.S210     | 108 | 2732.BL180-P     | 94       | 7220.850          | 138 |
| 023.5000        | 129 | 2070.4505       | 123 | 2505.251.16     | 15     | 2671.S610     | 108 | 2732.BL181       | 96       | 7220.870          | 138 |
| 061360          | 17  | 2070.TEGERA30   | 124 | 2505.251.51     | 15     | 2671.S910     | 108 | 2732.BL182       | 97       | 7220.870.V.SET    | 138 |
| 061360-1        | 17  | 2070.TEGERA805  | 125 | 2505.261-1.00   | 15     | 2671.SJ.B     | 109 | 2732.BLW175      | 97       | 7220.900          | 138 |
| 061368          | 17  | 2070.TEGERA810  | 125 | 2505.261-1.11   | 15     | 2671.SJ.B-1   | 109 | 2732.MyLine      | 98       | 7220.CL.49        | 138 |
| 061370          | 17  | 2070.TEGERA811  | 125 | 2505.261-1.16   | 15     | 2671.SJ210    | 108 | 2750.000         | 126      | AB-1144           | 33  |
| 061370-1        | 17  | 2070.TEGERA9101 | 125 | 2505.261-1.51   | 15     | 2671.SJ610    | 108 | 2750.100         | 126      | AB-1275           | 30  |
| 061378          | 17  | 2071.5201       | 124 | 2505.261.00     | 15     | 2671.SJ910    | 108 | 2750.101         | 126      | AB-2616           | 29  |
| 061380          | 17  | 2071.5201.SET   | 124 | 2505.261.11     | 15     | 2671.SS.B     | 109 | 2750.105         | 126      | AB-2616-1         | 29  |
| 061380-1        | 17  | 2071.5233       | 124 | 2505.261.16     | 15     | 2672.S215     | 109 | 2750.110         | 126      | AB-31000          | 26  |
| 061388          | 17  | 2071.5233.SET   | 124 | 2505.261.51     | 15     | 2672.S615     | 109 | 2750.7550        | 119, 126 | AB-31001          | 26  |
| 061390          | 17  | 2071.5241       | 124 | 2505.271-1.51   | 14     | 2672.SJ215    | 109 | 2750.7565        | 119, 126 | AB-31010          | 26  |
| 061390-1        | 17  | 2071.5241.SET   | 124 | 2505.271-1.K56  | 14     | 2672.SJ615    | 109 | 2760.AM110       | 103      | AB-31011          | 26  |
| 061398          | 17  | 2071.5242       | 124 | 2505.271-1.K716 | 14     | 2675.P7532    | 112 | 2760.AM110-1.4XL | 103      | AB-31064          | 22  |
| 061400          | 17  | 2071.5242.SET   | 124 | 2505.271-1.K725 | 14     | 2675.P7536    | 112 | 2760.AM110-1.5XL | 103      | AB-31092          | 19  |
| 061400-1        | 17  | 2071.9913       | 126 | 2505.271.K56    | 14     | 2675.P7537    | 112 | 2760.AM120       | 103      | AB-31094          | 19  |
| 061408          | 17  | 2500.B1505      | 82  | 2505.271.K59    | 14     | 2675.PL7542   | 112 | 2760.HB120       | 103      | AB-3110           | 30  |
| 061410          | 17  | 2500.B1508      | 82  | 2505.271.K713   | 14     | 2675.PL7546   | 112 | 2760.PB120.1     | 86       | AB-3120           | 30  |
| 061410-1        | 17  | 2500.B1603      | 82  | 2505.271.K716   | 14     | 2675.T7412    | 113 | 2760.PB120.2     | 86       | AB-3121           | 30  |
| 061418          | 17  | 2500.B1608      | 82  | 2505.271.K717   | 14     | 2675.T7416    | 113 | 2760.PB120.3     | 86       | AB-31378          | 30  |
| 089410          | 17  | 2500.B1612      | 82  | 2505.271.K718   | 14     | 2675.TL7422   | 113 | 2760.PB120.40    | 86       | AB-31628          | 24  |
| 089410-1        | 17  | 2500.B1613      | 83  | 2505.271.K719   | 14     | 2675.TL7426   | 113 | 2760.PCR125.1    | 86       | AB-31629          | 24  |
| 089418          | 17  | 2500.B1620      | 83  | 2505.271.K722   | 14     | 2680.P5522    | 111 | 2760.PCR125.2    | 86       | AB-31676          | 24  |
| 089418-1        | 17  | 2500.W1489.N    | 83  | 2505.271.K725   | 14     | 2680.P5525    | 111 | 2760.PCR125.3    | 86       | AB-31721          | 24  |
| 089420          | 17  | 2500.W1530      | 83  | 2505.275.51     | 14     | 2680.P5526    | 111 | 2770.BK150       | 115      | AB-31760          | 24  |
| 089420-1        | 17  | 2505.011-1.00   | 13  | 2505.275.K56    | 14     | 2680.P5527    | 111 | 2770.BK151       | 115      | AB-31761          | 24  |
| 089428          | 17  | 2505.011-1.11   | 13  | 2505.275.K722   | 14     | 2680.P5528    | 110 | 2780.GL803       | 104      | AB-31762          | 24  |
| 089428-1        | 17  | 2505.011-1.16   | 13  | 2505.275.K952   | 14     | 2680.P6525    | 110 | 2780.GL803-1     | 104      | AB-31763          | 24  |
| 089430          | 17  | 2505.011-1.51   | 13  | 2505.281-1.K725 | 14     | 2680.P6526    | 110 | 2780.GL813       | 104      | AB-31772          | 24  |
| 089430-1        | 17  | 2505.011.00     | 13  | 2505.281.51     | 14     | 2680.P6527    | 110 | 2780.GL813-1     | 104      | AB-31773          | 24  |
| 089438          | 17  | 2505.011.11     | 13  | 2505.281.K722   | 14     | 2680.P6532    | 110 | 2780.GL824       | 104      | AB-31774          | 24  |
| 089438-1        | 17  | 2505.011.16     | 13  | 2505.281.K725   | 14     | 2680.P6536    | 110 | 2780.GL834       | 104      | AB-31775          | 24  |
| 1000.030.1      | 88  | 2505.011.51     | 13  | 2560.801        | 87     | 2680.P6537    | 110 | 2790.100         | 118      | AB-31795          | 24  |
| 1000.030.1.blau | 88  | 2505.011.K722   | 13  | 2560.802        | 87     | 2680.P6512    | 110 | 2790.105         | 118      | AB-32120          | 29  |
| 1000.030.3      | 88  | 2505.011.K725   | 13  | 2560.830.1.60   | 86     | 2680.P6516    | 110 | 2790.110         | 118      | AB-32120-1        | 29  |
| 1000.030.3.blau | 88  | 2505.012.00     | 12  | 2560.835.1.50   | 86     | 2680.P6517    | 110 | 2790.201         | 118      | AB-32125          | 29  |
| 1000.030.3.R    | 88  | 2505.012.16     | 12  | 2560.860.S050   | 85     | 2685.S6552    | 111 | 2790.205         | 117      | AB-32125-1        | 29  |
| 1000.105.3      | 87  | 2505.012.51     | 12  | 2560.860.S100   | 85     | 2685.S6557    | 111 | 2790.206         | 117      | AB-32147          | 29  |
| 1000.105.5      | 87  | 2505.012.K717   | 12  | 2560.860.S110   | 85     | 2685.S6562    | 111 | 2790.207         | 117      | AB-32147-1        | 29  |
| 1000.106.3      | 87  | 2505.021.K956   | 11  | 2560.890        | 84     | 2685.S6567    | 111 | 2790.300         | 118      | AB-32189          | 29  |
| 1000.106.5      | 87  | 2505.021.K975   | 11  | 2560.890.2      | 84     | 2685.SJ5572   | 111 | 2790.305         | 118      | AB-32189-1        | 29  |
| 1000.3900.36-37 | 86  | 2505.021.K982   | 11  | 2560.890.2R     | 84     | 2685.SJ5576   | 111 | 2790.309         | 118      | AB-32238          | 28  |
| 1000.3900.38-39 | 86  | 2505.025.K56    | 12  | 2560.890.3G     | 84     | 2685.SJ5577   | 111 | 2790.310         | 119      | AB-32247          | 29  |
| 1000.3900.40-43 | 86  | 2505.025.K717   | 12  | 2560.890.3G-90  | 84     | 2685.SJ6572   | 111 | 2790.311         | 119      | AB-32251          | 28  |
| 1000.3900.44-46 | 86  | 2505.026.K961   | 11  | 2560.890.HGS    | 84     | 2685.SJ6576   | 111 | 2790.312         | 119      | AB-32252          | 28  |
| 1000.3900.47-48 | 86  | 2505.026.K966   | 11  | 2560.891        | 84     | 2685.SJ6577   | 111 | 2790.315         | 118      | AB-32255          | 29  |
| 1000.3910.36-37 | 86  | 2505.026.K968   | 11  | 2560.891.2R     | 84     | 2691.5.Namen  | 99  | 2790.316         | 118      | AB-32282          | 29  |
| 1000.3910.38-39 | 86  | 2505.027.K925   | 11  | 2560.891.3G     | 84     | 2701.ECO180   | 100 | 2795.153         | 119      | AB-32283          | 29  |
| 1000.3910.40-43 | 86  | 2505.027.K956   | 11  | 2560.893.R.050  | 84, 87 | 2702.ECO180   | 100 | 2795.160         | 119      | AB-32289          | 30  |
| 1000.3910.44-46 | 86  | 2505.027.K959   | 11  | 2560.893.R.100  | 84, 87 | 2703.ECO180   | 100 | 2795.200         | 119, 127 | AB-32300          | 25  |
| 1000.3910.47-48 | 86  | 2505.027.K975   | 11  | 2560.893.R.blue | 84     | 2710.MyLine   | 98  | 2795.200.MM      | 119, 127 | AB-32310          | 25  |
| 1010.RR-101     | 116 | 2505.030-1.51   | 12  | 2560.893.R.red  | 84     | 2710.WL180-P  | 90  | 2795.200.MM.R    | 119, 127 | AB-32370          | 32  |
| 1010.RR-102     | 117 | 2505.030.00     | 12  | 2560.894        | 83     | 2710.WL181-P  | 91  | 2900.605.100     | 127      | AB-32430          | 31  |
| 1010.RR-107     | 116 | 2505.030.51     | 12  | 2560.894.600    | 83     | 2710.WL182-P  | 91  | 2900.605.5       | 127      | AB-32450          | 31  |
| 1010.RR-108     | 116 | 2505.030.K56    | 12  | 2560.894.H      | 83     | 2710.WL185-P  | 90  | 2900.610.10      | 127      | AB-32600          | 25  |
| 1010.RR-112     | 117 | 2505.030.K59    | 12  | 2560.894.H-600  | 83     | 2710.WLW175-P | 92  | 2900.610.500     | 127      | AB-32610          | 25  |
| 1010.RR-114     | 117 | 2505.030.K719   | 12  | 2560.SG1.L      | 84     | 2711.MyLine   | 98  | 2920.2001        | 128      | AB-32650          | 25  |
| 1010.RR-201     | 116 | 2505.065-1.51   | 13  | 2560.SG1.M      | 84     | 2711.WL180-P  | 90  | 2920.2005        | 128      | AB-32700          | 25  |
| 1010.RR-202     | 117 | 2505.075-1.57   | 13  | 2560.SG1.S      | 84     | 2711.WL181-P  | 91  | 2920.2010.K      | 128      | AB-32710          | 25  |
| 1010.RR-207     | 116 | 2505.079        | 13  | 2560.SG1.XL     | 84     | 2711.WL182-P  | 91  | 2920.2050.K      | 128      | AB-32922          | 31  |
| 1010.RR-208     | 116 | 2505.101-1.00   | 13  | 2599.090.ESD    | 88     | 2711.WL185-P  | 90  | 500580           | 16       | AB-33230          | 31  |
| 1010.RR-212     | 117 | 2505.101-1.11   | 13  | 2599.100.ESD    | 88     | 2711.WLW175-P | 92  | 500588           | 16       | AB-33240          | 30  |
| 1010.RR-214     | 117 | 2505.101-1.16   | 13  | 2599.200.ESD    | 88     | 2712.MyLine   | 98  | 520840           | 16       | AB-34555          | 26  |
| 1011363         | 18  | 2505.101-1.51   | 13  | 2610.AM140      | 102    | 2712.WL180-P  | 90  | 520848           | 16       | AB-34556          | 26  |
| 1011363-1       | 18  | 2505.101.00     | 13  | 2610.AM140-K    | 102    | 2712.WL181-P  | 91  | 5221.21          | 120      | AB-34581          | 26  |
| 1011364         | 18  | 2505.101.11     | 13  | 2610.AM161      | 101    | 2712.WL182-P  | 91  | 5221.31.2        | 120      | AB-34621          | 25  |
| 1011364-1       | 18  | 2505.101.16     | 13  | 2625.P          | 108    | 2712.WL185-P  | 90  | 5221.31.IDP      | 120      | AB-351610         | 33  |
| 1011365         | 18  | 2505.101.51     | 13  | 2627.P          | 108    | 2712.WLW175-P | 92  | 5221.31.IDP.150  | 120      | AB-351620         | 33  |
| 1011365-1       | 18  | 2505.122.K56    | 12  | 2628.P215       | 107    | 2720.4260.L   | 81  | 5221.323         | 120      | AB-351710         | 33  |
| 1011366         | 18  | 2505.122.K59    | 12  | 2628.P615       | 107    | 2720.4260.M   | 81  | 5221.35016       | 120      | AB-351720         | 33  |
| 1011366-1       | 18  | 2505.122.K717   | 12  | 2628.P915       | 107    | 2720.4260.S   | 81  | 5221.35017       | 120      | AB-351920         | 33  |
| 1020876         | 17  | 2505.126.K56    | 12  | 2630.AM140      | 102    | 2720.4260.XL  | 81  | 5231.HSW1        | 126      | AB-352320         | 33  |
| 1020945         | 17  | 2505.126.K59    | 12  | 2630.AM140-K    | 102    | 2720.4260.XXL | 81  | 5231.HSW2        | 126      | AB-352510         | 33  |
| 1021400         | 17  | 2505.126.K714   | 12  | 2630.AM161      | 101    | 2720.GL180    | 95  | 583150           | 18       | AB-352520         | 33  |
| 1021411         | 17  | 2505.126.K718   | 12  | 2640.AM161-K    | 101    | 2720.GL180-P  | 93  | 583158           | 18       | AB-352610         | 33  |
| 2070.3100       | 120 | 2505.126.K719   | 12  | 2641.AM         |        |               |     |                  |          |                   |     |

# Alpha-Nummerischer Index

|            |    |                   |    |                 |     |                     |     |              |    |             |    |
|------------|----|-------------------|----|-----------------|-----|---------------------|-----|--------------|----|-------------|----|
| AB-3620    | 33 | AB-7131127        | 28 | BA-4660         | 77  | EL-729525           | 51  | JA-5302      | 35 | SI-52236-XL | 44 |
| AB-36721   | 24 | AB-7131128        | 27 | BA-4661         | 77  | EL-729551           | 52  | JA-5322      | 35 | SI-52342    | 42 |
| AB-36728   | 24 | AB-7131129        | 27 | BA-4663         | 77  | EL-729561           | 52  | JA-5342      | 35 | SI-52343    | 42 |
| AB-36729   | 24 | AB-7131131        | 27 | BA-5001         | 74  | EL-729571           | 52  | JA-5352      | 35 | SI-52357    | 42 |
| AB-36740   | 25 | AB-7131132        | 27 | BA-5002         | 74  | EL-729581           | 51  | JA-5362      | 35 | SI-52363    | 42 |
| AB-36741   | 25 | AB-7131133        | 28 | BA-5080         | 74  | EL-729591           | 51  | JA-5372      | 35 | SI-52371    | 43 |
| AB-36760   | 24 | AB-7131136        | 27 | BA-5081         | 74  | EL-729592           | 55  | JA-6418      | 38 | SI-52374    | 43 |
| AB-36761   | 24 | AB-7131137        | 27 | BA-5082         | 74  | EL-729593           | 55  | JA-6468      | 38 | SI-52375    | 43 |
| AB-36772   | 24 | AB-7131138        | 28 | BA-5518         | 75  | EL-729594           | 55  | JA-6498      | 38 | SI-52378    | 43 |
| AB-36773   | 24 | AB-7131141        | 19 | BA-5519         | 75  | EL-729601           | 51  | JA-7100      | 36 | SI-52385    | 43 |
| AB-36774   | 24 | AB-7131142        | 19 | BA-5520         | 76  | EL-729621           | 53  | JA-7108      | 36 | SI-52520    | 44 |
| AB-36775   | 24 | AB-7131150        | 27 | BA-5618         | 75  | EL-729630           | 53  | JA-7118      | 36 | SI-52520-XL | 44 |
| AB-36776   | 24 | AB-7131158        | 26 | BA-7003         | 76  | EL-729691           | 51  | JA-7128      | 36 | SI-52523    | 44 |
| AB-36795   | 24 | AB-7131827        | 27 | BA-7007         | 75  | EL-729695           | 51  | JA-8102      | 39 | SI-52523-XL | 44 |
| AB-36809   | 23 | AB-7131874        | 28 | BA-7008         | 74  | EL-729711           | 50  | JA-8201      | 81 | SI-52524    | 44 |
| AB-36813   | 23 | AT-1000-1ESD      | 59 | BA-7013         | 77  | EL-729720           | 50  | JA-8202      | 39 | SI-52524-XL | 44 |
| AB-36819   | 23 | AT-1000ESD        | 59 | BA-71462        | 76  | EL-729731           | 49  | JA-8303      | 39 | SI-52704    | 44 |
| AB-36872   | 23 | AT-1005-1ESD      | 59 | BA-71472        | 76  | EL-729755           | 50  | JA-8709H     | 39 | SI-52704-XL | 44 |
| AB-36874   | 23 | AT-1005ESD        | 59 | BA-71502        | 76  | EL-729831           | 49  | JA-8710M     | 39 | SI-52772-XL | 45 |
| AB-36900   | 32 | AT-1300-1ESD      | 59 | BA-71522        | 76  | EL-729905           | 50  | JA-8711L     | 39 | SI-52774-XL | 45 |
| AB-36902   | 19 | AT-1300ESD        | 59 | BA-7204         | 77  | EL-729910           | 49  | JA-9500      | 37 | SI-52933M   | 41 |
| AB-36903   | 22 | AT-1305-1ESD      | 59 | BA-72112        | 77  | EL-729915           | 51  | JA-9508      | 37 | SI-52933W   | 41 |
| AB-36910   | 32 | AT-1305ESD        | 59 | BA-7227         | 75  | EL-729920           | 51  | JA-9518      | 37 | SI-99360    | 82 |
| AB-36912   | 19 | AT-1600-1ESD      | 59 | BA-7228         | 74  | EL-729925           | 50  | JA-9520      | 37 | SI-99372    | 82 |
| AB-36913   | 22 | AT-1600ESD        | 59 | BA-7304         | 77  | EL-74101            | 53  | JA-9528      | 37 | SI-99520    | 45 |
| AB-37310   | 20 | AT-1605-1ESD      | 59 | BA-73181        | 76  | EL-74106            | 53  | JA-9568      | 37 | SI-99522-XL | 45 |
| AB-37312   | 20 | AT-1605ESD        | 59 | BA-73442        | 76  | EL-74121            | 53  | JA-9925      | 37 | SI-99525    | 45 |
| AB-37313   | 20 | AT-2000-1ESD      | 59 | BA-73742        | 76  | EL-74201            | 53  | JA-9945      | 37 | SI-99527-XL | 45 |
| AB-37315   | 20 | AT-2000ESD        | 59 | BA-74112        | 77  | EL-74304            | 55  | JA-9965      | 37 | SI-99530    | 45 |
| AB-37326   | 19 | AT-2005-1ESD      | 59 | BA-8424         | 74  | EL-74710            | 53  | JA-9985      | 37 | SI-99532-XL | 45 |
| AB-37327   | 19 | AT-2005ESD        | 59 | BA-8724         | 75  | EL-74720            | 53  | LE-1260      | 79 | SI-99534    | 45 |
| AB-37328   | 19 | AT-2600-1ESD.49   | 60 | BT-10100        | 82  | EL-74770            | 54  | LE-1261      | 79 | SI-99536-XL | 45 |
| AB-37329   | 19 | AT-2600ESD        | 60 | BT-10101        | 82  | EL-74801            | 54  | LE-1262      | 79 | SI-99610    | 45 |
| AB-37331   | 20 | AT-2605-1ESD.49   | 60 | BT-11300        | 82  | EL-74811            | 54  | LE-1980      | 79 | SZ-CP4000   | 57 |
| AB-37332   | 20 | AT-2605ESD        | 60 | BT-36634        | 71  | EL-74831            | 54  | LE-1985      | 79 | SZ-CP4100   | 57 |
| AB-37333   | 20 | AT-3200-1ESD      | 59 | BT-60449        | 71  | EL-749501           | 52  | LE-1988      | 79 | SZ-CP4100B  | 57 |
| AB-37335   | 20 | AT-3200ESD        | 59 | BT-63591        | 71  | EL-749531           | 52  | LE-8060      | 78 | SZ-CP4300   | 57 |
| AB-37341   | 20 | AT-3205-1ESD      | 59 | BT-63592        | 71  | EL-76106            | 53  | LE-8061      | 78 | SZ-CP4360   | 57 |
| AB-37342   | 20 | AT-3205ESD        | 59 | BT-63597        | 71  | EL-762551           | 54  | LE-8062      | 78 | SZ-CP4380   | 57 |
| AB-37343   | 20 | AT-4000-1ESD      | 60 | BT-66419        | 71  | EL-769711           | 50  | LE-8067      | 79 | SZ-SK40     | 57 |
| AB-37345   | 20 | AT-4000ESD        | 60 | BT-66420        | 71  | EL-769720           | 50  | LE-8075      | 79 | SZ-SK50     | 57 |
| AB-37360   | 20 | AT-4005-1ESD      | 60 | BT-66426        | 71  | EL-769905           | 50  | LE-8076      | 79 | SZ-SK60     | 57 |
| AB-37361   | 20 | AT-4005ESD        | 60 | BT-66633        | 71  | EL-769910           | 49  | LE-8078      | 79 | SZ-VD1000   | 57 |
| AB-37363   | 20 | AT-4600-1ESD      | 60 | BT-ACT124ESD    | 72  | EL-900019           | 81  | LE-8080      | 79 | SZ-VD1010   | 57 |
| AB-37365   | 20 | AT-4600ESD        | 60 | BT-Bickz736ESD  | 72  | EL-900020           | 81  | LE-8081      | 79 | SZ-VD1060   | 57 |
| AB-37370   | 23 | AT-4605-1ESD      | 60 | BT-CRYPTO-ESD   | 72  | EL-929563           | 52  | LE-8095      | 78 | SZ-VD1100   | 58 |
| AB-37374   | 23 | AT-4605ESD        | 60 | BT-GOAL-ESD     | 72  | EL-929652           | 52  | LU-10044     | 46 | SZ-VD1400   | 58 |
| AB-37375   | 23 | AT-92000          | 64 | BT-LEGEND-ESD   | 71  | EL-949502           | 52  | LU-10056     | 46 | SZ-VD1410   | 58 |
| AB-37376   | 23 | AT-99000          | 64 | BT-LOGIK-ESD    | 72  | EL-972312           | 49  | LU-10084     | 48 | SZ-VD1460   | 58 |
| AB-37520   | 21 | AT-99100          | 64 | BT-RAFT-ESD     | 72  | EL-972430           | 49  | LU-10174     | 47 | SZ-W100     | 58 |
| AB-37521   | 21 | AT-99200          | 64 | BT-SCORE-ESD    | 72  | EL-972440           | 49  | LU-10474     | 47 | SZ-W105     | 58 |
| AB-37530   | 21 | AT-A100ESD        | 63 | BT-SURF-ESD     | 72  | EL-974430           | 49  | LU-20044     | 46 | SZ-W120     | 58 |
| AB-37531   | 21 | AT-A240-1ESD      | 63 | BT-TURN-ESD     | 71  | EL-974440           | 49  | LU-20056     | 46 | SZ-W125     | 58 |
| AB-37630   | 21 | AT-A240ESD        | 63 | BT-ZIP-ESD      | 72  | EPApro.1000         | 133 | LU-20084     | 48 | SZ-W130     | 58 |
| AB-37631   | 21 | AT-A280-1ESD      | 63 | DPV-1000        | 114 | EPApro.1000.2W      | 133 | LU-20104     | 48 | SZ-W135     | 58 |
| AB-38200   | 22 | AT-A280ESD        | 63 | DPV-1010        | 114 | EPApro.1000.LI-1    | 134 | LU-20126     | 48 | SZ-W658     | 58 |
| AB-38202   | 22 | AT-A420ESD        | 63 | DPV-1026        | 114 | EPApro.1000.LI-2    | 134 | LU-20166     | 47 | SZ-W678     | 58 |
| AB-38210   | 22 | AT-A422ESD        | 62 | DPV-1027        | 114 | EPApro.1001.CU      | 133 | LU-20174     | 47 | SZ-W680     | 58 |
| AB-38212   | 22 | AT-A515ESD        | 63 | DPV-1030        | 114 | EPApro.1001.ID.HF   | 133 | LU-20266     | 47 | UP-20066    | 80 |
| AB-38330   | 21 | AT-A585ESD        | 63 | DPV-1031        | 114 | EPApro.1001.ID.LF   | 133 | LU-20277     | 47 | UP-20666    | 80 |
| AB-38332   | 21 | AT-CF2-1ESD       | 62 | DPV-1066        | 113 | EPApro.1001.TS      | 133 | LU-20366     | 47 | UP-21076    | 80 |
| AB-38600   | 22 | AT-CF2ESD         | 62 | DPV-1080        | 116 | EPApro.1001.WL1     | 133 | LU-20367     | 47 | UP-21086    | 80 |
| AB-38602   | 22 | AT-CX200ESD       | 63 | DPV-1081        | 116 | EPApro.1001.ZPM     | 133 | LU-20374     | 47 | UP-21096    | 80 |
| AB-3940    | 31 | AT-CX320ESD       | 63 | DPV-1082        | 116 | EPApro.1001.ZSF.SET | 133 | LU-20384     | 47 | UP-21106    | 80 |
| AB-39600   | 32 | AT-CX340ESD       | 63 | DPV-1085        | 116 | FT-0976             | 66  | LU-20387     | 47 | UP-21226    | 80 |
| AB-39610   | 32 | AT-CX40ESD        | 63 | DPV-1085.B      | 116 | FT-0977             | 66  | LU-20394     | 47 | UX-65658    | 68 |
| AB-39620   | 32 | AT-CX46ESD        | 63 | DPV-1086        | 116 | FT-1010             | 65  | LU-20404     | 47 | UX-65902    | 67 |
| AB-39630   | 32 | AT-CX50ESD        | 63 | DPV-1086.B      | 116 | FT-1015             | 65  | LU-20474     | 47 | UX-65938    | 67 |
| AB-3980    | 31 | AT-CX540ESD       | 63 | DPV-1200        | 115 | FT-1018             | 65  | LU-20477     | 47 | UX-65958    | 67 |
| AB-3990    | 31 | AT-CX56ESD        | 63 | DPV-1250        | 115 | FT-1024             | 65  | LU-30066     | 46 | UX-65978    | 68 |
| AB-4040    | 22 | AT-GX100ESD       | 61 | DPV-1600        | 113 | FT-1025             | 65  | LU-30076     | 46 | UX-65988    | 68 |
| AB-4045    | 22 | AT-GX130ESD       | 62 | DPV-3550.Schaum | 81  | FT-1041             | 66  | LU-30146     | 48 | UX-65998    | 68 |
| AB-4050    | 22 | AT-GX132ESD       | 62 | EL-204054       | 55  | FT-1050             | 65  | LU-30476     | 47 | UX-68342    | 69 |
| AB-4055    | 22 | AT-GX133ESD       | 62 | EL-204056       | 55  | FT-1051             | 65  | SI-12010     | 42 | UX-68362    | 68 |
| AB-4080    | 19 | AT-GX134ESD       | 62 | EL-71245        | 54  | FT-1060             | 65  | SI-12025     | 41 | UX-68372    | 68 |
| AB-4085    | 19 | AT-GX200ESD       | 61 | EL-712551       | 54  | FT-1061             | 65  | SI-12026     | 41 | UX-68428    | 68 |
| AB-4086    | 19 | AT-GX350ESD       | 62 | EL-71306        | 55  | FT-1062             | 65  | SI-12027     | 41 | UX-68438    | 68 |
| AB-4090    | 19 | AT-GX390ESD       | 62 | EL-71307        | 55  | FT-1063             | 65  | SI-12109     | 41 | UX-68468    | 68 |
| AB-4096    | 19 | AT-SL20-1ESD      | 60 | EL-71872        | 55  | FT-6060             | 66  | SI-12146     | 40 | UX-68488    | 68 |
| AB-5001    | 21 | AT-SL20ESD        | 60 | EL-719460       | 51  | FT-6061             | 66  | SI-12156     | 40 | UX-69062    | 69 |
| AB-5004    | 21 | AT-SL26-1ESD      | 60 | EL-719521       | 51  | FT-8210             | 66  | SI-12157     | 40 | UX-69078    | 69 |
| AB-5008    | 21 | AT-SL26ESD        | 60 | EL-719731       | 50  | FT-8211             | 66  | SI-12190     | 43 | UX-69362    | 69 |
| AB-5009    | 21 | AT-SL30-1ESD      | 61 | EL-719755       | 50  | FT-8220             | 66  | SI-12192     | 43 | UX-69378    | 69 |
| AB-5300    | 21 | AT-SL30ESD        | 61 | EL-72106        | 53  | FT-8221             | 66  | SI-12192R    | 43 | UX-69462    | 69 |
| AB-5310    | 21 | AT-SL32ESD        | 61 | EL-721071       | 53  | JA-1335             | 37  | SI-12194     | 42 | UX-69478    | 69 |
| AB-7131026 | 28 | AT-SL36-1ESD      | 61 | EL-72109        | 53  | JA-1605             | 36  | SI-12196     | 43 | UX-84262    | 70 |
| AB-7131027 | 28 | AT-SL36ESD        | 61 | EL-72110        | 49  | JA-1615             | 37  | SI-12225     | 41 | UX-84272    | 70 |
| AB-7131028 | 28 | AT-SL40-1ESD      | 61 | EL-72170        | 54  | JA-1708             | 37  | SI-12327M    | 41 | UX-84282    | 70 |
| AB-7131029 | 28 | AT-SL40ESD        | 61 | EL-72178        | 55  | JA-1738             | 37  | SI-12327W    | 41 | UX-84698    | 70 |
| AB-7131030 | 27 | AT-SL46-1ESD      | 60 | EL-72182        | 55  | JA-2102             | 34  | SI-52124     | 44 | UX-85428    | 68 |
| AB-7131031 | 27 | AT-SL46ESD        | 60 | EL-72245        | 54  | JA-2112             | 34  | SI-52125     | 44 | UX-85438    | 68 |
| AB-7131032 | 27 | AT-SL60-1ESD      | 61 | EL-722551       | 54  | JA-2142             | 34  | SI-52135     | 45 | UX-85608    | 67 |
| AB-7131033 | 28 | AT-SL60ESD        | 61 | EL-723351       | 53  | JA-2942             | 34  | SI-52137     | 44 | UX-85618    | 67 |
| AB-7131035 | 27 | AT-SL80ESD        | 61 | EL-724451       | 53  | JA-3020             | 39  | SI-52156-113 | 43 | UX-95538    | 69 |
| AB-7131036 | 27 | AT-SL82ESD        | 61 | EL-72752        | 54  | JA-3030             | 39  | SI-52156-153 | 43 | UX-95548    | 69 |
| AB-7131037 | 27 | AT-SL920-1ESD     | 60 | EL-728101       | 52  | JA-3045             | 38  | SI-52157     | 43 | UX-95598    | 69 |
| AB-7131038 | 28 | AT-SL920ESD       | 60 | EL-728110       | 52  | JA-3055             | 38  | SI-52162M    | 44 | UX-95608    | 69 |
| AB-7131041 | 27 | AT-SL9405-1ESD.49 | 61 | EL-728111       | 52  | JA-3100             | 38  | SI-52173     | 45 |             |    |
| AB-7131042 | 27 | AT-SL9405ESD      | 61 | EL-728121       | 52  | JA-3110             | 38  | SI-52175     | 45 |             |    |
| AB-7131047 | 28 | AT-TX360-1ESD     | 62 | EL-728181       | 52  | JA-3510R            | 36  | SI-52184     | 43 |             |    |
| AB-7131050 | 27 | AT-TX360ESD       | 62 | EL-72872        | 55  | JA-3700R            | 36  | SI-52185     | 43 |             |    |
| AB-7131056 | 26 | BA-32112          | 75 | EL-729461       | 52  | JA-3800R            | 35  | SI-52190     | 42 |             |    |
| AB-7131058 | 26 |                   |    |                 |     |                     |     |              |    |             |    |

## EPA requirements according to DIN EN 61340-5-1

| ESD control element  | Product qualification <sup>a</sup>   |   | Verification of the observance <sup>b</sup>                  |   |
|--|--|---|--|---|
|  | Test method  | Thresholds <sup>c</sup>   | Based on test method   | Thresholds <sup>c</sup>   |
| Work surfaces, storage racks and transport trolleys <sup>g</sup> | IEC 61340-2-3  | $R_{gp} < 1 \times 10^9 \Omega$<br>$R_{p-p} < 1 \times 10^9 \Omega$                                 | IEC 61340-2-3  | $R_g < 1 \times 10^9 \Omega$  |
| Connection point of the wrist strap                              |  |   |  | $R_g < 5 \times 10^6 \Omega$  |
| Floor covering   | IEC 61340-4-1 <sup>d,e</sup>   | $R_{gp} < 1 \times 10^9 \Omega$   | IEC 61340-4-1  | $R_g < 1 \times 10^9 \Omega$  |
| Ionization   | IEC 61340-4-7  | Decay (1000 V to 100 V and -1000 V to -100 V) < 20 s or offset voltage defined by user < $\pm 35$ V | IEC 61340-4-7  | Decay (1000 V to 100 V and -1000 V to -100 V) < 20 s or offset voltage defined by user < $\pm 35$ V |
| Seats  | IEC 61340-2-3 (Measurement of the resistance to potential grounding point) | $R_{gp} < 1 \times 10^9 \Omega$   | IEC 61340-2-3 (Measurement of the resistance against ground) | $R_{p-p} < 1 \times 10^{11} \Omega$ or threshold defined by user                                    |
| EPA clothing   | IEC 61340-4-9 or threshold defined by user                                 | $R^{p-p} < 1 \times 10^{11} \Omega$ or threshold defined by user                                    | IEC 61340-4-9 or method defined by user                      | $R_{p-p} < 1 \times 10^{11} \Omega$ or threshold defined by user                                    |
| EPA clothing with grounding properties                           | IEC 61340-4-9  | $R_{gp} < 1 \times 10^9 \Omega$   | IEC 61340-4-9  | $R_{gp} < 1 \times 10^9 \Omega$   |

|   |   |
|---|---|
| a | For the product qualification the environmental conditions for the verification should be (12 $\pm$ 3) % relative humidity and (23 $\pm$ 2) °C. If not defined in the indicated IEC standards, the minimum period for the conditioning to the ambient temperature for the product qualification should be 48 h. |
| b | The test methods in the column for the verification of the observance only refer to the basic test method. It is not expected that the test methods are completely followed.  |
| c | Symbols used in this chart: $R_g$ refers to the resistance to ground, $R_{p-p}$ refers to the resistance to the potential grounding point, $R_{p-p}$ refers to the point-to-point resistance  |
| d | The maximum permissible test voltage for the measuring of ESD floorings which should be used for an ESD program complying with this standard is 100 V.  |
| e | If a flooring is used to ground the personnel handling ESDs, reference is made to the system requirements according to chart 2.   |
| f | In situations where damage caused by the Charged Device Model (CMD) has to be taken into account a lower threshold of the point-to-point resistance $R_{p-p}$ von $1 \times 10^8 \Omega$ is recommended.  |
| g | Work surfaces are defined as any surface where an ESD-sensitive component is placed down.   |

## for personnel grounding according to DIN EN 61340-5-1

| Technical requirements   | ESD control element                               | Product qualification <sup>a</sup> |  | Verifizierung der Einhaltung  |                                      |
|--------------------------|---|------------------------------------|--|---|--------------------------------------|
|                          |   | Test method                        | Thresholds <sup>b</sup>  | Based on test method  | Thresholds <sup>b</sup>              |
| Personnel grounding      | Handgelenkerdungsbänder (Bänder und Erdungskabel) | IEC 61340-4-6                      | $R < 5 \times 10^6 \Omega$ or threshold defined by user  | See wrist strap system  |                                      |
|                          | Wrist straps (straps and grounding cable)         | IEC 61340-4-6                      |  |   |                                      |
|                          |   | Inside                             | $\leq 1 \times 10^8 \Omega$  | Not applicable  |                                      |
|                          |   | Outside                            | $> 1 \times 10^7 \Omega$   | Not applicable  |                                      |
|                          | Wrist strap system <sup>a</sup>                   | Not applicable                     |  | IEC 61340-4-6 Testing according to electrical contact resistance of the wrist strap | $R < 3,5 \times 10^2 \Omega$         |
|                          | Footwear  | IEC 61340-4-3 <sup>c</sup>         | $R \leq 1 \times 10^8 \Omega$  | See System person/footwear  |                                      |
|                          | System person / footwear / floor                  | IEC 61340-4-5                      | $R_g < 1 \times 10^9 \Omega$ and absolute value of the body voltage < 100 V (average of the 5 highest peaks) | IEC 61340-4-5   | $R_g < 1,0 \times 10^9 \Omega^{d,f}$ |
| System person / footwear | Not applicable                                    |                                    | See annex  | $R_{gp} < 1,0 \times 10^9 \Omega$   |                                      |

|   |  |
|---|--|
| a | In situations where EPA clothing (according to IEC 61340-4-9) is used as part of the wrist strap grounding path, the resistance of the entire system including person, protective clothing and grounding cable should be < $3,5 \times 10^7 \Omega$  |
| b | Symbols used in this chart: $R_g$ refers to the resistance to ground, $R_{gp}$ refers to the resistance to the potential grounding point, $R_{p-p}$ refers to the point-to-point resistance.   |
| c | For the product qualification of footwear according to IEC 61340-4-3 the environmental conditions for the verification should be (12 $\pm$ 3) % relative humidity and (23 $\pm$ 2) °C.   |
| d | A periodic test of the generated body voltage should be made to verify that the voltage is < 100 V.  |
| e | The resistance threshold applies to successive measurements of each individual foot, not both feet at the same time.   |
| f | The required threshold of < $1,0 \times 10^9 \Omega$ is the highest admissible value. Based on the measured resistance values for the product qualification of the system footwear and floor assuring a maximal generated body voltage of 100 V, the user should define an upper threshold and use these resistance values for the verification of the observance. |



## Labeling of professional footwear

| Basic requirements (extract)  | EN ISO 20345    | EN ISO 20347 |
|---|-----------------|--------------|
| Slip resistance (SRA, SRB or SRC)<br>Energy absorption of the toe cap | SB<br>200 joule | OB<br>-      |

| Additional requirements                                     | EN ISO 20345 | EN ISO 20347 |
|---|--------------|--------------|
| Closed heel<br>Antistatics<br>Energy absorption in the heel | S1           | 01           |
| Like S1<br>Plus water penetration and absorption            | S2           | 02           |
| Like S2<br>Plus penetration protection and profiled outsole | S3           | 03           |

DIN EN ISO 20345:2011 valid since December 2011

DIN EN ISO 20347:2012 valid since February 2012

| Requirements<br>(Extract of the standard) | Symbols | SB | S1 | S2 | S3 | OB | 01 | 02 | 03 |
|---|---------|----|----|----|----|----|----|----|----|
|---|---------|----|----|----|----|----|----|----|----|

| Basic requirements                |  |   |   |   |   |   |   |   |   |
|-----------------------------------|--|---|---|---|---|---|---|---|---|
| Shoes completely assembled        |  |   |   |   |   |   |   |   |   |
| Toe protection (200 joule)        |  | ● | ● | ● | ● |   |   |   |   |
| Slip resistance (SRA, SRB or SRC) |  | ● | ● | ● | ● | ● | ● | ● | ● |

| Additional requirements                |    |   |   |   |   |   |   |   |   |
|--|----|---|---|---|---|---|---|---|---|
| Shoes completely assembled             |    |   |   |   |   |   |   |   |   |
| Penetration protection                 | P  | ○ | ○ |   | ● | ○ | ○ |   | ● |
| Antistatic shoes                       | A  | ○ | ● | ● | ● | ● | ● | ● | ● |
| Energy absorption capacity in the heel | E  | ○ | ● | ● | ● | ● | ● | ● | ● |
| Heat insulation of the sole complex    | HI | ○ | ○ | ○ | ○ | ○ | ○ | ○ | ○ |
| Cold insulation of the sole complex    | CI | ○ | ○ | ○ | ○ | ○ | ○ | ○ | ○ |

| Shoe upper material              |     |   |   |   |   |   |   |   |   |
|----------------------------------|-----|---|---|---|---|---|---|---|---|
| Water penetration and absorption | WRU | ○ | ○ | ○ | ○ | ○ | ○ | ○ | ○ |

| Outsole                       |     |   |   |   |   |   |   |   |   |
|-------------------------------|-----|---|---|---|---|---|---|---|---|
| Behavior towards contact heat | HRO | ○ | ○ | ○ | ○ | ○ | ○ | ○ | ○ |
| Fuel resistance               | FO  | ● | ● | ● | ● | ○ | ○ | ○ | ○ |

- fulfills the prescribed requirements
- requirement can be fulfilled, but is not prescribed

## Excerpt from the general terms and conditions of DPV Elektronik-Service GmbH, Eppingen, Germany

### General terms and conditions of sale, delivery and payment (excerpt\*\*)

#### Conditions of delivery and payment

DPV Elektronik-Service GmbH exclusively delivers for the commercial sector! No selling to private individuals!

#### \*Flat-rate shipping costs per order

- Germany: 5.90 €
- Belgium, Denmark, France, Luxemburg, Netherlands, Austria, Poland: 10.00 €
- Great Briain, Italy, Sweden, Ireland, Norway, Spain, Portugal, Czech Republic, Hungary, Finland: 15.00€
- Others: depending on order. Please contact us.

the at-rate shipping costs are only valid for deliveries send as standard package!

**Delivery: unpaid ex warehouse including packaging**

**Delivery outside the EU only on request!**

#### Minimum oder value

- Within Germany: no minimum order value
- Within the EU: 50 €

**Oders outside the EU only on request!**

Flat-rate shipping costs  
**5,90 €\***  
per order (Germany)

All technical data and prices were correct at the time of printing. On publication of this catalog, all previous price lists will be invalid. All mentioned prices are in **Euro, plus VAT**. This catalog was created by a DTP system and with utmost care. We reserve the right to errors, price changes and technical modifikations. The catalog was printed on totally chlorine-free bleached paper.

Any reproduction from our catalog requires our approval.

**\*\* For the complete terms and conditions refere to: [www.dpv-elektronik.eu/agb](http://www.dpv-elektronik.eu/agb)**

**Current information about the General Data Protection Regulation (GDPR) is available under: [www.dpv-elektronik.eu/dsgvo](http://www.dpv-elektronik.eu/dsgvo)**

**Prices are available online at [www.dpv-elektronik.eu](http://www.dpv-elektronik.eu)**

Your price list can be found in your personal account in our online shop.  
After registration via [www.dpv-elektronik.eu](http://www.dpv-elektronik.eu) we shortly activate your personal access.



### ESD Management

- Static Management Program
- Permanent monitoring
- Analysis and assessment
- Trainings and formation
- Training documents



### Systems against electrostatics

- ESD professional and safety shoes
- Sole cleaning
- Heel grounders and overshoes
- Workwear
- Personal grounding systems
- Table and floor coverings
- Cleaning agents
- Work swivel chairs
- Measurement and test equipment
- Ionizing equipment
- Workplace accessories
- Labeling
- Transparent ESD plastic materials



### Packaging • Storage systems

- Packaging
- Containers
- Interlayers
- Parting inserts / partitions
- Transport pallets
- PCB magazines
- Transport / shelf trolleys
- Workstations
- Shelf racks
- Wheels and castors



### Precision tools

- Tweezers
- Precision tweezers
- Screwdrivers
- Bit inserts
- Torque screwdrivers
- Electric screwdrivers
- Torque measurement equipment
- Screw separating units
- Pliers
- Stripping / crimping tools
- Other tools
- Pneumatic cutters
- Processing tools
- Handling systems



### Machines • Devices

- PCB separators
- Suction equipment for cut-off removers and PCB separators
- Cut-off removers
- Component counting balances
- Component counting devices
- Component processing
- Vacuum packaging machines
- Cut-off saws



### Mounting accessories • Equipment

- Assembly stands
- Assembly frames
- Dispensing equipment
- Workstation lighting
- System workstation lighting
- Magnifier lamps
- Cleaning
- Maintenance aids
- Contact / mechanical greasing
- Protective lacquers
- Thermally conductive products
- Potting compounds



### Soldering • Desoldering

- Soldering stations
- Soldering irons and accessories
- Soldering tips
- Desoldering stations
- Hot air devices
- Solder stop masks
- Lead-free labels



### Solder • Metals

- Flux
- Recycling
- Solder
- Solder pastes





### DPV Elektronik-Service GmbH

Herrengrundstraße 1  
75031 Eppingen, Germany  
Phone: +49 (0)7262 9163-0  
Fax: +49 (0)7262 9163-90  
E-Mail: [info@dpv-elektronik.eu](mailto:info@dpv-elektronik.eu)  
Internet: [www.dpv-elektronik.eu](http://www.dpv-elektronik.eu)



### Sales Europe | International

Phone: +49 (0)7262 9163-200  
E-Mail: [export@dpv-elektronik.eu](mailto:export@dpv-elektronik.eu)



### Sales Switzerland

### COMPUMET AG

Theodorshofweg 22  
4310 Rheinfelden, Switzerland  
Phone: +41 (0)61 836 10 50  
E-Mail: [info@compumet.ch](mailto:info@compumet.ch)  
Internet: [www.compumet.ch](http://www.compumet.ch)

