



## EAZA Best Practice Guidelines: Callitrichidae

2022 Edition 3.2





## EDITORS AND CONTRIBUTORS

### TAG Chair

*Eric **Bairrão Ruivo***

ZooParc de Beauval, 41110 Saint Aignan sur Cher, France

### Editors 3.2 Edition - 2022

*Miranda **Stevenson***

Bristol Zoological Society, Bristol Zoological Society, Clifton, Bristol BS8 3HA, United Kingdom

*Anthony B. **Rylands**<sup>17</sup>*

Re:wild, Washington, DC, United States

### Contributors

*Eric **Bairrão Ruivo**<sup>1</sup>*

ZooParc de Beauval, 41110 Saint Aignan sur Cher, France

*Hannah M. **Buchanan-Smith**<sup>2</sup>*

Psychology, School of Natural Sciences, University of Stirling, Stirling FK9 4LA, Scotland, United Kingdom

*Morgane **Byrne**<sup>3</sup>*

Formerly Zoo d'Asson, Asson, France

*Dr Francis **Cabana**<sup>22</sup>*

Toronto Zoo

*Dr J. Bryan **Carroll**<sup>4</sup>*

Bristol Zoological Society, Bristol Zoo Gardens, Clifton, Bristol BS8 3HA, United Kingdom

*Dr Jonathan **Cracknell**<sup>23</sup>*

Cracknell Wildlife and Veterinary Services

*Aude Haelewyn **Desmoulins**<sup>5</sup>*

Parc Zoologique et Paysager du Reynou, Domaine du Reynou, 87110 Le Vigen, France

*John **Hayward**<sup>43</sup>*

National Theft Register – Exotic Species

*Yedra **Feltrer**<sup>6</sup>*

EAZA Reproductive Management Group

*Peter **Galbusera**<sup>7</sup>*

Royal Zoological Society of Antwerp, Koningin Astridplein 26, B-2018 Antwerpen, Belgium

*Tine **Griede**<sup>8</sup>*

(Formally) Hogeschool van Hall Larenstein, Postbus 1528, 8901 BV Leeuwarden, The Netherlands

*Pierre **Grothmann**<sup>9</sup>*

(Formerly Zoologischer Garten Magdeburg)

Zoo in der Wingst Amtsgericht Tostedt HRB 110664, Germany

*Warner **Jens**<sup>10</sup>*

Apenheul Primate Park, PO Box 97 7300 AB Apeldoorn, The Netherlands

*Kelly-Anne **Kelleher**<sup>21</sup>*

Zoolokal, UK

*Kristin **Leus**<sup>11</sup>*

CBSG Europe, Copenhagen Zoo & EAZA, p/a Annuntiatenstraat 6, 2170 Merksem, Belgium



**Nick Lindsay**<sup>12</sup>

( Formerly Zoological Society of London, Regent’s Park, London NW1 4RY, United Kingdom)

**Agustin Lopez Goya**<sup>13</sup>

Faunia Madrid– 28 Avenida Comunidades, 28032 Centro, Madrid, Spain

**Luc Lorca**<sup>14</sup>

Zoo d’Asson – 6 Chemin du Brouquet, 64800 Asson, France

**Jim Mackie**<sup>22</sup>

Zoological Society of London, Regent’s Park, London NW1 4RY, United Kingdom

**Stewart Muir**<sup>15</sup>

SWEP, Newquay Zoo, Trenance Park Newquay, Cornwall TR7 2LZ, United Kingdom

**Thierry Petit**<sup>16</sup>

Zoo de la Palmyre, 17570 Les Mathes, France

**Anthony B. Rylands**<sup>17</sup>

Re:wild, Washington, DC, United States

**Christoph Schwitzer**<sup>18</sup>

Dublin Zoo,, Phoenix Park, Dublin 8, Ireland

**Tai Strike**<sup>19</sup>

Zoological Society of London, Regent’s Park, London NW1 4RY, United Kingdom

**Dominic Wormell**<sup>20</sup>

Durrell Wildlife Conservation Trust; Les Augrès Manor, Trinity, Jersey JE3 5BP, Channel Islands, British Isles

## Acknowledgements

This is the 3.2 edition of the Best Practice Guidelines, published in 2022

This is part of the rolling programme of keeping the BPG updated. Its publication comes 20 years after the first edition! Changes to this edition are as follows: the species sheets have been updated in line with current taxonomic accepted knowledge; the Regional Collection Plan recommendations have been updated in line with the 2019 ICAP and Regional Collection Plan; a section on offshow areas has been added; the information on vitamin D and UVB exposure has been completely rewritten and expanded; a section on positive reinforcement training has been added; the section on transportation has been updated and rewritten and the veterinary section has been updated and additional illustrations added..

The editors thank all the contributors over the years that have made this document a landmark in current knowledge of the keeping of Callitrichids in Captivity. All are listed in the acknowledgement.

## Illustrations and distribution maps

All drawings and distribution maps used in these guidelines were done by Stephen D. Nash who kindly gave permission to use them in this publication. All copyrights of these drawings and maps belong to Stephen D. Nash and they cannot be used or reproduced without his authorisation.

### Cover and design

Dominic Wormell –artwork by Dominic Wormell

Durrell Wildlife Conservation Trust.



## **Disclaimer**

Copyright 2022 by EAZA Executive Office, Amsterdam. All rights reserved. No part of this publication may be reproduced in hard copy, machine-readable or other forms without advance written permission from the European Association of Zoos and Aquaria (EAZA). Members of the European Association of Zoos and Aquaria (EAZA) may copy this information for their own use as needed. The information contained in these EAZA Best Practice Guidelines has been obtained from numerous sources believed to be reliable. EAZA and the EAZA Callitrichid TAG make a diligent effort to provide a complete and accurate representation of the data in its reports, publications, and services. However, EAZA does not guarantee the accuracy, adequacy, or completeness of any information. EAZA disclaims all liability for errors or omissions that may exist and shall not be liable for any incidental, consequential, or other damages (whether resulting from negligence or otherwise) including, without limitation, exemplary damages or lost profits arising out of, or in connection with, the use of this publication. Because the technical information provided in the EAZA Best Practice Guidelines can easily be misread or misinterpreted unless properly analysed, EAZA strongly recommends that users of this information consult with the editors in all matters related to data, analysis and interpretation.

## **Publication and preamble**

Published by EAZA European Association of Zoos and Aquaria 2022





## EAZA Best Practice Guidelines for the Callitrichidae

### Preamble for the EAZA Best Practice Guidelines

Right from the very beginning it has been the concern of EAZA and the EEPs to encourage and promote the highest possible standards for husbandry of zoo and aquarium animals. For this reason, quite early on, EAZA developed the “Minimum Standards for the Accommodation and Care of Animals in Zoos and Aquaria”. These standards lay down general principles of animal keeping, to which the members of EAZA feel themselves committed. Some countries have defined regulatory minimum standards for the keeping of individual species regarding the size and furnishings of enclosures, etc., which, according to the opinion of authors, should definitely be fulfilled before allowing such animals to be kept within the area of the jurisdiction of those countries. These minimum standards are intended to determine the borderline of acceptable animal welfare. It is not permitted to fall short of these standards. How difficult it is to determine the standards, however, can be seen in the fact that minimum standards vary from country to country.

Specialists of the EEPs and TAGs have undertaken the considerable task of laying down guidelines for keeping individual animal species. Whilst some aspects of husbandry reported in the guidelines will define minimum standards, in general, these guidelines are not to be understood as minimum requirements; they represent best practice. As such the EAZA Best Practice Guidelines for keeping animals intend rather to describe the desirable design of enclosures and prerequisites for animal keeping that are, according to the present state of knowledge, considered as being optimal for each species. They intend, above all, to indicate how enclosures should be designed and what conditions should be fulfilled for the optimal care of the individual species.

Other relevant documents to refer to are: [EAZA Population Management Manual](#) and [EAZA Standards for Accommodation and Care](#) -links are to the EAZA website pages.

## CALLTRICHID TAG MEMBERS FROM mid 2022

### Chair:

Eric Bairrão Ruivo, Beauval -

### Vice-Chairs:

Dominic Wormell, Jersey -

Miranda Stevenson, Bristol –

Greg Clifton, Yorkshire Wildlife Park

### Program Co-ordinators:

#### EEPs:

Goeldi’s monkey (*Callimico goeldii*):

Susan O’Brien, Dublin -

White-fronted marmoset (*Callithrix geoffroyi*):

Agustín López Goya, Faunia

Golden-headed lion tamarin (*Leontopithecus chrysomelas*):



Peter Galbusera, Antwerp -

Black lion tamarin (*Leontopithecus chrysopygus*):  
Dominic Wormell, Jersey -

Golden lion tamarin (*Leontopithecus rosalia*):  
J. Bryan Carroll, Bristol -

Black-faced lion tamarin (*Leontopithecus caissara*):  
Kristin Leus, Copenhagen Zoo - [k](#)

Pied tamarin (*Saguinus bicolor*):  
Dominic Wormell, Jersey -

Emperor Tamarin (*Saguinus imperator subgrisescens*):  
Nicolas Lefrique, Beauval -

Cotton-top tamarin (*Saguinus oedipus*):  
Miranda Stevenson, Bristol -

Silvery marmoset (*Mico argentatus*):  
Zak Showell, Shaldon –

Red-bellied tamarin (*Saguinus labiatus*):  
Dave Rich, Newquay -

Red-handed tamarin (*Saguinus midas*):  
Greg Clifton, Yorkshire Wildlife Park -

Northern pygmy marmoset (*Cebuella pygmaea*):  
Southern pygmy marmoset (*Cebuella niveiventris*):  
Andrew Hope, Belfast

White-footed tamarin (*Saguinus leucopus*):  
Eric Bairrão Ruivo, Beauval -

Buffy-tufted-ear marmoset (*Callithrix aurita*):  
Dominic Wormell, Jersey –

Buffy-headed marmoset (*Callithrix flaviceps*):  
Dominic Wormell, Jersey - [d](#)

Common marmoset (*Callithrix jacchus*) and Black-tufted-ear marmoset (*Callithrix penicillata*):  
Kelly-Anne Kelleher, Zoolokal –(until August 2022)

### **Monitoring:**

Saddle-back tamarins (*Leontocebus fuscicollis*, *Leontocebus nigricollis* and *Leontocebus* spp.):  
Black-tailed marmoset (*Mico melanurus*): (Mon Phase Out)  
Moustached tamarin (*Saguinus mystax*): (Mon Phase Out)  
Black-and-white tassel-ear marmoset (*Mico humeralifer*) (Mon Phase out)  
And all other not managed callitrichid species



Luc Lorca, Asson –

**Communication, Marketing and Education**

Kelly-Anne Kelleher, Zoolokal

**Conservation**

Anthony Rylands, Re:wild -

**Animal Training Working Group Liaison**

Kelly-Anne Kelleher, Zoolokal -

**Nutrition**

Francis Cabana -

**Animal Welfare Liaison**

Dominic Wormell, Jersey -

**Population Management**

Kristin Leus, Copenhagen

**Veterinary**

Thierry Petit, La Palmyre -

**Research**

Peter Galbusera, Antwerp -

**General Advisor**

Warner Jens, Apeldoorn

**Link to the EAZA Executive Office**

Kelly van Leeuwen – (until August 2022)



## SUMMARY

This document reflects our current knowledge of the keeping of callitrichids in captive environments. It provides best practice information on the successful captive management of these small primates with a focus on integrating and supporting field conservation work in host countries.

**Section 1. Biology and Field Data** reflects our current knowledge of species in the natural environment using the most recent taxonomic information. This section refers to the *Regional Collection Plan for Callitrichids*, (Bairrão Ruivo et al 2019a) which adopts the One Plan Approach. The philosophy behind this is that *ex situ* conservation can be used more effectively as a conservation tool if it is part of an integrated approach to species conservation (IUCN, 2014). The potential need for a conservation role of an EAZA *ex situ* population has therefore been decided in consultation with *in situ* specialists. Several TAG members and species coordinators are involved in range-state species conservation planning processes that evaluate and incorporate *ex situ* activities as part of the overall conservation strategy. This is an important role of the TAG.

**Section 2. Management in Zoos** covers housing and exhibition, nutrition, food presentation and enrichment, social structure and behaviour. Callitrichids need to be kept in family groups, however their social structure results in eventual evictions of group members. Therefore, those keeping the animals need to ensure that they have sufficient enclosures to accommodate evicted animals in appropriate conditions. The Guidelines include comprehensive sections on managing evictions and holding surplus animals.

There is also useful information on the formation of non-breeding mixed or single-sex groups. The section on breeding includes an updated (2022) section on breeding control with a useful summary table for easy reference. Control of breeding is an essential component of successful managed programmes and this section provides comprehensive information to assist zoo veterinarians to decide on the most appropriate method for their animals. Managed programmes also rely on the movement of animals between zoos, and advice on capture, handling and transport is provided.

It is essential that callitrichids are provided with complex environments and there is detailed practical information on environmental enrichment. One method of enriching enclosures is the use of plants, and information on suitable species is provided.

A comprehensive veterinary section provides information on current knowledge on all aspects of medical care.

Some species present more challenges for successful management than others, and there is a section covering these special issues. Our knowledge can only increase through appropriate research and the final section covers ongoing and recommended research topics.

The document also contains a comprehensive reference section and four appendices.

Finally, this document is for callitrichids and their holders. It is essential that all keepers of these wonderful primates frequently refer to the guidelines and contact TAG members with any concerns or queries.



## Introduction

Welcome to this, the fourth (3.2) edition of the EAZA Best Practice Guidelines for the Callitrichidae. The first edition of the Husbandry Guidelines was published in 2002 and the second in 2010. This third edition was transposed from Husbandry to Best Practice Guidelines, including some updating of content, and was published in 2015. This edition, 3.2., published in 2022, is part of the TAG's rolling updating programme for guidelines.

An ICAP (Global Integrated Collection Assessment and Planning Workshop for Callitrichidae) took place in 2019 and the product of this were two documents, one on the ICAP itself (Bairrão-Ruivo *et al* 2019b) and a new Regional Collection Plan (Bairrão-Ruivo *et al* 2019a). These documents were developed in the spirit of the One Plan Approach and form the basis of the TAG actions in the Species Listings in Section 1.

Some species require considerable management due to small population sizes and difficulties in establishing multiple-generation breeding. Furthermore, our experience over the years tells us that we need constantly to seek advances in the care, wellbeing, and welfare of the animals in our breeding programmes. The Best Practice Guidelines have contributions from experts in husbandry, taxonomy, social behaviour, nutrition, and animal health and reflect what we see as best practice for our animals. We hope that it is helpful not only for EAZA zoos but also for zoos in other regions. In particular, we hope that they are useful for zoos in Latin America in the countries that are fortunate enough to have wild callitrichids. Most primate species are declining in numbers, as their habitat diminishes, and zoos have an increasingly important part to play in helping species in the wild.

Some species are vital for conservation programmes and the TAG is actively involved in several projects in range states including:

*Saguinus bicolor*, pied tamarin. This Critically Endangered species (last assessed on 26 January 2015) is under threat owing to deforestation and urbanisation and the captive population has an important role as an 'insurance population'. It is also a species that is not easy to maintain in captivity and considerable effort has been taken to give suitable guidance, which is available from Dominic Wormell, who is also involved in conservation efforts for the species in Brazil.

*Callithrix aurita*, buffy tufted-ear marmoset. The species is Endangered (last assessed on 26 January 2015), there are none in EAZA collections but the TAG is becoming involved in supporting field survey work in Brazil to determine the extent of hybridisation with *C. jacchus* and *C. penicillata*. There are some in captivity in Brazil and the species is managed as an EEP. TAG members and the PSG are involved with this evaluation and national action planning.

*Callithrix flaviceps*, buffy-headed marmoset. The species is Critically Endangered, it has a smaller range than *C. aurita*, and is also suffering from replacement and hybridisation *C. jacchus* and *C. penicillata*. In January 2022, it was placed on the list of the World's 25 Most Endangered Species. A conservation programme and plans for an *ex situ* colony are underway under the auspices of the Universidade Federal de Viçosa, Minas Gerais (Fabiano Rodriguez de Melo, pers. comm.). The species is managed as an EEP.





*Saguinus leucopus*, silvery-brown tamarin. The species is Vulnerable (last assessed on 26 January 2020), there are none in EAZA collections but a number in captivity in Colombia. The EAZA Callitrichid TAG currently supports *in situ* and *ex situ* conservation and conservation education of the *ex situ* population in Colombia. The species is managed as an EEP.

*Saguinus oedipus*, cotton-top tamarin. This species is Critically Endangered (last assessed on 25 February 2020) and there are many in EAZA collections. The management level is an EEP and the TAG actively supports Proyecto Titi in Colombia.

*Leontopithecus*, the lion tamarins. The TAG has been involved in the global programme for many years. The overall conservation programme for the golden lion tamarin (*Leontopithecus rosalia*) is a model for the “one plan approach” and the *ex situ* needs are clearly stipulated in the national action plan in Brazil. All of the four lion tamarins are Endangered: *Leontopithecus rosalia* (last assessed on 26 January 2015); *Leontopithecus chrysomelas* (assessed on 24 January 2020); *Leontopithecus chrysopygus* (assessed on 23 January 2021); and *Leontopithecus caissara* (assessed on 14 January 2021).

We hope that you will refer frequently to this document and find it useful. If you have experiences that you feel would be useful to include, or any points or queries you wish to raise, please let us know so that we can modify and improve future editions of the guidelines. Feel free to contact us.

**Eric Bairrão Ruivo - Chair Callitrichid TAG**

**Dominic Wormell - Vice-Chair Callitrichid TAG**

**Miranda Stevenson - Vice-Chair Callitrichid TAG**

**Greg Clifton – Vice-Chair Callitrichid TAG**

## **TAG Statement on Cause of Death in Studbook Species**

The Callitrichidae TAG requests all holders to ensure that cause of death is included in the studbook return. This is to enable studbook keepers to gain awareness of trends in diseases that affect the species concerned. If possible we would be grateful for a copy of all post-mortem examination reports, or at least a resume of the results. If a post-mortem examination was not carried out please let us know the reason for our records.

## **TAG Statement on Housing of Surplus Animals**

Callitrichids have a complex social system in which older offspring remain in their natal groups to experience the rearing of younger infants in order to become competent parents themselves. Although groups can reach quite large numbers and remain stable, however, evictions (aggressive expulsion of animals from the family by parents or siblings) are an inevitable event that will arise in all collections at some point.

It is, therefore, essential that any institution taking on a breeding group of callitrichids plan ahead for evictions and makes sure that sufficient accommodation is available so that evicted animals can be housed in environmentally and socially appropriate conditions.

Although efforts are always made by programme coordinators and studbook keepers to place animals that have been removed from their natal families, appropriate partners cannot always be found in the short term and it is the responsibility of the holding institution to ensure adequate



welfare standards in the interim. Institutions should therefore not take on a breeding group unless they can provide such reservoir accommodation when necessary.

Single individuals of different species can often be housed together successfully, and if no conspecific companion is available, this is preferable to housing a callitrichid alone. For further information on housing and welfare, please refer to the surplus and breeding control section in the *EAZA Callitrichid Husbandry Guidelines*.

## TAG Statement on Keeping Callitrichids by Private Individuals

In many European countries, certain primate species may be kept legally by private individuals.

The EAZA Callitrichidae Taxon Advisory Group believes that all captive marmosets and tamarins, lion tamarins, and Goeldi's monkey (Callitrichidae) should receive the same high standards of husbandry, whatever the nature of the institution or individual holding them, to ensure that the welfare of these primates is safeguarded and not compromised. The *EAZA Best Practice Guidelines for Callitrichidae* provides guidance on correct husbandry protocols. Due to their particular dietary, housing and social needs, these primate species are not suitable house pets.

All efforts should be made by the responsible authorities to ensure that Callitrichidae husbandry and welfare standards apply equally to all holders.

## TAG Statement on the use of Callitrichids in Public Demonstrations

EAZA has a statement on the use of animals in public demonstrations (approved 27 September 2014). <http://www.eaza.net/assets/Uploads/Standards-and-policies/Animal-Demonstrations.pdf>

*EAZA defines demonstrations as any case where an animal is demonstrating behaviours, trained or natural, while under the supervision or control of a trainer in the view of guests, with the intention of educating, inspiring, and entertaining our visitors. This would also include guest interactions and experiences. Training techniques used for demonstrations should not differ from day-to-day husbandry training techniques to guarantee animal welfare. Priority should also be placed on behavioural, environmental and social enrichment.*

Each animal taxon has specific issues; this section encompasses what the TAG states is appropriate for the use of callitrichids in public demonstrations, and therefore should be used in conjunction with the general EAZA Guidelines.

The nature of the family group structure and territorial behaviour in callitrichids makes it inherently unsuitable for them to be removed to a training/off-demonstration area or be kept solitary for the purpose of a demonstration. The TAG considers it unacceptable to move callitrichids between their enclosures and a demonstration space. Animals must not be removed from their family groups for the purpose of demonstrations or interaction with guests.

The TAG considers that the **only** acceptable use of callitrichids in demonstrations is by providing a commentary about the animals, in an enclosure that they regularly have access to, and therefore consider part of their territory. An example would be calling a group over to a keeper for food, allowing



the public better access for photography. Another example would be fully supervised ‘experiences’ where pre-booked guests are allowed to give food to the animals under keeper supervision, and, again, in the animals’ enclosure. When this occurs aspects of biosecurity should be taken into consideration (see veterinary section). Such encounters must be accompanied by a commentary explaining the biology and conservation of the species. Such encounters can be a very positive experience and have the potential to promote conservation and interest in the species. The training for such encounters should be that used for husbandry training (weighing, health monitoring, etc.) and the food provided part of the normal diet. The animals should NOT be trained to jump onto guests. Thus, to summarise, such encounters are only acceptable when:

- The animals come voluntarily for food, using routine positive reinforcement training methods
- The training utilised is part of the normal routine for husbandry training and the animals are not restricted by handling during, or as a preparation for, the demonstration
- The animals remain in their normal social and physical environment and are NOT moved to a different environment, for the purpose of the demonstration
- The animals only demonstrate natural and species-specific behaviour
- The animals approach voluntarily and have the option, at all times, to retreat from the audience
- Under no circumstances should guests handle the animals and contact between guests and animals should be restricted to the handing over of food items
- The demonstrations must only occur during the normal diurnal activity rhythm of the species

## **TAG Statement on Breeding Common Marmosets (*Callithrix jacchus*) and Black-tufted-ear Marmosets (*Callithrix penicillata*)**

With the ever growing threats to callitrichid species in the wild and the need to build up conservation assurance populations in captive care, both in the range country and internationally, the EAZA Callitrichid TAG strongly recommends that more common species which are not of conservation concern are not bred in the region.

Common marmosets and black-tufted-ear marmosets are abundant in captivity, they are robust and breed readily. They are not only found in many zoos but also rescue centres and sanctuaries throughout the region. They cope well in a range of habitats in Brazil and have been released from the pet trade into areas of Brazil where they did not historically occur. As a result, they now pose a threat, through hybridisation and displacement, to two highly endangered marmoset species – the buffy-headed marmoset, (*Callithrix flaviceps*), and the buffy tufted-ear marmoset (*Callithrix aurita*). As common and black-tufted-ear marmosets are taking up valuable space in captivity the TAG recommends that they should not be bred. This can be achieved by keeping single sex groups, or by the sterilisation of males or females.

*Approved by the EAZA Callitrichid Taxon Advisory Group, 19 June 2019*



# TABLE OF CONTENTS

Editors and Contributors

Acknowledgements

Illustrations and distribution maps

Disclaimer

Publication and preamble

Callitrichid TAG members from 2022

Summary

Introduction

TAG statements:

- cause of death in studbook species
- housing of surplus animals
- Keeping of Callitrichids by private individuals
- Use of Callitrichids in public demonstrations
- Breeding Common Marmosets (*Callithrix jacchus*) and Black-tufted-ear Marmosets (*Callithrix penicillata*)

## SECTIONS

<b>1. BIOLOGY</b>	<b>17</b>
1.1 Taxonomy	17
1.2 Morphology	21
1.3 Physiology	21
1.4 Longevity	21
<b>2. FIELD DATA</b>	<b>22</b>
2.1 Conservation status/Distribution/Ecology	22
2.2 Diet and feeding behaviour	22
2.2.1 Feeding Ecology	22
2.2.1.1 Foraging behaviour: gums	26
2.2.1.2 Fruit	28
2.3 Reproduction	29
2.4 Behaviour	30
<b>3. SPECIES ACCOUNTS</b>	<b>31</b>
<b>4. SECTION 4 – MANAGEMENT IN ZOOS</b>	<b>105</b>
4.1 Housing and exhibition of the Callitrichidae	105
4.1.1 Enclosure size	105
4.1.2 Door and tunnel design	106
4.1.3 Barriers	107
4.1.4 Orientation and location of enclosures	109
4.1.5 Cleaning and substrates	109
4.1.6 Furniture	109



4.1.7	Lighting and photoperiod	111
4.1.8	Temperature and humidity	111
4.1.9	Free-range enclosures	111
4.1.10	Offshow areas and their importance	112
<b>4.2</b>	<b><i>Feeding and nutrition</i></b>	<b>115</b>
4.2.1	Basic diet: food components and feeding regime	115
4.2.2	Diet Composition and requirements	117
4.2.3	Nutrient Recommendations	118
4.2.4	Vitamins	121
4.2.4.1.	Vitamin D and the need for UVB exposure	121
4.2.4.2.	Vitamin E	126
4.2.4.3.	Vitamin C	127
4.2.5	Calcium	127
4.2.6	Iron	128
4.2.7	Iodine	128
4.2.8	Other minerals	129
4.2.9	Method of feeding: eliciting natural foraging behaviour	129
4.2.10	Gums	130
4.2.11	Live foods & Animal products	132
4.2.12	Commercial products	134
4.2.13	Diet Transition and Monitoring	135
4.2.14	Implementation tips	136
4.2.15	Evaluation	138
4.2.16	Health considerations	138
4.2.16.1.	Obesity	138
4.2.16.2.	Seasonality	139
4.2.16.3.	Periodontal disease	139
4.2.16.4.	Gastrointestinal problems	139
4.2.17	Hypothetical Callitrichid diet	140
<b>4.3</b>	<b><i>Social structure and behaviour</i></b>	<b>141</b>
4.3.1	Group Structure	141
4.3.2	General behavioural repertoire and communication	142
4.3.3	Groups in captivity	144
4.3.4	Group formation	144
4.3.5	Group stability and group management	144
4.3.6	Mixed-species exhibits	145
4.3.6.1.	Methods of introduction	148
4.3.6.2.	Mixed-species tables	148
4.3.7	Housing surplus animals and managing evictions	151
4.3.7.1.	Formation of non-breeding mixed or single-sex groups	154
<b>4.4</b>	<b><i>Breeding</i></b>	<b>156</b>
4.4.1	Twinning	156
4.4.2	Reproductive strategies	157
4.4.3	Reproductive suppression	158
4.4.4	Infant care patterns among the Callitrichidae	158
4.4.5	Implications for captive management	159
4.4.6	Hand rearing	160
4.4.6.1.	The need to hand rear	160
4.4.6.2.	Physical condition of the infant	161
4.4.6.3.	Feeding regime	161





4.4.6.4.	Monitoring progress	162
4.4.6.5.	Reintroduction	162
4.4.7	Population and breeding control	163
4.4.7.1.	Introduction	163
4.4.7.2.	Current options for population control	164
4.4.7.3.	Chemical contraception	165
4.4.7.4.	Immunocontraception	170
4.4.7.5.	Intra-uterine devices (IUD)	171
4.4.7.6.	Termination of early pregnancy by regular prostaglandin injections	171
4.4.7.7.	Surgical methods of contraception	172
4.4.7.8.	Euthanasia	172
4.4.7.9.	Summary	173
4.4.7.10.	Possible arguments for and against euthanasia	175
4.5	<i>Environmental enrichment</i>	177
4.5.1	Introduction	177
4.5.2	What is the aim of enrichment?	177
4.5.3	Why is enrichment important?	178
4.5.4	What if we don't enrich?	179
4.5.5	Caution	179
4.5.6	Callitrichid ecology and foraging behaviour: implications for enrichment	180
4.5.7	An enriched environment	181
4.5.8	Artificial devices	182
4.5.9	Things to avoid	185
4.6	<i>Capture, handling and transport</i>	185
4.6.1	General principles	185
4.6.2	When and when not to capture	186
4.6.3	Methods of catching	186
4.6.4	Handling	190
4.6.5	Transportation	191
4.6.6	Safety during handling	195
4.6.7	Positive reinforcement training to facilitate improved medical management and welfare	196
4.7	<i>VETERINARY: Considerations for Health and Welfare</i>	208
4.7.1	Introduction	208
4.7.2	Routine Observation	208
4.7.3	Clinical Examination	209
4.7.4	Preventative Medicine and Disease Surveillance	211
4.7.4.1.	General Preventative Measures	211
4.7.4.2.	Disease Surveillance	212
4.7.4.3.	Quarantine	213
4.7.4.4.	Post-mortem Examination	215
4.7.4.5.	Vaccination	216
4.7.4.6.	Zoonoses	217
4.7.4.7.	Mixed Species Exhibits	217
4.7.5	Therapeutics	218
4.7.5.1.	General	218
4.7.5.2.	Administration	219
4.7.5.3.	Anaesthesia	222
4.7.5.4.	Contraception	223
4.7.5.5.	Microchip Identification	223
4.7.6	Common Disorders (brief description, treatment and prophylaxis)	223



4.7.6.1.	Digestive system	223
4.7.6.2.	Respiratory system	226
4.7.6.3.	Urinary system	227
4.7.6.4.	Reproductive system	227
4.7.6.5.	Locomotor system	228
4.7.6.6.	Nervous system	229
4.7.6.7.	Skin and mucous membranes	230
4.7.6.8.	Cardiovascular system	231
4.7.6.9.	General body condition	232
4.7.6.10.	Metabolic diseases	234
4.7.7	Haematology and Clinical Chemistry Tables of Callitrichida	234
4.7.7.1.	Haematology—Callitrichidae (Mean ± SD (n))	234
4.7.7.2.	Clinical Chemistries—Callitrichidae	236
4.8	<i>Recommended (and planned) ex situ research</i>	240
4.8.1	Veterinary medicine	241
4.8.2	Genetics	242
4.8.3	Contraception and reproductive pathology	242
4.8.4	Behavioural research/enrichment	242
4.8.5	Nutrition	243
4.9	<i>Security and Identification</i>	243
4.9.1	Introduction	243
4.9.2	Enclosure and Site Security	243
4.9.3	Animal Identification	247
4.9.4	Liaison with Police and Crime Prevention Officers	248
4.9.5	Support from EAZA EEO	248
<b>5.</b>	<b>SECTION 5 – References</b>	<b>249</b>
5.1	<i>References specific to enclosure design</i>	249
5.2	<i>References specific to vitamin D and UVB provision</i>	250
5.3	<i>References specific to positive reinforcement training</i>	252
5.4	<i>General References</i>	254
<b>6.</b>	<b>SECTION 6– Appendices</b>	<b>289</b>
6.1	<i>Appendix 1. Callitrichid plant interaction</i>	289
6.2	<i>Appendix 2. Training Guide for Scale Training Callitrichids</i>	290
6.3	<i>Appendix 3.</i>	291



## BIOLOGY AND FIELD DATA

### Authors:

Eric **Bairrão Ruivo**<sup>1</sup>, J. Bryan **Carroll**<sup>4</sup>, Aude **Desmoulins**<sup>5</sup> and Anthony B. **Rylands**<sup>17</sup>, Christoph **Schwitzer**<sup>18</sup>, Kristin **Leus**<sup>11</sup> and Luc **Lorca**<sup>14</sup>

## 1. BIOLOGY

### 1.1 Taxonomy

#### Family level

The taxonomy of the marmosets and tamarins has changed considerably since that proposed by Hershkovitz (1977, 1979, 1982). Hershkovitz recognized two families: Callimiconidae (*Callimico*) and Callitrichidae (*Cebuella*, *Callithrix*, *Saguinus* and *Leontopithecus*), distinguishing them from the remaining platyrrhine genera, which were lumped into the Cebidae. It was the morphological studies of Rosenberger (1980, 1981, 2011; see also Rosenberger *et al.*, 1990) that initiated a major change in thinking regarding the higher taxonomy of this group. His thesis involved placing the marmosets, tamarins and *Callimico* in a subfamily (Callitrichinae) in a redefined Cebidae, which otherwise included squirrel monkeys (*Saimiri*) and capuchin monkeys (*Cebus*); the two comprising the Cebinae. This arrangement and slight variations of it were subsequently amply reinforced and justified by numerous genetic studies (for example, Schneider *et al.*, 1993, 1996; Harada *et al.*, 1995; Nagamachi *et al.*, 1996, 1999; Schneider and Rosenberger, 1996). Established platyrrhine classifications today all accept the affinity of *Cebus*, *Saimiri* and the marmosets, tamarins and callimico. Some place them in separate families (Rylands *et al.*, 2000) and others as two subfamilies of the Cebidae (Groves, 1993, 2001, 2005). In this document we place Goeldi's monkey and all the marmosets, tamarins, and lion tamarins in the Family Callitrichidae.

Cronin and Sarich (1978), Seuánez *et al.* (1989), Pastorini *et al.* (1998), Chaves *et al.* (1999), Canavez *et al.* (1999a, 1999b), Neusser *et al.* (2001) and Buckner *et al.* (2015) have all demonstrated that *Callithrix* (*sensu* Groves, 2001) and *Callimico* are more closely related to each other than *Callithrix* is to *Saguinus* or *Leontopithecus* (for review see Pastorini *et al.*, 1998). Placing *Callimico* in a separate family or subfamily is not valid due to this finding, unless *Saguinus* and *Leontopithecus* are also separated out at the family or subfamily level; see Groves, 2004).

#### Genera and species

The taxonomy at the level of genera, species and subspecies has also changed since Hershkovitz's synthesis of 1977; he recognized 46 taxa in five genera—*Callimico* (but as a distinct family, Callimiconidae), *Cebuella*, *Callithrix*, *Saguinus* and *Leontopithecus*. Twelve new taxa have been described since 1983, a saddleback tamarin subspecies recognized by Hershkovitz (1977) has been discounted as a synonym (*acrensis* Carvalho, 1957) (see Peres *et al.*, 1996); we now recognize the validity of three marmosets (*Callithrix kuhlii* Coimbra-Filho, 1985, *Mico emiliae* [Thomas, 1920], *Cebuella niveiventris* Lönnberg, 1940) and the moustached tamarin *Saguinus labiatus rufiventer* (Gray,



1843), which Hershkovitz did not; and many of the taxa considered to be subspecies by Hershkovitz (1977) are now considered to be species.

A number of studies on the phylogenetic affinity of the pygmy marmoset, *Cebuella pygmaea*, to the Amazonian marmosets (*Callithrix*) have indicated that it could be considered congeneric (for example, Rosenberger, 1981; Barroso *et al.*, 1997; Porter *et al.*, 1997; Tagliaro *et al.*, 1997). Groves (2001, 2005) listed *Cebuella* as a subgenus of the genus *Callithrix* that embraces all of the marmosets. Most recently, Schneider and Sampaio (2015) concluded that *Cebuella* is a valid genus, separate from the Amazonian marmosets, *Mico* (see also Buckner *et al.* (2015)).

Although Hershkovitz (1977) recognized no subspecific forms for *Cebuella*, Napier (1976) and Van Roosmalen and Van Roosmalen (1997) argued that a form south of the Rio Solimões, *niveiventris* Lönnberg, 1940, was valid (see Groves, 2001, 2005; Rylands *et al.*, 2007). A phylogenetic study by Boubli *et al.* (2018) that included mtDNA cytochrome b gene and a reduced representation genome sequencing approach (ddRADseq) for geographically representative samples from Brazil, showed that the forms *pygmaea* Spix (from the north of the Solimões-Amazonas) and *niveiventris* Lönnberg (from the south of the Solimões-Amazonas) were distinct species (see also Garbino *et al.*, 2019b; Porter *et al.*, 2021; Boubli *et al.*, 2021).

Amazonian marmosets are more closely related to *Cebuella* than they are to the Atlantic Forest marmosets (Tagliaro *et al.*, 1997, 2001; Chaves *et al.*, 1999; Buckner *et al.*, 2015). To avoid paraphyly, therefore, there are only two options concerning the generic separation of the marmosets (see Groves, 2004): 1) All belong to one genus (*Callithrix*), a classification adopted by Groves (2001, 2005); or 2) all are placed into distinct genera, with a generic separation of the Amazonian marmosets (the *argentata* Group of Hershkovitz) on the one hand, and the eastern Brazilian (non-Amazonian) forms (the *jacchus* Group of Hershkovitz) on the other, as distinct genera. *Mico* Lesson, 1840, is the name available for the Amazonian *argentata* Group marmosets. This second classification, with the Amazonian marmosets being attributed to the genus *Mico* is followed by Rylands *et al.* (2000, 2008, 2009; Rylands and Mittermeier, 2008).

The *Saguinus nigricollis* group of Hershkovitz (1977; see also Cheverud and Moore, 1990) included two species, *Saguinus nigricollis* and *Saguinus fuscicollis*. A genetic analysis (mitochondrial cytochrome *b* and hypervariable region 1 of the D-loop) by Matauscek (2010; Matauscek *et al.*, 2011) showed that this group was paraphyletic, and as such required a re-assessment of the taxonomic status of the component species and subspecies (*sensu* Hershkovitz, 1977, 1982). Matauscek *et al.* (2011) identified four clades with the following compositions: 1) *S. f. illigeri*, *S. f. leucogenys* (north of the Río Pachitea); 2) *S. f. fuscicollis*, *S. f. leucogenys* (south of the Río Pachitea), *S. f. weddelli*, *S. melanoleucus*, *S. f. nigrifrons*; 3) *S. n. nigricollis*, *S. n. graellsii*; and 4) *S. tripartitus*, *S. f. lagonotus*.

In *S. fuscicollis sensu* Hershkovitz (1977), Matauscek *et al.* (2011) concluded that *lagonotus*, *tripartitus*, *nigrifrons*, *weddelli* and *fuscicollis* are morphologically distinct and well-defined taxa and recommended they be given species' status. The same is true for *nigricollis*, but with *graellsii* as a subspecies (*hernandezi* was not included in the study). They recommended that *melanoleucus*, although genetically very close to *weddelli*, be considered a subspecies of *S. weddelli* because of its distinct coat color. The northern populations of *leucogenys* and *illigeri* could be considered distinct species, but each with modified geographic distributions. Either the northern or the southern populations of *S. f. leucogenys* (*sensu* Hershkovitz, 1977) would require a new definition and name. The central Amazonian forms *avilapiresi*, *cruzlimai*, *primitivus*, and *mura* were not included in the



analysis of Matauschek *et al.* but are here provisionally attributed to the *fuscicollis*, *weddelli*, *melanoleucus*, *nigrifrons* clade as subspecies of *fuscicollis*. Future genetic analyses may well result in them being considered species. *Saguinus n. hernandezi* and *S. fuscus* were not included in the analysis of Matauschek *et al.* but are here attributed to the *S. nigricollis* clade, the former as a subspecies but the latter as a species following Cropp *et al.* (1999).

Hershkovitz (1977) listed *Saguinus tripartitus* as a subspecies of *S. fuscicollis*. Thorington (1988) argued for its species' status (see also Albuja, 1994), arguing that it was sympatric with *S. f. lagonotus*. It was listed as a species by Rylands *et al.* (1993) and Groves (2001, 2005), but a re-evaluation of the evidence for its distribution indicates that neither Hershkovitz (1977) nor Thorington (1988) had established its true geographic range (Rylands *et al.*, 2011). Rylands *et al.* (2011) concluded that it is not sympatric with *S. f. lagonotus*. A genetic analysis by Matauschek *et al.* (2011) found it to be a sister to *S. f. lagonotus*, but in a clade distinct from *weddelli*, *illigeri*, *nigrifrons*, *fuscicollis* and *leucogenys*.

*Saguinus fuscicollis cruzlimai* was described by Hershkovitz (1977) without provenance, and based on an illustration of a saddleback tamarin by Cruz Lima (1945) “said to be from the upper Rio Purus”, p.662). Sampaio *et al.* (2015) found it on the north bank of the Rio Inauini, left bank of the Rio Purus, and indicated that it probably extends north to the Rio Pauini, with *S. f. primitivus*, described by Hershkovitz in 1977 with an uncertain proveance, north of the Pauini to the Rio Tapauá. Morphometric and molecular genetic analyses and the coloration of the pelage indicate that *cruzlimai* differs from its neighbors sufficiently to be considered a full species.

A study by Gregorin and Vivo (2013) revalidated *Saguinus ursula* Hoffmannsegg, 1807, the type species of *Saguinus* Hoffmannsegg, 1807, naming a lectotype (one of four syntypes) from the vicinity of Belém, Pará. Its range is delimited in the east by the Rio Tocantins. *Saguinus niger* occurs west of the Rio Tocantins to the Rio Xingu. Differentiation was based on pelage coloration. Garbino and Martins Jr. (2018) argued that the epithet *ursula* should be used (not *ursulus*), on the assumption that the species was named after a proper noun and as such should be treated as a noun in apposition.

Rylands *et al.* (2016) reviewed the taxonomy of the Amazonian tamarins. Buckner *et al.* (2015) showed the small saddle-back tamarins diverged from the tamarin lineage about 9 mya and, considering their sympatry (mixed-species), separated them from the genus *Saguinus*, resurrecting the name *Leontocebus* Wagner 1839, with the type species designated by Miller (1912; p.380) being *Midas leoninus* (É Geoffroy Saint Hilaire, 1812) a synonym of *fuscus* Lesson, 1940.

### Species and subspecies of callitrichids described since 1983.

Callibella humilis (M.G.M van Roosmalen, T. van Roosmalen, Mittermeier and Fonseca, 1998) <b>Some authors regard Callibella to be a junior synonym of Mico (see Garbino et al., 2019).</b>	Black-crowned dwarf marmoset
Callithrix kuhlii Coimbra-Filho, 1985	Wied's black-tufted-ear marmoset
Mico nigriceps (Ferrari and Lopes, 1992)	Black-headed marmoset
Mico mauesi (Mittermeier, Ayres and Schwarz, 1992)	Maués marmoset
Mico marcai (Alperin, 1993)	Marca's marmoset





Mico saterei (Sousa e Silva Jr and Noronha, 1998)	Sateré marmoset
Mico manicorensis (M.G.M. van Roosmalen, T. van Roosmalen, Mittermeier and Rylands, 2000). Mico manicorensis is a junior synonym of Mico marcai (see Garbino, 2014)	Manicoré marmoset
Mico acariensis (M.G.M. van Roosmalen, T. van Roosmalen, Mittermeier and Rylands, 2000)	Rio Acarí marmoset
Mico rondoni Ferrari, Sena, Schneider and Silva Jr., 2010	Rondon's marmoset
Mico munduruku Costa-Araújo, Farias and Hrbek in Costa-Araújo, Melo, Canale, Hernández-Rangel, Messias, Rossi, F. E. Silva, M. N. F. da Silva, Nash, Boubli, Farias and Hrbek, 2019.	Munduruku marmoset
Mico schneideri Costa Araujo, Silva Jr., Boubli, Rossi, Hrbek and Farias in Costa-Araújo, J. Silva-Jr., Boubli, Rossi, Canale, Melo, Bertuol, F. Silva, D. Silva, Nash, Sampaio, Farias and Hrbek, 2021	Schneider's marmoset
Saguinus fuscicollis mura Röhe, Silva Jr., Sampaio and Rylands, 2009. Now Leontocebus fuscicollis mura (see Rylands et al. (2016).	Grey-fronted saddle-back tamarin
Leontopithecus caissara Lorini and Persson, 1990	Black-faced lion tamarin

We emphasize that the differences between the taxonomies of Groves (2001, 2005) and Rylands *et al.* (2000, 2008, 2009; Rylands and Mittermeier, 2008, 2013) are largely limited to their placement in the family Callitrichidae (Rylands *et al.*) or the subfamily Callitrichinae (Groves), and to the separation of marmosets into distinct genera (Rylands *et al.*) as opposed to combining them into one genus but distinguishing the same species' groups at the subgeneric level (Groves). So, for example, Groves calls the pygmy marmoset *Callithrix (Cebuella) pygmaea*, whereas Rylands *et al.* refer to it as *Cebuella pygmaea*. Likewise, Groves (2001) calls the silvery marmoset *Callithrix (Mico) argentata*, whereas Rylands *et al.* refer to it as *Mico argentatus*. Two other differences are 1) Groves (2001) lists the red-cap moustached tamarin as a full species, *Saguinus pileatus*, whereas Rylands *et al.* follow Hershkovitz in considering it a subspecies of *S. mystax*; and 2) Groves considers Graells' black-mantled tamarin to be a full species, *Saguinus graellsii*, whereas Rylands *et al.*, like Hershkovitz (1982), list it as a subspecies of *S. nigricollis* (now *Leontocebus nigricollis graellsii*). The taxonomies of both Groves (2001, 2005) and Rylands *et al.* (2000, 2008, 2009; Rylands and Mittermeier, 2008) are otherwise entirely concordant—they recognize the very same diversity of taxa.

Garbino (2015) discussed the recent changes in the genus names of the platyrrhines and, pertinent here, subsequently (Garbino *et al.*, 2018) recommended the use of subgenera for the tamarins: *Saguinus (Leontocebus)* – the white-mouthed tamarins; *Saguinus (Tamarinus)* – the moustached tamarins and the related mottled-faced tamarin (*inustus*); and *Saguinus (Saguinus)* – the *midas* tamarin group and the Colombian and Panamanian bare-face tamarins, *oedipus* species group. For this last group, Pocock (1917) described their distinctive features of the Colombia espoused their classification in the genus *Oedipomidas* Reichenbach.

Thus, in this document, as in the Regional Collection Plan, we use *Callithrix* for the Atlantic rainforest marmosets (the genus now endemic to Brazil), *Mico* for the Amazonian marmosets, and also now *Leontocebus* for Hershkovitz's *nigricollis* or white-mouth tamarin group. The TAG covers all species of the family and follows the most recent taxonomy, provided by Anthony Rylands. Any difference between the nomenclature used in the species lists and this taxonomy are referenced with footnotes in the text.



We list 64 species and subspecies of the family Callitrichidae—24 marmosets (*Cebuella*, *Mico* and *Callithrix*), 35 tamarins (*Saguinus*), four lion tamarins (*Leontopithecus*), and Goeldi's monkey (*Callimico*) (see Rylands *et al.*, 2000, 2006, 2008, 2009; Groves, 2001, 2005; Rylands and Mittermeier, 2008; Röhe *et al.*, 2009). These 64 callitrichids represent some 30% of the extant New World primates.

The Callitrichidae are generally thought to be phyletic dwarfs, i.e. they have evolved from a larger ancestor. During this dwarfing process the marmosets and tamarins have changed from the typical simian primate in several ways. They have acquired claw-like nails, rather than the typical flattened primate nail. They have lost full opposability of the thumb, although the big toe is still fully opposable. All but *Callimico goeldii* have lost the third molar, and all but *Callimico* have multiple births, twins being the rule rather than the exception

## 1.2 Morphology

The marmosets and tamarins are distinguished primarily by the elongated lower incisors of the marmosets, an adaptation to eating plant exudates (gummivory). The elongated lower incisors are about the same length as the lower canines, which are thus less prominent in the marmosets than the tamarins (Coimbra-Filho and Mittermeier, 1977). The tamarins are accordingly sometimes referred to as long-tusked, while the marmosets are referred to as short-tusked. Marmosets generally have a more complex caecum than the tamarins, probably an adaptation to increased gummivory among the former. Marmosets also have large and visually obvious genitalia that are displayed as part of ritualized threat behaviours. *Leontopithecus* do not have the dental adaptations of the marmosets, and hence have been aligned in their common name to the tamarins. Phylogenetically, however, they comprise the first offshoot, about 13.4 mya, of the marmoset lineage (Buckner *et al.*, 2015)—they are not tamarins, they are more closely related to the marmosets. Bridgewater (1972) got it right.

Callitrichids are small primates, and include the smallest simians, the pygmy marmosets *Cebuella*. The adult pygmy marmoset weighs around 120 g, while the largest of the extant callitrichids, the lion tamarins, *Leontopithecus*, weigh up to 750 g. Adult dwarf marmosets, *Callibella*, a little larger than *Cebuella*, weigh up to 185 gm. Most adult marmosets, *Callithrix* and *Mico*, weigh around 400–450g. The white-mouth tamarins, *Leontocebus*, are generally smaller than other tamarins, about 290 g to 396 g (Soini, 1983, 1990), although Smith and Jungers (1997) recorded weights of 468–484 g for the black-mantled tamarin, *L. nigricollis*. One could speculate that the larger size of *L. nigricollis* is related to the fact that it does not form mixed-species groups with the moustached tamarins as do the saddlebacks, having as such a comparatively broader adaptive zone. The remaining tamarin species *Saguinus* are larger, at around 450–550 g (Fleagle and Mittermeier, 1980; Soini 1983, 1990; F. Encarnación in Snowdon and Soini, 1988; Soini and Soini, 1990). Goeldi's monkey, *Callimico* weighs 355–535 g (Encarnación and Heymann, 1998). Morphological adaptations resulting from dwarfism are described above (Section 1.1 Taxonomy).

## 1.3 Physiology

Information on physiology of callitrichids comes from captive studies. As a result of their use as laboratory primates there is a considerable body of literature on their physiology. Relevant aspects of physiology are dealt with in later chapters.

## 1.4 Longevity

There have been few studies that record deaths of known-age callitrichids in the wild. In captivity callitrichids rarely survive into their 20s, and those that do, usually show signs of infirmity associated



with old age (J.B. Carroll, pers. obs.). However, there is an increasing number of specimens surviving into their 20s and even breeding at that age. We assume longevity in the wild is shorter.

## 2. FIELD DATA

### 2.1 Conservation status/Distribution/Ecology

The Callitrichidae are found only in the neotropical region of South America. The northernmost species, Geoffroy's tamarin (*Saguinus geoffroyi*), extends into southern Panama, but the family is not otherwise found in Central America. They occur in the Caribbean forests of northern Colombia and southern Panama (*Saguinus*), the eastern Andean forests and Amazon basin (*Callimico*, *Cebuella*, *Callibella*, *Mico*, *Leontocebus* and *Saguinus*), the cerrado (tropical savanna) of central Brazil (*Callithrix*), the caatinga (desert scrub and deciduous dry forest) of northeast Brazil (*Callithrix*), the Pantanal and Chaco of Bolivia, Brazil and Paraguay (*Mico*), and the Atlantic rainforest of the east and southeast of Brazil (*Callithrix* and *Leontopithecus*).

They occur in primary or secondary forest, and are most abundant in secondary (successional) or disturbed forest. They are arboreal, generally inhabiting the middle and lower storeys of the forest (Rylands, 1996).

### 2.2 Diet and feeding behaviour

#### 2.2.1 Feeding Ecology

In general, the Callitrichidae can perhaps best be described as frugivore-insectivores, feeding on a wide variety of fruits, arthropods and exudates and to a smaller extent buds, flowers, nectar, fungi, snails, small vertebrates (mostly lizards and frogs) and probably also bird's eggs and small birds. However, the proportion of each of these food items in the diet differs between species, within species, and between seasons. Similarly, the way in which the food items are procured differs among species. The callitrichid group as a whole, and within that the different genera and different species, have developed anatomical and behavioural adaptations to make optimum use of their foraging and feeding techniques. Each of these monkeys occupies its own feeding niche within its environment (Sussman and Kinzey, 1984; Ford and Davis, 1992; Garber, 1992; Rosenberger, 1992).

#### **Pygmy marmoset *Cebuella* and dwarf marmoset *Callibella***

Although there are documented instances of exudate feeding for every genus of the Callitrichidae, *Cebuella*, *Callibella* and some members of the genus *Callithrix* are among the most exudativorous (gummivorous) of primates (Power, 1996; Power and Oftedal, 1996; Van Roosmalen and Van Roosmalen, 2003). *Callithrix*, *Callibella* and *Cebuella* are the only callitrichid genera with dental adaptations for tree-gouging: the upper incisors are anchored in a fixed position while the relatively large (almost as long as the canines), chisel-like lower incisors of the cup-shaped anterior lower mandible scoop out the bark (Coimbra-Filho and Mittermeier, 1973; Garber, 1992; Rylands and de Faria, 1993; Power, 1996). They then either lick up the resulting exudate flow or scoop it up with their teeth. The other callitrichid genera (*Saguinus*, *Leontopithecus* and *Callimico*) do not have these adaptations for gouging, but they opportunistically feed on available exudates, a notable example being the profuse liberation of gum from the maturing pendulous seedpods of the legumes *Parkia pendula* and *P. nitida* in Amazonia, the former also in the Atlantic Forest (Peres, 2000). They exploit



injury sites on gum-producing trees and lianas that result from abrasion or windstorms (broken branches) or insects, besides holes gouged by squirrels or other animals and, in the case of some saddleback tamarins holes gouged by sympatric *Cebuella* (Soini, 1987; Snowdon and Soini, 1988).

The pygmy marmoset, *Cebuella* is a true exudate specialist and can be classified as an exudate feeder–insectivore (Soini, 1982, 1988, 1993; Power, 1996). Exudate feeding is a prominent activity of their daily life. On average, 32% of their total daily active time and 67% of their monthly feeding time is devoted to feeding on plant exudates (Ramirez *et al.*, 1977; Soini, 1982). Exudates are furthermore available and consumed all year round. The exudate portion of the diet is mainly complemented by insects and spiders whereas fruits, buds, flowers, nectar and vertebrates form only a minor part of the diet (Soini, 1982, 1988, 1993). Townsend (1999), however, observed a wild-caught pet pygmy marmoset catching and killing a bird. Insects are good sources of protein and lipids but are low in calcium and have low calcium:phosphorus ratios (Oftedal and Allen, 1996; Allen and Oftedal, 1996). They therefore appear to form a good complement for exudates which are high in complex polysaccharides and often contain significant quantities of minerals and especially calcium (Garber, 1992, 1993). (See also Box 1.6.1-1 on exudates and their digestion.)

### Marmosets, genera *Callithrix* and *Mico*

As indicated above, the marmosets, like *Cebuella*, have the necessary morphological adaptations to gouge holes in trees in order to feed on exudates (Coimbra-Filho, 1972; Coimbra-Filho and Mittermeier, 1976). There is however quite a bit of variation within the marmosets as far as the importance of exudates in the diet is concerned. The nutritional groupings for the marmoset genera *Callithrix* and *Mico* can perhaps best be described as follows (Rylands and de Faria, 1993):

Group 1: Highly exudativorous species: *C. jacchus*, *C. penicillata*

Group 2: Species less exudativorous than group 1 but better adapted for tree gouging than groups 3 and 4: *C. kuhlii*, *C. geoffroyi*

Group 3: Species relatively poorly adapted for tree-gouging, the proportion of exudates in the diet depending on availability: *C. aurita*, *C. flaviceps*

Group 4: Highly frugivorous species, relatively poorly adapted for tree gouging and more seasonally exudativorous: e.g., *M. humeralifer*, *M. argentatus*

For the animals of Group 1, which are expertly adapted for both acquiring and digesting exudates whenever the need arises (see Box 1.6.1-1), exudates form an important substitute for fruits at times and places when these are rare. Because this ensures the animals a regular supply of carbohydrates and some minerals (such as calcium) all year round, they can live in small home ranges in forest patches with highly seasonal availability of fruits and insects (disturbed forests and/or dry, harsh climates) (Stevenson and Rylands, 1988; Caton *et al.*, 1996). Extrapolating from this, it can be hypothesised that the marmosets of the lush and wetter Atlantic coastal forest (*C. kuhlii*, *C. aurita*, *C. flaviceps* and *C. geoffroyi*) depend less on exudates than *C. jacchus* and *C. penicillata*, but probably more so than the Amazonian marmosets (Stevenson and Rylands, 1988).

For Groups 2–4, exudate feeding is to a greater or lesser extent seasonal and mostly negatively correlated to the availability of fruit (Rylands and de Faria, 1993). These marmosets can perhaps be better described as frugivore–insectivores.



All marmoset species spend a considerable part of their day foraging for animal prey (24–30% of their daily activity, Stevenson and Rylands, 1988). Animal prey mostly consists of insects and spiders and, to a lesser extent snails, frogs, lizards, small birds and bird eggs. (See also 2.2.1.1 on exudates and their digestion.)

### Tamarins, genera *Saguinus* and *Leontocebus*

The bulk of the diet in all the tamarin species studied consists of insects and fruits (Snowdon and Soini, 1988). Tamarins in general can therefore be regarded as insectivore-frugivores.

They complement their diet with smaller (or seasonal) amounts of exudates (gum and/or sap), nectar, snails, honey, flowers, leaves, buds, fungi, bark and small vertebrates. The relative proportions of the different food items depend on the availability. Tamarins tend to maintain a considerable intake of invertebrates, mostly orthopteran insects, throughout the year (30–77% of total feeding and foraging time) (Terborgh, 1983; Soini, 1987; Garber, 1993).

Fruits form the most important plant food source for most of the year (ripe fruits account for 20–65% of total feeding time) (Snowdon and Soini, 1988; Garber, 1993), but what happens during peak fruiting seasons or periods of fruit scarcity depends on the species and the location. For example, the diet of the golden-handed tamarin *Saguinus midas* in French Guiana contained, on an annual basis, 47.1% fruit and 50.2% invertebrates, making it the most insectivorous species so far studied in French Guiana. Even during peak fruiting season this species did not increase its intake of fruit but took advantage of the concurrent greater insect availability and increased its insect intake, possibly as a result of competition with larger sympatric primates (Pack, 1999). Terborgh (1983) studied emperor tamarins *Saguinus imperator* and saddle-back tamarins *Leontocebus weddelli* at Cocha Cashu in Peru and found that *S. imperator* spent 34% of the daily time budget on insect feeding and 16% on plant material feeding. For *L. weddelli* this was 16% and 16% respectively (they spent a lot more time resting than *S. imperator*). During the wet season both species spent more than 95% of the total plant feeding time feeding on fruits. During the dry season *S. imperator* only spent 41% of the plant feeding time on fruits but spent 52% feeding on nectar. Plant feeding time spent feeding on fruits for *L. weddelli* during the dry season dropped to 16% to the advantage of feeding on nectar (75%). Garber (1988b), studying *S. mystax* and *L. nigrifrons* in northeastern Peru, also found that for these species, nectar rather than exudates was the main replacer of fruit during the dry season months (22–37% of foraging and feeding time). In contrast, the *L. illigeri* studied by Soini (1987) at a different site in northeastern Peru switched largely to exudate feeding rather than nectar feeding during the dry season. Although fruit was quantitatively the most important plant food resource during the wet season, during the peak dry season 58% of plant feeding time was spent consuming exudates much of them pirated from *Cebuella* (compared to 4% during the wet season) (Soini, 1987). Forty-five percent of daily activities consisted of insect foraging and 14% feeding on plant resources.

As mentioned above (see 2.2.1.1 gums), tamarins do not have the anatomical adaptations for tree gouging and for digesting large amounts of gum. They do feed on gums and sap opportunistically (at tree injury sites or holes gouged by other animals) but in most species exudate feeding is only a seasonal phenomenon and accounts for less than 5% of the total feeding time (Garber, 1993; Power, 1996; Power and Oftedal, 1996). Saddle-back tamarins appear to form an exception to this in that they consume gums more consistently throughout the year and at higher levels than other species (12% of monthly feeding time with a range of 5–58%) (Terborgh, 1983; Soini, 1987; Garber, 1988a; Power, 1996). Because captive tamarins did improve their ability to digest gum the longer they received it (although never reaching the efficiency of the marmosets) it is possible that the more constant





ingestion of gum by the saddle-back tamarin enables it to maintain a higher digestibility of this product than other tamarins. Saddle-back tamarins are also highly insectivorous and it is therefore possible that for them, gums serve primarily as a mineral (calcium) source rather than an energy source (Power, 1996).

### Lion tamarins, genus *Leontopithecus*

The lion tamarins can be classified as frugivore-insectivores, with fruits (preferably soft, sweet and pulpy fruits) and insects making up the bulk of their diet, complemented by smaller amounts of other invertebrates, flowers, exudates, nectar, fungus and small vertebrates such as frogs, small lizards and snakes and nestling birds (Coimbra-Filho and Mittermeier, 1973; Kleiman *et al.*, 1988; Rylands, 1993; Dietz *et al.*, 1997). Uniquely for lion tamarins, much foraging for prey takes place in epiphytes, particularly epiphytic bromeliads (see Section 2.2.1.1: foraging behaviour). Their foraging is highly manipulative, associated their long hands and fingers. Of the total daily activity budget, *L. chrysomelas* spent 24% feeding on plant foods, 13% foraging for animal prey and 3% feeding on animal prey and nearly half of the animal prey foraging took place in bromeliads (Rylands, 1989). Lion tamarins have also been observed to eat the fruits, leaf bases and flower petal bases of small bromeliads (Lorini and Persson, 1994; L. Oliveira, pers. comm.).

During the dry season, when fruit is rare, golden lion tamarins *L. rosalia*, golden-headed lion tamarins *L. chrysomelas* and black lion tamarins *L. chrysopygus* have all been observed to eat nectar and a small but significant amount of exudates (Peres, 1989; Rylands, 1993; Dietz *et al.*, 1997). Exudate feeding has so far not been observed for the black-faced lion tamarin *L. caissara*, but this may be because most observations were made during the rainy season when fruit was plentiful (Valladares-Padua and Prado, 1996). Like the tamarins, lion tamarins lack morphological adaptations for tree gouging and tend to be opportunistic exudate feeders (Peres, 1989; Rylands, 1989, 1993). However, *L. rosalia* has also been observed eliciting exudate flow by actively biting the base of certain lianas (Peres, 1989).

### Goeldi's monkey *Callimico goeldii*

Comparatively little is known about the feeding habits of *Callimico* in the wild (Pook and Pook, 1981; Heltne *et al.*, 1981). *Callimico* appears to be mainly frugivorous. During the wet season they exhibit a preference for soft, sweet fruits. From the invertebrate fraction, mainly insects and spiders are consumed. Occasionally the animals also feed on buds, young leaves, fruit of low epiphytes, ants, etc. During the dry season, when fruits become scarcer, gum from the pods of *Piptadenia* and *Parkia velutina* is consumed (Pook and Pook, 1981; Porter *et al.*, 2009). Interestingly, *Callimico* has been observed to consume fungi at a higher rate than any other primate, especially during the dry season (Hanson *et al.*, 2003, 2006; Porter *et al.*, 2009). The sporocarps that are consumed by this monkey have been found to comprise primarily structural carbohydrates, with small amounts of simple sugars and fat that would provide some energy to the animals (Hanson, *et al.*, 2006). Fungi are also notable in diets of *Callithrix flaviceps* and *C. aurita* (Corrêa *et al.*, 2000; Hilário and Ferrari, 2011).

As an adaptation to exudativory, marmosets have reduced small intestines and enlarged compartmentalized caecums, which allow for hindgut fermentation of the structural carbohydrates in gums (Coimbra-Filho *et al.*, 1980; Lambert, 1998). Hanson *et al.* (2006) suggested that because *Callimico* is phylogenetically close to marmosets, they would have a similar gut morphology, allowing for the digestion of fungi. In their nine-month field study of one group of *Callimico* in northern Bolivia, Porter *et al.* (2009) found the animals to exploit fungi during 42±9% of feeding observations. Ripe fruits accounted for 27±5%, arthropods for 14±2%, pod exudates for 12±3%, and trunk and stilt-root



exudates for 1±0% of feeding observations. Whereas feeding time on arthropods remained relatively constant throughout the year, the use of other food items varied (Porter *et al.*, 2009). The authors proposed that *Callimico* uses exudates as fallback foods during times of fruit scarcity.

#### 2.2.1.1. Foraging behaviour: gums

Exudate-feeding trees are often visited repeatedly for extended periods of time (Stevenson and Rylands, 1988). Exudate holes are also often scent-marked. In the case of *Cebuella*, a group usually has one principal exudate source tree for the dominant couple and the youngest offspring (Soini, 1982). The older offspring often have a more restricted access to this tree and for them the secondary source trees of the dominant couple and young offspring form the principal exudate sources.

For *Cebuella*, *Callithrix jacchus* and *C. penicillata*, and to a lesser extent the other marmosets, gum is an essential part of their diet in the wild (particularly at times when other food items are scarce) and exudate feeding and tree gouging occupies a large proportion of their daily activities. *Cebuella* and *Callithrix* species are able to truly gouge trees (see above). For the other callitrichid species exudates are of a limited and more seasonal importance. Some tamarins have been observed to extract gum from crevices by sticking a hand into the source and licking the exudate from the fingers (Snowdon and Soini, 1988). When feeding on the gum of the pods of *Parkia* trees, *Callimico* was observed to hang upside down by its hind feet from the branch that the stem was attached to. They then either reach the seed pods or pull them up by means of the flexible stem (Pook and Pook, 1981). Heymann (1999) observed *S. mystax* in the wild and found that most of the gum feeding took place in the afternoon.



## Exudates and gum digestion

There are four main types of exudates which are each structurally, chemically and nutritionally distinct from one another (Rizzini and Coimbra-Filho, 1981; Stevenson and Rylands, 1988; Lambert, 1998):

- **Resins:** Produced in resin ducts by conifers and some tropical angiosperms. Derivatives of the plant metabolites phenols and terpenes. Insoluble in water. Not known to be consumed by any primate species.
- **Gums:** Have a water-soluble fraction and are high in complex carbohydrates composed of non-starch, multibranched polysaccharides. Gums contain no fat and no vitamins but some gums have a small protein fraction (0.5%-35% by weight) and they often contain significant quantities of nutritionally important minerals such as calcium, magnesium and potassium (Garber, 1993). Many families of tropical angiosperms produce gums. Gums coagulate to form a gelatinous or solid mass. Readily consumed by Callitrichidae and some other primates.
- **Saps:** Exudates of xylem and phloem (all trees therefore produce sap). Water-soluble and high in simple, relatively easy to digest, carbohydrates.
- **Latex:** Similar to gum but milky white, yellow or red. Contain terpenes, tannins and resinous elements as well as small amounts of proteins and non-reducing sugars. Rarely consumed by primates. Latex turns rubbery or solid on exposure to air.

During gouging for gum or as a result of injury to a tree, gum often gets mixed with sap. All Callitrichidae, to a greater or lesser extent, therefore consume gums and saps. Only marmosets will exceptionally feed on latex (Rizzini and Coimbra-Filho, 1981; Stevenson and Rylands, 1988; Garber, 1993).

Gums are multi-branched,  $\beta$ -linked polysaccharides and are resistant to mammalian digestive enzymes. This means that microbial fermentation is required for the animal to access the energy from these carbohydrates (Power, 1996; Power and Oftedal, 1996; Caton *et al.*, 1996). The same appears to be true of their mineral content (Power, 1996). It can therefore be hypothesised that gum feeders have anatomical and physiological adaptations that help to increase the digesta residence time within those regions of the gut where fermentation occurs (Ferrari and Martins, 1992; Power and Oftedal, 1996). Indeed, the caecum and colon represent a larger portion of the gastro-intestinal tract in marmosets than in other callitrichids (Ferrari and Martins, 1992; Power, 1996). The blunt ended and U-shaped marmoset caecum is of equal calibre to the colon and shows sacculations (Ferrari and Martins, 1992; Caton *et al.*, 1996).

Because gums have a water-soluble fraction, they can be expected to travel with the liquid components of the digesta. Transit time studies carried out on *C. jacchus* by Caton *et al.* (1996) showed that in this species, fluid digesta are selectively retained in the large caecum. The study therefore suggests that the common marmoset employs a two-part digestive strategy (Caton *et al.*, 1996):

- 1) Rapid digestion in the stomach and the long small-intestine of high-quality foods such as fruits and insects for immediate energy requirements for daily activities.
- 2) Selective retention and fermentation in the caecum of the soluble complex polysaccharides from the exudates as well as very small particles from insect exoskeletons. Exoskeletons are primarily made of chitin, a stiff polysaccharide that can be broken down by microbial fermentation (Lambert, 1998). This fermentation in the caecum provides a slower but constant background production of energy.

A comparative digestibility and transit time study (Power, 1996; Power and Oftedal, 1996) on *Cebuella*, *Callithrix jacchus*, *Leontocebus fuscicollis*, *Saguinus oedipus* and *Leontopithecus rosalia* revealed that when fed a diet that contained gum arabicum, the transit time of the marmosets tended to increase (although not statistically significant) while their digestive efficiency remained unaffected. In the tamarins and the golden lion tamarin the transit time was unaffected by the gum but their digestive efficiency was reduced, confirming that tamarins and lion tamarins are anatomically and physiologically less well adapted to the ingestion and digestion of gums.



Animal prey foraging patterns of callitrichids can be broadly classified into at least three different categories (adapted from classification for *Saguinus* from Garber (1993)).

Pattern 1: Energetic foraging on thin, flexible branches.

Animals energetically climb, grasp and jump on thin flexible branches of low shrubs and vine tangles (0–5 m above the ground). Prey is caught by rapidly striking forelimbs, while hindlimbs maintain a firm grasp on the supporting vegetation (e.g., *Saguinus geoffroyi*).

Pattern 2: Stealthy stalk and pounce technique, or “leaf gleaning” technique.

Locomotion involves bouts of stealthy walking while continuously alert on the immediate surroundings. Animals creep along branches in the understorey and middle layers of the forest, often placing the head close to the branch and foliage while motionlessly looking along the branches and leaves, probably for profiles of camouflaged insects. Capture involves stalking, pouncing and trapping prey (for example, between two cupped hands). Hunt on exposed, visible (but often camouflaged) prey capable of rapid escape (e.g., *Cebuella* spp., *Callithrix* spp., *Mico* spp., *Saguinus mystax*, *Saguinus labiatus*, *Saguinus imperator*, and possibly *Saguinus midas*). Animals from this category occasionally also forage by manipulation (pattern 3).

Pattern 3: Manipulative specific site foraging.

This pattern is typified by cling-and-leap locomotion and vertical clinging postures on moderate to large supports, such as trunks and large branches. From a stable position, specific microhabitats such as knotholes, crevices, cracks, bark and other regions of the trunk are explored. For lion tamarins specifically, the most important microhabitat foraging sites are epiphytes and especially epiphytic bromeliads. The animals feed largely on non-mobile, hidden prey, a considerable proportion of which is located by touch rather than sight. The long, slender hands and fingers of the lion tamarins are excellently suited for this type of foraging (e.g., *Leontocebus* spp. (possibly also *L. nigricollis* and *S. bicolor*), and *Leontopithecus* spp. (see Bicca-Marques, 1999).

Little is known about the foraging habits of *Callimico* in the wild, and it is not yet clear to which, if any, of the above insect foraging patterns the species belongs. Animals have repeatedly been seen to jump down to the ground and immediately jump back up again, holding a large grasshopper in the mouth (Pook and Pook, 1981). Their cling-and-leap locomotion style at a preferred height of 2–3m above the ground may help with this prey catching technique.

#### **2.2.1.2. Fruit**

The methods for foraging for fruits are quite similar among the callitrichids (Rylands, 1981; Snowdon and Soini, 1988; Stevenson and Rylands, 1988). Most of the fruits eaten are small and are pulled or bitten off the tree and are then held in both hands while they are eaten. Larger fruits are eaten while still attached to the tree. *C. jacchus* was observed hanging upside-down from the hind legs to feed on dangling fruit (Stevenson and Rylands, 1988). With fruits larger than the animal, they cling to the outer surface of the fruit and gouge holes to the interior.

For most callitrichids, the indigestible bulk of the diet largely consists of seeds that are swallowed whole and are passed through the digestive tract largely unchanged (Heymann, 1992; Power, 1996; Dietz *et al.*, 1997). Callitrichids therefore appear to play a role as seed dispersers in the tropical forest (e.g., Passos, 1997).



## Overview of callitrichid feeding ecology (Table from NRC, 2003;

© National Academy of Sciences)

Scientific Name	Diet <sup>a</sup>	Behavior	Body Weight <sup>b</sup>	References	
<b>Fruit and insect foraging dominate diet, gums seasonally important</b>					
<b>Callithrix</b>					
<i>C. argentata</i>	Bare-ear marmoset	27% (24-30%) of total daily activity foraging for insects; therefore, total feeding time spent on insect foraging 56% (50-63%), fruit 33% (28-37%), exudates (gums) 11% (5-16%); when fruit scarce, exudate intake increased	Diurnal, arboreal mostly, multimale/multifemale group size 3-20 individuals	190-320 g females, 357-450 g males; <i>C. nigriceps</i> 370 g male, 390 g female	Ferrari, 1993; Ferrari & Ferrari, 1989; Ferrari & Rylands, 1994; Ford & Davis, 1992; Harrison & Tardif, 1994; Koenig, 1995; Muskin, 1984; Rylands, 1993; Rylands & de Faria, 1993; Stevenson & Rylands, 1988
<i>C. aurita</i>	Buffy tufted-eared marmoset				
<i>C. geoffroyi</i>	Geoffroy's tufted-eared marmoset				
<i>C. humeralifer</i>	Tassel-eared marmoset				
<i>C. kuhlii</i>	Wied's tufted-eared marmoset				
<i>C. mauesi</i>	Maues marmoset				
<i>C. nigriceps</i>	Black-headed marmoset				
<b>Fruit dominates, insects important, gums or nectar seasonal</b>					
<b>Leontopithecus</b>					
<i>L. caissara</i> <sup>c</sup>	Black-faced lion tamarin	Ripe fruit 53% (32-78%), insect foraging 25% (14-50%) of feeding time, unripe fruit 6-7%, exudates (gums) 9% (1-20%), nectar 7% (0-43%)	Diurnal, arboreal mostly, pairs or multimale/multifemale 2-3 adults/group, 2-16 total	361-794 g females, 437-710 g males	Albernaz, 1997; Butynski, 1982; Dietz et al., 1997; Ferrari, 1993; Ferrari & Rylands, 1994; Ford & Davis, 1992; Rylands, 1993; Tardif et al., 1993
<i>L. chrysomelas</i>	Golden-headed lion tamarin				
<i>L. chrysopygus</i>	Black lion tamarin				
<i>L. rosalia</i>	Golden lion tamarin				
<b>Gums dominate, insects important, fruit can depend on location</b>					
<b>Callithrix</b>					
<i>C. jacchus</i>	Common marmoset	Exudates (gums) 45% (24-70%), fruit 16% (14-30%), insect foraging 39% (30-70%), nectar in dry season; <i>C. pygmaea</i> exudates (gums) 60% (30-77%), fruit 8% (0-10%), insects 30% (20-33%)	Diurnal, arboreal mostly, multimale/multifemale, groups 1-15; <i>C. pygmaea</i> monogamous families, up to 4 litters living together	182-354 g females, 225-406 g males; <i>C. pygmaea</i> 112-140 g females, 99-160 g males	Coimbra-Filho & Mittermeier, 1978; Ferrari & Ferrari, 1989; Ferrari & Rylands, 1994; Ford & Davis, 1992; Ramirez, 1985a; Rylands & de Faria, 1993; Silva & Downing, 1995; Soini, 1982, 1988, 1993
<i>C. flaviceps</i>	Buffy-headed marmoset				
<i>C. penicillata</i>	Black tufted-eared marmoset				
<i>C. pygmaea</i> (was genus <i>Cebuella</i> )	Pygmy marmoset				
<b>Insects and fruit dominate, gums and nectar seasonally important</b>					
<b>Callimico</b>					
<i>C. goeldii</i>	Goeldi's monkey	Preferred food insects; also soft, sweet fruit in wet season, sticky coating of gum on pods in dry season; rarely buds or young leaves; diet similar to <i>Saguinus</i> spp. sometimes live with mixed <i>Saguinus</i> troops	Diurnal, arboreal mostly, monogamous pairs, some within group, 2-8 individuals	400-535 g	Ford & Davis, 1992; Helme et al., 1981; Mittermeier & Coimbra-Filho, 1977; Pook & Pook, 1981, 1982
<b>Saguinus</b>					
<i>S. bicolor</i>	Bare-faced tamarin	Insects 45% (30-77%), fruit 35% (13-74%), exudate 10% (0-37%), nectar 7% (0-35%), young leaves 3%, seeds; 34.8% of total activities foraging for insects, 17% plant foods; insect capture rate might be only 5.4% of prey-foraging time	Diurnal, arboreal, multimale/multifemale groups, 2-16 individuals; <i>S. imperator</i> , <i>S. labiatus</i> , and <i>S. midas</i> multimale/multifemale, but only 1 reproducing female	272-600 g females, 242-633 g males	Crandlemire-Sacco, 1988; Egler, 1992; Ferrari & Ferrari, 1989; Ford & Davis, 1992; Garber, 1984, 1988, 1993a,b; Harrison & Tardif, 1994; Lopes & Ferrari, 1994; Pack et al., 1999; Peres, 1993a; Ramirez, 1985a,b; Skinner, 1985; Silva & Downing, 1995; Soini, 1987; Terborgh, 1983
<i>S. fuscicollis</i>	Saddleback tamarin				
<i>S. geoffroyi</i>	Red-crested tamarin				
<i>S. imperator</i>	Emperor tamarin				
<i>S. inustus</i> <sup>c</sup>	Mottled-faced tamarin				
<i>S. labiatus</i>	Red-bellied tamarin				
<i>S. leucopus</i>	Silvery-brown bare-faced tamarin				
<i>S. midas</i>	Golden-handed tamarin				
<i>S. mystax</i>	Mustached tamarin				
<i>S. nigricollis</i>	Spix's black-mantled tamarin				
<i>S. oedipus</i>	Cotton-top tamarin				
<i>S. tripartitus</i> <sup>c</sup>	Golden-mantled saddleback tamarin				

<sup>a</sup> Diet format: mean (range).<sup>b</sup> Body weights in ranges whenever possible; single numbers are not averages but indicate that only one individual of the species has been weighed in the wild.<sup>c</sup> No data available from the wild but assumed to be similar to congeners.

## 2.3 Reproduction

The Callitrichidae were once thought to be monogamous and most callitrichid social groups have only a single breeding female. Many field studies, however, have noted multiple breeding males and, less frequently, more than one breeding female. In captivity at least breeding by subordinate females in most groups of most species is apparently suppressed physiologically. Subordinate females do not show oestrous cycles. The exception to this is the lion tamarins, in which subordinate females do



exhibit ovulatory cycles. It is thought that suppression of breeding in these species is by behavioural means.

With the exception of *Callimico*, all Callitrichidae typically have twin births. Singleton and triplet births are not, however, unusual. Quadruplet births occur rarely. In *Callimico*, twin births are exceptionally rare in captivity, and triplets and quadruplets have never been recorded.

All callitrichids show shared infant care, with all members of the group participating in carrying and grooming the infants. Sometimes the mother may only have the infants in order to feed them. All group members will usually share solid food with a weaning infant. Further information is given in Section 4.4 on breeding

## 2.4 Behaviour

Callitrichidae all live in social groups, within which a dominance hierarchy may, but not always, be evident. The composition of groups is highly variable, but usually contain several adults of both sexes. Most contain a single breeding female. This female may cohabit with several breeding males, and the group may also comprise offspring of various ages, some of adult age. Rarely, groups have been seen with more than one breeding female in the wild. Such groups are rarely stable over the long term in captivity.

Callitrichids show the typical range of primate social behaviours. In captivity, aggression between family group members is rare. A wide range of vocalisations is apparent. Facial expressions are more limited, but are nevertheless seen. Scent marking is a common means of communication.

There are three scent gland fields, the sternal, suprapubic and circumgenital. The appearance of the scent gland varies with gender and species. How much each scent gland field is used also varies with species and gender. It is thought that information such as identity, age and sexual condition can be conveyed through scent marks. Scent marks also have a territorial function, and territory boundaries are marked frequently.

The Callitrichidae are arboreal and travel is usually by quadrupedal locomotion. Some species will use vertical clinging and leaping to travel between vertical perches, while they will also sometimes go to the ground to travel from tree to tree.

They are diurnal, emerging from sleeping sites shortly after dawn and usually retreating to sleeping sites in the late afternoon before the sun begins to set. Group members usually sleep in contact or close proximity in a tree cavity or vine tangle.

Some species form associations with other species and will travel or forage in mixed groups, and defend a common territory.





### 3. SPECIES ACCOUNTS

Conservation status classification follows the *IUCN Red List of Threatened Species* (IUCN, 2009).

The Regional Collection Plan Status follows Bairrão Ruivo *et al* (2019a) and the EAZA RCP categories area as follows:

#### EAZA RCP categories

**EEP** – EAZA *Ex situ* Programme. The taxon needs proactive management by EAZA to fulfil its specified *ex situ* roles. This includes programmes that require proactive management to phase out the taxon or replace it with one or more other taxa. The proactive management may not necessarily include managing a population in the EAZA region (e.g., can involve activities by EAZA staff or TAG members to help manage an *ex situ* population/programme in a range state). EAZA can be the lead partner in the *ex situ* programme or can be a participating partner in a collaboration led by others (e.g., range state governments, NGOs, other zoo associations, etc.).

**MON-T Phase out** – The TAG will monitor the recommended elimination of this taxon from EAZA collections.

**MON-T DNO** – The taxon is currently not present in EAZA collections and it is not recommended that it be obtained in EAZA collections. Its presence/absence will be monitored by the TAG.

**MON-T** – The taxon is present in EAZA collections and while there is no specific role for the taxon (with associated management), there is also no active recommendation to replace or phase out the taxon. The TAG will monitor the numbers of this taxon in EAZA collections.





## Atlantic Forest marmosets - *Callithrix*

*Callithrix aurita* (É. Geoffroy Saint-Hilaire, 1812)

Common name:

**Buffy-tufted-ear marmoset**

IUCN Red List: Endangered (EN)  
CITES: Appendix 1  
Regional Collection Plan: EEP supporting *ex situ* population in Brazil

Taxonomy:

Previously considered a subspecies of *Callithrix jacchus* (see Hershkovitz, 1977).

Habitat & Distribution:

*Callithrix aurita* lives in upland evergreen and semi-deciduous forest above 400–500 m, in montane forests in southern Minas Gerais, Rio de Janeiro, and east and northeast São Paulo in south-east Brazil. *C. aurita* is threatened by slow, localised displacement by alien invasive *C. penicillata* and *C. jacchus*.

Morphology:

Buffy tufted-eared marmosets have black body fur with rufous speckling, a white blaze on the forehead, a rufous crown and yellowish/buffy ear tufts. They weigh around 400 to 450 g.

Reproduction:

There is no information available regarding life history in the wild.

Diet:

*Callithrix aurita* feeds on fruit, animal prey, exudates and fungus.

Behaviour:

Little is known about their social structure. Unlike other marmosets, this species has lower incisors poorly adapted for gouging trees to produce sap. As a result, exudate eating is usually confined to flow from damage caused by wood-boring insects. It is also reported that they use their lower front teeth to remove tree bark and eat termites and wood-boring insects.





*Callithrix flaviceps* (Thomas, 1903)

Common name:

**Buffy-headed marmoset**

IUCN Red List:

Critically Endangered (CR)

CITES:

Appendix 1

Regional Collection Plan:

EEP supporting potential *ex situ* population in Brazil

Taxonomy:

Previously considered a subspecies of *Callithrix jacchus* (see Hershkovitz, 1977). Closely related to *C. aurita*. Coimbra-Filho (1990) listed it as a subspecies *C. aurita*.

Habitat & Distribution:

Buffy-headed marmosets live in highland evergreen and semi-deciduous forest above 400 m in the Serra da Mantiqueira in southern Espírito Santo in southeast Brazil, south of the Rio Doce to the state boundary with Rio de Janeiro, west into eastern Minas Gerais in the Rio Manhuaçu basin

Morphology:

These animals are called buffy-headed because of the yellowish buff-coloured head and short yellow ear tufts. They grow up to an average of 231 mm with 322 mm of tail length and weigh around 406 g.

Reproduction:

Very little is known about this species regarding its life history, except that females may breed with a 6-month interval.

Diet:

*Callithrix flaviceps* feeds on gums, animal prey, fruits and seeds.

Behaviour:

Group size is around nine, varying between 5 and 15.





*Callithrix geoffroyi* (Humboldt, 1812)

Common names:

**Geoffroy's tufted-ear marmoset**

**White-faced marmoset**

**White-fronted marmoset**

IUCN Red List: Least Concern (LC)

CITES: Appendix 2

Regional Collection Plan: EEP

Taxonomy:

Previously considered a subspecies of *Callithrix jacchus* (see Hershkovitz, 1977).

Habitat & Distribution:

They live in secondary lowland, evergreen and semi-deciduous forest and forest edge up to 500 m. Disturbed forest is preferred over mature forest.

They occur in Espírito Santo and east and northeast Minas Gerais, north of the Rio Doce and south and east of the rios Jequitinhonha and Araçuaí in eastern Brazil.

Morphology:

Geoffroy's marmosets have a white face and forehead extending back over the crown. The ears have black tufts. The body is blackish/brown with distinctive brindled pattern with dark brown underparts. The tail is ringed. Adult Head and Body length measures around 198 mm, with a tail length of 290 mm. It weighs up to 350 g.

Reproduction:

There is little information available on this species' life history. The male coils his tail as a sexual display during copulation.

Behaviour:

Geoffroy's marmosets have been observed following army ant swarms to catch insects flushed from hiding by the ants. They occasionally feed with *Callicebus personatus*.

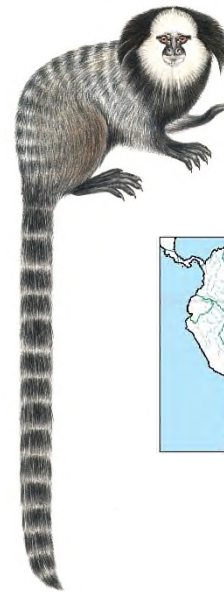



*Callithrix jacchus* (Linnaeus, 1758)

Common names:

**Common marmoset**

**White-eared marmoset**

IUCN Red List: Least Concern (LC)  
CITES: Appendix 2  
Regional Collection Plan: EEP – phase out in controlled manner

Taxonomy:

This species used to include *C. aurita*, *C. flaviceps*, *C. geoffroyi*, *C. kuhlii*, and *C. penicillate* as subspecies, but they are now all regarded as full species (de Vivo, 1991; Groves, 2001).

Habitat & Distribution:

Common marmosets live in scrub, swamps and tree plantations, areas with a wide range of exudate-producing trees in northeast Brazil, south as far as the rios Grande and São Francisco, northwest as far as the west bank of the Rio Parnaíba. They have been introduced into forests in north-east Brazil, south of the Rio São Francisco, south-east and south Brazil.

Morphology:

They have large white ear tufts. The tail has dark wide bands and pale narrow bands. They grow up to 188 mm with a tail length of 280 mm, and weigh up to 356 g. The caecum is specialised for exudate digestion.

Reproduction:

Weaning of infants occurs at around 2 months. They may reach sexual maturity at 12 months (females) and 16 months (males). The oestrous cycle lasts 28 days and gestation is 148 days. Females give birth to their first offspring at 20–24 months and breeding can occur with a 5–6-month interval. Usually they have twins, but one, three or even four offspring may result from pregnancy. Post-partum oestrus occurs within 9–10 days after a birth. The proceptive behaviour of the female is to stare at a male and flick her tongue in and out. During mating, the female looks back over the shoulder and opens her mouth.

Diet:

Common marmosets feed on fruit, gums and animal prey.

Behaviour:

They are more active in the early morning and late evening. The rest of the day is spent napping and grooming. Group size is usually around 8 individuals, varying between 3 and 15, but sometimes up to 20. This species has been imported to some regions and adapted to local conditions successfully. Vocalizations are, most commonly, a “phee”, a twitter, a “tsik” and a squeal. Infants have play vocalisations.

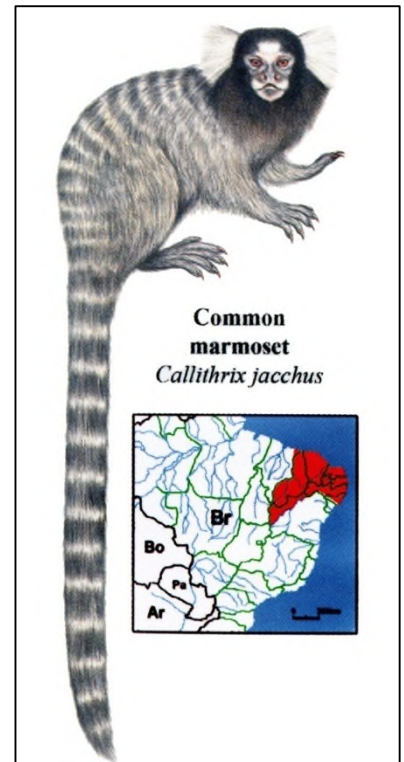



*Callithrix kuhlii* Coimbra-Filho, 1985

Common name:

**Wied's black tufted-ear marmoset**

IUCN Red List: Near Threatened (NT)  
CITES: Appendix 2  
Regional Collection Plan: MON-T DNO

Taxonomy:

Herskovitz (1977) considered *C. kuhlii* to be a hybrid of *C. jacchus penicillata* × *C. j. geoffroyi* (see Coimbra-Filho, 1985; Coimbra-Filho *et al.*, 2006).

Habitat & Distribution:

They live in secondary, lowland, evergreen and semi-deciduous forests and forest edge in east Brazil, between the Rio de Contas and Rio Jequitinhonha, in southern Bahia.

Morphology:

*Callithrix kuhlii* has a greyish body flecked with black and grey bands. In adults crown is brownish, ear tufts are black while the forehead, cheeks and throat are whitish. The thighs are reddish brown. They weigh approximately 350–400 g. They are similar to *Callithrix penicillata*.

Diet:

Fruit, insects, snails, gums and nectar.

Reproduction:

A species-specific, silent, open-mouth display initiates mating but little information is available concerning reproduction.

Behaviour:

They generally forage at heights of 6–13 m, but also catch insects and spiders on the ground that are disturbed by army ants. These marmosets occasionally associate with *Leontopithecus chrysomelas*, especially in more open areas.

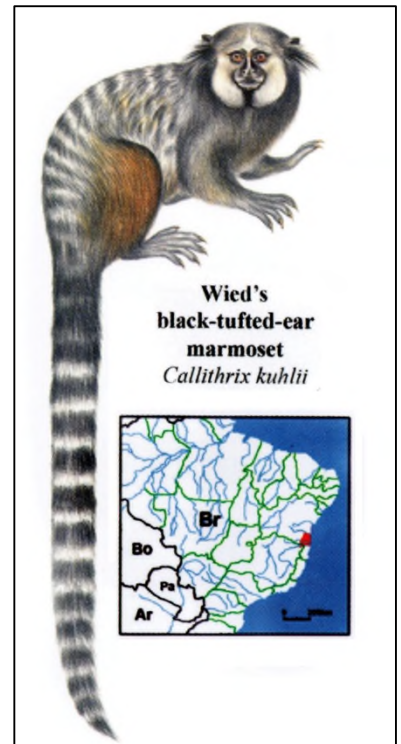



*Callithrix penicillata* (É. Geoffroy Saint-Hilaire, 1812)

Common names:

**Black-tufted-ear marmoset**

**Black-pencilled marmoset**

IUCN Red List: Least Concern (LC)  
CITES: Appendix 2  
Regional Collection Plan: EEP – phase out in controlled manner

Taxonomy:

Previously considered a subspecies of *Callithrix jacchus* (see Hershkovitz, 1977).

Habitat & Distribution:

Secondary forest, semi-deciduous forest and gallery forest in east central Brazil, in the states of Bahia, Minas Gerais, Goiás, and the southwest tip of Piauí, south of the rios Grande and São Francisco. Introduced into forests outside of its natural range in southeast Brazil.

Morphology:

These animals have black ear tufts and white forehead with light facial hair. Back and tail are banded. They grow up to 202–225 mm with a tail length of 287–325 mm and weigh between 182 and 225 g.

Reproduction:

There is no information on reproduction.

Diet:

Gums, fruit, animal prey (insects). There are reports of these marmosets, when in captivity, catching sparrows that fly into their cages.

Behaviour:

Average group size is 6.6 individuals varying between 3 and 9. They have smaller home ranges than other similar marmosets, a feature thought to be related to the high degree of gummivory they exhibit. They occasionally associate with *Leontopithecus chrysomelas*. Scent-marking is mostly performed in gum-feeding holes. At least four vocalizations are recognised by humans, among which are an alarm call, a threat call and a loud, piercing contact call.

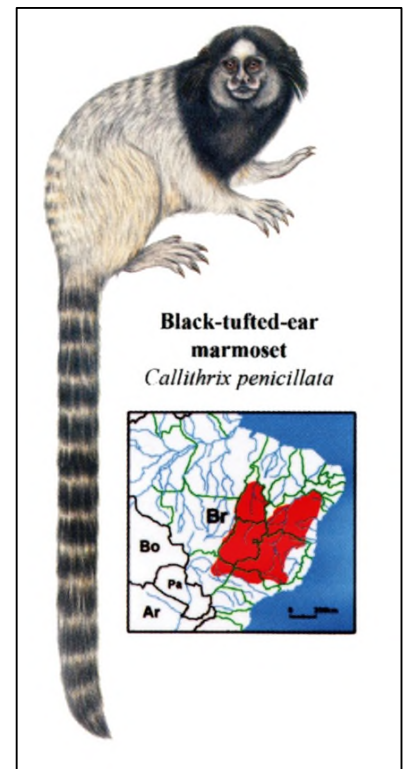





## Lion Tamarins – *Leontopithecus*

*Leontopithecus caissara* Lorini and Persson, 1990

### Common name:

**Black-faced lion tamarin**

IUCN Red List:

Endangered (EN)

CITES:

Appendix 1

Regional Collection Plan:

EEP -none *ex situ* at present but recommended for an insurance population

### Taxonomy:

Discovered and described in 1990. Coimbra-Filho (1990) indicated that *L. caissara* may be a subspecies of *L. chrysopygus*.

### Habitat and Distribution:

Primary lowland coastal forest (*restinga*) with many epiphytic bromeliads and palms. Distribution limited to the coastal region of southern São Paulo state and the island of Superagüi and parts of the coastal mainland in northern in Paraná State, Brazil.

### Morphology:

Black-faced lion tamarins have a golden body and black face. There are no data available on body length or weight.

### Reproductiono

No information available on life history or social structure but they are undoubtedly similar to the other lion tamarins.

### Diet:

No data available, but certainly fruit, gums, nectar and animal prey, such as frogs and lizards.

### Behaviour:

Nothing is known about group size.

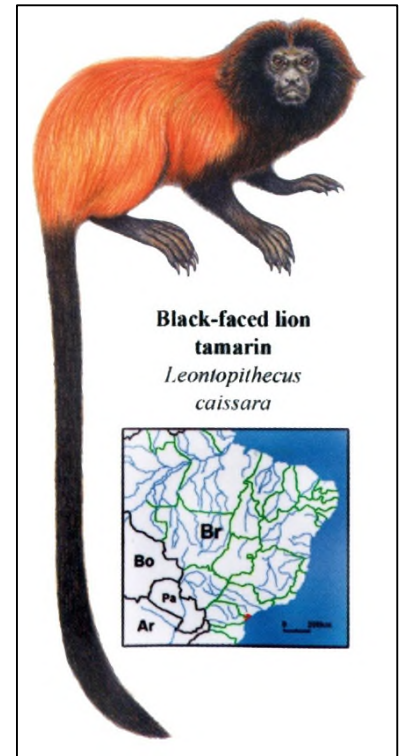





*Leontopithecus chrysomelas* (Kühl, 1820)

Common name:

**Golden-headed lion tamarin**

IUCN Red List: Endangered (EN)

CITES: Appendix 1

Regional Collection Plan: EEP

Taxonomy:

The lion tamarins, *Leontopithecus*, are considered separate species following Della Serra (1951) and Rosenberger and Coimbra-Filho (1984) (see Rylands *et al.*, 1993).

Habitat & Distribution:

Lowland forest, swamp, semi-deciduous and tall evergreen forest and old shaded cacao plantations (*cabruca*) from sea level to 112 m in eastern Brazil, between the Rio Jequitinhonha and Rio de Contas (Oliveira *et al.*, 2009).

Morphology:

Golden-headed lion tamarins have black fur all over the body, except for the head, arms, legs and part of the tail, which have golden fur. They grow up to 257 mm with a tail length of 376 mm and weigh between 480 and 700 g.

Reproduction:

Gestation is 128 days. Age of sexual maturity around 15 months. Subordinate females are not reproductively suppressed within their family groups, which may result in daughters becoming pregnant within groups.

Diet:

Fruit, gums (from *Parkia* bean pods), nectar and animal prey such as frogs and lizards.

Behaviour:

Average group size is around 7 individuals, varying between 5 and 8. They forage at a height of 12–20 m and search for insects in bromeliads, leaf litter trapped in vine tangles, bark and tree holes. These animals associate with *C. kuhlii* and *C. penicillata*. They use tree holes in primary forest as sleeping sites.

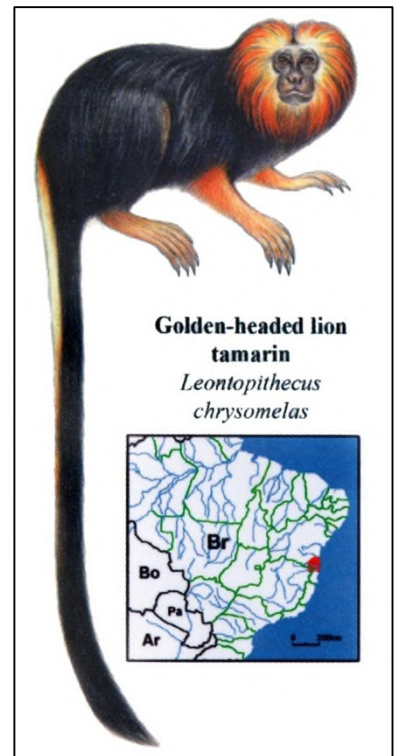



*Leontopithecus chrysopygus* (Mikan, 1823)

Common names:

**Black lion tamarin**

**Golden-rumped lion tamarin**

IUCN Red List: Endangered (EN)

CITES: Appendix 1

Regional Collection Plan: EEP

Taxonomy:

The lion tamarins, *Leontopithecus*, are considered separate species following Della Serra (1951) and Rosenberger and Coimbra-Filho (1984) (see Rylands *et al.*, 1993).

Habitat & Distribution:

These animals live in semideciduous riparian forest, to 100 m, in São Paulo State, in southeast Brazil, south of the Rio Tietê, north of the Rio Paranapanema, west to the Serra do Mar in the state of São Paulo. There are populations in about 20 forest fragments across the state. The Morro do Diabo State Park in the Pontal do Paranapanema, has 80% of the total population, and is currently the only viable population of the species with a population of around 1,200.

Morphology:

Black lion tamarins are not entirely black: they have a gold rump and gold at the base of the tail. The extent of the gold colouring varies between individuals. They are the largest of the lion tamarins, growing up to around 294 mm with a tail length of 376 mm and weigh between 540 and 750 g.

Reproduction:

Similar to *L. chrysomelas*.

Diet:

Fruit, gums and animal prey.

Behaviour:

Group size varies between 2 and 7 individuals. They come to the ground to forage for prey. Their home range is larger than those of other three species of lion tamarins because the forest has no bromeliads and has a distinct dry season, thus differing from the habitat of the lion tamarin species found near the coast. They use tree holes as sleeping sites.

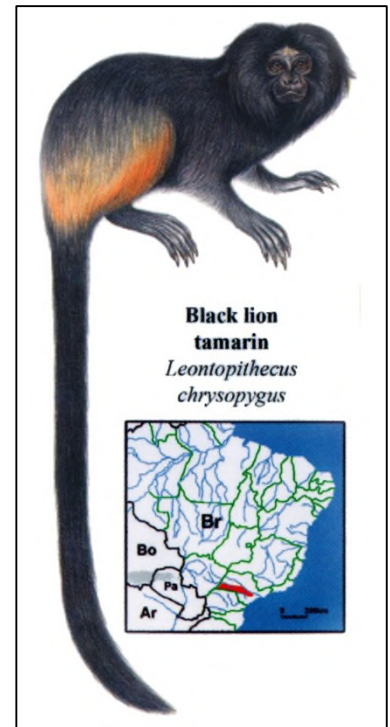



*Leontopithecus rosalia* (Linnaeus, 1766)

Common name:

**Golden lion tamarin**

IUCN Red List: Endangered (EN)

CITES: Appendix 1

Regional Collection Plan: EEP

Taxonomy:

The lion tamarins, *Leontopithecus*, are considered separate species following Della Serra (1951) and Rosenberger and Coimbra-Filho (1984) (see Rylands *et al.*, 1993).

Habitat & Distribution:

Primary and secondary lowland forest from sea level to 500 m in southeast Brazil, in the basin of the Rio São João, Rio de Janeiro.

Morphology:

All golden, reddish, orange or buffy, except for grey hairless face. Some individuals have blackish bands on the tail or around the face. They grow up to 261 mm with a tail length of 370 mm and weigh between 361 and 680 g.

Reproduction:

Weaning occurs at 3 months. They reach sexual maturity at about 15 months. Oestrous cycle is 21 days. Females give birth after a gestation of 129 days and the next births occur at a 6 to 12-month interval. Post-partum oestrus occurs 3–10 days after a birth. Shared infant care may not begin until a week or so after birth, but in established groups may be seen from day 1.

Diet:

Fruit, nectar, flowers, exudates, and animal prey, including insects and reptiles.

Behaviour:

Average group size is around 5 individuals, varying between 2 and 16. Sternal marking is more common than circumgenital. In captivity severe aggression has been reported to occur between adult females, even related females, within groups.

Reintroduction:

*Leontopithecus rosalia* has been the subject of a major reintroduction programme led by the National Zoological Park, Washington DC. By 1990, 75 individuals had been reintroduced. It has been estimated that the reintroduction programme has resulted in an 80% increase in available habitat for this species, as landowners are now prepared to set aside land for them. The golden lion tamarin programme has become a model success story for captive breeding and reintroduction. Intensive conservation action including reintroduction of zoo-born tamarins into forest fragments 1984–2000, increased numbers to about 3,700 in 2014. Beginning in November 2016, southeastern Brazil experienced the most severe yellow fever epidemic/epizootic in the country in 80 years. The first death of a golden lion tamarin due

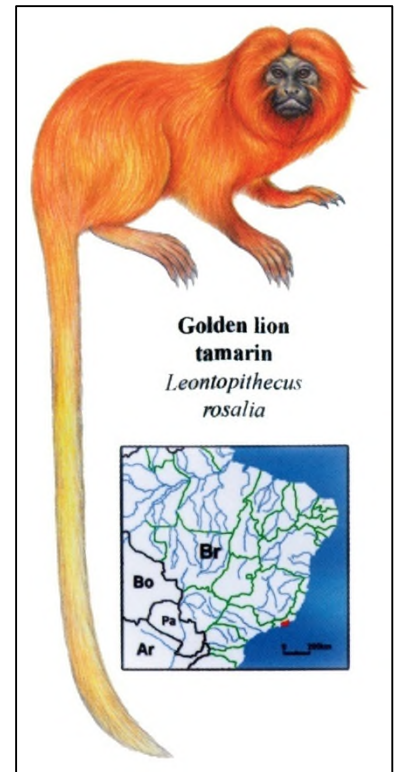



to yellow fever was recorded in May 2018, Tamarin numbers declined 32% from 2014 to about 2,516 individuals remaining *in situ* in 2019 (Dietz *et al.*, 2019).



## Amazonian marmosets –*Callimico*, *Cebuella*, *Callibella* and *Mico*

*Callimico goeldii* (Thomas, 1904)

### Common names:

**Goeldi's monkey, Callimico**

IUCN Red List: Vulnerable (VU)  
CITES: Appendix 1  
Regional Collection Plan: EEP

### Taxonomy:

Vàsàrhelyi (2002) studied the genetic structure of the founder stock of captive callimicos and concluded that there may be more than one cryptic subspecies or species.

### Habitat & Distribution:

Goeldi's monkeys live in tropical mixed-level rain forest with undergrowth and bamboo. Their habitat extends throughout the western Amazon basin, in Brazil, Bolivia, Peru and Colombia. It has never been recorded from Ecuador.

### Morphology:

This species grows up to an average of 222 mm and the tail length ranges from 255 to 324 mm. They weigh between 400 and 535 g. The fur is black, sometimes tipped with grey or brown. The hair is long and sticks out, sometimes resulting in a “dishevelled” appearance. The anterior crown of the head has characteristic upright hair. They have a clearly defined and visually obvious sternal scent gland. Adults have 36 teeth, having retained  $M_3$ , which has been lost in the other Callitrichidae.

### Reproduction:

Goeldi's monkeys have variable social structures in the wild. They range from monogamous pairs to multimale/multifemale groups with one breeding pair and sometimes more than one breeding female. Weaning of infants occurs at around 65 days. Both sexes typically reach maturity at about 13 months, although one female has been reported as conceiving at 8.5 months of age. Oestrous cycle duration is 24 days and gestation takes about 154 days (range 144–165). Females may give birth to their first offspring at about 16 months of age. A post-partum oestrus usually occurs at 5 to 10 days. Unlike all other Callitrichidae a single infant is the norm, and the infant care pattern is different to that typically seen in callitrichids. The female carries the offspring for about the first three weeks. The male and other group members then share the carrying until the infant is independent. From about day 42, infants start to travel independently.

### Diet:

Goeldi's monkeys feed on fruit and animal prey. Fungi are also now known to be an important food source. They prefer to forage below 5 m but they also feed at the top of tall trees when they are in fruit.

### Behaviour:

Group cohesion is very strong and group size varies between 2 and 8 individuals. They are diurnal and arboreal, preferring to travel below 5 m. Most locomotion is quadrupedal although vertical clinging





and leaping has been observed up to 4 m. They use tangles of vegetation below 15 m as sleeping sites. Goeldi's monkeys scent mark their tails by coiling the tail between the hind limbs and rubbing it against the genitals and the sternal scent gland. They have seven different calls, including a shrill long-distance call. Tamarins (*Saguinus*) often answer their calls.



## *Cebuella pygmaea* (Spix, 1823)

### Common name:

**Northern pygmy marmoset**

**Spix's pygmy marmoset**

IUCN Red List:

Vulnerable (VU)

CITES:

Appendix 2

Regional Collection Plan:

EEP currently managed as an EEP with *C. niveiventris*

### Taxonomy:

Groves (2001, 2005) places it in the genus *Callithrix*. Although Hershkovitz (1977) recognizes no subspecific forms, Napier (1976) and Van Roosmalen and Van Roosmalen (1997) argued for *niveiventris* Lönnberg, 1940 south of the Solimões (see Groves, 2001, 2005; Rylands *et al.*, 2009). A phylogenetic analysis by Boubli *et al.* (2018, 2021) showed that Spix's pygmy marmoset and *niveiventris* are distinct species (see also Garbino *et al.*, 2019a). They are distinguishable by the presence or absence of speckles on the genital skin.

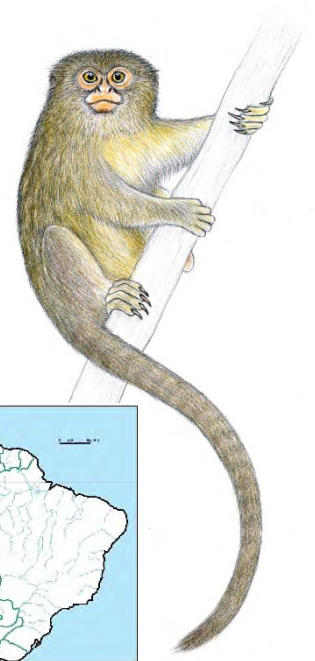

### Habitat & Distribution:

Floodplain forest near rivers, edges of agricultural fields, secondary growth forest, bamboo thickets north of the rios Solimões-Amazonas and Napo, south of the rios Japurá-Caquetá and Orteguzá. In Ecuador, it extends south, around the uppermost reaches of the Napo to meet the range of *C. niveiventris* (Boubli *et al.*, 2018; Porter *et al.*, 2021). *Leontocebus nigricollis* and *L. fuscus* are sympatric.

### Morphology:

These marmosets are the smallest South American primates. They have a tawny agouti body and a tawny gold-grey head. Their pelage coloration varies considerably but the ventral fur is tawny or yellowish tawny (see Boubli *et al.*, 2018; Garbino *et al.*, 2019a). They grow up to 136 mm with a tail length of 202 mm and weigh between 126 and 130g.

### Reproduction:

Social structure is monogamous family groups with offspring from up to four litters. Weaning of infants occurs at 3 months and they are fully independent at five months. Gestation lasts 130–142 days. In the wild females give birth to their first offspring (usually two, occasionally three) at 24 months, and the next births occur at 5–7-month intervals. Post-partum oestrus occurs within three weeks of a birth.

### Diet:

Mainly gums (67%), fruit, nectar and animal prey.

### Social behaviour:

Locomotion is quadrupedal with some vertical clinging and leaping (up to 5m). Group size is usually six, varying between 1 and 15. They gouge holes in bark of trees and revisit them each day to produce a steady supply of gums, regularly moving home ranges, depending on exudate availability. They do not usually forage on the ground, but will do so occasionally. They have at least 15 different





vocalizations, including a long-distance contact call, an alarm call, a chorus call. They have very small home ranges (approx. 0.5 ha).



## *Cebuella niveiventris* Lönnberg, 1940

### Common name:

**Southern pygmy marmoset**

IUCN Red List:

Vulnerable (VU)

CITES:

Appendix 2

Regional Collection Plan:

EEP (currently managed as an EEP with *C. pygmaea*)

### Taxonomy:

Groves (2001, 2005) places it as subgenus of the genus *Callithrix*. Although Hershkovitz (1977) recognizes no subspecific forms for *Cebuella*, Napier (1976) and Van Roosmalen and Van Roosmalen (1997) argued that a southerly (south of the Rio Solimões) form *niveiventris* Lönnberg, 1940 was valid (see Groves, 2001, 2005; Rylands *et al.*, 2009). A phylogenetic analysis by Boubli *et al.* (2018, 2021) showed that Spix's pygmy marmoset and *niveiventris* are distinct species (see also Garbino *et al.*, 2019a). They are distinguishable by the presence or absence of speckles on the genital skin.



### Habitat & Distribution:

Floodplain forest near rivers, edges of agricultural fields, secondary growth forest, bamboo thickets in central western Brazil, Ecuador and eastern Peru. The nominate subspecies occurs north of the Rio Solimões, while *C. p. niveiventris* occurs south of the rios Solimões-Amazonas and Napo, west of the Rio Madeira in Brazil and north of the Rio Madre de Dios in Peru and Bolivia

### Morphology:

These marmosets are the smallest South American primates. They have a tawny agouti body and a tawny gold- grey head. They grow up to 136 mm with a tail length of 202 mm and weigh between 126 and 130g.

### Reproduction:

Social structure is monogamous family groups with offspring from up to four litters. Weaning of infants occurs at 3 months and they are fully independent at five months. Gestation lasts 130–142 days. In the wild females give birth to their first offspring (usually two, occasionally three) at 24 months, and the next births occur at 5–7-month intervals. Post-partum oestrus occurs within three weeks of a birth.

### Diet:

Mainly gums (67%), fruit, nectar and animal prey.

### Social behaviour:

Diurnal and arboreal. Locomotion is quadrupedal with some vertical clinging and leaping (up to 5m). Group size is usually around 6 individuals, varying between 1 and 15. Pygmy marmosets gouge holes in bark of trees and revisit them each day to produce a steady supply of gums. These marmosets regularly move home ranges, depending on exudate availability. Although they do not usually forage on the ground, they will go to the ground to catch grasshoppers. In the dry season *Saguinus* spp. may visit the gum trees of pygmy marmosets to feed. *S. nigricollis*, *S. imperator* and *S. fuscicollis* are found



in the same area. Studies proved that they have at least 15 different vocalizations, including a long-distance contact call, an alarm call, a chorus call, and others. They have extremely small home ranges (about 0.5 ha).



*Calibela humilis* (M.G.M. van Roosmalen, T. van Roosmalen, Fonseca and Mittermeier, 1998)

Common name:

**Black-crowned dwarf marmoset**

IUCN Red List: Least Concern (LC)

CITES: Appendix 2

Regional Collection Plan: MON-T DNO

Taxonomy:

This marmoset was discovered and described in 1998. It was first described in the genus *Callithrix*. Van Roosmalen and Van Roosmalen (2003) placed it in its own genus, *Calibella*. Its cranial morphology is distinct from all other marmosets (Aguiar and Lacher, 2003; Van Roosmalen and Van Roosmalen, 2003). Its classification as a distinct genus is disputed. For – Aguiar and Lacher (2003) and Silva *et al.* (2018). Against – Schneider *et al.* (2012) and Garbino *et al.*, 2019b).



Habitat & Distribution:

*Calibella humilis* lives in secondary forest, south of the Rio Madeira, along the west bank of the Rio Aripuanã. The rios Mariépauá and Arauá may form the southern limit to its range, but its extent is not known. It is sympatric with the larger *Mico marcai*.

Morphology:

At 150–185 g and head-body length 160–170 mm, *Calibella humilis* is larger than the pygmy marmoset *Cebuella*. It is dark olive-brown above, orange-yellow to golden to greyish-yellow on the ventral surface, and easily distinguished from *Callithrix* on the basis of size.

Reproduction:

There is no information available regarding its life history.

Diet:

Assumed to be fruit, exudates, animal prey and insects. It spends a lot of time gouging bark on tree trunks.

Behaviour:

Poorly known at present, but it often assumes an upright squirrel-like posture on vertical trunks.



*Mico argentatus* (Linnaeus, 1766)

Common name:

**Silvery marmoset**

IUCN Red List: Least Concern (LC)

CITES: Appendix 2

Regional Collection Plan: EEP

Taxonomy:

Previously considered to have subspecies *melanurus* and *leucippe* (see Hershkovitz, 1977) that are here considered full species.

Habitat & Distribution:

Silvery marmosets live in tropical rain forest, deciduous dry forest and seasonally flooded white-river forests (*várzea*), up to 900 m. They occur in Brazilian Amazonia, south of the Rio Amazonas between the lower rios Tocantins and Tapajós, south along the right bank of the Tapajós to the Rio Cupari and left bank of the Rio Tocantins to about 4°S. Between the Xingu and Tocantins, its range is delimited by submontane and montane forests of the Guiana Shield.



Morphology:

*Mico argentatus* grow to around 210 mm with a tail length around 305 mm. Weight is 320–457g. The body colour varies from white to dark brown. The hairless ears and face are pink, mottled, or brownish in colour. The tail is black. Their caecum is specialized for exudate digestion.

Reproduction:

There is little information available on their life history but they follow a typical callitrichid pattern in captivity. Gestation is around 154 days. Females are sexually mature from about 15 months of age. Both sexes rhythmically lip-smack before mating.

Diet:

Silvery marmosets feed on fruit, animal prey and gums.

Behaviour:

As with life history, there is still little known about their social structure in the wild. In savannah habitats, groups will cross grassland from one tree clump to another. They use tree hollows, dense vegetation and vine tangles as sleeping sites. In the extreme eastern part of its range, this species is sympatric with *Saguinus niger*, and groups of the two species may form mixed-species associations. Glands in the circumgenital and sternal areas are used to scent-mark. They have a special play vocalization described as “ee-ee”.



*Mico leucippe* (Thomas, 1922)

Common name:

**Golden-white bare-ear marmoset**

IUCN Red List: Least Concern (LC)

CITES: Appendix 2

Regional Collection Plan: MON-T DNO

Taxonomy:

Previously considered to be a subspecies of *Callithrix argentata* (see Hershkovitz, 1977).

Habitat & Distribution:

This species occurs in the central Amazon of Brazil, in a small area in the state of Pará, between the rios Cuparí and Tapajós (right bank of the Rio Tapajós), south to the Rio Jamanxim.

Morphology:

Head and body predominantly whitish, tail and feet pale gold, facial skin and ears unpigmented or mottled.

Reproduction:

No specific information available at this time.

Diet:

Fruits, flowers, plant exudates (gums and nectar) and animal prey (including frogs, snails, lizards, spiders and insects).

Behaviour:

No specific information available at this time.





*Mico emiliae* (Thomas, 1920)

Common name:

**Sneathlage's marmoset**

IUCN Red List: Least Concern (LC)

CITES: Appendix 2

Regional Collection Plan: MON-T DNO

Taxonomy:

Herskovitz (1977) considered this species to be merely a dark form of *M. argentatus*.

Habitat & Distribution:

In the south of the state of Pará in the Brazilian Amazon. It occurs south from the Rio Irirí to the southern margin of Rio Peixoto de Azevedo, a right bank tributary of the Rio Teles Pires. The southern limits would evidently not be beyond the headwaters and upper Rio Paraguai, approximately 14°30'S, where *M. melanurus* occurs.

Morphology:

Blackish crown and greyish-brown back. Whitish face, cheeks and forehead, and absence of a pale whitish or orangey hip patch distinguish it from *M. melanurus*. Tail is black.

Reproduction:

No specific information available at this time.

Diet:

Fruits, flowers, plant exudates (gums and nectar) and animal prey (including frogs, snails, lizards, spiders and insects).

Behaviour:

No specific information available at this time.







*Mico munduruku* Costa-Araújo, Farias & Hrbek in Costa-Araújo, Melo, Canale, Hernández-Rangel, Messias, Rossi, F.E. Silva, M.N.F. da Silva, Nash, Boubli, Farias and Hrbek, 2019

Common name:

**Munduruku marmoset**

IUCN Red List: Vulnerable (VU)

CITES: Appendix 2

Regional Collection Plan: MON-T DNO

Taxonomy:

Newly described.

Habitat & Distribution:

In lowland primary and secondary terra firma forests in the southwest of Pará State, Brazil, occurring from the left margin of the Rio Jamanxim, below the mouth of Rio Novo River, possibly up to the right margin of the upper Rio Tapajós, below the mouth of the Rio Cururú. (Costa-Araújo *et al.*, 2019).

Morphology:

Face and ears pink and largely naked but with sparse white hairs on face around the nasal openings and on the lower lip and both surfaces, no ear tufts; crown, mantle and chest white; arms and hands white with a beige-yellowish spot on the elbow; lower back beige-yellowish; cream-coloured on the flanks and belly; outer surface of legs and rump pale orange-yellow; white hair on feet; tail pale orangey at the base on the ventral surface, but otherwise white.

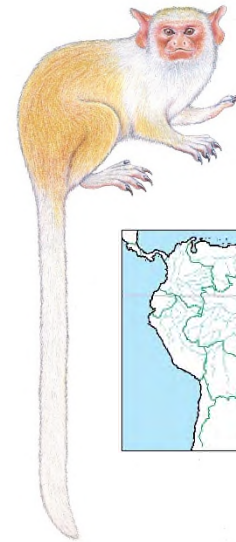



*Mico schneideri* Costa Araujo, Silva Jr., Boubli, Rossi, Hrbek & Farias in Costa-Araújo, J. Silva-Jr., Boubli, Rossi, Canale, Melo, Bertuol, F. Silva, D. Silva, Nash, Sampaio, Farias & Hrbek, 2021

Common name:

**Schneider's marmoset**

IUCN Red List: Not Evaluated (NE)

CITES: Appendix 2

Regional Collection Plan: MON-T DNO

Taxonomy:

Newly described.

Habitat & Distribution:

Primary and secondary terra firma forest, and in the Amazonia-Cerrado transition in the Juruena–Teles Pires interfluvium, in the north of the state of Mato Grosso, Brazil, between the Rio Juruena in the west and the Rio Teles-Pires in the east, extending south to their headwaters, as far as the town of Lucas do Rio Verde, where it may meet *M. melanurus*.



Morphology:

Face and ears pink; hairs on the face are short, mostly white but also black or black and white, denser around the nostrils and longer on the sides of the face; no ear tufts; white forehead, crown blackish; greyish-buff mantle and upper arms blackish golden hairs on hands; inside arms, neck and chest cream-coloured; back, rump outer thighs a uniform lead colour; belly pale orange; inside legs pure orange; golden-orange hairs on the feet; tail black.



*Mico melanurus* (É. Geoffroy, 1812)

Common name:

**Black-tailed marmoset**

IUCN Red List: Near Threatened (NT)

CITES: Appendix 2

Regional Collection Plan: MON-T Phase out

Taxonomy:

Previously considered to be a subspecies of *Callithrix argentata* (see Hershkovitz, 1977).

Habitat & Distribution:

In south-central Amazonia and the Pantanal of the Mato Grosso of Brazil, extending into Bolivia and Paraguay. It ranges south from the vicinity of the Serra do Sucunduri, interfluvium of rios Aripuanã and Juruena, into Mato Grosso, Pantanal and Bolivia, east of the Río Mamoré, and in the northeastern Paraguayan Chaco to approximately 20°S.

Morphology:

Facial skin and ears deeply pigmented, although sometimes there is mottling around the nose and muzzle. Forehead, crown and lower back predominantly brown, tail blackish; prominent whitish, pale hip and thigh patch (along dorsal surface of thigh), defined from brownish legs and sides of body. No ear tufts.

Reproduction:

No specific information available at this time.

Diet:

Fruits, flowers, plant exudates (gums and nectar) and animal prey (including frogs, snails, lizards, spiders and insects).

Behaviour:

No specific information available at this time.

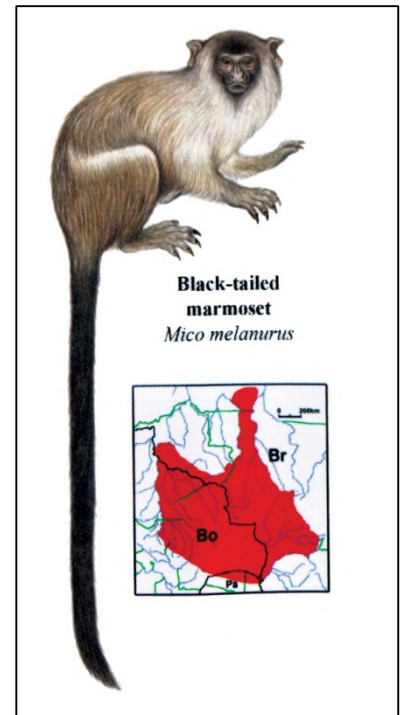



### *Mico intermedius* (Hershkovitz, 1977)

#### Common name:

**Aripuanã marmoset**

IUCN Red List: Least Concern (LC)

CITES: Appendix 2

Regional Collection Plan: MON-T DNO

#### Taxonomy:

Previously considered to be a subspecies of *Callithrix humeralifer* (see Hershkovitz, 1977).

#### Habitat & Distribution:

This species is found in dense primary and secondary rainforest, with distinct wet (December– March) and dry (May–October) seasons. They are more common in disturbed forests patches, with denser understories and vine tangles, resulting from tree falls or human disturbances. They are scarce in riparian, flooded forest and tall forest with minimal and sparse undergrowth. One group was observed in white-sand forest (smaller-leaved, with a floristic community quite distinct from the surrounding clay-soil forest). They occur between the rios Roosevelt and Aripuanã. *Mico intermedius* and *M. melanurus* are not sympatric between the Rios Aripuanã and Roosevelt as was supposed by Hershkovitz (1977).

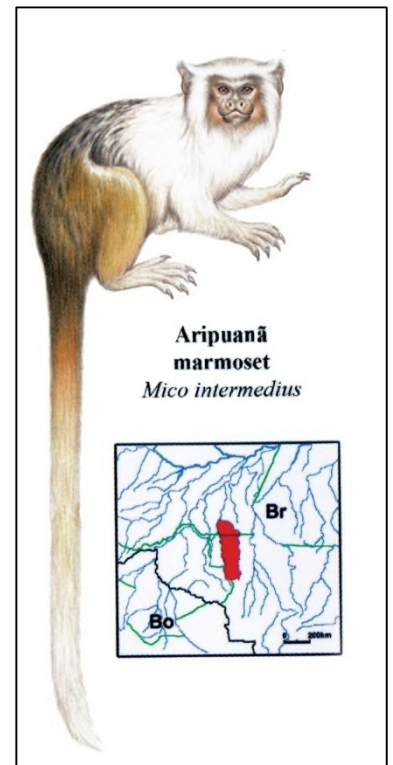

#### Morphology:

Similar to *M. melanurus* in such aspects as the distinct pale thigh stripe, similarly coloured hindquarters, a greyish crown (paler than *M. melanurus*), and the lack of an ear-tuft (it has a rudimentary tuft from behind the pinna only and not the well-developed tuft from within and around the pinna as in *M. humeralifer*). The face is variably depigmented (some individuals have quite dark greyish faces), the forequarters are paler, and varying parts of the tail are pale rather than black, when compared to *M. melanurus*.

#### Reproduction:

Breeding is generally restricted to a single female at any one time. In the single study of a group of Rio Aripuanã Marmosets, a female gave birth to three sets of twins in a year: early September (early wet season), early February (mid- to late wet season), and mid-July (dry season). Infants in three other groups were seen in August–September and January–February. Interbirth intervals for the female that produced twins three times were 148–162 days and 154–160 days, which is only a little longer than gestation of c.150 days. Births twice a year would seem to be the norm. One adult male carried infants on first he day of their birth. Other adult group members carried infants as soon as two days after their birth. Two males, however, were particularly active in carrying the twins, and three males were seen copulating with the breeding female, indicating the possibility of polyandry rather than a monogamous breeding system. After about three weeks, infants were carried separately and began to spend time off of their adult carriers. Parking of infants was seen occasionally.

#### Diet:

Fruits, small animal prey, especially insects, plant exudates (gums and nectar).



Behaviour:

Home range size of one group of Rio Aripuanã Marmosets that was studied over a full year was 28.2 ha, with monthly sizes from 11.5 ha to 21.5 ha. Less than one-half of the home range (44%) was used 90% of the time. Daily movements were 772–2115 m, with overall monthly means of 1200–1774 m; the group visited between one-third and a little less than one-half of its home range each day. Group size was 8–15 individuals, with a mean of 11.5 individuals among eight groups. Groups include 1–4 adult males, 1–5 adult females, and varying numbers of subadults, juveniles, and infants. Encounters between groups at the borders of their home ranges are characterized by calling, displaying, chasing, and scent marking. Displays, sometimes involving the majority of individuals in each group facing each other a few meters apart, include frowning (lowering the head and eyebrows and staring), rapid scratching of the tail (held in one hand and scratched with the other), and tail-raising (presenting their genitalia with the tail raised and looking back toward an opponents).



*Mico rondoni* Ferrari, Sena, Schneider and Silva Jr., 2010

Common name:

**Rondon's marmoset**

IUCN Red List: Vulnerable (VU)

CITES: Appendix 2

Regional Collection Plan: MON-T DNO

Taxonomy:

This species, for many years considered as *Callithrix emiliae*, following Vivo (1985), was formally described as a distinct species by Ferrari *et al.* (2010). Recognizing that this marmoset was not in fact a population of the form *emiliae* known from the Iriri basin to east, Rylands *et al.* (2009; and earlier publications) referred to this species as *Mico cf. emiliae*, awaiting the publication of its true taxonomic status by Ferrari *et al.*

Habitat & Distribution:

South-central Amazon in Brazil. The geographic range is delimited by the rios Mamoré, Madeira and Jiparaná rivers to the west, north, and east, respectively, and the Serra dos Pacaás Novos to the south, where it is replaced by *Mico melanurus*.

Morphology:

Silvery grey. Diagnostic features include the presence of blackish hairs on the forehead and sides of face, a distinct whitish patch, contrasting with the crown, on the centre of the forehead, blackish crown pelage that extends to the back of the head and to the front of the ears, lower dorsum and proximal portion of legs greyish brown, darkening to almost black on the tail, the fur on the legs darkens gradually to reddish brown on the shin, blackish on the ankle. Adult body weight: mean 330 g (n = 17) (Ferrari *et al.*, 2010).

Reproduction:

No specific information available at this time.

Diet:

Fruits, insects, plant exudates (gums and nectar) (Ferrari and Martins, 1992).

Behaviour:

In the wild it is sympatric with, and sometimes associates with, *Saguinus fuscicollis weddelli*.

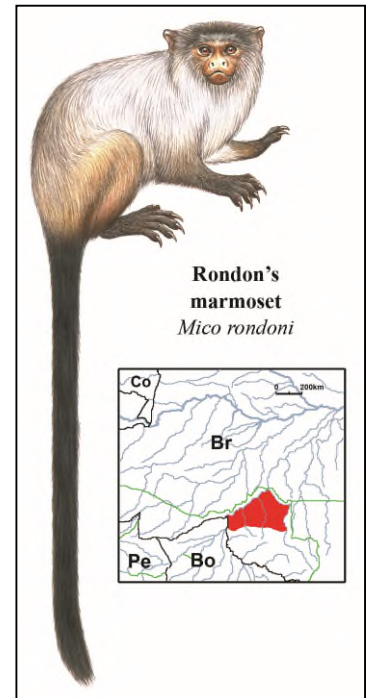



*Mico marcai* (Alperin, 1993)

Synonym: *Mico manicorensis* (M.G.M. Van Roosmalen, T. Van Roosmalen, Mittermeier and Rylands, 2000). See Garbino (2014)

Common name:

**Marca's marmoset**

IUCN Red List Near Threatened (DD)

CITES: Appendix 2

Regional Collection Plan: MON-T DNO

Taxonomy:

First described as a subspecies of *Callithrix argentata* (see Alperin, 1993).

Habitat & Distribution:

The central Amazon, Brazil; known only from its type locality, the mouth of the Rio Castanho (= Rio Roosevelt), left bank tributary of the Rio Aripuanã, in the state of Amazonas.

Morphology:

Dark face, unpigmented around the nostrils and covered with small hairs; crown dark brown; with hairs paler near to the base, white patch between the eyes, back of the neck and mantle showing a brown pattern (lightly ochre); middle and lower back reddish brown washed with brown and showing a variegated belt at the height of the hips and base of the tail; forelimbs, arm and forearm slightly paler than the back, hands slightly hirsute with the same colour as the forelimbs, thighs quite distinct from the rest of the body with a distinctly ochraceous colour on the inner and outer surfaces; tail dark brown, the first proximal inch quite distinct with ochraceous rings; the ventrum is reddish. Differs from *M. leucippe* and *M. argentatus* in a having very distinct coloration of the mantle, and from *M. melanurus* in not having the white patches on the hips, besides the white patch on the forehead. It differs from *M. emiliae* in having pale hands and feet, and a dark brown forehead.

Reproduction:

No specific information available at this time.

Diet:

Fruits, flowers, plant exudates (gums and nectar) and animal prey (including frogs, snails, lizards, spiders and insects).

Behaviour:

No specific information available at this time.

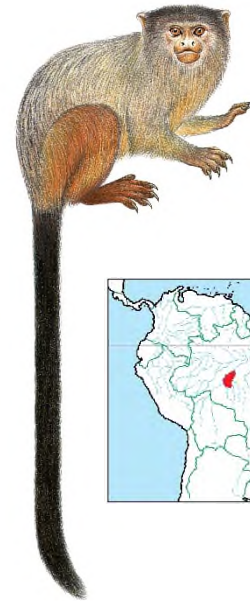





*Mico nigriceps* (Ferrari and Lopes, 1992)

Common name:

**Black-headed marmoset**

IUCN Red List: Near Threatened (NT)

CITES: Appendix 2

Regional Collection Plan: MON-T DNO

Taxonomy:

First described by Ferrari and Lopes (1992) in the genus *Callithrix*.

Habitat & Distribution:

Lowland rain forest and edge, in the southern central Amazon in Brazil.

Morphology:

These animals get their name from their black crown. They have a hairless black face with mottling, yellow lips and thighs, and a brown/black tail. The underparts are yellow to orange. Males have white hairless scrotum. They usually grow up to an average of 200 mm with a tail length of 320 mm, and weigh around 370 g.

Reproduction:

No data available.

Diet:

*C. nigriceps* feed on gum, fruit, seeds and insects (based on gut analysis).

Behaviour:

Nothing is known about group size. Locomotion is quadrupedal. No field studies have yet been published on this recently described species. It has no protected area.

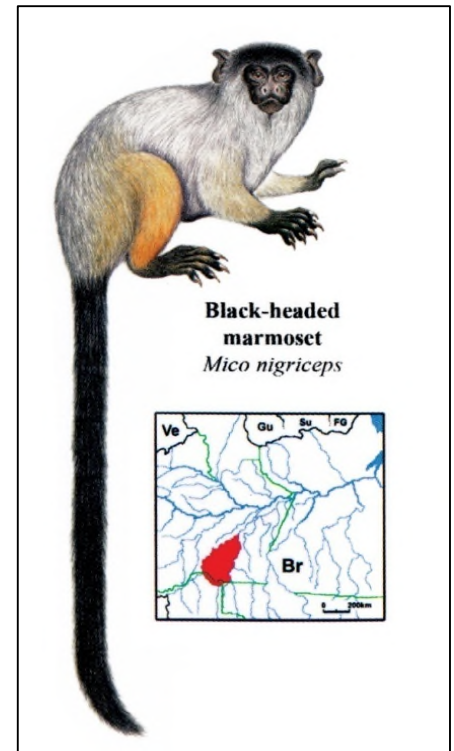



*Mico acariensis* (M.G.M. Van Roosmalen, T. Van Roosmalen, Mittermeier and Rylands, 2000)

Common name:

**Rio Acarí marmoset**

IUCN Red List: Least Concern (LC)

CITES: Appendix 2

Regional Collection Plan: MON-T DNO

Taxonomy:

Described by Van Roosmalen *et al.* (2000).

Habitat & Distribution:

These animals live in central Brazil, south of the Rio Amazonas-Solimões between the Rio Acarí and the Rio Sucunduri. The southern limit of the range is not fully determined.

Morphology:

Van Roosmalen *et al.* (2000) describe the Rio Acarí marmoset as the most colourful of the Amazonian marmosets. It is a member of the *Mico argentatus* group with bright orange lower back, underparts, legs and proximal end of the black tail. It has predominantly white upper parts and a black pigmented muzzle.

Reproduction:

There is no information available regarding their life history.

Diet:

Probably fruit, exudates, animal preys and insects.

Behaviour:

No information available.

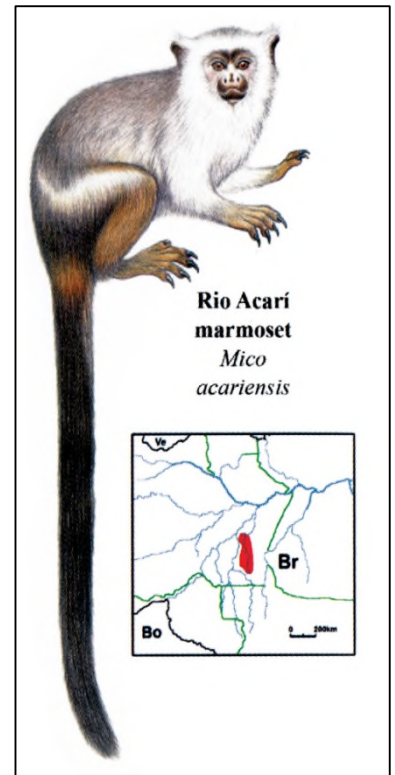



*Mico chrysoleucos* (Wagner, 1842)

Common name:

**Golden-white tassel-ear marmoset**

IUCN Red List: Least Concern (LC)

CITES: Appendix 2

Regional Collection Plan: MON-T DNO

Taxonomy:

Previously considered a subspecies of *Callithrix humeralifer* (see Hershkvoitz, 1977).

Habitat & Distribution:

Central Amazon in Brazil. Poorly known, it occurs in a north–south sliver, south of the Rio Amazonas, between the Rios Madeira and lower Aripuanã in the west and the Rio Canumã (= Cunumã) in the east.

Morphology:

Very pale marmoset, facial skin largely unpigmented, ears have long thick whitish tufts, head and trunk pale gold to whitish. Rump, tail, and fore- and hind limbs golden to orange.

Reproduction:

No specific information available at this time.

Diet:

Fruits, flowers, plant exudates (gums and nectar) and animal prey (including frogs, snails, lizards, spiders and insects).

Behaviour:

No specific information available at this time.

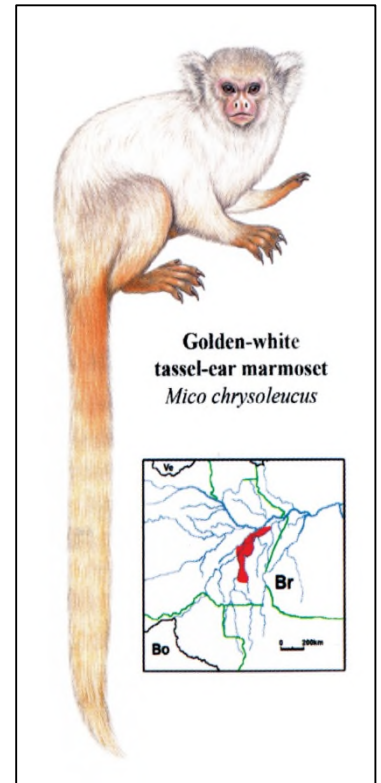



*Mico mauesi* (Mittermeier, Schwarz and Ayres, 1992)

Common name:

**Maués marmoset**

IUCN Red List: Least Concern (LC)

CITES: Appendix 2

Regional Collection Plan: MON-T DNO

Taxonomy:

Described by Mittermeier *et al.* (1992) in the genus *Callithrix*.

Habitat & Distribution:

Primary rain forest in the central Amazon, south of the Rio Amazonas. Limited in the north by the Paran  do Urari , in the east by the Rio Mau s-A u, in the west by the Rio Abacaxis, and in the south, between the rios Tapaj s and Sucunduri, to the Igarap  do Surubim.

Morphology:

They have a dark mantle and erect ear tufts. Back is banded. They grow up to 226 mm with a tail length ranging from 339 to 376 mm. There is no information on body mass.





*Mico saterei* (Silva Jr. and Noronha, 1998)

Common name:

**Sateré marmoset**

IUCN Red List: Least Concern (LC)

CITES: Appendix 2

Regional Collection Plan: MON-T DNO

Taxonomy:

First described by Silva Jr. and Noronha (1998) in the genus *Callithrix*.

Habitat & Distribution:

Central Amazon in Brazil, south of the Rio Amazonas. Limited in the north by the Paran  do Urari , in the east by the Rio Abacaxis, in the west by the rios Canum  and Sucunduri, and in the south, between rios Sucunduri and Abacaxis, to the vicinity of Igarap  do Arreganhado, an affluent of Sucunduri.



Morphology:

A bare-eared and distinctive marmoset. Most distinctive character is the morphology of the external genitalia. Both sexes and all age classes have two lateral pendular skin appendages. In the male, they are a narrowing of the inferior part of the scrotal lobes; in the female, they appear in the inguinal region, anterior to the vagina. The skin of the external genitalia is bright orange. Unpigmented facial skin except in the lateral parts of neck and small pigmented patches around the nose and mouth and above the eyes. Pigmented ears and a strong reddish orange patch on the posterior part of the ear lobe. *Mico saterei* has a distinct mantle contrasting with the dorsum and anterior limbs, and a well marked blackish-grey crown. Legs reddish brown; bright brownish orange ventrum.

Reproduction:

No specific information available at this time.

Diet:

Fruits, flowers, plant exudates (gums and nectar) and animal prey (including frogs, snails, lizards, spiders and insects).

Behaviour:

No specific information available at this time.



*Mico humeralifer* (É. Geoffroy Saint-Hilaire, 1812)

Common name:

**Black and white tassel-ear marmoset**

**Santarém marmoset**

IUCN Red List: Near Threatened (LC)

CITES: Appendix 2

Regional Collection Plan: MON-T Phase out

Taxonomy:

Previously considered to have subspecies *chrysoleucos* and *intermedius* (see Hershkovitz, 1977) that are here considered full species.

Habitat & Distribution:

These animals live in secondary forest with dense vines, south of the Rio Amazonas, between rios Maués and Tapajós.

Morphology:

Their colour varies, but they all have pale ear tufts, like fans. Their tail is distinctly or faintly banded. They measure up to 215 mm with a tail length of 355 mm and weigh between 280 and 310 g.

Reproduction:

There is no information available regarding their life history.

Diet:

Fruit, exudates, animal prey and insects.

Behaviour:

Group size is reported as varying between 8 and 15. Like some other marmosets, these have been observed following army ants and catching the insects they disturb. Scent-marking is performed by rubbing tree branches with the inside part of the arms. They vibrate their tongues to make “cricket-like” calls. They use vine-covered trees as sleeping sites.





## The white-mouthed tamarin or *nigricollis* group – *Leontocebus*

### *Leontocebus nigricollis* (Spix, 1823)

Subspecies: *L. n. nigricollis* Least Concern (NT) *L. n. hernandezi* Least Concern (LC), and *L. n. graellsii* Near Threatened (NT)

### *Leontocebus nigricollis nigricollis* (Spix, 1823)

#### Common name:

**Spix's black-mantled tamarin**

IUCN Red List: Least Concern (NT)

CITES: Appendix 2

Regional Collection Plan: MON-T Phase out

#### Taxonomy:

Following the phylogenetic analyses of Matauschek (2010) and Buckner *et al.* (2015), Rylands *et al.* (2016) placed all the members of Hershkovitz's (1977) white mouthed, *nigricollis*, group—black-mantled and saddle-back tamarins— in the genus *Leontocebus* Wagner, 1839.



#### Habitat & Distribution:

Primary and secondary humid tropical forests and edge habitat up to 914 m in Brazil, Colombia, Peru, and Ecuador. According to our current (poor) understanding of their ranges, they can be found between the rios Solimões-Amazonas, Napo and Içá-Putumayo (western range limit not exactly known).

#### Morphology:

These animals get their name from the black mantle, which reaches to the midback and, occasionally, beyond. They have hairless ears and grey/white hair around the muzzle. The rest of the body varies from red/brown to olivaceous. They grow up to 220–226 mm with a tail length of 356–361 mm and weigh around 470–480 g.

#### Reproduction:

Weaning of infants occurs at 2.8 months. There is no information on sexual maturity, oestrous cycle, gestation or age at first birth. In large groups a dominance hierarchy has been reported.

#### Diet:

Fruit, seeds, animal prey, flowers, gums and resins. Flying insects are caught with the mouth. Large insects are caught with hands, such as large grasshoppers, which they eat head first.

#### Behaviour:

This species is reported to be the only tamarin to form large, noisy groups, which last only for short periods and number up to 40 individuals. Average group size is 6.3 individuals, varying between 4 and 12. Groups may merge and forage together for 1.5 day. White-throated toucans (*Ramphastos*





*tucanus*) follow these tamarins when they are foraging. They use the chest and genital regions to scent mark branches and each other's backs. They use vine tangles for sleeping sites.



*Leontocebus nigricollis graellsii* (Jiménez de la Espada, 1870)

Common name:

**Graells' black-mantled tamarin**

IUCN Red List: Near Threatened (NT)

CITES: Appendix 2

Regional Collection Plan: MON-T Phase out

Taxonomy:

Following the phylogenetic analyses of Matauschek (2010) and Buckner *et al.* (2015), Rylands *et al.* (2016) placed all the members of Hershkovitz's (1977) white-mouthed, *nigricollis*, group—black-mantled and saddle-back tamarins—in the genus *Leontocebus* Wagner, 1839. Rylands *et al.* (2000) indicated that *graellsii* should be regarded as a separate species as Hernández-Camacho and Cooper (1976) suspected it was sympatric with a population of *S. n. nigricollis*. Groves (2001) listed it as species for this reason. Defler (2004) argued, however, that *nigricollis* and *graellsii* are not sympatric, and so we continue to list the latter as a subspecies.



Habitat & Distribution:

Primary and secondary lowland humid tropical forest, seasonally flooded palm swamp forest south of the Río Caquetá, to the north bank of the Napo, east between the ríos Napo and Putumayo to the Río Tamboryacu.

Morphology:

Head, neck, mantle, throat, chest and arms blackish-brown, ticked with buffy or grey hairs; lower back, rump, legs, tail-base dark brown; pale brown forehead and cheeks; facial skin black; grey-white hairs on muzzle; tail black.



*Leontocebus nigricollis hernandezi* (Hershkovitz, 1982)

Common name:

**Hernández-Camacho's black-mantled tamarin**

IUCN Red List: Least Concern (LC)

CITES: Appendix 2

Regional Collection Plan: MON-T Phase out

Taxonomy:

Following the phylogenetic analyses of Matauschek (2010) and Buckner *et al.* (2015), Rylands *et al.* (2016) placed all the members of Hershkovitz's (1977) white mouthed, *nigricollis*, group—black-mantled and saddle-back tamarins— in the genus *Leontocebus* Wagner, 1839. There are three subspecies of *L. nigricollis*: *L. n. nigricollis* (Spix, 1823, *L. n. graellsii* (Jiménez de la Espada, 1870) and *L. n. hernandezi* Hershkovitz, 1982.

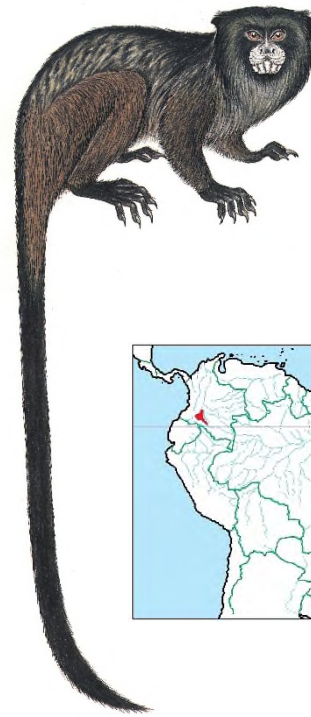

Habitat & Distribution:

Primary and secondary, markedly seasonal, dry tropical forest, between the ríos Caquetá, and Orteguzaza, east to the Río Guayabero.

Morphology:

Nape, mantle, throat blackish; mantle tapers down the back as a stripe onto the black tail; sides of lower back marbled orange-brown; neck, chest, limbs, rump, and sides of the body orange-agouti; sides of the crown and face pale; whitish hairs around muzzle.



*Leontocebus fuscus* Lesson, 1840

Common name:

**Lesson's Saddle-back Tamarin**

IUCN Red List: Least Concern (LC)

CITES: Appendix 2

Regional Collection Plan: MON-T Phase out

Taxonomy:

Considered a subspecies of *Saguinus fuscicollis* by Hershkvoitz (1977). See *Leontocebus fuscicollis fuscicollis*. Type species for the genus *Leontocebus* Wagner.

Habitat & Distribution:

Primary and secondary lowland rainforest between the rios Japurá-Caquetá and Iça-Putumayo, north of the Rio Solimões.

Morphology:

Mantle orange-brown, ticked with black; saddle, arms, rump, thighs marbled buffy and black; crown, forehead, cheeks black; facial skin black; grey on muzzle; sides of head reddish-blackish brown; hands and feet blackish mixed with orange; throat, chest, belly rufous; tail black, rufous under the base.

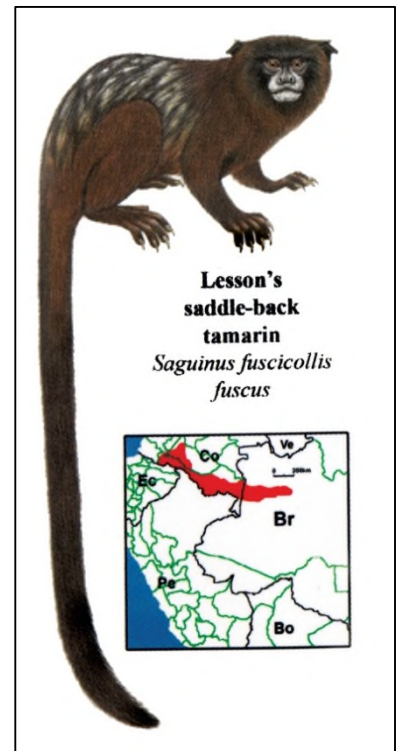

***Leontocebus fuscicollis*** (Spix, 1823)

Provisional subspecies: *L. f. fuscicollis* Least Concern (LC), *L. f. avilapresi* Least Concern (LC); *L. f. primitivus* Data Deficient (DD), and *L. f. mura* Near Threatened (NT)

***Leontocebus fuscicollis fuscicollis*** (Spix, 1823)Common name:**Spix's saddle-back tamarin**

IUCN Red List: Least Concern (LC)

CITES: Appendix 2

Regional Collection Plan: MON-T Phase out

Taxonomy:

Herskovitz (1977) recognized 14 subspecies: *S. f. fuscicollis*, *S. f. nigrifrons*, *S. f. leucogenys*, *S. f. weddelli*, *S. f. cruzlimai*, *S. f. primitivus*, *S. f. illigeri*, *S. f. lagonotus*, *S. f. tripartitus*, *S. f. fuscus*, *S. f. avilapiresi*, *S. f. acensis*, *S. f. melanoleucus*, and *S. f. crandalli*. The form *tripartitus* was subsequently considered to be a distinct species because of the (erroneous) supposition that it was sympatric with *S. f. lagonotus* (see Thorington, 1988). The subspecies *S. f. acensis* is a naturally occurring hybrid of *S. f. fuscicollis* and *S. f. melanoleucus* (see Peres *et al.*, 1996). A phylogenetic analysis by Matuschek (2010; Matuschek *et al.*, 2011) of the Peruvian saddleback tamarins showed that this group was paraphyletic, and as such required a re-assessment of the taxonomic status of the component species and subspecies (*sensu* Herskovitz, 1977, 1982). Matuschek *et al.* (2011) revealed four clades with the following compositions: 1) *S. f. illigeri*, *S. f. leucogenys* (north of the Río Pachitea); 2) *S. f. fuscicollis*, *S. f. leucogenys* (south of the Río Pachitea), *S. f. weddelli*, *S. melanoleucus*, *S. f. nigrifrons*; 3) *S. n. nigricollis*, *S. n. graellsii*; and 4) *S. tripartitus*, *S. f. lagonotus*. Matuschek *et al.* (2011) concluded that *lagonotus*, *tripartitus*, *nigrifrons*, *weddelli* and *fuscicollis* are morphologically distinct and well-defined taxa and recommended they be given species' status. The same was true for *nigricollis*, but with *graellsii* as a subspecies. They recommended that *melanoleucus*, although genetically very close to *weddelli*, be considered a subspecies of *S. weddelli* because of its distinct coat color. The northern populations of *leucogenys* and *illigeri* could be considered distinct species, but each with modified geographic distributions. Either the northern or the southern populations of *S. f. leucogenys* (*sensu* Herskovitz, 1977) would require a new definition and name. The central Amazonian forms *avilapiresi*, *cruzlimai*, *primitivus*, and *mura* were not included in the analysis of Matuschek *et al.* (2011) but are here provisionally attributed to the *fuscicollis*, *weddelli*, *melanoleucus*, *nigrifrons* clade as subspecies of *fuscicollis*. *Saguinus n. hernandezii* and *S. fuscus* were not included in the analysis of Matuschek *et al.* but are here attributed to the *S. nigricollis* clade, the former as a subspecies but the latter as a species following Cropp *et al.* (1999). Sampaio *et al.* (2015) determined that *cruzlimai* was a distinct species.

Goodman *et al.* (1998) argued that a divergence time of six or more million years ago should be reflected in separation at the generic level. Matuschek (2010) indicated the genus *Leontocebus* Wagner, 1840, for the *nigricollis* group tamarins, that evidently diverged from the remaining tamarins





between 11 and 9 million years ago. Buckner *et al.* (2015), agreeing with Mataushek (2010), also suggested the genus name *Leontocebus*. *Leontocebus* is the earliest name available with a type species that is a member of the *nigricollis* group—*Simia leonina* Humboldt, 1805. The name *Leontocebus* derives from the fact that *Simia leonina* was thought to be a lion tamarin (see Hershkovitz, 1949). In fact, it was a saddle-back tamarin (see Hershkovitz, 1957). Humboldt's "lion marmoset" was renamed by Lesson (1840, *Spec. Mamm. Bim. et Quadrum*, p.202) as *fuscus*. Taking up the suggestion of Mataushek (2010) and Buckner *et al.* (2015), from here on we place the black-mantled tamarins and the saddle-back tamarins in the genus *Leontocebus* Wagner, 1839 (see Rylands *et al.*, 2016). Note that Cabrera (1957) placed all the tamarins in the genus *Leontocebus*, with three subgenera: *Leontocebus*, *Oedipomidas* (*geoffroyi* and *oedipus*) and *Marikina* (*leucopus*, *bicolor*, and *martinsi*).

#### Habitat & Distribution:

Primary, secondary and lowland forest and in Brazil and Peru, west of the Rio Madeira and Rio Mamoré (except for an incursion by *L. w. weddelli* east of the Rio Madeira in the state of Rondônia) to the Andes and north to the Rio Caquetá in Colombia (*L. fuscus*).

#### Morphology:

Mantle dark agouti to blackish brown; back marbled black, with buffy or orange hairs; arms, and thighs black ticked with reddish-brown; crown, forehead, temples pale orangey; cheeks, neck, chest dark brown; whitish muzzle; hands and feet black; tail black. They grow up to 213–220 mm with a tail length of 318–324 mm, and weigh around 387–403 g.

#### Reproduction:

Weaning of infants occurs at 3 months. Sexual maturity occurs at about 15 months. Gestation is 145–152 days. Females give birth to their first offspring at 18 months and other births may occur at 6–12 month intervals.

#### Diet:

Wet season: fruit, sap, petioles. Dry season: nectar, fruit, sap, animal prey.

#### Behaviour:

Average group size is 5–8 individuals. Saddleback tamarins form mixed-species associations with many other species in different parts of their range. These include *Mico emiliae*, *Callimico goeldii*, *Plecturocebus moloch*, *Cheracebus torquatus*, *Saguinus imperator*, *Leontocebus nigricollis*, *Saguinus mystax* and *Saguinus labiatus*. Scent mark communication in this species has been intensely studied. They have at least 13 vocalisations, including a soft trill contact call, a long-distance loud whistle and an alarm call, to which emperor tamarins respond (and vice-versa). They use vegetation tangles and holes in trees as sleeping sites.



*Leontocebus fuscicollis avilapiresi* (Hershkovitz, 1966)

Common name:

**Ávila Pires' Saddle-back Tamarin**

IUCN Red List: Least Concern (LC)

CITES: Appendix 2

Regional Collection Plan: MON-T Phase out

Taxonomy:

See *Leontocebus fuscicollis fuscicollis*

Habitat & Distribution:

Primary, secondary and lowland forest and in Brazil and Peru, extending along the south bank of the Rio Solimões between the rios Juruá and Purus, including the basins of the rios Urucú, Coarí, and Tefé (Hershkovitz (1977). The southern limits are not known but possibly lie in the region of the north bank of the Rio Tapauá, an affluent of the Rio Purus, but saddleback tamarins have yet to be recorded from this region.

Morphology:

Mantle, rump, forehead, crown, upper arms, thighs, blackish-brown finely ticked with orange; neck, chest, belly brown and ticked with orange; lower arms and legs blacker; facial skin is black; whitish muzzle; lower legs darker than the thighs; hands and feet black; tail black, brown at the base.







*Leontocebus fuscicollis primitivus* (Hershkovitz, 1977)

Common name:

**Lako's saddleback tamarin**

IUCN Red List: Data Deficient (DD)

CITES: Appendix 2

Regional Collection Plan: MON-T DNO

Taxonomy:

See *Leontocebus fuscicollis fuscicollis*

Habitat & Distribution:

Primary, secondary and lowland forest in Brazil, between the rios Pauini and Tapauá, affluents of the Rio Purus, west possibly to the Rio Cuniuá.

Morphology:

Mantle, crown, arms, legs, rump, and chest brown, agouti-coloured; a distinct pale grey chevron on forehead, separated from the crown by a narrow blackish line; saddle weakly defined, more reddish; chin grey; throat and neck, blackish; upper surface of hands and feet dark agouti; tail blackish, agouti at the base,





*Leontocebus fuscicollis mura* (Röhe, Silva Jr., Sampaio & Rylands, 2009)

Common name:

**Grey-fronted Saddle-back Tamarin**

IUCN Red List: Near Threatened (NT)

CITES: Appendix 2

Regional Collection Plan: MON-T DNO

Taxonomy:

See *Leontocebus fuscicollis fuscicollis*

Habitat & Distribution:

Primary, secondary and lowland forest in Brazil between the rios Madeira and Purus, probably south to the Rio Igapó-Açú.

Morphology:

Mantle, forehead, crown, and chest dark brown with sparse greyish hairs; saddle strongly marbled ochreous dark brown to black; greyish around face; whitish muzzle; arms black ticked reddish-brown; thighs, rump, underparts and base of tail reddish-brown ticked black; hands, feet and tail black.





*Leontocebus tripartitus* (Milne-Edwards, 1878)

Common name:

**Golden-mantled saddle-back tamarin**

IUCN Red List: Near Threatened (NT)  
CITES: Appendix 2  
Regional Collection Plan: MON-T DNO

Taxonomy:

Herskovitz (1977) listed *Saguinus tripartitus* as a subspecies of *S. fuscicollis*. Thorington (1988) argued for its species status (see also Albuja, 1994). It was listed as a species by Rylands *et al.* (1993) and Groves (2001, 2005), but a re-evaluation of the evidence for its distribution indicates that both Herskovitz (1977) and Thorington (1988) were incorrect (Rylands *et al.*, in prep.), and any sympatry between *S. f. lagonotus* and *S. tripartitus* has yet to be confirmed.

Habitat & Distribution:

Lowland evergreen forest, between the ríos Curaray and Napo in Peru, west to the basins of the ríos Yasuní and Nashiño in Ecuador.

Morphology:

Mantle golden-orange to creamy; back marbled black, grey and golden; head, facial skin black; greyish-white muzzle; off-white chevron on forehead; arms orange-brown; thighs browner grizzled orange; chest, belly, and inside limbs orange; tail black. They grow up to 218–240 mm with a tail length of 316–341 mm. There is no information on weight.

Reproduction:

No data available on life history or social structure.

Diet:

Fruit, insects.

Behaviour:

Sizes of 14 groups observed on the Rio Aushir, Peru, ranged from 4 to 8, with a mean of 5.3. No field studies had been published up to 1995.





*Leontocebus lagonotus* (Jiménez de la Espada, 1870)

Common name:

**Red-mantled saddle-back tamarin**

IUCN Red List: Least Concern (LC)

CITES: Appendix 2

Regional Collection Plan: MON-T Phase out

Taxonomy: Considered a subspecies of *Saguinus fuscicollis* by Hershkowitz (1977). See *Leontocebus fuscicollis fuscicollis*

Habitat & Distribution:

Primary and secondary lowland rain forest, S of the ríos Napo and Curaray, S to ríos Santiago or Morona, Peru.

Morphology:

Mantle, rump, outer thighs, reddish to dark mahogany; saddle striated black and buffy; crown, forehead, throat, sides of head black; facial skin black; whitish muzzle; pale suggestion of a chevron on the forehead; hands and feet black; chest and arms reddish-black or black; tail black, reddish at base.

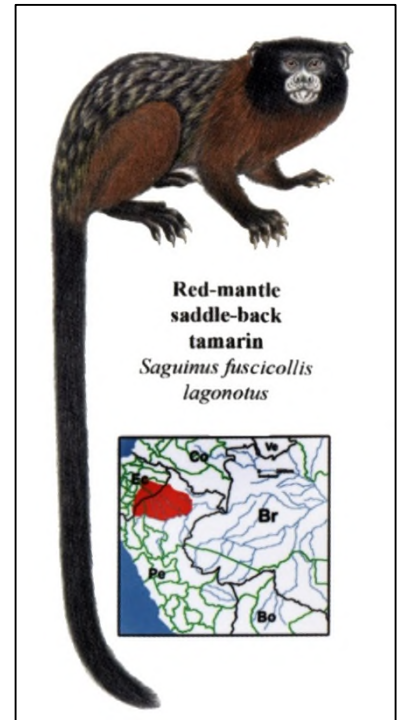



*Leontocebus leucogenys* (Gray, 1866)

Common name:

**Andean saddle-back tamarin**

IUCN Red List: Least Concern (LC)

CITES: Appendix 2

Regional Collection Plan: MON-T Phase out

Taxonomy: Considered a subspecies of *Saguinus fuscicollis* by Hershkvoitz (1977). See *Leontocebus fuscicollis fuscicollis*

Habitat & Distribution:

Primary and secondary forest, forest edge and riparian forest, east of the Andes, south of the Río Perene to the upper Río Ucayali in Peru.

Morphology:

Mantle, arms, throat, and upper part of the chest black or blackish brown; saddle marbled buffy and black; dark patch on orangey-brown thigh; rump orange; hands and feet black; lower chest, belly, and inner thighs reddish, washed with black; tail black, orangey-brown at the base.

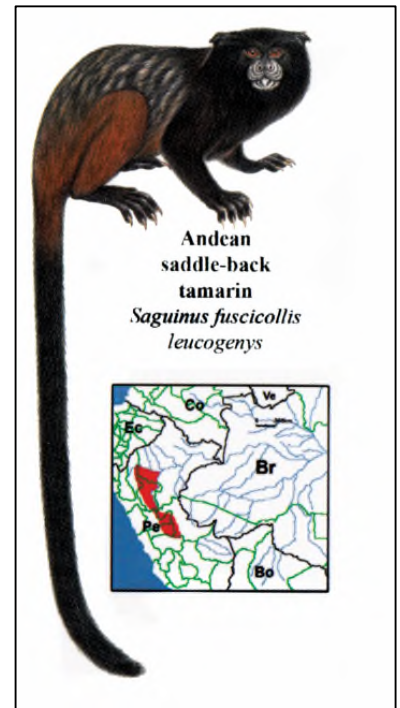



*Leontocebus illigeri* (Pucheran, 1845)

Common name:

**Illiger's Saddle-back Tamarin**

IUCN Red List: Least Concern (LC)

CITES: Appendix 2

Regional Collection Plan: MON-T Phase out

Taxonomy: Considered a subspecies of *Saguinus fuscicollis* by Hershkovitz (1977). See *Leontocebus fuscicollis fuscicollis*.

Habitat & Distribution:

Primary and secondary lowland forest and seasonally flooded white-water forest (*várzea*) between the rios Huallaga and Ucayali and lower Rio Tapiche in Peru.

Morphology:

Mantle (short), outer arms chestnut; forehead and crown black; saddle marbled black and grey or buffy to ocher; facial skin black, whitish muzzle; rump and thighs are reddish-orange; hands and feet black; chest, belly, and inner limbs reddish; tail black, base reddish.

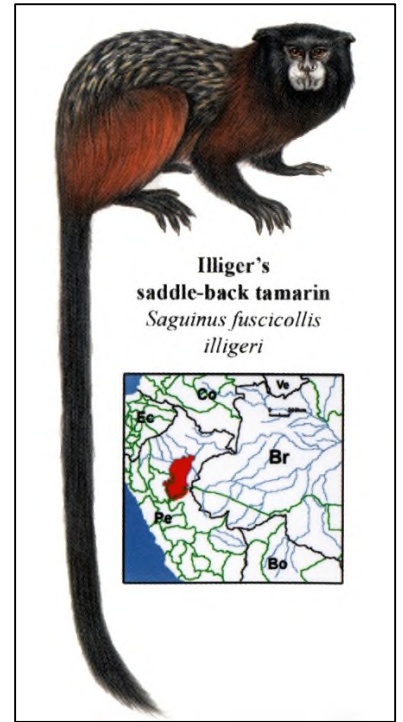



*Leontocebus nigrifrons* (l. Geoffroy Saint-Hilaire, 1850)

Common name:

**Geoffroy's saddle-back tamarin**

IUCN Red List: Least Concern (LC)

CITES: Appendix 2

Regional Collection Plan: MON-T DNO

Taxonomy: Considered a subspecies of *Saguinus fuscicollis* by Hershkvoitz (1977). See *Leontocebus fuscicollis fuscicollis*.

Habitat & Distribution:

Primary and secondary lowland forest between the ríos Amazonas and Yavarí, W the ríos Ucayali and Tapiche in Peru.

Morphology:

Mantle greyish brown; saddle striated and marbled black/greyish; forehead and sides of head black; crown buffy-orange; facial skin black; whitish muzzle; upper arms darker mantle; rump and thighs reddish-orangey; chest and forearms dark brown to black with orange or reddish hairs; hands, feet, tail black.

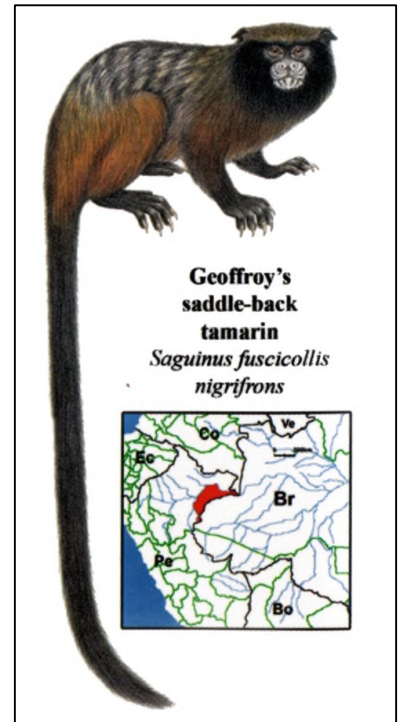





*Leontocebus cruzlimai* (Hershkovitz, 1966)

Common name:

**Cruz Lima's saddle-back tamarin**

IUCN Red List: Least Concern (LC)

CITES: Appendix 2

Regional Collection Plan: MON-T DNO

Taxonomy: Considered a subspecies of *Saguinus fuscicollis* by Hershkovitz (1977). See *Leontocebus fuscicollis fuscicollis*.



Habitat & Distribution:

Primary and secondary forest between the rios Teuini and Inauani, left bank affluents of the middle R. Purus in Brazil.

Morphology:

Mantle, crown, underparts, and limbs rusty-reddish orange; back marbled buffy on blackish brown; rump paler more yellowish; white chevron on forehead to the outer canthus of each eye; blackish fur on the sides of the face and neck; white muzzle; hands and feet blackish; tail black, base reddish at base.



*Leontocebus weddelli* (Deville, 1849)

Subspecies: *L. weddelli weddelli* Least Concern (LC), *L. w. melanoleucus* Least Concern (LC), and *L. w. crandalli*

*Leontocebus weddelli weddelli* (Miranda Ribeiro, 1912)

Common name:

**Weddell's saddle-back tamarin**

IUCN Red List: Least Concern (LC)

CITES: Appendix 2

Regional Collection Plan: MON-T Phase out

Taxonomy: Considered a subspecies of *Saguinus fuscicollis* by Hershkvoitz (1977). From their phylogenetic analysis, Matuschek (2010) and Matuschek *et al.* (2011) considered *weddelli* to be a distinct species in a clade which included besides *fuscicollis*, *leucogenys*, *melanoleucus*, and *nigrifrons*. The white saddle-back tamarin, *melanoleucus*, was found to be genetically very similar to *weddelli*, but Matuschek *et al.* (2011) recommended that considered a subspecies of *weddelli* because of its distinct coat color.

Habitat & Distribution:

Primary and secondary (successional) forest with dense understories, with a preference for the latter, in Brazil between the rios Purus and Madeira, in south-east Peru and northern Bolivia, east to the R. Beni.

Morphology:

Mantle, crown, sides of head, neck, chest, hands, feet, arms black or dark brown; saddle black, marbled buff; white chevron on forehead; facial skin black; muzzle greyish; rump, thighs, underparts reddish-orange; tail black.

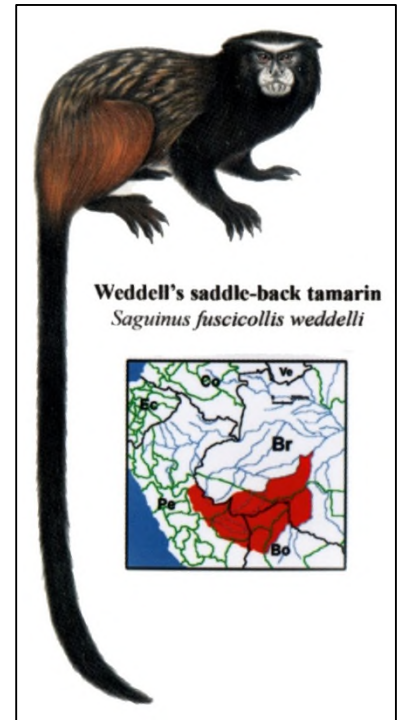



*Leontocebus weddelli melanoleucus* (Miranda Ribeiro, 1912)

Common name:

**White saddle-back tamarin**

IUCN Red List: Least Concern (LC)

CITES: Appendix 2

Regional Collection Plan: MON-T DNO

Taxonomy:

Considered a subspecies of *Saguinus fuscicollis* by Hershkovitz (1977). See *Leontocebus fuscicollis fuscicollis*. *Saguinus fuscicollis melanoleucus* and *S. f. crandalli* of Hershkovitz (1977) were listed as subspecies of *S. melanoleucus* by Coimbra-Filho (1990) and Groves (2001, 2005). Tagliaro *et al.* (2005) used data on ND1 mitochondrial DNA from one specimen of *melanoleucus* and six specimens of *S. f. weddelli* to test this hypothesis. Differences between *melanoleucus* and *weddelli* were no larger than among the *weddelli* specimens, thus failing to support Coimbra-Filho's (1990) separation. Matauschek *et al.* (2011) recommended that *melanoleucus*, although genetically very close to *weddelli*, be considered a subspecies of *S. weddelli* because of its distinct coat color.

Habitat & Distribution:

Primary and secondary (successional) forest with dense understories between the rios Juruá and Tarauacá, S from the mouth of the R. Eirú just into Peru to the R. Breu.

Morphology:

Almost entirely creamy white, often washed or streaked with yellowish buffy hairs; poorly defined white band on forehead; black ears, facial skin, and external genitalia; muzzle greyish; underparts whitish or yellowish; hands, feet silvery-buff.

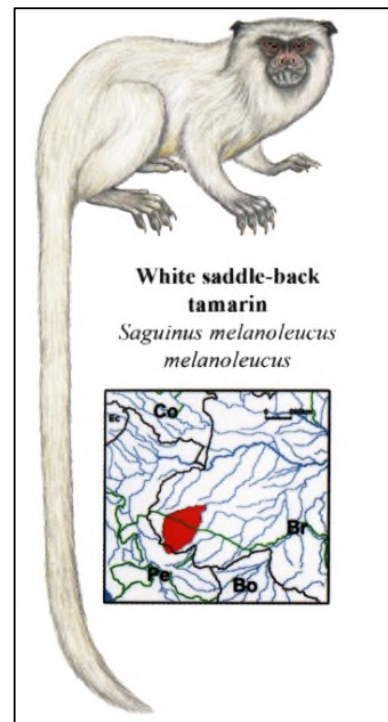



*Leontocebus weddelli crandalli* (Herskovitz, 1966)

Common name:

**Crandall's saddle-back tamarin**

IUCN Red List: Data Deficient (DD)  
CITES: Appendix 2  
Regional Collection Plan: MON-T DNO

Taxonomy:

*Saguinus fuscicollis melanoleucus* and *S. f. crandalli* of Herskovitz (1977) were listed as subspecies of *S. melanoleucus* by Coimbra-Filho (1990) and Groves (2001, 2005). Described from a captive tamarin in the New York Zoological Society. It may be a hybrid *fuscicollis* × *melanoleucus*. Here we list it as a subspecies of *weddelli* based on its supposed distribution in the wild.

Habitat & Distribution:

Provenance is unknown. Herskovitz (1977) indicated that it might be native to somewhere in the upper Purus basin on the border of Brazil and Peru.

Morphology:

Mantle and arms drab, whitish; the arms with slight ochraceous on the shoulders; saddle vermiculated buffy and black; rump, thighs and legs orange; belly and underside of legs predominantly orange; throat whitish; neck and chest ochraceous buff; facial skin pigmented with sparse grey hairs; broad whitish band on the forehead; upper surface of hands drab; upper surface of feet mixed buffy and orange with dark hairs showing through; tail dark brown except for orange on the surface of the proximal fifth (Herskovitz, 1977),

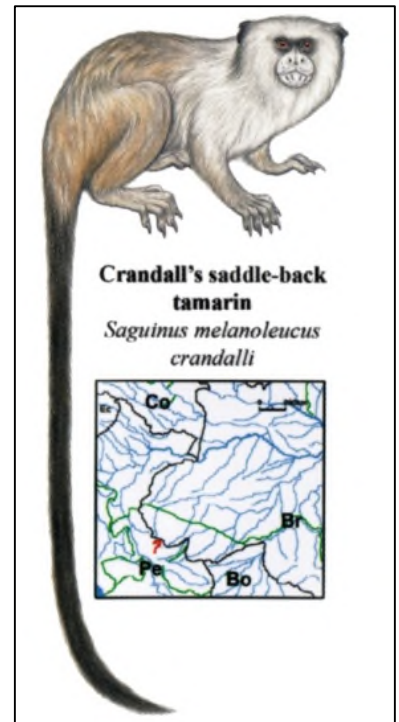



## Moustached tamarin and mottled-face tamarin, *mystax* species group – *Saguinus*

*Saguinus mystax* (Spix, 1823)

Subspecies: *S. m. mystax* Least Concern (LC), *S. m. pileatus* Least Concern (LC), and *S. m. pluto* (LC)

*Saguinus mystax mystax* (Spix, 1823)

Common name:

**Spix's moustached tamarin**

IUCN Red List: Least Concern (LC)

CITES: Appendix 2

Regional Collection Plan: MON-T Phase out

Taxonomy:

Habitat & Distribution:

Primary and secondary lowland forest in the Brazilian and Peruvian Amazon. They occur south of the Rio Amazonas–Solimões, from the Rio Tefé and middle Juruá, west to the ríos Ucayali and Tapiche and south to the ríos Urubamba and Inuya.

Morphology:

Males have unpigmented genitals. They grow up to around 258 mm with a tail length of 386 mm and weigh between 491 and 643 g.

Reproduction:

There is no information regarding age of weaning, birth interval, or age at first birth. They reach sexual maturity at 15–18 months of age. Gestation lasts 140–150 days.

Diet:

Fruit, insects and exudates.

Behaviour:

They spend most time during the day foraging for mobile prey (insects). Group size is usually about 5 individuals, varying between 2 and 16. Locomotion is quadrupedal. These animals associate with *S. fuscicollis* but use higher levels of the forest, foraging for insects at 15m. As well as scent marking the substrate directly, scent marking may be performed by urinating on to the hands. Individuals reportedly may rub their cheeks in the urine of sexual partners. Vocalizations include trill calls, whistles and chirps.

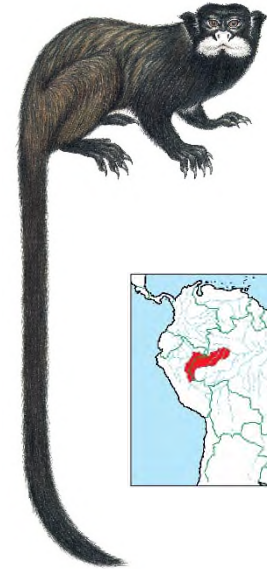



*Saguinus mystax pileatus* (I. Geoffroy Saint-Hilaire & Deville, 1848)

Common name:

**Red-capped moustached tamarin**

IUCN Red List: Least Concern (LC)  
CITES: Appendix 2  
Regional Collection Plan: MON-T DNO

Taxonomy:

Groves (2001) considered the form *pileatus* to be distinct and listed it as a full species. This is problematic, however, because it would appear that *pileatus* separates the geographic ranges of the other two forms. This being so, recognition of *pileatus* as a full species would demand that the nominate form and *pluto* should also be considered full species. A better understanding of the geographic distributions of these moustached tamarins is needed.

Habitat & Distribution:

Forests in the Brazilian Amazon. They occur south of the Río Amazonas–Solimões, east of the the Rio Tefé to the Rio Coarí, south to the Rio Pauiní or Rio Matoria in Brazil.

Morphology:

Mantle blackish-brown with buffy or orange ticking; crown and forehead to a thin line between the eyes, rusty-red; face black; pink on muzzle; white mustache; back and rump mixed blackish brown and buffy hairs; arms and thighs brown, blacker on hands and feet; tail black; external genitalia pink, covered with white hairs.





*Saguinus mystax pluto* (Lönnerberg, 1926)

Common name:

**White-rumped moustached tamarin**

IUCN Red List: Least Concern (LC)  
CITES: Appendix 2  
Regional Collection Plan: MON-T DNO



Taxonomy:

Groves (2001) considered the form *pileatus* to be distinct and listed it as a full species.

Habitat & Distribution:

Primary and secondary lowland rainforest west of the Rio Purus, north of the Rio Tapauá west as far as the Rio Coarí in Brazil.



Morphology:

Like *S. m. mystax* but for pink, white-haired anogenital-inguinal region and ventral tail-base. Mantle black, ticked buff; crown, head, arms, hands, feet, tail black; back and thighs like the mantle but buffier; muzzle pink with white mustache; black patch on chin; throat, chest, underparts blackish brown.





*Saguinus labiatus* (É. Geoffroy Saint-Hilaire, 1812)

Subspecies: *S. l. labiatus* Least Concern (LC), *S. l. rufiventer* Least Concern (LC), and *S. l. pluto* (LC)

*Saguinus labiatus labiatus* (É. Geoffroy Saint Hilaire, 1812)

Common name:

**Red-bellied tamarin**

IUCN Red List: Least Concern (LC)

CITES: Appendix 2

Regional Collection Plan: EEP for *S.labiatus*

Taxonomy:

Hershkovitz (1977) recognized only two subspecies—*labiatus* and *thomasi*.

Groves (2001) considered *rufiventer* to be valid.

Habitat & Distribution:

In primary and secondary forest between the rios Madeira and Purus, south from Rio Ipixuna, in Brasil, south to the north of Río Tahuamanú in Bolivia and southeast Peru.

Morphology:

Red-bellied tamarins have white hair around their lips and nose. Back and tail are black with silvery highlights. On the nape of the head they have a white triangle. Underparts are bright reddish orange. They grow up to around 261 mm with a tail length of 387 mm and weigh around 455–460 g.

Reproduction:

Gestation lasts 140–150 days. Most groups have one breeding female. Solitary males have been observed.

Diet:

Fruit, insects, exudates and nectar.

Behaviour:

Group size varies between 2 and 13. These animals forage and travel (occasionally together with *Leontocebus fuscicollis* that forage at lower heights) at heights of 3–32m. In captivity, males groom females more often than vice-versa. These tamarins associate with *Callimico goeldii* and *Leontocebus w. weddelli* and defend a common territory. Females are reported to scent mark more than males. Infants have a play vocalization. They use forks of trees about 12–18 m above the ground as sleeping sites.

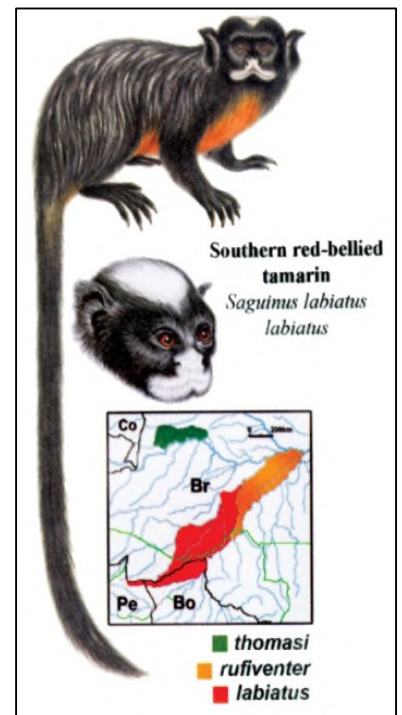



*Saguinus labiatus rufiventer* (Gray, 1843)

Common name:

Gray's Red-bellied Tamarin

IUCN Red List: Least Concern (LC)

CITES: Appendix 2

Regional Collection Plan: EEP for *S.labiatus*

Taxonomy:

Hershkovitz (1977) recognized only two subspecies—*labiatus* and *thomasi*. Groves (2001) considered *rufiventer* to be valid.

Habitat & Distribution:

In primary and secondary forest between the rios Madeira and Purus, south from the Rio Solimões to the north bank of the Rio Ipixuna (*S. l. rufiventer* [Gray, 1843]), and south from Rio Ipixuna, to the north of Río Tahuamanú (Bolivia and Peru) in southeast Peru (*S. l. labiatus*).

Morphology:

Like *S. l. labiatus*, but with a red, Y-shaped mark on the front of the crown and a slight silvery patch behind. Nape, mantle, blackish-brown; back black, marbled white; reddish/orangey underparts; throat and facial skin black; white mustache around the mouth; tail black, red/orangey under the base.

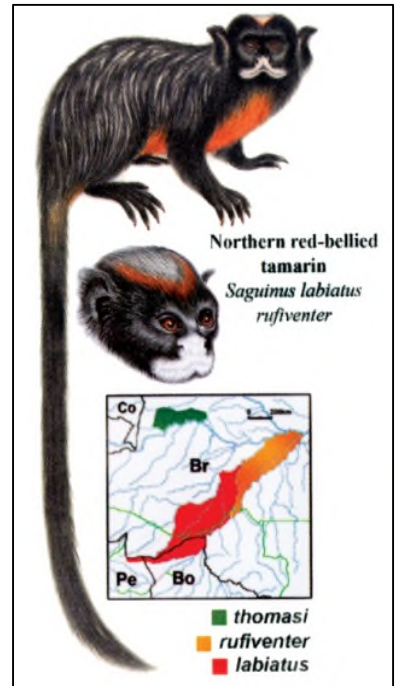



*Saguinus labiatus thomasi* (Goeldi, 1907)

Common name:

Thomas' Red-bellied Tamarin

EEP for EEP for *S.labiatus*

Taxonomy:

Hershkovitz (1977) recognized only two subspecies—*labiatus* and *thomasi*.  
Groves (2001) considered *rufiventer* to be valid.

Habitat & Distribution:

In primary and secondary forest between the rios Japurá and Solimões, from the Auatí-Paraná to the Rio Tonantins.

Morphology:

Nape and mantle blackish; back black, marbled white; orange (not reddish) underparts; throat, upper chest black; crown black, with a pale silvery mid-line; white moustache outlining the mouth; tail black, red or orangey under the base.

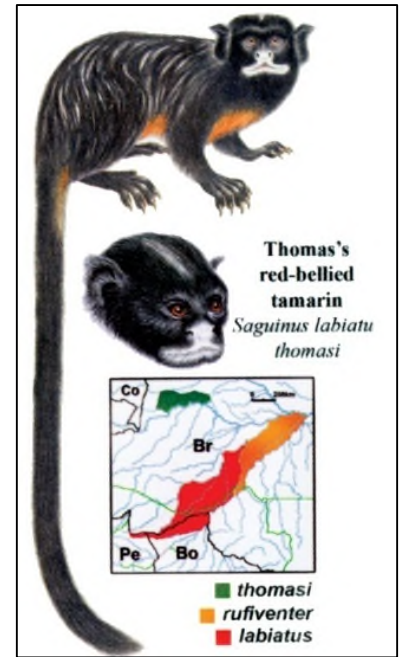



*Saguinus imperator* (Goeldi, 1907)

Subspecies: *S. i. imperator* (LC) and *S. i. subgriseescens* (LC)

*Saguinus imperator imperator* (Goeldi, 1907)

Common name:

**Black-chinned emperor tamarin**

IUCN Red List: Least Concern (LC)

CITES: Appendix 2

Regional Collection Plan: MON-T DNO

Taxonomy:

Habitat & Distribution:

Primarily lowland, evergreen and broadleaf forests up to 300 m, in Peru, Brazil and Bolivia in the southwest Amazon, east of the upper Rio Purus, between the rios Purus and Acre (*S. i. imperator*) and east of the upper Rio Juruá to the rios Tarauacá and Juruparí, west to the rios Urubamba and Inuya; and south of Río Tahuamanú (*S. i. subgriseescens*).

Morphology:

Emperor tamarins get their name from the regal appearance of their long white moustache. They have a black head, greyish brown body, a red-orange tail and white underparts. They grow up to 230–255 mm with a tail length of 390–415 mm and weight around 450 g. The subspecies can be distinguished by the shape of the moustache.

Reproduction:

There is little information regarding this species life history (weaning, sexual maturity, oestrous cycle, age of first birth, interbirth interval). Usually females give birth to two offspring, after a gestation of 140–145 days.

Diet:

Fruit, nectar, sap, fungi, flowers and animal prey. They also eat gum, in the late dry season and early wet season.

Social behaviour:

Average group size is four. They forage for insects on leaves, vines and branches in lower and middle levels by scanning and quickly attacking them. Emperor tamarins associate with *Saguinus fuscicollis*, with whom they share territory and are dominant to. Occasionally they associate with *Callicebus moloch*. Vocalizations include whistles, chirps and long, descending whistles. They announce their presence with loud vocalizations near territorial boundaries. They respond to the alarm calls of *Saguinus fuscicollis* and vice-versa. Group members sleep closely together in large vine-covered and isolated trees.

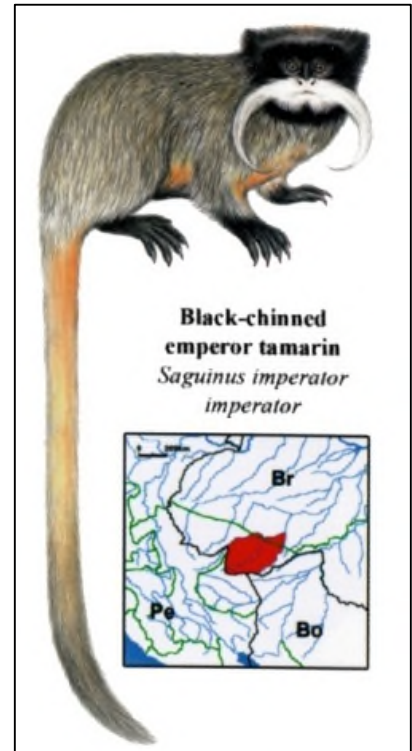



*Saguinus imperator subgriseus* (Lönnerberg, 1940)

Common name:

**Bearded emperor tamarin**

IUCN Red List: Least Concern (LC)

CITES: Appendix 2

Regional Collection Plan: EEP

Taxonomy:

Two subspecies; *S. i. imperator* and *S. i. subgriseus* (see Hershkovitz, 1979).

Habitat & Distribution:

Primarily lowland, evergreen and broadleaf forests up to 300 m, in Peru, Brazil and Bolivia in the southwest Amazon, east of the upper Rio Purus, between the rios Purus and Acre (*S. i. imperator*) and east of the upper Rio Juruá to the rios Tarauacá and Juruparí, west to the rios Urubamba and Inuya; and south of Río Tahuamanú (*S. i. subgriseus*).

Morphology:

Emperor tamarins get their name from the regal appearance of their long white moustache. They have a black head, greyish brown body, a red-orange tail and white underparts. They grow up to 230–255 mm with a tail length of 390–415 mm and weight around 450 g. The subspecies can be distinguished by the shape of the moustache.

Reproduction:

There is little information regarding this species life history (weaning, sexual maturity, oestrous cycle, age of first birth, interbirth interval). Females usually give birth to two offspring, after a gestation of 140–145 days.

Diet:

Fruit, nectar, sap, fungi, flowers and animal prey. They also eat gum, in the late dry season and early wet season.

Social behaviour:

Average group size is four. They forage for insects on leaves, vines and branches in lower and middle levels by scanning and quickly attacking them. Emperor tamarins associate with *Saguinus fuscicollis*, with whom they share territory and are dominant to. Occasionally they associate with *Callicebus moloch*. Vocalizations include whistles, chirps and long, descending whistles. They announce their presence with loud vocalizations near territorial boundaries. They respond to the alarm calls of *Saguinus fuscicollis* and vice-versa. Group members sleep closely together in large vine-covered and isolated trees.

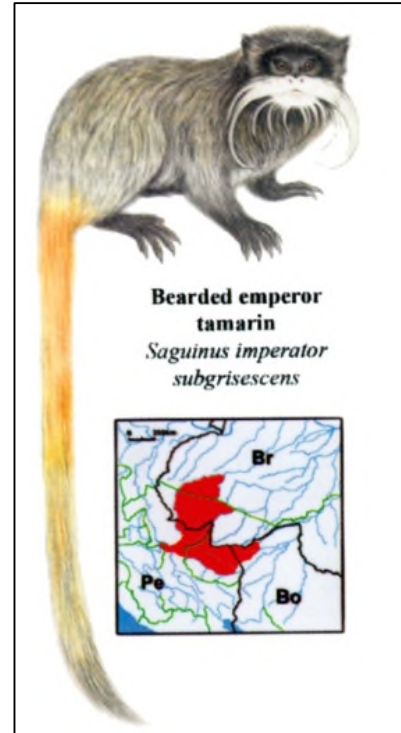



*Saguinus inustus* (Schwarz, 1951)

Common name:

**Mottled-faced tamarin**

IUCN Red List: Least Concern (LC)

CITES: Appendix 2

Regional Collection Plan: MON-T DNO

Taxonomy:

Monotypic. Defler (2004) indicated that there may be subspecific variation. The molecular genetic analysis of Buckner *et al.* (2015) indicated that *S. inustus* was a sister species to *S. mystax*.

Habitat & Distribution:

Rain forest in northern Brazil and southern Colombia. Between the upper rios Negro and Japurá–Caquetá, north to the ríos Apaporis and upper Guaviare.

Morphology:

Mottled-faced tamarins have a black body and naked black ears. The muzzle has a white patch of skin on each side and the genitalia are white. They grow up to around 233 mm with a tail length of 366 mm. There is no information on weight.

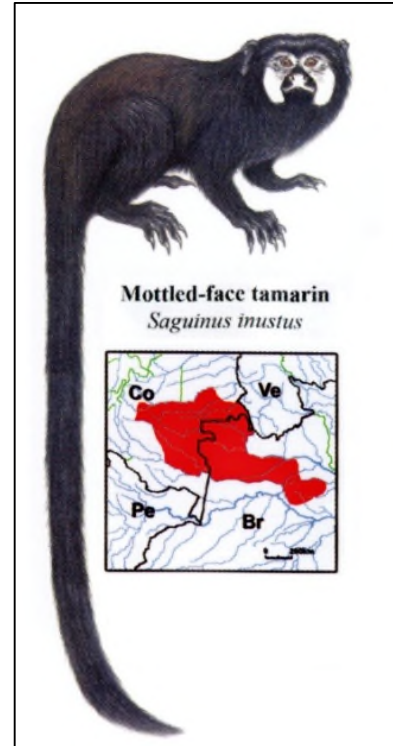





## Midas tamarins, *midas* species group – *Saguinus*

*Saguinus midas* (Linnaeus, 1758)

### Common names:

**Golden-handed tamarin**

**Red-handed tamarin**

IUCN Red List: Least Concern (LC)

CITES: Appendix 2

Regional Collection Plan: EEP

### Taxonomy:

Hershkovitz recognized two subspecies: *S. m. midas* (golden-handed tamarin)

and *S. m. niger* (black-handed tamarin). Rylands *et al.* (2000) and Groves (2001) regard these forms as separate species. Vallinoto *et al.* (2006) found that samples of *S. midas* from the Río Uatumã separated out from those from the Rio Trombetas to the east, about 200 km. This indicates a possibility that red-handed and yellow-handed forms of *S. midas* may be geographical races or distinct species (J. de Sousa e Silva Jr, pers. comm., April 2007).



### Habitat & Distribution:

They live in primary and secondary forests, edges, swamps, and forest patches in savannas, preferring open high canopy. They occur north of the Rio Amazonas, east of the rios Negro and Branco north to Guyana, east of the River Essequibo. Brazil, French Guiana, Suriname, and Guyana.

### Morphology:

Back, rump and thighs black, spotted, ticked with buff; face, head, shoulders, upper arms, tail, underparts black; hands and feet are orange or yellowish-orange; ears notched, bare and black. They grow up to an average of 240 mm with a tail length of 392 mm and weigh between 432 and 586 g.

### Reproduction:

Weaning of infants occurs at 2–3 months. They reach sexual maturity at 15 months. Oestrous cycle lasts around 23 days and gestation 140–168 days. They give birth to their first offspring (usually two) at the age of 24 months, and breed at 8.5 month intervals. Offspring are born in spring and summer and males do most of the infant carrying. These tamarins have been observed to mate from within a few hours of giving birth and two days after, mating being preceded by mock fighting and tonguing.

### Diet:

Golden-handed tamarins feed on fruit, seed, insects and animal prey.

### Behaviour:

Average group size is 5 individuals, varying between 2 and 12. Locomotion is quadrupedal. They prefer large branches and can leap up to 8 metres. The breeding female dominates the group, not being threatened by males. They scent mark before and after mating and during threat displays. The most





common vocalization is “pi-pi-pi”. This species associates with *Mico argentatus* in the small area where their ranges overlap.



*Saguinus niger* (É. Geoffroy Saint-Hilaire, 1803)

Common name:

**Western black-handed tamarin**

IUCN Red List: Vulnerable (VU)

CITES: Appendix 2

Regional Collection Plan: MON-T DNO

Taxonomy:

Herskovitz (1977) considered this form to be a subspecies of *S. midas*. Vallinoto *et al.* (2006) indicated that the Rio Tocantins may act as a barrier to gene flow for *Saguinus niger*. This was presaged in a molecular genetic analysis by Tagliaro *et al.* (2005). The form described as *Mystax ursulus umbratus* Thomas, 1922, from Cametá, Rio Tocantins, Pará, listed by Groves (2001, 2005) as a junior synonym of *S. niger*, and by Herskovitz (1977) as a junior synonym of *S. midas niger*, may in this case be considered a distinct geographical race or species (J. de Sousa e Silva Jr, pers.comm., April 2007).



Habitat & Distribution:

Primary lowland, montane, submontane and secondary forest, swamps, forest edge, south of the Rio Amazonas, east of the rios Xingu and Fresco to the Rio Tocantins, south to the Rio Gradaús. Also in the southwestern part of Marajó Is.

Morphology:

General coloration black. Middle and lower back striated with grey, buff or orange hairs. Similar to *Saguinus midas*, but upper surfaces of hands and feet black (orange or yellow in *S. midas*).



*Saguinus ursula* (Hoffmannsegg, 1807)

Common name:

**Eastern black-handed tamarin**

IUCN Red List: Vulnerable (VU)

CITES: Appendix 2

Regional Collection Plan: MON-T DNO

Taxonomy:

A study by Gregorin and Vivo (2013) revalidated *Saguinus ursula* Hoffmannsegg, 1807, the type species of *Saguinus* Hoffmannsegg, 1807, naming a lectotype (one of four syntypes) from the vicinity of Belém, Pará. *Saguinus niger* occurs west of the Rio Tocantins to the Rio Xingu. Differentiation was based on pelage coloration and molecular data.

Habitat & Distribution:

Primary lowland, submontane and secondary (successional) forest, swamps, forest edge, south of the R. Amazonas, east of the Rio Tocantins to forest patches at the transition to Cerrado and Caatinga in the state of Maranhão.

Morphology:

General coloration black. Differentiated from *S. niger* by mid-dorsal hair with a wide (5.0–55 mm) intermediary band of bright and golden buffy color; long (about 23–26 mm) dorsal hair at the inter-scapular region; and naked (not noticeably haired) face, hands and fingers (Gregorin and Vivo, 2013).





## Brazilian bare-face tamarins, *Saguinus bicolor* species group

*Saguinus bicolor* (Spix, 1823)

Common name:

**Pied tamarin**

IUCN Red List: Critically Endangered (CR)  
CITES: Appendix 1  
Regional Collection Plan: EEP

Taxonomy:

Previously comprising three subspecies – *S. b. bicolor*, *S. b. martinsi* and *S. b. ochraceus* (see Hershkovitz, 1977). Rylands *et al.* (2000) and Groves (2001)) place *S. bicolor* as a separate species, with the other two forms being subspecies of *S. martinsi*.

Habitat & Distribution:

Secondary forest, swamp, forest edge, white sand forest in north Brazil. *Saguinus bicolor* occurs north of the Rio Amazonas, east of the Rio Negro, in the vicinity of Manaus, the capital of the state of Amazonas, Brazil. It has a restricted range, extending only approximately 40–45 km to the north of Manaus, as far as the Rio Cuieiras, and east as far as the Rio Urubu.

Morphology:

Pied bare-face tamarins get their name from their black hairless face and ears. They grow up to 208–283 mm with a tail length between 335 and 420 mm, and weigh around 430 g.

Reproduction:

Little is known of this species in the field. Usually, females give birth to two offspring, with a birth interval of 6 months. Gestation and oestrous cycle length are known from captivity—approximately 160 and 21 days respectively. information provided under ‘Reproduction’

Diet:

Fruit, gum, animal prey, flowers, seedpod gums (dry season).

Behaviour:

Group size varies between 2 and 8 individuals. They use a stealthy approach to hunt and capture insects on leaves and branches at all levels of the canopy, up to 20m.

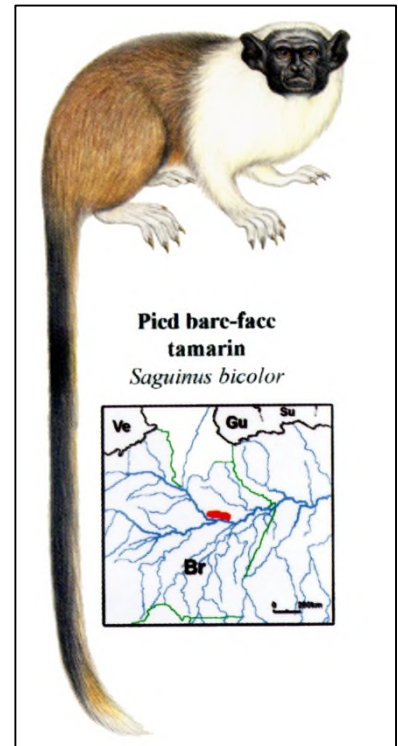



*Saguinus martinsi* (Thomas, 1912)

Subspecies: *S. m. martinsi* (LC) and *S. m. ochraceus* (NT)

*Saguinus martinsi martinsi* (Thomas, 1912)

Common name:

**Martins' bare-face tamarin**

IUCN Red List: Near Threatened (LC)

CITES: Appendix 2

Regional Collection Plan: MON-T DNO

Taxonomy:

Two subspecies: *S. m. martinsi* and *S. m. ochraceus* Hershkovitz, 1966. Previously considered to be subspecies of *S. bicolor* (see Hershkovitz, 1977). Rylands *et al.* (2000) and Groves (2001) place *S. martinsi* as a separate species, with the two subspecies.

Habitat & Distribution:

Forests between the rios Uatumã and Nhamundá (*S. m. ochraceus*) and rios Nhamundá and Erepecurú (*S. m. martinsi*), north of the Rio Amazonas in Brazil.

Morphology:

Bare, black face and ears. Upper surface a streaky mixture of buff, olivaceous, and brown with forequarters more dilute or faded than hindquarters.





*Saguinus martinsi ochraceus* Hershkovitz, 1966

Common name:

**Ochraceous bare-face tamarin**

IUCN Red List: Near Threatened (LC)  
CITES: Appendix 2  
Regional Collection Plan: MON-T DNO

Taxonomy:

Previously considered to be subspecies of *S. bicolor* (see Hershkovitz, 1977). Rylands *et al.* (2000) and Groves (2001) place it as subspecies of *S. martinsi*.

Habitat & Distribution:

Primary and secondary (successional) lowland rainforest, between the rios Uatumã and Nhamundá, north of the Rio Amazonas, Brazil.

Morphology:

Body paler than *S. m. martinsi*, generally yellowish-brown; golden-orange underparts; silvery to buffy the ruff and nape; neck and base of the mantle greyish-ocher or yellowish-gray; face, forehead, crown blackish; arms, hands and feet ochereous.

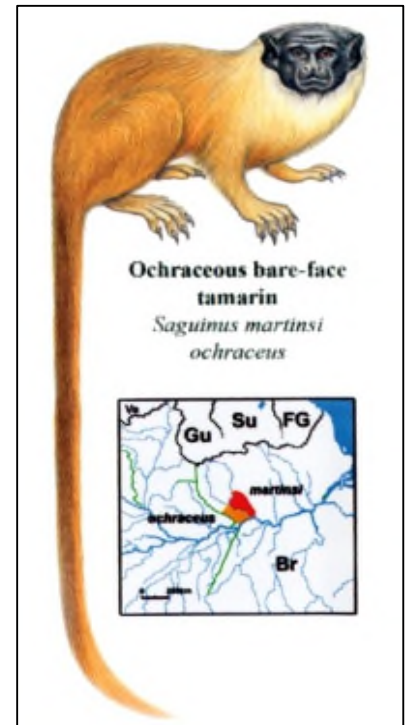



**Colombian and Panamanian bare-face tamarins, *oedipus* species group – *Saguinus***





*Saguinus oedipus* (Linnaeus, 1758)

Common name:

**Cotton-top tamarin**

IUCN Red List: Critically Endangered (CR)  
CITES: Appendix 1  
Regional Collection Plan: EEP

Taxonomy:

Herskovitz (1977) considered *Saguinus geoffroyi* to be a subspecies of *S. oedipus*. Comparative morphological studies by Hanihara and Natori (1987), Moore and Cheverud (1992) and Skinner (1991) argued for them being separate species (Rylands, 1993). Groves (2001, 2005) listed *S. geoffroyi* and *S. oedipus* as separate species.

Habitat & Distribution:

Secondary wet and dry forest and low vine tangles, from sea level to 1500 m, in the north-west forest region of Colombia, between the Río Atrato and the lower ríos Cauca and Magdalena, and in the northeast Choco, east of the Río Atrato.

Morphology:

They have a long, white, fan-like crest at the top of their grey head. Their back is brown and the half tail is red. Underparts, limbs and feet are white. They grow up to 232 mm with a tail length of 372 mm and weigh between 411 and 430 g. Often considerably bigger in captivity.

Reproduction:

These animals reach sexual maturity at about 18–24 months. Oestrous cycle lasts 23 days. Gestation is one of the longest for a tamarin at around 183 days. Post-partum oestrus occurs about 10 days after birth.

Diet:

Fruit, seeds, gum, animal prey (insects, mice and birds).

Behaviour:

Group size is usually around 7 individuals, varying between 3 and 13. *Saguinus oedipus* stand bipedally to display aggression and dominance. Females scent mark more often than males. Vocal repertoire is highly complex and includes a submission squeal, an alarm trill and a high-pitched whistle for aerial predators. Infants have a play vocalization. High tree forks and vine tangles are used as sleeping sites.

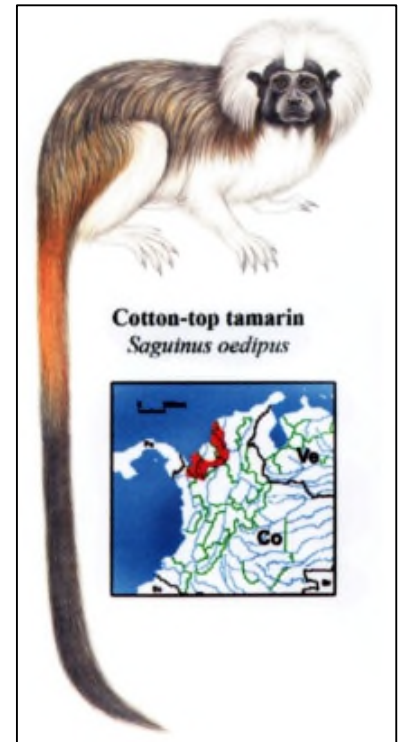



*Saguinus geoffroyi* (Pucheran, 1845)

Common name:

**Geoffroy's tamarin**

IUCN Red List: Near Threatened (NT)  
CITES: Appendix 1  
Regional Collection Plan: MON-T DNO

Taxonomy:

Hershkovitz (1977) considered *Saguinus geoffroyi* to be a subspecies of *S. oedipus*. Comparative morphological studies by Hanihara and Natori (1987), Moore and Cheverud (1992) and Skinner (1991) argued for them being separate species (Rylands, 1993). Groves (2001, 2005) listed *S. geoffroyi* and *S. oedipus* as separate species.

Habitat & Distribution:

Primary, secondary, moist tropical and dry forests. They prefer secondary growth with large trees. Often they are seen near shifting cultivated areas. Their range extends from southern northern Colombia into central and east Panama. In Colombia the species occurs along the Pacific coast, south as far as Río San Juan.

Morphology:

These animals have a flecked yellow, brown and black dorsal pelage. The ventrum is white. The face is almost bare and they have a triangular crown of short white fur, while the hair on the nape of the neck is reddish in colour. Their tail is red with a black tip. They grow up to 247–252 mm and weigh around 545 g.

Reproduction:

Weaning of infants occurs at 2–3 months. They reach sexual maturity at about 15 months. There is no information on oestrous cycle, age of first birth or birth interval. In the wild, the mating season occurs between January and February and the birth season is from April to June.

Diet:

Fruit, animal prey, flowers, gums and buds. Females eat exudates during gestation and lactation.

Behaviour:

Group size varies between 3 and 7 individuals. Scent-marking is made particularly where their home range overlaps with other groups. They have several vocalizations: long whistle for a long distance intragroup call, trills and long rasps for hostile situations. They use large emergent trees as sleeping sites.

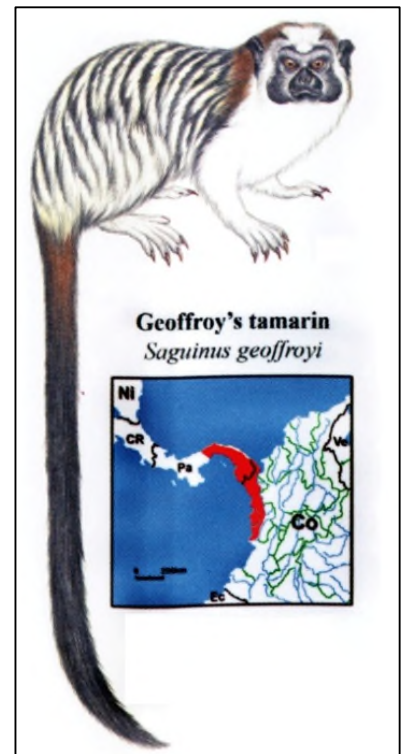



*Saguinus leucopus* (Günther, 1877)

Common names:

**Silvery-brown tamarin**

**White-footed tamarin**

IUCN Red List:

Vulnerable (VU)

CITES:

Appendix 1

Regional Collection Plan:

EEP supporting Colombian programme

Taxonomy:

Related to the *Saguinus oedipus*, bare-face tamarin, group (Hershkovitz, 1977).

Habitat & Distribution:

*Saguinus leucopus* live in primary and secondary forest near streams up to 1500 m. They usually prefer low and thick secondary growth and edge habitats. The species is endemic to Colombia, where it occurs centrally to the north of the country between the ríos Magdalena and Cauca from their confluence, south into west Caldas and north Tolima.

Morphology:

They have a brown body, whitish arms and legs, reddish orange underparts and blackish tails. They grow up to a length of 241–244 mm and weigh about 440 g.

Reproduction:

There is no information available regarding life history or sexual behaviour, except that infants have been seen in June in the wild.

Diet:

Their diet is primarily fruit, although it is likely that insects and exudates are eaten as well.

Behaviour:

Group size varies between 2 and 15 individuals. They use all heights of the forest. The most common vocalization of this species is the tee-tee, which is said to be “shrill and somewhat melancholic”.

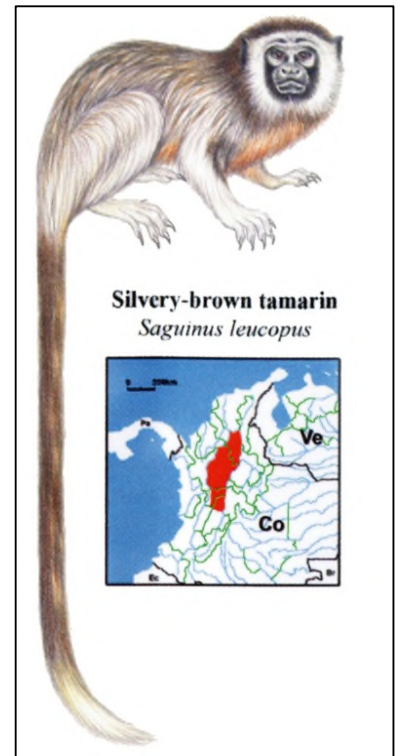



## 4. SECTION 4 – MANAGEMENT IN ZOOS

### *Author credits for sections:*

4.1 (Housing and Exhibit of the Callitrichidae): Warner **Jens**<sup>10</sup>, Nick **Lindsay**<sup>12</sup> and Dominic **Wormell**<sup>20</sup>

4.2 (Feeding and nutrition) Francis **Cabana**<sup>22</sup>, with contributions from Dominic **Wormell**, Nicky Hooper, Longleat Safari and Adventure Park; Ollie Szyszka, Veterinary Department, Marwell Wildlife; Amanda Ferguson, Research Department, ZSL; Lua Boon Kong, Zoology, Wildlife Reserves Singapore; Nili Avni-Magen, Tel-Aviv Zoo

And in previous versions from: Christoph **Schwitzer**<sup>18</sup>, Kristin **Leus**<sup>11</sup>, Luc **Lorca**<sup>14</sup>, Morgane **Byrne**<sup>3</sup>

4.3. (Social Structure and Behaviour): Hannah M. **Buchanan-Smith**<sup>2</sup> and J Bryan **Carroll**<sup>4</sup>

4.4. (Breeding): J. Bryan **Carroll**<sup>4</sup>, Yedra **Feltre**<sup>6</sup>, Peter **Galbusera**<sup>7</sup>, Warner **Jens**<sup>10</sup>, Kristin **Leus**<sup>11</sup>, Stewart **Muir**<sup>15</sup>, Tai **Strike**<sup>19</sup> and Dominic **Wormell**<sup>20</sup>

4.5. (Environmental Enrichment): Agustin **Lopez Goya**<sup>13</sup>, Warner **Jens**<sup>10</sup> and Dominic **Wormell**<sup>20</sup>

4.6. (Capture, Handling, positive reinforcement training and Transport): Eric **Bairrao Ruivo**<sup>1</sup>, Tine **Griede**<sup>8</sup>, Pierre **Grothmann**<sup>9</sup>, Dominic **Wormell**<sup>20</sup>, Kelly-Anne **Kelleher**<sup>21</sup> and Jim **Mackie**<sup>22</sup>

4.7. (Veterinary: Considerations for Health and Welfare): Pierre **Grothmann**<sup>9</sup>, Thierry **Petit**<sup>16</sup> **2017 update: Thierry Petit**<sup>16</sup> and Jonathan **Cracknell**<sup>23</sup>.

4.8. (Recommended and planned ex situ Research): Peter **Galbusera**<sup>7</sup>, Tine **Griede**<sup>8</sup>, Thierry **Petit**<sup>15</sup>

4.9. (Security and Identification): John **Hayward**<sup>24</sup> with contributions and examples from TAG members.

### 4.1 Housing and exhibition of the Callitrichidae

As with all captive animals, when considering the housing requirements of the Callitrichidae it must be remembered that not only is the quantity of space important, but also the quality of the space. In general terms an enclosure should provide a safe and secure environment so animals are not stressed at any time. As well as meeting the basic requirements for life in captivity, one should look at the natural history of the species in question when designing a captive habitat. The form and structural configuration of the exhibit should mimic the complex habitat of these animals in the wild taking into consideration how the animals use their habitat and their behaviours in that environment e.g., predator avoidance, sleeping behaviour, locomotion, etc. Callitrichids tend to inhabit primary and secondary rainforest habitat, living in several strata of the forest from canopy to just a few metres above the forest floor. Several of the species have even been observed descending to the forest floor periodically to forage for insects among the leaf litter. Knowledge such as this can help zoos design appropriate enclosures and night quarters for their animals. The recommendations below are based on experiences at Apenheul Primate Park and Durrell Wildlife Conservation Trust and other collections with long-standing experience of keeping callitrichids in captivity. In general the enclosure should provide a safe and secure environment so the animals are not under stress at any time.

#### 4.1.1 Enclosure size

Access outdoors, even if for a limited time or in off exhibit areas, is beneficial to the animals, providing them with fresh air and natural sunlight. Some combination of indoor and outdoor holding/exhibit



areas is, therefore, recommended. Since most callitrichids are about the same size, enclosures can often be interchangeable for many of the different species. Recommendations for enclosure size depend on several variables such as number of months/year and number of hours/day that the animals can go outside. Enclosures should be a minimum height of 2.5 metres, and the combined indoor/outdoor area accessible to the animal 80% of their waking hours year-round should be 32.5 cubic metres. Indoor enclosures should also have a minimum total floor size of 3 sq. metres, a height of 2.5 metres and be configured into at least two separable areas to enable easier cleaning and to hold new animals for introduction, for parturition or if unwell. Outdoor enclosures should be a minimum of 10 sq. metres, with a minimum height of 2.5 metres. For large family groups (>5) more room should be provided. Depending on the number of hours that the animals are inside or outside and the relative sizes of these enclosures, some adaptation to these recommendations is possible. Due to their small size, *Cebuella* enclosures may be slightly smaller depending on group size. For some species or groups, it may be necessary to provide off-show accommodation so that the animals can retreat from the public.

#### 4.1.2 Door and tunnel design

All animal doors and tunnels should be placed high (minimum 1.5–2m) above the substrate as it is unnatural for callitrichids to travel close to the ground. At least two doors (10 cm square) between each enclosure/holding facility should be constructed. They should be spaced wide enough apart to prevent dominant animals from controlling passage between enclosures. Doors should be able to be easily controlled by keepers from outside the cage either via slides or cable systems.

To conserve heat and prevent drafts in the inside areas, flaps can be added to the animal access doors. Several zoos now use soft perspex/pvc material as the draft excluder. This sits on an angled door frame and is easily lifted up by the tamarins and marmosets as they move in and out.

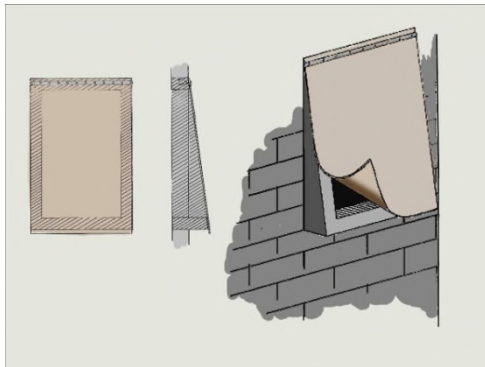

Perspex flaps at Apenheul Primate Park

Keeper doors should be large enough for easy entry, although entry into cages should be minimized to prevent stress to the animals. To assist with this, facilities should be designed to allow for keeper access to the nest boxes from outside the enclosure and feeding the animals without walking in the enclosure. By positioning the food and water receptacles at the front of the enclosure (see picture hereunder at Apeldoorn), a simple lifting plexiglass panel allows for placement or removal of food and water bowls.





Unless they are within an enclosed area such as an animal house, keeper doors should have a safety porch attached to avoid escapes when a keeper is working in with the animals.

Tunnels can be used to connect adjoining units or to link inside and outside enclosures. This provides an opportunity to build in a temporary holding area between two slides. It is possible to design this section to be removable as a capture and transfer tool (see Section 4.6 ). It is also possible to use this tunnel system to hold animals and read transponders.



Feeding station arrangements at Apenheul

Construction materials

**Indoor exhibits** for callitrichids should be made of non-toxic materials impervious to the weather, which allow for proper control of temperature, humidity and ventilation. While in the past many holding facilities were made of materials designed for ease of cleaning, recent knowledge of the importance of olfactory cues used by tamarins and marmosets has changed management practices and reduced the need for intensive cleaning protocols. Pest prevention and control is important to prevent possible predation or spread of disease, so solid materials such as concrete, cement, brick, certain types of plastic or solid wood are recommended.

**Outdoor exhibits** should, if possible, also be predator and pest proof and appropriate shelters should be provided in case of inclement weather. Provisions should be made for areas with direct sunlight and areas with shade. Cleaning is less of an issue as most will have natural substrates and natural climatic conditions will help maintain standards of hygiene. Minimizing access by vermin is also advisable in the outside area by the appropriate selection of materials.

### 4.1.3 Barriers

Typical barriers for primate exhibits are of five main types: Solid walls, glass walls, wire mesh, electric fencing or water. Some of these barriers fit certain terrain, climates, thematic goals and budgets better than others.

**Walls** are relatively low cost, easy to construct (except on slopes) and provide shade and wind barriers. For callitrichids they can be constructed of wood, concrete or cement and can be disguised by coating them with artificial rockwork.



**Glass** is used as a barrier primarily at public viewing areas and is generally used in conjunction with other materials (walls and wire) for containment. Benefits of glass are the ability for up close viewing, prevention of disease transmission and public feeding. Some of the drawbacks include high expense, reflection problems, and keeping the glass clean. Glass should be made opaque (rubbing soap on outside of enclosure, draping outside of enclosure with plastic or fabric) when animals are introduced to a new exhibit.

The use of **wire mesh** fencing or nylon netting as a barrier for callitrichids greatly increases the amount of usable surface area of an exhibit, providing much additional climbing space. It can also help when monitoring animal health, pregnant animals and in sex determination of young. It is an inexpensive and secure form of containment, but care must be taken to bury the mesh approximately 1 metre below the substrate to prevent predators such as foxes from digging under the fencing. Alternative to this is anchoring the fencing securely to a solid foundation. Regular maintenance of the mesh and protection from the elements (including the use of a safe paint) is important. The netting or fencing should be tightly strung with tension to prevent animals from becoming entangled in loose netting. Care also must be taken to use the proper gauge mesh to prevent young infants from being able to climb through or get their heads stuck in the mesh. Depending on the species this should be between 2 and 4 cm squares. One disadvantage of mesh enclosures is the necessity of the public to view the animals through mesh. With wire being a permeable barrier, safety and health factors of the callitrichids and visitors can also be of concern. A stand-off barrier preventing visitors from close proximity to the monkeys will help reduce the likelihood of disease transmission between the public and the animals.

**Electrified fencing** has been used successfully with callitrichids but must be used with care as the shock could be dangerous or fatal, especially for young animals. It is only advisable for use with very large enclosures. Occasionally it is used as a secondary barrier behind a primary barrier to keep out predators. For free-roaming callitrichids a monkey-proof perimeter barrier is also needed.

The use of **water** moats provides an unobstructed eye-level view for the visitor, permitting barriers to be less evident to the visitor, and can help immerse the visitor in the landscape of the animal. Moats are generally more expensive than walls or fencing, although, depending on local legislation, can be made fairly inexpensively using plastic pond liner for water containment. For callitrichids a depth of 0.4 metre is sufficient. Potential drawbacks are drowning, freezing of moats in winter (although callitrichids should not be kept outside in freezing weather) and increased viewing distance. The slope of the moat should be gentle (<30 degrees) on the animals' side to prevent animals from accidentally slipping into the moat. Branches can be provided at the water's edge as escape routes in case an animal falls in. Moat barriers also increase the needed space for the exhibit, with moat width for callitrichids being recommended at minimum of 4 metres (depending upon plantings on and around the enclosure). If using water as a barrier, additional cover or shelters should be provided to avoid airborne predation by birds of prey. Note that some callitrichids, especially *Leontopithecus chrysomelas* have been known to swim water barriers.

**Visitor barriers** – It is recommended that all callitrichid enclosures have a stand-off barrier for visitors to prevent them having direct contact with the animals. This is primarily to prevent possible health problems being transferred to the animals, e.g., herpes, but it also prevents feeding, and it may also reduce stress levels.





#### 4.1.4 Orientation and location of enclosures

Exhibits and holding enclosures should be orientated so that different groups of the same species are not within visual contact with each other. Visual contact can lead to increased levels of stress over territoriality, mate preference, etc. Visual barriers can be planted or hung outdoors to prevent visual contact. The use of solid walls between adjacent cages indoors can also solve this problem. Auditory barriers are helpful, as too much external noise can stress animals and prevent communication within the group. Strategic placement of plants within and between enclosures can help soften the aural environment and provide shade during the summer, especially important in hot climates. It is important that outside enclosures are open to sunlight especially in northern regions to allow the animals to sit in the sun during parts of the day.

There is some concern about housing callitrichids in tropical houses with large waterfalls in the same area. Vocalizations are a crucial form of communication for callitrichids and waterfalls can prevent these communications being heard by members of the group. It is also considered to be a possible hazard purely because of the impact of this background noise.

#### 4.1.5 Cleaning and substrates

In general, a substrate of natural materials such as wood bark, wood shavings, wood wool (excelsior) or mulch inside, and soil or grass outside is recommended. Woodwool should initially be used with care as some animals unfamiliar with it can become entangled in it. A recent innovation in substrate for callitrichids is the use of a “biofloor”, a thick covering of woodchips (25 cm) under which lays a filterpad, with a concrete floor and drain below the pad. The biofloor functions as a biological system to prevent build-up of pathogens or parasite infestation. Urine drains through the biofloor and out through the drain, while faeces are spot-cleaned. The biofloor requires total replacement every 3–4 years. More information on the biofloor system is available from Apenheul Primate Park. As mentioned earlier, callitrichids will frequently search through substrate for insects or pieces of food. A soft substrate will also decrease the possibility of injury to animals due to falls. The substrate for interior enclosures should cover an impervious floor with a drain. It should be able to be spot cleaned fairly frequently (2–3 times/week), and the entire substrate removed for intensive cleaning periodically (1–2 times/year) or in the event of the detection of disease pathogens / parasites. Most external substrates will be cleaned naturally via sunlight, rain, decay, etc. At least one interior cage should be maintained with the ability to remove substrate easily, in case an animal must be closely monitored for diarrhoea, etc. or for biological sample collection.

In callitrichids, scent marking is an important behaviour so cleaning regimes need to consider this. Cleaning cage fittings in rotation is one way to avoid causing stress to the animals if all their territory is sterilised at one time.

#### 4.1.6 Furniture

**Permanent** – At least one nest box of wood should be provided indoors for each family group, even if not used for sleeping. These boxes should be a minimum of 25 x 25 x 25 cm and made of wood and can double as capture boxes if fitted with appropriate slide doors. Doors should be approximately 10 cm square to allow access and egress by an adult with infants riding on its back. The access hole should have a slide which can be operated from outside the cage to allow easier capture of animals. The nest boxes should be placed high up in the enclosure. If groups grow large (more than 4 individuals) a second nest box is recommended, although even large families often prefer to use only one nest box.



Shelves or beams adequate for resting on should be provided at various heights along the walls of the enclosures. Ideally the nest boxes should be removable from the keeper corridor without the keeper needing to enter the animal exhibit.

**Temporary** – In addition to the permanent furnishings, natural materials such as tree branches, potted plants and ropes should be included in the enclosures to stimulate natural behaviour and to provide a variety of substrates for locomotion. For callitrichids the diameter should be appropriate to the animals' hand and foot anatomy (i.e., smaller for pygmy marmosets) with diameters between 1 and 3 cm. Larger branches or tree trunk pieces with natural bark, such as oak, can also be included. When placed horizontally these provide ideal resting places where animals can stretch out. The temporary furnishings should provide physical flexibility to the environment, simulating the softness and lack of rigidity of the animals' natural habitats. Flexible materials such as branches, ropes, and ladders (with rungs spaced appropriately) will promote exploratory and locomotor behaviour, stimulate muscle tone and balance, as well as providing shelter, cover, and visual barriers for animals. Remember that callitrichids will use vertical as well as horizontal perching to move around the enclosures. Exhibits and holding facilities should be designed to allow for flexibility, with thought given to multiple attachment points for ropes, etc., throughout the enclosures. Temporary furnishings also allow the changing of the configuration and structure of the animals' habitat, simulating the ever-changing habitats in nature. Temporary furnishings made of absorbent materials will also be used by the callitrichids for scent marking. Complete cleaning and/or removal of all such temporary furnishings should not be carried out. It should be done piecemeal in sequential stages. Major cleaning (with water and soaps) is necessary only once or twice per year. The changing of temporary furnishings will also help the animals to develop behavioural flexibility and to learn strategies to cope with changing pathways and navigation throughout their habitat. See section 4.5.

**Planting** – Obviously all plants available to the animals should be checked for toxicity before being placed in the enclosure. (See Appendix 1). Live plants are desirable as they promote many of the behaviours described above including gum feeding, provide perches and pathways through the environment, can harbour insects, provide cover and shade and will grow and change with time.

The BIAZA and EAZA Plant Groups have created a database of plant use in zoos. This very useful information source is on the ZOOLEX website. <http://www.zooplants.net> and access is easy after signing in.

Appendix 1 of these Guidelines contains a document on the use of plants with callitrichids, prepared by the TAG.

**Feeding and watering sites** – Ideally at least two feeding and watering sites should be available within the enclosures to ensure dominant animals are not preventing subordinate animals getting access to food and water. They should be placed in areas of easy access for all animals, at least 1.5 metres off of the ground. Ideally perches or shelves should be built adjacent to these sites to allow relaxed consumption of food. Food is usually presented in trays or bowls and water can be presented using “Lixit” devices, water bottles or in bowls. Water bottles hung from wire should be regularly checked for blockage or leakage. Care must be taken not to place food and water sites below perches or other areas that could lead to contamination with faeces or urine. The design of feeding and watering places should allow for removal of trays or bowls for cleaning or filling without the keeper needing to enter the enclosure.



#### 4.1.7 Lighting and photoperiod

Both the amount and quality of light, and the photoperiod (timing of light exposure throughout the day and year) are very important for callitrichids in captivity. In the wild some callitrichids experience different levels of light depending upon the strata they inhabit and the time of year. There is evidence that lengthening and shortening of daylight times throughout the year can trigger physiological changes related to reproduction. Artificial light can be used to simulate tropical day length changes, especially in temperate latitudes far from the tropics. The average number of daylight hours should be 12 hours with minimal light (if any) used at night. Consideration needs to be given to the use of ultra violet light in inside areas.

Windows and or skylights should always be provided for the animals. Natural sunlight is very important for the animals and lack of it can promote physiological changes related to reproduction, vitamin D synthesis (see 4.2.4.1) and even the intensity of coat colour in lion tamarins. Skylights and windows should be UV penetrable if possible. Allowing the animals to monitor the outside environment through windows can also lead to a reduction in stress by providing the animals more choice within their environment. Windows can also serve as enrichment providing changing visual stimulation. Care must be taken that window placement also allows the animals privacy from curious members of the public and disturbances from maintenance, construction, and other activities.

#### 4.1.8 Temperature and humidity

Most zoos keep their indoor callitrichid enclosures at a minimum of 18°C with no resultant problems, although some may maintain temperatures up to 24°C. In Apenheul during colder months when animals are still going outside, the temperature is maintained at 20°C inside so the difference between inside and outside will be less. Others maintain at slightly higher temperatures, up to 24°C. A basking spot should be provided (under a heat lamp or a heated shelf) where animals can go to warm up. This is less important during warmer weather but vital when the temperature outside is below 16°C. Recommended heating systems include heat lamps, radiators, or central heating. Care must be taken not to place any hot pipes or heating equipment within reach of the animals. Air conditioning or mist systems are used sporadically in some countries where temperatures reach very high levels (>32 °C).

Most zoos with outside enclosures permit their callitrichids free choice to go outside down to 5°C. Depending on the type of barriers (glass, wire or water) and weather conditions some zoos will give the animals free choice down to freezing point. Consideration can be given to providing a heat lamp outside.

Inside humidity should be kept at a minimum of 60% to promote good skin and coat condition. Humidity can be raised by placement of humidifiers in service areas, use of misters or simply placing pans of water near heating elements. Humidity and temperature should be monitored daily.

A ventilation system that ensures a CO<sub>2</sub> level below 0.1% everywhere in the enclosure should be installed. Indoor enclosures should have a full air circulation system with air inflow points positioned in the upper part of the enclosure building and air outflow points in the lowest parts.

#### 4.1.9 Free-range enclosures

Several species of the Callitrichidae have successfully been maintained in a free-ranging situation in the zoo, i.e. where there is no barrier between the animals and the public. Several factors, however,



must be taken into account, such as the species-typical group composition. All male or all female groups, or groups where one of the parents has died, may follow their natural instinct and try to leave the area in an attempt to find a partner. Because of the typically strong cohesion within a callitrichid family, it is not advisable to separate one or more animals and keep them inside to ensure the rest of the group will remain in the neighbourhood. By doing so there is a danger that group stability will suffer, and the group structure will fall apart.

Contact with visitors must be avoided. When the free-ranging area is large and interesting with enough possibilities for the animals to withdraw, callitrichids tend to keep a safe distance from visitors. A no-feeding regulation is essential to maintain this safe distance. Individuals who are hand-reared or animals which are emotionally attached to people (former pets, etc.) can cause problems and can easily change the attitude of the group towards people.

*Release procedure* – When releasing the animals for the first time into a strange environment, there is a chance that the animals, being unrestricted by any barrier, may panic and run off, and subsequently not be able to find their way back. It is advisable, therefore, initially to place a temporary cage inside the future free-roaming area connected via a tunnel to the animal door from the holding area. This cage can be very small (0.5 m<sup>3</sup> is sufficient.) but it must be furnished with wood. The animals may then be given access to this cage, so they have the opportunity to scan the environment and scent mark the cage, entrance and furnishings. After three to five days this cage can be removed except for the furniture which then serves as a recognition point. The outdoor slide must be easily accessible, preferably by more than one route.

An excellent review (Price *et al.* 2012), provides information on management techniques, advantages, disadvantages and problems.

#### **4.1.10 Offshow areas and their importance**

Callitrichids are the smallest true primates, having undergone evolutionary dwarfism to enable them to exploit greater foraging opportunities within the forest habitat (Ford, 1980; Montgomery and Mundy 2013). Their small size gives them advantages in several respects, such as the ability to exploit food resources on very thin terminal branches that could not support heavier primate species, but it also makes them far more vulnerable to predation (e.g. Ferrari and Beltrão-Mendes 2011). Wild marmosets and tamarins are highly tuned to be predator aware, constantly alert and looking out for each other in their family units. Vocal communication alerts others in the group to the presence of potential danger and a range of calls is used to identify the level of threat (Campell and Snowdon, 2007).

For such sensitive primates, captivity may cause a certain level of stress by taking away the option to move rapidly away from any perceived threat. Research on the effects of zoo visitors and other anthropogenic disturbance on primates in captivity tends to suggest that overall these have an aversive effect (Hosey, 2000; Fanson *et al.* 2012; Dancer and Burn, 2019), though many factors including species and individual differences, and social rank, have been found to moderate the changes observed (e.g. Cronin *et al.*, 2018; Woods *et al.*, 2019; Hashmi and Sullivan 2020). Effects such as increased antagonistic social behaviour and higher levels of behaviours indicative of anxiety, including stereotypic behaviour, may be observed, and access to offshow areas is often recommended (Sherwen *et al.*, 2015; Hashmi and Sullivan 2020).





Large human primates will probably be seen as a potential threat even through glass if allowed to come very close to the enclosure front or tap on the glass, and the constant gaze of onlookers will often be perceived as a threat. In most primates, eye contact is an implicit signal of threat, and often connotes social status and imminent physical aggression (Harrod et al 2020). A constant stream of visitors that are able to get up close to the front of the enclosure may therefore lead to a situation where the animals are in a constant fight or flight mode. Chronic stress can result and may be expressed in abnormal behaviour and/or raised levels of the “stress hormone” cortisol; for example, spider monkeys exhibit raised cortisol levels when more visitors are present (Davis et al 2005). Excessive anthropogenic noise from the public or from machinery such as heating and cooling can also cause stress (Kleist et al., 2018).

Chronic stress can eventually lead to debilitating effects on the immune system (Edes and Crews, 2017). A recent study by Cabana et al (2017) suggested that minimising stress may be protective in preventing marmoset wasting syndrome (MWS): more complex enclosures offering places to hide behind vegetation, refuges such as nest boxes and trees, and visual barriers shielding the monkeys from zoo visitors, resulted in a lower probability of MWS occurring, probably because of reduced stress levels.

It appears that some callitrichid species are more sensitive in captivity than others. While some may become accustomed to close presence and constant staring by visiting public, others may continue to perceive them as potential threat, and will either try to get away from the situation or, in some species, e.g. pied tamarins, confront the potential threat and display aggressively (Wormell et al 1996). Interestingly, pied tamarins also appear to be more prone than other callitrichids to developing MWS.

To reduce the potential threat response, all callitrichid enclosures should have an area that they can retreat to that is offshow to the viewing public. This area should be large enough for a full behavioural repertoire to be possible (Bryan et al., 2017; Yoshimoto et al., 2018), and heated, with a sleeping site, heat lamps, perches and platforms, enrichment etc. These areas will act as “safe zones” for the monkeys (Mallinson 1975).



*Outside onshow area with popholes allowing access to several different indoor offshow units – the pophole on the left is currently open.*



*Pophole to offshow area on left of picture*



It is also essential to have a shut off area in the offshow part of the enclosure that allows animals to be temporarily separated whilst still being in close contact with the rest of the group. These areas can be used when mixing individuals, collecting faecal/urine samples, separating individuals if sick or recovering from a veterinary procedure, or if aggression has occurred in a group, etc.

Another feature that can help reduce stress is for outdoor enclosures to be large and well planted so individuals housed there will be able to seek out private areas that are not on show if they feel the need to (e.g. Price et al., 2019). The areas to which they retreat to sleep overnight (in captivity this is usually a nest box), should also be offshow, as they seek safe nest sites in the wild and should feel safe and secure in these nest boxes in captivity (Caine, 1987).



*Offshow areas and how a slide separates a shut off area.*

## Conclusion

Giving callitrichids as many options of areas where they feel safe, including large, well-planted on-show enclosures and a safe off-show area big enough to allow them to behave naturally, can counteract visitor impacts at least to some extent, and encourage the monkeys to use on-exhibit areas more and thus be more visible to the public (Mallinson, 1975; Price et al., 2019).



## 4.2 Feeding and nutrition

### 4.2.1 Basic diet: food components and feeding regime

In most facilities, marmosets and tamarins are fed a mixture of a concentrate feeds (either “homemade” or commercial pellets and/or jellies), produce (a variety of fruit and vegetables) and some form of animal protein (insects, egg etc.). **The Callitrichid TAG has a nutrition working group and diet advice will change as our knowledge and understanding increases.**

#### Produce

In the wild, marmosets and tamarins feed on a wide variety of plant parts, mostly fruits. Offering produce in captivity allows for presenting the animals with this important dietary variation. It must however be remembered that commercial fruits and vegetables are generally higher in easily digestible carbohydrates and lower in fibre, protein and calcium than wild fruits (Britt *et al.* 2015; Oftedal and Allen, 1996; Kaumanns *et al.*, 2000). Vegetables are actually a closer nutritional match to fruits these animals would enjoy in the wild. For this reason, feeding fruits is not recommended for callitrichids. We cannot trust the animals to make a choice based on their nutritional requirements, but instead they may make a selection based on sugar content, fat content or novelty (Price, 1992). Providing a maximum of 3-4 different vegetables per day yet varying them daily or weekly can help eliminate selection bias, and keep the diet new, exciting and nutritionally appropriate. This will also allow for zoos to choose local and seasonal vegetables to help keep costs down. Paignton Zoo Environmental Park (UK) uses a three vegetable system (below) where all vegetables within one group are interchangeable, i.e. use some but not all depending on availability. Below are the three vegetable groups used successfully at Paignton Zoo Environmental Park (UK) however other successful combinations are possible.

#### A Veg

Cabbage (any sort)  
Chicory  
Collards  
Kale  
Lettuce (any sort)  
Spring greens  
Spinach  
Swiss chard  
Turnip greens  
Asparagus  
Brussel sprouts

#### B Veg

Broccoli  
Cauliflower  
Celery  
Corn  
Cucumber  
Fennel  
Leeks  
Mushrooms  
Okra  
Peas  
Onions  
Peppers  
Radishes  
Tomatoes  
Green beans  
Broad beans  
Avocado  
Artichoke

#### C Veg

Swede  
Squash (any sort)  
Pumpkin  
Sweet potato  
Turnips  
Jerusalem artichoke  
Mangels  
Beetroot  
Carrots  
Celeriac  
Parsnips  
Kohlrabi  
Aubergine  
Potato





It should be noted that fruit-free diets have been shown to be beneficial in other primate groups and may well be so for callitrichids, reported above. However, some health problems seen in larger species don't seem to be so prevalent in callitrichids. Therefore if a current diet is successful changes to a such a diet could await the analysis of the health benefits of a vegetable diet over a period of time so comparisons can be made.

### **Animal Products**

All marmosets and tamarins consume significant amounts of insects in the wild. Insects are good sources of protein and lipids, but a poor source of calcium and some vitamins. In addition, a large proportion of the time budget of the animals in the wild is taken up by foraging for invertebrates, and attempting to mimic this foraging behaviour can be an important source of environmental enrichment (Section 4.5). Invertebrates (preferable live ones) should therefore be offered to all marmosets and tamarins. These can be mealworms, crickets, grasshoppers etc. Apart from invertebrates, the only other sources of animal products which are recommended are eggs. Chicken, beef and animal meat as well as dairy products are discouraged. The feeding of baby mice is not encouraged – and forbidden by the IRMC (International Recovery and Management Committee) for lion tamarins because of the risk of infection with callitrichid hepatitis virus (Golden Lion Tamarin Management Committee, 1996) (also see Veterinary guidelines). Meat products have a different amino acid concentrations compared to insects. Dairy may contain potential allergens or compounds linked to inflammation. The inclusion of dairy in the diet is not conducive to optimal gut health. Callitrichids should receive most of their protein from insects and their concentrate feeds. Although not detrimental in small amounts, animal protein is not a daily requirement by any means.

### **Complete feeds**

In order to prevent nutritional deficiencies as a consequence of feeding commercial produce and insects, and in order to meet the specific nutrient requirements of callitrichids (see Section 2.2) is important to offer the animals a complete feed, which should be a commercial concentrate feed (pellet, jelly, gel, cake). The calcium content of invertebrate species offered can also be raised by feeding these a calcium-rich diet before they are offered to the monkeys (Ullrey, 1986; Crissey *et al.*, 1999). Although many different brands and forms of these feeds may be nutritionally appropriate, they should not be misused. The gel and jellies are not conducive to dental health. Making “mashes” and/or wetting down pellets are also discouraged as they do not provide a mechanical stimulation on the teeth (although for ill individuals with low appetite, providing a palatable diet is paramount). Home-made complete feeds are only recommended if they are nutritionally analysed to ensure they contain the right proportion of micronutrients. Generally we recommend a complete feed that has a protein content between (between 15-25% protein) and higher fibre (5-15%). Institutions not capable of providing enough insects regularly must resort to higher protein pellets.

### **Gum**

Gum is an essential part of all marmoset diets in the wild, particularly at times when other food items are scarce. Offering a replacement for wild exudates such as gum arabic (see Section 2.2.1.1) to these species in captivity is important physiologically and behaviourally, even if they may have a balanced diet without gum. Considering it a behavioural necessity, and the biochemical digestive challenges it



presents to the gut may well be important and beneficial (Wormell and Price, 2016). Some institutions and pilot studies even feel that the inclusion of gum in the diet may help to combat Marmoset Wasting Disease (Nash 1986). Because gum has to be fermented, it is beneficial for gut health and to cultivate optimal gut microbe communities. For tamarin species, gum arabic should also be offered a few times weekly every now and then by way of nutritional variety and behavioural enrichment.

### Seeds and Nuts

Generally, seeds and nuts are not recommended for callitrichids unless they are observed thoroughly chewing the seed and not swallowing them whole. Whole swallowed seeds increase the digestive passage rate (Power, 2010) and may compromise the nutrients ingested in the diet. Consequently, we will not be using nuts and seeds in our recommendations due to them not being necessary.

## 4.2.2 Diet Composition and requirements

### How much to feed

There are two main ways to estimate the amount of energy an animal needs. The first is scientific and involves using an equation to determine the amount of energy in kilocalories (kcal) or kilojoules (kJ) needed per day. A number of studies have measured the mean daily metabolisable energy (ME)\* intake for cotton-top tamarins (*S. oedipus oedipus*), however, we will only recommend one as they are somewhat similar. Please note that due to differences in environment and digestibility of diet, this number is only to be used as a starting point to then further increase or decrease the energy in the diet based on weight and behavioural changes.

#### Equation from Kirkwood (1983)

Results in kcal/day	$109 * (\text{body weight in kg})^{0.75}$
Results in kJ/day	$456 * (\text{body weight in kg})^{0.75}$
	(271 kJ/day or 65 kcal/day for a 0.5 kg animal)

The other method is cruder but has anecdotally been used in the zoo community. Very generally, small primates will consume a certain amount of their own body weight in food. Ideally this is measured as dry matter (DM) but this is not practical for zoo professionals to calculate. Consider this is usually an overestimation and monitoring following a diet change is absolutely necessary, but this does provide a starting point (Crissey *et al.*, 1999, 2003).

Body weight of species	% of body weight to be given as diet
<400 g	22-24
>400 g	16-20



### 4.2.3 Nutrient Recommendations

The estimated adequate nutrient concentrations (dry matter basis) in diets recommended for callitrichids original Table from NRC, 2003; adapted from Crissey *et al.*, 2003).

Nutrient	Concentration	Nutrient	Concentration
Crude protein, %	15-22 <sup>a</sup>	I, mg/kg	0.35
Essential n-3 fatty acids, %	0.5 <sup>b</sup>	Se, mg/kg	0.3
Essential n-6 fatty acids, %	2 <sup>c</sup>	Trivalent Cr, mg/kg	0.2
Neutral detergent fiber (NDF), %	10 <sup>d</sup>	Vitamin A, IU/kg	8,000
Acid detergent fiber (ADF), %	5 <sup>d</sup>	Vitamin D <sub>3</sub> , IU/kg	2,500 <sup>g</sup>
Ca, %	0.8	Vitamin E, mg/kg	100 <sup>h</sup>
Total P, %	0.6 <sup>e</sup>	Vitamin K, mg/kg	0.5 <sup>i</sup>
Non-phytate P, %	0.4	Thiamin, mg/kg	3.0
Mg, %	0.08	Riboflavin, mg/kg	4.0
K, %	0.4	Pantothenic acid, mg/kg	12.0
Na, %	0.2	Available niacin, mg/kg	25.0 <sup>j</sup>
Cl, %	0.2	Vitamin B <sub>6</sub> , mg/kg	4.0
Fe, mg/kg	100 <sup>f</sup>	Biotin, mg/kg	0.2
Cu, mg/kg	20	Folacin, mg/kg	4.0
Mn, mg/kg	20	Vitamin B <sub>12</sub> , mg/kg	0.03
Zn, mg/kg	100		

<sup>a</sup>Requirements for growth of young and for lactation are best met by the higher concentrations in this range. Required protein concentrations are markedly affected by amounts and proportions of essential amino acids. Taurine may be a dietary essential through the first postnatal year.

<sup>b</sup>Requirement can be met by  $\alpha$ -linolenic acid. Required concentration may be lower when supplied by eicosapentaenoic or docosahexaenoic acids.

<sup>c</sup>Requirement can be met by linoleic or arachidonic acids.

<sup>d</sup>Although not nutrients, NDF and ADF at or near indicated concentrations appear to be positively related to gastrointestinal health.

<sup>e</sup>Some of P in soybean meal and certain cereals is bound in phytate and poorly available.

<sup>f</sup>Iron-storage disease (hemosiderosis) is a potential problem, particularly when large quantities of fruits are offered, presumably because citrate or ascorbate promote iron absorption. Under these circumstances, it may be important to limit iron to near or slightly below this concentration. Particular attention should be given to iron concentrations in phosphorus and calcium supplements and to selection of sources that are low in this contaminant.

<sup>g</sup>There are anecdotal reports of higher vitamin D<sub>3</sub> requirements under some circumstances, perhaps related to impaired absorption in individuals with colitis.

<sup>h</sup>As all-*rac*- $\alpha$ -tocopheryl acetate.

<sup>i</sup>As phylloquinone.

<sup>j</sup>Niacin in corn, grain sorghum, wheat, barley, and their byproducts is poorly available unless they have undergone fermentation or wet-milling.

<sup>k</sup>Ascorbyl-2-polyphosphate is a vitamin C source that is biologically available and quite stable during feed processing and storage.

\* Digestible Energy (DE) = gross energy minus energy lost in faeces. Metabolisable Energy (ME) = DE minus energy lost in urine and as methane (in case of ruminants) (McDonald *et al.*, 1995).



## Diet proportions

We recommend a diet that is reflective of wild feeding ecologies. This translates to a diet high in produce, insects and gum and with only enough complete feed to provide essential micronutrients difficult to find in food items.

Category	Gummivorous	In-between	More frugivorous
Complete Feed	15	15	20
Insects	15	5	10
Vegetables	45	65	60
Gum	20	5	Regularly in small amounts
Fruits**	5	10	10

**\*\*To be used primarily for training**

**Gummivorous species:** *Callibella humilis*, *Callithrix argentata*, *C. aurita*, *C. flaviceps*, *C. geoffroyi*, *C. jacchus*, *C. penicillata*, *Cebuella pygmaea*, *C. niveiventris*

**In-Between species:** *Mico emiliae*, *M. melanurus*, *M. intermedia*, *Saguinus bicolor*, *S. fuscicollis*, *S. labiatus*, *S. mystax*, *S. imperator*, *S. oedipus*, *C. kuhlii*, *C. goeldii*

**More frugivorous species:** *Leontopithecus chrysopygus*, *L. caissara*, *L. chrysomelas*, *Saguinus midas*, *S. niger*, *S. nigricollis*, *Mico humeralifer*

It is recommended to obtain a variety of insects and to vary them throughout the week. Simply feeding mealworms or crickets/locusts may not be appropriate. Alternating both and opportunistically including snails, cockroaches, grasshoppers etc. are also encouraged.

## Technical Information on Dietary Composition

### Energy

By means of linear regression of ME intake of adult primates by weight, using log transformed data, Kirkwood and Underwood (1984) came up with an equation for primate inter-species mean ME requirement:

$$\begin{aligned} \text{(daily ME requirement for maintenance)} = & 405 \text{ kJ} \times (\text{Body weight in kg})^{0.75 \pm 0.047} \\ & (97 \text{ kcal} \times (\text{Body weight in kg})^{0.75}) \end{aligned}$$

Clarke *et al.* (1977) had earlier also calculated a primate inter-species mean ME requirement as 107 kcal/kg<sup>0.75</sup>/day.



These figures compare well with the gross energy requirement for reported by Morin (1980) and Barnard *et al.* (1988): 142–232 kcal/kg body mass/day. One has to bear in mind, however, that the amount of gross energy needed for maintenance is related to the digestibility of the diet (in other words, how much of the gross energy of the diet is digestible and metabolisable by a particular species). The apparent digestibility of gross energy in an artificial diet fed to five species of callitrichids ranged from 71 to 86% (Power, 1991). Yaxley (2007) found a voluntary intake of 137 kcal/day and 129 kcal/day in captive *Leontopithecus chrysomelas* and *L. rosalia*, respectively, fed a normal zoo diet. Energy expenditure due to resting metabolic rate in *Callimico* was calculated as 40.1 kcal/day based on a 12-hr active/inactive cycle (Power *et al.*, 2003). Thompson *et al.*, (1994) estimated that the ME equivalents for dietary carbohydrate, protein and fat for golden lion tamarins (*L. rosalia*) are 4.0, 4.1 and 9.0 kcal/gram respectively.

The studies on energy intake in cotton-top tamarins indicated that the energy intake of adults generally decreased with age and that, although energy intake did not markedly rise during pregnancy, the energy intake of females appeared to double during lactation in the weeks 3–6 post-partum (Kirkwood and Underwood, 1984).

### Protein

Commercial feeds for some New World primates such as cebids, callitrichids and *Callimico* tend to be high in protein (>20% on a dry matter basis) because New World primates have been said to have higher protein requirements than Old World monkeys (NRC, 1978). This is probably a result of the fact that in some studies, callitrichids on high protein diets were observed to “thrive better” (Kirkwood, 1983; Kirkwood *et al.*, 1983; Flurer and Zucker, 1985; Barnard *et al.*, 1988). In fact, protein deficiency has been discussed as a possible cause of “wasting marmoset syndrome” but was later rebuffed (Flurer and Zucker, 1985; Barnard *et al.*, 1988).

However, recent research has not supported higher protein requirements of New World primates. For *S. fuscicollis*, 2.8g protein (from casein)/kg body weight/day (7.3% of dietary dry matter) was shown to be sufficient (Flurer and Zucker, 1988). Protein requirements (from soy protein concentrate) for maintenance of nitrogen balance in adult common marmosets were 6.6% of dietary dry matter or 2.5 g/kg body weight/day (Flurer and Zucker, 1988). Yaxley (2007) found that captive lion tamarins *Leontopithecus chrysomelas* and *L. rosalia* had a crude protein intake of 13.6% and 9.6% of dietary dry matter (4.76 g/day and 3.35 g/day), respectively. The animals were in apparent good health, and the *L. chrysomelas* were breeding successfully. It was noted, however, that the animals were foraging for ants, caterpillars and flies in addition to their provisioned diet, which were not accounted for in the study and may well have increased protein intake (Yaxley, 2007). Tardif *et al.* (1998) did not find any differences in growth and reproduction between common marmosets fed purified diets containing 15% or 25% protein (as fractions of estimated dietary ME concentration). The minimal protein requirement for maintenance of common marmosets was estimated to be 6% of the diet (Flurer *et al.*, 1988). The animals started to eat their faeces if the protein level in the diet dropped below this value, or if the diet was lacking in the essential amino acids histidine and/or arginine (Flurer and Zucker, 1988). Estimated adequate concentrations of protein for post-weaning growth and reproduction of nonhuman primates range from 15 to 22% in the dry matter of diets containing conventional feed ingredients (NRC, 2003). Protein quality greatly affects the required concentration. Excess dietary protein may increase urinary calcium loss and thus dietary calcium requirements (NRC, 2003).



## 4.2.4 Vitamins

### 4.2.4.1. Vitamin D and the need for UVB exposure

In captivity, we try to mimic the optimum conditions that would exist in the wild and therefore callitrichids are best kept where they have exposure to natural light, not least to maintain a healthy circadian rhythm. For many mammals, including marmosets and tamarins, natural sunlight plays an important role in biological functions (Chun et al 2019), and the UVB element of light is essential for cutaneous vitamin D3 synthesis (Ziegler et al 2018). Vitamin D stimulates intestinal uptake of calcium and phosphate and maintains plasma and phosphate homeostasis. Hypovitaminosis of vitamin D usually occurs when there is insufficient exposure to sunlight or low dietary intake (e.g. Junge et al 2000). As it is a fat soluble vitamin and can be stored by the body, deficiencies may not be apparent for some time after the production in the skin or dietary intake has been reduced.

While vitamin D is known to have important functions in maintaining a healthy immune system, kidney function, regulating parathyroid gland, healthy skin and cancer prevention to name a few (Bikle, 1992; Giovannucci, 2009; Girgis et al 2013; Ghaly and Lawrence 2014), in callitrichids by far the most commonly reported disease that is associated with lack of adequate vitamin D is metabolic bone disease (MBD; Olson et al 2015). Bone pathologies (rickets and osteomalacia) involving bone deformities or fractures are clinical signs of severe deficiency. By the time these observations are made, the individual will almost certainly have been vitamin D deficient for a considerable length of time.

Vitamin D deficiency has been linked to certain human diseases which may be of concern to callitrichid primates not least wasting syndrome, or Marmoset wasting syndrome, (WMS). Research into inflammatory bowel disease (IBD) in the human primate have indicated that low levels of circulating vitamin D could be a contributing factor to the development of the disease (Fletcher et al. 2019). There is also a higher incidence of IBD in populations living at higher latitudes (Stein et al 2016), where populations will naturally receive less usable UVB from sunlight, which will in turn affect levels of vitamin D. Vitamin D has also been shown to be very important in regulating immune function and autoimmune diseases in humans (Vanherwegen et al 2017), and again, this is likely to be very important to callitrichid primates in captivity.

It appears that most neotropical primates differ from their Old World relatives in the ability to absorb vitamin D2 from dietary sources, and this has resulted in a greater occurrence of metabolic bone disease (MBD) in neotropical primates than in Old World monkeys and apes (Gacad and Adams, 1991). It has been suggested that neotropical primates have a certain amount of organ resistance to vitamin D (Takahashi et al 1985), perhaps a result of low affinity of D3 receptors (Lieberman et al 1985), or overexpression of a vitamin D response element binding protein, which competes with the vitamin D receptor (Adams et al 2003). This results in a higher requirement for circulating vitamin D3 than would be tolerated by Old World primates (Shinki et al. 1983; Adams et al 1985; Ziegler et al 2015).

Reference values for circulating vitamin D3 are available from a number of callitrichid species, both in the wild and in captivity, and suggest that 50-120 ng/ml probably represents a normal range (Power et al 1997; Crissey et al 1999; Bosseler et al 2018; Teixeira et al 2010, 2012; Ziegler et al 2015). Levels lower than 50 ng/ml may represent incipient vitamin D deficiency (Power et al 1997). The range of callitrichids in the neotropics typically has high light intensity, which may not be possible to simulate in many captive settings. This is especially likely in northern Europe, where for a large part of the year





the UVB component is not strong enough to stimulate enough vitamin D3 synthesis in the skin to produce normal circulatory levels (Killick et al 2015, 2017). Even in range countries, individuals kept in locations that have too much shade and do not have exposure to direct sunlight can develop serious health issues. Captive *C. penicillata* showing metabolic bone problems have been reported in captivity in Brazil despite having access to outside enclosures (Teixeira et al 2009), and *S. leucopus* in Colombia have also been reported to show MBD in outdoor captive enclosures that did not receive direct sunlight (C. Falla, pers. comm).

It is advisable to monitor vitamin D status through blood analysis during routine health checks. This will

facilitate the detection of incipient vitamin D deficiency and allow for the treatment of at-risk animals before any irreversible harm has occurred.

**A case example:** The incidence of MBD in pied tamarins in captivity appeared to be higher than in other callitrichids kept at Jersey Zoo, and an investigation found that infants born in the winter months of the year were far more likely to develop MBD, even though they were provided with dietary D3 supplements and had access to outside areas throughout the year. This suggests that the developing pied tamarins were suffering from hypovitaminosis D, despite exposure to natural light throughout the winter months and supplementation with vitamin D3 at levels that appeared adequate for other species of callitrichids at the zoo.

The addition of UVB lighting showed that exposure to artificially produced UVB produced much higher circulating blood levels of vitamin D than oral supplementation (see Figure below), and since the addition of UVB lighting during the winter months there have been no

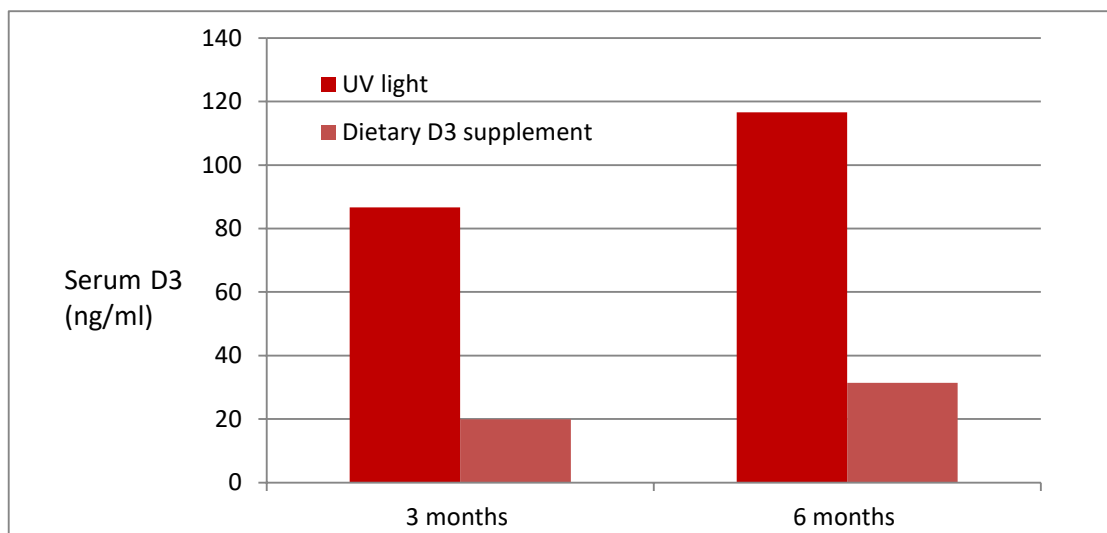

Although the importance of natural light for vitamin D production and calcium metabolism has been demonstrated in almost all mammalian species investigated (Baines 2020), the use of full spectrum and UVB lighting for mammals is still largely experimental, with vitamin D3 supplements being added to food instead. However, at least in some species, dietary supplementation may not lead to adequate levels of circulating vitamin D3 (Lopez et al 2001). Problems with bones in callitrichids have, however, been resolved by installation of UV lights in enclosures (Lopez et al 2001; Gacad et al 1992). We





therefore recommend providing access to outdoor areas that receive direct sun light, and in addition, using supplementary UVB lighting, especially in the winter months.

**Access to natural sunlight**

It is important to design outdoor enclosures to maximize the amount of UVB that callitrichids receive. This means taking into account orientation and aspect. Areas within the enclosure should be provided so that the monkeys can bask as a group in direct sunshine, a platform situated in an area that receives direct sun light, it is also very important to provide a lot of areas that provide shade as well, such as dense foliage.

UVB levels should be measured with a UV meter (eg. Solarmeter model 6.5R UV index). Although there is insufficient data to suggest specific UV levels for callitrichids, the “Ferguson Zones”, devised for reptiles and amphibians inhabiting different microhabitats, could be used as a basis for estimates (Ferguson et al., 2010; Baines et al., 2016; see table below from Baines, 2020).

Typical microhabitat /behaviour	Ferguson Zone	Suggested type of UV provision	Suggested UVI gradient
Crepuscular or shade dweller (Daylight with no direct sunlight, in very sheltered microhabitat)	1	Shade Method – low level, diffused UV resembling “daylight in the shade” across a large area of the enclosure	UVI from zero in full shade to approx. UVI 0.7 in more open areas
Partial sun / occasional basker (Daylight with some voluntary exposure to direct sunlight, in sheltered microhabitat)	2	Shade Method (as above) OR Sunbeam Method – higher UV irradiance in a brightly lit area resembling “a sunbeam” in a restricted area within the enclosure	UVI from zero in full shade to approx. UVI 1.0 in more open areas OR UVI with a maximum of UVI 3.0 in the “sunbeam” zone, with a gradient to zero in full shade
Open or partial sun basker (Daylight with frequent voluntary exposure to direct sunlight, in open habitat)	3	Sunbeam Method (as above)	UVI with a maximum between UVI 3.0 – 7.4 (depending upon species’ estimated typical sun exposure) in the “sunbeam” zone, with a gradient to zero in full
Midday sun basker (Near-constant exposure to direct sunlight in exposed habitat)	4	Sunbeam Method (as above)	UVI with a maximum between UVI 4.5 – 8.0 (depending upon species’ estimated typical sun exposure) in the “sunbeam” zone, with a gradient to zero in full



### Exposing callitrichids to UVB lights

There are several types of lighting that will deliver UVB, most of which have been developed for use with reptiles.

The correct positioning of UVB lights in enclosures is crucial, as lights are potentially extremely dangerous. At Durrell we have erred on the side of caution and at the nearest point the monkeys can approach, the UVB index level is set at approximately 2.0 to no more than 2.5 (upper end of Ferguson zone 1 and lower Ferguson zone II). This is measured with a Solarmeter UV index meter and checked regularly, at least every month, as levels of UVB output will vary between bulbs.



Mercury vapour and metal halide bulbs will get extremely hot and can provide a hot spot that the monkeys will want to bask under. Extreme care should be taken to make sure that the UVB index is not too high as individuals will tend to spend long periods under these lamps, which deliver heat as well UVB. Mercury vapour bulbs will vary greatly in their UVB output and will degrade in time so each bulb should be checked regularly.



*The usual set-up for heat lamps at Durrell is so the back of a basking monkey is at least 30cm away from the bulb.*



*UVB bulb above a platform. The platform position can be adjusted up and down the vertical support, bringing it closer or further away from the UVB bulb. As each bulb will often have a different output intensity, it is useful to have an adjustable platform.*



Fluorescent UVB-emitting tubes will supply a larger area with more even coverage of UVB at a given distance. Fluorescent compact bulbs are basically small tubes coiled to fit in a lamp fitting; they have a more limited range and coverage. While UVB tubes only deliver a small amount of heat and are merely warm to the touch, they must not be positioned in an area where monkeys will choose to rest against them for warmth as the levels of UVB would be extremely dangerous. The best option is to position them above a feed area so that a large surface of the perching is irradiated to the right level. Another option is to put a heat lamp and UVB tube alongside each other, so that while the monkeys rest under the heat lamp they will receive UVB at a safe level.

### Conclusion

The studies at Jersey Zoo and elsewhere, and the subsequent use of UVB heat lamps over the last 20 years, suggest that artificial UVB irradiation is a safe and effective method for maintaining adequate levels of circulating vitamin D3 in pied tamarins, and that it is superior to oral supplementation.

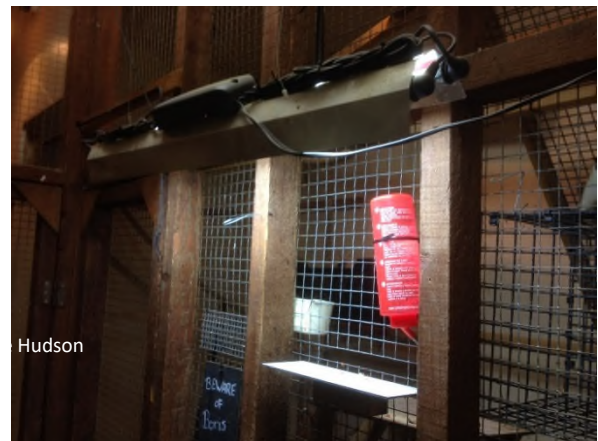

*UVB tube positioned on the outside of the enclosure in keeper service corridor, above the feed platform and water bottle.*



*UVB bulb positioned outside enclosure close to water bottle and food station, which will irradiate the animals when they come to drink or take food.*





*Fluorescent UVB tubes positioned on the ceiling of the inside area of an enclosure.*



*Tamarin basking under heat lamp but is also being irradiated by UVB from the tube positioned outside the enclosure. UVB rays will also fall on tamarins when they come to cage front to take food or water.*

#### 4.2.4.2. Vitamin E

Callitrichid requirements for vitamin E have been studied only in the common marmoset. To support normal plasma  $\alpha$ -tocopherol concentrations and inhibit hydrogen peroxide-induced haemolysis, 4 to 48 mg of D- $\alpha$ -tocopherol/kg of purified diet were required (McIntosh et al., 1987). When fish oils were added to a purified diet, requirements increased to over 95 mg of D- $\alpha$ -tocopherol/kg (Ghebremeskel et al., 1991). Young common marmosets had normal plasma  $\alpha$ -tocopherol concentrations on 130 IU or less of  $\alpha$ -tocopherol/kg of purified diet (Charnock et al., 1992). The NRC (2003) estimated that the requirement for vitamin E in a purified diet is in the range of >95–130 mg all-rac- $\alpha$ -tocopheryl acetate/kg dry matter. The estimated adequate vitamin E concentration in diets containing conventional feed ingredients was set at 100 mg all-rac- $\alpha$ -tocopheryl acetate/kg dry matter.



#### 4.2.4.3. Vitamin C

Like other simian primates studied, *Callithrix jacchus* and *Saguinus fuscicollis* were found to be unable to synthesize ascorbic acid or vitamin C (Flurer and Zucker, 1989). It is likely that vitamin C is an essential nutrient to all callitrichids. Vitamin C in extruded monkey biscuits usually deteriorates rapidly and because canned primate food does not contain vitamin C, fruits, vegetables and browse tend to be important sources of vitamin C in primate diets (Allen and Oftedal, 1996). Vegetables of the cabbage family, citrus fruits, rose hips and some types of browse are good sources of vitamin C (Allen and Oftedal, 1996).

The minimum vitamin C requirement for adult *C. jacchus* was found to be 15mg/kg metabolic weight (a diet with 500 ppm), which is much higher than that for humans (4mg/kg metabolic weight). However, the requirement of *S. fuscicollis* was much higher again than that of *C. jacchus* (requiring a diet with more than 2000 ppm) (Flurer and Zucker, 1989). There may therefore be considerable variation among callitrichid species. Luckily, Vitamin C is generally considered to be one of the least toxic vitamins. Indeed, in order to assure that adequate levels reach the animals, very high levels of vitamin C are often added to manufactured foods because of the instability of ascorbic acid (Allen and Oftedal, 1996). The NRC (2003) recommends 200 mg vitamin C/kg of dietary dry matter for post-weaning non-human primates (as a source, ascorbyl-2-polyphosphate is recommended).

#### 4.2.5 Calcium

The main function of calcium is to build bone material but other functions are also included such as in the muscular and nervous system. Unlike Vitamin D, calcium can only be obtained through nutrition. Many of the items naturally consumed by callitrichids, as well as those fed in captivity, are either low in calcium or have an adverse calcium/phosphorus relationship. These include fruits, vegetables and invertebrates. It is possible that in the wild callitrichids compensate for this by consuming plant gums which are high in calcium (Smith 2000). With a higher level of gum consumption in Marmosets this definitely provides a credible option for them. Although gums are high in calcium, the overall digestibility is very low. In captivity calcium is normally present in the complete (concentrate/pellet) diet offered, although dietary analysis is advised to ensure that this is not diluted by other items in the diet that are high in phosphorus. Other sources of calcium in captive diets include gums and possible supplementation where needed.

Calcium has a direct relationship with both Vitamin D and Phosphorus. Vitamin D aids calcium absorption into the bones and Phosphorus helps build bone material in direct relation with calcium. It is important that good levels of phosphorus are also present in the diet as this would otherwise effect bone strength in the same way as low levels of calcium, where the minerals are drawn away from the bone to provide adequate levels in circulation. The relationship between calcium and phosphorus is not equal however, it is important that higher levels of calcium are present in the diet at an advised ratio of 2:1 (calcium:phosphorus) and no less than 1:1. If phosphorus is more abundant in the diet than calcium this can lead to poor absorption of both minerals and the possibility of bone re-absorption leading to clear problems. When accounting for this difference in nutritional analysis it is important to look at the bioavailability of these minerals as although phosphorus levels might seem high these may not be necessarily digestible by the animal, as can be the case for phytate bound phosphorus, unless phytase is added to the diet to increase availability. Calcium absorption can be affected when diets



are high in dietary protein or sodium which will have to be accounted for in the levels of calcium supplied (NRC 2003).

Due to the high reproduction rate of callitrichids is likely that calcium requirements are high. This theory was given weight by a study by Power et al. (1999) which showed that the Common Marmoset (*Callithrix jacchus*) can distinguish between plain water and a calcium lactate solution, favouring the calcium solution especially when reproductive pressures were at a high. Recommendations for calcium levels as per dry matter of feed are 0.8%, with 0.6% of phosphorus (NRC 2003), however these are recommendations for primates in general and do not account for potential differences in species and demands caused by reproduction.

Calcium deficiencies can be moderated by the body provided these are short-term, for example during lactation, by utilizing the skeletal reserves without showing signs of deficiencies. In the longer term dietary calcium deficiency can lead to retarded growth and rickets in younger animals and osteoporosis in older animals. The symptoms are therefore similar to Vitamin D deficiency due to the finely held balance between these nutrients and mainly manifest through restricted movement (NRC 2003).

#### 4.2.6 Iron

Mammals only require trace amounts of iron, and iron deficiency is rare in healthy animals receiving solid food (Allen and Oftedal, 1996). The mammalian body normally regulates iron balance by controlling iron absorption, as it lacks effective means to excrete iron (Allen and Oftedal, 1996). Dietary excess of iron may be one of the significant causes of haemosiderosis and/or haemochromatosis in many captive wild animals, including marmosets and tamarins (Gottdenker et al., 1998). Gottdenker et al. (1998) investigated the livers of 232 callitrichids that died at the Bronx Zoo between 1978 and 1997. Of these, 94.4% had some degree of haemosideris and 82.3% had moderate to severe scoring. The fact that the haemosiderin deposition was predominantly intrahepatocytic, that there was a zonal gradient of hepatic haemosiderin, and that sinusoidal haemosiderin deposition increased with age, strongly suggested that the haemosiderosis in the callitrichids at the Bronx Zoo was primarily due to enteric iron absorption. The iron content of the diets of the Bronx marmosets (191.2–238.2 mg/kg) and tamarins (191.9–305.6 mg/kg) was higher than the 100 mg/kg dry matter NRC (2003) recommendation. The NRC (2003) provides the following note with their recommendation: “Because some primates appear to be susceptible to iron-storage disease, particularly in the absence of iron-binding polyphenols found in some plants and when large quantities of fruits are offered, it might be desirable to limit dietary iron concentrations to near or slightly below this concentration. However, this is difficult because of the iron associated with use of calcium phosphates (produced from rock phosphate) as a phosphorus source. Calcium phosphates produced from bone (as a byproduct of gelatine manufacture) are lower in iron. In either case, iron in the phosphate source is thought to be lower in bioavailability than iron in ferrous sulfate, as long as the intake of fruits and their associated citrate and ascorbate contents (which promote iron absorption) is limited.”

#### 4.2.7 Iodine

Iodine is important for thyroid function and thereby indirectly for metabolism regulation. Furthermore, adequate iodine supply is of importance during foetal brain and bone development and should therefore be available to pregnant individuals. Requirements could be around 0.65 mg I/g DM as at these levels signs of iodine deficiency were prevented (Mano et al. 1985). However, the NRC



(2003) state that levels sufficient for primates is 0.35 mg/kg DM. There are no symptoms associated with Iodine deficiency in adults, and symptoms only really manifest in the offspring of deficient females (NRC 2003). Therefore it is important to monitor the levels of Iodine in the diet provided to assure adequate levels are met.

#### 4.2.8 Other minerals

In the wild, moustached tamarins (*Saguinus mystax*) were observed to feed on surface soil and soil from the broken mound of leaf cutting ants. Analyses of soil samples suggested that the most likely hypothesis for the function of soil feeding in these animals was that it serves as mineral supplementation (Heymann and Hartmann, 1991).

#### 4.2.9 Method of feeding: eliciting natural foraging behaviour

It is important for callitrichids in captivity to be able to perform natural behaviours. How feeds are presented to animals in captivity can greatly benefit welfare and create a more interesting and naturalistic exhibit.

Callitrichids are arboreal animals and will foraging for food items at height rather than at ground level (Hoffman, 2004). Food items should be offered at height to encourage the natural foraging behaviour of these primates (Clutton-Brock, 2012). The use of shelving, platforms, net baskets hooked on ropes and large branches can help achieve this. Hanging flower baskets also make good callitrichid feed platforms and can be hung from anywhere in an enclosure.

As well as receiving many different potential types of feeds callitrichids should be fed multiple times a day anywhere from 2-5 separate feeds (Hoffman, 2004). This increases the amount of time spent foraging which may help mimic the activity budget of wild callitrichids as Callitrichids can spend up to 50% of each day foraging for food (Chamove, 1989; Hoffman, 2004).

Food based enrichment in Callitrichids normally revolves around gums in the diet as a natural precursor to gouging behaviours or live foods/bugs to forage or “hunt” for, but other areas of the diet are generally overlooked unless scattered or presented in a puzzle feeder or enrichment device.

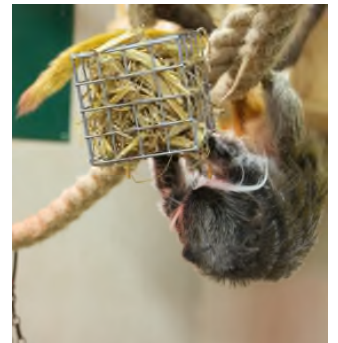





Presenting your feeds to callitrichids in a variety of ways can make the simplest of diets enriching to its recipients and will help benefit the mental health of these primates (Glick-Bauer, 1997). Longleat’s callitrichids currently use an ‘Enrichment Calendar’ purely for its feeding regime. Adapted from Husbandry guidelines of Common Marmoset *Callithrix jacchus* by Freeburn (2008), the enrichment-based plan divides the diet up into daily dietary presentations spread out over a month. A base of a calendar month is used to increase the level of variation. Longleat callitrichids are fed anywhere from 3 to 4 or more times depending on seasonal variance, which include meals of commercial pellet, fresh

**Callitrichid enrichment calendar.**

Please check the date on the calendar for food presentation and enrichment for today.  
Please also check tomorrow's #ota as additional preparation may be required e.g. freezing gum

<b>1</b> Pellet: DB Vegetables: PF/C Gum: GL Insects: SF	<b>2</b> Pellet: DS Vegetables: IB/W Gum: GL Insects: IB	<b>3</b> Pellet: SB Vegetables: SF/D Gum: GB Insects: IB	<b>4</b> Pellet: DB Vegetables: IB/B Gum: GL Insects: SF	<b>5</b> Pellet: PE Vegetables: SF/G Gum: GF Insects: IB	<b>6</b> Pellet: DB Vegetables: IB/C Gum: GL Insects: SF	<b>7</b> Pellet: DB Vegetables: IB/F Gum: GL Insects: IB	<b>8</b> Pellet: SB Vegetables: SF/G Gum: GL Insects: IB
<b>9</b> Pellet: DB Vegetables: IB/W Gum: GF Insects: SF	<b>10</b> Pellet: PE Vegetables: IB/D Gum: GL Insects: PF	<b>11</b> Pellet: DB Vegetables: SF/C Gum: GL Insects: IB	<b>12</b> Pellet: SB Vegetables: SF/D Gum: GL Insects: IB	<b>13</b> Pellet: DB Vegetables: PF/C Gum: GL Insects: SF	<b>14</b> Pellet: DB Vegetables: IB/G Gum: GL Insects: IB	<b>15</b> Pellet: DB Vegetables: SF/C Gum: GB Insects: IB	<b>16</b> Pellet: DB Vegetables: IB/M Gum: GF Insects: SF
<b>17</b> Pellet: DS Vegetables: IB/D Gum: GL Insects: PF	<b>18</b> Pellet: PE Vegetables: SF/F Gum: GL Insects: IB	<b>19</b> Pellet: DB Vegetables: IB/W Gum: GB Insects: SF	<b>20</b> Pellet: SB Vegetables: IB/G Gum: GL Insects: IB	<b>21</b> Pellet: DB Vegetables: PF/C Gum: GF Insects: SF	<b>22</b> Pellet: DS Vegetables: IB/G Gum: GL Insects: IB	<b>23</b> Pellet: DB Vegetables: SF/D Gum: GL Insects: IB	<b>24</b> Pellet: DB Vegetables: SF/F Gum: GL Insects: SF
<b>25</b> Pellet: DB Vegetables: IB/W Gum: GL Insects: SF	<b>26</b> Pellet: DB Vegetables: IB/M Gum: GF Insects: IB	<b>27</b> Pellet: PE Vegetables: SF/C Gum: GL Insects: IB	<b>28</b> Pellet: SB Vegetables: SF/C Gum: GL Insects: SF	<b>29</b> Pellet: DB Vegetables: IB/B Gum: GL Insects: IB	<b>30</b> Pellet: DB Vegetables: SF/G Gum: GL Insects: PF	<b>31</b> Pellet: DB Vegetables: IB/W Gum: GB Insects: SF	

**Symbol key**

<p><b>Pellet:</b> Dry in bowl = DB Soaked in bowl = SB Dry scattered = DS Plus extra = PE Marmoset gum Gum on logs = GL Gum on browse = GB Gum frozen = GF</p> <p><b>Insects:</b> In bowl = IB Scatter feed = SF In puzzle feeder = PF</p>	<p><b>Vegetable presentation</b> In bowl = IB Scatter feed = SF In puzzle feeder = PF</p> <p><b>Vegetable preparation</b> Chopped = C Diced = D Grated = G Whole = W Frozen = F Boiled = B Mashed = M E.g. Vegetables: IB/C = In bowl, chopped</p>	<p> = Browse, try to vary species used if possible. Can include leaf litter when browse is scarce.</p> <p> = Olfactory e.g. spraying scents, soaking sticks, sprinkling scents, scents from other animals (check suitability)</p> <p> = Novel items e.g. tyre, swing, hammock, mirror time, noise makers, bags, tubes.</p> <p> = Puzzle feeder e.g. forage platforms, boxes, tubes, gum tubs, Kong's, coconuts, milk bottles.</p> <p>Days with no symbols are rest days with no additional enrichment.</p>	<p>All of these can be enhanced by using different substrates in enrichment to change the texture and create interest (no substrate can also be beneficial)</p>
--	--	--	---

By Samantha Althorpe: April 2015 v2

produce, live foods and gums.

The calendar provides a quick and easy reference to which each feed is presented to the animals. This is a very simple way of enriching animals that is potentially inexpensive has minimal input and is not time consuming. The calendar also allows for prior preparation of enrichment items that may take time to prep or retrieve (i.e. Browse).

#### 4.2.10 Gums

Gums should be fed to callitrichids in captivity as part of the daily diet. It is also a behavioural necessity for some species and nutritional benefits for other species. It can be smeared on branches or filled into drilled in holes and reservoirs in natural barks and branches have proven successful with all species, even the less gummivorous ones (Kelly, 1993; Buchanan-Smith, 1998). This is more enriching, however difficult to quantify. Feeding the gum in a pot may not be as enriching, however it is easier to quantify to ensure required amounts are being ingested. The more enriching technique can be used after the necessary amount has been ingested daily within the pot. *Cebuella*, *Mico* and *Callithrix* species are able to gouge through tree bark in order to obtain gums in the wild, which is a behaviour easily replicated.



Traditionally gum is presented to captive callitrichid species in “gum logs or trees”. Designed of cuts of wood with either drilled holes or reservoirs to allow gums to be placed for callitrichids take the feeds from a more natural source (McGrew *et al.*, 1986). When drilling holes in lengths of wood establish a top to the length and drill the holes at an angle towards the top as to work as a pocket to contain the gum. They must be replaced regularly however to ensure hygienic practices as gum on logs is extremely hard to sanitise. Once again, providing gum in a pot limits this.

Using different techniques with gum placement and log design can create different feeding methods and of course varied enrichment. Key ideas for using gum logs should revolve around the species in which the gum log is being offer to. For example, for a *Callithrix species* group a gum log with smaller holes would be beneficial to encourage tree gouging (Wakenshaw,1999). This doesn't mean logs should be made easier for the species that are not true tree gougers, but only as a way of encouraging natural behaviours.

It must be ensured that gum does not overflow. It is possible that some over grooming can be caused by excess gum from where the animals cling to the log in order to obtain the gum inside. The tamarins are fed gum infrequently were as the marmosets now receive gum daily. To prevent this, the required amount of gum should be spread out on many gum feeders rather than fill up one. Holes can also be drilled into the top of the log feeder in order retain the gum.



Gum logs provide a great natural behavioural response, but variety itself can be enrichment (Kelly, 1993). If gum is fed in logs 6 out of 7 days and in a different receptacle for one, then this one day provides an opportunity for choice on how to forage with the new feeder item. This would be the same for other items such as bird feeders, Kongs™, and even spreading gums on browse.

In captivity, offering gum may not necessarily be a nutritional necessity (not if all necessary nutrients are present in sufficient amounts in the other portions of the diet), but it could be considered a behavioural necessity. However, there are benefits from feeding gum to marmosets (Wormell and Price,2016). *Cebuella* and *Callithrix* species are able to truly gouge trees (see above). Offering gum in reservoirs drilled in natural branches (Kelly, 1993; Buchanan-Smith, 1998), or use of an artificial gum tree as developed by McGrew *et al.* (1986) may stimulate them to not just lick the gum but also to actively gouge the wood. For the other callitrichid species exudates are of a limited and more seasonal importance. These animals can be offered gum every now and then by way of nutritional variety and behavioural enrichment. Since these species tend not to gouge trees, gum may also be offered to them by smearing it along the surface of trunks and branches in the enclosure. The exudates can then be either licked up, or if solidified, picked up with teeth or hands. Some tamarins have also been observed in the wild to extract gum from crevices by sticking a hand into the source and licking the exudate from the fingers (Snowdon and Soini, 1988). When feeding on the gum of the pods of the *Piptadenia* tree, *Callimico* was observed to hang upside down by its hind feet from the branch that the stem was attached to. They then either reach the seed pods or pull them up by means of the flexible stem (Pook and Pook, 1981). Hanging up gum dispensers from the roof on a flexible rope can help mimic this behaviour. Heymann (1999) hypothesized that in species with gastrointestinal tracts that



are not specially adapted to gum feeding, eating gum not long before bedtime may be a strategy to lengthen the amount of time the gum remains in the gut, and therefore the time available for bacterial fermentation of the gum (see also Jersey diet for callitrichids in the appendix to this section).

At the Singapore Zoo, gum arabic is offered thrice weekly to tamarin species and daily for marmoset species. In some species, particularly for *Saguinus oedipus*, *S. midas*, *S. labiatus*, *L. chrysomelas* and *Callimico goeldii*, the consumption of the gum arabic significantly increased faecal consistency in these species. There was a case where a 6-year-old *S. oedipus* breeding male in a free-ranging enclosure began to suffer from poor appetite and chronic diarrhoea. He was observed to be gradually losing body condition. His fur coat was thinning and the colour was fading. When offered gum arabic, he took to it readily and within 2 weeks, there was an improvement in his appetite and time spent on foraging. Within 1 month, he stopped having chronic diarrhoea, (with the occasional soft faeces). His fur coat began to improve and after 3 months, it was as good as new. In the same *S. saguinus* family group, gum arabic offered via a 5ml syringe is used as a lure for operant conditioning training. The gum's attractiveness as a lure is comparable to that of using sweet fruit cubes or juice. Using a syringe extends the time that the animal stands on the weighing scale and enables the animal care staff to be able to estimate each individual's intake of the gum arabic by volume as well. During extended hot, dry weather, a slightly less viscous gum arabic mixture is provided to indirectly increase the callitrichids' fluid intake, However, callitrichids do have their own preference for gum concentration, often preferring more concentrated gums (Herron *et al.*, 2001). Water should be available daily regardless.

The replacement of natural exudates most often offered to callitrichids in captivity is gum arabic. Gum arabic comes from Old World *Acacia* species and is a heterogenous, complex polysaccharide. Although we cannot yet be certain that this particular gum is nutritionally similar to the great variety of others that the animals find in the wild, there is a good chance that biochemically, gum arabic presents the same digestive challenge as the gums eaten by wild callitrichids (Power, 1996). It is also the only gum that is currently easily obtainable (e.g., in powder form) from pharmacies, bakeries and suppliers of manufacturers of confectionery.

#### 4.2.11 Live foods & Animal products

Live foods offer some of the best examples of potential for environmental enrichment even when simply tossed into an enclosure. Using feeders and dispensers will increase foraging time and can be positioned or hung from areas more suited to callitrichids (Ruivo *et al.*, 2010). Enrichment items are more commonly used for any live food that is not adapted for climbing or flying. Livefoods, like locust and crickets, can freely climb all levels of an exhibit (Buchanan-Smith, 1998, 1999a, 1999b).

Using a range in combinations of free ranging insects or slow release cages and foraging items will challenge any callitrichids foraging skills. Ideal enrichment items for live foods can be more natural using logs similar to those used to present gums, items filled with substrates, like turf, grasses, hay, straw, leaf litter, pebbles, etc. in which to root through. Sealed boxes will purpose build holes for "Blind" foraging will replicate more natural behaviours (Ruivo *et al.* 2010). Free climbing species can also be presented on fresh cut browse or live plants within an exhibit.



Insects can be presented in different ways to be more enriching. Live insects can be distributed at random from dispensers or tossed into the enclosure are perhaps most suited. A number of callitrichid species only infrequently forage on the floor. For these species devices that hold live invertebrates that cannot fly or hold on to branches and leaves very well (e.g., mealworms) should not be suspended such that the prey falls on the floor. They should be hung such that the prey falls on a substrate higher in the enclosure (e.g., a shelf with AstroTurf). Insects such as live crickets and grasshoppers are more likely to position themselves at all levels of the enclosure (Buchanan-Smith, 1998, 1999a, 1999b).

Alternatively, extractive foraging devices such as foraging boxes and baskets may be used. These can be filled with some sort of substrate such as saw dust, turf, hay, etc. mixed with mealworms or small bits of non-animal foods etc (see also Molzen and French, 1989). They can either be hung up to challenge the locomotor abilities of the animals or can be offered stationary. Both open baskets and closed devices with small holes for “blind” foraging can be used. This must be trialed as it may be less suitable for some species such as *S. oedipus*. Natural tree logs with natural or human-made crevices are equally suited. To mimic foraging in bromeliads for lion tamarins, small insects and food items in pineapple heads can be used. We recommend zoos to try both techniques and to see which works better with which species.

### Fresh Produce

Variation in different shapes and sizes of produce offered can increase interest for even the most “bland” of vegetables.



Environmental enrichment is the standard approach for encouraging foraging behaviour (Chamove, 1989). A varied diet of vegetables can be enriching on its own without the use of “novel” enrichment items when presented correctly. How you present food to callitrichids can and will be enrichment in itself, presenting the same foods cut in to chunks on one day and diced or grated on the following, is a quick and simple way of creating variation and exciting feeds with minimal effort.

Cutting produce differently will also change the nutritional content in some foods and can make some foods more appealing to callitrichids.

At Longleat, food items such as turnips, beetroot and radishes became more favourable being diced or grated than just chopped or presented in larger forms. Mashed food items have also proven to be popular, either crushed in a pestle and mortar, or mixed in a blender.





Cooking produce is another way in which to alter a diet's presentation, and the diet itself as even partially cooking items will alter the nutritional content (sweet potato, etc.). Boiling, blanching in a microwave or using a steam cooker is a variable of ways in which to prepare feeds. Cooking produce in captivity may increase the consumption of produce in captive animals and can be used to encourage fussy eaters or elderly callitrichids. With items that are often left by animals try cooking items for a set period of time and if the feed is consumed, then over a period of a few weeks slowly reduce the time in which the item is cooked until raw and monitor the items consumption rate and see if the callitrichids become accustomed to the produce. Cooking produce should not be done too often as it causes dependency and increased the soluble carbohydrates within the food item. Due to the more concentrated minerals and fibre fractions found in vegetables compared with fruit, this is a preferred alternative to supply medication to primates instead of fruit.



Substituting items from a set diet over the course of a week can also prove to have similar effect. Creating change to a strict diet can change the animals' perception of a particular food item when taken away, and can break up the repetitiveness of an unchanging diet (Farmerie *et al.*, 1999). Giving food items whole without any cutting is also enriching and would save a lot of keeper time chopping up food.



There are some potential negatives to preparing food in this manner and some precautions are advised: cooking feeds should be done sparingly as primate species can become accustomed to having their meals cooked and will develop fussy habits. Cooking, mashing, or even dicing the entirety of a callitrichids produce feed may result in the animals leaving the diet completely. Try sampling items prepped this way (1 or 2 items only) as a novelty until the animals are accustomed to having feeds presented this way.

Alternatively, reducing daily variations in produce given to 2 or 3 yet providing variety throughout the week has also shown to increase total food intake, especially for less dominant individuals. This also lets zoos provide seasonal and local produce items and works well with the ABC veg system.

#### 4.2.12 Commercial products

There are many different commercial products available to collections for feeding callitrichids. Many take the form of a pellet feed. Pellets are a popular "breakfast" food for callitrichids in captivity and are often presented straight from the bag, as the hard pellet will help with callitrichid dentition (Caldwell *et al.*, 2009).

This section offers other ways in which to feed captive callitrichids. With pellets they can be occasionally soaked in flavoursome liquids such as sugar free squashes and caffeine free teas. Although not recommended, some zoos have tried watered down honey, fresh fruit juices, Lorikeet nectar (*commercial lorikeet feed*), and pro-biotic yogurts, which when used in small quantities, all work well with captive primates and can help fussy eaters that





struggle with consuming the pellets (Caldwell *et al.*, 2009). Callitrichids have very strong dentition and don't require their pellets to be wet down or mashed.

### Group feeding, and placement



With presenting items in this manner there are a few considerations to remember: When using the methods mentioned above for presenting callitrichid feeds, the animals group complexity should be considered, like most primates dominant callitrichids may monopolise favourable feeds (Crissey *et al.*, 1999; Hoffman, 2004). Diets should be offered using multiple feeding stations or areas in which food is placed in the enclosure, to give subordinate animals the best chance at an equal opportunity to the diet. Using a range in heights and distance

between feeds will also help.

As a rule a minimum of a feeding station for every two animals in a group would be suitable, with precautions for known aggressors (If a group is known to be food aggressive then at least use a station per animal). Increasing the feeding stations will also increase foraging time (Bicca-Marques, 2005). Tying this in with environmental enrichment and methods mentioned above should hopefully keep captive callitrichids active and healthy.

### Enrichment doesn't need food!

Remember this is food-based enrichment through presentation, and should not be considered as the only form of enrichment required for captive callitrichids, but used in conjunction with environmental enrichment, correct enclosure design and even behavioural conditioning.

#### GOLDEN RULE FOR ENRICHMENT INVOLVING FOOD:

**DO NOT USE ADDITIONAL FOOD but only use food types and quantities that are part of the daily diet of the animal.**

### 4.2.13 Diet Transition and Monitoring

Diets should be reviewed regularly; to integrate new knowledge into practice and also to check that the diet and/or feeding practice has not 'drifted' from what it is supposed to be. This drift happens frequently, for a variety of reasons, so regular review is important. It is essential to ensure that training and enrichment food are taken from, and not additional to, the agreed diet ration.

If a review of the current diet and feeding practice indicates that improvements can be made - maybe a new diet has been formulated or certain items are no longer available and need to be replaced - the next stage is implementation. There are associated considerations and challenges depending on how different the new diet is and it is essential to monitor and record observations and results in order to evaluate the short and long term efficacy of the diet. I



#### 4.2.14 Implementation tips

**People engagement** - Sometimes changing a species diet can be controversial (e.g., moving towards fruit free diets). In this case it is essential that the whole keeping team is engaged and on board with this. One person not complying will make the whole process much longer and harder and for the animals. Higher management needs to be supportive and take the time to explain to all involved what the benefits are of diet change. There should be good communication and regular feedback between keepers, nutritionist, curators and vets as appropriate.

**Transition time** - It is recommended that transition be carried out slowly to give the animal time to become familiar with and accept new diet items. Additionally, the gut microbiota need to adapt to novel food or the different ratios of food items that are being offered. Depending on how radical the diet change is a period of 2 weeks is recommended with 25% of the old diet being replaced with new diet each quarter. This is flexible and can be altered as experienced keepers feel is appropriate. Encouraging some animals to eat novel diet items may take longer. This is where good keeper skills are invaluable to conceive strategies to encourage acceptance of new items. Being strict is important but set against this is an awareness of how far an individual animal can be pushed if it refuses to eat (fortunately this situation is very rare!).

If moving to a fruit free diet the recommendation is to remove the high value fruit first and replace with veg. After a few days take out the next high value fruit and so on.

**Presentation** – Experiment by varying the way the diet and individual items are presented as this can affect intake. In terms of size and shape items can be presented whole or in different shapes. Intake of courgette by Emperor tamarins at ZSL increased when it was presented in spiral strips (anecdotal) this may have been a novel effect but previously they would not eat any of the chopped courgettes. Whole vegetables (e.g., red pepper, courgette, lettuce) can be hung up which means the animals have to work harder and longer to get mouthfuls of food rather than popping in mouth sized chopped up items and again the novelty effect may encourage greater intake. It is not advised to present high value items whole in a large size as the animals may gorge on these. Placing mealworms in a whole curly endive/frisée lettuce resulted in greater intake of the lettuce and encouraged additional foraging time. Observations at ZSL showed the effect of different presentation on intake of vegetables varied between species eg. cotton top tamarins ate the same or more vegetables when these were presented whole whereas the Geoldi's monkey, Geoffroy's marmoset and golden lion tamarins ate less (N. Hausen, pers.comm.) The effect may be partly due to novelty and is likely to vary at the individual level however it may be useful to stimulate interest and use as occasional enrichment.

**Palatability** – It's essential a diet is palatable to the species. Novel items are often refused initially but later accepted. To encourage animals to eat vegetables they can be steamed, this will affect nutrient levels in an unfavourable way but may increase palatability, especially for root vegetables. It may then be possible to transition slowly to raw vegetables from a lightly steamed one, albeit not always easy.

**Timing of feeds** - The order that items are presented can have an effect on how well they are eaten. Some collections provide the items that they consider most important nutritionally first thing in the morning (usually pellets) and will not give any other food until this has been eaten. ZSL provides pellets to their animals from 6 am, a vegetable feed is given at lunchtime and live food is given in the afternoon.





**Be persistent!** - Persistence is vital. An animal may refuse an item many times before eventually accepting and eating it, so keep adding the item regularly to the diet - eventually these may be eaten (just like children with their greens).

#### **MONITORING & RECORDING** *'If you don't measure it you can't manage it'*

During a diet change (including the introduction of new food items or a change in ratios of food items presented) it is essential that the transition is monitored to ensure the diet works in the short and long term and to inform if further refinement or changes are to be made. The diet should be palatable, and the animals maintain a healthy weight and appropriate body condition. Ideally, the data collected should be empirical but due to time restraints this may not always be possible. All records should be stored in a centralised and accessible place for future reference (ZIMS for ISIS members). During transition the following should be monitored.

**Intake** - The amount of each diet item eaten should be recorded. If diet change is minor this can be done by eye anecdotally. Be as specific as possible with the assessment of amounts eaten; e.g., 'didn't eat much carrot' tells us very little whereas 'ate 40% of presented carrot' is much more informing. The most accurate way to assess is to conduct an intake study (Fidgett and Plowman, 2013) where each presented food item is weighed and the leftovers are weighed when food is removed at the end of the day/next morning so intake can be calculated. Intake can often be very different to the presented diet – especially if large quantities of food are given which enable the animal to select and satisfy its energy requirement with favoured items only. This will affect the nutrition the animal receives.

**Weight** –Animals weights should be recorded before, during and after diet transition. Ideally there should be no sudden changes and the animal should remain or move towards an agreed target weight. Reference weight ranges for wild callitrichids are listed in Section 3 -species accounts, and 'typical' weights can also be extracted from ZIMS. It is preferable to be able to weigh animals without catching up and restraining, which will cause some short-term stress. Animals can be encouraged onto scales by providing food (known weight) on top of weighing scales and taking a weight reading whilst the animal is feeding or more specific training can be employed (see 6.2 Appendix 6.2).

**Faecal Score** – Scoring faeces can indicate how well a diet is being digested. There are some generic scoring charts available for some primates. If one is not available, keepers can adapt or develop their own for a particular species or group of animals. Ideally, faeces' consistency should stay as it 'usually' is or improve. Keepers can develop their own chart for a species.

**Body Condition Score** – Body condition scoring callitrichids visually is challenging. If animals are trained so they can be viewed closely this helps greatly in assessing condition. Keepers will need to develop a chart for their species as there is no validated guide for any callitrichid species. This method is subjective and usually only useful for emaciated or obese individuals. Anything in between is difficult to gage. Coat quality is a better indicator and should also be scored.

**Behaviour changes** – Diet change may affect the behaviour of animals. Within a group aggression can heighten or lessen towards other group members, enclosure mates or keepers. In some primate species when high value items have been removed (fruit) this has resulted in a lowering of aggression as there is less to fight over (Britt *et al.*, 2015). In callitrichids at ZSL removal of fruit in one GHLT pair resulted in heightened aggression of one animal towards the keepers initially which included the keeper being bitten but this quickly settled back to normal levels. After fruit removal from the diet for a mixed primate exhibit a pair of GLTs exhibited much more normal behaviour; previous to fruit removal when the keeper entered the enclosure with the food dish the animals became over excited, would urinate and make screaming vocalisations. Observations on behaviour should be recorded to ZIMS



### 4.2.15 Evaluation

Short term evaluation on the diet transition can be carried out by reviewing the data collected as described above. It is important to specify a date to review the effectiveness of the new diet; this will vary depending on the diet and species. If there are any concerns during transition these should be fed back to the section head/nutritionist/vets/curator.

Longer term evaluation can only be carried out by consistent monitoring and recording. Health & dental records and breeding success over time will all inform efficacy of diet. If an animal is being restrained for some reason take the opportunity to gain as much information as possible; palpate to get BCS, take measurements, examine teeth, etc.

When evaluating a diet, the usual caveats should be considered. Groups & mixed taxa exhibits are harder to assess at an individual and species level as hierarchy can play a role in unequal food distribution, although this is likely to be less of a problem with the high value fruit removed. The presence of pests can complicate the picture and efforts should be made to eradicate these. At ZSL, two pairs of GHLTs were held in two different enclosures: one with pests (mice) the other pest free. Twice as much food was presented to the pair with pests. As well as representing a significant cost in food there is the increased risk of disease transmission, so do factor pest proofing into enclosure build and consider how the food is presented to limit access by pests. The use of timed automatic opening feeders can help; these can be filled with pellet then left closed at night, so the food is not accessible to pests then open automatically at 5.30am for animals to have an early morning feed. Research at ZSL found different activity and feeding patterns in four species. Geoldi's, Geoffroy's, and golden lion tamarins were all similar, not visiting the feeders until 7am but then fed until 5–6pm. The cotton top tamarins were visiting the feeder earlier at 5 am but also stopped feeding earlier at 3pm.

### 4.2.16 Health considerations

#### 4.2.16.1. Obesity

Several field studies of callitrichids have involved the collection of body weight measurements, but the majority of weight data were collected as parts of broader studies, and comparisons between wild and captive animals were not always made (e.g., Garber and Teaford, 1986; Garber, 1991). Studies such as that of Encarnación and Heymann (1998), Savage *et al.* (1993) and Araújo *et al.* (2000) found that captive callitrichids had higher body masses than wild conspecifics, which was considered to be a consequence of differences in diet and physical activity rather than constitutional. This provides an indication that captive animals may be at risk of becoming obese when overfed or incorrectly fed and emphasises the importance of carrying out research on weights in captive animals. Problems of concern in obese primates include skeletal abnormalities, heart disease, diabetes and some forms of cancer, all of which will affect an individual's welfare and longevity (Lane *et al.*, 1999; Schwitzer and Kaumanns, 2001; Bray, 2004). Excess or imbalanced feeding might also lead to higher body weights of infants, which in turn may cause birth complications. This is suspected to be the case with *S. imperator*, where 30% of all female mortality is due to dystocia and 18.2% of infants are stillborn (Mermet, 1999).

A number of European zoos have been experiencing a high proportion of stillbirths (up to 60 %) in golden-headed lion tamarins (A. Fens & M. Termaat, unpubl. data). The most common cause of these stillbirths has been dystocia caused by foetal macrosomia (disproportionately large young). The stillborn babies weighed on average 66 % more than healthy lion tamarins born in the wild (83 g vs. 50



g) (Napier & Napier, 1985; Ross, 1991). Preliminary investigations have suggested high amounts of dietary energy to be a likely factor contributing to foetal macrosomia in captive lion tamarins, and it has been recommended to decrease the amount of soluble carbohydrates in the diet, notable found in fruit and concentrates (A. Fens & M. Termaat, unpubl. data). Reducing overall calorific content of the diet will have a limit to its benefits as somewhere along the line, the animals will begin to alter their behaviour to conserve energy. This means that in order to treat obesity, different strategies must be employed such as: targetting amount of food given to a target body weight instead of current obese weight; providing more high fibre produce and pellets and less high sugar food items, this way they feel full but assimilate less energy; vary feed presentation and enrichment to encourage physical activity.

#### 4.2.16.2. Seasonality

In larger outdoor enclosures or free ranging conditions in northern climates animals may be more active in the summer than in the winter. Body weight and food intake may thus vary seasonally and should be monitored. This is an interesting area of husbandry which should be further researched.

#### 4.2.16.3. Periodontal disease

Animals require some harder and crunchy foods as well as soft foods in order to abrade the tartar from their teeth. Otherwise, this leaves them vulnerable to dental disease (Crissey *et al.*, 1999). Pygmy Slow Loris's are primates although of a different sub-order than callitrichids. A causal link was shown with the presence of fruit and lack of gum in the diet with occurrence of dental disease (Cabana and Nekaris, 2015). Captive diets should not rely heavily on fruits and instead should use gum Arabic and a variety of insects as their base. Pellets also should not be wetted down and "mashes" should be avoided.

#### 4.2.16.4. Gastrointestinal problems

Colitis is considered one of the most important life-threatening diseases in captive tamarins (Gozalo and Montoya, 1991). Chronic colitis is often associated with Wasting Marmoset Syndrome, and, in *Saguinus oedipus*, it is also found associated with colon cancer. Wasting Marmoset Syndrome is one of the most frustrating medical conditions encountered in as it cannot be properly diagnosed, and its clinical manifestations do not always link up. Common signs include, but are not limited to: chronic, unresponsive diarrhoea, rough hair coat and alopecia of the tail. Paralysis of the tail and hind limbs may occur in the later stages of this disease. Mortality rates among marmosets and tamarins that develop wasting are high, especially if caught late. Colitis may be multifactorial. One suspected cause is chronic exposure to a diet-related antigen to which the tamarins are allergic, such as proteins in wheat, soy and milk (Gozalo and Montoya, 1991; Gore *et al.*, 1999). Most commercially available products contain some of these allergens, including many food and aroma supplements (because of their excipients, i.e. soya lecithin). Animals presented diarrhea more frequently on gluten-containing diet and showed significantly increased body weight on gluten-free diet compared to negative animals. Clinical symptoms, including body weight and faeces consistency, ameliorated on gluten withdrawal (Kuehnel, 2013). Major brands now have gluten free diets, although they have completely different compositions and nutrients, making it impossible to determine if "gluten" is indeed the cause. A recent



analysis found that diets high in fruit, soluble carbohydrates and low in fibre are risk factors for wasting (Cabana *et al.* in review).

Bone and gastrointestinal disease/wasting were positively correlated, with marmosets being over seven times more likely to have either concurrent bone and gastrointestinal disease, or neither disease, as opposed to lesions in only one organ system. When used in tandem, serum albumin, and loss of body weight identified 100% of the marmosets affected with concurrent bone and gastrointestinal disease. Progressive body weight loss of 0.05% of peak body weight per day predicted which marmosets would develop disease prior to the terminal stage. Bone tissue-specific tests, such as quantitative analysis of radiographs and serum parathyroid hormone levels, were effective for distinguishing between marmosets with bone disease and those without. (Baxter, 2013).

#### 4.2.17 Hypothetical Callitrichid diet

The table below is hypothetical Callitrichid diet which may aid zoos when compiling diets.

Diets in grams for one average animal

	Early morning	Mid morning	Noon	Training	Evening
Callitrichid concentrate feed	30 g		10		
Fruit e.g. cherry toms/ cucumber		5	5		
Beans e.g. french		10	10		
Carrots		10	2		
Sweet potatoes/beetroot					
Carrots/Jerusalem artichokes			20	10	
Apples				5	

Gum Arabic\*

2g

3

+Crickets/ insects 3 times per week

5

+insects vary daily from crickets, locusts, grasshoppers, mealworms, superworms, cockroaches, silkworms and stick insects

\*Gum amounts written are in grams of the dry powder, does not include water. More gummiferous species would have a higher proportion of gum in their diets.



## 4.3 Social structure and behaviour

All of the marmosets and tamarins are very social; they engage in a variety of social behaviour and communicate with conspecifics primarily using visual, auditory and olfactory modalities. With the exception of *Callibella*, they rear their young cooperatively (e.g., Caine, 1993; Van Roosmalen and Van Roosmalen, 2003). There is evidence that such a cooperative rearing system has led to increased attention towards group members, to an improved ability to coordinate actions, increased social tolerance, and increased responsiveness to others' signals compared with closely related primate species (Burkart and Van Schaik, 2010).

### 4.3.1 Group Structure

In the wild, callitrichids are territorial, with flexible mating systems. Analyses of group size in shows that *Callithrix* and *Mico* tend to live in larger groups than *Cebuella*, *Saguinus*, *Leontopithecus* and *Callimico* (e.g., Ferrari and Lopes Ferrari, 1989; Rylands, 1993; Soini, 1993; Rehg, 2009). Few data are available for *Mico* but *M. humeralifer* (formerly *Callithrix humeralifer*) group sizes range from 4–13 (Rylands, 1981). *Callithrix* groups usually contain between 3 and 15 individuals (e.g., *C. jacchus* Hubrecht, 1984; Scanlon *et al.*, 1989; Digby and Barreto, 1993) with mean group sizes of 9–11; *Cebuella* group size ranges from 2 to 9 individuals, with a mean of 5–6 (Ferrari and Lopes Ferrari, 1989; Soini, 1993); *Saguinus* live in groups ranging up to 19 but mean group sizes range from 3 to 7 depending on species (Ferrari and Lopes Ferrari, 1989). *Leontopithecus* is more similar to *Saguinus*, with a range of 2–11 individuals and mean group sizes ranging from 4 to 7 (Rylands, 1993). *Callimico* group size is usually 7–9 individuals (e.g., Buchanan-Smith, 1991; Rehg, 2009). Occasional solitary individuals have been observed for all species studied. Often there is more than one adult of each sex in groups (e.g., *C. jacchus* Hubrecht, 1984; *M. humeralifer* Rylands, 1981; *S. geoffroyi* Dawson, 1977; *S. oedipus* Neyman, 1977; *S. mystax* Garber *et al.*, 1984; Soini, 1987; *S. fuscicollis* Terborgh and Wilson Goldizen, 1985). There have also been numerous cases reported of two reproductive females in one group in *C. jacchus* (Digby and Ferrari, 1994; Digby 1995; Ferrari and Digby, 1996; Roda and Mendes Pontes, 1998; Arruda *et al.*, 2005; de Sousa *et al.*, 2005), although breeding is often alternated or one set of offspring does not survive, sometimes due to infanticide by the other breeding female (Digby, 1995; Roda and Mendes Pontes, 1998). Groups are relatively stable, *Callithrix* possibly more than *Saguinus* (Ferrari and Lopes Ferrari, 1989), although there are immigrations, emigrations, births and disappearances (e.g., Arruda *et al.*, 2005). Females cycle throughout the year and males copulate with females throughout the year, including during pregnancy. Females ovulate soon after parturition, and can conceive again shortly after birth, when they are still lactating.

Despite the variety of social structure seen in the wild, in captivity groups are most stable when they consist of a heterosexual breeding pair and their offspring (e.g., Carroll, 2002; Gerber *et al.*, 2002a, 2002b). Sexual behaviour is inhibited in subordinate females by pheromones, visual stimuli and aggression from the breeding female (e.g., Saltzman *et al.*, 1997). Occasionally polygynous mating has been observed in captivity but the groups are less stable than those that consist of monogamous pairs (Carroll, 1986; Rothe and Koenig, 1991).

Callitrichid social and parenting behaviour has a large learnt component. It is vital, therefore, that young are left within their natal group as long as possible in order to gain social experience. As reproductive suppression occurs within groups, it is possible to leave offspring with their parents long after they are full grown. It is desirable for individuals to get caring experience with two sets of younger offspring, which requires offspring to be left in their family groups for a minimum of 13 months and



preferably longer if space allows for peaceful cohabitation. Early removal of young results in socially incompetent adults with poor success in rearing their own offspring (e.g., Tardif et al., 1984a, 1984b). This applies to sons as well as daughters, because fathers as well as mothers care for the young. While it is desirable for young to experience the rearing of younger siblings, this is not always possible, for example due to cessation of breeding in the group. In these cases individuals should stay with group mates at least until maturity, and if required for breeding be paired with an experienced mate. Infant care can also be learnt through successive births.

A fascinating twist that may underpin the evolution of cooperative rearing has recently been discovered (Ross *et al.*, 2007) and awaits confirmation. Due to genetic chimerism (when an animal has genetically distinct cells that come from different zygotes and are created by fertilized eggs, embryos or placenta chorions fusing together) the patterns of relatedness between twins and between other family members change. This chimerism applies to marmosets and tamarins with multiple births because in the womb, placentas grow quickly and their chorions fuse, creating a network of blood vessels through which cells can travel from one twin to the other. Chimeras may exist in almost any part of the body – blood, hair, liver, and even in germ cells, i.e. sperm and eggs. In such circumstances a twin will carry the genetic information of the other in their sperm or eggs, and as a result, one brother may contribute the genetic makeup of his twin brother's offspring, effectively fathering nephews or nieces! The full implications of this phenomenon have yet to be explored, but in addition to the scientific interest in its role in the evolution of the cooperative rearing system, it may have implications for population management in captivity and optimal maintenance of genetic diversity (Buchanan-Smith, 2010).

#### 4.3.2 General behavioural repertoire and communication

As diurnal social primates, callitrichids exhibit the range of behaviour expected for such a lifestyle. Maintenance behaviours include foraging, feeding, self grooming, etc. Affiliative behaviours include resting in proximity, sleeping in a huddled group (usually among vines, in forks of tree trunks, on large branches, in palms or in tree hollows, see Heymann, 1995; Smith *et al.*, 2007), allogrooming, playing, food sharing, courtship and mating. Providing appropriate furnishings to promote such affiliative behaviours is important. These may include large horizontal branches to allow grooming, and soft flat surfaces such as hammocks for play, and huddling. Agonistic behaviour includes aggressive posturing, aggressive approaches and occasionally, physical fighting. Such aggression is arguably more common in captive *Saguinus* than *Callithrix* (see Prescott and Buchanan-Smith, 2004), and the appropriate use of visual barriers may reduce the frequencies of such behaviour, together with maintaining other groups of the same species out of visual contact, as occasionally aggression can be redirected towards group members.

Despite their immense value in understanding behaviour and interpreting welfare, producing full ethograms has rather gone out of fashion. The best behavioural and vocal ethograms for the callitrichids are those in the two volumes of *Ecology and Behavior of Neotropical Primates* (Cebuella Soini, 1988; *Callithrix* Stevenson and Rylands, 1988, see also Stevenson and Poole, 1976; *Saguinus* Snowdon and Soini, 1988; *Leontopithecus* Kleiman *et al.*, 1988; *Callimico* Heltne *et al.*, 1981). Unlike the marmosets (*Callithrix*, *Mico* and *Cebuella*), the tamarins (*Saguinus* and *Leontopithecus*) do not use genital displays in inter-group encounters, or towards other threats. Goeldi's monkeys have an "arch-bristle-leap" display that is used to mob ground predators in the wild, or towards the public and keepers in captivity (Carroll, 1985).





Communication between and within groups is visual, acoustic, and olfactory. Visual communication includes a range of facial expressions and body postures as described in the ethograms. Like other simians, vision is the dominant sensory modality of callitrichids. It should be noted that all male and some female callitrichids are dichromatic (colloquially colour blind) whilst some females are trichromatic, having vision similar to that of humans. This raises questions about why some callitrichids are so colourful and has implications for captive studies and choice of colour for targets for positive reinforcement training (Buchanan-Smith, 2005).

As both predators and prey, callitrichids use sight to detect prey items and potential threats. They spend a considerable proportion of time engaged in vigilance behaviour in captivity and such alertness has been found to increase after stressful events (Bassett et al., 2003). Marmosets perform headcocking where they move their heads in the lateral direction. Young *C. jacchus* headcock more than older marmosets, and often this is in the context of novelty (Stevenson and Rylands, 1988). *Saguinus* perform a behaviour termed head flicking by Snowdon and Soini (1988), but it should not be confused with headcocking – head flicking is directed towards conspecifics as a hostile display. *Leontopithecus* will sometimes bob and up and down when staring threateningly (Kleiman et al., 1988).

The vocal repertoire of callitrichids is large, and there are calls used in specific contexts. Several vocal ethograms have been published including that of *C. jacchus* (Stevenson and Rylands, 1988); *S. oedipus* (Cleveland and Snowdon, 1982); *Leontopithecus* (Kleiman et al., 1988) and *Cebuella* (Soini, 1988). The long calls, which serve many possible functions including group defence against intruders, maintenance of group cohesion (e.g., reuniting separated group members), and mate attraction, have been studied extensively (e.g., Pook, 1977; Cleveland and Snowdon, 1982; Snowdon, 1993). Vocalizations are also important indicators in welfare assessment (Jones, 1997). Callitrichids can hear higher frequencies than humans (see Heffner, 2004 for a review). Ultrasonic frequencies present in the captive environment, such as a dripping tap, trolley wheels or computer monitors may adversely affect welfare (Clough, 1982).

Olfactory communication is well developed with three scent gland fields being present in the sternal, suprapubic and circumgenital areas (see Epple *et al.*, 1993). There are taxon specific differences in the relative size of these scent gland fields. *Callithrix* spp, for instance, have large circumgenital fields, with little obvious development of the sternal gland area. *Callimico* has a very obvious sternal scent gland, while *S. oedipus* has a large suprapubic gland. Olfactory communication is extremely complex both within and between species. Scent marks contain information on individual identity, rank and reproductive status, and play a role in reproductive suppression of subordinate females. They may also aid territorial defence, inter-group spacing and provide cues as to mate quality (Epple *et al.*, 1993). The rate of scent marking in wild *C. jacchus* ranges from 0.19 scent marks/hr to 0.45 scent marks/hr (Lazaro-Perea *et al.*, 1999), often much lower than is seen in captive conditions (Bassett *et al.*, 2003). Adults scent mark more frequently than young in captivity (de Sousa *et al.*, 2006). It is vitally important that scent marks are left to accumulate within enclosures. Scrupulous cleaning should not be carried out. When animals are transported, or are moved to another cage location, it is important that they are accompanied by an item of cage furniture that carries their scent marks.

Differences in foraging and feeding behaviours have been noted in relation to sensory adaptations. Tamarins are insectivore–frugivores and their dentition is not adapted for gnawing, unlike that of the marmosets. The long slender hands and fingers of *Leontopithecus* are used for probing for concealed prey in specific microhabitats. A considerable proportion of prey items are located by touch rather



than sight, and the most important foraging site is epiphytic bromeliads. There are also differences in foraging strategies amongst *Saguinus* (see Garber, 1993). More information is given in Section 2.2.

### 4.3.3 Groups in captivity

In spite of the range of group structure seen in the wild, as noted above, captive groups other than monogamous groups are rarely stable for long. In captivity, groups should comprise a single pair and their offspring. Relationships within groups are usually very amicable, with overt aggression rarely being seen. A dual dominance hierarchy has been reported with the breeding male and breeding female co-dominant over the younger males and females respectively. Behaviour studies have revealed, however, that the social group dynamics are, in fact much more complex. Groups in the wild are territorial and visual contact between captive groups of conspecifics is stressful and must be avoided.

### 4.3.4 Group formation

Breeding groups should be formed by putting an adult male with an adult female, Anzenberger and Falk, 2012). Ideally, the introduction should be a “soft introduction” with the two animals having visual and auditory contact with each other before being mixed. The introduction should, if possible, be carried out in neutral territory, or by allowing access to each other’s home cage rather than in the home cage of either animal. Having said that, aggression between newly mixed heterosexual pairs is usually slight and short-lived, even if they are introduced into an existing home cage area. Newly mixed pairs will often be seen allogrooming or sitting in contact within hours of being mixed. Problems of incompatibility are rare, and may be associated with an underlying behavioural problem (e.g., abnormal behaviours as a result of hand-rearing or long isolation). General practical guidance on managing primate introductions in laboratory situations is provided in the JWGR report (2009).

If circumstances require it, it is also possible to introduce an adult to an opposite sexed adult with young. This is sometimes necessary if one adult dies leaving a partner with young of various ages. Care should be taken, and the proposed “step-parent” should be allowed to interact with his/her intended pair mate for a short period in the absence of other family members, who may mob the unfamiliar group member (Tardif *et al.*, 2003). The older the young in the group, and the more young there are, the more difficult the mixing will be. Aggression may occur between the new animal and juveniles or subadults of the same sex. In general, it is better to remove any young animals that are older than about a year and that have infant-rearing experience. With very young infants it is better to allow them to progress beyond the neonatal stage before introducing a new male. Infanticide has been recorded among marmosets and tamarins, due either to incompetent parenting or to the introduction of a mother with dependent young to unfamiliar conspecifics. A soft introduction must be carried out in the latter circumstances, and the group monitored carefully to assess aggressive interactions.

### 4.3.5 Group stability and group management

In general, callitrichid groups are very stable over long periods of time and may grow to group sizes of 12 or more in captivity if space allows (e.g., Price and McGrew, 1990; Badihi *et al.*, 2007). Where groups contain young that are of adult age (15–21 months, see Yamamoto, 1993 for species differences in rates of development), however, individuals may become peripheralized and eventually expelled from the group. In many cases peripheralization may take place over a day or so, and although fighting takes place, severe injury is unusual. However, severe aggression can occur without warning and is



often associated with severe injury. Deep bite wounds may be inflicted and deaths have been known to occur as a result of such aggression (e.g., de Filippis *et al.*, 2009).

When peripheralization or overt aggression occurs, it is unlikely to be resolved by any other means than removal of either the aggressor or the victim. The choice of which to remove will be determined by the extent of injury, the extent of peripheralization and the age and social status of the participants. If, for instance, aggression is by a parent towards an offspring, the offspring should be removed. On the other hand, aggression is often seen between siblings, and it may be better to remove the aggressed sibling (if old enough) rather than the dominant animal. Removal of a dominant sibling may result in changes of dominance relationships that result in further aggression and peripheralization. Groups should, therefore, be monitored carefully following the removal of any animal, and particularly a dominant animal.

Among large lion tamarin groups, sequential events of aggression, peripheralization and removal of animals have been known to result in the complete, or almost complete, breakdown of a group. A group of over 12 at Jersey Zoo was reduced to three animals over a period of nine days. In order to manage groups to avoid such events, groups should be maintained at about six to eight individuals by removing older offspring at an appropriate time. Groups in which young are removed regularly may remain stable for many years. Providing large complex enclosures with places to hide from group mates allows larger groups to co-exist peacefully.

#### 4.3.6 Mixed-species exhibits

In the wild, callitrichids coexist with many other species of animals, sometimes forming close associations with them. Therefore, housing different species together with callitrichids is one way to enrich them socially, as mixed-species exhibits provide a more dynamic and varied environment (e.g., Leonardi *et al.*, 2010). There are some callitrichids that actively associate together in the wild: *Saguinus fuscicollis* with one of *S. mystax*, *S. labiatus*, *S. imperator* or *M. emiliae*, and occasionally the *Saguinus* pairing forms trispecific groups with *Callimico* (reviewed in Heymann and Buchanan-Smith, 2000). Indeed, studies at Belfast Zoological Gardens indicate that naturally associating species actively choose to be in proximity in captivity – when given the opportunity to separate in a free-ranging situation, members of the *S. labiatus* and *S. fuscicollis* mixed-species groups remained within 5m of each other for most of the time (Hardie *et al.*, 2003). Exhibiting callitrichids in their appropriate social context also allows the viewing public to gain greater understanding of the species' natural environment and observing interspecific interactions may create a more interesting and enjoyable viewing experience (Xanten, 1992; Hardie *et al.*, 2003; Dalton and Buchanan-Smith, 2005).

Mixed-species exhibits may be particularly beneficial for zoos where each species is below natural group sizes; by living in mixed-species groups the increased social complexity may lead to higher levels of both physical and psychological stimulation, enhancing primates' well-being (e.g., Heymann *et al.*, 1996; Thomas and Maruska, 1996; Hardie, 1997; Buchanan-Smith, 1999, Buchanan-Smith, 2012)). A number of positive inter-specific affiliative interactions have been observed amongst individuals in mixed-species groups, including grooming, play, huddling, sleeping together, solicitation and mating (Heymann and Sicchar-Valdez, 1988; Hardie *et al.*, 2003). As they would in the wild, individuals attend and respond to each other, and they can learn from one other, for example, about the presence, location, quantity of food, or how to solve a novel food task (see Hardie *et al.*, 1993; Prescott and Buchanan-Smith, 1999; Heymann and Buchanan-Smith, 2000). Another potential advantage may be



that mixed-species groups are often housed in a larger enclosure than the separate constituent single species would be (Xanten, 1990, 1992; Baker, 1992; Hardie *et al.*, 1993).

Despite such potential benefits, mixed-species exhibits are not without risks. There are health considerations relating to mixed-species exhibits with all possible combinations of animals. It should also be noted that mixed-species exhibits can compromise the ability of keepers to work intensively with some species of callitrichid and it should not be considered for some sensitive specimens or species, when new animals arrive in the collection, for first time breeding pairs, etc. If enclosures are not large, complex, and designed well enough to avoid inter-specific competition, chronic stress will decrease welfare and may lead to increased susceptibility to illness.

Furthermore, not all mixed-species exhibits are successful. Sodaro (1999) conducted a questionnaire study on housing neotropical primates in mixed-species exhibits, gaining information on the successful combinations, the failures and the methods of introduction used. Of 50 separate attempts reported with 16 different callitrichid species, the success rate was around 66%. The results from this survey indicate that even the best planning and introduction methods do not guarantee successful long-term cohabitation, and interspecific interactions should, like intraspecific interactions and relationships, be regarded as ever changing. In comparison with traditional housing of single-species groups, mixed-species troops may require higher levels of monitoring to ensure welfare is not compromised (Sodaro, 1999; Dalton and Buchanan-Smith, 2005; Leonardi *et al.*, 2010). Particular attention should be paid around times of change, such as births, deaths or other changes to group size or structure, and as juveniles mature. Although there are many factors contributing to how successful the captive primate mixed-species groups will be, whether they actively form associations in the wild is a key consideration (Hardie *et al.*, 2003).

One can divide mixed-species exhibits into three different types:

Type 1. One enclosure where two or more species are living together permanently.

Type 2. Each species has its own enclosure for the night and in daytime they have a communal enclosure.

Type 3. Single specimens from different species are put together for companionship.

The descriptions of the mixed-species exhibits described below are primarily based upon the questionnaire findings of Sodaro (1999) and a survey reported by Carroll (2002).

### Callitrichids with non-callitrichids

Callitrichids have been exhibited with a variety of different animals which were kept in the same enclosure permanently with callitrichids (Type 1). Combinations with birds or reptiles (e.g., turtles, iguanas and some other lizard species) have been successful, although tamarins in one zoo were reported to chew on the crests of adult green iguanas; one iguana eventually retaliated and bit the tail of a young tamarin! Other mammal species such as rodents (e.g., agouti, acouchi, or rock cavies) have been successful, but there are also reports of them being prone to aggression towards callitrichids, resulting in injuries, or in some cases deaths (Sodaro, 1999). There is one report that acouchis preyed upon newborn tamarins that fell to the ground (Sodaro, 1999). Other successful cohabitants include guinea pigs, sloths, tree porcupines, some other primates and small hoofstock.



One key to mixing different species is to make sure they do not share (or compete for) common resources (e.g., nest-boxes, food, water, resting or basking spots, etc.) (Dalton and Buchanan-Smith, 2005). All the species listed above use a different layer of the enclosure, or do not have the same climbing skills as the callitrichids and are not predators or prey of callitrichids. It is important to remember that callitrichids do take eggs and young birds from nests if they can.

When mixing callitrichids with animals that have less well-developed climbing abilities, it is recommended to:

- Give both species a refuge to which they can retreat to be by themselves if necessary (Type 2).
- Make sure all the species in the enclosure can eat without disturbance (e.g., temporarily separate them, or, when there are large size differences, provide the smaller animal with feeding sites that are not accessible to the larger species).
- Ensure the enclosure is furnished in such a way that there are enough escape routes.

Examples where groups of callitrichids are kept with other primates are shown in Tables 4.3.6.2. It should be noted that there are potential disease issues to be considered when mixing certain species. For example, it is recommended not to mix Callitrichidae with squirrel monkeys *Saimiri* spp., because of the risk of transmission of *Herpesvirus saimiri* (see also Section 4.7 Veterinary). There is also a considerable risk to callitrichids from *Herpesvirus ateles* found in about 50% of spider monkeys (King, N.W., 2001; Ramer *et al.*, 2000). **It is therefore not recommended, for veterinary reasons for callitrichids to be mixed with *Saimiri* or *Ateles*.**

Although there are some examples of keeping callitrichids together with various lemur species and woolly monkeys (*Lagothrix*), most zoos choose a combination with smaller cebids like *Pithecia*, *Callicebus*, *Saimiri* (in spite of the veterinary concerns) or *Aotus*.

### Callitrichids with callitrichids

Keeping two groups of different species of callitrichids together is often tried in various combinations with mixed results (see Tables 4.3.6.2) and Buchanan-Smith (2012). It appears that the main factors for success are whether the species naturally associate, together with the individual temperament of the animals concerned (Hardie *et al.*, 2003). The behaviour of one individual can change the dynamics of the entire group and, even after years of peaceful compatibility with another species, may result in fighting and irreversible incompatibility of the groups.

*Leontopithecus* and *Callithrix*, and the naturally associating *Saguinus* species (*S. fuscicollis*, *imperator*, *mystax* and *labiatus*) seem to be the most successful genera to mix. A natural combination of a trispecific troop of *S. labiatus*, *S. fuscicollis* and *Callimico* was successful until a cold spell, when the monkeys were forced into close proximity in a smaller heated area (Hardie *et al.*, 2003). This again emphasises the need for large spacious enclosures – both indoors and out, and available retreat areas so that close proximity can be avoided. Mixing groups of *S. oedipus* with any other callitrichids has been notably less successful. Combining two groups from the same species has no chance of success and is, therefore, not recommended.

Keeping single animals of different callitrichid species together (Type 3) is definitely possible and has been successfully done in a number of different institutions. Various combinations (even with *S. oedipus*) have been tried without problems (see Tables 4.3.6.2), but this also depends very much on



the individual behaviour of all animals involved. It is important to give all animals their own sleeping box even when they choose to use the same sleeping box. Callitrichids of different sexes of the same species but of different subspecies should not be put together due to the serious risk of interbreeding, which must be avoided. Animals of the same sex, however, or of different sexes when one is sterilised to prevent breeding, can be put together.

#### 4.3.6.1. Methods of introduction

Preparation and methods to introduce different species to each other are similar to introducing conspecifics. Prior to mixing it is important that individuals become familiar with each other and establish dominance. Providing auditory, visual, and olfactory contact can be done before physical touching through a wire mesh. It is also considered important that each species is allowed to become familiar with the new enclosure, individually, prior to mixing so that they can learn the physical terrain of the exhibit, potentially reducing the likelihood of being injured during falls or other accidents if chased by others. However, it is understood that this preparation period may not be feasible in all cases and whilst familiarisation with the different species and enclosure is preferable, some introductions have succeeded without it (Sodaro, 1999). Mixing on neutral territory may also reduce the likelihood of aggression between the different species.

#### 4.3.6.2. Mixed-species tables

The tables below are examples of mixed-species exhibits involving callitrichids from two surveys undertaken to look at combinations and successes of mixed exhibits (Sodaro, 1999; Carroll, 2002). These EAZA guidelines do not recommend or advise against any of the combinations given below (unless otherwise noted) as there is no fixed rule for what works and what does not work. The type is given where known.

#### GROUPS OF CALLITRICHIDS TOGETHER WITH PRIMATES OF OTHER FAMILIES

Species 1	Species 2	Type	Remarks
<i>Cebuella</i> sp	<i>Pithecia pithecia</i>		
<i>Cebuella</i> sp.	<i>Callicebus moloch</i>		Two unsuccessful attempts
<i>Callithrix jacchus</i>	<i>Pithecia pithecia</i>	2	One unsuccessful attempt
<i>Callithrix jacchus</i>	<i>Ateles geoffroyi</i>		<b>Not recommended for veterinary reasons</b>
<i>Mico melanurus</i>	<i>Callicebus moloch</i>		One unsuccessful attempt
<i>Leontopithecus chrysomelas</i>	<i>Pithecia pithecia</i>		One successful and one unsuccessful attempt
<i>Leontopithecus chrysomelas</i>	<i>Pithecia pithecia</i> + <i>Cebuella pygmaea</i>		
<i>Leontopithecus chrysomelas</i>	<i>Pithecia pithecia</i> + <i>Callithrix jacchus</i>		





Species 1	Species 2	Type	Remarks
<i>Leontopithecus chrysomelas</i>	<i>Aotus trivirgatus</i>		
<i>Leontopithecus chrysomelas</i>	<i>Saimiri</i> spp.	2	Not recommended for veterinary reasons
<i>Leontopithecus chrysomelas</i>	<i>Saimiri boliviensis</i>	2	Not recommended for veterinary reasons
<i>Leontopithecus chrysomelas</i>	<i>Lagothrix</i> spp.	2	
<i>Leontopithecus chrysomelas</i>	<i>Alouatta caraya</i>		One successful, one unsuccessful attempt
<i>Leontopithecus chrysomelas</i>	<i>Lemur catta</i>	2	
<i>Leontopithecus chrysomelas</i>	<i>Varecia variegata rubra</i>	2	
<i>Leontopithecus chrysomelas</i>	<i>Varecia variegata variegata</i>	2	
<i>Saguinus oedipus</i>	<i>Presbytes entellus</i>	2	One unsuccessful attempt
<i>Saguinus oedipus</i>	<i>Alouatta caraya</i>		
<i>Saguinus oedipus</i>	<i>Lagothrix lagotricha</i>		
<i>Saguinus oedipus</i>	<i>Pithecia pithecia</i>	2	Several successful, and one unsuccessful attempt reported.
<i>Saguinus oedipus</i>	<i>Saimiri sciureus</i>		Not recommended for veterinary reasons
<i>Saguinus imperator</i>	<i>Pithecia pithecia</i>	2	
<i>Saguinus imperator</i>	<i>Lagothrix</i> spp.	2	
<i>Saguinus midas</i>	<i>Aloutta caraya</i>		

#### GROUPS OF CALLITRICHIDS WITH OTHER CALLITRICHID SPECIES

Species 1	Species 2	Type	Remarks
<i>Cebuella</i> sp.	<i>Leontopithecus rosalia</i>		
<i>Cebuella</i> sp.	<i>Leontopithecus chrysomelas</i>		Two successful and one unsuccessful attempt
<i>Cebuella</i> sp.	<i>Saguinus imperator</i>		
<i>Cebuella</i> sp.	<i>Callithrix geoffroyi</i>		One unsuccessful attempt



Species 1	Species 2	Type	Remarks
<i>Callithrix geoffroyi</i>	<i>Saguinus leucopus</i>		
<i>Mico melanurus</i>	<i>Callimico goeldii</i>		One unsuccessful attempt
<i>Mico melanurus</i>	<i>Leontopithecus chrysomelas</i>		
<i>Saguinus imperator</i>	<i>Cebuella sp.</i>		
<i>Saguinus labiatus</i>	<i>Cebuella sp.</i>		
<i>Saguinus labiatus</i>	<i>Saguinus oedipus</i>		One unsuccessful attempt
<i>Saguinus mystax</i>	<i>Leontopithecus chrysomelas</i>		
<i>Saguinus oedipus</i>	<i>Callithrix jacchus</i>	2	Four unsuccessful attempts
<i>Saguinus oedipus</i>	<i>Saguinus labiatus</i>		One unsuccessful attempt
<i>Saguinus oedipus</i>	<i>Callimico goeldii</i>	2	Unsuccessful
<i>Leontopithecus chrysomelas</i>	<i>Cebuella sp.</i>		
<i>Leontopithecus chrysomelas</i>	<i>Callithrix jacchus</i>	2	
<i>Leontopithecus chrysomelas</i>	<i>Callithrix geoffroyi</i>		
<i>Leontopithecus chrysomelas</i>	<i>Saguinus midas midas</i>		
<i>Leontopithecus chrysomelas</i>	<i>Saguinus oedipus</i>		
<i>Leontopithecus chrysomelas</i>	<i>Callithrix argentata</i>		
<i>Leontopithecus chrysomelas</i>	<i>Callimico goeldii</i>		Several successful, and two unsuccessful attempts
<i>Leontopithecus rosalia</i>	<i>Callithrix jacchus</i>	2	
<i>Leontopithecus rosalia</i>	<i>Callithrix melanura</i>		
<i>Leontopithecus rosalia</i>	<i>Callithrix kuhli</i>		
<i>Leontopithecus rosalia</i>	<i>Saguinus oedipus</i>	2	Unsuccessful
<i>Leontopithecus rosalia</i>	<i>Saguinus bicolor</i>		
<i>Leontopithecus rosalia</i>	<i>Callimico goeldii</i>	2	
<i>Leontopithecus chrysopygus</i>	<i>Saguinus bicolor</i>		
<i>Leontopithecus chrysopygus</i>	<i>Saguinus oedipus</i>		

**INDIVIDUAL CALLITRICHIDS HOUSED TOGETHER**

Species 1	Species 2	Type	Remarks
<i>Cebuella</i> sp.	<i>Callimico goeldii</i>	3	
<i>Saguinus oedipus</i>	<i>Callimico goeldii</i>	3	
<i>Saguinus oedipus</i>	<i>Leontopithecus rosalia</i>	3	
<i>Leontopithecus chrysomelas</i>	<i>Saguinus oedipus</i>	3	
<i>Leontopithecus chrysomelas</i>	<i>Leontopithecus chrysopygus</i>	3	Unisex
<i>Leontopithecus chrysomelas</i>	<i>Leontopithecus rosalia</i>	3	Unisex
<i>Callithrix jacchus</i>	<i>Callithrix geoffroyi</i>	3	Unisex

**4.3.7 Housing surplus animals and managing evictions****TAG Statement**

Callitrichids have a complex social system in which older offspring need to remain in their natal groups to experience the rearing of younger infants in order to become competent parents themselves. However, although groups can reach quite large numbers and remain stable, evictions (aggressive expulsion of animals from the family by parents or siblings) are an inevitable event that will arise in all collections at some point.

Therefore, it is essential that any institution taking on a breeding group of callitrichids plans ahead for evictions and makes sure that sufficient accommodation is available so that evicted animals can be housed in environmentally and socially appropriate conditions.

Although efforts are always made by programme coordinators and studbook keepers to place animals that have been removed from their natal families, appropriate partners cannot always be found in the short term and it is the responsibility of the holding institution to ensure adequate welfare standards in the interim. Institutions should therefore not take on a breeding group unless they can provide such reservoir accommodation when necessary.

Single individuals of different species can often be housed together successfully, and if no conspecific companion is available, this is preferable to housing a callitrichid alone. For further information on housing and welfare, please refer to the surplus and breeding control section in these Best Practice Guidelines

**When should you remove an individual from a group?**

It is very important not to remove callitrichids from their groups until it is absolutely necessary. Once an adult individual has been out of a group for a period of approximately 2-4 days, or even less, it will usually be impossible to return it – leaving the group is a one-way door!



## Breakdown is natural

Dispersal happens in the wild; both evictions and apparently voluntary departures from groups have been observed in several species, and more than one animal may leave at the same time. Similarly, evictions in captivity may occur in clusters, so it is important to continue monitoring behaviour after an eviction in case of further aggression. In captivity, groups can be destabilised by the death of an individual, particularly a breeding adult, or if animals need to be separated from their families for medical treatment. Evictions are also common after a birth.

## Should we reduce group size before aggression occurs?

Some institutions practise pre-emptive cropping as opposed to taking out animals when aggression occurs. However, it is a normal part of callitrichid life for adult offspring to remain in their natal groups for some time, and indeed this is an essential learning experience, allowing them to develop competent parental behaviour. If (and only if) there are signs of tension in a group containing 8-10 individuals, remove some sexually mature siblings that already have rearing experience. Groups of 8 or below should not be cropped as taking animals out unnecessarily can de-stabilise the group.

## Detecting a problem

The most important part of managing callitrichids is to know the individuals in each group - they are all different and signs of tension can be subtle, a detailed knowledge of normal behaviour is vital if indications of tension are to be picked up. It is important to know what to look for in a given species. In the early stages, there may be no overt aggression. Dominant animals may show species-specific behaviour such as piloerection or arch walking (lion tamarins). The only obvious indication of a problem may be that one individual monitors another closely and avoids it; a subordinate animal may also show signs of submission or fear such as a “ngä” call. Once the situation deteriorates, the victim may retreat to the floor, or to an outside area. In extreme cases there may be fighting, at which point intervention is needed as in captivity fights can be fatal, although this is rare. The victim will usually scream loudly. Even if not attacked, an individual may be too afraid to come inside, or may be prevented from doing so, and if the weather is cold may die of hypothermia.

## Suggestions for managing different situations

### ***What if a breeding adult dies?***

If a breeding male dies, groups may remain stable for many months, and the incest taboo will usually prevent breeding for approximately 12 months. If a breeding female dies, however, the group will be very unstable if there are multiple female offspring still in the group. If there is only one female offspring left, with multiple male offspring, then the group will be more stable. Incest taboos will typically prevent breeding but this is not always reliable. While it appears to prevent incest in 100% of cases in *Callimico*, it may not be as strong in other species – in *Saguinus* it usually lasts 12 months, sometimes longer depending on the social situation, but as incest can occasionally occur even in intact families, groups that have lost a breeding adult should be monitored for signs of sexual behaviour. Introducing a new adult to a established family group with sexually mature offspring of the same sex still present will cause aggression and instability and is not advised. Immature animals can usually be left in the group for a time to gain rearing experience, but the situation should be monitored closely.



### ***What if there is severe aggression towards a breeding adult?***

Because of the risk of complete group breakdown if a breeding adult is removed, if an offspring is being aggressive towards a parent, always remove the offspring. If the aggression is coming from a breeding partner, then, depending on level of aggression, it is probably best to form a new pair.

### ***What if there is a twin fight?***

Twin fights are natural and usually happen 6-12 months after birth. These fights are to establish dominance and injuries are usually superficial, so it is usually only necessary to monitor the situation carefully. In the rare occasions when injuries are severe, remove the submissive animal. It is important to be familiar with each group's structure so you know you are dealing with a twin fight.

### ***What if a daughter or son evicts a sibling?***

This is most common between sexually mature same-sex siblings, but may also occur between the sexes. Some institutions habitually take out the aggressor, others the victim. Interestingly, a comparison of evictions in two cotton-top tamarin colonies suggests that these two strategies may have different consequences. In a colony at the University of Wisconsin, the aggressor was usually removed, but in the University of Stirling, the victim was usually taken out. Subsequent studies showed a difference between the two colonies in the age of victims of aggression: victims in Stirling were typically twice as old as victims in Wisconsin, and sexually mature (>18m) rather than immature (<18m). Why this should be the case is unclear, but it is possible that removing the aggressor skews the structure of the group towards younger animals, who are then more likely to be the recipients of aggression.

This suggests that in most situations, the submissive individual (victim) should be removed. If, though, the submissive individual is not sexually mature and has not had rearing experience, and the aggressor is sexually mature with experience, then remove the aggressor.

### ***Refugees: a natural process***

As noted above, dispersal is a natural occurrence and so there will always be a need to house animals outside their natal groups in captivity (see TAG statement on surplus animals). We all have to try to be prepared for this; the relevant species coordinator should be informed but it is unlikely that a move can be arranged straight away, and animals that are evicted are still often genetically important to the population. Institutions must therefore be prepared to hold evicted individuals for lengthy periods of time. If housing a breeding group it is vital to have reservoir accommodation, and preferably 2 enclosures as evictions can happen in clusters.

### ***Housing "surplus" animals***

The most important aspect of dealing with callitrichids that cannot be kept with their families is provided a social environment. If an appropriate pair cannot be set up, then the option of keeping more than one conspecific of the same sex together, or establishing a mixed-species group, should be explored.

A study by Thomassen (2012) found that single-sex groups are usually fairly stable, and also identified factors that may affect the stability of such groups. First, it is best to introduce all members of a group at the same time, and to avoid introducing new animals into already established single-sex groups.



As group sizes in which evictions occurred were generally larger, group size should be kept small (<5 for males and <3 for females). Supply only one nestbox, as the presence of more than one seemed to be associated with a greater likelihood of evictions, and clean the enclosure and nestbox regularly with soap – note that this is different from the usual recommendation for family groups.

If conspecific group mates are not available, mixed-species groups can be formed successfully. In Thomassen's survey, only one of 13 mixed-species groups was unstable.

#### **4.3.7.1. Formation of non-breeding mixed or single-sex groups**

As captive breeding programmes need to manage large numbers of animals to be genetically viable, there will always be the need to cater appropriately for animals that are not required for breeding at a particular time. Dispersal of individuals from their natal groups and group breakdown are natural occurrences in callitrichids, and will happen from time to time. Evictions of individuals or the need for animals to be taken out of their natal groups for other reasons, such as medical issues, will inevitably lead to the need to house monkeys in non-breeding situations, at least temporarily. As tamarins are very social primates it is very important that they are kept in a social situation. Individuals should be housed where possible with conspecifics, although if this is not possible, mixed-species groups can be set up with compatible species.

A need for non-breeding groups will always exist when managing a callitrichid breeding programme. Stable non-breeding mixed-sex or single-sex groups can be set up to hold animals that are not needed for breeding. It is important to remember that although animals may be referred to as "surplus", they may still be genetically important to the programme, if not at that particular time, then in the future. Single sex groups are a viable long-term alternative to the normal group structure of a pair and their offspring.

##### ***Procedure for setting up a single-sex pair.***

- Cotton-top tamarins, like all species of callitrichid, are very territorial animals and will aggressively defend their territories. Setting up a new non-breeding group should be carried out in an area where there are no conspecifics housed in close proximity.
- Making a new pair should ideally be carried out in a neutral area, i.e. an area that is new to both the individuals who are to be mixed, and one in which there are no scent marks present from any of the individuals involved. If this is not possible, the mix can be carried by introducing the individuals in a cage previously occupied by one of them, as long as this has had the scent marks thoroughly cleaned from it.
- Individuals should be introduced to a new area simultaneously, with one of the animals in a satellite unit so that the tamarins can be observed interacting through a mesh barrier. This limited physical contact is a precaution to minimise serious injury should the animals fight straight away. Access to the outside area should be denied initially so that it is easier to separate individuals if fighting does occur.
- After seeing signs that the tamarins are reacting positively to one another, place a food dish and platform next to the satellite unit to encourage interactions. The individuals should be mixed when observer is relatively confident that no fighting will occur. This may be after as little as 30 minutes but more usually it takes several hours and can even take days.
- If you are not completely confident that a positive social bond has been established, it is advisable to separate the two individuals overnight to avoid the risk of fighting when there are





no animal carers present to intervene. It is probably best to separate as a precautionary measure anyway.

- The new area should have only one nest box. In the wild a family group will spend the night altogether in one safe nest hole, so only providing one nest box per group is a more natural situation and will help group cohesion.
- Initially two food sites should be provided to lessen the risk of individuals fighting over resources.



*Pied tamarins in satellite cages within larger units.*

### ***Forming single sex groups with more than two individuals***

This should follow the same procedure as above if possible, with several satellite cages in a neutral area. All animals should be moved to the area at the same time if possible.

More food sites should be provided depending on the size of group. If 4 in the group, 4 should be provided initially and then reducing if necessary after the group has formed. It is always a good idea to provide more than one food site in groups more than 2 individuals, the more the better as it reduces aggression of feed.

In general it is easier to form larger single-sex groups of males than females. The average successful size of group is four for males and two for females; three or more females together tend to be less stable.

### ***Research on the stability of single-sex groups***

Findings from a survey carried out by Wendy Thomassen (a student at Van Hall Larenstein, Leeuwarden, the Netherlands) on behalf of the EAZA Callitrichid TAG on the stability of single-sex groups suggested that:



- Introducing all individuals at the same time is more likely to result in group stability. Groups in which all animals were introduced at one time were significantly less likely to evict animals than groups in which new group members were added after initial group formation.
- Providing only one nest box as opposed to several per group was more likely to result in stability: groups in which evictions occurred had a higher number of nest boxes in their enclosure
- Cleaning the perching regularly with disinfectant will help keep the group together: the enclosures of single-sex groups in which evictions occurred were never cleaned using disinfectants, while the enclosures of groups without evictions were cleaned with disinfectants in over a third of all cases.
- *Saguinus imperator* (both subspecies) is more likely to evict group members than other species of callitrichids.

Further research is needed to verify these results.

## 4.4 Breeding

Marmosets and tamarins have a rapid reproductive rate. They typically give birth to twins and there is no period of lactational anoestrus. A post-partum oestrus occurs within 10 days of parturition and conception rate at this oestrus is high. Some breeding females may be almost constantly pregnant. Gestation varies between species. The lion tamarins have the shortest gestation at 128 days, while most other species are reported to have a gestation of around 145 days. Cottontop tamarins have the longest known gestation at 183 days. Infant care is shared among group members. In most species other group members may participate in infant care by carrying the infant from day 1 or 2. Contrary to earlier reports this is also true for lion tamarins. Goeldi's monkey, on the other hand, is one exception to this, giving birth to a single infant with shared infant care not taking place until week three. Another is *Callibella* (now *Mico*) *humilis* which is also reported to have a single infant although only two births have been recorded in captivity (Van Roosmalen and Van Roosmalen, 2003).

In captivity the Callitrichidae are effectively monogamous. The dominant pair, who in most groups will be the parents of all other group members, suppress other adults within the group from breeding. This ensures that only the dominant pair breed, and generally means that inbreeding does not occur within groups. Rarely, however, incestuous matings and departures from monogamy occur. In the wild, a much more flexible reproductive strategy is apparent in most species for which good information is available.

These points are discussed in more detail below.

### 4.4.1 Twinning

The marmosets and tamarins are unique among simians in their habit of twinning. While single infants and triplets are not uncommon among marmosets and tamarins, the most frequent litter size is two (Hershkovitz 1977). Exceptions are *Callimico goeldii* who normally have single infants, and *Callibella* (now *Mico*) *humilis* which, as stated above, has only been recorded having single infants, although only two births have been recorded. Molecular data suggest that *Callimico*, *Callithrix* and *Cebuella* are more closely related to each other than to *Saguinus* and *Leontopithecus*, which, in turn, suggests that *Callimico* evolved from a twinning ancestor (Porter, 2007) Occasionally, quadruplet births have occurred, but there are no reports of all four infants being born alive in zoos or in the wild. The



incidence of triplets has been reported to increase with time in captive colonies of *C. jacchus* and may relate to a high protein diet in captivity (Hiddleston, 1977). It is unusual for all three infants of a triplet litter to be parent-reared in captivity (J B Carroll, pers. obs.). Evidence from DNA studies has provided good evidence that triplets have been reared to independence in a wild group of *C. jacchus* (Dixson *et al.*, 1992).

Callitrichid twins are dizygotic yet the fetuses share a placenta and amniotic sac. The placenta consists of two fasciated placental discs and there are, therefore, blood vessel connections between the twins. This results in so-called blood-chimerism and as a result, each of twins carries genetic material from the other. This is very rare in other mammals but normal in callitrichids (Hampton, 1973, Hershkovitz, 1977, Haig, 1999, Ross *et al.*, 2007). Where the twins are heterosexual, we can find both xx and xy cells in the each animal, which can be easily demonstrated through examination of karyotypes in blood smears. It has also been demonstrated that chimerism occurs in other somatic tissue, but perhaps most surprisingly in germ cells. Thus an offspring may carry genetic material from not only its sire and dam, but also from the twin of the sire and dam (Hampton, 1973, Ross *et al.*, 2007).

Some considerable discussion has centred around whether twinning is a primitive feature that has been retained, or a derived feature. Hershkovitz (1977) maintained that twinning was a primitive feature, while most other authorities have considered it derived, citing the highly specialised placentation, simplex uterus, and number of teats as evidence (e.g., Ford, 1980, Martin, 1990, 1992).

#### 4.4.2 Reproductive strategies

Care must be taken to distinguish between social group structure and mating relationships when discussing reproductive strategies. The presence in a group of more than one adult of either sex does not necessarily indicate that they are all reproductively active. They may, for instance, be non-reproductive mature offspring of the breeding male or female. In captivity, mature offspring may remain in a stable group and yet not enter a breeding relationship with their parents or siblings, as they are reproductively suppressed. The fact that a female may mate with more than one male is also not conclusive evidence of a polyandrous *breeding* system, although it is obviously suggestive of this. Only when paternity of offspring can be established will the breeding system be understood fully.

In fact, in spite of the many reports of group structure indicating that there may be more than one breeding pair in a wild callitrichid group, only a few studies have actually reported seeing females mated by more than one male. These are in *C. jacchus* (Hubrecht, 1984, *C. humeralifer* (Rylands, 1987), *S. fuscicollis* (Goldizen, 1988) and *L. rosalia* (A. Baker, pers. comm.). Even fewer studies have reported more than one breeding female in a social group at the same time. Among 2.4.6 cover these are *S. fuscicollis* (Terborgh and Goldizen, 1985), *S. oedipus* (E. Price, pers. comm. to JBC), *L. rosalia* (Baker *et al.*, 1993) and possibly *C. jacchus* (Scanlon *et al.*, 1988).

It is, however, not surprising that there is a paucity of data from wild groups. As Goldizen (1990) has pointed out, the marmosets and tamarins are small, difficult to habituate to the presence of observers, and mating may last only a few seconds. Goldizen's studies have shown, however, that even within a species (*S. fuscicollis*) the reproductive strategy may vary. She found groups to be monogamous, polyandrous, polygynous, and polygynandrous in their mating system. She suggested that this variability is related to demographic effects and the need for helpers to rear offspring successfully (Goldizen, 1990). Infant rearing is discussed more fully below.



### 4.4.3 Reproductive suppression

Reproductive suppression of subordinate females among captive callitrichid groups is a well-documented phenomenon (e.g., *C. jacchus*, Epple, 1972a, 1977, Abbott and Hearn (1987; Abbott, 1984; *S. fuscicollis*, Epple and Katz, 1984; *S. oedipus*, Ziegler *et al.*, 1987; Savage *et al.*, 1988). In *C. jacchus*, hormonal studies of females in peer groups have shown that the behaviourally dominant female is the only female to undergo normal ovulatory cycles (Abbott and Hearn, 1978). In nuclear family groups, it has also been shown that daughters do not exhibit ovulatory cycles and are therefore also suppressed in the three species *C. jacchus*, *S. fuscicollis*, and *S. oedipus* (Abbott *et al.*, 1981; Epple and Katz, 1984; Savage *et al.*, 1988). In *C. jacchus* some daughters do ovulate (although they do not cycle regularly) while still in their natal group (Abbott, 1984), and rarely this also occurs in *S. oedipus*. In *Leontopithecus*, on the other hand, daughters may undergo normal ovulatory cycles within their natal groups (French and Stribley, 1985; Van Elsacker, 1994). Young females are often subject to severe aggression from their mother when they mature (Kleiman, 1979) and are thus prevented from breeding through behavioural rather than physiological means.

Physiological suppression of female cycles is by no means absolute. There are several instances of breakdown of suppression in the literature (e.g., Abbott, 1984; Carroll, 1987) to suggest that something else is operating to prevent reproductive activity of daughters within their natal groups and effectively acts as an inbreeding avoidance mechanism. Incestuous matings resulting in pregnancy do occur rarely in established breeding groups. If one of the parents of a group is removed it has been reported that in time suppression will eventually cease to be effective and incestuous breeding occurs. If a breeding male is removed, or dies, and is replaced in a group with the surviving mother and her daughters, it should be expected that the male will breed with the daughters as well as the mother. While the group may remain stable for some time with more than one breeding female, it should be expected that eventually aggression between the females will occur resulting in the expulsion of one from the group.

### 4.4.4 Infant care patterns among the Callitrichidae

It has been suggested that twinning has major consequences for the breeding female among the Callitrichidae. Not only must the female carry twin fetuses through pregnancy, she must also rear them to independence. Kirkwood and Underwood (1984) showed that in captive cotton-top tamarins, *Saguinus oedipus*, energy intake by the female increased during lactation. Price (1990) showed in the same species that, when lactating, feeding rates of females increased to a peak during the second month following birth, and only declined when infants began to receive food from other group members. Dunbar (1988) has used models developed by Altmann (1980, 1983) to predict the costs of twinning to tamarin mothers. His predictions suggested that a callitrichid mother could rear twins only if she did not have to carry them as well. In short, the female needs help if she is to rear both twins successfully. Several researchers have suggested that this is the reason for the communal or cooperative pattern of infant care seen among the callitrichids in which several, if not all, group members are involved in infant carriage and provision of food (e.g., Kleiman, 1977; Sussman and Garber, 1987; Dunbar, 1988; Goldizen, 1990).

*Callibella* and *Callimico*, both reported to have single infants, differ in their infant care patterns. *Callimico* mothers typically care for their offspring alone for about the first three weeks of its life, after which shared care takes place. Shared care has not been reported at all in *Callibella*. *Callibella* is reported to park infants from about day 5 following birth, but these observations should be regarded cautiously as they are based on only two births in captivity.





Reviewers of the social and reproductive systems of the marmosets and tamarins have attempted to interpret the inter-relationship between the sex ratio of wild groups, the mating systems that they exhibit and the role of helpers providing extra-maternal care of the offspring. These communal breeding systems have been referred to as “cooperative polyandry” (Goldizen and Terborgh, 1986), “facultative polyandry” (Goldizen, 1987), or “functional polyandry” (Sussman and Garber, 1987). The variability shown both within and between callitrichid breeding systems is becoming increasingly apparent. For instance, differences have been highlighted between breeding systems of the marmosets and tamarins that probably relate to fundamental differences in their ecology (Ferrari and Lopes Ferrari, 1989). It is unlikely, therefore that such generalizations about the callitrichid breeding systems will be sustainable in the future.

#### 4.4.5 Implications for captive management

Marmosets and tamarins breed within a tight cohesive social unit in captivity. For successful breeding stress needs to be minimized and groups should be maintained in their usual enclosure and with their usual group structure. It is vital, for instance, that breeding females are not separated from their groups prior to or at parturition under normal circumstances.

Mating is rarely seen, particularly within established groups of callitrichids. Mating occurs during pregnancy and outside the ovulatory period of the non-pregnant cycle, and hence conception dates are rarely known. As a rule of thumb, pregnancy is detectable visually about two months prior to parturition if it is possible to get a clear view of the abdomen of the breeding female prior to any feeding during the day. At one month prior to parturition abdominal swelling is usually clearly visible. Not all pregnancies can be detected visually and gaining reliable estimates of parturition dates is difficult based on female size, but this is nevertheless a useful indicator of when parturition may occur. Another way to find out if a female is pregnant is by behavioural observation. In most cases when the female is pregnant, she will become (more) dominant over the male, and this can easily be seen by experienced keepers during feeding time. Also, like most primates, they will drink more water during pregnancy. These behaviours can be observed about 8 or 9 weeks after conception.

Births almost invariably occur overnight. Many zoos put soft substrate of woodwool or similar material on the cage floor in preparation for parturition in case of falls. Occasionally births occur during the day, but this is usually an indication of a problem, although pied tamarins have been often observed giving birth in the late afternoon rather than overnight. In some species there is a high rate of failure to rear young, such as *S. bicolor* and *S. imperator*. In the event of infants being abandoned by the parents all possible attempts must be made to reintroduce them and induce parent rearing. If this fails, however, handrearing may be attempted, depending on the policy of the species programme where one exists.

Dead and mutilated infants are reported relatively frequently and may be due to several reasons. Stress at the time of parturition may induce infanticide and underlines the importance of reducing stress for these animals particularly at the perinatal period. Behaviourally incompetent parents may kill or injure infants. Overzealous grooming by a parent or sibling may result in injury to infants and should be monitored carefully.

Landmarks in infant development are variable depending on many circumstances such as species, history of the family group (first-time mothers are likely to show later landmarks than established breeding groups), and group composition. In general, however, infants are carried for about two to



three weeks, after which time they may be seen taking tentative steps and mouthing food. By six weeks of age locomotion is mostly independent of the parents and weaning is well under way. By twelve weeks they are weaned and capable of independent existence. (See Stevenson, 1978 for details of development in *C.jacchus*).

As reported in the section on social behaviour, infant care has a largely learnt component. It is vital that young are left with their natal group to experience and participate in infant rearing in order to become competent parents themselves.

#### 4.4.6 Hand rearing

##### 4.4.6.1. The need to hand rear

Hand rearing may be necessary for a variety of reasons – rejection by the parents, ill health of the mother, weakness of the offspring or a triplet birth.

Careful consideration must be given as hand rearing requires a great deal of time and commitment. Unless the individuals are of genetic importance subsequent problems in hand-reared adults may be undesirable. With careful re-introduction they can, and do, breed normally, but can develop behavioural abnormalities and may become extremely aggressive towards their keepers.

Fostering may be considered as a preferred alternative to hand-rearing if a suitable foster mother is available.

If rejected, offspring may be found on the floor or the adults will be agitated, pulling them, trying to rub them off against perches and wire and in some cases biting them severely.

Every effort should be made to keep the baby within the group. Sometimes it is possible to remove the infant and feed it and try returning it to the group later or the next day but it is important to monitor the situation closely.

When infants are rejected or abandoned by parents, diet, grouping, specimen social history etc, must be evaluated. If no specific cause is identified and if stress is considered as a most probable cause, treatment with a neuroleptic drug can be tried on mother or father or both, but it must not be a substitute to poor housing conditions. For instance, zuclopenthixol can be given orally at 4 to 8 mg/kg every day a few weeks before and after delivery. Dosage has to be adapted to each individual so that sedative effects are not too much. This treatment helps mother (and father if necessary) accept infants and calm down. Then, parents gain experience and may be able to rear the next litter without treatment. There are cases where treatment had to be repeated 2 or 3 times and, at the end, natural rearing occurred.

If the offspring are being cared for but receiving no milk they will be restless, climbing over the adults continuously. As they become weaker they will hang from around the legs or the base of the tail of the parent. The infant's tail, normally held coiled, may be seen extended and limp. Contented babies, when very young, sleep most of the time. When not suckling they will cling tightly around the neck or shoulders of the parent.

In triplet births one baby usually dies. In several species three young have been reared but this is rare. Sometimes one dies very quickly but they may all die after some days as all three may not have





received enough nutrition. When removing a triplet the temptation is to take the smallest one, but this one has a better chance with its mother than if hand reared. The largest, strongest baby will respond better to hand rearing. You may consider handrearing two of triplets as they will then grow with each other's company and may become less imprinted. Several institutions, particularly laboratories, have successfully used a system of alternating which of triplets receives food, taking a different infant each day. In zoos animals tend to be handled less than in laboratories and the potential benefits of alternating between the triplets need to be weighed carefully against the stress to the carriers of the extra handling involved.

#### 4.4.6.2. Physical condition of the infant

An incubator is the best source of warmth. Heat lamps are not suitable, the heat is too intense and will dehydrate the babies. If an incubator is not available hot water bottles are good, but use caution and wrap them in several layers of towelling. Small babies die very quickly if too hot. 26.5–29 °C (80–85 °F) is ideal. Heated plant propagators are useful for older youngsters but are not usually warm enough for newborns. In a real emergency a domestic iron on the lowest setting wrapped in towelling in a box can be used as a heat source.

Should the baby be hypothermic when you remove it, you can raise its body temperature gently by holding it against your own body or holding it in your hand in a bath of warm water.

Hot water bottles do have one advantage in being easily transportable. They can be placed in a basket or carrier if you have to take the young ones with you anywhere.

The baby will need something to cling to; a small toy or, if this is not available, a couple of thick socks rolled together will do.

#### 4.4.6.3. Feeding regime

A syringe with a small teat on the end is the best thing for feeding. Dolls' bottles are usually too large and glass ones are awkward to use. Syringes also have the advantage of being calibrated so the amount of each feed can be recorded.

There are many accounts of milk formulae and various additives but experience has shown that a good quality milk substitute for human babies is quite adequate without additional vitamins etc.

Start by feeding the baby every 2 hours. The milk must be warmed to blood temperature; gauge this by holding the syringe against your cheek or wrist. Babies will not take milk that is too hot or too cold. It is best to wait a little while if they have been taken directly from the parents, as they may be distressed and will accept an artificial teat more readily if hungry. Hold the baby in an upright position to feed it, not lying on its back. This will help stop milk being inhaled and going into the lungs which can lead to pneumonia. If they sneeze it out of the nose dab it with tissue to prevent it being inhaled. Introduce the teat to the mouth and, if the baby sucks the teat immediately, release the milk *slowly*! If the infant does not suck at the teat try putting a drop on the lips to see if the baby will lick it. The first feed can be of just glucose or honey and water to start the system gently, the second feed diluted milk and thereafter as per the mixing instructions. The baby may take very small amounts at first, 0.5ml being average for the first few days.



Feed should be given only when the baby is hungry and sucking vigorously, as encouraging it to keep taking more milk can be fatal. Babies will not die of being slightly underfed, but overfeeding will kill them. As the volume of the feeds increases the frequency can be reduced: 3 hourly in the 2<sup>nd</sup> week, 4 hourly in the 3<sup>rd</sup> week, etc. Babies will be very hungry at some feeds, less at others, but this is quite normal.

As a basic rule one can say that when the baby drinks 10% of his bodyweight in 24 hours, it will stay alive but will not really grow. Between 15 and 20% is normal and the baby will grow. A maximum of 25% is only given when the animal is dehydrated or if it is underweight and has to catch up.

After each feed, it is necessary to stimulate the baby to urinate and defecate by gently rubbing the anus and genitals with some tissue or cotton wool which should be moistened with warm water. The first motion (meconium), is normally very thick and dark, after which they will be pale yellow. Should the baby become sore around the base of the tail use a little baby cream.

After the first week or so the baby will not need feeding at night – 06h00–24h00 being sufficient. After 4 weeks, very small amounts of cereal-based infant food should be introduced to the milk, gradually increasing it during weeks 5–6. By week 4 the baby will start taking soft banana or pear from your fingers. At this stage start leaving the baby with a small bowl of finely chopped food. By 12 weeks the baby will be fully weaned but may still appreciate some baby cereal in a bowl, particularly if this is not part of your normal adult feeding regime.

#### **4.4.6.4. Monitoring progress**

Weighing the babies daily and keeping a record of their weight gain is important. The weight should increase steadily, though not necessarily daily (a little weight loss may occur in the first couple of days). If there is gradual weight loss while they are still being fed milk consult your vet or seek further guidance. When the babies begin to wean and you start withholding bottle feeds a slight weight loss is normal.

Minor digestive problems can occur. Constipation, if the babies have not defecated after a couple of feeds, might be remedied by replacing a milk feed with glucose and water. Using water that has had a handful of rice boiled in it to make up the milk feed may help diarrhoea. The starch in the rice has a binding effect. If diarrhoea is severe and persistent feed the baby an electrolyte solution to ensure it does not dehydrate or lose body salts. If this is done for a couple of feeds it may solve the problem otherwise consult your vet. Be very cautious when using kaolin based remedies as they can cause intestinal blockage.

#### **4.4.6.5. Reintroduction**

Reintroduction should be started as soon as possible, and contact with the rest of the natal group is very important. Ideally during the day the infants should be kept within sight, sound and smell of the group, preferably in their container within the enclosure. Once the infants are mobile they should be released for short periods, gradually increasing until they are fully integrated. All interactions should be observed initially. If it is not possible to reintroduce infants to their family, mixing them with a single animal of any callitrichid species can be successful and is preferable to isolation.



EXAMPLE OF WEIGHT GAIN FOR A COTTON-TOP TAMARIN (*SAGINUS OEDIPUS*) AT LINCOLN PARK ZOO

Age	Weight	Average daily intake
Day 1	34g	6.5cc
Day 26	53g	17cc + solids
Day 48	76g	25cc + solids
Day 69	111g	18cc + solids

**Useful references for further information are:**

Saunders, N. and Sodaro, V (1999). Callitrichid husbandry manual, AZA Neotropical Taxon Advisory Group.

Pook, A.G. (1976) Development of hand-reared infants of four species of marmoset, 13<sup>th</sup> Annual Report, Jersey Wildlife Preservation Trust.

Pook, A.G. (1974) Handrearing and reintroduction of saddle-back tamarin, 11<sup>th</sup> Annual Report, Jersey Wildlife Preservation Trust.

**4.4.7 Population and breeding control**

Much of the information below was derived and adapted from the report of the Workshop on *Leontopithecus* population and breeding control held at the Royal Zoological Society of Antwerp, 20–21 November 1998. It does not necessarily reflect, however, a consensus opinion of the workshop or of other individuals involved with the workshop.

*The section on chemical and surgical contraception has been updated with current knowledge by the EAZA Reproductive Management Group in particular Veronica Cowl and Yerda Feltrer.*

**4.4.7.1. Introduction**

The irony of conservation breeding programmes is that every successful programme at some stage reaches a point where it is desirable to control the growth of the population. This may be because:

- there is a general surplus of animals of the species leading to space problems
- there is a surplus of animals of certain genetic lines which are over-represented
- there is a surplus of either males or females (depending on sex ratio at birth and breeding system of the species)
- there may be a danger, in case of large numbers of surplus animals, of animals ending up in commercial trade or uncontrolled breeding in the primate private sector
- medical and health reasons.

This means that almost every conservation breeding programme sooner or later hits this problem, even if there are not yet a sufficient total number of animals to ensure the viability of the species.

The optimal population control method would be one that:



**is effective:** the method must prevent breeding and/or keep stable or reduce the population.

**is reversible:** In case disaster strikes among the offspring and/or other relatives, it is important to still have the option to let contracepted animals breed again. Reversible contraceptives also allow the lengthening of generation time and/or inter-birth interval by getting the animals to start breeding later in life and/or build in breaks between pregnancies at certain stages of life.

**is safe and has no physiological/medical side effects** (so that physical welfare of the animals is not compromised)

**has no behavioural side effects and allows as many natural behaviours as possible to be exhibited**

In order to have a population of not just genetically and demographically, but also behaviourally healthy callitrichids, it is desirable for as many individuals as possible to be allowed/able to perform as many aspects of their natural behavioural repertoire as possible.

**is easy to use in view of daily animal management and animal welfare;** the less invasive the method, the less traumatic the experience for the animal and the easier the management for the keepers, veterinary staff and curators. The more invasive the technique, the longer the anaesthesia and the longer the animals are away from the group. However, anaesthetic drugs and anaesthetic techniques have improved considerably since the last edition of this manual (drugs are safer with fewer residual and side effects) and the authors feel that the need for a brief general anaesthesia should not be a deterrent to using a particular contraceptive method. The method should also not be too expensive so that it is accessible to all institutions “rich” and “poor”.

**causes little or no negative reactions with the public:** the display of groups of endangered animals which are part of a conservation breeding programme but which are prevented from breeding are perceived to be “educationally incorrect” by some zoos because they feel the animals can not be shown “the natural way” (i.e. looking after offspring etc.). When control methods are used which cause negative side effects for the animals or which include euthanasia of individuals, then negative PR becomes an even bigger concern for the participating institutions. On the other hand, some aspects of these perceived negative public relations can be counteracted by thoroughly and honestly educating the public about the problems/issues at hand.

#### 4.4.7.2. Current options for population control

##### How to choose the appropriate contraceptive/population control method

A variety of factors such as efficacy and safety of available methods, the animal's age, behavioural and social factors, the practicality of different delivery systems, and the individual's reproductive status must be considered when selecting an appropriate population control method. It is unlikely that the same method will be the most appropriate choice during all stages of an animal's life.

##### Family groups

The advantage with Callitrichidae is that in normal family groups a system of reproductive inhibition is often in operation whereby offspring do not reproduce with one another or with their parents, as long as they are in their natal group. Reproduction can therefore often be postponed by leaving offspring in their natal groups for a prolonged period of time. This type of “social contraception” is however not 100% effective. Polygyny does occur to a larger or lesser degree depending on the species and



circumstances and both in captivity and in the wild (De Vleeschouwer, 2000; De Vleeschouwer *et al.*, 2001).

The mechanisms that limit breeding to a single adult female also differ among callitrichid taxa. Ovarian function of female lion tamarins is not influenced by social factors – the cycles of daughters and subordinate females are indistinguishable from those of breeding adult females (French *et al.*, 2002). It is thought that the non-breeding of daughters and subordinate females in lion tamarins is maintained through behavioural mechanisms but exactly how this works has not yet been shown. Most daughters and subordinate females of other tamarins and marmosets will either not ovulate or show changed ovarian activity. However, it has been observed that some *S. oedipus* females would ovulate in the presence of a reproductive female and some daughters of *C. jacchus* living in the family group showed ovarian cyclicity (French and Snowdon, 1984).

### Unisex groups

Callitrichids can, in general, be kept in small (usually 2–3 animals) unisex groups. Groups of related animals (mothers with daughters, fathers with sons, brothers, sisters) appear to be most stable. Unrelated males can often be introduced to one another without major problems. More problems seem to occur with unrelated females although successful combinations of these have also been formed.

Keeping the animals in single sex groups appears to be an acceptable way of preventing breeding, at least in the shorter term. However, we must be aware of the fact that the animals do not get to practise an important part of their behavioural repertoire (courtship and mating behaviour). The potential negative effects of being in a unisex group for a long time need to be assessed and would be a recommended research project.

#### 4.4.7.3. Chemical contraception

##### Types of chemical contraception

- Gonadotrophin Releasing Hormone (GnRH) agonist
- *Suprelorin® (deslorelin) implants*
- Progestagen-containing hormonal contraception
- *Medroxyprogesterone acetate (MPA) injections (e.g., Depo-Provera®)*
- *Norplant (levonorgestrel) implants*
- *Implanon (etonogestrel) implants*
- *Note that melengesterol acetate (MGA) implants are not available in Europe and cannot be imported*

##### Placement of implants

For some contraception implants the recommendation is to place them between the shoulder blades; however, the authors would recommend the implants be placed subcutaneous in the inner part of the arm and use tissue-glue to close the skin. The implants can then be easily located and removed for (1) reversal to breeding or (2) replacement with a new implant.

##### Gonadotrophin releasing hormone (GnRH) agonist contraception

*Suprelorin® (deslorelin) implants:*



Product Information: GnRH agonists work by temporarily suppressing the reproductive endocrine system and preventing production of pituitary (FSH and LH) and gonadal hormones (oestradiol and progesterone in females and testosterone in males). The observed effects are similar to those following ovariectomy or castration, but are reversed after the hormone content of the implant is depleted. Deslorelin implants are designed to be fully reversible however, the effect of deslorelin (efficacy and reversibility) is species and individual specific and there are not data available for all species.. Males might need a much higher dose than females (i.e 2 implants vs 1 for females), there is data of full reversibility in female pygmy marmoset, male black tufted-ear marmoset, female golden lion tamarin, and male and female Goeldi's monkey. Deslorelin takes longer to reverse in younger animals than in matured animals, and also the longer it is used in an individual the longer it may take to reverse.

Dose: GnRH agonists are considered safe and reversible contraceptives, but dosages, duration of efficacy and latency for reversal are species and individual specific and are not well established for all species. Deslorelin can also be an effective contraceptive in males and it has also been used to ameliorate aggression but higher dosages are usually required. As a guide 1 implant for females and 2 implants for males should be effective.

In New World monkeys, Deslorelin has been used successfully in a wide variety of species such as the bare-faced tamarin, cotton-top tamarin, red-handed tamarin, golden headed lion tamarin, black tufted-ear marmoset, pygmy marmoset, common marmoset, spider monkey, squirrel monkey, black howler and white-faced saki (AZA WCC and EGZAC data). There is data of full reversibility in female pygmy marmoset, male black tufted-ear marmoset, female golden lion tamarin, and male and female Goeldi's monkey.

Deslorelin implants are available in two formulations: 4.7mg implant for an approximately 6-month contraception period and a 9.4mg implant for an approximately 12-month period of contraception. It must be emphasized that both implants release the GnRH agonist at the same rate; therefore, 2 or more implants of 4.7mg will only increase the dose given over the 6 month period (i.e. the duration of contraception does not increase, only the dose).

Deslorelin is currently manufactured and distributed in Europe by Virbac Animal Health.

Latency to effectiveness: as an agonist of the GnRH, deslorelin initially stimulates the reproductive system, which can result in oestrus and ovulation in females or temporary enhancement of testosterone and semen production in males. Down-regulation then follows the initial period of stimulation. Due to this initial stimulation phase, it is important to either separate treated animals from opposite sex during the period of enhanced fertility (usually recommended as 3 weeks) or use another form of contraception that will suppress this initial stimulation phase (megestrol acetate tablets daily at 5mg/kg, 7 days before and 7 days after the implant has been placed). Depo-Provera® injection should not be used to suppress stimulation phase due to a possible interaction at the cellular level which may inhibit down regulation and render the deslorelin implant ineffective

Oestrous cycles during contraceptive treatment: Deslorelin first stimulates then suppresses oestrus in females. In males, initial stimulation may be accompanied by increased aggression or sexual interest.

Duration and efficacy and reversibility: Duration of efficacy and reversibility are not well established for all species.

Use during pregnancy: GnRH agonists should not be used during pregnancy, as they may cause abortion.





Use during lactation: No known contraindications once lactation has been established.

Use in pre-pubertals or juveniles: Deslorelin may prevent epiphyseal closure of the long bones, resulting in taller individuals. The younger the individual the longer will take to revert back to breeding however, species differences may occur (AZA WCC).

Effects on behaviour: The Zoological Society of London has used deslorelin implants in female golden headed lion tamarins and no negative behavioural, social or side effects have been observed (Y. Feltrer, pers. comm.).

Precautions: In general, the effects on weight would be similar to those from ovariectomy or castration (AZA WCC). Reversibility data not well established for all species.

Reporting requirements: In order to increase our knowledge of the efficacy of contraception methods in the Callitrichidae family it is recommended that all individuals on contraception be reported to the European Group on Zoo Animal Contraception EGZAC ([www.egzac.org](http://www.egzac.org)). EGZAC works in association with the American Association of Zoos and Aquariums Wildlife Contraception Center (AZA WCC).

### **Progestagen-containing hormonal contraception**

Product Information: Parenteral progesterone analogues (such as MGA- not available in Europe-, Norplant 2 or Jadelle, Depo-Provera®, Implanon/Nexplanon) share the same contraceptive mechanism of interference with fertilization by thickening cervical mucus, interrupting gamete transport, and disruption of implantation. It is important to note that ovulation and cycling can occur but is unlikely and the degree of suppression is dose dependent.

Although these products are good contraceptives, and do not require daily medication events, a short anaesthetic procedure is required to place some of these products (except the Depo-Provera® injection). Anaesthesia can be short and the female can be reintroduced to the family group in less than 2 hours. The risk of losing the implant can be avoided by correct surgical technique.

Dose: To achieve effective contraception a much higher dose of progestagens is needed for callitrichids and other New World primates than for Old World primates. For dose rates for specific products and species you may contact EGZAC.

Latency to effectiveness: For the implants, although there is individual variation, threshold concentrations of the hormone should be reached in the blood within 1 to 3 days following IM insertion and within 1 week following SQ insertion. However, if the cycle stage is not known then extra time must be allowed; therefore, separation or alternative contraception should be used for at least 1 week (if IM) or 2 weeks (if SQ) following insertion. IM injection is roughly equivalent to implant insertion and therefore follows similar recommendations (AZA WCC)

Oestrous cycles during contraceptive treatment: Follicular growth may continue and therefore accompanied by oestrogen production sufficient enough to cause oestrus. Ovulation may also occur even though pregnancy does not ensue.

Duration and efficacy and reversibility: Parenteral progestins are designed to be reversible.

There appears to be a considerable number of cases of non-reversibility in golden-headed lion tamarins (De Vleeschouwer *et al.*, 2000a, but see DeMatteo *et al.* 2002 ). However, it seems that most



of the cases of failure to reverse were because the MGA implant wasn't removed, and these implants can continue releasing hormone well beyond the 2-year recommended replacement date. That 2-year date is conservative, calculated to prevent reversal in any individual. Nevertheless, De Vleeschouwer *et al.* (2004) indicated that never-implanted golden-headed lion tamarins were more likely to reproduce than females that previously received an MGA implant, regardless of whether this was removed or left to expire. This might not be the case for other type of progestagens such as etonorgestrel or levonorgestrel (Implnaon and Norplant)

In a few cases implant failure (i.e. unplanned pregnancies) has been reported – although this may have had more to do with under-dosing as commercially available human implants are often cut down in size, which may result in insufficient dosing; or implanting females in the very early stages of pregnancy.

Use during pregnancy: Parenteral progestagens during pregnancy don't seem to have any apparent effect on the pregnancy and don't interfere with parturition. Many callitrichid females have been purposefully implanted while pregnant to prevent the post-partum oestrus that occurs in this species. Of these pregnancies 88% resulted in live births and 12 % in abortion or stillbirth.

Use during lactation: Progestagens are sometimes prescribed for lactating women and are considered generally safe for nursing infants (AZA WCC).

Use in pre-pubertals or juveniles: possible long-term effects on fertility are not known (AZA WCC).

Effects on behaviour: Because progestagens can suppress ovulation it can be expected that courtship and mating behaviour will be affected in some way.

In families of golden-headed lion tamarins with non-implanted females at the Royal Zoological Society of Antwerp, proceptive behaviour and mounting behaviour mostly occur around the time of ovulation and therefore have a cyclic pattern (De Vleeschouwer *et al.*, 2000b,c). In families with implanted females this regular cyclic pattern of these behaviours was disrupted. The spread of these behaviours over time became irregular and differed between different groups (De Vleeschouwer *et al.*, 2000b).

This form of contraception allows maintaining of the normal family group in callitrichids where reproductive inhibition is still operational; therefore, just by implanting the breeding female more animals can be kept in a non-breeding situation.

Research at the Durrell Wildlife Conservation Trust indicated that there may be an increased risk of aggression in non-breeding groups of lion tamarins. However, other possible contributing factors such as age of the animals in the group and the group size interact with the effect of the contraception alone. There may be an effect of different types of management systems. Collaborative studies between zoos are necessary to increase the sample sizes (Price, 1998a,b).

In golden-headed lion tamarins females at the Royal Zoological Society of Antwerp, aggression was found to more likely occur in larger groups, in groups with a higher proportion of males and/or the number of sons. This effect was heightened and the thresholds for the effects lowered in groups where all offspring were older than 1 year, regardless of the population control method used (if any) (De Vleeschouwer *et al.*, 2003).

Precautions: In humans long term use of progestins has been linked to osteoporosis. To date, few studies have shown link between progestins treatment and serious health risks in nonhuman



primates.(Porton and Dematteo, 2005). There is some indication that contraceptives appear to affect the mood on nonhuman primates females in different individual ways and some females have been reported as more aggressive or “cranky” but this has not been reported in callitrichids.

Reporting requirements: In order to increase our knowledge of the efficacy of contraception methods in the Callitrichidae family it is recommended that all individuals on contraception be reported to European Group on Zoo Animal Contraception EGZAC ([www.egzac.org](http://www.egzac.org)). EGZAC works in association with the American Association of Zoos and Aquariums Wildlife Contraception Center (AZA WCC).

***Progestogen-containing depot injections [Medroxyprogesterone acetate (MPA) injections (e.g., Depo-Provera®) or proligestrone (Delvosteron®)]:***

- They are relatively inexpensive and widely available in the EU and UK.
- MPA is a synthetic derivative of progesterone administered as an acetate salt with anti-estrogenic activity suppressing ovulation.
- It is a fairly non-invasive procedure since it is administered by injection
- Depo-Provera injection can be used to prevent the post-partum oestrus until a suitable longer term implant can be placed or as longer term contraception.
- MPA has been used in *Callimico goeldii*, *L. chrysomelas*, *L. rosalia*, *Saguinus oedipus*, *S. midas*, *S. imperatus*, *S. geoffroyi*, *C. pygmaea*, *C. geoffroyi*, *C. penicillata* (DeMatteo, 1997; K Gold pers. comm.)
- MPA can have a variable length of duration (Porton *et al.*, 1992) and a much higher dose is needed than in Old World primates for efficacy: 20mg/kg body wt of Depo-Provera, effective for approximately 30 days, however reversibility may take longer in certain individuals.
- A dose of 50 mg/kg of Delvosteron has been used in a collection for short term contraception (1 or 2 injections three months apart) being effective for approximately 3 months.
- It has been used relatively infrequently with callitrichids.
- The long term use is not recommended since it can have possible deleterious effects on the uterus and mammary tissue.

***Norplant 2 or Jadelle (levonorgestrel):***

- “Jadelle” or Norplant 2 contains 2 implants with 75mg levonorgestrel (Bayer Schering Pharma) and is available in several European countries, excluding the UK.
- The long thin implant can be administered by injection (procedure comparable to inserting a microchip) but due to the stress sensitivity of callitrichids this still requires a short anaesthesia.
- It is designed for women and for use in callitrichids implants should be cut in a similar fashion as the Nexplanon/Implanon and inserted in a sterile way. It has been used very infrequently in callitrichids. Little can therefore be said about potential behavioural effects, medical side effects, the duration of contraceptive action and the reversibility of this method for this group of primates. However, extrapolating from Implanon/Nexplanon data would be helpful.



- It has been used in *Saguinus oedipus*, *Leontopithecus rosalia*, *L. chrysomelas*, *L. chrysopygus* (DeMatteo, 1997; K. Gold pers. comm.; E. Price pers. comm. and Dutton and Allchurch 1998; J.B. Carroll pers. comm.).
- In Jersey, a single rod of Norplant (equivalent to ½ a rod of Jadelle or Norplant 2, as Norplant is not longer available in the market) was inserted subcutaneously between the shoulder blades. Reproduction stopped in the three lion tamarin species and no reactions, complications, side effects or rejections of the implants were recorded. Two Jersey cotton-tops that were treated did conceive, which could mean they have lost their implants. There is not enough information to assess its efficacy and there are too few cases to assess duration of contraceptive action.

***Implanon / Nexplanon (etonogestrel 68mg):***

- Nexplanon may be effective for as long as 3 years, but replacement every 2 to 2.5 years is a more cautious recommendation.
- The long thin implant can be administered by injection and should be cut in a sterile fashion and then insert the appropriate dose (¼ to 1/3 of implant) but due to the stress sensitivity of callitrichids this still requires a short anaesthesia.
- Experience in a few collections recommends that no less than a quarter of a rod should be used. Generally, a third or a quarter of the implant has been successfully used in mainly marmosets. Using only a fifth of an implant resulted in a pregnancy in one marmoset.
- A was found to cause excessive decidualization of the uterine endometrium in a study of *Callimico*; if this result proves to be generally true, permanent infertility may result, and other progestagens would be expected to have the same effects (Asa *et al.*, 1996; Murnane *et al.*, 1996; DeMatteo, 1997). However, many people believe this effect in *Callimico* reverses spontaneously when the progestin treatment is withdrawn. In the common marmoset, endometrial changes appeared to be reversible (Möhle *et al.*, 1999). Further research is currently being carried out on this subject.

**4.4.7.4. Immunocontraception**

***Porcine Zona Pellucida (PZP) vaccine:***

Product Information: PZP stimulates the production of antibodies against the receptors for sperm on the zona pellucida of the egg preventing fertilisation. It is expected not to create the side effects seen with progestagen-containing hormonal contraceptives. This product is available from Dr. Jay Kirkpatrick, Montana, USA (e-mail [zoolab@wtp.net](mailto:zoolab@wtp.net) to inquire about import to the EU and UK) and needs an import license.

Dose: It can be administered by a single injection and is therefore less invasive; however, 2–3 injections are necessary for full effect.

Latency to effectiveness: PZP is not effective until after at least 2 injections (typically given at 2–4-week intervals), depending on the species and adjuvant. There must be a minimum 2-week interval after the last injection before the male is placed with the female (AZA WCC).



Oestrous cycles during contraceptive treatment: PZP should not suppress oestrous cycles.

Duration and efficacy and reversibility: So far it has been mostly used in ungulates and carnivores with varying success. If used for a long time (>3 years) it may cause permanent changes in the ovary leading to non-reversible contraception. This may be, among others, species and dosage dependant (Sainsbury, 1996; DeMatteo, 1997).

It has been used very infrequently in *Callimico goeldii*, *Saguinus oedipus*, *Callithrix jacchus* (DeMatteo, 1997; Hearn *et al*, 1983).

Use during pregnancy: Does not interrupt pregnancy or affect foetus (AZA WCC).

Use during lactation: No known contraindications (AZA WCC).

Use in pre-pubertals or juveniles: PZP-treated prepubertal white-tail deer and feral horses were fertile as adults, but there currently no information for other species.

Effects on behaviour: It does not suppress ovulation and oestrus therefore it can be expected to have less effect on the courtship and mating behaviour. However, in some primates can temporarily suppress oestrus.

Precautions: This method has been rarely used in callitrichids and primates in general. Little can therefore be said about potential behavioural effects, medical side effects, duration of contraception and the reversibility of this method for this group of primates. PZP can cause depletion of oocytes and in some primates it can cause temporary cessation of oestrous cycles; however, further studies are necessary to prove or disprove the above mentioned expectations/assumptions.

Reporting requirements: In order to increase our knowledge of the efficacy of contraception methods in the Callitrichidae family it is recommended that all individuals on contraception be reported to the European Group on Zoo Animal Contraception EGZAC ([www.egzac.org](http://www.egzac.org)). EGZAC works in association with the American Association of Zoos and Aquariums Wildlife Contraception Center (AZA WCC). Additionally, all institutions using PZP must submit a separate form obtained from Kim Frank at [zoolab@wtp.net](mailto:zoolab@wtp.net).

#### **4.4.7.5. Intra-uterine devices (IUD)**

Due to the very small size of callitrichid reproductive tracts these methods are not practical for this group of primates.

#### **4.4.7.6. Termination of early pregnancy by regular prostaglandin injections**

- Commonly used in laboratory callitrichids
- Maintains oestrus/sexual behaviour
- Requires monthly injections and therefore monthly capture
- Because urine samples need be collected regularly to determine ovulation and the best time for injection, and because animals need to be captured each month, this makes this a less practical method for zoos. There are also welfare implications from catching the animals so frequently.



- Ethical considerations concerning termination of pregnancy
- Commonly used in colonies kept for scientific purposes (e.g., *Callithrix jacchus* Summer *et al.*, 1985; *Callimico goeldii* Pryce *et al.*, 1993:) also tried in *Leontopithecus rosalia* (Monfort *et al.*, 1996).

#### 4.4.7.7. Surgical methods of contraception

- Vasectomy/tubal ligation/hysterectomy
  - Sexual hormone levels and cycles remain intact and sexual behaviour is therefore not affected.
  - Simple surgical technique.
  - Although some vasectomies can be reversed, it should be considered non-reversible.
  - For permanent contraception, vasectomy/tubal ligation/hysterectomy are to be recommended above the long-term use of any of the other contraceptive methods because there is less chance for negative side effects.
  - Castration and ovariectomy/ovariohysterectomy
  - The sexual hormone levels and cycles are affected and therefore sexual behaviour is affected.
  - Simple surgical technique.
  - It is non-reversible.
1. Sometimes indicated for medical and animal welfare reasons such as reproductive tract tumours, endometritis and pyometras, repeated c-sections, diabetes mellitus, severe spondylosis, etc.
  2. Castration and ovariectomy should be avoided because the effects on the social and sexual behaviour of the animals. Because these methods are irreversible, they should only be applied after recommendation from the coordinator and studbook keeper or following veterinary advice.

Reporting requirements: In order to increase our knowledge of the efficacy of contraception methods in the Callitrichidae family it is recommended that all individuals on contraception be reported to the European Group on Zoo Animal Contraception EGZAC ([www.egzac.org](http://www.egzac.org)). EGZAC works in association with the American Association of Zoos and Aquariums Wildlife Contraception Center (AZA WCC).

#### 4.4.7.8. Euthanasia

Because at the moment there is no alternative population control method available which does not have potential or certain negative effects on the animal's welfare, and because euthanasia allows the full range of natural behaviours to be experienced by the members of a family group, euthanasia should be offered as one of the options for population control for those institution that are legally able to do so and feel ethically sufficiently comfortable with doing so. **Possible arguments pro and contra euthanasia can be found in section 4.4.7.10.**

Institutions which have a breeding pair of European Breeding Programme (EEP) callitrichids could be given permission to continue breeding after the studbook keeper has recommended to stop breeding, if they prefer to euthanise surplus offspring rather than use one of the other population control methods.

The studbook keeper needs to advise the institution if there is a change in the need for breeding control in that group.





Please note:

In the case of lion tamarins *Leontopithecus* spp. and pied tamarins *Saguinus bicolor*, which belong to ICMBio (Institute Chico Mendes for Biodiversity Conservation of the Brazilian Ministry of the Environment) euthanasia cannot be offered as a management tool under any form unless ICMBio and the International Committee for the Conservation and Management of the Lion Tamarins give the studbook keeper explicit permission to do so. Also it should be noted that euthanasia for population control reasons is illegal in some European countries

#### 4.4.7.9. Summary

1. At the moment there is no single “right” method for population control in callitrichids. Every currently known procedure has its pros and cons. Because each situation is different, we recommend that for every individual case, the species co-ordinator and the institution together decide on the best mode of action for that group of animals.
2. For permanent contraception, vasectomy/tubal ligation/hysterectomy are to be recommended above the long-term use of any of the other contraceptive methods because there is less chance for negative side effects. Castration and ovariectomy should be avoided because the effects on the social and sexual behaviour of the animals. Because these methods are irreversible, they should only be applied after recommendation from the coordinator and studbook keeper or following veterinary advice.
3. For non-permanent contraception GnRH agonists and progestogen implants are considered the safest reversible contraceptives. MGA implants are no longer available in the EU.

For many of the Callitrichidae, however there is little detailed and sequential information on the possible physical, physiological and behavioural effects of any of these contraceptive methods, nor on the reversibility of these effects.

Both studbook keepers and individual institutions should do everything within their power to gather as much information as possible on both the individual that is contracepted and on the other members of the social group (see research recommendations below). That way, possible negative effects on individual species can be detected as soon as possible. Any results/feedback should be sent to EGZAC ([www.egzac.com](http://www.egzac.com)) so that further recommendations on callitrichid contraception can be issued.

4. When other, so far less frequently used, contraceptive methods are tested (e.g., deslorelin, levonorgestrel, etonogestrel or Depo-provera), both studbook keepers and individual institutions should do everything within their power to gather as much information as possible on both the individual that is contracepted and on the other members of the social group (see research recommendations below)
5. All encouragement should be given to the development of novel population control methods with high rates of reversibility and fewer side effects.
6. Intra-uterine devices, castration and ovariectomy should not be used for callitrichids.



7. Because at the moment there is no alternative population control method available which does not have potential or certain negative effects on the animal's welfare, and because euthanasia allows the full range of natural behaviours to be experienced by the members of a family group, euthanasia can be offered as one of the options for population control for those institution that are legally able to do so and feel ethically sufficiently comfortable with doing so. This should be allowed under the following conditions only:

7.1. In the case of lion tamarins (*Leontopithecus* spp.) and pied tamarins (*Saguinus bicolor*) (which belong to ICMBio (Institute Chico Mendes for Biodiversity Conservation of the Brazilian Ministry of the Environment)) euthanasia cannot be offered as a management tool under any form unless ICMBio give the studbook keeper explicit permission to do so.

7.2. Institutions which have a breeding pair of EEP callitrichids can be given the permission to continue breeding after the studbook keeper has recommended to stop breeding, if they prefer to commit to euthanise surplus offspring rather than use one of the other population control methods.

The studbook keeper will advise the institution if there is a change in the need for breeding control in that group.

8. The following data analyses, monitoring actions and research projects should be carried out as soon as possible. Studbook keepers and co-ordinators should carefully analyse their studbooks with regard to the effects of ALL population control methods (reversibility, physical and medical side effects, stability of groups, behavioural effects, survival of infants etc). If necessary, research projects should be set up to look at these aspects more closely.

A protocol should be drawn up regarding the collection of urine and faeces and the opportunistic application of ultrasound techniques for reproductive monitoring of females (pre- and post-contraception) in as many zoos as possible and for as many species and contraceptive methods as possible in order to solve questions such as:

*What is the best moment during the oestrus cycle of the female for implantation of a contraceptive?*

*What is the effect of the contraceptive method on the reproductive cycle of the female, does the female start cycling again after contraception has stopped and if so when?*

*What are the effects of the contraceptive method on the uterine and ovarian structures?*

For EEP species individual zoos should contact their EEP coordinators for addresses to where the samples should be sent for analyses.

Research should be carried out regarding the behavioural and physiological consequences of life in a unisex group

Evidence based recommendations are created by the EGZAC (EAZA Group on Zoo Animal Contraception) committee which is a collective group of veterinarians, animal managers and researches interested in wildlife contraception. These professionals have a wide variety of knowledge gained through years of experience and cover many different fields, their experience is also supplemented by the EGZAC database which holds almost 4,000 European records of contraception



use in different species of wildlife and the AZA WCC (American Zoo Association Wildlife Contraception Center) with over 33,000 International records. Contraception is used for population control, therapeutic use, behaviour management and improved animal welfare. Evidence of contraception use and specialist knowledge is used to provide all available options for a particular species and also the options to avoid so clients can make an informed decision. Section 6.3 Appendix 3 summarises the recommendations for Callitrichidae.

### Summary of Contraceptive Methods provided by EAZA is in 6.3 Appendix 3

#### 4.4.7.10. Possible arguments for and against euthanasia

Possible arguments for euthanasia

1. For welfare reasons, animals in captivity should be able to perform as many of their natural behaviours as possible. Because the very nature of the captive environment in itself already eliminates and/or influences a proportion of the natural behaviour (such as ranging behaviour, predator avoidance behaviour and much of the foraging behaviour) it is important that as many individuals as possible get to practise all the behaviour categories that can be performed in captivity. This includes courtship, mating and infant rearing behaviour.
2. For both conservation and education purposes, callitrichids should be shown to the public in a way which is as close to life in the wild as possible so that they can be a living testimony of their “true story”. This implies showing the public family groups with infants. For callitrichids in general, infant care is a very important aspect of their social life, not just for the breeding pair but also for all the siblings.
3. While trying to achieve a partnership between conservation and education, it is necessary to ensure that goals and actions necessary from a conservation point of view do not compromise educational goals and vice versa. For example, while population control is necessary (see introduction), we must attempt to achieve this while not compromising the educational message to the public. On the other hand, we must make sure that we are not too afraid to implement essential population management actions simply because of fear of negative PR. After all, providing the public with a clear and honest explanation of what we are trying to do and why, will often counteract those negative vibrations.  
  
Experience has shown already shown that it is possible to have a serious euthanasia policy in a zoo – provided that one is always very open about it, never hides it and uses every opportunity to tell the press and the visitors the reason for using euthanasia as a method for population control. It is crucial to understand – and to make people understand – that not accepting euthanasia may lead to a decrease in animal welfare caused by the lack of opportunity to perform natural behaviour.
4. By euthanising surplus offspring when they are evicted from the group, or when they are at an age when one would normally expect them to emigrate from the group (i.e. the older animals) one respects natural group dynamics.
5. By not contracepting the breeding female one avoids the risk of possible negative side effects and/or non-reversibility of the contraception. The latter is especially important in case disaster strikes the offspring of an important breeding pair.



6. One can not, and should not, force any institution to use euthanasia as a management tool. One can however, under strict guidelines, offer it as one of the possible tools for population control (with its own plusses and minuses, just like any other method) to those institutions which feel they are ethically comfortable with euthanasia and which are legally able to perform it.

7. Euthanasia can be a highly selective and efficient management tool. One can carefully control which animal should be euthanised, why and when. It may furthermore prevent surplus animals from ending up in sub-optimal housing conditions.

Possible arguments against euthanasia:

1. The euthanised animal would not have existed (and be killed) were it not for the “enrichment” of the others in the group.

2. We do not fully understand the social dynamics of wild callitrichids. For example:

What proportion of wild callitrichids get to breed during their lifetime? (it is highly unlikely that every callitrichid surviving to adulthood will get the opportunity to breed)

How long does a breeding callitrichid remain in a breeding position? (captive females probably start breeding earlier and breed for longer)

What is the duration of unisex groups in the wild?

Captive females most likely have higher reproductive outputs (mostly more litters per year) – is this physically detrimental to the female and does this tell the “true story”?

3. We tell the public that these endangered animals need saving but at the same time, we euthanise some of them. This may give a confusing PR message. We may be seriously underestimating the opposition to the concept of euthanasia. In many countries, cultures and minds of people, euthanasia is still “taboo”.

4. If one waits to euthanise animals until their expulsion from the group, there is a risk of the animal suffering during the eviction (although this is also the case in the wild). Close monitoring would be required.

5. Pregnancy and birth hold risks such as nutritional and energetic costs for the female (exhaustion etc.), illness and death. Contraception may be a better alternative to euthanasia.

6. Institutions that feel that euthanasia for this reason is unethical may object to any of “their” animals being sent to institutions that practise it (because it means that some offspring from these animals may end up being euthanised).

7. Humans deciding which animals should be removed from the group may result in artificial selection. Do we know enough about the group dynamics in the wild to decided which animals should be removed from the group and when? On the other hand, we are now faced with similar decisions when animals are taken out of the group to start a new breeding group elsewhere.



## 4.5 Environmental enrichment

### 4.5.1 Introduction

Primates come in all shapes and sizes and strengths. To enrich a gorilla's life in captivity can be quite expensive, but this is not the case with marmosets and tamarins. Of all the primate groups that are kept in captivity, the callitrichids are perhaps the easiest to provide with a highly stimulating environment. No matter what the budget or the size of the enclosure, there can be no excuse for the available space and husbandry techniques failing to provide enrichment.



Pied tamarins (*Saguinus bicolor*) investigating a rotten log.

### What is enrichment?

Enrichment can be described as any change in an animal's life that has a stimulating and beneficial effect. It is important to consider that there may be forms of enrichment that provide stressful stimuli but that may in fact confer benefits, either immediately or in the future, as well as more closely mimicking the natural environment and prompting behavioural responses that would be normal in the wild. Some behaviours that occur in response to perceived threats, for example, may be necessary for mental fitness, and indeed short acute stress may be needed to provide a healthy immune system. It can also promote positive social relationships (e.g., Chamove and Moodie, 1990). In another example, if groups or their descendants may be reintroduced to the wild, predator avoidance training may be an important part of management.

### 4.5.2 What is the aim of enrichment?

Enrichment has several aims:

- To stimulate natural behaviour
- To promote development of mental and physical skills by creating new stimuli, challenges and difficulties
- To avoid the development of abnormal behaviour



In other words, the aim of enrichment is to enhance and maintain both mental and physical wellbeing by maintaining a behavioural repertoire in a given species that is as full as possible, within ethical constraints.

### 4.5.3 Why is enrichment important?

Animals that do not live in an enriched environment will become stressed and then ill. Psychological and physical wellbeing are paramount to the health of an animal. Social animals in captivity tend to interact too much, leading to problems, While it seems counterintuitive that social primates could socialise too much, this is the biggest cause of problems in captivity: callitrichids in the wild spend up to half their day foraging (see Table); in captivity this figure is usually reduced significantly, leading to unnaturally high levels of social interactions, stress and ill health.

#### FEEDING/FORAGING TIMES FOR WILD CALLITRICHIDS.

Species	% time feeding/ foraging	Reference
<i>M. argentatus</i>	39	Veracini, 1998
<i>M. humeralifer</i>	47	Ferrari and Rylands, 1994; Ferrari and Digby, 1996
<i>C. flaviceps</i>	37	Ferrari and Rylands, 1994; Ferrari and Digby, 1996
<i>C. jacchus</i>	43	Digby and Barreto, 1996 ; Ferrari and Digby, 1996
<i>L. rosalia</i>	34–41	Dietz <i>et al</i> , 1997 ; Peres, 1989
<i>L. chrysopygus</i>	49	Albernaz, 1997
<i>L. chrysomelas</i>	40	Rylands, 1989
<i>S. fuscicollis</i>	26–40	Garber, 1993; Lopes and Ferrari, 1994
<i>S. mystax</i>	27–39	Garber, 1993
<i>S. nigricollis</i>	49	de la Torre <i>et al.</i> , 1995
<i>S. oedipus</i>	32	Savage, 1990
<i>S. bicolor</i>	24	Egler, 1992

There may be seasonal differences in the need to provide enrichment: in temperate climates where animals have outside as well as inside areas, winter has the obvious effect of confining animals indoors due to poor weather, and there are few insects and fruits naturally available. Inside areas tend to provide a far less enriched environment and this, along with closer proximity and thus probably higher levels of social interaction, can lead to increased stress levels. A comparison of cortisol in three callitrichid species showed that baseline levels were higher in the winter than in the summer (McCallister, 2005).





Neural networks during development of the brain are significantly different in animals raised in impoverished environments to that of enriched stimulating ones, and there is also evidence that a lack of stimulation leads to a decline in neural networks in impoverished environments.

Preparation for release back into the wild means that behaviour that may only be rarely expressed in captivity needs to be stimulated. For example, captive animals have been taken by predators after release into the wild (e.g., Valladares-Padua et al., 2000) as they are much less reluctant than wild-born animals to descend to the ground and may be unfamiliar with certain classes of predators as a result of lack of exposure. So it is important for a species to retain behavioural fitness, which may deteriorate with successive generations in captivity. Stimulating predator vigilance behaviour is a form of enrichment and will retain important wild behaviours. Obviously, this could have ethical constraints as stressful stimuli to animals in a captive environment may be deemed unacceptable.

Research in captivity requires animals that behave naturally. If captive marmosets and tamarins are not kept in an enriched environment that in some ways mimics the wild, they will not be able to exhibit most of their wild behavioural repertoire. Much behavioural research in captivity will then be pointless.

#### 4.5.4 What if we don't enrich?

A lack of enrichment can lead to stress; McCallister (2005) found that callitrichids in a free-ranging environment tended to have lower cortisol levels than those living in cages, though the effects were not statistically significant. Chronically heightened cortisol levels are known to depress the immune system leading to the development of disease. Ultimately, this could be a cause of death.

Signs that a callitrichid's environment is inadequate include:

- Stereotypical behaviour
- Passivity/lack of responsiveness
- Aggression
- Aimless locomotion
- Loss of interest in play
- Loss of sexual interest
- Self-harm
- Eating disorders e.g., coprophagy

#### 4.5.5 Caution

Callitrichids are often extremely sensitive. Their disposition is to be alert to predators as they have many in the wild. The use of enrichment must not cause chronic stress. While brief periods of acute stress can be beneficial to immune function, chronic stress will cause immune function failure.

The aim is to mimic a natural existence to improve health and wellbeing and reduce stress caused by the captive environment; too much or too frequent alteration in their environment can be detrimental. As callitrichids use many different forms of communication – visual, vocal, olfactory – there is great potential to use many different enrichment techniques, but overuse of any or all could also be a cause of stress.



#### 4.5.6 Callitrichid ecology and foraging behaviour: implications for enrichment

The intelligence and inquisitive nature of callitrichids, and the fact that they use many parts of the forest environment that they have evolved in, makes enrichment both easy and cheap.

The evolutionary dwarfism that callitrichids have undergone means they can use a huge variety of substrates. They are able to move along very thin, flexible supports and also, as they have claws instead of nails on their digits, cling to large rough tree trunks. Providing the opportunity to move around on all these different types of support and substrate is a basic requirement of enclosure design as it enables individuals to develop balance and coordination and the ability to judge distance and use a variety of different methods of locomotion, including climbing and leaping. Natural branches also provide an abrasive surface to stop claws becoming overgrown.

One-third to one-half of a wild callitrichid's day is spent feeding and foraging. *Leontopithecus* and marmoset species tend to spend more time than *Saguinus* foraging (see Table). One of the primary needs in captivity is therefore to increase foraging behaviour and much enrichment is based on this.

Insects are an important component of the diet of all callitrichids, and they forage for invertebrate prey in foliage, tree crowns, leaf litter accumulations and very occasionally on the forest floor. There is thus the potential to provide enrichment opportunities at all levels.



*Free-ranging silvery marmoset in Jersey feeding on natural tree exudates.*

The fact that different callitrichids forage in different ways also needs to be taken into account. The various genera have evolved to fit many different ecological niches, and even within a genus there are differences in foraging techniques. We need to consider the natural foraging styles of each species in developing appropriate enrichment techniques.

Marmosets have dentition that enables them to gouge holes in trees to extract gum, while although tamarins eat gum, they have to take advantage of ready-made holes. Marmosets also use gleaning to gather insects from foliage, and a sit-and-pounce technique for catching prey. The vast majority of a marmoset's foraging time may be spent scanning for insects rather than in the active manipulative foraging that tamarins use.

Lion tamarins have long hands that they can use to reach into holes and into the deep centres of plants such as bromeliads. This behaviour is frequently seen in captivity as lion tamarins probe every conceivable nook and cranny that they can in an enclosure. Lion tamarins will automatically investigate a hole with their hands when presented with the opportunity and frequently do so while looking in a different direction. Other species, such as cotton-top tamarins, may be much more reluctant to reach into holes when they can't see what is in them (E. Price, pers. comm.).



*Leontopithecus* seem to use higher levels of the forest than other tamarins. Their extended digits could be an adaptation specifically for foraging in holes and the leaf axes of bromeliads. They need less disturbed forest with more tree holes and bromeliads. Hanging plants with their associated gaps and crevices are easily provided and will stimulate the natural foraging behaviour of lion tamarins.

*Saguinus* species use many different foraging techniques. Body size differences may be of fundamental importance, and the use of lower levels in the forest may aid in hunting for insects.

#### 4.5.7 An enriched environment

Most enrichment tends to be food-based and aimed at increasing the proportion of their active period that the animals spend foraging. With a high-quality complex environment, even a small space can provide much of the enrichment a callitrichid needs without the need for artificial devices.

Enrichment should therefore start with good enclosure design. Size isn't everything: quality is better than quantity. An enclosure should be designed as if it were a small chunk of rainforest.

Complex branching/rope systems provide opportunities to move on a wide variety of fixed and mobile substrates, mimicking the structure of a forest.

Planting is the easiest way to create a semi-natural environment for callitrichid species where they can express their natural array of behaviours with little interference from staff. In tropical climates this



*An outdoor enclosure for callitrichids in Jersey, showing natural trees, cover provided by climbers and other fast-growing plants, roping to provide travel routes, and rotting perching providing foraging opportunities.*

can be done easily with plants endemic to the region the species comes from. Small fruiting or flowering trees, whilst taking a while to establish, will provide sensory stimulation for the animals – not only by providing fruit/flowers but also by encouraging insects into the enclosure which the animals can then forage on naturally.

For new enclosures in temperate climates the best plants are evergreen shrubs and trees and fast-growing climbers; ivy, *Hedera* spp., is ideal. As well as providing substrates to forage in it also gives cover for these naturally shy animals, and in more tropical climates it also has the advantage of providing shade.

Large pieces of wood in the enclosures will provide natural perching initially but are also a support for climbing plants to grow up. In addition, as the wood decays, it will provide a source of insects which the animals will have to forage for as they would in the wild. A simple piece of rotting log will provide great enrichment as it is investigated and pulled apart.

If ground space is limited or cannot be planted, hanging baskets can be used, either suspended from the cage roof or attached to large branches/perching. Filling these baskets with climbers, trailing plants, herbs and flowers



can turn the most basic enclosure into a more naturalistic environment which can then provide the animals with sensory stimulation and enrichment.



*Emperor tamarin foraging in ivy.*

#### **4.5.8 Artificial devices**

Simple foraging devices are often useful in indoor areas during periods of bad weather or in climates which are less than ideal. Enrichment devices need to be cheap to make, quick to use and easily serviced within the husbandry routine, and ideally reusable. If too elaborate and time-consuming, they won't be used and will slip from the daily routine in a busy animal carer's daily schedule.

Providing several different enrichment items in enclosures allows members of the groups to forage independently and therefore relieves tension and prevents fights over food.

Most methods are aimed at providing food in a more naturalistic way, increasing foraging and handling time. Techniques include:





Hanging rotten logs/creeper-covered logs. These will maintain their own populations of insects and grubs or can be sprinkled with treats.

Hanging baskets/plastic crates. These can be filled with substrates such as straw, hay, wood wool or wood shavings and hung up in enclosures to create foraging areas. Again, sprinkling a few insects into the substrate will encourage natural feeding behaviours from the animals.

Gum feeding devices. Several possibilities are available; a “gum-tree” (McGrew et al., 1986) can be constructed (these stimulate the natural behaviour of marmosets, requiring them to gnaw holes into the wood before the gum can be extracted), or more simple methods can be used. Gum tends to be preferred in liquid form rather than as solid chunks (Herron et al., 2001), and will be consumed by most species, though it is particularly liked by marmosets and as they are obligate gum feeders it should be provided daily for these species.



should be provided daily for these species.



*Wooden insect house being investigated by pied tamarin.*

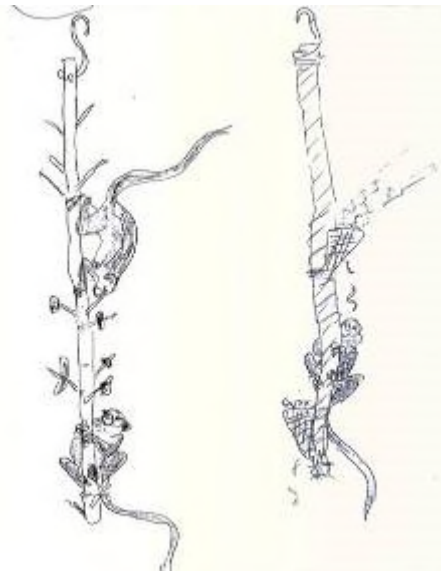

*Methods of attaching food to mobile structures such as hanging canes or ropes.*

Cane or rope “kebabs”, with fruit attached, so that the animals have to jump on to a moving substrate in order to reach the food.

Insect houses. These can be easily constructed and filled with bamboo pieces. These encourage self-sustaining insect populations into the animals’ enclosures which will in turn provide enrichment as the monkeys will forage constantly in and around the boxes looking for bugs.

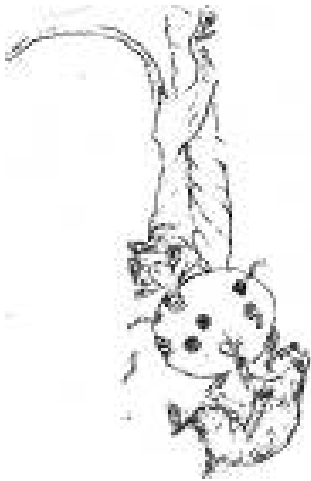

Coconut shell feeder



*Pied tamarin inspecting a log; mealworms or other treats are hidden in holes drilled into the wood.*



Puzzle Feeder

Logs or coconuts with large noies drilled into them. These are also a cheap but effective enrichment device. Insects can be introduced into the holes and will be released slowly, thus keeping the animals' attention for longer. Alternatively, honey can be put into the holes, encouraging the animals to manipulate the enrichment device and think up ways of retrieving the treat.

**Puzzle feeders, e.g., boxes with lids.**

A variety of food items can be used in these devices; insects are ideal. However, mealworms should not be used too much as their calcium-phosphorous ratio is not good. Care should also be taken not to use sweet foods such as dried fruit or honey too often as it can result in tooth abscesses. Goeldi's monkeys are particularly susceptible to these.

It is important that any string or cord used in the enclosures is not loose, making it possible for it to form a tourniquet around a limb – thick rope or chain is preferable.

**Other forms of enrichment**

While much enrichment is foraging-based, other forms of enrichment should not be ignored. A sprinkler system can mimic a rain shower and can encourage invertebrates into the enclosure during periods of dry weather when the enclosure may otherwise become quite bare. As noted previously, brief exposure to simulated predators can prompt rarely seen behaviours and increase social cohesion.



*Grooming platforms can be placed in sunny spots or under heat lamps.*

Simple platforms and shelters can have many benefits – marmosets and tamarins need the option to sleep in nest holes or rest in safe areas in the middle of the day. Clumps of lianas are often used by callitrichids as roosting spots (Van Roosmalen, 1981), and *Leontopithecus* uses tree holes for daily roosting activities.





Conduit tubing cut into sections provides shelter and privacy for the animals at very little cost. It can diffuse tension within groups as it allows cage mates a place to retreat to during conflict. It also gives nervous animals a place to hide when animal staff are servicing the enclosure.



*Pied tamarin with young on back using conduit tubing.*

It is also important to have resting platforms in high positions in an enclosure so animals can relax with a feeling of security – for this reason enclosures should be made as high as possible. Platforms also provide the opportunity for group members to groom one another, which helps in group cohesion. Such grooming is often observed on broad branches in the wild.

Olfactory and acoustic communication is also important for callitrichids. For example, occasional scent-based enrichment can be introduced, for example by putting a branch marked by another group into the enclosure. Aromatic plant scents such as

lavender and scented mayweed can be tried.

#### **4.5.9 Things to avoid**

It is important to make sure that the background noise level is not too loud as it may cause chronic stress. Laboratory guidelines on acceptable noise levels could be followed here, e.g., those imposed by the UK government (see United Kingdom Home Office, 1989).

It is also important to avoid over-cleaning so that scents communicating social information are not completely removed from the enclosure.

Social enrichment – the need for companionship – is vital. As all callitrichids are social animals they should never be kept solitary unless in extreme situations (such as abnormally aggressive behaviour). (See Section 4.3 on social structure.

## **4.6 Capture, handling and transport**

### **4.6.1 General principles**

The callitrichids can be said to be of a generally nervous disposition. This is probably a result of being highly tuned to avoid predators in the wild. When keeping marmosets and tamarins in captivity this should be taken into account during all aspects of husbandry, and possible or perceived threats should be eliminated as far as possible.

Handling should therefore not be part of any routine management. The capture of an animal should be carried out only by an experienced carer and only when absolutely necessary, as this will probably be one of the most stressful, and potentially harmful, experiences for a captive animal. Poor capture and handling can lead to tooth breakage or loss, limb fractures, and broken fingers and claws, all of which are avoidable.



Animals have been known to die during or just after capture and handling so methods which minimize any stress to the animal must be employed whenever possible.

It is also important to remember that the capture of an animal affects not only the animal being caught but also all those in the vicinity; frequent capture and handling can, therefore, create chronic stress and have a negative impact on the health of all animals nearby. Recurrent capture and handling will build a negative relationship between keepers and the animals they are working with, making the daily checks that are needed for these animals difficult.

The monkeys should not of course be pets but should have neutral relationships with their carers. This makes management easier, and it is likely that the animals will be healthier.

#### 4.6.2 When and when not to capture

The capture and handling of any animal should only be done if there is no alternative, and the decision should only be taken together by an experienced carer/ curator and vet, for example if the animal is suffering ill health or in extreme situations where an animal needs to be immediately removed from an area.

Although permanent ID marking, including insertion of microchips, tattooing, etc, requires animals to be caught up, it can usually be carried out when a specimen is having another veterinary procedure. Animals should not usually have to be caught and handled for any routine management such as weighing. Callitrichids can easily be trained with treats to sit on scales and be weighed (see Appendix 2) or to take oral medication, providing the carer has a good relationship with the animal. Relocating animals can also usually be achieved without handling, e.g., by transporting them in a mesh tunnel or their nestbox.

#### *Sexing animals*

When animals are caught up for ID-marking they should also be sexed. Callitrichids are relatively easy to sex; full details of the external genitalia and accessory structures are given in Hershkovitz (1977). In adults the male's scrotum and penis and the female's clitoris are easily distinguishable. In young animals, examination of the slit in the genital area determines sex. It is a small slit in the tip for males and a long slit running along the ventral surface for females.

#### 4.6.3 Methods of catching

##### **Tunnel**

Ideally, enclosures should contain a specific catch-up area – a tunnel that the animals run through daily works best, but a portable tunnel can also be very useful and can be used in multiple enclosures. A feed dish placed within the catch-up tunnel will get the animals used to using the tunnel every day. As for the vast majority of the time the animals will have no negative association with the tunnel, they will enter it freely, and on the infrequent occasions when an animal is caught by use of the tunnel it will not generally associate the tunnel with a trip to the vet centre.

The catch-up tunnel can be made entirely of metal mesh with a door at one end; the tunnel can be attached to the cage front with bungee cords, allowing for easy removal.



*Tunnel attached to front of cage, with string attached to door to allow it to be shut remotely.*



*Wooden comb used to divide, close off and move animals*

Once the animal has entered the tunnel the door can be shut remotely from the outside using a piece of string or wire. Alternatively the tunnel can be placed at the entrance/exit point between two areas of an enclosure that the animal uses daily so the tunnel is incorporated into the cage furnishings.

A wire or wooden comb that can be slid between the mesh can be used to secure the tunnel entrance and sheets or blankets can be used to cover the trap, giving the animal a dark environment that should minimize any stressful impact.



*Two golden lion tamarins trapped and separated within a single portable tunnel placed at the exit from their inside area.*



This method can also be employed when catching up groups, although it may take more time. It may also prove to be advantageous as either the entire group (when using a large catch-up tunnel) or several members at a time can be caught, limiting the group's exposure to stress. If a net was used to capture a group, by the time it came to the last animal's turn to be caught the individual would be highly stressed having seen its family netted, and the health risks and the risks of injury during capture would be significantly higher.

Separation of individuals within the tunnel can be accomplished using combs.



*A pillowcase placed over the end of the tunnel allows monkeys to be removed without handling.*

Removing the animal from the trap is simple: open the door, leaving the animal secured behind a comb, and place a pillowcase or similar around the entrance. Then, using the combs, push the monkey down towards the pillowcase. Once the animal has entered, the pillowcase can be closed and held.

A pillowcase is ideal as it allows the keeper to hold the monkey in the correct way whilst it is still being contained and allows the pillowcase to be peeled back so that only small parts of the animal can be exposed (i.e., head for anaesthesia mask or leg/back for medical injections).





Only when in the vet centre is the animal handled.

### Nestbox

In the unlikely event the monkey does not enter the trap, the next best method is to trap it in its nestbox. Often, if a keeper is in the monkey's enclosure, he/she can encourage it to enter the nestbox with treats or gentle pushing, or if the capture is planned for early morning or late evening the door can simply be shut once the animals have gone to sleep. Once secured in the nestbox the animal can be transported safely. Removing the monkey from the nestbox can be accomplished by running the animal into a mesh catch-up tunnel and then into a pillowcase as described previously.

If this procedure fails it may be necessary to handle the animal to remove it from the box. A pillowcase can be placed over a gloved hand, which the keeper then slides into the box. The keeper grasps the monkey and then pulls it out, covering the animal with the pillowcase as the hand is removed from the box. This method is usually the more difficult as the tamarin can press its back into the corner of the box, thus not allowing the keeper to obtain a safe grip on the animal. The animal will also use this position to bite the gloved hand trying to capture it, which can lead to tooth injuries.

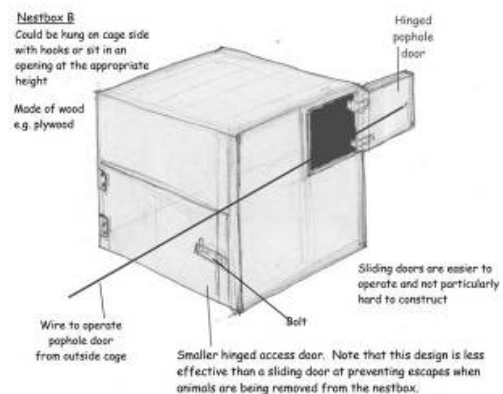

Using a nest box to capture a monkey.



## The net

**Capturing an animal with a net should be the last resort and undertaken only by a trained keeper.**

This method of capture can be extremely stressful for the animals involved and can often result in serious injuries to the animal. If a net is to be used the process should be as quick as possible and involve little or no chasing of the animal around an enclosure, and capture in the smallest enclosure possible is recommended. If a net is used it should be a light, easy-to-wield hoop. This should be fitted with a cloth bag rather than mesh, as the use of mesh bags can result in injury to trapped limbs.

The mouth of the net should be at least 30 cm diameter, and ideally should be padded around the perimeter.

When using the net method for catching an animal it is important to ensure that all other animals occupying the cage are separated off (either shut outside or separated into another area of the cage) to minimize the chance of them witnessing the capture and being stressed by the procedure. It may also be a good idea to have any other animals in the vicinity who will be able to see the process shut away in an area which does not allow them to see the catch-up.

With the tunnel method, as it is a minimal stress technique, it is not necessary to separate or shut away nearby animals.



*Cloth bag fitted to padded hoop (left); leather or suede gloves for handling (right).*

### 4.6.4 Handling

Handling should only be undertaken by an experienced carer. Damage is often caused during rough or inappropriate handling. The most common injury is that of teeth breakage, mainly canines. Injuries like this can lead to serious chronic long-term health issues. In extreme cases animals can die during handling.

The very fact of handling is extremely stressful and can be the precursor to a period of illness. Handling should be avoided before an animal is exported if possible as the added stress of travelling can cause serious harm.

All handling should occur outside and away from the enclosure the animal occupies, e.g., in a vet centre or another safe enclosed place. If animals are handled by their carers regularly within the enclosure, the relationship between the carer and the monkeys will break down. A negative relationship will make routine observation and other husbandry very difficult.

Whenever possible the handler should not let the animal that is being held see them. Callitrichids have very long memories!





The best grip to have is around the back just underneath the animal's armpits and can usually be achieved with only one hand. This allows the other hand to be free to peel back the pillowcase to present parts of the animal for veterinary inspection. The grip should not be too tight and if the animal bites into the glove the hand should *not* be pulled away as this will damage teeth – the glove should be removed when the animal relaxes its bite.

See Section 4.6.6 safety issues during capture and handling.

#### 4.6.5 Transportation

The transportation of callitrichids is one of the most stressful times and comes with the risk of health issues and, in extreme situations, death of animals in transit. Due to the risks involved, extremely careful planning should be undertaken prior to any crating and moving of individuals.

##### Planning a move

It is of the utmost importance to always double check that all parties and agencies at various points of the transit are aware of the details of the export. Constantly check updates on the travel arrangements to make sure there will be no delays and to lessen the chance that the crate is missed or not collected on time, which could have very serious consequences for the travelling primates. Make sure before sending that all concerned have the relevant contact telephone numbers etc. before proceeding. Track the transport if possible and ask for updates. Always double-check with the receiving institution about times and connections of transport.

The transit time should be kept to the shortest period and if possible, animal staff should travel with the monkeys to ensure their health, and check for any signs of undue stress. If possible, the crates should be delivered in person by the keeping staff who worked with the primates to be exported. If this is not possible, a trusted courier with experience of animal care should be used to ship the crate/s to and from institutions, airports, etc.

The very fact of handling is extremely stressful and can be the precursor to a period of illness. Handling should be avoided before an animal is exported if possible as the added stress of travelling can cause serious harm. Handling should also be avoided in the days/weeks after the transit, leaving the animals to calm down before any post import checks are carried out (see Section 4.6 on handling and transport).

Pre-export and post-export health checks that may involve handling and general anaesthetic should be carried out at least a week, and preferably longer, before or after transport to allow individuals to be as calm as possible and minimise the additional risk from the stress of transit.

##### Documentation and labelling

Make sure all the appropriate documentation is provided and is correct: lack of documentation will not only jeopardise the export, but may also cause extended delays which may be extremely stressful for the animals.

The container must be clearly labelled with the details of the sender and the receiving institutions. Make sure this is visible on two sides and on the top of the crate. The labelling must be securely attached and should not obstruct any of the ventilation apertures.



It is advisable to send all drafted documents to the authorities involved (BCP, CITES officers, Customs) 2 weeks ahead of travel for their review. Sometimes this is when a missing or incorrect document comes to light. Also, it is recommended to provide a set of original documents as well as copies, as these might be needed by the authorities and enables a smooth process.

### **Individual ID**

Before crating, all individuals must have a unique ID, usually a transponder chip or other recommended means of permanent ID (see Sections 4.7.5.5 and 4.9.3). This may be checked during transit by border control staff or others. The unique ID should correspond with the travel documentation accompanying the travel crate.

### **Transport: how and which animals.**

Animals should be in good health and considered fit to travel; veterinary and experienced animal staff should make this assessment prior to travel.

#### *Note that:*

Sick animals and pregnant or suckling females should not be transported.

Familiar animals should be able to keep in touch by seeing, smelling, and hearing each other.

Unfamiliar animals should be shipped in separate crates.

If more than one animal is to be transported in the same crate the individuals must have lived together in a socially stable situation before any export is considered.

It is usually the case that one or a pair of individuals that have been living together are exported in the same crate. Sometimes more individuals can travel in the same crate if it is big enough. Whole family groups can be exported and if scented material or some branching from their enclosure accompanies them and is installed in the new enclosure, it may help to prevent any destabilisation of the group, although normally family groups will remain stable after moves.

### **The crate**

An appropriate travel crate that can safely hold primates must be provided, together with security and cover to limit stress during the transit. Prior to export, the travelling crate should be placed in the enclosure with the animals to be exported so they can familiarise themselves with it. An item such as a piece of perching that has the scent of the animals on it can be placed in the container to help familiarise them with the space and thus help to reduce stress during transit.

The crate should ideally have two compartments to prevent draughts and to allow movement and seclusion at the choice of the animal. However, for air transport one should follow IATA regulations, which allows for only one compartment. Details can be found in the IATA Handbook which is updated annually (see IATA website, [www.iata.org](http://www.iata.org)). Some countries may also have specific requirements for crates and furnishings.

The compartments in the crate should be small so the animals cannot fall if there are sudden movements during transport and injure itself. Inside the crate they need some furniture (stick, piece of wood) to hold on to and stabilize themselves.



The crate should be made of wood and/or plastics. Metal gets too hot and is too noisy. Cardboard gets wet and is not strong enough. “Sky kennels” are a good option.

There should be no poisonous preservatives used in the wood or other material.

The crate should be well ventilated, but draughts must be avoided.

It should never be completely dark in the crate.

Since the crate is small it is advisable to give it some bright colours on the outside to prevent it from getting lost between other larger crates.

Handles or a bar around the crate should prevent neighbouring crates from closing off the ventilation holes.

Mesh on the outside of the crate must prevent people from putting objects or fingers in the ventilation holes, as well as stop the animals reaching their arms out.

One mesh window on the front and one for the inner compartment should allow Customs to see the animal. A burlap (hessian) cover/curtain should close the window on the outside to dim the light and prevent draughts.

The temperature in the crate should never drop below 15 °C nor rise above 25 °C.

There must be enough substrate (e.g. sawdust or wood chips) in the crate to prevent the animal from sitting in its urine and droppings.

Woodwool or similar material provides extra security and warmth.

The size of the crate should be at least 30 x 30 x 30 cm for a single animal crate and 40 x 40 x 40cm if a pair is transported in one crate.

The door or slide to open the crate/kennel should be securely shut and screwed shut, wired shut with a sky kennel. It should be relatively easy for those checking the health of the animals to open if there is concern for the health of any of the occupants. It should not be able to be opened with a simple latch or other mechanism that may be knocked and forced open in transit, doors/slide secured with screws and /or wire can be opened easily with the right tool but will securely keep the door shut during transit.

Food dish and water should be able to be accessed from outside crate. Food items can be added through a small flap cut in mesh and water bottle should be on outside of crate.



**Example**

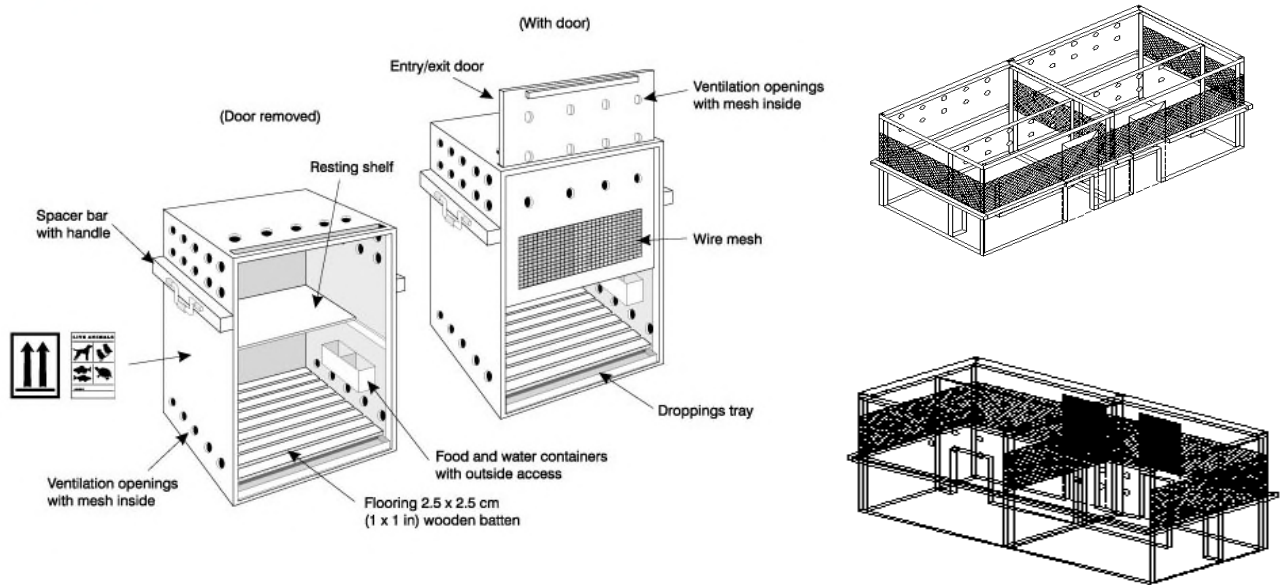

*(Left) "Sky kennels" can be used for transport. Note shavings, wood wool, food, water, and fine mesh and hessian covering openings. (Right) Examples of crate design. One with two compartments the other single.*

**During transit**

If the crate must wait to be picked up before or during any of the connections on route to destination it should be placed in a darkened area that is as far as possible from busy working areas while waiting to board the plane/train etc. Loud noise and bright lights will cause undue stress. Do not place the crate in a completely dark area.

**Diet, water during transit, and after arrival at new institution.**

At this stressful time, it is important to give individuals favoured food items and those that contain high water content, such as grapes, berries, cucumber etc. Water should be always provided and be accessible. This can be given via a small bottle with a ball bearing to avoid leakage during transit. This should be fixed externally and be easily removed for refilling.

Shipper instructions for feeding and watering must be given in writing and should accompany the shipment. If appropriate, over longer transits a record of feeding and watering should be made on the instruction document.



The details of the diet that the individuals are usually fed should be provided to the receiving institution so that the animals can continue with the same diet for several weeks after arrival. If the diet need to be changed, this should be done gradually.

### **Time of transport**

In countries of export or import with hot summers or cold winters, spring and autumn are the best times for transport. Otherwise extra care must be given to isolate or ventilate the crate. Ensure that the recipient of the animals knows well in advance of their arrival. Do not leave this for the transporter or carrier.

### **Post import medical checks**

Every examination that requires separation from group members and/or handling is highly stressful. It is important, therefore, to minimise handling during and in the weeks after transport. It is highly advisable to quarantine the newly arrived individual together with its future mate, if it is to be paired, rather than keep it 4–6 weeks in isolation. A complex enriched environment is as important during quarantine as it is before and after quarantine (see Section 4.5).

### **Important notes**

Many carriers limit or prohibit the carriage of CITES – listed species.

The size of aircraft compartment door and area of aircraft hold must be considered when determining the size of the container to be used.

Care must be taken to avoid physical contact with the animals by any couriers during transit. Diseases can be given to and indeed received from primates in transit.

#### **4.6.6 Safety during handling**

As even the smallest callitrichid can inflict deep bites, if handling is required it should always be done with gloves – preferably leather or suede, as if the animal does bite on the glove the material will be soft enough to minimise the risk of tooth damage whilst still preventing the keeper's skin from being broken. This is important as bites from primates carry the risk of disease transmission *both* from the animal to the handler *and* from handler to animal. As non-human primates and humans have a very high phylogenetic relationship there are a number of pathogenic organisms that can be transmitted. The risk may be greater than in handling other animal species.

NB. Marmosets and tamarins can bite through cloth. Surgical gloves do not give any protection against bites. See Section 4.6 for further comments on handling animals for veterinary procedures.

### **Minimizing risk of disease transmission**

It is very important for animal as well as human health that steps are taken to prevent direct contact – for example, the herpes simplex virus is present in 80% of humans, and is fatal to callitrichids. See veterinary section 4.7.4 for further information.

Health screening of animals for potential pathogens when leaving or entering a collection is a very important part of any health and safety protocol.



As the risk of disease transmission to and from members of the visiting public is very high if contact can be made through an animal enclosure perimeter, it is of the utmost importance that there is a standoff barrier around the front of the enclosure. This will also prevent any member of the public being bitten.

If there is any possibility of free contact between the public and animals, e.g., if monkeys are free-ranging, the situation should be closely monitored so that staff can intervene to prevent direct contact if necessary.



*A barrier inhibits any contact between primate and human visitors through a mesh-fronted enclosure.*

#### **4.6.7 Positive reinforcement training to facilitate improved medical management and welfare**

In zoos, training programmes are common for large carnivore and ape species due to necessity, as these species are often managed in a protected contact setting. Voluntarily shifting or recall training is an essential tool for the management of these species in zoos in order to enable care staff to carry out routine husbandry safely.

The widespread implementation of training programmes for callitrichid species has been slower to progress possibly due to the relative ease of capture and manual restraint and the low/minor risks associated with handling presented to keepers. However, for small prey species, of nervous disposition, one might argue that positive reinforcement training is even more important for them. Developing a positive relationship between a callitrichid and their human caregiver can lead to numerous benefits. Rather than being seen as a potential predator, the care staff can be positively associated with food.

At the most basic level, this will allow care staff to observe and monitor their animals more easily, Close observation of the animals in our care is essential for the highest standards of welfare. Negative associations with animal care staff, as a result of routine capture and manual handling, makes it





difficult for keepers to observe behaviour, locomotion, group dynamics as well as monitoring of health and if necessary early intervention to promote good welfare. Positive reinforcement training (PRT) can improve preventative health regimes by allowing close contact with animals and data collection, such as routine weighing, which can be used by veterinarians to assist with diagnosis of ill health.

It is the aim of this chapter to provide animal care staff with an understanding of the benefits of positive reinforcement training for the provision of the highest standards of husbandry and welfare for zoo housed callitrichids.

It is beyond the scope of this paper to discuss the science of operant conditioning and PRT in great detail, however it is important for readers to have a basic understanding of the various methods involved in operant conditioning and the reasons why PRT is the most suitable method to employ when working with callitrichids.

Operant conditioning is a type of learning based on the consequences of carrying out a particular behaviour. When an animal expressed a behaviour, did it result in a positive or negative outcome? Behaviours which are expressed which result in a positive outcome are more likely to be carried out in future, behaviours with a negative consequence are less likely to be expressed in future or at all.

Operant conditioning can be divided into four categories:

#### **Positive reinforcement**

When a callitrichid moves to a position underneath a basking spot, it is warmed in the heat. This leads to basking behaviours where the animal stretches out and lies down in the basking spot.

*Consequence* – The tamarin is **more** likely to sit under the heat lamp in future.

#### **Positive punishment**

An elder sibling takes food away from a younger sibling while it is being weaned onto solid foods. The sire chases away the older sibling while vocalising loudly. The elder sibling flees.

*Consequence* - In the future, the elder sibling will be **less** likely to take food away from its sibling.

#### **Negative reinforcement**

A young tamarin approaches the enclosure window when they see a visitor. Zoo visitors bang on the window.

*Consequence* - The tamarin is **less** likely to approach the window when they see visitors.

#### **Negative punishment**

A keeper hangs a gum log from a branch in a marmoset enclosure. The marmoset leaps from a branch onto the log causing it to fall from the branch into the water dish where it is inaccessible to them.

*Consequence* - The marmoset is **less** likely to leap onto the gum log in future

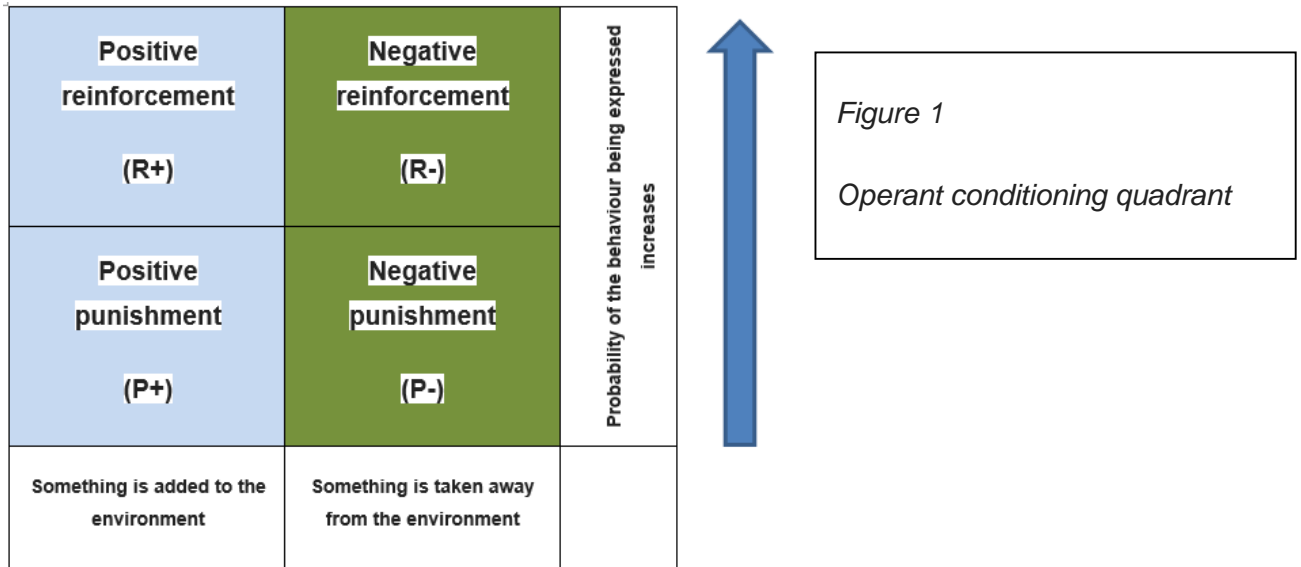

It is important to note that all of the types of learning described above *do* work to modify animal behaviour.

Before a training programme is initiated to modify a callitrichids behaviour, it is important to consider which method is the most appropriate to use.

Friedman (2010), highlights that both the intrusiveness of the procedure as well as its acceptability must be considered in addition to the effectiveness of the method.

The least intrusive, most positive and effective methods should be employed. This leads us to the use of PRT as it produces the least negative outcomes.

DEFRA (2012) states in the Secretary of States Standards for Modern Zoo Practice (SSMZP) that training methods should be based on positive reinforcement methods and that all training programmes should have a net welfare benefit to the animal. The EAZA standards for the accommodation and care of animals in zoos and aquariums (2019) supports this and highlights that PRT can be helpful in reducing stress and to facilitate management.

Positive reinforcement training (PRT) is a tool which can be employed by keepers to facilitate improved husbandry, welfare and medical management of Callitrichidae species.

Whittaker and Laule (2012) state that PRT for zoo-housed primates is particularly beneficial in the following circumstances

1. Voluntary co-operation in medical and husbandry procedures
2. Enhanced social management, utilising training that increases affiliative behaviours
3. Desensitisation to necessary techniques which could cause fear or discomfort
4. Increased environmental enrichment opportunities



Without husbandry training programmes, callitrichids may be unnecessarily stressed. Owen and Amory (2011) found that net capture of callitrichid species can induce high levels of acute stress that is detrimental to welfare. There is considerable behavioural and physiological evidence to show that positive reinforcement programmes reduce stress resulting from routine husbandry procedures in callitrichids (eg capture and handling in common marmosets (*Callithrix jacchus*); Bassett, Buchanan-Smith, McKinley, and Smith, 2003). In addition, use of PRT may yield more accurate physiological and haematological values when collected with an animal's voluntary participation in their medical management (Mattison, 2012), and therefore the correct treatment can be identified. Such voluntary cooperation may also lead fewer medical complications (Bassett et al. 2003).

Daily monitoring of an animal's health, monitoring of pregnancy, administering intramuscular injections, collecting samples such as saliva or urine can all be routinely achieved by keepers using PRT.

PRT programmes can provide opportunities for cognitive enrichment and an increase in control over their environment as highlighted by Wolfenson et al (2018). Control is a major factor in the relationships that we form with animals (Martin and Friedman, 2013). PRT creates learning opportunities which the animal can choose to participate in, providing an element of control. PRT provides opportunities for creating positive interactions between animals and their keepers.

It can be challenging to provide effective environmental programmes for neophobic individuals. Callitrichids with a positive relationship with keepers can be recalled to the site of an enrichment device and can be rewarded for interacting with it.

Studies on contra-free-loading have shown that many animals in certain circumstances prefer to work for a resources, rather than having free access to it and that provision of problem-solving tasks can result in a decrease in abnormal behaviours (Friedman, 2005). A lack of control can have negative behavioural and physiological consequences for animals and their care givers including depression, learning deficits, emotional problems and immune suppression (Friedman, 2010).

### **Which behaviours may be beneficial to train?**

PRT training programmes lead to improved relationships between keepers and the animals (Ward and Melfi 2015) and can be an enriching part of a zoo housed animals daily activity budget.

The speed at which a training programme progresses is due to a number of factors including the animals' environment, the animals' history, health status, the experience of the trainers and group dynamics. Generally, some behaviours are easier to accomplish than others for example station or target training are often easier to achieve than hand injection or urine collection. McKinley, Buchanan-Smith, Bassett and Morris (2003) showed that the time investment to train behaviours such as target training to allow in home-cage weighing, and urinate upon request in common marmosets is not excessive (i.e. 2-13 ten minute sessions per individual) and the benefits are recouped.

Mattison (2012) identifies three categories of behaviours which can be trained for medical management:



- **Foundation behaviours**

Re-call, target, and stationing are examples of foundation behaviours. Some of these behaviours may already be “trained” inadvertently through the animals daily husbandry routines. They are relatively quick and easy to accomplish and can be utilised by keepers during routine husbandry procedures on a regular basis.

- **Intermediate behaviours**

Crate training or aspects of manual restraint (eg entering a crush) are examples of intermediate behaviours. They are easier to train once several foundation behaviours are established.

Intermediate behaviours such as this are often maintained through weekly or bi-weekly training sessions or are carried out daily in advance of a veterinary procedure when required.

- **Advanced behaviours**

Acceptance of a hand injection or a mask for anaesthesia are examples of advanced behaviours. The final procedure as a result of the training can be slightly uncomfortable for the animal and so they can be the most challenging to train.

Certain basic or foundation behaviours such as recall or targeting can lead to more complex behaviours such as induction to anaesthesia or ultrasound.

For example, the targeting behaviour which allows for an animal to be positioned in front of a keeper can be used to position an animal onto a set of scales to be weighed or to manoeuvre an animal closer to or inside of a crate.

Behaviours 1-3 on the below list are useful foundation behaviours to establish which can assist with more advanced training programmes.

The behaviours listed below have a net welfare behaviour for callitrichids as they enable Zookeepers & Veterinarians to closely monitor health and facilitate improved husbandry routines.

### **1. Recall**

This is one of the most useful foundation behaviours and is very easy to establish. Asking the animals to come to you when requested in return for a food reward can often be learned within a few short sessions lasting less than a minute as long as a reward is provided each time the animals respond to the auditory cue.

For collections with callitrichids housed in large free roaming exhibits this is the quickest way to carry out daily visual health checks.

Asking the animals to come to you and to be attentive to your actions is an essential foundation behaviour which leads into every other trained behaviour you may wish to establish.



## 2. Target

Asking an animal to touch or hold onto a target (often a stick with an object on the end), can be very beneficial to train. While an animal is holding onto a target keepers are able to get more accurate weights, to move an animal into the required position for a veterinary exam and it can be used to apply topical medications to a specific area of the body or to undertake laser therapy.

## 3. Station

Requesting that an individual comes to rest on a particular place is very useful for a number of reasons. It can be an easy way of positioning individuals within a group so that a certain family member can be trained one on one while the rest of the family remain calm and on their own stations.

A tamarin or marmoset that has a solid stationing behaviour in place can be weighed, visually health checked, be medicated with reduced interference from the rest of their family and can be worked with while stationed on more advanced behaviours.

A callitrichid training station can be constructed in a number of ways; The most common type of station used for callitrichids is a fixed station or platform within the enclosure. The individual is rewarded each time that it moves towards and sits or stands on the platform when requested.

Moveable stations can also be constructed out of small pieces of astroturf or similar materials which trainers can move to different locations around the animals environment. A moveable station can be used in training crating or weighing behaviours.

**4. Crate training:** asking an animal to calmly enter a crate pre export reduces the risk of injuries being sustained through netting and manual restraint. It is also useful for weighing an individual and for veterinary procedures.

6. Weighing further details on scale training is in Appendix 6.2

7. Induction: asking an animal to calmly enter an induction chamber for anaesthesia utilising trained behaviour reduces the risk of injury to the animal in the process of capture and eliminates the risk of bites or other injury to keepers.

8. Palpation and/or Ultrasound

9. Injection: while not frequently utilized with zoo housed callitrichids, hand injections are able to be administered utilizing trained behaviour for things such as short acting contraception. The easiest way to administer an intramuscular injection for a callitrichid involves training into a crate with a crush as the injection is administered.

10. Stethoscope

11. Syringe feeding; this is useful to administer medications or can be used to encourage a callitrichid to remain in a certain position while other procedures are carried out (such as weighing, transponder reading or a visual health exam).

12. Urine collection



### 13. Transponder reading

#### **Antecedent arrangements**

Before we embark on a training programme it is essential that we consider the animals environment, behaviour, social grouping and any other factors which may impede the progress and success of the programme. There are two main antecedents, distant and direct, which will have an impact on the learning process. The distant antecedents are those which are species specific, the natural history and ethology of the animal. We need to research as much as we can about the species to find out what will play a part in the training process. What is our animal capable of, physically and mentally? What habitat do they favour? What is their natural activity budget? What are their senses – for example all male callitrichids are dichromatic (colour blind), whilst females may be dichromatic or have trichromatic colour similar to most humans. Understanding this should influence the choice of target colour (Buchanan-Smith, 2005). Much of this information for common marmosets can be found on the [marmosetcare.org](http://marmosetcare.org) website

Direct antecedents are the things that occur directly before a behaviour, in the wild these could be environmental changes such as rain falling causing an animal to seek shelter, in our training session it is conditioned stimuli such as a target stick appearing.

Consideration needs to be given to the training environment so that we are setting the animals up to succeed. Callitrichids are arboreal, live in familial social groups, diurnal, fast moving and most species spend a considerable amount of their time in the dense leafy forest canopy. Arboreal species will find it easier to learn new behaviours if they are trained at height (on raised platforms), rather than on the ground where the animals may feel more vulnerable. These antecedent considerations are based on providing a feeling of control in the environment.

Training groups of animals always raises challenges - do we separate to reduce competition for resources? Should we train together to ensure the animals do not experience separation anxiety? Social animals like callitrichids will be more comfortable if they are not physically separated from their family group but we still need to find a way of training each individual. One solution is stationing. A trainer can reinforce remaining calm on a station with the group while working with a particular individual with another behaviour.

Multiple trainers can also be effective at working with groups of callitrichids.

Delivering the food reward at exactly the right time can also be challenging – the use of the wooden stick with the reward on the end can help with distancing, and speed of delivery. A video example is shown here: <http://www.marmosetcare.com/care-in-captivity/handling-and-training.html>

Callitrichid species may be more comfortable and engage more with learned behaviours if the training area has visual barriers from the public, conspecifics and Zookeepers to reduce distractions.

#### **Selecting the trainers**

The natural laws of behaviour tell us that for each behaviour, there is an antecedent (something that triggers behaviour), and each behaviour has a consequence (something that follows it and determines





future probable behaviour). This is often referred to as the ABCs of behaviour and, according to Friedman (2009), this three term contingent is the smallest meaningful unit of behaviour analysis.

These behaviour sequences are constantly occurring in an animal's life, not just during formal training sessions, and every single interaction between a human and an animal is a potential learning experience. For example: a keeper opens a padlock on an enclosure door (antecedent), the tamarins recognise the sound of the keys and approach the door (behaviour), the keeper then places the food into designated areas and the tamarins obtain the food (consequence). In this scenario positive reinforcement is taking place as the behaviour of moving towards the door is reinforced (strengthened). The same sequence could result in negative reinforcement if the result of the animal approaching the door results in the animal being netted or herded into a crate.

Rewarding the requested behaviours consistently with the same clearly defined criteria, is a good way of communicating to an animal that if they offer behaviour X then consequence Y occurs.

Communication to your animal and consistency between trainers are an essential part of animal training, even once a behaviour is fully established, and it is important to make sure that all trainers are aware of body language and know the correct criteria for the target behaviour.

Clear, two-way communication is the cornerstone of successful animal training (Martin and Friedman, 2011).

Competent trainers will have undergone training themselves to learn about operant conditioning, and have practiced, and been observed training another human before they start training callitrichids. Poor training can lead to frustration, inadvertently rewarding undesirable behaviours and ultimately lead to welfare problems. Good trainers will have empathy with the animals to be trained, patience, a calm demeanour, be consistent in their behaviour and be able to analyse their own behaviour (Prescott et al. 2005).

Limiting the number of trainers involved at the early stages of a training programme to one or two members of staff is practical so that there is less inconsistency between trainers.

In fact, many recommend one person for the acquisition of new behaviors.

It is also important when selecting which staff will undertake a training programme, to evaluate the nature of the relationship that they have with the individuals or group.

Staff that have been involved with manual restraint and netting may have a negative association to the animals involved which may be expressed in the form of alarm calls, biting keepers or fleeing when they enter the enclosure. Staff with a more positive relationship with the animal will progress more quickly with training programmes but human - animal relationships can be strengthened using PRT (Ward and Melfi, 2015).

### **Reinforcers**

Before starting a training programme, it is important to identify what will be used as a primary reinforcer (what does the individual or group value and will be willing to express behaviours on cue to obtain).



Favoured food items from the diet are often used as primary reinforcers in training programmes with callitrichid species. In fact, the majority of all zoo animal training relies on food as the primary reinforcer.

Secondary reinforcers (also commonly referred to as an event marker or bridge) can also be a useful training aid and should be selected before commencing a training programme. Clickers are commonly used as they are cheap, easy to obtain, they can easily be affixed to training equipment for ease of use and many of them can be purchased with a cord to attach it to the wrist. However, whistles and a word can also be used. It is important to remember that the bridge has no innate meaning to the animal and must be paired with a primary reinforcer repeatedly for it to serve the desired purpose - which is to tell the animal when the correct behaviour criteria has been reached. For example, if the target behaviour is to get the marmoset to touch the target with his hand, marking the exact moment his hand touches it with a click or whistle can help it learn the correct criteria more quickly than without it as the specific behaviour has been highlighted or marked to clearly show the animal that the consequence of touching the target is that a reinforcer is delivered.

As with all aspects of animal training timing (contiguity) is key as is following up behaviour with reinforcer (contingency). A bridge must **always be followed up** with a primary reinforcer as the secondary reinforcer can never replace the thing the animal wants. Additionally, when used incorrectly, the bridge can lose any worth as a training aid (Friedman and Martin, 2011). For a video example see <http://www.marmosetcare.com/care-in-captivity/handling-and-training.html>

### **Motivation**

The process of building the desire to behave on cue for a chosen reinforcer is called motivation or motivating operations (Martin and Friedman, 2013), and is according to some trainers the single most important aspect of training.

Ideally, we should allow the animal to choose its reinforcer using a preference test by offering a variety of food items and count which one they prefer over a few attempts. Once a favoured food item has been identified from the diet (typically this will be livefood or food items which have the highest sugar or fat content), this should be isolated from the diet and only offered during training sessions to increase its value to the animal. The value of the reinforcer should be regularly re-assessed, and changed if necessary, to give the animal more choice during the training process. Hunger should never be used to increase motivation (Brown, 2012).

### **Shaping plans**

At the onset of a training programme, it is important to decide how the target behaviour will be achieved.

Complex behaviours such as injection training or presentation for ultrasound involve a series of behaviours being offered by the animal. The desired behaviour maybe one which the animal would not present naturally and so it is not possible to 'capture' it with reinforcement when observed.

Differential reinforcement of successive approximations (also referred to as shaping behaviour) is one method that trainers can use to ask for an animal to carry out a complex sequence of behaviours in exchange for a reward (Friedman, 2006).



Shaping of behaviour is commonly associated with B.F. Skinner who used operant conditioning and shaping behaviour to train pigeons in the 1930's to carry out complex chains of behavior in exchange for a reward (Gullapalli, 1997).

Shaping plans are a useful tool available to trainers as they enable us to methodically work through the process in small steps, only progressing onto the next step once the current behaviour is consistently offered when requested. If for any reason throughout a training programme, the animal begins to inconsistently offer the behaviour requested then the trainer can go back to the previous step in the shaping plan and continue from that point.

An example of a shaping plan for a red handed tamarin (*Saguinus midas*) to step onto scales on cue and wait is shown below:

- a. Look at scales
- b. Face scales
- c. Take a step toward scales
- d. Take two steps toward scales
- e. Walk up to scales
- f. Look at T-perch on scales
- g. Touch T-perch with hand
- h. Touch T-perch with both hands.
- i. Step into T-perch
- J. Step on T-perch and face trainer

#### **Duration and frequency of training sessions**

It is important to ensure that training sessions end on a positive note and that the length of sessions as well as the speed at which the programme is progressed should be appropriate for the species.

Knowing when to move between approximations of behaviour (the smaller criteria leading to the target behaviour) can be tricky. Sessions that are too long (>10 minutes) or are progressing too slowly between the stages can result in reduced efficiency - animals can learn one part of a behaviour so well that the next is harder to train. Conversely, moving too quickly can result in confusion and frustration resulting in a lack of participation or aggression towards conspecifics or keepers. With callitrichids, attention span and willingness to participate is very different across species (Savastano, Hason and McCann, 2003).

Salvastano et al (2003) described the results of the implementation of training programmes for 86 callitrichids in 26 social groups in Bronx Zoo. With the exception of the lion tamarin species, they found that tamarins typically were faster to approach and engage with their trainers and to learn new behaviours compared to marmoset species. The study found that marmosets had longer attention spans and took longer to begin engaging in training sessions than tamarin species.

Fewer, longer training sessions were found to be more appropriate for marmosets. One or two training sessions of 10-15 minutes in duration can yield positive results, compared to 5-10 shorter sessions (>5 minutes) for tamarins.



The level of participation in a training session by a tamarin or marmoset will vary between individuals due to the animals individual history, relationship with and experience level of the trainer and the training facilities available.

Each training programme will vary in the challenges presented and experienced callitrichid trainers will utilise an indepth understanding of the species natural behaviour and other antecedent arrangements before its onset.

Natural behaviour can be exploited (e.g. certain larger food items, such as a locust, may be taken from a trainer and eaten away from the group), enabling a trainer to work with individuals within the group who usually do not get first access to food or enrichment. Having two or more trainers can also be beneficial, so that a dominant individual who may be disrupting successful training, can be separated from the others. Training aggressive animals only after they had been fed eliminated aggression during training in common marmosets (McKinley et al. 2003).

### **Record keeping, documentation and evaluation**

Thorough and concise record keeping for training programmes enables trainers to effectively build on the work of the other trainers, increasing the speed at which a programme progresses.

It is important to describe behaviours in terms of their mechanics and to remove emotive language or to label the animals.

For example, in a training programme, a note may be that an animal behaved aggressively towards the trainer. This note is not very useful as the word aggressive is subjective and can be interpreted differently by each trainer.

By describing the sequence of observed behaviours, it is clear to all parties the specific sequence of events which occurred rather than the trainers interpretation of the behaviour which will vary.

Videos of training sessions can be a useful tool for evaluation of training sessions along with a training record card.

### **Summary**

It is inevitable that zoo housed callitrichids at some stage in their lives will require some form of medical management which can induce both acute and chronic stress.

Zoo housed animals often have significantly longer lifespans than their wild counterparts. Geriatric animals can require more frequent medical intervention and having a basic behavioural management plan in place can facilitate the increase in care required.

Some species of callitrichids are managed as an EAZA Ex-situ programme (EEP), breeding recommendations are often a necessary part of these programs. A recommendation can be issued for an individual to be transported to another collection as part of the programme.

There is increasing evidence that manual restraint and netting of callitrichids can result in negative outcomes for the animals involved.



Animal care staff have a duty to provide animals with the tools that they need to thrive within their environments.

PRT should no longer be considered an addition to an animal's husbandry but rather as an essential component of a basic husbandry routine.

The references to this section are at the end of the document.



## 4.7 VETERINARY: Considerations for Health and Welfare

### 4.7.1 Introduction

Before considering disease management in the Callitrichidae, it must be emphasised that the following basic husbandry foundations must be achieved first to ensure that these animals needs are met:

- Appropriate housing and environmental parameters
- Appropriate diet and water provision
- Appropriate social structure
- Appropriate enrichment and behavioural consideration
- Appropriate species selection for mixed exhibits, including appropriate demographic

These aspects of management are outlined in previous chapters and readers are advised to consider the needs of the specific animals in their care against the provision of the five domains as outlined in the WAZA Animal Welfare Strategy (Mellor *et al.*, 2015). Whilst not all diseases are a result of poor husbandry, provision of appropriate basic welfare needs for animals reduces the likelihood of disease outbreaks, avoidable mortality patterns and potential reduction in negative stressors. For instance, Steinmetz *et al.* (2011), demonstrated improved reproductive success, health and welfare between two groups of golden-headed lion tamarins (*Leontopithecus chrysomelas*) when comparing free-ranging animals to a group housed indoors under a different management regime. Many other similar examples are documented (Bakker *et al.*, 2015; Armstrong and Santymire, 2013). As part of any disease management programme, it is critical that the husbandry is reviewed and modified if found to be failing, especially considering any species-specific requirements and avoidance of applying a 'generic callitrichid' approach to the husbandry programme.

*Disclaimer: please note that many of the references concerning callitrichid health are predominantly with regard to common marmosets (Callithrix jacchus), or to a lesser degree cotton-top tamarins (4.6), as a result of these species being commonly used as a laboratory primate. There are considerable differences across the species and differences between the captive lab and the captive zoo management of primates. As such readers are directed to current zoo-based literature and knowledge of their own collection animals, accepting that there is useful cross over between the two health populations. The recommendations contained in this document are only intended as guidelines.*

### 4.7.2 Routine Observation

**It is essential that the different members of a family or group be checked at least daily.** This must include general appearance, behaviour, general demeanour and the animal's appetite. Observation should initially be from a distance with animals observed unawares and then followed up by closer examination to prevent animals from hiding any unusual behaviour. Using food rewards, insects for instance, offered by hand enables intimate observation of the general body condition, close examination of the face and mouth, quality of hair and coat, and any signs of pathology such as the presence of wounds, diarrhoea, excessive salivation, reduced movement or any abnormal swellings e.g., dental abscesses. It is vital that the observer is familiar with the normal appearance and behaviour for that individual, or, if not, that the observer discuss any abnormalities with a member of staff that is familiar with the individual animal.





If an individual behaves abnormally it is cause for concern and, at the very least, the specimen should be monitored closely. Veterinary examination is often preferred earlier rather than later if intervention is considered potentially necessary. Signs of disease are often difficult to recognize in callitrichids but a qualified and experienced keeper will know their individual animals and notice specimens exhibiting abnormal behaviour.



Medical training (examination & drug delivery)



Weighing *Saguinus bicolor* ©T. PETIT Zoo La Palmyre

Weight measurement is an extremely useful adjunct to visual observation. This can be relatively easily achieved through training supported by novel weigh scale designs which can include:

- Training to station into a small box placed on the scales (see appendix 2)
- Use of perching built into the scales and hand fed at the perch-scales with no confinement required
- Use of hanging scales as part of the routine enclosure design

### 4.7.3 Clinical Examination

Clinical examination follows on from routine history taking (anamnesis) and observation. Clinical examination is often important, but a veterinarian may not need to physically catch up the animal in certain, specific circumstances. Decision making can be undertaken on simple observation and consideration of the history for the individual animal, or those in contact with it, especially in situations where there are known pathogens in the collection. Accurate records are essential both from the veterinarian but also the keeping staff to allow evidence-based decision making to occur. Where a closer examination is required or samples are needed, then the primate must be caught for physical examination.

See Section 4.6 for physical restraint methods

Physical restraint is considered extremely stressful, especially for smaller primates. The keeper must work with the veterinarian to select the most appropriate method of restraint to achieve the desired outcome of the clinical examination. For even the larger callitrichids it can be challenging to obtain all but the basic samples and simple clinical examination can be challenging with the animal often struggling or calling. This must be weighed against a thorough clinical examination carried out under anaesthesia which, whilst less stressful, is not without its disadvantages also. However, if an animal



requires repeated examinations or sampling animals can be habituated to regular handling and blood collection (Kuehnel *et al.*, 2013).



*Physical restraint* ©T. PETIT Zoo La Palmyre

Whether conscious or under anaesthesia, clinical examination should consist of:

- Document the animal's identification (ARKS, tattoo and/or microchip number)
- Ensure the weight is recorded – if conscious it is often easier to do this first, especially if using perch type scales
- Confirm sex (even if already documented – surprising how many are sexed incorrectly but also useful to develop experience across the species)
- Physical examination including palpation of the abdominal cavity, the lymph nodes, and the bones and joints ensuring there is a good range of movement with the appendicular skeleton
- Oral examination – mucous membranes, lips and the dentition
- Auscultation of the heart and lungs – if conscious this is extremely challenging
- Body temperature – note can be increased if excessive chase or stressed animal, rectal can be challenging depending on the size of thermometer, consideration should be given to some of the paediatric auricular thermometers commonly available. Temperature reading subcutaneous microchips are particularly effective in callitrichids (Cilia, 1998).

Additional diagnostics tests are commonplace as adjuncts to the basic clinical examination:

- **Radiography** – simple and relatively simple to achieve under anaesthesia, two views essential to fully assess animals. Note with face mask inductions or maintenance under anaesthesia gaseous insufflation of the stomach is not uncommon. Wagner and Kirberger (2005a) provide a useful description of normal radiographic anatomy. Casteleyn *et al.* (2012) provides an excellent review of skeletal anatomy.
- **Ultrasound** – useful and can be performed without clipping in most Callitrichids, care not to cover in gel and monitor thermoregulation as easily become hypothermic if particularly long ultrasound procedure. Wagner and Kirberger (2005b) provide a useful description of normal



ultrasonography anatomy, with Oerke *et al.* (1996) providing useful descriptions of ultrasonographic reproductive assessment in common marmosets.

- **Electrocardiography** – simple technique, useful to file the ends of alligator clips to prevent trauma to the patient and care when applying spirit, paying attention to thermoregulation.
- **Non-invasive blood pressure monitoring** – NIBP can be a useful adjunct in both the conscious and the anaesthetised patient, it has been used as a link to both cardiac and other metabolic problems in common marmosets to great effect (Mietsch and Einspanier, 2015; Mietsch *et al.*, 2016)
- **Fibroscopy** – both oral and rectal routes have been performed, along with bronchoscopy.
- **Computed tomography** - CT has been described in a number of species, du Plessis (2015) is particularly useful description of normal CT anatomy of the Common marmoset. PET-CT is also being used experimentally and may have uses in a zoo and wildlife situation.
- **MRI** – MRI is well reported in callitrichids but higher rated machines or specialist equipment is often required to get resolution in the smaller patients, advances in paediatric MRI will transform small primate MRI in the near future. Normal anatomy is available for *Callithrix jacchus* (Newman *et al.*, 2009).
- **Clinical pathology** – biochemistry and haematology are well described for a large number of species, with values available for both wild, captive zoo and captive laboratory Callitrichidae. A selection of normal ranges for blood profiles are included in Table 4.7.7 and expected results can also be found in ZIMS Medical Resources



Colonoscopy

©T. PETIT Zoo La Palmyre

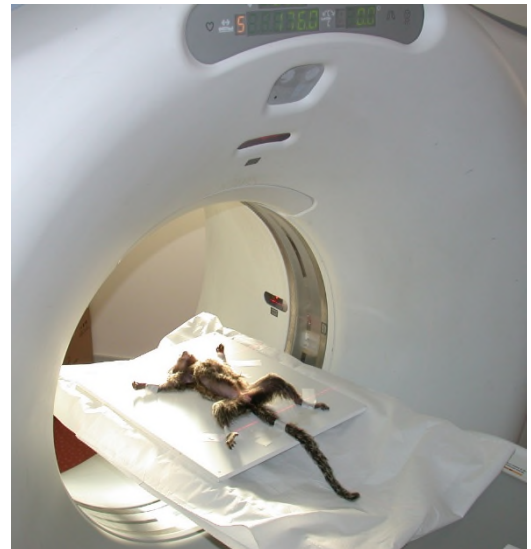

CT Scan examination of a *C. jacchus* specimen.

## 4.7.4 Preventative Medicine and Disease Surveillance

### 4.7.4.1. General Preventative Measures

High standards of hygiene are required in order to avoid the spread of pathogens:





- Food: dishes should be cleaned and disinfected daily, perishable fruits and similar items should be stored in a fridge, pellets and other concentrate food should be kept out of reach of rodents, birds, insects and feral cats.
- Water: containers should be cleaned and disinfected daily.
- Enclosures: foot-baths and pest control are needed. The role of transmission of disease by pest species is extremely important for many species, and specialist advice should be sought to reduce or eliminate them. This includes ticks, insects such as cockroaches, snails and slugs, rodents, birds and feral cats.
- Movement equipment: transport cages, bags and nets used for capture should be disinfected after use.
- Keeper hygiene: staff must adhere to best practice personal hygiene to prevent spread of disease to primates. In the case where infectious disease is present staff should review with the veterinary team any risks, particularly of note are cold sores of herpes simplex virus (human herpesvirus 1 and 2) which can be fatal to callitrichids.

## General preventative measures

- Hygiene: food, water, building,

capture nets, transport cages..

- Pest control

- Foot path



### 4.7.4.2. Disease Surveillance

Disease surveillance programmes can be as simple or complex as required by the collection and is often based on access to a veterinarian, financial resources and historical knowledge of the pathogen history of a collection. As a minimum a callitrichid disease surveillance programme should consist of:

- Daily observation and recording of any abnormal behaviour or other events
- Faecal parasitology and bacteriology screening a minimum of once a year, but preferably 6-monthly to assess for parasites and common pathogenic bacteria with treatment given accordingly



- Quarantine of all new arriving specimens
- Post-mortem examination of all animals, preferably including histopathology and other further diagnostics to ascertain any underlying pathology that may impact the living collection
- A robust zoonoses management programme that mitigates zoonotic and reverse zoonotic disease between keeping staff and animals
- (Opportunistic sampling)

Other testing can be undertaken as required by the collection veterinarian and suggested pre-import or quarantine testing are outlined below.

When the opportunity arises, following clinical examination or health reviews, serum samples should be stored at  $-20^{\circ}\text{C}$  or below. This serum bank can be very helpful for reference, retrospective serology and for various research works. Note, this must take into consideration national legislation and blood should not be taken solely for research unless under licence in certain countries.

Screening for pathogens in faeces or swabs should follow best practice. Some micro-organisms which are shed intermittently (e.g., *Salmonella* spp.) or do not survive very long after sampling (e.g., *Entamoeba histolytica*) may require special techniques or prolonged surveillance methods. When disease is suspected, it is essential that sampling technique follows best practice as outlined by the receiving laboratory to increase the chances of detecting these, sometimes delicate, pathogens (e.g., *Shigella* sp.). In some cases direct preparation in house can be more effective in combination with external lab sent samples.

#### 4.7.4.3. Quarantine

Prior to any animal transfer, the receiving establishment must be provided with a complete history for each specimen that includes:

- species and subspecies
- identification (including microchip, tattoo or other identifying method)
- age and sex
- rearing – hand-reared or parent-reared
- social experience
- current diet
- medical records
- training history

Pre-import testing is preferred to prevent an animal being transported that may have medical concerns that would prevent inclusion into the receiving collection's colony, however in cases where any abnormal findings are minor or can be resolved in quarantine then this should not impact any transfer of animals. The sending collection must provide documentation verifying that:

- The animal was either born at the premises of origin or has been there for at least two years (OIE recommendation).
- One TB test has been performed within 30 days prior to transport. Any reaction to human (mammalian old or human PPD) or bovine tuberculin is deemed positive. (OIE recommendation for primates is two TB tests within the 30 days – except in callitrichids).
- The sending collection has had no incidence of TB over the previous 5 years.



- Faecal screening for *Campylobacter*, *Salmonella*, *Shigella*, *Yersinia (enterocolitica and pseudotuberculosis)*, and parasites has been conducted within 30 days prior to transport.
- There has been treatment (with an avermectin) for any ectoparasites and endoparasites within 30 days prior to transport.

Additional tests that are useful and may be requested as part of pre-movement screening:

- Radiographs – whole body lateral and VD
- Biochemistry and haematology (with serum stored)

**All callitrichids entering a collection should undergo quarantine isolation.** The details of such a procedure may sometimes be required in the veterinary import conditions in case of an international transfer or as part of balai legislation.

If not otherwise specified by the import requirements, this period must be at least 30 days, increasing up to 12 weeks if animals are coming from the wild or a collection without veterinary supervision (e.g., a confiscated animal). It should be clearly understood that such a short term covers only the incubation period for most of the bacterial and viral respiratory and enteric diseases. It will not cover some of the longer incubating diseases such as tuberculosis, which can take as long as 6 months or more before clinical signs are noted. Therefore, if not already done so, surveillance testing must be performed in order to establish the health status of the newly received animal. The following should be done soon after arrival in addition to the tests outlined above:

- identification check
- sex confirmation
- weight record
- clinical examination

Social animals require group quarantine which may require co-terminus with already resident animals and therefore pre-export testing is paramount in these cases.

Quarantine facilities must comply with national and EU legislation. This often requires double-fencing with a gap of 3m from any other resident species, unless solid construction to avoid droplet transmission. Ventilation must be secure enough to prevent primate escape (double wire mesh advised). Provision for separation and treatment of individuals within isolation unit. PPE must completely cover the body, and masks and eye protection should be worn (unless the local veterinary authority agrees otherwise). Any incident exposing humans to primate blood or saliva must be reported immediately to the local veterinary authority. Staff must not eat, drink or smoke in the isolation unit. Staff must report any personal illness to their supervisor. Hand-washing facilities must be present in each animal holding room with hot and cold running water, and the staff must use them regularly. Footbaths (using approved disinfectants agreed by the local veterinary authority) must be used between each animal holding room, and each room must have dedicated equipment that is not transferred between enclosures.





#### 4.7.4.4. Post-mortem Examination

**A complete post-mortem examination should be carried out on each dead callitrichid even if the cause of death is already known.** This is very important because this provides a check on the presence or absence of concurrent disease that may be relevant for the surviving members of the colony.

Likewise, newly born and dead callitrichids must be necropsied. For obvious management reasons it is very important to differentiate still-born animals (due to infection, inadequate nutrition, other) from newborn which are born live and then killed or abandoned by the parents at birth.

Microscopic examination and other tests for parasites, bacteria and even viruses should follow a macroscopic post-mortem examination.

Necropsy should be carried out as soon as possible after death. If there is a delay, the body should be stored in a refrigerator (but not frozen) to reduce autolysis. Following post-mortem examination, relevant tissues should be stored as fixed tissue for future examination. It is also useful to consider storing plain tissues at  $-20^{\circ}\text{C}$  or below. This may allow further diagnostic analyses at a later date and may be useful for research purposes. In the case of those species in breeding programs, the Species Coordinator should be contacted for special requests regarding tissue and data collection, it is useful to be aware of any current tissue requests prior to death to facilitate rapid and effective sample collection.

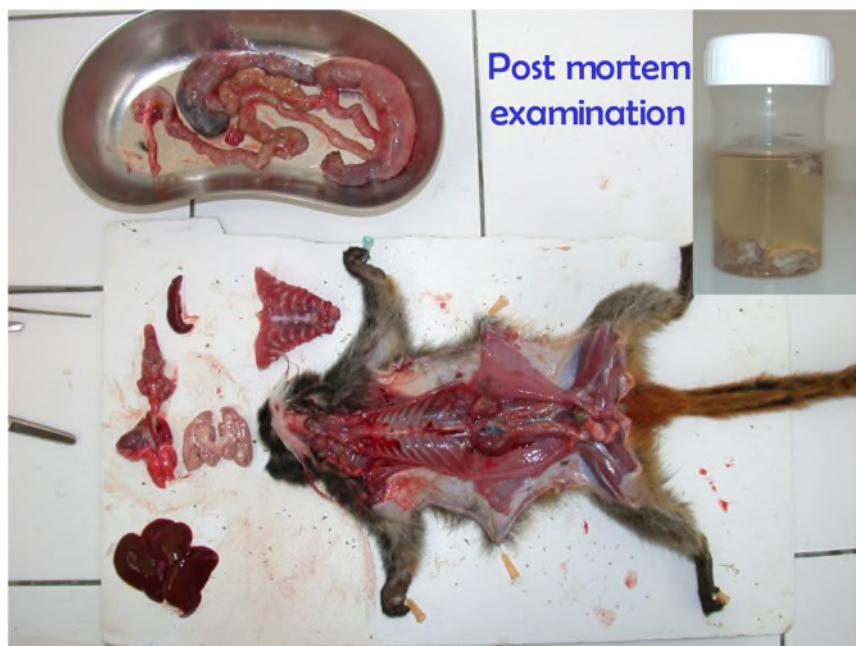

Necropsy of a *Saguinus imperator*

It is important that the coordinator routinely receives a copy of the post-mortem report in order to monitor widespread health problems for the species. A post-mortem report should ideally be written in English or at least the main points should be translated into English. A minimum standard should include following information:

- individual data: species (English and/or scientific name), age, sex, identifiers (transponder, tattoo, etc.), housename, local ID and/or studbook no.
- condition: body condition, weight,
- contraception status (presence of, type, and when administered)



- main findings in gross pathology
- main findings in histopathology
- identified agents (parasites, bacteria, viruses)
- diagnosis including cause of death
- any other relevant results

Specific health problems may occur in some callitrichid species. If specific examination of dead specimens is required or special tissues/organs should be collected, the coordinator must inform all participating institutions that this is required (Section 4.8).

#### **4.7.4.5. Vaccination**

Restraint for vaccination can be a very stressful procedure and vaccination programs must not be implemented without due consideration.

Killed virus preparations for vaccination against tetanus and rabies should be considered for animals with outdoor access in endemic areas. Measles vaccination is also reported, especially if callitrichids are maintained in close contact with keeping staff.

Tetanus - vaccination with IM tetanus toxoid has been described in common marmosets at 0 months, with boosters at 3 months and 12 months (NEUBERT et al., 1994). Alternative regimes are described. Boosters advised at intervals of between 5-10 years.

Measles – vaccination with live attenuated measles vaccine must not be used in callitrichids as it may lead to disease and even fatalities. Inactivated (killed) measles vaccine is available in some countries but is discontinued in others due to associated health risks and poor protection compared to the live vaccine in humans.

Rabies – killed rabies vaccine must be used. Annual revaccination likely required but not reported in callitrichids. Common marmosets are reported to be a potential source of exposure for human cases of rabies (Favoretto et al., 2001) and care must specifically be taken for any field programmes or when working with wild caught specimens.

Yersiniosis (pseudotuberculosis) – available from Utrecht University (NL) but its effectiveness is still questionable, protocols are described (Bielli et al., 1999). Autogenous vaccines are probably another option to use.

Tuberculosis - Vaccination with BCG for tuberculosis is not recommended for primates. It only provides short lived protection in non-human primates but more importantly there is no way of distinguishing between tuberculin reactions from BCG vaccination or natural infection.

When vaccines are used the type, batch number and source of vaccine should be recorded in the medical records, as well as the site of injection in the case of injectable products.

Recommendations on vaccination programs for primates can be found in Lewis (2003), Mahoney (2005) and Voevodin and Marx (2009).



#### 4.7.4.6. Zoonoses

Various pathogens can cause disease in both humans and callitrichids and the risk of transmission between the two groups always exists. Most zoo animals are now captive bred and the risk from exotic pathogens is very low.

Diseases may spread by various methods such as physical contact (bites, scratches, exposure to excreta), ingestion and air transmission. Common sense hygiene measures are vital in order to avoid exposing keepers to these risks, they include:

- frequent hand washing
- wearing specific work clothing
- using disposable gloves in case of handling
- keeping hands away from the face
- eating, drinking and smoking in animal areas should not be allowed.

all bites and other injuries should be reported, cleaned, disinfected and treated, if necessary, as soon as possible, according to a protocol set up with the organisation's occupational health support or a local human medical practitioner

Pregnant female keepers may need to stop working with primates due to these considerations, as well as immuno-suppressed workers.

Similarly, keepers should be monitored since they may shed relevant pathogens.

Yearly keeper tests for faecal bacteria and parasites, throat swabs for *Streptococcus* and *Haemophilus*, skin-tests for tuberculosis should be considered, but may not be appropriate for all collections. Moreover, sick staff members should not work with primates or prepare food since cold, flu and other viruses could then be passed to the colony.

***It should be noted that Herpes simplex (common cold sore virus) is fatal to callitrichids.*** Keepers and other personnel with cold sores should not be allowed to work in callitrichids areas (see Section 4.7.6.6 on Nervous System). People other than the relevant zoo staff should not be allowed into callitrichids housing areas. General information on the risk and prevention of primate-primate (including human) disease can be found in Lewis (2003).



Many callitrichids are utilized in walk through exhibits and particular care must be taken in surveillance programmes for zoonotic disease as best practice but also as part of national zoo licencing legislation.

Keeper with mask and disposable gloves

#### 4.7.4.7. Mixed Species Exhibits

Mixing callitrichids with other callitrichids species or other primate or non-primate species is a common practice but must be carefully considered especially with regard to disease management.



A comprehensive description can be found in Section 4.3.6.

## 4.7.5 Therapeutics

### 4.7.5.1. General

Administering treatment to a callitrichid can be challenging if attempting without physically handling the animal. The standard routes of administration can be utilized and maybe used as preventative or responsive therapy. **It may be necessary to treat all the family members or indeed the entire collection in case of a contagious disease.**

Any sick animal may require isolation for prolonged treatment and care, however such a situation is stressful and may lead to the eviction of the individual when reintroduced to the family group. This must be kept in mind and the isolated individuals should at least have visual and auditory contact with their relatives whenever possible. Keeping a specimen to be treated in a small mesh cage inside the main enclosure may be a solution, unless a contagious disease is suspected and the risk versus the benefit is considered too great.



*Isolated specimen with close contact with others ©T. PETIT Zoo La Palmyre*

Heating and supportive therapy are of utmost importance in these small species with limited reserves. Fluids can easily be given subcutaneously or intraperitoneally, the latter route being highly recommended in case of emergency. Intravenous infusions are possible but difficult to perform and one can try the intra-osseous route (femur). It is sometimes useful to force-feed sick callitrichids with liquid food or food substitutes used for human therapy.

In general, seriously ill animals often do not respond well to treatment so the emphasis must be on prevention of disease.

**Physical restraint:** The animal can be held with leather gloves or just disposable gloves if the animal is weak or sedated. Attention must be paid to its teeth. Even weak animals can administer a deep bite, which carries a risk of infection. This is a particularly important consideration with sick animals that may be suffering from infectious diseases. One hand stabilizes the upper body with the thumb and the forefinger around the neck; the other hand holds the hind legs. Another possibility is to hold the arms in the back of the specimen. See sections 4.6 and 4.7.3 for more details.





#### 4.7.5.2. Administration

Specific treatment may be given by different routes such as parenteral (IV, IM, SC, IP, IO), local or oral. As a result of their relatively small size (body mass 100g-800g) precise calculation of dosage of treatment is very important.

**Per os (PO):** The oral route depends on the appetite of the specimen and injections should be preferred if the primate is anorexic. Administering the treatment in the food given to the whole group is possible but may lead to very variable intake due to food preferences, hierarchy and even compatibility with the food (Carrere, 2016). Palatable pediatric treatments for human babies can be very useful for acceptance of oral therapy. Medical training can be used in order to make the specimens individually receptive to a syringe with a liquid with or without medication. Nasogastric tubes have been reported in marmosets (Fortman *et al.*, 2002).

**Intravenous (IV) / Blood sampling:** The specimen may be anaesthetised or not, it is recommended in all but a few rare cases anaesthesia be used to facilitate blood sampling or IV injection to reduce stress to the animal and potential damage to the small veins. The most common site for blood sampling or intravenous administration is the femoral vein. The animal is held on the back, the thighs being opened or the animal is placed in lateral recumbency and the upper limb lifted to reveal the medial aspect of the lower limb. The femoral vein can often be seen without the need for clipping, if not the femoral artery and the more superficial femoral vein can be located by palpation of the arterial pulse. A 0.6 to 0.8 mm diameter needle is inserted into the vein and 1ml or more blood may be drawn dependent on the body size of the species in question. Note when using extension tubing on needles the clinician must consider the additional dead space in the tubing when withdrawing blood. An alternative site that is useful, especially in the shocked or recumbent animal is the jugular vein. Intravenous cannulas can be placed but are often only tolerated in the moribund animal, for any short to long term fluid or IV support consideration should be given to the placement of intra-osseous canulae instead.

Section 4.7.7 provides tables on haematological and serum biochemistry reference ranges for a number of select species. More details may be found for additional species in ZIMS medical.



*Femoral vein & jugular vein / blood sampling ©T. PETIT Zoo La Palmyre*

**Intramuscular (IM):** IM injection is relatively easily administered in both the conscious or the anaesthetised animal and is the most common parenteral administration route used. Care must be given that the volume of injection is not excessive in relation to the body size of the species being treated. The muscle group used is limited by the size of the animal and the access available during



restraint. The anterior muscles of the thigh are most commonly used and most easily accessible, but consideration can be given to the caudal muscles of the hind limb, the lumbar and pelvic musculature and those overlying the humerus.

**Subcutaneous (SC):** SC injection can be useful especially to deliver fluids. The skin over the dorsal aspect of the small primate is relatively loose and is the most common site used. Again care must be given to the volume injected and the reason the route is being selected. In moribund patients, especially those that are hypothermic, SC administration may be poorly absorbed and consideration should be given to more direct routes in critically ill animals e.g., intra-osseous.

**Intra-peritoneal (IP):**

The animal (anaesthetised or not) is held on its back. The abdominal muscle is elevated by pinching it between the thumb and the forefinger at the midline. Once the needle has penetrated the abdominal wall, it can be readily palpated within the abdomen to assure that the injection is not within a loop of bowel or is subperitoneal.



*Intraperitoneal injection* ©T. PETIT Zoo La Palmyre



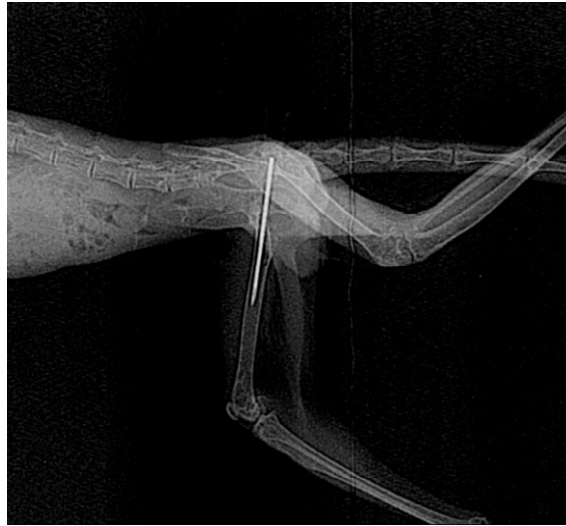

*Intraosseous injection & X-Ray control ©T. PETIT  
Zoo La Palmyre*

**Intra-osseous (IO):** Baitchman *et al.*, 2006 describe the use of intra-osseous cannula using a 22 gauge, 3.8cm spinal needle placed into the femur. Alternatively, hypodermic needles can be used but these pose the risk of becoming blocked with bone or tissue during application. Intra-osseous cannulae are well tolerated and are useful for short to medium term fluid therapy and for administering intravenous analgesia, antibiotics and other pharmacological agents. Using radiography can be useful to confirm location and should be performed using two views to ensure location is appropriate.

**Intra-dermal (ID):** Intra-dermal techniques are primarily used for allergen testing either for tuberculosis testing or for other allergen testing such as food intolerances or suspected skin complaints. The most common use is for tuberculosis testing. There is no universally accepted method for tuberculosis testing of primates. The method generally recommended is the intradermal injection of 0.1 ml of tuberculin at the edge of the eyelid or on the abdominal skin. The abdominal site is preferred for the small species like the Callitrichidae where the 0.1ml volume can be damaging to the eyelid structure. Bovine and avian PPD are usually used and swelling and/or erythema occurring within 72 hours is considered a positive result. Other tests may be tried in suspect cases (serology, radiography, bacterial culture, others) but they are not routinely used.

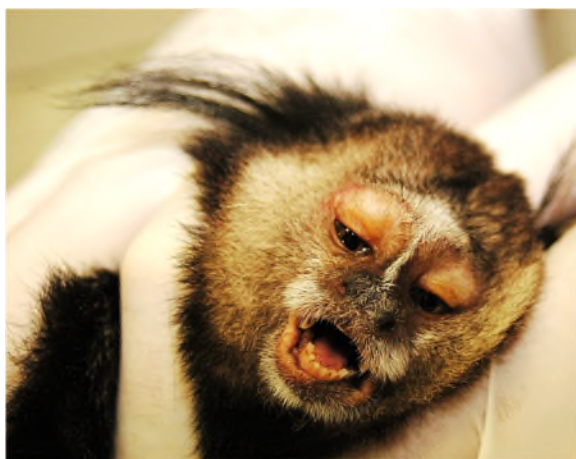



TB skin test ©T. PETIT Zoo La Palmyre

**Topical:** Topical application of many drugs is possible but care should be taken to prevent ingestion by the individual animal or other animals if grooming. This is relatively simple and can be applied anywhere but behind the head or between the shoulder blades can be utilised. If required animals can be temporarily separated whilst the agent dries, as described above.

#### 4.7.5.3. Anaesthesia

**GASEOUS ANAESTHESIA:** The most commonly used method for anaesthetising callitrichids in zoos is using gaseous (or volatile) induction either via induction chamber or via gas mask following physical restraint. Anecdotally the use of induction chambers appears to be less stressful and the occurrence of aerophagia appears reduced when compared to physical restraint and facemask induction. One of the authors has worked with keepers to design nest boxes so that the animal can run into the nest box which is then closed and removed from the wall and acts as the induction chamber.



**INJECTABLE ANAESTHESIA:** Non-volatile methods can be used in callitrichids with intramuscular injection being the most common with ketamine alone or ketamine and a tranquilliser/neuroleptic drug (xylazine, medetomidine, acepromazine, diazepam, others) or tiletamine and zolazepam. When using ketamine and medetomidine the antagonist atipamezole can be given and then recovery is much quicker. Gaseous anaesthesia can be used as an adjunct to non-volatile inductions to prolong anaesthesia.

Reported intra-muscular injection techniques reported include:

- 10-20 mg/kg ketamine
- 2 mg/kg ketamine + 2,5 mg/kg xylazine
- 5 mg/kg ketamine + 100 µg/kg medetomidine
- 8-10 mg/kg zolazepam + 8-10 mg/kg tiletamine



Care must be taken as the volumes are often small and any errors in administration can prolong anaesthesia or have other profound effects.

#### 4.7.5.4. Contraception

Breeding program recommendations sometimes require temporary or permanent suppression of reproduction in some groups. This can be achieved through different techniques such as:

- **TEMPORARY:** a number of different methods (injections, hormonal implants) have been used in callitrichids. See Section 4.4.7.3 for further details.

- 



- **PERMANENT:** Ovariectomy, ovari hysterectomy and hysterectomy as well as vasectomy (Morris and David, 1993) and castration are all reported in the literature. The surgical techniques are similar to the classical ones for other mammals. For recommendations on procedures to use please see Section 4.4.7.7 for further details.

**The Species Coordinator must be consulted in all cases of temporary or permanent contraception of animals in coordinated breeding programs**

Ovariectomy in a *Callithrix geoffroyi*

#### 4.7.5.5. Microchip Identification

The microchip is a useful method for permanently identifying individual animals. The microchip should be inserted subcutaneously between the shoulders. It has been reported that the implant may migrate and may even be lost via the insertion site or later. To potentially avoid this problem, insert the microchip in a caudal direction towards the tail, i.e. caudally to the insertion site to reduce the likelihood of migration back through the insertion site. The site may also be sealed with a drop of tissue adhesive although this is not always necessary.

### 4.7.6 Common Disorders (brief description, treatment and prophylaxis)

#### 4.7.6.1. Digestive system

Faecal analyses (cytology, Gram coloration, occult blood, parasites, bacterial culture) are of the utmost importance. They help diagnose infectious versus non-infectious diseases and guide the first intention treatment.





**Bacterial infections:** *Salmonella*, *Shigella*, *Campylobacter*, and *Yersinia* are classically involved in severe enteritis and therapy necessitates antibiotics as well as fluids, gastrointestinal protectorants and even corticosteroids (against toxins). As the faecal-oral route is the common mode of infection, hygiene and sanitation are of utmost importance for other primates and for the keepers.

**Pseudotuberculosis** due to *Yersinia pseudotuberculosis* may cause an acute disease with lethargy and diarrhea or, more commonly, a chronic infection with loss of weight. The post-mortem examination reveals an ulcerative enterocolitis and the presence of numerous small necrotic foci in the mesenteric lymph nodes, and often most noticeably in the liver and spleen. It is not possible to macroscopically differentiate the infections caused by *Y. pseudotuberculosis* from *Y. enterocolytica* and from tuberculosis or tularemia. It is therefore very important to ask for bacterial culture. It is thought that the pathogen is transmitted by ingestion of food contaminated by rodents and birds. Hygiene of the food (storage and preparation) is the best way to avoid this infection. A dead vaccine has been produced and delivered in Europe but its effectiveness is questionable.

Severe gastroenteritis is also observed in cases of leptospirosis and rodents are also the source of contamination of the environment.

Also ***Clostridium piliforme* (Tyzzer's disease)** has caused fatal necrotizing typhlocolitis in two post-natal cotton-top tamarins.

**Viral infections:** "Callitrichid hepatitis" or lymphocytic choriomeningitis is a viral disease so far only found in zoos. There are few specific clinical signs and mortality rates are high. Necropsy findings include swollen liver, fluid in body cavity and occasionally hemorrhages and jaundice. It is caused by an Arenavirus carried by mice and a classical mode of transmission to callitrichids is by feeding them pinkies. It is not recommended, therefore, to offer these items. They can also be contaminated when hunting and eating wild mice.

**Severe gastroenteritis may be due to measles or Hepatitis A viruses.**

**Parasites:** Each time a diarrheal episode is investigated, a faecal screening for parasites is necessary. Drawings of the most common parasites ova found in primates can be found in Fowler (1986). Finding a new parasite in a collection must lead to investigate the parasite life cycle and to control the intermediate hosts when they occur.

In the case of nematodiasis (e.g., infection by *Strongyloides* spp.), a drug of the benzimidazole family or Ivermectin must be used.

Treatment for *Prostenorchis elegans* is much more difficult. A high dosage of mebendazole (100 mg/kg) may be unsuccessful and surgical removal of the digestive worms may be required. Cockroaches are the intermediate hosts of this parasite.

In case of *Capillaria hepatica* infection, eggs and adults are found in the biliary ducts of the liver. These eggs are not shed in the faeces and examination of the stools is of no help for the diagnosis. Unembryonated eggs are shed by rodents and must pass through the intestine of a carnivore before becoming embryonated and being ingested by a new rodent or accidentally by a primate.

*Gongylonema pulchrum* is a parasite of the mouth, lips and esophagus.



*Trichospirura leptostoma* is a parasite of the pancreatic duct and can lead to a wasting disease (see specific chapter below). Flukes parasitizing biliary tract are also known.

If amoebiasis (e.g. infection by *Entamoeba histolytica*) is recognized, the treatment requires metronidazole. The same drug can be used for *Giardia* which causes diarrhea and malabsorption.

*Cryptosporidium* is a Protozoa which can cause severe enteritis and death. No specific treatment is available and a thorough disinfection (using disinfectant for coccidiosis) of the enclosures should follow this diagnosis.

**Fungi:** Moniliasis is caused by *Candida* sp. This fungus normally occurs in the digestive tract and infection classically occurs in the mouth and the intestines after a prolonged antibiotic treatment. If necessary, it may be treated with amphotericin B or miconazole.

**Inflammatory diseases:** Non infectious diarrhoea may be due to diet and/or stress and inflammatory colitis resembling Crohn's disease in man can be seen. It generally severely affects the general condition of the callitrichids (see specific chapter below).

**Hepatosiderosis: Hepatic hemosiderosis is an important cause of debility and premature death in captive marmosets.** Studies indicate that the dietary iron intake can directly influence hepatic iron concentration in these primates. The dietary iron content should be investigated if such a liver lesion is recognized. The National Research Council's recommended value is 180mg/kg of diet. One must also consider that the vitamin C enhances gut absorption of iron and, consequently, citrus fruits should not be part of the diet.

**Hyperbilirubinemia** is found in golden lion tamarin females where this benign pathology causes jaundice. Affected specimens are removed from the breeding programs because the etiology is not understood.

**Gall bladder stones:** These cystine stones have been found in several species, mostly as incidental radiographic or post-mortem findings. But they can cause cholelithiasis and even lead to perforation of the gall bladder and, then, peritonitis. This is a great cause for concern in lion tamarins, there is no known specific cause.

**Gastric bloat:** This acute condition occurs for unknown reasons and may be associated with other conditions such as diarrheal episodes. It requires immediate relief via intubation of the stomach.

**Neoplasms:** Colonic adenocarcinomas associated with chronic colitis are classically described in cotton-top tamarins (*Saguinus oedipus*).

**Rectal prolapse:** Rectal prolapse may be associated with chronic diarrhea. Many cases involve intussusception and surgical treatment should be considered. Action must be done quickly as the specimen itself or the other members of the family will explore and damage this strange red thing. The gut can be sutured to the abdominal wall in order to prevent recurrence but the main cause of the prolapse must be searched for and treated.

**Teeth:** Tooth decay is common and is mostly due to inadequate diets, accidents and age. It is essential that potential sources of infection be treated and the teeth should be examined each time a specimen is handled, whether or not a tooth problem is suspected (loss of appetite, salivation or difficulty when



chewing). Root infections of the upper canine often produce a swollen lesion below the eye and recurrent abscesses require extraction of the tooth.

#### 4.7.6.2. Respiratory system

**Bacterial infections:** Symptoms include coughing, sneezing, nasal discharge and breathing difficulties. The following pathogens are often found at bacteriological examination: *Streptococcus*, *Klebsiella*, *Haemophilus*, *Bordetella*, *Pasteurella*, and *Staphylococcus*. Overheated environments and low humidity may favor these infections and their spread. Maintaining the inside temperature at 18 to 20°C and giving access to outdoor enclosures as often as possible seems to be a good solution.

These diseases require antibiotic treatments and supportive therapy when the general condition of the animal is affected.

**Tuberculosis is not frequent in callitrichids but this possibility must not be forgotten.**

**Viral infections:** Several viruses (*measles*, *influenza*, *parainfluenza*, *Sendai*, *herpesvirus* etc) may cause fatal diseases. Sources of contamination are usually humans (and mice for Sendai) and, consequently, anybody suffering from a respiratory infection should be kept out of the premises.

**Parasitic infections:** Toxoplasmosis is contracted by ingesting food contaminated with cat faeces or eating small preys such as rodents and birds. Signs of acute pneumonia are noticed but digestive and nervous system signs may also be recorded. The tachyzoites are recognized on microscopic examination of the lung (Juan-Sallés *et al.*, 1998). This infection is often fatal, especially for infants. Treatment is theoretically possible with sulfonamide and pyrimethamine, but it is much wiser to control vermin and feral cats.

Strongyliasis may be revealed by coughing and dyspnea. Faecal examination is necessary for etiological diagnosis, and treatment requires classic anthelmintic drugs.

**Fungal infections:** *Cryptococcus neoformans* may cause a respiratory disease and must be treated with amphotericin B. Infection by *Aspergillus* does not seem to occur frequently in non-human primates.

**Diaphragmatic hernia:** A high incidence of retrosternal diaphragmatic hernia is known to occur in the captive population of golden lion tamarins (*Leontopithecus rosalia*). Due to the location and degree of the defect, clinical signs are related to the protrusion of abdominal organs into the thorax cavity. This condition may be detected by X-ray. It is unknown whether the hernia is genetically transmitted and it is essential that this lesion be searched for whenever opportunities occur (laparotomy, X-ray examination, necropsy) and the information be sent to the breeding program coordinator. The condition has also been found in a few specimens of golden-headed lion tamarins. Diagrams to help with the recognition of diaphragmatic hernia on

**Congenital defects:**  
diaphragmatic hernia in GLT  
(decreased after breeding management changes)

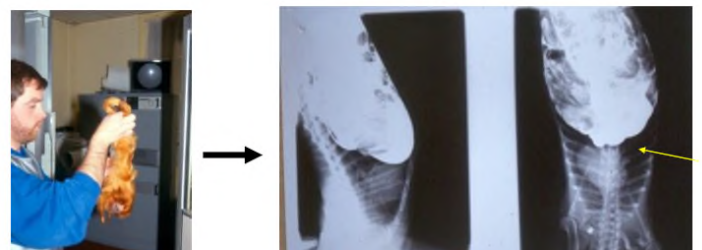

Diaphragmatic hernia searched at necropsy and by radioscopy in *Leontopithecus rosalia* specimens





autopsy, and the coding of its severity can be found in the golden lion tamarin husbandry manual (golden lion tamarin Management Committee, 1996)

#### 4.7.6.3. Urinary system

**Glomerulonephropathies are quite common in callitrichids.** Immune mediated mechanisms may lead to deposition of immunoglobulin in glomeruli and then to glomerulonephritis. Glomerulonephritis is a frequent finding at post-mortem examination in *Callimico*.

Pyelonephritis and bacterial cystitis may occur.

Leptospirosis causes nephritis, hemolysis, hemoglobinuria and icterus. Primates can get contaminated when eating rodents or in case their food is contaminated by rodent urine.

In pygmy marmosets, a renal disease looking like hypertensive nephropathy is associated with vascular lesions.

#### 4.7.6.4. Reproductive system

**Pregnancy diagnostic** is possible by the means of visual examination, abdominal palpation, radiography, echography, and blood and urine analyses.

**Abortions and stillbirths: Females often produce two young twice a year, and abortions and stillbirths are not rare.** Many infectious diseases (toxoplasmosis, leptospirosis and listeriosis for instance) may specifically lead to these pathologies and laboratory examination of the fetuses is very important for understanding the problem. It is at least absolutely necessary to differentiate stillborn babies from live born, which have died shortly after birth because of maternal neglect. Abortions may also be caused by stress.

**Dystocia:** Monitoring pregnant females by daily observation of appetite, increase in abdominal girth, locomotion, and alertness will enable early intervention if a delivery problem occurs. As soon as the problem is diagnosed, **one must not hesitate to perform a caesarean section** (general anesthesia, linear laparotomy) because the other options (use of oxytocin, forceps) often lead to complications. The female generally recovers very quickly and may be able to reproduce again a few months later.

**Placenta praevia** is a condition where the placenta is not at the right place. Uterine hemorrhages can occur before delivery because it covers the opening of the cervix and dystocia resulting in the mother's death is possible.

**Bacterial infection:** As stated above, this may lead to abortions and infertility. Acute post-partum infections can be fatal.

**Hormonal implants:** Melengestrol acetate implants may predispose to endometrial hyperplasia and, then, to endometritis or pyometra. Implanted females should, therefore, be monitored for evidence of uterine lesions.

**Neoplasms:** There are on-going studies to evaluate the potential carcinogenic effects of melengestrol acetate implants (mammary adenocarcinoma and uterine carcinoma). Such neoplasms should be reported to the breeding program coordinator.

Prostates are often increased in size in aging males.

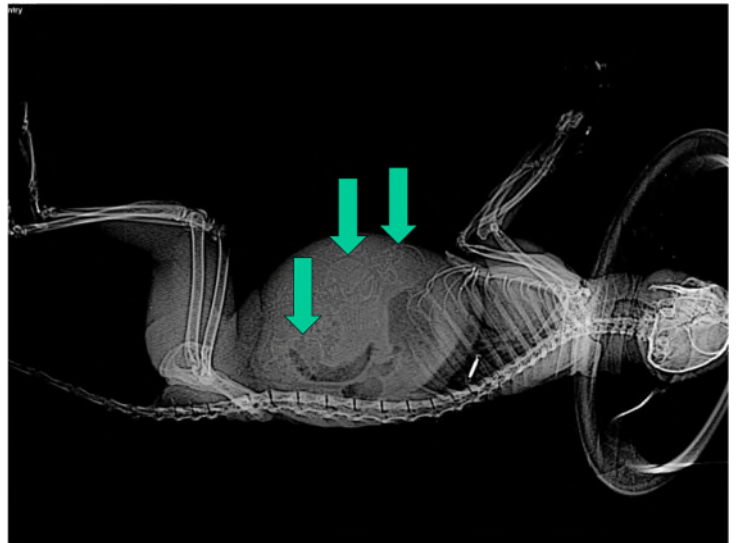

Left: Easy pregnancy diagnosis in a *Saguinus imperator*  
Right: X-Ray of a pregnant *Saguinus oedipus* with triplets

#### 4.7.6.5. Locomotor system



**Nutritional diseases:** Metabolic bone diseases (rickets in growing animals and osteomalacia in adults) may develop if the diet is not properly balanced for proteins, calcium, phosphorus and vitamin D3, and if the callitrichids are not exposed to sufficient sun light or artificial ultraviolet light (See specific section for further information on diet). UV meters should be used to check whether enclosures are sufficiently exposed to direct sunlight.

UV meter and poor exposition to sun light ©T. PETIT Zoo La Palmyre



These metabolic diseases may also accompany primary diseases of the kidneys, liver and intestines as the integrity of these organs is necessary for the proper absorption and use of the different elements of the diet. Clinical signs are lethargy, inappetence, weight loss, skeletal deformities, fractures and paralysis of the hind legs. Normal circulating levels of 1 alpha, 25-dihydroxyvitamin D3 are 4 to 10 times higher than in other primates.

**Congenital defects** such as lack of bones, deformed fingers... have been seen, sometimes associated with a treatment of the mother during pregnancy.

Congenital defect in a Callithrix jacchus due to giving Thiabendazole to the pregnant female.

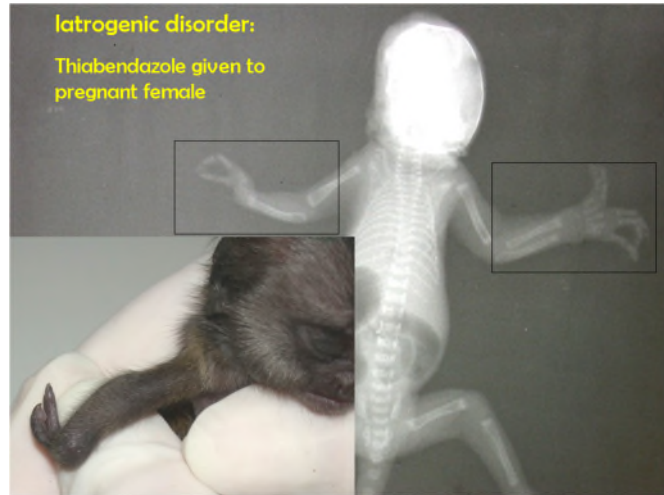

**Fractures of the long bones and dislocations are not rare after traumas.** Diagnostic may be quite easy with or without X-Rays. Dislocations can be easily replaced on an anaesthetized specimen but fractures may be difficult to manage due to the small size of the bones. Such specimens can be isolated for a while and this “cage therapy” usually gives good results.

**Necrosis** of extremities (tail, fingers) is common after severe traumas (bites) or in case of Wasting Disease.

**Wasting syndrome:** Muscular atrophy, weakness and even paralysis of the hind limbs are classically reported in marmosets suffering from this syndrome. See under “General body condition”.

#### 4.7.6.6. Nervous system

Etiological diagnostic requires CSF examination and is often possible only at necropsy.

**Bacterial infection:** Several bacteria may cause meningitis and encephalitis with the following possible symptoms: anorexia, lethargy, ataxia, paresis, paralysis, abnormal postures and involuntary eye movements. **Diplococcus pneumoniae and Haemophilus influenzae are commonly found in healthy humans and are possible causes for such infections in primates following respiratory contamination.** Antibacterial drugs able to penetrate the blood brain barrier are necessary for treatment (amoxicillin, ampicillin, sulfonamides).

**Parasitic infection:** Toxoplasmosis may cause ataxia, paresis and convulsions. See under “Respiratory System: Parasitic infection”.

Encephalitozoonosis: *Encephalitozoon cuniculi* may be an emerging disease in callitrichid colonies. Infections have occurred at least in tamarins and lion tamarins. The infection seems to be transferred vertically and causes high mortality in neonatal and juvenile specimens. The main pathologic findings were vasculitis, myocarditis, hepatitis, interstitial pneumonia, skeletal myositis, meningoencephalitis, adrenalitis, tubulointerstitial nephritis, myelitis, sympathetic ganglioneuritis, and retinitis. Central



nervous system lesions were the most prominent findings in cotton-top tamarins (Reetz *et al.*, 2004, Juan-Sallés *et al.*, 2006).

The raccoon parasite, *Baylisascaris*, may cause cerebrospinal nematodiasis (larva migrans).

**Fungal infection:** *Cryptococcus neoformans* causes ataxia and epilepsy. It must be treated with amphotericin B.

**Viral infection:** Contact with humans with open herpes oral lesions, or with squirrel monkeys and other cebids, which can carry other herpes viruses, can lead to fatal cases in callitrichids. Vesicles and ulcers are noticed on the skin and mucous membranes. A severe encephalitis may kill the monkey within 2 days (King, 2001; Hall *et al.*, 2004; Ramer *et al.*, 2000).

Encephalitis is also a possible symptom of measles.

Callitrichids are susceptible to Equine Encephalitis Viruses and it is suspected that they are also susceptible to West Nile Encephalitis Virus.

**Epilepsy:** Epileptic seizures may be due to diseases of the central nervous system or to head traumas and hypoglycemia. Lead toxicity (primates eating or chewing some paints) may also cause this symptom.

Epilepsy has been reported in lion tamarins (*Leontopithecus* spp.) and investigations are ongoing to determine the cause of this occurrence. Any cases of unknown origin should be reported to the breeding program coordinator.

**Botulism** may kill callitrichids after paralysis of the larynx and respiratory muscles. They become intoxicated after ingestion of badly preserved animal products and the first sign is that they are unable to swallow. Diagnosis is difficult, and requires detection of the toxin in the digestive tract of the dead specimen thanks to mice inoculation (Petit, 1991).

**Traumas:** new-born fallen from parents or helpers on hard soil may present severe central nervous system hematomas which can be fatal.

#### 4.7.6.7. Skin and mucous membranes

**Colour anomalies** are sometimes noticed in newborn *Callimico goeldi*. Vitiligo is an acquired lack of pigmentation and affected specimens may present white spots. Etiology is not completely understood.

**Ectoparasites:** Mites (*Sarcoptes* or sarcoptiforme species, *Demodex*) have been recorded in callitrichids. Associated clinical signs include pruritus, alopecia, thickening and scaling of the skin and even loss of appetite and weight loss. Diagnosis is based on identification of the parasite in skin scrapings through a microscope and treatment requires classical external drugs such as pyrethroids, amitraz. Finding *Demodex* parasites without any clinical signs seems to be frequent at least in *Callimico goeldii*, they may be part of their normal skin fauna.





**Ticks** are not common and not dangerous by themselves, but they can be vector for blood parasites such as *Babesia* (see babesiosis under “cardiovascular system”). Fleas have also been recorded in very poor condition animals.

Bites by cage mates may lead to abscesses which require debridement. Another complication of these small traumas on the extremities is necrosis.

**Zinc deficiency** has been associated with alopecia and thickening of skin of the tail, perineum, limbs and trunk. This condition improves after providing Zinc in drinking water.



Tick on a *Callithrix jacchus*

**Wasting Marmoset Syndrome:** alopecia of the tail and necrosis of the extremities (tail and fingertips) are seen under this condition.

**Viral infection:** see “viral infections of the nervous system”.

#### 4.7.6.8. Cardiovascular system

**Bacterial endocarditis:** can follow local infections and chronic bacteremia. It is therefore very important to efficiently treat infections such as tooth abscesses.

**Viral infection:** EMCV may be a threat to callitrichids. It is transmitted by feed contaminated by rodent faeces and urine.

**Parasitic infection:** Microfilariae of the genus *Dipetalonema* can be seen in the blood of callitrichids while adults are found in pleural and peritoneal spaces where they may cause inflammation.

Babesiosis is caused by a blood parasite transmitted by ticks. The sick specimen exhibits anaemia and icterus and may quickly die unless specific and supportive treatment is given.

**Parastrongylus dujardini:** This helminth is found in small rodents and squirrels (the final hosts) and its larvae develop in slugs (intermediate hosts). Small primates may become infected, probably when biting and consuming slugs. This life cycle may be similar to that of *Angiostrongylus vasorum*, which is well known in dogs.

As adult worms live in the right side of the heart and in the pulmonary artery, callitrichids die due to cardiac insufficiency and severe pneumonia. Diagnosis may sometimes be possible using the Baermann test which reveals larvae in faeces. Treatment is ineffective once clinical signs occur.



*Parastrongylus dujardini* infection. Adult worm in right ventricle.



This has been reported from five French zoos and sporadic similar cases have occurred in Germany, Switzerland and Italy. Collections should be alerted to this parasite and necropsies should always include histological examination of the organs. The worms are not always present in the heart and only histological examination of the lungs will inform you about the cause of a pneumonia.

In order to know more about this parasitic disease and its distribution, the TAG is interested to receive any information such as positive Baermann tests or necropsy results including parasitic pneumonia and/or heart worms in your collection. Contact Thierry Petit at Zoo Palmyre.

**Cardiac insufficiency:** cardiomyopathies due to vitamin E and/or Selenium deficiency, to infections, anaemia... are possible. Pygmy marmosets which are offered high cholesterol diets may have arteriosclerosis and exhibit symptoms associated with hypertension.

Vitamin E deficiency may be involved in the development of haemolytic anaemia, myopathy, and steatitis in callitrichids.

**Anticoagulant drugs intoxication:** rodent control procedures are much needed but they always use anticoagulant drugs, which can be fatal to callitrichids in case they chase and eat “treated” rodents. Massive haemorrhages in various organs occur and can be fatal. Treatment involves vitamin K. Transfusion is also to be considered.



Intraosseous transfusion ©T. PETIT Zoo La Palmyre

#### 4.7.6.9. General body condition

**Wasting syndrome:** *chronic loss of weight and muscle wasting of unknown etiology has often been reported in marmosets and is referred to under the collective name “Wasting Marmoset Syndrome” or WMS.*

The affected specimens show loss of weight, ungroomed or “spiky” coat, lethargy, muscular atrophy and weakness. Diarrhoea is not a constant accompanying sign but is often seen (chronic enteritis and colitis). Some of the most common blood abnormalities are severe anaemia, hypocalcaemia and low





total protein. Examination of the muscle sometimes shows morphological changes similar to those in vitamin E deficiency and examination of the bones may reveal signs of metabolic bone disease.

Although a change in the intestinal bacterial flora and the presence of parasites in the pancreas have been suggested as possible etiologies, one must also consider that it has been associated with low dietary protein concentration and low serum vitamin E levels. More recent research studies suggest that lesions are similar to lesions found in human beings affected by Celiac Sprue which cause is hypersensitivity to some cereal proteins.

Treatment of any kind is rarely successful in the long term. The following can be tried: broad spectrum antibiotics, vitamin E and Selenium, iron, Calcium and vitamin D3, high protein diet, kaolin, electrolytes. The addition of gum arabic (Acacia gum) to the diet of Geoffroy's marmoset *Callithrix geoffroyi* has been found to be helpful in treating chronic diarrhoea, and reversing weight loss associated with it (Carroll 1997, Herron *et al.*, 2001). The removal of wheat derived items (gluten) from the diet and use of sulfasalazine should be tried in case of colitis similar to human Celiac Sprue and Crohn disease.

**Septicemia:** This is quite frequent and may be encountered after a digestive infection, a bite or other trauma. The following pathogens have commonly been isolated from the blood: *Aeromonas hydrophila*, *Campylobacter* spp., *Corynebacterium pseudotuberculosis*, *Escherichia coli*, *Haemophilus* spp, *Klebsiella pneumoniae*, *Pasteurella multocida*, *Pseudomonas aeruginosa*, *Salmonella* spp, *Shigella* spp, *Staphylococcus* spp., *Streptococcus* spp., *Yersinia* spp. Septicemia is usually fatal if not treated as an emergency.

*Toxoplasma gondii* infection is discussed under “parasitic infections of the respiratory system” but the course of an acute infection is often septicemic with general symptoms leading to death in a few days.

**Neoplasms:** some herpes viruses (*Herpesvirus ateles*, *Herpesvirus saimiri*, Human EBV) can experimentally cause lymphoproliferative disease in callitrichids.

**Hypothermia:** abandoned newborn callitrichids often exhibit hypothermia if they are not quickly found. Please, note that hand-raising a callitrichid should be done with the agreement of the EEP coordinator. Sick specimens, young or adult, may also be hypothermic and it is always important to provide warmth to them. It can be done by the mean of heating lamps or pads, hair drier and even warm enema or stomach tubing with warm liquid in emergency conditions.

Hypothermia during anaesthetic procedure is common and should be prevented.

**Hypoglycemia:** a high incidence of this condition is seen in callitrichids, probably due to their high metabolic rates and frequency of feeding. Animals are found on the soil and weak. It can be fatal but it is usually reversed with IP infusion of glucose or with tube feeding sugar or fruits. A quick diagnosis is possible with the help of a glucometer.

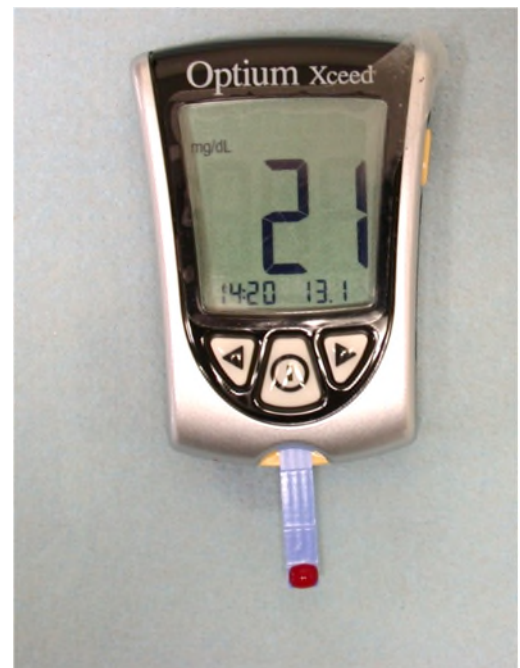



#### 4.7.6.10. Metabolic diseases

Amyloidosis is a quite frequent condition where modified proteins are deposited in several organs. This is secondary to chronic inflammation such as enteritis. These proteins cannot be eliminated and symptoms vary widely depending upon the site of amyloid deposition.

Haemosiderosis and haemochromatosis: hemosiderosis has been discussed under digestive disorders but other organs may be affected in the case of haemosiderosis and haemochromatosis.

Diabetes: obesity and gestation may also be associated with diabetes. There is an ongoing project supported by the TAG investigating diabetes in callitrichids.

Lipidosis: this abnormal hepatorenal lipid deposition due to disturbance in lipid metabolism associated with obesity and diabetes has been described.

### 4.7.7 Haematology and Clinical Chemistry Tables of Callitrichida

#### 4.7.7.1. Haematology—Callitrichidae (Mean ± SD (n))

	<i>Callithrix jacchus</i>	<i>Cebuella</i> sp.	<i>Mico argentata</i>	<i>Callithrix geoffroyi</i>
	Common marmoset	Pygmy marmoset	Silvery marmoset	White-fronted marmoset
WBC 10 <sup>3</sup> /UL	6.1 ± 2.2 (30)	9.6 ± 8.5 (48)	8.2 ± 2.3 (4)	8.08 ± 3.6 (8)
RBC 10 <sup>6</sup> /UL	5.6 ± 0.78 (25)	6.5 ± 1.2 (42)	6.1 ± 1.1 (2)	6.7 ± 0.89 (5)
HGB gm/dl	15.0 ± 1.4 (40)	13.6 ± 1.6 (19)	15.5 ± 1.2 (8)	16.7 ± 1.0 (4)
HCT %	44.6 ± 7.1 (45)	42.5 ± 4.9 (46)	46.4 ± 7.1 (11)	50.8 ± 3.8 (8)
MCH mg/dl	25.8 ± 2.7 (24)	66.8 ± 12.2 (42)	24.8 ± 0.4 (2)	23.6 ± 2.6 (3)
MCHC uug	34.2 ± 4.5 (39)	32.3 ± 2.2 (19)	34.1 ± 1.8 (8)	33.2 ± 3.6 (4)
MCV fl	74.3 ± 10.9 (24)	66.8 ± 12.2 (42)	74.3 ± 1.1 (2)	74.2 ± 8.5 (5)
SEGS 10 <sup>3</sup> /UL	3.2 ± 1.5 (24)	4.6 ± 3.7 (46)	3.3 ± 1.3 (3)	5.1 ± 2.1 (6)
BANDS 10 <sup>3</sup> /UL	0.17 ± 0.08 (5)	0.26 ± 0.41 (7)	–	–
LYMPHS 10 <sup>3</sup> /UL	3.0 ± 1.6 (24)	4.6 ± 4.7 (46)	4.3 ± 1.03 (3)	3.5 ± 4.1 (6)
MONOS 10 <sup>3</sup> /UL	0.25 ± 0.18 (15)	0.32 ± 0.47 (40)	0.47 ± 0.63 (3)	0.24 ± 0.12 (6)
EOS 10 <sup>3</sup> /UL	0.23 ± 0.14 (15)	0.15 ± 0.19 (27)	0.20 ± 0.13 (2)	0.075 ± 0.015 (2)
BASOS 10 <sup>3</sup> /UL	0.16 ± 0.15 (7)	0.15 ± 0.13 (25)	–	0.085 ± 0.0 (1)
NRBC /100wbc	3.0 ± 2.0 (13)	2.0 ± 1.0 (22)	2.0 ± 0 (1)	18.0 ± 28.0 (3)
Platelet cnt 10 <sup>3</sup> /UL	609 ± 200 (6)	–	–	–

	<i>Saguinus oedipus</i>	<i>Saguinus imperator</i>	<i>Saguinus mystax</i>	<i>Saguinus fuscicollis</i>
	Cotton-top tamarin	Emperor tamarin	Moustached tamarin	Saddle-back tamarin
WBC 10 <sup>3</sup> /UL	11.2 ± 5.2 (95)	9.5 ± 3.7 (54)	12.3 ± 2.8 (23)	8.7 ± 4.06 (12)
RBC 10 <sup>6</sup> /UL	6.3 ± 0.61 (76)	6.4 ± 0.90 (52)	6.06 ± 0.65 (10)	5.39 ± 1.02 (15)



	<i>Saguinus oedipus</i>	<i>Saguinus imperator</i>	<i>Saguinus mystax</i>	<i>Saguinus fuscicollis</i>
	Cotton-top tamarin	Emperor tamarin	Moustached tamarin	Saddle-back tamarin
HGB gm/dl	15.9 ± 1.7 (82)	14.1 ± 1.6 (47)	14.3 ± 1.9 (27)	14.0 ± 2.5 (20)
HCT %	47.9 ± 5.0 (99)	45.5 ± 5.6 (53)	48.2 ± 6.5 (36)	44.4 ± 6.6 (22)
MCH mg/dl	25.4 ± 1.5 (71)	22.6 ± 2.4 (46)	24.2 ± 0.7 (5)	26.4 ± 3.3 (15)
MCHC uug	33.1 ± 2.3 (81)	31.3 ± 1.9 (47)	30.1 ± 2.6 (27)	33.1 ± 3.9 (19)
MCV fl	76.3 ± 5.4 (74)	71.6 ± 8.0 (52)	78.2 ± 5.7 (10)	78.9 ± 7.6 (14)
SEGS 10 <sup>3</sup> /UL	7.03 ± 4.5 (90)	5.2 ± 2.4 (54)	5.1 ± 1.8 (17)	8.2 ± 4.5 (5)
BANDS 10 <sup>3</sup> /UL	0.33 ± 0.50 (20)	0.27 ± 0.34 (5)	0.08 ± 0.01 (2)	–
LYMPHS 10 <sup>3</sup> /UL	3.3 ± 1.7 (90)	3.6 ± 2.4 (54)	6.4 ± 2.5 (17)	1.9 ± 0.92 (5)
MONOS 10 <sup>3</sup> /UL	0.54 ± 0.44 (80)	0.51 ± 0.41 (49)	0.85 ± 0.52 (16)	0.30 ± 0.12 (3)
EOS 10 <sup>3</sup> /UL	0.21 ± 0.17 (47)	0.23 ± 0.16 (24)	0.39 ± 0.26 (12)	0.28 ± 0.17 (3)
BASOS 10 <sup>3</sup> /UL	0.10 ± 0.06 (24)	0.16 ± 0.10 (24)	0.22 ± 0.20 (5)	0.18 ± 0.08 (2)
NRBC /100wbc	1.0 ± 1.0 (22)	2.0 ± 4.0 (8)	3.0 ± 2.0 (15)	9.0 ± 19 (9)
Platelet cnt 10 <sup>3</sup> /UL	361 ± 74 (14)	626 ± 224 (5)	840 ± 142 (5)	546 ± 113 (3)
RETICS %	–	1 7.7± 0.0 (1)	–	–

	<i>Saguinus geoffroyi</i>	<i>Saguinus labiatus</i>	<i>Saguinus midas</i>	<i>Saguinus nigricollis</i>
	Geoffroy's tamarin	Red-bellied tamarin	Red-handed tamarin	Black-and-white tamarin
WBC 10 <sup>3</sup> /UL	13.5 ± 5.9 (14)	13.4 ± 4.4 (3)	15.6 ± 6.7 (48)	17.2 (1)
RBC 10 <sup>6</sup> /UL	6.2 ± 0.73 (11)	5.8 ± 1.8 (3)	6.3 ± 0.56 (15)	6.0 (1)
HGB gm/dl	15.0 1.2 (19)	14.1 ± 4.0 (3)	16. 1 ± 1.9 (47)	14.1 (1)
HCT %	46.3 ± 3.8 (20)	39.3 ± 11.7 (3)	49.5 ± 5.5 (61)	42.0 (1)
MCH mg/dl	24.6 ± 1.3 (9)	24.4 ± 1.5 (3)	26.5 ± 1.2 (15)	23.5 (1)
MCHC uug	32.0 ± 1.5 (18)	36.1 ± 0.80 (3)	32.9 ± 2.5 (46)	33.6 (1)
MCV fl	71.3 ± 9.8 (11)	67.5 ± 3.6 (3)	80.1 ± 3.6 (15)	70.0 (1)
SEGS 10 <sup>3</sup> /UL	8.5 ± 5.1 (14)	7.2 ± 3.2 (3)	8.7 ± 4.7 (37)	11.7 (1)
BANDS 10 <sup>3</sup> /UL	0.11 ± 0.0 (1)	0.21 ± 0.23 (3)	1.05 ± 1.8 (11)	–
LYMPHS 10 <sup>3</sup> /UL	4.1 ± 1.3 (14)	5.2 ± 1.9 (3)	5.2 ± 3.2 (39)	4.3 (1)
MONOS 10 <sup>3</sup> /UL	0.73 ± 0.82 (14)	0.72 ± 0.21 (3)	1.1 ± 0.82 (35)	0.86 (1)
EOS 10 <sup>3</sup> /UL	0.12 ± 0.10 (4)	0.0 ± 0.0 (1)	0.63 ± 0.67 (27)	0.344 (1)
BASOS 10 <sup>3</sup> /UL	0. 11 ± 0.09 (5)	0.08 ± 0.0 (1)	0.18 ± 0.11 (12)	–
NRBC /100wbc	1.0 ± 1.0 (5)	–	7.0 ± 10.0 (15)	–
Platelet cnt 10 <sup>3</sup> /UL	386 ± 0 (1)	–	397 ± 132 (5)	–
RETICS %	–	–	6.4 ± 3.5 (3)	–



	<i>Leontopithecus rosalia</i>	<i>Callimico goeldi</i>
	Golden Lion tamarin	Goeldi's monkey
WBC 10 <sup>3</sup> /UL	8.1 ± 3.7 (378)	6.2 ± 2.8 (262)
RBC 10 <sup>6</sup> /UL	6.2 ± 0.85 (305)	6.6 ± 0.71 (250)
HGB gm/dl	15.3 ± 1.9 (343)	14.3 ± 1.7 (261)
HCT %	45.6 ± 5.1 (375)	44.1 ± 5.0 (270)
MCH mg/dl	24.8 ± 2.8 (296)	21.5 ± 1.8 (250)
MCHC uug	33.7 ± 2.4 (323)	32.5 ± 2.3 (261)
MCV fl	74.0 ± 9.1 (302)	66.0 ± 5.2 (250)
SEGS 10 <sup>3</sup> /UL	5.3 ± 3.1 (338)	3.3 ± 2.09 (257)
BANDS 10 <sup>3</sup> /UL	0.14 ± 0.17 (99)	0.12 ± 0.11 (41)
LYMPHS 10 <sup>3</sup> /UL	2.4 ± 1.5 (339)	2.5 ± 1.5 (257)
MONOS 10 <sup>3</sup> /UL	0.30 ± 0.27 (272)	0.18 ± 0.15 (223)
EOS 10 <sup>3</sup> /UL	0.29 ± 0.30 (231)	0.16 ± 0.17 (154)
BASOS 10 <sup>3</sup> /UL	0.16 ± 0.16 (80)	0.04 ± 0.04 (15)
NRBC /100wbc	2.0 ± 2.0 (51)	2.0 ± 3.0 (40)
Platelet cnt 10 <sup>3</sup> /UL	502 ± 165 (113)	8 72 ± 233 (108)
RETICS %	–	0.0 ± 0.0 (5)

#### 4.7.7.2. Clinical Chemistries—Callitrichidae

	<i>Callithrix jacchus</i>	<i>Cebuella pygmaea</i>	<i>Mico argentata</i>	<i>Callithrix geoffroyi</i>
	Common marmoset	Pygmy marmoset	Silvery marmoset	White-fronted marmoset
Glucose mg/dl	177 ± 65 (16)	161 ± 78 (43)	220 ± 85 (3)	243 ± 179 (4)
BUN mg/dl	19 ± 5 (15)	18 ± 8 (42)	11 ± 6 (3)	16 ± 1 (4)
Creatinine mg/dl	0.7 ± 0.2 (10)	0.5 ± 0.2 (28)	–	0.6 ± 0.2 (4)
Uric acid mg/dl	0.5 ± 0.2 (10)	3.6 ± 6.8 (11)	–	0.3 ± 0.4 (2)
Calcium mg/dl	9.5 ± 1.1 (17)	10.0 ± 2.0 (35)	9.0 ± 0.9 (6)	10.2 ± 0.4 (5)
Phosphorus mg/dl	5.3 ± 1.9 (15)	7.2 ± 4.3 (18)	7.2 ± 2.2 (6)	5.0 ± 0.5 (4)
Sodium mEq/L	147 ± 8 (12)	156 ± 6 (13)	153 ± 1 (2)	164 ± 0 (2)
Potassium mEq/L	4.9 ± 2.6 (12)	3.8 ± 1.5 (13)	3.4 ± 0.3 (2)	2.9 ± 1.7 (2)
Chloride mEq/L	103 ± 11 (10)	116 ± 8 (2)	96 ± 6 (2)	115 ± 1 (2)
Iron mcg/dl	129 ± 0 (1)	–	–	55 ± 51 (2)
Bicarbonate mMol/L	–	5.8 ± 1.0 (4)	–	–
Cholesterol mg/dl	176 ± 73 (7)	216 ± 95 (23)	88 ± 28 (2)	106 ± 81 (4)
Triglycerides mg/dl	160 ± 43 (2)	129 ± 43 (10)	–	290 ± 260 (2)



	<i>Callithrix jacchus</i>	<i>Cebuella pygmaea</i>	<i>Mico argentata</i>	<i>Callithrix geoffroyi</i>
	Common marmoset	Pygmy marmoset	Silvery marmoset	White-fronted marmoset
Total proteins gm/dl	6.8 ± 1.0 (17)	6.1 ± 0.9 (33)	7.5 ± 0.6 (3)	7.7 ± 0.7 (4)
Albumin gm/dl	5.1 ± 0.6 (4)	4.2 ± 0.8 (13)	–	–
Globulin gm/dl	1.7 ± 0.5 (4)	2.1 ± 0.7 (13)	–	–
AST (SGOT) IU/L	112 ± 112 (11)	64 ± 51 (35)	7 ± 1 (2)	109 ± 32 (3)
ALT (SGPT) IU/L	13 ± 24 (14)	15 ± 23 (30)	0 ± 0 (2)	14 ± 10 (4)
Tot. Bilirubin mg/dl	0.2 ± 0.3 (8)	0.3 ± 0.3 (13)	–	0.1 ± 0.1 (2)
Dir. Bilirubin mg/dl	0.0 ± 0.0 (1)	0.0 ± 0.0 (5)	–	–
Indir. Bilirubin mg/dl	0.1 ± 0.0 (1)	0.3 ± 0.3 (5)	–	–
Alk Phosp. IU/L	125 ± 64 (13)	322 ± 260 (31)	211 ± 29 (2)	97 ± 19 (4)
LDH IU/L	551 ± 429 (7)	354 ± 270 (13)	312 ± 8 (2)	414 ± 302 (3)
CPK IU/L	543 ± 0 (1)	768 ± 1055 (14)	–	180 ± 50 (2)
CO2 mMol/L	–	14.8 ± 8.3 (4)	–	–
GGT IU/L	–	5 ± 3 (7)	–	–
Lipase U/L	–	192 ± 188 (2)	–	–

	<i>Saguinus oedipus</i>	<i>Saguinus imperator</i>	<i>Saguinus mystax</i>	<i>Saguinus fuscicollis</i>
	Cotton-top tamarin	Emperor tamarin	Moustached tamarin	Saddle-back tamarin
Glucose mg/dl	179 ± 82 (62)	151 ± 58 (50)	117 ± 63 (18)	173 ± 66 (6)
BUN mg/dl	15 ± 8 (69)	14 ± 4 (49)	13 ± 5 (19)	14 ± 5 (4)
Creatinine mg/dl	0.7 ± 0.3 (60)	0.6 ± 0.2 (50)	0.7 ± 0.4 (3)	0.5 ± 0.2 (4)
Uric acid mg/dl	1.0 ± 0.7 (25)	0.2 ± 0.2 (17)	–	0.8 ± 0.1 (2)
Calcium mg/dl	8.9 ± 0.9 (67)	9.2 ± 0.8 (49)	8.7 ± 1.2 (24)	8.9 ± 0.9 (8)
Phosphorus mg/dl	4.8 ± 1.5 (61)	5.5 ± 1.8 (47)	8.0 ± 3.0 (20)	5.2 ± 1.1 (7)
Sodium mEq/L	150 ± 8 (52)	156 ± 8 (40)	154 ± 7 (13)	154 ± 1 (4)
Potassium mEq/L	4.0 ± 0.8 (55)	3.9 ± 0.9 (40)	4.9 ± 1.6 (13)	3.4 ± 0.7 (4)
Chloride mEq/L	1 ± 8 (51)	12 ± 5 (41)	104 ± 8 (13)	110 ± 1 (4)
Iron mcg/dl	127 ± 73 (5)	–	–	–
Magnesium mg/dl	2.4 ± 0 (1)	–	–	–
Bicarbonate mMol/L	20.5 ± 7.0 (4)	16.8 ± 5.4 (15)	–	–
Cholesterol mg/dl	121 ± 42 (60)	106 ± 45 (50)	106 ± 79 (13)	65 ± 12 (3)
Triglycerides mg/dl	69 ± 32 (30)	103 ± 71 (25)	–	80 ± 0 (1)
Total proteins gm/dl	6.6 ± 0.7 (64)	6.3 ± 0.7 (50)	6.5 ± 0.7 (15)	7.5 ± 1.0 (50)
Albumin gm/dl	3.8 ± 0.5 (49)	3.5 ± 0.5 (43)	3.5 ± 1.0 (2)	4.2 ± 0.2 (2)
Globulin gm/dl	2.8 ± 0.5 (49)	2.8 ± 0.5 (43)	2.3 ± 1.3 (2)	2.5 ± 0.1 (2)
AST (SGOT) IU/L	157 ± 56 (57)	156 ± 69 (48)	56 ± 85 (14)	491 ± 892 (5)
ALT (SGPT) IU/L	38 ± 41 (63)	18 ± 15 (45)	7 ± 14 (15)	26 ± 32 (4)



	<i>Saguinus oedipus</i>	<i>Saguinus imperator</i>	<i>Saguinus mystax</i>	<i>Saguinus fuscicollis</i>
	Cotton-top tamarin	Emperor tamarin	Moustached tamarin	Saddle-back tamarin
Tot. Bilirubin mg/dl	0.2 ± 0.2 (58)	0.4 ± 0.3 (46)	0.1 ± 0.1 (6)	0.3 ± 0.4 (2)
Dir. Bilirubin mg/dl	0.0 ± 0.1 (13)	0.2 ± 0.2 (2)	–	–
Indir. Bilirubin mg/dl	0.2 ± 0.1 (12)	0.2 ± 0.1 (2)	–	–
Amylase SU	575 ± 400 (23)	1202 ± 354 (29)	496 ± 0 (1)	–
Alk Phosp. IU/L	184 ± 110 (57)	179 ± 119 (48)	358 ± 341 (14)	129 ± 68 (4)
LDH IU/L	460 ± 319 (32)	290 ± 92 (19)	594 ± 326 (13)	390 ± 226 (3)
CPK IU/L	645 ± 706 (26)	766 ± 574 (18)	–	–
CO2 mMol/L	18.1 ± 8.3 (26)	17.8 ± 3.9 (6)	24 ± 0 (1)	11.7 ± 3.5 (2)
GGT IU/L	21 ± 21 (26)	8 ± 5 (27)	–	–
Lipase U/L	40 ± 16 (9)	342 ± 609 (5)	–	–
Cortisol ug/dl	570 ± 0 (2)	–	–	–





	<i>Saguinus geoffroyi</i>	<i>Saguinus labiatus</i>	<i>Saguinus midas</i>
	<b>Geoffroy's tamarin</b>	<b>Red-bellied tamarin</b>	<b>Red-handed tamarin</b>
Glucose mg/dl	199 ± 65 (9)	281 ± 47 (2)	186 ± 69 (29)
BUN mg/dl	15 ± 6 (9)	14 ± 2 (2)	15 ± 6 (25)
Creatinine mg/dl	0.7 ± 0.1 (8)	0.5 ± 0.0 (2)	0.6 ± 0.3 (18)
Uric acid mg/dl	0.3 ± 0.2 (4)	–	4.9 ± 0.0 (1)
Calcium mg/dl	8.9 ± 1.2 (11)	9.4 ± 0.3 (2)	7.7 ± 0.9 (38)
Phosphorus mg/dl	6.3 ± 3.1 (10)	2.5 ± 1.0 (2)	6.8 ± 2.5 (33)
Sodium mEq/L	149 ± 7 (6)	–	153 ± 4 (17)
Potassium mEq/L	4.3 ± 0.9 (6)	–	4.2 ± 1.7 (16)
Chloride mEq/L	103 ± 10 (6)	–	109 ± 6 (15)
Iron mcg/dl	136 ± 6 (2)	–	–
Bicarbonate mMol/L	18.5 ± 2.1 (2)	–	–
Cholesterol mg/dl	96 ± 40 (6)	–	136 ± 98 (14)
Triglycerides mg/dl	127 ± 31 (4)	–	73 ± 0 (1)
Total proteins gm/dl	6.4 ± 0.6 (11)	6.0 ± 0.0 (1)	6.3 ± 1.0 (26)
Albumin gm/dl	3.6 ± 0.7 (5)	–	3.8 ± 0.6 (8)
Globulin gm/dl	2.5 ± 0.5 (5)	–	2.4 ± 0.5 (8)
AST (SGOT) IU/L	287 ± 420 (9)	–	113 ± 79 (21)
ALT (SGPT) IU/L	54 ± 80 (9)	13 ± 4 (2)	8 ± 11 (21)
Tot. Bilirubin mg/dl	0.3 ± 0.3 (7)	–	0.7 ± 0.8 (13)
Dir. Bilirubin mg/dl	0.0 ± 0.0 (2)	–	–
Indir. Bilirubin mg/dl	0.2 ± 0.0 (2)	–	–
Amylase SU	649 ± 536 (5)	–	–
Alk Phosp. IU/L	180 ± 109 (9)	–	225 ± 197 (20)
LDH IU/L	316 ± 94 (5)	–	574 ± 427 (12)
CPK IU/L	968 ± 1179 (2)	–	–
CO2 mMol/L	–	–	13.9 ± 5.1 (5)
Fibrinogen gm/dl	–	200 ± 0 (1)	–



	<i>Leontopithecus rosalia</i>	<i>Callimico goeldii</i>
	Golden-lion tamarin	Goeldi's monkey
Glucose mg/dl	156 ± 85 (309)	124 ± 44 (226)
BUN mg/dl	14 ± 6 (315)	23 ± 8 (216)
Creatinine mg/dl	0.5 ± 0.2 (263)	0.7 ± 0.4 (138)
Uric acid mg/dl	0.6 ± 0.5 (148)	0.6 ± 0.2 (123)
Calcium mg/dl	9.2 ± 0.9 (277)	9.8 ± 0.7 (181)
Phosphorus mg/dl	4.8 ± 2.1 (259)	5.4 ± 2.2 (167)
Sodium mEq/L	149 ± 4 (229)	150 ± 5 (162)
Potassium mEq/L	3.7 ± 0.9 (230)	4.4 ± 0.8 (166)
Chloride mEq/L	106 ± 5 (234)	108 ± 26 (156)
Iron mcg/dl	210 ± 75 (19)	100 ± 27 (6)
Magnesium mg/dl	1.52 ± 0.62 (19)	2.48 ± 0.27 (8)
Bicarbonate mMol/L	20 ± 7.4 (5)	18.3 ± 2.9 (3)
Cholesterol mg/dl	73 ± 30 (207)	108 ± 26 (156)
Triglycerides mg/dl	102 ± 86 (147)	84 ± 27 (6)
Total proteins gm/dl	6.6 ± 0.7 (304)	6.6 ± 0.6 (213)
Albumin gm/dl	3.7 ± 0.5 (199)	4.1 ± 0.6 (129)
Globulin gm/dl	2.9 ± 0.6 (197)	2.6 ± 0.5 (129)
AST (SGOT) IU/L	108 ± 53 (285)	120 ± 38 (224)
ALT (SGPT) IU/L	86 ± 81 (295)	70 ± 54 (226)
Tot. Bilirubin mg/dl	0.7 ± 0.8 (278)	0.4 ± 0.2 (208)
Dir. Bilirubin mg/dl	0.2 ± 0.4 (89)	0.1 ± 0.1 (12)
Indir. Bilirubin mg/dl	0.3 ± 0.3 (87)	0.2 ± 0.1 (12)
Amylase SU	917 ± 1065 (59)	349 ± 103 (6)
Alk Phosp. IU/L	73 ± 52 (259)	157 ± 68 (144)
LDH IU/L	439 ± 298 (179)	300 ± 163 (128)
CPK IU/L	704 ± 766 (169)	793 ± 1147 (111)
CO2 mMol/L	19.5 ± 6.0 (140)	19.8 ± 6.2 (119)
Fibrinogen gm/dl	167 ± 82 (6)	100 ± 0 (1)
GGT IU/L	53 ± 67 (143)	39 ± 35 (115)
Lipase U/L	25 ± 25 (40)	25 ± 13 (6)

#### 4.8 Recommended (and planned) ex situ research

As shown in the literature review (and see EAZA Callitrichidae TAG website), extensive *ex situ* research has been done on Callitrichidae. Many projects are currently ongoing (see below), involving a wide range of disciplines/subjects. Additional information is required in a number of areas to fill in obvious gaps or validate existing data, particularly where there are contradictory viewpoints. Some of the questions raised may be addressed through the use of husbandry questionnaires, with a more in depth assessment of specific aspects carried out through research programmes.



Opportunistic *sampling* for future research is recommended. When the opportunity arises, serum (and liver tissue for genetic research) samples should be taken and stored at –20°C or below. This serum bank can be very helpful for further diagnostic procedure (reference, serology etc) and for various research works (see Section 4.7). All holders are urged to send samples to the EAZA Biobank – for further information see <https://www.eaza.net/conservation/research/eaza-biobank/>.

#### 4.8.1 Veterinary medicine

*Yersinia pseudotuberculosis* (see also Section 4.7). At Pasteur in Lille, a novel anti-*Yersinia* mucosal vaccination strategy using recombinant lactic acid bacteria has been developed and tested in mice (Daniel *et al.*, 2009). Michel Simonet is willing to test different routes for the inoculation of the vaccine and to do some more studies on different animals (guinea pigs, which are very sensitive to pseudoTB, for instance). More research is required to answer questions concerning antigenic presentation and delivery. We should not only think about *Y. pseudotuberculosis* – there are also many fatal infections of *Y. enterocolitica*. The post-mortem looks very similar (see Grothmann, 2007).

*Protozoans* are also a problem. Magdeburg Zoo has *Giardia* and *Entamoeba* intermittently in the emperor tamarin *S. imperator*. *Entamoeba histolytica* infections in captive monkeys in Belgian zoos have been recently reported (Levecke *et al.*, 2007) and further research is required to fully assess the scope of the problem.

*Trypanosoma cruzi* and intestinal helminths infect wild golden lion tamarins and golden-headed lion tamarins (Monteiro *et al.*, 2007). Lillian Silva Catenachi (BioBrasil, CRC, RZSA) and Filipe Reis (Brasília University) are assessing the prevalence in GHLTs as well as in domestic animals (potential sources for zoonoses; Chagas’ disease and Leishmaniosis). It might be useful to expand *Trypanosoma* research by Rafael Monteiro from wild into captive populations of lion tamarins (possible transfer through placenta).

*Parastrongylus dujardini* - this helminth is found in small rodents and squirrels (the final host) and its larvae develop in slugs (intermediate host). Thierry Petit is carrying out research on this parasite which causes cardio-pulmonary problems and see page.

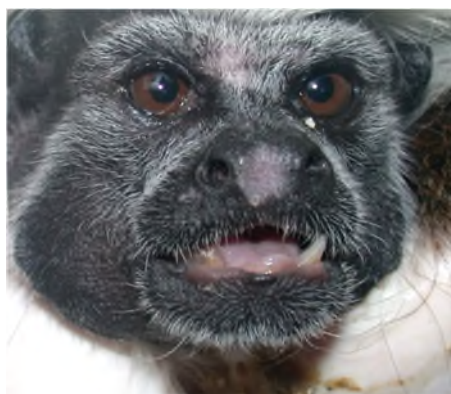

*Coloration change* (SSP/ Thierry Petit, La Palmyre/ Sharon Redrobe, Twycross): Loss of pigment could be either 1) metabolic (hormones, nutrition) or 2) genetic or 3) immune-mediated (e.g., Vitiligo, other syndromes reported in humans). Skin biopsies and histology research are recommended.

Vitiligo in a CTT: white spots are not stable, size increases or decreases and location may change.

*Use of Clopixol in cotton-top tamarins Saguinus oedipus*: at Zoo la Palmyre clopixol has been used on a mother with a poor rearing history (Thierry Petit, pers. comm.). They have found that she rears when she receives the drug, but not when she isn’t given it. After several trials, she gained experience and was finally able to rear infants without the drug. Subsequently, this protocol was used on other



primate species in other zoo with success. But it must be used in well documented cases, not when the failure is attributable to bad social grouping and/or inadequate environment.

*Marmoset wasting syndrome* (see e.g., Araújo de Moraes *et al.*, 2007).

*Research on pied tamarins S. bicolor* is ongoing at Durrell Wildlife Conservation Trust in Jersey. Pied tamarins morbidity and mortality are high, the main health problems being wasting syndrome and metabolic bone disorders. The species' confrontational nature and its unique responses to some situations continue to pose a challenge. Research therefore continues to be vital both in understanding this species' particular needs in captivity, and in planning conservation strategies in the wild which may include translocation and reintroduction

#### 4.8.2 Genetics

As *inbreeding* often has negative consequences for the survival and reproduction of an organism, Pedro Galetti and Gisele Orefice (Sao Paulo Zoo) conducted a study based on molecular analyses on inbreeding depression in GLTs (golden lion tamarins), in comparison to GHLTs (golden headed lion tamarins).

Sometimes the fitness of offspring is lowered by the inheritance of genetic material inherited through the parent with opposite sex. Philippe Helsen at CRC/RZSA is hence doing research on "*Mother's curse*" by investigating genes, using studbook data, that are transmitted via one parent (Y-chromosomes and mitochondrial DNA); in progress (involving 2 callitrichid species)

#### 4.8.3 Contraception and reproductive pathology

Several methods of contraception (*see also section 4.4.7*): are available for male and female callitrichids. In females, GnRH agonists (Suprelorin, Lupron) will inhibit oestrus while progestagen-based contraceptives (Implanon/Nexplanon, Jadelle) will inhibit fertilisation although menstruation will continue to occur with regular cyclicity. The choice of implant may affect social dynamics in callitrichid groups and is an important but relatively understudied area of research.

It is recommended that all individuals on contraception be reported to the European Group on Zoo Animal Contraception EGZAC ([www.egzac.org](http://www.egzac.org)). EGZAC works in association with the American Association of Zoos and Aquariums Reproductive Management Center (AZA RMC). EGZAC are particularly interested in dosage, reversibility after contraception, information on failures and side effects, as well as social changes following contraception. Updated contraceptive guidelines can be found at <http://egzac.org/Documents/Callitrichid%20EGZAC%20guidelines%202017.pdf>.

Reproductive pathology: reproductive choices including breeding/non-breeding and using contraception may have effects on reproductive health and social dynamics however, explicit links have not been found yet. If *reproductive pathologies* are found in your animals, EGZAC would be interested in copies of any histopathologic exam results or post-mortem reports as well as the reproductive history

#### 4.8.4 Behavioural research/enrichment

Behavioural research is needed to improve management: "What are the potential negative effects of being in a unisex group for a long time" (see also 4.4.7.2 "How are subordinate females behaviourally repressed"? But also "What is the influence of *social group composition* on female reproductive success and reproductive strategies in cooperative breeding callitrichids ". The latter is currently being investigated by Katherine Flach (Durham University) on 5 species (TAG approval April 2017).



Sometimes ex-situ experience with enrichment can be also useful for wild populations. Dr Larry Ulibarri and Leslie Gotuaco (University of Oregon) are investigating the best *road crossing structures*, and temporary methods for linking forest fragments; partially based on ex-situ experiences, for callitrichids in the wild (report will be sent to Callitrichidae TAG).

#### 4.8.5 Nutrition

Diet preference in captivity (Yaxley, 2007): A feed intake study, using continuous focal observation, food weight measurements and published food compositions, was carried out to assess the nutrient intakes of captive lion tamarins and the existence of food preferences when a heterogeneous diet is offered. There were clear preferences shown towards certain food items over others and diets selected by individuals were lacking in diversity. However, although differences did occur in individual nutrient intakes, a lack of quantitative data made it difficult to assess the diets being consumed by the tamarins. More research is necessary to replace suggested levels given with known levels appropriate for these species.

*Diet composition, overweight and obesity:* In many primates there is an effect of body condition on reproduction. Body condition itself can be affected by rearing in captivity. It is important that collections regularly weigh, and keep records of weights of, animals. Most usefully these should be entered into ZIMS.

*Litter size* in captivity: Research on the incidence of singletons, twins and triplets in callitrichids in captivity and if there is any correlation with generation level (time) in captivity, nutrition factors, ... .

### 4.9 Security and Identification

#### 4.9.1 Introduction

Small primates kept in zoological parks and other collections are always vulnerable to theft due to international demand for such animals, especially those with a high degree of rarity and threat in the wild. The EAZA survey on thefts (2010-2015) showed an alarming increasing in the thefts of primates, compared to the previous survey (2000-2005).

Being subject to CITES these small primates can be difficult to obtain legally. The following are Annex A: *Callimico goeldii*, *Callithrix aurita*, *Callithrix flaviceps*, *Leontopithecus* spp., *Saguinus bicolor*, *Saguinus geoffroyi*, *Saguinus leucopus*, *Saguinus martinsi*, *Saguinus oedipus*. The remaining species are all Annex B. These animals are valuable not only in the European market but also abroad, especially for the pet market. They are currently fashionable pets in Russia and China.

Therefore, the TAG considered it useful to provide security advice to holders. Obviously, each collection will have to assess which are the most appropriate methods and equipment, for their particular circumstances.

#### 4.9.2 Enclosure and Site Security

A number of security measures should be employed to prevent theft. These basically comprise secure and robust construction and alarm and monitoring systems. Holders should be aware that thieves may have carried out a survey of the site, and making them aware that security systems are in operation may deter potential theft.



Callitrichids are often housed in internal/external enclosures, and these are sometimes comprised of timber and mesh. This affords limited protection to being stolen; metal frames and strong mesh are more of a deterrent to thieves. However, whatever the structure, additional security should always be installed to help prevent the animals from being removed and to deter thieves.

All openings, doors, gates, inner bolt holes should be secured with high tensile steel. Closed shackled quality padlocks should be used, thereby preventing the use of bolt croppers having access to the open hasp. Closed shackled padlocks (see diagram) have the advantage of being more difficult to cut with tools such as bolt croppers. Alarmed padlocks can also be considered. These emit an audible signal if tampered with, but care would need to be taken that these did not 'go off' too easily.



Bolt croppers

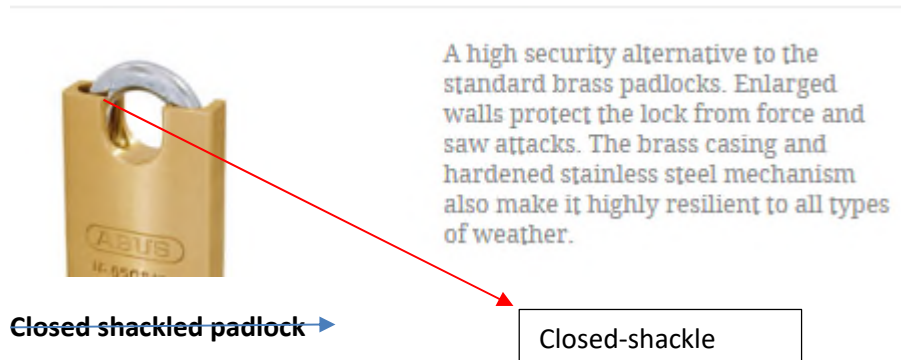

A high security alternative to the standard brass padlocks. Enlarged walls protect the lock from force and saw attacks. The brass casing and hardened stainless steel mechanism also make it highly resilient to all types of weather.

Closed shackled padlock →

Closed-shackle

Padbars (i.e. bar with hasp) on doors and frames should have the added protection of internal metal plates and secured with tensile steel bolts, i.e. not just fixed to flimsy material from which they can more easily be wrenched off.

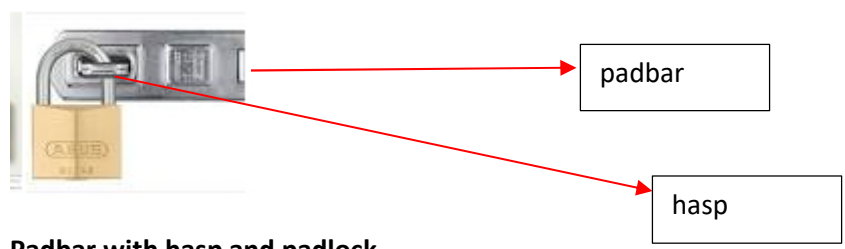

padbar

hasp

Padbar with hasp and padlock



This is our entry level alarm padlock for general purpose security. It has a good solid 8mm shackle with plenty of clearance to fit to a number of applications. It can be locked with the alarm in both activated and deactivated modes.





### Exampe of alarmed padlock

If wooden structures form part of the enclosure perimeter, they can be further protected by the installation of inner steel sheets or builders mesh to prevent intruders gaining access via roof, sides and rear panels.

Door hinges must not have screws externally accessible to perpetrators – but be fixed internally as well with bolts and/or metal bars.

Wire mesh can be fitted with vibration sensors, especially if double lined and not activated by the animals within. Vibration sensors are commonly used on fences to deter intruders and can be switched off when staff are present and switched on for overnight protection. A good example is laser motion detectors, which can be placed around the vulnerable areas of the zoo. These can give an audible alarm, and/or dial a prearranged telephone number.

It is vital to have high levels of security on the actual structure, whilst at the same time avoiding unduly disturbing the animals. To achieve this, external infra-red beam systems could be considered, either via the installation of actual hard-wired units or the more recently developed ‘wireless’ battery operated PIR multi beam units which will activate only by the bulk and size of an approaching human person and not by birds or smaller mammals in the area.

Such a system can be linked to a main control panel situated at an appropriate ‘manned’ location on site and being powered by electricity. Also linked to that system can be CCTV (and a multiplex recorder), floodlighting, audible alarms and pre-recorded verbal announcements that intruders have been detected on site and authorities are attending. *A video multiplexer (also known as a video mux, CCTV multiplexer, or colour quad processor) allows video signals from multiple CCTV security cameras, or other analog video devices, to be combined and display the multiple video streams on one monitor. This allows the video from all cameras to be recorded on a recording device that has only one video input, such as a surveillance VCR. For example, if you have four security cameras, each of the four video signals from each camera is synchronized by the CCTV multiplexer and recorded on the same video tape.*

A further available highly valuable piece of equipment is the ‘dial-out unit’. With this whenever any part of the whole system is activated or disturbed by an intruder, an immediate signal can be sent to an operative’s mobile telephone.

These systems can be user-friendly for staff as any zone can be switched off, by the use of a hand-held fob.

It is often the case that thieves will remove small primates together with the nest boxes. Boxes should be securely fixed via bolts and steel bands to allow access to the animals but preventing illegal removal. All nest boxes should be marked with UV pens or other means (e.g., GPS units) for evidence if ever stolen. No other bags, sacks or surplus containers should be accessible to the thieves, for the purpose of transporting stolen animals from the site. It is possible to fit a small electric radio tag to a nest box (e.g., hidden in the base) for about €60.00 per unit. This is a device which emits a signal which can be tracked using a mobile phone, or an online connection. Care must be taken to ensure that batteries are replaced, and that the unit remains active. The unit can be turned on remotely, however, using the ‘phone connection. Details can be obtained from Nic Dunn at Shaldon Zoo.



Electric radio tag which can be put in a compartment of a nest box.

The nest box (photo and diagram below) shows a compartment for the tracker and various other facilities for securing the nest box, a runner for shutting animals in, and holes for veterinary use for anaesthesia.





## NEST-BOX-DESIGN¶

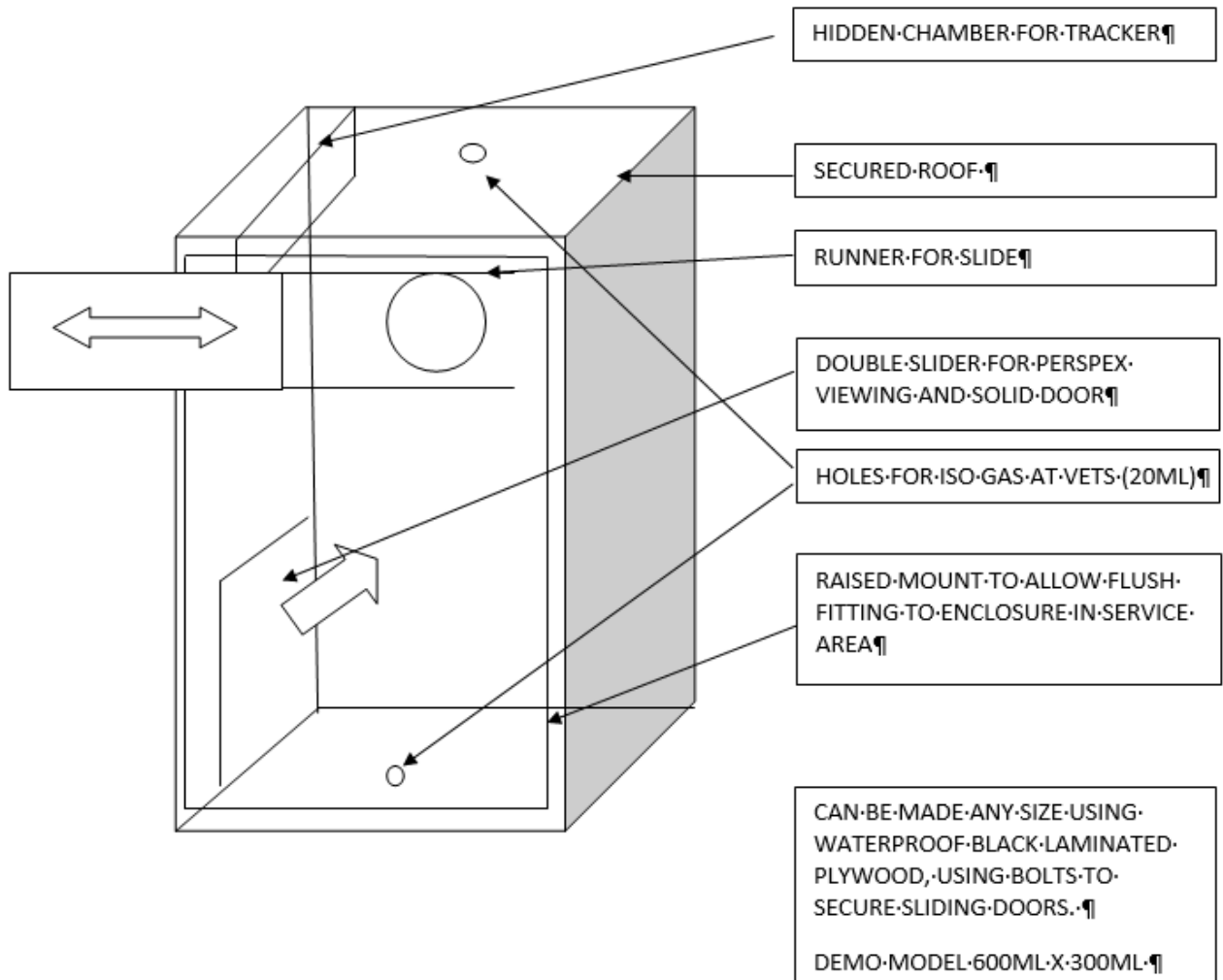

### 4.9.3 Animal Identification

All animals should be regularly photographed especially depicting any unique identification markings or features, signed, dated and stored securely. All animals **MUST** be microchipped i.e. **MICROCHIPPING is essential**. The recently developed mini-microchip is available with a reduced size of 8mm compared with the usual 12mm transponder. This is also a legal requirement for many species of callitrichid.

Another more recent deterrent is DNA marking, where a unique piece of DNA is used as a marker which is only visible under UV light. This spray can be used on objects and animals. See <https://www.selectadna.co.uk/dna-asset-marking/dnamedium>, for example and further information.

An additional possibility is to hold individual (tissue) samples of each animal. Such samples allow, at a later stage (when needed; with the help of EAZA researchers), to extract and characterize the DNA (which is individual specific). Samples (blood for example) can be obtained during (routine) medical



examinations or by plucking some hairs (whenever handling of the animals is needed). Storage and cataloguing can be done in conjunction with the BioBank Initiative and ZIMS.

It may be possible to collect paw prints (i.e., hand and footprints) which are probably unique for each individual, as they are in other species of primate. This can be done using ink-pads which are produced in several formats.

<http://www.sirchie.com/products/fingerprint-taking/ink-pads/1-5-8-diameter-ceramic-pocket-fingerprint-pad.html#.WC8kLsv2aM8>

#### **4.9.4 Liaison with Police and Crime Prevention Officers**

All collections should have a good relationship with their local crime prevention officers and wildlife crime personnel. These people should be kept informed of all security measures taken by the zoo. The local officers should report animal thefts to Europol.

Europol <https://www.europol.europa.eu/> is an EU agency and was formed in 2010. It is the EU's law enforcement agency. One of its remits is to fight illicit trafficking of endangered animal species. Therefore, they should be involved when callitrichids are stolen from zoos and collections in Europe.

#### **4.9.5 Support from EAZA EEO**

All thefts, and attempted thefts, should be reported to the EAZA Executive Office. The EAZA guidance document on animal thefts is in preparation, and holders will be informed as soon as this is available.



## 5. SECTION 5 – References

*These references refer to this document. Additional ex situ research on Callitrichidae is available on the Callitrichid TAG page on the EAZA website and is regularly updated by the KMDA team at Antwerp.*

### 5.1 References specific to enclosure design

Bryan, K., Bremner-Harrison, S., Price, E. and Wormell, D., 2017. The impact of exhibit type on behaviour of caged and free-ranging tamarins. *Applied Animal Behaviour Science*, 193, 77-86.

Cabana, F., Maguire, R., Hsu, C.D. and Plowman, A., 2018. Identification of possible nutritional and stress risk factors in the development of marmoset wasting syndrome. *Zoo Biology*, 37(2), 98-106.

Caine, N.G., 1987. Vigilance, vocalizations, and cryptic behavior at retirement in captive groups of red-bellied tamarins (*Saguinus labiatus*). *American Journal of Primatology*, 12(3), 241-250.

Campbell, M.W. and Snowdon, C.T., 2007. Vocal response of captive-reared *Saguinus oedipus* during mobbing. *International Journal of Primatology*, 28(2), 257-270.

Cronin, K.A., Bethell, E.J., Jacobson, S.L., Egelkamp, C., Hopper, L.M. and Ross, S.R., 2018. Evaluating mood changes in response to anthropogenic noise with a response-slowing task in three species of zoo-housed primates. *Animal Behavior & Cognition*, 5(2), 209-221.

Dancer, A.M. and Burn, C.C., 2019. Visitor effects on zoo-housed Sulawesi crested macaque (*Macaca nigra*) behaviour: Can signs with 'watching eyes' requesting quietness help? *Applied Animal Behaviour Science*, 211, 88-94.

Davis, N., Schaffner, C.M. and Smith, T.E., 2005. Evidence that zoo visitors influence HPA activity in spider monkeys (*Ateles geoffroyii rufiventris*). *Applied Animal Behaviour Science*, 90(2), 131-141.

Edes, A.N. and Crews, D.E., 2017. Allostatic load and biological anthropology. *American Journal of Physical Anthropology*, 162, 44-70.

Ferrari, S.F. and Beltrao-Mendes, R., 2011. Do snakes represent the principal predatory threat to callitrichids? Fatal attack of a viper (*Bothrops leucurus*) on a common marmoset (*Callithrix jacchus*) in the Atlantic Forest of the Brazilian Northeast. *Primates*, 52(3), 207.

Ford, S.M., 1980. Callitrichids as phyletic dwarfs, and the place of the Callitrichidae in Platyrrhini. *Primates*, 21(1), pp.31-43.

Harrod, E.G., Coe, C.L. and Niedenthal, P.M., 2020. Social structure predicts eye contact tolerance in nonhuman primates: evidence from a crowd-sourcing approach. *Scientific Reports*, 10(1), 1-9.

Hashmi, A. and Sullivan, M., 2020. The visitor effect in zoo-housed apes: the variable effect on behaviour of visitor number and noise. *Journal of Zoo and Aquarium Research*, 8(4), 268-282.

Hosey, G., 2000. Zoo animals and their human audiences: what is the visitor effect? *Animal Welfare* 9: 343-357.

Kleist, N.J., Guralnick, R.P., Cruz, A., Lowry, C.A. and Francis, C.D., 2018. Chronic anthropogenic noise disrupts glucocorticoid signaling and has multiple effects on fitness in an avian community. *Proceedings of the national academy of sciences*, 115(4), E648-E657.



Mallinson, J.J.C., 1975. The design of two marmoset complexes at the Jersey Zoological Park. *Jersey Wildlife Preservation Trust Annual Report* 12, 21-26.

Montgomery, S.H. and Mundy, N.I., 2013. Parallel episodes of phyletic dwarfism in callitrichid and cheirogaleid primates. *Journal of Evolutionary Biology* 26, 810-819.

Sherwen, S.L., Harvey, T.J., Magrath, M.J., Butler, K.L., Fanson, K.V. and Hemsworth, P.H., 2015. Effects of visual contact with zoo visitors on black-capped capuchin welfare. *Applied Animal Behaviour Science*, 167, 65-73.

Woods, J.M., Ross, S.R. and Cronin, K.A., 2019. The social rank of zoo-housed Japanese macaques is a predictor of visitor-directed aggression. *Animals*, 9(6), 316.

Wormell, D., Brayshaw, M., Price, E. and Herron, S. (1996). Pied tamarins *Saguinus bicolor bicolor* at the Jersey Wildlife Preservation Trust: Management, behaviour and reproduction. *Dodo* 32, 76-97.

Yoshimoto, T., Takahashi, E., Yamashita, S., Ohara, K. and Niimi, K., 2018. Larger cages with housing unit environment enrichment improve the welfare of marmosets. *Experimental Animals*, 67(1), 31-39.

## 5.2 References specific to vitamin D and UVB provision

Adams, J.S., Gacad, M.A., Baker, A.J., Gonzales, B. and Rude, R.K., 1985. Serum concentrations of 1, 25-dihydroxyvitamin D<sub>3</sub> in Platyrrhini and Catarrhini: A phylogenetic appraisal. *American journal of primatology*, 9(3), pp.219-224.

Adams, J.S., Chen, H., Chun, R.F., Nguyen, L., Wu, S., Ren, S.Y., Barsony, J. and Gacad, M.A., 2003. Novel regulators of vitamin D action and metabolism: lessons learned at the Los Angeles zoo. *Journal of cellular biochemistry*, 88(2), pp.308-314.

Baines, F., 2020. The provision of UVB to mammals. Available from: [fbaines@uvguide.co.uk](mailto:fbaines@uvguide.co.uk)

Baines, F., Chattell, J., Dale, J., Garrick, D., Gill, I., Goetz, M., Skelton, T. & Swatman, M. 2016. How much UV-B does my reptile need? The UV-Tool, a guide to the selection of UV lighting for reptiles and amphibians in captivity. *Journal of Zoo and Aquarium Research* 4(1): 42 - 63.

Bikle, D.D., 1992. Clinical counterpoint: vitamin D: new actions, new analogs, new therapeutic potential. *Endocrine reviews*, 13(4), pp.765-784.

Bosseler, L., Bakker, J., Duchateau, L., Remarque, E., Langermans, J.A., Cornillie, P. and Chiers, K., 2018. 25-OH-vitamin D, parathyroid hormone, and calcium serum levels in captive common marmosets (*Callithrix jacchus*): Reference values and effect of age, sex, season, and closure of long bone epiphyses. *Journal of medical primatology*, 47(3), pp.172-177.

Chun, R.F., Shieh, A., Gottlieb, C., Yacoubian, V., Wang, J., Hewison, M. and Adams, J.S., 2019. Vitamin D binding protein and the biological activity of Vitamin D. *Frontiers in endocrinology*, 10, p.718.

Crissey, S.D., Meehan, T.P., Langman, C. and Pruett-Jones, M.A., 1999. Vitamin D metabolites 25 (OH) D and 1, 25 (OH) 2D and kidney function indices and the relationship to diet in Goeldi's monkeys (*Callimico goeldii*). *Zoo Biology* 18(6), pp.565-574.





Ferguson, G., Brinker, A., Gehrman, W., Bucklin, S., Baines, F. and Mackin, S. 2010. Voluntary Exposure of Some Western-Hemisphere Snake and Lizard Species to Ultraviolet-B (UVB) Radiation in the field: How Much UVB Should a Lizard or Snake Receive in Captivity? *Zoo Biology* 29 (3) 317-334.

Fletcher, J., Cooper, S.C., Ghosh, S. and Hewison, M., 2019. The role of vitamin D in inflammatory bowel disease: mechanism to management. *Nutrients*, 11(5), p.1019.

Gacad, M.A. and Adams, J.S., 1991. Endogenous blockade of 1, 25-dihydroxyvitamin D-receptor binding in New World primate cells. *The Journal of clinical investigation*, 87(3), pp.996-1001.  
Gacad, M.A., Deseran, M.W. and Adams, J.S., 1992. Influence of ultraviolet B radiation on vitamin D3 metabolism in vitamin D3-resistant New World primates. *American journal of primatology*, 28(4), pp.263-270.

Ghaly, S. and Lawrance, I., 2014. The role of vitamin D in gastrointestinal inflammation. *Expert review of gastroenterology & hepatology*, 8(8), pp.909-923.

Giovannucci E, 2009. Expanding roles of Vitamin D. *Journal of Clinical Endocrinology and Metabolism* 94, 418-420.

Girgis, C.M., Clifton-Bligh, R.J., Hamrick, M.W., Holick, M.F. and Gunton, J.E., 2013. The roles of vitamin D in skeletal muscle: form, function, and metabolism. *Endocrine reviews*, 34(1), pp.33-83.

Junge, R. E., F.H. Gannon, I. Porton, W. H. McAlister and M.P. Whyte. 2000. Management and Prevention of Vitamin D Deficiency Rickets in Captive-born Juvenile Chimpanzees (*Pan troglodytes*). *Journal of Zoo and Wildlife Medicine* 31, 361 – 369.

Killick, R., Saunders, R. and Redrobe, S.P., 2015. Summer and winter vitamin D3 levels in four lemur species housed at a British zoo, with reference to UVB levels. *Journal of Zoo and Wildlife Medicine*, 46(3), pp.498-505.

Killick, R., Saunders, R. and Redrobe, S.P., 2017. Summer and winter vitamin d3 levels in seven platyrrhine species housed at a british zoo, with reference to natural uvb levels. *Journal of Zoo and Wildlife Medicine*, 48(3), pp.732-741.

Liberman, U.A., de Grange, D. and Marx, S.J., 1985. Low affinity of the receptor for 1 $\alpha$ , 25-dihydroxyvitamin D3 in the marmoset, a new world monkey. *FEBS letters*, 182(2), pp.385-388.

Lopez, J., Wormell, D. and Barbon, A.R., 2001. Preliminary evaluation of the efficacy and safety of a UVB lamp used to prevent metabolic bone disease in pied tamarins *Saguinus bicolor* at Jersey Zoo. *DODO-TRINITY*-, 37, pp.41-49.

Olson, E.J., Shaw, G.C., Hutchinson, E.K., Schultz-Darken, N., Bolton, I.D., Parker, J.B., Morrison, J.M., Baxter, V.K., Pate, K.M., Mankowski, J.L. and Carlson, C.S., 2015. Bone disease in the common marmoset: radiographic and histological findings. *Veterinary pathology*, 52(5), pp.883-893.

Power, M.L., Oftedal, O.T., Savage, A., Blumer, E.S., Soto, L.H., Chen, T.C. and Holick, M.F., 1997. Assessing vitamin D status of callitrichids: Baseline data from wild cotton-top tamarins (*Saguinus oedipus*) in Colombia. *Zoo Biology*, 16(1), pp.39-46.



Shinki, T., Shiina, Y., Takahashi, N., Tanioka, Y., Koizumi, H. and Suda, T., 1983. Extremely high circulating levels of 1 $\alpha$ , 25-dihydroxyvitamin D3 in the marmoset, a new world monkey. *Biochemical and biophysical research communications*, 114(2), pp.452-457.

Stein, A.C., Gaetano, J.N., Jacobs, J., Kunnavakkam, R., Bissonnette, M. and Pekow, J., 2016. Northern latitude but not season is associated with increased rates of hospitalizations related to inflammatory bowel disease: results of a multi-year analysis of a national cohort. *PloS one*, 11(8), p.e0161523.

Takahashi, N., Suda, S., Shinki, T., Horiuchi, N., Shiina, Y., Tanioka, Y., Koizumi, H. and Suda, T., 1985. The mechanism of end-organ resistance to 1 $\alpha$ , 25-dihydroxycholecalciferol in the common marmoset. *Biochemical Journal*, 227(2), pp.555-563.

Teixeira, D.S., Castro, L.C.G., Nóbrega, Y.K.M., Almeida, R.C., Gandolfi, L. and Pratesi, R., 2010. 25-Hydroxy-vitamin D levels among *Callithrix penicillata* primate species raised in captivity. *Journal of medical primatology*, 39(2), pp.77-82.

Teixeira, D.S., Nobrega, Y.K.M., Valencia, C.E.U., Gandolfi, L., Pratesi, R. and Castro, L.C.G., 2012. Evaluation of 25-hydroxy-vitamin D and parathyroid hormone in *Callithrix penicillata* primates living in their natural habitat in Brazil. *Journal of Medical Primatology*, 41(6), pp.364-371.

Vanherwegen, A.S., Gysemans, C. and Mathieu, C., 2017. Regulation of immune function by vitamin D and its use in diseases of immunity. *Endocrinology and Metabolism Clinics*, 46(4), pp.1061-1094.

Ziegler, T.E., Kapoor, A., Hedman, C.J., Binkley, N. and Kemnitz, J.W., 2015. Measurement of 25-hydroxyvitamin D<sub>2</sub>&3 and 1, 25-dihydroxyvitamin D<sub>2</sub>&3 by tandem mass spectrometry: A primate multispecies comparison. *American journal of primatology*, 77(7), pp.801-810.

Ziegler, T.E., Kapoor, A., Binkley, N.C., Rice, K.S., Rogers, J., Jolly, C.J. and Phillips-Conroy, J.E., 2018. Comparison of vitamin D metabolites in wild and captive baboons. *American journal of primatology*, 80(12), p.e22935.

### 5.3 References specific to positive reinforcement training

Bassett, L., Buchanan-Smith, H.M., McKinley, J., Smith, T.E., (2003), *Effects of training on stress-related behaviour of the common marmoset (Callithrix jacchus) in relation to coping with routine husbandry procedures*, *Journal of Applied Animal Welfare Science*, 6(3):221-233.

Brown, S., (2012), *Small mammal training in the veterinary practice*, *Veterinary clinics of north america, exotic animal practice, exotic animal training and learning*, Volume 15, Number 3, September 2012, Elsevier Inc, USA

Buchanan-Smith, H.M. (2005) Recent advances in color vision research. *American Journal of Primatology*: 67, 393-398.

Department for Environment Food and Rural Affairs (DEFRA), (2012), Secretary of States Standards for Modern Zoo Practice, Appendix 7 – training of animals, pp 42, <http://www.defra.gov.uk/wildlife-pets/zoos/>

EAZA, (2019), Standards for the accommodation and care of animals in Zoos and Aquaria, Approved by EAZA Annual General Meeting, 25<sup>th</sup> April 2019), Accessed online 25.2.20,



<https://www.eaza.net/assets/Uploads/Standards-and-policies/2019-04-EAZA-Standards-for-Accommodation-and-Care.pdf>

· Friedman.S.G., (2001), The ABCs of behaviour, Utah state University, <http://www.behaviorworks.org/files/articles/ABCs%20of%20Behavior%202004.pdf>

Friedman.S.G, (2005), He said, she said, science says, Accessed online 25.5.20, <http://www.behaviorworks.org/files/articles/He%20Said,%20She%20Said,%20Science%20Says.pdf>

Friedman.S.G, (2006), Shaping new behaviours, Behaviour works, Accessed online 26.5.20, <http://www.behaviorworks.org/files/articles/Shaping%20New%20Behaviors.pdf>

Friedman.S.G, (2009), Functional assessment: hypothesizing predictors and purposes of problem behaviour to improve behaviour change plans, Accessed online 25.5.20, <http://www.behaviorworks.org/files/articles/Functional%20Assessment.pdf>

Friedman.S.G, (2010), What's wrong with this picture? Effectiveness is not enough, APDT Journal March/April, Accessed online 25.5.2020, <http://www.behaviorworks.org/files/articles/APDT%20What's%20Wrong%20with%20this%20Picture%20-%20Dogs.pdf>

Gullapalli.V, (1997), Reinforcement learning of complex behaviour through shaping, Advances in Psychology, Volume 121, pp 302-314, Elsevier science B.V

Martin.S, Friedman.S.G. (2011), *Blazing clickers*, [www.behaviourworks.org/files/journals/blazing%20clickers.pff](http://www.behaviourworks.org/files/journals/blazing%20clickers.pff)

Martin.S, Friedman.S.G, (2013), The power of trust, (Presented at the IAATE conference 2013), Accessed online 25.5.20, <http://www.behaviorworks.org/files/articles/The%20Power%20of%20Trust.pdf>

Mattison.S, (2012), Training birds and small mammals for medical behaviors, Veterinary clinics of North America, Exotic animal practice, exotic animal training and learning, Volume 15, Number 3, September 2012, Elsevier Inc, USA.

McKinley, J., Buchanan-Smith, H. M., Bassett, L., & Morris, K. (2003). Training common marmosets (*Callithrix jacchus*) to cooperate during routine laboratory procedures: ease of training and time investment. *Journal of Applied Animal Welfare Science*, 6(3), 209-220.

· Owen.Y, Amory.J, (2011), *A case study employing operant conditioning to reduce stress of capture for red bellied tamarins (Saguinus labiatus)*, Journal of applied animal welfare science, 14:124-137, Taylor and Francis Group Ltd.

· Prescott.M.J, Bowell.V.A, Buchanan-smith.H.M, (2005), *Training laboratory-housed non-human primates, part 2: Resources for developing and implementing training programmes*, National centre for the replacement, refinement and reduction of animals in research, 20 Park Crescent, London, W1B 1AL

Savastano.G, Hanson.A, McCann.C, (2003), *The development of an operant conditioning training program for new world monkeys at the Bronx zoo*, Journal of applied animal welfare science, 6(3), 247-261, Lawrence Erlbaum Associates Inc.



Ward,S, Melfi.V, (2015), Keeper-animal interactions: Differences between the behaviour of zoo animals affect stockmanship, Accessed online 25.5.20, <https://journals.plos.org/plosone/article?id=10.1371/journal.pone.0140237>

Wolfensohn.S, Shotton.J, Bowley.H, Davies.S, Thompson.S, Justice.W.S.M, (2018), Assesment of Welfare in Zoo animals: Towards optimum quality of life, Animals (Basel), Accessed online 22.5.20, <https://www.ncbi.nlm.nih.gov/pmc/articles/PMC6071229/>

## 5.4 General References

ABBOTT, D.H. (1984): Behavioural and physiological suppression of fertility in subordinate marmoset monkeys. Am. J. Primatol. 6: 169–186.

ABBOTT, D.H., BARRETT, J. and GEORGE, L.M. (1993): Comparative aspects of the social suppression of reproduction in female marmosets and tamarins. In: Marmosets and Tamarins: Systematics, ecology, and behaviour, A.B. Rylands (ed.). Oxford University Press, Oxford. 152–163.

ABBOTT, D.H. and HEARN, J.P. (1978): Physical, hormonal and behavioural aspects of sexual development in the marmoset monkey, *Callithrix jacchus*. J. Reprod. Fert. 53: 155–166.

ABBOTT, D.H., McNEILLY, A.S., LUNN, S.F., HULME, M.J. and BURDEN, F.J. (1981): Inhibition of ovarian function in subordinate female marmoset monkeys (*Callithrix jacchus jacchus*). J. Reprod. Fert. 63: 335–345.

AGUIAR, J.M. and LACHER Jr., T.E. (2003): On the morphological distinctiveness of *Callithrix humilis* Van Roosmalen *et al.* 1998. Neotrop. Primates 11(1): 11–18.

ALBERNAZ, A.L. (1997): Home range size and habitat use in the black lion tamarin (*Leontopithecus chrysopygus*). Int. J. Primatol. 18: 877–887.

ALBERNAZ, A.L. and MAGNUSSON, W.E. (1999): Home-range size of the bare-ear marmoset (*Callithrix argentata*) at Alter do Chão, central Amazonia, Brazil. Int. J. Primatol. 20(5): 665–677.

ALBUJA, L. (1994): Nuevos registros de *Saguinus tripartitus* en la Amazonia ecuatoriana. Neotrop. Primates 2(2): 8–10.

ALLEN, M.A. and OFTEDAL, O.T. (1996): Essential nutrients in mammalian diets. In: Wild Mammals in Captivity, Kleiman, D.G., Allen, M.E., Thompson, K.V. and Lumpkin, S. (eds.). The University of Chicago Press, Chicago. 117–128.

ALPERIN, R. (1993): *Callithrix argentata* (Linnaeus, 1771): considerações taxonômicas e descrição de subespécie nova. Bol. Mus. Para. Emílio Goeldi, Sér. Zool. 9(2): 317–328.

ALTMANN, J. (1980): Baboon Mothers and Infants. Harvard University Press, Cambridge, MA.

ALTMANN, J. (1983): Costs of reproduction in baboons (*Papio cynocephalus*). In: The Cost of Survival in Vertebrates, Aspey, W.P. and Lustick, S.I. (eds.). Ohio State University Press, Columbus, OH. 67–88.

ANZENBERGER, G. and FALK, B. (2012): Monogamy and family life in callitrichid monkeys: Deviations, social dynamics and captive management. Int. Zoo Yearb. 46: 109-122.

ANTUNES, S.G., DE GROOT, N.G., BROK, H., DOXIADIS, G., MENEZES, A.A.L., OTTING, N. and BONTROP, R.E. (1998): The common marmoset: a New World primate species with limited Mhc Class II variability. Proc. Nat. Acad. Sci. USA 95(20): 11745–11750.

AQUINO, R. and ENCARNACIÓN, F (1996): Distribución geográfica de *Saguinus tripartitus* en la Amazonía del Perú. Neotrop. Primates 4(1): 1–4.



- AQUINO, R., IQUE, C. and GÁLVEZ, H. (2005): Reconocimiento preliminar de la densidad y estructura poblacional de *Saguinus tripartitus* Milne-Edwards en la Amazonía peruana. *Rev. Peru. Biol.* 12(3): 435–440.
- ARAÚJO, A., ARRUDA, M.F., ALENCAR, A.I., ALBUQUERQUE, F., NASCIMENTO, M.C. and YAMAMOTO, M.E. (2000): Body weight of wild and captive common marmosets (*Callithrix jacchus*). *Int. J. Primatol.* 21(2):317–324.
- ARAUJO DE MORAES I., LILENBAUM W., ALENCAR N., PEREIRA ALMOSNY N., DE MELLO and CERQUEIRA A., UCHOA C., dos REIS FERREIRA A.M., PISSINATTI A. (2007): Wasting syndrome in *Saguinus martinsi* (“Martin’s bare-face tamarin”) – Callitrichidae – Primates: Case report. *Acta Veterinaria Brasilica* 1(3): 94–98.
- ARAUJO SANTOS, F.G. DE, BICCA-MARQUES, J.C., CALEGARO-MARQUES, C., DE FARIAS, E.M.P. and AZEVEDO, M.A.O. (1995): On the occurrence of parasites in free-ranging callitrichids. *Neotrop. Primates* 3(2): 46-47.
- ARMSTRONG, D.M. and SANTYMIRE, R.M. (2013): Hormonal and behavioural variation in pied tamarins housed in different management conditions, *Zoo Biol.* 32: 299-306
- ARRUDA, M.F., ARAUJO, A., SOUSA, M.B.C., ALBUQUERQUE, F.S., ALBUQUERQUE, A.C.S.R. and YAMAMOTO, M.E. (2005): Two breeding females within free-living groups may not always indicate polygyny: alternative subordinate female strategies in common marmosets (*Callithrix jacchus*). *Folia Primatol.* 76: 10–20.
- ASA, C.S., PORTON, I., BAKER, A.M. and PLOTKA, E.D. (1996): Contraception as a management tool for controlling surplus animals. In: *Wild Mammals in Captivity*, D.G. Kleiman, M.E. Allen, K. V. Thompson and S. Lumpkin (eds). The University of Chicago Press: Chicago. 451–467.
- AZEVEDO, C.V.M., CAMILLO, C.S., XAVIER, C.A., MOREIRA, L.F.S., DE SOUSA, M.B.C. and MARQUES, N. (2001): Grooming circadian rhythmicity, progesterone levels and partner preference of the reproductive pair of a captive common marmoset (*Callithrix jacchus*) family group during pregnancy and after parturition. *Biol. Rhythm Res.* 32 (2): 145–157.
- AZEVEDO, C.V.M., MENEZES, A.A.L., MOREIRA, L.F.S. and MARQUES, N. (1998): Circadian rhythmicity of grooming behavior during pregnancy in a marmoset (*Callithrix jacchus*) family group in captivity. *Biol. Rhythm Res.* 29(5): 563–571.
- AZEVEDO LOPES, M.A.O. and REHG, J.A. (2003): Observation of *Callimico goeldii* with *Saguinus imperator* in the Serra do Divisor National Park, Acre, Brazil. *Neotrop. Primates* 11(3): 181–183.
- BADIHI, I., MORRIS, K. and BUCHANAN-SMITH, H.M. (2007): The effects of complexity and choice, together with the loss of them, on the behaviour of a family group of common marmosets (*Callithrix jacchus*). *Lab. Prim. Newsl.* 46: 1–5.
- BAINES, F., CHATTEL, J., DALE, J., GARRICK, D., GILL, I., GOETZ, M., SKELTON, T., SWATMAN, M. (2016): How much UV-B does my reptile need? The UV-tool, a guide to the selection of UV lighting for reptiles and amphibians in captivity. *JZAR* 4(1): 42–63.
- BAIRRÃO RUIVO, E., STEVENSON, M., WORMELL, D., RYLANDS, A., HAUSEN, N., HERRMANN, K. AND LEUS, K. (eds.). (2019a). EAZA Regional Collection Plan for Callitrichids: Final Report. EAZA Executive Office, Amsterdam, The Netherlands.
- BAIRRÃO RUIVO, E., STEVENSON, M., WORMELL, D., HAUSEN, N., HERRMANN, K. AND LEUS, K. (eds.). (2019b). Global Integrated Collection Assessment and Planning Workshop for Callitrichidae: Final Report. EAZA Executive Office, Amsterdam, The Netherlands.
- BAITCHMAN, E.J., CALLE, P.P., JAMES, S.B., LINN, M.J. and RAPHAEL, B.L. (2006); Leptospirosis in Wied’s marmosets (*Callithrix kuhlii*), *J. Zoo Wildl. Med.* 37(2), 182–185
- BAKER, A.J. (1994): Bicolored tamarins born at the Philadelphia Zoo. *AZA Communique* (October): 18.
- BAKER, A.J. and DIETZ, J.M. (1996): Immigration in wild groups of golden lion tamarins (*Leontopithecus rosalia*). *Am. J. Primatol.* 38(1): 47–56.
- BAKER, A.J. and WOODS, F. (1992): Reproduction of the emperor tamarin (*Saguinus imperator*) in captivity, with



comparisons to cotton-top and golden lion tamarins. *Am. J. Primatol.* 26(1): 1–10.

BAKER, B. (1992): Guess who's coming to dinner: an overview of mixed-species primate exhibits. AAZPA Regional Conference Proceedings, Baltimore, Maryland: 62–67.

BAKKER, J., OUWERLING, B., HEDIT, P.J., KONDOVA, I., LANGERMANS, J.A.M. (2015): Advantages and risks of husbandry and housing changes to improve animal well being in a breeding colony of common marmosets, *JAALAS*, 54(3), 273-279.

BALLOU, J.D. (1989): Emergence of the captive population of golden-headed lion tamarins *Leontopithecus chrysomelas*. *Dodo, J. Jersey Wildl. Preserv. Trusts* 26: 70–77.

BARNARD, D., KNAPKA, J. and RENQUIST, D. (1988): The apparent reversal of a wasting syndrome by nutritional intervention in *Saguinus mystax*. *Lab. Anim. Sci.* 38: 282–288.

BARROSO, C.M.L., SCHNEIDER, H., SCHNEIDER, M.P.C., SAMPAIO, I., HARADA, M.L., CZELUSNIAK, J. and GOODMAN, M. (1997): Update on the phylogenetic systematics of New World monkeys: further DNA evidence for placing the pygmy marmoset (*Cebuella*) within the genus *Callithrix*. *Int. J. Primatol.* 18(4): 651–674.

BARTECKI, U. and HEYMANN, E.W. (1987): Field observation of snake mobbing in a group of saddle-back tamarins, *Saguinus fuscicollis nigrifrons*. *Folia Primatol.* 48: 199–202.

BARTECKI, U. and HEYMANN, E.W. (1990): Field observations on scent-marking behaviour in saddle-back tamarins, *Saguinus fuscicollis* (Callitrichidae, Primates). *J. Zool., Lond.* 220: 87–99.

BASSETT, L., BUCHANAN-SMITH, H.M., MCKINLEY, J. and SMITH, T.E. (2003): Effects of training on stress-related behavior of the common marmoset (*Callithrix jacchus*) in relation to coping with routine husbandry procedures. *J. Appl. Anim. Welfare Sci.*, 6: 221–233.

BAXTER, V.K., SHAW, G.C., SOTUYO, N.P., CARLSON, C.S. and OLSON, E.J. (2013): Serum albumin and body weight as biomarkers for the antemortem identification of bone and gastrointestinal disease in the common marmoset. *PLoS ONE* 8(12): e82747.

BERNARD, J. and WRITER, S. (1993): Enriching animal lives. *Bison* (Brookfield Zoo, Chicago) 7(2): 18–25.

BICCA-MARQUES, J.C. (1999): Hand specialization, sympatry, and mixed-species associations in callitrichines. *J. Hum. Evol.* 36: 349–378.

BICCA-MARQUES, J. C. and CALEGARO-MARQUES, C. (1995): Updating the known distribution of the pygmy marmoset (*Cebuella pygmaea*) in the state of Acre, Brazil. *Neotrop. Primates* 3(2): 48–49.

BIELLI, M., LAUZI, S., PRATELLI, A., MARTINI, M., DALL'ARA, P., and BONIZZI, L. (1999): Pseudotuberculosis in marmosets, tamarins and Goeldi's monkeys housed at a European zoo. *J. Zoo Wildl. Med.* 30(40): 532–536.

BOUBLI, J. P., SILVA, M.N.F. DA, RYLANDS, A.B., NASH, S.D., BERTUOL, F., NUNES, M., MITTERMEIER, R.A., BYRNE, H., SILVA F E. DA, RÖHE, F., SAMPAIO, I., SCHNEIDER, H., FARIAS, I.P. and HRBEK, T.P. 2018. How many pygmy marmoset (*Cebuella* Gray, 1870) species are there? A taxonomic re-appraisal based on new molecular evidence. *Mol. Phylogenet. Evol.* 120: 170–182.

BOUBLI, J.P., JANIAC, M. C., PORTER, L.M., DE LA TORRE, S., CORTÉS-ORTIZ, L., DA SILVA, M.N.F., RYLANDS, A. B., NASH, S., BERTUOL, F., BYRNE, H., SILVA, F.E., RÖHE, F., DE VRIES, D., BECK, R.M.D., RUIZ-GARTZIA, I., KUDERNA, L.F.K., MARQUES-BONET, T., HRBEK, T., FARIAS, I.P., VAN HETEREN, A.H. AND ROOS, C. (2021): Ancient DNA of the pygmy marmoset type specimen *Cebuella pygmaea* (Spix, 1823) resolves a taxonomic conundrum. *Zool. Res.* 42(6): 761–771.

BOX, H. (1995): Biological propensities of the Callitrichidae—a much used little-known group. *Lab. Anim.* 29(3): 237–243.

BRACK, M. (1990): IgM-nephropathy (-nephritis) in callitrichids (Primates, Anthropoidea, Platyrrhini, Callitrichidae). *J. Vet. Med., ser. A.* 37(9): 692–707.





- BRAND, H.M. (1980): Influence of season on birth distribution in marmosets and tamarins. *Lab. Anim.* 14 (4): 301–302.
- BRAY, G.A. (2004): Medical consequences of obesity. *J. Clin. Endocrinol. Metab.* 89(6): 2583–2589.
- BRIDGWATER, D.D. ed. (1972): *Saving the Lion Marmoset*. Wild Animal Propagation Trust, Wheeling, West Virginia.
- BRITT, S., COWLARD, K., BAKER, K. and PLOWMAN, A. (2015): Aggression and self-directed behavior of captive lemurs (*Lemur catta*, *Varecia variegata*, *V. rubra* and *Eulemur coronatus*) is reduced by feeding fruit-free diets. *J. Zoo Aqu. Res.* 3: 52–58.
- BROOKS, P. (1995): Primate Care. Ivester, K. and Crowley Dittmar, E. (eds.) Simian Society of America, Saint Louis, MO.
- BUCHANAN-SMITH, H.M. (1990): Polyspecific association of two tamarin species, *Saguinus labiatus* and *Saguinus fuscicollis*, in Bolivia. *Am. J. Primatol.* 22: 205–214.
- BUCHANAN-SMITH, H.M. (1991): Field observations of Goeldi's monkey, *Callimico goeldii*, in northern Bolivia. *Folia Primatol.* 57: 102–105.
- BUCHANAN-SMITH, H.M. (1998): Enrichment of marmosets and tamarins – considerations for the care of captive callitrichids. In: Guidelines for environmental enrichment, D.A. Field (ed.). Association of British Wild Animal Keepers, West Sussex. 183–201.
- BUCHANAN-SMITH, H.M. (1999a): Exploration of unfamiliar areas and detection of potentially threatening objects in single- and mixed-species groups of tamarins. *Int. J. Comp. Psychol.* 12: 2–20.
- BUCHANAN-SMITH, H.M. (1999b): Marmosets and tamarins are not all the same. 4th International Conference on Environmental Enrichment. Edinburgh, Scotland, 29 August – 3 September 1999. Abstract Book. Edinburgh Zoo: Edinburgh. 21.
- BUCHANAN-SMITH, H.M. (1999c): Environmental enrichment in captive marmosets and tamarins. <http://arrs.envirolink.org/psyeta/hia/vol8/buchanan.html>.
- BUCHANAN-SMITH, H.M. (2005): Recent advances in color vision research. *Am. J. Primatol.* 67: 393–398.
- BUCHANAN-SMITH, H.M. (2010): Marmosets and tamarins. In: The UFAW Handbook on the care and Management of Laboratory animals and Other Research Animals, Eighth ed., R. Hubrecht and J. Kirkwood (eds.). Wiley-Blackwell, Oxford. 543–563.
- BUCHANAN-SMITH, H.M. (2012): Mixed species exhibition of Neotropical primates: analysis of species combination success. *Int. Zoo. Yb.* 46: 150-163.
- BUCHANAN-SMITH, H.M. and HARDIE, S.M. 1997. Tamarin mixed-species groups: An evaluation of a combined captive and field approach. *Folia Primatol.* 68(3–5): 272–286.
- BUCKNER, J. C., LYNCH-ALFARO, J., RYLANDS, A.B. and ALFARO, M.E. (2015): Biogeography of the marmosets and tamarins (Callitrichidae). *Mol. Phylogenet. Evol.* 82: 413–425.
- BURITY, C.H.F., ALVES, M.U. and PISSINATTI, A. (1997b): Dental changes in three species of *Leontopithecus* (Callitrichidae, Primates) kept in captivity. *Rev. Brasil. Cienc. Vet.* 4 1): 9–12.
- BURITY, C.H.F., DASILVA, M.R., DE SOUZA, A.M. and PISSINATTI, A. (2009): Morphometric aspects of the tongue in captivity *Leontopithecus chrysomelas* Kuhl, 1820 (Callitrichidae, Primates). *Rev. Brasil. Med. Vet.* 31 (3): 168–172.
- BURITY, C.H.F., MANDARIM DE LACERDA, C.A. and PISSINATTI, A. (1997a): Craniometric sexual dimorphism in *Leontopithecus* Lesson, 1840 (Callitrichidae, primates). *Primates* 38(1): 101–108.



- BURKART, J.M. and VAN SCHAİK, C.P. (2010): Cognitive consequences of cooperative breeding in primates? *Anim. Cogn.* 13: 1–19
- BURTON, M. and BURTON, R. (1975): Grand dictionnaire des animaux. Edito-Service S.A., Genève.
- CABANA, F. and NEKARIS, K.A.I. (2015): Diets high in fruits and low in gum exudates promote the occurrence and development of dental disease in pygmy slow loris (*Nycticebus pygmaeus*). *Zoo Biol.* 34(6): 547–553.
- CABRERA, A. (1957): Catalogo de los mamíferos de América del Sur. *Revista del Museo Argentino de Ciencias Naturales “Bernardino Rivadavia”* 4(1): 1–307.
- CAINE, N.G. (1993): Flexibility and co-operation as unifying themes in *Saguinus* social organization and behaviour: The role of predation pressures. In: *Marmosets and Tamarins: systematics, behaviour, and ecology*, A.B. Rylands (ed.). Oxford University Press, Oxford. 200–219.
- CAINE, N.G., and WELDON, P.J. (1989): Responses by red-bellied tamarins (*Saguinus labiatus*) to fecal scents of predatory and non-predatory Neotropical mammals. *Biotropica* 21(2): 186–189.
- CALEGARO-MARQUES, C., BICCA-MARQUES, J.C. and AZEVEDO M.A.O. (1995): Two breeding females in a *Saguinus fuscicollis weddelli* group. *Neotrop. Primates* 3(4): 183.
- CALLE, P., RAPHAEL, B.L., JAMES, S., MOORE, R., MCALOOSE, D. and BAITCHMAN, E. (2006): Cholelithiasis in four callitrichid species (*Leontopithecus*, *Callithrix*). *J. Zoo Wildl. Med.* 37(1): 44–48.
- CAMPBELL, M.W. and SNOWDON, C.T. (2007): Vocal response of captive-reared *Saguinus oedipus* during mobbing. *Int. J. Primatol.* 28(2): 257–270.
- CANAVEZ, F.C., MOREIRA, M.A.M., SIMON, F., PARHAM, P. and SEUÁNEZ, H.N. (1999a.): Phylogenetic relationships of the Callitrichinae (Platyrrhini, Primates) based on beta2-microglobulin DNA sequences. *Am. J. Primatol.* 48(3): 225–236.
- CANAVEZ, F.C., MOREIRA, M.A.M., LADASKY, J. J., PISSINATTI, A., PARHAM, P. and SEUÁNEZ, H.N. (1999b): Molecular phylogeny of New World primates (Platyrrhini) based on beta2-microglobulin DNA sequences. *Mol. Phylogenet. Evol.* 12(1): 74–82.
- CARROLL, J.B. (1985): Pair bonding in Goeldi’s monkey *Callimico goeldii* (Thomas 1904). *Dodo, J. Jersey Wildl. Preserv. Trusts* 22: 57–71.
- CARROLL, J.B. (1986): Social correlates of reproductive suppression in captive callitrichid family groups. *Dodo, J. Jersey Wildl. Preserv. Trusts* 23: 80–85.
- CARROLL, J.B. (1997): A comparative summary of the nutritional adaptations and needs of callitrichids and application to captive management. In: *Marmosets and Tamarins in Biological and Biomedical Research*, C. Pryce, L. Scott and C. Schnell (eds.). DSSD Imagery: Salisbury, UK. 70–77.
- CARROLL, J.B. (ed.) (2002): *EAZA Husbandry Guidelines for the Callitrichidae*. Bristol, Clifton and West of England Zoological Society, Bristol, U.K.
- CARRERE, L. (2016): Étude pharmacocinétique de l’ivermectine administrée par voies orale et intramusculaire à la dose de 400 µg/kg, chez les Callithricidés, réalisée au Zoo de La Palmyre, Thèse pour le diplôme d’état de docteur en pharmacie, Université de Poitiers, France.
- CASTELEYN, C., BAKKER, J., BREUDGELMANS, S., KONDOVA, I., SAUNDERS, J., LANGERMANS, J.A.M., CORNILLIE, P., VAN DEN BROECK, W., VAN LOO, D., VAN HOOREBEKE, L., BOSSELER, L., CHIERS, K. and DECOSTERE, A. (2012): Anatomical description and morphometry of the skeleton of the common marmoset (*Callithrix jacchus*). *Lab. Anim.* 46: 152-163.
- CATON, J.M., HILL, D.M., HUME, I.D. and CROOK, G.A. (1996): The digestive strategy of the common marmoset, *Callithrix jacchus*. *Comp. Biochem. Physiol.* 114A(1): 1–8.



- CHAMOVE A.S. and MOODIE, E.M. (1990): Are alarming events good for captive monkeys? *Appl. Anim. Behav. Sci.* 27: 169–17.
- CHARNOCK, J.S., ABEYWARDENA, M.Y., POLETTI, V.M. and MCLENNAN, P.L. (1992): Difference in fatty acid composition of various tissues of the marmoset monkey (*Callithrix jacchus*) after different lipid supplemented diets. *Comp. Biochem. Physiol.* 101A: 387–393.
- CHAVES, R., SAMPAIO, I., SCHNEIDER, M.P.C., SCHNEIDER, H., PAGE, S. L. and GOODMAN, M. (1999): The place of *Callimico goeldii* in the callitrichine phylogenetic tree: evidence from von Willebrand Factor Gene Intron II sequences. *Mol. Phylogenet. Evol.* 13: 392–404.
- CILIA, J., PIPER, D.C., UPTON, N., and HAGAN, J.J. (1998): A comparison of rectal and subcutaneous body temperature measurement in the common marmoset, *J. Pharmacol. Toxicol. Methods* 40(1): 21–26
- CLAPP, N.K. and TARDIF, S.D. (1985): Marmoset husbandry and nutrition. *Dig. Dis. Sci.* 30(12) (December 1985 Supplement): 175–235.
- CLARKE, M.E., COATES, M.E., EVA, J.K., FORD, D.J., MILNER, C.K., O'DONOGHUE, P.N., SCOTT, P.P. and WARD, R.J. (1977): Dietary standards for laboratory animals: report of the Laboratory Animals Centre Diets Advisory Committee. *Lab. Anim.* 11: 1–28.
- CLEVELAND, J. and SNOWDON, C.T. (1982): The complex vocal repertoire of the adult cotton-top tamarin (*Saguinus oedipus oedipus*). *Zeit. Tierpsychol.* 58: 231–270.
- CLOUGH, G. (1982): Environmental effects on animals used in biomedical research. *Biol. Rev. Cambridge Phil. Soc.* 57: 487–523.
- COIMBRA-FILHO, A. F. (1972): Aspectos inéditos do comportamento de sagüis do gênero *Callithrix* (Callitrichidae, Primates). *Revta. Brasil. Biol.* 32: 505–512.
- COIMBRA-FILHO, A. F. (1985): Sagüi-de-Wied *Callithrix kuhli* (Wied, 1826). *FBCN/Inf.*, Rio de Janeiro 9(4): 5.
- COIMBRA-FILHO, A. F. (1990): Sistemática, distribuição geográfica e situação atual dos símios brasileiros (Platyrrhini—Primates). *Revta. Brasil. Biol.* 50: 1063–1079.
- COIMBRA-FILHO, A.F. and MAIA, A.D.A. (1979): The process of molting of the fur in *Leontopithecus rosalia rosalia* Callitrichidae primates. *Revta. Brasil. Biol.* 39 (1): 83–94
- COIMBRA-FILHO, A.F. and MITTERMEIER, R.A. (1976): Exudate-eating and tree-gouging in marmosets. 262: 630.
- COIMBRA-FILHO, A.F. and MITTERMEIER, R.A. (1977): Tree-gouging, exudate-eating and the “short-tusked” condition in *Callithrix* and *Cebuella*. In: *The Biology and Conservation of the Callitrichidae*, D.G. Kleiman (ed). Smithsonian Institution Press, Washington, D.C. 105–115.
- COIMBRA-FILHO, A. F., CRUZ ROCHA, N. DA and PISSINATTI, A. (1980). Morfofisiologia do ceco e sua correlação com o tipo odontológico em Callitrichidae (Platyrrhini, Primates). *Rev. Brasil. Biol.* 40: 177–185.
- COIMBRA-FILHO, A.F., RYLANDS, A.B., MITTERMEIER, R.A., MENDES, S.L., KIERULFF, M.C.M. and PINTO, L.P. de S. (2006): The taxonomic status of Wied’s black-tufted-ear marmoset, *Callithrix kuhli* (Callitrichidae, Primates). *Primate Conserv.* (21): 1–24.
- COLLILAS, O.J., RUIZ, J., TRAVI, B. and CLAVER, J. (1982): The common marmoset, *Callithrix jacchus*: reproduction and diseases in captivity. *Rev. Med. Vet., Argentina* 63(6): 440–454.
- CORRÊA, H.K.M., COUTINHO, P.E.G. and FERRARI, S.F. (2000): Between-year differences in the feeding ecology of highland marmosets (*Callithrix aurita* and *Callithrix flaviceps*) in southeastern Brazil. *J. Zool., Lond.* 252: 421–427.
- Costa-Araújo, R., Melo, F.R. de, Canale, G.R., Hernández-Rangel, S.M., Messias, M.R., Rossi, R.V., Silva, F.E., da Silva, M.N.F., Nash, S.D., Boubli, J.P., Farias, I.P. and Hrbek, T. 2019. The Munduruku marmoset: a new monkey species from southern Amazonia. *Peer J* 7: e7019. doi: 10.7717/peerj.7019.



- CRISSEY, S., LINTZENICH, B. and SLIFKA, K. (1999): Diets for callitrichids—management guidelines. In: SSP Callitrichidae Husbandry Manual, V. Sodaro and N. Saunders (eds). Brookfield Zoo: Chicago.
- CRISSEY, S.D., GORE, M., LINTZENICH, B.A. and SLIFKA, K. (2003): Callitrichids: nutrition and dietary husbandry. AZA: Nutrition Advisory Group Handbook, Fact sheet 013.
- CRONIN, J.E. and SARICH, V.M. (1978): Marmoset evolution: the molecular evidence. In: Primates in Medicine. 10, N. Gengozian and F. Deinhardt (eds.), pp.12–19.
- CROPP, S. J., LARSON, A. and CHEVERUD, J. M. (1999): Historical biogeography of tamarins, genus *Saguinus*: the molecular phylogenetic evidence. Am J. Physical Anthropol. 108: 65–89.
- CRUZ LIMA, E. DA. 1945. Mammals of Amazônia, Vol. 1. General Introduction and Primates. Contribuições do Museu Paraense Emílio Goeldi de História Natural e Etnografia, Belém do Pará.
- SAMPAIO, R., RÖHE, F., PINHO, G., SILVA-JÚNIOR, J. S., FARIAS, I. P. and RYLANDS, A. B. 2015. Re-description and assessment of the taxonomic status of *Saguinus fuscicollis cruzlimai* Hershkovitz, 1966 (Primates, Callitrichinae). Primates 56: 131–144.
- DA SILVA, H. and FRIAS DE OLIVEIRA, C. (1988): Estudo do comportamento e estrutura social de um casal de saguins imperador (*Saguinus imperator subgrisescens*). Universidade Técnica de Lisboa, Lisbon.
- DA SILVA, H. and FRIAS DE OLIVEIRA, C. (1988): Preferências manuais de um casal de saguins imperador (*Saguinus imperator subgrisescens*) do Zoo de Lisboa, em Contexto Alimentar. Universidade Técnica de Lisboa, Lisbon.
- DA SILVA MOTA, M.T., FRANCI, C.R. and CORDEIRO DE SOUZA, M.B. (2006): Hormonal changes related to paternal and alloparental care in common marmosets (*Callithrix jacchus*). Horm. Behav. 49(3): 293–302.
- DALTON, R. and BUCHANAN-SMITH, H.M. (2005): A mixed-species exhibit of Goeldi's monkeys and pygmy marmosets (*Callimico goeldii* and *pygmaea*) at Edinburgh Zoo. Int. Zoo Yearb. 39: 176–184.
- DANIEL, C., SEBBANE, F., POIRET, S., GOUDERCOURT, D., DEWULF, J., MULLET, C., SIMONET, M. and POT, B. (2009): Protection against *Yersinia pseudotuberculosis* infection conferred by a *Lactococcus lactis* mucosal delivery vector secreting LcrV. Vaccine 27(8): 1141–1144.
- DAWANCE, S. (1993): Een omervverblijf voor de *Leontopithecus chrysomelas*. Unpublished report.
- DAVID, J.M., EDWARD, D., HUBBARD, G.B. (2009): Spontaneous pathology of the common marmoset (*Callithrix jacchus*) and tamarins (*Saguinus oedipus*, *Saguinus mystax*); J. Med. Primatol. 38: 347–359.
- DAWSON, G.A. (1977): Composition and stability of social groups of the tamarin, *Saguinus oedipus geoffroyi*, in Panama: Ecological and behavioral implications. In: The Biology and Conservation of the Callitrichidae, D.G. Kleiman (ed). Smithsonian Institution Press, Washington, DC. 23–37.
- DE FILLIPIS, B., CHIAROTTI, F. and VITALE A. (2009): Severe intragroup aggressions in captive common marmosets (*Callithrix jacchus*). J. Appl. Anim. Welfare Sci. 12: 214–222.
- DIETZ, J.M., HANKERSON, S.J., ALEXANDRE, B.R., HENRY M.D., MARTINS, A.F., FERRAZ, L.P. AND RUIZ-MIRANDA C. R. 2019. Yellow fever in Brazil threatens successful recovery of endangered golden lion tamarins. **Sci. Rep. 9: 12926.**
- DE LA TORRE, S., CAMPOS, F. and DE VRIES, T. (1995): Home range and birth seasonality of *Saguinus nigricollis graellsii* in Ecuadorian Amazonia. Am. J. Primatol. 37: 39–56.
- DE LAET, A. (1994): Influence of hormonal anticonception on the social behaviour of the golden-headed lion tamarin (*Leontopithecus chrysomelas*) in captivity. 1st Benelux-Congress of Zoology, 1994, 1: 17. (Abstract).
- DE LAET, A. (1994): Invloed van hormonale anticonceptie op het sociaal gedrag van goudkopleeuwaapjes (*Leontopithecus chrysomelas*) in gevangenschap. Undergraduate thesis, University of Antwerp, Antwerp. 72pp.



- DE OLIVEIRA, M.S., ARAUJO LOPES, F., ALONSO, C. and YAMAMOTO, M.E. (1999): The mother's participation in infant carrying in captive groups of *Leontopithecus chrysomelas* and *Callithrix jacchus*. *Folia Primatol.* 70(3): 146–153.
- DE OLIVEIRA, M.S., YAMAMOTO, M.E., LOPES, FIVA A., SILVA, T.B., SOUZA, C.C., ARAUJO, R.A.P. and ALONSO, C.S. (1996): Comparison on infant carrying in captive *Leontopithecus chrysomelas* and *Callithrix jacchus*. University of Wisconsin–Madison. XVIth Congress of the International Primatological Society and the XIXth Conference of the American Society of Primatologists. 1996: 697. (Abstract).
- DE SOUZA, M.B.C., ALBUQUERQUE, A.C.S.R., ALBUQUERQUE, F.S., ARAUJO, A., YAMAMOTO, M.E. and ARRUDA, M.F. (2005): Behavioral strategies and hormonal profiles of dominant and subordinate common marmoset (*Callithrix jacchus*) females in wild monogamous groups. *Am. J. Primatol.* 6: 37–50.
- DE SOUZA, M.B.C., NOGUEIRA MOURA, S.L. and MENEZES, A.A.L. (2006): Circadian variation with a diurnal bimodal profile on scent-marking behavior in captive common marmosets (*Callithrix jacchus*). *Int. J. Primatol.* 27: 263–272.
- DE SOUZA, M.B.C., XAVIER, N.S., DA SILVA, H.P.A., DE OLIVEIRA, M.S. and YAMAMOTO, M.E. (2001): Hand preference study in marmosets (*Callithrix jacchus*) using food reaching tests. *Primates* 42(1): 57–66.
- DE VLEESCHOUWER, K. (2000): Social organisation, reproductive biology and parental care: an investigation into the social system of the golden-headed lion tamarin (*Leontopithecus chrysomelas*) in captivity. PhD thesis, Universitaire Instelling Antwerpen: Antwerp. 270pp.
- DE VLEESCHOUWER, K., HEISTERMANN, M. and VAN ELSACKER, L. (1998): Proceptive displays and the timing of mountings of golden headed lion tamarins (*Leontopithecus chrysomelas*): Is the female's reproductive status concealed? *Adv. Ethol.* 1998; 33–56.
- DE VLEESCHOUWER, K., HEISTERMANN, M., LEUS, K. and VAN ELSACKER, L. (2000b): An evaluation of the suitability of contraceptive methods in golden-headed lion tamarins (*Leontopithecus chrysomelas*), with emphasis on melengestrol acetate (MGA-) implants: 2. Behavioural and endocrinological effects. *Animal Welfare* 9: 385–401.
- DE VLEESCHOUWER, K., HEISTERMANN, M., VAN ELSACKER, L. and VERHEYEN, R.F. (2000c): Signaling of reproductive status in captive female golden-headed lion tamarins (*Leontopithecus chrysomelas*). *Int. J. Primatol.* 21(3): 445–465.
- DE VLEESCHOUWER, K., CHAPOIX, G. and VAN ELSACKER, L. (2001b): Male-female investment in the development of sociosexual relationships in golden-headed lion tamarins. First Meeting of the Asociación Primatológica Española (APE) and First European Workshop on Primate Research. 2001: *Folia Primatol.* 72(4): 371. (Abstract).
- DE VLEESCHOUWER, K., LEUS, K., KRISTIN Y.G., and VAN ELSACKER, L. (2003): Characteristics of reproductive biology and proximate factors regulating seasonal breeding in captive golden-headed lion tamarins (*Leontopithecus chrysomelas*). *Am. J. Primatol.* 60(4): 123–137.
- DE VLEESCHOUWER, K., LEUS K. and VAN ELSACKER, L. (2002): Comments from the AZA Contraception Advisory Group on evaluating the suitability of contraceptive methods in golden-headed lion tamarins (*Leontopithecus chrysomelas*)—Reply to DeMatteo *et al.* *Anim. Welfare* 11(3): 349–350.
- DE VLEESCHOUWER, K., LEUS K. and VAN ELSACKER, L. (2003): Stability of breeding and non-breeding groups of golden-headed lion tamarins (*Leontopithecus chrysomelas*). *Anim. Welfare* 12(2): 251–268.
- DE VLEESCHOUWER, K., LEUS K. and VAN ELSACKER, L. (2001a): Multiple breeding females in captive groups of golden-headed lion tamarins (*Leontopithecus chrysomelas*): causes and consequences. *Folia Primatol.* 72(1): 1–10.
- DE VLEESCHOUWER, K., LEUS K. and VAN ELSACKER, L. (2000a): An evaluation of the suitability of contraceptive methods in golden-headed lion tamarins (*Leontopithecus chrysomelas*), with emphasis on Melengestrol acetate (MGA) implants: (I) effectiveness, reversibility and medical side-effects. *Anim. Welfare* 9(3): 251–271.





- DE VLEESCHOUWER, K., LEUS K. and VAN ELSACKER, L. (2004): Re-assessing the reversibility of melengestrol acetate (MGA) implants in golden-headed lion tamarins (*Leontopithecus chrysomelas*): a comparison with golden lion tamarins (*Leontopithecus rosalia*). *Anim. Welfare* 13: 183–191.
- DEBYSER, I.W.J. (1995): Platyrrhine juvenile mortality in captivity and in the wild. *International journal of primatology*, 1995. 16 (6): 909–933.
- DECLERCK, L. (1992): De respons van het goudkopleeuwaapje (*Leontopithecus chrysomelas*) op geurstoffen van predatoren. Undergraduate thesis, University of Antwerp. 63pp.
- DEFLER, T. R. (2004): *Primates of Colombia*. Tropical Field Guide Series, Conservation International, Washington, DC.
- DEL PORTILLO H.A. and DAMIAN, R.T. (1986): Experimental *Schistosoma-mansoni* infection in a small New World monkey the saddle-back tamarin *Saguinus fuscicollis*. *Am J. Trop. Med. Hyg.* 35 (3): 515–522.
- DELLA SERRA, O. (1951): Divisão do gênero *Leontocebus* (macacos, Platyrrhini) em dois subgêneros sob bases de caracteres dento-morfológicos. *Pap. Avuls., São Paulo* 10(8): 147–154.
- DEMATTEO, K. (1997): AZA Contraception Advisory Group Contraception Report. Part I. Primates. 1st edition. St. Louis Zoological Park, St. Louis, MO.
- DEMATTEO, K.E., PORTON, I.J., and ASA, C.S. (2002): Comments from the AZA Contraception Advisory Group on evaluating the suitability of contraceptive methods in golden-headed lion tamarins (*Leontopithecus chrysomelas*). *Anim. Welfare* 11: 343–348.
- M.C., BERTHIER, J.L. and CAILLE, P. (1987): Contribution to the study of herpesvirus infections in Callitrichidae. *Verhandlungsbericht des Internationalen Symposiums uber die Erkrankungen der Zootiere*. 1987. 29: 255–260.
- DETLING, A.C. (2002): Reproduction and development in Goeldi's monkey (*Callimico goeldii*). *Evolutionary anthropology*, 2002. 11: 207–210 Supplement 1.
- DIETZ J.M., PERES, C.A. and PINDER, L. (1997): Foraging ecology and use of space in wild golden lion tamarins (*Leontopithecus rosalia*). *Am. J. Primatol.* 41: 289–305.
- DIGBY, L. (1995): Infant care, infanticide, and female reproductive strategies in polygynous groups of common marmosets (*Callithrix jacchus*). *Behav. Ecol. Sociobiol.* 37: 51–61.
- DIGBY, L.J. and BARRETO, C.E. (1996): Activity and ranging patterns in common marmosets (*Callithrix jacchus*). Implications for reproductive strategies. In: *Adaptive Radiations of Neotropical Primates*, M.A. Norconk, A.L. Rosenberger and P.A. Garber (eds.). Plenum Press, New York. 173–185.
- DIGBY, L.J. and BARRETO, C.E. (1993): Social organization in a wild population of *Callithrix jacchus*. I. Group composition and dynamics. *Folia Primatol.* 61: 123–134.
- DIGBY, L.J. and FERRARI, S.F. (1994): Multiple breeding females in free-ranging groups of *Callithrix jacchus*. *Int. J. Primatol.* 15: 389–397.
- DIXSON, A.F., ANZENBERGER, G., MONTEIRO DA CRUZ, M.A.O., PATEL, I. and JEFFREYS, A.J. (1992): DNA fingerprinting of free-ranging groups of common marmosets (*Callithrix jacchus jacchus*) in NE Brazil. In: *Paternity in primates: genetic tests and theories*, R.D. Martin, A.F. Dixson and E.J. Wickings (eds). Karger, Basel. 192–202.
- DOKIN, V.P., POLESHCHUK, V.F., GULYAEVA, T.V. and BALAYAN, M.S. (1986): Management of the colony of marmosets. *Vestnik Akademii Meditsinskikh Nauk SSSR* (3): 6–9.
- DUNBAR, R.I.M. (1988): *Primate Social Systems*. Croom Helm, London.
- DU PLESSIS, W.M. (2015); *Computed Tomography of the thorax and abdomen of the clinically normal common marmoset (Callithrix jacchus)*, PhD thesis, Faculty of Veterinary Science, University of Pretoria, 126pp.
- DUTTON, C.J. and ALLCHURCH, A.F. (1998). *Contraception of mammals at JWPT*. *Dodo* 34: 134–144.





- EDINBURGH ZOO (1999): Proceedings of the 4th International conference of environmental enrichment. Edinburgh Zoo, Edinburgh.
- EGLER, S.G. (1991a): Dietary habits of *Saguinus bicolor bicolor* (Primates, Callitrichidae) in Manaus region, Amazonas. In: A Primatologia no Brasil – 3, A.B. Rylands and A.T. Bernardes (eds.). Sociedade Brasileira de Primatologia, Belo Horizonte. 213–214
- EGLER, S.G. (1991b): Double-toothed kites following tamarins. *Wilson Bulletin* 103(3): 510–512.
- EGLER, S.G. (1992): Feeding ecology of *Saguinus bicolor bicolor* (Callitrichidae: Primates) in a relict forest in Manaus, Brazilian Amazonia. *Folia Primatol.* 59: 61–76.
- EGLER, S.G. (1993): First field study of the pied tamarin, *Saguinus bicolor bicolor*. *Neotrop. Primates* 1(2): 13–14.
- EGLER, S.G. (2000):. Ecologia alimentar e sazonalidade em primatas neotropicais: gênero *Saguinus*. In: A Primatologia no Brasil – 7, C. Alonso and A. Langguth (eds). Sociedade Brasileira de Primatologia, João Pessoa, Paraíba. 81–95.
- ENCARNACIÓN, F.C. and HEYMANN, E.W. (1998): Body mass of wild *Callimico goeldii*. *Folia Primatol.* 69: 368–371.
- EPIPHANIO, S., GUIMARÃES, M.A.B.V., FEDULLO, D.L., CORREA, S.H.R. and CATÃO-DIAS, J.L. (2000): Toxoplasmosis in golden-headed lion tamarins (*Leontopithecus chrysomelas*) and emperor tamarins (*Saguinus imperator*) in captivity. *J. Zoo Wildl. Med.* 31(2): 231–235.
- EPIPHANIO, S., CORREA, S.H.R., SANTOS, R.T.M. and CATÃO-DIAS, J.L. (1999a): Síndrome mieloproliferativa compatível com leucemia mielóide aguda em mico-leão-de-cara-dourada (*Leontopithecus chrysomelas* Kuhl, 1820). Congresso IX Brasileiro de Primatologia. Sociedade Brasileira de Primatologia Museu de Biologia Prof. Mello Leitão: 124(57)
- EPIPHANIO, S., GUIMARÃES, M., FEDULLO, D.L., CORREA, S.H.R. and CATÃO-DIAS, J.L. (1999b): Toxoplasmosis in *Leontopithecus chrysomelas* (Kuhl,1820) and *Saguinus imperator* (Goeldi,1907). *Verhandlungsbericht des Internationalen Symposiums über die Erkrankungen der Zoo- und Wildtiere 1999*, 39: 443–444.
- EPPLE, G. (1970): Maintenance, breeding and development of marmoset monkeys, Callitrichidae, in captivity. *Folia Primatol.* 12: 56–76.
- EPPLE, G. (1972a): Social communication by olfactory signal in marmosets. *Int. Zoo Yearb.* 12 :36–42.
- EPPLE, G. (1977): Notes on the establishment and maintenance of the pair bond in *Saguinus fuscicollis*. In: *The Biology and Conservation of the Callitrichidae*, D.G. Kleiman (ed.), Smithsonian Institution Press, Washington, DC. 231–237.
- EPPLE, G., BELCHER, A.M., KUEDERLING, I., ZELLER, U., SCOLNICK, L., GREENFIELD, K.L. and SMITH, A.B. III (1993): Making sense out of scents: species differences in scent glands, scent-marking behaviour, and scent-mark composition in the Callitrichidae. In: *Marmosets and Tamarins: systematics, behaviour, and ecology*, A.B. Rylands (ed). Oxford University Press, Oxford. 123–151.
- EPPLE, G. and KATZ, Y. (1984): Social influences on estrogen excretion and ovarian cyclicity in saddle back tamarins (*Saguinus fuscicollis*). *Am. J. Primatol.* 23 :87–98.
- ESCAJADILLO, A., BRONSON, R.T., SEHGAL, P.K. and HAYES, K.C. (1981): Nutritional evaluation in cotton-top tamarins (*Saguinus oedipus*). *Lab. Anim. Sci.* 31:161–165.
- FARMERIE, M., NEFFER, D., & VACCO, K. (1999): Enrichment and operant conditioning of callitrichids. In V. Sodaro & N. Saunders (Eds). *Callitrichid Husbandry Manual*. Chicago: Chicago Zoological Society, pp:64-89.
- FAVORETTO, S.R., DE MATTOS, C.C., MORAIS, N.B., ALVES ARAÚJO, F.A., and DE MATTOS, C.A. (2001): Rabies in marmosets (*Callithrix jacchus*), Ceará, Brazil. *Emerg. Infect. Dis.* 7(6), 1062-1065
- FERRARI, S.F. (1993a): Ecological differentiation in the Callitrichidae. In: *Marmosets and Tamarins: systematics, behaviour, and ecology*, A.B. Rylands (ed). Oxford University Press, Oxford. 314–328.



- FERRARI, S.F. (1993b): The adaptive radiation of Amazonian callitrichids (Primates, Platyrrhini). *Evolución Biológica* 7: 81–103.
- FERRARI, S.F. (1993c): An update on the black-headed marmoset, *Callithrix nigriceps* Ferrari and Lopes 1992. *Neotrop. Primates* 1(4): 11–13.
- FERRARI, S.F. (1994): The distribution of the black-headed marmoset, *Callithrix nigriceps*: a correction. *Neotrop. Primates* 2(1): 11–12.
- FERRARI, S.F., CORRÊA, H.K.M. and COUTINHO, P.E.G. (1996c): Ecology of the “southern” marmosets (*Callithrix aurita* and *Callithrix flaviceps*), how different, how similar? In: Adaptive radiations of Neotropical primates, M. A. Norconk, A. L. Rosenberger and P. A. Garber (eds). Plenum Press, New York. 157–171.
- FERRARI, S.F., CRUZ NETO, E.H. DA, IWANAGA, S., CORRÊA, K.M. and RAMOS P.C.S. (1996a): An unusual primate community at the Estação Ecológica dos Três Irmãos, Rondônia, Brazil. *Neotrop. Primates* 4(2): 55–56.
- FERRARI, S.F. and DIEGO, V.H. (1993): Rethinking the status of *Callithrix flaviceps*. *Neotrop. Primates* 1(3): 2–3.
- FERRARI, S.F. and DIGBY, L.J. (1996): Wild *Callithrix* groups: Stable extended families? *Am. J. Primatol.* 38: 19–27.
- FERRARI, S.F., IWANAGA, S. and SILVA, J.L. DA. (1996b): Platyrrhines in Pimenta Bueno, Rondônia, Brazil. *Neotrop. Primates* 4(4): 151–153.
- FERRARI, S.F., IWANAGA, S., RAMOS, E.M., MESSIAS, M.R., RAMOS, P.C.S. and CRUZ NETO, E.H. DA. (1999a): Expansion of the known distribution of Goeldi’s monkey (*Callimico goeldii*) in south-western Brazilian Amazonia. *Folia Primatol.* 70: 112–116.
- FERRARI, S.F. and LOPES FERRARI, M.A. (1989): A re-evaluation of the social organization of the Callitrichidae, with reference to the ecological differences between genera. *Folia Primatol.* 52: 132–147.
- FERRARI, S.F. and LOPES FERRARI, M.A. (1990a): Predator avoidance behavior in the buffy-headed marmoset, *Callithrix flaviceps*. *Primates* 31: 323–338.
- FERRARI, S.F. and LOPES FERRARI, M.A. (1990b): A survey of primates in central Pará. *Bol. Mus. Paraense Emílio Goeldi, série Zool.* 6(2): 169–179.
- FERRARI, S.F. and LOPES, M.A. 1992a. New data on the distribution of primates in the region of the confluence of the Jiparaná and Madeira rivers in Amazonas and Rondônia, Brazil. *Goeldiana Zool.* (11): 1–12.
- FERRARI, S.F. and LOPES, M.A. (1992b): A new species of marmoset, genus *Callithrix* Erxleben 1777 (Callitrichidae, Primates) from western Brazilian Amazonia. *Goeldiana Zool.* (12): 1–3.
- FERRARI, S.F., LOPES, M.A., CRUZ NETO, E.H. DA, AUREA, M., SILVEIRA, E.S., RAMOS, E.M., RAMOS, P.C.M., TOURINHO, D.M. and MAGALHÃES, N.F.A. (1995): Primates and conservation in the Guajará-Mirim State Park, Rondônia, Brazil. *Neotrop. Primates* 3(3): 81–82.
- FERRARI, S.F. and MARTINS, E.S. (1992): Gummivory and gut morphology in two sympatric callitrichids (*Callithrix emiliae* and *Saguinus fuscicollis weddelli*) from western Brazilian Amazonia. *Am. J. Phys. Anthropol.* 88: 97–103.
- FERRARI, S.F. and MENDES, S.L. (1991): Buffy-headed marmosets 10 years on. *Oryx* 25(2):105–109.
- FERRARI, S.F. and RYLANDS, A.B. (1994): Activity budgets and differential visibility in field studies of three marmosets (*Callithrix* spp.). *Folia Primatol.* 63:78–83.
- FERRARI, S.F., SENA, L. and SCHNEIDER, M.P.C. (1999b). Definition of a new species of marmoset (Primates: Callitrichinae) from southwestern Amazonia based on molecular, ecological, and zoogeographic evidence. In: Livro de resumos: IX Congresso Brasileiro de Primatologia, Santa Teresa, Espírito Santo, 25–30 July 1999, p.80. (Abstract).
- FERRARI, S.F., SENA, L., SCHNEIDER, M.P. C. and SILVA JR., J.S. (2010): Rondon’s marmoset, *Mico rondoni* sp.n., from southwestern Brazilian Amazonia. *Int. J. Primatol.* 31(5): 693–714.



- FIDGETT, A.L. and PLOWMAN, A. (2013): Nutrition and diet evaluation in: BIAZA Research Handbook, J. Bishop (ed.). 154–174.
- FITZGERALD, A. (1935): Rearing Marmosets in Captivity. *J. Mammal.* 16 (3): 181–188.
- FLEAGLE, J.G. (1988): Primate adaptation and evolution. Academic Press: San Diego.
- FLEAGLE, J.G. and MITTERMEIER, R.A. (1980): Locomotor behavior, body size, and comparative ecology of seven Surinam monkeys. *Am. J. Phys. Anthropol.* 52: 301–314.
- FLURER, C., KROMMER, G. and ZUCKER, H. (1988): Endogenous N-excretion and minimal protein requirement of the common marmoset. *Lab. Anim. Sci.* 38: 183–186.
- FLURER, C. and ZUCKER, H. (1985): Long term experiments with low dietary protein levels in Callitrichidae. *Primates* 26(4): 479–490.
- FLURER, C. and ZUCKER, H. (1988): Coprophagy in marmosets due to insufficient protein (amino acid) intake. *Lab. Anim.* 22 :330–331.
- FLURER, C. and ZUCKER, H. (1989): Ascorbic acid in a New World monkey family: species difference and influence of stressors on ascorbic acid metabolism. *Zeit. Ernährungswiss.* 28: 49–55.
- FORD, S.M. (1980): Callitrichids as phyletic dwarfs, and the place of the Callitrichidae in Platyrrhini. *Primates* 21(1): 31–43.
- FORD, S.M. and DAVIS, L.C. (1992): Systematics and body size: implications for feeding adaptations in New World monkeys. *Am. J. Phys. Anthropol.* 88: 415–468.
- FORD, S.M., PORTER, L. and DAVIS, L.C. (eds.). (2009): *The Smallest Anthropoids: the marmoset/callimico radiation.* Springer, New York.
- FORSTER, F.C. (1995): Exploratory behavior and learning in laboratory marmosets (*Callithrix jacchus jacchus*): comparisons between experimental-cage and home-cage activity. *Primates* 36(4): 501–514.
- FORTMAN, J.D., HEWETT, T.A. and TAYLOR BENNETT, B. (2002): *The Laboratory Nonhuman Primate,* CRC Press, Boca Raton, Florida.
- FOWLER, M.E. (ed.) (1986): *Zoo and Wild Animal Medicine.* 2<sup>nd</sup> Ed. (Chapter “Primates”).
- FOWLER, M.E. and MILLER, R.E. (eds.) (1999): *Zoo and Wild Animal Medicine. Current Therapy 4.* (Chapter “Diseases of the Callitrichidae”): 369–377.
- FOWLER, M.E. and MILLER, R.E. (eds.) (2003): *Zoo and Wild Animal Medicine.* 5<sup>th</sup> Ed. (Chapter “Other primates excluding great apes”)
- FOX, M., BRIEVA, C., MORENO, C., MACWILLIAMS, P. and THOMAS, C. (2008): Hematologic and serum biochemistry reference values in wild-caught white-footed tamarins (*Saguinus leucopus*) housed in captivity. *J. Zoo Wildl. Med.* 39(4): 548–557.
- FREDRIKSSON-AHOMAA, M., NAGLIC, T., TURK, N., SEOL, B., GRABAREVIC, Z., BATA, I., PERKOVIC, D. and STOLLE, A. (2007): Yersiniosis in zoo marmosets (*Callithrix jacchus*) caused by *Yersinia enterocolitica* 4/O3. *Vet. Microbiol.* 121(3–4): 363–367.
- FRENCH, J.A. 1997. Regulation of singular breeding in callitrichid primates. In: Cooperative breeding in mammals, N.G. Solomon and J.A. French (eds). Cambridge University Press, New York. 34–75.
- FRENCH, J.A. and SCHAFFNER, C.M. 1995. Social and developmental influences on urinary testosterone levels in male black tufted-ear marmosets (*Callithrix kuhli*). *Am. J. Primatol.* 36(2): 123. (Abstract)
- FRENCH, J.A. and SCHAFFNER, C.M. 1997. Development, dominance, and domestic life: Testosterone and social behavior in *Callithrix kuhli*. Programa e Resumos: VIII Congresso Brasileiro de Primatologia and V Reunião Latino-americano de Primatologia, p.182. Sociedade Brasileira de Primatologia, João Pessoa. (Abstract)



- FRENCH, J.A. and SCHAFFNER, C.M. 1999. Contextual influences on sociosexual behavior in monogamous primates. In: *Reproduction in context*, K. Wallen and J. E. Schneider (eds.). MIT Press, Cambridge, MA. 325–353.
- FRENCH, J.A. and SNOWDON, C.T. (1984): Reproduction behaviour in marmosets and tamarins: an introduction. *Am. J. Primatol.* 6: 211–213.
- FRENCH, J.A. and STRIBLEY, J.A. (1985): Patterns of urinary oestrogen excretion in female golden lion tamarins (*Leontopithecus rosalia*). *J. Reprod. Fert.* 75: 537–546.
- FRENCH, J.A. and STRIBLEY, J.A. (1987): Synchronisation of ovarian cycles within and between social groups in golden lion tamarins (*Leontopithecus rosalia*). *Am. J. Primatol.* 12: 469–478.
- FRENCH, J.A., SCHAFFNER, C. M. and SHEPHERD, R.E. (1993): Responses to conspecific intruders in Wied's black-tufted ear marmoset (*Callithrix kuhli*) vary as a function of resident–intruder familiarity. *Am. J. Primatol.* 30(4): 311. (Abstract)
- FRENCH, J.A., SCHAFFNER, C.M., SHEPHERD, R.E. and MILLER, M.E. (1995): Familiarity with intruders modulates agonism toward outgroup conspecifics in Wied's black-tufted-ear marmoset (*Callithrix kuhli*). *Ethology* 99: 24–38.
- FRENCH, J.A., BREWER, K.J., SCHAFFNER, C.M., SCHALLEY, J., HIGHTOWER-MERRITT, D L., SMITH, T.E. and BELL, S.M. (1996a): Urinary steroid and gonadotropin excretion across the reproductive cycle in female Wied's black-tufted-ear marmosets (*Callithrix kuhli*). *Am. J. Primatol.* 40(3): 231–245.
- FRENCH, J.A., PISSINATTI, A. and COIMBRA-FILHO, A.F. (1996b): Reproduction in captive lion tamarins (*Leontopithecus*): seasonality, infant survival, and sex ratios. *Am. J. Primatol.* 39(1): 17–33.
- FRENCH, J.A., PHILLIPS, K.T. and PROSKOCIL, B.J. (1999): Urinary cortisol profiles throughout development in male marmosets (*Callithrix kuhli*). *Am. J. Primatol.* 49(suppl. 1): 54. (Abstract)
- FRENCH, J.A., DE VLEESCHOUWER, K., BALES, K. and HEISTERMAN, M. (2002): Lion tamarin reproductive biology. In: *Lion Tamarins: Biology and conservation*, D.G. Kleiman and A.B. Rylands (eds.). Smithsonian Institution Press, Washington, DC. 133–156.
- FRIANT, S.C., CAMPBELL, M.W. and SNOWDON, C.T. (2008): Captive-born cotton-top tamarins (*Saguinus oedipus*) respond similarly to vocalizations of predators and sympatric nonpredators. *Am. J. Primatol.* 70(7): 707–710.
- GALBUSERA, P. and GILLEMOT, S. (2008). Polymorphic microsatellite markers for the endangered golden-headed lion tamarin, *Leontopithecus chrysomelas* (Callitrichidae). *Conserv. Genet.* 9(3): 731–733.
- GALVÃO-COELHO, N.L., SILVA, H.P.A., LEO, A.D. and DE SOUSA, M.B.C. (2008): Common marmosets (*Callithrix jacchus*) as a potential animal model for studying psychological disorders associated with high and low responsiveness of the hypothalamic-pituitary-adrenal axis. *Rev. Neurosci.* 19(2–3): 187–201.
- GARBER, P.A. (1993): Seasonal patterns of diet and ranging in two species of tamarin monkeys: Stability versus variability. *Int. J. Primatol.* 14: 145–166.
- GARBER, P.A. (1988a): Diet foraging patterns and resource defence in a mixed species troop of *Saguinus mystax* and *Saguinus fuscicollis* in Amazonian Peru. *Behavior* 105: 18–34.
- GARBER, P.A. (1988b): Foraging decisions during nectar feeding by tamarin monkeys (*Saguinus mystax* and *Saguinus fuscicollis*, Callitrichidae, Primates) in Amazonian Peru. *Biotropica* 20(2): 100–106.
- GARBER, P.A. (1992): Vertical clinging, small body size and the evolution of feeding adaptations in the Callitrichinae. *Am. J. Phys. Anthropol.* 88: 469–482.
- GARBER, P.A. (1993): Feeding ecology and behaviour of the genus *Saguinus*. In: *Marmosets and Tamarins: Systematics, behaviour and ecology*, A.B. Rylands (ed). Oxford University Press, Oxford, 273–295.
- GARBER, P.A. (1994): Phylogenetic approach to the study of tamarin and marmoset social systems. *Am. J. Primatol.* 34: 199–219.



- GARBER, P.A. and TEAFORD, M.F. (1986): Body weights in mixed species troops of *Saguinus mystax mystax* and *Saguinus fuscicollis nigrifrons* in Amazonian Peru. *Am. J. Phys. Anthropol.* 71: 331–336.
- GARBER, P.A., MOYA, L. and MALAGA, C. (1984): A preliminary field study of the moustached tamarin *Saguinus mystax* in north-eastern Peru. *Folia Primatol.* 42: 17–32.
- GARBINO, G.S.T. (2014): The taxonomic status of *Mico marcai* (Alperin 1993) and *Mico manicorensis* (van Roosmalen *et al.* 2000) (Cebidae, Callitrichinae) from southwestern Brazilian Amazonia. *Int. J. Primatol.* 35: 529–546.
- GARBINO, G.S.T. (2015): Defining genera of New World monkeys: The need for a critical view in a necessarily arbitrary task. *Int. J. Primatol.* 36:1049–1064.
- GARBINO, G.S.T. and MARTINS-JUNIOR, A.M.G. (2018): Phenotypic evolution in marmoset and tamarin monkeys (Cebidae, Callitrichinae) and a revised genus-level classification. *Mol. Phylogenet. Evol.* 118: 156–171.
- GARBINO G.S.T., CASALI, D.M, NASCIMENTO, F.O. and SERRANO-VILLAVICENCIO, J.E. (2019a): Taxonomy of the pygmy marmoset (*Cebuella* Gray, 1866): Geographic variation, species delimitation, and nomenclatural notes. *Mammal. Biol.* 95: 135–142.
- GARBINO, G.S.T., SERRANO-VILLAVICENCIO, J.E. and GUTTIEREZ, E.E. (2019b): What is in a genus name? Conceptual and empirical issues preclude the proposed recognition of *Callibella* (Callitrichidae) as a genus. *Primates* 60(2): 155–162.
- GAUTIER-HION, A., BOURLIÈRE, F. and GAUTIER J.-P. eds. (1988): *A Primate Radiation: Evolutionary biology of the African guenons*. Cambridge University Press: Cambridge, UK.
- GERBER, P., SCHNELL, C.R. and ANZENBERGER, G. (2002a): Behavioral and cardiophysiological responses of common marmosets (*Callithrix jacchus*) to social and environmental changes. *Primates* 43: 201–216.
- GERBER, P., SCHNELL, C.R. and ANZENBERGER, G. (2002b): Comparison of a beholder's response to confrontations involving its pairmate or two unfamiliar conspecifics in common marmosets (*Callithrix jacchus*). *Evol. Anthropol.* 11(suppl. 1): 117–121.
- GHEBREMESKEL, K., HARBIGE, L.S., WILLIAMS, G., CRAWFORD, M.A. and HAWKEY, C. (1991): The effect of dietary change on *in vitro* erythrocyte hemolysis, skin lesions and alopecia in common marmosets (*Callithrix jacchus*). *Comp. Biochem. Physiol.* 100A: 891–896.
- GLATSTON, A.R. (1998): The control of zoo populations with special reference to primates. *Anim. Welfare* 7: 269–281.
- GOLDEN LION TAMARIN MANAGEMENT COMMITTEE (1996): *Husbandry protocol for Leontopithecus rosalia rosalia*, the golden lion tamarin. Smithsonian Institution, Washington, DC.
- GOLDIZEN, A.W. (1987): Facultative polyandry and the role of infant carrying in wild saddle-back tamarins (*Saguinus fuscicollis*). *Behav. Ecol. Sociobiol.* 20: 99–109.
- GOLDIZEN, A.W. (1988): Tamarin and marmoset mating systems: unusual flexibility. *Trends Ecol. Evol.* 3: 36–40.
- GOLDIZEN, A.W. (1990): A comparative perspective on the evolution of tamarin and marmoset social systems. *Int. J. Primatol.* 11(1): 63–83.
- GOLDIZEN, A.W. and TERBORGH, J. (1986): Cooperative polyandry and helping behavior in saddle-backed tamarins (*Saguinus fuscicollis*). In: *Primate Ecology and Conservation*, J. Else and P. Lee (eds.). Cambridge University Press, Cambridge, UK. 191–198.
- GONÇALVES, F.B., BELÍCIO, A.S. and AZEVEDO, C.V.M. (2009): Effect of nest box availability on the circadian activity rhythm of common marmosets (*Callithrix jacchus*). *Folia Primatol.* 80 (3): 175–188
- GOODMAN, M., C. A. PORTER, J. CZELUSNIAK, S. L. PAGE, H. SCHNEIDER, J. SHOSHANI, G. GUNNELL, and C. P. GROVES. (1998): Toward a phylogenetic classification of primates based on DNA evidence complemented by fossil evidence. *Mol. Phylogenet. Evol.* 9: 585–598.





- GORE, M., BRACH, M., BRANDES, F., MOTTHES, T., LENZNER, R. and KAUP, F.-J. (1999): Effects of wheat in callitrichid diet. In: First European Zoo Nutrition Meeting, 8–11th January 1999, Rotterdam, Hatt, J.-M. (ed.). Abstract Book. 41.
- GOTTDENKER, N., MCNAMARA, T. and EMMETT BRASELTON, W. (1998): Evaluation of hemosiderosis in captive Callitrichidae. Proc. AAZV & AAWV Joint Conference: 63–70.
- GOZALO, A. and MONTOYA, E. (1991): Mortality causes of the moustached tamarin (*Saguinus mystax*) in captivity. J. Med. Primatol. 21: 35–38.
- GRIEDE, T. (1989): Guidelines for adequate housing and care on non-human primates in zoos. National Foundation for Research in Zoological Gardens, Amsterdam.
- GREGORIN, R. and VIVO M. DE (2013): Revalidation of *Saguinus ursula* Hoffmannsegg (Primates: Cebidae: Callitrichinae). Zootaxa 3721(2): 172–182.
- GROTHMANN, P. (2007): Zur Prävalenz fakultativ pathogener Bakterien in deutschen Zoos mittels Yersinia- und Burkholderia-selektierender Nährmedien. Dissertation at [http://elib.tiho-hannover.de/dissertations/grothmannp\\_ws07.pdf](http://elib.tiho-hannover.de/dissertations/grothmannp_ws07.pdf)
- GROVES, C. P. (1993): Order Primates. In: Mammal Species of the World: A taxonomic and geographic reference, 2nd edition, D. E. Wilson and D. M. Reeder (eds). Smithsonian Institution Press, Washington, DC. 243–277.
- GROVES, C.P. (2001): Primate Taxonomy. Smithsonian Institution Press, Washington, DC.
- GROVES, C.P. (2004): The what, why and how of primate taxonomy. Int. J. Primatol. 25(5): 1105–1126.
- GROVES, C.P. (2005): Order Primates. In: Mammal Species of the World: A taxonomic and geographic reference, 3rd edition, Vol. 1, D.E. Wilson and D.M. Reeder (eds). Johns Hopkins University Press, Baltimore. 111–184.
- HAIG, D. (1999): Chimerism in callitrichid primates. Am. J. Primatol. 49: 285–296.
- HAMPTON, S.H. (1973): Germ cell chimerism in male marmosets. Am. J. Phys. Anthropol. 38(2): 265–68.
- HANIHARI T. and NATORI, M. (1987): Preliminary analysis of numerical taxonomy of the genus *Saguinus* based on dental measurements. Primates 28(4): 517–523.
- HANSON, A.M., HALL, M.B., PORTER, L.M. and LINTZENICH, B. (2006): Composition and nutritional characteristics of fungi consumed by *Callimico goeldii* in Pando, Bolivia. Int. J. Primatol. 27(1): 323–346.
- HANSON, A.M., HODGE, K.T. and PORTER, L.M. (2003): Mycophagy among primates. Mycologist 17: 6–10.
- HARADA, M. L., SCHNEIDER, H., SCHNEIDER, M. P. C., SAMPAIO, I., CZELUSNIAK, J. and GOODMAN, M. (1995): DNA evidence on the phylogenetic systematics of New World monkeys: support for the sister-grouping of *Cebus* and *Saimiri* from two unlinked nuclear genes. Mol. Phylogenet. Evol. 4(3): 331–349.
- HARDIE, S.M. (1997): Exhibiting mixed species groups of sympatric tamarins *Saguinus* species at Belfast Zoo. Int. Zoo Yearb. 35: 261–266.
- HARDIE, S.M., DAY, R. and BUCHANAN-SMITH, H.M. (1993): Mixed species *Saguinus* groups at Belfast Zoological gardens. Neotrop. Primates, 1: 19–21.
- HARDIE, S.M., PRESCOTT, M.J. and BUCHANAN-SMITH, H.M. (2003): Ten years of tamarin mixed-species troops at Belfast Zoological Gardens. Prim. Rep. 65: 21–38.
- HATT, J., GREEST, P., POSTHAUS, H. and BOSSART, W. (2004): Survey in a colony of captive common marmosets (*Callithrix jacchus*) after infection with Herpes Simplex Type 1-like virus. J. Zoo Wildl. Med. 35 (3):387–390.
- HEARN, J.P. (1983): The common marmoset (*Callithrix jacchus*). In: Reproduction in New World primates. Hearn, J.P. (ed). MTP Press, Lancaster. 181–215.
- HEFFNER, R.S. (2004): Primate hearing from a mammalian perspective. Anat. Rec. 281A: 1111–1122.





- HELTNE, P.G., WOJCIK, J.F. and POOK, A.G. (1981): Goeldi's monkey, genus *Callimico*. In: Ecology and Behavior of Neotropical Primates. Vol. 1. A.F. Coimbra-Filho and R.A. Mittermeier (eds). Academia Brasileira de Ciências, Rio de Janeiro. 169–209.
- HERRON, S., PRICE, E. and WORMELL, D. (2001): Feeding gum arabic to New World monkeys: species differences and palatability. *Anim. Welfare* 10: 249–256.
- HERSHKOVITZ P. (1949): Mammals of northern Colombia. Preliminary report No. 4: Monkeys (Primates), with taxonomic revisions of some forms. *Proc. U.S. Natl. Mus.* 98: 323–42.
- HERSHKOVITZ, P. (1957): The systematic position of the marmoset, *Simia leonina* Humboldt (Primates). *Proc. Biol. Soc. Wash.* 70: 17–20.
- HERSHKOVITZ, P. (1966a): On the identification of some marmosets Family Callithricidae (Primates). *Mammalia* 30(2): 327–332.
- HERSHKOVITZ, P. (1966b): Taxonomic notes on tamarins, genus *Saguinus* (Callithricidae, Primates) with descriptions of four new forms. *Folia Primatol.* 4: 381–395.
- HERSHKOVITZ, P. (1968): Metachromism or the principle of evolutionary change in mammalian tegumentary colors. *Evolution* 22: 556–575.
- HERSHKOVITZ, P. (1970): Dental and periodontal diseases and abnormalities in wild-caught marmosets (Primates – Callithricidae). *Am. J. Phys. Anthropol.* 32(3): 377–394.
- HERSHKOVITZ, P. (1975): Comments on the taxonomy of Brazilian marmosets (*Callithrix*, Callitrichidae). *Folia Primatol.* 24:137–172.
- HERSHKOVITZ, P. (1977): Living New World monkeys (Platyrrhini) with an Introduction to Primates, Vol. 1. The Chicago University Press, Chicago.
- HERSHKOVITZ, P. (1979): Races of the emperor tamarin, *Saguinus imperator* Goeldi (Callitrichidae, Primates). *Primates* 20(2): 277–287.
- HERSHKOVITZ, P. (1982): Subspecies and geographic distribution of black-mantle tamarins *Saguinus nigricollis* Spix (Primates: Callitrichidae). *Proc. Biol. Soc. Wash.* 95(4): 647–656.
- HEYMANN, E.W. (1992a): Seed ingestion and gastrointestinal health in tamarins. *Lab. Prim. Newsl.* 31(3): 15–16.
- HEYMANN, E.W. (1992b): Associations of tamarins (*Saguinus mystax* and *Saguinus fuscicollis*) and double-toothed kites (*Harpagus bidentatus*). *Folia Primatol.* 59: 51–55.
- HEYMANN, E.W. (1995): Sleeping habits of tamarins, *Saguinus mystax* and *Saguinus fuscicollis* (Mammalia; Primates; Callitrichidae), in north-eastern Peru. *J. Zool., Lond.* 237: 211–226.
- HEYMANN, E.W. (1999): Aspects of the feeding ecology of wild tamarins: is there something to learn for nutrition in captivity. Hatt, J.-M. (ed.), First European Zoo Nutrition Meeting, 8–11th January 1999, Rotterdam. Abstract Book. 67.
- HEYMANN, E.W. (2000a): Spatial patterns of scent marking in wild moustached tamarins, *Saguinus mystax*: no evidence for a territorial function. *Anim. Behav.* 60: 723–730.
- HEYMANN, E.W. (2000b): Field observations on the golden-mantled tamarin, *Saguinus tripartitus*, on the Río Curaray, Peruvian Amazonia. *Folia Primatol.* 71: 392–398.
- HEYMANN, E.W. (2003): Scent marking, paternal care, and sexual selection in callitrichines. In: Sexual selection and reproductive competition in primates: new perspectives and directions, C.B. Jones (ed). Special Topics in Primatology, Vol. 4. American Society of Primatologists, Norman, OK.
- HEYMANN, E.W. and BUCHANAN-SMITH, H.M. (2000): The behavioural ecology of mixed-species troops of callitrichine primates. *Biol. Rev. Cambridge Phil. Soc.* 75: 169–190.



- HEYMANN, E.W. and HARTMANN, G. (1991): Geophagy in Moustached tamarins: *Saguinus mystax* (Platyrrhini: Callitrichidae) at the Rio Blanco, Peruvian Amazonia. *Primates* 32(4): 533–537.
- HEYMANN, E.W. and SMITH, A.C. (1999): When to feed on gums: temporal patterns of gumnivory in wild tamarins, *Saguinus mystax* and *Saguinus fuscicollis* (Callitichinae). *Zoo Biol.* 18: 459–471.
- HEYMANN, E.W. and SOINI, P. (1999): Offspring number in pygmy marmosets, *Cebuella pygmaea*, in relation to group size and the number of adult males. *Behav. Ecol. Sociobiol.* 46: 400–404.
- HEYMANN, E.W. and SICCHAR VALDEZ, L.A. (1988): Interspecific social grooming in a mixed troop of tamarins, *Saguinus mystax* and *Saguinus fuscicollis* (Platyrrhini: Callitrichidae), in an outdoor enclosure. *Folia Primatol.* 50: 221–225.
- HEYMANN, E.W., SICCHAR, V.L.A. and TAPIA, R.J. (1996): Experiences with mixed species housing of tamarins, *Saguinus fuscicollis* and *Saguinus mystax* (Primates: Callitrichidae), in an outdoor enclosure. *Zool. Garten*, 66: 381–390.
- HIDDLESTON, W.A. (1977): The production of the common marmoset *Callithrix jacchus* as a laboratory animal. Unpublished.
- HILÁRIO, R.R. and FERRARI, S.F. (2011): Why feed on fungi? The nutritional content of sporocarps consumed by buffy-headed marmosets, *Callithrix flaviceps* (Primates: Callitrichidae), in southeastern Brazil. *J. Chem. Ecol.* 37: 145–149.
- HOELZLE, L.E., CORBOZ, L., OSSENT, P. and WITTENBRINK, M.M. (2004): Tularaemia in a captive golden-headed lion tamarin (*Leontopithecus chrysomelas*) in Switzerland. *Vet. Rec.* 155(2): 60–61.
- HOLST, B. (1997): Proceedings of the 2nd Environmental Enrichment Conference, 21–25 August, Copenhagen. Copenhagen Zoo, Copenhagen.
- HUBRECHT, R.C. (1984): Field observations on group size and composition of the common marmoset (*Callithrix jacchus jacchus*), at Tapacurá, Brazil. *Primates* 25:13–21.
- HUNT, R.D., GARCIA, F.G. and HEGSTED, D.M. (1969): Hypervitaminosis D in New World Monkeys. *Am. J. Clin. Nutr.*, 22: 358-366.
- IUCN (2009). 2009 IUCN Red List of Threatened Species. International Union for Conservation of Nature (IUCN), Species Survival Commission (SSC), Gland, Switzerland and Cambridge, UK. Website: <<https://www.iucnredlist.org>>.
- IUCN (2014): IUCN Species Survival Commission Guidelines on the Use of *Ex Situ* Management for Species Conservation. Version 2, Gland, Switzerland. [http://www.cbsg.org/sites/cbsg.org/files/IUCN\\_SSC\\_ex\\_situ\\_guidelines\\_FINAL.pdf](http://www.cbsg.org/sites/cbsg.org/files/IUCN_SSC_ex_situ_guidelines_FINAL.pdf)
- JAQUISH, C.E., GAGE, T.B. and TARDIF, S.D. (1991): Reproductive factors affecting survivorship in captive Callitrichidae. *Am. J. Phys. Anthropol.* 84 (3): 291–305.
- JENSON, H.B., ENCH, Y., ZHANG, Y.J., GAO, S.J., ARRAND, J.R. and MACKETT, M. (2007): Characterization of an Epstein-Barr virus-related gammaherpesvirus from common marmoset (*Callithrix jacchus*). *J. General Virol.* 83: 1621–1633.
- JOHNSON, E.O., KAMILARIS, T.C., CARTER S., GOLD P.W. and CHROUSOS, G.P. (1991): “Environmental stress” and reproductive success in the common marmoset (*Callithrix jacchus*). *Am. J. Primatol.* 25: 191–201.
- JONES, B.S. (1997): Quantitative analysis of marmoset vocal communication. In: Handbook: Marmosets and Tamarins in Biological and Biomedical Research, C. Pryce, L. Scott and C. Schnell (eds). DSSD Imagery, Salisbury. 145–151.
- JUAN-SALLÉS C., GARNER, M.M., DIDIER, E.S., SERRATO, S., ACEVEDO, L.D., RAMOS-VARA, J.A., NORDHAUSEN, R.W., BOWERS, L.C. and PARÁS, A. (2006): Disseminated encephalitozoonosis in captive, juvenile, cotton-top (*Saguinus oedipus*) and neonatal emperor (*Saguinus imperator*) tamarins in North America. *Vet. Pathol.* 43(4): 438–446.



- JUAN-SALLÉS, C., PRATS, N., MARCO, A.J., RAMOS-VARA, J.A., BORRÁS, D. and FERNÁNDEZ, J. (1998): Fatal Acute Toxoplasmosis in Three Golden Lion Tamarins (*Leontopithecus rosalia*). *J. Zoo Wildl. Med.* 29 (1): 55–60.
- JOINT WORKING GROUP ON REFINEMENT (JWGR) (2009): Refinements in husbandry, care and common procedures for non-human primates. Ninth report of the BVA/WF/FRAME/RSPCA/UFPAW Joint Working Group on Refinement, M. Jennings and M.J. Prescott (eds). *Lab. Anim.* 43, S1:1–S1:47.
- KAPLAN, E. and SHEIMIDINE, N. (2010): Factors influencing weight changes in callitrichids at the Bronx Zoo. *Zoo Biol.* 29: 55–566.
- KAUMANN, W., HAMPE, K., SCHWITZER, C., STAHL, D. (2000): Primate nutrition: Towards an integrated approach. In: *Zoo Animal Nutrition*, J. Nijboer, J. M. Hatt, W. Kaumanns, A. Beijnen and U. Gansloßer (eds.). Filander Verlag Furth, The Netherlands. 91–106.
- KELLY, K. (1993): Environmental enrichment for captive wildlife through the simulation of gum-feeding. *Anim. Welfare Info. Newsl.* 4(3): 1–10.
- KENNY, D., CAMBRE, R.C., LEWANDOWSKI, A., PELTO, J.A., IRLBECK, N.A., WILSON, H., MIERAU, G.W., SILL, F.G. and ALBERTO PARAS GARCIA, M.V.Z. (1993): Suspected vitamin D3 toxicity in pacas (*Cuniculus paca*) and agoutis (*Dasyprocta agouti*). *J. Zoo Wildl. Med.* 34: 129–139.
- KINGSTON, W.R. (1969): Marmosets and tamarins. *Lab. Anim. Handb.* 4: 243–250.
- KIRKWOOD, J.K. (1983): Effects of diet on health, weight and litter size in captive cotton-top tamarins *Saguinus oedipus oedipus*. *Primates* 24(4): 515–520.
- KIRKWOOD, J.K., EPSTEIN, M.A. and TERLECKI, A.J. (1983): Factors influencing population growth of a colony of cotton-top tamarins. *Lab. Anim.* 17: 35–41.
- KIRKWOOD, J.K. and UNDERWOOD, S.J. (1984): Energy requirements of captive cotton-top tamarins (*Saguinus oedipus oedipus*). *Folia Primatol.* 42: 180–187.
- KITCHEN, A.M. and MARTIN, A.A. (1996): The effects of cage size and complexity on the behaviour of captive common marmosets, *Callithrix jacchus jacchus*. *Lab. Anim.* 30(4): 317–326.
- KLEIMAN, D.G. (1977): Monogamy in mammals. *Quart. Rev. Biol.* 52: 39–69.
- KLEIMAN, D.G. (1978): The development of pair preferences in the lion tamarin (*Leontopithecus rosalia*): male competition or female choice? In: *Biology and Behaviour of Marmosets*, H. Rothe, H.J. Wolters and J.P. Hearn (eds). Eigenverlag Rothe, Göttingen. 203–208.
- KLEIMAN, D.G. (1979): Parent-offspring conflict and sibling competition in a monogamous primate. *Am. Nat.* 114: 753–760.
- KLEIMAN, D.G., ALLEN, M.E., THOMPSON, K.V. and LUMPKIN, S. (eds) (1993): *Wild Mammals in Captivity*. The University of Chicago Press: Chicago.
- KLEIMAN, D.G., HOAGE, R.J. and GREEN, K.M. (1988): The lion tamarins, genus *Leontopithecus*. In: *Ecology and Behavior of Neotropical primates*, Vol. 2., R.A. Mittermeier, A.B. Rylands, A.F. Coimbra-Filho and G.A.B. da Fonseca (eds). World Wildlife Fund, Washington, DC. 299–347.
- KLEIMAN, D.G., THOMPSON, K.V. and BAER, C.K. (2010): *Wild mammals in Captivity: Principles and techniques for zoo management*. 2nd Edition. The University of Chicago Press: Chicago.
- KNOX, K.L. and SADE, D.S. (1991): Social-behavior of the emperor tamarin in captivity—components of agonistic display and the agonistic network. *Int. J. Primatol.* 12 (5): 439–480.
- KUEHNEL, F., MIETSCH, M., BUETTNER, T., VERUERT, I., ABABNEH, R. and EINSPAINER, A. (2013): The influence of gluten on clinical and immunological status of common marmosets (*Callithrix jacchus*). *J. Med. Primatol.* 42: 300–309.



- KUHAR, C.W., BETTINGER, T.L., SIRONEN, A.L., SHAW, J.H. and LASLEY, B.L. (2003): Factors affecting reproduction in zoo-housed Geoffroy's tamarins (*Saguinus geoffroyi*). *Zoo Biol.* 22(6): 545–559.
- LAMBERT, J.E. (1998): Primate digestion: interactions among anatomy, physiology and feeding ecology. *Evol. Anthropol.* 7(1): 8–20.
- LANE, M.A., INGRAM, D.K. and ROTH, G.S. (1999): Calorie restriction in nonhuman primates: Effects on diabetes and cardiovascular disease risk. *Toxicol. Sci.* 52: 41–48.
- LAZARO-PEREA, C., SNOWDON, C.T. and ARRUDA, M.F. (1999): Scent-marking behavior in wild groups of common marmosets (*Callithrix jacchus*). *Behav. Ecol. Sociobiol.* 46: 313–324.
- LEHTI, E. (1993): Environmental Enrichment and Marmoset Behaviour. Helsinki Zoo, Helsinki. 20–21.
- LEONARDI, R., BUCHANAN-SMITH, H.M., DUFOUR, V., MACDONALD C. and WHITEN, A. (2010): Living together: behavior and welfare in single and mixed species groups of capuchin (*Cebus apella*) and squirrel monkeys (*Saimiri sciureus*). *Am. J. Primatol.* 72: 33–47.
- LEONG, K.M., TERRELL, S.P. and SAVAGE, A. (2004): Causes of mortality in captive cotton-top tamarins (*Saguinus oedipus*). *Zoo Biol.* 23(2): 127–137.
- LEVECKE, B., DORNY, P., GEURDEN, T., VERCAMMEN, F. and VERCRUYSSSE, J. (2007): Gastrointestinal protozoa in non-human primates of four zoological gardens in Belgium. *Vet. Parasitol.* 148: 236–246.
- LEWIS, J.L. (2003) Preventative Health Measures for Primates and Keeping Staff in British and Irish Zoological collections. 6<sup>th</sup> Edition. IZVG, 13.
- LOPES, M.A. and FERRARI, S.F. (1994): Foraging behavior of a tamarin group (*Saguinus fuscicollis weddelli*) and interactions with marmosets (*Callithrix emiliae*). *Int. J. Primatol.* 15: 373–387.
- LÓPEZ, J., WORMELL, D. AND RODRÍGUEZ, A. (2001): Preliminary evaluation of the efficacy and safety of a UVB lamp used to prevent metabolic bone disease in pied tamarins *Saguinus bicolor* at Jersey Zoo. *Dodo* 37: 41–49.
- LORINI, M.L. and PERSSON, V.G. (1994): Status of field research on *Leontopithecus caissara*: the black-faced lion tamarin project. *Neotrop. Primates* 2(suppl.): 52–55.
- LORINI, V. G. and PERSSON, M. L. (1990): Uma nova espécie de *Leontopithecus* Lesson, 1840, do sul do Brasil (Primates, Callitrichidae). *Bol. Mus. Nacional, Rio de Janeiro, nova sér. Zoologia* 338: 1–14.
- LÖTTKER, P., HUCK, M., HEYMANN, E.W. and HEISTERMANN, M. (2004): Endocrine correlates of reproductive status in breeding and nonbreeding wild female moustached tamarins. *Int. J. Primatol.* 25(4): 919–937.
- LUCAS, N.S., HUME, E.M. and SMITH, H.H. (1937): On the breeding of the common marmoset (*Hapale jacchus* Linn) in captivity when irradiated with ultra-violet rays. 2. A ten years' family history. *Proc. Zool. Soc.* 1937. Series A, Part 2. 107: 205–211.
- LUETJENS, C.M., WESSELMANN, R. and KUHLMANN, M. (2006): GnRH-antagonist mediated down-regulation of the estrous cycle in marmosets. *J. Med. Primatol.* 35(6): 361–368.
- MAHONEY, J. (2005): Medical Care. In: *The Laboratory Primate*, S. Wolfe-Coote (ed.). Elsevier Academic Press, Chapter 16: 241-257.
- MALLINSON, J.J.C. (1975): Breeding marmosets in captivity. In: *Breeding Endangered Species in Captivity*, R.D. Martin (ed.). Academic Press, London. 203–212.
- MALLINSON, J.J.C. (1986): International efforts to secure a viable population of the golden-headed lion tamarin *Leontopithecus chrysomelas*. XIth Congress of the International Primatological Society. 1986: 1–8.
- MALLINSON, J.J.C. (1989): A summary of the work of the International Recovery and Management Committee for Golden-headed lion tamarin *Leontopithecus chrysomelas* 1985–1990. *Dodo, J. Jersey Wildl. Preserv. Trusts* 26: 77–86.



- MALLINSON, J.J.C. (1996): The history of golden lion tamarin management and propagation outside of Brazil and current management practice. *Zool. Garten* 66(4): 197–217.
- MALLINSON, J.J.C. (2001): Saving Brazil's Atlantic rainforest: Using the golden-headed lion tamarin *Leontopithecus chrysomelas* as a flagship for a biodiversity hotspot. *Dodo* 37: 9–20.
- MANO, M.T., POTTER, B.J., BELLING, G.B. and HETZEL, B.S. (1985): Low-iodine diet for the production of severe I deficiency in marmosets (*Callithrix jacchus jacchus*). *Brit. J. Nutr.* 54: 367–372.
- MARTIN, R.D. (1990): Primate origins and evolution: a phylogenetic reconstruction. Chapman and Hall, London.
- MARTIN, R.D. (1992): Goeldi and the dwarfs: the evolutionary biology of the small New World monkeys. *J. Hum. Evol.* 22: 367–393.
- MATAUSCHEK, C. (2010): Taxonomy, Phylogeny and Distribution of Tamarins (Genus *Saguinus* Hoffmannsegg, 1807). Thesis, Universität Göttingen, Göttingen.
- MATAUSCHEK, C., ROOS, C. and HEYMANN, E. W. (2011): Mitochondrial phylogeny of tamarins (*Saguinus*, Hoffmannsegg 1807) with taxonomic and biogeographic implications for the *S. nigricollis* species group. *Am. J. Phys. Anthropol.* 144: 564–574.
- MCCALLISTER J.M. (2005). Behavioural and Physiological Differences between Callitrichid Primates. PhD dissertation, Queen's University of Belfast, Belfast.
- MCDONALD, P., EDWARDS, R.A., GREENHALGH, J.F.D. and MORGAN, C.A. (1995): *Animal Nutrition*. 5<sup>th</sup> edition. Longman, Essex.
- MCGREW, W.C., BRENNAN, J.A. and RUSSELL, J. (1986): An artificial "gum-tree" for marmosets (*Callithrix j. jacchus*). *Zoo Biol.* 4: 45–50.
- MCGREW, W.C. and WEBSTER, J. (1995): Birth seasonality in cotton-top tamarins (*Saguinus oedipus*) despite constant food-supply and body-weight. *Primates* 36(2): 241–248.
- MCINTOSH, G.H., BULMAN, F.H., LOOKER, J.W., RUSSELL, G.R. and JAMES, M. (1987): The influence of linoleate and vitamin E from sunflower seed oil on platelet function and prostaglandin production in the common marmoset monkey. *J. Nutr. Sci. Vit.* 33: 299–312.
- MELLO, M.F.V. DE, MONTEIRO A.B.S., FONSECA, E.C., PISSINATTI, A. and REIS FERREIRA, A.M. (2005): Identification of *Helicobacter* sp. in gastric mucosa from captive marmosets (*Callithrix* sp.; Callitrichidae, Primates). *Am. J. Primatol.* 66: 111–118.
- MELLOR, D.J., HUNT, S., and GUSSET, M. (2015): *Caring for Wildlife: The World Zoo and Aquarium Animal Welfare Strategy*. WAZA Executive Office, 87
- MENDES, S.L. (1997a): Hybridization in free-ranging *Callithrix flaviceps* and the taxonomy of the Atlantic forest marmosets. *Neotrop. Primates* 5(1): 6–8.
- MENDES, S.L. (1997b): Padrões geográficas e vocais em *Callithrix* do grupo *jacchus* (Primates, Callitrichidae). PhD thesis, Universidade Estadual de Campinas, Campinas, Brazil.
- MENDES, S.L., VIELLIARD, J.M.E. and MARCO JR., P. DE (2009): The vocal identity of the *Callithrix* species (Primates, Callitrichidae). In: *The Smallest Anthropoids: The marmoset/callimico radiation*, S.M. Ford, L. Porter, and L.C. Davis (eds.). Springer, New York. 63–84.
- MENZEL, E.W. and JUNO, C. (1982): Marmosets (*Saguinus fuscicollis*): are learning sets learned? *Science* 217: 750–752.
- MENZEL JR., E.W., JUNO, C. and GARRUD, P. (1985): Social foraging in marmoset monkeys and the question of intelligence [and discussion]. *Phil. Trans. Roy. Soc. Lond. series B, Biol. Sci.* 308 (1135): 145–158.
- MERMET, N. (1999): *Medical Management and Mortality of Emperor Tamarins—preliminary report*. La Vallée des Singes: Romagne, France. 12pp.



- MIETSCH, M. and EINSPANIER, A. (2015): Non-invasive blood pressure measurement: values, problems and applicability in the common marmoset. *Lab. Anim.* 49(3): 241-250
- MIETSCH, M., BALDAUF, K., REITEMEIER, S., SUCHOWSKI, M., SCHOON, H.-A. and EINSPANIER, A. (2016): Blood pressure as prognostic marker for body condition, cardiovascular, and metabolic disease in the common marmoset (*Callithrix jacchus*), *J. Med. Primatol.* 45: 126-138.
- MITTERMEIER, R.A., SCHWARZ, M. and AYRES, J.M. (1992a): A new species of marmoset, genus *Callithrix* Erxleben 1777 (Callitrichidae, Primates), from the Rio Maués region, state of Amazonas, Central Brazilian Amazonia. *Goeldiana Zool.* (14): 1–17.
- MITURA, A., LIEBERT, F., SCHLUMBOHM, C. and FUCHS, E. (2012): Improving the energy and nutrient supply for common marmoset monkeys fed under long-term laboratory conditions. *J. Med. Primatol.* 41: 82–88.
- MÖHLE, U., HEISTERMANN, M., EINSPANIER, A. and HODGES, J.K. (1999): Efficacy and effects of short- and medium term contraception in the common marmoset (*Callithrix jacchus*) using melengestrol acetate (MGA) implants. *J. Med. Primatol.* 28: 36–47.
- MOLZEN, M. and FRENCH, J.A. (1989): The problem of foraging in captive callitrichid primates: behavioral time budgets and foraging skills. In: *Housing, Care and Wellbeing of Captive and Laboratory Primates*, E.F. Segal (ed.). Noyes Publications: Park Ridge, NJ. 89–101.
- MONFORT, S.L., BUSH, M. and WILDT, D.E. (1996): Natural and induced ovarian synchrony in golden lion tamarins (*Leontopithecus rosalia*). *Biol. Reprod.* 55: 875–882.
- MONTEIRO R.V., DIETZ, J.M., RABOY, B. BECK, B., VLEESCHOWER, K.D., BAKER, A., MARTINS, A. and JANSEN, A.M. (2007): Parasite community interactions: *Trypanosoma cruzi* and intestinal helminths infecting wild golden lion tamarins *Leontopithecus rosalia* and golden-headed lion tamarins *Leontopithecus chrysomelas* (Callitrichidae, L., 1766). *Parasitol. Res.* 101: 1689–1698.
- MOORE, A.J. and CHEVERUD, J.M. (1992): Systematics of the *Saguinus oedipus* group of the bare-faced tamarins: evidence from facial morphology. *Am. J. Phys. Anthropol.* 89: 73–84.
- MOORE, M.T. (1997): Behavioural adaptation of captive-born golden-headed lion tamarins *Leontopithecus chrysomelas* to a free-ranging environment. *Dodo, J. Wildl. Preserv. Trusts* 33: 156–157.
- MORAES, I.A., STUSSI, J.S.P., LILENBAUM, W., PISSINATTI, A., LUZ, F.P. and FERREIRA, A.M.R. (2004): Isolation and identification of fungi from vaginal flora in three species of captive *Leontopithecus*. *Am. J. Primatol.* 64(3): 337–343.
- MORIN, M.L. (1980): Progress report #8 on “Wasting Marmoset Syndrome”. Dept. HEW, PHS, NIH, Bethesda, MD.
- MORRIS, T.H. and DAVID, C.L. (1993): Illustrated guide to surgical technique for vasectomy of the common marmoset. *Lab. Anim.* 27: 381–384.
- MUNSON, L. (1993): Adverse effects of contraceptives in carnivores, primates and ungulates. *Proceedings of the annual meeting/American Association of Zoo Veterinarians (AAZV) 1996*: 284–289.
- MURNANE, R.D., ZDZIARSKI, J.M., WALSH, D.F., KINSEL, M.J., MEEHAN, T.P., KOVARIK, P., BRIGGS, M., RAVERTY, S.A. and PHILLIPS, L.G. (1996): Melengestrol acetate-induced exuberant endometrial decidualisation in Goeldi’s marmoset (*Callimico goeldii*) and squirrel monkeys (*Saimiri sciureus*). *J. Zoo Wildl. Med.* 27: 315–324.
- NACKAERTS, V. 1998. De variatie in de vaderzorg bij het goudkopleeuwaapje, *Leontopithecus chrysomelas*, in gevangenschap. Undergraduate thesis, University of Antwerp, Antwerp. 60pp.
- NAGAMACHI, C.Y., PIECZARKA, J.C., MUNIZ, J.A.P.C., BARROS, R.M.S. and MATTEVI, M.S. (1999): Proposed chromosomal phylogeny for the South American primates of the Callitrichidae family (Platyrrhini). *Am. J. Primatol.* 49: 133–152.





- NAGAMACHI, C.Y., PIECZARKA, J.C., SCHWARZ, M., BARROS, R.M.S. and MATTEVI, M.S. (1997): Comparative chromosomal study of five taxa of genus *Callithrix*, group *Jacchus* (Platyrrhini, Primates). *Am. J. Primatol.* 41(1): 53–60.
- NAPIER, J.R. (1985): *The Natural History of the Primates*. British Museum of Natural History, London.
- NAPIER, P. H. (1976): *Catalogue of the Primates in the British Museum (Natural History)*. Part I. Families Callitrichidae and Cebidae. British Museum (Natural History), London.
- NASH, L.T. (1986): Dietary, behavioural, and morphological aspects of gummivory in primates. *Am. J. Phys. Anthropol.* 29 S7: 113-137
- NATIONAL RESEARCH COUNCIL (NRC) (1978): *Nutrient Requirements of Non-human Primates*. National Academy of Sciences, Washington, DC.
- NATIONAL RESEARCH COUNCIL (NRC) (2003): *Nutrient requirements of non-human primates*. 2<sup>nd</sup> edition. National Academy of Sciences, Washington, DC.
- NEUBERT, R., HELGE, H. and NEUBERT, D. (1994): Proliferative capacity of marmoset lymphocytes after tetanus vaccination and lack of 2,3,7,8-tetrachlorodibenzo-p-dioxin to reduce a booster effect, *Life Sciences*, 56(6): 437-444.
- NEUSSER, M, STANYON, R., BIGONI, F., WIENBERG, J. and MÜLLER, S. (2001): Molecular cytotaxonomy of New World monkeys (Platyrrhini)—Comparative analysis of five species by multi-color chromosome painting gives evidence for a classification of *Callimico goeldii* within the family of Callitrichidae. *Cytogenet. Cell. Genet.* 94(34): 206–215.
- NEWMAN, J.D., KENKEL, W.M., ARONOFF, E.C., BOCK, N.A., ZAMETKIN, M.R., and SILVA, A.C. (2009): A combined histological and MRI brain atlas of the common marmoset monkey, *Callithrix jacchus*, *Brain Res. Rev.* 62(1), 1-18
- NEYMAN, P.F. (1977): Aspects of the ecology and social organization of free-ranging cotton-top tamarins (*Saguinus oedipus*) and the conservation status of the species. In: *The Biology and Conservation of the Callitrichidae*, D. G. Kleiman (ed.). Smithsonian Institution Press, Washington, DC. 39–71.
- NICKLE, D.A. and HEYMANN, E.W. (1996): Predation on Orthoptera and other orders of insects by tamarin monkeys, *Saguinus mystax mystax* and *Saguinus fuscicollis nigrifrons* (Primates: Callitrichidae), in north-eastern Peru. *J. Zool., Lond.* 239: 799–819.
- NIEVERGELT, C.M. and MARTIN, R.D (1999): Energy intake during reproduction in captive common marmosets (*Callithrix jacchus*). *Physiol. Behav.* 65(4–5): 849–854.
- NORVAL, W. (2001): Herpesviruses of Nonhuman Primates. In: *Infectious Diseases of Wild Mammals*, E.S. Williams and I.K. Barker (eds.). 3rd Edition. Manson Publishing Ltd, London, UK. 147–157.
- NUVRAJ SANGHERA (2006): Does trichromatic colour vision influence selective colour preference in three species of Platyrrhine monkeys? Zoology BSc (Hons) John Moore’s University, Liverpool.
- O’CONNELL, D., MOORE, M.T., PRICE, E.C. and FEISTNER, A.T.C. (2001): From enclosure to wood: Initial responses of *Leontopithecus chrysomelas* groups at Jersey Zoo to a change in environment. *Dodo, J. Jersey Wildl. Preserv. Trusts* 37: 21–33.
- OERKE, A.K., EINSPANIER, A., and HODGES, J.K. (1996) Non-invasive monitoring of follicle development, ovulation, and corpus luteum formation in the marmoset monkey (*Callithrix jacchus*) by ultrasonography, *Am. J. Primatol.* 39: 99-113.
- OFTEDAL, O.T. and ALLEN, M.A. (1996): The feeding and nutrition of omnivores with special emphasis on primates. In: *Wild Mammals in Captivity*, D.G. Kleiman, M.E. Allen, K.V. Thompson, K and S. Lumpkin (eds.). The University of Chicago Press, Chicago. 148–157.



- OLIVEIRA, L.C., HANKERSON S.J., DIETZ, J.M. and RABOY, B.E. (2009): Key tree species for the golden-headed lion tamarin and implications for shade-cocoa management in southern Bahia, Brazil. *Anim. Conserv.* 13(1): 60-70.
- O'REGAN H.J. and KITCHENER A.C. (2005): The effects of captivity on the morphology of captive, domesticated and feral mammals. *Mammal Rev.* 35: 215–230.
- PACK, K.S. (1999): The insectivorous-frugivorous diet of the golden-handed tamarin (*Saguinus midas midas*) in French Guiana. *Folia Primatol.* 70: 1–7.
- PASSOS, F.C. (1997): Seed dispersal by black lion tamarins, *Leontopithecus chrysopygus* (Primates, Callitrichidae) in southeastern Brazil. *Mammalia* 61(1): 109–111.
- PASTORINI, J., FORSTNER, M.R.J., MARTIN, R.D. and MELNICK, D.J. (1998): A reexamination of the phylogenetic position of *Callimico* (Primates) incorporating new mitochondrial DNA sequence data. *J. Molec. Evol.* 47(1): 32–41.
- PERERS, V.M. and GUERRA, M.O. (1998): Growth of marmoset monkeys *Callithrix jacchus* in captivity. *Folia Primatol.* 69(5): 266–272.
- PERES, C.A. (1989a): Costs and benefits of territorial defense in wild golden lion tamarins, *Leontopithecus rosalia*. *Behav. Ecol. Sociobiol.* 25: 227–233.
- PERES, C. A. (1989b): Exudate-eating by wild golden lion tamarins, *Leontopithecus rosalia*. *Biotropica* 21(3): 287–288.
- PERES, C.A. (2000): Identifying keystone plant resources in tropical forests: The case of gums from *Parkia* pods. *J. Trop. Ecol.* 16: 287–317.
- PERES, C. A., PATTON J. L. and DA SILVA, M. N. F. DA. (1996): Riverine barriers and gene flow in Amazonian saddle-back tamarins. *Folia Primatol.* 67(3): 113–124.
- PETERS, C.T.M. (ed.) (1998): Harpij Verrijkingsboek. Stichting Nationaal Onderzoek Dierentuinen: Amsterdam.
- PETERS, V.M. and DE OLIVEIRA GUERRA, M. Reproduction and maintenance of two species of marmoset in captivity. *Rev. Brasil. Biol.* 1998. 58(2): 169–173.
- PETIT, T. (1991): Seasonal outbreaks of botulism in captive South American monkeys. *Veterinary Record* 128 (13): 311–312
- PINES, M.K., KAPLAN, G. and ROGERS, L.J. (2005): Use of horizontal and vertical climbing structures by captive common marmosets (*Callithrix jacchus*). *Appl. Anim. Behav. Sci.* 91 (3–4): 311–319.
- PISSINATTI, T.A., PISSINATTI, A. and BURITY, C.H.F (2007): Myocardial stereology in captive *Callithrix kuhlii* (Callitrichidae, Primates): healthy animals versus animals affected by wasting marmoset syndrome (WMS). *Pesq. Vet. Brasil.* 27 (2): 75–79.
- POCOCK, R.I. 1917. The genera of Hapalidae (marmosets). *Ann. Mag. Nat. Hist.*, 8th series, 20: 247–258.
- PORFÍRIO, S. and LANGGUTH, A. (1996): Development of infant behavior in captive *Leontopithecus chrysomelas*. University of Wisconsin–Madison. XVIth Congress of the International Primatological Society and the XIXth Conference of the American Society of Primatologists. 1996: 520. (Abstract)
- POLESCHCHUK, V.P., BALAYAN, M.S., FROLOVA, M.P., DOKIN, V.P., GULYAEVA, T.V. and SOBOL, A.V. (1988): Diseases of wild-caught moustached tamarins (*Saguinus mystax*) in captivity. *Zeit. Versuchstierkd.*, 1988. 31 (2): 69–75.
- POOK, A.G. (1976): Development of hand-reared infants of four species of marmoset. 13th Annual Report. Jersey Wildlife Preservation Trust, Jersey, British Isles.



- POOK, A.G. (1977): A comparative study of the use of contact calls in *Saguinus fuscicollis* and *Callithrix jacchus*. In: The Biology and Conservation of the Callitrichidae. D.G. Kleiman (ed.). Smithsonian Institution Press, Washington, DC. 271–280.
- POOK, A.G. and POOK, G. (1981): A field study of the socio-ecology of the Goeldi's monkey (*Callimico goeldii*) in northern Bolivia. *Folia Primatol.* 35: 288–312.
- PORTER, C.A., CZELUSNIAK, J., SCHNEIDER, H., SCHNEIDER, M.P.C., SAMPAIO, I. and GOODMAN, M. 1997. Sequences of the primate epsilon-globin gene: implications for systematics of the marmosets and other New World primates. *Gene* 205(1–2): 59–71.
- PORTER, L.M. (2007): The Behavioural Ecology of Callimicos and Tamarins in Northwestern Bolivia. *Primate Field Studies*. Pearson Prentice Hall, NJ.
- PORTER, L.M., GARBER, P.A. and NACIMENTO, E. (2009): Exudates as a fallback food for *Callimico goeldii*. *Am. J. Primatol.* 71: 120–129.
- PORTER, L.M., DE LA TORRE, S., PÉREZ-PEÑA, P. and CORTÉS-ORTIZ, L. (2021): Taxonomic diversity of *Cebuella* in the western Amazon: Molecular, morphological and pelage diversity of museum and free-ranging specimens. *Am. J. Phys. Anthropol.* 175(1): 251–267.
- PORTON, I., ASA, C. and BAKER, A. (1992): Survey results on the use of birth control methods in primates and carnivores in North American Zoos. American Association of Zoological Parks and Aquaria, Contraceptive Task Force, St Louis Zoological Park, USA.
- PORTON, I.J. and DEMATTEO, K.E. (2005): Contraception in nonhuman Primates. In: *Wildlife contraception: issues, methods, and applications*, C.S. Asa and I.J. Porton (eds.). The Johns Hopkins University Press, Baltimore, MD. 119–148.
- POWER, M.L. (1991): Digestive Function, Energy Intake and the Response to Dietary Gum in Captive Callitrichids. PhD dissertation. University of California, Berkeley, CA.
- POWER, M.L. (1992). Nutritional consequences of diet self-selection by captive golden lion tamarins. AAZPA 1992 Regional Proceedings. American Association of Zoological Parks and Aquariums, Wheeling, WV. 147–151
- POWER, M.L. (1996): The other side of callitrichine gumnivory—digestibility and nutritive value. In: *Adaptive Radiations in Neotropical Primates*, M.A. Norconk, A.L. Rosenberger and P.A. Garber (eds.). Plenum Press, New York. 97–110.
- POWER, M.L. and OFTEDAL, O.T. (1996): Differences among captive callitrichids in the digestive responses to dietary gum. *Am. J. Primatol.* 40: 131–144.
- POWER, M.L., OFTEDAL, O.T., SAVAGE, A., BLUMER, E.S., SOTO, L.H., CHEN, T.C. and HOLICK, M.F. (1997): Assessing vitamin D status of cotton-top tamarins (*Saguinus oedipus*) in Colombia. *Zoo Biol.* 16: 39–46.
- POWER, M.L., TARDIF, S., LAYNE, D.G. and SCHULKIN, J. (1999): Ingestion of calcium solutions by common marmosets (*Callithrix jacchus*). *Am. J. Primatol.* 47: 255–261.
- POWER, M.L., TARDIF, S.D., POWER, R.A. and LAYNE, D.G. (2003): Resting energy metabolism of goeldi's monkey (*Callimico goeldii*) is similar to that of other callitrichids. *Am. J. Primatol.* 60: 57–67.
- PRESCOTT, M. J. and BUCHANAN-SMITH, H. M. (1999): Intra- and inter-specific social learning of a novel food task in two species of tamarin. *Int. J. Comp. Psychol.* 12: 71–92.
- PRESCOTT, M.J. and BUCHANAN-SMITH, H.M. (2004): Cage sizes for tamarins in the laboratory. *Anim. Welfare*, 13: 151–158.
- PRICE, E.C. and MCGREW, W.C. (1990): Cotton-top tamarins (*Saguinus o. oedipus*) in a semi-naturalistic captive colony. *Am. J. Primatol.* 20: 1–12.



- PRICE, E.C. (1990): Reproductive Strategies of Cotton-top Tamarins. Unpublished Ph.D. Thesis, University of Stirling, Stirling, UK.
- PRICE, E.C. (1992): The nutrition of Geoffroy's marmoset at the Jersey Wildlife Preservation Trust. *Dodo, J. Jersey Wildl. Preserv. Trusts* 28: 58–70.
- PRICE, E.C. (1998b): Group Instability Following Cessation of Breeding in Marmosets and Tamarins: An Update and Re-evaluation. Unpubl. report, Jersey Wildlife Preservation Trust Jersey, British Isles
- PRICE, E.C. (1998): Incest in captive marmosets and tamarins. *Dodo, J. Jersey Wildl. Preserv. Trusts* 34: 25–31.
- PRICE, E.C., ASHMORE, L.A. and MCGIVERN, A.M. (1994): Reactions to zoo visitors to free-range monkeys. *Zoo Biol.* 13(4): 355–373.
- PRICE, E.C., HERRON, S., WORMELL, D. and BRAYSHAW, M. (1999): Getting primates to eat pellets: The nutrition of New World monkeys at Jersey Zoo. *Dodo, J. Jersey Wildl. Preserv. Trusts* 35: 57–66.
- PRICE, E.C., WORMELL, D., BRAYSHAW, M., FURRER, S., HEER, T. and STEINMETZ, H.W. (2012): Managing free-ranging callitrichids in zoos. *Int. Zoo Yb.* 12: 123–136.
- PRYCE, C.R., JURKE, M., SHAW, H.J., SANDMEIER, I.G. and DOEBELI, M. (1993): Determination of ovarian cycle in Goeldi's monkey (*Callimico goeldii*) via the measurement of steroids and peptides in plasma and urine. *J. Reprod. Fert.* 99: 427–435.
- PUPEA, R., CLOTHILDE, M., TAVRSEA, H. and BARROSH, M. (2011): Introduction of gum Arabic and guar to the diet of captive black-tufted ear marmosets, *Appl. Anim. Behav. Sci.* 133: 246–253
- RAMER, J.C., GARBER, R.L., STEELE, K.E., BOYSON, J.F., O'ROUKE, C. and THOMSON, J.A. (2000): Fatal lymphoproliferative disease associated with a novel gammaherpesvirus in a captive population of common marmosets. *Lab. Anim. Sci.* 50: 59–68.
- RAMIREZ, M.F., FREESE, C.H. and REVILLA, J.C. (1977): Feeding ecology of the pygmy marmoset, *Cebuella pygmaea*, in northeastern Peru. In: *The Biology and Conservation of the Callitrichidae*, D.G. Kleiman (ed.). Smithsonian Institution Press, Washington, DC. 91–104.
- REETZ, J., WIEDEMANN, M., AUE, A., WITTSTATT, U., OCHS, A., THOMSCHKE, A., MANKE, H., SCHWEBS, M. and RINDER, H. (2004): Disseminated lethal *Encephalitozoon cuniculi* (genotype III) infections in cotton-top tamarins (*Oedipomidas oedipus*)—a case report. *Parasitol. Int.* 53(1): 29–34.
- REHG, J.A. (2006): Seasonal variation in polyspecific associations among *Callimico goeldii*, *Saguinus labiatus*, and *S. fuscicollis* in Acre, Brazil. *Int. J. Primatol.* 27(5): 1399–1428.
- REHG, J.A. (2009): Ranging patterns of *Callimico goeldii* (callimico) in a mixed species group. In: *Smallest Anthropoids: The marmoset/callimico radiation*, S.M. Ford, L.M. Porter and L.C. Davis (eds). Springer New York. 241–258.
- RIZZINI, C.T. and COIMBRA-FILHO, A.F. (1981): Lesões produzidas pelo sagüi, *Callithrix p. penicillata* (É. Geoffroy, 1812), em árvores do cerrado (Callitrichidae, Primates). *Revta. Brasil. Biol.* 41: 579–583.
- RODA, S.A. and MENDES PONTES, A.R. (1998): Polygyny and infanticide in common marmosets in a fragment of the Atlantic forest of Brazil. *Folia Primatol.* 69: 372–376.
- RÖHE, F., SILVA JR, J. DE S., SAMPAIO, R. and RYLANDS, A.B. (2009): A new subspecies of *Saguinus fuscicollis* (Primates, Callitrichidae). *Int. J. Primatol.* 30(4): 533–551.
- ROSENBERGER, A.L. (1980): Gradistic views and adaptive radiation of platyrrhine primates. *Z. Morph. Anthropol.* 71(2): 157–163.
- ROSENBERGER, A.L. (1981): Systematics: the higher taxa. In: *Ecology and Behavior of Neotropical Primates*, Vol. 1, A.F. Coimbra-Filho and R.A. Mittermeier (eds.). Academia Brasileira de Ciências, Rio de Janeiro. 9–27.



- ROSENBERGER, A.L. (1992): Evolution of feeding niches in New World Monkeys. *Am. J. Phys. Anthropol.* 88: 525–562.
- ROSENBERGER, A.L. (2011): Evolutionary morphology, platyrrhine evolution, and systematics. *Anat Rec.* 294: 1955-1974.
- ROSENBERGER, A.L. and COIMBRA-FILHO, A.F. (1984): Morphology, taxonomic status and affinities of the lion tamarins, *Leontopithecus* (Callitrichinae, Cebidae). *Folia Primatol.* 42: 149–179.
- ROSENBERGER, A.L., SETOYUCHI, T. and SHIGEHARA, N. (1990): The fossil record of callitrichine primates. *J. Hum. Evol.* 19: 209-236.
- ROSS, C.N., FRENCH, J.A. and ORTÍ, G. (2007): Germ-line chimerism and paternal care in marmosets (*Callithrix kuhlii*). *Proc. Nat. Acad. Sci.* 104: 6278–6282.
- ROTHER, H., and KOENIG, A. (1991): Variability of social organization in captive common marmosets (*Callithrix jacchus*). *Folia Primatol.* 57: 28–33.
- ROTHER, H., KOENIG, A. and DARMS, K. (1993): Infant survival and number of helpers in captive groups of common marmosets (*Callithrix jacchus*). *Am. J. Primatol.* 30 (2): 131–137.
- ROWE, N. (1996): *The Pictorial Guide to the Living Primates*. Pogonias Press, New York.
- RUSSO, G. (2009): Biodiversity's bright spot. *Nature, Lond.* 462: 266–269.
- RUTHERFORD, J.N. and TARDIF, S.D. (2008): Placental efficiency and intrauterine resource allocation strategies in the common marmoset pregnancy. *Am. J. Phys. Anthropol.* 137 (1): 60–68.
- RYLANDS, A.B. (1981): Preliminary field observations on the marmoset, *Callithrix humeralifer intermedia* (Hershkovitz, 1977) at Dardanelos, Rio Aripuanã, Mato Grosso. *Primates* 22: 46–59.
- RYLANDS, A.B. (1984a): Marmosets and Tamarins. In: *The Mammal Encyclopaedia*, D.W. Macdonald (ed.), pp.341–347. George, Allen and Unwin, London.
- RYLANDS, A.B. (1984b): Exudate-eating and tree-gouging by marmosets (Callitrichidae, Primates). In: *Tropical Rain Forest: The Leeds Symposium*, A.C. Chadwick and S.L. Sutton (eds). Leeds Philosophical and Literary Society, Leeds. 155–168.
- RYLANDS, A.B. (1985): Tree-gouging and scent-marking by marmosets. *Anim. Behav.* 33(4):1365–1367.
- RYLANDS, A.B. (1986): Ranging behaviour and habitat preference of a wild marmoset group, *Callithrix humeralifer* (Callitrichidae, Primates). *J. Zool., Lond. (A)* 210: 489–514.
- RYLANDS, A.B. (1987): Infant carrying in a wild marmoset group *Callithrix humeralifer*: Evidence for a polyandrous mating system. In: *A Primatologia no Brasil 2*, M. T. de Mello (ed.), Sociedade Brasileira de Primatologia, Brasília, 131–145.
- RYLANDS, A. B. (1989a): Evolução do sistema de acasalamento em Callitrichidae. In: *Etologia de Animais e de Homens*, Anais do V Encontro de Etologia, Departamento de Psicologia Experimental, Universidade de São Paulo, 2–4 October 1986, C. Ades (ed.), Edicon, Editora da Universidade de São Paulo, São Paulo. 87–108.
- RYLANDS, A.B. (1989): Sympatric Brazilian callitrichids: The black-tufted-eared marmoset, *Callithrix kuhlii*, and the golden-headed lion tamarin, *Leontopithecus chrysomelas*. *J. Hum. Evol.* 18: 679–695.
- RYLANDS, A.B. (1990). Scent-marking behaviour of wild marmosets, *Callithrix humeralifer* (Callitrichidae, Primates). In: *Chemical Signals in Vertebrates 5*, D.W. Macdonald, D. Müller-Schwarze and S. E. Natynczuk (eds.). Oxford University Press, Oxford. 415–429
- RYLANDS, A.B. (1993a): The ecology of lion tamarins, *Leontopithecus*: some intrageneric differences and comparisons with other callitrichids. In: *Marmosets and Tamarins: Systematics, behaviour and ecology*, A.B. Rylands (ed.). Oxford University Press: Oxford. 296–313.



- RYLANDS, A.B. (1993b): The bare-face tamarins *Saguinus oedipus oedipus* and *Saguinus oedipus geoffroyi*: subspecies or species? *Neotrop. Primates* 1(2): 4–5.
- RYLANDS, A. B. 1996. Habitat and the evolution of social and reproductive behavior in Callitrichidae. *Am. J. Primatol.* 38: 5–18.
- RYLANDS, A.B. and FARIA, D.S. DE (1993): Habitats, feeding ecology, and home range size in the genus *Callithrix*. In: *Marmosets and Tamarins: Systematics, behaviour, and ecology*, A.B. Rylands (ed.). Oxford University Press, Oxford. 262–272.
- RYLANDS, A.B. and MITTERMEIER, R.A. (2008): The diversity of the New World primates: An annotated taxonomy. In: *South American Primates: Comparative perspectives in the study of behavior, ecology, and conservation*, P. A. Garber, A. Estrada, J.C. Bicca-Marques, E.W. Heymann, and K.B. Strier (eds). Springer, New York. 23–54.
- RYLANDS, A.B. and MITTERMEIER, R. A. (2013a): Family Callitrichidae (marmosets and tamarins). In: *Handbook of the Mammals of the World. Vol. 3. Primates*, R.A. Mittermeier, A.B. Rylands and D.E. Wilson (eds.). Lynx Edicions, Barcelona. 262–305.
- RYLANDS, A.B. and MITTERMEIER, R.A. (2013b): Species accounts of Callitrichidae. In: *Handbook of the Mammals of the World. Vol. 3. Primates*, R.A. Mittermeier, A.B. Rylands & D.E. Wilson (eds.). Lynx Edicions, Barcelona. 306–346.
- RYLANDS, A.B., MONTEIRO DA CRUZ, M.A.O. and FERRARI, S.F. (1989): An association between marmosets and army ants in Brazil. *J. Trop. Ecol.* 5(1): 113–116.
- RYLANDS, A.B., COIMBRA-FILHO, A.F. and MITTERMEIER, R.A. (1993): Systematics, distributions, and some notes on the conservation status of the Callitrichidae. In: *Marmosets and Tamarins: Systematics, behaviour and ecology*, A.B. Rylands (ed.). Oxford University Press, Oxford. 11–77.
- RYLANDS, A.B., SCHNEIDER, H., LANGGUTH, A., MITTERMEIER, R.A., GROVES, C.P. and RODRÍGUEZ-LUNA, E. (2000). An assessment of the diversity of New World primates. *Neotrop. Primates* 8(2): 61–93.
- RYLANDS, A.B., GROVES, C.P., MITTERMEIER, R.A., CORTÉS-ORTIZ, L. and HINES, J.J. (2006): Taxonomy and distributions of Mesoamerican primates. In: *New Perspectives in the Study of Mesoamerican Primates: Distribution, ecology, behavior and conservation*, A. Estrada, P. Garber, M. Pavelka and L. Luecke (eds). Springer, New York. 29–79.
- RYLANDS, A.B., MITTERMEIER, R.A. and COIMBRA-FILHO, A.F. 2007. The systematics and distributions of the marmosets (*Callithrix*, *Callibella*, *Cebuella*, and *Mico*) and callimico (*Callimico*) (Callitrichidae, Primates) In: *The Smallest Anthropoids: The Marmoset/Callimico Radiation*, S.M. Ford, L.M. Porter and L. C. Davis (eds.), Springer, New York. 25–61.
- RYLANDS, A.B., MITTERMEIER, R.A., SILVA JR, J.S., HEYMANN, E.W., DE LA TORRE, S., KIERULFF, M.C.M., NORONHA, M. DE A. and RÖHE, F. (2008): *Marmosets and Tamarins. Pocket identification guide*. Tropical Pocket Guide Series, Conservation International, Arlington, VA.
- RYLANDS, A.B., COIMBRA-FILHO, A.F. and MITTERMEIER, R.A. (2009): The systematics and distributions of the marmosets (*Callithrix*, *Callibella*, *Cebuella*, and *Mico*) and callimico (*Callimico*) (Callitrichidae, Primates). In: *The Smallest Anthropoids: The marmoset/callimico radiation*, S. M. Ford, L.M. Porter and L. C. Davis (eds.). Springer, New York. 25–61.
- RYLANDS, A.B., MATAUSCHEK, C., AQUINO, R., ENCARNACIÓN, F., HEYMANN, E.W., DE LA TORRE, S. and MITTERMEIER, R.A. (2011): The range of the golden-mantle tamarin, *Saguinus tripartitus* (Milne Edwards, 1878): distributions and sympatry of four tamarins in Colombia, Ecuador, and northern Peru. *Primates* 52(1): 25–39.
- RYLANDS, A.B., HEYMANN, E.W., LYNCH ALFARO, J.W., BUCKNER, J., ROOS, C., MATAUSCHEK, C., BOUBLI, J.-P., SAMPAIO, R. and MITTERMEIER, R.A. 2016. Taxonomic review of the New World tamarins (Callitrichidae, Primates). *Zool. J. Linn. Soc.* 177: 1003–1028.
- SAINSBURY, A.W. (1996): The humane control of captive marmoset and tamarin populations. *Anim. Welfare* 6: 231–242.





- SALTZMAN, W., SCHULTZ-DARKEN, N.J. and ABBOTT, D.H. (1997): Familial influences on ovulatory function in common marmosets (*Callithrix jacchus*). *Am. J. Primatol.* 41: 159–177.
- SAMPAIO, R., RÖHE, F., PINHO, G., SILVA-JÚNIOR, J. S., FARIAS, I. P. and RYLANDS, A. B. 2015. Re-description and assessment of the taxonomic status of *Saguinus fuscicollis cruzlimai* Hershkovitz, 1966 (Primates, Callitrichinae). *Primates* 56: 131–144.
- SANCHEZ, S., PELAEZ, F., FIDALGO, A., MORCILLO, A. and CAPEROS, J.M. (2008): Changes in body mass of expectant male cotton-top tamarins (*Saguinus oedipus*). *Folia Primatol.* 79(6): 458–462.
- SANTOS, C.V. and MARTINS, M.M. (2000): Parental care in the buffy-tufted-ear marmoset (*Callithrix aurita*) in wild and captive groups. *Revta. Brasil. Biol.* 60(4): 667–672.
- SASSEVILLE, V.G., SIMON M.A., CHALIFOUX L.V., LIN K.C. AND MANSFIELD K.G. (2007): Naturally occurring Tyzzer's disease in cotton-top tamarins (*Saguinus oedipus*). *Comp. Med.* 57(1): 125–127.
- SAVAGE, A. (1990): The reproductive biology of the cotton-top tamarin (*Saguinus oedipus oedipus*) in Colombia. PhD dissertation, University of Wisconsin-Madison, Madison.
- SAVAGE, A., GIRALDO, L.H., BLUMER, E.S., SOTO, L.H., BURGER, W. and SNOWDON, C.T. (1993): Field techniques for monitoring cotton-top tamarins (*Saguinus oedipus oedipus*) in Columbia. *Am. J. Primatol.* 31: 189–196.
- SCANGA, C.A., HOLMES, K.V. and MONTALI, R.J. (1993): Serologic evidence of infection with Lymphocytic Choriomeningitis virus, the agent of callitrichid hepatitis, in primates in zoos, primate research centers, and a natural reserve. *J. Zoo Wildl. Med.* 24(4): 469–474.
- SCANLON, C.E., CHALMERS, N.R. and CRUZ, M.A.O.M. DA (1988): Changes in the size, composition, and reproductive condition of wild marmoset groups (*Callithrix jacchus jacchus*) in Northeast Brazil. *Primates* 29: 295–305.
- SCANLON, C.E., CHALMERS, N.R. and MONTEIRO DA CRUZ, M.A.O. (1989): Home range use and the exploitation of gum in the marmoset *Callithrix jacchus jacchus*. *Int. J. Primatol.* 10: 123–136.
- SCHNEIDER, H. and ROSENBERGER, A.L. (1996): Molecules, morphology, and platyrrhine systematics. In: *Adaptive Radiations of Neotropical Primates*, M.A. Norconk, A.L. Rosenberger and P.A. Garber (eds.). Plenum Press, New York. 3–19.
- SCHNEIDER, H. and SAMPAIO, I. (2015): The systematics and evolution of New World primates – a review. *Mol. Phylogenet. Evol.* 82: 348–357.
- SCHNEIDER, H., SCHNEIDER, M.P.C., SAMPAIO, I., HARADA, M.L., STANHOPE, M., CZELUSNIAK, J. and GOODMAN, M. (1993): Molecular phylogeny of the New World monkeys (Platyrrhini, Primates). *Mol. Phylogenet. Evol.* 2(3): 225–242.
- SCHNEIDER, H., SAMPAIO, I., HARADA, M.L., BARROSO C.M.L., SCHNEIDER, M.P.C., CZELUSNIAK, J. and GOODMAN, M. (1996): Molecular phylogeny of the New World monkeys (Platyrrhini, Primates) based on two unlinked nuclear genes: IRBP Intron 1 and epsilon-globin sequences. *Am. J. Phys. Anthropol.* 100: 153–179.
- SCHNEIDER, H., BERNARDI, J.A.R., DA CUNHA, D.B., TAGLIARO, C.H., VALLINOTO, M., FERRARI, S.F. AND SAMPAIO, I. (2012): A molecular analysis of the evolutionary relationships in the Callitrichinae, with emphasis on the position of the dwarf marmoset. *Zool. Scr.* 41: 1–10.
- SCHOENFELD, D. (1989): Effects of environmental impoverishment on the social behavior of marmosets (*Callithrix jacchus*). *Am. J. Primatol. Suppl.* 1: 45–51.
- SCHRADIN, C. and ANZENBERGER, G. (2003): Mothers, not fathers, determine the delayed onset of male carrying in Goeldi's monkey (*Callimico goeldii*). *J. Hum. Evol.* 45(5): 389–399.
- SCHROEDER, C., OSMAN, A.A., RGGENBUCK, D. and MOTHEs, T. (1999): IgA-gliadin antibodies, IgA-containing circulating immune complexes, and IgA glomerular deposits in wasting marmoset syndrome. *Nephrol. Dial. Transplant.* 14 (8): 1875–1880.



- SCHROEPPEL, M. (2004): Gerontological observations on two male callitrichids (Callitrichidae). *Zool. Garten* 74(2): 88–94.
- SCHULTZ, A. (1972): *Les primates*. Editions Rencontre: Lausanne.
- SCHWITZER, C. and KAUMANN, W. (2001): Body weight of ruffed lemurs (*Varecia variegata*) in European zoos with reference to the problem of obesity. *Zoo Biol.* 20: 261–269.
- SCHWITZER, C., POLOWINSKY, S.Y. and SOLMAN, C. (2009): Fruits as foods – common misconceptions about frugivory. In: *Zoo Animal Nutrition IV*. M. Clauss, A. Fidgett, G. Janssens, J.-M. Hatt, T. Huisman, J. Hummel, J. Nijboer and A. Plowman (eds.) Filander Verlag, Fuerth.
- SELMÍ, A.L., MENDES, G.M., BOERE, V., COZER, L.A.S., FILHO, E.S., and SILVA, C.A. (2004): Assessment of dexmedetomidine/ketamine anesthesia in golden-headed lion tamarins (*Leontopithecus chrysomelas*). *Vet. Anaesth. Analg.* 31(2): 138–145.
- SELMÍ, A.L., *et al.* (2004): Comparison of medetomidine-ketamine and dexmedetomidine- ketamine anesthesia in golden-headed lion tamarins. *Canadian Veterinary J. – Can. Vet. J.* 45(6): 481–485.
- SENE THIAM, N. (2000): Analysis of the Management Plan of the European Captive Population of Golden-headed Lion Tamarin (*Leontopithecus chrysomelas*) and Proposal of Reproductive Strategy. Unpublished Report. 86pp.
- SEUÁNEZ, H. N., FORMAN, L., MATAYOSHI, T. and FANNING, T. G. (1989): The *Callimico goeldii* (Primates, Platyrrhini) genome: karyology and middle repetitive (LINE-1) DNA sequences. *Chromosoma* 98: 389–395.
- SILVA, F.E., COSTA-ARAÚJO, R., BOUBLI, J.P., SANTANA, M. I., FRANCO, C. L. B., BERTUOL, F., NUNES, H., SILVA JR., J.S. FARIAS, I. and HRBEK, T. (2018): In search of a meaningful classification for Amazonian marmosets: should dwarf marmosets be considered *Mico* congenetics? *Zool. Scr.* 47: 133–143.
- SILVA, H.P.A. and SOUSA, M.B.C. (1997): The pair-bond formation and its role in the stimulation of reproductive function female common marmosets (*Callithrix jacchus*). *Int. J. Primatol.* 18(3): 387–400.
- SILVA JR., J. S. and NORONHA, M. de A. (1998): On a new species of bare-eared marmoset, genus *Callithrix* Erxleben, 1777, from central Amazonia, Brazil (Primates: Callitrichidae). *Goeldiana Zool.* (21): 1–28.
- SKINNER, C. (1991): Justification for reclassifying Geoffroy's tamarin from *Saguinus oedipus geoffroyi* to *Saguinus geoffroyi*. *Prim. Rep.* 31: 77–83.
- SLEEPER, B. (1977): *Primates*. Chronicle Books, San Francisco, CA.
- SMITH, A.C. (2000): Composition and proposed nutritional importance of exudates eaten by saddleback (*Saguinus fuscicollis*) and mustached (*Saguinus mystax*) tamarins. *Int. J. Primatol.* 21: 69–83.
- SMITH, A.C., KNOGGE, C., HUCK, M., LÖTTKER, P., BUCHANAN-SMITH, H.M. and HEYMANN, E.W. (2007): Long term patterns of sleeping site use in wild saddleback (*Saguinus fuscicollis*) and mustached tamarins (*S. mystax*): Effects of foraging, thermoregulation, predation and resource defense constraints. *Am. J. Phys. Anthropol.* 134: 340–353.
- SMITH, K.M., MCALOOSE, D., TORREGROSSA, A.M., RAPHAEL, B.L., CALLE, P.P., MOORE, R.P. and JAMES, S.B. (2008): Hematologic iron analyte values as an indicator of hepatic hemosiderosis in Callitrichidae. *Am. J. Primatol.* 70(7): 629–633.
- SMITH, R.J. and JUNGERS, W.L. (1997): Body mass in comparative primatology. *J. Hum. Evol.* 32: 523–559.
- SMITH, T.E. and ABBOTT, D.H. (1998): Behavioral discrimination between circumgenital odor from peri-ovulatory dominant and anovulatory female common marmosets (*Callithrix jacchus*). *Am. J. Primatol.* 46 (4): 265–284.
- SMITH, T.E. and FRENCH, J.A. (1997a): Psychosocial stress and urinary cortisol excretion in marmoset monkeys (*Callithrix kuhli*). *Physiol. Behav.* 62: 225–232.
- SMITH, T.E. and FRENCH, J.A. (1997b): Social and reproduction conditions modulate urinary cortisol excretion in black tufted-ear marmosets (*Callithrix kuhli*). *Am. J. Primatol.* 42: 253–267.



- SMITH, T.E. and FRENCH, J.A. (1997c): Separation-induced activity in the hypothalamic-pituitary adrenal axis (HPA) in a social primate, Wied's black tufted-ear marmosets (*Callithrix kuhli*). *Am. J. Primatol.* 42(2): 150. (Abstract)
- SMITH, T.E. and MCGREER-WHITWORTH, B. (1996): Psychosocial stress and urinary cortisol excretion in marmoset monkeys (*Callithrix kuhli*). Abstracts. XVth Congress of the International Primatological Society, XIXth Conference of the American Society of Primatologists. Abstract No. 086. Madison, Wisconsin, USA, 11–16 August 1996. (Abstract)
- SMITH, T.E., MCGREER-WHITWORTH, B. and FRENCH, J.A. (1998): Close proximity of the heterosexual partner reduces the physiological and behavioral consequences of novel-cage housing in black tufted-ear marmosets (*Callithrix kuhli*). *Horm. Behav.* 34(3): 211–222.
- SMITH, T.E., SCHAFFNER, C.M., and FRENCH, J.A. (1995): Regulation of reproductive function in subordinate female black tufted-ear marmosets (*Callithrix kuhli*). *Am. J. Primatol.* 36(2): 156–157. (Abstract)
- SMITH, T.E., SCHAFFNER, C.M. and FRENCH, J.A. (1997): Social and developmental influences on reproductive function in female Wied's black tufted-ear marmosets (*Callithrix kuhli*). *Horm. Behav.* 31(2): 159–168.
- SCHNEIDER, H., BERNARDI, J. A. R., CUNHA, D. B. D., TAGLIARO, C. H., VALLINOTO, M., FERRARI, S. F. and SAMPAIO, I. (2012): A molecular analysis of the evolutionary relationships in the Callitrichinae, with emphasis on the position of the dwarf marmoset. *Zool. Scripta* 41: 1-10.
- SNOWDON, C.T. (1993): A vocal taxonomy of the callitrichids. In: *Marmosets and tamarins: systematics, behaviour, and ecology*. A.B. Rylands (ed.). Oxford University Press, Oxford. 78–94.
- SNOWDON, C.T. and SOINI, P. (1988): The tamarins, genus *Saguinus*. In: *Ecology and Behavior of Neotropical Primates*. Vol. 2., R.A. Mittermeier, A.B. Rylands, A.F. Coimbra-Filho and G.A.B. da Fonseca (eds). World Wildlife Fund (WWF), Washington, DC. 223–297.
- SODARO, V. (1999): *Housing and Exhibition of Mixed Species of Neotropical Primates*. Chicago Zoological Society, Brookfield Zoo, Brookfield.
- SODARO, V. (2008): *2008 Survey on Mixed Species Housing*. Chicago Zoological Society, Brookfield Zoo, Brookfield.
- SODARO, V. and SAUNDERS, N. (1999): *Callitrichid Husbandry Manual*. Neotropical Primate Taxon Advisory Group, Chicago Zoological Park, Chicago.
- SOINI, P. (1982): Ecology and population dynamics of the pygmy marmoset, *Cebuella pygmaea*. *Folia Primatol.* 39: 1–21.
- SOINI, P. (1987): Ecology of the saddle-back tamarin *Saguinus fuscicollis illigeri* on the Río Pacaya, northeastern Peru. *Folia Primatol.* 49: 11–32.
- SOINI, P. (1988): The pygmy marmoset, *Cebuella pygmaea*. In: *Ecology and Behavior of Neotropical Primates*, Vol 2, R.A. Mittermeier, A.B. Rylands, A.F. Coimbra-Filho and G.A.B. da Fonseca (eds.). World Wildlife Fund (WWF), Washington, DC. 79–129.
- SOINI, P. (1990): Nota sobre el hallazgo de una subespecie adicional de *Saguinus fuscicollis* (Primates, Callitrichidae). In: *La Primatología en el Perú*. Proyecto Peruano de Primatología (ed). Proyecto Peruano de Primatología, Lima, Perú. 314–317.
- SOINI, P. (1993): The ecology of the pygmy marmoset, *Cebuella pygmaea*: some comparisons with two sympatric tamarins. In: *Marmosets and Tamarins: Systematics, behaviour and ecology*, A.B. Rylands (ed). Oxford University Press, Oxford. 257–261.
- SOINI, P. and SOINI, M. (1982): Distribución geográfica y ecología poblacional de *Saguinus mystax* (Primates, Callitrichidae). Informe de Pacaya No 6 Ordelloreto, DRA/DFP, Iquitos, Peru.



- SOINI, P. and SOINI, M. (1990): Distribución geografía y ecología poblacional de *Saguinus mystax* (Primates, Callitrichidae). In: La Primatología en el Perú. Proyecto Peruano de Primatología (ed). Proyecto Peruano de Primatología, Lima, Perú. 272–313.
- SPAULDING, B. and HAUSER, M. (2005): What experience is required for acquiring tool competence? Experiments with two callitrichids. *Anim. Behav.* 70(3): 517–526.
- STAFFORD, B.J., ROSENBERGER, A.L., BAKER, A.J., BECK, B.B., DEITZ, J.M. and KLEIMAN, D.G. (1996): Locomotion of golden lion tamarins (*Leontopithecus rosalia*): the effects of foraging adaptations and substrate characteristics on locomotor behavior. In: Adaptive Radiations of Neotropical Primates, M.A. Norconk., A.L. Rosenberger and P.A. Garber (eds.). Plenum Press, New York. 111–132.
- STEINMETZ, H.P., HATT, J.M., ISENBÜGEL, E., OSSENT, P. and ZINGG, R. (2004): Disease risk assessment in a free roaming population of golden-headed tamarins (*Leontopithecus chrysomelas*) in comparison to traditional captive management. BVZS/WAWV/RVC/ZSL Conference November 2004 (GB)
- STEINMETZ, H.W., ZINGG, R., OSSENT, P., EULENBERGER, U., CLAUSS, M. and HATT, J.M. (2011): Comparisons of indoor and captive, free-roaming management in golden-headed lion tamarins (*Leontopithecus chrysomelas*) at Zürich Zoo, *Anim. Welfare* 20: 205-210
- STEVENSON, M.F. (1978): The Ontogeny of playful behaviour in family groups of the common marmoset. *Recent Advances in Primatology I*: 139-143.
- STEVENSON, M.F. and POOLE, T.B. (1976): An ethogram of the common marmoset (*Callithrix jacchus jacchus*): general behavioural repertoire. *Anim. Behav.* 24: 228–235.
- STEVENSON, M.F. and RYLANDS, A.B. (1988): The marmosets, genus *Callithrix*. In: Ecology and Behavior of Neotropical Primates, Vol. 2, R.A. Mittermeier, A.B. Rylands, A.F. Coimbra-Filho and G.A.B. da Fonseca (eds.). World Wildlife Fund, Washington, DC. 131–222.
- STEVENSON, M.F. and LEUS, K. (2014): Assessing the species: a one plan approach to collection planning. *Zooquaria* 88: 16-17.
- SUMMERS, P.M., WENNINK, C.J. and HODGES, J.K. (1985): Cloprostenol-induced luteolysis in the marmoset monkey (*Callithrix jacchus*). *J. Reprod. Fert.* 73: 133–138.
- SUSSMAN, R.W. and GARBER, P.A. (1987): A new interpretation of the social organisation and mating system of the Callitrichidae. *Int. J. Primatol.* 8(1): 73–92.
- SUSSMAN, R.W. and KINZEY, W.G. (1984): The ecological role of the Callitrichidae: A review. *Am. J. Phys. Anthropol.* 64: 419–449.
- TAGLIARO, C. H., SCHNEIDER, H., SAMPAIO, I., SCHNEIDER M.P.C., VALLINOTO, M. and STANHOPE, M. (2005). Molecular phylogeny of the genus *Saguinus* (Platyrrhini, Primates) based on the ND1 mitochondrial gene and implications for conservation. *Genet. Molec. Biol.* 28(1): 46–53.
- TAGLIARO, C. H, SCHNEIDER, M.P.C., SCHNEIDER, H., SAMPAIO, I.C. and STANHOPE, M. J. (1997): Marmoset phylogenetics, conservation perspectives, and evolution of the mtDNA control region. *Mol. Biol. Evol.* 14(6): 674–684.
- TAGLIARO, C. H., SCHNEIDER, M. P. C., SCHNEIDER, H., SAMPAIO, I. C. and STANHOPE, M. J. (2001): Molecular studies of *Callithrix pygmaea* (Primates, Platyrrhini) based on Transferrin intronic and ND1 regions: Implications for taxonomy and conservation. *Genet. Mol. Biol.* 23(4): 729–737.
- TAKAHASHI, N., SUDA, S., SHINKI, T., HORIUCHI, N., SHIIMA, Y., TANKOKA, Y., KOISUMI, H. and SUDA, T. (1985): The mechanisms of end-organ resistance to 1-alpha, 25 dihydroxycholecalciferol in the common marmoset. *Biochem. J.* 227: 555–563.



- TARDIF, S.D., HARRISON, M.L. and SIMEK, M.A. (1993): Communal infant care in marmosets and tamarins: Relation to energetics, ecology, and social organization. In: *Marmosets and Tamarins: Systematics, behaviour, and ecology*, A.B. Rylands (ed.). Oxford University Press, Oxford. 220–234.
- TARDIF, S., JAQUISH, C., LAYNE, D., BALES, K., POWER, M., POWER, R. and OFTEDAL, O. (1998): Growth variation in common marmoset monkeys (*Callithrix jacchus*) fed a purified diet: Relation to caregiving and weaning behaviors. *Lab. Anim. Sci.* 48: 264–269.
- TARDIF, S.D., POWER, M., OFTEDAL, O.T., POWER, R.A. and LAYNE, D.G. (2001): Lactation, Maternal behavior and infant growth in common marmoset monkeys (*Callithrix jacchus*): Effects of maternal size and litter size. *Behav. Ecol. Sociobiol.* 51 (1): 17–25.
- TARDIF, S.D., POWER, M.L., ROSS, C.N., RUTHERFORD, J.N., LAYNE-COLON, D.G. and PAULIK, M.A. (2009): Characterization of obese phenotypes in a small nonhuman primate, the common marmoset (*Callithrix jacchus*). *Obesity* 17(8): 1499–1505.
- TARDIF, S.D., RICHTER, C.B. and CARSON, R.L. (1984a): Effects of sibling-rearing experience on future reproductive success in two species of Callitrichidae. *Am. J. Primatol.* 6: 377–380.
- TARDIF, S.D., RICHTER, C.B. and CARSON, R.L. (1984b): Reproductive performance of three species of Callitrichidae. *Lab. Anim. Sci.* 34: 272–275.
- TARDIF, S.D., SMUCNY, D.A., ABBOTT, D.H., MANSFIELD, K., SCHULTZ-DARKEN, N. and YAMAMOTO, M.E. (2003): Reproduction in captive common marmosets (*Callithrix jacchus*). *Comp. Med.* 53: 364–368.
- TELLO, N.S., HUCK, M. and HEYMANN, E.W. (2002): *Boa constrictor* attack and successful group defence in moustached tamarins, *Saguinus mystax*. *Folia Primatol.* 73: 146–148.
- TERBORGH, J. (1983): *Five New World primates. A study in comparative ecology*. Princeton University Press, Princeton, NJ.
- TERBORGH, J. and GOLDIZEN, A.W. (1985): On the mating system of the cooperatively breeding saddleback tamarin (*Saguinus fuscicollis*). *Behav. Ecol. Sociobiol.* 16: 293–299.
- THOMAS, W.D. and MARUSKA, E.J. (1996): Mixed species exhibits with mammals. In: *Wild Mammals in Captivity: Principles and techniques*, D.G. Kleiman, M.E. Allen, K.V. Thompson and S. Lumpkin (eds.). University of Chicago Press, Chicago. 204–211.
- THOMASSEN W. (2012): Evictions in Captive Single-sex Groups of Callitrichidae. EAZA Callitrichid TAG, Amsterdam.
- THOMPSON, S.D., POWER, M.L., RUTLEDGE, C.E. and KLEIMAN, D.G. (1994): Energy metabolism and thermoregulation in the golden lion tamarin (*Leontopithecus rosalia*). *Folia Primatol.* 63: 131–143.
- THORINGTON JR., R.W. (1988): Taxonomic status of *Saguinus tripartitus* (Milne-Edwards, 1878). *Am. J. Primatol.* 15: 367–371.
- TOWNSEND, W.R. (1999): An observation of carnivory by a captive pygmy marmoset (*Cebuella pygmaea*). *Neotrop. Primates* 7: 75–76.
- TRAYLOR-HOLZER, K., LEUS, K. and MCGOWAN, P. (2013): Integrating assessment of *ex situ* management options into Species Conservation Planning. *WAZA Mag.* 14: 6–9.
- TUTTLE, R.H. (1986): *Apes of the World*. Noyes Publications, Park Ridge, NJP
- ULLREY, D.E. (1986). Nutrition of primates in captivity. In: *The Road to Self-sustaining Populations*, K. Benirschke (ed.). Springer Verlag, New York. 823–835.
- ULLREY, D.E., BERNARD, J., PETER, G.K., LU, Z., CHEN, T.C., SIKARSKIE, J.G. and HOLICK, M.F. (1999): Vitamin D intakes by cotton-top tamarins (*Saguinus oedipus*) and associated serum 25-hydroxyvitamin D concentrations. *Zoo Biol.* 18: 473–480.





- VALLADARES-PADUA C., MARTINS C.S., WORMELL D. and SETZ, E.Z.F. (2000): Preliminary evaluation of the reintroduction of a mixed wild-captive group of black lion tamarins (*Leontopithecus chrysopygus*). *Dodo* 36: 30–38.
- VALLADARES-PADUA, C. and PRADO, F. (1996): Notes on the natural history of the black-faced lion tamarin *Leontopithecus caissara*. *Dodo, J. Jersey Wildl. Preserv. Trusts* 32: 123–125.
- VALLINOTO, M., ARARIPE, J., REGO, P. S., TAGLIARO, C. H., SAMPAIO, I. and SCHNEIDER, H. (2006): Tocantins River as an effective barrier to gene flow in *Saguinus niger* populations. *Genet. Mol. Biol.* 12: 823–833.
- VAN DE VEEGAETE, P. (1991): De proximale invloeden op moederzorggedrag bij goudkopleeuwaapjes (*Leontopithecus chrysomelas*) (Callitrichidae). Undergraduate thesis, University of Antwerp, Antwerp. 55pp.
- VAN ELSACKER, L., HEISTERMANN, M., HODGES, J.K., DE LAET, A. and VERHEYEN, R.F. (1994): Preliminary results on the evaluation of contraceptive implants in golden-headed lion tamarins, *Leontopithecus chrysomelas*. *Neotrop. Primates* 2(suppl.): 30–32.
- VAN ELSACKER, L., DE MEURICHY, W., VERHEYEN, R.F. and WALRAVEN, V. (1992): Maternal differences in infant carriage in golden-headed lion tamarins (*Leontopithecus chrysomelas*). *Folia Primatol.* 59(3): 121–126.
- VAN ROOSMALEN, M. G. M. and VAN ROOSMALEN, T. (1997): An eastern extension of the geographical range of the pygmy marmoset, *Cebuella pygmaea*. *Neotrop. Primates* 5(1): 3–6.
- VAN ROOSMALEN, M.G.M. and VAN ROOSMALEN, T. (2003): The description of a new marmoset genus, *Callibella* (Callitrichinae, Primates), including its molecular phylogenetic status. *Neotrop. Primates* 11: 1–11.
- VAN ROOSMALEN, M. G. M., VAN ROOSMALEN, T., MITTERMEIER, R. A. and FONSECA, G. A. B. (1998): A new and distinctive species of marmoset (Callitrichidae, Primates) from the lower Rio Aripuanã, state of Amazonas, central Brazilian Amazonia. *Goeldiana Zool.* (22): 1–27.
- VAN ROOSMALEN, M.G.M., VAN ROOSMALEN, T., MITTERMEIER, R.A. and RYLANDS, A.B. (2000): Two new species of marmoset, Genus *Callithrix* Erxleben, 1777 (Callitrichidae, Primates) from the Tapajós/Madeira interfluvium, south central Amazonia, Brazil. *Neotrop. Primates* 8(1): 2–18.
- VÀSÁRHELYI, K. (2002): The nature of relationships among founders in the captive population of Goeldi's monkey (*Callimico goeldii*). *Evol. Anthropol. (suppl. 1)*: 155–158.
- VASQUEZ, M.R.O. AND HEYMANN, E.W. (2001): Crested eagle (*Morphnus guianensis*) predation on infant tamarins (*Saguinus mystax* and *Saguinus fuscicollis*, Callitrichinae). *Folia Primatol.* 72: 301–303.
- VERACINI A. (1998): Activity pattern in a wild group of *Callithrix argentata*. Poster presentation, XVIIth Congress of the International Primatological Society, Antananarivo, Madagascar, August 1998: 10–14.
- VIVO, M. DE. (1985): On some monkeys from Rondônia, Brasil (Primates: Callitrichidae, Cebidae). *Pap. Avuls. Zool., São Paulo* 4: 1–31.
- VIVO, M. DE. (1991). Taxonomia de *Callithrix* Erxleben, 1777 (Callitrichidae, Primates). Fundação Biodiversitas, Belo Horizonte, Brazil.
- VOEVODIN, A.F. and MARX, P.A. (2009): *Simian Virology*. Wiley-Blackwell, New York
- WADSWORTH, P.F., HIDDLESTON, W.A., JONES, D.V., FOWLER, J.S.L. and FERGUSON, R.A. (1982): Hematological coagulation and blood chemistry data in red-bellied tamarins *Saguinus labiatus*. *Lab. Anim.* 16(4): 27–33.
- WAGNER, W.M., and KIRBERGER, R.M. (2005a): Radiographic anatomy of the thorax and abdomen of the common marmoset (*Callithrix jacchus*). *Vet. Radiol. Ultrasound* 46(3): 217-224.
- WAGNER, W.M., and KIRBERGER, R.M. (2005b): Transcutaneous ultrasonography of the abdomen in the normal common marmoset (*Callithrix jacchus*). *Vet. Radiol. Ultrasound* 46 (3), 251-258.





- WAKENSHAW, V. (1996–1997): Report on the Management and Husbandry of *Callithrix jacchus geoffroyi*. Shaldon Wildlife Trust: Shaldon, UK.
- WASHABAUGH, K.F., SNOWDON, C.T. and ZIEGLER, T.E. (2002): Variations in care for cottontop tamarin, *Saguinus oedipus*, infants as a function of parental experience and group size. *Anim. Behav.* 63 (6): 1163–1174.
- WATCHMAN, L.M., KRAMER, J.A., MILLER, A.D., HACHEY, A.M., CURRAN, E.H., MANSFIELD, K.G. (2011): Differential contribution of dietary fat and monosaccharide to metabolic syndrome in the common marmoset (*Callithrix jacchus*). *Obesity* 19:1145–1156.
- WHEATON, C.J., SAVAGE, A., SHUKLA, A., NEIFFER, D., QU, W., SUN, Y. and LASLEY, B.L. (2011): The use of long acting subcutaneous levonorgestrel (LNG) gel depot as an effective contraceptive option of cotton-top tamarins (*Saguinus oedipus*). *Zoo Biol.* 30: 498–522.
- WINDLE, C.P., BAKER, H.F., RIDLEY, R.M., OERKE, A.K. and MARTIN, R.D. (1999): Unrearable litters and prenatal reduction of litter size in the common marmoset (*Callithrix jacchus*). *J. Med. Primatol.* 28(2): 73–83.
- WOLTERS, J. and IMMELMANN, K. (1989): Marmosets and tamarins. In :Grzimek’s Encyclopedia of Mammals. Vol. 4. McGraw-Hill, New York.
- WOOD, C., BALLOU, J.D. and HOULE, C.S. (2001): Restoration of reproductive potential following expiration or removal of melengestrol acetate contraceptive implants in golden lion tamarins (*Leontopithecus rosalia*). *J. Zoo Wildl. Med.* 32(4): 417–425.
- WORMELL, D. and PRICE, E. (2001): Reproduction and management of black lion tamarins *Leontopithecus chrysopygus* at Jersey Zoo. *Dodo* 37: 34–40.
- WORMELL, D. and PRICE, E. (2016): Effect of dietary changes on the health of captive Geoffroy’s marmosets *Callithrix geoffroyi*. *Solitaire* 27: 22-24.
- WORMELL, D., HUNT, J., BAIRRÃO RUIVO, E. and PRICE, E. (2012): Enriched environment for callitrichids. *Solitaire* 23: 8-12.
- WORMELL, D., LEUS, K., STEVENSON, M., BAIRRÃO RUIVO, E. and RYLANDS, A.B. (2014): Regional Collection Plan for Callitrichidae, Edition 3. EAZA, Amsterdam.
- XANTEN, W.A. (1990): Marmoset behaviour in mixed species exhibits at the National Zoological Park, Washington. *Int. Zoo Yearb.*, 29: 143–148.
- XANTEN, W.A. (1992): Mixed-species exhibits: Are they worth it? AAZPA Regional Conference Proceedings. 59–61.
- YAMAMOTO, M.E. (1993): From dependence to sexual maturity: The behavioural ontogeny of Callitrichidae. In: Marmosets and Tamarins: Systematics, behaviour, and ecology, A.B. Rylands (ed.). Oxford University Press, Oxford. 235–254.
- YAMAMOTO, M.E., ALBUQUERQUE, F.S., LOPES, N.A. and FERREIRA, E.S. (2008): Differential infant carrying in captive and wild common marmosets (*Callithrix jacchus*). *Acta Ethol.* 11 (2): 95–99.
- YAXLEY, M. (2007): Diet Selection and Nutrient Intakes of Captive Lion Tamarins. MSc dissertation, Writtle College, University of Essex.
- YOUNG, R. (1998): Environmental enrichment: an introduction. In: ABWAK—guidelines for environmental enrichment, D.A. Field (ed). Association of British Wild Animal Keepers (ABWAK): West Sussex, UK. 15–28.
- YUE, M.Y., JENSEN, J.M. and JORDAN, H.E. (1980): Spirurid infections (*Rictularia* sp.) in golden marmosets (A). *Leontopithecus rosalia* (syn. *Leontideus rosalia*) from the Oklahoma City Zoo. *J. Zoo Anim. Med.* 11 (3): 77–80.
- ZELLI, S., FENG, Y., SHEH, A., EVERITT, J., BERTRAM, F., PASTER, B. and FOX, G. (2015): Isolation and characterization of a novel *Helicobacter* species, *Helicobacter jaachi* sp. nov., from common marmosets (*Callithrix jacchus*). *J. Med. Microbiol.* 64: 1063–1073.



ZIEGLER, T.E., SAVAGE, A., SCHEFFLER, G. and SNOWDON, C.T. (1987): The endocrinology of puberty and reproductive functioning in female cotton-top tamarins (*Saguinus oedipus oedipus*) under varying social conditions. Biol. Reprod. 37: 618–627.

Websites:

ANIMALS USED IN SCIENTIFIC PROCEDURES.

[https://www.gov.uk/government/uploads/system/uploads/attachment\\_data/file/228831/0107.pdf](https://www.gov.uk/government/uploads/system/uploads/attachment_data/file/228831/0107.pdf)



## **6. SECTION 6– Appendices**

### **6.1 Appendix 1. Callitrichid plant interaction**

# CALLITRICHID PLANT INTERACTION



**FUNDACIÓN**  
PARQUES REUNIDOS

**Agustín López Goya**  
General Curator



Casa de Campo S/N  
28011 - Madrid (SPAIN)  
Skype:agustin.lopez.goya  
<http://www.faunia.es>  
<http://zoomadrid.com>



EAZA Executive Office

c/o Artis Royal Zoo  
PO Box 20164  
1000 HD Amsterdam  
The Netherlands

Phone: +31 20 520 0750  
Fax: +31 20 520 0752  
Email: [info@eaza.net](mailto:info@eaza.net)  
Website: [www.eaza.net](http://www.eaza.net)

**EAZA CALLITRICHID TAG MEETING**

Edinburgh 2013



## Why should we carry on a study of possible poisoning of callitrichids by toxic plants ?

- Poisoning by plants are common in Zoo animals
- Almost all callitrichids facilities contain a great variety of plant species.
- In facilities that do not have natural plants, these are entered as enrichment.



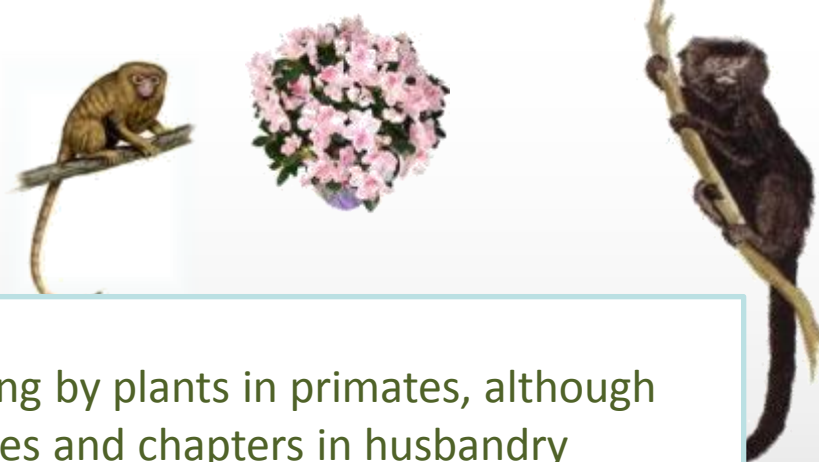

## Looking for information regarding this topic

- We have not found any specific book on poisoning by plants in primates, although there are plenty of information in internet websites and chapters in husbandry guidelines.

1. EAZA Husbandry guidelines for Callitrichidae. Second Edition 2010.

2. Callitrichid Husbandry manual: Vince Soraro and Nancy Saunders. “Enrichment and operant conditioning of Callitrichids” - there is a list (table 3) pag: 69/71, of recommended plants. (ed) (1999).

3. Goeldi’s Monkeys (*Callimico goeldii*) Husbandry Manual  
Vince Sodaro, (ed) (2004).

Brookfield Zoo, 3300 Golf Road, Brookfield, IL, 60513-1095, U.S.A.

4. Different Websites about toxic plants in mammals and primates.

Based on these references we have listed several classifications:

- Poisonous plants if eaten
- Poisonous plants to the touch
- Recommended plants
- Used plants





# POISONOUS PLANTS AND TREES ACCORDING TO LITERATURE:

## IF EATEN

**Azalea (leaves)**

Bittersweet (berries, and juice)

Bleeding Heart (leaves, and tubers)

**Burning Bush (leaves)**

Castor Bean (seeds)

Christmas Rose (roots)

Columbine (berries)

**Cyclamen (tubers)**

Daffodil (bulbs)

Delphinium (leaves)

**Dieffenbachia (leaves)**

Dogwood (fruits)

Deadly Nightshade (berries)

**Elephant ear (all parts)**

Four o'clock (roots and seeds)

Foxglove (leaves)

Holly (berries)

Horse chestnut (nuts, leaves)

Huckleberry (unripe berries, leaves)

Hyacinth (bulbs)

Hydrangea (leaves)

Iris (Underground stem)

**Ivy, most kinds (leaves)**

**Impatiens plant (stem, leaves)**

Jimson weed (all parts)

**Lily of the Valley (all parts)**

Lupines (seeds and berries)

May apple (roots)

Mistletoe (leaves and berries)

Mock orange (fruit)

Monkshood (all parts)

Mountain laurel (all parts) Milkweeds (leaves

and stems)

Narcissus (bulbs)

**Oak Tree (all parts)**

**Oleander ( all parts)**

Pinks (seeds)

**Potato (green tubers, sprouts)**

Privet (leaves and berries)

**Philodendron (stems, leaves)**

Poinsettia (all parts)

Rhododendron (all parts)

Rhubarb (leaves)

Sweet Pea (stem)

Tobacco (foliage)

Wild Black Cherry (wilted leaves)

Tulip (bulb)

Yews (leaves, bark and seeds)

## LEGEND

There are plants with different degrees of toxicity that could affect our animals or not depending on many variables.

The species marked in red are those that appear most frequently in the literature as dangerous to callitrichids.

The species marked in blue are those that although known to be poisonous are commonly used in callitrichid facilities without any poisonous episode detected

# POISONOUS PLANTS AND TREES ACCORDING TO LITERATURE:

## IF TOUCHED

Poison Oak (leaves)  
Milkweed (milky sap)  
Nettle (leaves)  
Pionsettia (milky sap)  
Poison Ivy (all parts)

Poison sumac (leaves)  
Primrose (leaves, stem)  
Rubber plant (milk sap)  
Thistle (leaves)





## RECOMMENDED PLANTS AND TREES ACCORDING TO LITERATURE:

- Acacia sp.
- Bambusa sp.
- Morus sp.
- Musa sp.
- Populus sp.
- Rosa sp.
- Salix sp.



## OTHER USED PLANTS AND TREES IN CALLITRICHID FACILITIES:

- Acer sp.
- Aechmea sp.
- Aglaonema sp.
- Alocasia sp.
- Bromeliad sp.

- Dieffenbachia amoena**
- Dracaena deremensis
- Ficus sp.
- Lonicera sp.

- Magnolia tree.
- Malus sp.
- Passiflora edulis
- Philodendron sp.**
- Sansevieria sp.

- Spathiphyllum sp.
- Strelitzia sp.
- Ulmus sp.
- Vitis sp.



The authors from the literature do not guarantee the toxicity / non-toxicity of these plants but have supplied them as a source of information.



## Why should we carry on a study of possible poisoning of callitrichids by toxic plants ?

- Poisoning by plants is common in Zoo animals
- Almost all callitrichids facilities contain a great variety of plant species.
- In facilities that do not have natural plants, these are entered as enrichment.
- As the information found in the literature is somewhat confusing we decided to do a survey**







# Survey of possible poisoning of callitrichids by toxic plants

## Questionary results



**In the months of May-June of 2013 we sent a questionnaire to institutions that keep callitrichids about facilities with natural plants inside and possible animal poisoning.**

- Of the many zoos questioned, 39 have sent answer, the last one sent in late July.
- Of the 39 institutions only 4 lack of vegetation inside the facilities, but they use plants as enrichment.
- Of the 35 institutions that have plants inside, 13 not controlled them by a horticulture team.
- Regarding the question: Do you know of any cases of possible poisoning of callitrichids by plants?

A single center (Jászberény Zoo) said yes with a case of *Taxus baccata* poisoning that only caused intestinal problems to a *Saguinus oedipus* individual.

Other Zoo (Jerez) had a very strange situation where 1.1 *Callimico goeldi* died (both specimens in a short period of time, < 1 week). The only difference was that they provided fresh fruits of *Phoenix canariensis*. The necropsia results were not definitive but were compatible with intoxication.

The results of the survey shows that the more common plants inside the callitrichid facilities are:



Abelia sp.	Conocarpus fascifolius	Malus malus	Rhododendron bipinnatifidum
Acer sp.	Coprosma repens	Maranta sp.	Rhus typhina
Alocasia spec.	Cornus mas	Mentha sp.	Ripogonum scandens
Ampelopsis sp.	Corylus avellana	Meryta sp.	Ripsalis sp.
Anthurium sp.	Cotoneaster sp.	Morus sp.	Robinia pseudoacacia
Arbutus unedo	Crataegus sp.	Musa paradisiaca	Rubus idaeus
Arundo donax	Dracaena sp.	Olea europaea,	Salix sp.
Avena sativa	Dryas lutescens	Parthenocissus tricuspidata	Solanum nigrum
Bambuseae spec	Fagus sp.	Peperomia sp.	Solanum dulcamara
Berberis vulgaris	Feijoa (A. sellowiana)	Persea americana	Spathiphyllum floribundum
Betula pendula	Ferns (Various)	Phillostachys sp.	Theobroma cacao
Casuarina cunninghamii	Ficus sp	Phoenix sp.	Tipuana tipu
Chamaerops humilis	Forsytia sp.	Picea abies	Triticum aestivum
Choisya ternata	Hebe sp.	Pinus sp.	Ulmus minor
Cindaxio sp.	Hedera helix	Prunus nigra	Viburnum tinus
Citrus sp.	Humulus lupulus	Pseudosasa japonica	Vitex lucens
Clivia sp.	Juniperus sp.	Punica granatum	Vitis vinifera sylvestris
Coffea arabica	Laurus nobilis	Pyracantha coccinea	Wegelia candida
	Livistonia rotundifolia	Pyrus sp.	Wisteria chinensis
	Lonicera sp.	Quercus sp.	Yucca sp.





## Survey of possible poisoning of callitrichids by toxic plants

### CONCLUSIONS:

1. Living plants are used in all zoos, and many species are present. Even with this large number of species there is only one known case of poisoning and two possible cases in other zoo recorded.
2. It seems that the different institutions are informed previously when introducing plants for not adding toxic species.
3. Some toxic plants are commonly used in callitrichid enclosures without poisoning.
4. Callitrichids species seem to be quite resistant to digestive problems resulting from consumption of plants (if they really do it)

### 39 institutions answered

Augsburg GmbH	Koln
Al Bustan	Landau
Amersfoort	La Palmyre
Barcelona	Leipzig
Battersea	London
Bauval	Mulhouse
Bristol	Ogrod
Burford	Olomouc
Colchester	Peaugres
Dortmund	Poznan
Drayton	Saldowildlifetrust
Dublin	Santillana
Dudley	Servion
Erfurt	Sigean
Faunia	Singapur
Heidelberg	Sóstó
Jerusalem	South Lakes
Jászberény	Tabernas
Jerez	Wellington
	Wuppertal



## **6.2 Appendix 2. Training Guide for Scale Training Callitrichids**

# Animal Training Guide

For

## Scale Training Callitrichid's



Greg Clifton and Kris Hern  
Twycross Zoo, UK

**tz**  
Twycross Zoo  
EXPLORING THEIR WORLD

Commissioned by the EAZA Callitrichid TAG

# Animal Training Guide For Scale Training Callitrichid's

**Greg Clifton**

Primate Keeper

**Kris Hern**

Animal Training Manager

## **Twycross Zoo**

Burton Road

Atherstone

Warwickshire

England, UK

CV9 3PX

**Tel:** +44(0)844 474 1777

**Email:** [greg.clifton@twycrosszoo.org](mailto:greg.clifton@twycrosszoo.org)

**Email:** [kris.hern@twycrosszoo.org](mailto:kris.hern@twycrosszoo.org)

## Introduction

At Twycross Zoo we are currently scale train many of our primates to ensure good weight management.

What is the ideal weight? First a healthy weight for each species is established using current available data. Then taking into consideration age, size and condition of each individual, the animals are comparatively assessed.

## Why is training important?

Animal training plays an important role in the health and welfare of the animals and helps facilitate effective veterinary care. With training, a clinical examination/ assessment can be made without the need for a full anaesthetic; this is particularly useful in on-going cases and as part of monitoring plans. Scale training helps to ensure accurate and up-to-date weights are available for medication dosing and health monitoring.



## Benefits of scale training

- Regular weights can be obtained without the need for capture and restraint, reducing stress.
- Diets can be increased or decreased appropriately.
- Weight gain or loss can be recognised at an early stage.
- Weight can be monitored during gestation.
- Accurate weights ensure accurate drug doses can be calculated.

## Body condition score (BCS)

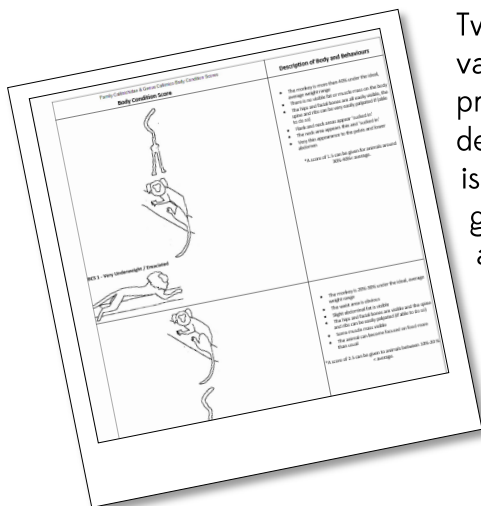

Twycross Zoo is currently trialling the use of body condition scoring with various species of primates. Charts have been designed for various primates to record body condition. These charts have a diagram and description of each body condition with a score, for example a BCS of 1 is an animal that is grossly underweight and BCS 5 is an animal that is grossly overweight. Ideally animals should have a BCS of 3, which is an animal in healthy condition.

Scale training can be used with BCS to help ensure optimum condition. BCS is recorded monthly by visual assessment. Validation of BCS as a method is ongoing and opportunistic. When clinical examinations under general anaesthetic are carried out by the veterinary team accurate weights and assessment of body condition are obtained at this point, to compare and validate the visual BCS.



# Training Terminology

## Operant conditioning

Operant conditioning is a type of learning in which the likelihood of a specific behaviour is increased or decreased due to the consequence each time the behaviour is exhibited, so that the subject comes to associate the pleasure or displeasure of the consequence with the behaviour.



## Positive reinforcement

Positive reinforcement is something that the subject wants or needs, and wants more of.

Because the subject wants more of the reinforcement the behaviour is likely to be repeated in order to receive more reinforcement.

There are two types of positive reinforcement: primary and secondary.

1. Primary reinforcement is something that an animal needs to survive; it is a basic biological need e.g. food, water, space.
2. Secondary reinforcement is something that the animal wants or desires e.g. physical contact or social interaction.

## Reinforcement delivery

The delivery of the reinforcement must occur the very instant the behaviour is taking place. When reinforcement is delivered the subject is being informed precisely what behaviour they did correctly.

## The bridge

The bridge is a marker signal. It connects the behaviour to the reinforcement.

There are three types of bridge:

1. Audible
2. Visual
3. Tactile



With proper application the bridge gives us the unique ability to precisely mark the exact moment the behaviour has been successfully completed. The bridge is also used during the training process to mark the individual steps that will lead to the desired behaviour.



## Application of the bridge

The association of food (primary reinforcement) to the bridge becomes so strong that the use of the bridge alone is reinforcing to the subject. This is precisely why the bridge must be applied correctly each time it is used. The bridge always says “Yes, that behaviour is correct and reinforcement will be forthcoming”

The bridge itself must be precise as well. The bridge, whether it be audible, tactile or visual must be clearly applied.

Examples:

1. A whistle produces one short, clear sound.
2. The word “good” is said once, quickly and clearly.
3. The clicker is clicked firmly once.

The bridge usually terminates a behaviour and is therefore used at the peak of the desired behaviour.

## Discriminative stimulus or Sd

In order to distinguish between different behaviours each behaviour that is trained must have an Sd which is understood by both trainer and animal.

Discriminative stimulus (Sd) is a learned signal for a specific behaviour. It discriminates one behaviour from the other. It asks for a conditioned behaviour.

There are three types of Sd:

1. Audible
2. Visual
3. Tactile



## What is shaping?

At Twycross Zoo a formatted shaping plan template is used by all our keepers. It asks for the vital information such as:

- Species and ZIMS number of animal.
- Trainer's name.
- Location of where the training will take place.
- Tools – which tools will be required for the training (clicker, target etc.)
- Reinforcement – what is being used as reinforcement, any preferred preferences for that individual.
- Cues – what cues will be used, verbal, tactile etc.
- Behaviour – what is the behaviour being trained.
- Other information – information that may be relevant to the training e.g. history of the animal.

Keepers can use a variety of methods to shape behaviour. Twycross Zoo's training program uses operant conditioning with positive reinforcement as the primary tool. It is mandatory for the keeper to fill out a training approval and planning form in order to communicate how s/he intends to train a particular behaviour. When any method is selected it should be one that will make the most sense for that animal based on its natural history, individual history and the specifics of a particular situation.



Once this information has been collected the shaping plan can be developed. The behaviour is broken down into small steps.

The first step is to teach the bridge (if the animal doesn't already know this). Think like the animal: is it quite an inquisitive animal? Does it get spooked easily? These questions are important to help assess the composition of the steps. Callitrichids are generally timid so a behaviour such as teaching a target (which is an item to touch or follow) may have to be shaped using small steps; starting with the target in view whilst doing general husbandry duties. Then have the target in hand whilst feeding etc. this will accustom the animal much more easily, rather than introducing the target straight away in a training session which could scare the animal.

Each step is followed by bridging and reinforcing the correct behaviour. Once the animal has completed the current step it can then move on to the next step. The animal behaviour must guide the speed of progress.



Desensitising the scales during a training session



Bringing the target closer to the scales



Using the target to get the animal to go on the scales



Reading a weight





## Tools of the trade

Before beginning training you need to make sure you have the equipment to make the training session more successful. Being prepared for the training session before you start can make it more rewarding for you and your animal.



### Weighing scales

Many different types of scales can be used when training Callitrichids. However, scales which can read little/low amounts e.g. kitchen scales have to be used.



### Weighing handles/Stand

Using weighing handles/stands may allow for better results from a training session to get an individual weighed. For example, weighing handles/stands can be made easily with minimum cost by using a broom handle and a piece of wood. Velcro can also be used to secure the stand in order to prevent unnecessary movement, which could potentially startle the animal being weighed. This can be achieved by attaching it to both the weighing handle/stand and the scales themselves.





## Targets

A "target" is a tool used for Callitrichids when training, primarily to introduce the animal to the reinforcement component of operant conditioning, leading to moving the animal onto the scales. The idea of a target is for the individual to follow and touch the target when requested. Using a target will accelerate the process of getting the animal onto the scales as it gives them something to follow. A target can be made out of various materials e.g. a small bamboo cane, a stick or even a wooden spoon. However, the concept of 'touch' must be taught so that in the event the original target has to be replaced, the animal recognises the new target as the reinforcement tool.



## Training pouch

A training pouch is a good way of keeping food rewards safe while training. It also helps the animal focus on the training session as the food is hidden. Anything can be used as a training pouch as long as the food can be accessed quickly once the action has happened.

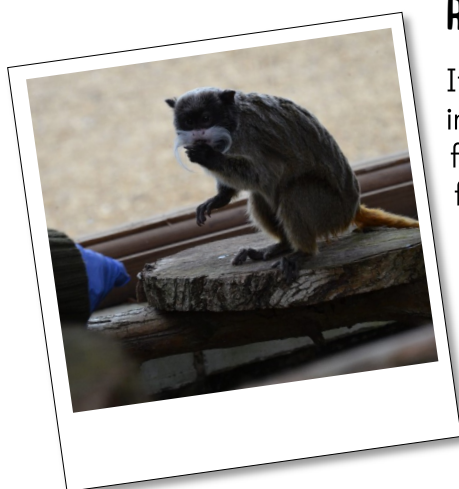

## Reinforcement food types for Callitrichids

It is important to use food items the animal will enjoy in order to improve the chances of getting the required action. The size of the food item is also important. Small food items allow the animal to eat faster, which allows for a greater chance of the behaviour being captured. However, make sure the food used is from the animal's diet and not an extra as this will help maintain the animal's weight.

### Type of food used

- Fruits.
- Dried fruits e.g. sultanas, raisins.
- Pellets.
- Live foods e.g. mealworms, wax worms.

## Recording training sessions

When training it is vitally important to record the progress of training sessions in order to monitor the various stages of the process regarding both trainer and animal. This gives a clear picture of how well both parties are progressing, whether to move onto the next training step or return to a previous step.

### The other benefits of keeping animal training records are:

- Trainers can routinely review past training records for patterns. For example, training records can be used to assess routine causes of periodic aggression or identify differences in relative success in training various behaviours. Trainers can use these past records to predict situations that may be the precursors to breakdown in trained behaviours.
- See exactly what stage the training is at.
- How long a particular behaviour has taken to train.
- See any problems with particular steps of training.

There are many ways training sessions can be recorded. Paper records are the most widely used and come in various styles and formats. Twycross Zoo has a formatted training record sheet. This allows data to be easily imputed into the animal training records section of Zoological Information Management System (ZIMS). More details of how to input this data into ZIMS can be found below.

### Training records should have the following information:

- Name of trainer.
- Animal name and local ID.
- Behaviour being trained.
- Training start date.
- Behaviour completed date.

The training record sheet should also contain a section where the animal training sessions which have been undertaken can be imputed. This should clearly show the following:

- Date
- Time
- Rating of session – always set a mutual understanding of what the ratings should be
- Any aggression shown
- Step (of the shaping plan)
- Percentage – this gives a quick and clear view of how the training is progressing with that particular step
- Comments – any comments about the session can be highlighted

It is important after each training session to complete the training records immediately as it will be fresh in your memory. Additionally by reviewing the training records before starting a new training session a specific training goal for the next training session can be identified.

The way animal training was previously recorded meant a lot of paper work on each individual animal by the keeper. ZIMS has allowed this particular process to become much easier and quicker.





# Zoological Information Management System (ZIMS)

The animal training section part of ZIMS is found by performing a basic animal search on the animal being trained and clicking on the 'More Detail' tab. This leads into a page containing a box named 'Training Information'. Clicking on this allows another tab, named 'Action', to be accessed, with the following options:

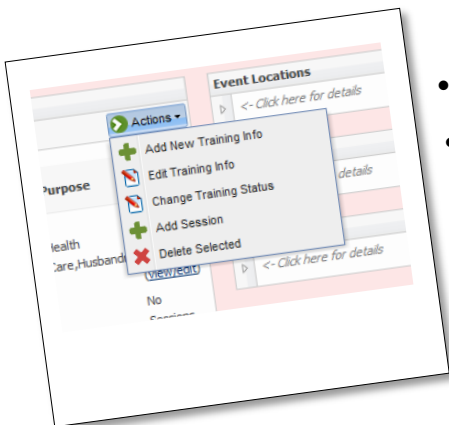
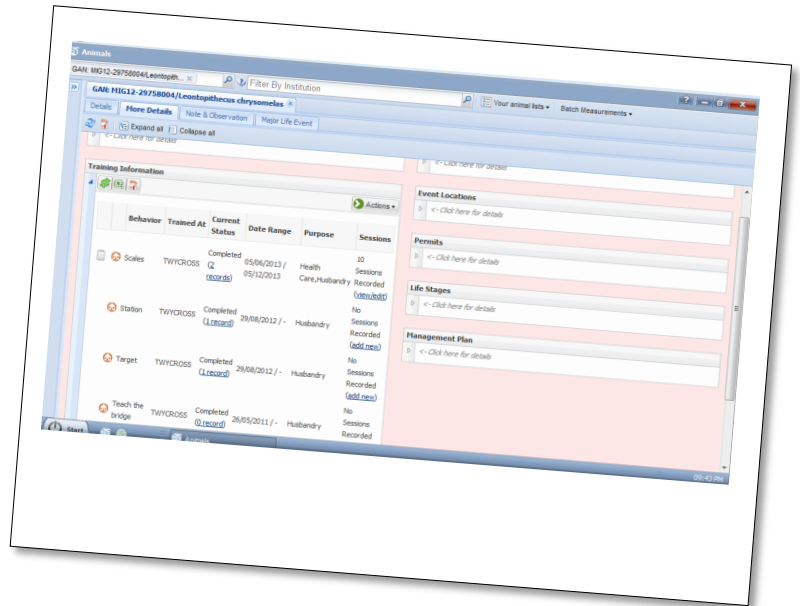

- Add new training information.
- Edit training information.
- Change training status.
- Add session.
- Remove selected.

## Add new training information:

All information regarding the training can be input into this section of ZIMS. Naming the behaviour being trained, the purpose of training, training status (whether it is complete, in progress etc.), which institute the training is being carried out, the training start and end date and a section to record any other details.

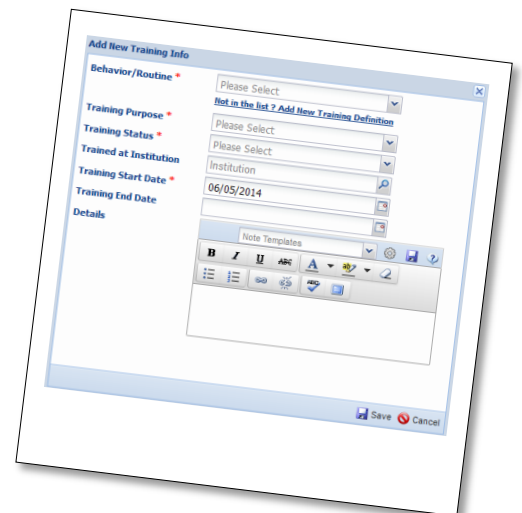



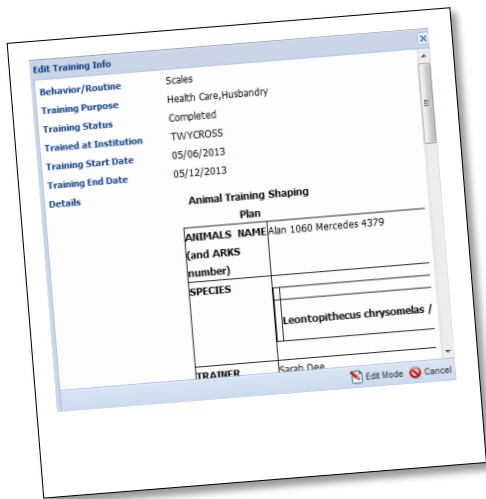

## Edit training information:

This function allows you to edit any of the information that is put in so you can change any of the training information. This is done by clicking on behaviour then applying this action.

## Change training status:

This is a quick way of just changing the training status. There are a lot of options to choose from which is very useful as sometimes training sessions can be postponed for several of reasons

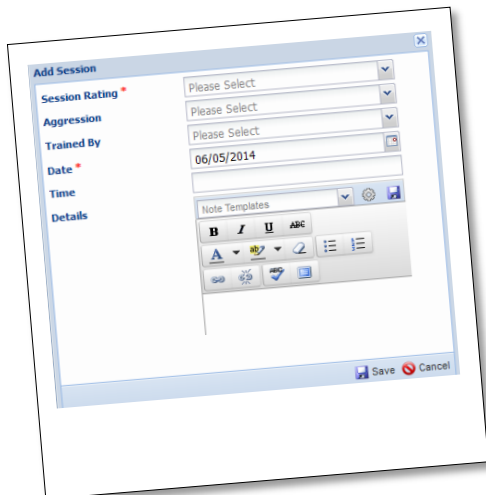
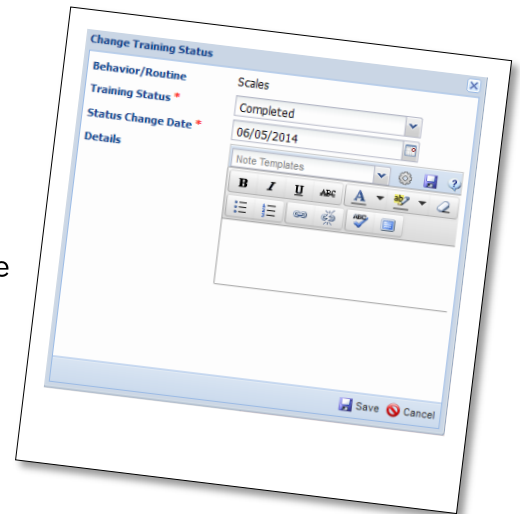

## Add session

This is where you actually record the animal training session. The details here include the session rating, aggression, trained by whom, date, time and any details.

## Future training goals

We would also like to have each individual Callitrichid touch trained, meaning they will allow various parts of their body, to be touched or physically examined to ascertain the animal's current body condition. However 'touch' training could also allow keepers to check skin or coat condition and injuries, without the need for capture and restraint.

Future training will hopefully combine touch and scale training, providing more accurate body condition scores. Visual assessment, physical examination, the animals' weight, age, size and condition will all help to validate this and will hopefully contribute to an improved reference catalogue of ideal species weights.

## **Acknowledgements**

Twycross Zoo

EAZA Callitrichid TAG

Annelise Braidley, Twycross Zoo

Katie Waller, Twycross Zoo

If you would like anymore information on Callitrichid training  
or on any other training done at Twycross Zoo please do email.

We are happy to help.



## 6.3 Appendix 3.

### Summary Table of Contraceptive Methods for Callitrichidae



# Primates: *Callitrichidae*

Contraceptive methods:	GnRH agonist (implant)	GnRH agonist (injection)	Progestagen (implants)	Progestagen (implant)	Progestagen (injection)	Progestagen (injection)	Surgical/ Permanent
<b>Contraceptive Product:</b>	Deslorelin acetate	Leuprolide acetate	Etonogestrel 68 mg	Levonorgestrel 2x 75mg	Medroxyprogesterone acetate	proligestrone 100mg/ml	N/A
<b>Commercial Name:</b>	Suprelorin ®	Lupron ®	Implanon® Nexplanon®	Jadelle®	Depo-Provera®, Depo-Progevera®	Delvosteron®	Vasectomy
<b>Product Availability</b>	4.7mg ('Suprelorin 6') and 9.4 mg ('Suprelorin 12') widely available through veterinary drug distributors in the EU.	Leuprolide acetate licenced for human use	Manufactured by Organon. Available through human drug distributors	Manufactured by Bayer Schering Pharma AG. Available through human drug distributors	Manufactured by Pfizer. Widely available throughout Europe through human drug distributors.	Manufactured by MSD animal Health UK, Intervet Europe. Licensed for use in female dogs, cats, and ferrets; available through veterinary distributors.	N/A
<b>Restrictions and/or permit required by Importing Country:</b>	The EAZA RMG recommends: always check with your local licencing authority	Data deficient	The EAZA RMG recommends: always check with your local licencing authority	The EAZA RMG recommends: always check with your local licencing authority	The EAZA RMG recommends: always check with your local licencing authority	The EAZA RMG recommends: always check with your local licencing authority	N/A
<b>Mechanism of action:</b>	GnRH agonist suppress the reproductive endocrine system, preventing production of pituitary and gonadal hormones. As an agonist of the GnRH initially stimulates the reproductive system -which can result in oestrus and ovulation in females or temporary enhancement of testosterone and spermatogenesis in males- therefore additional contraception needed during this time. Please see below and refer to Deslorelin datasheet for detailed information	GnRH agonist suppress the reproductive endocrine system, preventing production of pituitary and gonadal hormones	Interference with fertilization by thickening cervical mucus, interrupting gamete transport, disruption of implantation, inhibition of LH surge necessary for ovulation	Interference with fertilization by thickening cervical mucus, interrupting gamete transport, disruption of implantation, inhibition of LH surge necessary for ovulation	Anti-estrogenic activity. Interference with fertilization by thickening cervical mucus, interrupting gamete transport, disruption of implantation, inhibition of LH surge necessary for ovulation	Anti-estrogenic activity. Interference with fertilization by thickening cervical mucus, interrupting gamete transport, disruption of implantation, inhibition of LH surge necessary for ovulation	Surgical procedure in which the ductus deferens are cut, tied, cauterized, or otherwise interrupted
<b>Insertion/Placement:</b>	Subcutaneous, in a place where it can be easily detected or seen for removal at a later date (i.e. Upper inner arm); refer Suprelorin fact sheet for effective method of implant placement (tunnelisation)	Injectable	Subcutaneous. The EAZA RMG recommends subcutaneous, upper inner arm for visibility (aid for later removal)	Subcutaneous. The EAZA RMG recommends subcutaneous, upper inner arm for visibility (aid for later removal)	Injectable intramuscular	Injectable subcutaneously - do not inject intradermally or into subcutaneous fat or scar tissue	Surgical
<b>Females</b>		<b>Data deficient</b>					
<b>Dose</b>	1 x 4.7 mg or 1 x 9.4 mg implant is recommended in callitrichids <b>DO NOT CUT IMPLANT</b>	Dosing information is not available; extrapolation from human literature is likely the best place to start	Recommended 1/3 to 1/4 implant, depending on species and weight; but never less than 1/4.	Recommended 1/2 rod, depending on species and weight. Doses not well established	MPA can have a variable length of duration and, like in the other progestagens, a much higher dose is needed than in Afro-Eurasian primates for efficacy: 20mg/kg body weight of Depo-Provera is effective for approximately 30 days. For these reasons MPA is only advisable as a short term contraceptive to suppress post-partum oestrus	A dose of 50 mg/kg of Delvosteron has been used in a collection for short term contraception being effective for approximately 3 months. This drug is only advisable as a short term contraceptive e.g. to suppress post-partum oestrus, introduction of newly vasectomised male. Repeated use not advised.	N/A
<b>Latency to effectiveness:</b>	3 weeks average - additional contraception needed during this time ( <b>PLEASE see product data sheet</b> ) to suppress the stimulation phase. In callitrichids 5mg megestrol acetate pills (Megace) have been used daily 7 days before and 7 days after implant has been placed	Same as deslorelin with an initial stimulation phase and suppression should then occur 3-4 weeks later (please refer to deslorelin and lupron datasheet for more details)	In general inhibition of ovulation after 1 day when inserted on day 1-5 of cycle or when replacing oral progestogen. As the right stage during oestrus cycle is often unknown, it is advised to separate the sexes for at least 7-14 days after insertion of the implant.	In general inhibition of ovulation after 1 day when inserted on day 1-5 of cycle or when replacing oral progestogen. As the right stage during the oestrus cycle is often unknown, it is advised to separate the sexes for at least 7-14 days after insertion of the implant.	1-3 days post injection. However, if the cycle stage is not known then extra time must be allowed; therefore, separation of the sexes should be used for at least 1 week. Depo-Provera injection can be used to prevent the post-partum oestrus until a suitable longer term implant can be placed or as longer term contraception.	1-3 days post injection. However, if the cycle stage is not known then extra time must be allowed; therefore, separation of the sexes should be used for at least 1 week. Delvosteron injection can be used to prevent the post-partum oestrus until a suitable longer term implant can be placed or as longer term contraception.	N/A
<b>Oestrus cycles during contraceptive treatment:</b>	Initial oestrus and ovulation (during the 3 weeks of stimulation) then no oestrus cycle. To suppress the initial oestrus and ovulation you can follow the megestrol acetate protocol mentioned above.	Same as deslorelin.	Oestrus is inhibited.	Oestrus is inhibited.	Oestrus behaviour may be observed.	Oestrus behaviour may be observed. Ovulation and cycling can occur in adequately contracepted individuals (but is unlikely and the degree of suppression is dose dependent).	N/A
<b>Use during pregnancy:</b>	<b>Not recommended</b>	<b>Not recommended</b>	In non-human interference with parturition has not been observed.	In non-human primates progestagens normally do not interfere with parturition.	In non-human primates progestagens normally do not interfere with parturition.	In non-human primates progestagens normally do not interfere with parturition.	N/A
<b>Use during lactation:</b>	No contraindications once lactation established	No contraindications once lactation established	Considered safe for nursing; Does not affect lactation, but etonogestrel is excreted in milk.	Considered safe for nursing infant.	Considered safe for nursing infant.	Considered safe for nursing infant.	N/A
<b>Use in prepubertals or juveniles:</b>	<b>Data deficient</b> in this group, see product information sheet. Possible long-term effects on fertility are not known therefore use in prepubertal individuals should be carefully evaluated.	<b>Data deficient</b> in this group, see product information sheet	The use of synthetic progestagens in prepubertals or juveniles has not been fully assessed. Possible long-term effects on fertility are not known therefore use in prepubertal individuals should be carefully evaluated.	The use of synthetic progestagens in prepubertals or juveniles has not been fully assessed. Possible long-term effects on fertility are not known therefore use in prepubertal individuals should be carefully evaluated.	The use of synthetic progestagens in prepubertals or juveniles has not been fully assessed. Possible long-term effects on fertility are not known therefore use in prepubertal individuals should be carefully evaluated.	The use of synthetic progestagens in prepubertals or juveniles has not been fully assessed. Possible long-term effects on fertility are not known therefore use in prepubertal individuals should be carefully evaluated.	N/A
<b>Duration</b>	Duration of efficacy has not been well established as a guide: 4.7 mg implants will suppress for a <b>minimum</b> of 6 months; 9.4mg will be effective for a <b>minimum</b> of 12months. In general, duration of effect is longer than the minimum stated.	Not well established, duration of effect being likely related to the dose. Higher doses result in longer duration of effect. This is extremely <b>data deficient</b>	2-3 years in various primates	2-3 years in various primates	Dose dependant: 30 days in general. However, effects could last 1-2 years in some individuals.		N/A



Reversibility	Considered reversible but every species has not been tested, duration to reversibility extremely variable with some females giving birth to offspring between 6 months to 5 years after estimated implant expiry. We have a reversal rate of 41%. Implants were removed in 50% of cases. Removal of implant to aid reversibility is recommended.	Considered reversible but every species has not been tested. duration to reversibility extremely variable.	Designed to be fully reversible but individual variation can occur. To increase potential for full reversibility implants must be removed. A recent study has demonstrated that if implants are removed, 83% of marmosets reversed within 5-12.5 months <sup>8</sup> . We have various records of reversal in callitrichids, with time to birth ranging between 5-7 months after the estimated implant expiry. In most cases it is unknown whether implants were removed.	Designed to be fully reversible but individual variation can occur. To increase potential for full reversibility implants must be removed.	Designed to be fully reversible but individual variation can occur. Our records demonstrate a 95% reversal rate in females allowed to breed following Depo-Provera with many conceiving immediately following the estimated contraception expiry date.	Designed to be fully reversible but individual variation can occur	N/A
Effects on Behaviour	None observed except lack of libido. There are anecdotal reports of change of hierarchy with the behavioural implications that this may have	Same as deslorelin	Effects on behaviour have not been studied, every individual may react differently. Because progestagens can suppress ovulation it can be expected that courtship and mating behaviour will be affected in some way. Further research in the subject is necessary.	Effects on behaviour have not been studied, every individual may react differently. Because progestagens can suppress ovulation it can be expected that courtship and mating behaviour will be affected in some way. At high doses can have masculinising effect. Further research in the subject is necessary.	Effects on behaviour have not been studied, every individual may react differently as it binds readily to androgen receptors and is antiestrogenic, females may experience male-like qualities (increased aggression, development of male secondary sex characteristics, etc.) Further research in the subject is necessary.		N/A
Effects on sexual physical characteristics	Similar to gonadectomy		Some signs of oestrus behaviour might occur. Ovulation may also occur even though pregnancy does not ensue.	Some signs of oestrus behaviour might occur. Ovulation may also occur even though pregnancy does not ensue.	See above	See above	N/A
Males	Data deficient	Data deficient see comment for deslorelin	Not Recommended	Not Recommended	Not Recommended	Not Recommended	Reported
Dose	1 x 4.7 mg or 1 x 9.4 mg implant is recommended in callitrichids	Usually a higher dose than in females are required in males. Data deficient	N/A	N/A	N/A	N/A	N/A
Latency to effectiveness:	Depending on the species there may be fertile sperm present in vas deferens for 6-8 weeks post treatment or even longer. Testosterone decreases after 3-4 weeks but sperm can stay fertile for many weeks after. Libido will decrease with decreasing testosterone concentrations therefore the risk of pregnancy decreases. Additional contraception in females is needed during this time or you should separate the sexes	Depending on the species there may be fertile sperm present in vas deferens for 6-8 weeks post treatment or even longer. Testosterone decreases after 3-4 weeks but sperm can stay fertile for many weeks after. Libido will decrease with decreasing testosterone concentrations therefore the risk of pregnancy decreases. Additional contraception in females is needed during this time or you should separate the sexes	N/A	N/A	N/A	N/A	Depending on species and individual, perhaps as long as 2 months or more
Use in prepubertals or juveniles:	Data deficient in this group, see product information sheet	Data deficient in this group, see product information sheet	N/A	N/A	N/A	N/A	Data deficient
Duration and Reversibility	Reversibility has been demonstrated in <i>Callithrix</i> and <i>Callimico</i> sp. within 1 year of implant expiry.	No data yet but deslorelin is considered reversible. Data deficient in this group, see product information sheet.	N/A	N/A	N/A	N/A	The procedure should not be used in males likely to be recommended for subsequent breeding as reversal is unlikely
Effects on Behaviour	Testosterone related aggression is likely to decrease. Data deficient in this group, see product information sheet.	Testosterone related aggression is likely to decrease. Data deficient in this group, see product information sheet.	N/A	N/A	N/A	N/A	Vasectomy will not affect androgen-dependant behaviours
Effects on sexual physical characteristics	Decrease in body size, feminisation of males.	Decrease in body size, feminisation of males.	N/A	N/A	N/A	N/A	None observed in non-human primates
<b>General:</b>							
Side effects	Similar to gonadectomy; especially weight gain	Similar to gonadectomy; especially weight gain	Possible weight gain. The EAZA RMG recommends always reading the manufacturer's data sheet	Possible weight gain. At high doses can have masculinising effect. The EAZA RMG recommends always reading the manufacturer's data sheet	Long term use is not recommended since it can have possible deleterious effects on the uterus and mammary tissue. We have anecdotal evidence of one female who developed endometrial hyperplasia after a single injection. Progestins are likely to cause weight gain in all species. In the human literature, Depo-Provera® has been linked to mood changes. Because it binds readily to androgen receptors and is antiestrogenic, females may experience male-like qualities (increased aggression, development of male secondary sex characteristics, etc.). The EAZA RMG recommends always reading the manufacturer's data sheet	Possible weight gain. The EAZA RMG recommends always reading the manufacturer's data sheet	N/A
Warnings	Causes initial gonadal stimulation; correct administration essential - see product information sheet	Causes initial gonadal stimulation	Interaction with other drugs are known to occur and may influence protection against pregnancy. In some diabetic animals progestagens has led to an increased insulin requirement. For this reason, progestagens are contraindicated in diabetes or not recommended. The EAZA RMG recommends always reading the manufacturer's data sheet.	Interaction with other drugs are known to occur and may influence protection against pregnancy. In some diabetic animals progestagens has led to an increased insulin requirement. For this reason, progestagens are contraindicated in diabetes or not recommended. The EAZA RMG recommends always reading the manufacturer's data sheet.	We have anecdotal evidence of one female who developed endometrial hyperplasia after a single injection. Interaction with other drugs are known to occur and may influence protection against pregnancy. In some diabetic animals progestagens has led to an increased insulin requirement. For this reason, progestagens are contraindicated in diabetes or not recommended. The EAZA RMG recommends always reading the manufacturer's data sheet.	Interaction with other drugs are known to occur and may influence protection against pregnancy. The EAZA RMG recommends always reading the manufacturer's data sheet.	Infection of the surgical wound might occur. Intradermal closure of the skin is advised together with prophylactic antibiotic treatment and NSAID

Reporting Requirements: In order to increase our knowledge of the efficacy of contraception methods in the Callitrichidae family it is recommended that all individuals on contraception be reported to the EAZA RMG

**References:**

- 1) Callitrichid Husbandry Guidelines
- 2) Noah Compendium of data sheets - Delvosteron - <http://www.noahcompendium.co.uk>
- 3) Asa, C.S. & Porton, I.J. (eds.) (2005) Wildlife Contraception: Issues, Methods, and Applications. The Johns Hopkins University press: Baltimore.
- 4) Murnane, R. D., Zdziarski, J. M., Walsh, T. F., Kinsel, M. J., Meehan, T. P., Kovarik, P., ... & Phillips Jr, L. G. (1996). Melengestrol acetate-induced exuberant endometrial decidualization in Goeldi's marmosets (*Callimico goeldii*) and squirrel monkeys (*Saimiri sciureus*). *Journal of Zoo and Wildlife Medicine*, 315-324.



- 5) Wood, C., Ballou, J. D., & Houle, C. S. (2001). Restoration of reproductive potential following expiration or removal of melengestrol acetate contraceptive implants in golden lion tamarins (*Leontopithecus rosalia*). *Journal of Zoo and Wildlife Medicine*, 32(4), 417-425.
- 6) Mustoe, A. C., Jensen, H. A., & French, J. A. (2012). Describing ovarian cycles, pregnancy characteristics, and the use of contraception in female white-faced marmosets, *Callithrix geoffroyi*. *American Journal of Primatology*, 74(11), 1044-1053.
- 7) Wheaton, C. J., Savage, A., Shukla, A., Neiffer, D., Qu, W., Sun, Y., & Lasley, B. L. (2011). The use of long acting subcutaneous levonorgestrel (LNG) gel depot as an effective contraceptive option for cotton-top tamarins (*Saguinus oedipus*). *Zoo Biology*, 30(5), 498-522.
- 8) Roubos, S., Louwerse, A. L., Langermans, J. A., & Bakker, J. (2021). Retrospective Analysis of the Effectiveness and Reversibility of Long-Acting Contraception Etonogestrel (Implanon®) in Common Marmosets (*Callithrix jacchus*). *Animals*, 11(4), 963.

**Disclaimer:** The EAZA RMG endeavours to provide correct and current information on contraception from various sources. As these are prescription only medicines it is the responsibility of the veterinarian to determine the dosage and best treatment for an individual