

*Proceedings of the International Symposium on:*

# **TROPICAL PEAT LANDS**

*Bogor, Indonesia, 22-24 November 1999*

*Editors:*

**Toshio IWAKUMA**

**Takashi INOUE**

**Takashi KOHYAMA**

**Mitsuru OSAKI**

**Herwint SIMBOLON**

**Harukuni TACHIBANA**

**Hidenori TAKAHASHI**

**Noriyuki TANAKA**

**Kazuo YABE**

**March 2000**

**Graduate School of Environmental Earth Science  
Hokkaido University, Sapporo and  
Research and Development Center for Biology,  
The Indonesian Institute of Sciences, Bogor**

## Contents

|   |     |
|---|-----|
| Foreword  | i   |
| Preface   | iii |
| <b>Part 1. Peat Science</b>   |     |
| 1- 1 Analyses of the second layer of peat swamp<br>Seiichi Tokura, Sawahiko Shimada, Hiroshi Tamura, Hidenori Takahashi and<br>Norio Nishi  | 3   |
| 1- 2 The estimation of carbon resource in a tropical peatland: A case study in Central<br>Kalimantan, Indonesia<br>Sawahiko Shimada, Hidenori Takahashi, Masami Kaneko and<br>Akira Haraguchi                               | 9   |
| 1- 3 Preliminary study on geomorphology in the Central Kalimantan Plain with special<br>reference to the tropical peat formation<br>Kazoumi Hirakawa and Yoshiomi Kurashige   | 19  |
| 1- 4 Chemical compounds in gas emitted from tropical peat soil with burning with and<br>without oxygen<br>Masanori Okazaki, Chu-ichi Watanabe, Masato Yoshikawa,<br>Chihiro Yamaguchi and Norio Yoshimura                   | 27  |
| 1- 5 Some characteristics of tropical podzols in Kalimantan<br>M. Djuwansah   | 33  |
| <b>Part 2. Soil Sciences</b>  |     |
| 2-1 Chemical properties of peat pore water in Central Kalimantan with special<br>reference to vertical profile<br>Akira Haraguchi, Sawahiko Shimada, Suwarno, Midori Akioka,<br>Kazuo Yabe and Hidenori Takahashi           | 41  |
| 2-2 Boron contents of tropical peat soils in Southeast Asia<br>Koyo Yonebayashi and Hidekazu Yamada   | 49  |
| 2-3 Microbial biomass in tropical peat soil<br>Kazuyuki Inubushi and Abdul Hadi   | 55  |
| 2-4 Survey of peat soils in Sebangau-Kahayan water-catchment, Central Kalimantan<br>for laccase producing fungi and their organic decomposing ability<br>Typuk Artiningsih, Sehat Jaya Tuah, Edi Mirwanto and Mitsuru Osaki | 61  |
| 2-5 Microbial population and greenhouse gases formation in tropical peatlands under<br>different land uses<br>Abdul Hadi and Kazuyuki Inubushi  | 69  |
| 2-6 Aspect and mechanism of peat fire in tropical peatland: A case study in Central<br>Kalimantan, 1997<br>Aswin Usup, Suwido H. Limin and Hidenori Takahashi   | 79  |
| 2-7 Characterization and population of nitrogen-fixing bacteria from peat soil in<br>Kahayan water-catchment, Central Kalimantan<br>Sri Purwaningsih, Typuk Artiningsih, and Mitsuru Osaki                                  | 89  |
| 2-8 Measurement of water potential in plant and soil by the electric capacitance method<br>Yoshio Kano  | 93  |



### Part 3. Agriculture and Environment

|     |   |     |
|-----|---|-----|
| 3-1 | Biological clean-up of biomass wastes using sawdust and an artificial soil matrix<br>Minoru Terazawa  | 101 |
| 3-2 | Whole aspect on nature and management of peat swamp forest in Thailand<br>Tanit Nuyim   | 109 |
| 3-3 | Management practices for sustainable cultivation of crop plants on tropical peatland<br>Kamarudin Ambak and Lulie Melling   | 119 |
| 3-4 | Utilization of inland peat for food crop commodity development requires high input and is detrimental to peat swamp forest ecosystem<br>Suwido H. Limin, Layuniati and Yahya M. Jamal | 135 |
| 3-5 | Discussion on rural development of peat swamp area of Central Kalimantan from hydrological aspect<br>Takashi Inoue  | 145 |

### Part 4. Forest Ecosystem

|      |   |     |
|------|---|-----|
| 4-1  | Floristic composition of peat swamp forest in Mensemat-Sambas, West Kalimantan<br>Mustaid Siregar and Edy Nasriadi Sambas   | 153 |
| 4-2  | Preliminary study on growth, mortality and recruitment of tree species in peat swamp forest at Tanjung Puting National Park, Central Kalimantan<br>Edy Mirwanto and Ruddy Polosakan   | 165 |
| 4-3  | Preliminary study on the water relations of tropical peat land plants<br>Beth Paul Naiola and Mitsuru Osaki   | 173 |
| 4-4  | Checklist of plant species in the peat swamp forests of Central Kalimantan, Indonesia<br>Herwint Simbolon and Edi Mirwanto  | 179 |
| 4-5  | Plants diversity of peat swamp forest in Riau Province, Sumatra<br>Johanis P. Moge and M. Mansur  | 191 |
| 4-6  | Initial phase of secondary succession in the exploited peat swamp forest ( <i>Shorea albida</i> ) at Sungai Damit, Belait in Brunei Darussalam<br>Shigeo Kobayashi  | 205 |
| 4-7  | Proposed methodology on determination of photosynthetic capacity of peatland vegetation: soybean as a study case<br>Tania June and Mitsuru Osaki  | 215 |
| 4-8  | Litter decomposition process in two contrastive nutrient limited forest types in Central Kalimantan<br>Joeni S. Rahajoe, Takashi Kohyama and Suwido H. Limin  | 223 |
| 4-9  | Study on leaf element concentrations of some dominant tree species grown in peat swamp forest, Central Kalimantan<br>Sehat Jaya Tuah, Mitsuru Osaki and Suwido H. Limin   | 233 |
| 4-10 | Nitrogen and carbon cycles of peat swamp forests and surrounding areas in Narathiwat, Thailand, Inferred from $\delta^{13}\text{C}$ and $\delta^{15}\text{N}$ analyses<br>Takeshi Matsubara, Narin Boontanon, Shingo Ueda, Proespichaya Kanatharana and Eitaro Wada | 245 |
| 4-11 | Mangrove litter-fall studies at the PT Freefort Indonesia project area<br>Cecep Kusmana, Pratita Puradyatmika, Yahya A. Husin, Gerry Shea and Darrel Martindale   | 255 |

|      |  |     |
|------|--|-----|
| 4-12 | Vegetation analysis of Suaq Balimbing peat swamp forest, Gunung Leuser National Park-South Aceh<br>Purwaningsih and Razali Yusuf                   | 275 |
| 4-13 | Primary production of a heath (kerangas) forest in Lahei, Central Kalimantan<br>Kazuki Miyamoto, Takashi Kohyama, Eizi Suzuki and Herwint Simbolon | 283 |

## Part 5. Peatland and Technology

|     |  |     |
|-----|--|-----|
| 5-1 | Photosynthetically active radiation transmittance within alder ( <i>Alnus japonica</i> Steud) stand in Kushiro Mire<br>Bismart Ferry Ibie and Hidenori Takahashi   | 291 |
| 5-2 | Water balance of a peat swamp forest in the upper catchment of the Sebangau River, Central Kalimantan, Indonesia<br>Masayuki Kayama, Hidenori Takahashi and Suwido H. Limin  | 299 |
| 5-3 | Polycyclic aromatic hydrocarbon (PAHs) in Central Kalimantan<br>Nori Tanaka, Siwat Pongpiajun, Shuniz Tanaka and Toshio Iwakuma  | 307 |
| 5-4 | River and peatland technology in the Sebangau River basin<br>Tadaoki Itakura, Harukuni Tachibana, Hidenori Takahashi,<br>Mitsuhiko Kamiya, Koken Utozawa, Nyoman Sumawijaya, Inga Torang,<br>Untung Darung, Suwido H. Limin and Suprihanto Notodarmojo | 315 |
| 5-5 | The effects of environmental factors on diurnal changes of ground water table in a tropical peat swamp forest<br>Hidenori Takahashi, Masayuki Kayama and Suwido H. Limin   | 321 |
| 5-6 | Application of remote sensing and GIS to monitor peatland multi-temporal in Central Kalimantan<br>H.-D.V. Boehm and F. Siegert   | 329 |
| 5-7 | Infiltration test on the Palangkaraya peat<br>Nyoman Sumawijaya  | 349 |

## Part 6. Aquatic Environment

|     |  |     |
|-----|--|-----|
| 6-1 | Ground water recharge in Central Kalimantan deducted from isotopic hydrology<br>Nori Tanaka, Siwat Pongpiajun and Toshio Iwakuma   | 359 |
| 6-2 | Surface water quality in Central Kalimantan, Indonesia<br>Masaaki Kurasaki, Dede I. Hartoto, Takeshi Saito, Mika Suzuki-Kurasaki<br>and Toshio Iwakuma                           | 367 |
| 6-3 | Relationship of water level to water quality in an oxbow lake of Central Kalimantan<br>Dede I. Hartoto   | 375 |
| 6-4 | Limnological characteristics of Lake Rengas fishery reserve in Central Kalimantan<br>Awalina and Dede Irving Hartoto   | 387 |
| 6-5 | Distribution of Phytoplankton in some oxbow lakes of Central Kalimantan<br>Sulastri and Dede I. Hartoto  | 397 |
| 6-6 | Seasonal changes of phytoplankton species in relation to environmental factors in an oxbow lake of Central Kalimantan, Indonesia<br>Kumiko Kusakabe, Toshio Iwakuma and Sulastri | 413 |

|      |  |     |
|------|--|-----|
| 6-7  | Effect of artificial mixing of surface and bottom waters and lime treatment on the abundance and primary productivity of phytoplankton in Lake Sabuah<br>Ardianor, Enan M. Adiwilaga, Hefni Effendi and Fifi Widjaya | 423 |
| 6-8  | Turnover rate of aquatic macrophytes in the irrigation ponds around Lake Shinji and Lake Nakaumi, Japan<br>Hiedenobu Kunii   | 437 |
| 6-9  | A Preliminary study on the dynamics of zooplankton community in two humic lakes of Central Kalimantan<br>Sulmin Gumiri, Abdul Hafid, Toshio Iwakuma, Ryo Komatsu and Kumiko Kusakabe                                 | 443 |
| 6-10 | Diel and seasonal feeding activities of fishes in an oxbow lake of Central Kalimantan, Indonesia<br>Ryo Komatsu, Sulmin Gumiri, Dede Irving Hartoto and Toshio Iwakuma   | 455 |
| 6-11 | Concept for developing sustainable local fish resource in Central Kalimantan<br>Matling Torang and Tariono Buchar  | 471 |

## **Part 7. Human Dimensions**

|     |   |     |
|-----|---|-----|
| 7-1 | Role of peat forest in the Banjarese traditional land management (BTLM) system<br>Budi Mulyanto, Basuki Sumawinata, Suwardi and Gunawan Djajakirana   | 483 |
| 7-2 | The massive exploitation of peat swamp forest potentiality has not successfully increased the local people's prosperity in Central Kalimantan<br>Suwido H. Limin and Patricia Erosa Putri                         | 491 |
| 7-3 | Rehabilitation of devastated peat lands and establishment of sustainable agro-systems through buffer zone planning in Central Kalimantan<br>Mitsuru Osaki, Hanny Wijaya, Suwido Hester Limin and Herwint Simbolon | 499 |
| 7-4 | Livelihood role of inland floodplain ecosystem for local community related to fisheries commodity: A review<br>Uras Tantulo Palis   | 503 |
| 7-5 | Socio-economic values of wetlands for Dayak community in Central Kalimantan<br>Tampung N. Saman and Suwido H. Limin   | 515 |
| 7-6 | Problems of developing ruminants livestock in inland peat of Central Kalimantan<br>Robertho Imanuel Aden  | 529 |

## **Appendix**

|                      |     |
|----------------------|-----|
| List of participants | 535 |
|----------------------|-----|

## Foreword

Tropical peatland is one of the seriously endangered ecosystems on the earth, which currently is facing serious consequence of climate and developmental perturbation. The needs for better management and sustainable development mandate detailed study of the ecosystems from many aspects. The JSPS (Japan Society for the Promotion of Science)-LIPI (Indonesian Institute of Sciences) Core University Program entitled "Environmental Management of Tropical Wetland Ecosystem in Southeast Asia" (1997-2006) was established in 1997 for filling up the needs.

During the past 3 years basic knowledge on tropical peatlands have been accumulated to a greater extent both within the first 3-years' collaboration within this program and the research conducted by various other projects. We organized an International Symposium on Tropical Peatland Management (TROPEAT99) for the purpose of discussing results of the studies conducted under the program, and also gathering and exchanging any other information related to tropical peatland ecosystems obtained from other studies. The symposium was also designed to clarify the main issues to be addressed and future directions in tropical peatland management.

The two-day symposium was very successful resulting in more than 60 presentations and hot discussion. The exchange of knowledge must have enhanced the progress of the science on tropical peatlands and the ecosystems in their watershed areas. We believe that the present volume which contains state-of-the-art of the tropical peatland science is useful for scientists, students and also policy makers and will promote the collaboration in the future.

**Norio NISHI**  
Dean,  
Graduate School of  
Environmental Earth Science  
Hokkaido University

**Arie BUDIMAN**  
Director,  
Research and Development Center for  
Biology  
Indonesian Institute of Sciences

## Preface

The knowledge on wetlands has been improved year by year with the growing global concern on the importance of the ecosystem in maintaining biodiversity and climate both locally and globally since the international conventions on wetlands in 1970s (the Ramsar Convention) and on biodiversity in 1990s. However the ecosystems of tropical wetlands are still far less understood in comparison with the temperate wetlands. The rate of deforestation in tropical peatlands, which highly depends on the economic pressure, is accelerating and it urges us further to accumulate our knowledge on the wetlands for developing the proper conservation strategy.

The purpose of the International Symposium on Tropical Peatlands (TROPEAT99) held at Ciloto, Bogor, Indonesia during 22-23 November 1999 was to meet the needs. The number of contributors was, to our excitement, larger than our expectation, so that the meeting was held in parallel oral sessions and a poster session. About 170 participants attended from Japan, Indonesia, Malaysia, Thailand and Germany to present the most up-to-date knowledge on science of tropical peatlands to address the issues on conservation and management of the area.

This volume consists of 7 parts. Part 1 ("Peat science", 5 papers) deals with the physico-chemical properties and geomorphological background of the formation of peat in Southeast Asia. In Part 2 ("Soil science", 8 papers), biochemical and microbial processes in the tropical soil systems are discussed. Chemical properties in the peat pore water and a new methodology for obtaining water potential are presented. In Part 3 ("Agriculture and environment", 5 papers), various strategies of peatland management are presented from the experiences in Thailand, Malaysia, Indonesia and Japan. A total of 13 papers are compiled in part 4 ("Forest ecosystem"), covering the topics of natural vegetation, plant succession in exploited area, photosynthesis, litter-fall and its decomposition, elemental composition of leaf and nitrogen and carbon cycles within a peat swamp forest, and a heath forest. In Part 5 ("Peatland and technology", 7 papers), meteorological and hydrological properties are discussed based on the in situ monitoring and the infiltration test in Central Kalimantan. Examples of applying satellite imagery and GIS are also demonstrated in analyzing the vegetation change caused by deforestation and land fire events. In Part 6 ("Aquatic environment", 11 papers), physico-chemical properties and biological features, i.e., phytoplankton, zooplankton and fish, are examined in relation to the drastic change in water level in humic oxbow lakes. Other topics are the application of stable isotope to the study on groundwater hydrology in Kalimantan and the turnover of aquatic macrophytes in irrigation ponds in Japan. This symposium also featured the topics of "Human dimensions", which makes it unique in this kind of symposium. Six papers on the topics appear in Part 7. The traditional methods of exploitation and management of peat swamp forests are re-evaluated and put in contrast with the modern massive exploitation. Several study plans are presented to establish a buffer zone between natural and exploited areas and to utilize peatland systems for fisheries and to raise livestock. Forest or land fire occurs frequently in tropical peatlands, causing a severe health problem in ENSO years such as in 1997. Several papers report how the fire spread over the peat soil (Part 2), chemical compounds emitted from burning peat (Part 1) and the fate of polyaromatic hydrocarbons in the presence of humic substances in the field (Part 5).

In the present volume tropical peatland ecosystems are examined from various angles combining the hottest issues in environmental sciences. Many studies are conducted in close connection to each other at the same locations of Kalimantan in the same period, which indeed made this volume comprehensive. However, the most startling feature of the volume is its inclusion of the important papers conducted outside this region. With these contributions, it has been made possible to present comparative and universal scientific outcome on tropical peatlands.

Sapporo  
March 2000  
**Editors**

**Part 1**  
**Peat Science**

## **Analyses of the Second Layer of Peat Swamp**

**Seiichi TOKURA<sup>1</sup>, Sawahiko SHIMADA<sup>2</sup>, Hiroshi TAMURA<sup>1</sup>,  
Hidenori TAKAHASHI<sup>2</sup> and Norio NISHI<sup>3</sup>**

<sup>1</sup> Faculty of Engineering, Kansai University, Suita, Osaka 564-8680, Japan

<sup>2</sup> Division of Geo-Science, Graduate School of Environmental Earth Science,

<sup>3</sup> Division of Bio-Science, Graduate School of Environmental Earth Science,  
Hokkaido University, Sapporo 060-0810, Japan

### **Abstract**

A purity of silica has been found as a second layer of peat swamp and a few grains of titanium have also found in silica layer as a contaminant. Contaminated several minerals were washed out by a couple of simple rinse with water and resulted silica was applied for X-ray fluorescence analysis to be almost complete silicon (100 w% for silica and 99.88 w% for oxygen). The titanium grain contains 4.13w% of silicon, 54.65w% of titanium and 41.22w% of oxygen. As titanium grain is unable to remove from silica grains unlikely other contaminants and heavier metal than silicon, we can expect to find the higher titanium content in lower layer of silica.

### **Introduction**

Peat swamp has been investigated to convert for the rice paddy in Indonesia to meet for shortage of rice. There are various problems on the conversion of peat land to rice paddy such as lack of weather data through the year, hardness to maintain environmental conditions after the conversion, basic information of composition of peat swamp etc. The preservation of water is the most important problem for the growth of rice plant in the peat swamp, because it is hard to retain the water due to the network composition by fine woods like a filter paper. A large volume of clay or soil is almost impossible to supply to block the water permeation through network of peat land due to geological composition of land, though mud is effective to preserve the water in peat swamp.

Although so many disadvantages were proposed on the peat land fire such as serious influence on the lung function due to aerosol from peat land fire, Prof. T. Kohyama has found the reservation of water around the fire point in peat swamp. This observation gave the useful suggestions to use the sand from second layer of peat swamp on the preservation of water on peat swamp, since the sand tended to become fine particle following to heat treatment around 1,000°C for 1 hour.

The second layer of peat swamp was collected to analyze its contents around Palangka Raya, Central Kalimantan, Indonesia. The second layer of peat swamp brown color around Palangka Raya and became to white following to several rinses by water. Both samples (crude and rinsed) were applied for X-ray diffraction analysis and X-ray fluorescence analysis to detect sand components. The purified sample was treated by heat at 1,000°C for 1 hour to obtain the sand of fine particle size. The fine quartz sand has an advantage for the production of a fused quartz, which is adapted to reform fine quartz sand. The quartz sand has to break its network structure by the addition of Na<sub>2</sub>O as shown in Fig. 1 to produce the fused quartz. As quartz is also has several crystalline structure as shown in Scheme 1, we can select proper crystalline structure depend on the application.



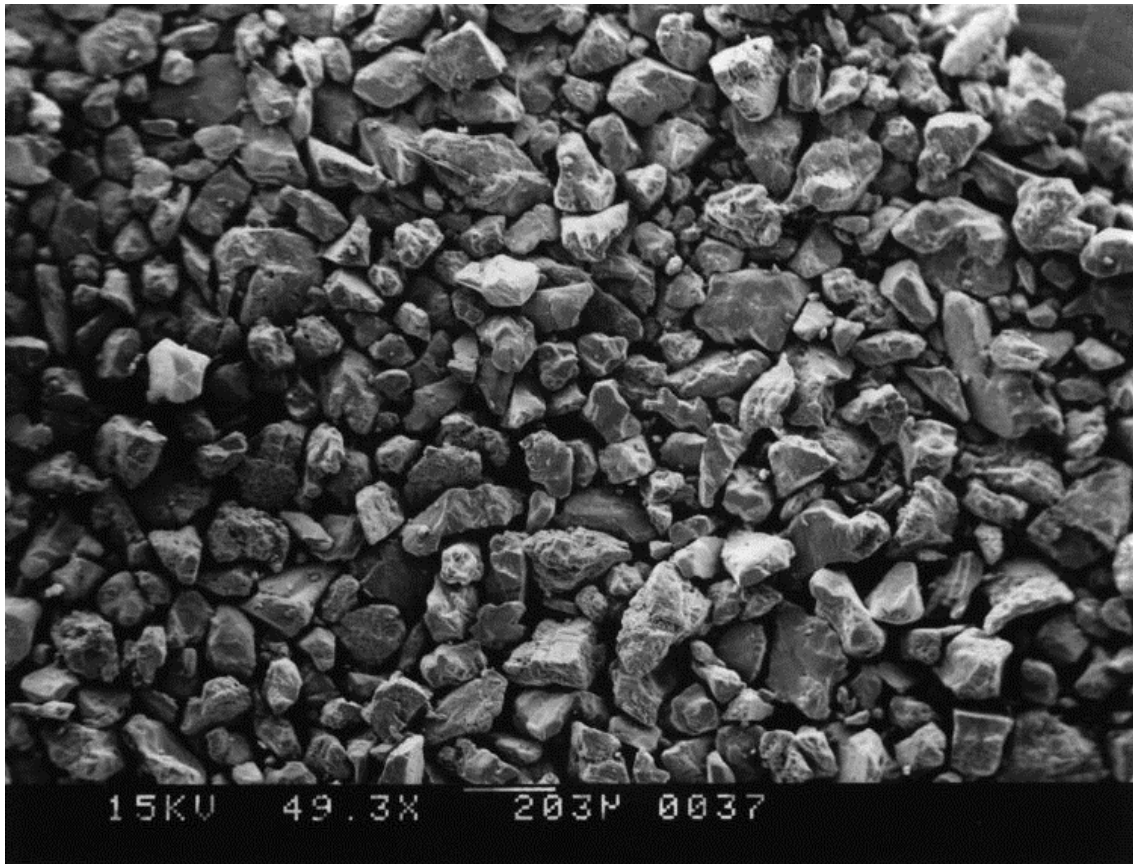
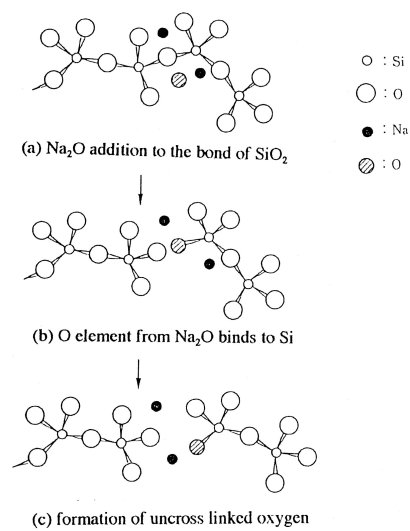

Fig. 1. SEM image of rinsed sand.



Scheme 1. Break of silicon network by  $\text{Na}_2\text{O}$

### Experiments

Sand was collected at Palangka Raya, Central Kalimantan-Indonesia and rinsed with de-ionized water twice followed by drying in air. X-ray fluorescence analysis was achieved to estimate mineral contents. Also the shape of grain was confirmed by scanning electron microscopic (SEM) observation.

### Results and Discussion

The almost uniform sizes of sand were shown in Fig. 1 for rinsed sample of SEM picture. There were several unidentified peaks in the X-ray fluorescence spectrum on crude sample in addition to major peak due to  $\text{SiO}_2$  and minor one due to  $\text{TiO}_2$  as shown in Fig. 2a and 2b. Only one peak, on the other hand, due to  $\text{SiO}_2$  was given on the upper layer of the sand. A 100% of purity was given for  $\text{SiO}_2$  by X-ray fluorescence analysis (46.74% for silicon and 53.26% for oxygen were found which were identical with those for theoretical values) as shown in Fig. 3. An almost homogeneous size distribution of sand was probably due to sedimentation. So the lower layer is composed of larger size of sands. The homogeneous size distribution would be big advantage for the industrial application together with high purity, if it were allowed to operate under the regulation of environmental conception. Since  $\text{SiO}_2$  particles were found to become smaller size following to heat treatment around  $1,000^\circ\text{C}$  as shown in Fig. 4, it may apply for the filler against water penetration through  $\text{SiO}_2$  layer. Among  $\text{SiO}_2$  grains, a different shape of grain was found on SEM picture as shown in Fig. 5. The X-ray fluorescence analysis proved the existence of titanium in the grain as shown in Fig. 6. The purity of titanium oxide was estimated to be more than 88% from oxygen content though there was a slight contaminant.

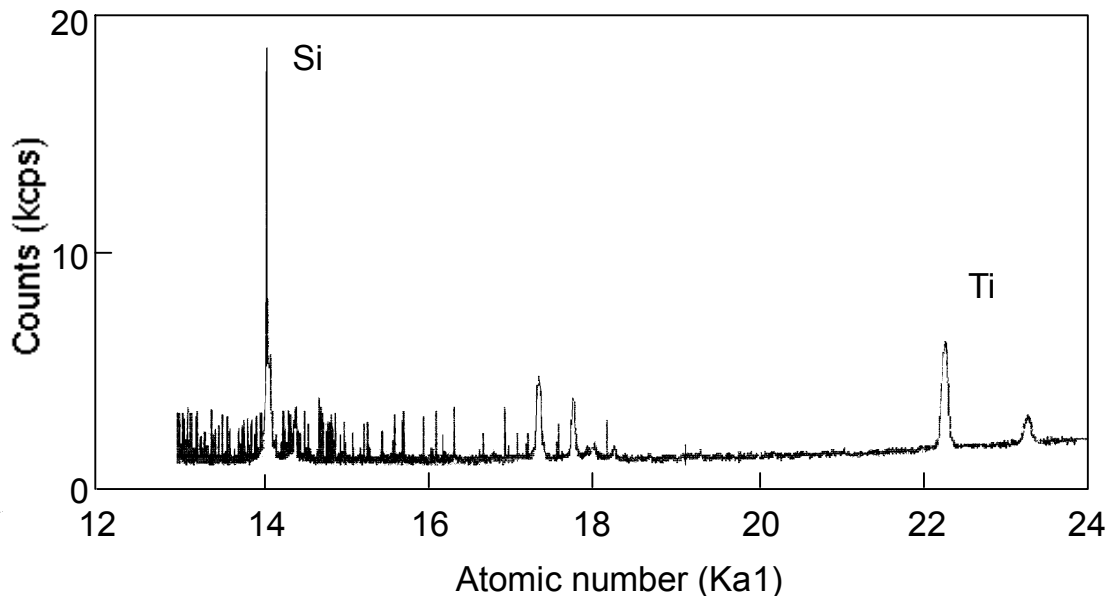

Fig. 2a. X-ray fluorescence spectrum of rinsed sand.

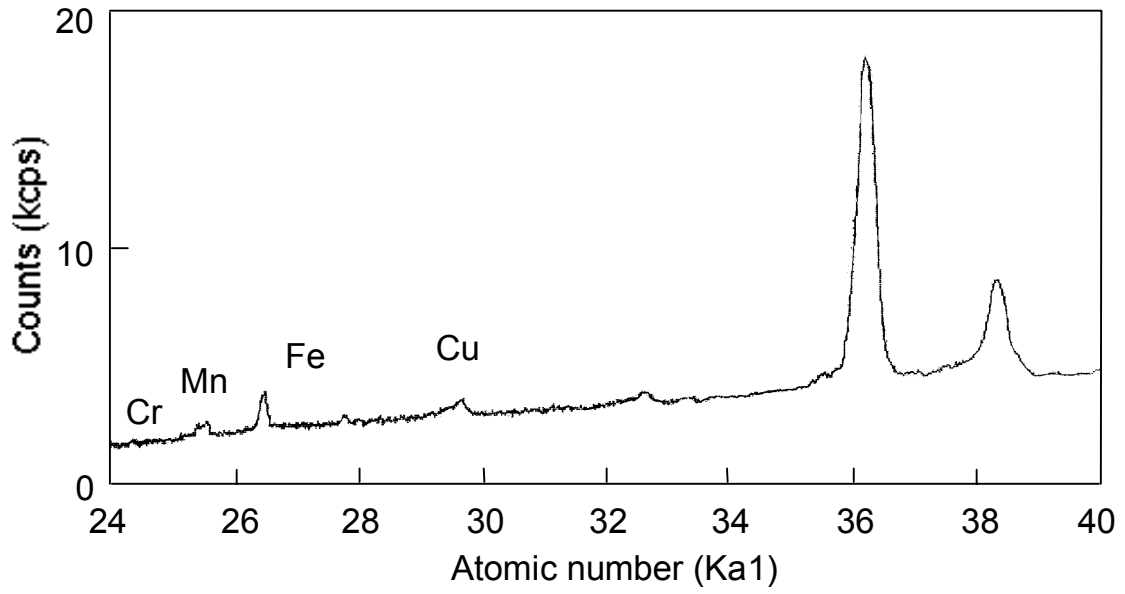

Fig. 2b. X-ray fluorescence spectrum of rinsed sand.

|       | Concentration |       |        |       |
|-------|---------------|-------|--------|-------|
|       | WT %          | AT%   | "O"%   | %S.E. |
| SiK   | 46.74         | 33.33 | 100.00 | 0.73  |
| O     | 53.26         | 66.67 |        |       |
| ----- |               |       |        |       |
|       | 100.00        |       |        |       |

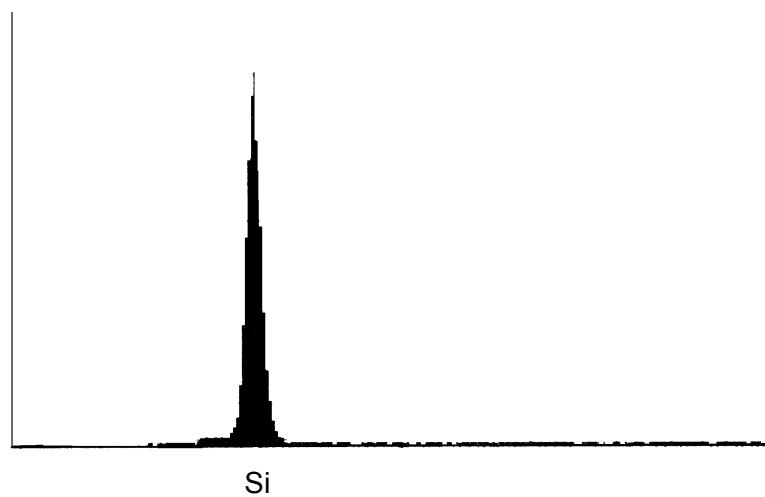

Fig. 3. X-ray fluorescence analysis for rinsed sand.

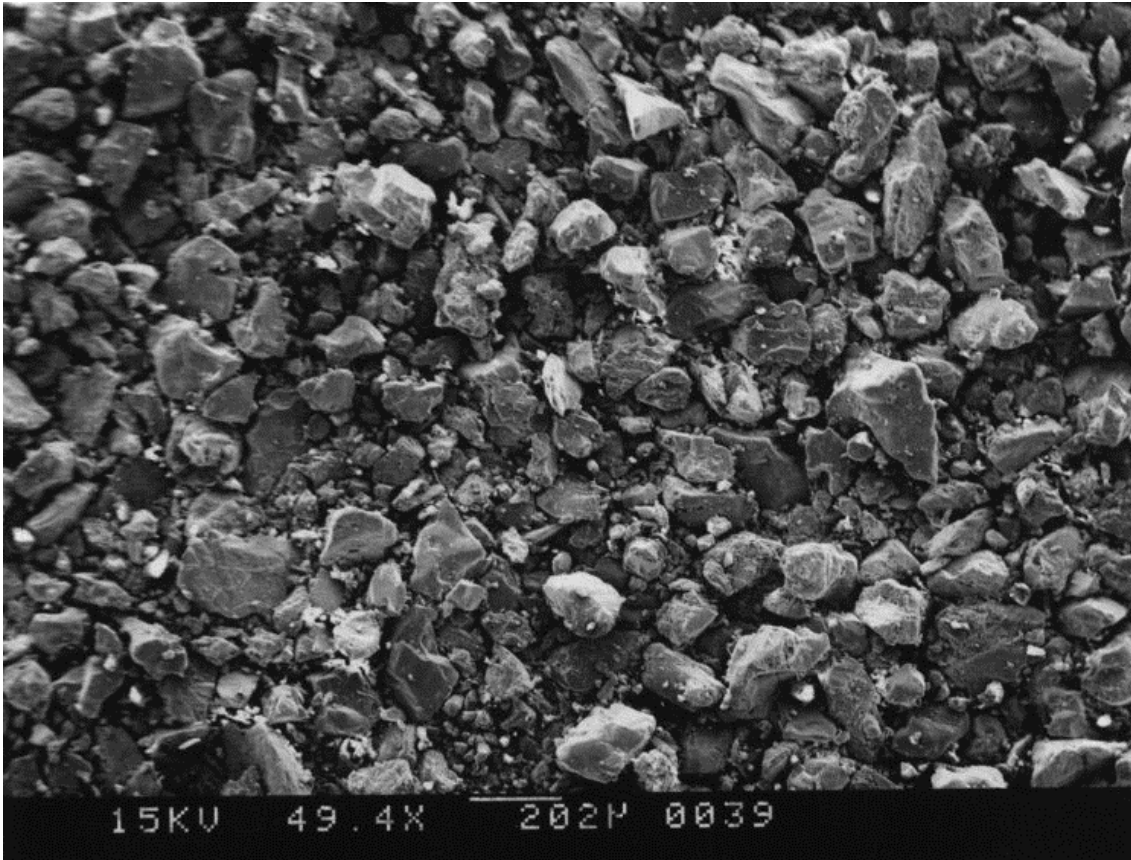

Fig. 4. SEM image of quartz sand heat-treated around 1000°C.

Since  $\text{SiO}_2$  tends to form strong network structure,  $\text{Na}_2\text{O}$  is requested to break the network prior to convert to the quartz of excellent quality as shown Scheme 1. Resulted quartz might be useful as optical fiber, which is the most favorable application of silica sands. The general process to produce quartz optical fiber is melting of highly purified silicon chloride in the presence of oxygen and hydrogen gasses at high temperature. The refractive index of produced quartz tends to be relatively high due to contamination of water. However, the quartz from peat swamp  $\text{SiO}_2$  would be low refractive index and low cost due to the absence of hydrogen gas on the production of quartz following to the degradation of silicon oxide network by  $\text{Na}_2\text{O}$ .

The composition of peat swamp has to be maintained as former natural figure. However, the conversion of destroyed peat swamp would be permitted to satisfy human demand following reconstruction of basement structure for agricultural and industrial spaces after the recovery of woods area corresponding to hypothetical volume of carbon dioxide respiration before destruction by fire or agricultural operation. Also total volume of silica layer to apply for industrial purpose has to be limited on the viewpoint of reconstruction of nature for living thing.

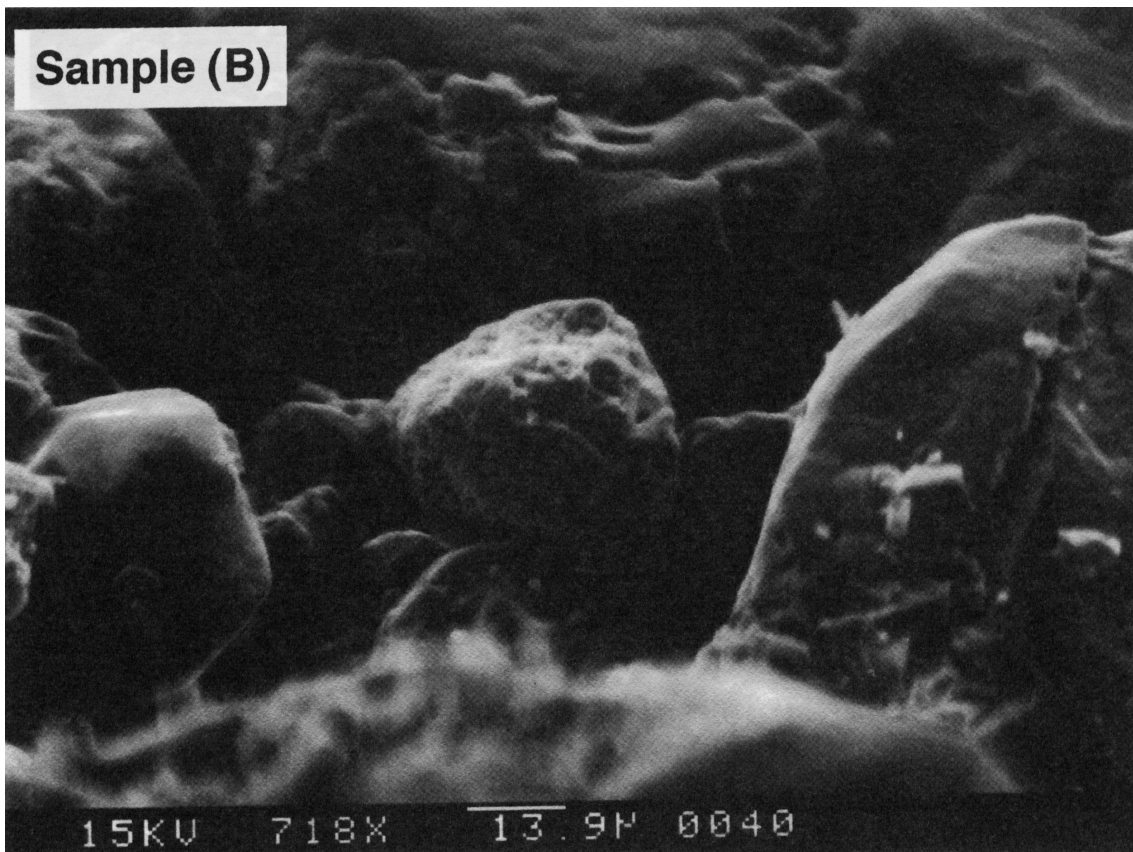

Fig. 5. Expanded SEM image of quartz sand heat treated around 1000°C.

|       | Concentration |       |       |       |
|-------|---------------|-------|-------|-------|
|       | WT %          | AT%   | "O"%  | %S.E. |
| SiK   | 4.13          | 3.81  | 8.84  | 2.34  |
| TiK   | 54.65         | 29.53 | 91.16 | 0.71  |
| O     | 41.22         | 66.67 |       |       |
| ----- |               |       |       |       |
|       | 100.00        |       |       |       |

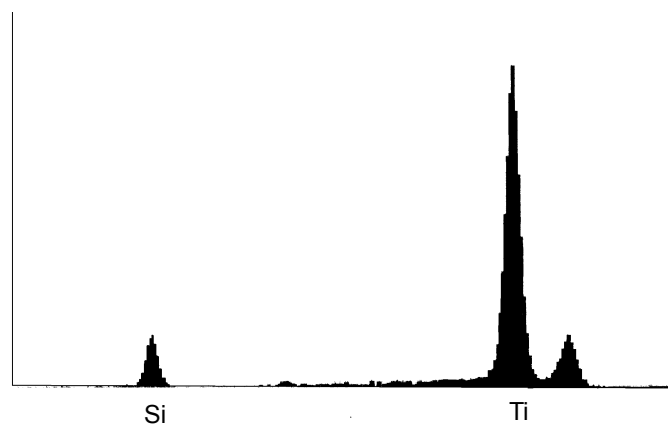

Fig. 6. X-ray fluorescence analysis for heat treated sample.

## **The Estimation of Carbon Resource in a Tropical Peatland: A Case Study in Central Kalimantan, Indonesia**

**Sawahiko SHIMADA<sup>1</sup>, Hidenori TAKAHASHI<sup>1</sup>, Masami KANEKO<sup>2</sup>  
and Akira HARAGUCHI<sup>3</sup>**

<sup>1</sup>Graduate School of Environmental Earth Science, Hokkaido University, Sapporo, Japan

<sup>2</sup>Hokkaido Institute of Environmental Science, Sapporo 060-0819, Japan

<sup>3</sup> Faculty of Science, Niigata University, Niigata 950-2181, Japan

### **Abstract**

Total amount of carbon resource in tropical peatlands is needed to evaluate the importance of the peatland conservation and management. A new method was developed and applied for estimation of carbon resource in a tropical peatland of Central Kalimantan.

The carbon content and distribution in the peat layers measured in different types of peatlands, and the volumetric distribution of peat estimated from the geographic information were used in this new method.

Based on the geographical information from the Land System Map of Regional Physical Planning Programme for Transmigration (RePPPProT, 1985), the peatland in Central Kalimantan were classified into five types, basin/domed, terrace, riverine, marginal and coastal peatland.

The average volumetric carbon density ( $CD_v$ ) of the terrace peatland ( $71.5 \text{ kg m}^{-3}$ ) showed significantly greater value ( $P < 0.01$ ) than those of marginal ( $53.6 \text{ kg m}^{-3}$ ) and coastal peatland ( $48.7 \text{ kg m}^{-3}$ ). The distribution of  $CD_v$  in the peat layer of each peatland type has no significant change with depth. For estimation and mapping of peat depth, a multiple linear regression model was used in this study. Five geographic factors, i.e. elevation, slope, distance from a river, distance from Java Sea and distance from a watershed boundary were used in the model.

**Key words:** carbon resource, Central Kalimantan, multiple regression, peat depth, peatland types, volumetric carbon density

### **Introduction**

Peatlands accumulate carbon over thousands of years and act as carbon (C) sinks. C resource of the peatlands in the world is estimated at 329-528 Pg ( $=10^{15} \text{ g}$ ), which account for more than one fifth of the terrestrial C and one third of the whole soil C (Post et al., 1982; Immirzi and Maltby, 1992). In Indonesia, 3.72 Mha of total peat swamp forest had developed (Maltby and Immirzi, 1996), furthermore, 1997/98 forest fire had burnt huge area, not only the surface vegetation but also the underlying peat, of the peat swamp forest in Kalimantan and Sumatra (Page and Rieley 1998). Owing to these drastic land use changes in recent years, an enormous amount of carbon has been released to the atmosphere from tropical peatlands. It is therefore necessary to clarify total amount of C resource in tropical peatlands to evaluate the importance of the peatland conservation and management. Fifteen percent (ca. 70 Pg) of global peatland C exists in tropical peatlands (Immirzi and Maltby, 1992), and from 15.93-19.29 Gt of C resides in Indonesian peatlands, although peat deeper than 6 m is not quantified (Sorensen, 1993). Sorensen (1993) calculated the value of sequestered C by assuming that C content is constant at 53.44% and bulk density of  $114.22 \text{ kg m}^{-3}$ . Since the great lack of detailed data, particularly in the tropics, on volumetric distribution of peat layers and peat C content

characteristics, it is difficult to estimate accurate amount of C resource without any assumption. This work has done in Central Kalimantan to derive a new method that can be easily applied and updated to estimate C resource in a tropical peatland.

### Methodology

Most of the estimation models for temperate peatlands are calculated by classifying peatland types and apply their mean values of bulk density, C content and peat depth as representatives (e.g. Gorham, 1992; Botch *et al.*, 1995). However, these models cannot be applied in the tropical peatlands because peat depths vary drastically within a peatland type and sometimes reaches up to 20 m (e.g. Rieley *et al.*, 1992). Hence, we used volumetric carbon density ( $CD_v$ ), multiplying bulk density (BD) by carbon content (CC), to trace C content characteristics per unit volume, and derived a new model as eq. (1) by classifying peatland types (i) and divided into grid cells horizontally (j) and vertically (k) (Fig. 1).

$$TC = \sum_{i=1}^n A_i \sum_{j=1}^m d_{ij} \sum_{k=1}^l CD_{vij} \quad (1)$$

where TC: total amount of carbon resource; A: peatland area; d: peat depth;  $CD_v$ : volumetric carbon density; n: number of peatland types patches; m: number of grid cells; l: number of peat layer in depth; i,j,k: natural number. Each parameter is measured or estimated as below. The geographical and the statistical analysis were carried out with Arc View GIS (ESRI) and STATISTICA (StatSoft Inc.), respectively.

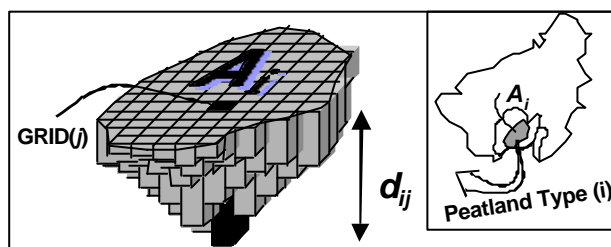

Fig. 1. Model scheme of calculating carbon resource. A: peatland area; d: peat depth

### Area and classification of peatland

Based on Land System Map of Regional Physical Planning Programme for Transmigration (RePPPProT, 1985), we classified the peatland types of Central Kalimantan into terrace, basin/domed, riverine, and marginal peatland (Table 1; Fig.2a). Area of each peatland type was calculated from this map.

### Sampling and analysis of volumetric carbon density

The study sites were located in four different peatland types (Table 2, Fig. 1b). Data of plot PK3 (Neuzil 1997) were added in order to increase number of samples (Table 2, Fig. 1-b). For comparison, some data of Riau (BK5, SK6), Sumatra and Keramat (WK3), West Kalimantan (Neuzil 1997) were also studied (Table 2, Fig. 1a). Since the bases of these peat deposit locate at ca. 0 m a.s.l., we categorized these peatlands as coastal peatlands (Table 1) according to the previous category based on the topographical location (Andriess 1974; Anderson 1983; Rieley *et al.* 1996).

Table 1. General description, mineralogy and altitude of each peatland type in the tropics.

| Peatland type | General description                                 | Mineralogy  | Altitude (m) |
|---------------|---|---|--------------|
| Riverine      | Swampy floodplains mainly within terraces           | Recent alluvium (riverine) Peat                       | 0-43         |
| Terrace       | Peat-covered sandy terraces                         | Peat<br>Old alluvium (sand)                           | 5-50         |
| Basin/Domed   | Peat basins or domes                                | Peat  | 2-10         |
| Marginal      | Peat basin margins                                  | Peat<br>Recent alluvium (riverine, estuarine/ marine) | 1- 5         |
| Coastal*      | Coastal peatlands of the maritime fringe and deltas | Peat<br>Recent alluvium (estuarine/ marine)           | 1- 5         |

Note: All the criteria are modified from RePPProT (1985) except for with the asterisked, which are modified from Rieley *et al.* (1996)

Table 2 Characteristics of the study sites and their corresponding peatland types of Central Kalimantan and coastal peatlands in Sumatra and West Kalimantan.

| Site             | Latitude | Longitude | Elevation<br>(m a.s.l.) | Peatland type | <i>N</i> | Peat depth (m)<br>[Min] | Peat depth (m)<br>[Max] | Mineral layer<br>below peat |
|------------------|----------|-----------|-------------------------|---------------|----------|-------------------------|-------------------------|-----------------------------|
| Setia Alam Jaya  | 2°19'S   | 113°54'E  | 12*                     | Terrace       | 3        | [1.8]                   | [4.1]                   | Sand <sup>†</sup>           |
| Marang           | 2°06'S   | 113°46'E  | 18*                     | Terrace       | 1        |                         | 3.0                     | Sandy clay <sup>†</sup>     |
| PK3 <sup>a</sup> | 2°06'S   | 113°45'E  | 31*                     | Terrace       | 1        |                         | 6.4                     | Sandy clay                  |
| Petukketimpun    | 2°08'S   | 113°53'E  | 14*                     | Terrace       | 1        |                         | 1.8                     | Sandy clay <sup>†</sup>     |
| Tumbangnusa      | 2°21'S   | 114°08'E  | 14*                     | Basin/Domed   | 1        |                         | 3.7                     | Sandy clay <sup>†</sup>     |
| Pankoh-B         | 2°52'S   | 114°04'E  | 20*                     | Basin/Domed   | 1        |                         | 5.9                     | Clay <sup>†</sup>           |
| Pankoh-M         | 2°52'S   | 114°05'E  | 17*                     | Marginal      | 2        | [2.4]                   | [5.3]                   | Clay <sup>†</sup>           |
| Tanjung Mas      | 2°40'S   | 113°00'E  | 13*                     | Marginal      | 2        | [3.8]                   | [4.1]                   | Clay <sup>†</sup>           |
| Lahei            | 1°56'S   | 114°11'E  | 34*                     | Riverine      | 9        | [1.2]                   | [7.5]                   | Sand <sup>†</sup>           |
| WK3 <sup>b</sup> | 1°25'S   | 109°09'E  | 9                       | Coastal       | 1        |                         | 6.5                     | Clay                        |
| BK5 <sup>c</sup> | 1°32'S   | 109°05'E  | 9                       | Coastal       | 1        |                         | 8.0                     | Clay                        |
| SK6 <sup>c</sup> | 1°40'S   | 109°02'E  | 14                      | Coastal       | 1        |                         | 13.7                    | Clay                        |

*N*: number of coring points. \*values are interpolated from BAKOSURTANAL (1997); †observed in the field. Compiled from references as follows:<sup>a</sup>Moore *et al.* (1996), Neuzil (1997);<sup>b</sup>Moore *et al.* (1992), Neuzil *et al.* (1993), Neuzil (1997);<sup>c</sup>Neuzil *et al.* (1993), Supardi *et al.* (1993), Neuzil (1997)

Peat samples were collected, divided into 40 cm<sup>3</sup> pieces, oven-dried at 90°C over 24 h and stored for the analysis. Dry bulk density (BD) was determined after measuring peat dry mass. Carbon content (CC) was measured with a CHN elemental analyzer (Elementar Vrio EL). Volumetric C density (CD<sub>v</sub>) was calculated by multiplying BD by CC. Since there were a lot of peat layers contain sand or clay near at the bottom of the peat layer and sometimes within the pure peat layer of riverine peatland, we separated these layers and categorized as sandy/clayey layers. ANOVA (Sheffe's test) were used to determine differences between mean values of CD<sub>v</sub> among peatland types. Sampling depths were nondimensionalized by dividing the peat thickness of the sampling points in order to trace vertical CD<sub>v</sub> difference.



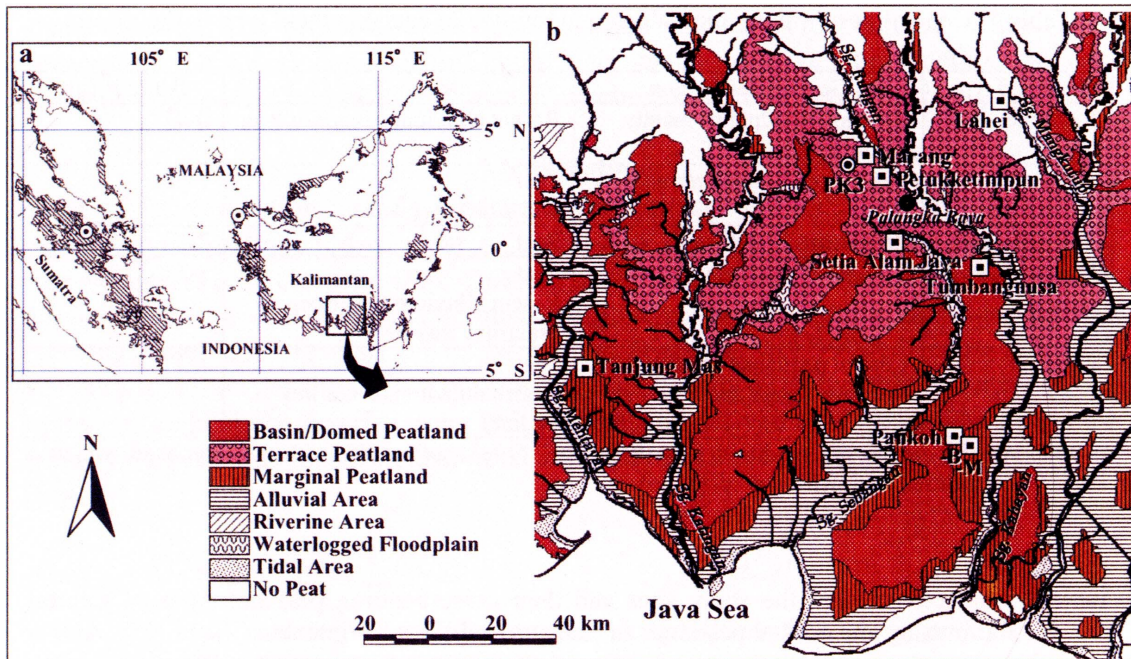

Fig. 2. a: Peatland distribution of Sumatra and Kalimantan. Modified from the Digital Chart of the World (DCW, 1993) and BAKOSURTANAL (1997). Circled points indicate plots of Neuzil (1997). b: Peatland type map of Central Kalimantan. Modified from RePPPProT (1985). Squared points indicate study plots. Circled point (PK3) indicates a plot of Neuzil (1997).

### Estimation of peat depth

Data on the depths of peat layers in Central Kalimantan were collected by peat boring (Table 2) and compiled from previous reports (Table 3).

50 m grid elevation map were interpolated (inverse distance weighted interpolation, power: 2) from the elevation point from the maps of National Coordination Agency For Surveys And Mapping (BAKOSURTANAL, 1997). Slope and watershed were derived from the elevation map (Fig. 3). Distances from the nearest river and Java Sea were calculated from digitized river line and coastline, respectively, which derived from BAKOSURTANAL (1997). A series of stepwise multiple regression of peat depth against geographic parameters (elevation, slope, distance from river, distance from Java Sea, distance from watershed boundary) was carried out for terrace, marginal, basin/domed peatland and waterlogged floodplain (cf. Fig 2b). Riverine peatland was excluded from the regression model because its distribution largely affected by microtopography.

Table 3. Compiled data used for regression model of estimating peat thickness.

| Site name  | N  | Peat depth (m) |        | References   |
|------------|----|----------------|--------|--|
|            |    | [Min]          | [Max]  |  |
| PK2-6      | 4  | [2.4]          | [7.2]  | Neuzil (1997), Moor <i>et al.</i> (1996)   |
| PR0.5-8    | 6  | [4.0]          | [7.0]  | Morley (1981)  |
| Setia Alam | 78 | [2.0]          | [10.5] | Rieley <i>et al.</i> (1995), Rieley <i>et al.</i> (1996), Shephered <i>et al.</i> (1997) |
| KC10-40    | 66 | [0.2]          | [3.7]  | Euroconcert (1984)   |

N: number of coring points.

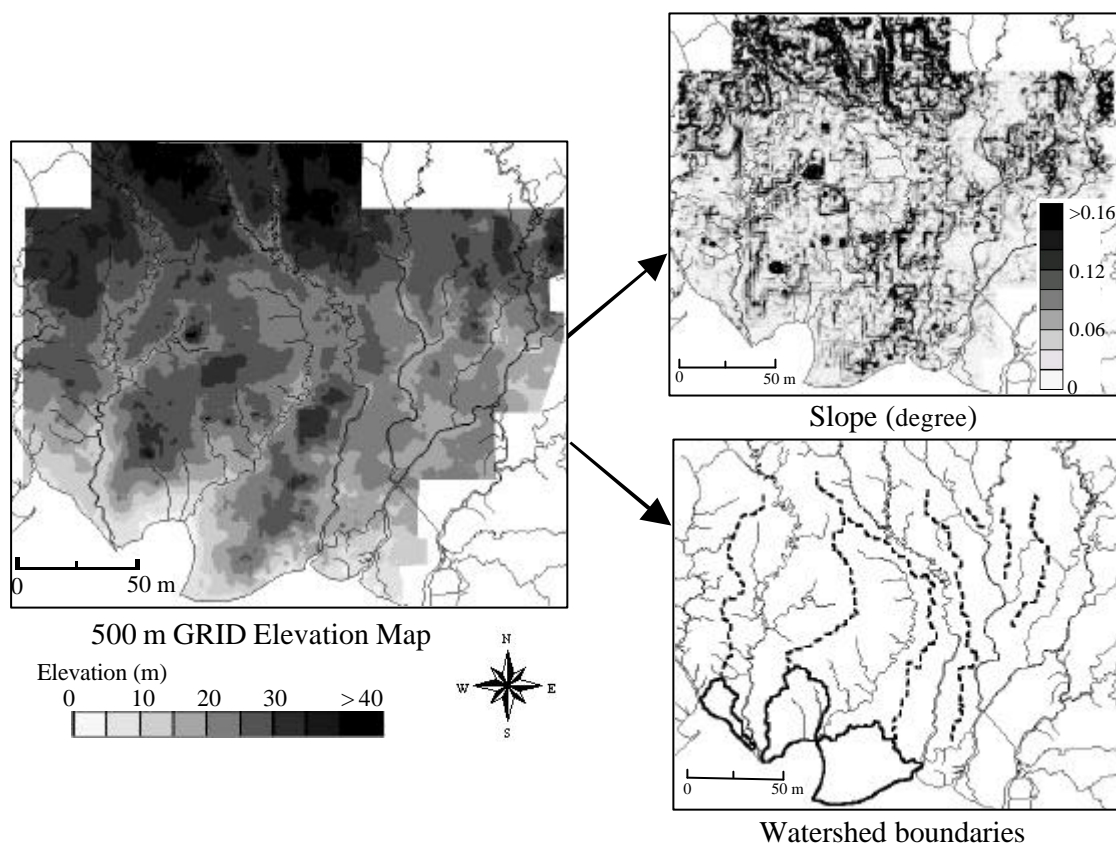

Fig. 3. Elevation map of Central Kalimantan and derived maps of slope and watershed boundaries. The elevation map was interpolated from point data of BAKOSURTANAL (1997).

## Results and Discussion

### Characteristics of volumetric carbon density

The correlation coefficients ( $r$ ) of  $CD_V$  against nondimensionalized peat depth of riverine, terrace, domed/basin, marginal and coastal peatland are -0.22, -0.10, -0.63, -0.12 and 0.21, respectively. No significant relationships within each peatland type were found between  $CD_V$  and nondimensionalized peat depth with the exception within based/domed peatland (Fig. 4), however 2 core data of basin/domed peatland are not enough to clarify significant correlation.

Since  $CD_V$  value does not change with depth in most of the cases, the mean  $CD_V$  values are calculated from the top to bottom of the peat layers. Input of sand or clay derives significant change ( $P < 0.05$ ) of the peat characteristics, i.e. increase in BD and  $CD_V$ ; decrease in CC. The mean  $CD_V$  value of riverine ( $64.5 \text{ kg m}^{-3}$ ) and basin/domed peatland ( $55.8 \text{ kg m}^{-3}$ ) is not significantly different ( $P > 0.05$ ) with any other peatland types except for sandy/clayey layer ( $87.8 \text{ kg m}^{-3}$ ). The mean  $CD_V$  value of the terrace peatland ( $71.5 \text{ kg m}^{-3}$ ) shows significantly greater ( $P < 0.01$ ) than those of marginal ( $53.6 \text{ kg m}^{-3}$ ) and coastal peatland ( $48.7 \text{ kg m}^{-3}$ ), although CC and BD values are not significantly different ( $P > 0.05$ ) among all peatland types (Table 4).

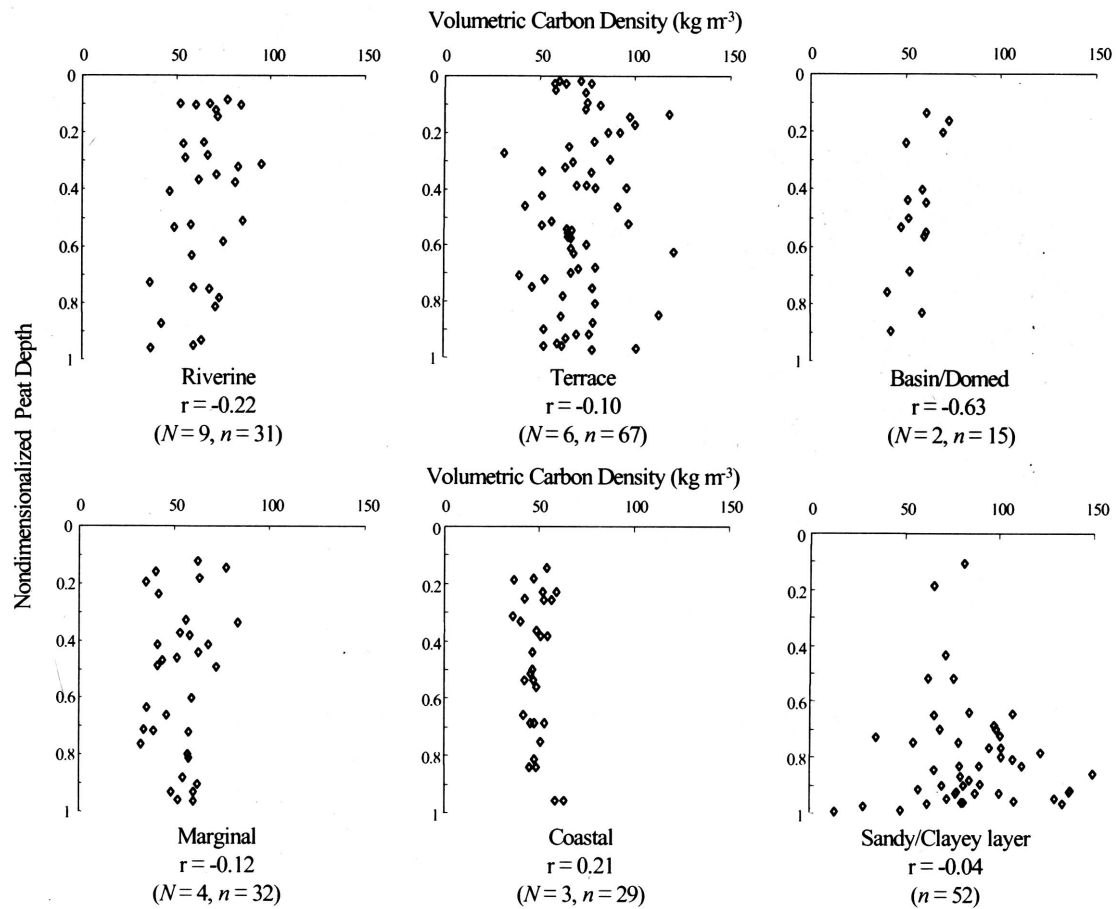

Fig. 4. Variations in volumetric carbon density with normalized peat depth for all peatland types and sandy/clayey layer. Values of coastal peatland and some ( $n = 9$ ) of basin/domed peatland are adopted from Neuzil (1997).  $r$ : correlation coefficient of volumetric carbon density versus normalized peat depth.  $N$ : number of coring point;  $n$ : number of samples.

Table 4. Peat characteristics of different peatland types in Central Kalimantan and coastal peatland.

| Peatland type        | $n$ | CC               | BD                | CD                   |
|----------------------|-----|------------------|-------------------|----------------------|
|                      |     | % dry weight     |                   | $\text{kg m}^{-2}$   |
| Riverine             | 31  | $55.5 \pm 4.2^a$ | $117 \pm 27.5^b$  | $64.5 \pm 14.0^{dc}$ |
| Terrace*             | 67  | $57.6 \pm 4.8^a$ | $124 \pm 31.3^b$  | $71.5 \pm 17.3^d$    |
| Basin/Domed          | 15  | $57.0 \pm 4.5^a$ | $98.0 \pm 22.3^b$ | $55.8 \pm 8.7^{dc}$  |
| Marginal             | 32  | $56.6 \pm 3.9^a$ | $96.0 \pm 25.1^b$ | $53.6 \pm 12.5^c$    |
| Coastal <sup>†</sup> | 29  | $57.3 \pm 2.8^a$ | $84.1 \pm 11.5^b$ | $48.7 \pm 6.3^c$     |
| Sandy/Clayey layer   | 52  | $35.9 \pm 14.7$  | $301 \pm 179$     | $87.8 \pm 30.0$      |

$n$ : number of samples; CC: carbon content; BD: dry bulk density;  $CD_v$ : volumetric carbon density. \*some data ( $n = 9$ ) are adapted from Neuzil (1997). <sup>†</sup>all the data are adapted from Neuzil (1997). Values are the mean  $\pm$ s.d. Values followed by the same letter are not significantly different at the  $P < 0.05$  significance level.

Sieffermann *et al.* (1988) reported the existence of high peats, which is developed on podzolic terraces and formed accumulation in older period (ca. 10000-5000 years BP) than the other peatlands (ca. 6000-2000 years BP) reported previously (e.g. Anderson, 1983). These high peats topographic characteristics coincide with those of the terrace peatland classification, and sampling plots of Marang, PK3, Petukketimpun and a part of Setia Alam Jaya are within the high peats area on the map derived by Sieffermann *et al.* (1988). Hence, the chemical and physical C compaction from the longer decomposition period may attribute to the greater  $CD_V$  value of terrace peatland.

**Regression models for peat depth estimation**

The aspect that the period and the condition of accumulation are different, stepwise regression models were carried out separately for terrace peatland and for the other peatland type (basin/domed, marginal peatland) with waterlogged floodplain. The regression equations are shown as eqs. (2) and (3), respectively:

$$d = 4.60 + 1.02L_R - 0.276 h + 12.4 \mathbf{F} \tag{2}$$

$$d = -2.48 + 0.547 L_R + 0.0500 L_S + 0.0877 L_W + 11.0 \mathbf{F} \tag{3}$$

where  $d$ : peat depth (m);  $L_R$ : distance from river (km);  $L_S$ : distance from Java Sea (km);  $L_W$ : distance from watershed boundary (km);  $\mathbf{F}$ : slope (degree);  $h$ : elevation (m a.s.l.);  $r^2 = 0.538$  ( $F(3,83)=32.27$ , and  $P<0.001$ ) for terrace peatland and  $r^2 = 0.747$  ( $F(4,72)=53.13$ , and  $P<0.001$ ) for basin/domed, marginal peatland and waterlogged floodplain. From the value of standardized estimate of coefficient,  $L_R$  was a best contributor for the prediction of both models (Table 5).

Table 5. Functions for estimating peat thickness of a Central Kalimantan peatland.

| Variables    | Terrace peatland         |                 |                                      | Basin/domed, marginal peatland, and water-logged floodplain |                 |                                      |
|--------------|--------------------------|-----------------|--------------------------------------|---|-----------------|--------------------------------------|
|              | Coefficient              | <i>t</i> -value | Standardized estimate of coefficient | Coefficient   | <i>t</i> -value | Standardized estimate of coefficient |
| Constant     | -2.48                    | -1.87           |                                      | 4.60  | 7.04            |                                      |
| $L_R$        | 0.547                    | 7.14            | 0.811                                | 1.02  | 8.71            | 0.802                                |
| $L_S$        | 0.0500                   | 6.15            | 0.425                                |   |                 |                                      |
| $L_W$        | 0.0877                   | 1.77            | 0.210                                |   |                 |                                      |
| $h$          |                          |                 |                                      | 0.276   | -5.54           | -0.520                               |
| $\mathbf{F}$ | 11.02                    | 1.65            | 0.103                                | 12.4  | 2.46            | 0.212                                |
|              | $r^2 = 0.747$            |                 |                                      | $r^2 = 0.538$   |                 |                                      |
|              | $r^2$ (adjusted) = 0.733 |                 |                                      | $r^2$ (adjusted) = 0.521                                    |                 |                                      |
|              | SE = 1.77                |                 |                                      | SE = 1.95   |                 |                                      |
|              | $F(4,72) = 53.1$         |                 |                                      | $F(3,83) = 32.3$  |                 |                                      |
|              | $P < 0.001$              |                 |                                      | $P < 0.001$   |                 |                                      |
|              | $N = 77$                 |                 |                                      | $N = 87$  |                 |                                      |

The map of estimated peat thickness can be derived from the regression models (Fig. 5), although watersheds area which flow into Java Sea is not concerned. Some overestimated parts appeared in the map around high elevated areas between rivers miscounting that the areas are deep peat dome tops. More detailed variables to eliminate those errors and also more distributed surveyed data on peat depth are needed to derive more accurate map of peat thickness distribution.

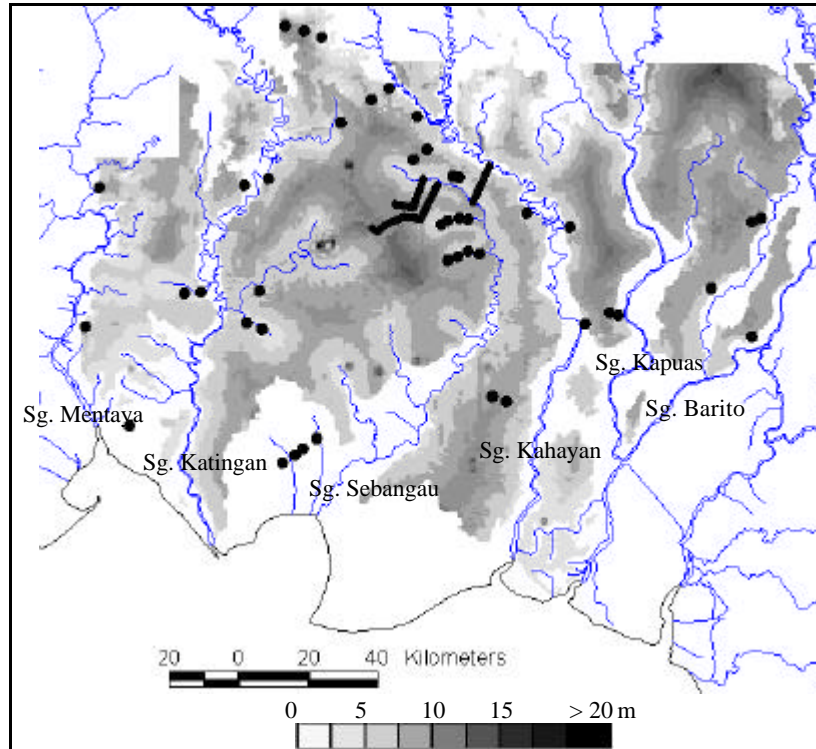

Fig.5 Map of estimated peat thickness. Circled points indicate coring points ( $N$ ).

#### Estimation model of carbon resource

The results that  $CD_V$  does not change with the depth in most of the cases and has its unique value within each peatland type, the estimation model of eq. (1) can be converted to eq. (4).

$$TC = \sum_{i=1}^n A_i CD_{Vi} \sum_{j=1}^m D_{ij} \quad (4)$$

where  $TC$ : total amount of carbon resource;  $A$ : peatland area;  $d$ : peat depth;  $CD_V$ : volumetric carbon density;  $n$ : number of peatland types patches;  $m$ : number of grid cells;  $i, j$ : natural number. Total amount of 5.5 Pg C can be calculated from the eq. (4) between sg. (river) Mentaya and Sg. Barito, although watersheds area which flow into Java Sea is not quantified. This amount accounts for one tenth of C in total tropical peatlands (Immirzi and Maltby, 1992).



### References

- Anderson, J. A. R. 1983. The tropical peat swamps of western Malaysia. In: *Mires: Swamp, Bog, Fen and Moor, Ecosystem of the world 4B*. pp. 181-199, Elsevier, Amsterdam
- Andriesse, J P. 1974. Tropical lowland peats in South-East Asia. Dep. Agric. Res., R. Trop. Inst., Amsterdam, Commum. 63
- BAKOSURTANAL. 1997. Peta rupabumi Indonesia 1: 50000, National Coordination Agency for Surveys And Mapping
- Botch, M. S., Kobak, K. I., Vinson, T. S. and Kolchugina, T. P. 1995. Carbon pools and accumulation in peatlands of the former Soviet Union. *Global Biogeochemical Cycles*, **9**(1): 37-46
- ESRI. 1993. The Digital Chart of the World for Use with ARC/INFO<sup>^</sup> software from ESRI, Redlands, CA
- Euroconsult/ Nedeco. 1984. *Nationwide Study of Coastal and Near-coastal Swampland in Sumatra, Kalimantan and Irian Jaya; Final Report*. P3D, Dit. Jen. Pengairan, Min. of Public Works
- Gorham, E. 1991. Northern peatlands: Role in the carbon cycle and probable responses to climatic warning. *Ecological Applications*, **1**(2):182-195
- Immirzi, P. and Maltby, E. with Clymo, R. S. 1992. *The Global Status of Peatlands and their Role in Carbon Cycling. Report No.11*, The Wetland Ecosystems Research Group, University of Exeter, U.K.
- Maltby, E., Immirzi, C. P. 1996. Introduction: The sustainable utilisation of tropical peatlands. In: *Tropical Lowland Peatlands of Southeast Asia: Proceedings of a Workshop on Integrated Planning and Management of Tropical Lowland Peatlands*. pp. 1-14, IUCN
- Moore, T. A. and Hilbert, R. E. 1992. Petrographic and anatomical characteristics of plant material from two peat deposits of Holocene and Miocene age, Kalimantan, Indonesia. *Review of Palaeobotany and Palynology*, **72**:199-227
- Moore, T. A., Shearer, J. C. and Miller, S. L. 1996. Fungal origin of oxidised plant material in the Palangkaraya peat deposit, Kalimantan Tengah, Indonesia: Impactions for 'inertinite' formatoin in coal. *International Journal of Coal Geology*, **30**: 1-23
- Morley, R. J. 1981. Development and vegetation dynamics of a lowland ombrogenous peat swamp in Kalimantan Tengah, Indonesia. *Journal of Biogeography*, **8**:383-40
- Neuzil, S. G., Supardi, Cecil, C. B., Kane, J. S. and Soedjono, K. 1993. Inorganic geochemistry of domed peat in Indonesia and its implication for the origin of mineral matter in coal. In: *Modern and Ancient Coal-Forming Environments*. pp. 23-44, Geological Society of America Special Paper 286
- Neuzil, S. G. 1997. Onset and rate of peat and carbon accumulation in four domed ombrogenous peat deposits, Indonesia. In: Rieley, J. O. & Page, S.E. (Eds) *Biodiversity and Sustainability of Tropical Peatlands*. pp. 55-72, Samara Publishing Limited, Cardigan
- Page, S. E. and Rieley, J. O. 1998. Executive summary: Field research programme 1996/1997. Report to the South-east Asian Rainforest Research Committee of the Royal Society. Kalimantan Peat Swamp Forest Research Project, Universities of Nottingham, Leicester and Palangka Raya
- Post, W. M., Emanuel, W. R., Zinke, P. J. and Stagenberger, A. G. 1982. Soil carbon pools

- and world life zones. *Nature*, **298**:156-159
- RePPPProT. 1985. Land systems and land suitability series at 1:250 000 scale. Accompanying Maps of Review of Phase 1B Results, Central Kalimantan. Regional Physical Planning Programme for Transmigration. UK Overseas Development Administration and Directorate Bina Program. Jakarta, Ministry of Transmigration Programme for Transmigration
- Rieley, J. O., Sieffermann, G. R. and Page, S. 1992. The origin, development, present status and importance of the lowland peat swamp forests of Borneo. *Suo*, **43**(4,5): 241-244
- Rieley, J. O. and Page, S. E. 1995. The ecology and environmental importance of the peat swamp forest in the Sungai Sebangau catchment, Central Kalimantan, Indonesia. Jul.-Sept. 1993 and 1994. A field study programme funded by the Conservation Foundation Earthwatch and Private Subscription.
- Rieley, J. O. and Page, S. E. 1996. Biodiversity and sustainability of tropical peat swamp forest. A report of field research carried out in Central Kalimantan, Indonesia, Aug.-Sept. 1995.
- Rieley, J. O., Ahmad-Shah, A. A., and Brady, M. A. 1996. The extent and nature of tropical peat swamps. In: *Tropical Lowland Peatlands of Southeast Asia: Proceedings of a Workshop on Integrated Planning and Management of Tropical Lowland Peatlands*. pp. 17-53, IUCN
- Sorensen, K.W. 1993. Indonesian peat swamp forests and their role as a carbon sink. *Chemosphere*, **27**(6): 1065-1082
- Shepherd, P. A., Rieley, J. O. and Page, S. E. 1997. The relationship between forest vegetation and peat characteristics in the upper catchment of Sungai Sebangau, Central Kalimantan. In: Rieley, J. O. & Page, S.E. (Eds) *Biodiversity and Sustainability of Tropical Peatland*. pp. 191-210, Samara Publishing Limited
- Sieffermann, R. G., Fournier, M., Triutomo, S., Sadelman, M. T. and Semah, A. M. 1988. Velocity of tropical peat accumulation in Central Kalimantan Province, Indonesia (Borneo). In: *Proceedings of the 8th International Peat Congress*. pp. 90-98, Leningrad 1
- Supardi, Subekty, A., D. and Neuzil, S. G. 1993. General geology and peat resources of the Siak Kanan and Bengkalis Island peat deposits, Sumatra, Indonesia. In: *Modern and Ancient Coal-Forming Environments*. Geological Society of America Special Paper 286, pp. 45-62.

## **Preliminary Study on Geomorphology in the Central Kalimantan Plain with Special Reference to the Tropical Peat Formation**

**Kazuomi HIRAKAWA<sup>1</sup> and Yoshimasa KURASHIGE<sup>2</sup>**

<sup>1</sup> Graduate School of Environmental Earth Science, Hokkaido University

<sup>2</sup> School of Environmental Science, The University of Shiga Prefecture

### **Abstract**

On the basis of newly produced contour map, some aspects of characteristics and evolution and evolution of landforms in the Central Kalimantan Plain was examined particularly in relation to tropical peat development. Widely distributed deep weathering saprolith and residual hills are the definite evidence indicating the long history of this Plain. Depositional surface of kerangas sand is also predominant landforms, in comparison with the relatively narrow area of Holocene alluviation. Peat development appears to have been strongly influenced by the landform evolution of the Plain such as the response of rivers to the sea level change, channel migration, underfitting of rivers probably due to the climatic change. Further geomorphological view is absolutely needed for understanding tropical peat formation.

### **Introduction**

Development of the thick lowland peat is frequently reported from the tropical zone of the world. It is said that approximately 6.8 Mha peats entirely occupy the lowland up to 60 m or so above sea level in Central Kalimantan. Thick peat cores and/or their geologic cross sections reported so far are obtained almostly in the region between the present Kahayan River and the Katingan River including the uppermost Sebangau River basin in the Central Kalimantan Plain. However very little is known on the precise distribution of the peat. We have only a rough distribution map of peat by Sieffermann (1988), as shown in Fig. 1. Although considerable attention has been paid to the peat and the forest in Central Kalimantan (eg. Shepherd, *et al.*, 1997), but almost nothing is known of the geomorphological evolution. Basic configuration of landforms in Central Kalimantan Plain should be the key issue to discuss not only the formation process, distribution and the other issues of the tropical peat development, but also the hydrological condition. Any topographic maps in the scales of 1:25,000 or 1:50,000 have not yet been published for the Central Kalimantan Plain. Then we produced a contour map based on the elevation data on the map 1:50,000 issued from BAKOSURTANAL (1997) as shown in Fig. 2. Comparing this contour map with the peat distribution so far discussed (Fig. 1), we should discuss some fundamental issues on the geomorphological influence to peat development.

In this preliminary report, we will present some geomorphological interpretation of the Central Kalimantan Plain with reference to (1) its geomorphological characteristics and (2) the sedimentary environment for the peat development. Some noticeable observations in the field will be added.

### **Landforms and Subsurface Geology**

#### **General view**

The contour map involves many characteristic aspects of landforms (Fig. 2). It must be above all pointed that the Kalimantan Plain is in low elevation. For example, although



the Palangkaraya area is situated inland ca. 120 km from the coast, the elevation is only 15-20 m above sea level or lower than 15 m along the present river level. The area up to the elevation of 100 m asl, more than 200 km inland from the coast, roughly corresponds to the boundary between the plain and the high mountains. However we have landforms such as hills, terraces along the rivers almostly to the area near the present coast, except for the lower Barito River alluvial plain. Katingan River and Sebangau River are at present flowing within the narrow floodplain cutting the terrace landform down to the coast. Only Kapuas River and Barito River have relatively wide present flood plain in the lower reaches up to the height of ca. 10 m above sea level. This alluviation might be caused by that the Barito river system has a wide area of drainage basin in the mountainous region higher than 2000 m above sea level and much amount of sediment supply. Sebangau River basin where the peat is most wildely developing occupies only the area lower than 20 m above sea level.

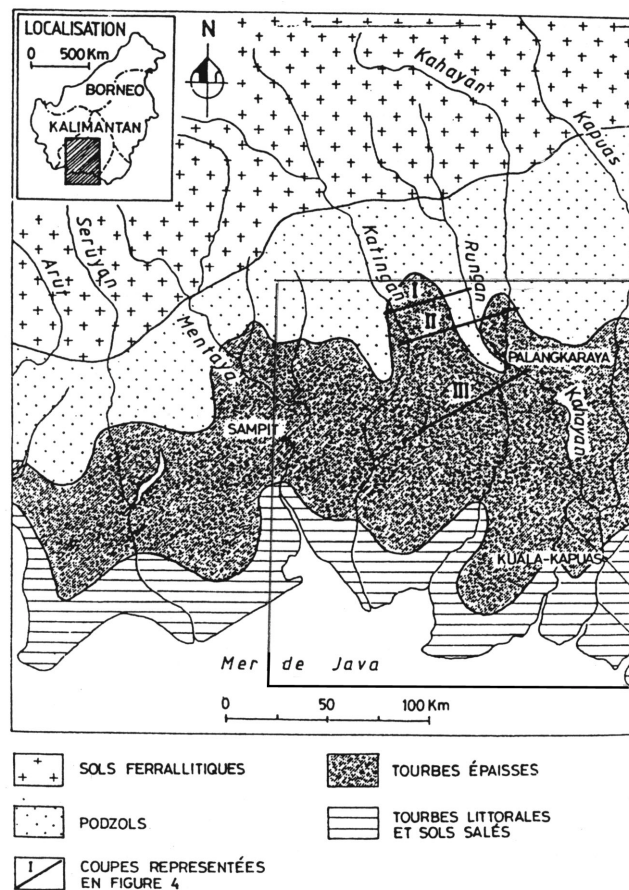

Fig. 1 Distribution of peat and soils in the Central Kalimantan Plain (after Sieffermann, 1988). Box shows the area for Fig. 2.

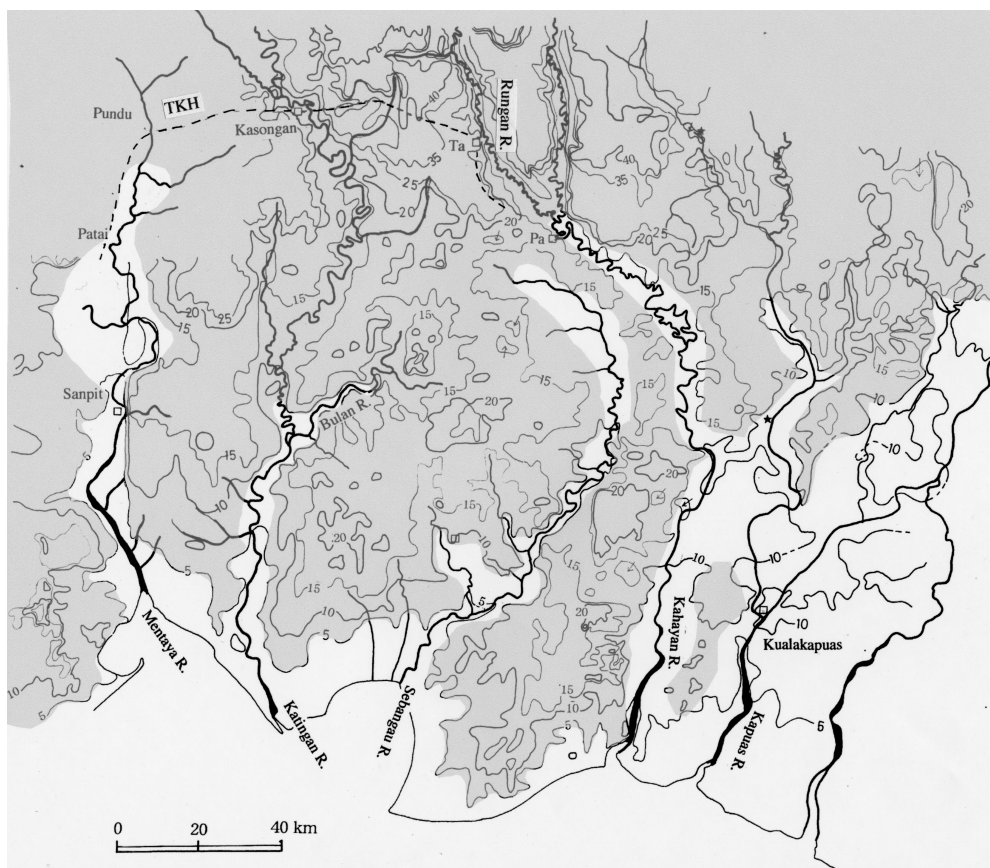

Fig. 2 Topographic (contour) map of the Central Kalimantan Plain. Contour lines are drawn on the basis of the elevation map of 1:50,000 BAKOSURTANAL (1997). Shadow area indicates the Pleistocene kerangas terraces with residual hills and saprolith weathering. Pa: Palangkaraya, Ta: Tangkiling, TKH: Trans Kalimantan Highway

### Residual hills and weathering

There are residual hills consisting of basement rocks in many places. They are distributed above the plain surface up to ca 100~150 m, as shown for example in Tangkiling Village (cf. Fig.3). Very sharp interface at a weathering front over granite is often typically developed. They are surrounded by the gentle slopes, whose subsurface is deeply weathered to be laterite soil. These landforms and related soils represent a geomorphological sequence of “inselberg and pediment”. At Bukit Batu along the Trans-Kalimantan Highway, to the east of Town Kasongan, similar but smaller landforms and soils including many corestones on the hills and tafoni, weathering pits and grooves are typically developed (Fig.3).

At many localities particularly from Kasongan Town to Sampit City (ex. near Pundu and Patai Villages: see Fig. 2) along the Trans-Kalimantan Highway, we easily notice the deep weathering into the basement rocks which might be basic rocks. We should identify this deep weathering as Saprolite development. The Saprolite horizon must reach the depth more than several tens of meters. It must be noted that similar isolated residual hills are distributed at some localities even near the present coast, judging from the contour configuration representing the isolated small hills.

The submergence of the Sunda shelf seems to contribute such distribution of residual hills. This geomorphological condition appears to provide a fundamental geomorphological environment for the development of coastal peat swamps but there is little evidence of former extensions of the peats to higher levels. These landforms and weathering phenomena must be resulted from the stripping of saprolite to expose fresh rock as bedrock-rooted boulder inselbergs. It is said that these erosional residuals, whether of fresh or saprolite, are the product of a long history.

In the western Kalimantan, Valetton *et al.* (1991) cited the bauxites on the residual hills. It is well known that the formation, evolution and destruction of lateritic formation is closely related to the history of the landform. The time for significant laterite development ensures that they record the environmental changes of weathering and pedogenesis over long periods. It is absolutely certain that the landform of Central Kalimantan Plain is founded by the etchplain with the thick saprolith development.

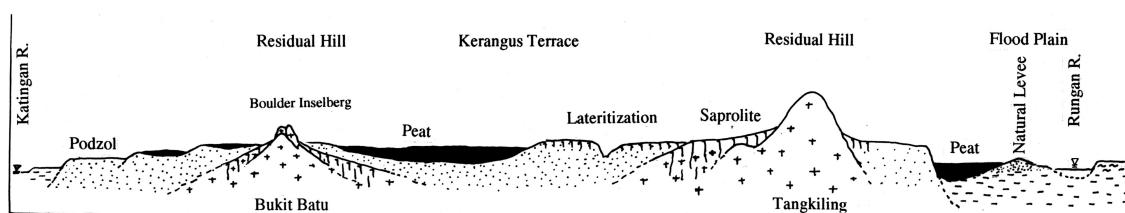

Fig. 3 Schematic cross section of landforms of the Central Kalimantan Plain  
This section is according to the landforms between Tangkiling and Kasongan Town  
vicinity along the Trans Kalimantan Highway

### Kerangas Plain

The low-lying Central Kalimantan Plain mainly consists of arkose sand called kerangas, which is podzolized white sand deposits. These characteristic sand deposits have been noted from many tropical humid areas, which is described by Duchaufour (1982) as tropical hydromorphic podzols. Brabant (1987) showed that the correspondence of podzols in Central Kalimantan with the distribution of broad flat interfluvial Quaternary sandy sediments.

It must be first of all stressed that terraced landform with residual hills widely occupies the Central Kalimantan Plain. This Kerangas Plain probably consists of two or three different terraces. As is observed near the Tangkilin Village 2-3 m thick lateritic yellow~red soil is developing on the terrace (Fig.3), while lower terrace surfaces are composed of fresh kerangas sand only with tropical podzol. This sediments contain little-worn gold and angular quartz shards. They appear as podzolized white sand at present, forming terrace-like features that fall more steeply towards the coast line than the gently inclined floodplains. It is noticeable that the kerangas terrace represented by

narrow intervals of contour lines 5, 10 and 15 m can be widely followed particularly in the almost whole region between the Kahayan River and the Mentaya River. The dissection of the kerangas surface is more or less taking place. In particular these valleys in the lower reaches, like ex. Bulan River, must have once been deepened in response to the lowering of sea level during the Last Glacial period, and again buried along with the Holocene transgression. The uppermost area of these small dissecting valleys sometimes shows shallow depression. This landform development and related depressional landform in the valley head area seem to be a relevant condition for the peat formation.

How and when has the vast gentle kerangas alluviation taken place? Is the kerangas plain alluvial fan of the Glacial stage in origin? There are large accumulations of alluvial sediments during the Pleistocene also in West Kalimantan. They fall into two groups such as the older terrace deposits of >40 ka and the younger flood plain sediments of < 10.5 ka. (Thorp *et al.*, 1990). Thomas (1994) stressed that the sediments may relate to prolonged late Pleistocene low sea levels, combined with drier climate. He suggests that the particular episodes of sedimentation occurred at each of warming peaks on the curve of paleotemperatures for the last glacial cycle. However we need to collect such evidence directly from the Central Kalimantan Plain.

According to Thomas (1994) sudden floods, and rapid deposition might have been the conditions of sedimentation. The late Pleistocene alluviation in Central Kalimantan are almost entirely fluvial in origin and form distinct terraces. Thomas (1994) considers that the rapid deposition and aggradation are clear and large accumulation of kerangas in Kalimantan Plain appears to have been deposited as a result of rapid erosion in small catchment area. It might from this view lead to the conclusion that catchment conditions must have exposed the fragile saprolites to high runoff and severe erosion under an open vegetation cover, although the drainage area of rivers are entirely in an equatorial forest at present.

### **Holocene alluviation**

It is well known that the Java Sea had almost entirely landed to be Sundaland during the Pleistocene low sea level, where extensions of present drainage occurred to have constituted the huge drainage systems. The sea level rise since the Last Glacial Maximum should lead to accumulation in the lower reaches of each river.

Judging from the contour configuration, however, the Holocene transgression seems to have influenced to the development of the Central Kalimantan Plain only in a restricted area. The present meander belt is formed cutting several meters into the kerangas Plain. This implies that the landform development and related subsurface geology in the meander belt are totally different from those of the surrounding kerangas plain. Along such large rivers as the Kahayan River and the Barito River, contour lines of 5 and 10 m intrudes ca. 50~60 km from the river mouth toward the inland. Particularly the flood plain along the Barito River is very widely developed to show a different contour line configuration from those of the other rivers. The Katingan River develops a cusped delta indicating enough sediment supply. In contrast, the Sebangau River has not prominent sedimentation, but a drowned landform. These areas should be strongly affected by the Holocene transgression.

### **Abandoned drainage basin and underfitting of river**

Along the lower reach of Rungan River, a tributary of Kahayan River, there exists thick peat formation in the flood plain (Fig.3). Rungan does not have the drainage basin in the high mountains, but restricted almostly within the kerangas plain at maximum 100 m above sea level. However it has comparatively large channel and wide meandering and natural levee or abandoned inter-channel bar. This alluvial lowland of the Rungan River is developed cutting the kerangas Plain. The width of meander belt is almost same as that along the Kahayan River, which occupies the drainage basin in the high mountains up to 1,000 m above sea level.

An important fact for understanding the development of the Rungan River system is that suspended load is not occurring even in the high water condition during the present rainy season. This means that the present the Rungan River is underfitting to the former larger river valley probably during the Last Glacial period. Rungan River during the Last Glacial period probably had much more run-off to produce the larger alluvial plain. The vast area of former flood plain becomes a stagnant water condition during every rainy season, that is the adequate environment for peat development. This must be the condition for the development of thick peat, 3~4 m in thickness.

It must be also noticed that there are some abandoned drainage basins that should have been produced by the large-scale shift of main river channels. The typical example is the Sebangau River basin, which has a drainage area only within the Plain below ca. 15 m above sea level. In comparison with such characteristic drainage area, it has relatively wide alluvial lowland covered with dense vegetation. Such misfitted present Sebangau River implies that river piracy had once occurred around Palangkaraya and thus the upper drainage basin including high mountain region had been cut off from the present Kahayan River System. Vast swampy area of the Bulan River, a tributary of the Katingan River seems to have been influenced by the downcutting and followed burying associated with sea level change through the Last Glacial to Holocene. Thick peat along the Bulan River must depend on this landform evolution.

### **Some Aspects on the Present Alluviation from Different Areas**

#### **Subsurface sediment from Palangkaraya to Kuala Kapuas**

We observed the subsurface deposit outcropping along the present river cliff. Although our observation is restricted only at several places, we could not any thick peat in this region, but always the fluvial silty deposits. It is particularly significant that subsurface deposits are composed of silt and clay also along the canal excavating the Plain between the Kahayan River and the Kapuas River in this region. Also in the 1Mha area near Dadahup, thick peat is not recognized. According to the distribution map of peat by Sieffermann (Fig. 1), thick ombrogenous peat must be distributed in this region, even though this part of the Kahayan-Barito alluvial plain consists of Holocene fluvial sediments.

#### **Subsurface sediment of the upstream from Palangkaraya**

Along the present river channel, the fine sediment can be continuously observed. They consist of the alluvial lowland of the meandering belt. For example, at the site where the village Bawan situated, alluvial deposits of 4 m in thickness are outcropped: upper ca. 3 m is homogeneous light yellowish brown silt~clayey sediments and shows the occurrence of pseudogley process at present. These deposits unconformably overlies the

dark brown silt~fine sand with laminae or cross bedding containing organic matter. This depositional sequence appears to indicate the general facies of the alluvial lowland in relation to the present meander belt, as far as the upstream region from around Palangkaraya is concerned. The upper silt and clay are supposed to be the deposits due to the recent alluviation, or overbank deposits. On the basis of C-14 date of the organic material,  $1920 \pm 60$  yBP (Beta-131268), the rate of the present alluviation is ca. 2mm/year.

In some places we can observe that these deposits were once cut and then buried by peat. This fact means that the cut off of river channel due to the meandering or the channel shifting within the meander belt is occurring. Peat can be formed only in such a favorable condition within the present meander belt. We should collect such peat at different places in order to obtain the absolute dates and to discuss the variable issues on fluvial geomorphology and present fluvial environment.

### **Thick peat near Palanglaraya**

Only at a site (Berengbengkel) on the Plain near Palangkaraya where the new canal/ditch is excavated, thick woody peat is outcropped. The peat is composed mainly of rainforest trees. The thickness is at least 2.5 m. The base of the peat is not yet outcropped. At this site, several kerangas rip up clasts of 30-50 cm in diameter were contained in the peat formation. These rip up clasts are very significant to discuss the sedimentary environment of the thick peat formation. The rip up clasts must have been eroded by stream water from the nearby river bank while the rainforest tree trunks and the other organic matter had accumulated in the stagnant water condition. Therefore this thick peat is not ombrogenous in origin, but have been developed in or near the (abandoned) river channel. The present fluvial environment of the upper Sebangau River or many abandoned channels during the rainy season appears to represent such a condition. This fluvial environment could be produced by the occurrence of large-scale stream piracy.

### **Concluding Remarks**

On the basis of the topographic map- interpretation and field observation, we can draw some concluding remarks and perspectives as follows:

1. Landforms of the Central Kalimantan Plain are basically consisting of erosional plain with residual hills and saprolith indicating the long-term development. More field description as well as laboratory work are absolutely needed to examine the soil formation under the humid tropical environment.
2. Pleistocene kerangas Plain or geomorphologically terraced surface had developed stripping and burying this erosional surface. Distribution of the ombrogenous peat reported in the previous papers almostly correspond to the kerangas terrace surface. It is not so easy to decide, whether the peat on the kerangas terrace is of ombrogenous or not, judging from the landforms in this regions.
3. Landform evolution since the Last Glacial stage to Holocene must be examined for understanding the development of tropical peat, particularly on the formation process, distribution and type of peat.
4. Present alluviation is restricted to the area along the river channel. C-14 dates of buried tree trunk and fragments often found in this deposits indicate the rate of present alluviation, ca. 2mm/year.



5. The most important and fundamental factor for the peat accumulation in the tropical region is relatively long duration of water stagnation in every year. Occurrence of peat appears to be topographically controlled. They occur in the abandoned meander channel as a plug sediment within the meander belt. On the other hand, most significant thick peat should have been associated with the large-scale channel migration or with shallow depression on the kerangas Plain. The typical example is the uppermost Sebangau River, where the main river had once shifted to the present Kahayan River. Therefore, the present Sebangau River is strongly misfitted to the former large channel and wide meander belt to produce an adequate environment for the peat formation.

6. Considering such geomorphological control of peat formation, the distribution of peat in the Central Kalimantan Plain might have been overestimated in volume. Precise mapping including the views from geomorphological and Quaternary geological development of the Central Kalimantan Plain is still needed.

### References

- BAKOSURTANAL. 1997. Peta rupabumi Indonesia 1:50,000, National Coordination Agency for Surveys and Mapping.
- Brabant, P. 1987. La repartition de podzols a Kalimantan. In *Podzols et Podzolisation*. pp. 13-24, AFES and INRA.
- Duchaufour, P. 1982. *Pedology, Pedogenesis and Classification*. Allen, London.
- Sieffermann, R. G. 1988. Le systeme des grandes tourbieres equatoriales. *Annal. Geographie*, 544: 642-666.
- Thorp, M. B. and Thomas, M. 1990. The timing of alluvial sedimentation and floodplain formation in the lowland humid tropics of Ghana, Sierra Leone and Kalimantan. *Geomorphology*, 4: 409-422.
- Thorp, M., Thomas, M., Martin, T. and Whalley, W. 1990. Late pleistocene sedimentation and landform development in western Kalimantan (Indonesia, Borneo). *Geologie en Mijnbouw*, 69: 133-150.
- Shepherd, P. A., Rieley, J. O. and Page, S. E. 1997. The relationship between forest vegetation and peat characteristics in the upper catchment of Sungai Sebangau, Central Kalimantan. In: *Biodiversity and Sustainability of Tropical Peatland*, pp. 191-210, Samara Pub.,
- Thomas, M. 1994. *Geomorphology in the Tropics*. Wiley, 460 pp.

## **Chemical Compounds in Gas Emitted from Tropical Peat Soil with Burning with and without Oxygen**

**Masanori OKAZAKI<sup>1</sup>, Chu-ichi WATANABE<sup>2</sup>,  
Masato YOSHIKAWA<sup>1</sup>, Chihiro YAMAGUCHI<sup>1</sup> and Norio YOSHIMURA<sup>1</sup>**

<sup>1</sup> Tokyo University of Agriculture and Technology, 2-24-16,  
Nakacho, Koganei, Tokyo 184-8588 Japan

<sup>2</sup> Frontier Laboratories LTD, 61-2, Otusbo, Otsuki,  
Koriyama, Fukushima 963-0201 Japan

### **Introduction**

The forest fire is connected to the human activities, such as the sifting cultivation, constructing roads, and agricultural development. The big fire gave the serious damage in tropical forest. Especially in 1997, severe forest fire occurred under the dry weather condition (Usup *et al.*, 1999). There are few information on the compounds in gas emitted from the burning of tropical peat soils, although the smoke affected the lung of human beings and disturbed the aircraft control (Okazaki *et al.*, 1999). The objective of this study is to identify the compounds in gas emitted from the burning of tropical peat soil using double shot pyrolysis (DSPy)-capillary gas chromatography (GC)-mass spectrometry (MS). The analysis of organic compounds in plant, soil organic matter and humic substances has been performed by Curie-point pyrolysis-gas chromatography, although it had the identification problems of lots of peaks (Samukawa *et al.*, 1991a, b, 1992). In this report double shot pyrolysis-gas chromatography-mass spectrometry was used.

### **Materials and Methods**

Soil samples were taken from the surface horizon around Mukah and Dalat area of Sarawak: Igan, Dalat, Talau, Mudan, and Mukah (Fig. 1). They were classified into Tropical deep peat soils and Tropical shallow peat soils. The Mukah sample was fractionated by the sieves of 2, 1, 0.5, 0.21, 0.149, 0.105, 0.075 and 0.045 mm in pore size. Carbon and nitrogen content in soil samples were determined by the CN corder (Yanagimoto MT-500). DSPy (Frontier Lab, PY2020D)-capillary GC (Hewlett Packard, HP6890 Series GC System)-MS (Hewlett Packard, HP 5973 Mass Selective Detector) was used for the identification of compounds in gas (Fig. 2). The combination analysis of thermal desorption and pyrolysis of substances have been done (Watanabe, 1996). One mg of soil sample was taken into the sampler. The separation and identification of compounds in gas emitted by the combustion in the pyrolizer was performed by the capillary gas chromatography and mass spectrometry system with Wiley Library (Data Base). Analytical conditions are as follows, pyrolysis temperature: 600°C, carrier gas He: 50 kPa, 1 ml min<sup>-1</sup>, split vent flow: 100 ml min<sup>-1</sup>, gas chromatography detector: FID, column: 5% diphenylpolysiloxane, 30 m (0.25 mm in diameter, 0.25 µm film), column temperature: 40°C (3 min) to 320°C at 10°C min<sup>-1</sup>, m/z: 29-500, scan speed: 2 scans s<sup>-1</sup>.



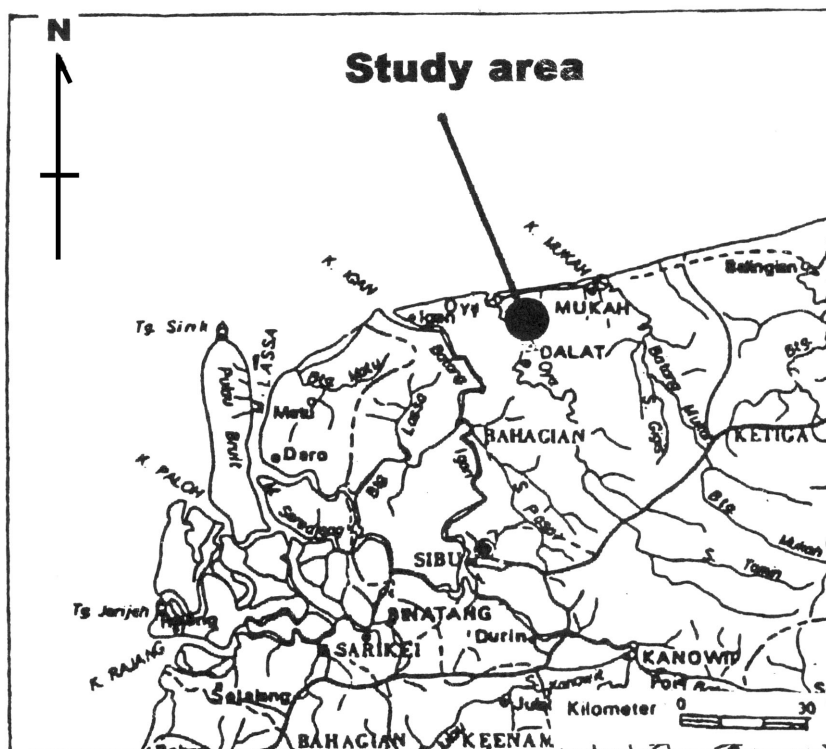

Fig. 1. Study area.

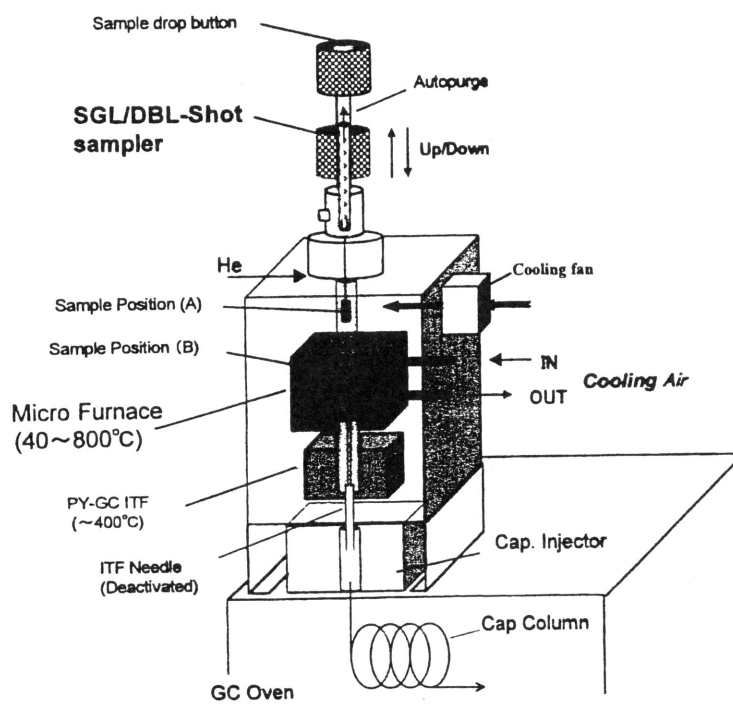

Fig. 2. Double-shot pyrolysis-GC-MS analysis.

## Results and Discussion

### Carbon and nitrogen content in tropical peat soils

Total carbon and nitrogen content in soil samples shown in Table 1 vary from 383 to 548 g kg<sup>-1</sup> and 15.8 to 20.8 g kg<sup>-1</sup>, respectively. The C/N ratios of the samples were in the range of 18.4 to 33.7, with the highest value in Balan. These figures indicated the chemical properties of typical tropical peat soils (Yonebayashi *et al.*, 1991; Yamaguchi *et al.*, 1994). The Mukah sample fractionated by the sieves showed the decreasing tendency of the C/N ratios with the decrease in the particle diameter, suggesting the contribution of high nitrogen content by microorganisms (Table 2).

Table 1. Tropical peat soil samples used.

| Location | Classification | Land use                  | Horizon<br>cm | TC  | TN   | C/N  |
|----------|----------------|---------------------------|---------------|-----|------|------|
| Igan     | Shallow        | Farmer's garden           | 2-17          |     |      |      |
| Mudan    | Shallow        | Farmer's garden           | 0-15          | 383 | 20.8 | 18.4 |
| Mukah    | Deep           | Sago plantation           | 0-10          | 542 | 16.4 | 33.0 |
| Balan    | Shallow        | Farmer's garden           | 0-22          | 533 | 15.8 | 33.7 |
| Talau    | Deep           | Sago experimental station | 0-15          | 548 | 16.8 | 32.6 |

Table 2. Physical fractionation and organic matter content in the Mukah sample.

| Diameter, mm | Total carbon, g kg <sup>-1</sup> | Total nitrogen, g kg <sup>-1</sup> | C/N  |
|--------------|----------------------------------|------------------------------------|------|
| > 2          | 423.0                            | 20.5                               | 20.6 |
| 1-2          | 509.1                            | 19.8                               | 25.8 |
| 0.5-1        | 256.8                            | 11.4                               | 22.7 |
| 0.21-0.5     | 506.3                            | 21.7                               | 23.4 |
| 0.149-0.21   | 491.4                            | 23.0                               | 21.4 |
| 0.105-0.149  | 469.3                            | 22.8                               | 20.6 |
| 0.075-0.105  | 523.3                            | 26.0                               | 20.1 |
| 0.045-0.075  | 424.5                            | 22.0                               | 20.6 |
| 0.045-0.075  | 539.5                            | 26.5                               | 20.3 |

### Compounds in gas emitted from the burning of tropical peat soils

From the gas chromatograms and mass spectrograms of the gas components from Mudan more than 80 compounds were identified as aliphatic and aromatic hydrocarbons, furfurals and organic acids: acetic acid, benzene, pyridine, toluene, furfural, methyl-xylene, styrene, 5-methyl-furfural, phenol, o-cresol, p-cresol, 2-methoxyphenol, catechol 2,3-dihydrobenzofurane, levoglucosan, hydrocarbons with 12 to 32 carbon numbers and so on (Fig. 3). Aliphatic hydrocarbons showed longer retention time than aromatic hydrocarbons. Benzene is one of the cancer-causing substances for workers (National Astronomic Institute, 1994) (Table 3). Levoglucosan is one of the characteristic substances that emitted from the combustion of the paper or cellulose sample. Fig. 3 also shows the hydrocarbons with 4 to 32 carbon numbers which have none (saturated),

one (mono) and two (dien) double bonding. The chromatograms showed the similar patterns among different soil samples. However, the different concentrations in phenol were obtained, with the highest value in the Mukah sample. The different amounts of compounds emitted from the combustion of tropical peat soil samples were found, based on the temperature and oxygen gas concentrations (Fig. 4).

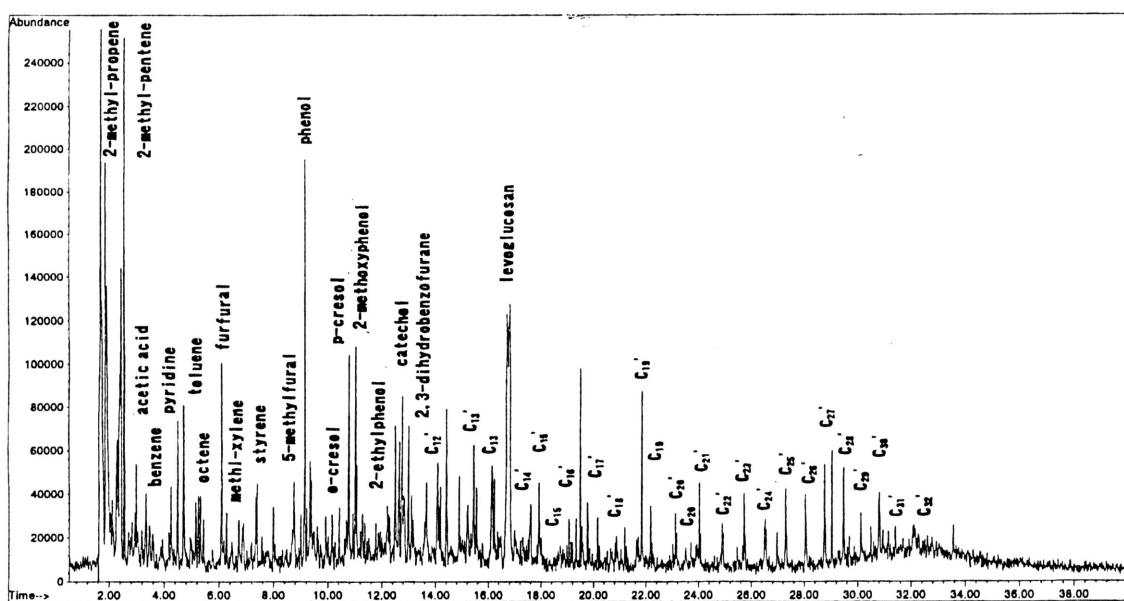

Fig. 3. Gas chromatogram of the gas emitted from the combustion of the Mudan sample.

Table 3. Tentative table of cancer-causing substances for workers (1981).  
(National Astronomic Institute, 1994)

| Substance                          |                                |
|------------------------------------|--------------------------------|
| 4-aminodiphenyl                    | $C_6H_5C_6H_4NH_2$             |
| Vinyl chloride*                    | $CH_2=CHCl$                    |
| Asbestos                           | (chrysotile $Mg_6Si_4O_{11}$ ) |
| 2-naphtylamine                     | $C_{10}H_7NH_2$                |
| 4-nitrodiphenyl                    | $C_6H_5C_6H_4NO_2$             |
| Bis(chloromethyl)ether             | $ClCH_2OCH_2Cl$                |
| Benzidine                          | $H_2NC_6H_4C_6H_4NH_2$         |
| Benzene                            | $C_6H_6$                       |
| Benzotrichloride                   | $C_6H_3Cl_3$                   |
| Nickel (Refine)**                  |                                |
| Soot, Tar, Pitch and Mineral oil** |                                |
| Chromium compounds**               |                                |
| Arsenic compounds**                |                                |

\* Vinyl monomer

\*\* All of the cancer-causing compounds were not identified.

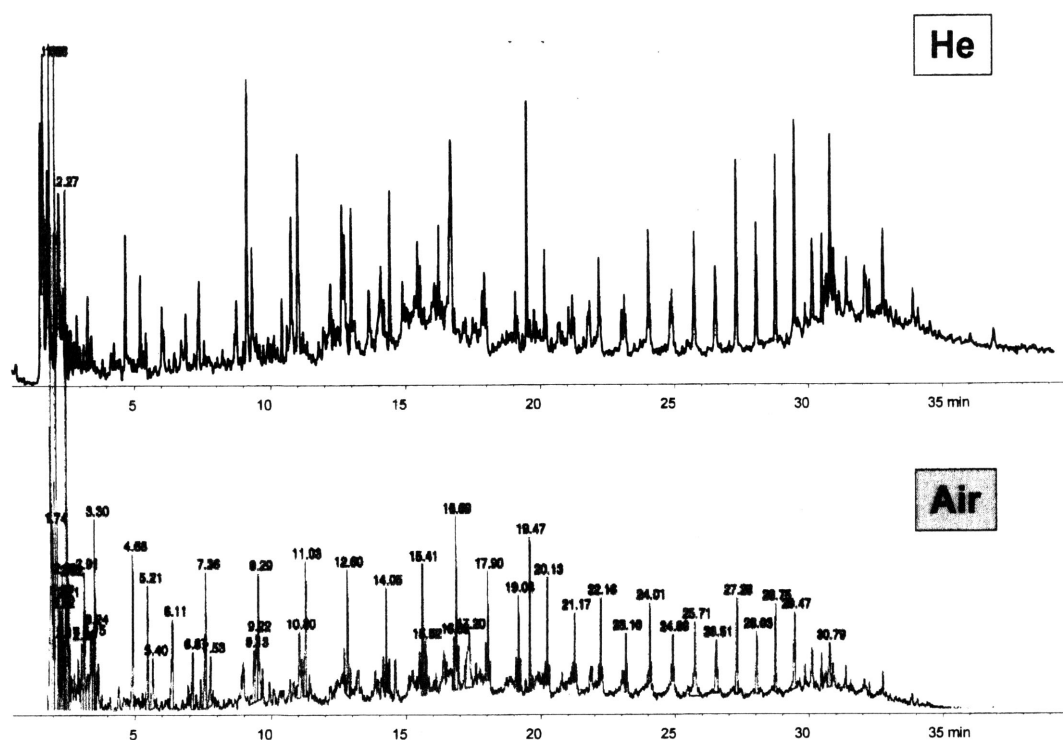

Fig. 4. Comparison of pyrograms in inert and air circumstances at 600°C.

### Conclusion

More than 80 compounds emitted from tropical peat soil samples with burning were identified using double-shot pyrolysis-capillary gas chromatography-mass spectrometry.

### References

- National Astronomic Institute. 1994. *Annual Scientific Book*, Maruzen, Tokyo, p. 586.
- Okazaki, M., Watanabe, C., Yoshikawa, M., Yamaguchi, C. and Yoshimura, N. 1999. Chemical compounds in gas emitted from tropical peat with burning with and without oxygen. *Abstracts of International Symposium on Tropical Peatland Management, Ciloto, Indonesia*, JSPS and LIPI, p. 31.
- Samukawa, K., Matsuyama, M., Akimori, N. and Komai, Y. 1991a. Chemical characterization of *Chrysanthemum coronarium* roots grown under deficiency of iron nutrient condition by curie-point pyrolysis-gas chromatography-mass spectrometry. *Jpn. J. Soil Sci. Plant Nutr.*, 62: 593-598
- Samukawa, K. Akimori, N., Nakata, T. and Komai, Y. 1991b. Chemical characterization of soil organic matter by Curie-point pyrolysis-gas chromatography-mass spectrometry. *Jpn. J. Soil Sci. Plant Nutr.*, 62: 599-605
- Samukawa, K., Kawaguchi, M. and Komai, Y. 1992. Chemical characterization of soil humic acid by Curie-point pyrolysis-gas chromatography-mass spectrometry. *Jpn. J. Soil Sci. Plant Nutr.*, 63: 10-15
- Usup, A., Takahashi, H. and Limin, S.H. 1999. Aspect and mechanism of peat fire in a tropical peatland: A case study in Palangkaraya, Central Kalimantan, 1997.

*Abstracts of International Symposium on Tropical Peatland Management, Bogor, Indonesia*, JSPS and LIPI, p. 50.

Watanabe, C. 1996. Challenge to the reproducibility of pyrolysis-gas chromatography and its further development. *Bunseki (Analysis)*, 1996(9): 747-752.

Yamaguchi, C., Okazaki, M. and Kaneko, T. 1994. Sago palm growing on tropical peat soil in Sarawak with special reference to copper and zinc. *Sago Palm*, 2: 21-30.

Yonebayashi, K., Okazaki, M., Kyuma, K., Takai, Y., Zahari, A.B., Jiraval, P. and Pisoot, V. 1991. Chemical decomposition of tropical peat. *Tropical Peat: Proceedings of the International Symposium on Tropical Peatland, 6-10 May 1991, Kuching, Sarawak, Malaysia*, Malaysian Agricultural Research Development Institute and Department of Agriculture, Sarawak, pp. 158-168.

## **Some Characteristics of Tropical Podzols in Kalimantan**

**M. DJUWANSAH**

Research and Development Center for Geotechnology - LIPI

### **Abstract**

Tropical podzols in Kalimantan have been discussed in term of morphology, geochemistry, and chemical fertility. Tropical podzols widespread in Kalimantan on flat to gently sloping lowland. Kerangas forest generally covers this soil. The solum is very thick, formed by continuous intensive leaching for long period. The fertility of the soils is characterized by acidity and poor in nutrient elements. The understanding of water cycle in kerangas forest is indispensable to determine both improvement and rehabilitation design.

### **Introduction**

Podzols commonly occur in humid tropic. It differs from those in temperate climate by the great thickness of the solum produced by continuous intensive leaching. Giant podzols (Dames, 1962) or tropical podzols generally apply to name this soil to distinguish it from ordinary podzols. Tropical podzol greatly extends in three provinces of Kalimantan and in Serawak, on flat to gently sloping lowland. Particularities of Kalimantan for the formation of podzols are that geologically, the biggest part of Kalimantan is a cratonic block where volcanism is absent and, climatically, posses a high rainfall since it situated at the equatorial zone. Low fertility status is another characteristic of this soil. The typical land cover of tropical podzols is Kerangas forest, which is easily recognized by its poor in species diversity (Suzuki *et al.*, 1999).

The objective of this review is to give the illustration on the podzols in Kalimantan and the general overview of it roles in the ecology of Kalimantan, mainly on water resources.

### **Methods**

A soil profile described in this report was observed at gold mining site at Mandor area in West Kalimantan. Samples have been taken from each horizon of this profile. Fertility Analyses have been carried out following the method elaborated at the Soil Laboratory of R&D Center for Geotechnology - LIPI, summarized below. Mineralogical analyses have been carried out using Philips XRD analyzer with Cu-K $\alpha$  radiation at two $^\circ$ /min rotation speed. Composition of major elements in mineral fraction of the soil has been also analyzed.

### **Results**

#### **Geographic setting**

Kerangas forest, as the marker of tropical podzols in Kalimantan, extends widely, occupies the central part of the islands. This forest formation is mostly widespread at gently sloping lowland plain, situated between dipterocarp forest which covers hilly area and swamp forest which cover flood plains or mangrove which cover tidal plains.

The general pattern of podzols distribution situated at large physiographic transition between coastal area and hilly area of the island. Most of the parent materials

of this soil consist of unconsolidated eroded materials, such as colluvium and alluvium deposits. By the presence of relatively high porosity of these parent materials, the mechanism of leaching and soil formation is very intensive that forms a very thick weathering profile.

The Humidity of forest floor is high in most of the years, often inundated either periodically or permanently. Moreover, inundation inhibited organic matter decomposition and provokes plant debris accumulation and form of peat deposit. It is not surprised that kerangas forest soil profile is found beneath several meter peat deposit, mainly at the downstream at the border of coastal area as the consequence of sea level change.

### Soil morphology

The typical morphology of soil profile, from the surface toward the depth consists of:

- (1) A-0 Horizon: consist of vegetation litter or peat layer.
- (2) A-2 Horizons: mixture of organic and mineral fractions.
- (3) A-2 or A-E bleached Horizon: white sands and silt.
- (4) A-3 or A-B horizon: the transition between A and B-horizon.
- (5) B-2 or B-humic or Placic Horizon: loose and structureless black brown sands, silt, and clay when wet and become hard, if dry.
- (6) A-3 Horizon: kaolinitic layers or sandy sediments
- (7) C-Horizon: parent materials.

A-0 horizon could be presents as very thick peat deposits at inundated area. At undulating area, A-0 is thinner or lack. A1 and A3 normally thinner: less than 10 cm. Whereas A2 and B-2 are generally thick: two to five meters. The total thickness of soil profile in flat area may reach seven-eight meters, whereas at undulating area solum is generally less thick than in the flat area. In the dry undulating area, white sandy A2 horizon could appear as soil surface. Moreover at severely eroded area, often all A-horizon was completely removed and B-horizon sinks at soil surface.

For most cases its very difficult to make a complete soil profile for description of tropical podzols in Kalimantan due to high water table, beside the solum depth. A detailed soil profile described below is an example of a complete profile which could be observed at a dug pit where the water was pumped for gold mining in Mandor area, west Kalimantan (Table 1).

Table 1. Profile description of podzols at Mandor, West Kalimantan.

| Depth, cm | Horizon         | Description   |
|-----------|-----------------|---|
| 0 - 5     | A0              | Hemic Peat and Roots.   |
| 5 - 20    | A1              | Black (2,5 Y 2/0 to 2/1) sandy peat / peaty sand, medium to coarse sub angular blocky; friable to loose consistency; many medium to fine roots; slightly sticky and not plastic; gradual boundary |
| 20-100    | A2 or AE        | White (10YR 7/1) quartz sand; loose; clear and wavy boundary  |
| 100-300   | B-h or B-placic | Black (2,5 YR 2/1) pan inter fingering with yellowish hard iron pan; sandy; structureless; very hard in dry condition and very friable to loose when wet.   |
| <300      | Parent material | Sedimentary laminar structured blacky sands and clays.  |

The described soil profile shows a trace of important erosion. The thickness of A-2 horizon seems very reduced comparing to B-2 which is theoretically the product of accumulation of leached materials from A-horizons.

Soil texture is sand predominant in all depth of the profile. Soil structure and consistency is varied from one horizon to another. In A-0 Horizon, weak to medium sub angular blocky is developed. In A2 the structure is less developed. Loose sands found in A-2 horizon indicating the low proportion of clay. At B-2 horizon, the structure is not developed when wet. After drying B-2, become hard pan, indicating the formation of cementing agent upon drying of clay and complexes metal and organic matter.

Normally high sand fraction content related to high porosity. However, in fact Kerangas Forest soil has a bad drainage property that inundation and flooding usually happen after rainfall. Factors that may reduced porosity could be originated from other smaller sized constituent of soil mass distributed within inter granular pore space of sandy materials. In point of view of soil morphology, B-2 horizon could be suspected as the zone of low porosity in soil profile. High content of clay in C-Horizon could be the important reducer of soil porosity as well.

**Geochemistry**

Geochemistry of major elements and its distribution within soil profile is listed in Table 2.

Table 2. Chemical composition of major elements (%)

| Horizon | SiO <sub>2</sub> | Al <sub>2</sub> O <sub>3</sub> | Fe <sub>2</sub> O <sub>3</sub> | MnO  | TiO <sub>2</sub> | P <sub>2</sub> O <sub>5</sub> | CaO  | MgO  | Na <sub>2</sub> O | K <sub>2</sub> O | H <sub>2</sub> O | LOI  |
|---------|------------------|--------------------------------|--------------------------------|------|------------------|-------------------------------|------|------|-------------------|------------------|------------------|------|
| A1      | 89.86            | 1.83                           | 0.04                           | -    | 0.62             | 0.97                          | 0.11 | 0.02 | 0.06              | 0.49             | 0.79             | 3.53 |
| A2      | 91.95            | 1.70                           | 0.43                           | 0.02 | 0.75             | 1.35                          | 0.02 | 0.02 | 0.58              | 0.58             | 0.19             | 1.20 |
| B       | 88.41            | 3.50                           | 0.93                           | -    | 0.98             | 0.88                          | 0.06 | 0.01 | 0.48              | 0.49             | 1.51             | 4.05 |

SiO<sub>2</sub> is clearly predominant in chemical composition. This indicates that the mineralogical property of the soil is much enriched by quartz. XRD diagram of B-Horizon shows that only Quartz and Kaolinite, which is detected by XRD, analyses. Whereas the quantity of other minerals is very small that could not be detected. In all profiles, the proportion of other elements is less than 10 %. The most of major element concentrations rarely exceed 1%. Iron and Aluminum could be present as oxy-hydroxide minerals such as Goethite and Haematite and Gibbsite, since the content of Crystal-H<sub>2</sub>O is significant, mainly at B- Placic Horizon.

The evidence of illuviation on B-horizon appears only for Aluminum, iron and Titanium. Whereas for other elements, the trace of leaching mechanism is not significantly show.

**Chemical fertility**

Some important chemical fertility parameters are listed in table 3. In general, soil is very acid and poor in nutrient content. The richer part of the soils is at A-0 and B-Placic Horizons and the poorest is A2-horizon. The richness of these horizons seems related to the high value Exchange Capacity (EC). The content of humic substances in both A-0 and B-2 horizons is high (Table 3).



Table 3. Some parameters of chemical soil fertility

| Depth,<br>cm | pH               |     | C-Org<br>% | N Total<br>% | P <sub>2</sub> O <sub>5</sub><br>mg/100g | K <sub>2</sub> O<br>mg/100g | CEC, meq/100g    |                  |                 |                | EC,<br>meq/100g | KCl - 1N<br>meq/100g |                |
|--------------|------------------|-----|------------|--------------|--|-----------------------------|------------------|------------------|-----------------|----------------|-----------------|----------------------|----------------|
|              | H <sub>2</sub> O | KCl |            |              |  |                             | Ca <sup>++</sup> | Mg <sup>++</sup> | Na <sup>+</sup> | K <sup>+</sup> |                 | Al <sup>3+</sup>     | H <sup>+</sup> |
| 0-5          | 3.2              | 2.9 | 13.4       | 0.40         | 2.71                                     | 21.2                        | 1.80             | 0.59             | 0.28            | 0.17           | 25.56           | 1.27                 | 2.96           |
| 5-20         | 3.3              | 3.1 | 2.0        | 0.10         | 1.97                                     | 12.2                        | 0.52             | 0.23             | 0.17            | 0.12           | 5.93            | 0.04                 | 0.22           |
| 20-100       | 3.8              | 3.6 | 0.8        | 0.04         | 2.06                                     | 10.2                        | 1.54             | 0.22             | 0.24            | 0.11           | 2.18            | 0.53                 | 0.22           |
| 100-300      | 5.5              | 5.2 | 23.3       | 0.06         | 3.74                                     | 91.1                        | 1.45             | 0.09             | 0.27            | 1.27           | 34.82           | 0.03                 | 0.92           |
| <300         | 5.0              | 4.5 | 0.06       | 0.01         | 3.43                                     | 18.5                        | 0.51             | 0.19             | 0.15            | 0.05           | 11.97           | 1.02                 | 1.62           |

The contents of all nutrients in the soils are low to very low in whole profile according to FAO criteria (1982). Comparing to chemical composition of the soil mineral fraction (Table 2), the content of available bases within the soils (Table 3) is far lower, even though the content of potassium calcium, magnesium and sodium in the mineral fraction is far from abundant. It seems that most of mineral originated nutrients still presents as non-available form.

### Discussion

In spite of few data, the above presentation is pointed at the illustration of general properties of tropical podzols and related ecological problems in Kalimantan. Tropical podzols are known as poor soil. However, even in small quantity, this soil still has nutrient reserves, stored within mineral fraction. The problem is that most of this nutrient present under non-available form for plants. Non-available status of the nutrients due particularly to physico-chemical environment such as acidity. Under natural forest, non-available status of mineral originated nutrients is not an important problem as long as the nutrient cycle is still in a closed cycle. Many scientists believe that in tropical forest, plants uptake their nutrients from decomposed litter.

In disturbed forest such as timber exploited forest, this closed cycle cannot longer be maintained. New nutrient input from mineral soils below organic layer will be needed. One effort could be done to accelerate nutrient availability is to improve physico-chemical environment to be able for nutrient transformation from non-available status into available forms, among others by acidity control. The effort of physico-chemical milieu improvement is more important than fertilizer adding since fertilizer will be useless if the surrounding is unfavorable for nutrient availability.

To introduce milieu improvement within the soils, the understanding of water cycle and soil-plant-water relationship is indispensable, particularly in the forest of Kalimantan where the quantity and quality of water is not easily controllable.

### Acknowledgement

All reported data obtained from Mandor-West Kalimantan during fieldwork at 1993 and from Lahei-Central Kalimantan during fieldwork at 1998. Thanks to Dr. Suzuki and Dr. Kohyama who have kindly invited to participate in the two fieldworks and provided financial supports.

### References

- Dames. 1962. *Soil Research in the Economic Development of Sarawak*. FAO report no 1512.
- Driessen P. M. and Suhardjo, H. 1974. On the defective grain formation of sawah rice on peat. In: *Proc. ATA 106 Midterm Seminar*. Soil Res. Inst. Bogor.
- Hardon, H. J. 1937. Padang soils an example of podsol in tropical lowland. In: *Proc. Kom. Akad. Wet.*
- Siefferman, R. G. 1980. Le systeme de grand turbieres equatoriales. Unpubl. Orstom-Paris
- Suzuki, E., Kohyama, T., Simbolon, H., Haraguchi, A., Tsuyuzaki, S., Nishimura, T. and Seino, T. 1999. Vegetation of kerangas and peat swamp forests in Lahei, Central Kalimantan. In: *Environmental Conservation and Land Use Management of Wetland in Southeast Asia. Hokkaido University-R&D Center for Biology – LIPI, Ann. Rep. Apr. 1998-Mar. 1999.*

**Part 2**  
**Soil Sciences**

## **Chemical Properties of Peat Pore Water in Central Kalimantan with Special Reference to Vertical Profile**

**Akira HARAGUCHI<sup>1</sup>, Sawahiko SHIMADA<sup>2</sup>, SUWARNO<sup>3</sup>, Midori AKIOKA<sup>1</sup>,  
Kazuo YABE<sup>4</sup> and Hidenori TAKAHASHI<sup>2</sup>**

<sup>1</sup> Faculty of Science, Niigata University, Niigata 950-2181, Japan

<sup>2</sup> Graduate School of Earth Environmental Science, Hokkaido University,  
Sapporo 060-0810, Japan

<sup>3</sup> Bogor Agricultural University, Jl.Raya Pajajaran, Bogor, 16144 West Java, Indonesia

<sup>4</sup> Sapporo School of the Arts, Minami-ku, Sapporo 005-0864, Japan

### **Abstract**

We studied the chemical properties of peat pore water in the catchment of the Sebangau River, Central Kalimantan, Indonesia. We compared the chemical processes in tropical peat from Paduran in the lower catchment of the river and Bakung, Rasau, and Setia Alam Jaya in the upper catchment with those in temperate peat from Furen mire in eastern Hokkaido. The pH of the peat pore water in tropical peatland was lower than that in temperate peatland. The pH of the middle peat layer was lowest in the upper catchment of the river. This would be the combined result of precipitation at the peat surface and mineral supply from the underlying mineral layer. The pH of the bottom peat layer was lowest in the lower catchment of the river. This would be due to the oxidation of pyrite in the underlying mineral layer. The peat was constantly oxidative from top to bottom, although the redox potential decreased from top to bottom. This condition promotes the oxidation of pyrite.

### **Introduction**

Peatland is the largest pool of carbon in the world, estimated to be 329-528 Pg, accounting for one-third of the whole soil carbon pool (Post *et al.*, 1982; Immerzi *et al.*, 1992; Schimel, 1995). Maltby and Immerzi (1993) estimated that 15% of global peatland carbon is in the tropics, mostly in Indonesian peat swamp forests. The peat swamp forests are decreasing rapidly because of development for agriculture. Carbon dioxide and methane produced in their decomposition are thought to contribute to global warming.

Although peat covers a considerable area of tropical wetlands (Anderson, 1983; Neuzil, 1997), not enough fundamental data have been obtained. The process of peat formation and the chemical and physical properties of the peat are closely related to the topography, geology, hydrology, and climate of a site. In this study we aimed to clarify the chemical properties of peat with special reference to the coastal-inland gradient in the location of peatlands along a river system. We also compared the chemical properties of peat between tropical and temperate regions.

### **Study Area**

We surveyed four sites in the catchment of the Sebangau River, Central Kalimantan, Indonesia; Setia Alam Jaya, Bakung, Rasau and Paduran (Fig. 1). We also surveyed a site in Furen mire, eastern Hokkaido, Japan. Site characteristics are summarized in Table 1.

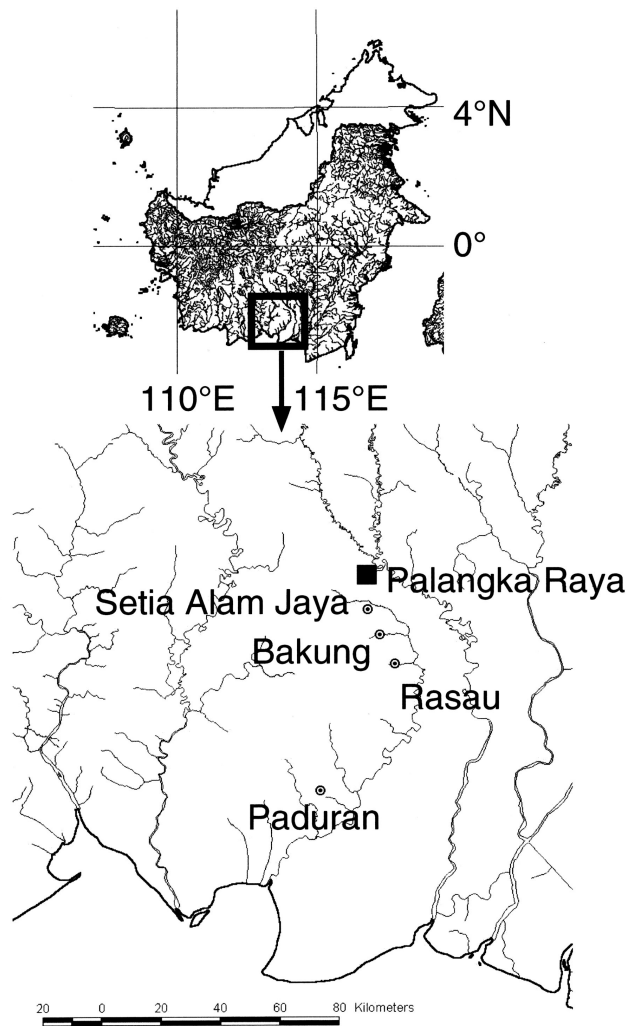

Fig. 1 The study area in Central Kalimantan.

Table 1. The characteristics of the study sites.

| Area            | Location                                    | Land use                       | Sediment | Pyrite  |
|-----------------|---|--------------------------------|----------|---------|
| Setia Alam Jaya | upper catchment of Sebangau River           | natural forest                 | sand     | absent  |
| Bakung          | upper catchment of Sebangau River           | natural forest                 | sand     | absent  |
| Rasau           | upper catchment of Sebangau River           | natural forest                 | clay     | absent  |
| Paduran         | lower catchment of Sebangau River           | paddy field,<br>natural forest | clay     | present |
| Furen           | lower catchment of Furen River,<br>Hokkaido | mire                           | clay     | absent  |

Setia Alam Jaya ( $2^{\circ}18'S$ ,  $113^{\circ}55'E$ ) lies in the upper catchment of the Sebangau River. The site is ca. 2.5 km from the river at an altitude of ca. 12 m a.s.l. The land system at the site is classified as 'Peat Covered Sandy Terraces' (RePPProT, 1985). The forest at this site is dominated by *Calophyllum hosei*, *Palaquim cochlearifolium*, *Parastemon*

*spicatus*, and *Combretocarpus rotundatus* (Shepherd *et al.*, 1997).

Bakung (2°24'S, 113°56'E) lies near the Bakung River, a tributary in the upper catchment of the Sebangau River, at an altitude of ca. 12 m a.s.l. The land system at the site is classified as 'Permanently Waterlogged Plain' (RePPPProT, 1985).

Rasau (2°30'S, 114°00'E) lies near the Rasau River, a tributary in the upper catchment of the Sebangau River, at an altitude of ca. 12 m a.s.l. The land system at the site is classified as 'Peat Basin/ Dome' (RePPPProT, 1985).

Paduran (2°53'S, 113°46'E) lies near the Paduran Canal in the lower catchment of the Sebangau River at an altitude of ca. 9 m a.s.l. The canal was built in 1986-1988. The land system at the site is classified as 'Alluvial Floodplain between Swamps' (RePPPProT, 1985). The study site was at Paduran I, one of three transmigration areas at Paduran.

Furen mire (43°17'N, 145°15'E) lies in the north-east of Japan and in the cool-temperate zone. The vegetation consists of ombrogenous Sphagnum mire and minerotrophic *Phragmites australis* (Cav.) Trin. ex. Steud. or *Alnus japonica* (Thunb.) Steud. community.

### Materials and Methods

We took sample cores with an Eijelkamp peat sampler, which can collect 50 cm (400 cm<sup>3</sup>) of core. Peat pore water was collected from bulk peat samples by filtering through nylon mesh (ca. 0.2 mm). The pH, electrical conductivity (EC), and redox potential (Eh) of the pore water were measured immediately after sampling.

Samples and measurements were taken in August 1998 in Paduran and Setia Alam Jaya, and in August 1999 in Bakung and Rasau.

### Results and Discussion

#### *Setia Alam Jaya*

We collected a sample core to a depth of 405 cm in natural forest. The pH of the peat pore water reached a maximum of 4.42 at a depth of 15 cm and decreased with increasing depth (Fig. 2). The pH fluctuated between 3.7 and 4.1 from 50 cm to the bottom, except at 370 cm. The EC was 10 mS m<sup>-1</sup> at the peat surface; it increased to 29 mS m<sup>-1</sup> at 85 cm, then decreased with increasing depth, but tended to increase again at the bottom. Eh increased from the surface to the depth of 100 cm and then decreased to the bottom. However, it remained >540 mV, and the peat was oxidative from top to bottom.

#### **Bakung**

We collected a peat core sample to a depth of 800 cm in natural forest just besides the Bakung River. The depth of the peat layer was 980 cm, and the bottom mineral layer was sand. The pH was ca. 5.5 at the surface; it reached a minimum of 3.12 at 290 cm, then increased to 5.02 at 800 cm (Fig. 3). The EC was 55 mS m<sup>-1</sup> at the surface, decreasing to 10 - 29 mS m<sup>-1</sup> below 25 cm. It tended to decrease with increasing depth, but increased again at the bottom. The Eh was 500mV at the surface, and it tended to decrease with increasing depth to a minimum of 420 mV at the bottom. The peat was oxidative from top to bottom.

Setia Alam Jaya (Central Kalimantan)

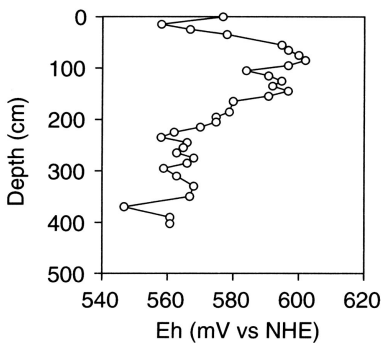
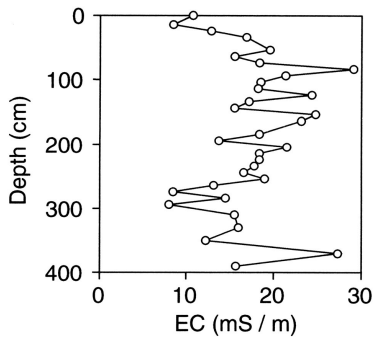
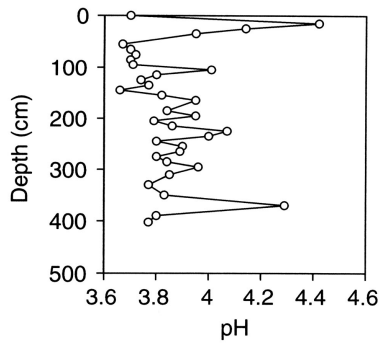

Bakung (Central Kalimantan)

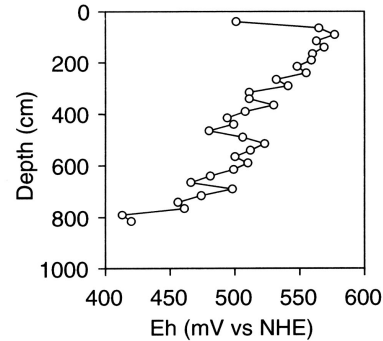
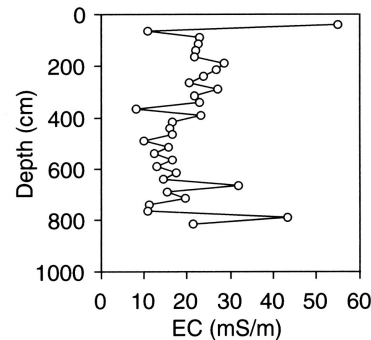
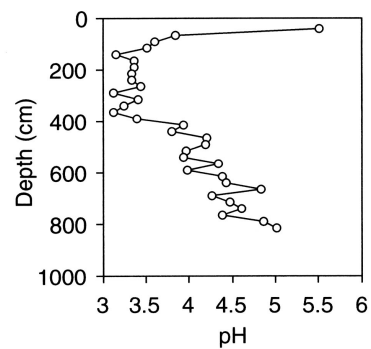

Fig. 2. pH (top), EC (middle) and Eh (bottom) of the peat pore water in natural forest a Setia Alam Jaya, Central Kalimantan.

Fig. 3. pH (top), EC (middle) and Eh (bottom) of the peat pore water in natural forest at Bakung, Central Kalimantan.

### Rasau

We collected two peat samples. Site P1 was ca. 100 m from the Rasau River, and P2 was just beside the river. Both sites were in natural forest. The depths of peat were 200 cm at P1 and 400 cm at P2. The underlying mineral layer was clay at both sites. The pH of the peat pore water tended to decrease with depth (Fig. 4). The pH was 3.9 - 4.0 at the surface; it reached a minimum of 3.3 - 3.6 at 80 - 180 cm, and was 4.0 - 4.5 at the bottom of the peat layer. The EC tended to decrease from the surface to the bottom, although it increased slightly at the bottom. At P1, the EC was  $28.4 \text{ mS m}^{-1}$  at the surface and was  $19.4 \text{ mS m}^{-1}$  at the bottom. At P2, it was  $10.2 \text{ mS m}^{-1}$  at the surface and  $6.8 \text{ mS m}^{-1}$  at the bottom. The Eh tended to decrease from the surface to the bottom. Its minimum value was 414 mV at the bottom of P2, but the peat layer was rather oxidative from top to bottom.

**Paduran**

In the forest at Paduran (site P1), the depth of the peat was 95 cm, and the ground water table was at 0 cm. The pH, EC, and Eh of the peat pore water were 3.47 - 3.66, 25 - 95 mS m<sup>-1</sup>, and 350 - 420 mV, respectively (Fig. 5). At the margin of the forest (site P2), the depth of the peat was 115 cm, and the water table was near the surface. The pH, EC, and Eh were 3.30 - 3.56, 31 - 108 mS m<sup>-1</sup>, and 370 - 580 mV, respectively. On cultivated land (site P3), the depth of the peat was 40 cm, and the water table was at -10 cm. The pH, EC, and Eh were 3.63 - 3.91, 79 - 113 mS m<sup>-1</sup>, and 200 - 410 mV, respectively.

At all sites, the pH tended to decrease from the surface to the bottom. The EC at Paduran was higher than inland; this would be the effect of sea salt, because the area is only 30 km from the coast. The EC and Eh tended to decline with increasing depth. The

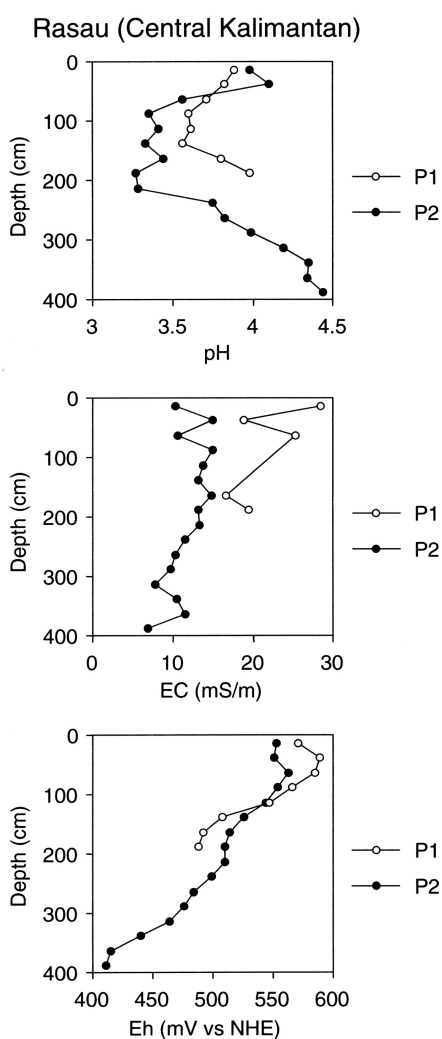

Fig. 4 pH (top), EC (middle) and Eh (bottom) of the peat pore water in natural forest at Rasau, Central Kalimantan. P1 is 100 m from the Rasau River, and P2 is just beside the river.

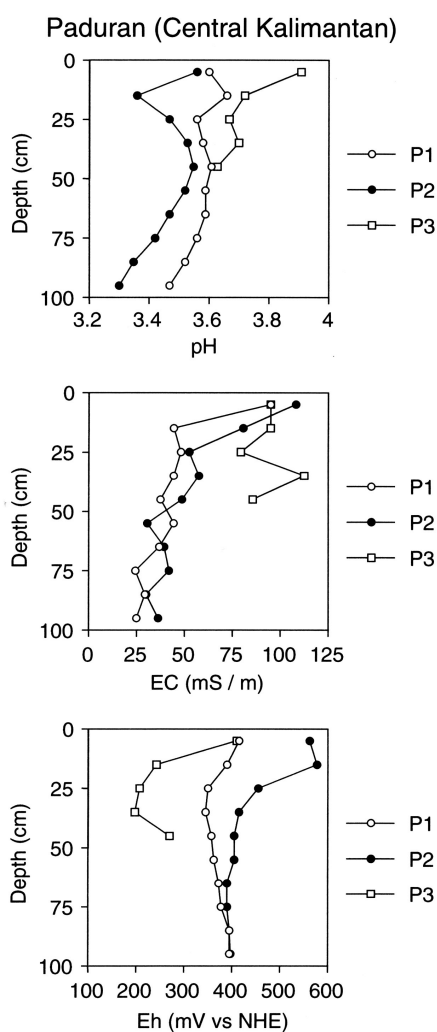

Fig. 5 pH (top), EC (middle) and Eh (bottom) of the peat pore water at Paduran, Central Kalimantan. P1, natural forest; P2, margin of forest; P3, cultivated land.



vertical profile of pH had different features from the profiles in the upper catchment of the river: the pH was lowest at the bottom of the peat layer. This would be due to the effect of sulfuric acid produced by the oxidation of the pyrite that occurs in the underlying mineral layers. The oxidative condition of the peat would enable this.

### Furen mire, northern Japan

At Furen mire, a cool temperate peatlands in northern Japan, three peat core samples were collected: from the *Sphagnum* community (site L1), the *Alnus japonica* forest (site L10), and the *Phragmites australis* community (site L15). The depth of the peat was 2.0 - 3.0 m, and the underlying mineral layer was sand. The pH tended to increase with increasing depth. In the *Sphagnum* community, the pH was 5.26 at the surface and 5.61 at the bottom (Fig. 6). In the *A. japonica* forest, the pH was 5.48 at the surface and 5.91

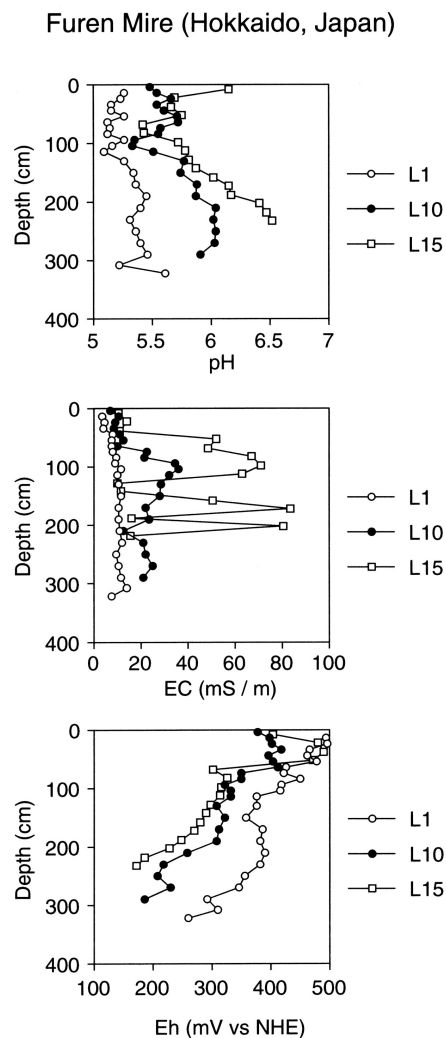

Fig. 6 pH (top), EC (middle), and Eh (bottom) of the peat pore water in Furen mire, north eastern Japan. L1, *Sphagnum* community; L10, *Alnus japonica* forest; L15, *Phragmites australis* community.

at the bottom. In the *Phragmites* community, the pH was 6.15 at the surface; it reached a minimum of 5.42 at 70 cm, then increased to 6.52 at the bottom. The EC tended to increase with increasing depth, although the fluctuations were extremely large, especially at L15. The redox potential tended to decrease with increasing depth. The Eh was 380 - 490 mV at the surface and 170 - 260 mV at the bottom. The Eh was lower than in the tropical peat.

### Conclusion

The pH of the peat pore water in tropical peatland was lower than that in temperate peatland. The pH of the middle peat layer was lowest in the upper catchment of the Sebangau River. This would be the combined result of precipitation at the peat surface and mineral supply from the underlying mineral layer. The pH of the bottom peat layer was lowest in the lower catchment of the river. This would be due to the oxidation of pyrite underlying the peat layer. The peat was constantly oxidative from top to bottom. This condition promotes the oxidation of minerals, including pyrite.

### Acknowledgements

The authors thank Mr. Yahya M. Jamal of the University of Palangka Raya for support in the field work. This work was financially supported by the Core University Program of JSPS, Grants-in-Aid from Ministry of Education (No. 10680557), and The Foundation for Earth Environment.

### References

- Anderson, J.A.R. 1983. The tropical peat swamps of western Malesia. In: *Ecosystems of the World 4B, Mires: Swamp, Bog, Fen and Moor, Regional Studies*. Elsevier Scientific Publishing, Amsterdam, The Netherlands, pp.181-199.
- Immirzi C.P., Maltby, E. and Clymo, R.S. 1992. *The Global Status of Peatlands and their Role in Carbon Cycling*. Report. No. 11, The Wetland Ecosystems Research Group, University of Exeter, UK.
- Maltby, E. and Immirzi, C.P. 1993. Carbon dynamics in peatlands and other wetland soils regional and global perspectives. *Chemosphere*, 27: 999-1023.
- Neuzil, S.G. 1997. Onset and rate of peat and carbon accumulation in four domed ombrogenous peat deposits, Indonesia. In: Rieley, J.O. and Page, S.E. (eds.), *Tropical Peatlands*, Samara Publishing Limited, Cardigan, UK, pp. 55-72.
- Post, W.M., Emanuel, W.R., Zinke, P.J. and Stagenberger, A.G. 1982. Soil carbon pools and world life zones. *Nature*, 298: 156-159.
- RePPPProT 1985. Land system and land suitability series at 1:250000scale. Accompanying maps of review of phase 1B results, Central Kalimantan. Regional physical planning programme for transmigration. UK Overseas Development Administration and Directorate Bina Program. Jakarta, Ministry of Transmigration.
- Schimel, D.S. 1995. Terrestrial ecosystems and the carbon cycle. *Global Change Biology*, 1: 77-91.
- Sphepherd, P.A., Rieley, J.O. and Page, S.E. 1997. The relationship between forest vegetation and peat characteristics in the upper catchment of Sungai Sebangau, Central Kalimantan. In: Rieley, J.O. and Page, S.E. (eds.), *Tropical Peatlands*, Samara Publishing Limited, Cardigan, UK, pp. 191-210.

## Boron Contents of Tropical Peat Soils in Southeast Asia

Koyo YONEBAYASHI and Hidekazu YAMADA

Faculty of Agriculture, Kyoto Prefectural University, Kyoto, Japan

### Introduction

Boron (B) is one of the essential elements to vascular plants. B is essential for pollen tube growth and silk receptiveness to pollen (Marschner, 1986), and B deficiencies can reduce root growth rate (Bohnsack and Albert, 1977). The absorption of B by plant roots would differ from that of other ionized species since B is present in solution as undissociated  $H_3BO_3$  (Barber, 1995). The availability of B is largely influenced by soil pH, being most available in the acidic pH range and less available with increasing pH, primarily due to the adsorption by soil colloids (Mahler *et al.*, 1988).

In general, B in soil can be divided into three categories: (i) B in primary minerals, such as tourmaline (borosilicate mineral), (ii) B adsorbed by soil constituents such as clay minerals, hydroxy oxide of Al and Fe, organic matter, and (iii) B in soil solution as boric acid and borate ions (Keren and Bingham, 1985).

In case of tropical peat soils, B will occur as complex with carbohydrate in peat materials or adsorbed by organic matter, and boric acid in soil solution being low pH of them. Little is known about B contents of tropical peat soils with respect to the sustainable availability of B to plants.

This study aimed to clarify the status of B in tropical peat soils of Southeast Asia.

### Materials and Methods

#### Study sites

Peat soils were sampled from five soil profiles of coastal swamps in southern Thailand, southern Peninsular Malaysia, and Sarawak, Malaysia as shown in Table 1 (Yonebayashi *et al.*, 1994; Funakawa *et al.*, 1996). Four or five layers were sampled by 20 cm depth from the peat profiles.

Table 1. Study sites

| Site  | Location                    | Vegetation       |
|-------|-----------------------------|------------------|
| MAT   | Muar, Johor, Malaysia       | Natural forest   |
| BC-10 | Bacho, Narathiwat, Thailand | Secondary forest |
| NM-1  | Naman, Sibul, Sarawak       | Secondary forest |
| NM-2  | Naman, Sibul, Sarawak       | Secondary forest |
| NM-3  | Naman, Sibul, Sarawak       | Secondary forest |

#### Chemical analysis

Calcium, magnesium, sodium, potassium, iron, manganese, zinc, and copper contents were analyzed by atomic absorption spectroscopy after digestion by dry combustion. Phosphorus content was determined by colorimetry with molybdenum blue after digestion with nitric and sulfuric acids. Available B contents were determined for the

extract with hot water and the extract with 2% mannitol-0.02M acetate buffer (pH4.5) solution. One gram of soil was placed in Teflon test tube and 8 ml of extract solution was added. The test tube was heated in block heater at 135°C, and refluxed for 15 min. The suspension was centrifuged and filtrated with 3  $\mu\text{m}$  membrane filter. An aliquot of supernatant proceeded with ICP-AES determination of B.

### Results and Discussion

Mean chemical composition of peat profiles analyzed in this study was shown in Fig.1. The N, P, and K contents decreased with soil depth, especially K content of deeper layer was very low and less than one third of that of surface layer. Ca and Mg contents were almost constant with soil depth and showed very low contents. Mean contents of Fe, Mn, Zn, and Cu were almost steady with soil depth and showed very low values. From the analysis of the distribution of heavy metals, as water soluble, calcium exchangeable, oxides, weakly chelated, strongly chelated, carbonates, sulfides, and nonextractable forms, major parts of Cu and Fe were complexed with humic substances or non-extractable form, and were not available to plants. Especially the low content of Cu of the surface soil was very severe for the plant growth.

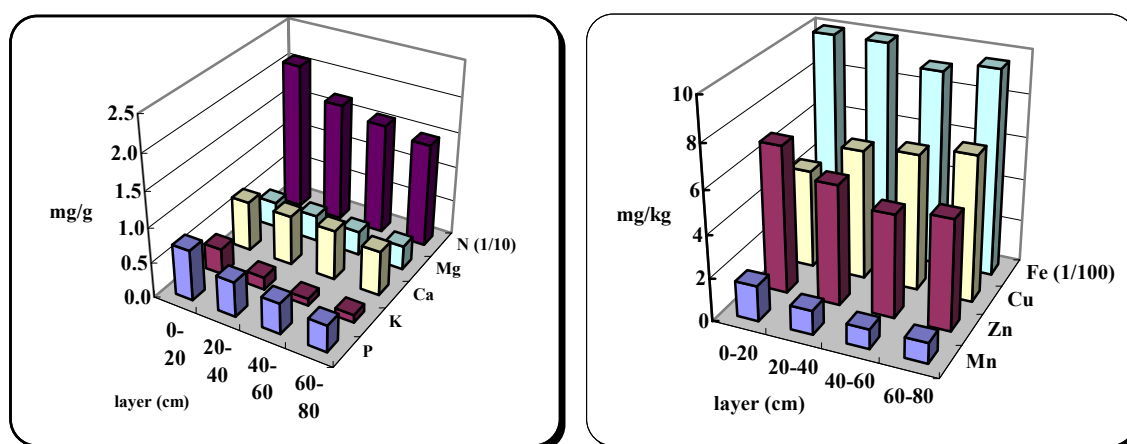

Fig. 1. Mean chemical composition of peat profiles analyzed.

For the study of B status in peat soils, two extraction methods were used. Both methods extract available B from soils. Hot water extractable B of surface soils of 0 to 20 cm depth were 0.04-0.56  $\text{mg kg}^{-1}$  of soils and those of subsoils decreased with depth until 60cm except SA1 soil, as shown in Fig 2. And it was not detected in the subsoils of 40-60 cm depth except SA1. Mean contents of them for surface soils and subsoils of 40 to 60 cm depth were 0.26 and 0.02  $\text{mg kg}^{-1}$ , respectively (Table 2).

Mannitol-acetate buffer extractable B ranged from 0.13 to 0.35  $\text{mg kg}^{-1}$  for surface soils and from 0.03 to 0.20  $\text{mg kg}^{-1}$  for subsoils. Mannitol-acetate extractable B content decreased with soil depth until 60cm and increased at 60 to 80cm layer in some soils (SA1, MAT, BC10) (Fig 3). Mean contents of them for surface soils and subsoils were 0.26 and 0.10  $\text{mg kg}^{-1}$ , respectively (Table 2).

Mean content of hot water extractable B and mannitol-acetate extractable B of surface soil showed same value. Though the hot water extractable B of 40 to 60 cm is less than one tenth of that of surface soil, the mannitol-acetate extractable B of 40 to 60 cm is about one third of that of surface soil.

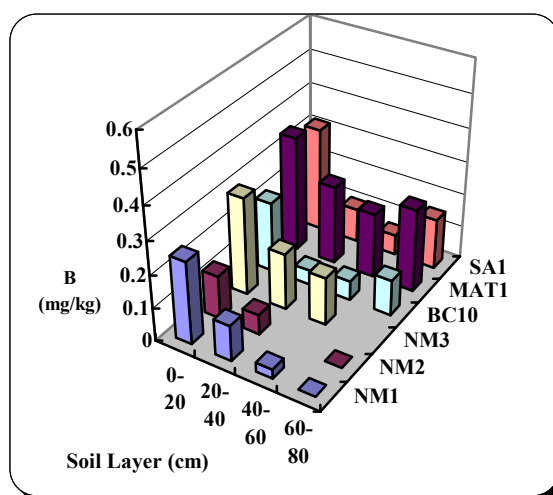
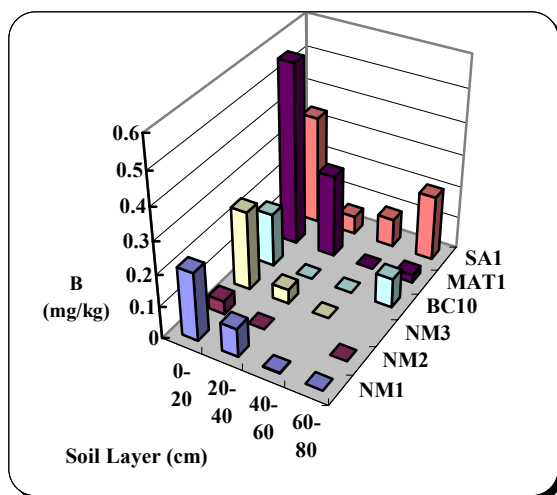

Fig. 2. Hot water extractable B content. Fig. 3. Mannitol-acetate extractable B content.

Table 2. Mean contents of available soil B of tropical peat soils

| Soil                     | Depth, cm | Hot water extractable B              | Mannitol-acetate extractable B |
|--------------------------|-----------|--------------------------------------|--------------------------------|
|                          |           | Average (range), mg kg <sup>-1</sup> |                                |
| Surface soil             | 0 – 20    | 0.26 (0.04 - 0.56)                   | 0.26 (0.13 - 0.35)             |
| Subsoils                 | 20 – 40   | 0.07 (0 - 0.26)                      | 0.12 (0.05 - 0.24)             |
| Subsoils                 | 40 – 60   | 0.02 (0 - 0.09)                      | 0.10 (0.03 - 0.20)             |
| Critical level for plant |           | 0.3 - 1.5                            |                                |

Extraction of the air-dried soil with hot water would remove soluble B that was in soil solution under natural condition. The B in solution occurs as the undissociated acid H<sub>3</sub>BO<sub>3</sub> under the low pH of peat soils. This extractable B is considered to be “readily available” B. Some of the B of peat soils in natural state seems to have coordinated to the cis-hydroxyl group of the carbohydrate in peat materials. At the extraction of the soils with mannitol solution, the cis-hydroxyl group of the mannitol forms the complex by coordinating to the boron. Therefore, extraction of the soil with mannitol-acetate buffer removes soluble plus adsorbed or complexed B. This extractable B was considered to be “total available” B.

Critical levels of hot water extractable B reported in the literature ranged from 0.3 to 1.5 mg kg<sup>-1</sup> for various crops and soils (Barber, 1984). Readily available B was absolutely deficient in subsoils and was not sufficient even in surface soils of tropical

peat soils. Mean content of total available B for subsoils was five times that of readily available B, but not sufficient to plant growth.

The B which deducted the readily available B from the total available B seems to be the carbohydrate complex. Most of the B in the surface layer soil is readily available form, and the carbohydrate complex is few. Total available B of the subsoil are under the half of the surface soil, and many of them is the carbohydrate complex, and the readily available B is very few. Though much peat of the subsoil is undecomposed, the B which coordinated in the carbohydrate of the plant tissue in decomposition process exists as potentially available form. Readily available B in the surface soil is the B which occurred by mineralization of the fallen litter at the soil surface, and the circulation of the boron is carried out between plant and surface soil as shown in Fig. 4. It seems to supply the B, which is necessary for the plant growth, barely by the circulation of readily available B in the surface soil, because the readily available B of the subsoil is extremely little. It is necessary to mind the supply of the B in agricultural development for the careless development cut off the circulatory system of the B.

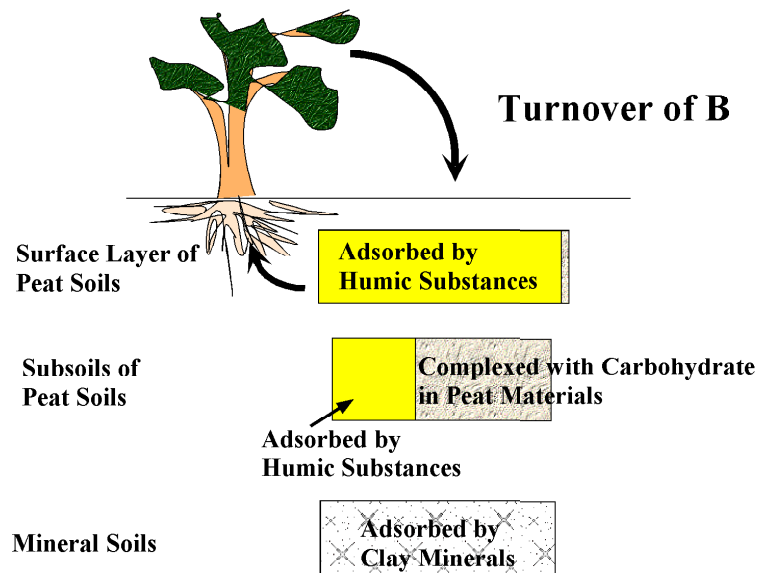

Fig. 4. Boron status in tropical peat soils.

### Summary

Peat soils were sampled from coastal swamps in southern Thailand, southern Peninsular Malaysia, and Sarawak, Malaysia. Available B contents were determined for hot water extract and mannitol-acetate buffer extract.

Hot water extractable B of surface soils of 0 to 20 cm depth were 0.04-0.56 mg kg<sup>-1</sup> of soils and those of subsoils decreased with depth. Mean contents of them for surface soils and subsoils of 40 to 60 cm depth were 0.26 and 0.02 mg kg<sup>-1</sup>, respectively. Mannitol-acetate buffer extractable B ranged from 0.13 to 0.35 mg kg<sup>-1</sup> for surface soils and from 0.03 to 0.20 mg kg<sup>-1</sup> for subsoils. Mean contents of them for surface soils and subsoils were 0.26 and 0.10 mg kg<sup>-1</sup>, respectively.

Critical levels of hot water extractable B reported in the literature ranged from 0.3 to 1.5

mg kg<sup>-1</sup> for various crops and soils (Barber, S.A., 1984). Hot water extractable B means readily available B, which is absolutely deficient in subsoils and is not sufficient even in surface soils of tropical peat soils. Assuming mannitol-acetate extractable B intends total available B in peat soils, mean content of total available B for subsoils was five times that of readily available B, but not sufficient to plant growth.

### References

- Barber, S.A. 1995. *Soil Nutrient Bioavailability: A Mechanistic Approach*. Wiley, N.Y.
- Bohnsack, C.W. and Albert, L.S. 1977. Early effects of boron deficiency on indole-acetic acid oxidase levels of squash root tips. *Plant Physiol.*, 59: 1047-1050.
- Funakawa, S., Yonebayashi, K., Shoon, Y.F., and Khun, E.C.O. 1996. Nutritional environment of tropical peat soils in Sarawak, Malaysia based on soil solution composition. *Soil Sci. Plant Nutr.*, 42: 833-843
- Keren, R. and Bingham, F.T. 1985. Boron in water, soils and plants. In: Stewart, B.A. (ed.), *Advances in Soil Science, Vol. 1*. pp. 229-276, Springer-Verlag, N.Y.
- Mahler, R.L., Saxena, M.C., and Aeschlimann, J. 1988. In: *World Crops: Cool Season Food Regime*. pp.278-289, Kluwer Academic Publ., Netherlands.
- Marschner, H. 1986. *Mineral Nutrition of Higher Plants*. Academic Press, San Diego.
- Yonebayashi, K., Okazaki, M., Pechayapisit, J., Vijarnsorn, P., Zahari, A.B., and Kyuma, K. 1994. Distribution of heavy metals among different bonding forms in tropical peat soils. *Soil Sci Plant Nutr.*, 40: 425-434.

## **Microbial Biomass in Tropical Peat Soil**

**Kazuyuki INUBUSHI<sup>1</sup> and Abdul HADI<sup>2</sup>**

<sup>1</sup>Faculty of Horticulture, and <sup>2</sup>Graduate School of Science and Technology,  
Chiba University, Matsudo, Chiba 271-8510 Japan

### **Abstract**

Microbial biomass plays three roles in soil; first as driving force of bio-elements such as C, N, P etc.; second as nutrient pools for plant production and; third as environmental monitor to detect impact on soil. We tried to measure microbial biomass in tropical peat soil in Sarawak, Malaysia and South Kalimantan, Indonesia by ATP and chloroform-fumigation extraction methods. Results of ATP measurements indicate that surface soil contained comparable amounts of biomass as cultivated arable soil, but deeper soil (<50 cm) also retained significant amount of biomass. On the other hand, chloroform-fumigation method failed to measure biomass probably due to high amount of extractable C and N in peat soil. Organic matter dynamics as affected by land-use change in tropical peat soil is discussed.

### **Introduction**

Microbial biomass plays three important roles in soil. First as driving force of dynamics of bio-elements such as C, N, P etc.; second as nutrient pools for plant production, and third as monitor of soil environment to detect impact of changes in soil conditions as early indicator (Powlson *et al.*, 1987) which may be caused by land-use change, biomass burning and so on in tropical peatland. It has been estimated that the total area under tropical peat land is around 29 million ha over the world (Takai, 1997). Large portions of this tropical peat soil exists in the Borneo Island (Driesen, 1978; Takai 1997), the world third largest island and belong to three countries; Indonesia, Malaysia, and Brunei. There are, however, few reports dealing with tropical peat soil, particularly on microbial biomass, which play important role in dynamics of soil organic matter changes.

The organic matter in the peat soils is naturally decomposed slowly but continuously. Decomposition of organic matter is basically the degradation of complex organic compounds, converting by heterotrophs. The decomposition causes the loss of mass (commonly stated as ground subsidence) and releases by-products, such as CO<sub>2</sub> and methane, both being greenhouse gases, leading to the formation of a more stable peat soil. Since tropical peat land contains large amounts of soil nitrogen (Ismunadji and Soepardi, 1984; Driesen, 1978), it could be the source of nitrous oxide emission, another greenhouse gas as well as distracting stratospheric ozone layer.

The demands for peatland for agricultural and aquacultural uses have been increasing (Ahmad *et al.*, 1986; Radjagukguk, 1991; Kyuma, 1992). A large portion of the peatland in South Kalimantan was, for instant, reclaimed when a vast conversion of natural wetland into rice field and settlement occurred in this province (Moehansyah, 1988; MacKinnon *et al.*, 1996). Meanwhile, in Sarawak (Malaysia) much of peatland was drained excessively and cultivated to oil palm (Ahmad *et al.*, 1986; Inubushi *et al.*, 1998). The peat soil converted so far has proven to be an efficient rice producer as well as upland-field crops (Ismunadji and Soepardi, 1984; Radjagukguk, 1990).



The conversion of peatland always starts with the construction of drainage ditches in order to reduce the excess water that is commonly associated with natural peatland. Theoretically, the submerged (anaerobic) condition of the natural tropical peat soil is favorable for anaerobic bacteria, whereas oxic condition is favorable for aerobic microfauna. Therefore, both natural and converted tropical peat soil can potentially control the dynamics of nutrient in microbial biomass. However, there is no quantitative data on the microbial biomass in tropical peat soils. In addition, the mechanisms involved in the dynamics of greenhouse gases in tropical peat soil are poorly understood. Since the ecosystem of the peat land is very vulnerable and readily affected by human activities (Reddy and Patrick, 1993; Tay *et al.*, 1991), improper land management could lead to increase loss of land resource and hence could enhance environmental risks. Therefore a more detailed knowledge about the functioning of the ecosystem of peat soil is truly needed. This paper focused on the dynamics of microbial biomass in tropical peatland, as well as the proper approach to measure it.

### Site Description, Materials and Methods

Soil samples were taken in the peatland of the Borneo Island comprised of four sites; one site in Sarawak, Malaysia; and three sites in South Kalimantan, Indonesia. In all sites, the peat soils were characterized by irregular complex of poorly decomposed woody materials down to at least 2 meter in depth. Surface soil was relatively dry in general for Sago palm plantation by the recent excess drainage in Sarawak. Their adjacent secondary forest was composed mainly of Alan (*Shorea albida*) and classified as Alan swamp forest. Peat soil in Amuntai, South Kalimantan was similar as Sarawak. However soils were wetter due to that the sampling was done in wet season. Sampling sites in South-Kalimantan were set according to land-use change. Detail site description in Kalimantan was described in Hadi and Inubushi (2000).

Soil samples (equivalent to 1-2 g oven dried soil) were taken from surface layer (0-20 cm) and deeper layers (20-40, 40-60, 60-80, 80-100 cm, for Sarawak). Microbial biomass in each soil sample was estimated by adenosine-5' triphosphate (ATP) (Jenkinson and Oades, 1979). Briefly, microbial cells were destructed by ultra sonic and ATP was extracted by trichloroacetic acid. Then luciferine-luciferase mixture was added to the filtrated extract to see bioluminescence. Another standard method for soil microbial biomass measurement, chloroform fumigation-extraction methods (Brookes *et al.*, 1985), was also employed to peat soil in Sarawak. This method is based on cell-lysis after chloroform fumigation, extracted cell components after fumigation being quantified as carbon or nitrogen basis.

### Results and Discussion

#### Soil chemical and physical properties

Composition pattern along with soil profile shows that unique organic acids were accumulated in tropical peat soil (Fig. 1). Soil densities changed from 0.12-0.13 g mL<sup>-1</sup> at upper 40 cm to 0.02 g mL<sup>-1</sup> below 40 cm which indicates changes of water table in this site, and these changes are corresponded with accumulations of sulfate and acetic acid at interface layer at 40 cm. Ground water contained large amount of dissolved carbon especially in the plantation field soil. Peatlands in this area were characterized by strong acidity; the pH values (measured with glass rod electrode after 1 h shaking with distilled water using a 1:5 (soil:water) ratio) were always below 5. Organic matter

contents of peat layers (estimated by dry combustion method, Black *et al.*, 1965) lied between 331.2 and 946.9 g organic matter kg<sup>-1</sup> dry soil. The contents of total nitrogen of peat layers (measured with method described by Black *et al.*, 1965) varied from 7.0 to 23.1 g N kg<sup>-1</sup> dry soil.

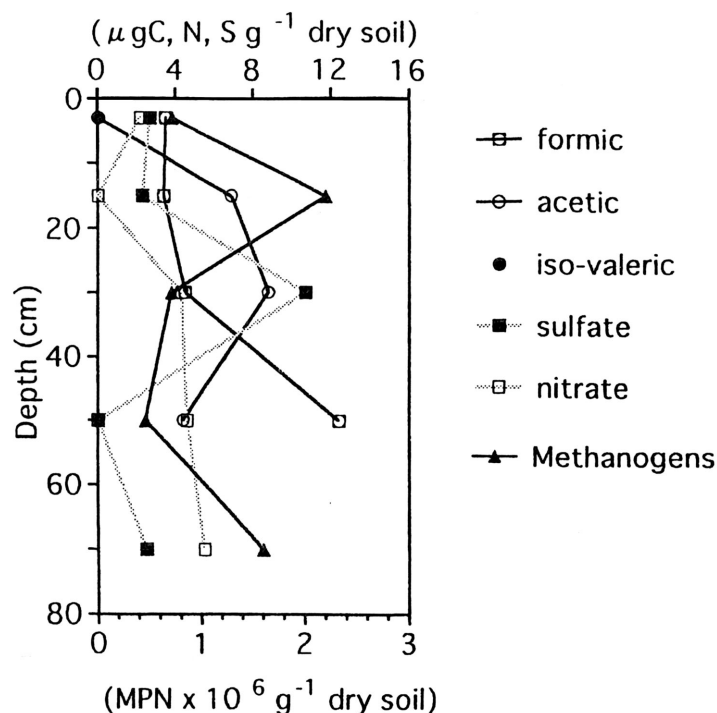

Fig. 1. Composition of organic acids and amount of sulphate, nitrate and methanogenic bacterial population along the peat soil profile in Sarawak, Malaysia (Inubushi *et al.*, 1998)

### Soil microbial biomass

ATP content ranged from 5 nmol g<sup>-1</sup> soil at the surface layer to about 3 nmol g<sup>-1</sup> soil below 80 cm in Sarawak, decreasing gradually with soil depth (Fig. 2). These ATP contents indicate that living organisms were most abundant at surface layer, while more than half still remained in the deeper soil layers. Microbial activities of biomass such as CO<sub>2</sub> production, methane formation and oxidation were also not negligible in deeper soil layer (Inubushi *et al.*, 1998).

In Kalimantan, ATP seemed to decrease along with land-use history. A-1 (secondary forest) had highest ATP; 7.70 nmol g<sup>-1</sup>, followed by A-2 (paddy soil after 2 year running); 7.09 nmol g<sup>-1</sup>, then lowest at A-3 (rice-soybean rotation for 6 years); 1.89 nmol g<sup>-1</sup>. This imply that microbial biomass depressed after changing peat land from secondary forest to arable land, although more careful examination should be carried out.

Fumigation-extraction method showed quite different soil profile as ATP. Microbial biomass accumulated at deeper layer rather than in surface layer (Figs. 2, 3). This may be due to the high amount of unstable soil organic matter remained in the peat

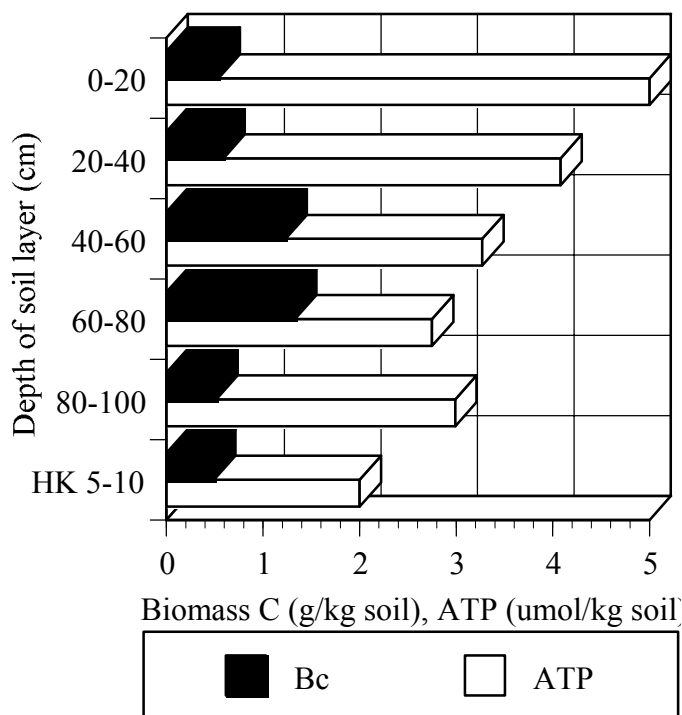

Fig. 2. Microbial Biomass in peat soil (Comparison of FE and ATP methods)

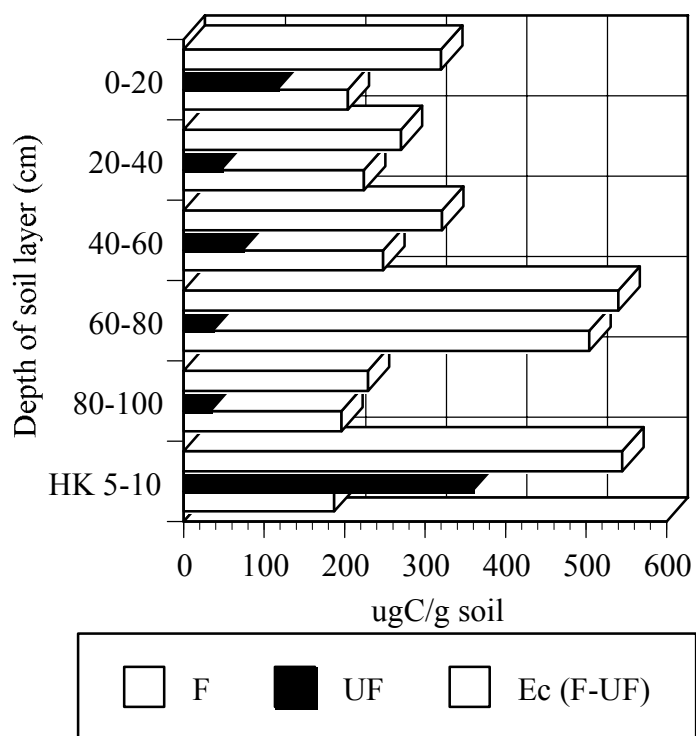

Fig. 3. Microbial Biomass in peat soil (Chloroform-fumigation extraction method)

soil, thus this method to determine microbial biomass” which was defined as the difference of extracted carbon or nitrogen in fumigated soil and unfumigated soil, could not be applicable to peat soil. Similar phenomena were also observed in compost which contain large amount of soluble organic matter (Rajbanshi and Inubushi, 1998).

### Conclusion

Microbial biomass in tropical peat soil in Sarawak, Malaysia and South Kalimantan, Indonesia was measured by ATP and chloroform-fumigation extraction methods. Results of ATP measurements indicate that surface soil contained comparable amounts of biomass as cultivated arable soil, but deeper soil (<50 cm) also retained significant amount of biomass. On the other hand, chloroform-fumigation method failed to measure biomass probably due to high amount of extractable C and N in peat soil. Therefore further investigation by ATP method to see the effect of land-use would be required.

### References

- Ahmad, Md S., Kamarudin, A. and Ismail, A. B. 1986. Agronomic consideration on peatland development: A Malaysian experience. In: *Prod. 2nd International Soil Management Workshop, Thailand/Malaysia*, pp.195-211.
- Black, C.A., Evans, D.D., White, J.J., Ensminger, L.E. and Clerk, F.E. 1965. *Method of Soil Analysis, Part 2*, American Society of Agronomy, Madison, Wisconsin, pp.1572.
- Brookes, P.C., Landman, A., Pruden, G. and Jenkinson, D.S. 1985. Chloroform fumigation and release of soil nitrogen: A rapid direct method for measuring microbial biomass nitrogen in soil. *Soil Biol. Biochem.*, 17: 837-842.
- Driesen, P.M. 1987. Peat soil. In: *Soil and Rice*, IRRI, Los Banos, Philippines, pp.763-779.
- Hadi, A. and Inubushi, K. 2000. Microbial population and greenhouse gases formation in tropical peatlands under different land uses. In: *Proceedings of the International Symposium on Tropical Peatlands, Bogor, Indonesia, 22-23 November 1999*.
- Inubushi, K., Hadi, A., Okazaki, M. and Yonebayashi, K. 1998. Effect of converting wetland forest to sago palm plantations on methane gas flux and organic carbon dynamics in tropical peat soil, *Hydrological Processes*, 12: 2073-2080.
- Ismunadji and Soepardi, G. 1984. Peat soil: problems and crop production. In: *Organic Matter and Rice*, IRRI, Los Banos, Philippines, pp.489-502.
- Jenkinson, D.S. and Oades, J.M. 1979. A method for measuring adenosine triphosphate in soil, *Soil Biol. Biochem.*, 11: 193-199.
- Kyuma, K. 1992. Climate, geology and geomorphology of insular Southeast Asia in relation to formation and distribution of tropical peat, In: Kyuma *et al.* (eds.), *Coastal Lowland Ecosystem in Southern Thailand and Malaysia*, Kyoto University, pp.31-40.
- Moehansyah. 1988. Capability of tidal swampy area of South Kalimantan for housing. Fac. of Agriculture, Lambung Mangkurat University. 1-11 (in Indonesian).
- MacKinnon, K., Hatta, G., Halim, H. and Mangalik, A. 1996. *The Ecology of Kalimantan*, Periplus Edition (UK), Singapore, 802 pp.
- Powelson, D.S., Brookes, P.C. and Christensen, B.T. 1987. Measurement of soil microbial biomass provided an early indication of changes in total soil organic matter due to straw incorporation, *Soil Biol. Biochem.*, 19: 159-164.

- Rajbanshi, S.S. and Inubushi, K. 1998. Chemical and biochemical changes during laboratory-scale composting of allelopathic plant leaves, *Biol. Fertil. Soils*, 26: 66-71.
- Radjagukguk, B. 1990. Management of peatland productivity for lowland rice. In: Taher *et al.*, (eds.), *Pengelolaan Sawah Bukaan Baru Menunjang Swasembada Pangan dan Program Transmigrasi*. Faperta Univ. Prasakti/Balittan Sukarami, pp. 217-235 (in Indonesian with English summary)
- Reddy, K.R. and Patrick, H.W., Jr. 1993. Wetland soil-opportunities and challenges. *Soil Sc. Soc. Am. J.*, 57: 1145-1147.
- Takai, Y. 1997. Environmental characteristic and Management in Peat/Acid Sulfate Soils of Southeast Asia. *MAB Report, Japan, 1996-1997*: 31-49.
- Tay, T.H., Zahari, A.B. and Ahmad, Md S. 1991. Ameliorating peat for crop production: Its impact to the environmental. In: *Proceeding of International Seminar: Impact of Agriculture Productivity on the Environment*.

## Survey of Peat Soils in Sebangau-Kahayan Water-Catchment, Central Kalimantan for Laccase Producing Fungi and Their Organic Decomposing Ability

Typuk ARTININGSIH<sup>1</sup>, Sehat Jaya TUAH<sup>2</sup>, Edi MIRMANTO<sup>1</sup>  
and Mitsuru OSAKI<sup>3</sup>

<sup>1</sup> Research and Development Center for Biology, LIPI, Bogor, Indonesia.

<sup>2</sup> Department of Forestry, Faculty of Agriculture, University of Palangka Raya,  
Central Kalimantan, Indonesia.

<sup>3</sup> Laboratory of Plant Nutrition, Faculty of Agriculture, Hokkaido University,  
Sapporo, Japan.

### Abstract

Eleven soil samples collected from different sites were screened for laccase production using guaiacol agar plates. The sites were native deep peat, burn deep peat, and abandoned area. Out of 105 isolates, only 30 isolates gave positive test for qualitative lignin degradation. Ten fungal isolates were selected further for quantitative study of wood/lignin degradation. The basidiomycetes proved to be better laccase producers and decomposers of organic-matter. These gave comparable results to a known white-rot fungus, *Corioloopsis* sp., *Fomes* sp., *Polyporus* sp., and *Amauroderma* sp. degraded wood sawdust causing a total weight loss of 12.8%, 12.3%, 8.7%, and 6.5% respectively, and lignin loss up to 12.4% in 30 days. The finding of three different activities of lignin degrading fungi were further selected for collecting the isolates.

**Key words:** degradation, guaiacol, lignin, white-rot fungus, *Polyporus* sp., *Fomes* sp., *Corioloopsis* sp., *Amauroderma* sp.

### Introduction

Laccase is widely found in nature including in certain fungi that degrade lignin and is known to cause Bavendamm's reaction (Kawai *et al.*, 1999). Fachraeus *et al.* (1958) was first detected laccase in the fruiting bodies of basidiomycetes fungi. Later, the development of Bavendamm test was of considerable significance for differentiating white- and brown-rot fungi. Many white-rot fungi produced extracellular phenoloxidase, which is shown by the formation of coloured oxidation products in the media containing phenol, such as guaiacol. Whereas brown-rot fungi lack such activity (Higuchi, 1982). Since then, various methods have been demonstrated to detect laccase production and attempts made to establish correlation with lignin degradation (Nobles, 1958; Kirk and Kelman, 1965; Harkin and Obst, 1973).

The phenomena of fungi in ligninolysis still remain unknown, however, laccase has been considered to be one of the important enzymes. It plays a key role in ligninolysis by causing its demethylation (Kirk and Chang, 1975). Its involvement has been fairly substantiated by genetic studies in which laccase-less mutants were unable to degrade lignin (Ander and Eriksson, 1976). Microbiology of lignin degradation has revealed fungi, particularly the white-rot basidiomycete, to be an important group of organisms though certain brown-rot and soft-rot fungi and bacteria can cause ligninolysis to a limited extent (Ander and Eriksson, 1976).

Several numbers of fungi have been reported for laccase production and lignin

degradation. The use of Bavendamm's reaction for determining the lignin-degrading abilities of fungi has also been reported. However, no study has been undertaken to directly isolate such fungi from peat ecosystem, which might better degrading species. Keeping this in view, a survey of soil samples collected from different areas to isolate laccase-producing fungi.

## **Material and Method**

### **Collection of soil samples**

Eleven soil samples were collected from three different sites of peat ecosystem in Sebangau – Kahayan water catchment, Central Kalimantan. The locations were a) native deep peat (6 plots namely A8, A10, D4, D6, G8, and G2), b) burn deep peat (5 plots namely A5, A7, D1, D9, G9), and c) abandoned area or native shallow peat (5 plots namely A8, D2, D4, G2, and J8). Each sample was taken in plastic bags from each site. The samples were stored at refrigerator until further processing.

### **Screening of laccase producing fungi**

Soil sample (1 g) was suspended in 10 ml of 0.85% (w/v) physiological solution which was prepared freshly before used. The solution was agitated on a rotary shaker and allowed to settle.

PDA (Potato Dextrose Agar) medium containing guaiacol 0.5% (v/v) was inoculated with 0.1 ml soil suspension and incubated at 28°C for a maximum of 10 days. Population was counted everyday for each triplicate.

Each fungus was isolated and subcultures made as soon as browning of agar occurred until the isolates were pure. The isolate, which reddish brown colour under or around the colony, was recorded as a positive test for laccase and selected for further study. The selected isolate was tested to find any correlation between laccase production and lignin degradation by the methods of Bavendamm reaction and Sundman reaction.

### **Laccase activity (polyphenol oxidase)**

From cultures on solid PDA, each selected fungus was inoculated into 50 ml of sterilized PDA broth containing lignin (indulin AT) 1% (w/v). The cultures were incubated stationarily at 28°C for 10 days. Triplicate flasks were applied for each fungus. After incubation, the filtrate was centrifuged at 10.000 g for 15 min at 4°C. Guaiacol was used as the substrate for measuring laccase from supernatant enzyme. The reaction mixture (5 ml) contained of 3.9 ml acetate buffer (10 mM, pH 5), 1 ml guaiacol (1.75 mM) and 0.1 ml enzyme extract. The mixture was incubated at 25°C for 2 h and the absorbance was read at 450 nm. In the blank, guaiacol was substituted by buffer. The formation of coloured products was taken as indicative of laccase activity, which was expressed in relative terms as colorimetric units per ml of the enzyme.

### **Degradation of wood sawdust**

Ten fungal isolates were selected to study their wood (lignin) degrading ability since these gave comparatively better laccase activity. Three grams (dry weight) of wood sawdust was sterilized then inoculated with 15 ml of culture grown in PDA broth. Uninoculated substrate served as the control. After 30 days of incubation, triplicate samples were further processed. Ten ml of acetate buffer (10 mM, pH 5) was added to each flask then shaken for 20 min.

### Identification of the isolated fungi

The isolated fungi with laccase potentiality were identified based on their colonial morphology by microscopical study. Fungi, such as *Gilmaniella* sp., and *Moniliella* sp. were identified according to Barron (1972) and Ellis (1976). Basidiomycetes were identified according to clamp connections, hyphal system, and spores (Breitenbach and Kranzlin, 1986).

### Results and Discussion

The highest population of fungi found in 10–20 cm depths for native, burn, and abandoned area respectively (Fig. 1). It seems that fungal-population density is correlated to depths, which the more depths the density becomes less. This also revealed that the fungi isolated from those locations mostly are aerobic. The native deep peat may provide better source for fungal ecosystem, while that the abandoned area remains poor with reflects to low fungal density.

Using guaiacol and indulin AT as a source of lignin performed screening of fungi for laccase activity. In this study, it found 30 isolates gave positive results on laccase production although 4 isolates were a negative on guaiacol medium. All isolates, which gave positive results on guaiacol, lignin, and guaiacol-lignin medium respectively, were white-rot fungi (Table 1). Mostly brown-rot fungi gave a negative results on guaiacol, although some are positive on guaiacol-lignin medium (Table 2). On guaiacol medium, the three-imperfecti fungi isolated as follows *Paecilomyces* sp., *Gilmaniella* sp., and *Moniella* sp. showed positive reaction (Table 3.).

Table 1. Laccase production on lignin-guaiacol, lignin, and guaiacol media by white-rot fungi isolated from soil and their performance for Bavendamm and Sundman test (lignin degradation)

| Culture No. | Type of fungus           | Colour production on |        |          | Bavendamm test | Sundman Test |
|-------------|--------------------------|----------------------|--------|----------|----------------|--------------|
|             |                          | Lignin guaiacol      | Lignin | Guaiacol |                |              |
| pA1-3       | <i>Daedalea</i> sp.      | +                    | +      | +        | +              | +            |
| pA1-15      | <i>Fomes</i> sp.         | +                    | +      | +        | +              | +            |
| pA118-3     | <i>Polyporus</i> sp.     | +                    | +      | +        | +              | +            |
| BH4         | <i>Polyporus</i> sp.     | +                    | +      | +        | +              | +            |
| D6-1        | <i>Polyporus</i> sp.     | +                    | +      | +        | +              | +            |
| A9-3        | <i>Coriolopsis</i> sp.   | +                    | +      | +        | +              | +            |
| D4-1        | <i>Stereum</i> sp.       | +                    | +      | +        | +              | +            |
| D2-3        | <i>Trametes</i> sp.      | +                    | +      | +        | +              | +            |
| A3-2        | <i>Phanerochaete</i> sp. | +                    | +      | +        | +              | +            |
| D1-2        | <i>Lenzites</i> sp.      | +                    | +      | +        | +              | +            |
| G2-1        | <i>Amauroderma</i> sp.   | +                    | +      | +        | +              | +            |
| A7-2        | NI                       | +                    | +      | +        | +              | +            |

NI = Not identified



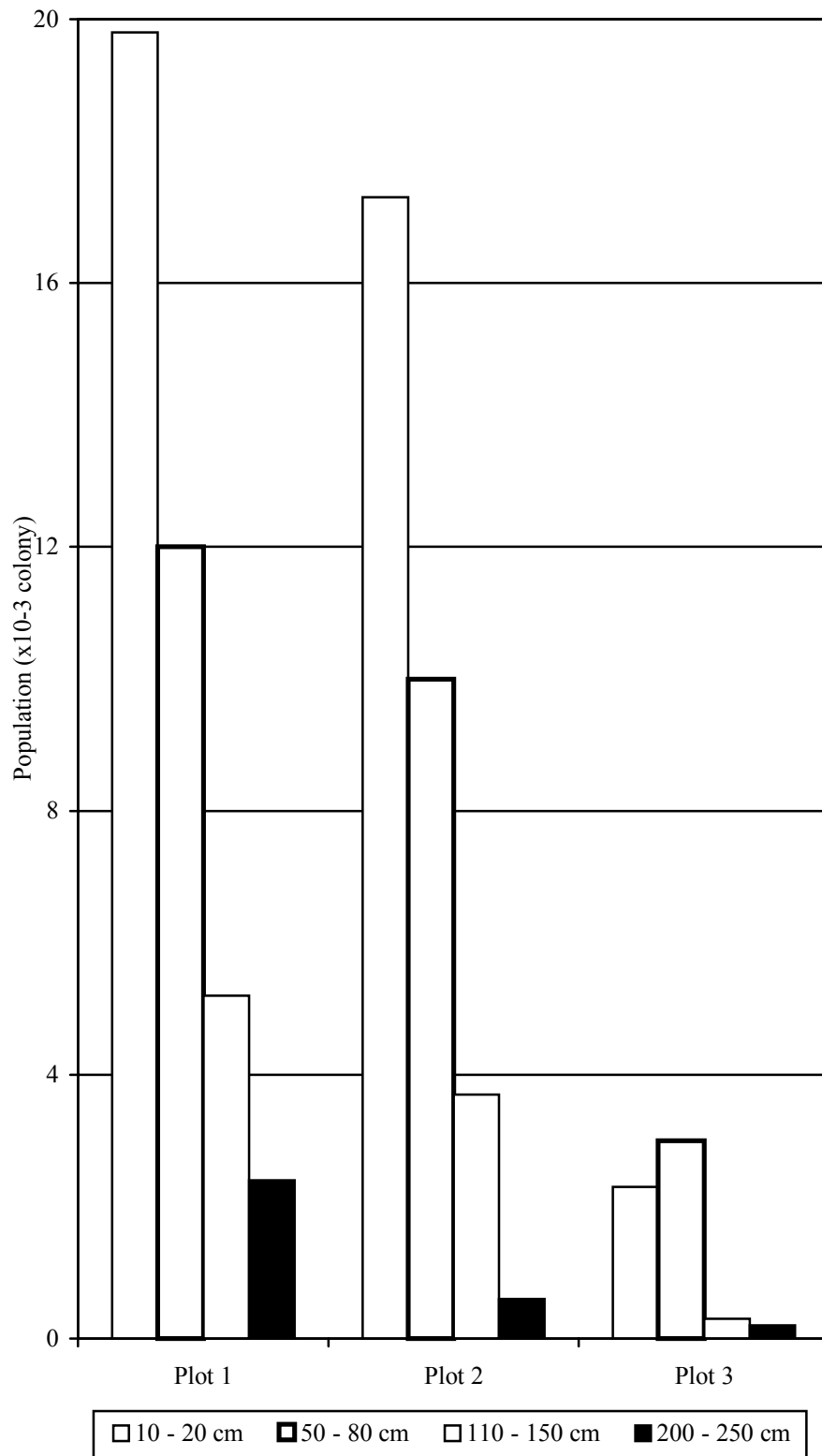

Fig. 1. Fungal population isolated from different locations and depths.

Table 2. Laccase production on lignin-guaiacol, lignin, and guaiacol media by brown-rot fungi isolated from soil and their performance for Bavendamm and Sundman test (lignin degradation)

| Culture No. | Type of fungus        | Colour production on |        |          | Bavendamm test | Sundman test |
|-------------|-----------------------|----------------------|--------|----------|----------------|--------------|
|             |                       | Lignin guaiacol      | Lignin | Guaiacol |                |              |
| G4-1        | <i>Poria</i> sp.      | -                    | -      | -        | -              | -            |
| D6-1        | <i>Lentinus</i> sp.   | -                    | -      | +        | +              | -            |
| A8-1        | <i>Serpula</i> sp.    | +                    | -      | +        | -              | -            |
| G2-3        | <i>Fomitopsis</i> sp. | -                    | -      | +        | -              | -            |
| G2-1        | <i>Coniophora</i> sp. | +                    | -      | -        | -              | -            |
| D2-2        | NI                    | -                    | -      | -        | -              | +            |
| G2-1        | NI                    | -                    | -      | -        | -              | -            |
| G8-1        | NI                    | -                    | -      | -        | -              | +            |
| G9-2        | NI                    | +                    | -      | +        | +              | +            |
| D9-2        | NI                    | -                    | -      | -        | -              | -            |
| A10-1       | NI                    | -                    | -      | +        | -              | -            |

NI = Not identified

Table 3. Laccase production on lignin-guaiacol, lignin and guaiacol media by other fungi isolated from soil and their performance for Bavendamm and Sundman test (lignin degradation)

| Culture No. | Type of fungus          | Colour production on |        |          | Bavendamm test | Sundman Test |
|-------------|-------------------------|----------------------|--------|----------|----------------|--------------|
|             |                         | Lignin guaiacol      | Lignin | Guaiacol |                |              |
| J8-3        | <i>Gilmaniella</i> sp.  | +                    | -      | +        | +              | +            |
| D4-3        | <i>Paecilomyces</i> sp. | -                    | +      | -        | +              | +            |
| J8-3        | <i>Moniella</i> sp.     | -                    | -      | +        | +              | -            |
| G8-1        | NI                      | +                    | +      | -        | +              | +            |
| G8-2        | NI                      | +                    | -      | +        | +              | +            |
| G10-1       | NI                      | +                    | -      | -        | -              | -            |
| G9-2        | NI                      | +                    | +      | -        | +              | +            |

NI = Not identified

Although most of isolated fungi gave positive results on guaiacol, the colour intensity was varied. All the isolates of white-rot fungi gave a red colour on those three different medium respectively, in which followed by the positive reaction for Bavendamm tests. Meanwhile, few isolates of brown-rot fungi gave very light red colour and mostly gave negative reaction on Bavendamm test. It seems that brown-rot isolates required lignin substitution to induce laccase production on guaiacol, even though the reaction is also weak.

Lignin degradation was clearly showed only by white-rot fungi with associated to respective laccase activity and weight loss (Table 4). The lignin degradation of brown-rot isolates was less compared to that of white-rot isolates. As reported earlier, white-rot fungi is one of the most efficient lignin degraders (Leisola *et al.*, 1982; Reid, 1995; Kawai *et al.*, 1999).

Table 4. Decomposition of wood sawdust by different fungi

| Fungi                   | Per cent loss |        | Laccase activity<br>(U/ml) |
|-------------------------|---------------|--------|----------------------------|
|                         | Total weight  | Lignin |                            |
| White-rot fungi         |               |        |                            |
| <i>Amauroderma</i> sp.  | 6.5           | 5.0    | 1.04                       |
| <i>Corioloopsis</i> sp. | 12.8          | 12.4   | 2.57                       |
| <i>Polyporus</i> sp.    | 8.7           | 6.3    | 1.33                       |
| <i>Fomes</i> sp.        | 12.3          | 11.6   | 2.68                       |
| Brown-rot fungi         |               |        |                            |
| <i>Poria</i> sp.        | 6.0           | 3.5    | 0.01                       |
| <i>Lentinus</i> sp.     | 5.4           | 1.9    | -                          |
| <i>Serpula</i> sp.      | 5.8           | 2.4    | 0.001                      |
| Other fungi             |               |        |                            |
| <i>Gilmaniella</i> sp.  | 2.3           | 0.1    | 0                          |
| <i>Paecilomyces</i> sp. | 3.8           | 0.5    | 0.01                       |
| <i>Moniella</i> sp.     | 2.1           | 0.03   | 0                          |

The results revealed good evidence on the correlation of phenoloxidase production, Bavendamm test with lignin-degrading capacity. Thus, all isolates of white-rot fungi produced colored zones followed by lignin loss and respective laccase activity. The highest lignin loss was resulted from *Corioloopsis* sp. (A9-3) and *Fomes* sp. (pA1-15). On the opposite, brown-rot isolates resulted in only little decrease in lignin with low laccase activity.

### Conclusions

The study suggests that oxidation of guaiacol accompanied by Bavendamm test may provide a simple method for screening fungi with lignin-degrading capacity. It means that the isolates can oxidize phenols in agar media, they might utilize lignin. Several fungi are induced by lignin (indulin AT), therefore any induced activity should have been evident by colorization of one or more of the media containing phenols.

White-rot fungi provided representative phenoloxidase activity whereas low phenoloxidase activity was found in brown-rot fungi. A more in-depth study of identification within this is necessary.

Tropical peat soils are a rich source of highly ligninolytic strains. They should be examined more closely.

### References

- Ander, P. and Eriksson, K.E. 1976. The importance of phenoloxidase activity in lignin degradation by the white-rot fungus *Sporotrichum pulverulentum*. *Arch. Microbiol.*, 109: 1-8.
- Barron, G.L. 1972. *The Genera of Hyphomycetes from Soil*. Robert E Krieger Publishing Company, New York.
- Breitenbach, J and Kranzlin, F. 1986. *Fungi of Switzerland, Vol. 2*. Verlag Mykologia, Switzerland.
- Ellis, M.B. 1976. *More Dematiaceous Hyphomycetes*. Commonwealth Mycological

Institute. Kew, Surrey, England.

- Fachraeus, G. T. and Ljungren, H. 1958. Production of high laccase yields in cultures of fungi. *Physiol. Plant.*, 11: 631-643.
- Harkin, J.M. and Obst, J.R. 1973. Syringaldazine an effective reagent for detecting laccase and peroxidase in fungi. *Experientia*, 29: 381-387.
- Higuchi, T. 1982. Biodegradation of lignin: biochemistry and potential applications. *Experientia*, 38: 159-166.
- Kawai, S., Nakagawa, M., and Ohashi, H. 1999. Aromatic ring cleavage of a non-phenolic  $\beta$ -O-4 lignin model dimer by laccase of *Trametes versicolor* in the presence of 1-hydroxybenzotriazole. *FEBS Letters*, 446: 355-358.
- Kirk, T.K. and Chang, H.M. 1975. Decomposition of lignin by white-rot fungi. II. Characterization of heavily degraded lignin from decayed spruce. *Holzforschung*, 29: 56-64.
- Kirk, T.K. and Kelman, A. 1965. Lignin degradation as related to the phenoloxidases of selected wood decaying basidiomycetes. *Phytopathology*, 55: 739-745.
- Leisola, M., Brown, C., Laurila, M., Ulmer, D., and Fiechter, A. 1982. Polysaccharide synthesis by *Phanerochaete chrysosporium* during degradation of kraft lignin. *J. Appl. Microbiol. Biotechnol.*, 15: 180-184.
- Nobles, M.K. 1958. A rapid test for extracellular oxidase in cultures of wood inhabiting hymenomycetes. *Can. J. Bot.*, 36: 91-99.
- Reid, I.D. 1995. Biodegradation of lignin. *Can. J. Bot.*, 73(suppl. 1): S1011-S1018.

## **Microbial Population and Greenhouse Gases Formation in Tropical Peatlands under Different Land Uses**

**Abdul HADI<sup>1,2</sup> and Kazuyuki INUBUSHI<sup>1\*</sup>**

<sup>1</sup> Faculty of Horticulture, Chiba University, Matsudo, Chiba 271-8510, Japan

<sup>2</sup> Faculty of Agriculture, Lambung Mangkurat University, Banjarbaru 70714, Indonesia

\* Corresponding author

### **Abstract**

Microbial population and formation of N<sub>2</sub>O, CH<sub>4</sub> and CO<sub>2</sub> in tropical peatlands under different land uses were studied in the laboratory. Three sites in South Kalimantan and 1 site in Hokkaido were chosen to represent different land uses. The three sites in South Kalimantan comprised of A-1 - secondary forest, A-2 - cultivated to rice since 1996 (2 year running), and A-3 - cultivated to rice during the first 3 year since 1992 and cultivated to rice-soybean in rotation since then. Site in Hokkaido (H) is a reserved area appeared as secondary forest. Soil physicochemical properties and number of microorganisms were determined soon after soil sampling. To study the effect of moisture content and land use management on the formation of N<sub>2</sub>O, CH<sub>4</sub> and CO<sub>2</sub>, soil moisture content of soil samples were adjusted to 60% moisture level or submerged. Soil samples were then transferred into 120 ml serum bottles, five bottles for each treatment, and incubated at 28°C for 60 days.

The results of experiment suggested that converting forest to agricultural fields considerably decreased the contents of organic carbon and numbers of microorganisms. At the same time, converting tropical peatlands to agriculture land enhanced the formation of N<sub>2</sub>O. Land use change of tropical peatlands, however, did not lead to a significant increase in CH<sub>4</sub> emission because the formation rates were considerably low irrespective to land use management. The effect of land use change in tropical peat soil on the formation of CO<sub>2</sub> was also not significant.

### **Introduction**

Peatlands are composed by soils which contain at least 30% by weight of organic matter, in the top of 40 cm and cover at least 80% of the area (FAO, 1988). Approximately 29 million ha is tropical peatlands worldwide (Takai, 1997). A large portion of this tropical peatlands exists in the Borneo Island (Driesen, 1981; Takai 1997), which belongs to three countries (i.e. Indonesia, Malaysia and Brunei).

Recently, large areas of natural peatlands have been converted for agricultural and aquacultural purposes in South Kalimantan (Indonesia) because of the intensification of agriculture due to growing population in this area (Moehansyah, 1988; MacKinnon et al., 1996). Rice crop have been grown on most peatland in South Kalimantan (about 200,000 ha) (Ismunadji and Soepardi, 1984; Radjagukguk, 1990).

Large amounts of ammonium (NH<sub>4</sub><sup>+</sup>), nitrate (NO<sub>3</sub><sup>-</sup>) and organic carbon accumulate when organic matter in peat soil undergoes either aerobic or anaerobic decomposition (Driesen, 1981; Ismunadji and Soepardi, 1984). This could pose a great threat to the environment by emitting various gases like nitrous oxide (N<sub>2</sub>O), methane (CH<sub>4</sub>) and carbon dioxide (CO<sub>2</sub>). However, there is a lack of quantitative information regarding the emission of N<sub>2</sub>O, CH<sub>4</sub> and CO<sub>2</sub> from natural and converted peatland (Terry *et al.*, 1981, Bouwman, 1990; Agustin *et al.*, 1998, Inubushi *et al.*, 1998). The

effect of land use change of tropical peatlands on soil microbial population is poorly understood. Since the ecosystem of the peat land is very vulnerable and readily affected by human activities (Reddy and Patrick, 1993; Tay *et al.*, 1996), improper land use management could lead to increased loss of land resource and hence could enhance environmental risks. Thus a more detailed knowledge about the functioning of the ecosystem of peat soil is truly needed. The present study was therefore carried out to investigate the microbial population and formation of  $N_2O$ ,  $CH_4$  and  $CO_2$  in tropical peatlands under different land uses.

### Materials and Methods

Three sites in South Kalimantan and 1 site in Hokkaido were chosen to represent different land uses. The three sites in South Kalimantan comprised of A-1 - secondary forest, A-2 - cultivated to rice since 1996 (2 year running), and A-3 - cultivated to rice during the first 3 year since 1992 and cultivated to rice-soybean in rotation since then. Site in Hokkaido (H) is a reserved area appeared as secondary forest. Each site was surveyed following  $100 \times 100$  m separate grids. Soil samples were taken up to a depth of 15 cm from randomly selected points during the late raining season of 1998. Each sample was a composite of points taken about 30 m apart. The moisture contents of the soil samples were 71, 63, 31 and 86 % for A-1, A-2, A-3 and H, respectively.

Contents of organic carbon, total nitrogen, water soluble organic carbon (SOC), ammonium and nitrate-N, cation exchangeable capacity (CEC), numbers of total culturable bacteria and fungi, number of cellulolytic microorganisms, and numbers of  $NH_4^+$  oxidizers and denitrifiers were determined soon after soil sampling. To study the effect of moisture content and land use management on the formation of  $N_2O$ ,  $CH_4$  and  $CO_2$ , deionized  $H_2O$  was added to soils from rice-soybean rotation field (A-3); while other samples were dried to bring them to 60% moisture level. Soil samples were transferred into 120 ml serum bottles, five bottles for each treatment, and incubated at  $28^\circ C$  for 60 days. The water status of soils were maintained at the initial condition during the entire period by adding distilled water every 2 days. Bottles were only stoppered 2 days before each gas sampling, aside from this the bottles remained un-stoppered throughout the incubation. Gas sampling was carried out in triplicate at 2, 5, 13 and 46 days of incubation. The  $NH_4^+$  and  $NO_3^-$  concentrations were measured when the formation rate of  $N_2O$  were maximum (i.e. 0, 5 and 60 days of incubation). Another set of soil samples were prepared similarly and incubated under flooded condition (i.e. 2 cm water depth) by adding deionized water.

To determine the optimum moisture level for optimum  $N_2O$  emission, soil samples from paddy field (site A-2) were first brought to 70, 80 and 100% moisture levels and submerged condition, and were then taken into 120 ml serum bottles. These soil samples were incubated at  $28^\circ C$  for 2 days and analyzed for  $N_2O$  emission.

The contents of organic carbon, total nitrogen, cation exchangeable capacity (CEC), and numbers of total culturable bacteria and fungi were determined with methods described by Black *et al.* (1965). Water soluble organic carbon (SOC) was determined with method described by Murase *et al.* (1996) after 1 h extraction on mechanical shaker with distilled water at 1:5 (soil:water) ratio. The concentrations of ammonium and nitrate-N were measured in KCl extract by using the nitroprusside (Anderson and Ingram, 1989) and hydrazine reduction (Hayashi *et al.*, 1997) methods, respectively. Numbers of cellulolytic bacteria and fungi were determined with method

described by Suyama *et al.* (1993). Numbers of ammonium oxidizer and denitrifiers were determined by methods described by Rowe *et al.* (1977) and Black *et al.* (1965), respectively. Gas samples were taken with gas-tight syringe and the concentrations of N<sub>2</sub>O, CH<sub>4</sub> and CO<sub>2</sub> were quantified with gas chromatograph (Shimadzu 7A, Japan) equipped with electron capture (EC), flame ionization (FI) and thermal capture (TC) detectors for N<sub>2</sub>O, CH<sub>4</sub> and CO<sub>2</sub>, respectively.

Soil dry weight and volume of head space of bottles were finally measured gravimetrically.

### Results and Discussion

Land use change significantly affected the contents of organic carbon and total nitrogen of tropical peat soil (Table 1). The content of organic carbon was the lowest in paddy field (site A-2), followed by rice-soybean rotation field (site B-3) and secondary forest (site A-1). This indicated that the loss of organic matter was more from paddy field as compared to secondary forest or rice-soybean rotation field. The loss of soil carbon is mainly through biomass burning that is commonly practiced during land clearing of natural tropical peatlands. Crops rotation (i.e. rice-soybean rotation) resulted in a higher soil organic carbon than rice crop alone.

Table 1. Physicochemical properties of soil used.

| Site      | Site code | Land use                                       | Org C<br>g kg <sup>-1</sup> | Total N | CEC<br>c+mol kg <sup>-1</sup> |
|-----------|-----------|--|-----------------------------|---------|-------------------------------|
| Japan     |           |  |                             |         |                               |
| Obihiro   | H         | Reservation area,<br>secondary forest          | nd                          | nd      | nd                            |
| Indonesia |           |  |                             |         |                               |
| Amuntai   | A-1       | Secondary forest                               | 475.1                       | 23.1    | 103.7                         |
|           | A-2       | Paddy field,<br>2 year running                 | 225.0                       | 21.0    | 120.1                         |
|           | A-3       | Rice-soybean rotation field,<br>6 year running | 311.2                       | 13.2    | 103.5                         |

Total nitrogen was the lowest in rice-soybean rotation field (A-3), followed by secondary forest (site A-1) and paddy field (A-2) (Table 1). The reason for remarkable decrease in total nitrogen in rice-soybean rotation field remained unknown. The decrease in total nitrogen in paddy field may be due to the biomass burning as mentioned earlier for soil organic carbon.

Similar to soil total nitrogen, water soluble organic carbon and NH<sub>4</sub><sup>+</sup> were the lowest in rice-soybean rotation field (site A-3), followed by rice field (site A-2) and secondary forest (site A-1) (Fig. 1). However, the nitrate contents in three sites considered in this study did not differ significantly.

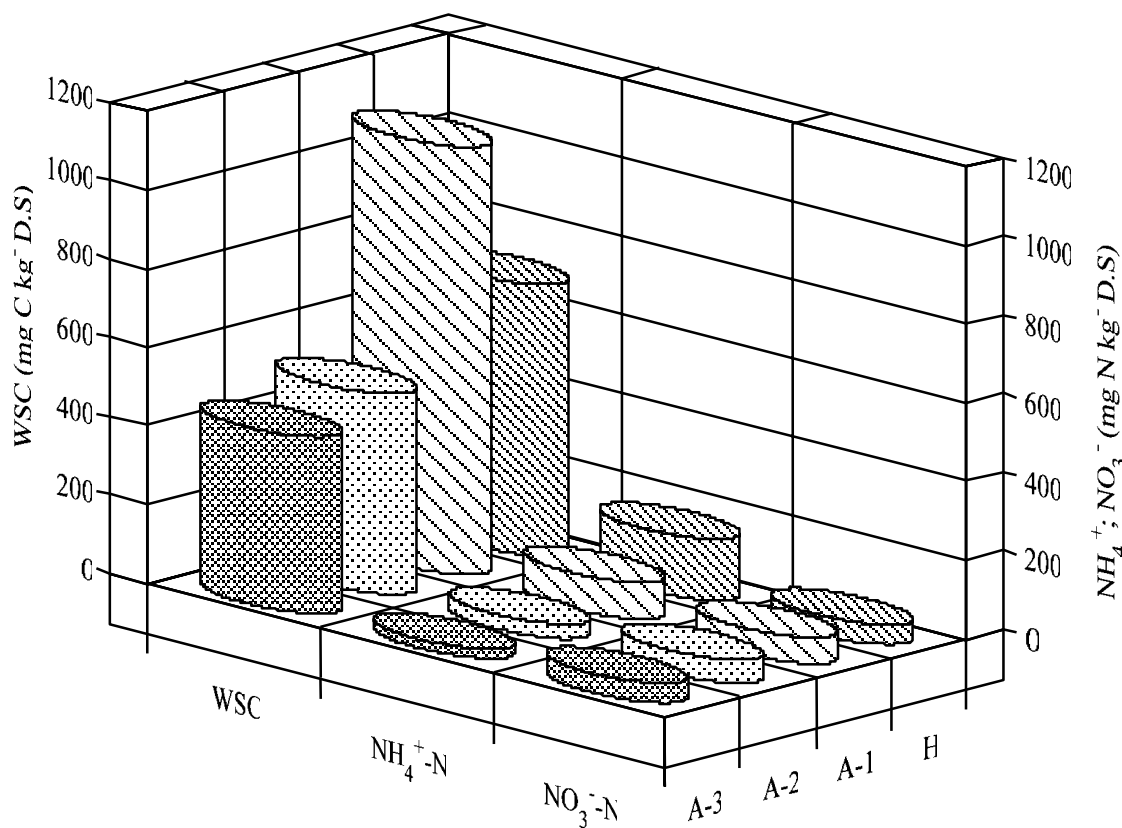

Fig. 1. Concentrations of water soluble carbon (SOC),  $\text{NH}_4^+$  and  $\text{NO}_3^-$  in tropical peat soils as affected by land-use change.

Numbers of total culturable bacteria and fungi in rice-soybean rotation field (A-3) was about 10 times less than that in secondary forest (both in tropics, site A-1, and temperate, site H). Similarly, numbers of cellulolytic bacteria and fungi in rice soybean rotation field (site A-3) was 10 times lower than that in secondary forest (A-1). However, the number of bacteria and fungi in paddy field (site A-2) were comparable to that in secondary forests (site A-1 and site H) (Fig. 2). This indicated that land use change, for long term in particular (i.e. 6 years), had a significant impact on the number of bacteria and fungi.

Ammonium oxidizers are responsible for the conversion of  $\text{NH}_4^+$  to  $\text{NO}_3^-$  while denitrifiers are responsible to the conversion of  $\text{NO}_3^-$  to  $\text{N}_2\text{O}$  (Paul and Clark, 1996). It was found that the numbers of  $\text{NH}_4^+$  oxidizers and denitrifiers in paddy field (A-1) were about 50 times less than that in secondary forest (A-1), and their numbers in rice-soybean rotation field (site A-3) were about 10 times lower than that in paddy field (A-2) (Fig. 3). These results suggested that land use change of tropical peatlands suppressed the numbers of both  $\text{NH}_4^+$  oxidizer and denitrifiers (Fig. 3). Fig. 3 also showed that the number of  $\text{NH}_4^+$  oxidizers was always higher than that of denitrifiers, irrespective to land use management.



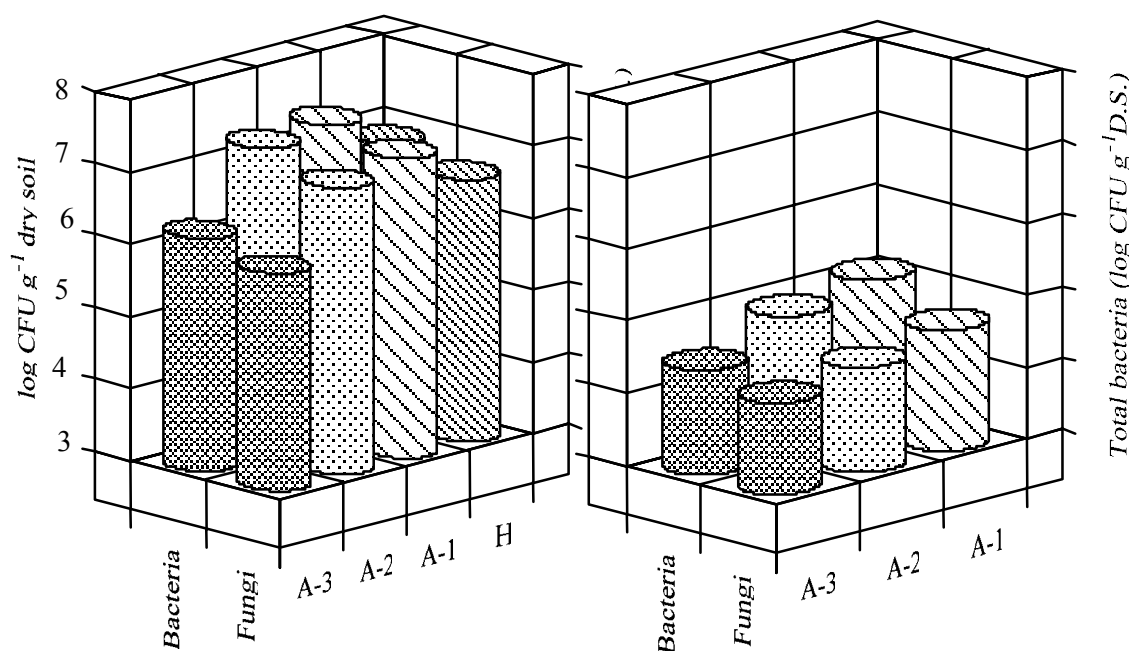

Fig. 2. Populations of total culturable bacteria, total culturable fungi (left) and cellulolytic bacteria and fungi (right) as affected by land-use change, Determination of cellulolytic neither bacteria nor fungi was done for site H.

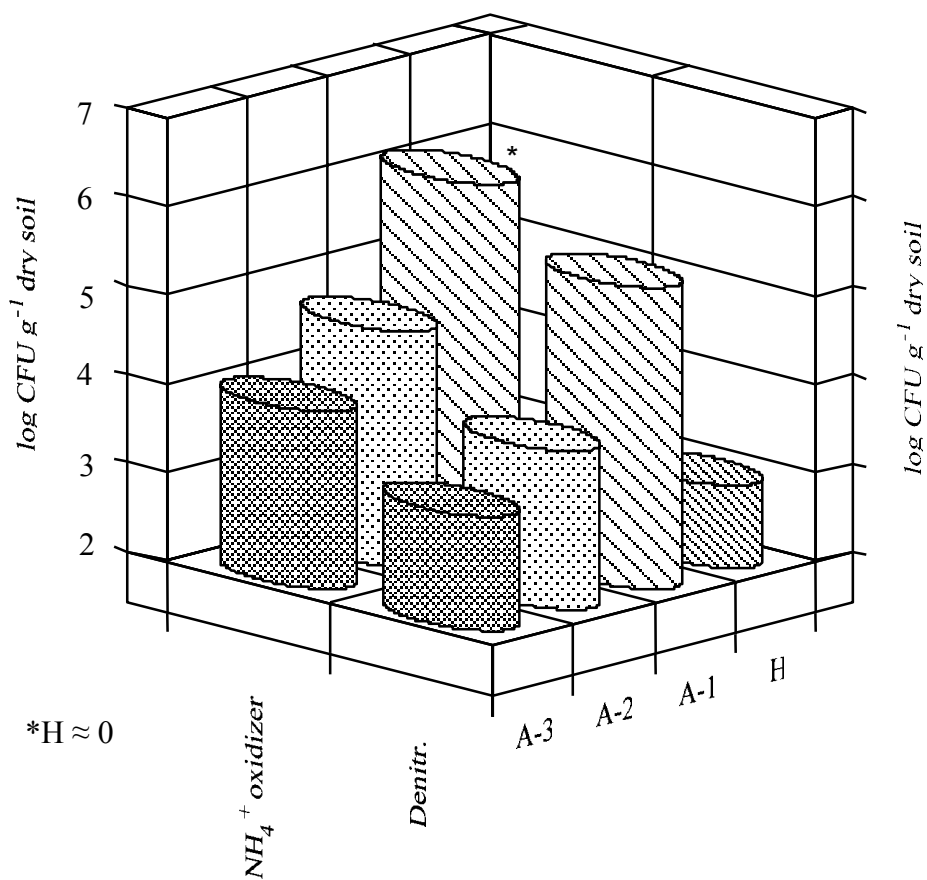

Fig. 3. Populations of  $\text{NH}_4^+$  oxidizer and denitrifiers in peat soils as affected by land-use change.

Soil moisture content and land use management significantly affected the formation of N<sub>2</sub>O, CH<sub>4</sub> and CO<sub>2</sub> (Fig. 4). Their effects were especially pronounced on the formation rates of N<sub>2</sub>O and CH<sub>4</sub>. At moisture content of 60%, paddy field formed (A-2) as much N<sub>2</sub>O as that of secondary forest (A-1) which was higher than that of rice-soybean field (A-3).

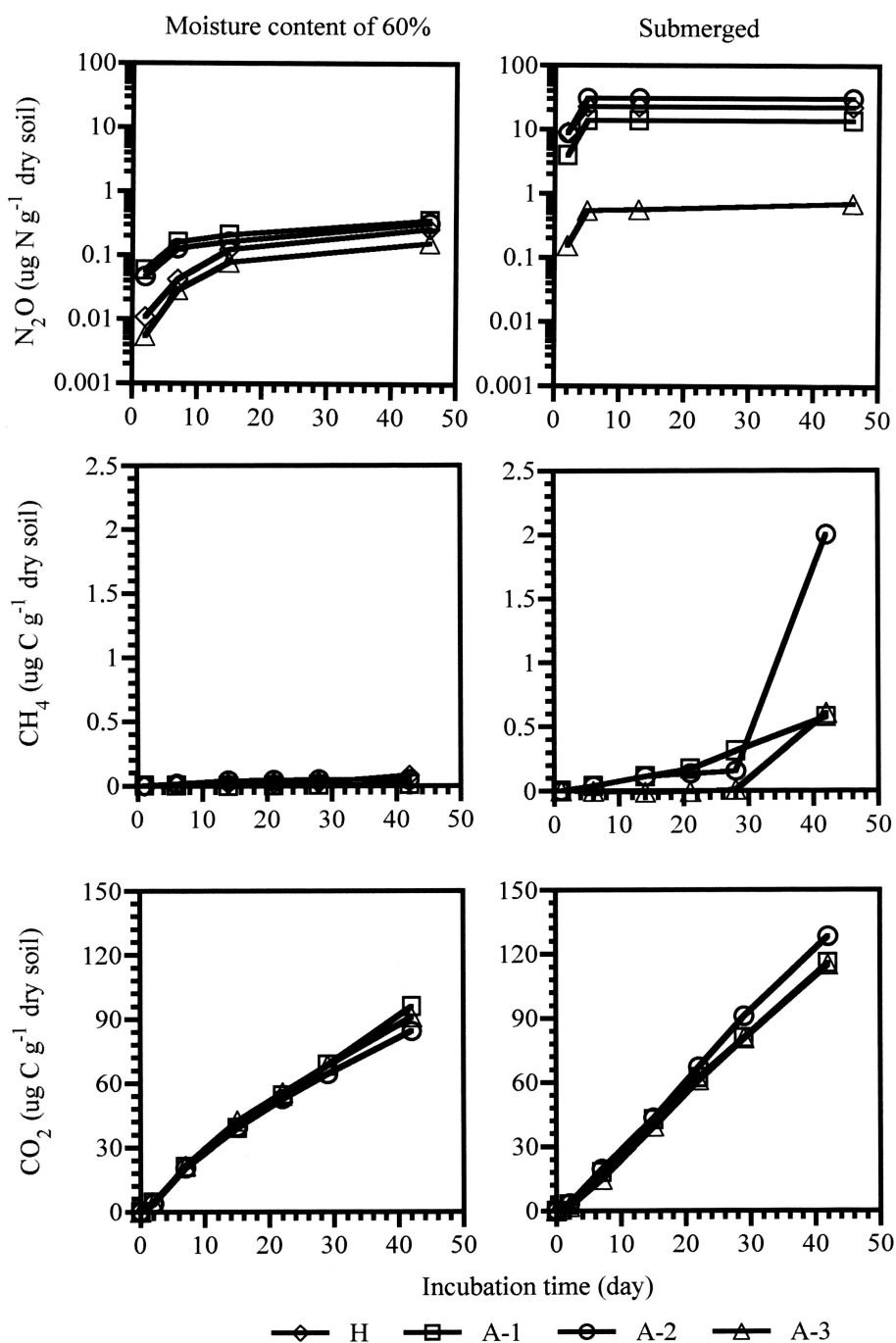

Fig. 4. Cumulative amounts of N<sub>2</sub>O, CH<sub>4</sub> and CO<sub>2</sub> during 46 days of incubation under moisture content of 60% and submerged conditions. Site H was not analyzed for CH<sub>4</sub> and CO<sub>2</sub>.

Under submerged conditions, N<sub>2</sub>O formations were highest in paddy field (A-2), followed by secondary forest (A-1) and rice-soybean rotation field (A-3) (Fig. 4). This indicated that conversion of natural tropical peatlands to cultivated land (i.e. rice field) initially increased N<sub>2</sub>O formation. The continued use of tropical peatlands as for rice-soybean rotation field, N<sub>2</sub>O formation rate reduced to below natural peatlands rate. Similar result obtained from tropical grassland has been reported by Keller and Reiner (1994). Though the number of NH<sub>4</sub><sup>+</sup> oxidizer and denitrifiers were lower in paddy field (site A-2) than secondary forest (site A-1) (Fig. 3), the N<sub>2</sub>O formation rate was higher. This indicated that the conversion of natural peatlands initially increase the activities of NH<sub>4</sub><sup>+</sup> oxidizer and denitrifiers in producing N<sub>2</sub>O. The decrease in N<sub>2</sub>O formation rate in rice-soybean rotation field (site A-3) probably due to the less numbers of NH<sub>4</sub><sup>+</sup> oxidizer and denitrifiers in this field (Fig. 3).

Paddy field (site A-2) formed more CH<sub>4</sub> than secondary forest (A-1) or rice soybean rotation field when the soil samples were submerged for more than 45 days (Fig. 4). The formation rates, however, were considerably low and even much lower than those obtained from temperate peatlands (Fecher and Hammond, 1992; Wada et al., 1998), indicating that land use change of tropical peatlands did not lead to a significant increase in CH<sub>4</sub> emission. Similar result has been reported by Inubushi et al. (1998).

Moisture content significantly affected the formation rate of CO<sub>2</sub>; the CO<sub>2</sub> formation rate was higher in soil incubated under submerged condition than that of soil incubated at moisture content of 60%, irrespective to land use management (Fig. 4). Moisture content of 60% seemed to limit the CO<sub>2</sub> formation. This is attributed to lower activity and proliferation of microorganism due to insufficiency of water availability (Paul and Clark, 1996). The water content of 60% is considerably high for mineral soil, but considerably low for peat soil because of low bulk density of peat soil.

During the 60 days of incubation at 60% moisture content, the concentrations of ammonium decreased with time of incubation; while nitrate changed alternatively (Table 2).

Table 2. Effect of moisture content and land use management on NH<sub>4</sub><sup>+</sup> and NO<sub>3</sub><sup>-</sup> concentrations in topical peat soils taken from paddy field (site A-2).

| Day | Treatment | Site*: | NH <sub>4</sub> <sup>+</sup> (μg g <sup>-1</sup> soil) |       |       | NO <sub>3</sub> <sup>-</sup> (μg g <sup>-1</sup> soil) |      |      |
|-----|-----------|--------|--|-------|-------|--|------|------|
|     |           |        | A-1  | A-2   | A-3   | A-1  | A-2  | A-3  |
| 0   | MC 60 %   |        | 157.0  | 143.0 | 190.0 | 0.5  | 20.0 | 32.8 |
| 5   | MC 60 %   |        | 147.0  | 39.0  | 19.0  | 16.1   | 7.2  | 23.3 |
|     | Submerged |        | 8.3  | 152.0 | 189.7 | 0  | 5.3  | 10.0 |
| 60  | MC 60 %   |        | 77.5   | 9.4   | 14.1  | 2.5  | 42.2 | 38.0 |
|     | Submerged |        | 25.6   | 59.4  | 201.0 | 0  | 17.2 | 22.0 |

MC 60%: moisture content of 60%

Under submerged conditions, the concentration of  $\text{NH}_4^+$  and  $\text{NO}_3^-$  decreased during the first 5 days of incubation and increased later on, except paddy field (site A-2) that exhibited opposite pattern to that of  $\text{NH}_4^+$  (Table 2).

The  $\text{N}_2\text{O}$  formation in soil taken from site A-2 was strongly affected by soil water content (Fig. 5). The formation rate of  $\text{N}_2\text{O}$  was lower when the soil was incubated at water content of 70% or 80% and became higher (i.e., 30 folds) when the water content was increased to 100%. The formation rate of  $\text{N}_2\text{O}$  in soil under submerged conditions was lower than that at water content of 100%. It is more likely that at moisture content of 100%, the  $\text{N}_2\text{O}$  production was higher than its consumption, resulting in a maximum  $\text{N}_2\text{O}$  emission. Contrary, under submerged conditions, some of the produced  $\text{N}_2\text{O}$  might have reduced to  $\text{N}_2$  before reaching the head space. The presence of supernatant water might have also provided less diffusivity of soil (Keller and Reiners, 1994; Mosier and Delgado, 1997). Both processes might contribute to less emission of  $\text{N}_2\text{O}$  from submerged samples.

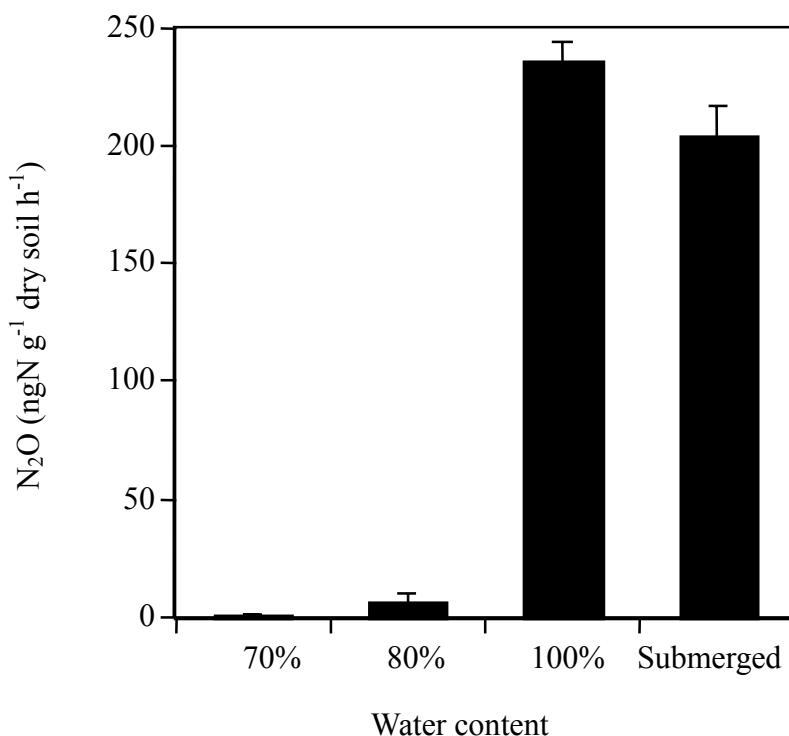

Fig. 5. Effect of moisture on the formation rates of  $\text{N}_2\text{O}$  in soil taken from site A-2 (rice field) in South Kalimantan.

### Conclusions

It can be concluded that converting forest to agricultural fields considerably decreased the contents of organic carbon and numbers of microorganisms. At the same time, converting tropical peatlands to agriculture land enhanced the formation of  $\text{N}_2\text{O}$ . Land use change of tropical peatlands, however, did not lead to a significant increase in  $\text{CH}_4$  emission because the formation rates were considerably low irrespective to land use

management. The effect of land use change on the formation of CO<sub>2</sub> was also not significant.

### Acknowledgment

We acknowledge Prof. Dr. R. Kondoh and Dr. T. Tsutsuki (Obihiro Univ. of Agriculture and Veterinary Medicine) for providing the soil samples. The field work in South Kalimantan was possible by the help of Mr. Muhammad Haridi (staff of Agricultural Extension Station in Amuntai). Dr. H. Tsuruta of NIAES is acknowledged due to providing fund to the authors' attendance to this symposium.

### References

- Agustin, J., Merbach, W., Sreffens, L. and Snelinski, B. 1998. Nitrous oxide fluxes of disturb mineratrophic peatlands. *Agribiol. Res.*, 51: 47-57.
- Anderson, J.M. and Ingram, J.S.I. 1989. Colorimetric determination of ammonium. In: *Tropical Soil Biology and Fertility*, ISSS, CAB International, Wallingford, pp. 42-43.
- Black, C.A., Evans, D.D., White, J.J., Ensminger, L.E. and Clerk, F.E. (eds.). 1965. *Method of Soil Analysis, Part 2*. American Society of Agronomy, Inc., Publisher. Madison, Wisconsin, USA. pp.1572.
- Bouwman, A.F. 1990. Introduction. In: Bouwman, A.F. (ed.), *Soils and the Greenhouse Effect*. John Wiley & Sons, New York, pp. 25-35.
- Driesen, P.M. 1981. Peat soil. In: IRRI (ed), *Soil and Rice*. IRRI, Los Baños, Philippines, pp. 763-779.
- FAO. 1988. Revised Legend of the FAO-Unesco Soil Map of the World. *World Soil Resources Report No. 60*. Rome, pp. 109.
- Fechner, E.J. and Hemmond, H.F. 1992. Methane transport and oxidation in the unsaturated zone of a spagnum peatland. *Global Biochem. Cycle*, 6: 33-44.
- Hayashi, A., Sakamoto, K. and Yoshida, T. 1997. A rapid method for determination of nitrate in soil by hydrazine reduction procedure, *Jpn. J. Soil Sci. Plant Nutr.*, 68 (3): 322-326. (in Japanese).
- Inubushi, K., Hadi, A., Okazaki, M. and Yonebayashi, K. 1998. Effect of converting wetland forest to sago palm plantations on methane flux and organic carbon dynamics in tropical peat soil, *Hydrological Processes*, 12: 2073-2080.
- Ismunadji and Soepardi, G. 1984. Peat soil: problems and crop production. In: IRRI (ed.), *Organic Matter and Rice*, IRRI, Los Banos, Philippines, pp. 489-502.
- Keller, M. and Reiners, W.A. 1994. Soil-atmosphere exchange of nitrous oxide, nitric oxide and methane under secondary succession of pasture to forest in the Atlantic lowland of Costa Rica, *Global Biogeochem. Cycle*, 8: 399-409.
- McLaren, R.G. and Cameron, K.C. 1996. Soil, plant and fertilizer nitrogen. In: *Soil Science*, Oxford University Press, Auckland, New Zealand, pp. 192-206.
- Moehansyah. 1988. Capability of tidal swampy area of South Kalimantan for housing. Fac. of Agriculture, Lambung Mangkurat University. 1-11 (in Indonesian).
- Mosier, A.R. and Delgado, J.A. 1997. Methane and nitrous oxide fluxes in grasslands in western Puerto Rico. *Chemosphere*, 35: 2059-2082.
- Murase, J., Kimura, M. and Kawatsuka, S. 1996. Methane emission and its fate in paddy field, Effect of percolation on methane flux distribution to the atmosphere and subsoil, *Soil Sci. Plant Nutr.*, 39: 63-70.

- Paul, E.A. and Clerk, F.E. 1996. *Soil Microbiology and Biochemistry*. Academic Press, Inc. San Diego, pp. 273.
- Radjagukguk, B. 1990. Management of peatland productivity for lowland rice. In Taher et al., (eds), *Pengelolaan Sawah Bukaan Baru Menunjang Swasembada Pangan dan Program Transmigrasi*. Faperta Univ. Prasakti/Balittan Sukarami, 217-235 (in Indonesian with English summary).
- Reddy, K. R. and Patrick, H.W., Jr. 1993. Wetland soil-opportunities and challenges. *Soil Sc. Soc. Am. J.* , 57: 1145-1147.
- Rowe, R., Todd R. and Waide, J. 1977. Microtechnique for most-probable-number analysis, *Appl. Environ. Microbiology*, 33: 675-680.
- Suyama, K., Yamamoto, H., Naganawa, T., Iwata, T. and Komada, H. 1993. A plate count method for aerobic cellulose decomposers in soil by congo red staining. *Soil Sci. Plant Nutr.*, 39: 361-365.
- Takai, Y. 1997. Environmental characteristic and Management in Peat/Acid Sulfate Soils of Southeast Asia. *MAB Report, Japan*, 1996-1997: 31-49.
- Tay, T.H., Zahari, A.B. and Ahmad, Md. S. 1991. Ameliorating peat for crop production: Its impact to the environmental. In: *Proceeding of International Seminar : Impact of Agriculture Productivity on the Environment*.
- Terry, R.E., Tate, R.L. III, and Duxbury, J.M. 1981. Nitrous oxide emission from drained, cultivated organic soils of South Florida, *J. of the Air Pollution Assoc.*, 31: 1173-1177.
- Wada, Y., Inubushi, K., Hadi, A., Sugii, H., Ishida, T., Yoh, M., Konohira, E. and Tsuruta, H. 1998. Measurement of methane flux from Ozegahara wetlands in 1997 and factors controlling methane emission, *Res. Rep. Div. Environ. Planning, NIEAS*, 14: 89-104.

## **Aspect and Mechanism of Peat Fire in Tropical Peat Land: A Case Study in Central Kalimantan 1997**

**Aswin USUP<sup>1</sup>, Hidenori TAKAHASHI<sup>2</sup> and Suwido H. LIMIN<sup>1</sup>**

<sup>1</sup> Dept. Agronomy, Faculty of Agriculture, University of Palangkaraya,  
Central Kalimantan, Indonesia

<sup>2</sup> Laboratory of Geoecology, Geosince, Graduate School of Environmental Earth Science,  
Hokkaido University, Sapporo 060-0810, Japan.

### **Abstract**

Forest/peat fires occur every year in tropical peatland of Southeast Asia. The areas and damages by the forest/peat fires are different with year. The impact of the peat fire on tropical peat soil depends on the local climate and response of fuel material to release of heat energy through the combustion. The fire are confined and controlled in a small area by rainfall under the normal weather condition. But it became without control under such a extremely dry weather condition as dry season in 1997.

Some aspects of peat forest fire in the peat swamp forest of Central Kalimantan were shown and analyzed in relation to microclimate, hydrological condition, peat material and vegetation.

The bulk density of peat becomes very low to 0.1-0.2 g in dry condition. The peat materials become porous and hydrophobic one in such a condition. This means the peat fire is closely related to weather, the moisture content and distribution within the peat.

The fire extension into peat layer has a different mechanism with other solid materials, because of its low density, high porosity and hydrophobic characteristics. Peat layer was partly burned made a hole on the top layer, and the hole introduced the fresh air into the deeper peat layer.

### **Introduction**

The Central Kalimantan province was the most affected area by the 1997/1998 land and forest fires in Indonesia. The fire occurred mostly in tropical peat and peatland ecosystems in the region. This is mainly because peatlands comprised of organic matters either already decomposed or still continue to decompose which are prone to fire hazards especially during persistent drought. Peatland ecosystems in Central Kalimantan are estimated to occupy almost 2.5 million hectares with various types of vegetation. Peat swamp forests are of paramount important due to their inherent and unique characteristics that reflect their natural resource functions. Once these ecosystems are affected by extensive fires, it will not be easy and requires a very long time to recover or even lost forever.

The occurrence of tropical peatland fire depends on the availability of fuel or vegetation type, rainfall and water table level. This fire is categorised as a unique fire, due to its small ignition, spread slowly and with relatively long time period. The underground fire can reach the depth up to 100 - 150 cm, and usually very difficult to be extinguished. This paper will attempt to describe the peat fire event in Central Kalimantan in 1997.

### **General Forest and Land Fires in Indonesia**

The forest fire in Indonesia occurred in 1984 covers 15,079.74 ha. The affected areas

include South and West Sumatera, West Java and East Nusa Tenggara. In this country, the extended dry periods happened every five years that contribute to the periodicity of the occurrence of big forest and land fires. In 1985, the forest and land fires affected the area of 4,256,986 ha spreading out in 11 provinces, followed by similar fire in 1991 that occurred in 23 provinces covering 11,888,118 ha. The biggest forest and land fires occurred in 1997 covered 25 provinces with the total area reaching 26,399,200 ha. The extent of forest and land fires is depicted in Fig. 1.

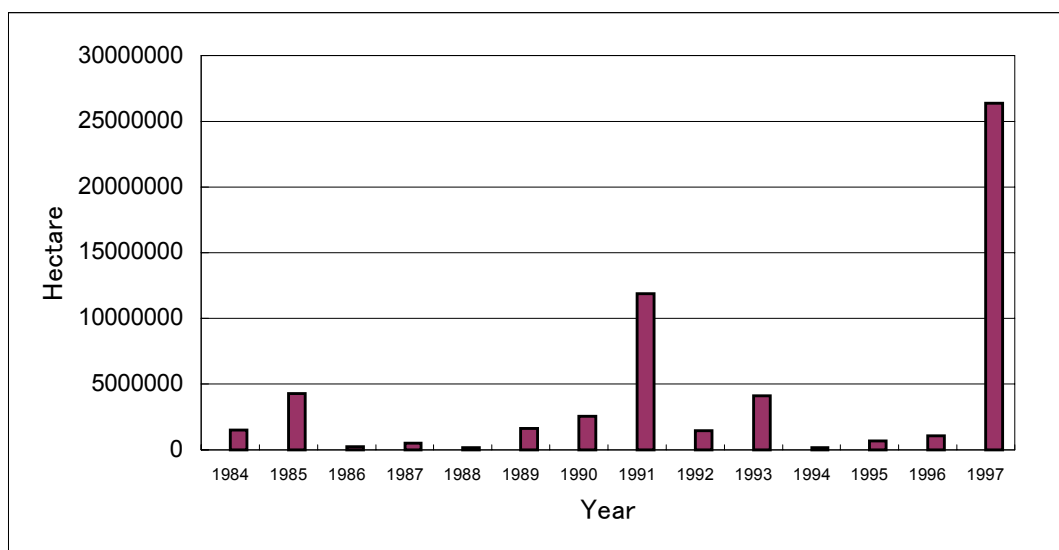

Fig. 1. Forest and land fire in Indonesia from 1984 to 1997 (Source Indonesia Ministry of Environment-UNDP 1998).

### Forest and Land Fires in Central Kalimantan

In Central Kalimantan, the forest and land fires occur every year. These fires are caused by various human activities such as land clearing by farmers in opening land for ladang (traditional agriculture), rubber plantation and rattan plantation. In the traditional agricultural practice, the use of fire is a part of local people (Dayak people) life. It started since their great grandparents period. There are many benefits of using the fire for land clearing such as increasing the accessibility, controlling pest and diseases, improving soil fertility and reducing weed competition.

The events of the 1991 and 1997 forest and land fires were not controllable. The main causes of these fires were an extreme dry season, massive development of palm oil plantation, and forest clearing for transmigration settlement in Central Kalimantan.



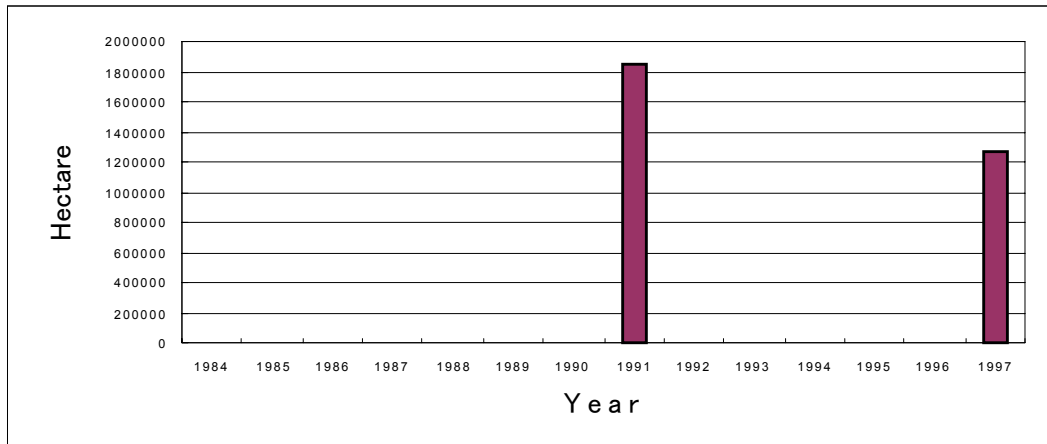

Fig. 2. Burned forest areas in Central Kalimantan from 1984 to 1997 (source: Ministry of Environment Indonesia-UNDP, 1998).

### Peat Vegetation Types in Central Kalimantan

There is essentially infinite variability in fuel, types, amount, size, shape, position and arrangement of vegetation in tropical peat swamp forests. Forest floor materials such as litter and duff on the top organic soil will be ignited during fire event. These ignitions may develop into smoldering ground fires that could remain all day or even months, consume amount of duff or deep organic soil, resulting in a significant ecological and landscape change. Moisture is an important factor in discouraging ignition of ground fires. Following figures show several vegetation types in tropical peat land.



Fig. 3. Variability of peat soil vegetation in dry season as a potential fuel



Fig. 4. The small tree on peat land, that contains a kind of oil making it easy to be burned



Fig. 5. The peat land origin vegetation, usually grow in saturated water table condition and rarely burned.





Fig. 6. As a consequence of lowering ground water table, various types of grasses and alang-alang (*Imperata cylindrica*) grow on open peat, which is prone to fire.



Fig. 7. Fire in peat land that produce a dense smoke, small ignition and spread slowly.

### Characteristics of Peat soil in Central Kalimantan

Approximately 10% of peat soil occur in tropical areas as a result of the decomposition of litters, leaves, branches which are common under the forest and basin areas with saturated water table (Rieley *et al.*, 1997). The peat soils are potential fuel for continuous fires in drought. Its vulnerability to fire depends on its ground water level. Following figures show various soil conditions in open areas of Kalamangan, Central Kalimantan.



Fig. 8. Tropical Peat soil condition in Kalamangan Indonesia, there are many wood debris in the surface



Fig. 9. Arrangement of wood in the Tropical peat soil in Kalamangan Indonesia

### Weather Condition in Central Kalimantan

#### Rainfall

In Central Kalimantan province, the total annual rainfall from August 1993 to July 1997 fluctuated considerably. The lowest rainfall (42 mm) occurred on May, whereas the highest (308 mm) occurred on March. The monthly rainfall varies greatly from year to year. In dry season of September 1994, for example, the total rainfall was only 0.5 mm. However, in September 1995 such value rose up to 222.5 mm (Takahashi *et al.*, 1997).

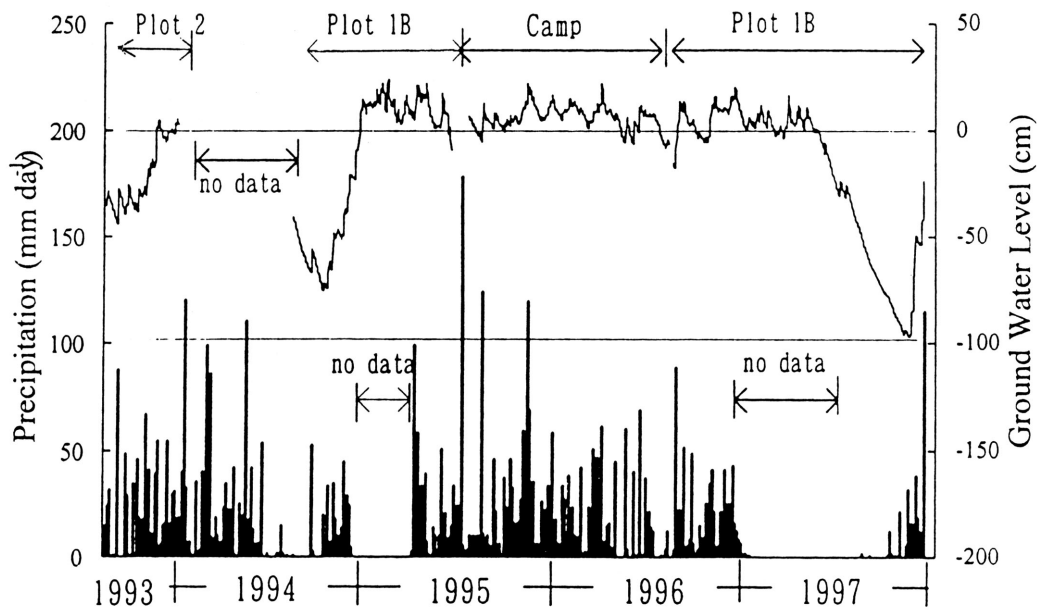

Fig. 10. Rainfall and ground water level in Sabangau Central Kalimantan from September 1993 to December 1997 (Takahashi *et al.*, 1997).

#### Mechanism of Tropical Peat Fire

The process of burn holes development, smoldering and consumption of peat soil during peat fire is not well understood. Ignition of spot or the number of spots may be initiated by fire brand or by the passage of fire front from a surface fire, if the conditions are suitable. Once ignition occurs, the fire begins to burn downward and laterally. As smoldering progresses, a basin configuration is created. Lateral spread below the surface becomes the dominant form of spread as vertical spread reaches organic soil or smoldering moisture limits.



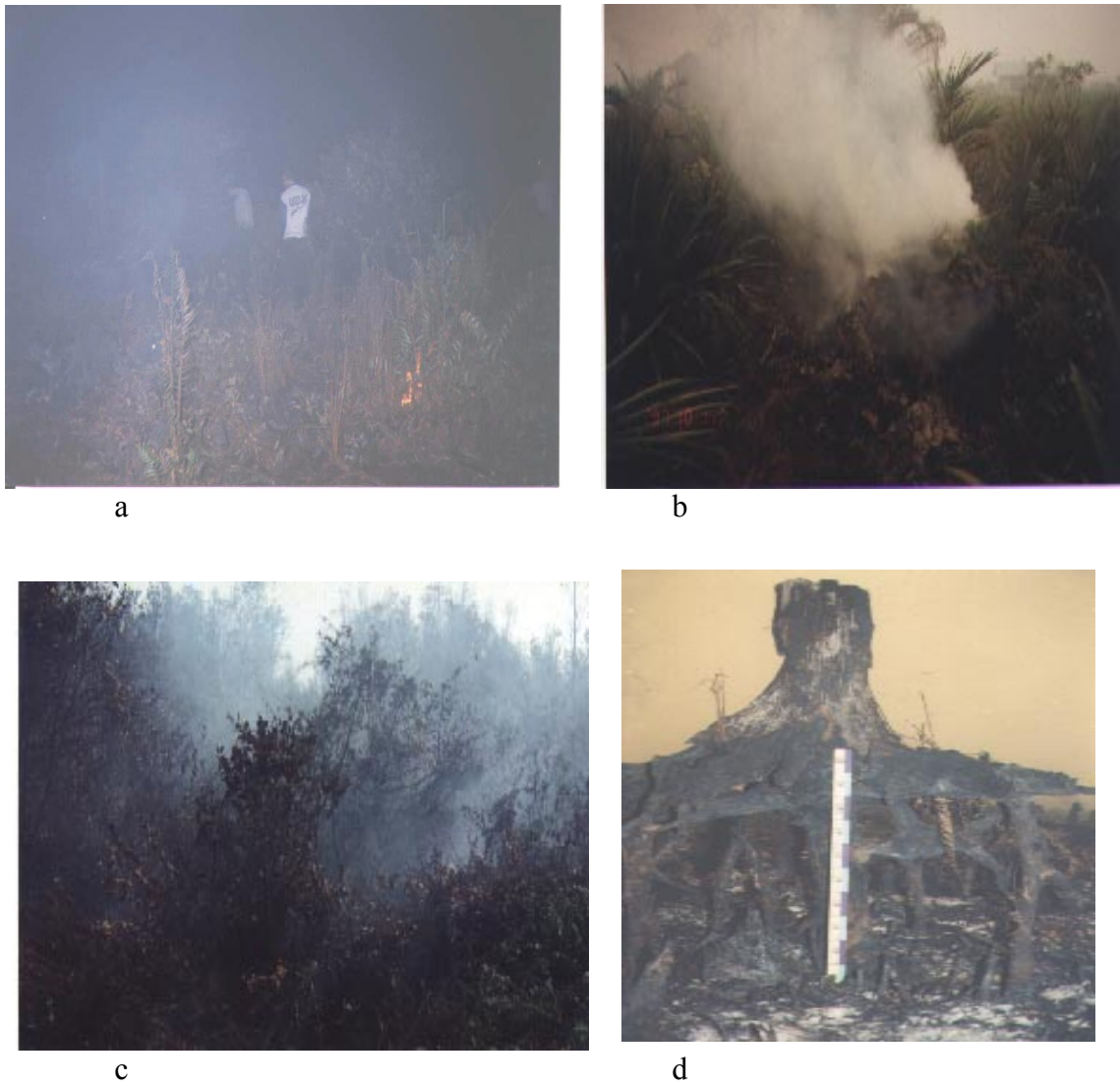

Fig. 11. The pattern of peat fires differ among fuels and vegetation types. (a) smoldering in surface fire, (b) fire produced many smoke as convection heat, (c) small trees remain fires, (d) a stump of big tree remain after burning

## Aspect and mechanism of peat fire

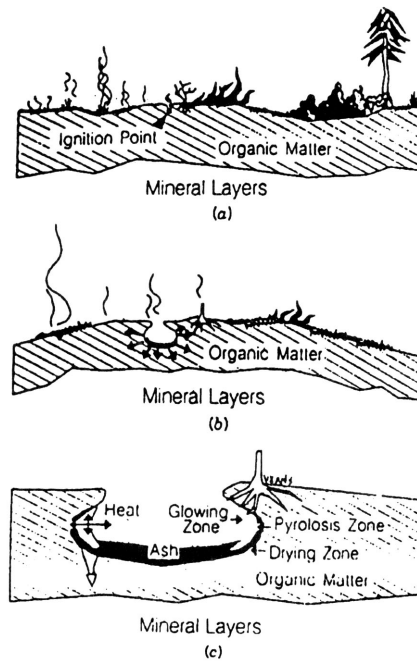

Fig. 12 Illustration developing of peat fire, (a) smoldering ignition on fire surface, (b) spread of burn hole from the initial point, (c) spread of burn to horizontal spread (Adapted from Pyne *et al.*, 1996).

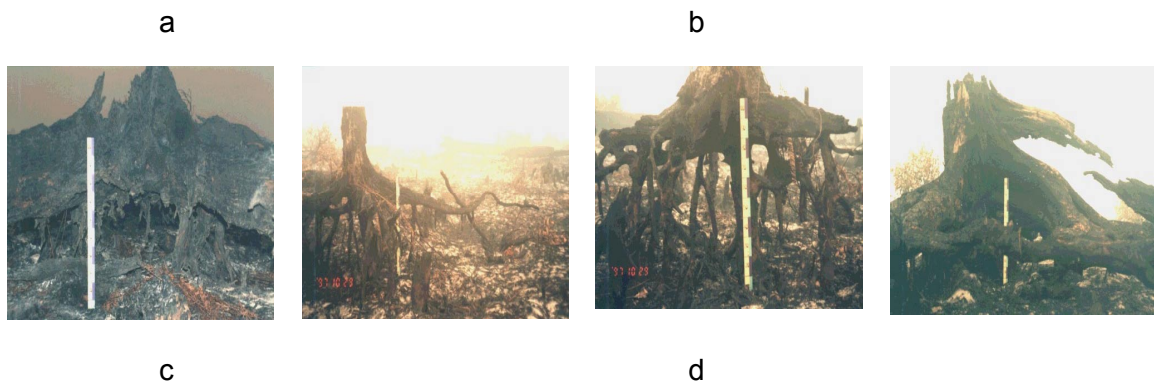

Fig. 13. Ancient tree stumps after burning in 1997.

## References

- Effendy, E. 1998. Overcoming peat resources fire in west Kalimantan. *Proceeding of the International Cross Sectoral Forum on Fire Management in South East Asia, Tropical Forest Fire, Prevention, Control, Rehabilitation and Trans-Boundary Issue*. National Development Planning Agency, Indonesia, JICA and ITTO.

- Jhamtani, H. 1998. Forest and land fires in Indonesia: An evaluation of factors and management efforts. *Proceeding of the International Cross Sectoral Forum on Fire Management in South East Asia, Tropical Forest Fire, Prevention, Control, Rehabilitation and Trans-Boundary Issue. National Development Planning Agency, Indonesia, JICA and ITTO.*
- Nicolas, M. V. J. and Bowen, M. R. 1999. Field Approach Peat Fire and Coal Seam Fire in South Sumatera Province, Indonesia. (Indonesian version) UNDP and Forestry and Plantation Department South Sumatera Province.
- Ueda, T. 1998. Monitoring forest fires by using meteorological satellite information. *Proceeding of the International Cross Sectoral Forum on Fire Management in South East Asia, Tropical Forest Fire, Prevention, Control, Rehabilitation and Trans-Boundary Issue. National Development Planning Agency, Indonesia, JICA and ITTO.*
- Pyne, J. S., Patricia, A. L. and Richard, L. D. 1996 *Introduction to Wildland Fire 2nd edn.* John Wiley and Sons, Inc. New York.
- Surjadi, H. and Jhamtani, H. (ed). 1998. *Forest and Land Fires In Indonesia, Effect, Factor and Evaluation,* Indonesia Ministry of Environmental and UNDP.
- Takahashi, H., Shimada, S. and Limin, S. H. 1999. Effects of dense haze on solar radiation and ground water level of tropical peat swamp forest in Central Kalimantan, Indonesia. In: *Environmental Conservation and Land Use Management of Wetland Ecosystem in Southeast Asia, Annual Report for April 1998-March 1999, Core University Program between Hokkaido University and R&D Center for Biology-LIPI sponsored by JSPS.* pp. 25-35.



## **Characterization and Population of Nitrogen-Fixing Bacteria from Peat Soil in Kahayan Water-Catchment, Central Kalimantan**

**Sri PURWANINGSIH<sup>1</sup>, Typuk ARTININGSIH<sup>1</sup> and Mitsuru OSAKI<sup>2</sup>**

<sup>1</sup> R&D Center for Biology, LIPI, Bogor, Indonesia

<sup>2</sup> Graduate School of Agriculture, Hokkaido University, Sapporo, Japan

### **Abstract**

Nitrogen-Fixing Bacteria (NFB), which was collected from peat soil of six locations around Kahayan water-catchment in Central Kalimantan, has been successfully isolated and characterized. The peat soil samples were taken from four different depths as follows: 0-10 cm, 10-30 cm, 30-50 cm, and 50-60 cm. The growth characteristic was observed by using Yeast Extract Mannitol Agar medium (YEMA) mixed respectively with brom thymol blue and congo red as indicators.

Eighteen NFBs were isolated from twenty-one soil samples. The most number of populations was shown by the samples collected from Garung (Pulang Pisau) at 0-10 cm soil depth. Those 18 isolates grow well on YEMA medium, and mixed media of YEMA and brom thymol blue. As well, those isolates did not absorb the red color of congo red. Thirteen isolates can be grouped as fast growing, while the others belong to slow growing NFB.

**Key words:** Nitrogen-Fixing Bacteria, YEMA, brom thymol blue, congo red

### **Introduction**

Central Kalimantan, one of provinces in Indonesia, is widely covered by peat ecosystem. Nowadays, the condition of peat ecosystem in Central Kalimantan is varied. Some areas are disturbed, opened by individual farmers, damaged because of extensive fire, and few areas remain natural.

Peat soil is characterized by high content of organic-matter but low in available mineral, and strongly acid in reaction. In these soil conditions, as nitrogen and phosphorus were particularly low, not only plant growth, but also microorganisms were restricted. The significant role of microorganism in mediating mineral transformation or nutrient cycle has been recognized very well. Several attempts have been focused on the use of plant growth promoting rhizobacteria (Lynch, 1983), non-symbiotic or free-living N-fixing bacteria (Rao, 1981), and phosphate-solubilizing microbes (Illmer and Schinner, 1992).

Many diazotrophic bacteria were occasionally isolated from rhizosphere soil or a variety of non-leguminous plants (Dobereiner, 1992). A newly discovered diazotrophic bacteria occurred in large numbers (up to  $10^6$  per gram fresh weight) in the stems of sugar cane (Gills *et al.*, 1989). Application of these inoculants has broadened up for sustainability agriculture as well as possibility of increasing microbial activity within peat ecosystem. However, study on microbial application for plant growth especially in the peat ecosystem was very limited.

One of our aims in this study was to isolate and find the potential non-symbiotic N-fixing bacteria from different locations of peat ecosystem, then evaluate the growth.

## Materials and Methods

### *Soils*

Twenty one of soil samples were collected randomly from 6 locations as followed 1) Muara Bahaur, as a mangrove ecosystem; 2) Bahaur Hilir, paddy's field; 3) Pangkoh 9E, covered by grass; 4) Pangkoh 3, close to canal and mostly have been logged, 5) Pangkoh 3, logging area with alang-alang predominantly plant, and 6) Garung, Pulang Pisau, undisturbed peat forest. The samples from each location were taken from different depth soil: 0 – 10 cm, 10 – 30 cm, 30 – 50 cm, and 50 – 60 cm. Each sample was sealed in plastic bag, then stored at refrigerator.

### *Microbial isolation*

One gram of each soil samples was mixed with 9 ml of 0.85% NaCl solution and shaken in vortex. Serial dilutions of  $10^{-1}$  up to  $10^{-5}$  were prepared. The suspension of 0.1 ml was plated on selected media corresponding to the intended microorganism. According to Vincent (1970), YEMA medium (Yeast Extract Mannitol Agar) was used for isolating bacteria with nitrogen-fixing capability. One litter medium consists of 0.5 g  $K_2HPO_4$ , 0.2 g  $MgSO_4$ , 0.1 g NaCl, 3 g  $CaCO_3$ , 10 g Mannitol, 3 g yeast extract, 20 g agar, and pH was adjusted to 6.8.

### *Growth measurement*

Nitrogen-fixing bacteria from the soil samples were enumerated by spread plate analysis on solid agar media. Three plates were used for each sample. The plates were incubated at 28 °C for maximum 7 days, and developing colonies were counted everyday. The total colony was calculated as CFU (colony per gram soil) (Lynch, 1983).

For measuring the capacity of nitrogen-fixing and growth rate, the pure isolates was grown in YEMA medium containing congo red and brom thymol blue respectively, following the method of Somasegaran and Hoben (1984). The congo-red indicator was used for detecting the potentiality of the isolate for fixing nitrogen. Meanwhile, the indicator of brom thymol blue was used for measuring the growth rate of each isolate.

## Results and Discussion

By using serial dilution technique, it has been found 18 isolates out of 21 soil samples. The isolation was done based on the morphology characteristics. The macroscopic characteristic of N-fixing bacteria was milky-white colony or clear colony like dropping-water with round shape and the surface is triangle-shape (Soekartadiredja, 1992).

The bacterial population from each location was varied. The bacterial population was also significantly affected by soil depth (Table 1). It is likely that the highest population of N-fixing bacteria found in natural peat forest (Garung), followed by the one from area close to canal (Pangkoh 3A).

At lower depth, the bacterial number was clearly decreased as low as  $0.01 \times 10^5 \text{ g}^{-1}$ , even was not found in 10–20 cm depth from the samples of Pangkoh 9E and Pangkoh 3A. These results suggest that these bacteria are associated with an aerobic habitat. The results indicate that a much higher population of bacteria exists in the soil of Garung, Pulang Pisau as a semi natural peat forest. It might be expected that plant growth in this location is better than the one of others.

Table 1. Enumeration of N-fixing bacteria from different locations and soil depths.

| Location  | Bacterial population (CFU g <sup>-1</sup> soil, × 10 <sup>5</sup> ) |            |            |            |
|---|---|------------|------------|------------|
|   | 0 – 10 cm   | 10 – 20 cm | 30 – 50 cm | 50 – 60 cm |
| Muara Bahaur – mangrove forest                  | 38.66   | 43.00      | 16.00      | 5.37       |
| Bahaur Hilir – paddy's field                    | 1.70  | 0.66       | 0.33       | 0.01       |
| Pangkoh 9E – covered by grass                   | 10.33   | -          | -          | -          |
| Pangkoh 3A – close to canal                     | 48.66   | 0.66       | -          | -          |
| Pangkoh 3B – covered by alang-alang             | 5.33  | 0.33       | 0.01       | 0.03       |
| Garung, Pulang Pisau – semi natural peat forest | 85.00   | 0.40       | 0.21       | 0.01       |

Table 2. Growth of N-fixing bacteria on various media.

| Isolate | Growth medium |            |              |
|---------|---------------|------------|--------------|
|         | YEMA          | YEMA + BTB | YEMA + CR    |
| 1       | ++            | ++         | pink         |
| 2       | ++            | ++         | pink         |
| 3       | +             | +          | light yellow |
| 4       | ++            | ++         | pink         |
| 5       | ++            | ++         | pink         |
| 6       | ++            | ++         | pink         |
| 7       | +             | +          | pink         |
| 8       | ++            | ++         | pink         |
| 9       | ++            | ++         | pink         |
| 10      | ++            | ++         | pink         |
| 11      | ++            | ++         | pink         |
| 12      | ++            | ++         | pink         |
| 13      | ++            | ++         | pink         |
| 14      | +             | +          | pink         |
| 15      | +             | +          | pink         |
| 16      | +             | +          | light yellow |
| 17      | ++            | ++         | pink         |
| 18      | ++            | ++         | pink         |

++ : fast growing

+ : slow growing

BTB : Brom Thymol Blue

CR : Congo Red

As shown in Table 2, thirteen isolates were classified as fast growing bacteria, which could be seen from the change color of brom thymol blue from blue to yellow color.

The potentiality of bacteria for fixing nitrogen could be detected from the color of colony occurring in YEMA medium mixed with congo red. The colony of bacteria with nitrogen-fixing capacity was not absorbed red-color of congo red. In this study, we found 16 isolates with nitrogen-fixing capability. However, these preliminary results should be followed by identification of isolated bacteria.

### Conclusion

The bacterial population was significantly decreased by soil depths and varied by locations. The bacterial population in natural peat forest (Garung, Pulang Pisau) was higher than the ones other locations, which presumably to be organic-matter preference.

Eighteen numbers of bacteria were isolated from different locations of peat ecosystem, in which thirteen isolates were included to nitrogen-fixing bacteria.

### References

- Dobereiner, J. 1992. History and new perspectives of diazotrophs in association with non-leguminous plants. *Symbiosis*, 13: 1-13.
- Gills, M., Kersters, K., Hoste, B., Janssens, D., Kroppenstedt, R. M., and Stephen, M. .P. 1989. *Acetobacter diazotrophicus* sp. nov., a nitrogen fixing acetic acid bacterium associated with sugarcane. *International Journal of Systematic Bacteriology*, 39: 361-364.
- Illmer, P. and Schinner, F. 1992. Solubilization of inorganic phosphate by microorganisms isolated from forest soils. *Soil. Biol. Biochem.*, 24: 389-395.
- Lynch, J. M. 1983. *Soil Biotechnology*. Blackwell Sci. Publ., London
- Rao, S. S. 1981. *Biofertilizers in Agriculture*. Oxford and IBH Pub. Co.
- Soekartadiredja, 1992. Perubahan inefektivitas dan efektifitas penambatan pada galur rhizobium setelah perlakuan pasasi in vivo. Thesis. Universitas Padjadjaran, 231 halaman.
- Somasegaran, P and Hoben, H. J. 1984. Methods in legume rhizobium technology. University of Hawaii. Report of NIFTAL Project.
- Vincent, J. M. 1970. *A Manual for the Practical Study of the Root Nodule Bacteria*. International Biological Programme, London. Handbook No. 15.

## Measurement of Water Potential in Plant and Soil by the Electric Capacitance Method

Yoshio KANO

Tokyo University of Agriculture and Technology  
Graduate school of Bio-Applications and Systems Engineering  
2-24-16, Nakacho, Koganei, Tokyo 184-8588 Japan

### Summary

It is important to know water potential in plants and in many kind of soil for increase or control of plants. As the dielectric constant of water is very large, capacitance of ceramic capacitor is proportional to content of water in its capacitor. When ceramic base of capacitor is contact with plant or soil, water potential of capacitor keep balance with that of plants or soil. The very small deference of capacitance, that is, from a few pico farads to a few femto farads, is measured by developed electric circuit. This effective circuit is consist of OP amplifier, digital IC and phase sensitive detector. Then, water potential of many kind of plants and soil are able to measure for their control. This measuring method is very useful for all kind of controlling water potential in the field of agriculture, biology and civil engineering.

**Keywords:** water potential, plant, moisture, soil, capacitance, dielectric constant

### 1. Principle

When a capacitor of ceramic base is contact with plant or soil, water potential of capacitor holds the balance that of plants or soil. Then, electric capacitance of ceramic capacitor is proportional to content of water in its capacitor as shown in Fig.1. As the dielectric constant of water is very large ( $\epsilon \approx 80$ ), the capacitance of ceramic capacitor is proportional to the content of water in its capacitor. If electric capacitance is measured, water potential is known.

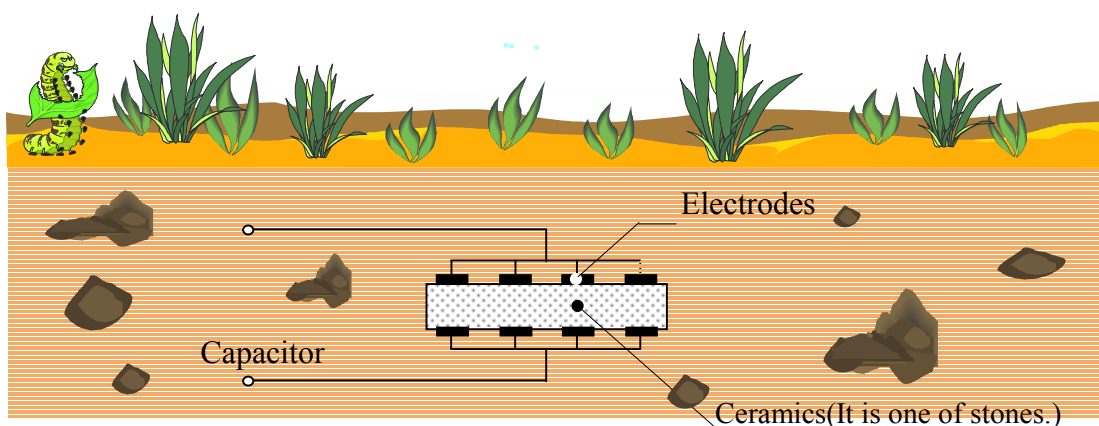
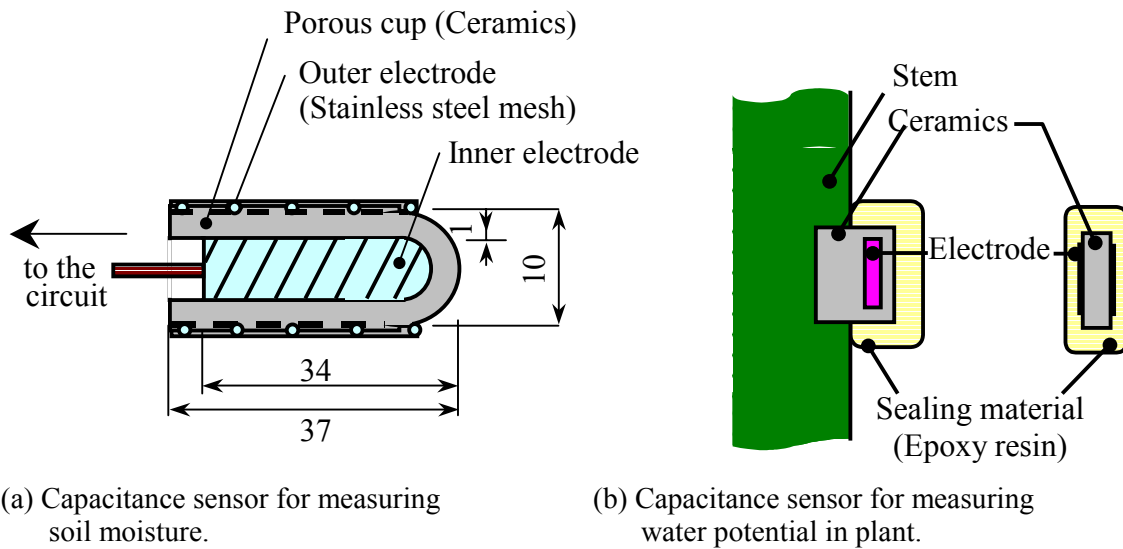

Fig.1. Water content holds the balance between the ceramic capacitor and surroundings.

## 2. Developed Capacitance Sensor for Measuring Water Potential

Any shape of capacitance sensor will be developed as it is desired. Two types are shown in Fig.2. The soil type that is shown in Fig.2(a) is used for measuring water potential in the soil, and the plant type that is shown in Fig. 2(b) is for water potential in the plant body.



(a) Capacitance sensor for measuring soil moisture.

(b) Capacitance sensor for measuring water potential in plant.

Fig. 2. Developed capacitance sensor for measuring water potential.

The soil type consists of a stick electrode, mesh or spiral shape electrode and ceramics. This soil type sensor is stuck into soil or is buried in soil. The capacitance between these two electrodes is proportional to Water Potential of soil.

The plant type consists of a thin ceramics ( $5 \times 5 \times 1$  mm), two electrodes evaporated metal on the surface of ceramics and sealing material (epoxy resin). When a small piece of ceramics is contacted with vessel of plant, water potential of the ceramics equals to that of the plant. Water potential in a living plant is able to measure for its control using the sensor shown in Fig.2(b) and the developed electric circuit written as follows.

## 3. Developed Electric Circuit

The very small difference of capacitance, that is, from a few pico-Farads to a few femto-Farads, is measured by developed electric circuit. This effective circuits are consist of OP amplifier, digital IC and phase sensitive detector shown in Fig.3. Oscillator (O.S.C.) gives constant voltage to the C/V converter. If the C changes of the sensor, output voltage of C/V changes and it is detected and phase synchronous detector (P.S.D.). The output voltage is proportional to the change of capacitance of the sensor, that means water potential. A little more detail block diagram is shown in Fig.4.

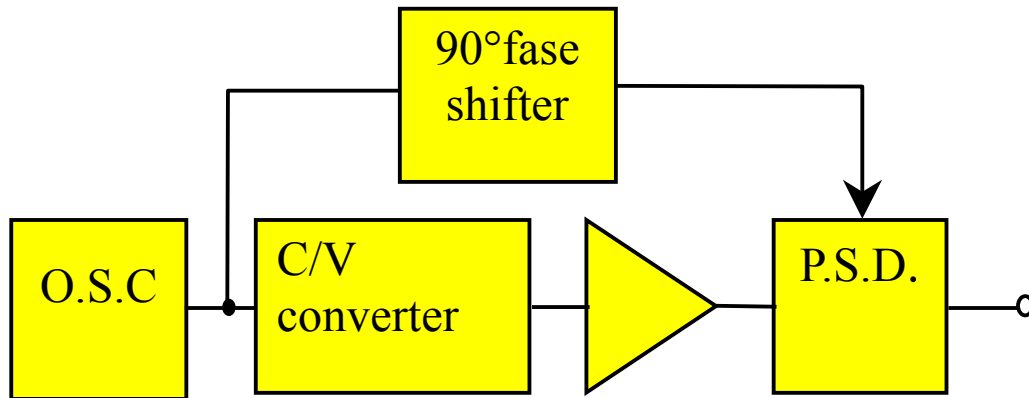

Fig.3. Fundamental block diagram of developed electric circuit of V/C converter for measuring of water potential.

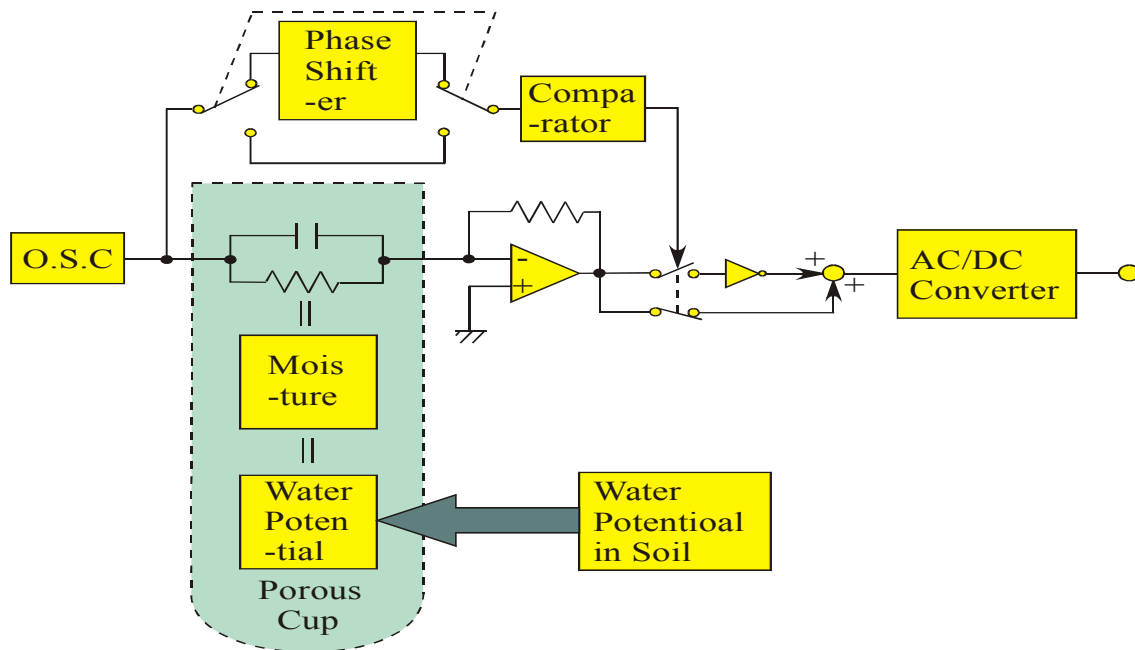

Fig. 4. Developed electric circuit of V/C converter and phase detector for measuring of water potential.

#### 4. Characteristic of Developed Electric Circuit of V/C Converter

Actual capacitance is measured for correction. The standard capacitances which values are known, are used. It is shown in Fig.5 in which the output voltage is linear proportional to the capacitance.

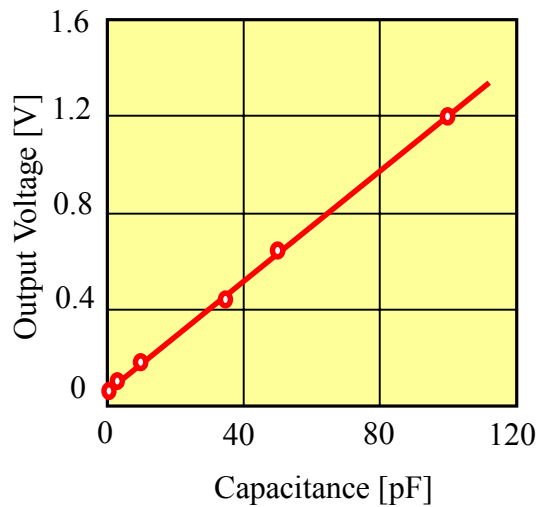

Fig. 5. Output voltage characteristic of the capacitance sensor and c/v converter

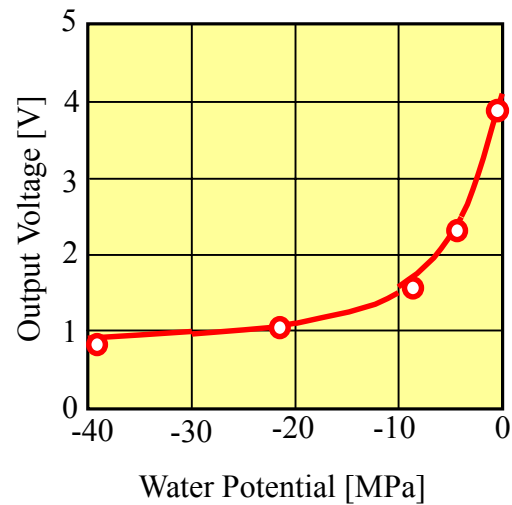

Fig.6. Output voltage characteristic of water potential of soil

### 5. Actual Measurement of Soil Moisture

Water potential of many kind of soil is able to measure for their control using the soil type sensor shown in the Fig.2(a). This measuring method is very useful for controlling water potential in the all kind of soil from sand to clay, because ceramics of sensor is recognized one of stone in soil. Output voltage characteristic of water potential of soil is shown in Fig.6.

### 6. Actual Measurement of Water Potential in Plant

Water potential in a living plant is able to measure for its control using the sensor shown in Fig.2(b). When a small piece of ceramics is contacted with vessel of plant, water potential of the ceramics equals to that of the plant. This measuring method is very useful for all kind of controlling water potential in a living plant. Actual measurement is shown in Fig.7, which show the change of water potential in a living plant poinsettia (*Euphorbia pulcherrima*) when light 5,000 lx is switched on and off. It shows the water potential decreases during the light is on because of water evaporation from leaves.

### 7. Conclusion

It is important to measure water potential in plants and many kind of soil for increase or control of plants.

- (1) Ceramic capacitance sensor is developed.
- (2) When ceramic base of capacitor is contact with plant or soil, water potential of ceramics keeps balance with that of plants or soil.
- (3) Capacitance of ceramic capacitor is proportional to content of water in its capacitor.
- (4) The very small deference of capacitance, that is, from a few pico farads to a few femto farads, is measured by developed electric circuit, when water potential changes.



- (5) This effective circuit consists of OP amplifier, digital IC and phase sensitive detector.
- (6) Water potential of many kinds of plants and soil are able to measure for their control.
- (7) This measuring method is very useful for all kind of controlling water potential in the field of agriculture, biology and civil engineering.

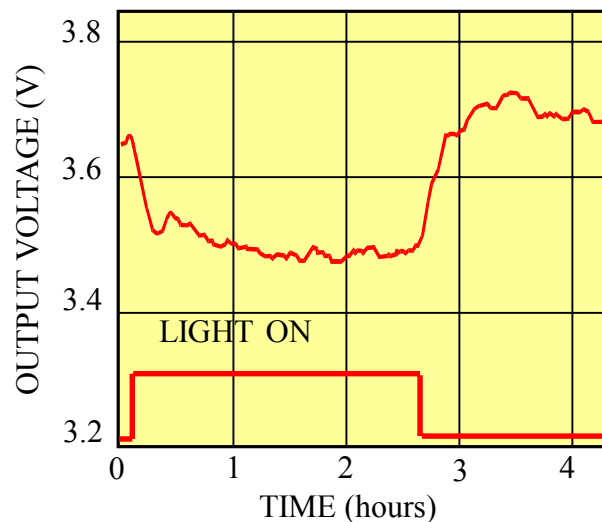

Fig. 7 The change of water potential in a living plant when a light is switched on and off.

### References

- Boyer, J.S. 1969. Energy transfer in plants. *Science*, 163:1219-1220.
- Kano, Y., Itoh, T., Hasebe, S., Watanabe, T. and Yamada, O. 1991. Non-contact measurement of stem diameter by linear DC motor with position detector, *Trn.IEEJ*, 111-D, No.5.
- Molz, J., Kerns, D. V., Jr., Peter, C. M. and Done, J. H. 1979. A circuit analog model for studying quantitative water. *Plant Physiology*, 64: 712-716.
- Nonami, H. and Schulze, E.D. 1989. Cell water potential, osmotic potential, and turgor in the epidermis ad mesophyll of transpiring leaves: combined measurements with the cell pressure probe and nanoliter osmometer, *Planta*, 177: 35-46.
- Nonami, H., Wu, Y. and Boyer, J. S. 1993. Direct demonstration of a growth-induced water potential gradient, *Plant Physiology*, 102:13-19.
- Rose, D. A. and Charles-Edwards, D. A. 1981. *Mathematics and Plant Physiology*. Academic Press.

**Part 3**  
**Agriculture and Environment**

## **Biological Clean-up of Biomass Wastes Using Sawdust as an Artificial Soil Matrix**

**Minoru TERAZAWA**

Laboratory of Forest Chemistry, Division of Environmental Resources,  
Graduate School of Agriculture, Hokkaido University,  
Sapporo 060-8589, Hokkaido, Japan  
Tel: +81-11-706-2512, Fax: +81-11-706-4180,  
E-mail: mtera@for.agr.hokudai.ac.jp

### **Abstract**

Biomass wastes such as garbage, human excrement, and cattle manure will decompose and separate into water and carbon dioxide in garbage automatic decompose-extinguisher (GADE), bio toilet (BT) and livestock manure fermented (LF) systems, respectively. All the systems contain sawdust an artificial soil matrix and the waste is converted to organic fertilizer rich in N, P, and K or soil conditioner. Establishment of a forestry, agriculture, and fishery biomass wastes recycling system (FAFBRCS) is discussed.

**Key words:** garbage, sawdust, artificial soil, compost, aerobic bacteria, biomass wastes

### **1. Introduction**

Sustainable development in our society depends on three basic ideas:

- 1) The limited resources of field and forest, river and sea be used as efficiently as possible,
- 2) biomass wastes not be discarded but recaptured in the form of usable resources, and
- 3) these usable recaptured resources be returned to the production sites of biomass.

This paper introduces an approach to realize these ideas so as to lessen the environmental distress this century has brought to our society.

### **2. Utilization of Unutilized Resources**

The primary unutilized resources of the forest industry are sawdust and bark. These are usually incinerated, and while there may be no great crime in using biomass as fuel; the preferred use for such biofiber is as matrix: an artificial soil matrix. This artificial soil matrix can convert food related wastes (garbage), human excrement, and livestock manure into a multipurpose resource.

The benefits of the use of the artificial soil matrix are derived from the characteristics of sawdust as a matrix:

1) high porosity, 2) high void volume ratio, 3) high water and air retention, 4) high drainage, 5) high bacterial tolerance, 6) low apparent density, and 7) biodegradability.

Characteristics 1)-4) create an ideal environment for aerobic bacteria to thrive, decompose, and separate garbage into carbon dioxide and water without generating odor. After several months the process produce a compost rich in N, P, and K.

High bacterial tolerance of woody material allows us to use the sawdust as an artificial soil matrix for a long period in the GADE, BT, and LMF machines and low apparent density of sawdust saves energy when mixing the matrix.

The key characteristic, however, is the essential biodegradability of the sawdust,

which makes it the ideal ingredient for establishing a biomass waste recycling system.

## **2.1 Recovering Food Waste**

The recovery of food waste is effected using a GADE (garbage automatic decomposer-extinguisher) system, that is, the high rate composting of food wastes using sawdust biofiber as an artificial soil matrix.

Two types of GADE machines are differentiated. The one is for room temperature conditions and the other is for thermophilic conditions.

### ***2.1.1 Composting in room temperatures***

This GADE machine is for family of four to five. The compost machine uses a rotor to turnover, distribute, and interally constantly aerate the daily food waste load deposited among the sawdust. Food waste is reduced entirely to water and carbon dioxide by the action of soil bacteria in room temperature conditions, leaving fumins and minerals. After several months of operation, the sawdust has been converted into N, P, and K enriched compost.

### ***2.1.2 Composting in high temperatures***

This GADE machine is for institutional food waste management. A rotor churns a sawdust, rice bran, or oat bran matrix in a heated tub (80°C) with variable moisture content, allowing for bioconversion of the wastes by thermophilic bacteria for every day. The partially-cured compost can be used as feed (the bran-based product is ideal for chicken farming).

When sawdust is used in this GADE machine as a matrix, a user can operate the machine continuously for two to three months and the compost formed are utilized as partially-cured organic fertilizer.

In both machines, in order to provide a rich environment for the aerobic microbe activity and multiplication, it is best to use a sawdust in which moisture content and temperature can be easily controlled.

### ***2.1.3 The significance of the introduction of the GADE system***

The wide spread introduction of the GADE systems using a bacteria seeded organic matrix to decompose food waste, and the further development of a forest, agriculture and fishery biomass recycling system (FAFBRCS), through which the biomass can be returned to natural ecosystems, would be of great environmental significance, as outlined in the following five categories:

#### ***(i) The use of the GADE system would;***

- 1) decrease the stress of keeping smelly waste inside the kitchen,
- 2) relieve municipalities of the necessity of collecting food waste,
- 3) enable source-separated collection of other fractions of municipal solid waste,
- 4) decrease the air pollution associated with waste incineration, and the soil and ground water pollution associated with landfills,
- 5) lessen the need for new incinerators,
- 6) relieve citizen protest against the construction of incinerators, and
- 7) have an educational effect on the consciousness of environmental hygiene and resource recovery.

**(ii) *The effective use of sawdust would;***

- 1) add value to food and certain urban industrial waste,
- 2) contribute to the vitality of the forest industry through use of sawdust, bark, street tree trimmings, and forest thinning, and
- 3) promote managed forestry on land either removed from agricultural production through crop quotas or for environmental reasons, not forgetting urban forests.

**(iii) *The introduction of the GADE system would;***

- 1) promote the establishment of the requisite production, transport, and service sectors,
- 2) stimulate the refurbishing of kitchens, and
- 3) convert householders into, not just consumers but also producers, bring about a change in the recycling system.

**(iv) *Thermophilic composting would;***

- 1) enable the conversion of food waste into livestock feed,
- 2) decrease the odor from livestock manure, contribute to livestock health, and improve meat quality, and
- 3) create a means for the recovery of manure for the same livestock to use as a stable fertilizer.

**(v) *The use of GADE compost would;***

- 1) provide fertilizer municipal parks and roadside green spaces, and improve crop quality in rural regions,
- 2) be a source of organic fertilizer, work against the damage caused by burn-and-slash agriculture in tropical regions,
- 3) prevent soil depletion caused by the intensive farming of cassava, kenaf and fast-growing hybrid plantation trees, and
- 4) create new business chance such as mushroom farming using the N, P, and K enriched sawdust as cultivation bed and molding factory making seedling-pots for agriculture and forestry use.

In summary, municipal food waste, certain industrial waste, and forest and agricultural waste may all be streamered together via the FAFBRCS system to produce a new and environmentally-friendly resource.

## **2.2 Recovery of Human Waste**

Human waste can also be regarded as resources the same as agricultural waste. The spread of the flush toilet has reached the point where sewage treatment of this waste water has become prohibitively expensive. A re-evaluation of the costs and benefits of the various biosolids treatment systems is in order, and the biotoilet should be included in such a consideration.

### **2.2.1 *The wastefulness of the flush toilets***

The benefits of the flush toilet are low odor and quick and hygienic removal of waste. However, problems of flush toilets are:

- 1) the cost of toilet stools and cisterns, 2) the cost of water supply and sewage

pipng, 3) the cost of sewage treatment plants construction, 4) the cost of sawege treatment, 5) odors emanating from the toilets and sewage treatment facilities, 6) massive use of clean water, 7) the necessity for disposal of sewage sludge, and 8) possible pollution of water by discharge of water containing water soluble organic and inorganic materials.

### ***2.2.2 The revolution of the forest products toilet***

In the biotoilet (BT), the tile septic tank and its attendant plop, are replaced by a composting chamber filled with sawdust. After use of the toilet, the pushing of a button activates a turning screw, and the sawdust is immediately and slowly turned over. The biosolids are incorporated without sound or odor into the artificial soil matrix of by sawdust.

Unlike the copious amount of water used in the flush toilet, any excrement in the biotoilet is cleaned off, when necessary, with a small amount of water through a water jet. After half a year of use, the product becomes a loose, handlable, easily-used compost.

#### ***(i) Experience of a culture shock***

After the first use of the biotoilet, you are instantly ashamed of all of the water you have wasted so far in using the flush toilets. It is a kind of a culture shock.

The need of the water barrier in the current flush toilet to prevent the rising of sewer gas leads to the situation where the toilet must be frequently flushed if you wish to avoid living with the smell of your own waste.

In contrast, the biotoilet seat is just as simple a hole found with the septic tank toilet. But owing to the action of an exhaust cylinder fitted into the composting chamber, warm air from the composting material is circulated outside, and no odor rises into the toilet room. Of course, no odor has been generated during the operation of the biotoilet.

In addition, food wastes can be disposed of in a BT, obviating the necessity for a separate GADE machine such as "MAM" or "BIOSELF" for food wastes in the kitchen.

#### ***(ii) Characteristics of biotoilets***

Characteristics of biotoilet are superior to those of flush toilet for the following reasons:

1) odor free, 2) no flush water use, 3) relatively cheap, 4) conversion of human wastes into valuable recyclates, 5) less the burden on conventional sewage treatment plants, 6) capable of treating any organic solid wastes including food related waste (garbage) and toilet papers, 7) environmentally-friendly, and 8) effective in emergencies.

#### ***(iii) Types of biotoilets***

Types of biotoilets are classified into two categories. The first ones are biotoilets for human beings and the second ones are biotoilets for animals.

A) Biotoilets for humans: 1) Domestic fixed biotoilets: for household use, 2) Public fixed biotoilets: in schools, hospitals, stations, airports, parks, etc., 3) Public tranferable biotoilets: for emergencies, big events, recreation areas, hiking courses or lodges in the mountains, in parks, etc. For handicapped people using wheelchairs. 4) Chair style portable biotoilets: can be set up inside a bed room for people who need help getting to and from the toilet room in hospital or at home.

B) Biotoilets for animals: 1) Pet biotoilets: for cats and dogs. 2) Large scale biotoilets: for livestock manure (See section 2.3).

**(iv) *Biotoilets for the 21st century***

The biotoilet is suitable for rural towns considering the implementation of flush toilets, cottage and resort areas (removal of biosolid compost bears no resemblance to the stink of the conventional vacuuming of septic tanks), and any area that has forest resources close at hand. In particular, suburban developments recently converted from farmland are best served by the biotoilet. As the trend of returning to rural areas accelerates, rural residents will no longer be ashamed of not having a flush toilet; rather, they will be proud to be able to have a biotoilet.

With changing times comes changing attitudes. The eco-biotoilet is representative of the in-region recycling, environmental protection, efficient energy use, and low pollution life style we all wish to see in the 21st century.

**(v) *Starting point for changing our life style***

Although flush toilet system is a symbol of the civilization of our modern life, the system has several problems for achieving sustainable development of our society. We need to pay attention to the wastefulness of the system and to seek for new ways.

1) Even human wastes should be regarded as precious resources, which must not be disposed after dilution. 2) Instead of wasteful flush toilets, environmentally-friendly biotoilets should be accepted in to our daily lives. 3) The basic principle of the biotoilet is the same as that of the GADE system; they depend on the physical and chemical properties of woody material, sawdust, which acts as an artificial soil matrix in both the systems. 4) Rate of decomposition of human waste is faster than that of garbage because of the large number of bacteria derived from human wastes. 5) Promote the biotoilet as the most advanced toilet in the sense of modernization. 6) Local governments should stock biotoilets to use when there is a natural disaster such as Hanshin-Awaji earthquake. 7) In national parks, mountain sites, and sight seeing resorts, biotoilets seem to be the most appropriate because they harmonize with nature. 8) Acceptance of biotoilets may be the starting point for changing our life style in the 21st century and achieving sustainable development for our society. 9) Solar and wind energy should be used in future as the power for the operation of biotoilets set outdoor.

**2.3 Processing of Livestock Manure**

The processing of livestock manure has become a crisis topic worldwide. But a livestock biotoilet would have to be radically different in design from the one serving the household.

For example, a cow produces forty times more waste than a human. A hundred-head dairy herd would therefore produce the equivalent of 4,000 people, or 1,000 households, or 1,000 biotoilets.

**2.3.1 *Heating, vacuum evaporation, fermentation and drying apparatus***

The first trick is dewatering the slurry; a mixture of manure and water. A process has been developed that combines vacuum dehydration, heated fermentation, and drying of the fermented materials. The development of this single-vessel machine was designed for the management of brewery dregs, sugar beet pulp, *tofu* sludge, and fisheries waste (CK, C-Luck Co. Ltd.). It came about as an extension of the initial successful development of technology for the treatment of such slurry state food waste after congealing with coagulants.

The machine is also ideal for the treatment of the slurry of livestock manure. Though a little expensive, considering the environmental impact of the conventional management of livestock manure, it is well worth the investment.

### **2.3.2 Livestock manure fermenter**

Sawdust functions as an artificial soil matrix in the GADE and BT systems because of its special characteristics as described in section 2. When sawdust is used in a cattle shed as litter, it should be used in the same way as used in the GADE and BT systems until it loses its special characteristics through deterioration.

A larger amount of sawdust is used as litter in a cattle shed than usual, and after the moisture content of the sawdust matrix become 70-80%, the sawdust is removed automatically and moved by a conveyor belt to a livestock manure fermenter (LMF). During the biodegradation process of the manure in the LMF, temperature of the sawdust matrix increases more than 60°C and kills ordinary bacteria including *Escherichia coli*.

After the manure degrades in the sawdust matrix in the LMF, the sawdust, which is now bacteria free, is reused again in the cattle shed as litter. The process is repeated until the characteristics of the sawdust have changed and it can no longer function as an artificial soil matrix.

## **3. Conclusions**

(1) Instead of separately managing perish-able food waste, non-perishable sawdust, and biomass wastes from forest and field, sawdust should be used as an artificial soil like matrix to convert food waste and other low-structure biomass into a valuable fertilizer or soil conditioner resource.

(2) The conventional “mixed/centralized/large scale” management of municipal waste is critically flawed. A switch to “source separated/decentralized/low volume” management of foodwaste would enable recovery and recycling of garbage without odor generation.

(3) The introduction of GADE processing would be a critical element in the further implementation of the FAFBRCS, biomass recovery system, with all of the accompanying benefits.

(4) The end of the era of the flush toilet is near. The resource recovery eco-biotoilet era is about to come. This toilet is particularly well suited to areas nearby forests and farmland.

(5) The sheer volume of livestock manure is beyond the capacity of GADE machines, even when using coagulants. Instead, a novel vacuum dehydration/heated composting/drying in-vessel system can be used for this tremendous biomass management problem.

(6) LMF system seems to be more reasonable from a cost performance in view point of than conventional solid/liquid separation treatment.

## **4. Papers Related**

- Horisawa, S., Sunagawa, M., Tamai, Y., Matsuoka, Y., Miura T. and Terazawa, M. 1999. Biodegradation of non-lignocellulosic substances II. --Physical property and deterioration of sawdust as an artificial soil matrix. *J. Wood Science*, 45
- Kitsui, T., Terazawa, M. 1999. Environmentally- friendly toilets for the 21st century, Bio-Toilet (BT; Dry Closet, DC). In: *Proceedings of the 10th International*



- Symposium on Wood and Pulping Chemistry (ISWPC)*, Yokohama, Japan, pp.120-121.
- Terazawa, M. 1992. Structure of forestry and agriculture, and fishery biomass recovery systems—The complete and odor-free oxidative breakdown of non-lignocellulosic high molecular weight matter—, *ALPHA*, 6(12): 4-14 (in Japanese).
- Terazawa, M. 1995. Establishment of forestry, agriculture and fishery biomass recovery systems—The complete and odor-free bioconversion of food wastes—. *Mokuzai Gakkaishi*, 42(7): 629- 633 (in Japanese).
- Terazawa, M. 1995. The biocleanup and recovery of non-lignocellulosic waste (food wastes). *Nihon Mokuzai Gakkai, the 4th Quater Research Reports II*, 23-28 (in Japanese).
- Terazawa, M., Horisawa, S., Tamai, Y. and Miura, T. 1995. A novel system for complete garbage decomposition using sawdust and aerobic soil bacteria. In: *Proceedings of the 7th E.C. Conference on Biomass for Energy and Industry*, Florence, Italy, pp. 589-594.
- Terazawa, M. 1996. Screening of biological active substances in the sawdusts used in GADE system. In: *Proceedings of the 1st International Wood Science Seminar*, Kyoto, Japan, pp. 115-119.
- Terazawa, M. 1996. The structure of forestry, agriculture and fisheries biomass recovery systems, *Research Report to the Japanese Ministry of Education* (in Japanese).
- Terazawa, M. 1997. Biological cleanup and recovery of biomass wastes. In: *Proceedings for International Workshop*, Palangka Raya, Indonesia, pp. 102-107.
- Terazawa, M., Horisawa, S., Tamai, Y. and Yamashita, K. 1999. Biodegradation of non-lignocellulosic substances I. —System for complete degradation of garbage using sawdust and aerobic soil bacteria—, *J. Wood Science*, 45(4) .
- Terazawa, M. 1999. Bio-Toilets, environmentally-friendly toilets for the 21st century, —Dry closet using sawdust as an artificial soil matrix—, In: *Proceedings of 1st International Symposium on Biomass Recycling/Composting*, Sapporo, Japan.

## **Whole Aspect on Nature and Management of Peat Swamp Forest in Thailand**

**Tanit NUYIM**

Princess Sirindhorn Peat Swamp Forest Research and Nature Study Center  
P.O. Box 37, Sungaikolok, Narathiwat, 96120. Thailand

### **Abstract**

The total area of peat swamp in Thailand currently comprises about 64,555 ha, of which 48% (30,969 ha) is found in Narathiwat province along the east coast of Thai peninsula near the Malaysian border. The secondary forest covers mostly the remaining peat swamp area (86%) in Thailand. The extensive primary peat swamp forest remain almost all in Toe-Deang peat swamp forest in Narathiwat province (8,403 ha), and only 629 ha is scattered into three other areas. (Chukwamdee *et.al.*, 1999).

Since the primary peat swamp forest in Thailand remain too small, it is absolutely vital that this valuable nature resource should be conserved carefully and appropriately because peat swamp forest reserve huge amount carbon and water, and conserve biological diversity including very rare species existed in only peat swamp. Such conservation should be managed by reliable information from more basic science such as peat swamp forest ecosystem, silviculture technique of rehabilitation, and more applied technique such as local knowledge and field experiment including forest fire control and wise utilization of peat resource. Therefore, in current paper, whole aspect on nature and management of peat swamp forest in Thailand is described owing to the research result and conservation experience during past almost 10 years.

**Keyword:** peat swamp forest, reforestation, rehabilitation, forest fire, biological diversity

### **Introduction**

Thai people call peat swamp forest as Pa Phru. However, it's just become well-known since about ten years ago because of very small area in Thailand that is about 0.13% of the country or about 0.48 % of the whole forest. Because recognized the peat swamp forest give a lot of benefits of nature resource to the people who inhabit the surrounding area, and have most important role on environment conservation such as carbon and water storage which are more conspicuous than the other kind of forests. By these reasons, Thai people and government are now getting interests in the peat swamp forest.

### **Distribution of Peat Swamp in Thailand**

Almost all of peat swamp forest in Thailand are distribution in the southern part (63,982 ha) and southeast coast (537 ha) where are found in Narathiwat, Nakhonsi Thammarat, Chumphon, Surat Thanee, Songkla, Pattani, Yala, Trang, Phuttalung, Phuket, Krabi, Trat and Rayong provinces (Table 1). Most of peat swamp area (86%) is the 8,403 ha and 629 ha secondary forest. The primary peat swamp forest area are about 9,032 ha (14%) of which located in Toe-Deang peat swamp forest, Narathiwat province and in other peat swamp forest such as Bacho peat swamp forest (575 ha), Narathiwat Ban Dan peat swamp forest (5 ha), Trang and Kuntulee peat swamp forest, Surat thanee (48 ha), respectively. (Chukwamdee *et al.* 1999) The age of peat in Toe-Deang peat swamp at 1-2 m deep level is about 700-1,000 years old. (Sinskul, 1998)

Table 1. Distribution of peat swamp forest in Thailand

| Region             | Province     | Secondary forest (ha) | Primary forest (ha) | Total (ha)    | Remark            |
|--------------------|--------------|-----------------------|---------------------|---------------|-------------------|
| Southern part      |              |                       |                     |               |                   |
|                    | Narathiwat   | 21,992                | 8,978               | 30,970        | Toedaeng 8,403 ha |
|                    | Nakhonsi     | 18,946                | -                   | 18,946        | Bachoe 575 ha     |
|                    | Thammarat    |                       |                     |               |                   |
|                    | Chumphon     | 3,285                 | -                   | 3,285         |                   |
|                    | Surat Thanee | 1,542                 | 48                  | 1,590         |                   |
|                    | Songkla      | 4,829                 | -                   | 4,829         |                   |
|                    | Pattani      | 1,205                 | -                   | 1,205         |                   |
|                    | Yala         | 190                   | -                   | 190           |                   |
|                    | Trang        | 86                    | 6                   | 92            |                   |
|                    | Phuttalung   | 2,768                 | -                   | 2,768         |                   |
|                    | Phuket       | 63                    | -                   | 63            |                   |
|                    | Krabi        | 47                    | -                   | 47            |                   |
|                    | <b>Total</b> | <b>54,951</b>         | <b>9,032</b>        | <b>63,982</b> |                   |
| South east coast   |              |                       |                     |               |                   |
|                    | Trat         | 453                   | -                   | 453           |                   |
|                    | Rayong       | 120                   | -                   | 120           |                   |
|                    | <b>Total</b> | <b>573</b>            | <b>-</b>            | <b>573</b>    |                   |
| <b>Grand Total</b> |              | <b>55,523</b>         | <b>9,032</b>        | <b>64,555</b> |                   |

Source : Jirasak *et al.* 1999

### Flora in Peat Swamp Forest

The floristic composition of peat swamp forest is extremely complicated, consisting of 124 families and 470 species of which 109 families and 437 species of flowering plants, and 15 families and 33 species of ferns (Phengkai *et al.*, 1991). Tree species growing in peat swamp have adapted themselves to survive in waterlogged ecosystem, for which they make short taproots and wide spread roots, including lateral roots, pneumatophores and many split roots. Dominance tree species in primary peat swamp forest are *Syzygium pyrifolium*, *Ganua motleyana*, *Camptosperma coriaceum*, *Macaranga pruinosa*, *Calophyllum teysmannii*, *Neesia malayana*, *Endiandra macrophylla*, *Syzygium obatum*, *Sterculia bicolor*, *Stermonurus secumdiflorus*, *Syzygium muelleri*, and *Baccaurea bracteata* (Bunyavajchwin, 1995; Hara *et al.*, 1995). Dominance tree species in secondary peat swamp forest are *Melaleuca cajuputi* and *Macaranga pruinosa*.

### Fauna in Peat Swamp Forest

Wild fauna of amphibians, reptiles, birds and mammal listed in peat swamp forest are 17 species, 50 species, 196 species, and 62 species, respectively. Following wild fauna in Thailand were firstly discovered in peat swamp forest; Dayak fruit bat (*Dayacopterus spadiceus*), red-cheeked flying squirrel (*Hylopetes lepidus*), singapore rat (*Rattus annandalei*), rufous tailed shama (*Copsychus pyrropygus*), Malaysia blue fly-catcher (*Cyornis turcosa*), rough-sided frog (*Rana glandulosa*), and Malayan brown snake (*Xenelaphis hexagonatus*). Other rare and endangered fluna are flat-headed cat (*Felis planiceps*), otter civet (*Cynogale bennetti*), and grey-headed fish-eagle (*Ichthyophaga ichhyaetus*). These 3 species have been found only in the peat swamp forest (Pitayakajorwate *et al.*, 1997).

### **Macrofungi in Peat Swamp**

The macrofungi of at least 67 species are found in peat swamp, which are classified into 1 Myxomycota, 6 Ascomycota, and 60 Basidiomycota. The commonest genera are *Ganoderma*, *Phellinus*, *Microporus*, *Termitomyces*, *Lentinus*, *Marasmius*, *Marasmiellis*, and *Pycnoporus* (Chalermpongse *et al.*, 1998).

### **Soil in Peat Swamp Forest**

Most of peat soils are consisted of the woody materials that contain high of amount lignin. The peat layer in Thailand is typically 0-3.8 m thick, although that is more than 20 m in Poland (Paprocka and Podstolski, 1996). The peat soil have characteristics of very low bulk density, high organic carbon content, extremely wide C/N ratio, extremely acidic, and high CEC, but very low in exchangeable cations, zinc and copper (Pisoot, 1999). The soil in peat swamp is not suitable for agriculture (G.M.T. Cooperation, 1994).

### **Water Condition in Peat Swamp Forest.**

In peat swamp forest, pH of the water is different among soil types that the water run through. Normally, the pH value of water inside primary peat swamp forest is almost the same as that outside primary peat swamp forest. However, pH decrease is observed after water pass through the area without peat covered, because sub soil under peat in Thailand is consisted of (potential) acid sulfate soil. Generally, the dept of water in peat swamp area is about 10-40 cm above ground, and fluctuate seasonally owing to periodical dry and wet seasons. During long dry period, as water level decrease down to 2 cm under ground level, fire damage become very severe in peat swamp during dry season.

### **Causes of the Damage of Peat Swamp in Thailand**

Once peat swamp dry up by the over drainage of water from inside peat swamp areas, forest fire break out frequently (Suzuki and Hara, 1995). In some areas, peat layers are all destroyed by the repeated burning, resulting in devastated lands that are not suitable for growing field crops. Utilization of peat swamp forest for agricultural purposes can be found in some areas, but not much when compared to other types of forest. Moreover, deforestation and intruding of human community causes also the loss of peat swamp.

### **Plant Succession of Peat Swamp Forest after Destruction by Forest Fire**

After the land was burned for 3-5 months, 3 types of peat land were identified as; 1) *Melaleuca cajuputi* regrowth area, 2) *Macaranga* spp. regrowth area, and 3) no tree regrowth area. After burning, *Melaleuca cajuputi* become the major pioneer species because this species only have a benefit to seed dispersion system by fire fruits of this species open by high temperature occurred during fire, and the seeds are dispersed to the ground (Tange *et al.*, 1995). However, in some area *Macaranga* spp. become dominants species. Since *Macaranga* spp. are rarely found in these area before fire damage, seeds disperse system of *Macaranga* spp. after fire should be studied in future. No tree regrowth area may be understood by as seed dispersion of pioneer species. When the peat land is burned again, it is easily covered with *Melaleuca cajuputi* because of benefit ability of seeds dispersion. Thus as *Melaleuca cajuputi* a become pure stand in most of the deforested peat swamp area, and can be found everywhere in, the people have been misunderstanding that peat swamp forest is as *Melalueca* forest

Thus, if the succession of deforested (mainly fire damaged) peat swamp area occurs naturally, as *Melaleuca cajuputi* will cover all most of the areas, reforestation is required for recovery of original peat swamp forest. In another outstanding evidence in peat swamp forest damaged by fire, native palms spp. have very strong tolerance to fire, and easily recover the growth. Therefore, native palms spp., especially sago palm are useful as barrier for fire protection.

### Reforestation in disturbed peat swamp area

Royal Forest Department (RFD), Ministry of Agriculture, and Cooperative are the organizations that are taking care of reforestation in Thailand. During 102 years since RFD was established, 640 ha of peat swamp areas have been reforested. This amount of areas is quite small compared to other types of forest, because of lacking of scientific data, lacking of seedling management techniques, including, and costing for investment in this type of forest compared to other types of forest. However, techniques on reforestation in peat swamp areas have been developed during the past about 10 years are as follows.

#### 1. The promising species for rehabilitation

The experimental results on rehabilitating trials for peat swamp species at Royal Pikulthong Project, Narathiwat were as follows. 1) Of 15 species at age 3 years in the 1988 plot, growth of *Acacia mangium* was the best, but all these trees died at 5.5 years (Table 2). 2) Of 13 species at age 5.5 years, *Ganua motleyana* showed the highest survival rate (90 %), *Melaleuca cajuputi* showed the fastest growth by the indicators of

Table 2. Survival percentage and growth characteristics of each plant species in 1988 at Toe-Daeng peat swamp

| No | Species             | Growth characteristic |       |  |         |       |                 |         |       |               |       |                 |      |               |      |                          |                    |
|----|---------------------|-----------------------|-------|--|---------|-------|-----------------|---------|-------|---------------|-------|-----------------|------|---------------|------|--------------------------|--------------------|
|    |                     | Survival (%)          |       | Stem diameter (cm) at 10 cm above ground |         |       | Tree height (m) |         |       | Stem biomass* |       | Branch biomass* |      | Leaf biomass* |      | Stem volume*             |                    |
|    |                     | 5.5 yr.               | 9 yr. | 3 yr.                                    | 5.5 yr. | 9 yr. | 3 yr.           | 5.5 yr. | 9 yr. | kg/tree       | t/ha  | kg/tree         | t/ha | kg/tree       | t/ha | 1000m <sup>3</sup> /tree | m <sup>3</sup> /ha |
| 1  | <i>Macaranga</i>    | 48                    | 48    | 3.0                                      | 5.5     | 8.4   | 1.7             | 2.4     | 3.9   | 1.7           | 2.91  | 0.92            | 1.71 | 0.48          | 0.81 | 4.20                     | 6.94               |
| 2  | <i>Syzygium py.</i> | 82                    | 82    | 2.2                                      | 4.0     | 9.3   | 1.4             | 2.2     | 4.6   | 1.0           | 2.07  | 1.47            | 3.23 | 0.65          | 1.42 | 1.59                     | 3.47               |
| 3  | <i>Ganua</i>        | 90                    | 88    | 1.8                                      | 4.0     | 7.2   | 1.2             | 2.0     | 3.4   | 0.3           | 0.59  | 0.06            | 0.13 | 0.05          | 0.11 | 0.78                     | 1.76               |
| 4  | <i>Sterculia</i>    | 85                    | 84    | 2.6                                      | 6.3     | 9.6   | 1.6             | 2.6     | 3.7   | 0.6           | 1.16  | 0.08            | 0.17 | 0.04          | 0.08 | 1.84                     | 3.93               |
| 5  | <i>Stemonurus</i>   | 72                    | 72    | 2.3                                      | 4.0     | 6.9   | 1.2             | 1.6     | 2.8   | 0.3           | 0.49  | 0.68            | 1.22 | 0.08          | 0.15 | 0.73                     | 1.34               |
| 6  | <i>Dialium</i>      | 76                    | 76    | 2.1                                      | 3.4     | 5.3   | 1.4             | 2.5     | 3.8   | 0.9           | 1.82  | 0.16            | 0.31 | 0.15          | 0.3  | 1.30                     | 2.54               |
| 7  | <i>Fagraea</i>      | 61                    | 47    | 3.3                                      | 5.4     | 6.4   | 2.0             | 3.5     | 3.7   | 1.2           | 1.89  | 1.23            | 1.93 | 0.21          | 0.33 | 2.42                     | 3.81               |
| 8  | <i>Melaleuca</i>    | 88                    | 83    | 6.0                                      | 12.5    | 15.8  | 2.5             | 6.4     | 8.7   | 5.9           | 12.87 | 2.25            | 4.90 | 1.22          | 2.65 | 17.36                    | 37.9               |
| 9  | <i>Syzygium ob.</i> | 83                    | 81    | 3.7                                      | 7.8     | 9.1   | 2.2             | 4.6     | 5.8   | 4.2           | 8.72  | 4.80            | 9.86 | 1.52          | 3.14 | 7.17                     | 14.8               |
| 10 | <i>Polyalthia</i>   | 23                    | 22    | 1.2                                      | 2.2     | 3.8   | 0.6             | 1.0     | 1.6   | 0.1           | 0.03  | 0.01            | 0.01 | 0.01          | 0.01 | 0.15                     | 0.08               |
| 11 | <i>Baccaurea</i>    | 87                    | 87    | 3.7                                      | 7.0     | 8.1   | 1.5             | 3.1     | 1.6   | 1.7           | 3.66  | 1.08            | 2.33 | 0.26          | 0.57 | 3.11                     | 6.68               |
| 12 | <i>Horsfieldia</i>  | 80                    | 79    | 2.4                                      | 5.4     | 8.7   | 1.4             | 1.8     | 3.5   | 0.5           | 0.96  | 0.07            | 0.13 | 0.09          | 0.19 | 1.12                     | 2.23               |
| 13 | <i>Vatica</i>       | 49                    | 49    | 1.8                                      | 4.0     | 6.2   | 1.5             | 2.4     | 3.3   | 0.7           | 1.00  | 0.27            | 0.38 | 0.13          | 0.18 | 1.50                     | 2.12               |

\* estimated at 5.5 years after planting

average diameter 10 cm above ground (12.5 cm), tree height (6.4 m), and stem yield (12.9 ton/ha) (Table 2). *Syzygium oblatum* showed the highest yield in same of stem, branch and leaf (21.7 ton/ha). 3) Of 15 species at age 4 years in 1993 plot, *Alstonia spathulata* had the highest growth (13.1 cm), *Calophyllum teysmannii* had highest height (3.4 m), and *Ixora grandifolia* and *Alstonia spathulata* had the similar highest survival rate (97 %) (Table 3).

Table 3. Survival percentage and growth characteristics of each species planted in 1993 at Toe-Deang Peat Swamp

| No | Species             | at 1 year old |          |        | at 2 years old |          |        | at 3 years old |          |        | at 4 years old |          |        |
|----|---------------------|---------------|----------|--------|----------------|----------|--------|----------------|----------|--------|----------------|----------|--------|
|    |                     | Survival (%)  | Growth*  |        | Survival (%)   | Growth*  |        | Survival (%)   | Growth*  |        | Survival (%)   | Growth*  |        |
|    |                     |               | D10 (cm) | Ht (m) |                | D10 (cm) | Ht (m) |                | D10 (cm) | Ht (m) |                | D10 (cm) | Ht (m) |
| 1  | <i>Cinnamomum</i>   | 82            | 1.8      | 0.9    | 79             | 3.1      | 1.3    | 78             | 4.2      | 1.5    | 78             | 5.6      | 1.8    |
| 2  | <i>Alstonia</i>     | 97            | 4.0      | 1.2    | 97             | 6.7      | 1.7    | 97             | 10.6     | 2.0    | 97             | 13.1     | 2.5    |
| 3  | <i>Ixora</i>        | 96            | 1.5      | 0.8    | 97             | 2.6      | 1.4    | 97             | 3.2      | 1.9    | 97             | 4.2      | 2.0    |
| 4  | <i>Polyalthia</i>   | 90            | 1.1      | 0.6    | 69             | 1.5      | 0.8    | 79             | 1.8      | 1.0    | 76             | 2.4      | 1.1    |
| 5  | <i>Mangifera</i>    | 90            | 1.1      | 0.5    | 81             | 1.7      | 0.8    | 81             | 2.3      | 1.0    | 81             | 3.0      | 1.1    |
| 6  | <i>Calophyllum</i>  | 95            | 1.4      | 0.9    | 94             | 2.5      | 1.7    | 94             | 3.6      | 2.6    | 94             | 4.9      | 3.4    |
| 7  | <i>Neesia</i>       | 75            | 1.4      | 0.4    | 69             | 2.4      | 0.9    | 67             | 3.1      | 1.3    | 67             | 4.1      | 1.4    |
| 8  | <i>Persea</i>       | 63            | 0.7      | 0.5    | 47             | 1.4      | 0.8    | 29             | 1.5      | 1.0    | 28             | 2.0      | 1.2    |
| 9  | <i>Dacryodes</i>    | 35            | 0.7      | 0.4    | 29             | 1.3      | 0.7    | 22             | 1.9      | 0.9    | 22             | 3.0      | 1.5    |
| 10 | <i>Sandoricum</i>   | 81            | 1.4      | 0.9    | 79             | 2.4      | 1.4    | 78             | 3.4      | 1.9    | 78             | 4.3      | 2.5    |
| 11 | <i>Litsea</i>       | 79            | 1.3      | 0.8    | 72             | 2.3      | 1.2    | 69             | 2.9      | 1.6    | 71             | 3.9      | 1.9    |
| 12 | <i>Camptosperma</i> | 90            | 2.1      | 0.3    | 88             | 3.9      | 0.9    | 88             | 5.9      | 1.3    | 88             | 7.5      | 1.7    |
| 13 | <i>Garcinia</i>     | 63            | 0.9      | 0.6    | 61             | 1.1      | 0.9    | 58             | 1.5      | 1.2    | 53             | 1.9      | 1.3    |
| 14 | <i>Aglaia</i>       | 79            | 0.9      | 0.4    | 56             | 1.3      | 0.6    | 32             | 1.7      | 0.9    | 26             | 2.5      | 1.2    |
| 15 | <i>Olea</i>         | 89            | 1.4      | 0.5    | 81             | 1.5      | 0.9    | 75             | 2.1      | 1.2    | 75             | 3.0      | 1.6    |

\*D10 indicates stem diameter at 10 cm above ground, and Ht indicates tree height

The growth rate of individual species was not constant (Fig. 1). For example, growth rate (estimated by tree height) of *Calophyllum teysmannii* increased after one year, that of *Cinnamomum rhynchophyllum* decreased after one year, and that of *Dacryodes incurvata* increased suddenly after 3 years.

## 2. Techniques for planting

The mound effect on tree growth was examined among 5 species, because most of trees are growing well in natural mounded condition in peat swamp. Five species were planted in mounded plot (50 cm height from ground, 70-90 cm round) and unmounded (ordinal ground level) plot. After 3 years, all species grew better in mounded plot than in unmounded plot because of presumably appropriate oxygen supply and less weeds growth at first years (Fig 2). As tree growth estimated by tree height was improved almost two times in mounded plot of *Syzygium* species compared to unmounded plot, these species require the mound construction for rehabilitation. However, as the cost for mound construction is expensive, further study on the costs and benefits of mound construction is required for large area of rehabilitation.

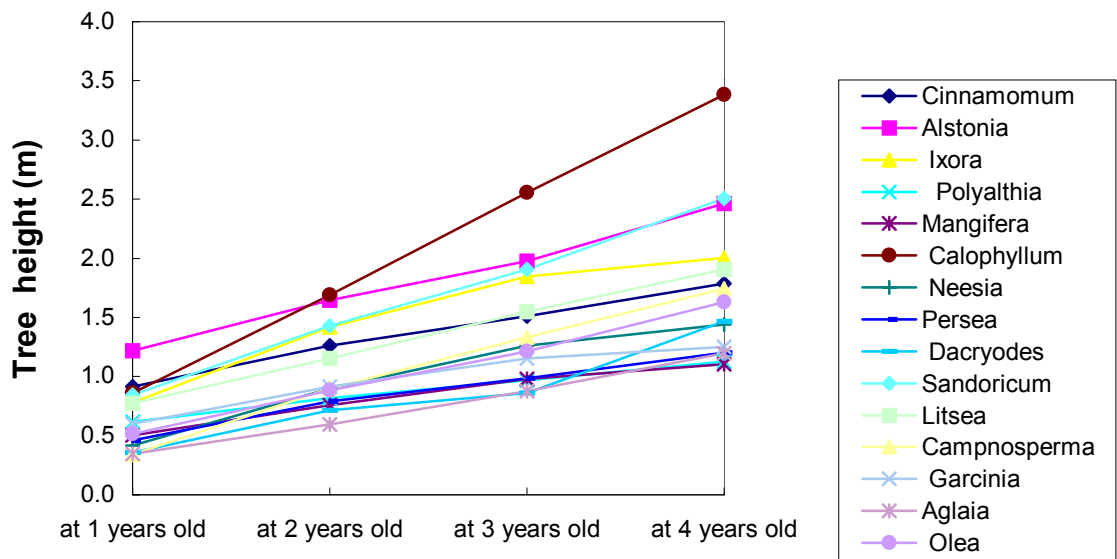

Fig. 1. Changes of average tree height (m) of each species planted in 1993 at To-Deng peat swamp

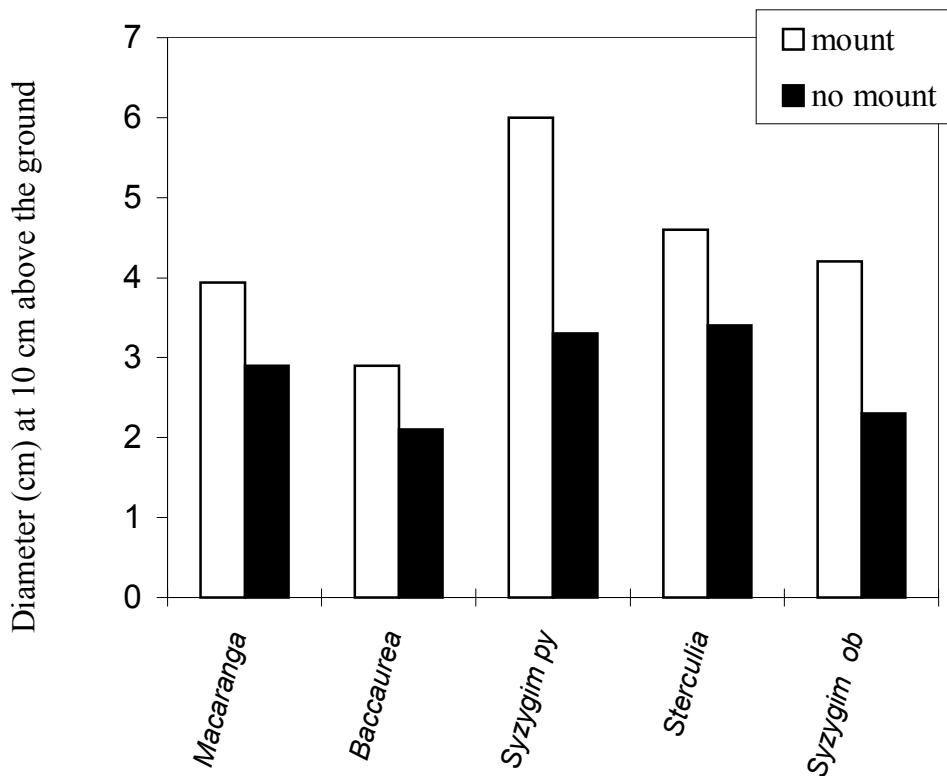

Fig. 2. Effect of mound construction on diameter at 10 cm above ground (cm) of 5 species at 3 years old

Soil improvement by effect on diameter and tree height of 5 trees species applying organic fertilizer, chemical fertilizer and liming showed no significant effect on diameter and tree height of 5 trees species.

By weeding, the growth and biomass of *Macaranga pruinosa* was improved through the increase of stem diameter, stem biomass and branch biomass, but survival percentage, tree height, and width of crown were not effected by weeding. Monthly weeding caused to higher productivity that diameter, stem biomass and branch biomass, were improved around 2, 4 and 6 times greater in weeding than in non weeding (Nuyim, 1997).

Wise choice of tree species is crucial for success in reforestation (Chareon *et al.*, 1979). Optimum species should be matched to the site and the objectives of planting. Consequently the most promising species so far tested for rehabilitation of degraded peatland are *Syzygium oblatum*, *Syzygium pyrifolium*, *Sterculia bicolor*, *Calophyllum teysmannii*, *Alstonia spathalata*, and *Sandoricum beccarianum*. *Melaleuca cajuputi* is also a promising species for woodlot in community forest. The mound construction in planting helps the seedling growth for especially *Syzygium* species.

## Management of Peat Swamp Forest

### 1. Forest fire and its control

It was said whether the peat swamp forest in Thailand or peat swamp in the world would be left for the next generation to see or to study. To conserve the peat swamp forest, forest fire is the major factor. Once forest fire occur in dried peat swamp area, adjacent areas are burned down in a spreading fire. In this condition, it is difficult to extinguish completely by even human power or use of any kind of machines. Making a deep ditch using big tractor to reach the level of underground water is one way to protect the fire broaden to neighboring area, and also water pump namely "Look Ped" is suitable to stop the beginning of fire. However, incredible amount of water is required to fill up the burned peat layer to extinguish the fire completely. In 1998, Toe Deang peat swamp forest was burned continuously from May to June because of a severe drought in this year. By this fire, about 2,374 ha of forest was destroyed. This was the biggest fire damage of peat swamp forestry in Thailand ever happened. Finally, artificial rain fall from helicopter completely ceased fire of which project was supported by His Majesty King Phumipol.

### 2. Making of forest zone

Peat swamp area should be divided into some zone according to vegetation, and geographic topography, and natural resource utilization. For instance, peat swamp forest at Narathiwat province are consisted of 3 zones, 1) **preservation zone** which is restricted against people use, and is used for scientific studies only, 2) **conservation zone** which is allowed for necessary utilization and is rahabilitated as much as possible, and 3) **development zone** which can be used for sustainable agriculture and agroforestry.

### 3. Declaration as National Park or Wildlife Sanctuary

Based on very strict law of National Forest and Wildlife Sanctuary, under supporting and managing by the full-time officer or worker, the conservation or protection of pear swamp forest is bound in duty.



#### **4. Effective utilization of natural resources**

Peat swamp forest is rich in natural resources such as starch from sago palm, fruit of *Eloiodoxa* spp., *Lygodium* spp., honey, and timber use of *Melaleuca* tree, 50 cm. Utilization and management of this kind of forest should be considered by the principle of Maximum Sustainable Yield with minimum environmental disturbance. The reforest area in peat land should be managed by planting some cultivation crops such as oil palm, rice, pineapple, and so on, otherwise reforest area will be extinct by frequent fire.

#### **5. Research activity, nature study, public announcement and tourism**

Several researches in peat swamp forest are still required because of very few academic back ground in past. To realize and appreciate an importance of peat swamp forest on what it has many functions in nature, public services are also very important, which for example are the construction of footpath into the forest, making the media such as panels pamphlets to distribute the knowledge on peat swamp forest, or information to tourists. Princess Sirindhorn Peat Swamp Forest Research and Nature Study Center under the Royal Pikunthong Development Project is the only one center for doing these kinds to activity in Thailand.

#### **Acknowledgement**

Special thanks go to Mr. Smit Bunsermsuk from RFD for improving the English and commenting on the text of this paper.

#### **References**

- Bunyavajchewin, S. 1995. Canopy structure of Toe-Dang primary peat swamp forest at Narathiwat Province, Southem Thailand. *Thai For. Bull. (Bot.)*, 23: 1-17.
- Chalermpongse, A., Thapyai, C. and Ramanwony, K. 1998. *Biodiversity of Microorganisms at Toe-Dang Peat Swamp Forest Ecosystems in Norathiwat*. 13 p
- Chukwamdee, J., Anansiriwat, A., Meepol, W., Jintanugool, J. and Havanon, S. 1999. Study on distribution of swamp forest in Thailand. *Journal of Thai Forestry*, 1: 23-32.
- Hara, K., Suzuki, K., Niyomdhum, C. and Nuyim, T. 1995. Vegetation structure of peat swamp forests in Narathiwat, Thailand . In: Vijamsorn, P. (ed.), *Proceedings of the International Workshop on Global Environmental Studies on Greenhouse Gas Emission and Tropical Peat. Swamp in Southeast Asia*. pp. 25-34, Tokyo, Nodai Research Instilute, Tokyo University of Agriculture.
- Kyuma, K. 1995. Climate, land and soil condition of the Narathiwat. Province as the background of the swamp forest project. In: Vijamsorn, P. (ed.), *Proceedings of the International Workshop on Global Environmental Studies on Greenhouse Gas Emission and Tropical Peat Swamp in Southeast Asia*. pp. 9-16, Tokyo, Nodai Research Institute. Tokyo University of Agriculture.
- Paprocda, I. O. and Podstolski, R. 1996. Peat in Poland. In: *Proceedings of the 10th International Peat Congress, Vol. 2. Bremen, Germany, 27 May-2 June 1996*. pp. 101-106.
- Phengkklai, C., Niyomdhum, C. and Ueachirakan, W. 1991. *Flora in Peat Swamp Areas of Narathiwat, Thailand*. Phikulthong Study Centre.
- Pitayakajorwate, P., Niyomdham, C., Urapeepatanapong, C. and Sinna, T. 1997. *The Nature Study Trial Guidebook "Peatswamp Forest"*. Sirmdhorn Research and

- Nature Study Center. 28 pp.
- Sinskul, S. 1998. *Basic Geology of Toe-Dang Peat Swamp*. Geology Department. 4 pp. (sheet)
- Suzuki, K. and Hara, K. 1995. Ecological rehabilitation of the tropical swamp forest. In: Vijamsorn, P. (ed.), *Proceedings of the International Workshop on Global Environmental Studies on Greenhouse Gas Emission and Tropical Peat Swamp in Southeast Asia*. pp 17-24, Tokyo, Nodai Research Institute. Tokyo University of Agriculture.
- Takai, Y. 1996. Environmental characteristics and conservation in boggy region of Southeast Asia. In: Vijamsorn, P. and Daigo, K. (eds.), *Proceedings of International Seminar on Environmental Conservation and Sustainable Agriculture Land Management in Boggy Region, Narathiwat, Thailand 5-8 November 1996*. pp. 3-25, Department of Land Development and Japan International Cooperation Agency (JICA)

## **Management Practices for Sustainable Cultivation of Crop Plants on Tropical Peatland**

**Kamarudin AMBAK<sup>1</sup> and Lulie MELLING<sup>2</sup>**

<sup>1</sup>Malaysian Agricultural Research and Development Institute (MARDI),  
Pontian, Johor, Malaysia

<sup>2</sup>Department of Agriculture, Kuching, Sarawak, Malaysia.

### **Abstract**

Most of the tropical peatland is found in Southeast Asia where it occupies some 20 million hectares, mainly concentrated around the Sunda Flat of Malaysia and Indonesia. It is part of the important rain forest ecosystem which is very sensitive and very fragile. Due to vast human development, some of these areas had been inevitably converted to agriculture, industrial and settlement sites. Utilisation of peatland for agriculture pose a lot of problems. Progressive drainage is a prerequisite for peatland development for agriculture. However, upon drainage the peat shrink and subsides and thus to sustain its usage in the long run will be difficult to accomplish. Therefore in order to sustain its utilisation for agriculture, a proper management practices need to be adopted and practiced. This paper highlights some of the important management practices for crop cultivation on tropical peatland with special reference to the Malaysian experience.

### **Introduction**

Peatland, peat or muck is a common term referring to organic soils that has been defined as Histosol according to Soil Taxonomy (Soil Survey Staff, 1975). In the tropics, tropical peatland formed part of the important rain forest ecosystem. About 80% of the tropical peatland are found in the coastal lowlands of Southeast Asian region (Driesen, 1978) where it occupies some 21 million hectares, mainly concentrated around the Sunda Flat of Malaysia and Indonesia (Dent, 1986). This peatland in its natural state is swampy and is one of the most fragile and sensitive ecosystems that support various unique flora and fauna of the tropics. Malaysia has approximately 2.7 million hectares of peatland of which 1 million hectares are distributed in Peninsular Malaysia and another 1.7 million hectares in East Malaysia. Due to vast human development and shortage of customary agriculture land, utilization of marginal soils, particularly the peatland, is on the increase, especially for agriculture, horticultural uses and human settlement.

The proper and efficient utilisation of these lands for agriculture would contribute significantly towards a long-term economic growth of the country. On the other hand, if its utilisation is not well managed, its economic usefulness would be short lived and the country may loose one of its most valuable resources. This is because the tropical peatland is a marginal and fragile soil and it is a non-renewable resource. Progressive drainage is a prerequisite for peatland development for agriculture. However, upon drainage the peat shrinks and subsides and thus to sustain its usage in the long run will be difficult to accomplish. Therefore in order to sustain its utilisation for agriculture, a proper management practices need to be adopted and advocated. This paper highlights some of the important management practices for sustainable crop cultivation on tropical peatland with special reference to the Malaysian experience.

The understanding of the specific properties and behaviour of the peat is very important to prevent excessive and rapid exhaustion of the peat natural fertility. The peatland environmental importance, role and functions need to be well recognised when reclaiming for any agricultural development.

### **Peatland Characteristics**

Among the important inherent characteristics of the Malaysian peatland are the presence of a dense mass of woody materials, usually water-logged in its natural state, shrinkage and subsidence upon drainage, irreversible drying if excessively drained, extreme acidity and low fertility status. Agricultural development on this peatland is mainly restricted by those problems associated with the inherent characteristics.

### **Physical properties**

The Malaysian peat is generally reddish brown to very dark brown in colour depending on the stage of decomposition. It was estimated that the Malaysian peat is made up of more than 50 % of semi-decomposed stumps and logs (Coulter, 1950). Recent studies by Yonebayashi *et al.* (1992) further confirmed this estimate.

It has a high moisture content and water holding capacity of 15-30 times of their dry weight (Tay, 1969). The high water content results in high buoyancy and high pore volume leading to low bulk density and low bearing capacity. Its average bulk density values ranges from 0.05 to 0.40 g/cm<sup>3</sup> (Driessen and Rochimah 1976; Ismail, 1984) and the particle density ranges from 1.4 to 1.8 g/cm<sup>3</sup> depending on the mineral constituents of the peat. Thus, the total porosity ranges from 75 to 95% on volume basis. Coupled with variable depths of the peat materials, they restrict the use of machinery and impose limitation to the types of crops that can be grown. Top-heavy tree crops, such as oil palm, rubber and coconut trees tend to lean and fall over as a result of poor root anchorage on deep peat areas. Even the hole-in-hole planting of the oilpalm is not entirely satisfactory as the problem of lodging and root exposure and damage is still prevalent (Singh *et al.*, 1986).

The ash content is usually less than 10% (Wong, 1991; Melling, 1997) showing a very high content of organic matter. This is indicated by a loss of ignition value exceeding 90% (Melling, 1997). Excessive drainage of the peat will cause a transformation of its colloids resulting in it having the properties of irreversible drying. Subsequently, the peat soils may lose their available water after four to five weeks of continuous drying. Thus, it is very susceptible to burning. On intensively cultivated areas, water availability in the top soil is critically low. Studies by Salmah (1992) suggest that the wilting point (15 bar) of a typical peat soil is almost equivalent to 5 bar suction. As such, shallow rooted crops need to be regularly irrigated in the dry season.

The common soil profile morphology of Malaysian peat consists of three distinct layers differentiated by its level of humification. They are the sapric, hemic and fibric as it goes down the soil profile. The thickness of these three layers varies depending on the water table and cultivation practices (Melling *et al.*, 1998). Some augerings had shown that the sapric material could extend down to a depth of 110–120 cm (Tie, 1988; Melling *et al.*, 1998). In the virgin peat dome, sapric materials may be absent, and the hemic layer can be less than 20 cm. The sapric-hemic-fibric sequence can also be reversed as the mineral substratum is approached. The occurrence of vacant layers within the top 50cm of a virgin peat profile is quite high. Thus the rate of subsidence

will vary depending on the sequence and thickness of the three layers of the peat profile.

The peat soils are very dynamic. This is because the peat will undergo subsidence and oxidation upon drainage. Initially, it involves principally the loss of buoyancy and compaction of the organic column under its own weight. The compaction results in the changes in the hydrogeological parameters like the hydraulic conductivity, bulk density, pore volume and moisture content. The subsequent dominant process that may last for decades is the oxidation and shrinkage. The rate of subsidence varies strongly depending on the peat profile morphology, peat composition, peat depth, depth of drainage and land use. Due to the differential rate of subsidence upon drainage, the microrelief of the peat surfaces becomes hummocky. A subsidence of 60 cm has been recorded for a drained deep peat (water table level of 75–100cm below the surface) in the first two years after reclamation followed by a rate of 6 cm per annum (Tie and Kueh, 1979). On this basis, a subsidence of approximately 200cm can be expected for the first 25 years after reclamation.

The peatland in their natural state plays an important role in the hydrological cycle whereby it acts like an aquifer by absorbing and storing water during the wet seasons and slowly releases it to the surrounding environment through streams and rivers or underground seepage during drier periods. The dense and close canopy of the forest further enhance the humidity of the atmosphere, cools the surrounding air and ultimately stabilizes the climate of the region. Thus virgin peatland is an important catchment area (Boelter, 1966).

The peat are generally classified as the ombrogenous peat (rainfed) and therefore poor in nutrients (oligotrophic). They are generally dome-shaped. The surface convexity becomes more pronounced with distance from the sea.

### **Chemical properties**

The thickness of the organic horizon, the nature of the subsoil and the frequency of flooding (Tie and Kueh, 1979) influence the chemical composition of the peat. This means that the older and thicker the organic horizon, the more impoverished are the surface layers. If the soil is regularly flooded, it has a higher amount of mineral content and is more fertile. A typical chemical characteristic of the Malaysian peat is as shown in Table 1.

The peat soils usually have very low mineral content with organic matter content more than 90%. It is very acidic in nature with a pH generally below 4.0 (Wong, 1991). With the occurrence of organic acids such as phenolic compound monomers which are known to be detrimental to crop growth (Tadano *et al.*, 1991), the lime requirement of these soils for the cultivation of dryland crops is normally high. These soils have a high CEC of 40–143 cmol kg<sup>-1</sup>). Thus these soils are strongly buffered. However, the high CEC is not due to the presence of Na, K, Ca or Mg but because of the presence of exchangeable H<sup>+</sup>. The peat has very low amounts of exchangeable bases causing them to have low percentage base saturation. The N content of peat is rather high but its availability for plant uptake is rather low.

The high C:N ratio coupled with the low pH results in low mineralisation of the peat. The electrical conductivity values are generally less than 1 mmhos/cm but may go up to more than 4 mmhos/cm in some areas near to the sea. Micronutrients, particularly Cu, and Zn are very deficient. Boron is also among the most deficient micronutrient in

the Malaysian peat (Ambak *et al.* 1991 and Ambak and Tadano, 1991)

Table1. Typical chemical characteristics of a Malaysian peat<sup>1</sup>.

| Property              | Topsoil (0-25 cm) | Subsoil (50-100 cm) |
|-----------------------|-------------------|---------------------|
| pH (H <sub>2</sub> O) | 3.7               | 3.8                 |
| Organic Carbon (%)    | 41.1              | 43.8                |
| Total N (%)           | 1.58              | 1.25                |
| Exch. Ca (me/100 g)   | 5.68              | 4.02                |
| Exch. Mg (me/100 g)   | 4.55              | 4.19                |
| Exch. K (me/100 g)    | 0.41              | 0.18                |
| Exch. Na (me/100 g)   | 0.65              | 0.65                |
| CEC (me/100 g)        | 70.8              | 66.4                |
| Available P (ppm)     | 79                | 9                   |
| Total P (ppm)         | 401               | 149                 |
| Total Ca (ppm)        | 1468              | 457                 |
| Total Mg (ppm)        | 526               | 373                 |
| Total K (ppm)         | 283               | 143                 |
| Available Cu (ppm)    | 0.14              | 0.16                |
| Available Zn (ppm)    | 0.96              | 0.52                |
| Available Mn (ppm)    | 5                 | 2                   |
| Available Fe (ppm)    | 10                | 2                   |

<sup>1</sup>Anderson series

Source : Melling, *et al.* (1999)

### Peatland Utilisation

According to available statistics as reported by Abdul Jamil *et al.* (1989) and Melling *et al.* (1999), approximately 868,375 ha of peat are under cultivation, representing 32 % of the total peat area in Malaysia (Table 2). Out of this, about 313,600 ha, are being utilised for agriculture in Peninsular Malaysia and 554,775 ha in the state of Sarawak. Oilpalm, at present, is the most important crop being grown on the peatland (Table 3). It is the principle crop for plantation establishment as it is proven to be relatively profitable. A well managed oil palms growing on drained peat often has better yield than those planted on upland soils. In the state of Sarawak, the area planted with oilpalm is more than double those planted in Peninsular Malaysia.

Sago is being planted on a large scale only in the state of Sarawak since it is traditionally a staple source of starch for the people of Sarawak. Rubber and coconut are traditionally planted by smallholders as cash crops especially during the post war period when these commodities fetched a high price. However, coconut is not grown on a large scale on the peatland in Sarawak. Except for oilpalm and sago, other crops such as coconut, padi, pineapple and mixed horticulture crops (including vegetables and field crops) are being much more planted in Peninsular Malaysia than in Sarawak. Fruit trees are also being grown on the peatland especially on the shallow peat. Those that have potential on peat includes rambutan, jack fruit, papaya and 'ciku'. Other perennials that have potential are dwarf coconut, tea, mulberry and breadfruit.

Table 2. Peatland developed for agriculture in Malaysia.

| Region                           | State /Division | Total area (ha) | Area developed for agriculture (ha) | % Peat area developed for agriculture |
|----------------------------------|-----------------|-----------------|-------------------------------------|---------------------------------------|
| Peninsular Malaysia <sup>1</sup> |                 |                 |                                     |                                       |
|                                  | Johore          | 298,500         | 145,900                             | 49                                    |
|                                  | Pahang          | 282,500         | 17,100                              | 6                                     |
|                                  | Selangor        | 194,300         | 59,900                              | 31                                    |
|                                  | Perak           | 107,500         | 69,700                              | 65                                    |
|                                  | Terengganu      | 88,000          | 13,900                              | 16                                    |
|                                  | Kelantan        | 7,400           | 2,100                               | 28                                    |
|                                  | Negeri Sembilan | 6,300           | 5,000                               | 79                                    |
|                                  | Total           | 984,500         | 313,600                             | 32                                    |
| Sarawak <sup>2</sup>             |                 |                 |                                     |                                       |
|                                  | Sibu            | 502,466         | 269,571                             | 54                                    |
|                                  | Sri Aman        | 340,374         | 50,836                              | 15                                    |
|                                  | Miri            | 314,585         | 66,114                              | 21                                    |
|                                  | Samarahan       | 205,479         | 50,836                              | 25                                    |
|                                  | Sarikei         | 172,353         | 61,112                              | 35                                    |
|                                  | Bintulu         | 168,733         | 47,591                              | 28                                    |
|                                  | Limbang         | 34,730          | 8,715                               | 25                                    |
|                                  | Kuching         | 26,827          | n.a                                 | -                                     |
|                                  | Total           | 1,765,547       | 554,775                             | 31                                    |
|                                  | Grand Total     | 2,750,047       | 868,375                             | 32                                    |

Source: <sup>1</sup>Abdul Jamil *et al.* (1989) n.a = not available

<sup>2</sup>Melling *et al.* (1999)

Table 3 The utilisation of peatland for agriculture in Peninsular Malaysia and Sarawak

| Type of crops      | Peninsular Malaysia <sup>1</sup> (ha) | Sarawak <sup>2</sup> (ha) | Total area (ha) |
|--------------------|---------------------------------------|---------------------------|-----------------|
| Oil Palm           | 146,730                               | 330,669                   | 477,399         |
| Sago               | -                                     | 64,229                    | 64,229          |
| Rubber             | 98,143                                | 23,000                    | 121,143         |
| Coconut            | 29,701                                | -                         | 29,701          |
| Padi               | 15,013                                | 2,000                     | 17,013          |
| Pineapples         | 14,690                                | 1,895                     | 16,585          |
| Mixed horticulture | 5,810                                 | 908                       | 6,718           |
| Miscellaneous      | 7,425                                 | 369                       | 7,794           |
| Total              | 317,512                               | 423,070                   | 740,582         |

Source : <sup>1</sup>Abdul Jamil *et al.* (1989)

<sup>2</sup>Melling *et al.* (1999)

### Sustainable Management Practices

In the true sense of the word, sustainable agriculture may not be appropriately used for peatland utilisation as the land will shrink and subside once it is developed for agriculture. Nevertheless, it may be construed to mean prolonging the life span of the

peatland by minimising its rate of subsidence by adopting appropriate water, soil and crop management strategies.

### **Water Management**

Water management is the most important and critical factor for crop growth and production on peatland. It not only lowers the water levels but also has significant influence on the crop management, peat subsidence and irreversible drying of the peat. Inefficient water management in times of limited water supply or excess is one of the main yield limiting factors. Therefore a good water management system requires a good functional drainage system.

#### ***1. Drainage and drainability***

Drainage is a prerequisite for any agriculture utilization on peat. Without drainage establishment of dryland crops is difficult, as the Malaysian peatland is formed in lowland basins whereby water table is normally high and fluctuate according to rainfall. Drainage is therefore an important aspect of water management for agricultural development on peatland. Drainage network for agriculture on peatland should be able to lower the water table as well as to evacuate the water from rainstorm that could cause flooding. This is important to prevent damage to agricultural crops, as most of them cannot withstand prolonged flooding. The drainage network therefore, should be able to drain the flood water within this time limit, failing which could result in yield reduction or even dying of the crops. The drainage system should consist of a network of interconnected field, collection and main drains. The intensity varies with the nature of the soil and rainfall. The drainage system need to be designed to cater for its unusually high rainfall which can be as high as 4,000-5,000 mm per year to minimize the effects of flash floods. These rainfalls are not equally distributed over the year. There are seasonal wet and dry seasons. Hence, the drainage system needs to be designed to cater for these variations.

The drainage system should consist of shallow drains and narrower spacing instead of deep drains with large spacing (Ritzema *et al*, 1998), so that it would be easier to build the water level control structure across the drain. To further regulate the water table and to prevent the ingress of tidal river water, which in many instances is brackish, water gates are constructed at the discharge end of the main drains. Regular and proper maintenance of the drains is essential if they are to continue to function efficiently. Desilting needs to be done. Weeds are major problems. If they are left unchecked, can choke the system, adversely affecting the capacity and flow. Therefore frequent rounds of degrassing is required to keep them under control.

A drainage system can hardly be expected to perform both the tasks of removing floodwater and conserving water at the same time, particularly in peat soil area. Other water conservation methods such as mulching, rain-harvesting and temporary detention storage should be considered.

The consequence of drainage is that it bleeds the peat swamp the very medium that is its basis of existence. This will trigger the inevitable process of irreversible subsidence, which is a hard-to-overcome constraint of developing and utilizing of the peatland for agriculture development (Andriess 1988). Thus it is important that the peatland should not be over-drained. Over drainage will increase the rate of subsidence and the occurrence of flooding, the reduction of the water holding capacity, an increase



in the occurrence of acid-sulphate soils, forest fire, irreversible drying, pest and termite attack, nutrient imbalance and decrease the crops yield. All these phenomena will have an adverse effect on the sustainable utilization of the peat soil for agriculture and thus significantly shortens the economic usefulness of the land.

In planning the drainage system of the peatland, it is also important to consider the drainability potential of the selected area that can be sustained. In this context, sustainable drainability refers to gravity drainage, which can only be possible and economical, if the mineral subsoil level is above the mean water level of the nearest water body into which the drainage water is discharged. This is because the ground surface is still above this level even after all the peat has disappeared through decomposition. Therefore gravity drainage can be sustained almost indefinitely. But it becomes more difficult and uneconomical or even impossible to have gravity drainage if the peat is below the mean water level. Gravity drainage also becomes even more difficult if they are situated further away from the water bodies because an additional hydraulic head of at least 20cm per kilometre has to be allowed for. When this happens, the area will become waterlogged and development of the area will have to be abandoned unless very expensive measures such as bunding and pumping are resorted to.

## **2. *Water-table control***

As drainage is important, maintaining constant groundwater levels within the optimal range for crop production is also as important. The ground water levels should be maintained as high as possible using appropriate water level control structures. A series of weirs are constructed across the collection drain at strategic positions to maintain the required water levels and to be able to control the water levels at a higher level during periods of low rainfall, to prevent over drainage. The spacing depends on the type of land use and the thickness of the peat layer.

An example of a water management system, based on similar design principles can be found at United Plantations in Perak (Singh *et al.*, 1986). In their oil palm plantations on peat soil, they have constructed a series of structures in the collector drains to control the water level in a block of 50ha. In the block, an intensive tertiary drainage system, with spacing of about 30m, maintains the ground water level depth at 0.6 to 0.9m below the soil surface.

The water table requirements differs according to the crop type. The optimal water table level varies on the depth of the root zone of each crop. It also has varied temporal requirements depending on the stage of crop growth as well as field activities such as tilling and harvesting. Ideally, water table should be designed about 20cm below the root zone of crops after taking into consideration the rate of capillary rise and capillary fringe in peat. These changes need to be accounted for adequately in order to achieve optimal production. For example, crops with shallow rooting zone of about 30cm will suffer from unnecessary moisture stress if grown in a field with mid-field drainage level designed at 90cm. Several optimum average water tables have been identified for best performance of some crops as shown in Table 4.

Dropping the watertable too low below the root zone due to subsidence would adversely affect the yield, particularly during the drier months. The slow vertical water conductance of the peat restricts the water recharge to the rooting zone of the crops by capillary rise, thus subjecting the crops to moisture stress. This requires that the

watertable should be maintained at the highest possible water level consistent with the crops grown. During the dry season, the water table should be higher to curb the occurrence of peat fire.

Table 4. Water table requirements for crops grown on peat

| Crops        | Water table (cm) | References  |
|--------------|------------------|---|
| Oil palm     | 50 – 75          | Singh <i>et al.</i> (1986)                        |
| Pineapple    | 60 – 90          | Tay (1980); Zahari <i>et al.</i> (1989)           |
| Sago         | 20 – 40          | Melling, <i>et al.</i> (1998)                     |
| Cassava      | 15 – 30          | Tan and Ambak (1989); Zahari <i>et al.</i> (1989) |
| Groundnut    | 65 – 85          | Ambak <i>et al.</i> (1992)                        |
| Soybean      | 25 – 45          | Ambak <i>et al.</i> ( <i>op cit</i> )             |
| Maize        | 75               | Ambak <i>et al.</i> ( <i>op cit</i> )             |
| Sweet potato | 25               | Ambak <i>et al.</i> ( <i>op cit</i> )             |
| Asparagus    | 25               | Ambak <i>et al.</i> ( <i>op cit</i> )             |
| Vegetables   | 30 - 60          | Leong and Ambak (1987)                            |

The choice of crops grown on a particular peat basin is very important. This choice dictates the required drainage depth. It is unwise to develop one part of the same swamp for deep rooting crops demanding a water table depth of 75 cm (e.g. oil palm), if on the neighbouring estate, attempts are being made to keep the water table levels at 30 cm (e.g. Sago). Hence, this creates a conflict in water table requirements. The choice of crops in relation to the location of the water catchment area should also be well considered so as not to affect the role of the peat swamp as a source of water supply.

Pests such as rats (predominantly *Rattus tiomanicus*) and termites (*Coptotermes curvignatus*) can be reduced or prevented with high water table and good water management.

Maintaining the water table as high as possible will be able to encourage a rapid growth of *Nephrolepis*, which acts as a cover crop so as not to expose the peat surfaces, and maintains a cooler surrounding. The exposed peat surfaces tend to form organic crusting and this will decrease infiltration and increase surface runoff causing an increase in peat erosion. Leguminous cover crops are not encourage because it will increase the rate of mineralisation of the peat, thus increasing the rate of subsidence.

Optimal fertilisers, pesticides and herbicides application can be well coordinated with good field water management. The peat developers and planters need to understand the impact of the application of these inputs with the varying moisture status to maximise crop development and productivity. Ensuring the appropriate water level has bearings on the correct application of inputs and minimising residuals.

### 3. Irrigation

When the water table can be controlled at the optimum level as required by specific crop, water management is not much a problem, except during early stage of crop establishment. The planting schedule then can be timed in such away that it coincides with the wet season.

If the water table cannot be controlled and is always deeper than the required depth,

irrigation is necessary, especially for short term crops. This is important in order to supply water for crop growth as well as to prevent excessive drying of the top soil. Leafy vegetables grown on peat often showed mid-day wilting during hot weather condition. This could be attributed to the shallow soil profile that is occupied by the roots. Water uptake in peat does not follow the pattern found in mineral soil. Water availability in peat soil is limited to a water tension equivalent of only 5 bars (wilting point) compared to 15 bars for mineral soils (Lucas, 1982; Salmah, 1992). Thus water depletion in the peat profile as the plant transpire will be much faster than the corresponding mineral soils.

Different crops have different growth stages sensitive to water stress. Knowing the different stages would enable one to irrigate at the critical time so as to minimize water stress and optimize water usage. Lucas (1982) reported that the productivity of field crops grown on peat decreased markedly as the amount of available water falls below 30% of the total available water.

For planting of annuals, irrigation measures must be considered. The planting schedule and irrigation system required must take into consideration the amount of water available in the soil above the water table, amount of rainfall and distribution and evapotranspiration of the area. There must be appropriate control measures on the water supply sources for back irrigation particularly during the dry period.

#### **4. Flooding**

In order to minimize the occurrence of soil subsidence, the best approach is to flood the soil and adopt aquatic usage of the peatland such as planting hydrophilic (water-loving) or water-tolerant plants of economic importance, namely Chinese water chestnuts (*Eleocharis tuberosa*), Chinese spinach (*Amaranthus hybridus*), 'kangkong' (*Ipomoea aquatica*), water cress etc. In the Florida Everglades, when the soil is not cultivated, especially during the off-season, it is a common practice to flood the whole field (Synder *et al.*, 1978).

### **Soil Management**

In principle, peat is an excellent soil substrate for growing crops, because of its high amount of pores, which provide abundant oxygen supply for root growth above the fully water saturated zone. It has large moisture retention capacity and hence transplanted crops establish themselves much faster than on mineral soils. However, due to certain inherent negative characteristics such as high acidity, low in base saturation and poor in certain macro and micronutrients, peat soil is generally considered as a marginal soil. Thus, with appropriate soil management practices, it can be sustainably utilised for agriculture.

#### **1. Burning**

Open burning of any area is not an environmentally friendly practice and it should never be encouraged. However, when the peatland is initially cleared and developed from virgin jungles, the land surface is full of undecomposed woody debris which hinders immediate usage of the land for crop cultivation. The undecomposed woody mass need to be removed at least to plough depth before the soil can be utilized for agriculture (Md. Sharif *et al.*, 1986). The use of machinery to clear these debris is difficult as the soil is soft and unworkable and thus requires intensive labour inputs. Therefore, initial burning

seems to be unavoidable unless there is a technology that can transform these woody mass into a well decomposed materials in a relatively short time. Thereafter, the practice of burning by farmers to liberate nutrients as well as to sterilize the soil should not be advocated. This is to prevent the accelerated physical soil loss.

## 2. Liming

Farmers usually burn the soil, either along the planting rows or as a blanket burning before planting. Burning improved the soil pH up to 5.5 to 7, released available nutrients and partially sterilized the soil. Although the benefits is immediate, but the amount of soil loss is tremendous and therefore it is not a sustainable practice and burning as stated earlier should not be encouraged. The best alternative is to use liming materials such as calcium carbonate or wood ashes. Studies have shown that rubber wood ash is superior to oil bunch ash as a soil ameliorant for vegetable production on peat (Md. Sharif *et al.*, 1986). In oil palm estate, oil palm bunch ash is being recommended as it contains high amount of potash (Yim *et al.*, 1984). However, difficulty in obtaining wood ashes limits its commercial application.

Liming is necessary for cultivation of dryland crops on peatland, except those acid tolerant crops such as pineapple and tapiocca. In general, about 2.5 tons/ha lime is required to bring the virgin peat pH of about 3.5 to about pH 4.0 (Joseph *et al.*, 1974). Table 5 shows yield responses to varying amount of lime for several short term crops.

Table 5. Mean yield of some short term crops in relation to lime.

| Crop         | Product      | Yield (tons/ha) at levels of hydrated lime |       |       |       |
|--------------|--------------|--|-------|-------|-------|
|              |              | 0  | 3.5   | 7.0   | 14.0  |
| Tapioca      | fresh tubers | 43.45                                      | 54.26 | 48.36 | 42.73 |
| Groundnut    | dry seeds    | 0.404                                      | 0.891 | 1.285 | 1.041 |
| Guinea grass | dry grass    | 10.92                                      | 15.91 | 17.74 | 19.33 |
| Sweet potato | fresh tubers | 9.33                                       | 19.65 | 20.75 | 24.57 |
| Chilli       | fresh chilli | 0.082                                      | 0.392 | 0.606 | 0.625 |
| Sorghum      | dry seeds    | 0.867                                      | 1.509 | 1.986 | 2.294 |
| Soil pH      | -            | 3.6  | 3.8   | 4.1   | 4.3   |

Source: Joseph *et al.* (1974)

## 3. Nutrient Requirements

The problem of low fertility status of peat soil could be overcome through appropriate fertilizer application. Generally, N and K requirements are high for vegetables and field crops (Leong *et al.*, 1993). Calcium and magnesium requirements are adequately supplied through liming. For perennials, especially oil palm, potash is most deficient while nitrogen and phosphorus, the rate of fertilizer required is in the region of about 209, 8 and 220 kg/ha of N, P205 and K20, respectively, given in three split application at 3,6 and 9 months after planting.

There are indications that plant nutrients vary with the depth of water table. Phosphorus and potassium requirements are normally greater with a high water table probably as a result of restricted root development (Lucas, 1982). Tay (1980) observed that pineapple yield responses to potassium were influenced to a large extent by water

table depths. Only at water table below 40 cm depth does increasing levels of potassium application leads to increase in pineapple yield. Fertilizer application in areas with extreme water table level, either too low or too high, was not beneficial to the crop.

Copper, boron and zinc deficiencies are common on Malaysian peatland. This is normally overcome through ground application as well as foliar sprays. In pineapple cultivation symptoms attributed to copper (green dieback) and zinc (crooked neck) have been reported (Joseph *et al.*, 1974). This is normally overcome through foliar application of about 5.6 kg/ha of copper sulphate, and zinc sulphate, respectively. The 'peat yellow' found in oil palm (Turner and Bull, 1967) has been identified as being due to copper deficiency (Ng and Tan, 1974). This symptoms however, was effectively cured by spraying with zinc sulphate (Singh, 1983). In tapioca, copper deficiency, as shown by curled or cupped young leaves, was successfully and economically cured through ground application of about 13 kg/ha of copper sulphate (Chan and Ramli, 1986). Boron deficiency in papaya is normally overcome by spraying 0.25 % boric acid every 2 weeks for the first 3 months of planting followed by ground application of 5 gm borax/tree.

In the reclamation of peat, the felling of natural forest vegetation causes a substantial change in the nutrient content in the ecosystem due to interrupted cycling, release of nutrients from decomposition of organic materials and compaction of the drained surface soil (Dent, 1986). The degradation of the chemical properties of peat with land clearing has a detrimental effect on yields of crops grown on it. After a few years of cropping, yield of crop tend to drop sharply. For example, the average pineapple yield from eleven years old (74 ton/ha), at the Peninsular Pineapple Plantation in Simpang Renggam, Johore, is somewhat 25% higher than those from the 20-25 years old fields (59 ton/ha), although with similar fertilizer inputs (Tay *et al.*, 1987).

Thus, to ensure optimum and sustainable utilization of the peatland, adequate and appropriate applications of essential crop nutrients is very crucial.

#### **4. Cultural Practices**

Another important aspect to be considered under soil management practices in order to sustain the usage of peatland is the cultural practices commonly adopted for peat soils. Is it necessary to till the soil or to adopt minimum tillage approach? For growing vegetables and root crops such as sweet potatoes, is it necessary to plant them on raised beds? Is it necessary to clean the weeds throughout the entire field? Our limited experience on planting crops on peat revealed that minimum or no tillage practice normally is as good as tilling the soil. Thus, non tillage practice should be adopted since it not only reduce soil disturbance but it reduces the input cost. In the cultivation of sweet potatoes, it was observed that tuber yields was significantly higher with those planted without beds as compared to those planted on beds. Thus, making beds should not be a normal practice for planting sweet potatoes on the peatland, provided that the land is well drained and the water table is kept at optimum level.

#### **Crop Management**

With proper management, various types of field crops, pasture, vegetables, pineapple, banana and coffee could be successfully grown on the Malaysian peatland. The agronomic requirements such as planting distances, fertilizer levels and management

procedures are well documented (Leong *et al.*, 1993).

### **1. Crop Suitability**

Selection of suitable crops that adapt well on drained and undrained peat is important for successful utilization of peat soils for agriculture. Among the introduced crops, pineapple showed highest adaptability on drained peat (Tay and Wee, 1972). It adapts very well to the high acidity and low fertility nature of the Malaysian peatland.

Tapioca is another crop that perform well on peat soils. Its high tolerance to acidity requires little amount of lime (Chew, 1971; Joseph *et al.*, 1974). The fibrous and loose nature of these soils encourage tuberization and facilitate harvesting. As such, yield as high as 50 tons/ha can be expected.

Oil palm has been found to be one of the perennial crops fairly suitable on medium to shallow peat. Yield as high as 13 tons/ha in the third year of planting was reported (Yim *et al.*, 1984). Rubber, coconut and coffee are the most popular crops among small farmers.

Sago adapts well and give good yields without any fertilizer input (Ahmad and Sim, 1975) on undraied / minimum drained peat. However, the crop takes a very long time (15 to 20 years) to mature. Rice is another crop that grows on undrained peat but very often having, the problem of sterility which produces empty husk (Driesen, 1978; Dent, 1986). Some fruit trees are found to grow well in native swamp forests of Sumatra and Kalimantan, namely, 'jambu air' (*Eugenia* spp.), wild species of mangosteen (*Garcinia* spp.), passion fruit (*Passiflora* spp.) and 'rambutan' (*Nephelium* spp.) (Anderson, 1976).

The search for suitable crops that can adapt well on drained and undrained peat with minimum soil amendmets is continuously being sought. Some of the crops that show potential are jackfruit, guava, breadfruit (sukun), 'ciku' and papaya.

### **2. Cropping Practices**

In order to reduce soil loss through biochemical oxidation, it is important that the soil surface should not be left barren. Some kind of vegetation such as grasses or legumes should be allowed to grow except at the planting hole. Similarly, clean weeding, particularly when dealing with perennial crops such as oil palm and coffee, should not be practiced. Some kind of leguminous creeper, *Canavalia maritima* can be grown satisfactorily with minimum inputs (Singh, 1986). It shows good tolerance to high acidity and establishing itself fairly quickly in the planting avenues.

Alternative approach to burning of crop residues as normally practiced in pineapple cultivation should be seriously looked into as burning is an environmentally unfriendly practice. Crop residues should be turned into composts and plough back into the soil. This practice not only give added nutrients but also helps to offset soil loss through subsidence.

### **Conclusion**

Part of the peatland in Malaysia has been successfully reclaimed for agriculture. Various crops have been economically grown under suitable agronomic practices and proper water management. Efforts to overcome various agronomic problems through research have met with some success. This is particularly true with pineapple and some short term crops such as tapioca, maize, sweet potato and vegetables.

Maximize usage of the already developed peat rather than opening up more peat swamp forest should be emphasized. Developed peat areas in the integrated agriculture development projects (IADP) such as in the West Johore IADP and South-West Selangor IADP in Peninsular Malaysia, should be fully utilized for crop cultivation. Where peatland had been drained and developed for agriculture, measures to conserve it to the fullest should not be ignored. Even though the soil continue to shrink and subside at the onset of draining, the rate of soil loss can be slowed down

The sustainable utilisation of peat for agriculture development must be approach from a total management perspective. It should be well understood, however that, even with the best water management, subsidence cannot be arrested. It is the price one has to pay for the use of tropical peatlands. The irreversible process of subsidence can only be arrested through complete re-saturation of the peat. There should be continued efforts by everyone concerned to look for optimum ways of controlling the subsidence of peat especially by appropriate water management. Therefore, the sustainable utilisation of peat for agriculture development is actually to prolong the lifespan of the productivity of the peatland.

#### **Acknowledgement**

The authors wish to record their gratitude to Director General of MARDI and Director, Department of Agriculture, Sarawak for allowing this paper to be presented and to Dr. M. Osaki for the invitation and financial arrangements for the senior author to be present at this Symposium.

#### **References**

- Abdul Jamil, M.A, Chow, W.T., Chan, Y.K. and Siew K.Y. 1989. Land use of peat in Peninsula Malaysia, Bengkel Kebangsaan Penyelidikan dan Pembangunan Tanah Gambut, 21-22 1989, MARDI, Selangor.
- Ahmed, M. I. and Sim, E. S. 1975. Utilisation of peat soil for sago palm cultivation in Sarawak. In: *Proc. 3rd Asean Soil Conf., Kuala Lumpur*. pp. 433-440.
- Ambak, K; Tan, S.L. and Zahari, A/B. 1992. Effect of watertable on the growth and performance of crop plants in peat soils, *Proc. Nat. IRPA Seminar (Agriculture Sector)*.
- Ambak, K. and Tadano, T. 1991. Effect of micronutrient application on the growth and occurrence of sterility in barley and rice in a Malaysian deep peat soil. *Soil Sc. Plant Nutr.*, 37: 715-724.
- Ambak, K., Zahari, A. B. and Tadano, T. 1991. Effect of liming and micronutrient application on the growth and occurrence of sterility in maize and tomato in a Malaysian deep peat soil. *Soil Sc. Plant Nutr.*, 37: 689-698.
- Anderson, J. A. R. 1976. Observations on the ecology of five peat swamp forests in Sumatra and Kalimantan. *Soil Res. Inst. Bogor. Indonesia. Bull.*, 3.
- Andriessse, J.P. 1988. Nature and management of tropical peat soils. *FAO Soils Bulletin*, 59. Rome: FAO
- Boelter, D. H. 1966. Hydrologic characteristics of organic soils in Lakes States watersheds. *J. Soil Water Conserv.*, 50-53.
- Chan, S.K. and Ramli, K. 1986. Evaluation of three methods of copper fertilization for cassava on peat. Preprint National Seminar of Recent Advances on Soil and Water Management in Malaysia Agriculture, organized by Malaysian Society of Soil

- Science in Kuala Lumpur on 20th March 1986.
- Chew, W. Y. 1971. Yield and growth responses of some legumes and root crops grown on acid peat to magnesium lime, *MAJ*, 48(2): 142-58.
- Coulter, J.K. 1950. Peat formations in Malaya. *Mal. Agric. J.*, 33; 63-61
- Dent, F. J. 1986. Southeast Asian coastal peats and their use: An over view. In: *Proc. 2nd Intern. Soil Management Workshop, Thailand/Malaysia*, 27-53.
- Driesen, P. M. 1978. Peat Soils. In: *Soil and Rice*. IRRI, Los Banos, Phillipines pp. 763-779.
- Driesen, P. M. and Rochimah, L. 1976. The physical properties of lowland peats from Kalimantan. *Soil Res. Inst., Bogor, Indonesia, Bull.* No.3.
- Ismail A.B. 1984. Characterization of lowland organic soils in Peninsular Malaysia. In: *Proceedings of Workshop on Classification and Management of Peat in Malaysia, Kuala Lumpur*.
- Joseph, K.T., Chew, W.Y. and Tay, T.H. 1974. Potential of peat for agricultural. MARDI Report No. 16.
- Leong, A. C. and Ambak, K. 1989. Water management for vegetable cultivation on peat. *Berita Penyelidikan MARDI 23/87 Jilid 9, Bil. 2/87, Serdang. MARDI (In Malay)*.
- Leong, A. C., Abdul Rahman, H., Abdul Rahim, M. and Ramlah, M. 1993. Agronomic requirements of crops on peat. In: *Pros. Bengkel Kebangsaan Penyelidikan dan Pembangunan Tanah Gambut, 21-22 Feb. 1989, MARDI*. pp. 39-52.
- Lucas, R.E. 1982. Organic soils (Histosols): Formation, distribution, physical and chemical properties and management for crop production. Research Report 435 FarScience. Michigan State University, East Lansing.
- Md. Sharif, A., Ambak, K. and Ismail, A. B. 1986. Agronomic consideration on peatland development - A Malaysian experience. In: *Proc. 2nd Intern. Soil Management Workshop, Thailand/Malaysia 7-18 Apr. 1986*.
- Melling L 1997. Adsorption of Cu & Zn in Tropical Peat Soil. MAgSc Thesis, University of Reading, UK
- Melling L, Teck, F. H. and Teng. C. S. 1998. Management of peat swamp. *Seminar on Land Use & Coastal Zone Management, 11-12 August 1998, Kuching, Sarawak, Malaysia*
- Melling L, Ambak, K., Osman, J. and Husni, A. 1999. Water management for the sustainable utilization of peat soils for agriculture. Paper presented at the *International Conference & Workshop on Tropical Peat Swamps, 27-29th July, 1999, Penang, Malaysia*.
- Ng, S.K. and Tan, Y.P. 1974. Nutritional complexes of oil palms planted on peat in Malaysia.I. Foliar symptoms, nutrient composition and yield. *Oleagineaux*, 29; 1-14
- Ritzema, H.P, Abd. Hassan, M. M. and Moens, R P 1998. A new approach to water management of tropical peatlands: a case study from Malaysia. *Irrigation and Drainage Systems*, 12: 123-139.
- Salmah, Z. 1992. Water management in deep peat soils in Malaysia. Ph. D. Thesis, Cranfield Institute of Technology, Silsoe College, England.
- Salmah, Z. 1998. Appropriate water management systems for coastal peat basin development in Sarawak in workshop on development of independent peat basin A new approach for peatland development
- Singh, G. 1983. Micro-nutrient studies of oil palm on peat. In: *Proc. Seminar on*



- Fertilizers in Malaysian Agric. Malaysian Society of Soil Science, Serdang, March 1983.*
- Singh, G., Tan, Y.P., Padman, C.V. Rajah and Lee, F. W. 1986. Experiences on the cultivation and management of oilpalms on deep peat in United Plantation Berhad. In: *Proc. 2nd Intern. Soil Management Workshop, Thailand/Malaysia 7-18 Apr. 1986.*
- Soil Survey Staff. 1975. Keys to Soil Taxonomy. Agency for International Development United States Department of Agriculture, Soil Management Support Services. SMSS Technical Monograph No. 19.
- Snyder, G.H., Burdine, H.W., Crockett, J.R., Gascho, G.J. Harrison, D.S., Kidder, G., Mishoe, J.W. Myhre, D.L., Pate, F.M. and Smith, S.F. 1978. Water table management for organic soil conservation and crop production in the Florida Everglades. Fla. Agr. Exp. Sta. Bul. 801.
- Tadano, T., Ambak, K., Yonebayashi, K., Hara, T., Vijarnsorn, P., Nilnond, C. and Kawaguchi, S. 1991. Nutritional factors limiting crop growth in tropical peat soils. In: *Soil Constraints on Sustainable Plant Production in the Tropics. Proc. 24th International Symposium on Tropical Agriculture Research Series No. 24*, pp. 146-156.
- Tan, S.L. and Ambak, K. 1989. A lysimeter study on the effect of watertable on cassava grown on peat. *MARDI Res. J.*, 17:137-142.
- Tay, H. 1969. The distribution, characteristics, uses and potential of peat in West Malaysia. *Journal of Tropical Geography*, 29: 57-63.
- Tay, T.H. 1980. Some effects of watertable and potassium levels on pineapple grown on Malaysian peat. Ph. D. Thesis, University of Cambridge, England.
- Tay, T.H. and Wee, Y.C. 1972. Liming of peat soils and its effects on pineapple. *Malays. Pineapple*, 2; 53-59.
- Tay, T. H., Zahari, A. B. and Sharif Ahmad, Md. 1987. Ameliorating peat for crop production, its impact on environment. *Paper presented at the Seminar on the Impact of Agricultural Production on Environment, Chiang Mai, Thailand, 17-20th Dec. 1987.*
- Tie, Y.L. and Kueh, H.S. 1979. A review of lowland organic soils of Sarawak. Tech. Paper No. 4, Res. Branch, Dept. of Agric. Sarawak, Malaysia.
- Turner, P.D. and Bull, R.A. 1967. Diseases and disorders of oil palm in Malaysia, Kuala Lumpur, Inc. Soc. of Planters.
- Unit Perancang Negeri Sarawak. 1998. Integrated Development Plan Study For Coastal Peat Land Sarawak, Interim Report, Kuching.
- Wong, M.H. 1991. The distribution, characteristic and agricultural utilisation of peat in Sarawak. Department of Agriculture, Sarawak.
- Yim, K.N., Tay, C.S., Mohd., P.Y., Mohd., T.D. and Ariffin, I. 1984. Early performance of oil palm on deep peat in RISDA Mini Estate, Parit. Seraya, West Johore Integrated Agriculture Development Project. In: *Proc. of Workshop on Classification and Management of Peat in Malaysia*. pp. 19-37, The Malaysian Soc. of Soil Sci.
- Yonebayashi, K., Okazaki, M. and Pechayapisit, J. 1992. Woody fragments in tropical peat soils. In: Kyuma K. *et al.* (eds.), *Coastal Lowland Ecosystems in Southern Thailand and Malaysia*. pp. 233-247, Showado-Printing Co., Sakyoku, Kyoto, Japan.

Zahari, A.B., Ambak, K. and Ghazalli, M. Z. 1989. The management of peat soils for agriculture production in Malaysia with special emphasis on watertable management at farm level. In: Spigarelli, S.A. (ed.), *International Symposium on Peat/Peatland Characteristics and Uses*, pp. 28-38.

## **Utilization of Inland Peat for Food Crop Commodity Development Requires High Input and is Detrimental to Peat Swamp Forest Ecosystem**

**Suwido H. LIMIN, LAYUNIATI and Yahya M. JAMAL**  
Faculty of Agriculture, University of Palangkaraya

### **1. Background**

The province of Central Kalimantan with an area of approximately 153,564 km<sup>2</sup>, contains 2,651,724 ha (or around 17.3%) of peatland. Based on the geographical site and the influence of seawater overflow, peatland can be grouped into two types: **inland peat** (the type of peatland that is not influenced by the overflow of seawater), and **coastal peat** (the type of peat that is mainly influenced by seawater). Both of these types of peatland have their own characteristics. The inland peat is not only identified as thick peat reaching about more than 17 m, but also poor peat. This is due to the decomposition process within this type of peat which is at the level of fibric or hemic process. In addition, the support material beneath the peat is mainly quartz and granite.

In contrast, coastal peat is shallow peat of about 25–100 cm, having highly fertile soil. It is due to the enrichment caused naturally by the sea water sediment. Its maturity is usually sapric or hemic and the under layer materials are dominated by mineral tough soil.

Peat swamp forest is not only important as the habitat for flora and fauna having high economic values and rarely found, but it is also important as carbon storage. If vegetation on the peat layer is destroyed, the ecosystem will change accordingly, and at the same time will increase the concentration of CO<sub>2</sub> in the atmosphere.

Up to the present the government has executed development programmes, often without taking into account undeniable fact and past experiences. Every separate sector makes different plans and carries out their own programs in disintegrated ways, and underestimating every research findings. The successful experience in managing peat in Sumatera has been assumed to be a successful method and applicable to Central Kalimantan. The real fact that can be easily understood about this problem is that of the cases of agriculture within the area of ex-transmigration in Bereng Bengkel (Kalampangan). The farmers in this area have not been able to manage successfully their farming areas, except the area surround their resident areas (0.25 ha). In this way, a lot farming areas have now become unproductive. Factors that caused the failure of the transmigration program in Bereng Bengkel have not been identified by the government for further development planning, as well as the negative impact in the long run on the ecosystem in this area.

### **2. The Utilization of Peat Swamp Forest**

In 1950s, the local Dayak community had intensively cultivated shallow peat both in the coastal and inland areas. Within the inland area (peat is locally called “LUWAU”), within the area of river banks or around the valley, which characterized by mineral clay, for natural raining-regulated rice field (Sawah tadah hujan). Where as within the tidal areas, the local community only traditionally cultivated rice farming around the river banks by establishing small canal for circulating the tidal water into the rice fields.

Before the establishment of big canals and the placement of the transmigrants within the tidal areas was implemented, Palingkau area has been identified as the leading rice producer for Central Kalimantan, but now instead of producing rice, Palingkau is importing rice from other areas.

In 1980s, the government started to utilize or conserve thick peat swamp areas within inland, which dominantly characterized by sand and granite, for agriculture. The examples of peat exploitation for agriculture through transmigration program are in the area of Kalampangan (Ex of Technical Executing Unit of Bereng Bengkel) Transbangdep Tahai, and the northern part of 1 million hectares of PLG project.

## **2.1 Kalampangan (Ex of Technical Executing Unit of Bereng Bengkel) and Transbangdep Tahai**

### **2.1.1 Agriculture**

#### *a. Technology*

Up to the present, the local farmers are still heavily relying on ash for fertilization, resulted from the burning of grass and wood waste. The burning process has been carried out consistently on the peat layer. Consequently, upper peat layer of about 20-30 cm has been seriously damaged. To help the crop grow well, it was estimated about 300–500 g of ash / plant needed in every plantation period. Without using ash, the local farmers would not be able to grow what so ever, except by utilizing other kind of fertilizer such as manure.

In 1984/1985 a true experiment was worked out on the utilization of peat by mixing it with mineral soil as much as 40 tonnes / ha and given along the plant lines. The mixture of peat with mineral soil, lime organic fertilizer and other micro-element showed a better result. However, there will always be problems to require mineral soil in great amount as the source of the mineral soil is limited, as well as the dug areas will resulted in environmental degradation.

#### *b. Commodity*

The leading commodity developed by the local farmers is mainly vegetable such as “sawi”, Salad, Cucumber and “Kangkung” where as the main “palawija” is maze (corn).

Generally the pattern of plantation is mono - culture type within a very limited scale, the farmers only cultivated the house yards as large as 0.25 ha. The size of the plots that have been utilized is usually as follows: For salad type of vegetation: 10.0 m × 1.0m. **Sawi**: 20.0 m × 15.0 m, cucumber: 25.0 m × 20.0 m, **Kangkung (hipomoea)**: 20.0 m × 15.0 m and for corn: 50.0 × 25.0 m. Most of the local farmers utilized the plots within those sizes, since these sizes are manageable when provided enough ash.

The revenue resulted from those practices was very little when the ash needed had to be bought. For example, to grow 125,000 corn crops, there should be about 37.5 tonnes/ha with the assumption that every corn consumes 300 g/plant. Whereas the price of ash in Palangka Raya is about Rp. 600 – Rp. 800/kg. If the ash within this area is sold on the price about Rp. 500/kg, the production cost will be as much as Rp.18,750,000 /ha. Based on the assumption that 75% of the crops will generate corn and out of this, only 30% of corn having good quality (28.25 corn/ha), so that the gross

product that will be resulted and gained by the farmers is about Rp. 19,687,500/ha, by the assumption that the price of the corn is Rp. 700/corn. The low rate of assumption in this case, the assumption was based on the findings made by Limin (1992) by utilizing 4 tonne of dolomite ha, 21 tonnes /ha manure and 180 kg, of phosphate  $P_2O_5$ /ha, resulted in good quality corn of  $> 12$  cm. This was only about 21,49-26.85%. Based on these figures, the net income would be smaller, if the need for nitrogen, phosphate, potassium, manure lime, pesticide, including cost for preparing the land, and maintenance until harvesting time. However the local farmers have never included those costs, mainly the costs of ash and the cost resulted from the utilization of manpower.

There are also constrains in developing plantation commodity. For example, coconut never would grow well outside the house yard. Where as rubber trees which were planted within the area of thick peat ranging from about 2.75-3.00 m. Those rubber trees when reaching the age of 12 years old, they could only reach varied dbh ranging from 11.0-54.0 cm, and there were only 11% of the rubber tree population reaching  $\geq 40$  cm, which satisfied the tapping criteria. The small amount of the rubber trees reaching tapping criteria denoted that rubber trees were hardly grow in the thick peat area.. In addition to the slow growth, the appearance of the tree trunk was very rough and stiff (Fig. 1). Sunarko (1996) asserted that the type of hybrid rubber trees which were sowed based on the seed, when reaching the age of 5–6 years, were generally 60% of the population could reach 40–45 cm of dbh.

### **2.1.2 Physical condition of the environment**

Based on direct observation on the field and information attained from the local farmers, it was proven that the farming areas would get dry easily, especially when the intensity of rain was low. This was actually the effect of soil water level decrease as further effect of the establishment of the excessive drainage system. There has been a clear indication of this problem, in every dry season the land should be watered with a great amount of water since the land is badly dry.

The rate of soil surface subsidence has also been significant, it is ranging from 1.0–3.0 cm per annum and it is very much depend on the local hydrological condition. Based on the result of water level measurement n the field, it was found out that within the period of 18 years, the peat surface subsidence has reached 36 cm (Fig. 2). Limin (1998) asserted that as the result of over drainage system develop, water soil had been drastically decreased. This in turn had resulted in great change of temperature and humidity on the upper peat layer. This change caused the proliferation of kind and type of soil microorganism that might have contributed restructuring of organic matter, so that the land surface gradually lowered. It is also asserted that the decrease of soil level was also resulted from the process of continues leaching of peat layer by erosion (water or wind).

On the other hand, in a certain area where peat layer structure have been very much changed, there has been exchange of vegetation grow. Fig. 3 shows that a certain type of vegetation, “alang-alang” (*Imperata cylindrica*) is growing very well in the area. In addition, the areas of peat swamp forest, which have hydrological status changes, in fact were easily caught fire. The burnt peat layer was ranging from 10 -100 cm or even more. The depth of burnt peat layer was depending on the availability of the organic materials and the depth of the soil water level. (Fig. 4).



Fig. 1. Rubber (Planted 1987; 11,0 % Dbh  $\geq$  40 cm)



Fig. 2. Subsidence (36 cm for 18 years period)



Fig. 3. Vegetation change: Alang-alang (*Imperata cylindrica*) Growing well.



Fig. 4. Peat fire characteristics

As the effect of many hindrances and high cost of input and technology needed for growing vegetation as well as corn, up to present  $\pm$  80% (700 ha) of farming areas in Kalampangan has been unproductive.

### 2.1.3 Population

Based on the report of Transmigration Office of Central Kalimantan, the number of transmigrants in Transbangdep Tahai and Kalampangan until 1999 were 3,433 people, as presented in Table 1. It is important to note that the increase in the number of population within these areas has not been followed by the increase of housing facilities, this was due to the strict use of the areas, as farming areas. The decrease of the number of house holds in the area of Transbangdep Tahai, from 230 house holds to 176 house holds, was actually indicating that transmigration program within those areas was failed. This was due to the soil condition, it was poorer than those in Kalampangan areas. In addition, it is important to assert here that almost 80% of farmers in Kalampangan area have been working in many different sectors other than farming, such as daily public workers, illegal mining, and illegal logging and so on.

Table 1. The number of families in Bereng Bengkel and Tahai

| Locations                    | Placement |          |                  | Delivery |          |                  | November 1999 |                  |
|------------------------------|-----------|----------|------------------|----------|----------|------------------|---------------|------------------|
|                              | Year      | Families | Number of people | Year     | Families | Number of people | Families      | Number of people |
| Bereng Bengkel (Kalampangan) | 1979/1980 | 500      | 2112             | 1985     | 487      | 2125             | 515           | 2415             |
| Transbangdep (Tahai)         | 1991      | 230      | 800              | 1996     | 230      | ?                | 176           | 1018             |

Source : Transmigration Office of Central Kalimantan

### 2.1.4 Research findings of UNPAR staff

Based on the research finding of Limin (1998) on the residual effect of manure, dolomite, and phosphate on the thick peat in Kalampangan area. It was found out that the treatment by using manure, dolomite and phosphate in this area could only effective as long as 22 months. Within those periods, the area was planted sweet corn in first sequence, Chili in the second sequence, and then sweet corn in the third sequence. Chili was again planted in the fourth sequence, but it was fail. This was clearly denoting that the residue effect of those inputs was not effective any more. To know for sure about this case, half of each sequence above was given retreatment by inputting dolomite, manure, and phosphate. It was found out that Chili which were planted within the area that was re-input with those materials, could grow well, and productive. Where as those planted within the area without re-treatment, were all die. For further information on the problems of the utilization of thick peat for agriculture can be clearly seen through Figs. 5 and 6.



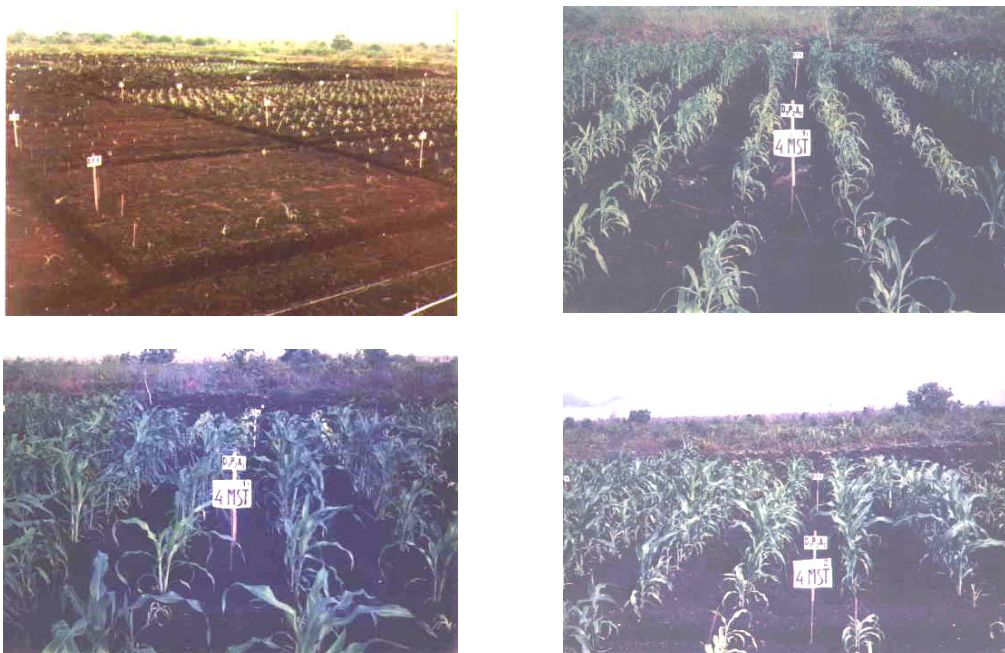

Fig. 5. Sweet corn plants were planted without lime and manure input.



Sequent IV (1st) residual effect



New treatment sequent IV (regrowing) on the right are plants planted using residual effect



Sequent IV (regrowing)



Sequent IV (regrowing)

Fig. 6. Chili plants replanted (re-treatment) with lime, manure and phosphate.



## **2.2 The Development of One Million Hectare**

The opening of peat swamp forest area known as the One Million hectare Peat land Development Project (PLG), right from the beginning has brought about conflict. In the first meeting on PLG in December 1995 in Central Kalimantan, the writer has reminded the government to be careful in establishing the canals as what had been planned, because they would bring about problems. The problems would be **“The swampy areas could be dry and the dry areas could become swampy or wet or there would be areas having those two characteristics wet and dry”**. In addition, “it had been proven that thick peat areas would never be productive for rice cultivation, as well as for other crops and big scale plantation”. The utilization of thick peat having more than 1 m deep, would gradually make the peat useless, as well as flora and fauna on the peat. The reformation of the peat layer would not happen in a very short time, as according to Rieley *et al.* (1996), the age of peat within the Sabangau catchment areas in Central Kalimantan within the depth of about 2–10 m, was about 960-9600 years.

### ***2.2.1 The establishment of canals and their problems***

The total length of canal has been completed up to the middle of 1998 was 2,008.7 km. This was covering 183.1km of the first primary canal, 620.5 km of the second primary canal, 241.1 km of support primary canal, 964 km of secondary and tertiary canals developed for irrigating 17,500 ha rice fields.

But later, the canal, which was established for irrigating the rice fields, could not be functioned due to the lack of water source from the upper stream of the Kahayan, Kapuas, and Barito rivers. However, if the idea of dumping the three rivers for water supply for irrigation, had been done, we could be sure, the new disaster would have happened, because there were many residences in the northern part of the area would be totally flooded. In fact, so far those canals have been effectively used for transporting logs resulted from illegal logging. In this case, instead of irrigating the rice fields, those canals have been effective used for illegal logging activities and they surely threatening the environmental sustainability. In addition, those canals would bring about two extreme conditions: extended drought and flood. Then these two conditions would support the exchange of vegetation. Further more, the potential danger of long dry season is land and forest fire. Based on the data on the spreading of hot spots in 1997, land and forest fire had always been started from the openly dry areas where there were many human activities.

### ***2.2.2 The placement of transmigrants and its problems***

There were 15,200 families or 62,379 people of transmigrants have been placed in the areas of Dadahup and Palingkau, and Lamunti. The problem was that in the 1998/1999 sowing period, there were about 30,000 ha rice fields destroyed by rat enemy. By manipulating this rat issue, the main cause of harvesting failure, the government could easily provide a big amount of budget, i. e. Rp. 52.1 billion for solving the rat problem. This was thought to be easy and simple as well as accurate. Of this budget Rp. 8.4 billion spent for buying 770 units of chainsaw and Rp. 12.4 billion spent for buying 309 tonnes of rat poison. In fact, both the chainsaw and the rat poison are of great threat to the environmental sustainability. Those chainsaws would facilitate illegal logging, where as rat poison would be able to destroy any bio-organism both those are living on land and in water including human beings within the area, especially those who use

water for daily consumption. The government's policy on the above problem solving was very controversial, besides underestimating the substantial causes of the agricultural failure. This would even bring about other new complicated environmental problems. According to Limin *et al.* (1999), the causes of agricultural failure mentioned above was really contributed by many factors, among others were soil characteristics, hydrology aspect, as well as the qualification of the farmers themselves. Where as rat problem came later, consuming those poorly grew rice crops.

It was suggested to the government not to look at the partial causes of the agricultural problems in the area, as well as their problem solving. Rat attack was actually due to the extreme ecosystem change, as well as due to rat food chain destruction. For this reason, the government was suggested to carry out the rearrangement of land use, i.e. among others by placing transmigrants into the area where rice cultivation is feasible. In other words that peat areas having >50cm characterized by sand and granite underneath, and those areas which are having more than 100 cm peat, characterized by clay underneath, should be reforested with local trees, and followed by the closing of the canals. Furthermore those farmers who are not farmers by profession, should be returned to their former profession or should be returned back to their original places.

### **2.3 Coastal Areas**

The development of coastal areas for agriculture by highly depend on the irrigation system, which chopped the whole area in such a destructive manner, in fact have not been able to bring about satisfactorily out comes. As the result of high "firit" content of the soil and poor hydrology system in managing the area, many transmigrants had abandoned their farming areas. Therefore, in many cases, the area of transmigration has become unproductive. The unproductive areas have not been well identified by the government. To underestimate and neglect those unproductive areas and letting those canals unfunctional, with out any effort for the best solution, is actually showing that the government consistency in maintaining extended poverty, and would surely resulted in ecosystem damage.

For example, within the area of Kapuas reGENCY, Central Kalimantan, a costal area of about 31,976 ha (agricultural area) has been cleared off for 18,272 families (79.82 people) of transmigrant (the previous data of placement). If the whole of the area had been rowed with rice, the yield was estimated to be about 3.3–4.8 tonnes per ha (based on the report), so that, a sowing period would have produced 105,520.8–153,484.8 tonnes rice. Based on the rice need per capita that was estimated 120/Kg/anum, the rice need of the transmigrants was estimated to only 9,579.840 tonnes/anum. However, that on fact the rice need has been highly satisfied by importing rice from outside of the area. This has been again the clear indication that the agriculture area of transmigrants has been to many cases become unproductive.

### **3. Conclusion**

- (1) The utilization of thick inland peat for agriculture and plantation must be stopped, because it has been proven that it has facilitated environmental degradation, and required high input in many cases.
- (2) Every peat areas which have been opened within the area of PLG as well as within the other areas should be reevaluated for appropriate use as follows:

- (2.1) Peat areas which are having > 50 cm deep, and characterized by sand or granite underneath, and
- (2.2) Peat areas which are having > 100cm deep, and characterized by mineral clay underneath, must be designated for conservation areas, i.e. by planting local highly economic value trees such as *Jelutong*, *Gemor*, *Ramin*, *Meranti* and so on.
- (3) Every canal within the area of PLG must immediately be closed, mainly those crossing through peat areas of having > 100 cm deep.
- (4) To let those wide canals open, going through the thick peat areas, would result in hydrology changes, soil surface subsidence and as well as vegetation change.
- (5) The utilization of peat swamp forest should be specialized for the local commodity (including its fauna). In this way it is believed that the peat swamp forest will produce not only forest product with high economic value but also result in sustainable and well-balanced ecosystem.
- (6) Being in the serious damage of ecosystem now, it would be better to work out the approach known as selling the wood without cutting the forest for the need of credit carbon/ carbon storage.

#### References

- Limin, S. H. 1998. Residual Effect of Lime, Phosphata and Manure on Crops Commodities in Inland Peat. The University of Palangka Raya.
- Limin, S. H. *et al.* 1999. Kertusakan Lingkunan di Kalimantan Tengah terancam semakin hebat Dengan Proses yang Cepat.
- Limin, S. H., Saman, T. N., Erosa, P. P. and Layuniati. 1999. Concept for prospective management of peat swamp forest in Central Kalimantan. *A Paper for International Workshop on Sustainable Management of Peat Swamp Forests. Kuantan – Peninsular Malaysia, 16 –18 November 1999. CIMTROP UNPAR, Palangka Raya.*
- Rieley, J. O., Page, S. and Shepherd, P. 1996. *Biodiversity and Sustainablity of Tropical Peat Swamp Forest* (In Collaboration with Suwido H. Limin, The University of Palangka Raya, Central Kalimantan, Indonesia). East Midlands Environmental Consultants, Nottingham, UK.

## **Discussion on Rural Development of Peat Swamp Area of Central Kalimantan from Hydrological Aspect**

**Takashi INOUE**

Graduate School of Agriculture, Hokkaido University  
Kita 9 Nishi 9, Kita-ku, Sapporo-shi, 060-8589, Japan  
Tel.: +81-(0)11-706-2554, Fax.: +81-(0)11-706-4177  
e-mail: tino@env.agr.hokudai.ac.jp

### **Abstract**

Chaotic and disordered development practice is now undertaken on peat swamp area of lowland Central Kalimantan. The existing development plan seems to be quite absurd, because it does not reflect the situation and the nature of the area.

On this paper, the necessity of recognizing area's present condition, the land zoning principle, priority of development, etc., is discussed with special reference to the hydrological view points. In order to establish appropriate land use planning, it is essential to know present conditions of the area and the ability of its potential resources. The importance of establishing monitoring stations is also emphasized.

### **1. Introduction**

Development on tropical peat swamp is now undertaken on many coastal areas of Southeast Asia. The pressure of exploitation is also getting very high in the coastal region of Central Kalimantan, Indonesia. It is well known that both boreal and tropical peatland are very sensitive landscape when the impact from human activity influences its system. Hydrological condition is the most influential factor to the peat land environment. But in case of Central Kalimantan, almost nothing has been taken in considering the conservation of the hydrological conditions of the peatland, and it means, on sustainable and environmentally tolerant peatland utilisation, too. In this paper, the brief background of peatland development in both boreal peatland (Hokkaido) and tropical peatland (Central Kalimantan) are compared and discussed through the view point of land use and its history. Problems, keys and hints for more adequate development are mentioned.

### **2. Our Recent Experiment on Peatland Development in Hokkaido and Indonesia**

Hokkaido is quite 'young' region in Japan. It means that it is young in development, which recently opened, compared to the other regions in Japan. It has agricultural history of only one century or so. But nowadays, Hokkaido, especially on lowland peatland areas, is completely 'developed', or 'consolidated' for agricultural production. The farmlands are settled systematically in rectangular shape, and fully equipped with roads, irrigation canals and drainage ditches. More or less, the area in natural condition is very limited. The hydrological conditions are artificially controlled. No part of agricultural area is wasted, or abandoned on large scale.

Same kind of neatly managed land use can be found in Java and Bali of Indonesia. The agricultural land use of these areas is so tidy and well managed by local people. These Japanese, Javanese, and Balinese farmers have something in common with the

experiment on rice cultivation, or common way-of-thinking based on rice cultivation. They do not like 'disordered' land use form.

The very important fact is that all these results of development are not achieved at once, of course. They are accumulated step by step spending through quite long time of span.

### **3. Failure of MRP and Condition of Lowland Central Kalimantan**

Looking to the conditions of lowland area of Central Kalimantan, we found the situation is largely different from that of peatland area of Hokkaido, or from Java and Bali. As Limin *et al.* (1999) and many others already mentioned, Mega Rice Project (MRP), a tremendous huge project conducted and failed in the area of lowland Central Kalimantan. In case of MRP, it seems that no careful consideration was paid for peatland development, and the 'rice-cultivating people's way of thinking' was simply and directly adopted.

The development plan of MRP did not refer the natural conditions of the area, in spite of recommendation given by 'environmental impact assessment' team in 1997 and re-evaluation team in 1998. It seems that the plan was designed only on the desk, not in the field. The plan seems to put its goal to catch up with the agricultural style in Java or Bali, but the natural and social condition is far from its adaptable level. As a result of the project, chaotic and disordered development practice was undertaken in peat swamp area of Central Kalimantan.

The most apparent evidence of this is the canal system built by MRP. Its route is simply drawn on the desk, not referring to the topological and hydrological conditions of the site. We can find many canals that are dried up, or partly dammed up into several sections to avoid over-drainage when we fly over the area. It is obviously shown that those canals are functionally useless for irrigation or drainage purpose. These evidences also apparently show that the plan was drawn without considering the gradient of the water flow, which is most essential for canal design. The quite basic questions must be thrown to the planners; "Why did they draw such plan? Did they really intend the water to flow there? And, for what purpose they planned the canals?"

### **4. Land Use**

There are three principles that are already agreed in agricultural group of Japan Society for the Promotion of Science (JSPS) program.

1. No need for new exploitation (or opening) of the forest.
2. Establishing the sustainable production system on the land that already opened for agriculture.
3. Restoring or rehabilitating the damaged forest and abandoned land.

From 1998, agricultural group of JSPS program started several researches on agricultural conditions of this area, visiting several villages and making interviews with local people. Many villages that we visited are transmigration villages, and almost all farmers possess 2 hectares of land and home yard. We found some of them are relatively in good situation. But according to the interview with them, it become apparent that many of them cannot fully utilise their 2 hectares farmland, mainly because of lack of labour. They do not have enough labour, cattle which they can use, and no machinery. Many of them only use 1 hectare or so. In the surroundings of the

village and utilised farmlands, there is a vast area of abandoned lands, which once prepared for agricultural use, that we can still utilise without opening the forest.

I also want to point out that several villages are doing relatively fine in agriculture. Some of them are near to the city so that they can supply vegetables and fruits. They have good market. But not only with those in lucky situation, some other villages are doing several efforts to improve their agricultural conditions. We need to put more attention to those villages that are trying to get more opportunity. We need to encourage the existing farmers and villages to improve their ability of agriculture.

As already mentioned, there are quite vast lands still exist that are over-exploited. It means that, there is some extent of lands that once opened, but no one can utilise because of its natural condition. These lands mainly found in the dead end of the canal (*anjir*), interior land that is very far from the river. The soil is poor, and we commonly can found peat deposit.

Such abandoned or damaged land seems to be quite difficult for agricultural use, due to soil nutrient condition, drainage condition, and house hold conditions, etc. Such area should be concerned as the buffer between the developing area and the native forest. We need more discussion on land use of this buffer zone. To establish low-intense land use, like forest for fuel use, may be the one idea

Conservation of the forest is another important matter. Quite a large area was already opened for agricultural purpose. Large part of this area is still remained unused. So why we need to open another virgin land for development? So many researchers emphasise on the regional and global importance of tropical peat swamp forests. We also need to recognise that new exploitation is waste of nation's resources. They are not only wasting land resources, water resources, or biological resources, but also wasting a lot of money and people's tax.

### **5. Keys for Developing Lowland Central Kalimantan**

First, it should be emphasised again that there are no needs for new exploitation of the forest. It should be conserved as one of the treasure of Indonesia, and we need to hand it over to our next generation.

Second, we must recognise that there is no sustainable use of tropical peat itself, as Rieley (1999) and many others already emphasis. We already found several places that the peat layer almost disappeared. All those area faced to the difficulty of agricultural production, and also the degradation of environment, such as water pollution. It is much better to exclude peatland from developing area, but when we need to deal with tropical peat, we should consider about the problem caused by the rapid disappearance of peat.

Third point is that the rice is not only the crop that should be considered to cultivate in this region. The way of thinking of rice-cultivating people such as Japanese, Javanese and Balinese must be omitted. Many other crops or agricultural form beside rice cultivation must be considered.

Fourth, we need to think deeply about the goal of development. The economical growth is not only the goal. The local people's quality of life must be considered, too. There are no issue if the development effects the people's way of life directly, but several evidences suggest that there are many problems exist on this matter.

The conservation of tropical peat swamp forest is not only the required answer in this area. Local people really need the development. It is quite difficult question to find

out the answer, to find out the break through to the environmentally adaptable development.

We need to learn a lot of hints from the evidence of traditional land use style. Sumawinata (1992) mentioned the Banjarese people's practices on land use of lowland area. The principle is 1) to keep the drainage to the minimum, so as to depress the oxidation of pyritic sediments, 2) to employ traditional methods of swampland rice cultivation, and 3) to conserve secondary *Melaleuca* forest by shifting cultivation of rice with long-term planting and long-term fallowing periods. It is very important to learn from these traditional farming systems, because they should have been harmonised with the environment of this area for long time.

Learning from the history of development of this area is also significant. We already know that some areas near to the coast have more than fifty years of history of agricultural land use. More or less, there are many transmigration villages with more than ten years of history after its establishment. The local people there have a lot of experience and know-how on development and management of their land.

Learning from practices of leading farmers, or advance and energetic farmers of the area is also important. We meet many farmers who are trying to improve their farming. They suggest many things on land management and farming practices in the area. Many hints may be learned from the field.

### **6. Importance of Hydrological View Points**

It is quite important to know how is the condition of groundwater (or surface water), its form and range of fluctuations, influence of the canal on the surroundings, etc. on peat land. The hydrological conditions play a basic role in movement of many substances, sustainability of peat itself, and agricultural productivity.

In 1998, with collaboration with the University of PalangkaRaya, hydrological monitoring stations on three sites in the area were established. One in the farmland, one in the abandoned shrub, and another in the forest. The purpose of measurement is to clarify the water balance on each land use, and to measure the speed of land subsidence. For this purpose, we set transect and benchmark on each site and conducting levelling survey. Transect was also settled to define the influence of drainage to the groundwater table. At each of these monitoring stations, we are measuring amount of rainfall, groundwater level, atmospheric temperature, and soil surface temperature. Each of them is measured continuously by using data logger.

Compare to the other monitoring factors such as biological study, monitoring of hydrological condition is quite simple, easy, and fast to detect. The influence of impact will appear immediately to the change in hydrological condition. Moreover, the hydrological study is essential for revealing the characteristics and nature of the peatland. Without any hydrological information and knowledge, any kind of conservation and/or development work could not be done. It is highly necessary to gain more information on hydrology and related interests on tropical peatland.

### **Acknowledgements**

The author wish to thank Dr. Mitsuru Osaki of Hokkaido University, Dr. Supiandi Sabiham of Bogor Agricultural University (IPB), Ir. Mr. Suwido H. Limin, Ir. Mr. Adi Jaya, and Ir. Mr. Sehat Jaya of the University of Palangka Raya, Ir. Mr. Dedi Kusnadi

Kalsim, Dr. Suwarno and Ir. Mr. Untung Sudadi (IPB), and other members whom we work and discussed together during the field study in Central Kalimantan in 1998 and 1999.

#### References

- Limin, S. H., Jaya, A. and Sulistiyanto, Y. 1999. Mega Project on tropical peatland: Viewpoint from Central Kalimantan. *International Conference and Workshop on Tropical Peat Swamps "Safe-guarding a Global Natural Resources"*, Penang 27-29 July, 1999.
- Rieley, J. 1999. Key-note speech, International Conference and Workshop on Tropical Peat Swamps "Safe-guarding a Global Natural Resources"; Penang 27-29 July, 1999
- Sumawinata, B. 1992. Adaptive agricultural practices and land use cycles on pyritic sediments in South Kalimantan. *Southeast Asian Studies*, 30 (1): 93-104.



# **Part 4**

## **Forest Ecosystem**

## Floristic Composition of Peat Swamp Forest in Mensemat-Sambas, West Kalimantan

Mustaid SIREGAR and Edy Nasriadi SAMBAS

Research and Development Center for Biology, The Indonesian Institute of Sciences  
Jalan Juanda 22, Bogor 16122, Indonesia, E-mail: herbogor@indo.net.id

### Abstract

The floristic composition of a 1.05 ha (70 m by 150 m) plot in an old-growth peat swamp forest was studied at Mensemat, Sambas Regency, West Kalimantan. Number of species and density of trees with more than 10 cm in diameter was 86 species and 698 trees/ha, while small tree of 2-10 cm in diameter was 100 species and 5043 trees/ha, respectively. The most abundant trees were *Blumeodendron elatriospermum* (47 trees/ha), *Cyatocalyx biovulatus* (39 trees/ha), *Blumeodendron tokbrai* (32 trees/ha), *Lithocarpus encleisacarpus* (30 trees/ha) and *Syzygium chlorantha* (30 trees/ha) with greater number of individual at smaller diameter classes. The most diverse families are Euphorbiaceae, Annonaceae and Dipterocarpaceae represented mostly by small-sized trees ranging between diameter 2-30 cm and rarely exceeding dbh 60 cm.

**Key words:** peat swamp forest, floristic composition, Mensemat, West Kalimantan.

### Introduction

Most of the peat swamp forest around Sambas Regency; West Kalimantan has been disturbed due to land conversion and logging. Some of the disturbed peat swamp areas were drained by artificial canals and have been converted into agricultural land, such as for rubber, coffee, pineapple and other fruits plants. The fast land conversion for agricultural land was the most serious threat to the conservation of the peat swamp forest areas, including its biodiversity. Besides decreasing in forest area, converted peat swamps with their canals system have been known also degrading the remaining peat swamp forest ecosystem near by. Ibrahim and Chong (1992), in a study at a peat swamp forest of Selangor, Peninsular Malaysia, indicated that the accumulated shrinkage of the peat has caused tree roots uprooted and fallen down due to decreasing water level as an impact of drainage of the surrounding agricultural activities.

To anticipate the disappearing various important data about the peat swamp forest at this area, we carried out a study on the floristic richness of the forest. This study will be the first step for a more functionally study in the future.

### Study Site and Method

The study was conducted at the primary peat swamp forest near Mensemat village, Sambas Regency, West Kalimantan in February 1993 (Fig. 1). The average annual precipitation at Sambas, about 15 km away from the study site, was 2795 mm. The highest monthly rainfall was 337 mm (recorded in December) and the lowest was 138 mm (in July).

A plot of 70 m by 150 m (1.05 ha) was established in an intact peat swamp forest near Mensemat Village (MPSF). The plot was divided into 105 subplots of 10 m by 10 m, and those trees with *DBH* of more than 10 cm were enumerated their species, measured their diameter, total height and height of the first live branch. A sub-subplot

of 5 m × 5 m was systematically nested within each subplot. Those small trees with diameter 2.0-9.9 cm at 50 cm above the ground within sub-subplots were also enumerated.

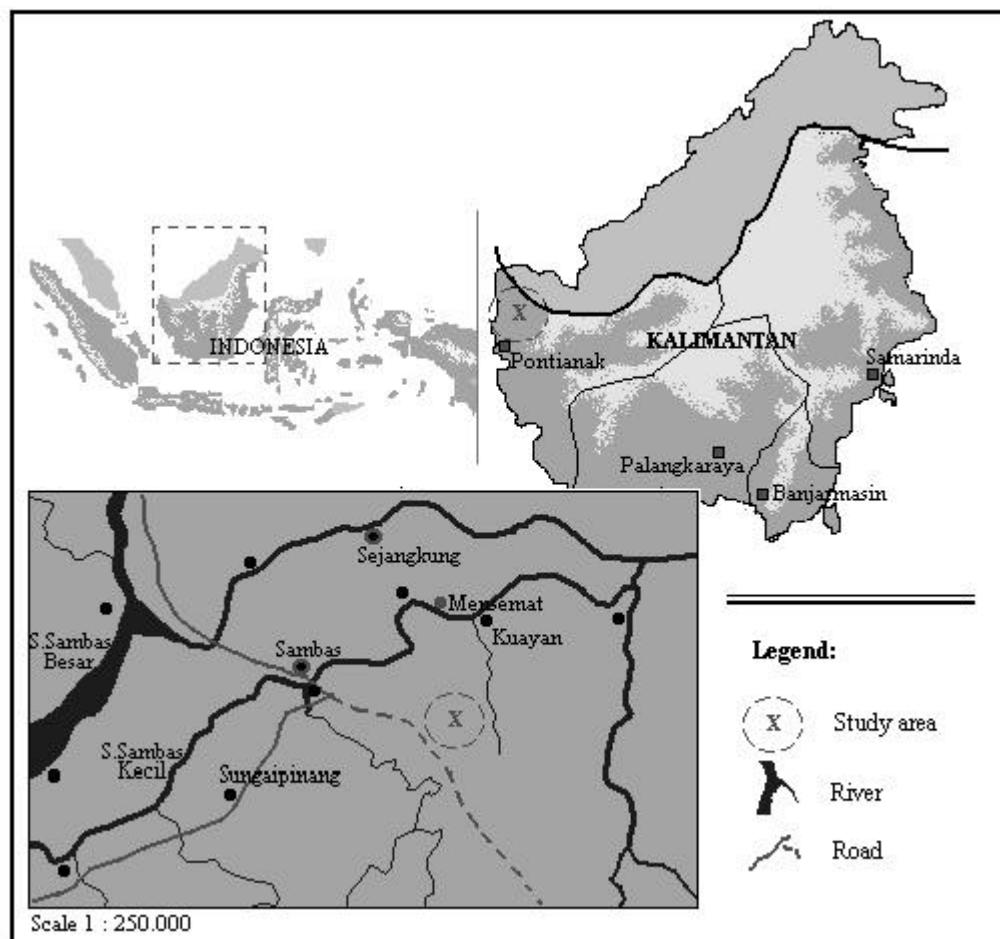

Fig. 1. Location of the study site at Mensemat, Sambas Regency, West Kalimantan

Some physical parameters of the plot were also measured during the field study. Ranges of the peat depth in plot was 2.0 - 4.0 m, pH was 3.2-3.6 and groundwater level was 30-50 cm under land surface, however the areas were flooded during the rainy season (October-December) in every years. Some chemical contents of peat sample collected from the plot were analyzed and the results were presented in Table 1.

## Results and Discussion

### *Density and diversity*

Number of species of tree more than 2 cm in diameter within the plot was 115 species belonging to 74 genera and 35 families (Table 2) and density was 5741 trees/ha. Among them tree with more than 10 cm *dbh* was 86 species (58 genera, 31 families) and the density was 698 trees/ha, while the small tree (2 - 9.9 cm diameter) was 100 species (67 genera, 33 families) and density was 5043 trees/ha.

Table 1. Quantitative data of the analytical results of the peat in the plot

|                    |                   |                          |                        |
|--------------------|-------------------|--------------------------|------------------------|
| Peat depth         | 1900 cm - 4000 cm | Exchangeable cations:    |                        |
| Water content      | 153.8 % - 448.7 % | - Ca                     | 2.78 – 11.04 me/100 g  |
| pH :               |                   | - Mg                     | 4.24 – 10.11 me/100 g  |
| - H <sub>2</sub> O | 3.2 – 3.6         | - K                      | 0.12 – 0.80 me/100 g   |
| - KCl              | 2.4 – 2.7         | - Na                     | 0.11 – 2.76 me/100 g   |
| C-organic          | 51.2 % - 57.0 %   | Cation Exchange Capacity | 208.5 – 277.2 me/100 g |
| N-total            | 0.73 % - 1.90 %   | Base Saturation          | 3.8% - 10.0%           |
| C/N                | 29.5 % - 77.9 %   | Al                       | 1.07 – 8.69 me/100 g   |
| P-available        | 3.19 % - 26.20 %  | H                        | 6.26 – 17.56 me/100 g  |

For comparison, Sudarmanto (1994) recorded 433 trees tree of more than 10 cm in diameter, consisted of 122 species in a 1-ha plot at the peat swamp forest of Gunung Palung National Park, West Kalimantan. In a peat swamp forest of Tanjung Puting National Park, Central Kalimantan, Mirmanto *et al.* (1999) reported 728 trees of more than 5 cm in diameter and 96 species within a 1-ha plot. Still in the Tanjung Puting National Park, Hamidi (1991) recorded 108 species in a 0.75ha-plot with density of 812 trees/ha. Saribi and Riswan (1997) recorded a tree density of peat swamp forest of Nyaru Menteng Arboretum, Central Kalimantan which was far higher i.e., 1004 trees/ha, but with less total species i.e. 64 species as conversion from a 0.5ha-plot (Table 3).

Table 2. List of tree species larger than 2 cm diameter recorded in the study plot.

| No. | Species  | Family           | Important value (%) |                            |
|-----|--|------------------|---------------------|----------------------------|
|     |  |                  | Trees (>10cm dbh)   | Small trees (2-9.9cm dia.) |
| (1) | (2)  | (3)              | (4)                 | (5)                        |
| 1.  | <i>Aglaia aspera</i> <sup>2</sup>                                      | Meliaceae        | -                   | 0.60                       |
| 2.  | <i>Alangium havilandii</i> Bloemb. <sup>1 2</sup>                      | Alangiaceae      | 3.34                | 2.27                       |
| 3.  | <i>Anaxagorea</i> sp. <sup>2</sup>                                     | Annonaceae       | -                   | 0.23                       |
| 4.  | <i>Anisoptera marginata</i> Korth. <sup>1 2</sup>                      | Dipterocarpaceae | 0.86                | 0.43                       |
| 5.  | <i>Antidesma trunciflorum</i> <sup>2</sup>                             | Euphorbiaceae    | -                   | 0.20                       |
| 6.  | <i>Archidendron borneensis</i> <sup>2</sup>                            | Fabaceae         | -                   | 0.50                       |
| 7.  | <i>Baccaurea bracteata</i> <sup>1</sup>                                | Euphorbiaceae    | 0.95                | -                          |
| 8.  | <i>Beilschunicdia</i> sp. <sup>2</sup>                                 | Lauraceae        | -                   | 0.21                       |
| 9.  | <i>Bhesa paniculata</i> Arn. <sup>1 2</sup>                            | Celastraceae     | 4.69                | 4.83                       |
| 10. | <i>Blumeodendron elatriospermum</i> <sup>1 2</sup>                     | Euphorbiaceae    | 17.53               | 4.59                       |
| 11. | <i>Blumeodendron tokbrai</i> (Bl.) J.J.Sm. <sup>1 2</sup>              | Euphorbiaceae    | 12.64               | 8.22                       |
| 12. | <i>Blumeodendron</i> sp. <sup>1</sup>                                  | Euphorbiaceae    | 0.35                | -                          |
| 13. | <i>Brackenridgea palustris</i> Bartell. <sup>1 2</sup>                 | Ochnaceae        | 0.72                | 0.49                       |
| 14. | <i>Buchanania arborescens</i> (Bl.) Bl. <sup>1 2</sup>                 | Anacardiaceae    | 0.34                | 0.34                       |
| 15. | <i>Calophyllum rigidum</i> <sup>1 2</sup>                              | Clusiaceae       | 0.66                | 1.64                       |
| 16. | <i>Camnosperma coriaceum</i> (Jack.) Hall.f. ex v. Steen. <sup>2</sup> | Anacardiaceae    | -                   | 0.49                       |
| 17. | <i>Cansjera rheodii</i> <sup>2</sup>                                   | Opiliaceae       | -                   | 0.83                       |
| 18. | <i>Chionanthus laxiflorus</i> <sup>2</sup>                             | Oleaceae         | -                   | 7.76                       |
| 19. | <i>Cratoxylum arborescens</i> (Vahl.) Bl. <sup>2</sup>                 | Clusiaceae       | -                   | 0.24                       |
| 20. | <i>Cratoxylum glaucum</i> <sup>1</sup>                                 | Clusiaceae       | 0.39                | -                          |
| 21. | <i>Croton oblongus</i> <sup>2</sup>                                    | Euphorbiaceae    | -                   | 1.04                       |

Table 2 (continued)

| (1) | (2)  | (3)              | (4)   | (5)   |
|-----|--|------------------|-------|-------|
| 22. | <i>Cryptocarya erectinervia</i> <sup>2</sup>                     | Lauraceae        | -     | 1.95  |
| 23. | <i>Cryptocarya zollingeriana</i> <sup>1 2</sup>                  | Lauraceae        | 0.44  | 11.80 |
| 24. | <i>Ctenolophon parvifolius</i> Oliver <sup>1 2</sup>             | Ctenolophonaceae | 2.80  | 5.85  |
| 25. | <i>Cyathocalyx biovulatus</i> Boerl. <sup>1 2</sup>              | Annonaceae       | 12.49 | 6.20  |
| 26. | <i>Dialium</i> sp. <sup>2</sup>                                  | Fabaceae         | -     | 0.21  |
| 27. | <i>Dillenia pulchela</i> <sup>2</sup>                            | Dilleniaceae     | -     | 0.67  |
| 28. | <i>Diospyros bantamensis</i> <sup>1 2</sup>                      | Ebenaceae        | 2.32  | 9.77  |
| 29. | <i>Diospyros hermaproditica</i> <sup>2</sup>                     | Ebenaceae        | -     | 0.22  |
| 30. | <i>Diospyros maingayi</i> Hk.f. <sup>1 2</sup>                   | Ebenaceae        | 0.35  | 0.71  |
| 31. | <i>Diospyros oblongus</i> <sup>1 2</sup>                         | Ebenaceae        | 1.10  | 0.34  |
| 32. | <i>Diospyros</i> sp. <sup>1</sup>                                | Ebenaceae        | 4.32  | -     |
| 33. | <i>Dryobalanops lanceolata</i> <sup>1 2</sup>                    | Dipterocarpaceae | 10.10 | 15.71 |
| 34. | <i>Dryobalanops rappa</i> <sup>1</sup>                           | Dipterocarpaceae | 1.41  | -     |
| 35. | <i>Durio graviolens</i> <sup>1 2</sup>                           | Bombacaceae      | 0.38  | 0.55  |
| 36. | <i>Dyera lowii</i> <sup>1 2</sup>                                | Apocynaceae      | 11.91 | 2.30  |
| 37. | <i>Elaeocarpus glaber</i> <sup>1 2</sup>                         | Elaeocarpaceae   | 1.00  | 2.22  |
| 38. | <i>Elaeocarpus mastersii</i> King. <sup>1 2</sup>                | Elaeocarpaceae   | 5.58  | 2.52  |
| 39. | <i>Elaeocarpus petiolatus</i> <sup>1 2</sup>                     | Elaeocarpaceae   | 0.35  | 4.12  |
| 40. | <i>Endiandra ochracea</i> Kosterm. <sup>1 2</sup>                | Lauraceae        | 0.72  | 0.23  |
| 41. | <i>Erycibe</i> sp. <sup>2</sup>                                  | Convolvulaceae   | -     | 0.65  |
| 42. | <i>Syzygium chlorantha</i> <sup>1 2</sup>                        | Myrtaceae        | 12.00 | 2.62  |
| 43. | <i>Syzygium jambolooides</i> <sup>2</sup>                        | Myrtaceae        | -     | 6.98  |
| 44. | <i>Syzygium oblata</i> <sup>1 2</sup>                            | Myrtaceae        | 7.22  | 1.75  |
| 45. | <i>Syzygium sexangulata</i> <sup>2</sup>                         | Myrtaceae        | -     | 15.46 |
| 46. | <i>Syzygium spicata</i> <sup>2</sup>                             | Myrtaceae        | -     | 0.71  |
| 47. | <i>Syzygium</i> sp. 1 <sup>2</sup>                               | Myrtaceae        | -     | 0.27  |
| 48. | <i>Syzygium</i> sp. 2 <sup>2</sup>                               | Myrtaceae        | -     | 0.89  |
| 49. | <i>Syzygium</i> sp. 3 <sup>1</sup>                               | Myrtaceae        | 3.20  | -     |
| 50. | <i>Ganua coriacea</i> <sup>1</sup>                               | Sapotaceae       | 6.23  | -     |
| 51. | <i>Ganua motleyana</i> (de Vr.) Pierre ex Dubard. <sup>1 2</sup> | Sapotaceae       | 10.25 | 4.36  |
| 52. | <i>Garcinia dioica</i> <sup>2</sup>                              | Clusiaceae       | -     | 0.44  |
| 53. | <i>Garcinia dulcis</i> <sup>1 2</sup>                            | Clusiaceae       | 0.74  | 1.41  |
| 54. | <i>Garcinia forbesii</i> <sup>1 2</sup>                          | Clusiaceae       | 0.38  | 2.05  |
| 55. | <i>Garcinia rostrata</i> <sup>1</sup>                            | Clusiaceae       | 0.58  | -     |
| 56. | <i>Glochidion rubrum</i> <sup>1 2</sup>                          | Euphorbiaceae    | 0.35  | 0.77  |
| 57. | <i>Gluta beccarii</i> <sup>1 2</sup>                             | Anacardiaceae    | 3.74  | 0.52  |
| 58. | <i>Gonystylus bancanus</i> (Miq.) Kurz. <sup>1 2</sup>           | Thymelaceae      | 0.40  | 4.55  |
| 59. | <i>Gymnacranthera contracta</i> <sup>1</sup>                     | Myristicaceae    | 6.71  | -     |
| 60. | <i>Horsfieldia glabra</i> <sup>1 2</sup>                         | Myristicaceae    | 0.35  | 0.46  |
| 61. | <i>Ilex macrophylla</i> <sup>1 2</sup>                           | Aquifoliaceae    | 1.80  | 2.46  |
| 62. | <i>Jakia ornata</i> Wall. <sup>1 2</sup>                         | Rubiaceae        | 0.57  | 0.65  |
| 63. | <i>Knema cinerea</i> <sup>1 2</sup>                              | Myristicaceae    | 0.67  | 8.18  |
| 64. | <i>Koompasia malaccensis</i> <sup>1</sup>                        | Fabaceae         | 9.35  | -     |
| 65. | <i>Lithocarpus bennettii</i> <sup>1 2</sup>                      | Fagaceae         | 2.19  | 1.69  |
| 66. | <i>Lithocarpus encleisacarpus</i> <sup>1 2</sup>                 | Fagaceae         | 10.96 | 14.18 |
| 67. | <i>Litsea gracilipes</i> Hook.f. <sup>2</sup>                    | Lauraceae        | -     | 8.80  |
| 68. | <i>Litsea nidularis</i> Gamble <sup>1 2</sup>                    | Lauraceae        | 2.04  | 13.52 |
| 69. | <i>Litsea resinosa</i> Bl. <sup>1 2</sup>                        | Lauraceae        | 1.17  | 4.42  |
| 70. | <i>Litsea</i> sp. <sup>1</sup>                                   | Lauraceae        | 0.40  | -     |
| 71. | <i>Lophopetalum javanicum</i> <sup>1 2</sup>                     | Celastraceae     | 0.92  | 1.35  |
| 72. | <i>Macaranga caladifolia</i> Becc. <sup>1 2</sup>                | Euphorbiaceae    | 2.79  | 4.00  |
| 73. | <i>Macaranga curtsii</i> <sup>1 2</sup>                          | Euphorbiaceae    | 6.46  | 1.26  |
| 74. | <i>Macaranga depressa</i> <sup>2</sup>                           | Euphorbiaceae    | -     | 1.55  |
| 75. | <i>Macaranga hosei</i> <sup>1 2</sup>                            | Euphorbiaceae    | 1.35  | 4.85  |

Table 2 (continued)

| (1)  | (2)  | (3)              | (4)   | (5)   |
|------|--|------------------|-------|-------|
| 76.  | <i>Macaranga triloba</i> <sup>1</sup>                        | Euphorbiaceae    | 0.36  | -     |
| 77.  | <i>Magnolia candollii</i> (Blume) H.Keng <sup>1 2</sup>      | Magnoliaceae     | 1.01  | 2.59  |
| 78.  | <i>Mangifera longipetiolata</i> <sup>1 2</sup>               | Anacardiaceae    | 4.20  | 0.41  |
| 79.  | <i>Mezzetia havilandii</i> <sup>1 2</sup>                    | Annonaceae       | 4.17  | 0.57  |
| 80.  | <i>Mezzetia parviflora</i> <sup>1 2</sup>                    | Annonaceae       | 2.82  | 8.65  |
| 81.  | <i>Neoscortechinia kingii</i> Pax.et K.Hoffm. <sup>1 2</sup> | Euphorbiaceae    | 5.53  | 11.93 |
| 82.  | <i>Nephelium maingayi</i> Hiern. <sup>1 2</sup>              | Sapindaceae      | 5.42  | 8.63  |
| 83.  | <i>Nothaphoebe cuneata</i> <sup>1 2</sup>                    | Lauraceae        | 2.55  | 2.36  |
| 84.  | <i>Palaquium leiocarpum</i> Boerl. <sup>1 2</sup>            | Sapotaceae       | 6.75  | 1.87  |
| 85.  | <i>Parastemon urophyllus</i> (A.DC.) A.DC. <sup>1 2</sup>    | Rosaceae         | 4.23  | 1.39  |
| 86.  | <i>Parishia maingayi</i> Hk.f. <sup>1 2</sup>                | Anacardiaceae    | 4.11  | 1.26  |
| 87.  | <i>Parkia sumatrana</i> <sup>1</sup>                         | Fabaceae         | 0.71  | -     |
| 88.  | <i>Peltopherum</i> sp. <sup>2</sup>                          | Fabaceae         | -     | 0.39  |
| 89.  | <i>Pometia pinnata</i> Forst. <sup>1 2</sup>                 | Sapindaceae      | 1.46  | 2.11  |
| 90.  | <i>Polyalthia glauca</i> (Hassk.) Boerl. <sup>1 2</sup>      | Annonaceae       | 1.41  | 2.42  |
| 91.  | <i>Polyalthia lateriflora</i> <sup>1 2</sup>                 | Annonaceae       | 1.04  | 0.98  |
| 92.  | <i>Pygeum lompongum</i> <sup>1</sup>                         | Rosaceae         | 0.35  | -     |
| 93.  | <i>Randia</i> sp. <sup>1 2</sup>                             | Rubiaceae        | 1.64  | 0.33  |
| 94.  | <i>Sandoricum emarginatum</i> Hiern. <sup>1 2</sup>          | Meliaceae        | 0.39  | 0.64  |
| 95.  | <i>Santiria apiculata</i> <sup>1 2</sup>                     | Burseraceae      | 0.33  | 3.44  |
| 96.  | <i>Santiria laevigata</i> Bl. <sup>1 2</sup>                 | Burseraceae      | 1.73  | 0.20  |
| 97.  | <i>Santiria oblongifolia</i> <sup>2</sup>                    | Burseraceae      | -     | 2.30  |
| 98.  | <i>Santiria rubiginosa</i> Bl. <sup>1 2</sup>                | Burseraceae      | 0.49  | 0.21  |
| 99.  | <i>Santiria tomentosa</i> Bl. <sup>1 2</sup>                 | Burseraceae      | 0.80  | 0.59  |
| 100. | <i>Sarcotheca glauca</i> (Hk.f.) Hall.f. <sup>1 2</sup>      | Oxalidaceae      | 0.69  | 0.77  |
| 101. | <i>Shorea leprosula</i> <sup>1 2</sup>                       | Dipterocarpaceae | 2.38  | 4.82  |
| 102. | <i>Shorea macrantha</i> (Brandis) Sym. <sup>1 2</sup>        | Dipterocarpaceae | 2.14  | 1.19  |
| 103. | <i>Shorea parvifolia</i> <sup>1 2</sup>                      | Dipterocarpaceae | 7.73  | 1.89  |
| 104. | <i>Shorea</i> sp. <sup>2</sup>                               | Dipterocarpaceae | -     | 0.24  |
| 105. | <i>Stemonurus scorpioides</i> <sup>1 2</sup>                 | Icacinaceae      | 9.44  | 1.51  |
| 106. | <i>Tetractomia holtumii</i> <sup>1 2</sup>                   | Rutaceae         | 20.74 | 10.43 |
| 107. | <i>Tricalysia singularis</i> <sup>2</sup>                    | Rubiaceae        | -     | 0.23  |
| 108. | <i>Tristania bakhuizeni</i> <sup>1 2</sup>                   | Myrtaceae        | 0.47  | 0.27  |
| 109. | <i>Vatica</i> sp. <sup>2</sup>                               | Dipterocarpaceae | -     | 0.21  |
| 110. | <i>Xanthophyllum eurhycum</i> <sup>1 2</sup>                 | Polygalaceae     | 0.37  | 1.68  |
| 111. | <i>Xanthophyllum scootechiinii</i> <sup>1 2</sup>            | Polygalaceae     | 2.76  | 4.25  |
| 112. | <i>Xerospermum cuspidatum</i> <sup>2</sup>                   | Sapindaceae      | -     | 1.86  |
| 113. | <i>Xerospermum laevigatum</i> <sup>1 2</sup>                 | Sapindaceae      | 3.98  | 6.39  |
| 114. | <i>Xylophia coriifolia</i> Ridl. <sup>1 2</sup>              | Annonaceae       | 2.09  | 2.41  |
| 115. | <i>Xylophia glauca</i> <sup>1</sup>                          | Annonaceae       | 5.18  | -     |

Note: <sup>1</sup> Trees (> 10 cm dbh) <sup>2</sup> Small trees (2 - 9.9 cm diameter)

When the species number of each study site in Table 2 presented in a figure of species number-areas relationships, it was shown that the species richness on primary forest seemed higher than have in the secondary forest (Fig. 2).

The most abundant tree (>10 cm dbh) at the plot was *Blumeodendron elatrospermum* (47 trees/ha), followed by *Cyatocalyx biovulatus* (39 trees/ha), *Blumeodendron tokbrai* (32 trees/ha), *Lithocarpus encleisacarpus* (30 trees/ha), and *Syzygium chlorantha* (30 trees/ha). These species are usually abundant on dbh 10 - 30 cm and rarely reached 60 cm dbh (Fig. 3). *Lithocarpus encleisacarpus* dominated lower

layer (8 - 15 m height) while other dominant species occupied the upper layer (15 - 25 m height) of forest canopies.

Table 3. Species numbers, density and basal area of tree species (> 10 cm *dbh*) in the study site and other eleven plots of peat swamp forests in Kalimantan.

| Locations | Plot size (ha) | $\Sigma$ Species | Density (tree/ha) | Basal area (m <sup>2</sup> / ha) |
|-----------|----------------|------------------|-------------------|----------------------------------|
| MPSF      | 1.05           | 86               | 698               | 24.29                            |
| PNm       | 0.50           | 64               | 1004              | 52.40                            |
| SNm *     | 0.50           | 49               | 926               | 51.32                            |
| Pse       | 1.0            | 61               | 513               | 17.67                            |
| PSp       | 0.20           | 42               | 535               | 14.27                            |
| SSp *     | 0.20           | 31               | 260               | 6.37                             |
| PGp       | 1.0            | 122              | 433               | 28.03                            |
| PTp1      | 0.75           | 108              | 812               | 40.03                            |
| PTp2      | 1.0            | 96               | 728               | 43.01                            |
| STp *     | 1.0            | 50               | 1132              | 8.19                             |
| SBs *     | 0.40           | 32               | 251               | 15.21                            |
| Sin *     | 0.45           | 37               | 301               | 20.90                            |

Legend: \* secondary forest; MPSF from this study, PTp2 from Mirmanto *et al.* (1999), STp from Yusuf (1999), others from Saribi and Riswan (1997). MPSF: Mensemat Village, Sambas, West Kalimantan; PNm: Nyaru Menteng Arboretum, Palangkaraya, Central Kalimantan; PTp1, PTp2 and STp: Tanjung Puting National Park, Central Kalimantan; PGp: Gunung Palung National Park, West Kalimantan; PSe: Selatai, Lalang Village, Tayan Hilir, Sanggau, West Kalimantan; PSp: Sungai Pelang, South Matan Hilir, Ketapang, West Kalimantan; SSp: Sungai Pelang, South Matan Hilir, Ketapang, West Kalimantan (7 years after logging); SBs: PT Bina Samaktha II, Sampit, Central Kalimantan; SIn: PT Inhutani III, Sampit, Central Kalimantan (heavy over logged); SNm: Nyaru Menteng Arboretum, Palangkaraya, Central Kalimantan (23 years after logging).

Fig. 3 showed that 5 species which were the most abundant in plot, generally had average *dbh* per tree relatively small, although *Blumeodendron elatriospermum* and *Syzygium chlorantha* were classified as 5 species that had biggest total basal area (Table 4), only by their abundant number of individuals.

Among 86 species recorded in the plot, 30 species had individuals with *dbh* more than 30 cm, or about 8 % of total number of trees. The most abundant within these 30 species was *Dyera lowii* and *Koompasia malaccensis*, 6 trees/ha each. A tree diameter classes distribution (Fig. 4) showed a drastically decrease on *dbh* more than 20 cm.

The plot was established in an old forest stand and had never been opened for agriculture previously. Eight coppices in the plot were recognized as former cutting, and 43 trees were uprooting falling (most of the uprooting falling trees had *dbh* more than 20 cm). No wonder, the uprooting falling trees was one of the causes of the decreasing tree density on the large *dbh* class. But the extreme effect from peat medium, which could impede the growth of some tree species, might be another cause.

It was not known precisely what the cause of falling trees in the plot; it might be related to the process of draining water on agricultural areas surrounding the plot. The

process led to lowering of the water table and hence increasing decomposition of peat, which consequently caused peat subsidence. Root systems will expose and provide poor anchorage to support heavy crowns and the trees become liable to windfalls during heavy storms (Ibrahim and Chong, 1992). Some species such as *Dyera lowii* and *Koompassia malaccensis* could grow big for they were supported by deep rooting system and big buttress.

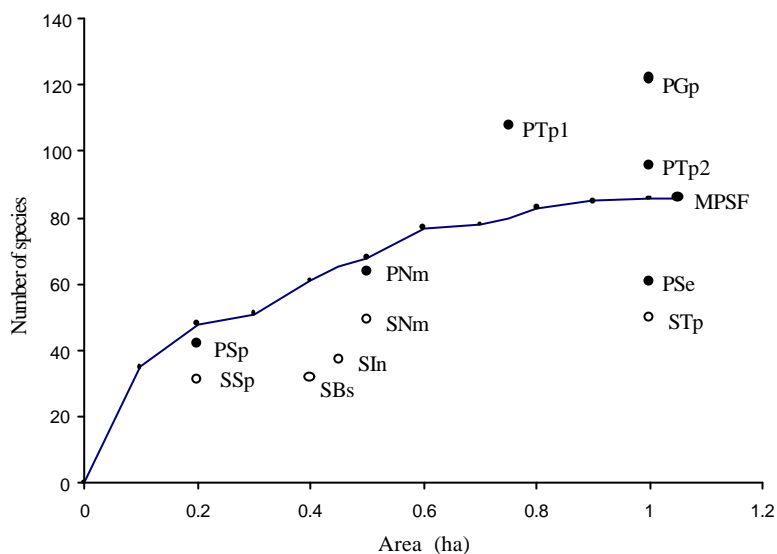

Fig. 2. Species area curve (> 10 cm dbh) of MPSF plot and species numbers of small plots in eleven Kalimantan peat swamp forest (Legend: see Table 3)

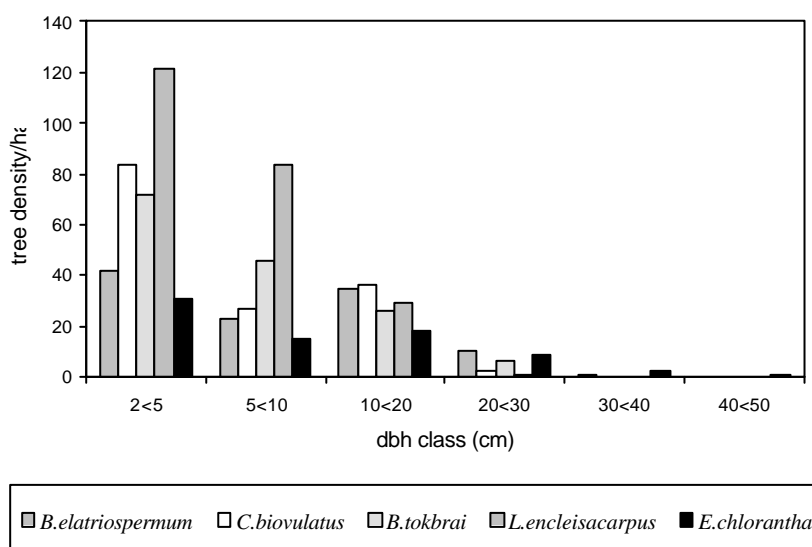

Fig. 3. Diameter class distribution of the five most abundant species in the plot



Table 4. Ten important tree species (&gt; 10 cm dbh) based on greater basal area in the plot.

| Species                               | Basal area (m <sup>2</sup> /ha) | Mean of Basal area (m <sup>2</sup> /tree) | Density (tree /ha) |
|---------------------------------------|---------------------------------|---|--------------------|
| 1 <i>Dyera lowii</i>                  | 1.99                            | 0.17                                      | 11.4               |
| 2 <i>Koompasia malaccensis</i>        | 1.67                            | 0.22                                      | 7.6                |
| 3 <i>Blumeodendron elatriospermum</i> | 1.16                            | 0.02                                      | 46.7               |
| 4 <i>Tetractomia holtumii</i>         | 1.08                            | 0.06                                      | 18.1               |
| 5 <i>Syzygium chlorantha</i>          | 0.95                            | 0.03                                      | 30.4               |
| 6 <i>Syzygium oblata</i>              | 0.91                            | 0.09                                      | 10.5               |
| 7 <i>Ganua motleyana</i>              | 0.89                            | 0.13                                      | 6.7                |
| 8 <i>Palaquium leiocarpum</i>         | 0.76                            | 0.06                                      | 12.4               |
| 9 <i>Parastemon urophyllus</i>        | 0.73                            | 0.19                                      | 3.8                |
| 10 <i>Blumeodendron tokbrai</i>       | 0.68                            | 0.02                                      | 32.4               |

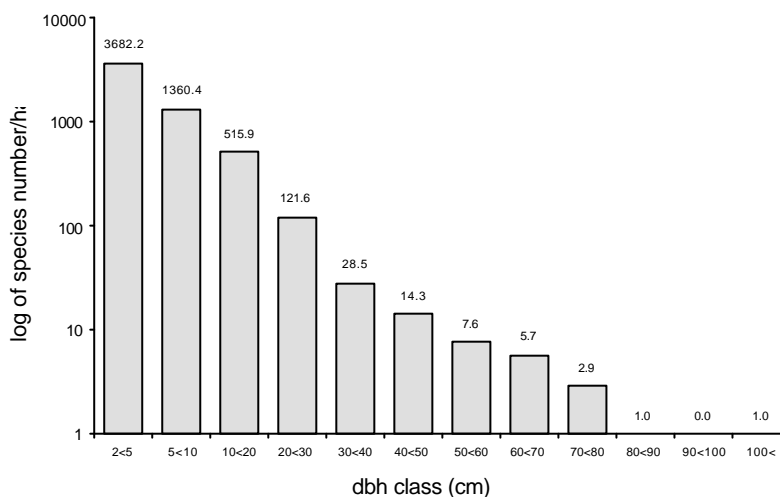

Fig. 4. Diameter class distribution of all trees more than 2 cm diameter in the plot

The family with the highest number of species in the plot was Euphorbiaceae (13 species), followed by Myrtaceae (9 species), Annonaceae, Lauraceae and Dipterocarpaceae with 8 species each. The most frequent species among Euphorbiaceae was *Blumeodendron elatriospermum*; Myrtaceae was commonly represented by *Syzygium*, and the most abundant was *Syzygium chlorantha*; Annonaceae was mostly represented by *Cyatocalyx biovulatus*; Lauraceae was represented by 5 genera but relatively small in individual number, while Dipterocarpaceae was mostly represented by *Dryobalanops lanceolata*. Euphorbiaceae has been reported as one of the biggest family in Malesia, either in peat swamp forest (Ibrahim and Chong, 1992; Mirmanto *et al.*, 1993; Sambas *et al.*, 1994; Sambas and Suhardjono, 1994) or in lowland Dipterocarpaceae forest (Kartawinata *et al.*, 1981; Abdulhadi *et al.*, 1989). The abundance of species of Myrtaceae in the study site might be related to podsol soil type under the peat layer. The similar soil type was often found on heath forest where Myrtaceae was very dominant.

The commercial timbers species of Dipterocarpaceae was represented by *Shorea leprosula*, *S. macrantha*, *S. parvifolia* and *Shorea* sp., although these 4 species were not so dominant in the study plot. Species with the highest density of small trees (2-9.9 cm *dbh*) was *Dryobalanops lanceolata* (247 trees/ha) and rank sixth for its tree with *dbh* more than 10 cm (of 27.6 trees/ha) (Table 5), but the biggest tree was only 24 cm *dbh*. It was not known clearly the cause of the absence of this species on bigger diameter, and also very difficult to confirm whether the ruin of falling trees were *D. lanceolata* or not. The other possibility was the stem diameter growth of *D. lanceolata* at the plot had been maximum. Anderson (1973) and Ashton (1982) did not mention that *D. lanceolata* distributes in the peat swamp forest. Also, the species is very seldom found in the peat swamp forests and hence the peat might be the limiting factor for the species to grow bigger. Other evidence that *D. lanceolata* has been grown maximum on the diameter class 20-30 cm in the plot was that generative phase has been started on the trees with *dbh* of 15 cm. This was different from other species of the same genus i.e. *Dryobalanops rappa* that was found growing bigger (Fig. 5). Ashton (1982) reported that *D. rappa* was distributed in peat swamp forests. However, this species seemed in regeneration crisis, since the tree with diameter class less than 10 cm was absence in the plot (Table 5). The explanation could be high mortality and infrequent flowering and fruiting.

Table 5. Density and basal area of Dipterocarpaceae species in the plot

| Species                              | Small trees (2-9.9 cm <i>dbh</i> ) |                                 |   | Trees ( $\geq$ 10 cm <i>dbh</i> ) |                                 |   |
|--------------------------------------|------------------------------------|---------------------------------|---|-----------------------------------|---------------------------------|---|
|                                      | Density (tree /ha)                 | Basal area (m <sup>2</sup> /ha) | Mean of Basal area (m <sup>2</sup> /tree) | Density (tree /ha)                | Basal area (m <sup>2</sup> /ha) | Mean of Basal area (m <sup>2</sup> /tree) |
| <i>Anisoptera marginata</i> Korth.   | 7.6                                | 0.022                           | 0.003                                     | 1.9                               | 0.062                           | 0,033                                     |
| <i>Dryobalanops lanceolata</i> Burck | 247.0                              | 2.242                           | 0.009                                     | 27.6                              | 0.575                           | 0,021                                     |
| <i>Dryobalanops rappa</i> Becc.      | 0.0                                | 0.0                             | 0.0                                       | 2.9                               | 0.161                           | 0,056                                     |
| <i>Shorea leprosula</i> Miq.         | 68.4                               | 0.526                           | 0.008                                     | 3.8                               | 0.321                           | 0,084                                     |
| <i>Shorea macrantha</i> Brandis.     | 19.0                               | 0.137                           | 0.007                                     | 3.8                               | 0.225                           | 0,059                                     |
| <i>Shorea parvifolia</i> Dyer        | 26.6                               | 0.198                           | 0.007                                     | 19.0                              | 0.420                           | 0,022                                     |
| <i>Shorea</i> sp.                    | 3.8                                | 0.016                           | 0.004                                     | 0.0                               | 0.0                             | 0.0                                       |
| <i>Vatica</i> sp.                    | 3.8                                | 0.007                           | 0.002                                     | 0.0                               | 0.0                             | 0.0                                       |

### Forest regeneration

Only one gap of more than 100 m<sup>2</sup> was found in the plot, the size was 400 m<sup>2</sup>, caused by uprooting tree felling and a part by formerly cutting. Based on the mosaics structures and height of canopies, the forest in the plot can be drawn into 3 growth phases i.e. gap, building and mature (Fig. 6). Bushes and trees with less than 10 cm diameter and canopy less than 10 m height generally occupied the gap phase. Species occupying the gap phase area were tolerant to sunlight, such as: *Macaranga beccarii*, *Poycilospermum* sp., *Glochidion* sp., and *Uncaria* sp. Seedlings *Dryobalanops lanceolata*, *Blumeodendron elatiospermum*, *Gonystylus bancanus*, and *Litsea nidularis*, were also residing in the plot. Many *Macaranga* (*M. caladifolia*, *M. curtsii*, *M. hosei*, and *M. triloba*), *Lithocarpus encleisacarpus*, *Lithocarpus benettii*, *Elaeocarpus petiolatus*, *Elaeocarpus mastersii*, *Litsea nidularis* and *Litsea resinosa* were recorded to occupy the building phase forest that was slightly exposed to sunlight.

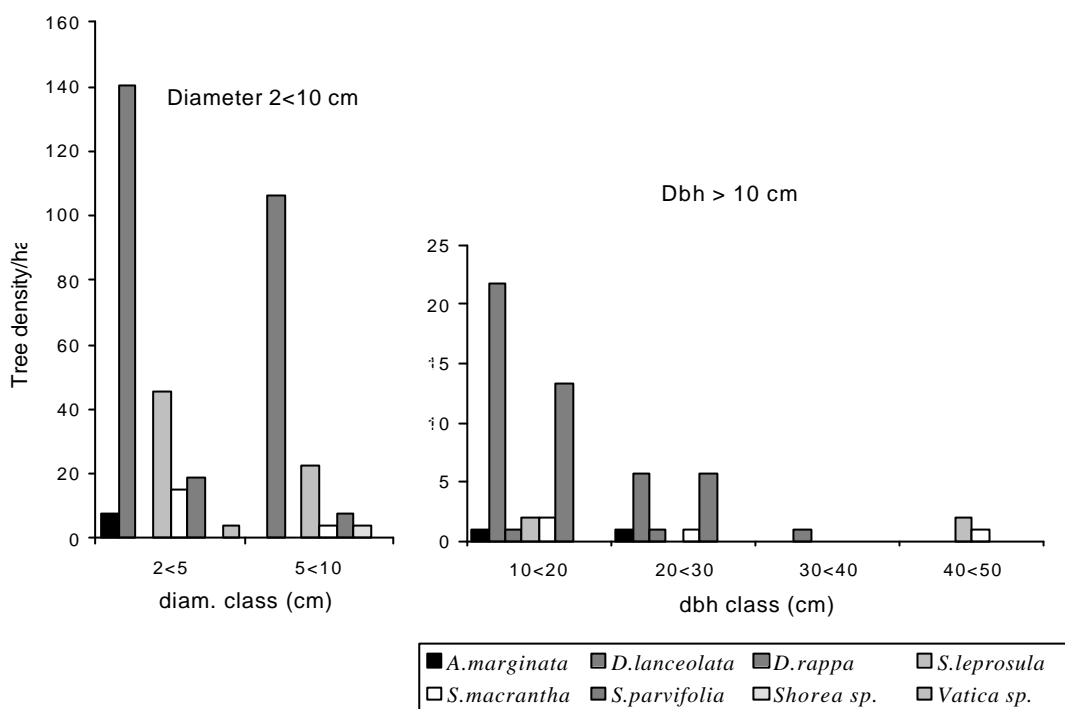

Fig. 5. Diameter class distribution of the Dipterocarpaceae species in the plot

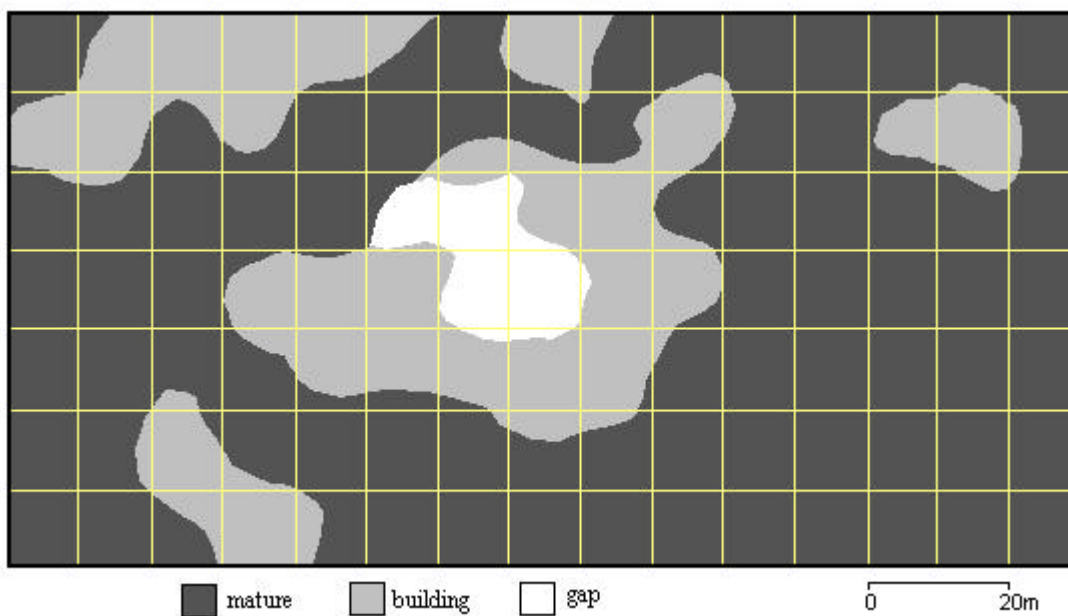

Fig. 6. The mosaic of canopy phases in the plot

Primary species that were found to occupy the building phase area were *Dryobalanops lanceolata*, *Blumeodendron elatriospermum*, *Blumeodendron tokbrai*, *Cyatocalyx biovulatus*, and *Syzygium chlorantha*. In building phase forest, the stratification was relatively simple with main canopy at height range 12-18 m. In mature phase forest, the stratification was continuous consisting of 4 strata i.e., stratum more than 25 m; 15-25 m; 8-15 m; and less than 8 m. The emergent trees with height reaching 45 m were mainly represented by *Koompasia malaccensis* and *Dyera lowii*.

According to species abundance and frequency of availability at each growth phase, small trees (less than 10 cm dbh) of *Dryobalanops lanceolata* seemed more distributed in the gaps and buildings. Although the light intensity was not measured, it is assumed that the forest floor of the gap phase was much more exposure to sunlight than of the building phase and than of the mature phase, hence the seedling of *D. lanceolata* might be tolerant to sunlight. On the contrary, seedlings and small trees of *B. elatriospermum*, *S. chlorantha*, *Cryptocarya zollingeriana*, *Syzygium sexangulata*, and *Litsea nidularis* prefer closed areas for their development, since they were found more abundant in the mature phase forest. Seedlings of other important species such as *B. tokbrai*, *Cyatocalyx biovulatus*, *Dyera lowii*, *Gonystylus bancanus*, and *Lithocarpus encleisacarpus* were distributed evenly in building and mature phase forests. However, we still need further study for confirm the ecophysiology of each species, since some other factors such as wildlife and insects, wind, human being and other mechanical factors, were also taking part in affecting the distribution of seedlings (Polunin, 1960; Richrads, 1964).

#### Acknowledgements

The authors wish to thanks Mr. Mustofa Kamal (National University) and Mr. Ismail (Herbarium Bogoriense-LIPI, Bogor) for collecting and identifying the specimens, Messrs. Ahyar, Hamdi, H. Sarnubi, Mardjuki, Sabeni and Sahuri for their assistant during the field study.

#### References

- Abdulhadi, R., Mirmanto, E. and Yusuf, R. 1989. Struktur dan komposisi petak hutan Dipterocarpaceae di Ketambe, Taman Nasional G. Leuser, Aceh. *Ekologi Indonesia*, I (2); 29-36.
- Anderson, J.A.R. 1973. *Trees of Peat Swamp Forest of Sarawak*. Forest Dept. Sarawak. 200 p.
- Ashton, P.S. 1982. Dipterocarpaceae. *Flora Malesiana*, I (92). pp. 37-552.
- Hamidi, A. 1991. Keberadaan dan perkembangan banir dalam sstruktur dan komposisi hutan hujan tropik Tanjung Puting, Kalimantan Tengah. *Skripsi* Fakultas Biologi, Univ. Nasional, Jakarta.
- Ibrahim, S. and Chong, P.H. 1992. Floristic composition of Virgin Jungle Reserve (VJR) at Kuala Langat South Peat Swamp Forest, Selangor, Peninsular Malaysia. *Malayan Nature Journal*, 46: 85-95.
- Kartawinata, K., Abdulhadi, R. and Partomihardjo, T. 1981. Composition and structure of a lowland Dipterocarp forest at Wanariset, East Kalimantan. *Malay. Forester*, 44 (2&3); 397-406.
- Mirmanto, E., Suhardjono and Susiarti, S. 1993. Struktur dan komposisi pohon hutan gambut di Kalimantan Barat. *Pros. Sem. Hasil Litbang SDH*. Puslitbang

- Biologi-LIPI, Bogor. pp. 273-285.
- Mirmanto, E., R Polosakan and Simbolon, H. 1999. Penelitian ekologi hutan gambut di Taman Nasional Tanjung Puting, Kalimantan Tengah. *Paper presented in Seminar of Biodiversitas dan Pengelolaan Hutan Gambut Secara Berkelanjutan, Bogoi 12 Februari 1999.*
- Polunin, N. 1960. *Introduction to Plant Geography, and Some Related Sciences.* Longmans. 640 p.
- Richards, P.W 1964. *The Thopical Rain Forest. An Ecological Study.* Cambridge Univ. Press. Cambridge.
- Sambas, E.N., Susiarti, S. and Suhardjono. 1994. Struktur dan komposisi hutan gambut di Kabupaten Sanggau, Kalimantan Barat. In: *Pros. Sem. Hasil Litbang SDH. Puslitbang Biologi-LIPI, Bogor* pp. 344-350.
- Sambas, E.N. and Suhardjono. 1994. Struktur dan komposisi pohon hutan gambut primer dan sekunder di Kabupaten Ketapang, Kalimantan Barat. In: *Pros. Sem. Hasil Litbang SDH. Puslitbang Biologi-LIPI, Bogor.* pp. 351-358.
- Saribi, A.H. and Riswan, S. 1997. Peat swamp forest in Nyaru Menteng Arboretum, Palangkaraya, Central Kalimantan, Indonesia: Its tree species diversity and secondary succession. *Paper presented on the Seminar on Tropical Ecology held by Japan Society of Tropical Ecology 21-22 June 1997, Shiga, Japan.*
- Sudarmanto, B. 1994. Fitososiologi hutan rawa gambut tropika di Taman Nasional Gunung Palung, Kalimantan Barat. Skripsi Fakultas Biologi, Universitas Nasional, Jakarta.
- Yusuf, R. 1999. Komposisi, Struktur vegetasi dan degradasi jenis pada hutan sekunder setahun setelah kebakaran di kawasan Taman Nasional Tanjung Puting, Kalimantan Tengah. *Paper presented in Seminar of Biodiversitas dan Pengelolaan Hutan Gambut Secara Berkelanjutan, Bogor, 12 Februari 1999.*

## **Preliminary Study on Growth, Mortality and Recruitment of Tree Species in Peat Swamp Forest at Tanjung Puting National Park, Central Kalimantan**

**Edi MIRMANTO and Ruddy POLOSOKAN**

Research and Development Center for Biology, Indonesian Institute of Sciences

### **Abstract**

Forest trees in one-hectare permanent plot on Tanjung Puting National Park, C. Kalimantan established in 1998 were re-measured to monitor the forest dynamics. The results show that average girth increments was 0.9 cm/yr ranging from 0.4 cm/yr to 3.9 cm/yr. The highest growth rate was found on trees with diameter (DBH) between 30 and 40 cm. The number of trees with DBH greater than 4.8 cm was changed from 1998 to 1999, by death of 27 trees and recruitment of 49 trees. The total basal area changed from 40.77 m<sup>2</sup>/ha to 41.89 m<sup>2</sup>/ha, by loss 0.62 m<sup>2</sup>/ha of death and 0.76 m<sup>2</sup>/ha increases by growth, and 0.98 m<sup>2</sup>/ha increases by recruitment. The floristic composition was nearly stable.

**Key words:** peat-swamp forest, mortality, recruitment, girth increment, Tanjung Puting, Kalimantan

### **Introduction**

It was well known that peat swamp forest is the unique ecosystem but it is fragile and sensitive for development. So the extent of this forest type is dependent on the land utilization and conservation effort. According to some information, Indonesia has about 27 million hectare of peat-swamp forest that distributed in Sumatra, Kalimantan and Irian Jaya. However this wide area has been decreasing time by time, because of some human activities. Unfortunately some activities have resulted in many problems, such as land degradation and especially in biodiversity loss.

On the other hand, the knowledge of the peat-swamp forest especially for their biodiversity, ecological function and dynamics of this forest is still limited. Efforts to reclaim of the disturbed peat-swamp forest need long-term plant demographic studies. So far there has been little such long-term study where permanent plots have been laid down in the primary peat-swamp forest to study establishment, growth and mortality of tree species. The present paper is a preliminary result of long-term study in peat-swamp forest at Tanjung Puting National Park, Central Kalimantan that concern on recruitment, growth and mortality of tree species.

### **Study Area**

The study has been made in the peat-swamp forest near camp Leaky, which is a small part of Tanjung Puting National Park. The area is belonging to Kumai district, Kotawaringin Barat, Central Kalimantan and geographically this area is situated at 2°45'45.8"S and 111°56'41.4"E. The altitude was about 20 m above sea level and located at about 230 km northeast of Palangka Raya (the capital city of Central Kalimantan).

According to Schmidt and Ferguson (1957) classification, the climate in the study area is belonging to type of A, with mean annual rainfall of 2,400 mm. The temperature varied from 25°C up to 33°C, with high (90 %) in humidity.

The vegetation here consists of some forest types, such as lowland dipterocarp forest, peat-swamp forest, heath (kerangas) forest and open area covered by grass of *Imperata cylindrica* and ferns of *Gleichenia liniaris*. The peat-swamp forest distributed in some areas as mosaic surrounded by others forest types. The condition in general was flooded and only some small area was relatively dry, with the peat layer depth varied from 1 to 3m.

### Methods

A permanent plot of 100m × 100m was established in 1998 and then has been divided into 100 sub-plots of 10m × 10m. Within each sub-plot all tree with girth breast high over 15 cm were tagged, measured and identified their species. In 1999, girth of all tagged trees within one-hectare plot was re-measured in order to understand their girth increments. In addition all tagged death-trees within plot were recorded and others trees that reach up to gbh 15 cm were also measured and identified their species.

### Results and Discussion

#### *Forest structure and composition*

Mirmanto *et al.* (1998) have reported the structure and floristic composition of this forest. Accordingly there are 1680 individuals of trees with dbh > 4.8 cm were recorded within one-hectare plot with total basal area of 40.77 m<sup>2</sup>/ha. Out of all individuals most (55.7 %) of them were small size (DBH < 10 cm) and only 2.2 % with diameter greater than 50 cm, represent by *Ganua motleyana*, *Glutta wallichii* and *Shorea fallax*.

Within one-hectare plot 141 species of tree belonging to 84 genera and 43 families were recorded. The *Glutta wallichii*, *Neoscortechinia philippinensis*, *Gonystyllus bancanus* and *Shorea fallax* were the dominant species both in tree stage and sapling stage. The first two species (*Glutta wallichii* and *Neoscortechinia philippinensis*) were dominant for both density and basal area, whereas *Gonystyllus bancanus* and *Shorea fallax* only dominate for basal area. Another's species such as *Ganua motleyana*, *Ptychopyxis kingii* and *Baccaurea racemosa* were dominant especially in density.

#### *Growth rate*

During one-year period almost all individual within plot increase their girth breast high (gbh), except for 32 individuals were stagnant and 19 individuals were decrease in gbh. All those 51 individuals that may have miss-measurement were excluded from calculation.

Growth rate for some commonest tree species are shown in Table 1. The growth rate given are annual girth increments calculated for each size class. Although the girth increment had great variety among individuals in the same diameter class, but the trend still can be detected. There are tendency that trees with diameter between 30 cm and 50 cm tended grows most quickly. Almost all tree species presented in Table 1, seemed follow this pattern, except for *Baccaurea racemosa*, *Baccaurea motleyana* and *Camposperma coriacea*.

Those three species together with *Ostodes macrophylla* and *Neoscortechinia philippinensis* may categorize as the under-canopy species, indicated by most of tree high were less than 20 m. On the other hand, *Glutta wallichii*, *Ganua motleyana* and *Ptychopyxis kingii* were belonging to main-canopy species, indicated by the maximum high may reach up to 35 m. Some emergent tree species such as *Koompasia malaccensis*,

*Cratoxylum glaucum* and *Combretocarpus rotundus* was only represent a little number of individuals, so it was not enough for calculations.

Table 1. Girth increments (cm /yr) for some commonest tree species over one-year

| Species                               | Diameter class (cm) |      |      |      |      |      |      |      | Total |
|---------------------------------------|---------------------|------|------|------|------|------|------|------|-------|
|                                       | <10                 | -20  | -30  | -40  | -50  | -60  | -70  | -80  |       |
| <i>Baccaurea racemosa</i>             | 0.6                 | 0.8  | 0.9  | 0.8  |      |      |      |      | 0.77  |
| <i>Baccaurea motleyana</i>            | 0.5                 | 0.8  | 1.0  | 1.2  | 1.0  | 0.9  |      |      | 0.82  |
| <i>Camnosperma coreacea</i>           | 0.6                 | 1.1  | 2.2  | 2.5  | 2.1  | 1.2  | 0.7  | 0.6  | 1.38  |
| <i>Ganua motleyana</i>                | 0.4                 | 0.8  | 0.9  | 1.1  | 0.7  | 0.6  |      |      | 0.75  |
| <i>Glutta wallichii</i>               | 0.7                 | 1.1  | 1.6  | 2.4  | 2.0  | 0.9  | 0.6  |      | 1.33  |
| <i>Neoscortechinia philippinensis</i> | 0.6                 | 0.9  | 1.0  | 0.8  | 0.9  |      |      |      | 0.80  |
| <i>Ostodes macrophylla</i>            | 0.9                 | 1.2  | 0.8  | 0.8  | 0.6  |      |      |      | 0.86  |
| <i>Ptychopyxis kingii</i>             | 0.7                 | 0.8  | 2.0  | 2.4  | 2.2  | 0.9  | 0.7  |      | 1.50  |
| Total                                 | 0.59                | 0.87 | 1.09 | 1.44 | 1.04 | 0.85 | 0.77 | 0.62 | 0.90  |

Highest overall growth rates among tree species presented in Table 1, were 1.5 cm/year for *Ganua motleyana* and 1.4 cm/year for *Glutta wallichii*. All those two species were main-canopy species. The overall growth rate for among main-canopy species varied from 1.3 cm/yr to 1.5 cm/yr. On the other hand, the lowest growth rate were 0.77 cm/yr for *Baccaurea racemosa* and 0.75 cm/yr for *Neoscortechinia philippinensis*. Those two species were under-canopy species, and the overall growth rate among them varied from 0.75 cm/yr to 0.86 c/yr. So, there is tendency that the main-canopy species most quickly grow than under-canopy species.

All of the main-canopy species, in this case, are characteristic for peat-swamp forest species and with a relatively high in growth rates. This demonstrates the importance of the native species to maintain the extent of the peat-swamp forest.

### **Mortality**

The total number of tree death recorded over one year period was 27 individuals with total basal area of 0.62 m<sup>2</sup>/ha (Table 2). It is only about 2% of total of trees and 1.5% total basal area recorded within one-hectare plot.

Highest overall death tree among tree species presented in Table 2 was 5 individuals for *Baccaurea racemosa*; 4 individuals for *Baccaurea motleyana* and *Eugenia virens*; and 2 individuals for *Aglaia ganggo*. Others 12 tree species was only represent by single individual respectively.

The interesting point from this result is that the most of death tree species were belonging to family of Euphorbiaceae (Table 3), and some of them were under-canopy species. There are big differences in mortality between main-canopy species and under-canopy species. The main-canopy species show a relatively low in mortality rates, whereas the under-canopy species have a higher rate (Table 2). This is may be because the differences in longevity between these species group. More than 70 % of death trees are under-canopy species, whereas the main-canopy death tree species only represent by about 20 %. In addition so far, there is no emergent death tree species recorded.



Table 2. Density (D= individual /ha) and basal area (BA= m<sup>2</sup> /ha) of death-trees within plot over one year

| Species                            | D  | BA    | D (%)  | BA (%)   |
|------------------------------------|----|-------|--------|----------|
| <i>Acronichya laurifolia</i>       | 1  | 0.026 | 3.85   | 4.174.17 |
| <i>Adinandra dumosa</i>            | 1  | 0.022 | 3.85   | 3.533.53 |
| <i>Aglaiia ganggo</i>              | 2  | 0.066 | 7.69   | 10.59    |
| <i>Artocarpus kemando</i>          | 1  | 0.028 | 3.85   | 4.49     |
| <i>Baccaurea motleyana</i>         | 4  | 0.077 | 15.38  | 12.32    |
| <i>Baccaurea racemosa</i>          | 5  | 0.036 | 19.23  | 5.76     |
| <i>Dialium maingayi</i>            | 1  | 0.029 | 3.85   | 3.64     |
| <i>Diospyros polyalthioides</i>    | 1  | 0.023 | 3.85   | 3.68     |
| <i>Dysoxylum arborescens</i>       | 1  | 0.022 | 3.85   | 3.53     |
| <i>Endiandra rubescens</i>         | 1  | 0.086 | 3.85   | 14.18    |
| <i>Eugenia virens</i>              | 4  | 0.055 | 15.38  | 8.80     |
| <i>Ganua motleyana</i>             | 1  | 0.038 | 3.85   | 6.08     |
| <i>Gymnacranthera eugeniifolia</i> | 1  | 0.024 | 3.85   | 3.85     |
| <i>Gynotroches axillris</i>        | 1  | 0.025 | 3.85   | 4.00     |
| <i>Jackia ornata</i>               | 1  | 0.037 | 3.85   | 5.92     |
| <i>Pimeleodendron papaveriodes</i> | 1  | 0.035 | 3.85   | 5.46     |
| Total                              | 27 | 0.623 | 100.00 | 100.00   |

Table 3. Density (D= individual /ha), basal area (BA= m<sup>2</sup> /ha) and number of species (NS) within plot over one-year according to family

| Family         | NS | D  | BA    | D (%)  | BA (%) |
|----------------|----|----|-------|--------|--------|
| Ebenaceae      | 1  | 1  | 0.023 | 3.85   | 3.68   |
| Euphorbiaceae  | 3  | 10 | 0.148 | 38.46  | 23.54  |
| Fabaceae       | 1  | 1  | 0.029 | 3.85   | 3.64   |
| Lecythidaceae  | 1  | 1  | 0.037 | 3.85   | 5.92   |
| Meliaceae      | 2  | 3  | 0.088 | 11.54  | 14.12  |
| Moraceae       | 1  | 1  | 0.028 | 3.85   | 4.49   |
| Myristicaceae  | 2  | 12 | 0.110 | 7.70   | 18.03  |
| Myrtaceae      | 1  | 1  | .0551 | 15.38  | 8.80   |
| Rhizophoraceae | 1  | 1  | 0.025 | 3.85   | 4.00   |
| Rutaceae       | 1  | 1  | 0.026 | 3.85   | 4.17   |
| Sapotaceae     | 1  | 1  | 0.038 | 3.85   | 6.08   |
| Sapotaceae     | 1  | 1  | 0.022 | 3.85   | 3.53   |
| Total          | 16 | 27 | 0.623 | 100.00 | 100.00 |

### Recruitment

During one-year period, there are 49 individuals of small (< 15 cm GBH) tree were reach up to 15 cm or more in GBH (Table 4). A highest overall recruited tree was 23 individuals for *Baccaurea racemosa*, and 9 individuals for *Ardisia laevigata*. Other higher recruited tree species were *Litsea diversifolia* (4 individuals), *Polyalthia laterifolia* (3 individuals) and *Pternandra cordata* (2 individuals). The dipterocarp species, which represent by *Shorea fallax* was only one recruited tree recorded.

Out of 49-recruited tree, 36 (73.4 %) of them are under-canopy species and 11

(2.2 %) are main-canopy species. In addition there are only 2 individuals of emergent recruited trees were recorded. Most of recruited tree were always found in 1998, except for *Ardisia laevigata* and *Pternandra cordata*. Those two species were under-canopy forest and together with other under-canopy species, such as *Baccaurea racemosa* have higher rate of recruitments. On the other hand most of main canopy species have a low rate in recruitments. However two main-canopy species such as *Polyalthia laterifolia* and *Polyalthia laterifolia* have a relatively high in rate of recruitment. In addition some recruited emergent species also recorded, even though in lower rate of recruitments. This result suggests that under-canopy species have importance role in maintain of the forest ecosystem.

Table 4. Density (D= individual/ha) and basal area (BA= m<sup>2</sup> /ha) of recruited tree species within plot over one year

| Species                         | D  | BA   | D (%)  | BA (%) |
|---------------------------------|----|------|--------|--------|
| <i>Ardisia laevigata</i>        | 9  | 0.18 | 18.37  | 18.45  |
| <i>Aromodendron nutans</i>      | 1  | 0.02 | 2.04   | 2.05   |
| <i>Baccaurea racemosa</i>       | 23 | 0.46 | 46.94  | 46.65  |
| <i>Diospyros buxifolia</i>      | 1  | 0.02 | 2.04   | 2.05   |
| <i>Diospyros polyalthioides</i> | 1  | 0.02 | 2.04   | 2.05   |
| <i>Eugenia perpuncticulata</i>  | 1  | 0.02 | 2.04   | 2.05   |
| <i>Eugenia virens</i>           | 1  | 0.02 | 2.04   | 2.05   |
| <i>Horsfieldia glabra</i>       | 1  | 0.02 | 2.04   | 2.05   |
| <i>Litsea diversifolia</i>      | 4  | 0.08 | 8.16   | 8.20   |
| <i>Polyalthia laterifolia</i>   | 3  | 0.06 | 6.12   | 6.15   |
| <i>Pternandra cordata</i>       | 2  | 0.04 | 4.08   | 4.10   |
| <i>Shorea fallax</i>            | 1  | 0.02 | 2.04   | 2.05   |
| <i>Tetramerista glabra</i>      | 1  | 0.02 | 2.04   | 2.05   |
| Total                           | 49 | 0.98 | 100.00 | 100.00 |

Table 5. Density (D= individual /ha) and basal area (BA= m<sup>2</sup> /ha), and number of species (NS) within plot over one year according to family

| Family           | NS | D  | BA   | D (%)  | BA (%) |
|------------------|----|----|------|--------|--------|
| Annonaceae       | 1  | 3  | 0.06 | 6.12   | 6.15   |
| Combretaceae     | 1  | 1  | 0.02 | 2.04   | 2.05   |
| Dipterocarpaceae | 1  | 1  | 0.02 | 2.04   | 2.05   |
| Ebenaceae        | 2  | 2  | 0.04 | 4.08   | 4.10   |
| Euphorbiaceae    | 1  | 23 | 0.46 | 46.94  | 46.65  |
| Lauraceae        | 1  | 4  | 0.08 | 8.16   | 8.20   |
| Magnoliaceae     | 1  | 1  | 0.02 | 2.04   | 2.05   |
| Melastomataceae  | 1  | 2  | 0.04 | 4.08   | 4.10   |
| Myrsinaceae      | 1  | 9  | 0.18 | 18.37  | 18.45  |
| Myristicaceae    | 1  | 2  | 0.04 | 4.08   | 4.10   |
| Myrtaceae        | 2  | 1  | 0.02 | 2.04   | 2.05   |
| Total            | 13 | 49 | 0.98 | 100.00 | 100.00 |

**Basal area and density**

During one-year period there are any changed both in density and basal area of tree within one-hectare plot (Table 6). The basal area increase from 40.77 m<sup>2</sup> /ha to 41.89 m<sup>2</sup> /ha and density increase from 1680 to 1702 individuals /ha. The tree density increase because the increase of tree density from recruitment was greater than lost of tree by death. The increase of tree density also followed by increase of basal area, because the increase of basal area of survived trees and from recruited trees were greater than the lost by death.

Table 6. Basal area (BA= m<sup>2</sup> /ha) and density (D= individual /ha) change of tree species within plot from 1998 to 1999

| From 1998 to 1999                  | BA     | BA (%) | D    | D (%)  |
|------------------------------------|--------|--------|------|--------|
| In 1998                            | 40.77  | 100.00 | 1680 | 100.00 |
| Loss by tree death until 1999      | - 0.62 | - 1.51 | - 27 | - 1.61 |
| Increase by growth until 1999      | 0.76   | 1.88   |      |        |
| Increase by recruitment until 1999 | 0.98   | 2.40   | 49   | 2.92   |
| In 1999                            | 41.89  | 102.77 | 1702 | 101.31 |

The tree density change in this study was little bit higher than two others study sites (Table 7). It was resulted from the relatively lower in tree mortality and higher in tree recruitment. In total the basal area change also higher than two others study site. However the growth rate, which expressed in increase of basal area by increment, was lowest among three study sites. This is may demonstrate the characteristic of peat-swamp forest that grows on poor habitat and consequence is lower in forest growth and primary productivity.

Table 7. Basal area (BA= m<sup>2</sup> /ha) and density (D= individual /ha) change of trees in three study sites

|                         | This study |      | G. Halimun * |      | Barito Ulu ** |      |
|-------------------------|------------|------|--------------|------|---------------|------|
|                         | BA         | D    | BA           | D    | BA            | D    |
| <i>First year</i>       | 40.77      | 1680 | 39.64        | 995  | 46.87         | 879  |
| Loss by tree death      | - 0.62     | - 27 | - 0.85       | - 25 | - 1.02        | - 18 |
| Increase by growth      | 0.76       |      | 0.89         |      | 0.96          |      |
| Increase by recruitment | 0.98       | 49   | 0.49         | 25   | 0.39          | 20   |
| <i>Second year</i>      | 41.89      | 1702 | 40.17        | 995  | 47.20         | 881  |

\*) Mean of 2 plots (Suzuki *et al.*, 1998) \*\*) Mean of 5 plots (Mirmanto, 1996)

In general the preliminary results of this study was closer to the G. Halimun results rather than Barito Ulu. It was expected that those two study sites (this study and G. Halimun) were relatively poor habitat, which resulted in slower of some forest ecological process. However the data presented in this paper is a result from a short time period of study, so the further study must be conducted to clarify this result.

### Conclusions

Based on the results presented above, there are tentative conclusions:

1. The floristic composition was nearly stable.
2. Although some tree died and others were recruited the forest seemed to be stable condition.
3. The further measurement is needed in order to monitor of the forest dynamics, and also to understand the constancy of tree growth.

### Acknowledgements

The study was a part of JSPS-LIPI Core University Program on wetland ecosystems between Research and Development Center for Biology, The Indonesian Institute of Sciences (RDCB-LIPI) and Graduate School of Environmental Earth Science, Hokkaido University, Japan. The authors wish to thank Messrs. Zainal Fanani, Agus Ruskandi and Yosman of the Herbarium Bogoriense, Bogor for their cooperation during the fieldwork and plant identification.

### References

- Mirmanto, E. 1996. A lowland rain forest fertilization experiment in Central Kalimantan, Indonesia. MSc thesis. Dept. of Biol. and Mol. Sciences, University of Stirling, Stirling, Scotland.
- Mirmanto, E., Polosakan, R. and Simbolon., H. 1999. Penelitian ekologi hutan gambut di Taman Nasional Tanjung Puting, Kalimantan Tengah. *Paper presented in the Seminar of Biodiversitas dan Pengelolaan Hutan Gambut Secara Berkelanjutan, Bogor, 12 Februari 1999.*
- Schmidt, F.H. and Ferguson, J.A. 1951. Rainfall types based on wet and dry period ratios for Indonesia with Western New Guinea. *Djawatan Meteorologi dan Geofisika, Jakarta Verhandelingen, No.42.*
- Suzuki, E., Yoneda, M., Simbolon, H., Fanani, Z., Nishimura, T. and Kimura, M. 1999. Monitoring of vegetational changes on permanent plots in Gunung Halimun National Park. In: Simbolon, H., Yoneda, M. and Soegardjito, J. *Research and Conservation of Biodiversity in Indonesia Vol. IV GunungHalimun: The Last Submontane Forest in Java. A Joint Project with LIPI, PHPA and JICA, Bogor. 60-72pp.*

## Preliminary Study on the Water Relations of Tropical Peat Land Plants

Beth Paul NAIOLA<sup>1</sup> and Mitsuru OSAKI<sup>2</sup>

<sup>1</sup> Treub Laboratory, Botany Division, R&DC for Biology, The Indonesian Institute of Science (LIPI), PO Box 110, Bogor, Indonesia. Email: herbogor@indo.net.id;

<sup>2</sup> Faculty of Agriculture, Hokkaido University, Sapporo, 060-8589, Japan,  
Fax: +81-(0)11-706-3845, E-mail: mosaki@chem.agr.hokudai.ac.jp;

### Abstract

This paper presenting and discussing results of the preliminary experiment on water relations of tropical peat land in Central Kalimantan. The discussion is based on the result of preliminary field study in 1998. Our data were gathered from the first year of study on osmotic properties of three tree species (tumih, *Combretocarpus rotundatus*), belangeran, *Shorea balangeran* and ramin, *Gonystylus bancatus*). The results revealed that during flooding period (August 1998) those plants were still retained their positive turgor pressure. We expected that due to the flooding conditions (hence, creating anoxia/hypoxia), the cells/tissues should have collapsed, thus the points generated from pressure chamber to build Pressure-Volume (P-V) curves from each species were no longer formed ordinary shape i.e. a non linear. However, the P-V curves did not show any anomalies, thus led us to conclude that those species seems retained some ability to cope with flooding stress. Those results are discussed and projected to the future study of plant water relations in conjunction with productivity of peat land plants. The future study will be complemented with other aspects including seasonal and diurnal fluctuations of osmotic properties of plant cells/tissues, seasonal fluctuations of cellular/tissue solutes in conjunction with the osmotic properties and seasonal and diurnal fluctuations of stomatal behaviour in conjunction with plant water potential components.

### Introduction

Water is one of the main phenomenon dominating the life cycle of biodiversity components in tropical peat land area in Central Kalimantan. However, the existence of water is no longer as a determinant positive factor in the life of plants in that area; instead, water has become a factor creating other problems i.e. flooding stress. *Rhizosphere* is the part of plant which undergoes most severe stress (especially during flooding phenomenon) in peat environment, creating anoxia and/or hypoxia conditions i.e. when the oxygen supply for root consumption is being reduced mainly by microorganism respiration. Anaerobic respiration may leads to the synthesis and translocation of some toxic components, and affected various processing activities within plants. One of the main factors being interfered by flooding in peat land area is the *water relations of plants*.

In a broad sense, the effect to plant water relations may have touched a number of basic biological processes within plants such as water (hence nutrient) transport, osmotic properties of cells/tissues and gas exchange between plant surface and atmosphere.

The purpose of this study is to observe the osmotic properties of tissues/cells of plants growing in the peatland area. The results may be used to interpret the adaptation

ability of peatland plants to the harsh environmental conditions such as flooding, and possibly conjunctioned with their (plants) productivity.

### Materials and Method

The study was held in Laboratory of the Faculty of Agriculture, The University of Palangkaraya, Palangkaraya, Central Kalimantan, Indonesia in August 1998, while the source of samples was Sebangau River area in Setia Alam site. Three local tree species were used namely tumih, *Combretocarpus rotundatus*, belangeran, *Shorea balangeran* and ramin, (*Gonystylus bancatus*). These species are known as quite dominant for this area.

The approach was made from measuring the water potential components i.e. total water potential, osmotic potential and turgor pressure of the plant tissue/cells. The samples were collected early morning by crossing over the (flooded) R. Sebangau by a small boat and (passing the remains of the old bridge over water used by the exploiters for cutting off and transported the ramins) collecting twigs of these plants. The collected samples were quickly put into a plastic bag, saturated with water to reduce transpiration, and sealed. The samples were then taken back to the laboratory with the distance about 10 km. It was need about two hours from collecting the samples until starting the measurement.

To derive total water potential (which is actually xylem water potential), a Scholander Pressure Chamber was used. A single leaf-bearing twigs or a single shoot in adequately mature (fully expanded) were selected, quickly sealed into the chamber, and high pressure nitrogen gas was released. The pressure was then applied slowly until the sap appeared on the cut end of the sample. Water potential was recorded i.e. the value of gas pressure at which the sap first appeared on the surface of the sample's cut end (Boyer, 1967; Hellkvist *et al.*, 1974; Ritchie and Hinckley, 1975). This was observed by a hand-lens. The balance pressure is actually equal (but opposite in sign) to the xylem pressure potential (Hellkvist *et al.*, 1974). The balance pressure when sap appeared from the cut end is a function of plant water potential (Scholander *et al.*, 1965; Boyer, 1967).

Osmotic potential at full turgor ( $\Psi_{\pi(100)}$ ) was generated from Pressure-Volume (P-V) curves, constructed by the same pressure chamber, following the steps as described by Tyree and Hammel (1972), Sinclair and Venables (1983). A P-V curve is derived from the tissue water potential isotherm, the relationship between the change of total water potential and volume of the tissue or cells within a living sample (Richter *et al.*, 1980; Tyree and Jarvis, 1982). To construct a P-V curve, the twig was selected, cut under water (to avoid a possible air bubble blockage), the cut end placed in a container filled with water and covered with a plastic bag for rehydration to allow the tissues to reach full turgor. Tissue paper, saturated with water, was placed in the chamber to reduce the loss of water via transpiration during the P-V curve construction (Sinclair and Venables, 1983).

Due to flooding conditions, it was need only about two hours the samples to be rehydrated to achieve full turgor. After the sample was sealed into the chamber, the pressure was gradually increased. The sap extruded was collected with a pre-weighed transparent plastic tube (0.5 cm in dia. 10 cm in length) containing colored (pink) tissue paper. The difference between two respective weighing is the amount of extruded sap for that pressure increment. The cumulative weight of the extruded sap was then plotted

against the reciprocal of the corresponding balance pressure to construct a P-V curve. To obtain a  $\psi_{\pi}$  value, the linear part of the P-V curve was extrapolated to reach the y-axis, where the point of intersection was the reciprocal of the initial osmotic potential.

Turgor pressure was estimated as the difference between total water potential and osmotic potential according to equation  $\Psi = \Psi_{\pi} + \Psi_p$ , where  $\Psi$  is water potential,  $\Psi_{\pi}$  is osmotic potential and  $\Psi_p$  is turgor pressure (Sutcliffe, 1979; Tyree and Jarvis, 1982; Kramer, 1983).

### Results and Discussion

The results of the measurement are presented in Table 1. The total water potential of all species were nearly zero, showing that the plants are nearly fully turgid due to flooding conditions. It is clear that all the species retained their positive turgor pressure. Data in Table 1 were tested for their significance by a simple model *one way anova*.

Table 1. Results of water potential component measurements (n=3). i.e. water potential  $\Psi$  (-MPa), osmotic potential  $\Psi_{\pi}$  (-MPa) and turgor pressure  $\Psi_p$  (MPa) in 3 tree species of the Sebangau River, Central Kalimantan

| Species                    | $\Psi$      | $\Psi_{\pi}$ | $\Psi_p$    |
|----------------------------|-------------|--------------|-------------|
| tumih                      |             |              |             |
| <i>C. rotundatus</i>       | 0.20        | 1,00         | 0.80        |
|                            | 0.05        | 0.85         | 0.80        |
|                            | 0.05        | 0.76         | 0.71        |
| $\bar{A}$                  | <b>0.10</b> | <b>0.87</b>  | <b>0.77</b> |
| balangeran                 |             |              |             |
| <i>Shorea balangeran</i>   | 0.05        | 1.00         | 0.95        |
|                            | 0.05        | 1.34         | 1.25        |
|                            | 0.05        | 1.41         | 1.36        |
| $\bar{A}$                  | <b>0.05</b> | <b>1.25</b>  | <b>1.20</b> |
| ramin                      |             |              |             |
| <i>Gonystylus bancatus</i> | 0.05        | 1.30         | 1.25        |
|                            | 0.05        | 1.39         | 1.34        |
|                            | 0.05        | 1.16         | 1.11        |
| $\bar{A}$                  | <b>0.05</b> | <b>1.28</b>  | <b>1.51</b> |

No significance was found between species in their water potential ( $\Psi$ ). This is due to the flooding conditions where all the tissues are in very saturated with water. While it does significant for osmotic potential ( $\Psi_{\pi}$ ) and turgor pressure ( $\Psi_p$ ).

The  $\Psi_{\pi}$  for tumih (-0.87 MPa) indicating smaller water absorption, compared to other 2 species and possible tissue disorder due to flooding stress (less tolerant); while the  $\Psi_{\pi}$  of 2 species ramin and balangeran (-1.25 MPa and -1.28 MPa) are reasonably more negative, close to some terrestrial species when well watered. Lower negative value of  $\Psi_{\pi}$  apparently shows that more solutes may have accumulated in the tissues/cells

to generate the osmotic values. We guessed that those solutes are may be some salts which have dissolved from plant parts in the peat water and transported to the cells by transpiration stream. Higher salt concentration in peat water may has led those plants to regulate their tissue osmotic values. Another possibility is that some organic solutes may have been synthesized to be rolled as “negative charge” for some excessive toxic salts translocated to the leaves.

The greater  $\Psi_{\pi}$  of a species in flooding conditions may have more productivity gaining since there would be bigger delta between  $\Psi$  and  $\Psi_{\pi}$ , thus would generate bigger  $\Psi_p$ , although  $\Psi_p$  of these species has approached to maximum as  $\Psi$  were nearly zero. Turgor pressure is usually recognized to play an important role in the maintenance of growth and leaf expansion (Drew, 1987). In other plant groups such as in grapes (Schultz and Matthews, 1993) and sunflower (Chimente and Hall, 1994), turgor could be retained may not always be associated with the continuation of growth, but rather the extension of the survival period, as there was a negative association between osmotic regulation and leaf expansion.

The results of species rank test using the LSD 5% level on the significant parameters ( $\Psi_{\pi(100)}$  and  $\Psi_p$ ) is presented in Table 2. It is clear that the values of  $\Psi_{\pi(100)}$  in ramin and balangeran are not significantly different for each other, but they are to tumih. The same phenomenon is also shown for  $\Psi_p$ , where the two species is not significantly different each other, but they are for tumih as well.

It seems that tumih would achieve quickly wilting point as their turgor pressure are smaller compared to the other two species. Wilting in flooding conditions are due to the reduction of water absorption since the sudden increase of root resistant to saturated water in their milieu. The increase of root resistant to water transport is caused by toxicity of high  $\text{CO}_2$  concentration (Kramer, 1983). Another reason may be due to anaerobic conditions which lead to synthesise of some toxic components such as ethanol, aldehydes and lactic acid which accumulated in the rhizosphere to cause destruction of absorption areas (Kramer, 1983). These conditions may cause disintegration in water transport, thus ilting may happen.

Table 2. Species rank on  $\Psi_{\pi(100)}$  and  $\Psi_p$  in 3 tree species of peat land area in the Sebangau River, Central Kalimantan spillited by LSD 5% analysis. Values marked with the same letter within a column are not significantly different.

| Parameter         | Ranking composition |                   |
|-------------------|---------------------|-------------------|
| $\Psi_{\pi(100)}$ | ramin               | 1.28 <sup>a</sup> |
|                   | balangeran          | 1.25 <sup>a</sup> |
|                   | tumih               | 0.87 <sup>b</sup> |
| $\Psi_p$          | ramin               | 1.23 <sup>a</sup> |
|                   | balangeran          | 1.19 <sup>a</sup> |
|                   | tumih               | 0.77 <sup>b</sup> |



### Conclusion

We expected that due to the flooding conditions (hence, creating anoxia/hypoxia), the cells/tissues should have collapsed, thus the points generated from pressure chamber to build Pressure-Volume (P-V) curves (not displayed) from each species were no longer formed ordinary shape i.e. a non linear (cf. Table 1 as well). However, no sign of wilting detected within the 3 species (i.e. when  $\Psi_p$  reached zero), due to sudden increase of root resistant which caused by decreasing of water absorption, also, the P-V curves did not show any anomalies, thus seems that these three species have shown some indications to stand in flooding conditions. These plants still retain their positive turgor pressure thus tissues/cells are active; the values of  $\Psi_p$  in balangeran and ramin even not far behind the values of some tropical “terrestrial” species when in well-watered conditions. As in pupsa (*Schima wallichii*) recorded in January 1994 (rainy season) was -1.65 MPa (Naiola *et al.*, 1997) and rambutan (*Naphelium lappaceum*) in August 1994 was -1.6 MPa (Naiola, unpublished data). Those have led us to conclude that those species seems to retain some abilities to cope with flooding stress.

However, we did not surely know exactly when the flooding started to cover these plants before the field reading taken, thus the duration of flood may one of the main reason. Thus future study should involve a more and regular field reading to show the realistic time of flooding phenomenon (including seasonal and diurnal fluctuations of osmotic properties of plant cells/tissues, seasonal fluctuations of cellular/tissue solutes in conjunction with the osmotic properties). Some supportive aspects are also proposed in the future study i.e. the comparisons of plant water relations aspects with the same species growing in “terrestrial” conditions, and combining the data for interpretation the productivity of plants due to flooding stress. Another proposed aspect is to study the effect of hypoxia/anoxia in the accumulation of “toxic” components in the guard cells (for example as ABA) thus influencing stomatal behavior (conductivity/resistance) in conjunction with plant water potential components during flooding in peat land.

### References

- Boyer, J. S. 1967. Water potential measured with a pressure chamber. *Plant Physiology*, 42: 133-137.
- Chimenti, C. C. and Hall, A. J. 1994. Responses to water stress of apoplastic water fraction and bulk modulus of elasticity in sunflower (*Helianthus annuus* L.) genotypes of contrasting capacity for osmotic adjustment. *Plant and Soil*, 166: 101-107.
- Drew, M. C. 1987. Function of root tissues in nutrient and water transport. In: Gregory, P. J., Lake, J. V. and Rose, D. A. (eds.), *Root development and function*. Cambridge University Press. Cambridge.
- Hellkvist, J., Richards, G. P. and Jarvis, P. G. 1974. Vertical gradient of water potential and tissue water relations in sitka spruce trees measured with the pressure chamber. *Journal of Applied Ecology*, 11: 637-667.
- Kramer, P. J. 1983. *Water Relations of Plants*. Academic. Orlando.
- Naiola, B. P., Sambas, E., Suciati, M., Juhaeti, T. and Syarif, F. 1997. Biological approach on the reclamation of degraded tropical forest land due to mining activities. *Proceedings of the Vth Annual Meeting of the Indonesian Mining Science Society, Jakarta 29 August 1996*. pp. 129-138 (in Indonesian).

- Richter, H., Duhme, F., Glatzel, G., Hinckley, T. M. and Karlic, H. 1980. In: Grace, J., Ford, E. D. and Jarvis, P. G. (eds.), *Plants and their atmospheric environment*. Blackwell, Oxford, pp 263-272.
- Ritchie, G. A. and Hinckley, T. M. 1975. The pressure chamber as an instrument for ecological research. *Advances in Ecological Research*, 9: 165-254.
- Scholander, P. F., Hammel, H. T., Hemmingsen, E. A., Bradstreet, E. D. and Hemmingsen, E. A. 1965. Sap pressure in vascular plants. *Science*, 148: 339-346.
- Schultz, H. R. and Matthews, M. A. 1993. Growth, osmotic adjustment, and cell-wall mechanics of expanding grape leaves during water deficits. *Crop Science*, 33: 287-294.
- Sinclair, R and Venables, W. N. 1983. An alternative method for analyzing pressure-volume curves produced with the pressure chamber. *Plant, Cell and Environment*, 6: 211-217.
- Sutcliffe, J.F. (1979). *Plants and Water*. Edward Arnold. London.
- Tyree, M. T. and Hammel, H. T. 1972. The measurement of turgor pressure and the water relations of plants by the pressure-bomb technique. *Journal of Experimental Botany*, 23: 267-282.
- Tyree, M. T. and Jarvis, P. G. 1982. Water in tissues and cells. In: *Physiological Plant Ecology II. Encyclopedia of Plant Physiology*, 12B, pp. 35-77. Springer-Verlag. Berlin.

## Checklist of Plant Species in the Peat Swamp Forests of Central Kalimantan, Indonesia

Herwint SIMBOLON and Edi MIRMANTO

Research and Development Center for Biology, The Indonesian Institute of Sciences  
Jalan Juanda 22, Bogor 16122, Indonesia, E-mail: herbogor@indo.net.id

### Abstract

The present paper intends to prepare the checklist of plant species in the peat swamp forest of Central Kalimantan, Indonesia. The list was constructed mainly based on the specimens collected during the expeditions conducted at Lahei in August 1997, Tanjung Puting National Park in June 1998 and at Sebangau River areas in August 1999. More than 310 species (78 family) of plants have been listed from these areas. Some families with the most diverse species in the areas were Myrtaceae (4 genus, 35 species), Euphorbiaceae (12 genus, 29 species), Clusiaceae (2 genus, 20 species), Dipterocarpaceae (3 genus, 12 species) and Myristicaceae (4 genus, 11 species). Most of the observed peat swamp forests have been disturbed due to logging, land cover conversions and forest fires. The dominant tree species in the peat swamp forest along the riverbanks of Lahei was *Semecarpus longifolius* and *Shorea balangeran*, in Tanjung Puting National Park was *Glutta wallichii* and *Neoscortechinia philippinensis*, and in Sebangau River areas was *Palaquium leicocarpum* and *Syzygium densinervium*. Those plant species encountered during the expedition were listed and some notes on the species were also given.

### Introduction

Ecologically, wetland ecosystem is unique ecosystems due to its large carbon sinks (the so-called warming substance), and its high endemism of biodiversity. The peat swamp forest is the most important one among wetland ecosystems. Peat swamp ecosystem covers an area of about 400 million ha of earth surfaces, mostly in temperate areas and only 10% of them are found in tropics. It was estimated that Indonesia has about 27 million ha (distributed in Sumatra, Kalimantan (Borneo) and Irian Jaya islands), that is more than 60% of the tropical peat land resources. Recently, Indonesian peat swamp forests had been drained and converted into agricultural lands in a very spectacular rate. Unfortunately, many of them were unsuccessful, creating major land degradation and biodiversity loss while in the other hand, little is known on the natural biodiversity, natural function and values of peat swamp forests.

The unsuccessful land conversion and management of a recent project so called "one-million hectares" of peat swamp forests in Central Kalimantan for example was basically related to our poor knowledge on the peat swamp forest ecosystem of the area. The main reason was peat swamp forests in tropical countries have been little studied so far. The first comprehensive study on the peat swamp forests of Southeast Asia is the works conducted by Anderson in North Kalimantan (Sarawak and Brunei), started from 1954. He also then conducted some ecological surveys in Sumatra and Western Malaysia (Anderson, 1961, 1963, 1964, 1972, 1983). Up to the present, Anderson's works remain the substantial studies of peat swamp forest of Southeast Asia. Recently, some other studies on the diversity of plants in peat swamp forests have been reported from Peninsular

Malaysia (Ibrahim, 1997), Southern Thailand (Kaneko, 1992), West Kalimantan (Siregar and Sambas, 1999) and Central Kalimantan (Saribi and Riswan, 1997; Shepherd *et al.*, 1997; Mirmanto *et al.*, 1999; Suzuki *et al.*, 1999). The present paper intends to prepare the checklist of plant species collected from peat swamp forests in Central Kalimantan, Indonesia.

### Methods

A 1-ha permanent plot (100 m by 100 m) was established on a peat swamp forest in Lahei, Central Kalimantan in August 1997 with the goal of understanding the community and population dynamics of the forest. All trees with *DBH* more than 5 cm within the plot were identified to species. In order to gather much more information on the flora of peat swamp forest in the area, an exploration was also carried out by crossing over the entire peat swamp forests around the permanent plot. By doing so the overall plant diversity in the peat swamp forest of the area would be represented. Plant species encountered from the plot and during exploration were recorded and herbarium specimens were collected, treated with alcohol, then sent to Herbarium Bogoriense, Research and Development Center for Biology-LIPI in Bogor for further identification.

The similar methods (plot establishment and exploration) were also conducted in Tanjung Puting National Park in June 1998 and in Setia Alam Jaya area of Sebangau River in August 1999. Those measured plants from plots and encountered plants during the exploration in those areas were identified and noted to construct the present checklist of plant species in peat swamp forests of Central Kalimantan. The list of tree species was also improved from the secondary data of ecological studies reported from the areas, such as Shepherd *et al.* (1997), Mirmanto *et al.* (1999) and Suzuki *et al.* (1999).

### Overview on the Observed Sites

#### *Lahei Area*

The explored sites were the peat swamp forests along the banks of Mangkutup River, a branch of Kapuas River. The areas is about 3-4 km east of the recent settlement Kampung Babugus, Desa Lahei, Kecamatan Mentagai, Kabupaten Kapuas, about 2 hours by car from Palangkaraya, the capital of Central Kalimantan Province. The forests along the road from Palangkaraya to Kampung Babugus were formed up by mainly heath (*kerangas*) forest type, while peat swamps forest only about 100-500 m depths along the riverbanks. Most of the heath forests along the road have been disturbed due to slash and burn cultivation and tree extraction. During the August 1997 field study, these disturbed heath forests along the road were almost entirely burnt, while the peat-swamp forests were remaining unburned until December 1999.

*Semecarpus longifolius*, *Buchanania sessifolia* (Anacardiaceae) and *Shorea balangeran* (Dipterocarpaceae) mainly dominated the canopy layer of peat swamp forests along the riverbank. *Vatica oblongifolia* (Dipterocarpaceae) was also a common species, though it rarely became canopy trees. While in the heath forest near by, the common species were consisted of *Cotylelobium lanceolatum*, *Dryobalanops rappa* (Dipterocarpaceae) and *Palaquium leiocarpum* (Sapotaceae, also distributed in peat swamp forests). Number of species, density and basal areas of trees with diameter at breast height more than 5 cm in a 1-ha plot in the areas were 70, 1557, and 45.6 m<sup>2</sup>, respectively (see Suzuki *et al.*, 1998 for forest structure).

### **Tanjung Puting National Park Area**

The exploration was made in the Leakey base camp areas, the upper stream of Sekonyer River, within the area of Tanjung Puting National Park. Geographically the area was located at 2°45'45.8" S and 111°56'41.4" E latitude and, at about 20 m altitude, with the annual precipitation about 2,400 mm, daily temperature ranged from 25 to 32°C, and mean air humidity was 90 %. The vegetation along the Sekonyer River up to the Leakey base camp have been disturbed due to the forest logging, only the forests in the upper stream were remain intact. Some peat swamp forests around Kumai Village areas in the river mouth and along the Sekonyer River were burnt during the extensive 1998-forest fire in Indonesia, following the long dry season period in 1997-1998.

The vegetation along the river from Kumai Village to the observed site were gradually changes, from mangrove dominated by *Rhizophora* spp., *Bruguiera* spp., *Cerbera manghas* and *Xylocarpus granatum* in the beach, changed into pure *Nypha fruticans* forest stand behind the mangrove, were dominated by *Glutta wallichii*, *Neoscortechinia philippinensis*, *Gonystyluand* swamp or peat swamp forests in the upper stream. The peat swamp forests of the area *s bancanus* and *Shorea fallax*. Other frequently observed species in the peat swamp forests of the areas were *Ganua motleyana*, *Ptychopyxis kingii* and *Baccaurea racemosa*, and also other species of Euphorbiaceae, Anacardiaceae, Annonaceae and Myrtaceae. Number of species, density and basal areas of trees with diameter at breast height more than 5 cm in a 1-ha plot in the areas were 141, 1653, and 46.8 m<sup>2</sup>, respectively (see also Mirmanto *et al.*, 1999 for structure and species composition of the forest).

### **Sebangau River Area**

The exploration was made in the peat swamp forest of the Setia Alam Jaya logging concession, about 1-3 km from the logging base camp, of Sebangau River upper water catchments areas. Most of the explored sites have been disturbed due to the selective logging. The degree of forest disturbance varies along the explored site depending on the intensity of logging. Shepherd *et al.* (1997) had reported the forest vegetation and peat characteristic of the areas. The vegetation of the areas was divided, from the river edge to the watershed, into several types, such as: riverine, mixed peat swamp, low pole, medium pole and tall interior forests. Each forest type has distinct differences in forest structure and tree species composition (see Shepherd *et al.*, 1997 for the species composition in each forest type). Number of species, density and basal areas of trees with diameter at breast height more than 5 cm within 6 plots of 0.25-ha each established in the areas were 110, 4607 trees and 43.6 m<sup>2</sup>, or about 90-100 species, 3071 trees and 29.1 m<sup>2</sup> per ha, respectively. The tree density of plot in Sebangau was almost twice of the similar forest type in either Lahei or Tanjung Puting National Park areas. These figures also indicated that the Sebangau forests were much more disturbed than other two areas and the forest were mainly constructed of small trees. Some of the most common species in Sebangau study site were *Palaquium leicocarpum*, *Syzygium (Eugenia) densinervium*, *Hydnocarpus* sp., *Xanthophyllum palembanicum* and *Shorea guiso*. Those species were found often both in upper canopy and sub-canopy layers.

### **Plant Species in the Peat Swamp Forests of Central Kalimantan**

Checklists of the plant species collected from these three locations of peat swamp forests in Central Kalimantan are presented on the List 1. In the present paper, more than 310

species (78 family) of plants have been listed from the peat swamp forests of the areas. The most diverse families in species numbers were Myrtaceae (4 genus, 35 species), Euphorbiaceae (12 genus, 29 species), Clusiaceae (2 genus, 20 species), Dipterocarpaceae (3 genus, 12 species) and Myristicaceae (4 genus, 11 species). Notes on the species distribution and commercial values were also given in the list.

Results of our observation indicated that there are differences in the dominant tree species among observed sites (see also Mirmanto *et al.*, 1999, Suzuki *et al.*, 1999, Yusuf, 1999). The dominant species in the peat swamp forest of Lahei was *Semecarpus longifolius* and *Buchanania sessifolia* (Anacardiaceae); in Tanjung Puting National Park was *Glutta wallichii* (Anacardiaceae) and *Neoscortechinia philippinensis* (Euphorbiaceae), while in Sebangau River was *Palaquium leocarpum* (Sapotaceae) and *Syzygium densinervium* (Myrtaceae). The differences in the dominant tree species among observed sites might be related to the degree of forest disturbance, intensity of logging, peat depth and other edaphic factors.

The present listed species from Central Kalimantan were mainly consisted of tree plants. Number of species of some families, such as: Myrtaceae, Euphorbiaceae and Clusiaceae in the Central were much more than have in North Kalimantan. Contrarily, number of species of shrubs, herbs, epiphytes and climbers, such as Araceae, Arecaceae, Asclepiadaceae, Orchidaceae and Rubiaceae in the present list from Central were much lower than of listed from North Kalimantan. As a whole, the total number of present list were smaller than of species listed from Sarawak and Brunei (376 species; Anderson, 1963), but it does not mean that the species diversity of peat swamp forest in Central less than of in North Kalimantan (Sarawak and Brunei). The present list was resulted from a few short time expeditions to Central Kalimantan; hence, increasing the intensity and observed areas will still may increase the number of species encountered. A special attention should be paid to shrubs, herbs, epiphytes and climbers when conducting other explorations in order to represent the flora of peat swamp forests in Central Kalimantan.

In the past, almost all of the forest areas in Central Kalimantan were allocated for timber extraction using selective logging techniques. As the consequences, the present remaining peat swamp forests (including protected areas) have ever been logged at least once before. Only few areas in the remote upper stream beyond apparent limit of logging activity remain relatively undisturbed. Even up to the present, the peat swamp forests within Tanjung Puting National Park for example, are still intensively disturbed due to illegal logging makes the forests fragile to a wild forest fires. The extensive forest destruction caused by either tree extraction, slash and burn cultivation and wild forest fires were among the reasons for decreasing the present biodiversity of peat swamp forests in Central Kalimantan.

Some logged commercial timber tree species from the peat swamp forests of Central Kalimantan were *Gonystylus bancanus*, *Agathis borneensis*, *Lophopetalum* spp., *Camnosperma* spp. *Calophyllum rhizoporum*, *Calophyllum hosei*, *Shorea* spp. *Dipterocarpus* spp. *Dialium maingayi*, *Koompassia malaccensis*, *Sindora leiocarpa*, *Cratoxylum* spp., *Scaphium macropodum* and some other species. Those species were still observed at present in the field, however in smaller size (less than 20 cm in *DBH*) although those species may naturally grown up to more than 40 cm *DBH* in an intact peat swamp forest. *Shorea albida* is the characteristic species of the peat swamp forests of Sarawak and Brunei, and its distribution extends from Pontianak in the West to Sarawak and Brunei in the North of Kalimantan. In certain areas of Sarawak, the species may form pure

stand (Anderson 1963; Yamada 1995). The species so far was not encountered during our field observation, neither in an ecological study plots at Sambas, West Kalimantan (Siregar and Sambas 1999). However, we were not sure yet whether the species not distributed in the peat swamp forests of Central Kalimantan.

As has been reported by many researchers, the diversity of tree plants in peat swamp forest areas was not as high as that of in lowland mixed dipterocarp forests. The tree diversity of peat swamp forests in some areas of Central Kalimantan was about 70, 90-100 and 141 species per 1-ha plot in Lahei, Sebangau River and Tanjung Puting National Park areas, respectively. The tree diversity of other peat swamp forest study sites were 86 species in a 1.05-ha plot at Mensemat-Sambas, West Kalimantan (Siregar and Sambas, 1999) and 61 species in a 1-ha plot at Nyaru Menteng-Palangkaraya, Central Kalimantan (Saribi and Riswan, 1977). Diversity of tree species per ha in peat swamp forest was much lower than of a mixed dipterocarp forest (270-314 species) in West Kalimantan (Suzuki, 1999). The tree diversity of peat swamp forest was about equal to that of heath forest type (70 species) in Kalimantan (Suzuki *et al.*, 1999) and to that of sub-mountain forest (115 species), but higher than tree diversity of mountain forest (45 species) of West Java area (Suzuki *et al.*, 1997). Nevertheless, we still need more study for understanding the biodiversity of peat swamp forests, and their important on maintaining carbon sink and water balance.

#### Acknowledgements

Authors wish to thank Mr. Zainal Fanani, Wardi and Aden Muhidin for their cooperation during the field collections. Dr. Takashi Kohyama and Dr. Eizi Suzuki gave valuable information on the tree species and the forest condition around Lahei areas in the late 1999. The study was a part of JSPS-LIPI Core University Program on wetland ecosystems between Research and Development Center for Biology, The Indonesian Institute of Sciences (RDCB-LIPI) and Graduate School of Environmental Earth Science, Hokkaido University, Japan. The paper was compiled during Herwint Simbolon in Hokkaido University as a JSPS-Research Fellow.

#### References

- Anderson, J. A. R. 1961. The ecological type of the peat swamp forest of Sarawak and Brunei in relation to their silviculture. Ph D Thesis, University of Edinburgh, Scotland, UK.
- Anderson, J. A. R. 1963. The flora of peat swamp forest of Sarawak and Brunei including a catalogue of all recorded species of flowering plants, ferns and fern allies. *Garden Bulletin (Singapore)*, **29**: 131-228.
- Anderson, J. A. R. 1964. The structure and development of the peat swamps of Sarawak and Brunei. *Journal of Tropical Geography*, **18**: 7-16.
- Anderson, J. A. R. 1972. *Trees of peat swamp forest of Sarawak*. Forest Department of Sarawak.
- Anderson, J. A. R. 1983. The tropical peat swamps of Western Malaysia. In: Gore, A.J.P. (ed.), *Ecosystem of the World, Vol. 4B: Mires: Swamp, Bog, Fen and Moor*. Elsevier, Amsterdam.
- Ibrahim, S. 1997. Diversity of tree species in peat swamp forest in Peninsular Malaysia. In: Rieley, J. O. and Page, S. E. (eds.), *Tropical Peatlands*. pp. 202-220, Samara Publ., Cardigan UK.

- Kaneko, N. 1992. Comparison of forest structure of tropical peat swamp forest in Southern Thailand and Malaysia. In: Kyuma, K., Vijarnsoros, P. and Zakaria, A. (eds.), *Coastal Lowland Ecosystem in Southern Thailand and Malaysia*. pp. 152-163, Kyoto, Japan.
- Mirmanto, E., Polosakan, R. and Simbolon, H. 1999. Gatra ekologi hutan gambut di Taman Nasional Tanjung Puting, Kalimantan Tengah. *Paper presented at the Workshop of Biodiversity and Sustainable Management of peat-swamp forest in Indonesia. Bogor, 12 February 1999.*
- Saribi, A. H. and Riswan, S. 1997. Peat swamp forest in Nyaru Menteng Arboretum, Palangkaraya, Central Kalimantan, Indonesia: Its tree species diversity and secondary succession. *Paper presented on the Seminar on Tropical Ecology, 21-22 June 1997, Shiga, Japan.*
- Shepherd, P. A., Rieley, J. O. and Page, S. E. 1997. The relationship between forest vegetation and peat characteristics in the upper catchment of Sungai Sebangau, Central Kalimantan. In: Rieley, J. O. and Page, S. E. (eds), *Tropical Peatlands*. pp. 191-202, Samara Publ., Cardigan UK.
- Siregar, M. and Sambas, E. N. 1999. Floristic composition of Mensemat Peat Swamp Forest at Sambas, West Kalimantan. *Paper presented at the International Symposium on Tropical Peatland Management, Cisarua-Bogor 22-23 November 1999, Indonesia.*
- Stoneman, R. 1997. Ecological studies in the Badas peat swamps, Brunei Darussalam. In: Rieley, J. O. and Page, S. E. (eds.), *Tropical Peatlands*. pp. 221-230, Samara Publ., Cardigan UK.
- Suzuki, E. 1999. Diversity in specific gravity and water content of wood among Bornean tropical rainforest trees. *Ecol. Research*, **14**: 211-224.
- Suzuki, E., Yoneda, M., Simbolon, H., Muhidin, A. and Wakiyama, S. 1997. Establishment of two permanent plots in Gunung Halimun National Park for study of vegetation structure and forest dynamics. In: Yoneda, S., Simbolon, H. and Soegarjito, J. (eds.), *Biodiversity Research and Conservation in Gunung Halimun National Park*. pp. 36-55, LIPI-PHPA-JICA Bogor.
- Suzuki, E., Kohyama, T. and Simbolon, H. 1999. Vegetation of fresh water swampy areas in West and Central Kalimantan. *Paper presented on the Workshop of Biodiversity and Sustainable Management of peat-swamp forest in Indonesia. Bogor, 12 February 1999.*
- Suzuki, K. and Niyomadhan, C. 1992. Phytosociological study on tropical peat swamp. Vegetation at Narathiwat, Thailand. In: Kyuma, K., Vijarnsoros, P. and Zakaria, A. (eds.), *Coastal Lowland Ecosystem in Southern Thailand and Malaysia*. pp. 88-121, Kyoto, Japan.
- Suzuki, K., Abu Baker, Z. and Hasson, M. 1992. Phytosociological study on tropical peat swamp. Vegetation at Muar, Malaysia. In: Kyuma, K., Vijarnsoros, P. and Zakaria, A. (eds.), *Coastal lowland ecosystem in Southern Thailand and Malaysia*. pp. 122-151, Kyoto, Japan.
- Yamada, I. 1995. *Tropical Rain Forest of Southeast Asia, A Forest Ecologist's View*. University of Hawaii Press, Honolulu.
- Yusuf, R. 1999. Analisis vegetasi dan degradasi jenis di hutan gambut setelah kebakaran dalam kawasan Taman Nasional Tanjung Puting, Kalimantan Tengah. *Paper presented at the Workshop of Biodiversity and Sustainable Management of peat-swamp forest in Indonesia. Bogor, 12 February 1999.*



List 1. Checklist of the plant species collected from peat swamp forest areas in Central Kalimantan. Numbers following family names are the number of genera (species) distributed in Sarawak and Brunei, after Anderson (1963).

**Aceraceae**

*Acer niveum* (*laurinum* Hassk.)

**Anacardiaceae** 7(11)

*Buchanania arborescens* (Bl.) Bl. The third most dominant species in the study plot of Lahei area (Suzuki *et al.* 1999), also found in Sarawak.

*Camnosperma coriaceum* (Jack.) Hall. f., commercial timber tree species, also in Sarawak, Malay Peninsula and Thailand.

*Glutta wallichii* (Hook. f.) Ding Hou. Is the first most dominant species in the study plot of Tanjung Puting National Park (Mirmanto *et al.*, 1999).

*Mangifera quadrifida* Jack

*Parishia insignis* Hook. f., also in Malay Peninsula and Thailand.

*Semecarpus longifolius* Bl. The second most dominant species in the study plot of Lahei area (Suzuki *et al.*, 1999).

**Anisophyllaceae**

*Combretocarpus rotundatus* (Miq.) Danser, also in Sarawak.

**Annonaceae** 12 (17)

*Melodorum kentii* (Bl.) Miq.

*Mezzettia havilandii* (Boerl.) Ridley

*Mezzettia leptopoda* (Hook. f. & Thomson) Oliv., also in Sarawak.

*Phaeanthus crassipetalus*

*Polyalthia glauca* (Hassk.) Boerl., also in Sarawak, Malay Peninsula and Thailand.

*Polyalthia hypoleuca* Hook. f. & Thomson, also in Sarawak and Malay Peninsula.

*Polyalthia lateriflora* King., also in Malay Peninsula.

*Polyalthia sumatrana* Miq. (Kurz.)

*Xylopiia caudata* Hook. f. & Thomson

*Xylopiia fusca* Maingay, also in Sarawak, Malay Peninsula and Thailand.

**Apocynaceae** 5(6)

*Alstonia ngustiloba* Wall. Very common in open area and riverside at Tanjung Puting National Park.

*Alyxia reinwardtii* Bl.

*Chilocarpus tortulosa* (Baill.) Mgf

*Dyera costulata* (Miq.) Hook. f.

*Dyera eximia*

*Dyera lowii* Hook. f., also in Sarawak.

*Urceola brachysepala* Hook. f. also in Sarawak.

**Aquifoliaceae**

*Ilex wallichii*

*Ilex cymosa* Bl. also in Thailand.

**Araceae** 9(9)

*Aglaonema simplex*

**Araucariaceae**

*Agathis borneensis* Warb., a commercial timber tree species, have been planted for enrichment planting.

**Areaceae** 7(7)

*Pinanga* sp.

**Asclepiadaceae** 2(6)

*Hoya* sp.

**Asteraceae**

*Vernonia arborea* Buch.-Ham.

**Bonnetiaceae**

*Ploiarium alternifolium* (Vahl.) Melchior, also in Sarawak.

**Burseraceae** 2(6)

*Canarium hirsutum* Willd.

*Dacryodes rugosa* (Bl.) H. J. Lam

*Santiria apiculata* A. W. Benn.

*Santiria griffithii* (Hook. F.) Engl.

*Santiria laevigata* Bl., also in Malay Peninsula.

*Santiria oblongifolia* Bl., also in Malay Peninsula.

*Santiria rubiginosa* Bl., also in Sarawak and Malay Peninsula.

**Casuarinaceae** 1(1)

*Gymnostoma sumatranum* (Jungh. ex. de Vriese) L. A. S. Johnson

**Celastraceae** 3(4)

*Bhesa paniculata* Arn., also in Sarawak and Malay Peninsula.

*Lophopetalum* sp., a commercial timber tree species.

**Clusiaceae** 3(16)

*Calophyllum biflorum* M.R. Handerson & Wyatt Smith, a commercial timber tree species.

*Calophyllum fragrans* Ridley, also in Sarawak.

*Calophyllum hosei* Ridley, a commercial timber tree species.

*Calophyllum inophyllum* King, a commercial timber tree species.

*Calophyllum lowii*

*Calophyllum rhizophorum* Boerl. & Koord., commercial timber tree species, also in Sarawak.

*Calophyllum sclerophyllum* Vesque, a commercial timber tree species.

*Calophyllum soulattri* Burm. f., also in Sarawak and Malay Peninsula.

*Callophyllum teysmannii* Miq., a commercial timber tree species.

*Calophyllum* sp.

*Cratoxylum arborescens* (Vahl.) Bl., a commercial timber tree species.

*Cratoxylum glaucum* Korth., a commercial timber tree species.

*Garcinia apetala*

*Garcinia bancana* Miq., also in Malay Peninsula and Sarawak.

*Garcinia cuneifolia*

*Garcinia cuspidata*, also in Sarawak.

*Garcinia dioica* Bl.

*Garcinia lateriflora* Bl.

*Garcinia maingayi* Hook. F.

*Garcinia mangostana* L.

*Garcinia penangiana*

*Garcinia rostrata*, also in Malay Peninsula.

*Garcinia vidua* Ridley, also in Sarwak.

**Commelinaceae**

*Forrestia molissima*

**Connaraceae** 3(3)

*Cnestis platantha* Driff.

**Cornaceae** 1(1)

*Mastixia trichotoma* Bl.

**Crypteroniaceae**

*Dactylocladus stenostachys* Oliv., also in Sarwak.

**Cucurbitaceae** 1(1)

*Momordia charantia* L.

*Trichosanthes* sp.1. New species recorded from Lahei area

*Trichosanthes* sp.2

**Cyperaceae** 2(2)

*Fimbristylis pauciflorum*. Very common in open peat-land area and as indicator of peat-land

*Hypolythrum* sp. Very common in open peat-land area and as indicator of peat-land

*Scleria* sp.

*Thoracostachyum bancanum* (Miq.) Kurz, also in Sarawak.

**Daphniphyllaceae**

*Daphniphyllum laurinum* (Benth.) Baill.

**Dilleniaceae** 2(2)

*Dillenia pulchella* (Jack) Gilg., also in Sarawak, Malay Peninsula and Thailand.

*Dillenia suffruticosa* (Griff.) Mart. Common small tree in the open area and river side

**Dipterocarpaceae** 7(15)

*Dipterocarpus coriaceus* V. Sl., also in Sarawak.

*Shorea balangeran* (Korth.) Burk. The first most dominant species in the study plot of Lahei area (Suzuki *et al.*, 1999).

*Shorea fallax* Meijer. Is the forth most dominant species in the study plot of Tanjung Puting National Park (Mirmanto *et al.*, 1999).

*Shorea guiso* (Blanco) Bl., a commercial timber tree species.

*Shorea leprosula* Miq., also in Malay Peninsula.

*Shorea ovalis* (Korth.) Bl.

*Shorea parvifolia* Dyer, also common in open dry-land forest

*Shorea platycarpa* Helm., also in Malay Peninsula.

*Shorea teysmanniana* Dyer ex Brandis, also in Sarawak.

*Shorea* sp.

*Vatica mangachopai* Blanco, also in Sarwak.

*Vatica rassak* (Korth.) Bl.

**Ebenaceae** 1(4)

*Diospyros buxifolia* (Bl.) Hiern.

*Diospyros clavipes*

*Diospyros dajakensis*

*Diospyros evena* Bakh., also in Sarawak.

*Diospyros fuberulata*

*Diospyros hermaphroditica* (Zoll.) Bakh.

*Diospyros maritima* Bl.

*Diospyros pendula* Hasselt ex Hassk.

*Diospyros polyalthoides* Korth ex Hiern.

*Diospyros pseudomalabarica* Bakh., also in Sarawak.

*Diospyros siamang* Bakh., also in Malay Peninsula and Sarwak.

*Diospyros* sp.

**Elaeocarpaceae**

*Elaeocarpus angustifolius* Bl.

*Elaeocarpus glaber* Bl.

*Elaeocarpus griffithii* (Wight) A. Gray, also in Malay Peninsula.

*Elaeocarpus longipetiolatus*

*Elaeocarpus mastersii* King, also in Malay Peninsula.

*Elaeocarpus ovalis*

*Elaeocarpus petiolatus* (Jack) Wallich

*Elaeocarpus winklerii*

**Euphorbiaceae 11(17)**

*Antidesma montanum* Bl., also in Malay Peninsula.

*Antidesma coriaceum* Tul, also in Sarawak.

*Aporosa falcifera* Hook. f.

*Aporosa frutescens* Bl.

*Aporosa lucida*

*Baccaurea bracteata* Muell. Arg., also in Sarawak, Malay Peninsula and Thailand.

*Baccaurea javanica* (Bl.) Muell. Arg.

*Baccaurea kunstleri* King

*Baccaurea macrocarpa* (Miq.) Muell. Arg.

*Baccaurea motleyana* (Muell. Arg.) Muell. Arg.

*Baccaurea racemosa* (Reinw. ex Bl.) Muell. Arg.

*Blumeodendron tokbrai* (Bl.) J. J. Sm., also in Malay Peninsula and Sarwak.

*Breynia* sp.

*Cnesmone* sp. Edible liana, have been domesticated

*Glochidion littorale*

*Glochidion rubrum* Bl.

*Glochidion superbum* Baill.

*Macaranga amissa* Airy Shaw

*Macaranga caladifolia* Becc., also in Sarawak.

*Macaranga conifera* (Zoll.) Muell. Arg.

*Macaranga puncticulata*, also in Sarawak and Malay Peninsula.

*Macaranga tanarius* (L.) Muell. Arg.

*Macaranga triloba* (Bl.) Muell. Arg.

*Neoscortechinia kingii* (Hk. f.) Pax et K. Hoffm., also in Sarawak.

*Neoscortechinia nicobarica* (Hk. f.) Pax et K. Hoffm.

*Neoscortechinia philippinensis* (Merr.) V. Welzen. Is the second most dominant species in the study plot of Tanjung Puting National Park (Mirmanto *et al.*, 1999).

*Ostodes macrophylla*

*Pimelodendron papaverioides* J. J. Smith, also in Malay Peninsula.

*Ptychopyxis kingii* Ridley

**Fabaceae 8(8)**

*Adenanthera pavonina* L., also in Sarawak.

*Archidendron microcarpum* (Benth.) Nielsen, a commercial timber tree species.

*Dialium maingayi* Baker

*Dialium* sp.

*Koompassia malaccensis* Maingayi ex Benth., commercial timber tree species, also in Sarawak and Malay Peninsula.

*Miletia* sp.

*Sindora leiocarpa* Backer ex K. Heyne, commercial timber tree species, also in Sarawak.

**Fagaceae 2(5)**

*Castanopsis foxworthyi* Schottky ex Winkler, also in Sarawak.

*Castanopsis* sp.

*Lithocarpus dasystachyus* (Miq.) Rehd., also in Sarawak.

*Lithocarpus* sp.

**Flacourtiaceae 2(2)**

*Hydnocarpus* sp.

**Hypericaceae 1(2)**

*Cratoxylum arborescens* (Vahl) Bl., commercial timber tree species, also in Malay Peninsula and Sarawak.

*Cratoxylum glaucum* Korth., commercial timber tree species, also in Sarawak.

**Icacinaceae**

*Platea excelsa* Bl., also in Sarawak.

*Stemonurus scorpioides* Becc.

**Lauraceae 9(18)**

*Alseodaphne coriacea* Kosterm.

*Cinnamomum sintoc* Bl.

*Litsea accendens*

*Litsea euneura*

*Litsea paludosa*

*Litsea resinosa* Bl., also in Malay Peninsula, Sarawak and Thailand.

*Litsea rufo-fusca*

*Litsea turfosa* Kosterm.

**Lecythidaceae**

*Barringtonia reticulata*

*Barringtonia* sp.

**Leeaceae**

*Leea indica* (Burm.f.) Merr.

**Linaceae** 2(2)

*Ctenolophon parvifolius* Oliv., also in Sarawak

**Loganiaceae** 1(2)

*Fagraea racemosa* Wall., also in Sarawak.

**Loranthaceae** 3(3)

*Helixanthera cylindrica* (Jack) Danser

**Magnoliaceae** 1(1)

*Jasminum pubescens* Willd.

*Michelia* sp.

**Melastomataceae** 4(8)

*Astronia spectabilis* Bl.

**Meliaceae** 3(3)

*Aglaia rubiginosa* (Hiern) Pannel, also in Malay Peninsula.

*Aglaia odoratissima* Bl.

*Aglaia tomentosa* Teijsm. & Binnend.

*Dysoxylum arborescens* (Bl.) Miq.

*Dysoxylum densiflorum* (Bl.) Miq.

*Dysoxylum alliaceum* (Bl.) Bl.

*Sandoricum emarginatum* Hiern, also in Sarawak.

*Sandoricum koetjape* (Burm. f.) Mern

**Moraceae** 3(27)

*Artocarpus mangiayi* Hook. f., also in Malay Peninsula.

*Artocarpus* sp.

*Ficus deltoidea* Jack

*Ficus deltoidea* var. *intermedia*

*Ficus deltoidea* Jack var. *motleyana* (Miq.) Burck., also in Sarawak.

*Ficus sumatrana* Miq., also in Sarawak.

*Ficus sundaica* Bl., also in Sarawak.

*Ficus* sp.

**Myristicaceae** 4(7)

*Gymnacranthera eugeniifolia* Sincl., also in Malay Peninsula and Sarawak.

*Horsfieldia crassifolia* (Hk. f. et Th.) Warb., also in Malay Peninsula, Sarawak and Thailand.

*Horsfieldia glabra* (Bl.) Warb.

*Horsfieldia subglobosa* (Miq.) Warb.

*Knema glauca* (Bl.) Warb.

*Knema intermedia* (Bl.) Warb., also in Sarawak and Malay Peninsula.

*Knema cinera* (Poir.) Warb.

*Knema laurina* (Bl.) Warb.

*Myristica elliptica* Wall., also in Thailand.

*Myristica lowiana* King, also in Sarawak and Malay Peninsula.

*Myristica tomentosa* Thunb.

**Myrsinaceae** 5(11)

*Ardisia laevigata*

*Maesa ramentacea* (Roxb.) Wall

*Embelia ribes* Burm.

**Myrtaceae** 3(16)

*Rhodamnia cinerea* Jack

*Rhodomyrtus tomentosa* (Aiton) Hassk.

*Syzygium aquaea* Burm.

*Syzygium castaneum*

*Syzygium caudatilimba*

*Syzygium cerina* M.R. Henderson, also in Sarawak.

*Syzygium cuprea* Koord. & Valeton

*Syzygium claviflora* Roxb., also in Malay Peninsula.

*Syzygium densinervium*

*Syzygium ecostulata*

*Syzygium fusiformes* (Duthie) Merr & Perry.

*Syzygium garcinifolia* King.

*Syzygium grandis* Wight, also in Malay Peninsula and Thailand.

*Syzygium havilandii* Merr., also in Sarawak.

*Syzygium incarnata* Elm., also in Sarawak.

*Syzygium jamboloides* K. et V.

*Syzygium leucoxydon* (Korth.) Miq., also in Sarawak.

*Syzygium lineata* (Bl.) Duthie, also in Sarawak.

*Syzygium multibracteata*

*Syzygium napiformis* K. & V., also in Thailand.

*Syzygium nemastrina* M. R. Hend., also in Sarawak.

*Syzygium oblata* Roxb., also in Thailand.

*Syzygium ochneocarpa* Merr.

*Syzygium opaca* Poir.

*Syzygium palembanica* (Miq.) Merr.

*Syzygium perpuncticulata*

*Syzygium polyantha*

*Syzygium spicata* Lamk., also in Sarawak, Malay Peninsula and Thailand.

*Syzygium subdecussata* Wallich ex Duthie

*Syzygium virens* (Bl.) Koord. & Valeton.

*Syzygium* sp.

*Tristania bakhuzenia* Backer.

*Tristania grandifolia* Ridley, also in Sarawak.

*Tristania obovata* R. Br., also in Sarawak.

*Tristania whiteana* Griffith.

**Nepenthaceae** 1(5)

*Nepenthes ampullaria* Jack., also in Sarawak

*Nepenthes gracilis* Korth., also in Sarawak.

*Nepenthes mirabilis*  
*Nepenthes rafflesiana* Jack., also in Sarawak.

**Ochnaceae** 3(4)

*Euthemis leucocarpa* Jack., also in Sarawak.

**Olacaceae** 4(5).

*Strombosia ceylanica* Gardner

**Oleaceae** 2(4)

*Chionanthus ramiflorus* Roxb.

**Orchidaceae** 12(17)

*Bulbophyllum acuminatum*  
*Dendrobium destichophyllum*  
*Eria pulchella*  
*Dipodium* sp.

**Pandanaceae** 1(4)

*Pandanus* sp., also in Sarawak.  
*Freycinetia* sp., also in Sarawak.

**Podocarpaceae**

*Dacrydium pectinatum* de Lauben f.

**Polygalaceae** 2(4)

*Xanthophyllum amoenum* Chodat, also in Sarawak.  
*Xanthophyllum eurhynchum* Miq.  
*Xanthophyllum obscurum* A.W. Benn.  
*Xanthophyllum palembanicum*  
*Xanthophyllum* sp.

**Proteaceae**

*Helicia excelsa*

**Rhizophoraceae** 2(2)

*Carallia brachiata* (Lour.) Merr., also in Sarawak.  
*Combretocarpus rotundatus* (Miq.) Dans., also in Sarawak.  
*Gynotroches axillaris* Bl., also in Malay Peninsula and Sarawak.

**Rocaceae** 2(3)

*Parastemon urophyllum* A. DC., also in Sarawak and Malay Peninsula.  
*Parastemon spicatum* Ridley, also in Sarawak.  
*Prunus arborea* (Bl.) Kalkman var. *arborea*, also in Malay Peninsula.

**Rubiaceae** 18(22)

*Gaertnera vaginans* (DC) Merr.  
*Gardenia pterocalyx* Val. , also in Sarawak.  
*Lucinaea montana* Korth.  
*Psychotria laxiflora* Bl.

*Psychotria viridiflora* Reinw.

*Randia* sp.

*Tarrena fragrans* (Bl.) Koord. And Val., also in Sarawak.

*Timonius flavescens* (Jack) Backer

*Timonius* sp.

*Uncaria* sp.

**Rutaceae** 2(3)

*Acronichya laurifolia*  
*Acronychia porteri* Hook. f.  
*Evodia accedens* Bl.

**Sapindaceae** 3(4)

*Lepisanthes amoena* (Hask.) Leenh.  
*Nephelium* sp.  
*Pometia pinnata* Forst., also in Sarawak.

**Sapotaceae** 4(12)

*Ganua motleyana* Pierre., also in Sarawak, Malay Peninsula and Thailand.  
*Madhuca* sp.  
*Palaquium cochleariifolium* P. van Royen, also in Sarawak.  
*Palaquium leiocarpum* Boerl, also in Sarawak.  
*Palaquium ridleyi* King & Gamble, also in Sarawak and Malay Peninsula.  
*Planchonella maingayi* (C. B. Clarke) P. V. Royen, also in Malay Peninsula.  
*Planchonella obovata*

**Sterculiaceae** 2(4)

*Scaphium macropodum* (Miq.) Beumee ex K. Heyne, commercial timber tree species, also in Sarawak.  
*Sterculia bicolor* Masters, commercial timber tree species, also in Sarawak, Malay Peninsula and Thailand.

**Symplocaceae**

*Symplocos celastrifolia* Griff. ex Clarke

**Tetrameristicaceae**

*Tetramerista glabra* Miq., a commercial timber tree species.

**Theaceae** 2(4)

*Adinandra dumosa* Jack  
*Eurya acuminata* DC  
*Haemocharis ovalis* (Chois) O. Ktze.  
*Ploiarium alternifolium* (Vahl) Melchior  
*Schima wallichii* (DC) Korth.  
*Ternstroemia coriacea* R. Scheffer.

*Ternstroemia magnifica* Stapf ex Ridley, also in Sarawak.

**Thymelaeaceae** 2(4)

*Gonystylus bancanus* Miq., a commercial timber tree species. The species is the third most dominant in the study plot of Tanjung Puting National Park (Mirmanto *et al.*, 1999), also in peat swamp of Sarawak and Malay Peninsula.

*Wilestroemia androsaemiflora* DC

**Tiliaceae** 2(5)

*Microcos* sp.

**Ulmaceae**

*Gironniera subaequalis* Planch.

*Trema orientalis*

**Urticaceae** 1(2)

*Poikilospermum suaveolens* (Bl.) Merr., also in Sarawak.

**Verbenaceae** 3(3)

*Callicarpa longifolia* Lam.

*Vitex pinnata* L.

**Vitaceae**

*Cissus javana*

*Ampelocissus thyrsoiflora* Planch., also in Sarawak.

**Ferns:**

**Aspleniaceae**

*Asplenium* sp.

*Trichomanes* sp.

**Blechnaceae**

*Stenoclaena palustris*

**Davalliaceae**

*Humata angustata*

**Hymenophyllaceae**

*Hymenophyllum* sp.

**Oleandraceae**

*Nephrolepis biserrata* Schott.

**Polypodiaceae**

*Platycterium* sp.

**Pteridaceae**

*Pteris* sp.

## Plants Diversity of Peat Swamp Forest in Riau Province, Sumatra

Johanis P. MOGEA and M. MANSUR

Research and Development Center for Biology LIPI, Bogor, Indonesia

### Abstract

Studies on a population density of trees in the peat swamp forest in Desa Plintung, Desa Sumber Jaya, and Desa Pulau Muda all in Riau Province Sumatra using transect line method of 1,000 × 20 m, 2,000 × 20 m, and 4,000 × 20 m respectively had been conducted. Shrubs and herbs were observed qualitatively by their present. The area is a wide flat about 10 to 20 km from east coast of Sumatra which lay at about 5-15 m above sea level. In total 131 species of plants had been recorded, namely 78 species in Desa Plintung, 75 species in Desa Sumber Jaya, and 68 species in Desa Pulau Muda. Five trees species which have high relative density 14% or more which mean the tree species consists of one to three trees per hectare are: bintangur (*Callophyllum soulattri*), balam (*Palaquium hexandrum*), meranti bako (*Shorea uliginosa*), terentang (*Camnosperma coriaceum*), and ramin (*Gonystylus macrophyllus*). Shrubs are dominated by *Cyrtostachys lakka*, *Maccaranga diepenhortii*, *Uncaria glabrata*, *Santiria laevigata*, *Eleiodoxa conferta*, *Glochidion rubrum*, and *Macaranga triloba*. Herbs are dominated by bakung hutan (*Crinum asiaticum*), paku resam (*Gleichenia linearis*), *Lygodium* sp., *Nepenthes ampularia*, *Asplenium nidus*, *Nephrolepis bisserata*, *Nephrolepis excelata*, and *Scleria laevis*.

Comparison of the tree plants of the peat swamp forest above to other observation which had been done along time ago in 1976 by Anderson in three localities in Sumatra revealed that the tree species diversity of the peat forest is very high as it is shown that from 53 trees species in the present study and 22 trees species reported by Anderson, only five tree species occur in the previous ones, the other eleven are not found in the present study. The number of tree species which occur in both peat forest in Sumatra, Borneo, and Sulawesi are also very few. Eight tree species are both occurred in Sumatra and Borneo namely *Shorea uliginosa*, *Gonystylus bancanus*, *Dyera lowii*, *Mangifera havilandii*, *Mezzettia leptopoda*, *Garcinia rostrata*, *Palaquium warsufolium*, and *P. alternifolium*. Only *Callophyllum soulattri*, *Dyospyros malabarica*, and *Livistona rotundifolia* occur in both Sumatra and Sulawesi's peat forest.

Some trees of peat swamp forest are recorded as rare plants based on the IUCN Plant Red List Categories 1994, there are *Ailanthus integrifolia* (Simaroubaceae) and *Cyrtostachys lakka*. The latter are rare in Sumatra, not threatened in Sarawak but endangered to extinct from the wild in Brunei and Singapore.

**Keywords:** Plant diversity, peat swamp forest, population density, conservation status

### Introduction

The peat swamp forest in Indonesia is about 6.53 million ha (Riswan, 1998) distributed in Sumatra, Java, Kalimantan, Sulawesi, Moluccas, and Irian Jaya. In Riau Province of Sumatra, the size of peat swamp forest is about 383,750 ha. The swamp peat forest might cover about 40% of the main land province. However, information on the flora of the peat swamp forest so far is very few. On the other hand it is very important to understand the role of the flora and all other components of biotic and non biotic of the area before people could utilize the peat swamp forest for the need of an economic development. In fact, it has been planned that many of the swampy peat forest areas of

the province will be converted to particularly an oil palm plantation. Before the execution of this conversion, it is important to be considered that the conversion should give a maximum benefit in the long run particularly for the people around the area which means will result a very little damaged to the environment including to the habitat of the flora and fauna. To evaluate the existing flora and fauna, hence in this case it is important to inventory a plant population before the peat swamp forests are gone. That means a study of plant diversity is needed to be conducted.

The present study of the plant diversity of the swamp peat forest in the province was actually done in 1996 by coincidence when the authors were invited by the Ministry of Forestry to participate in a team with some related specialists to study a conservation and biodiversity in the area to examine whether there is any endangered and rare plants to be protected, what species it belongs to, how big is the population, and how do we might be protected and utilize the swampy peat forest area based on the sustainable manner.

### Materials and Methods

The areas of study located at an ombrogen swamp peat forest of the Riau Province on a wide flat about 10 - 20 km from east coast of Sumatra which lay about 5 - 15 m above sea level. The peat layer is about 2.5 to 3 m deep from the surface ground. To study of the plant diversity, three observed peat swamp forest sites belonging to a forest concession area of a timber company were chosen. The temporary line transect plots were set up namely in Desa Plitung of 101°33'E - 1°12'N with a transect plot of 1,000 by 20 m, Desa Sumber Jaya of 101°47'E - 1°03'N with the transect plot of 2,000 by 20 m; and Desa Pulau Muda of 103°01'E - 0°40'S with the transect plot of 3,000 by 20 m. The transect plots were preferably followed the existing foot paths. Desa Plitung has the best quality of peat which consists of mature sapric at the above layer and hemic at the bottom layer; whilst the peat in Desa Sumber Jaya considered moderate and the peat in Desa Pulau Muda is still very young (Anonym, 1997). To facilitate during conducting the observation, the transect plot were divided into tree subplots of 10 by 10 m for tree observation, in each of the tree subplot a 5 by 5 m shrub subplot was set up to study of liana and shrub; and in each shrub subplot, a 1 by 1 m herb subplot was also set up for the study of herbs and tree seedlings. Using those plots above, the relative trees density were accounted, as well as for shrubs and herbs. Tree is the plant which have stem more than 10 cm in diameter, usually it has stem of more than 15 m tall. Shrub has a stem of 2.0-9.9 cm in diameter, and about 5-7 m tall; and herbs have mostly a fleshy stem of less than 1.9 cm and plant with up to 3 m tall. Voucher plant specimens were collected particularly for a determination in the Herbarium Bogoriense. After the specimens had been determined than the analysis of the tree plant relative density was conducted. The results had been compare to the floristic data from peat swamp forest of Sumatra (Anderson, 1976a, b), Borneo (Anderson, 1983), and Sulawesi (Anonym, 1978).

### Results and Discussion

The number of tree species in Desa Plitung is 45, in Desa Sumber Jaya 28, and in Desa Pulau Muda is 25, the total number is 53 (Table 1). Based on their similarity on the present in the observed sites, the tree species may be divided on seven groups. Group 1 consisted of 15 species which were present on all of the three observed sites. The dominant species in the group were *Calophyllum soulattri* which had three trees in a



Table 1. List of number of trees from the three observed sites

|                                  | P  | J  | M  | T  |
|----------------------------------|----|----|----|----|
| GROUP 1:                         |    |    |    |    |
| <i>Calophyllum soulattri</i>     | 16 | 12 | 14 | 42 |
| <i>Palaquium hexandrum</i>       | 12 | 8  | 1  | 31 |
| <i>Shroea uliginosa</i>          | 6  | 7  | 3  | 16 |
| <i>Cannosperma coriacea</i>      | 4  | 4  | 6  | 14 |
| <i>Gonystylus bancanus</i>       | 5  | 3  | 4  | 12 |
| <i>Gonystylus macrophyllus</i>   | 4  | 5  | 3  | 12 |
| <i>Palaquium burckii</i>         | 6  | 4  | 2  | 12 |
| <i>Shorea teysmanniana</i>       | 4  | 2  | 4  | 10 |
| <i>Mangifera griffithii</i>      | 4  | 3  | 2  | 9  |
| <i>Diospyros maritima</i>        | 2  | 4  | 2  | 8  |
| <i>Eugenia claviflora</i>        | 2  | 2  | 2  | 6  |
| <i>Knema laurina</i>             | 2  | 2  | 1  | 5  |
| <i>Stemonurus scorpioides</i>    | 2  | 1  | 2  | 5  |
| <i>Tetramerista glabra</i>       | 1  | 2  | 2  | 5  |
| <i>Litsea grandis</i>            | 1  | 1  | 2  | 4  |
| GROUP 2:                         |    |    |    |    |
| <i>Aglaia odorata</i>            | 4  | 0  | 0  | 4  |
| <i>Pandanus</i> sp.              | 4  | 0  | 0  | 4  |
| <i>Garcinia rostrata</i> *       | 3  | 0  | 0  | 3  |
| <i>Alseodaphne oblanceolata</i>  | 2  | 0  | 0  | 2  |
| <i>Diospyros malabarica</i>      | 2  | 0  | 0  | 2  |
| <i>Eugenia bankensis</i>         | 2  | 0  | 0  | 2  |
| <i>Actinodaphne macrophylla</i>  | 1  | 0  | 0  | 1  |
| <i>Canarium denticulatum</i>     | 1  | 0  | 0  | 1  |
| <i>Dacryodes rostrata</i>        | 1  | 0  | 0  | 1  |
| <i>Diospyros hermaphroditica</i> | 1  | 0  | 0  | 1  |
| <i>Drypetes</i> sp.              | 1  | 0  | 0  | 1  |
| <i>Gomphia serrata</i>           | 1  | 0  | 0  | 1  |
| <i>Labisia pumila</i>            | 1  | 0  | 0  | 1  |
| <i>Palaquium walsurifolium</i>   | 1  | 0  | 0  | 1  |
| <i>Polyalthia laterifolia</i>    | 1  | 0  | 0  | 1  |
| <i>Shorea</i> sp. 1              | 1  | 0  | 0  | 1  |
| <i>Shorea</i> sp. 2              | 1  | 0  | 0  | 1  |
| GROUP 3:                         |    |    |    |    |
| <i>Ailanthus integrifolia</i>    | 0  | 2  | 0  | 2  |
| <i>Palaquium obovatum</i>        | 0  | 2  | 0  | 2  |
| <i>Parastemon urophyllum</i>     | 0  | 2  | 0  | 2  |
| <i>Diospyros</i> sp.             | 0  | 1  | 0  | 1  |
| GROUP 4:                         |    |    |    |    |
| <i>Exocarpus latifolius</i>      | 0  | 0  | 2  | 2  |
| <i>Glochidion zeylanicum</i>     | 0  | 0  | 2  | 2  |

Table 1. Continued.

|                                   | P | J | M | T |
|-----------------------------------|---|---|---|---|
| GROUP 5:                          |   |   |   |   |
| <i>Dillenia excelsa</i>           | 3 | 2 | 0 | 5 |
| <i>Antidesma phanerophlebium</i>  | 2 | 1 | 0 | 3 |
| <i>Garcinia nigrolineata</i>      | 1 | 2 | 0 | 3 |
| <i>Livistona rotundifolia</i>     | 2 | 1 | 0 | 3 |
| <i>Dillenia pulchella</i>         | 1 | 1 | 0 | 2 |
| <i>Elaeocarpus glaber</i>         | 1 | 1 | 0 | 2 |
| <i>Xanthophyllum palembanicum</i> | 1 | 1 | 0 | 2 |
| GROUP 6:                          |   |   |   |   |
| <i>Ficus</i> sp. 1                | 5 | 0 | 4 | 9 |
| <i>Ficus</i> sp. 2                | 5 | 0 | 2 | 7 |
| <i>Gymnacrantha forbesii</i>      | 2 | 0 | 4 | 6 |
| <i>Acronychya porteri</i>         | 1 | 0 | 1 | 2 |
| <i>Knema cinerea</i>              | 1 | 0 | 1 | 2 |
| <i>Knema intermemdia</i>          | 1 | 0 | 1 | 2 |
| GROUP 7:                          |   |   |   |   |
| <i>Nothophoebe coriacea</i>       | 0 | 2 | 2 | 4 |
| <i>Garcinia parviflora</i>        | 0 | 2 | 1 | 3 |

Note: P = Desa Plitung, J = Desa Sumber Jaya, M = Desa Pulau Muda , T = Total tree number

hectar, followed by *Palaquium hexandrum* which had two trees in a hectar, and *Shorea uliginosa* which had one tree in a hectar. Group 2 consisted of 17 species which only occurred in Desa Plitung; the dominant species in the group was *Aglaia odorata*, the tree *Pandanus* sp., and *Garcinia rostrata*, each consisted three to four trees in the 12 ha. According to Anderson (1976b) the latter species is found as well in a heath forest in Sumatra. Group 3 consisted of four species which were only found in Desa Sumber Jaya, namely *Ailanthus integrifolia*, *Palaquium odoratum*, *Parastemon urophyllum*, and *Diospyros* sp. Group 4 consisted of two species which were only found in Desa Pulau Muda namely *Exocarpus laltifolius* and *Glochidion zeylanicum*. Group 5 consisted of seven species which occurred in both Desa Plitung and Desa Sumber Jaya. The dominant species were *Dillenia excelsa*, *Antidesma phanerophlebium*, *Garcinia nigrolineata*, and *Livistona rotundifolia*, each had three to five trees in the 12 ha. Group 6 consisted of six species which occurred in both Desa Plitung and Desa Pulau Muda; the dominant species were *Ficus* sp. 1, *Ficus* sp. 2, and *Gymnacrantha forbesii* each consisted of between six to nine trees in the 12 ha. Group 7 consisted of two species which were presented in both Desa Sumber Jaya and Desa Pulau Muda namely *Nothophoebe coriacea* and *Garcinia parviflora*. Group 1 shows thought there are similarity but species diversity in each sites are quite high particularly as show in the Group 2 where Desa Plitung had very diverse and high number of tree species. These will considered that more sites may be observed, the more diverse tree species may be expected.

Fifteen dominant tree species of the Group 1 as cited in Table 2, based on the relative density (%) may be figured as follows: *Calophyllum soulattri* (42.80), *Palaquium hexandra* (36.60), *Shorea uliginosa* (17.30), *Cannosperma coriacea* (16.70), *Gonystylus macrophyllus* (14.00), *G. bancanus* (13.75), *Palaquium burckii* (13.30),

*Shorea teymaniana* (11.70), *Diospyros maritima* (10.10), *Mangifera griffithii* (8.45), *Eugenia claviflora* (6.60), *Tetramerista glabra* (5.80), *Knema laurina* (5.35), *Litsea grandis* (4.55), and *Stemonurus scorpioides* (3.20).

The trees diameter in Desa Pintung were in general much bigger compare to the trees diameter in Desa Pulau Muda, but the total fifteen trees density (%) in Desa Pulau Muda (74.05) is much higher compare to the trees density in Desa Plintung (57.60). The bigger tree diameter in Desa Plintung may be correlated to the much mature of the peat compare to Desa Pulau Muda which has much young peat land. These evidence is supported the result of study by Rieley *et al.* (1998) which mentioned that the structure and composition of tree species is depended on the type and composition of peat layer.

The tree species showed three layers canopy, the first layer canopy of 30-40 m tall consisted of bintangur (*Calophyllum soulattri*), meranti anak (*Shorea teysmanniana*), meranti bako (*Shorea uliginosa*), and suntai (*Palaquium burckii*). The second layer canopy of 20 - 30 m tall consisted of ramin (*Gonystylus bancanus* and *G. macrophyllus*), terentang (*Cannosperma coriacea*), gerunggang (*Cratoxylum arborescens*), and kelumpang (*Litsea grandis*). The third layer canopy of 10-20 m tall consisted of kelat putih (*Eugenia claviflora*), *E. fascigiata*, manggis hutan (*Garcinia nigrolineata*), pasir-pasir (*Stemonurus scorpioides*), tengkek burung (*Acronychya porteri*), *Ilex macrophylla*, and mempelas (*Mangifera griffithii*).

Table 2. List of 15 dominant trees and their relative density (%) in the observed sites

|                                | P     | J     | M     | T     |
|--------------------------------|-------|-------|-------|-------|
| <i>Calophyllum soulattri</i>   | 12.80 | 15.00 | 15.00 | 42.80 |
| <i>Palaquium hexandrum</i>     | 9.60  | 12.00 | 15.00 | 36.60 |
| <i>Shorea uliginosa</i>        | 4.80  | 8.75  | 3.75  | 17.30 |
| <i>Cannosperma coriacea</i>    | 3.20  | 6.00  | 7.50  | 16.70 |
| <i>Gonystylus macrophyllus</i> | 4.00  | 6.25  | 3.75  | 14.00 |
| <i>Gonystylus bancanus</i>     | 4.00  | 3.75  | 6.00  | 13.75 |
| <i>Palaquium burckii</i>       | 4.80  | 6.00  | 2.50  | 13.30 |
| <i>Shorea teysmanniana</i>     | 3.20  | 2.50  | 6.00  | 11.70 |
| <i>Diospyros maritima</i>      | 1.60  | 6.00  | 2.50  | 10.10 |
| <i>Mangifera griffithii</i>    | 3.20  | 3.75  | 2.50  | 8.45  |
| <i>Eugenia claviflora</i>      | 1.60  | 2.50  | 2.50  | 6.60  |
| <i>Tetramerista glabra</i>     | 0.80  | 2.50  | 2.50  | 5.80  |
| <i>Knema laurina</i>           | 1.60  | 2.50  | 1.25  | 5.35  |
| <i>Litsea grandis</i>          | 0.80  | 1.25  | 2.50  | 4.55  |
| <i>Stemonurus scorpioides</i>  | 1.60  | 0.80  | 0.80  | 3.20  |
| S                              | 57.60 | 77.55 | 74.05 |       |

Note: Sites P = Desa Plintung, J = Desa Sumber Jaya, M = Desa Pulau Muda,

T = Total density relative of the species (%), S = Total relative density of 15 species (%)

Compared to a previous report by Anderson (1976a) who studied in three other localities in Sumatra revealed that the trees composition is very much different. From 16 trees species mentioned by Anderson (1976a) only five species are present in our observed sites namely *Palaquium burckii*, *Shorea uliginosa*, *Gonystylus bancanus*, *Cannosperma coriacea*, and *Shorea teysmanniana*. Other 11 trees species are not present

in our study. This evidence again indicates that other tree species may be expected from different places of the peat swamp forest (see Table 3). Based on the number of tree species of the study namely 53 plus 11 species as an addition of the previous study by Anderson (1976a) then the total tree number of species is become 64.

Compare to other inventory tree species of Borneo (16 species), the trees in Sumatra are very much more in number of species. So far only eight species are also found in the present study namely *Shorea uliginosa*, *Gonystylus bancanus*, *Dyera lowii*, *Mangifera havilandii*, *Palaquium walsurifolium*, *Mezzettia leptopoda*, *Garcinia rostrata*, and *Palaquium alternifolium* (Table 3). From Celebes only three species are recorded namely *Calophyllum soulattri*, *Diospyros malabarica*, and *Livistona rotundifolia*. Those number of tree species indicate that the diversity of the tree species in Sumatra is very high (64 species), followed by Borneo (eight species) and Sulawesi (three species). The small tree species diversity in Borneo and Celebes might be due to lack of published data, we believe that the species tree diversity in Borneo and Celebes will be higher than the number figured above.

Table 3a. List of tree composition in Sumatra, Borneo, and Sulawesi

|                                | P | A | B | S |
|--------------------------------|---|---|---|---|
| <i>Palaquium hexandrum</i>     | + | 0 | 0 | 0 |
| <i>Gonystylus macrophyllus</i> | + | 0 | 0 | 0 |
| <i>Mangifera griffithii</i>    | + | 0 | 0 | 0 |
| <i>Palaquium burckii</i>       | + | + | 0 | 0 |
| <i>Cannosperma coriacea</i>    | + | + | 0 | 0 |
| <i>Shorea teysmaniana</i>      | + | + | 0 | 0 |
| <i>Shorea uliginosa</i>        | + | + | + | 0 |
| <i>Gonystylus bancanus</i>     | + | + | + | 0 |
| <i>Diospyros malabarica</i>    | + | 0 | 0 | + |
| <i>Livistona rotundifolia</i>  | + | 0 | 0 | + |
| <i>Calophyllum soulattri</i>   | + | 0 | 0 | + |
| <i>Garcinia rostrata</i>       | + | 0 | + | 0 |
| <i>Artocarpus rigidus</i>      | 0 | + | 0 | 0 |
| <i>Durio carinatus</i>         | 0 | + | 0 | 0 |
| <i>Eugenia elliptica</i>       | 0 | + | 0 | 0 |
| <i>Shorea platycarpa</i>       | 0 | + | 0 | 0 |
| <i>Strombosia javanica</i>     | 0 | + | 0 | 0 |
| <i>Tristania obovata*</i>      | 0 | + | 0 | 0 |
| <i>Dyera lowii</i>             | 0 | + | + | 0 |
| <i>Mangifera havilandii</i>    | 0 | + | + | 0 |
| <i>Palaquium walsurifolium</i> | 0 | + | + | 0 |
| <i>Mezzettia leptopoda</i>     | 0 | + | + | 0 |
| <i>Palaquium alternifolium</i> | 0 | + | + | 0 |

P= Trees of Sumatra from the present study; A= Trees of Sumatra after Anderson (1976a), B= Trees of Borneo after Anderson (1976b), S= Trees of Celebes after Anonym (1978) and Susanto (1984).

Table 3b. List of trees composition in Sumatra, Borneo, and Sulawesi

|                                | PA | B | S |
|--------------------------------|----|---|---|
| <i>Artocarpus rigidus</i>      | +  | 0 | 0 |
| <i>Cannosperma coriacea</i>    | +  | 0 | 0 |
| <i>Durio carinatus</i>         | +  | 0 | 0 |
| <i>Eugenia elliptica</i>       | +  | 0 | 0 |
| <i>Gonystylus macrophyllus</i> | +  | 0 | 0 |
| <i>Mangifera griffithii</i>    | +  | 0 | 0 |
| <i>Palaquium burckii</i>       | +  | 0 | 0 |
| <i>Palaquium hexandrum</i>     | +  | 0 | 0 |
| <i>Shorea platycarpa</i>       | +  | 0 | 0 |
| <i>Shorea teysmaniana</i>      | +  | 0 | 0 |
| <i>Strombosia javanica</i>     | +  | 0 | 0 |
| <i>Tristania obovata*</i>      | +  | 0 | 0 |
| <i>Dyera lowii</i>             | +  | + | 0 |
| <i>Garcinia rostrata</i>       | +  | + | 0 |
| <i>Gonystylus bancanus</i>     | +  | + | 0 |
| <i>Mangifera havilandii</i>    | +  | + | 0 |
| <i>Mezzettia leptopoda</i>     | +  | + | 0 |
| <i>Palaquium alternifolium</i> | +  | + | 0 |
| <i>Palaquium walsurifolium</i> | +  | + | 0 |
| <i>Shorea uliginosa</i>        | +  | + | 0 |
| <i>Calophyllum soulattri</i>   | +  | 0 | + |
| <i>Diospyros malabarica</i>    | +  | 0 | + |
| <i>Livistona rotundifolia</i>  | +  | 0 | + |

PA= Trees of Sumatra from the present study plus Trees of Sumatra after Anderson (1976a), B= Trees of Borneo after Anderson (1976b), S= Trees of Celebes after Anonym (1978) and Susanto (1984).

Due to the time constrain only existing shrubs and herbs were able to be accounted. In Desa Plintung 21 numbers of shrubs species were recorded, in Desa Sumber Jaya 33, and in Desa Pulau Muda 29, in total there were 58 species (Table 4).

*Cyrtostachys lakka*, *Macaranga diepenhorstii*, and *Uncaria glabrata* were present in all the sites; but 11 species were only found in Desa Plintung (Group 2), 14 species were only in Desa Sumber Jaya (Group 3), and 11 species were only in Desa Pulau Muda (Group 4). Four species namely *Santiria laevigata*, *Eleiodoxa conferta*, *Glochidion rubrum*, and *Macaranga triloba* were found in both in Desa Plintung and Desa Sumber Jaya (Group 5). Three species namely *Psychotria* sp.1, *Cryptocarya erectinerva*, and *Medinilla crassifolia* were found in both in Desa Plintung and Desa Pulau Muda (Group 7). The similar case was noticed for Desa Sumber Jaya and Desa Pulau Muda; 12 species were found in both Desa Sumber Jaya and Desa Pulau muda (Group 6). This evidence indicates that the diversity of shrubs was also very high.

Table 4. List of shrubs in the observed sites

|  | P | J | M |
|--|---|---|---|
| GROUP 1:   |   |   |   |
| <i>Cyrtostachys lakka</i>                              | + | + | + |
| <i>Macaranga diepenhorstii</i>                         | + | + | + |
| <i>Uncaria glabrata</i>                                | + | + | + |
| GROUP 2:   |   |   |   |
| <i>Archidendron clyperia</i>                           | + | 0 | 0 |
| <i>Calamus</i> sp. 1                                   | + | 0 | 0 |
| <i>Daemonorops</i> sp.                                 | + | 0 | 0 |
| <i>Dissochaeta</i> sp.                                 | + | 0 | 0 |
| <i>Korthalsia</i> sp.                                  | + | 0 | 0 |
| <i>Myristica</i> sp.                                   | + | 0 | 0 |
| <i>Pinanga</i> sp.                                     | + | 0 | 0 |
| <i>Piper</i> sp.                                       | + | 0 | 0 |
| <i>Santiria griffithii</i>                             | + | 0 | 0 |
| <i>Trema orientalis</i>                                | + | 0 | 0 |
| <i>Ziziphus angustifolius</i>                          | + | 0 | 0 |
| GROUP 3:   |   |   |   |
| <i>Diospyros pilosnathera</i>                          | 0 | + | 0 |
| <i>Cleidion spiciflorum</i>                            | 0 | + | 0 |
| <i>Diospyros siamang</i>                               | 0 | + | 0 |
| <i>Dysoxylum</i> sp.                                   | 0 | + | 0 |
| <i>Eugenia acuminatissima</i>                          | 0 | + | 0 |
| <i>Eugenia fascigiata</i>                              | 0 | + | 0 |
| <i>Eugenia formosa</i>                                 | 0 | + | 0 |
| <i>Eugenia jamboloides</i>                             | 0 | + | 0 |
| <i>Horsfieldia crassifolia</i>                         | 0 | + | 0 |
| <i>P. excelsa</i> var. <i>borneensis</i> <sup>1)</sup> | 0 | + | 0 |
| <i>Plectronia didyma</i>                               | 0 | + | 0 |
| <i>Poikilospermum suaveolens</i>                       | 0 | + | 0 |
| <i>Ternstroemia glabra</i>                             | 0 | + | 0 |
| <i>Uncaria acida</i>                                   | 0 | + | 0 |
| GROUP 4:   |   |   |   |
| <i>Alyxia floribunda</i>                               | 0 | 0 | + |
| <i>Ardisia</i> sp.                                     | 0 | 0 | + |
| <i>Blumeo. subrotundifolium</i>                        | 0 | 0 | + |
| <i>Calamus</i> sp. 2                                   | 0 | 0 | + |
| <i>Pandanus</i> sp. 2                                  | 0 | 0 | + |
| <i>Paratocarpus forbesii</i>                           | 0 | 0 | + |
| <i>Lecananthus erubescens</i>                          | 0 | 0 | + |
| <i>Garcinia forbesii</i>                               | 0 | 0 | + |
| <i>Psychotria sarmentosa</i>                           | 0 | 0 | + |
| <i>Tristania bakhuiizenii</i>                          | 0 | 0 | + |
| <i>Tristania whittianum</i>                            | 0 | 0 | + |
| GROUP 5:   |   |   |   |
| <i>Santiria laevigata</i>                              | + | + | 0 |
| <i>Eleiodoxa conferta</i>                              | + | + | 0 |
| <i>Glochidion rubrum</i>                               | + | + | 0 |
| <i>Macaranga triloba</i>                               | + | + | 0 |

Table 4. (Continued).

|   | P | J | M |
|---|---|---|---|
| GROUP 6:                                      |   |   |   |
| <i>Cratoxylum arborescens</i>                 | 0 | + | + |
| <i>Diospyros sumatrana</i> var. <sup>2)</sup> | 0 | + | + |
| <i>Eugenia densiflora</i>                     | 0 | + | + |
| <i>Eugenia lineata</i>                        | 0 | + | + |
| <i>Eugenia</i> sp.                            | 0 | + | + |
| <i>Garcinia</i> sp.                           | 0 | + | + |
| <i>Ilex cymosa</i>                            | 0 | + | + |
| <i>Ilex macrophylla</i>                       | 0 | + | + |
| <i>Planchonella obovata</i>                   | 0 | + | + |
| <i>Randia grandis</i>                         | 0 | + | + |
| <i>Ternstroemia foetida</i>                   | 0 | + | + |
| <i>Timonius wallichianus</i>                  | 0 | + | + |
| GROUP 7:                                      |   |   |   |
| <i>Psychotria</i> sp. 1                       | + | 0 | + |
| <i>Cryptocarya erectinervia</i>               | + | 0 | + |
| <i>Medinilla crassifolia</i>                  | + | 0 | + |

Note : P = Plintung, J = Sumber Jaya, M = Pulau Muda

1) = *Platea excelsa* var. *borneensis* 2) = *Diospyros sumatrana* var. *decipiens*

Herbs were the smallest number of species accounted but they were very significantly and visible covered the forest ground, hence the herbs in the three sites were looked very similar. In Desa Plintung there were 13 species, in Desa Sumber Jaya 15 species, and in Desa Pulau Muda 15 species, in total there were 19 species. The nine dominant species (Group 1) occurred in the three sites namely: *Crinum asiaticum*, *Dischidia* sp., *Glechiria linearis*, *Lygodium* sp., *Nepenthes ampularis*, *Asplenium nidus*, *Nepenthes bisserata*, *Nepenthes excelata*, and *Schleria laevis* (Table 5); but *Bulbophyllum macranthum* and *Dianella nemorosa* were only found in Desa Plintung (Group 2), *Bulbophyllum odoratum* was only found in Desa Sumber Jaya (Group 3), and *Pandanus* sp.3 was only found in Desa Pulau Muda (Group 4). *Rhaphidophora apiculata* was found both in Desa Plintung and Desa Sumber Jaya (Group 5); four species namely *Alocasia longiloba*, *Alpinia* sp., *Nepenthes rafflesiana*, and *N. reinwardtii* were found in both Desa Sumber Jaya and Desa Pulau Muda (Group 6), *Nepenthes gracilis* was found in both Desa Plintung and Desa Pulau Muda (Group 7).

In all total plant species observed in these three sites study is 131 species (Table 6) consisting of 64 trees species (including 11 species which were reported by Anderson in 1976a), 58 shrubs species including liana, and 19 herbs species. *Calophyllum soulattri* and *Palaquium hexandra* may be regarded as a tree species forest type of the sites; *Cyrtostachys lakka*, *Macaranga diepenhorstii*, and *Uncaria glabrata* for the shrubs; and *Crinum asiaticum*, *Glechiria linearis*, *Nepenthes bisserata*, *N. excelata*, and *Schleria laevis* may be considered for the herbs.

Table 5. List of herbs in the sites

|                                | P | J | M |
|--------------------------------|---|---|---|
| GROUP 1:                       |   |   |   |
| <i>Crinum asiaticum</i>        | + | + | + |
| <i>Dischidia</i> sp.           | + | + | + |
| <i>Glechinia linearis</i>      | + | + | + |
| <i>Lygodium</i> sp.            | + | + | + |
| <i>Nepenthes ampularia</i>     | + | + | + |
| <i>Asplenium nidus</i>         | + | + | + |
| <i>Nephrolepis bisserata</i>   | + | + | + |
| <i>Nephrolepis excelata</i>    | + | + | + |
| <i>Schleria laevis</i>         | + | + | + |
| GROUP 2:                       |   |   |   |
| <i>Bulbophyllum macranthum</i> | + | 0 | 0 |
| <i>Dianella nemorosa</i>       | + | 0 | 0 |
| GROUP 3:                       |   |   |   |
| <i>Bulbophyllum odoratum</i>   | 0 | + | 0 |
| GROUP 4:                       |   |   |   |
| <i>Pandanus</i> sp             | 0 | 0 | + |
| GROUP 5:                       |   |   |   |
| <i>Rhaphidophora apiculata</i> | + | + | 0 |
| GROUP 6:                       |   |   |   |
| <i>Alocasia longiloba</i>      | 0 | + | + |
| <i>Alpinia</i> sp.             | 0 | + | + |
| <i>Nepenthes rafflesiana</i>   | 0 | + | + |
| <i>Nepenthes reinwardtii</i>   | 0 | + | + |
| GROUP 7:                       |   |   |   |
| <i>Nepenthes gracilis</i>      | + | 0 | + |

Note: P = Plintung; J = Sumber Jaya; M = Pulau Muda

Regarding a forest damaged, however the forest in Desa Pulau Muda is much better protected compare to the one in Desa Plintung and Desa Sumber Jaya. The forests in Desa Plintung and Desa Sumber Jaya had much illegal trees cutting and hence had many opened areas. In around the areas of study a punak's tree (*Tetramerista glabra*) was over harvested for making a plank house, as well as ramin (*Gonystylus macrophyllus* and *G. bancanus*) as an exotic raw materials for a furniture. Even in the Tanjung Puting National Park in Central Kalimantan, this ramin was illegally over exploited (Rieley, 1998). According to local people it was said that dried barks of medang lendir (*Nothophoebe coriacea*) were exported to Taiwan as raw materials for making flammable substance to avoid mosquitos. In 1997 the fresh bark valued of Rp. 200 per kg, the dried bark valued Rp. 600 per kg.

According to World Conservation Monitoring Centre (1994), few of the plant mentioned above are necessary to be noted for their conservation status due to only found in a small population, such as the tree *Ailanthus integrifolia* (Simaroubaceae). *Gonystylus bancanus* and *G. macrophyllus* (Gonystylaceae) which they are considered over harvested for their "gaharu" and the punak tree are apparently not yet evaluated. And surprisingly *Palaquium burckii* and *P. walsurifolium* are not threatened. No shrubs



above are reported in the WCMC's book as rare or endangered except small tree or shrubs of the lipstick palm or sealing wax palm *Cyrtostachys lakka* is rare in Sumatra, but reported endangered to extinct in the wild in Brunei and Singapore, and not threatened in Sarawak. For herbs, just remind that all the wild species of orchid and all pitcher plants of *Nepenthes* are in the very strict supervision by CITES rules. However, again according to the WCMC's book some of the pitcher plant *Nepenthes ampularia*, *N. rafflesiana*, and *N. reinwardtii* which were found there are surprisingly also not threatened. The genus *Nepenthes* is very unique plant and even interesting and beautiful for ornamental.

Table 6. List of plant species in the observed sites

|  |                                |
|--|--------------------------------|
| <i>Acronychya porteri</i>                        | <i>Dissochaeta</i> sp.         |
| <i>Actinodaphne macrophylla</i>                  | <i>Drypetes</i> sp.            |
| <i>Aglaia odorata</i>                            | <i>Dysoxylum</i> sp.           |
| <i>Ailanthus integrifolia</i>                    | <i>Elaeocarpus glaber</i>      |
| <i>Alocasia longiloba</i>                        | <i>Eleiodoxa conferta</i>      |
| <i>Alpinia</i> sp.                               | <i>Eugenia acuminatissima</i>  |
| <i>Alseodaphne oblanceolata</i>                  | <i>Eugenia bankensis</i>       |
| <i>Alyxia floribunda</i>                         | <i>Eugenia claviflora</i>      |
| <i>Antidesma phanerophlebium</i>                 | <i>Eugenia densiflora</i>      |
| <i>Archidendron clyperia</i>                     | <i>Eugenia fascigiata</i>      |
| <i>Ardisia</i> sp.                               | <i>Eugenia formosa</i>         |
| <i>Asplenium nidus</i>                           | <i>Eugenia jamboloides</i>     |
| <i>Blumeoden. subrotundifolium</i>               | <i>Eugenia lineata</i>         |
| <i>Bulbophyllum macranthum</i>                   | <i>Eugenia</i> sp.             |
| <i>Bulbophyllum odoratum</i>                     | <i>Exocarpus latifolius</i>    |
| <i>Calamus</i> sp.1                              | <i>Ficus</i> sp. 1             |
| <i>Calamus</i> sp.2                              | <i>Ficus</i> sp. 2             |
| <i>Calophyllum soulattri</i>                     | <i>Garcinia forbesii</i>       |
| <i>Cannosperma coriacea</i>                      | <i>Garcinia nigrolineata</i>   |
| <i>Canarium denticulatum</i>                     | <i>Garcinia parviflora</i>     |
| <i>Cleidion spiciflorum</i>                      | <i>Garcinia rostrata*</i>      |
| <i>Cratoxylum arborescens</i>                    | <i>Garcinia</i> sp.            |
| <i>Crinum asiaticum</i>                          | <i>Glichenia linearis</i>      |
| <i>Cryptocarya erectinervia</i>                  | <i>Glochidion rubrum</i>       |
| <i>Cyrtostachys lakka</i>                        | <i>Glochidion zeylanicum</i>   |
| <i>Dacryodes rostrata</i>                        | <i>Gomphia serrata</i>         |
| <i>Daemonorops</i> sp.                           | <i>Gonystylus bancanus</i>     |
| <i>Dianella nemorosa</i>                         | <i>Gonystylus macrophyllus</i> |
| <i>Dillenia excelsa</i>                          | <i>Gymnacrantha forbesii</i>   |
| <i>Dillenia pulchella</i>                        | <i>Horsfieldia crassifolia</i> |
| <i>Diospyros hermaphroditica</i>                 | <i>Ilex cymosa</i>             |
| <i>Diospyros malabarica</i>                      | <i>Ilex macrophylla</i>        |
| <i>Diospyros maritima</i>                        | <i>Knema cinerea</i>           |
| <i>Diospyros pilosnathera</i>                    | <i>Knema intermemdia</i>       |
| <i>Diospyros siamang</i>                         | <i>Knema laurina</i>           |
| <i>Diospyros sumatrana</i> var. <i>decipiens</i> | <i>Korthalsia</i> sp.          |
| <i>Diospyros</i> sp.                             | <i>Labisia pumila</i>          |
| <i>Dischidia</i> sp.                             | <i>Lecananthus erubescens</i>  |

|   |  |
|---|--|
| <i>Litsea grandis</i>                             | <i>Platea excelsa</i> var. <i>borneensis</i> |
| <i>Livistona rotundifolia</i>                     | <i>Plectronia dydyma</i>                     |
| <i>Lygodium</i> sp.                               | <i>Poikilospermum suaveolens</i>             |
| <i>Macaranga diepenhorstii</i>                    | <i>Polyalthia laterifolia</i>                |
| <i>Macaranga triloba</i>                          | <i>Psychotria sarmentosa</i>                 |
| <i>Mangifera griffithii</i>                       | <i>Psychotria</i> sp.                        |
| <i>Medinilla crassifolia</i>                      | <i>Randia grandis</i>                        |
| <i>Myristica</i> sp.                              | <i>Rhaphidophora apiculata</i>               |
| <i>Nephenthes ampularia</i>                       | <i>Santiria griffithii</i>                   |
| <i>Nephenthes gracilis</i>                        | <i>Santiria laevigata</i>                    |
| <i>Nephenthes rafflessiana</i>                    | <i>Schleria laevis</i>                       |
| <i>Nephenthes reinwardtii</i>                     | <i>Shorea teymanniana</i>                    |
| <i>Nephrolepis bisserata</i>                      | <i>Shroea uliginosa</i>                      |
| <i>Nephrolepis exceltata</i>                      | <i>Shorea</i> sp. 1                          |
| <i>Nothophoebe coriacea</i>                       | <i>Shorea</i> sp. 2                          |
| <i>Palaquium burckii</i>                          | <i>Stemonurus scorpioides</i>                |
| <i>Palaquium hexandrum</i>                        | <i>Ternstroemia coriacea</i>                 |
| <i>Palaquium obovatum</i> var. <i>occidentale</i> | <i>Ternstroemia foetida</i>                  |
| <i>Palaquium walsurifolium</i>                    | <i>Tetramerista glabra</i>                   |
| <i>Pandanus tectorius</i> var. <i>littoralis</i>  | <i>Timonius wallichianus</i>                 |
| <i>Pandanus</i> sp.1                              | <i>Trema orientalis</i>                      |
| <i>Pandanus</i> sp.2                              | <i>Tristania bakhuizenii</i>                 |
| <i>Parastemon urophyllum</i>                      | <i>Tristania whittianum</i>                  |
| <i>Paratocarpus forbesii</i>                      | <i>Uncaria acida</i>                         |
| <i>Pinanga</i> sp.                                | <i>Uncaria glabrata</i>                      |
| <i>Piper</i> sp.                                  | <i>Xanthophyllum palembanicum</i>            |
| <i>Planchonella obovata</i>                       | <i>Ziziphus angustifolius</i>                |

### Conclusion

Though the floristic study above can be regarded as a preliminary, it was revealed that the plant diversity of the peat swamp forest of the Riau Province of Sumatra is quite high. In all, total plant species observed in these three sites study plus tree species studied by Anderson (1976a, b) is 131 species (Table 6) consisting of 64 trees species, 58 shrubs species including liana, and 19 herbs species. It seems that more sites will be studied, then the species plant number will be increased. To get a complete knowledge therefore a more extensive and comprehensive study on this type of forest still needed in the future, particularly to fill the gap of knowledge regarding the plant diversity which eventually may be very useful for a production of sustainable forest management. Few plant species have to be noticed due to some threats unless it may become extinct from the wild.

### Acknowledgement

First of all we would like to thank Ir. Soewardi a leader of the team from the Forestry Ministry Office who offered us the job in conducted the study. P.T. Satria Perkasa Agung gave us excellent facilities and funding for conducting the study until the technical report was ready. We thank as well to Mr. Wardi and Mr. Deden Girmansyah both are our colleagues in the institute who assisted us during the field observation and

did a very hardwork in identifying the plant under guidance of Mr. Ismail and Mr. Zainal Fanani.

#### Literature Cited

- Anderson, J.A.R. 1976a. Observation on the ecology of five peat swamps in Sumatra and Kalimantan. In: Anwar, J., Damanik, S.J., Hisyam, N. and Whitten, A. J. 1984. *Ekologi Ekosistem Sumatera: Hutan Rawa Gambut*. pp. 245-262, Gadjah Mada Univ. Press. Yogyakarta.
- Anderson, J.A.R. 1976b. Observation on the ecology of five peat swamps in Sumatra and Kalimantan In: Whitmore, T.C. 1975. *Tropical Rain Forest of the Far East*. Claredon, Oxford.
- Anderson, J.M., Proctor, J. and Vallack, H.W. 1983. Ecological studies in four constrasting lowland rain forest in Gunung Mulu National Park, Sarawak III. Decomposition process and nutrient losses from litter. *J. Ecol.*, 71: 505 - 527 In: Anwar, J., Damanik, S.J., Hisyam, N. and Whitten, A. J. 1984. *Ekologi Ekosistem Sumatera*, p. 255. Gadjah Mada Univ. Press. Yogyakarta.
- Anonym. 1997. Laporan Pengkajian dan Penelahaan Permohonan Pemanfaatan Kawasan Lindung Gambut Untuk Hutan Tanaman Industri Atas Nama P.T. Satria Perkasa Agung di Propinsi Riau. Departemen Kehutanan. Jakarta. Mimeograph.
- Anonym. 1978. in Whitten, A.J., Mustafa, M. and Henderson, G.S. 1987. *Ekologi Sulawesi; Hutan RawaGambut*. pp. 492-493, Gadjah Mada Univ. Press. Yogyakarta.
- Anwar, J., Damanik, S.J., Hisyam, N. and Whitten, A. J. 1984. *Ekologi Ekosistem Sumatera: Hutan Rawa Gambut*. pp. 245-262. Gadjah Mada Univ. Press. Yogyakarta. 653 pp.
- Rieley, J., Page, S. and Limin, S. 1998. Peat swamp forest types in the upper catchment of Sungai Sebangau, Central Kalimantan. *Proceedings in Environmental Conservation and Land Use Management of Wetland Ecosystem in Southeast Asia, 6-9 August 1997, Palangka Raya, Central Kalimantan, Indonesia*. pp. 29-34.
- Riswan, S. 1998. The occurrence and Distribution of Peat Swamp Forest in Indonesia. *Proceedings in Environmental Conservation and land Use Management of Wetland Ecosystem in Southeast Asia. 6-9 August 1997. Palangka Raya, Central Kalimantan, Indonesia*. pp. 11 - 22.
- Susanto. 1984. In: Whitten, A.J., Mustafa, M. and Henderson, G.S. 1987. *Ekologi Sulawesi; Hutan RawaGambut*. pp. 492-493. Gadjah Mada Univ. Press. Yogyakarta. 845 pp.
- Threatened Plants Unit. 1993. Conservation Status Listing: Indonesia. World Conservation Monitoring Centre. Cambridge. U.K. List: 218 pp.; data sources for Indonesia: 13 pp.; statistic: 1 p.; index: 22 pp.
- Whitten, A.J., Mustafa, M. and Henderson, G.S. 1987. *Ekologi Sulawesi; Hutan RawaGambut*. pp. 492 - 493. Gadjah Mada Univ. Press. Yogyakarta. 845 pp.

## **Initial Phase of Secondary Succession in the Exploited Peat Swamp Forest (*Shorea albida*) at Sungai Damit, Belait in Brunei Darussalam**

**Shigeo KOBAYASHI\***

Center for International Forestry Research (CIFOR), Jalan CIFOR,  
Situgede, Sindangbalang, Bogor, INDONESIA

Phone: +62-251-622622, fax: +62-251-622100, e-mail: s.kobayashi@cgiar.com

\* Present address: Forestry & Forest products Research Institute, Tsukuba, Ibaraki, JAPAN  
Phone: +81-298-73-3211, e-mail: ksige@ffpri.affrc.go.jp

### **Abstract**

Tropical forests are decreasing at the rate of 16.9 million hectares per year due mainly to clearing for agriculture and shifting cultivation. Timber harvesting results in more than 5 million hectares of tropical forest becoming degraded logged-over forests every year without any adequate managements. Processes of secondary succession provide significant information for the rehabilitation of degraded tropical forests. *Shorea albida* which established pure stands, are now to have been harvesting without plantation. The natural regeneration is the most difficult in this stand because of the long period of flowering and the extremely severe environment. Therefore, the clarification on the initial phase of vegetation recovery at the harvested site will be suggested as the feature of future forest projects at peat swamp areas.

As the results of survey, vigorous vegetation recovery was recorded for 46 months after harvesting. Among of the species, *Pandanus andersonii* and *Nephrolepis biserrata* reproduced vigorously and established their dominance. The number of species increased according to the time lapse after harvesting. 50-60 species/100 m<sup>2</sup> were observed for 45 months after harvesting. However, an average of 30 species was surveyed in the natural forest. Species composition was changing according to time. Natural regeneration by Dipterocarp species was very poor and only three species were observed such as *Dryobalanops rappa*, *Shorea inaequilatealis* and *S. albida*. Nevertheless, the former dominant *S. albida* was recorded at only one plot (3.1/ha). Therefore, the *S. albida* forest will be taken over by different forest types.

### **Introduction**

Tropical forests are decreasing at the rate of 16.9 million hectares per year due mainly to clearing for agriculture and shifting cultivation. Timber harvesting results in more than 5 million hectares of tropical forest becoming degraded logged-over forests every year without any adequate management. The peat lands are widely distributed in Asia of 22.2 million ha compared with 5.2 million ha in America and 3.5 million ha in Africa. 18.2 million ha of peat exist in insular Asia (Kyuma *et al.*, 1986). Tropical peat lands constitute one of the most important areas for the land utilization in insular Asia. Peat swamp forests in Borneo Island are commercially harvested such as timbers, Meranti (*Shorea*), Ramin (*Gonystylus*), Keruing (*Dipterocarpus*) and Tolong (*Agathis*) mainly (Kobayashi 1988). They are converted to oil palm and rubber plantations or agriculture fields, sometimes. These logged-over peat swamp forests are recognized as low values of forest resources without successful natural regeneration. Abandoned agriculture fields and plantations are also degraded such as grasslands, climber covered jungle, low

valued secondary vegetation, ground subsidence of peat and accelerated peat decomposition (1994).

Therefore, the specific *Shorea albida* (Alan) forest which established the pure stand, is now to be exploited without application of Alan plantation. The natural regeneration of *S. albida* is the most difficult in this stand because of the long period of flowering and the extremely severe environment (Anderson, 1964; Funakawa *et al.*, 1995). The initial phase of vegetation recovery at the harvested site is suggested as the feature of future forest projects at peat swamp areas (Kobayashi, 1994). Processes of secondary succession provides significant information for the rehabilitation of degraded tropical forests (Tilman, 1997). Initial secondary succession as the biodiversity changes was described as exponential increase which facilitation and competition process are observed (Auclair *et al.*, 1971; Callaway *et al.*, 1997).

Therefore, the final study target is to be decided the facilitation process or competition process at the initial vegetation recovery for the rehabilitation of degraded peat swamp forest.

Purposes of this study are:

- (1) to clarify the natural forest structure at the study site (Alan Bunga) for the future forest projection.
- (2) to clarify the initial phase of vegetation recovery (dominance changes, plant diversity changes, species composition changes) 1 to 46 months after forest harvesting.
- (3) to clarify the recovered vegetation types as “facilitation process” or “competition process”.
- (4) to discuss the possibility of the Alan forest recovery and necessity of the treatment for the rehabilitation of degraded Alan forest ecosystem.

### Site Description and Methods

#### *Site*

The study site is located on the east part of Belait Peat Swamp Forest Reserve, where attains on the water pipe from Badas to Seria. Badas is relatively higher than Seria in elevation. Peat dominates over the study site, Kerangas (white silica sand) is distributed at Badas, and sand soil is composed under mixed swamp forests overlaying peat and mud clay near Seria, comparatively. The study site on the vegetation recovery after forest harvesting is located 25 km from Kuala Belait, on the side of Sungai Damit where is one of the Sungai Belait river branches in the Belait Peat Swamp Forest Reserve.

The landform of tropical peat swamp forms convex dome at this study site. Different forests types are observed from outside of dome to center such as the mixed swamp forest dominated *Dryobalanops rappa*, Alan Batu, Alan Bunga, Alan Padang and Padang Paya forest. Among of these forests, Alan forests occupy wide area and consist of pure *S. albida* stands (Ashton, 1964; Kobayashi, 1988).

According to Soil taxonomy, peat of different Alan forest types is classified into Oligotrophic Tropofibrists at this study site. Hemic material is dominated until 20-80 cm in depth and loose fibric material becomes fluid in upper horizon held by root system which appears under the ground water level (Kobayashi, 1989; Swanson *et al.*, 1989).

This study site was exploited from 1 to 7 months interval at the blocks (200 m × 200 m) from 1981 to 1988.

### Methods

Experimental site is shown in Fig.1. Each quadrat size is 10 m × 10 m in 200 m × 200 m where *Shorea albida* was harvested from 1 month to 46 months after harvesting for the exploited area and 15 plots were set (Fig. 1). Quadrat of 30 m × 30 m is for the natural forest. Vegetation survey was conducted on the species composition, the dominance and height of each species by Braun-Blanquet's method.

Mean diversity and total diversity were calculated using dominance value (Lloyd *et al.*, 1964; Pielou, 1975). Species composition table was made to examine relationships between the vegetation types and the following characteristics of each species.

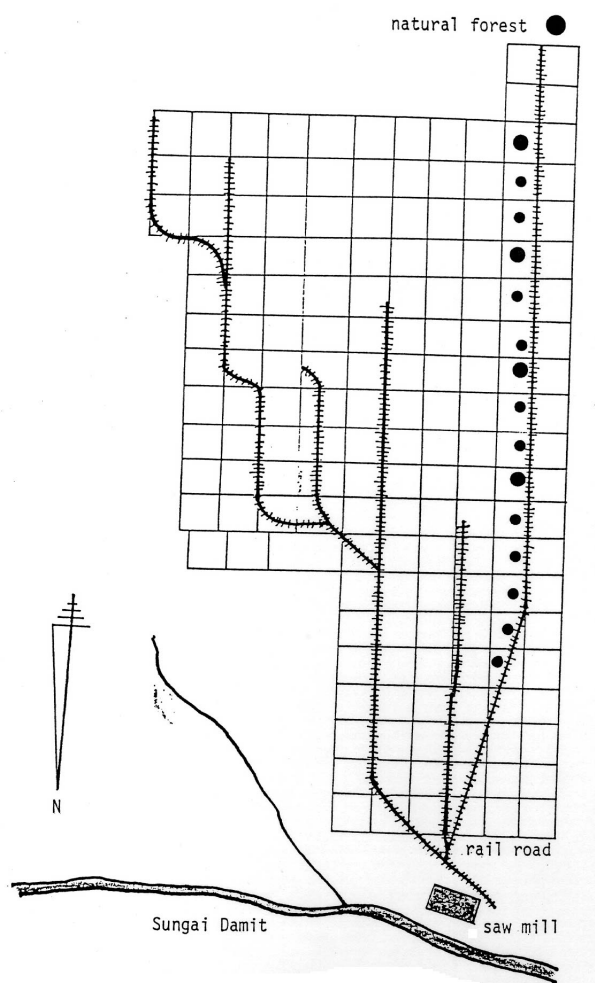

Fig. 1. Location of study site at Sungai Damit, Brunei. Quadrat represents the harvest unit and its size is about 200 m × 200 m. Dot indicates survey unit.

### Results and Discussions

#### *The structure of Alan natural forest*

The structure of Alan natural forest is characterized its mono-dominance by *Shorea albida* (Alan) which is classified into three types such as Alan Batu (DBH = 87.8 cm, height = 49.0 m), Alan Bunga (DBH = 65.0 cm, height = 48.0 m) and Alan Padang

(DBH = 38.7 cm, height= 33.3 m). The experimental forest consists of 77.7/ha in density, 60.9 m<sup>2</sup>/ha in basal area and more than 65 cm in DBH. This forest is classified into Alan Bunga (Fig. 2). Alan Bunga forest is pure stand which is peculiar in natural tropical forest (Kobayashi, 1988). When this Alan forest is harvested, it becomes like a clear-cutting except remaining a few bad quality individuals which will be easily fallen down by wind and have difficulties to blossom (Kobayashi, 1997). The natural regeneration of Alan forest seems to be difficult, although the vegetation recovery is observed vigorously in the peat swamp forest. Therefore, *S. albida* forest must be conserved on the view of biodiversity.

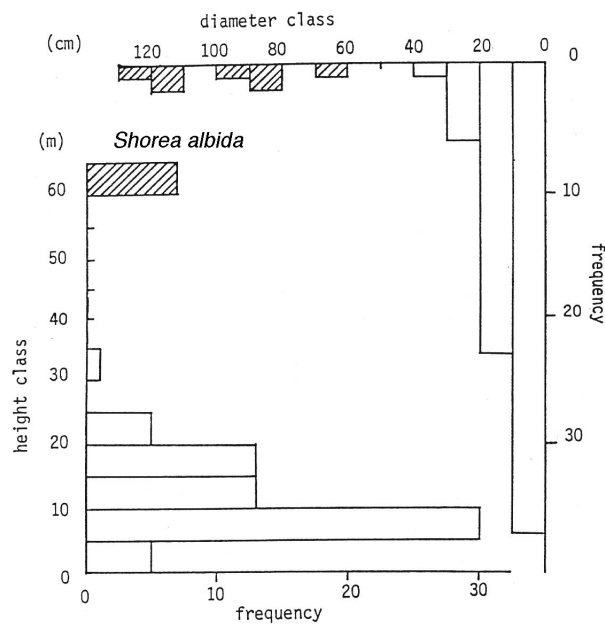

Fig. 2. Natural forest structure of *Shorea albida* at Sungai Damit, Brunei. Quadrat size is 30 m × 30 m.

### **Changes of plant diversity during initial secondary succession**

Vigorous vegetation recovery is observed that change of species number per 100 m<sup>2</sup> indicates to increase linearly as  $Y = 5.5 + 0.9X$  ( $R = 0.8447$ ) according to time sequence after harvesting. "Y" is species number and "X" is month after harvesting. Maximum species number is recorded as 67 species/100 m<sup>2</sup> for 46 months after harvesting compared with 26 species/100 m<sup>2</sup> at the natural forest (Table 1). The herb and fern recover quickly at first one year and the shrub and climber become co-dominance following time. Almost herb and fern have disappeared for four years after harvesting and some shrub and climber remain until mature phase. These co-existing species play the role to be competitor and/or facilitator for secondary succession (Holmgren *et al.*, 1997; Li *et al.*, 1998). Especially, fern and climber play their rolls as competitors typically. Among of recovered species, *Pandanus andersonii* and *Nephrolepis biserrata* establish their dominance at early phase of two to four years (Fig. 3). *N. biserrata* disappears during initial phase. *P. andersonii* is expected to remain to dominate undergrowth at mature phase (Table 1).

Table 1. Changes of species composition at peat swamp forest after harvesting of *Shorea albida*, Brunei. Quadrat size is 10 m × 10 m.

| Species no.<br>Months after logging<br>Species name   | Plot no |     |     |     |     |     |     |    |    |    |    |    |    |    |    | E0 |
|---|---------|-----|-----|-----|-----|-----|-----|----|----|----|----|----|----|----|----|----|
|   | E16     | E15 | E14 | E13 | E12 | E11 | E10 | E9 | E8 | E7 | E6 | E5 | E4 | E3 | E2 |    |
|   | 14      | 16  | 14  | 20  | 23  | 20  | 29  | 27 | 26 | 32 | 46 | 54 | 44 | 48 | 67 | 26 |
|   | 1       | 8   | 12  | 15  | 18  | 22  | 26  | 33 | 35 | 38 | 41 | 42 | 43 | 45 | 46 |    |
| <i>Pandanus andersonii</i>                            | +       | 1   | 2   | 2   | 1   | 3   | 3   | 3  | 5  | 2  | 4  | 4  | 3  | 3  | 3  | 5  |
| <i>Nephrolepis biserrata</i>                          |         | 2   | 4   | 4   | 2   | 5   | 3   | 3  | 3  | 4  | 3  | 4  | 3  | 1  | 1  |    |
| <i>Plastris (leminding)</i>                           | 1       | +   | 1   | +   | +   | 1   | 1   | 1  | 1  | 1  | +  | 1  | +  |    | +  |    |
| <i>Picus punctata</i> (Moraceae)                      | +       | +   | +   | 2   | 1   | 2   | +   | 3  | 2  | 1  | +  | 1  | +  | +  | +  |    |
| <i>Timonius flavescens</i>                            | +       | 1   | +   | +   | +   |     | 2   |    | +  | 1  |    |    |    | +  | 3  |    |
| <i>Symplocos</i> (Symlocaceae)                        | +       |     |     |     |     | +   |     | 1  |    | +  |    |    |    |    |    |    |
| <i>Nepenthes gracilis</i>                             |         |     |     |     | 1   |     | 1   | +  |    |    | +  |    | 1  |    |    |    |
| <i>Poikilopernum annesenus</i>                        |         |     | +   |     |     |     |     |    | 2  |    |    |    |    |    |    |    |
| <i>Macaranga puncticulata</i> (Euphorbiaceae: Mahang) |         |     |     |     | +   |     |     |    |    | 1  | +  |    |    |    |    |    |
| <i>Ilex hypoglauca</i>                                | +       | +   | +   | +   | +   |     |     | +  |    |    |    |    | 2  | 1  |    |    |
| <i>Diospyros buxifolia</i>                            | +       | +   |     |     |     | +   | 1   |    |    |    |    |    |    | 1  | 1  |    |
| <i>Eugenia cerina</i> (Myrtaceae: Ubah)               |         |     |     | 2   | 3   | +   | 3   | 1  | +  |    | 3  | 1  | 4  | 3  |    |    |
| <i>Ganua curtisii</i> (Nyatoh)                        |         |     |     | +   |     |     | 1   |    |    |    | +  | 1  | 1  |    | +  |    |
| <i>Lithocarpus sundaica</i>                           |         |     | +   | 1   | +   |     |     | 2  | +  | +  | +  | 2  | 1  | 2  |    |    |
| <i>Litsea cylindrocarpa</i> (Medang)                  |         |     |     |     |     | 1   |     | +  | +  | 1  | 2  | 2  | +  | 2  | 2  | 2  |
| <i>Nepenthes rafflesia</i>                            |         |     |     |     | 1   | +   | +   |    |    |    | 1  | 1  | 1  | 3  | 1  |    |
| <i>Knema</i>  |         |     |     |     |     | +   |     |    |    |    |    |    |    | 1  | 1  |    |
| <i>Platea excelsa</i>                                 |         |     |     |     |     |     |     | 1  |    |    |    |    | +  | 2  |    |    |
| <i>Polyalthia hypoleuca</i>                           |         |     |     |     |     |     |     |    |    |    |    |    |    | 2  | 2  |    |
| <i>Annamonomus</i> (Lauraceae)                        |         |     |     |     |     |     |     |    |    |    |    |    |    | 2  |    |    |
| <i>Ixonanthes reticulata</i>                          |         |     |     |     |     |     |     |    |    |    |    |    |    | 3  |    |    |
| <i>Tetorastigma</i> (Vitaceae)                        | +       |     | +   | 1   | 1   | +   | 2   | +  | +  | 1  | +  | +  |    | +  | +  |    |
| <i>Euphorbiaceae</i>                                  |         |     | 1   | 1   |     | 2   | 2   | 2  | 1  | 3  | 3  | 2  | 3  | +  | +  | +  |
| <i>Paederia</i> (Rubiaceae)                           | +       |     |     |     | 4   | 1   | 1   | 1  | 1  | 1  | +  | 3  | +  | +  | +  | +  |
| <i>Leucananthus</i> (Rubiaceae)                       |         |     |     |     | 1   | +   | 1   | 1  |    | 1  | 1  | 1  | +  | +  | +  | +  |
| <i>Dryobalanops rappa</i>                             |         |     |     |     |     |     |     |    | 1  |    | 2  |    | 2  |    |    |    |
| <i>Shorea albida</i>                                  |         |     |     |     |     |     |     |    |    |    |    |    |    |    |    | 4  |
| <i>Gonystylus forbesii</i> (Ramin)                    |         |     |     |     |     |     |     |    |    |    |    |    |    |    |    | 2  |

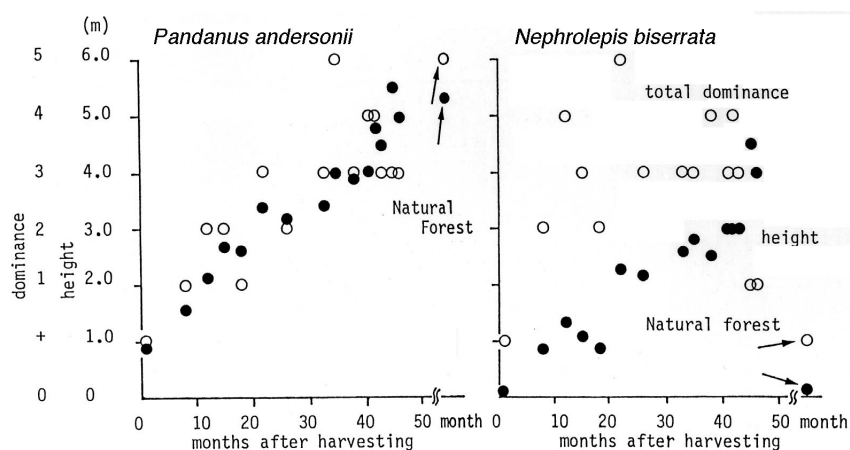

Fig3. Changes of total dominance and height in two dominant species (*Pandanus andersonii*, and *Nephrolepis biserrata*) after harvesting of *Shorea albida* forests at Peat Swamp, Sungai Damit, Brunei.



Mean and total diversity increase until 3.594 and 945.7 at 46 months after harvesting, but the natural forest indicates 2.145 in mean diversity and 502.0 in total diversity respectively (Figs. 4, 5). This change is caused by reproductive methods of each species, clear cutting like, and lack of seed sources. Secondary succession shows exponential increase at initial phase and then gradually decrease (Auclair *et al.*, 1971; Kobayashi, 1987). This study indicates same trend regarding biodiversity at the mature Alan forest.

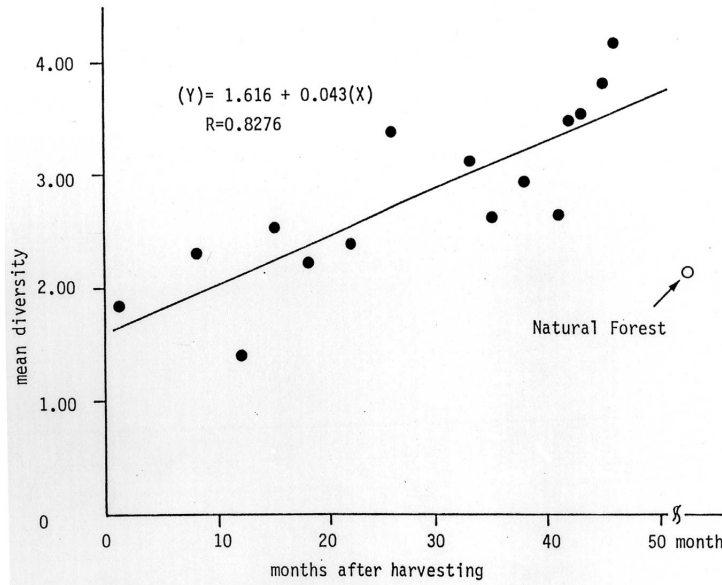

Fig4. Changes of mean diversity in Peat Swamp after harvesting of *Shorea albida* natural forests at Sungai Damit, Brunei.

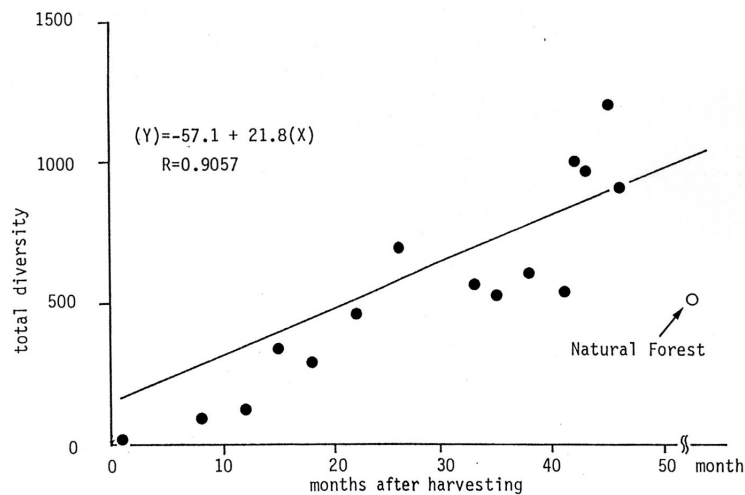

Fig5. Changes of total diversity in Peat Swamp after harvesting of *Shorea albida* natural forests at Sungai Damit, Brunei. Total diversity represents that mean diversity multiplies total dominance values.

**Perspective for the forest recovery**

Initial vegetation recovery is classified into Shrub, Herb, Fern and Climber types. Shrub and Herb types are considered as facilitation process and Fern and Climber types are competition process during secondary succession according to species changes, although *S. albida* forest is not expected to re-establish (Fig. 6). This perspective is recognized coupled with natural regeneration by Dipterocarp species and Ramin is very poor. Three species are observed such as *Dryobalanops rappa*, *Shorea inaequilatealis* and *S. albida* (Table 2). The former dominant *S. albida* was recorded at only one plot (3.1/ha). Therefore, the *S. albida* forest will be taken over by different forest types which are expected low value resources. If *S. albida* forest and/or high value forest is maintained, silviculture treatments such as enrichment planting, mixed plantation and accelerating methods must be applied to these logged-over peat swamp forests.

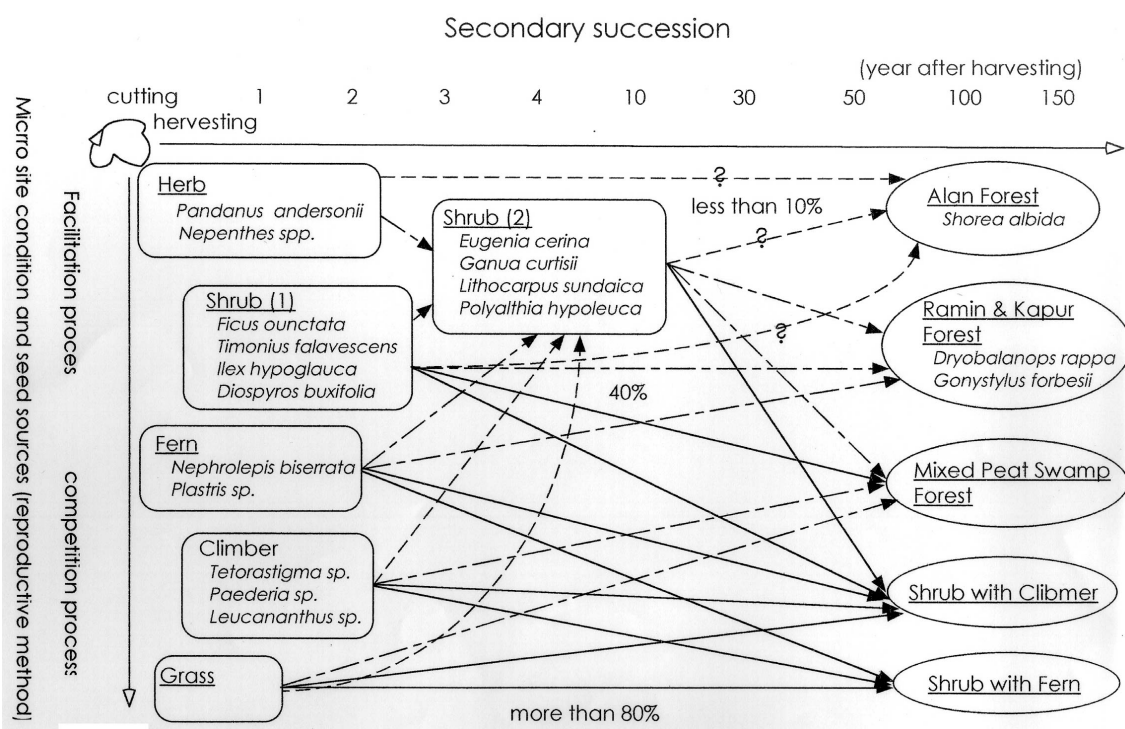

Fig. 6. Secondary succession process and projection of future forest recovery based on species composition and dominance changes at initial phase of succession.

For trying to answer against these questions, I surveyed initial vegetation recovery and have classified into undergrowth vegetation types for the predictions of species changes on a logged-over tropical peat swamp Alan forest. The influences and roles of vegetation types on the secondary succession have been discussed as the facilitation process or competition process related to environment (Holmgren *et al.*, 1997; Li *et al.*, 1998) and each interaction (Callaway *et al.*, 1997). Fern and Climber types indicate the composition process, because they remain same type, smallest species number and smallest recruit to the woody shrub 46 months after forest harvesting. Herb and Shrub

types represent the facilitation process because of higher species number and the highest recruit to the woody shrub. Shrub and Fern types will be classified into lower criteria based on the furthermore monitoring. Even though the vegetation recovery shows the facilitation process, I can not expect the Alan forest recovery caused by lack of Alan seedlings.

Table 2. Condition of species natural regeneration of Dipterocarp species in the Peat Swamp forest. Sungai Damit after harvesting of *Shorea albida*.

| Plot no  | Species                       | Density<br>(/100 m <sup>2</sup> ) | Height<br>(cm) |
|----------|-------------------------------|-----------------------------------|----------------|
| E16 (1)* | <i>Dryobalanops rappa</i>     | 0.5                               | 39             |
| E10 (26) | <i>Dryobalanops rappa</i>     | 0.2                               | 384            |
|          | <i>Shorea albida</i>          | 0.5                               | 20             |
| E8 (35)  | <i>Dryobalanops rappa</i>     | 1.0                               | 389            |
| E5 (42)  | <i>Dryobalanops rappa</i>     | 3.0                               | 570            |
| E3 (45)  | <i>Dryobalanops rappa</i>     | 5.0                               | 650            |
| E2 (46)  | <i>Shorea inaequilatealis</i> | 5.0                               | 710            |

\* Months after harvesting

Rehabilitation of this degraded tropical peat swamp forest must be initiated by the inventory study (Lee, 1979). And the recovered vegetation will be classified into facilitation and competition processes. Enrichment planting by Alan cuttings must be applied at the competitive vegetation, because Alan cuttings have been produced by special techniques to overcome some difficulties (Uchimura *et al.*, 1994).

### Conclusion

- (1) The structure of a natural forest indicates its mono-dominance by *Shorea albida* which consists of 77.7/ha in density, 60.9 m<sup>2</sup>/ha in basal area and more than 65 cm in DBH. Therefore, this forest became like a clear-cutting except remaining a few bad quality individuals.
- (2) Vigorous vegetation recovery is recorded as 67 species/100m<sup>2</sup> for 46 months after harvesting compared with 26 species/100m<sup>2</sup> at the natural forest. Among of the species, *Pandanus andersonii* and *Nephrolepis biserrata* established their dominance and *P. andersonii* will be expected to remain to dominate undergrowth at mature phase.
- (3) Mean and total diversity increase until 3.594 and 945.7 at 46 months after harvesting, but the natural forest indicates 2.145 in mean diversity and 502.0 in total diversity respectively. This change is caused by reproductive methods of each species, clear cutting like, and lack of dominant seed source.
- (4) Shrub and Herb types are considered as facilitation process, and Fern and Climber types are competition process during secondary succession, although *S. albida* forest is not expected to re-establish.
- (5) Natural regeneration by Dipterocarp species and Ramin is very poor. Three species are observed such as *Dryobalanops rappa*, *Shorea inaequilatealis* and *S. albida*. The former dominant *S. albida* was recorded at only one plot (3.1/ha). Therefore, the *S. albida* forest will be taken over by different forest types which are expected low value

resources. If *S. albida* forest and/or high value forest is maintained, silviculture treatments such as enrichment planting, mixed plantation and accelerating methods must be applied to these logged-over peat swamp forests.

#### Acknowledgement

I would like to thank Emi Ueda, FFPRI, for her help and useful comments. This study was supported by JICA technical cooperation project in Brunei Darussalam. Table 2. Condition of natural regeneration of Dipterocarp species in the Peat Swamp forest, Sungai Damit after harvesting of *Shorea albida*.

#### References

- Auclair, A.N. and Goff, F.G. 1971. Diversity relations of upland forest in the western Great Lakes area. *The American Naturalist*, 105: 499-528.
- Anderson, J.A.R. 1964. The structure and development of the peat swamps of Sarawak and Brunei. *J. Trop. Geogr.*, 18: 7-16.
- Ashton, P. S. 1964. *Manual of the Dipterocarp Trees of Brunei State*. Oxford Univ. 242 pp.
- Callaway, R. M. and Walker, L. R. 1997. Competition and facilitation: a synthetic approach to interaction in plant communities. *Ecology*, 78: 1958-1965.
- Furukawa, H. 1988. Stratigraphic and geomorphic studies of peat and giant podzols in Brunei. I. Peat. *Pedology. Jpn.*, 32: 26-42 (in Japanese).
- Funakawa, S., Yonebayashi, K., Shoon, J. F. and Khun, E. C. O. 1995. Nutritional environment of tropical peat soils in view of soil solution composition. In: Yonebayashi, K. and Pang, L. C. (eds.), *Environmental Rehabilitation of Tropical Peat Land: Sustainable Land Use and Soil Ecosystems In Peat Land*, Kyoto, pp. 65-75.
- Kobayashi, S. 1987. Biodiversity of coniferous forests in Japan. *Species Ecology*. VIII. 35-45. (in Japanese)
- Kobayashi, S. 1988. The maintenance and effective use of forest resources in Negara Brunei Darussalam. Forest Research Note in Brunei Darussalam. 11-1. pp.175.
- Kobayashi, S. 1988. Peat swamp forest, tropical heath forest and mixed Dipterocarp forest related to forestry in Brunei Darussalam. *Nettai-Ringyou*, 11: 17-23 (in Japanese).
- Kobayashi, S., Ochiai, Y., Jilli, R. and Wahid, R. 1994. Preliminary study on composting tropical peat. *Bull. For. & For. Prod. Res. Inst.*, 366: 79-87 (in Japanese).
- Kobayashi, S. 1994. Effects of harvesting impacts and rehabilitation of tropical rain forest. *J. Plant Res.*, 107: 99-106.
- Kobayashi, S. 1997. Site conditions of peat swamp forest and vegetation recovery process after harvesting in Seria, Brunei Darussalam. *International Workshop on Environmental Management of Wetland Ecosystem in South East Asia. Abstracts. JSPS. Palangka Raya*. p. 29.
- Kobayashi, S. 1997. Forest structure and regeneration process of peat swamp forest (*Shorea albida*) in Brunei Darussalam. *Abstracts. JICA/PUREHUT. Samarinda*. p. 34.
- Kyuma, K., et al. (TARQ). 1986. Lowland swamp in South East Asia. Norin-Tokei. pp. 301 (in Japanese).
- Lee, H. S. 1979. Natural regeneration and reforestation in the peat swamp forests of

- Sarawak. *TARQ Tropical Agriculture Research Series*, 12: 51-60.
- Li, X. and Wilson, S. D. 1998. Facilitation among woody plants establishing in an old field. *Ecology*, 79: 2964-2705.
- Lloyd, M. and Ghelardi, R.J. 1964. A table for calculating the "Equitability" component of species diversity. *J. Animal Ecology*, 33: 217-225.
- Pielou, E.C. 1975. *Ecological Diversity*. Wiley-Intersci.
- Swanson, D.K. and Grigal, D.F. 1989. Vegetation indicators of organic soil properties in Minnesota. *Soil Sci. Am. J.*, 53: 491- 495.
- Tilman, D. 1997. Community invasibility, recruitment limitation, and grassland biodiversity. *Ecology*, 78: 81-92.
- Tilman, D., Wedin, D. and Knops, J. 1996. Productivity and sustainability influenced by biodiversity in grassland ecosystems. *Nature*, 379: 718-720.
- Uchimura, Y., Asaishi, H. and Kurosu, K. 1994. Study on the cuttings production of the peat swamp tree species in Sarawak, Malaysia. In: *Proc. Inter. Workshop BIO-REFOR, Yogyakarta*, pp. 144-148.

## Proposed Methodology on Determination of Photosynthetic Capacity of Peatland Vegetation: Soybean as a Study Case

Tania JUNE<sup>1</sup> and Mitsuru OSAKI<sup>2</sup>

<sup>1</sup>Bogor Agriculture University, Bogor

<sup>2</sup>Faculty of Agriculture, Hokkaido University, Sapporo, 060-8589, Japan,

E-mail: mosaki@chem.agr.hokudai.ac.jp;

### Introduction

Type of vegetation/crop living in a peatland ecosystem depends on the soil and agroclimatic conditions. By observing the dominance of a certain vegetation, the level of soil fertility, and agroclimatic suitability of that vegetation can be obtained. Plant dominance is determined by the ability of plants to photosynthesize effectively and accumulate assimilate for growth.

Potosynthetic capacity, that is the potential capacity of a plant to photosynthesize at a highest rate under a certain environment, can be used as parameters showing how good the plant perform under a certain environmental conditions. Also, by comparing photosynthetic capacity of a same type of vegetation under different environmental condition give us information on the suitability of a certain location for this type of vegetation.

The poster presented here introduced the method to obtain  $V_{cmax}$  and  $J_{max}$  from gas exchange measurement using the model of Farquhar *et al.* (1980) and Faquhar and von Caemmerer (1982), in order to be able to identify modification or acclimation in the model parameters of peatland vegetation. Examples of measurement on soybean were shown.

### Methodology

#### Models of leaf photosynthesis

Leaf photosynthesis can be described by the equations developed by Farquhar *et al.* (1980) and Farquhar and von Caemmerer (1982). The basic assumption underlying the model is that the rate of photosynthesis is controlled by the amount of activated enzyme RuBP carboxylase-oxygenase (Rubisco), the rate of regeneration of RuBP, and the relative partial pressures of CO<sub>2</sub> ( $c_i$ ) and O<sub>2</sub> at the site of CO<sub>2</sub> fixation. Therefore, under a given set of environmental conditions, the net CO<sub>2</sub>-assimilation rate,  $A$ , is taken as being either the Rubisco-limited rate,  $A_v$ , or the predicted RuBP-regeneration limited rate of photosynthesis,  $A_j$ , whichever is the lower at a particular  $c_i$  (This holds for  $c_i > \Gamma^*$ ).  $A$  has units of  $\mu\text{mol m}^{-2} \text{s}^{-1}$ .

$$A_j = \frac{J}{4} \left( \frac{c_i - \Gamma^*}{c_i + 2\Gamma^*} \right) - R_d \quad (1)$$

$$A_v = V_{cmax} \left( \frac{c_i - \Gamma^*}{K_c \left( 1 + \frac{O}{K_o} \right) + c_i} \right) - R_d \quad (2)$$

$$A = \min (A_j, A_v) \quad (3)$$

where  $c$  is partial pressure of CO<sub>2</sub> in the leaf (μbar);  $\Gamma^*$  = CO<sub>2</sub> compensation partial pressure in the absence of dark respiration ( $P_a$ );  $R_d$  = dark respiration by the leaf which continues in the light (μmol m<sup>-2</sup> s<sup>-1</sup>);  $O$  = ambient partial pressure of oxygen (21%);  $K_c$  and  $K_o$  are Michaelis-Menten constants for carboxylation and oxygenation by Rubisco ( $P_a$ ), respectively;  $V_{cmax}$  is the maximum rate of Rubisco activity in the leaf; and  $J$  is the actual electron transport rate (μmol m<sup>-2</sup> s<sup>-1</sup>).

The temperature dependence of  $K_c$  and  $K_o$  follows an Arrhenius function:

$$K_c = K_{c,25} \exp \left[ \frac{E_c}{298.2R} \left( 1 - \frac{298.2}{(T + 273)} \right) \right] \quad (4)$$

$$K_o = K_{o,25} \exp \left[ \frac{E_o}{298.2R} \left( 1 - \frac{298.2}{(T + 273)} \right) \right] \quad (5)$$

where  $R$  is the universal gas constant, 8.3144 J mol<sup>-1</sup> K<sup>-1</sup>, and  $T$  is temperature in °C.  $E_c$  and  $E_o$  are the apparent activation energies and the 25 subscript refers to the value at 25°C.

The effect of temperature on the CO<sub>2</sub> compensation point of photosynthesis in the absence of mitochondrial respiration follows the equation of von Caemmerer *et al.* (1994):

$$T^* = 36.9 + 1.88(T - 25) + 0.036(T - 25)^2 \quad (6)$$

The photosynthesis parameters  $K_c$  (Pa),  $K_o$  (Pa),  $\Gamma^*$  (Pa) and related activation energies (J mol<sup>-1</sup>) for  $K_c$  and  $K_o$  at 25°C are 40.4, 24800, 3.69 and 59400, 36000, respectively (Badger and Collatz 1977; von Caemmerer *et al.* 1994).

The rate of electron transport,  $J$ , follows the equation by Farquhar and Wong (1984):

$$J = \frac{Ia_2 + J_{max} - \sqrt{(Ia_2 + J_{max})^2 - 4\Theta Ia_2 J_{max}}}{2\Theta} \quad (7)$$

where  $J_{max}$  is the maximum light-saturated rate of electron transport of the leaf (μmol m<sup>-2</sup> s<sup>-1</sup>),  $\Theta$  is the curvature factor of the light response curve that varies from 0 (rectangular hyperbola) to 1 (two straight lines quasi Blackman). The value of  $\Theta$  is usually taken as 0.7 (Evans and Farquhar, 1987),  $a_2$  is the quantum yield of electron transport at low light and  $I$  is the light intensity incident on the leaf.

### Estimation of model parameters

There are seven parameters that need to be estimated:  $K_c$ ,  $K_o$ ,  $\theta$ ,  $a_2$ ,  $V_{cmax}$ ,  $J_{max}$  and  $R_d$ .  $K_c$  and  $K_o$  indicate the intrinsic kinetic properties of Rubisco. They are relatively constant, varying only with temperature for all C<sub>3</sub> species (Berry and Björkman 1980,

Jordan and Ogren 1984), and hence in this analysis the values presented by Badger and Collatz (1977) and von Caemmerer *et al.* (1994) were used. However, the values of  $J_{\max}$ ,  $V_{\text{cmax}}$  and  $R_d$  can vary greatly between species and growth conditions (Farquhar and von Caemmerer 1982), and hence they should be estimated for all treatments at different leaf temperatures. From the measurement of the light response curves, where the incident light ranged from 0 to 1650  $\mu\text{mol m}^{-2} \text{s}^{-1}$ ,  $R_d$  can be determined by extrapolation of a linear regression at the lower end of the response curve (at  $I = 0\text{-}150 \mu\text{mol m}^{-2} \text{s}^{-1}$ ). Using this interpolated  $R_d$  along with  $\Gamma^*$  corrected for each temperature using Eq. (6),  $J$  was calculated from Eq. (1) and then  $J_{\max}$ ,  $a_2$  were estimated by fitting the  $J$ -light curve with Eq. (7).  $V_{\text{cmax}}$  was estimated from the lower end of the  $c_i$  response curve at  $c_i$  up to around 200  $\mu\text{bar}$ . Temperature dependence of  $K_c$  and  $K_o$  follows Eqs. (4) and (5).

### Gas exchange measurement: soybean as an example

Rates of  $\text{CO}_2$ -assimilation of soybean leaves (grown under different  $\text{CO}_2$  and temperatures) were measured over a wide range of  $\text{CO}_2$  concentrations (50-900  $\mu\text{mol mol}^{-1}$ ), photon flux densities (0-1650  $\mu\text{mol m}^{-2} \text{s}^{-1}$ ) and leaf temperatures (15-35°C). Leaf to air vapour pressure difference was maintained at about 12.5 mbar. Irradiance at the leaf surface for all  $\text{CO}_2$  exchange measurements was maintained at 1200  $\mu\text{mol m}^{-2} \text{s}^{-1}$ , except during measurement of the light response curve. Each different  $\text{CO}_2$  concentration was maintained for at least 30 min to reach a steady state gas exchange, while each light intensity was maintained for at least 20 min before the measurements were recorded. Measurements have to be made on expanded leaves of the third trifoliolate (14-16 days after emergence of the leaves with emergence is defined as leaf length of 2 cm).

### Results of Measurements on Soybean

#### $\text{CO}_2$ response curve, $V_{\text{cmax}}$

Fig. 1 shows the relationship obtained experimentally between the  $\text{CO}_2$ -assimilation rate and  $c_i$  at different measurement temperatures for plants grown at low (20/15°C) and high temperature (32/27°C) with both 350 and 700  $\mu\text{mol mol}^{-1}$   $\text{CO}_2$  concentrations.

In general, the response curves show a typical crossing-over due to increases in the  $\text{CO}_2$ -compensation point and the RuBP-regeneration rate with increasing temperature. The response is similar to that found by Kirschbaum and Farquhar (1984) for *Eucalyptus pauciflora*.

#### Light-electron transport curve: $J_{\max}$

Fig. 2 shows examples of the light response curve of electron transport for plants grown at  $[\text{CO}_2]$  of 350  $\mu\text{mol mol}^{-1}$  and temperatures of 32/27°C and 20/15°C (day/night) measured at three different temperatures. The electron transport rate ( $J$ ) was calculated using Eq. (1).



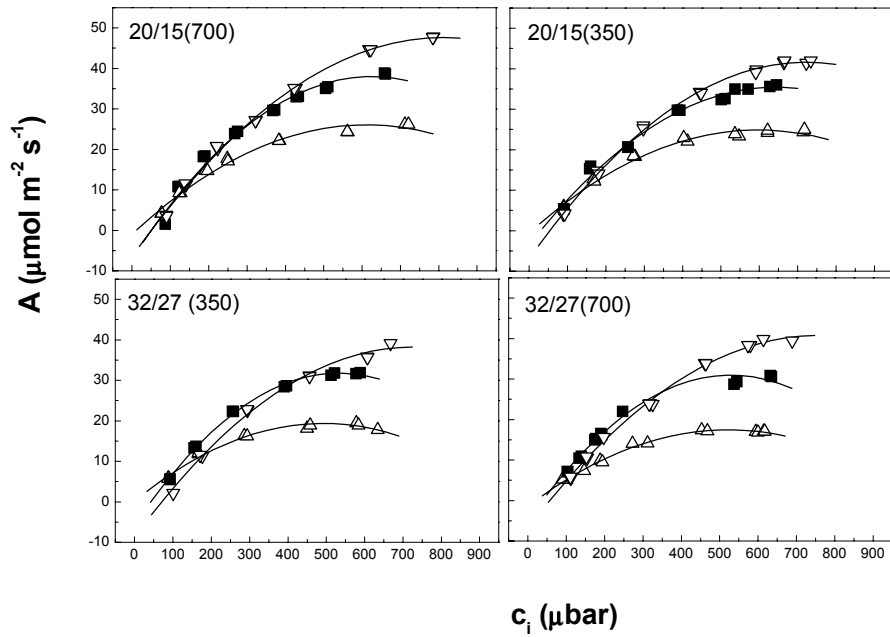

Fig. 1. Relationship between net  $\text{CO}_2$ -assimilation rate ( $A$ ) and intercellular concentration of  $\text{CO}_2$  ( $c_i$ ) obtained at 3 temperatures ( $\Delta$ :  $15^\circ\text{C}$ ;  $\blacksquare$ :  $25^\circ\text{C}$  and  $\nabla$ :  $35^\circ\text{C}$ ) of soybean leaves grown at different  $[\text{CO}_2]$  and temperature. Measurement was done with light intensity of  $1200 \mu\text{mol m}^{-2} \text{s}^{-1}$ . Solid lines are splines connecting the data points as a guide to the eye (June, 2000).

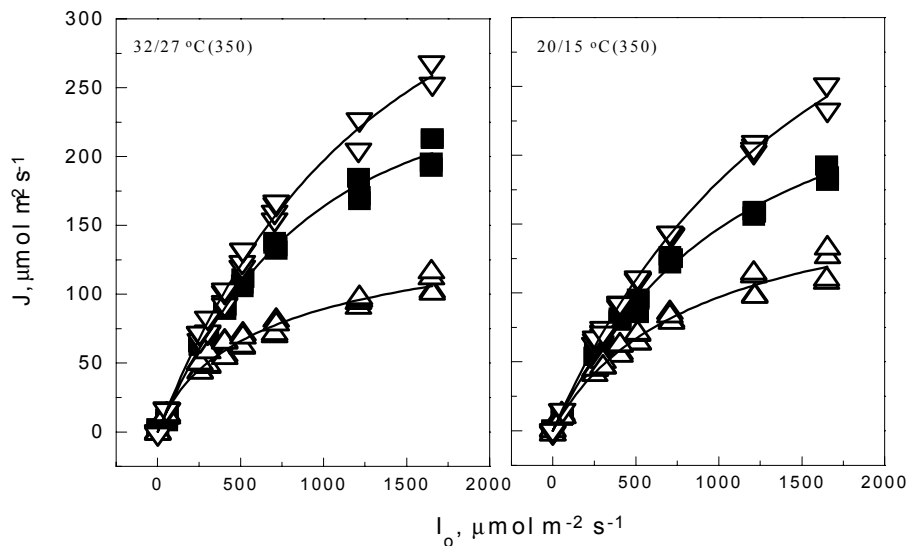
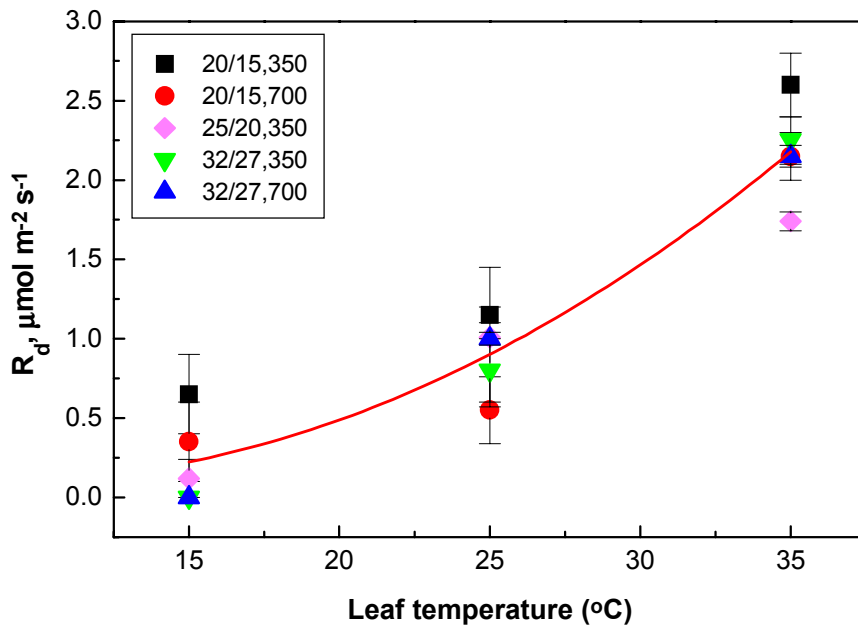

Fig. 2. Light response curves of the electron transport rate measured at three temperatures ( $\Delta$ :  $15^\circ\text{C}$ ;  $\blacksquare$ :  $25^\circ\text{C}$  and  $\nabla$ :  $35^\circ\text{C}$ ). Plants were grown under different conditions as indicated in the graph and measured at  $[\text{CO}_2]$  of  $700 \mu\text{mol mol}^{-1}$  (June, 2000).

The temperature dependence of  $R_d$  is shown in Fig. 3. The values were obtained by fitting a linear regression to net  $\text{CO}_2$ -assimilation rate data at irradiance  $< 150 \mu\text{mol m}^{-2} \text{s}^{-1}$  and extrapolating to zero irradiance. Considerable variation in the values of  $R_d$  can be observed among growth conditions, but there were no significant differences. This is consistent with measurements of  $R_d$  in cotton leaves grown with elevated  $[\text{CO}_2]$  (Thomas *et al.*, 1993) and in *Eucalyptus pauciflora* (Kirschbaum and Farquhar, 1984).



**Fig. 3.** Temperature dependence of  $R_d$ . The values of  $R_d$  were determined from the extrapolation of the linear regression of the A-light response curve at low light ( $< 150 \mu\text{mol m}^{-2} \text{s}^{-1}$ ). Different symbols refer to different groups of data. The solid line is the average best fit second degree polynomial from all growth conditions:  $R_d = 0.328 - 0.051 T + 0.00299 T^2$  (with  $R^2 = 0.92$ ,  $N=15$  and  $P < 0.0001$ ) (June, 2000).

#### Fitted value of $V_{\text{cmax}}$ and $J_{\text{max}}$

The result as shown in Fig. 1 and Fig. 3 can then be fitted using Eqs. (1) - (7) to get the  $V_{\text{cmax}}$  and  $J_{\text{max}}$  value as seen in Table 1.

#### Conclusion

This methodology is very reliable and very easy to do, and it gave us an insight of the adaptability of the photosynthetic capacity of plants to environmental conditions. As the photosynthetic model is highly mechanistic, different environmental condition exposed to the plants during its growing condition can be well described by its parameters. Hence, by using this methodology, choosing suitable plants for a certain condition or studying plant performance at different environmental conditions can be conducted. Using a portable gas exchange system (for example: LICOR 6400), measurement can be conducted easily in the field.

Table 1. List of model parameters with  $\pm$  standard error, for each measurement at 3 leaf temperatures and a CO<sub>2</sub> concentration of 700  $\mu\text{mol mol}^{-1}$ . Nitrogen supply for all plants was 16 mM. Fitting of the light response curve was done using  $\Theta = 0.7$ . Leaves for light response curves were different to those leaves used in CO<sub>2</sub> response curve measurement (June, 2000).

| Growth condition<br>day T/[CO <sub>2</sub> ] | Leaf Temperature<br>(°C) | Fitted from light response curve, measured at 700 $\mu\text{mol mol}^{-1}$ CO <sub>2</sub> (Eq. 2) |                  | Fitted from CO <sub>2</sub> response curve, measured at light of 1200 $\mu\text{mol m}^{-2} \text{s}^{-1}$ (Eq. 2). |                   |                  |                                     |
|--|--------------------------|--|------------------|---|-------------------|------------------|-------------------------------------|
|  |                          | a <sub>2</sub>   | J <sub>max</sub> | V <sub>cmax</sub>   | J <sub>1200</sub> | J <sub>max</sub> | J <sub>max</sub> /V <sub>cmax</sub> |
| 20/350                                       | 15                       | 0.17±0.00  | 184±12.5         | 46± 3   | 102± 9            | 111              | 2.4                                 |
|  | 25                       | 0.22±0.00  | 261± 3.0         | 120±10  | 203± 8            | 251              | 2.1                                 |
|  | 35                       | 0.26±0.01  | 345± 3.1         | 230± 0  | 225± 5            | 290              | 1.3                                 |
| 20/700                                       | 15                       | 0.16±0.02  | 139± 7.06        | 58± 8   | 128± 1            | 143              | 2.5                                 |
|  | 25                       | 0.26±0.01  | 301±24.5         | 118± 3  | 195± 5            | 238              | 2.0                                 |
|  | 35                       | 0.28±0.01  | 349±40.1         | 240± 7  | 258± 4            | 357              | 1.5                                 |
| 25/350                                       | 15                       | 0.13±0.05  | 153±16.3         | 55± 0   | 113± 8            | 124              | 2.3                                 |
|  | 25                       | 0.22±0.01  | 290±31.2         | 118± 8  | 222± 4            | 284              | 2.4                                 |
|  | 35                       | 0.28±0.02  | 372± 0.2         | 190±10  | 263± 8            | 369              | 1.9                                 |
| 32/350                                       | 15                       | 0.21±0.03  | 117± 3.4         | 38±10   | 66±21             | 69               | 1.8                                 |
|  | 25                       | 0.26±0.01  | 256±21.9         | 106±19  | 163±28            | 190              | 1.8                                 |
|  | 35                       | 0.28±0.01  | 369±28.4         | 170±35  | 203±13            | 251              | 1.5                                 |
| 32/700                                       | 15                       | 0.15±0.01  | 133± 0.7         | 39± 1   | 85± 5             | 91               | 2.3                                 |
|  | 25                       | 0.21±0.01  | 229± 5.0         | 105± 5  | 153± 3            | 176              | 1.7                                 |
|  | 35                       | 0.23±0.00  | 369± 4.8         | 208± 3  | 230± 5            | 299              | 1.4                                 |

### References

- Badger, M. R. and Collatz, G. J. 1977. Studies on the kinetic mechanism of ribulose-1,5-bisphosphate carboxylase and oxygenase reactions, with particular reference to the effect of temperature on kinetic parameters. *Carnegie Institute of Washington Yearbook*, **76**: 355-361.
- Berry, J. and Bjorkman, O. 1980. Photosynthetic response and adaptation to temperature in higher plants. *Annual Review of Plant Physiology*, **31**: 491-543.
- Boden, T. A., Kaiser, D. P. *et al.* 1994. A compendium of data on global change. *Trends '93*, Oak Ridge National Laboratory.
- De Pury, D. G. G. and Farquhar, G. D. 1997. Simple scaling of photosynthesis from leaves to canopies without the errors of big-leaf models. *Plant, Cell and Environment*, **20**: 537-557.
- Evans, J. R. 1983. Nitrogen and photosynthesis in the flag leaf of wheat (*Triticum aestivum* L.). *Plant Physiology*, **72**: 297-302.
- Farquhar, G. D. and von Caemmerer, S. 1982. Modelling of photosynthetic responses to environmental conditions. In: Lange, O. L., Nobel, P. S., Osmond, C. B. and Ziegler, H. *Physiological Plant Ecology. II. Encyclopedia of Plant Physiology, New Series*. Berlin, Springer-Verlag. **12B**: 548-577.
- Farquhar, G. D., von Caemmerer, S. *et al.* 1980. A biochemical model of photosynthetic CO<sub>2</sub> assimilation in leaves of C<sub>3</sub> species. *Planta*, **149**: 78-90.
- Farquhar, G. D. and Wong, S. C. 1984. An empirical model of stomatal conductance. *Australian Journal of Plant Physiology*, **11**: 191-210.

- Field, C. and Mooney, H. A. 1986. The photosynthesis-nitrogen relationship in wild plants. On the economy of form and function. T. J. Givnish. Cambridge, Cambridge University Press: 25-55.
- Jordan, D. B. and Ogren, W. L. 1984. The CO<sub>2</sub>/O<sub>2</sub> specificity of ribulose, 1,5-bisphosphate carboxylase/oxygenase. Dependence on ribulosebisphosphate concentration, pH and temperature. *Planta*, **161**: 308-313.
- June, T. 2000. Modelling soybean (*Glycine max* L. Merr) photosynthesis: scaling up from leaf to canopy. PhD Thesis, Australian National University. Canberra, Australia.
- Lloyd, J., Wong, S. C. et al. 1995. Measuring and modelling whole-tree gas exchange. *Australian Journal Plant Physiology*, **22**: 987-1000.
- Reynold, J. F. and Acock, B. 1985. Predicting the response of plants to increasing carbon dioxide: a critique of plant growth models. *Ecol. Model.*, **29**: 107-129.
- von Caemmerer, S. and Farquhar, G. D. 1981. Some relationships between the biochemistry of photosynthesis and the gas exchange of leaves. *Planta*, **153**: 376-387.
- von Caemmerer, S., Evans, J. R. et al. 1994. The kinetics of ribulose- 1,5-bisphosphate carboxylase/oxygenase in vivo inferred from measurements of photosynthesis in leaves of transgenic tobacco. *Planta*, **195**: 88-97.

## Litter Decomposition Process in Two Contrastive Nutrient Limited Forest Types in Central Kalimantan

Joeni S. RAHAJOE<sup>1</sup>, Takashi KOHYAMA<sup>2</sup> and Suwido H. LIMIN<sup>3</sup>

<sup>1</sup> Research and Development Centre for Biology - LIPI, Indonesia

<sup>2</sup> Graduate School of Environmental Earth Science, Hokkaido University, Japan

<sup>3</sup> University of Palangkaraya, Central Kalimantan, Indonesia

### Abstract

Litter fall and litter decomposition process in two contrastive of forest types, i.e. heath and peat swamp forest were studied in Lahei, northeast of Central Kalimantan, Indonesia, to quantify seasonality of litter fall and mineral cycling. Sampling was carried out from February 1998 to February 1999 and will be continued until March 2000.

Litter fall ( $t\ ha^{-1}year^{-1}$ ) measured by litter traps, was 6.64 (total), 3.5 (leaves) and 2.6 (stem < 2cm) in heath forest. In peat swamp forest ( $t\ ha^{-1}year^{-1}$ ) that was 5.3 (total), 2.9 (leaves) and 1.5 (stem < 2 cm). During rainy season, the peak of litter fall was observed in heath forest in early December, while in dry season it was occurred in July. In peat swamp forest during dry season, the peak was observed in June. The fall rate of stems with diameter  $\geq 2$  cm was slower than that of small stems (< 2 cm). The rate of stem  $\geq 2$  cm was higher in peat swamp forest than in heath forest.

The decomposition process of leaves from three dominant species in heath forest; (i) Bintangur Marutan (*Calophyllum pulcherrimum*), (ii) Belawan (*Tristania* sp.), (iii) Hangkang (*Palaquium* sp.), and three dominant species in peat swamp forest; (i) Rasak (*Vatica* cf. *rassak*), (ii) Kandorin (*Buchanania sessifolia*), and (iii) Umpa (*Gluta* cf. *laurifolia*) was monitored using litter bags. *Tristania* sp. in heath forest decomposed more rapidly than the other species, while in peat swamp forest, Kandorin (*Buchanania sessifolia*) was decomposed rapidly than others.

### Introduction

Tropical forests produce large amounts of litters, such as: leaves, flowers and fruits, trash and woody fraction (Burghouts *et al.*, 1993). So far, only a few studies have been done on the litter decomposition in lowland rain forest of South-east Asia (Proctor, 1984). Studies on quantitative and qualitative aspects of the litterfall are important for the following reasons; to provide an index of production, to give information on decomposition rates, to give information on tree phenology and to quantify an important pathway in mineral cycles and to indicate efficiency of these cycles (Proctor *et al.*, 1983; Burghouts *et al.*, 1993).

Proctor *et al.* (1983) conducted a study on the litter fall of a heath forest in Gunung Mulu National Park, Malaysia and found that the weight loss of leaves in fine mesh litter bags in heath forest was higher than of in alluvial and dipterocarp forests. Leaf litter deposition and decomposition is critical pathway of organic matter and nutrient flux in tropical forest systems (Burghouts *et al.*, 1993; Wieder and Wright, 1995). The impact of trees on litter decomposition, nutrient availability and soil acidity depends on the chemical composition of litterfall and canopy leachate (Burghouts *et al.*, 1993; Vitousek and Turner 1994). Variations in decomposition rates across species and sites are correlated with environmental factors, such as: humidity, pH, amount of solar radiation

reaching the forest floor (Zhang and Zak, 1995), soil organisms (Gallardo and Merino, 1993), and substrate quality (Vitousek and Turner, 1994).

This paper reports the studies on seasonal changes and the quantities of litter fall, and the estimation of decomposition rate of dominant tree species in heath and peat swamp forests.

## Methods

### Study site

The study was conducted in two different types of inland forests (peat swamp and heath forests) in Lahei village, northeast of Palangkaraya, Central Kalimantan. A 1-ha permanent plot was established in each forest type in August 1998 for a population dynamics study. Suzuki *et al.*, (1998) reported that the peat swamp forest plot was dominated by Rasak (*Vatica oblongivolia*), Kandorin (*Buchanania sessilifolia*), and Umpa (*Gluta cf. laurifolia*); while heath forest plot was dominated by Bintangur Marutan (*Calophyllum pulcherrimum*), Belawan (*Tristaniopsis* sp.), and Hangkang (*Palaquium* sp.). The tree density of heath forest was higher than peat swamp forest, however, heath forest mainly consisted of small trees (the biggest tree diameter was 69.7 cm), while peat swamp forest consisted of larger trees (the biggest tree diameter was 100.2 cm). The highest trees were 37 m in heath forest and 38 m in peat swamp forest and number of species was 116-147 in heath forest and 73 species in peat swamp forest.

### Litterfall observation

Twenty-five litter traps are installed randomly within each 1-ha permanent plot of peat swamp and heath forests. Every litter trap was circle in shape and the surface areas was 0.785 m<sup>2</sup>. Each litter trap was placed 1m above ground level and tied up among four of 1-m long PVC poles stuck into the soil. Those trapped litter falls were collected every 2 weeks within a 12-month of study period in heath forest and only during the dry season of the same period for peat swamp forest type.

Litterfall were separated into (i) coarse leaf litterfall (leaf fraction  $\geq 1$  cm; LLF), (ii) leaf fraction ( $< 1$  cm); (iii) twigs or woody litterfall ( $\geq 2$ cm diameter); reproductive parts (fruits and flowers) (Burghout *et al.*, 1993); and (iv) the materials that could not be classified either by species or element were left as "others". Those fractions were dried in an oven and weighed separately.

### Litter bags experiment

Litterbags experiment was also conducted in order to study the decomposition rate of litterfalls of each dominant species and mixed litters in each forest types. Some trees with various stem diameters of each mentioned dominance species in peat swamp and heath forest plots from outside permanent plots were cut off for collecting their leaves and branches. Leaves and branches of selected cut trees were divided by species for further litterbags experiment. Leaves from forest floor of both forest types were also collected and treated as mixed litters. Leaves and small branches of each species from cut trees and from forest floor (mixed litters) were dried in air condition.

Air-dried leaves of each species and mixed litters were filled into two types of litterbags; those are nylon litterbags with the mesh size of 1 mm (coarse mesh) and of 0.35 mm (fine mesh). Each litterbag was filled up with 100 g air-dried leaf samples of each species. Two hundred litterbags (50 bags each of 4 types air-dried litters, i.e. litters

of 3 dominant species and mixed litters) were distributed systematically in each 1-ha permanent plot of heath and peat swamp forest types at the end of January 1988 and let them to decompose naturally in the fields.

Litterbag of each species of coarse and fine mesh bags were then collected periodically from each forest type and the remaining leaves within each litterbag were weighed after dried in an oven at 75°C until the mass weight constant. The remaining weights of leaves were corrected using ash content by burning leaf sample in a muffle oven at 800°C over 8 h, for correction factor of litter contaminated by mineral soil (Murphy, 1998).

The rate of organic matter decomposition is calculated by using the widely applied differential equations:

$$dW/dt = k W$$

where  $W$  represents the mass of the litter (organic matter),  $t$  is expressed in day, and  $k$  is the decomposition constant (rate). The value of the decomposition constants  $k$  for particular litter was estimated by fitting the regression line  $W(t) = W_0 e^{kt}$  (the integrated from the equation) putting  $W_0$  at the  $t = 0$  is 100% (Laskowski *et al.*, 1995).

## Results

### Quantity and seasonality of litter fall

The composition of litters collected from heath and peat swamp forest is shown in Table 1. Leaves constituted the majority (53 % in heath forest and 55 % in peat swamp forest) of the litterfall, and were followed by stem (38.7 % in heath forest and 27.57 % in peat swamp forest) (Table 1).

Table 1. Litter production from twenty-five 0.785 m<sup>2</sup> litter traps in peat swamp and heath forest. The litterfall rates are based on the summed 2-week collections for each trap.

| Component         | Heath forest<br>ton ha <sup>-1</sup> year <sup>-1</sup> | Percent | Peat swamp forest<br>ton ha <sup>-1</sup> year <sup>-1</sup> * | Percent |
|-------------------|---|---------|--|---------|
| Leaves ≥ 1 cm     | 3.51  | 52.87   | 2.93   | 55.25   |
| Stem < 2 cm       | 2.57  | 38.70   | 1.46   | 27.57   |
| Stem ≥ 2 cm       | 0.002   | 0.03    | 0.45   | 8.55    |
| Reproductive part | 0.29  | 4.38    | 0.13   | 2.51    |
| Others            | 0.12  | 1.84    | 0.17   | 3.25    |
| Leaves < 1 cm     | 0.15  | 2.19    | 0.15   | 2.87    |
| Total             | 6.65  | 100.00  | 5.30   | 100.00  |

\* estimated from 8-month data

The total litterfall in heath forest was higher than peat swamp forest. Each litter component (leaves, reproductive part, stem ≥ 2 cm, leaves < 1 cm and others) in heath forest was higher than peat swamp forest, while stem with diameter ≥ 2 cm was higher in peat swamp forest.

Figure 1a and 1b show seasonal variations in the total quantity of litter fall of each element in heath and peat swamp forest. In heath forest during dry period, the total amount was fluctuated markedly, with a peak in April and a major peak in July, and another peak in September. On wet period the peak began in middle October, with a

major peak in early December, and another peak in January. The sampling of litterfall in peat swamp forest was done in dry season, with a peak in late April and the major peak in June, and another peak in late July.

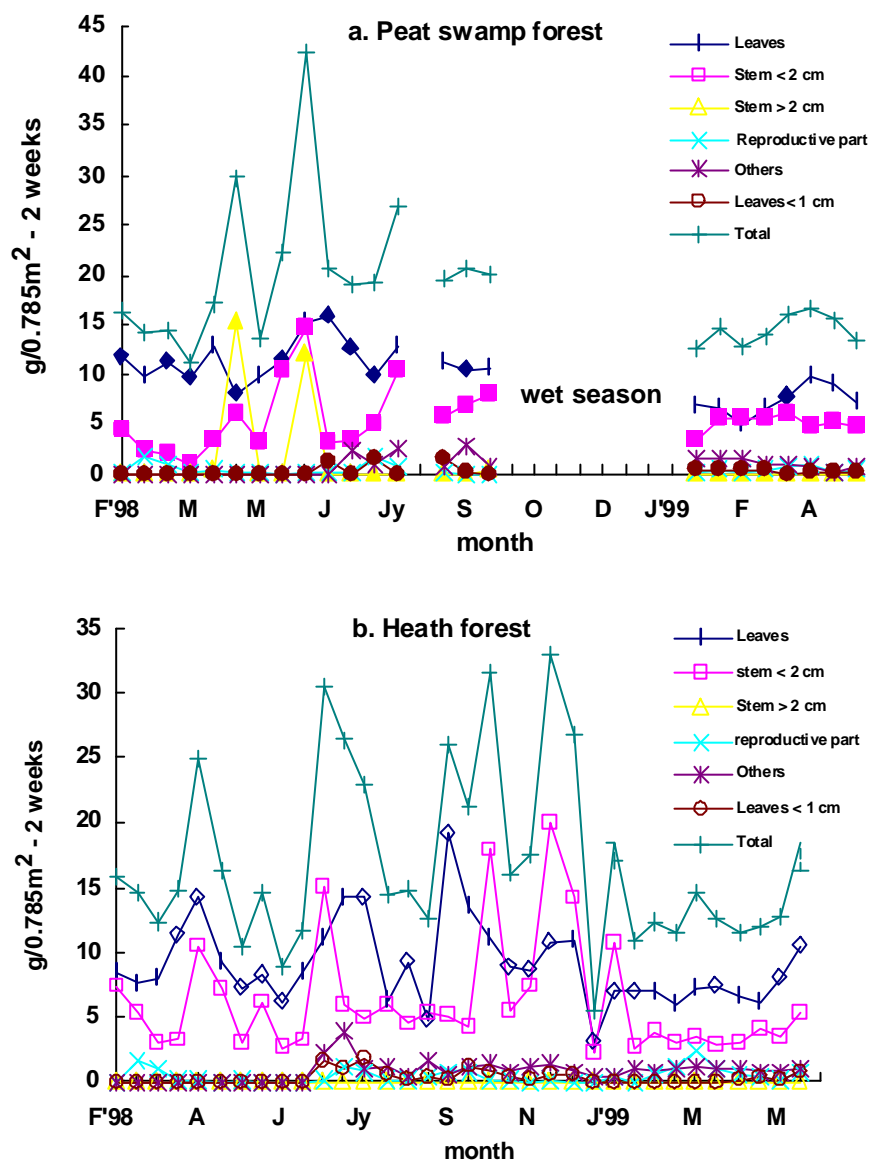

Fig. 1. Seasonal variation of litter fall in peat swamp (a) and heath forest (b).

### Decomposition rate of litter

Decomposition rate and the percentage of original litter mass remaining over time for all the species in the two ecosystems is shown in Figs. 2 and 3. In peat swamp forest, the decomposition rate ranged between  $k = 0.0008 \text{ day}^{-1}$  for *V. oblongivolia* and 0.0026 for *B. sessilifolia*, whereas in heath forest the value was higher, ranging from 0.0012 for *C. pulcherrimum* to 0.0039 for *Tristaniopsis* sp. The decomposition rate of *Tristaniopsis* sp. ( $k = 0.0037$ , fine mesh and  $k = 0.0039$ , coarse mesh) was higher than the other species (Table 2).



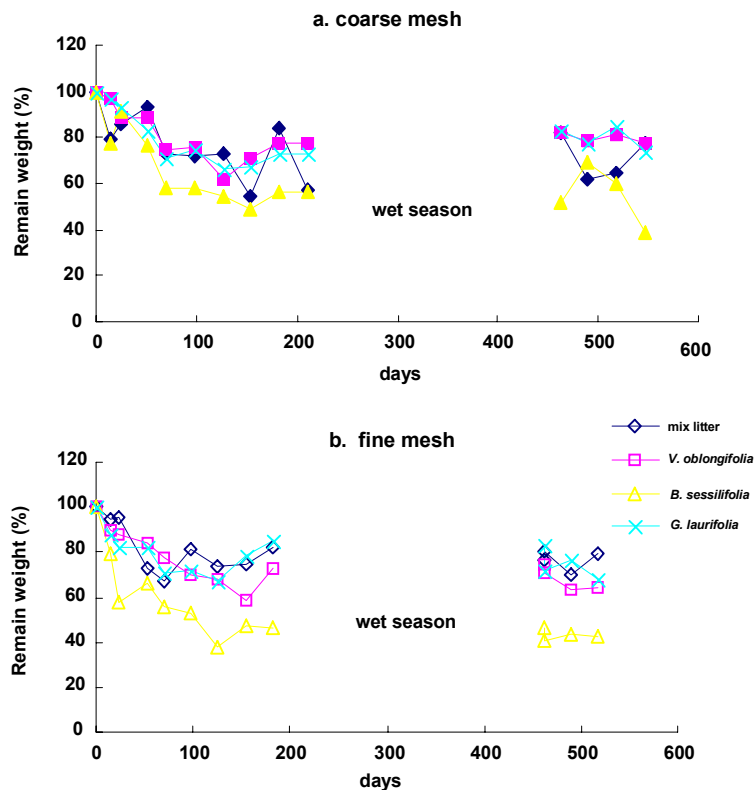

Fig. 2. Remaining weight of leaves of dominant species in various litter bags in peat swamp forest.

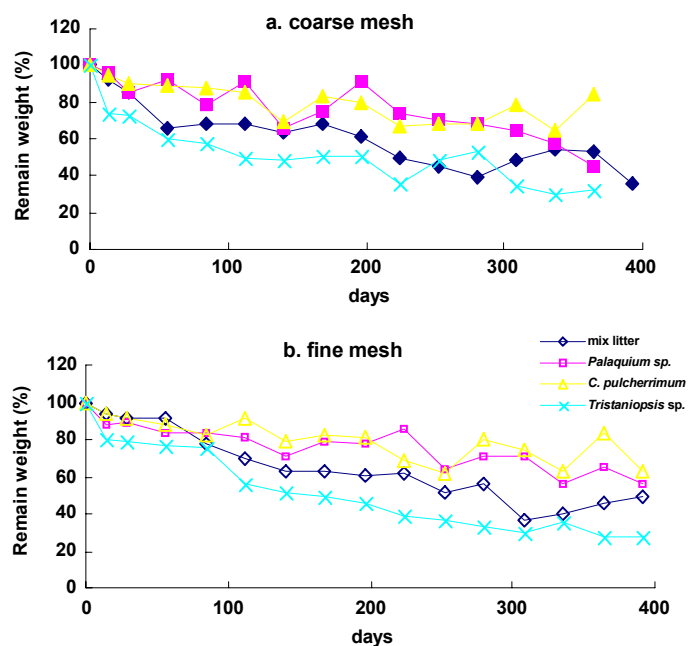

Fig. 3. Remaining weight of leaves of dominant species in various litter bags in heath forest.

In peat swamp forest, remaining mass of *B. sessilifolia* was lower than the others species. Decomposition rate of *B. sessilifolia* with  $k = 0.0026$  (fine mesh) and  $k = 0.002$  (coarse mesh) was faster than that of *G. cf. laurifolia* ( $k = 0.0009$ , fine and coarse mesh), *Vatica oblongivolia* ( $k = 0.0012$ , fine mesh;  $k = 0.0008$ , coarse mesh) and mix litter ( $k = 0.0009$ , fine mesh;  $k = 0.0012$ , coarse mesh) (Table 2).

Table 2. The rate of decomposition of the dominant trees species in peat swamp and heath forest in Central Kalimantan.

| Forest type       | Species                  | decomposition rate day <sup>-1</sup> ( $k$ ) |             |
|-------------------|--------------------------|--|-------------|
|                   |                          | fine mesh                                    | coarse mesh |
| Peat swamp forest | <i>V. oblongifolia</i>   | 0.0012                                       | 0.0008      |
|                   | <i>B. sessilifolia</i>   | 0.0026                                       | 0.002       |
|                   | <i>G. cf. laurifolia</i> | 0.0009                                       | 0.0009      |
|                   | mix litter               | 0.0009                                       | 0.0012      |
| Heath forest      | <i>C. pulcherrimum</i>   | 0.0012                                       | 0.0012      |
|                   | <i>Tristaniopsis</i> sp. | 0.0037                                       | 0.0039      |
|                   | <i>Palaquium</i> sp.     | 0.0017                                       | 0.0015      |
|                   | mix litter               | 0.0027                                       | 0.0025      |

The decomposition rates of the dominant tree species in peat swamp and heath forest were not significantly different between fine and coarse mesh of litter-bags, except for *Tristaniopsis* sp. ( $p < 0.022$ ) (Table 3).

The weight loss of mixed litter in fine mesh bags after 1 year was 54.4% in heath forest and 19.5% in peat swamp forest. In coarse mesh that was 45.5% in heath forest and 37.9% in peat swamp forest. The weight loss of mix litter in fine and coarse mesh in the two main study sites may be ranked in the order: heath forest > peat swamp forest. This view means that the mix litter of heath forest was decomposed more rapidly than the mix litter in peat swamp forest (Table 2).

Table 3. p-Value of litter mass lost between mesh size in peat swamp and heath forest.

|           | Peat swamp forest        |         | Heath forest             |         |
|-----------|--------------------------|---------|--------------------------|---------|
|           | species                  | p-value | species                  | p-value |
| Mass lost | <i>V. oblongifolia</i>   | 0.24    | <i>Palquium</i> sp.      | 0.69    |
|           | <i>B. sessilifolia</i>   | 0.06    | <i>C. phulcherrimum</i>  | 0.55    |
|           | <i>G. cf. laurifolia</i> | 0.8     | <i>Tristaniopsis</i> sp. | 0.022*  |
|           | mix litter               | 0.38    | mix litter               | 0.052   |

\* Significant at  $P < 0.05$ .

## Discussion

### Quantity and seasonality of litter fall

The total litterfall of heath forest in Lahei (6.6 ton ha<sup>-1</sup> year<sup>-1</sup>) was lower than those in heath forest in Gunung Mulu National Park (9.2 ton ha<sup>-1</sup> year<sup>-1</sup>). The leaf litter fall was 52.9% of total litterfall in heath forest. It was smaller than those which were reported by Proctor *et al.* (1983), that leaf litter of heat forest in Gunung Mulu National Park

accounted for 60.9% of total litter fall (Table 4).

Reproductive parts were higher in Gunung Mulu National Park than in Lahei, but the stem with diameter < 2 cm were higher in Lahei. The stem with the diameter  $\geq$  2 cm and leaves (< 1 cm) were not recorded in Gunung Mulu National Park.

Table 4. Estimated litterfall from thirty-five 0.25 m<sup>2</sup> litter traps in Heath forest in Gunung Mulu National Park, Sarawak (Proctor *et al.*, 1983).

| Component          | Heath forest | Percent |
|--------------------|--------------|---------|
| Leaves $\geq$ 1 cm | 5.6          | 60.9    |
| Stem < 2 cm        | 2.2          | 23.9    |
| Stem $\geq$ 2 cm   | -            | -       |
| Reproductive part  | 0.32         | 3.48    |
| Others             | 1.1          | 12.0    |
| Leaves < 1 cm      | -            | -       |
| Total              | 9.2          | 100     |

The litter fall data from peat swamp forest was presented only during dry period. It was difficult to collect the litter during rainy season, because of high water level. The data was predicted from eight months observation. It should be higher than the prediction because during rainy season, the litter is expected to fall more than in dry season. This prediction was based on the litterfall data from heath forest which showed the increasing litterfall during rainy season. The leaf litter of peat swamp forest were 55.2 %, this value were lower than those in fresh water swamp in Tasek Bera Malaya, which was reported to be 78.3 % (Furtado *et al.*, 1980).

This research showed a peak of total litterfall in heath forest during wet period in October and November 1998. This result was similar to litterfall in heath forest in Gunung Mulu NP, where the peak of litterfall was occurred in rainy season in April and June 1978. It might be caused of high winds contributed to the peak of litter fall. John (1973) in Ghana and Rai (1986) in Karnataka noted higher litter fall associated with the strong wind at the beginning of the wet season. Beside that, the varied seasonal pattern of species shedding their leaves is another reason that causes the peak of litter occurred in rainy season.

### Decomposition rate of litter

Weight losses of mixed litter in peat swamp forest ranged from 19.5 % year<sup>-1</sup> (the slowest in the fine mesh) and in heath forest 54.4% (the fastest in the fine mesh). Comparable range for *C. pulcherrimum*, are 16.2% year<sup>-1</sup>, *Tristaniopsis* sp. 67.5-72.3% year<sup>-1</sup>, *Palaquium* sp. 35.4-55.5% year<sup>-1</sup> in heath forest and for *V. oblongivolia* 21.3-29.3% year<sup>-1</sup>, *B. sessilifolia* 30.5-59.7% year<sup>-1</sup>, and *G. cf. laurifolia* 22.7-28.2% year<sup>-1</sup>. Data from Anderson (1983) for two species of leaves and mix litters were collected from forest floor in 40  $\mu$ m mesh (fine) and coarse 7-20 mm mesh bag gives a range 50-63% year<sup>-1</sup> in four tropical lowland forests in Sarawak, Malaysia. Edward (1977) found that for six species of leaves in 8 mm mesh bags give a range of 26-95% year<sup>-1</sup> (average 40% year<sup>-1</sup>) in four montane rain forest sites in New Guinea. Tunner (1981) in four Jamaican montane rain forests, used 2 mm mesh litter bags containing fifteen species give the same range of

decay rates as Edwards (1977) with a mean value of 47% year<sup>-1</sup>. These results suggest that the decomposition rates of leaves in heath and peat swamp forest is lower than those in lowland tropical rain forest in Malaysia and in lower montane rain forest in New Guinea and Jamaica.

The decomposition processes in peat swamp and heath forest were not significantly different between the type of litter bags (Table 3 and Fig. 4). This result was similar to the research conducted in Gunung Mulu National Park (Anderson *et al.*, 1983). Even the decomposition rate between the type of litter bags was not significant, there was still differences in decomposition rate among the type of litter bags. The differences are largely caused by the feeding activities of invertebrate saprotrophs but include losses of large fragments due to abiotic processes (Anderson *et al.*, 1983), losses by leaching, especially in coarse mesh.

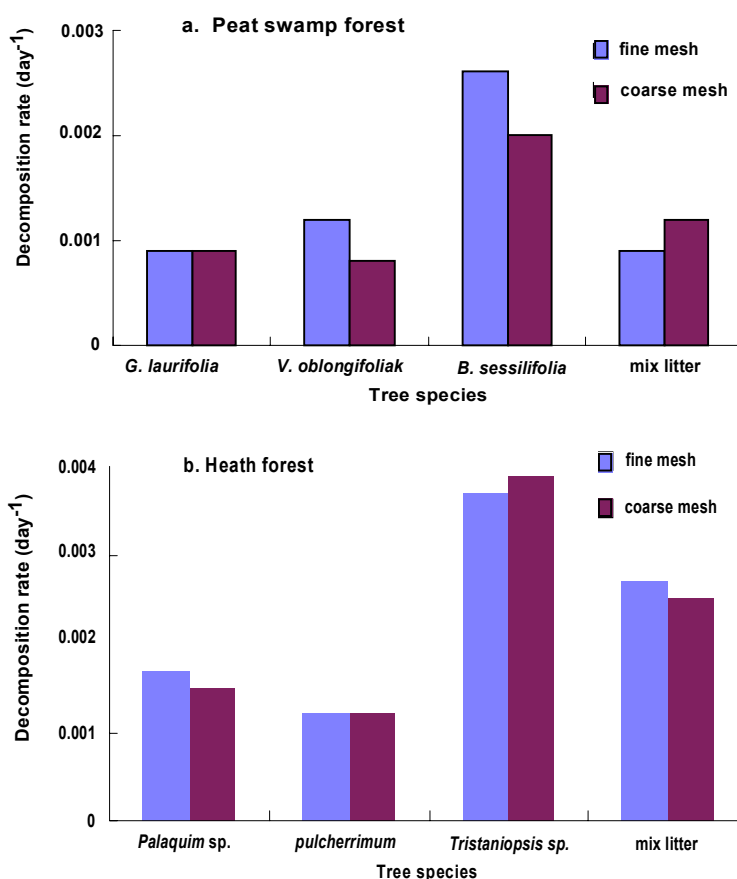

Fig. 4. Comparison between different mesh size of litter bags in peat swamp and heath forest.

### Acknowledgments

Authors wish to thank Mr. Arief, M. Amir and Aden Muhidin (RDC for Biology-LIPI) and Mr. Agung, Nathalius, Shylphanus, Kitso, Yarden (of local residents) for their cooperation during the field study. The study was financially supported by the Japan Society for the Promotion of Science.

## References

- Anderson, J. M., Proctor, J. and Vallack, H. W. 1983. Ecological studies in four contrasting lowland rain forest in Gunung Mulu National Park, Sarawak. III. Decomposition processes and nutrient losses from leaf litter. *Journal of Ecology*, **71**: 503-527.
- Burghout, T. B. A., Korthals, G. E. G. W. and De Vries, T. H. 1993. Litter fall, leaf-litter decomposition and litter invertebrates in primary and selectively logged dipterocarp forest in Sabah. East Malaysia *Spatial heterogeneity of nutrient cycling in Bornean rain forest*. FEBO-DRUK B.V. The Netherlands. pp.15-28.
- Edwards, P. J. 1977. Studies of mineral cycling in a mountane rain forest in New Guinea II. The production and disappearance of litter. *Journal of Ecology*, **65**: 971-992.
- Ewel, J. J. 1976. Litterfall and leaf decomposition in a tropical forest succession in eastern Guatemala. *Journal of Ecology*, **64**: 293-308
- Gallardo, A. and Merino, J. 1993. Leaf decomposition in two Mediterranean ecosystem of Southwest Spain: influence of substrate quality. *Ecology*, **74**: 152-161.
- John, D. M. 1973. Accumulation and decay of litter and net production of forest in tropical West Africa. *Oikos*, **24**: 430-435.
- Murphy, K. L., Klopatek, J. M. and Klopatek, C. C. 1998. The effects of litter quality and climate on decomposition along an elevational gradient. *Ecologia Applications*, **8**(4): 1061-1071.
- Proctor, J., Anderson, J. M., Fogden, S. C. L. and Vallack, H. W. 1983. Ecological studies in four contrasting lowland rain forests in Gunung Mulu National Park, Sarawak. II. Litterfall, litter standing crop and preliminary observation on herbivory. *Journal of Ecology*, **71**: 261-283.
- Proctor, J. 1984. Tropical forest litterfall. II. The data set. Tropical rain forest. In: Chadwick, A.C. and Sutton, S.L. (eds.), *The Leeds Symposium*. pp. 83-113, Leeds Philosophical and Literary Society. Leeds.
- Laskowski, R., Niklinska, M. and Mayanski, M. 1995. The dynamics of chemical elements in forest litter. *Ecology*, **76**: 1393-1406.
- Rai, S. N. and Proctor, J. 1986. Ecological studies on four rain forests in Kartakana, India. II. Litterfall. *Journal of Ecology*, **74**: 455-463.
- Suzuki, E., Kohyama, T., Simbolon, H., Akira, H., Tsuyuzaki, S., Nishimura, T. and Seino, T. 1999. Vegetation of kerangas (heath) and peat swamp forests in Lahei, Central Kalimantan. In: *Annual Report of Environmental Conservation and Land Use Management of Wetland Ecosystem in South Asia. Core University Program between Hokkaido University, Japan and R & D Center of Biology, LIPI Indonesia. Sponsored by Japan Society for the Promotion Science*.
- Swift, M. J., Heal, O. W. and Anderson, J. M. 1979. *Decomposition in Terrestrial Ecosystems*. Blackwell Scientific Publication. London.
- Vitousek, P.M. and Turner, D.R. 1994. Litter decomposition on the Mauna Loa environmental matrix, Hawaii: patterns, mechanisms, and models. *Ecology*, **75**: 418-429.
- Weider, R.K. and Wright, S.J. 1995. Tropical forest litter dynamics and dry season irrigation on Barro Colorado Island, Panama. *Ecology*, **76**: 1971-1979.
- Zang, Q. and Zak, J. C. 1995. Effect of gap size on litter decomposition and microbial activity in a subtropical forest. *Ecology*, **76**: 2196-2204.

## Study on Leaf Element Concentrations of Some Dominant Tree Species Grown in Peat Swamp Forest, Central Kalimantan

Sehat Jaya TUAH<sup>1</sup>, Mitsuru OSAKI<sup>1</sup> and Suwido Hester LIMIN<sup>2</sup>

<sup>1</sup> Graduate School of Agriculture, University of Hokkaido, Japan.

<sup>2</sup> Faculty of Agriculture, University of Palangka Raya, Central Kalimantan.

### Abstract

With the aim of understanding the ecological characteristics of peat swamp forest ecosystem, which paid due regard to the foliage nutritional traits under a great pressure of persistent land degradation and deforestation, a preliminary study has been carried out in Central Kalimantan. At the initial stage, 4 of 1 ha permanent plots have been established at Kalampangan Zone, Central Kalimantan. The study site covered a primary or relatively undisturbed peat swamp forest and fire-damaged areas representing the different magnitude of human interference upon them. Results of this study showed that the ranges of peat thickness, ground water level, fresh peat soil pH, EC and Eh varied greatly following the nature of the study plots. The pH of peat soil at study site was very low (pH<4). It is probably due to high organic matter constituents which producing some organic acid compounds through decomposition process under waterlogged conditions. In terms of mineral concentrations, it was observed that the mean concentration of macro-elements in plant leaves at the whole study plots following the same order as follows: N>K>Ca>Mg>P. In addition, it was also observed that in many plant studied, some micro-elements such as Fe, Mn and Zn were found below the critical levels for adequate growth. However, there were no symptoms of these nutrients disorder appeared. Among other plants studied, *Combretocarpus rotundatus* and *Eugenia* sp. tend to accumulate Al more than the others. However, most of the plants were found maintaining high concentrations of Al and Na in their leaf tissues compared to other microelements. Further studies should be addressed to know more the physiological characteristics of both *Combretocarpus rotundatus* and *Eugenia* sp. in terms of adaptation mechanisms to the poor-nutrient habitat of PSF.

**Key words:** Kalampangan zone, native peat swamp forest, fire-damaged area, leaf element concentrations, peat thickness, ground water level, and poor-nutrients habitat.

### Introduction

Peatlands are wetland ecosystems that are characterized by the accumulation of organic matter, which is produced and deposited at a greater rate than that decomposed leading to the formation of peat. Tropical peatlands, in particular, inland and transitional peat have been recognized as nutrient-poor environment. However, natural or relatively undisturbed peatlands are covered by diverse species of peat swamp forest as climax vegetation. It is assumed that those native plants had an inherent mechanism to be tolerant to the harsh environment of the peatland ecosystems. In this poor nutrient ecosystem, there are two aspects of nutritional trait that considered to be the most essential; (1) nutrient cycle within ecosystem, and (2) nutritional characteristics of individual plants therein. To determine the nutrient cycle, it is required a fully understanding towards the magnitude of litter supply, litter decomposition, nutrient supply from soil, precipitation and river, and nutrient loss from soil. Nutrient cycling is

very complicated because there are various attributes, processes and mechanisms involved. Litter decomposition, for instance, is governed by various factors such as nutrient compositions of litter, soil microbial activity, small animals, water and temperature conditions, nutrient supply by flood, sometimes fire occurrence, and other related components. Thus, it is appear that only to understand the process of litter decomposition, many factors should be viewed and analyzed.

In terms of requirement for nutrients, there is a general range in which a plant can survive, which is depending on species, tissue and age of the plant. In the case of peatland ecosystems, as it is also acknowledge occurs in tropical forest, many scientists argued that most of nutrients stored in vegetation in the form of biomass. In addition, plant species can also be recognized by way of their typical elemental compositions. Therefore, those natural plants can also be used as bio-indicator of changing environment. Since there has been very limited information available concerning the nutritional traits of plants those grown on tropical peatland ecosystems, the current study was aimed to understand clearly the nutritional traits on peatland ecosystems from ground vegetation standpoint. To this end, detailed sampling of plant compartments mainly leaves of peat swamp forest trees and associated vegetation has been carried out in Central Kalimantan, Indonesia.

This recent study is aimed to determine nutrient composition in leaf of some dominant tree species that naturally grown in peat swamp forest. Inherent nutritional characteristics of mineral elements in those tree species is also identified and elucidated.

## **Materials and Methods**

### ***Study site***

Field investigation has been carried out in Central Kalimantan where study site and experimental plots were established. The research site comprised a primary or natural peat swamp forest and fire-damaged area of inland peat, which representing different magnitude of human interference upon them. Primary or natural peat swamp forest site was defined as a relatively undisturbed area of peat swamp forest, whereas fire-damaged area was a site that affected by massive wildfires in 1996-1997. In June 1999, 4 of 1-hectare study plots were established at Kalamangan Zone, which is located between 2°19' to 2°21' south latitude and 114°00' to 114°03' east longitude. Two of the study plots laid on deep peat and the rests two plots located on shallow peat. Using a grid system, each of the 1-ha study plots divided into 100-sub plots of 10 m × 10 m in size. 20-sub plots out of 100 then selected systematically in where sampling, all field measurements and monitoring are employed. Samplings are conducted toward leaf and bark of predominant trees and also peat soils with different depth; whereas field measurements and monitoring applied to obtain data on peat depth, peat water table, tree biomass, plant root systems, forest profile diagram, litter fall and litter decomposition. Some related and necessary instruments were installed within the selected plots. This recent report, however, is solely based on the study that was carried out on leaf element concentrations of some dominant tree species found in the study plots.

### ***Determination of peat depth and ground water level***

During the dry season of July and August 1999, peat depths and ground water levels were determined. Twenty dip-wells (2 m long) were inserted into peat soil layer on

selected subplots, in where peat borings were also conducted. Along with the measurement of peat depth and ground water level, fresh peat soil pH, electric conductivity (EC) and redox-potential (Eh) were directly determined in the field after the fresh peat soil firstly squeezed and shook properly. These field determinations of pH and EC have done using a portable pH combination electrode and EC meter (TOA Electronics Ltd.), respectively. Meanwhile, redox status of tropical peat soil was determined using a portable potential meter equipped with platinum electrode and Ag/AgCl (3.3 mol/l KCl) as reference electrode, and determination was made following the different depth of peat soil layers.

#### ***Leaf samples preparation and analytical methods***

Mature leaves (including shoots) of trees were collected and mixed from several plants found within selected subplots. The mature leaves were firstly washed with deionized water, dried in an oven at 80°C for 24 h, then ground and homogenized using a tungsten carbide vibrating mixer mill.

Prior to determine its total elemental concentrations, plant tissues were digested by a mixed solution of sulfuric acid - H<sub>2</sub>O<sub>2</sub>. N concentration was determined by the semi-micro Kjeldahl method, whereas P, K, Ca, Mg, Na, Fe, Mn, Zn, Al and Si concentrations by Inductively Coupled Plasma Atomic Emission Spectrometry (SHIMADZU ICPS-7000).

### **Results and Discussion**

#### ***Peat depth and ground water level***

Results of the peat depth and ground water level measurement are shown in Table 1, whereas its distribution at entire study plot is illustrated in Fig. 1. According to the range of peat thickness (Table 1), it seems that the peat layer in Plot 1 and Plot 2 was relatively deep than that in Plot 3 and Plot 4. Meanwhile, ground water level in entire study plots was remained high (less than 1 m from the surface), though the period of measurement was in dry season of July and August 1999. This is indicating that peat soil has a high water holding capacity and therefore it is very important as source of water particularly during the dry period. In addition, during the period of August to December 1999 it was also found that the atmospheric and below ground temperatures seem to be fluctuated over the study plots which ranged from 20.35°C– 32.91°C and 25.68°C – 27.02°C, respectively.

Table 1. Peat thickness and ground water level measured in study plots

| Plot | Peat thickness, m<br>mean (range) | Ground water level, cm<br>mean (range) |
|------|-----------------------------------|--|
| 1    | 4.14 (4.00 – 4.35)                | 45.75 (22 – 77)                        |
| 2    | 4.79 (4.03 – 5.20)                | 26.88 (15 – 46)                        |
| 3    | 4.27 (3.50 – 4.67)                | 53.40 (35 – 69)                        |
| 4    | 4.11 (3.35 – 4.84)                | 51.25 (27 – 71)                        |



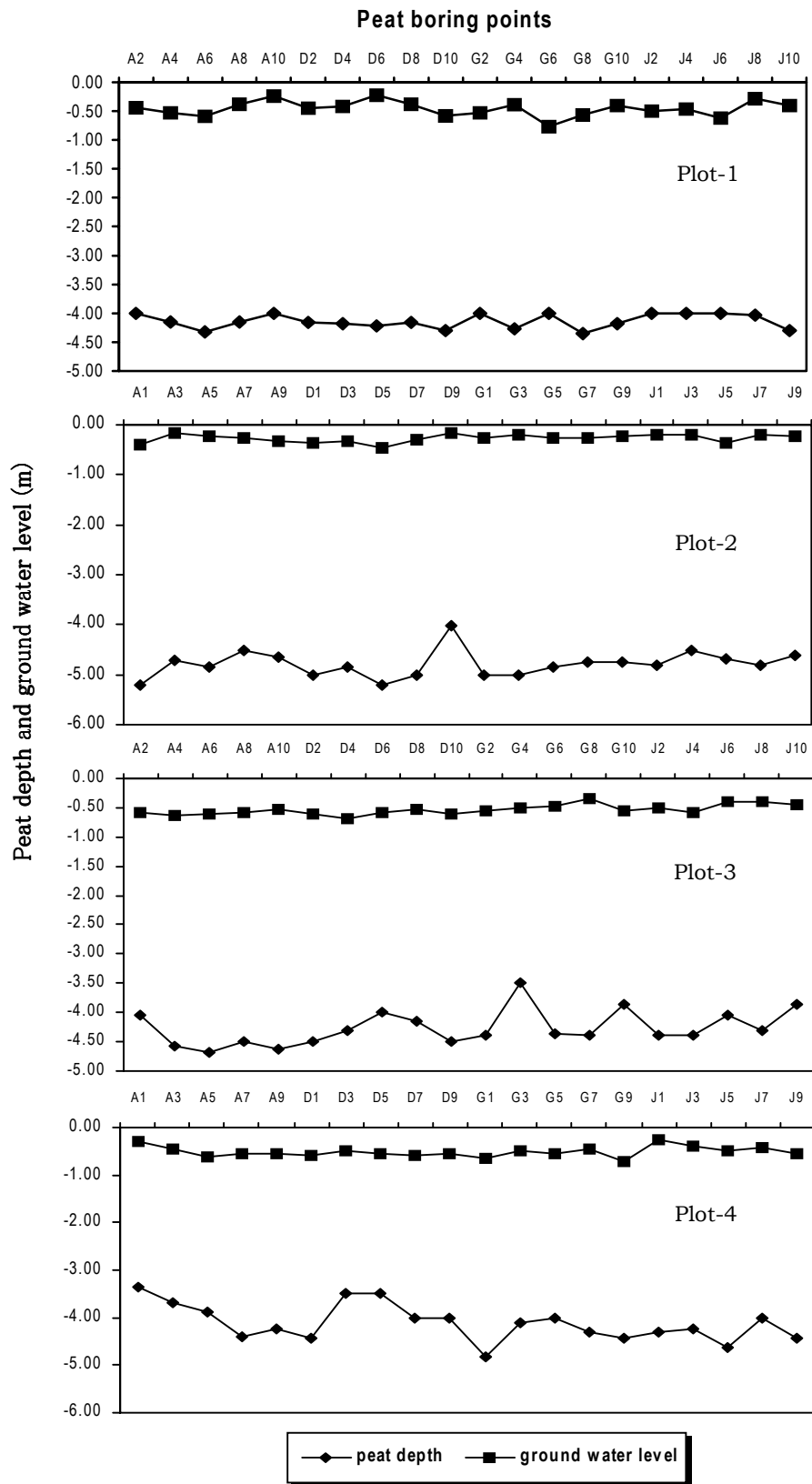

Fig. 1. Distribution of peat depth and ground water level at study plots

**Fresh soil pH, electric conductivity and redox potential**

Mean values and ranges of pH, EC and Eh that were measured in whole study plots presented in Table 2. However, the results reported here were mainly for the surface of peat soil layer (10 – 20 cm in depth) and subsoil layer (20–50 cm in depth). It was found that the mean range values of pH varied among the peat core depth in entire study plots. The pH in Plot 1 and 2 was relatively low compared to that in Plot 3 and 4. In contrast, the mean values of EC were high in Plot 3 and 4 compared to that in Plot 1 and 2. This is probably because the position of plot 3 and 4 near to the river of Sebangau, and may sometimes influence by flooding water. In general, there was no significant different between the mean values of fresh peat soil pH on the surface (3.09–3.31) and on subsoil (2.97–3.34) in all study plots. This is indicating that the peat soil at study site has very low pH (<4). The acid soil reactions (low pH) were also measured by Sabiham *et al.* (1997) at Bereng Bengkel site, and Shepherd *et al.* (1997) under mixed swamp forest of Sebangau. Both of these sites area adjacent to this current study site. A high organic matter constituent probably the main cause of acid reaction of the peat soils. In the whole study plots, *Combretocarpus rotundatus* was found as the abundant tree species. This tree species is assumed containing a high proportion of lignin. This lignin then undergoes decomposition through biodegradation under anaerobic conditions producing phenolic acids (Sabiham *et al.*, 1997).

Table 2. pH, EC and Eh of peat soil on different core depth at study plots

| Plot | Core depth, cm | Fresh soil pH mean (range) | Electric conductivity mean (range), $\mu\text{Scm}^{-1}$ | Redox-potential mean (range), mV |
|------|----------------|----------------------------|--|----------------------------------|
| 1    | 10 – 20        | 3.09 (2.92 - 3.25)         | 152.86 (103.10 - 254.42)                                 | 386 (349 - 422)                  |
|      | 20 – 50        | 2.97 (2.85 - 3.13)         | 120.36 (103.30 - 158.64)                                 | 394 (359 - 432)                  |
| 2    | 10 – 20        | 3.12 (3.04 - 3.25)         | 73.85 (63.86 - 87.20)                                    | 355 (320 - 385)                  |
|      | 20 – 50        | 2.98 (2.89 - 3.08)         | 76.24 (62.94 - 82.10)                                    | 369 (332 - 399)                  |
| 3    | 10 – 20        | 3.31 (3.22 - 3.41)         | 60.64 (51.22 - 81.42)                                    | 295 (274 - 308)                  |
|      | 20 – 50        | 3.34 (3.28 - 3.41)         | 55.19 (43.56 - 69.76)                                    | 297 (287 - 308)                  |
| 4    | 10 – 20        | 3.17 (2.97 - 3.32)         | 72.08 (55.82 - 85.12)                                    | 329 (303 - 347)                  |
|      | 20 – 50        | 3.14 (3.00 - 3.25)         | 56.84 (50.18 - 63.86)                                    | 335 (306 - 362)                  |

Moreover, oxidation-reduction is one of the general measures, which describes chemical status of water or soil environments. Eh is a measure of oxidized and reduced ratio of materials in solution, therefore it is strongly affected by oxygen status of the substances. In peat soils, oxygen supply from atmosphere to soil is limited by the low diffusion rates within water over the soil. This, therefore, low Eh value is commonly found in the peat soils at all study plots as shown in Table 2. However, the mean Eh values were found relatively high in Plot 1 and 2 than that in Plot 3 and 4. Soils with low Eh value affects plants not only by the inhibition of respiration due to low oxygen contents, but also by the detrimental effects of toxins which are produced under reduced condition of the soils. Data obtained from this study show that Eh values were generally decreased with the increasing depth of peat from the surface. This probably relates to the low oxygen diffusion rates within the peat and extensive oxygen consumption by the peat microorganisms on the surface layer. In addition, ground water level is also performing a strong influence to the Eh value.

### ***Some dominant tree species of PSF found in study plots***

The previous works of Anderson (1976) in Sarawak and Brunei reported that the formation of peat swamp forest is supported by lowland peat soil. This lowland peat soil is oligotrophic and recognized as ombrogenous peat, where precipitation is the main source of nutrients (Brunig, 1973). Most peat swamps have concentric forest zones, changing from an outer uneven-canopied high forest, similar to lowland dipterocarp forest, to zones of lower height, decreased tree girth and less species richness towards the center of the swamp. Therefore, Whitmore (1990) affirmed that the peat swamp forest (PSF) formation is quite distinctive with a rather restricted flora. The PSF in Central Kalimantan is quite extensive in area, yet very little is known about their forest species composition and structure. A great loss of the PSF biodiversity is continuously occurred, since most of the dominant and commercially important tree species have been extensively logged.

As shown in Table 3 and 4, it was identified at least 21 family of trees and 4 family of shrubs under native or relatively undisturbed PSF (Plot 1 and Plot 3). Meanwhile, over fire-damaged area (Plot 2 and Plot 3) at least 18 family of trees and 4 species of ferns were identified. Under native or relatively undisturbed peat swamp forest (Plot-1 and Plot-3), woody plant density of more than 1.3 m in height, including shrub and vine species was very dense. Canopy closure was moderate and around 75%. Major tree species found in the top canopy layer were *Gonystylus bancanus*, *Calophyllum inophyllum*, *Shorea* sp., *Tetrameristra glabra*, *Combretocarpus rotundatus*, *Mangifera* sp., *Camnosperma coriaceum*, and *Eugenia* sp. In addition, family of Pandanaceae, Orchidaceae, Arecaceae, and Nepheteaceae were abundantly found as the main shrub layer. There was no apparent of nutrient disorders on tree leaves. In contrast, the plots under fire-damaged area (Plot 2 and 4) had lost many canopy trees caused very sparse in canopy closure. Canopy height was about 20-25 m and the density of residual stands was very low. However, woody plant density of more than 1.3 m in height was abundant because of many seedlings and saplings regenerated naturally after the fire. Major tree species in the stand were *Palaquium* sp., *Combretocarpus rotundatus*, *Mangifera* sp., *Cratoxylum arborescens*, *Buchanania sessifolia*, *Tetrameristra glabra*, *Callophyllum* sp. and *Dyera* sp. Ferns occurred very frequently as the forest floor vegetation. In general, the species composition in native or relatively undisturbed PSFs of this study was relatively poor compared to that in PSFs of Selangor and Pahang (Harun *et al.*, 1999).

### ***Mineral Concentrations in Leaves***

As has widely been recognized that tropical peatland ecosystem was classified as nutrient-poor habitat, and the native plants that grown therein argued to maintaining an inherent mechanism to be adapted. In this study, mature leaves (including shoots) of tree species above 10 cm in diameter at breast height that naturally distributed in whole study plots were sampled and analyzed for their element concentrations. About 40 tree species Plot 1, 22 tree and 2 fern species from Plot 2, 29 tree species from Plot 3, and 6 tree and 2 fern species from Plot 4 were sampled analyzed. However, the results presented in Table 5 are only for some dominant species as the main part of the top canopy layer of the PSF at Kalamangan Zone, Central Kalimantan.

Table 3. Some abundant species found in native or relatively undisturbed peat swamp forest

| Family           | Genus-Species                    | Growth form |
|------------------|----------------------------------|-------------|
| Anacardiaceae    | <i>Buchanania sessifolia</i>     | Tree        |
|                  | <i>Camnosperma coriaceum</i>     | Tree        |
|                  | <i>Mangifera</i> sp.             | Tree        |
| Anisophylleaceae | <i>Combretocarpus rotundatus</i> | Tree        |
| Annonaceae       | <i>Polyalthia hypoleuca</i>      | Tree        |
|                  | <i>Xylopius fusca</i>            | Tree        |
| Apocynaceae      | <i>Dyera costulata</i>           | Tree        |
| Aquifoliaceae    | <i>Ilex macrophylla</i>          | Tree        |
| Burseraceae      | <i>Santiria laevigata</i>        | Tree        |
| Caesalpiniaceae  | <i>Koompasia malaccensis</i>     | Tree        |
| Clusiaceae       | <i>Garcinia dioica</i>           | Tree        |
| Dipterocarpaceae | <i>Shorea blangeran</i>          | Tree        |
|                  | <i>Shorea rugosa</i>             | Tree        |
|                  | <i>Shorea</i> spp.               | Tree        |
|                  | <i>Shorea teysmanniana</i>       | Tree        |
|                  | <i>Shorea uliginosa</i>          | Tree        |
|                  | <i>Shorea retusa</i>             | Tree        |
|                  | <i>Vatica umbonata</i>           | Tree        |
| Ebenaceae        | <i>Diospyros oblonga</i>         | Tree        |
| Euphorbiaceae    | <i>Antidesma bunius</i>          | Tree        |
|                  | <i>Baccaurea bracteata</i>       | Tree        |
|                  | <i>Macaranga semiglobosa</i>     | Tree        |
|                  | <i>Neoscortechinia kingii</i>    | Tree        |
| Guttiferae       | <i>Calophyllum hosei</i>         | Tree        |
|                  | <i>Calophyllum inuphyllum</i>    | Tree        |
|                  | <i>Calophyllum rhizophorum</i>   | Tree        |
|                  | <i>Calophyllum sclerophyllum</i> | Tree        |
|                  | <i>Calophyllum</i> sp. (1)       | Tree        |
| Hypericaceae     | <i>Cratoxylum arborescens</i>    | Tree        |
| Lauraceae        | <i>Alseodaphne coriacea</i>      | Tree        |
|                  | <i>Litsea resinosa</i>           | Tree        |
| Meliaceae        | <i>Sondoricum emarginatum</i>    | Tree        |
| Myristicaceae    | <i>Myristica lowiana</i>         | Tree        |
| Myrtaceae        | <i>Eugenia havilandii</i>        | Tree        |
|                  | <i>Eugenia lepidocarpa</i>       | Tree        |
|                  | <i>Eugenia</i> sp. (1)           | Tree        |
|                  | <i>Eugenia</i> sp. (2)           | Tree        |
|                  | <i>Eugenia</i> sp. (3)           | Tree        |
|                  | <i>Tristania maingayi</i>        | Tree        |
| Rosaceae         | <i>Parastemon urophyllum</i>     | Tree        |
| Sapotaceae       | <i>Ganua motleyana</i>           | Tree        |
|                  | <i>Palaquium leiocarpum</i>      | Tree        |
|                  | <i>Palaquium</i> sp. (1)         | Tree        |
|                  | <i>Palaquium</i> sp. (2)         | Tree        |
| Theaceae         | <i>Tetramerista glabra</i>       | Tree        |
| Thymelaeaceae    | <i>Gonystylus bancanus</i>       | Tree        |
| Pandanaceae      | <i>Pandanus</i> sp.              | Shrub layer |
| Orchidaceae      | <i>Spathoglottis</i> sp.         | Shrub layer |
| Arecaceae        | <i>Calamus</i> sp.               | Shrub layer |
| Nepenthaceae     | <i>Nepenthes</i> sp.             | Shrub layer |

Table 4. Some abundant species found in fire damaged area

| Family           | Genus-Species                    | Growth form |
|------------------|----------------------------------|-------------|
| Anacardiaceae    | <i>Buchanania sessifolia</i>     | Tree        |
|                  | <i>Mangifera sp.</i>             | Tree        |
| Anisophylleaceae | <i>Combretocarpus rotundatus</i> | Tree        |
| Annonaceae       | <i>Xylopia fusca</i>             | Tree        |
| Apocynaceae      | <i>Dyera costulata</i>           | Tree        |
| Clusiaceae       | <i>Garcinia dioica</i>           | Tree        |
| Dipterocarpaceae | <i>Shorea blangeran</i>          | Tree        |
|                  | <i>Shorea rugosa</i>             | Tree        |
|                  | <i>Shorea teysmanniana</i>       | Tree        |
| Ebenaceae        | <i>Diospyros oblonga</i>         | Tree        |
| Euphorbiaceae    | <i>Neoscortechinia kingii</i>    | Tree        |
| Fabaceae         | <i>Dialium patens</i>            | Tree        |
| Guttiferae       | <i>Calophyllum inuphyllum</i>    | Tree        |
|                  | <i>Calophyllum sclerophyllum</i> | Tree        |
|                  | <i>Calophyllum sp. (1)</i>       | Tree        |
| Hypericaceae     | <i>Cratoxylum arborescens</i>    | Tree        |
| Lauraceae        | <i>Cinnamumun sp.</i>            | Tree        |
|                  | <i>Litsea firma</i>              | Tree        |
| Myrtaceae        | <i>Eugenia lepidocarpa</i>       | Tree        |
|                  | <i>Eugenia sp. (1)</i>           | Tree        |
| Polygalaceae     | <i>Xanthophyllum sp.</i>         | Tree        |
| Rosaceae         | <i>Parastemon urophyllum</i>     | Tree        |
| Sapotaceae       | <i>Palaquium leiocarpum</i>      | Tree        |
|                  | <i>Palaquium sp. (1)</i>         | Tree        |
| Theaceae         | <i>Tetramerista glabra</i>       | Tree        |
| Thymelaeaceae    | <i>Gonystylus bancanus</i>       | Tree        |
| FERNS            | <i>Lycopodium cernuum</i>        | Shrub layer |
|                  | <i>Stenochalena palustris</i>    | Shrub layer |
|                  | <i>Nephrolepis biserrata</i>     | Shrub layer |
|                  | <i>Pteridium esculentum</i>      | Shrub layer |

As can be seen in Table 5, that the mineral concentrations in mature leaves of some dominant plants in all study plots were varied greatly according to the species and the site of origin. There was a similar pattern in the average concentration of macro elements of the plant species for whole study plots, as in the following order: N>K>Ca>Mg>P. In contrast, the average concentration of microelements was found similar in Plot 1 and 4, but slightly different in Plot 2 and Plot 3. In Plot 1 and 4, the order of leaf element concentrations was Na>Al>Mn>Fe>Si>Zn, whilst the following orders of Na>Mn>Al>Fe>Si>Zn and Al>Na>Mn>Fe>Si>Zn were appeared in Plot 3 and Plot 3, respectively. In this study, although some microelements such as Fe, Mn and Zn found below the critical levels for adequate growth, there were no symptoms of these nutrients disorder observed. This is denoting that the concentrations of those microelements have sufficient enough to support the plant growth in peat soils.

Table 5. Leaf element concentrations of some dominant plant grown in peat swamp forest at Kalamangan Zone, Central Kalimantan

| Species  | N    | P   | g kg <sup>-1</sup> |      |      | mg kg <sup>-1</sup> |     |     |    |       |     |
|--|------|-----|--------------------|------|------|---------------------|-----|-----|----|-------|-----|
|  |      |     | K                  | Ca   | Mg   | Na                  | Fe  | Mn  | Zn | Al    | Si  |
| <b>Native-Deep Peat [Plot-1]</b>               |      |     |                    |      |      |                     |     |     |    |       |     |
| <i>Camnosperma coriaceum</i>                   | 12.8 | 0.5 | 8.8                | 5.7  | 5.6  | 589                 | 55  | 192 | 15 | 121   | 59  |
| <i>Calophyllum inuphyllum</i>                  | 10.8 | 0.3 | 6.0                | 3.2  | 1.3  | 488                 | 114 | 31  | 12 | 28    | 47  |
| <i>Calophyllum sclerophyllum</i>               | 19.2 | 0.3 | 5.0                | 21.4 | 4.0  | 459                 | 40  | 30  | 7  | 110   | 57  |
| <i>Diospyros oblonga</i>                       | 15.2 | 0.3 | 11.9               | 3.9  | 4.3  | 308                 | 46  | 591 | 8  | 37    | 51  |
| <i>Palaquium leiocarpum</i>                    | 19.6 | 0.3 | 7.3                | 5.1  | 2.9  | 395                 | 629 | 28  | 9  | 72    | 66  |
| <i>Dyera costulata</i>                         | 16.2 | 0.4 | 5.8                | 6.9  | 2.8  | 219                 | 44  | 382 | 16 | 49    | 46  |
| <i>Antidesma bunius</i>                        | 13.0 | 0.1 | 7.6                | 1.8  | 3.7  | 252                 | 54  | 40  | 26 | 309   | 88  |
| <i>Mangifera</i> sp.                           | 14.0 | 0.2 | 13.0               | 6.4  | 3.6  | 277                 | 51  | 34  | 8  | 31    | 55  |
| <i>Ilex macrophylla</i>                        | 24.9 | 0.3 | 6.7                | 10.3 | 2.9  | 228                 | 42  | 42  | 13 | 31    | 18  |
| <i>Eugenia havilandii</i>                      | 16.2 | 0.3 | 12.5               | 5.8  | 3.6  | 526                 | 132 | 168 | 34 | 1     | 21  |
| <i>Shorea teysmanniana</i>                     | 16.8 | 0.3 | 5.4                | 10.7 | 3.5  | 201                 | 68  | 654 | 13 | 35    | 35  |
| <i>Tetramerista glabra</i>                     | 10.5 | 0.2 | 8.6                | 4.5  | 1.9  | 697                 | 70  | 27  | 12 | 28    | 58  |
| <i>Gonystylus bancanus</i>                     | 9.4  | 0.2 | 7.4                | 4.6  | 1.9  | 280                 | 82  | 29  | 8  | 1     | 39  |
| <i>Combretocarpus rotundatus</i>               | 14.0 | 0.5 | 7.3                | 5.5  | 2.0  | 373                 | 91  | 826 | 45 | 7756  | 44  |
| <b>Fire Damaged Area-Deep Peat [Plot-2]</b>    |      |     |                    |      |      |                     |     |     |    |       |     |
| <i>Calophyllum inuphyllum</i>                  | 8.6  | 0.2 | 4.8                | 6.7  | 2.0  | 485                 | 51  | 117 | 16 | 13    | 33  |
| <i>Calophyllum sclerophyllum</i>               | 15.8 | 0.5 | 21.2               | 10.8 | 4.5  | 299                 | 87  | 180 | 48 | 36    | 32  |
| <i>Diospyros oblonga</i>                       | 10.6 | 0.3 | 5.5                | 14.1 | 2.2  | 240                 | 66  | 985 | 47 | 45    | 34  |
| <i>Eugenia lepidocarpa</i>                     | 9.6  | 0.2 | 12.2               | 10.1 | 1.7  | 218                 | 70  | 23  | 9  | 55    | 49  |
| <i>Cratogeomys arborescens</i>                 | 15.1 | 0.6 | 9.9                | 6.6  | 1.0  | 327                 | 73  | 520 | 29 | 14    | 36  |
| <i>Palaquium leiocarpum</i>                    | 12.9 | 0.3 | 16.1               | 6.9  | 2.6  | 406                 | 60  | 25  | 10 | 38    | 60  |
| <i>Dyera costulata</i>                         | 17.6 | 0.6 | 14.8               | 7.5  | 2.4  | 378                 | 64  | 224 | 20 | 8     | 26  |
| <i>Tetramerista glabra</i>                     | 11.8 | 0.3 | 11.3               | 7.7  | 2.8  | 393                 | 96  | 28  | 9  | 50    | 44  |
| <i>Combretocarpus rotundatus</i>               | 16.5 | 0.7 | 8.7                | 7.2  | 2.1  | 516                 | 173 | 454 | 30 | 2084  | 65  |
| <i>Lycopodium cernuum</i> [Fern-1]             | 8.1  | 0.5 | 14.4               | 12.7 | 12.1 | 126                 | 95  | 125 | 25 | 103   | 60  |
| <i>Pteridium esculentum</i> [Fern-2]           | 9.3  | 0.4 | 16.7               | 0.8  | 1.1  | 198                 | 51  | 52  | 20 | 37    | 26  |
| <b>Native-Shallow Peat [Plot-3]</b>            |      |     |                    |      |      |                     |     |     |    |       |     |
| <i>Shorea blangeran</i>                        | 17.0 | 0.6 | 11.5               | 8.8  | 2.5  | 522                 | 314 | 355 | 84 | 59    | 64  |
| <i>Calophyllum inuphyllum</i>                  | 10.5 | 0.4 | 11.1               | 10.6 | 3.0  | 706                 | 62  | 72  | 21 | 57    | 49  |
| <i>Calophyllum sclerophyllum</i>               | 9.6  | 0.4 | 19.0               | 7.9  | 4.9  | 561                 | 64  | 227 | 38 | 23    | 25  |
| <i>Diospyros oblonga</i>                       | 17.6 | 0.4 | 16.1               | 7.1  | 2.8  | 469                 | 49  | 448 | 11 | 40    | 56  |
| <i>Eugenia lepidocarpa</i>                     | 18.3 | 0.3 | 6.3                | 10.5 | 1.8  | 647                 | 77  | 49  | 12 | 275   | 79  |
| <i>Dyera costulata</i>                         | 11.9 | 0.3 | 8.0                | 9.0  | 3.1  | 237                 | 121 | 41  | 12 | 73    | 103 |
| <i>Ilex macrophylla</i>                        | 11.0 | 0.4 | 11.7               | 15.5 | 2.4  | 487                 | 102 | 39  | 11 | 200   | 97  |
| <i>Shorea teysmanniana</i>                     | 8.0  | 0.3 | 9.2                | 15.0 | 1.4  | 290                 | 93  | 73  | 14 | 49    | 33  |
| <i>Tristania maingayi</i>                      | 8.7  | 0.4 | 17.7               | 6.1  | 2.4  | 820                 | 43  | 26  | 7  | 66    | 102 |
| <i>Tetramerista glabra</i>                     | 13.0 | 0.4 | 10.6               | 5.9  | 1.6  | 673                 | 84  | 169 | 9  | 49    | 60  |
| <i>Gonystylus bancanus</i>                     | 8.1  | 0.3 | 17.6               | 5.9  | 2.3  | 471                 | 48  | 23  | 7  | 63    | 93  |
| <i>Eugenia</i> sp.                             | 13.6 | 0.5 | 14.0               | 4.4  | 2.5  | 551                 | 52  | 497 | 37 | 10149 | 30  |
| <i>Combretocarpus rotundatus</i>               | 12.3 | 0.4 | 11.6               | 4.8  | 2.6  | 512                 | 49  | 485 | 33 | 9751  | 55  |
| <b>Fire Damaged Area-Shallow Peat [Plot-4]</b> |      |     |                    |      |      |                     |     |     |    |       |     |
| <i>Buchanania sessifolia</i>                   | 23.0 | 0.6 | 5.9                | 13.8 | 2.5  | 675                 | 76  | 226 | 16 | 85    | 52  |
| <i>Mangifera</i> sp.                           | 14.6 | 0.5 | 9.0                | 5.6  | 3.0  | 549                 | 104 | 248 | 24 | 100   | 41  |
| <i>Palaquium</i> sp.                           | 18.6 | 0.4 | 5.0                | 4.8  | 3.8  | 262                 | 38  | 114 | 16 | 17    | 24  |
| <i>Tetramerista glabra</i>                     | 13.6 | 0.2 | 11.0               | 3.0  | 1.0  | 924                 | 39  | 25  | 13 | 28    | 49  |
| <i>Combretocarpus rotundatus</i>               | 18.2 | 0.5 | 9.7                | 6.6  | 2.4  | 585                 | 79  | 437 | 46 | 4367  | 56  |
| <i>Lycopodium cernuum</i> [Fern-1]             | 18.7 | 0.6 | 15.2               | 1.5  | 1.5  | 426                 | 142 | 62  | 20 | 311   | 53  |
| <i>Pteridium esculentum</i> [Fern-2]           | 16.1 | 0.3 | 13.0               | 4.8  | 4.1  | 895                 | 118 | 166 | 20 | 141   | 47  |

Moreover, among other plants studied, *Combretocarpus rotundatus* and *Eugenia* sp. tend to accumulate Al more than the others. If the criteria of Al accumulator plant that introduced by Chenery and Sporne (1976) should be referred, so these native plants of PSF can be categorized as Al accumulator plants. As shown in Table 5, that the species of *Combretocarpus rotundatus* in whole study plots accumulates Al more than 1000 mg kg<sup>-1</sup> in its leaf (including shoot), whereas *Eugenia* sp. was only found in Plot 3. In addition, all the plants studied were found maintaining high concentrations of Al and Na in their leaf tissues compared to the other elements as such Fe, Mn, Zn and Si. Osaki *et al.* (1998) argued that this phenomenon remained inherent to plant characteristics regardless of soil conditions as observed over native plants that grown in various adverse soils in Peninsular Thailand. Although further study need to be addressed to the adaptation mechanisms of plants that grown and survive in nutrient-poor habitat of PSF, Jordan (1991) argued that as part of the mechanisms the plant often performed a large root biomass, root concentration near surface, aerial roots, mycorrhizae, tolerance of acid soils, nutrient uptake kinetics, long life span, leaf morphology and physiology, allelopathy, nutrient translocation, efficiency of nutrient use, reproduction, silica concentration, bark, epiphylls, and drip tips. As observed in this study, the most abundant trees recorded belong to families rich in defense compounds such as latex, essential oils, resins, and tannins. In addition to these mechanisms, Berendse *et al.* (1999) concluded that plant species could increase their success in nutrient poor habitats along three different lines. First, they can maximize the acquisition of nutrients by increasing their competitive ability for soil nutrients. Second, is by changing the efficiency with which the nutrients that are present in the plant are used for carbon assimilation and subsequent growth. Third, is by increasing the length of the time period during which nutrients can be used.

### Conclusions

- Based on the range of peat thickness, it was observed that Plot 1 and Plot 2 covered by deep peat than that in Plot 3 and 4. Meanwhile, ground water level in entire study plots was remained high, indicating that peat soils are considerable important as water storage, particularly during dry season. Therefore, over-drain on peatlands may lead to rapid rates of peat oxidation and decomposition. Consequently, peat subsidence may occur at a very fast rate, especially under tropical conditions.
- The peat soil at study site has very low pH (<4), this is assumed due to a high organic matter constituents which producing some organic acid compounds through decomposition process under waterlogged conditions. Whilst, the mean values of EC were remained high over the study plots nearby the Sebangau River (Plot 3 and 4). Eh values, on the other hand, were generally decreased with the increasing depth of peat from the surface layer. Perhaps, this relates to the low oxygen diffusion rates within the peat and extensive oxygen consumption by the peat microorganisms on the surface layer.
- In terms of the dominant plant species recorded from entire study plots, it was identified at least 21 family of trees and 4 family of shrubs under native or relatively undisturbed PSF (Plot 1 and Plot 3). Meanwhile, over fire-damaged area (Plot 2 and Plot 3) at least 18 family of trees and 4 species of ferns were recorded.
- The same successive order of the average concentration of macro elements in plants studied was observed in whole study plots, namely: N>K>Ca>Mg>P. On the other

hand, some microelements such as Fe, Mn and Zn were observed below the critical levels for adequate growth of the plants studied, but no symptoms of these nutrients disorder found.

- Among other plants studied, *Combretocarpus rotundatus* and *Eugenia* sp. tend to accumulate Al more than the others. However, most of the plants studied were found maintaining high concentrations of Al and Na in their leaf tissues compared to the other elements as such Fe, Mn, Zn and Si.
- Further studies should be addressed to know more the physiological characteristics of *Combretocarpus rotundatus* and *Eugenia* sp. in terms of adaptation mechanisms to poor-nutrients habitat of PSF. In addition, the possible relationships among elements measured are also requiring for further analysis and interpretation.

### References

- Anderson, J.A.R. 1976. Observations on the ecology of five Peat Swamp Forests in Sarawak and Kalimantan. Soil Research institute of Bogor, Indonesia, Bulletin 3: 45-55.
- Brendse, F., de Kroon, H. and Braakhekke, W.G. 1999. Acquisition, use, and loss of nutrients, *In: Pugnare, F.I. and Valladares, F. (eds.), Handbook of Functional Plant Ecology*. Marcel Dekker, Inc., New York, pp. 315-340.
- Brunig, E.F. 1973. Species richness and stand diversity in relation to site and succession of forests in Sarawak and Brunei (Borneo). *Amazoniana*, 4: 293-320.
- Chenery, E.M. and Sporne, K.R. 1976. A note on the evolutionary status of aluminium-accumulators among dicotyledons. *New Phytol.*, 76: 551-554.
- Harun, I., Shamsudin M., Appanah, S. and Sahat, S. 1999. Survey of flora in Peat Swamp Forests of Selangor. Paper presented at the Workshop on Sustainable and Integrated Management of Peat Swamp Forests in Peninsular Malaysia, 16-18 November 1999, Kuantan Pahang, Malaysia.
- Jordan, C.F. 1991. Nutrient cycling processes and tropical forest management, *In: Gomez-Pompa, A., Whitmore, T.C. and Haley, M. (eds.), Rain Forest Regeneration and Management*. UNESCO and The Parthenon Publishing Group, Paris.
- Osaki, M., Watanabe, T., Ishizawa, T., Nilnond, C., Nuyim, T., Sittibush, Ch. and Tadano, T. 1998. Nutritional characteristics in leaves of native plants grown in acid sulfate, peat, sandy podzolic, and saline soils distributed in Peninsular Thailand. *Plant and Soil*, 201: 175-182.
- Sabiham, S., Prasetyo, T.B. and Dohong, S. 1997. Phenolic acids in Indonesian Peat, *In: Rieley and Page (eds.). Biodiversity and Sustainability of Tropical Peatlands. Proceedings of the International Symposium on Biodiversity, Environmental Importance and Sustainability of Tropical Peat and Peatlands, held in Palangka Raya, Central Kalimantan, Indonesia 4-8 September 1995*. Samara Publishing Limited, UK.
- Shepherd, P.A., Rieley, J.O. and Page, S.E. 1997. The relationship between forest vegetation and peat characteristics in the upper catchment of Sungai Sebangau, Central Kalimantan, *In: Rieley and Page (eds.). Biodiversity and Sustainability of Tropical Peatlands. Proceedings of the International Symposium on Biodiversity, Environmental Importance and Sustainability of Tropical Peat and Peatlands, held in Palangka Raya, Central Kalimantan, Indonesia 4-8 September 1995*.



Samara Publishing Limited, UK.  
Whitmore, T.C. 1990. *An Introduction to Tropical Rain Forests*. Clarendon Press,  
Oxford.

## **Nitrogen and Carbon Cycles of Peat Swamp Forests and Surrounding Areas in Narathiwat, Thailand, Inferred from $\delta^{13}\text{C}$ and $\delta^{15}\text{N}$ Analyses**

**Takeshi MATSUBARA<sup>1</sup>, Narin BOONTANON<sup>2</sup>, Shingo UEDA<sup>3</sup>,  
Proespichaya KANATHARANA<sup>4</sup> and Eitaro WADA<sup>2</sup>**

<sup>1</sup> The College of Cross-Cultural Communication and Business, Shukutoku University

<sup>2</sup> Center for Ecological Research, Kyoto University

<sup>3</sup> College of Bioresources Science, Nihon University

<sup>4</sup> Faculty of Science, Prince of Songkla University

Stable isotope analysis has been recognized as a useful tool for ecological research, especially on ecosystem structure and dynamics such as food web and nutrient dynamics in forests. In this paper we introduce briefly what kind of information a stable isotope analysis gives us and then demonstrate the results of a case study in a peat swamp ecosystem at Narathiwat, Thailand. We clarified the characteristics of nitrogen and carbon cycles in the peat swamp ecosystem and estimated the contribution of biological products at Narathiwat peat swamps as food resource for the people living in this area.

### **What Kind of Information Stable Isotope Analysis Gives Us?**

Light elements composing organic matters, such as hydrogen, carbon, nitrogen, oxygen and sulfur, have a dominant “light isotope” with the nominal atomic weight, and one or two “heavy” isotopes with a natural abundance of a few or less than few percent (Table 1). These heavy isotopes are called stable (in some cases silent) isotopes. The nature of these isotopes is quite similar in chemical and biological reactions. But the isotopes have their own particular thermodynamic and rate constants. Consequently, variation in the isotope ratios of biogenic substances depends on the isotopic composition of reactant, metabolic pathways, and kinetic modes of reaction dynamics. Every biogenic

Table 1. Average terrestrial abundances of the stable isotopes of major elements in ecological studies.

| Element  | Isotope         | Abundance(%) |
|----------|-----------------|--------------|
| Hydrogen | <sup>1</sup> H  | 99.985       |
|          | <sup>2</sup> H  | 0.015        |
| Carbon   | <sup>12</sup> C | 98.89        |
|          | <sup>13</sup> C | 1.11         |
| Nitrogen | <sup>14</sup> N | 99.63        |
|          | <sup>15</sup> N | 0.37         |
| Oxygen   | <sup>16</sup> O | 99.759       |
|          | <sup>17</sup> O | 0.037        |
|          | <sup>18</sup> O | 0.204        |
| Sulfur   | <sup>32</sup> S | 95.00        |
|          | <sup>33</sup> S | 0.76         |
|          | <sup>34</sup> S | 4.22         |
|          | <sup>35</sup> S | 0.014        |

material, accordingly, have their own inherent isotopic composition (Wada and Hattori 1991). For instance, a human with 50 kg of body weight has 225 g of heavier isotopes (Fig.1). Human life depends on the material cycles of natural environment and its body has their own isotopic pattern of light elements corresponding to its own positions in matter cycle. This is the reason why the isotopic composition of organisms provides useful information on diet analysis, identify nutrient sources and individual feeding behavior, organisms function and position in a food web. In following part we focus on carbon and nitrogen stable isotopes, which are most frequently used for ecological studies.

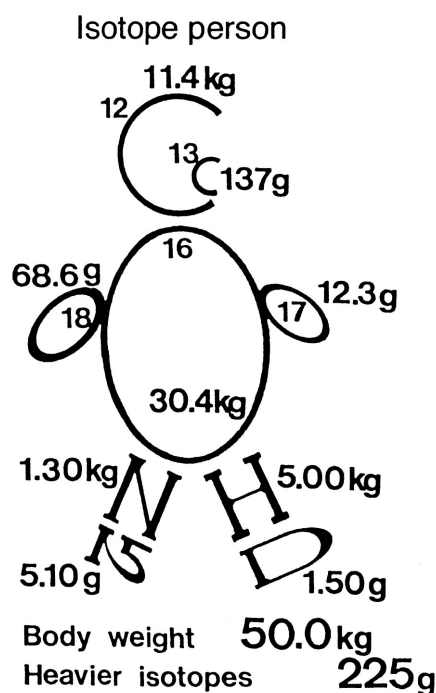

Fig. 1. Isotope person. This person explain isotope balance of light elements composing human body (adapted a brochure from the Mitsubishi Kasei Institute of Life Sciences with permission).

Natural abundance of stable isotopes is explained as the  $\delta$ -notation:

$$\delta X = [(R_{\text{sample}}/R_{\text{standard}}) - 1] \times 1000,$$

where X is <sup>13</sup>C or <sup>15</sup>N and R is <sup>13</sup>C/<sup>12</sup>C or <sup>15</sup>N/<sup>14</sup>N, respectively. Then,  $\delta$  units are quoted relative to an internationally recognized standard which is set to 0 ‰. For nitrogen, the standard is atmospheric nitrogen, because this isotope pool is well homogenized across the planet's surface. For carbon, the standard is the carbonate fossil, *Bellemnitella americana*, from the Pee Dee Formation in South Carolina, U.S.A. (PDB). Since the accepted standard is limited by availability of the material except nitrogen, samples are measured against a laboratory reference materials so-called "working standard" which have been calibrated against the international standard.

$\delta^{13}\text{C}$  and  $\delta^{15}\text{N}$  of an animal provide information on its diets.  $\delta^{13}\text{C}$  of animals are used as an indicator of diet (DeNiro and Epstein, 1978; Rau *et al.*, 1983; Fry *et al.*, 1984) (Fig. 2). A stepwise enrichment of  $\delta^{15}\text{N}$  along food chain is widely recognized among animals with an enrichment factor of  $3.4 \pm 1.1$  ‰ (DeNiro and Epstein, 1981; Minagawa and Wada, 1984; Wada *et al.*, 1987) (Fig. 2).  $\delta^{15}\text{N}$  of an animal is thus used as an indicator of trophic level of animals.

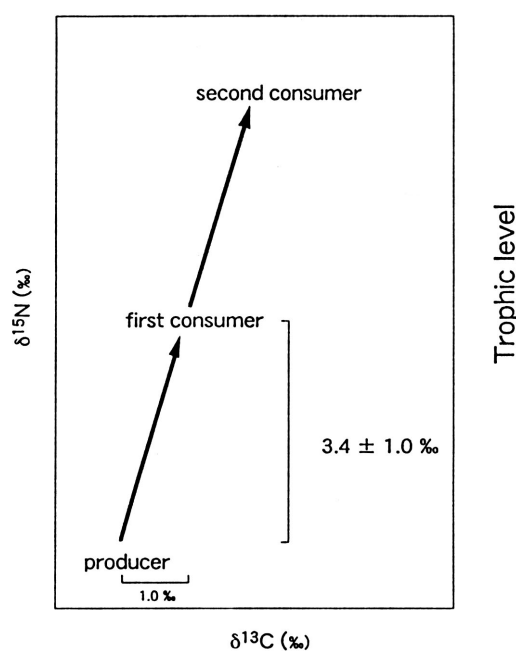

Fig. 2. Schematic  $\delta^{13}\text{C}$  -  $\delta^{15}\text{N}$  map of a food web. Regarding  $\delta^{13}\text{C}$ , the relation is only in protein chain, because during synthesizing lipid  $\delta^{13}\text{C}$  value depress dramatically.

$\delta^{13}\text{C}$  of plants is characterized according  $\text{CO}_2$  assimilation system known as  $\text{C}_3$ ,  $\text{C}_4$  and CAM-systems: average  $\delta^{13}\text{C}$  value of  $\text{C}_3$  plants is  $-26$  ‰ and that of  $\text{C}_4$  and CAM is ca.  $-14$  ‰ (O'Leary 1981). The  $\delta^{13}\text{C}$  becomes high in an aquatic environment where  $\text{CO}_2$  diffusion is restricted (Sweeney *et al.*, 1978).  $\delta^{15}\text{N}$  is closely correlated with forms of nitrogen uptaken by plants as well as organism's growth rate.

According to previous studies, average  $\delta^{13}\text{C}$  and  $\delta^{15}\text{N}$  value of terrestrial ecosystems are  $-25$  and  $6$  ‰ (Fig. 3). Then, if denitrification and/or  $\text{NH}_3$  volatilization activate in an ecosystem, light nitrogen ( $^{14}\text{N}$ ) emit faster than heavier nitrogen ( $^{15}\text{N}$ ). Consequently,  $\delta^{15}\text{N}$  of organisms in the ecosystem reveals relatively heavy  $\delta^{15}\text{N}$  value. If nitrogen fixation activate and/or inorganic nitrogen in precipitation is major nitrogen source in a ecosystem,  $\delta^{15}\text{N}$  of organisms become close to  $0$  ‰ and/or  $-5$  ‰, respectively, because  $\delta^{15}\text{N}$  values of nitrogen in atmosphere and in precipitation are  $0$  ‰ and  $-5$  ‰, respectively. In the case of  $\delta^{13}\text{C}$ , active photosynthesis and water stress enrich  $\delta^{13}\text{C}$  value of plant leaves (Fig. 3).

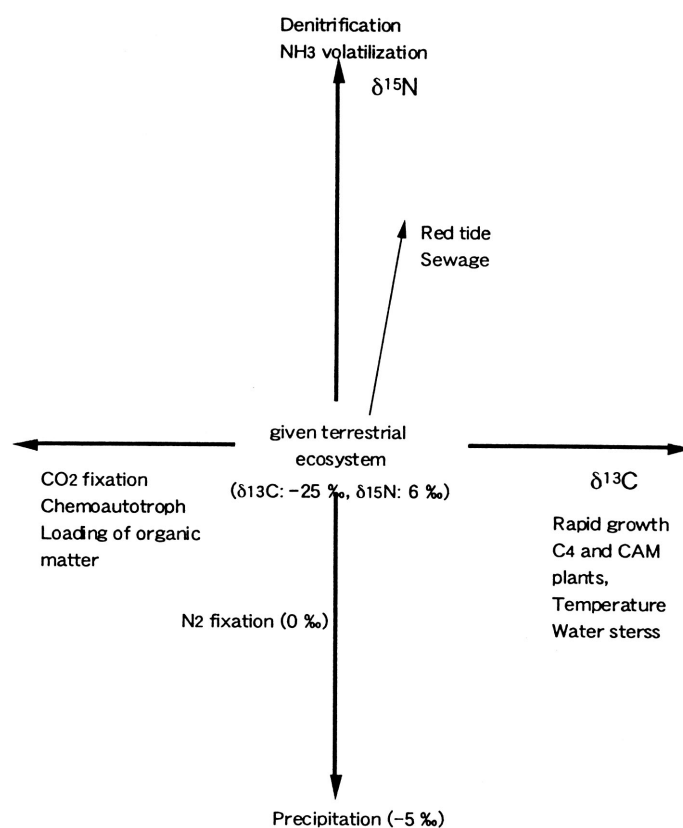

Fig. 3. Fluctuation of  $\delta^{13}\text{C}$  and  $\delta^{15}\text{N}$  values and factors affecting the isotope values in a terrestrial ecosystem.

The other example is isotope ratio of human scarp hair.  $\delta^{13}\text{C}$  value distinguishes  $\text{C}_3$  plants, as mentioned above.  $\delta^{13}\text{C}$  and  $\delta^{15}\text{N}$  values also distinguish most marine fishes, meat, and dairy products (Wada *et al.*, 1991). Since most commercial plants are cultivated in the presence of chemical fertilizers ultimately made from atmospheric nitrogen, the  $\delta^{15}\text{N}$  of  $\text{C}_3$  plants tends to overlap that of leguminous plants (ca. 0 ‰), which can fix atmospheric nitrogen biologically. Most marine fishes caught as human foods are usually carnivorous and on higher trophic positions in a food web. Hence their  $^{15}\text{N}$  contents become relatively high (Wada *et al.*, 1991). For instance, the  $\delta^{13}\text{C}$  and  $\delta^{15}\text{N}$  values indicate trend of food consumed in Japan. The values of commercial foods in Japan are becoming close to those of American foods, partly because some foods, such as wheat, potato and soybeans, are imported from the U. S. In addition, assorted food for livestock cultured in Japan has been prepared by using imported materials, including corn ( $\text{C}_4$  plant) from the U. S.

Due to these background human  $\delta^{13}\text{C}$  and  $\delta^{15}\text{N}$  decrease its  $\delta^{15}\text{N}$  values. These effects are major reasons for the hair isotope characteristics in Indian (less than 9 ‰), Chinese, Korean, and Japanese populations (less than 11 ‰). Whereas the different usage of  $\text{C}_3$  and  $\text{C}_4$  plants make a large difference in the  $^{13}\text{C}$  content of the food.  $\delta^{13}\text{C}$  of human hair differentiates Europeans (ca. -20.5 ‰) from Americans (ca. -17.5 ‰), because the ultimate source of organic matter for the former depends mainly on  $\text{C}_3$  plants, whereas the diet of the latter depends more heavily on corn.

**Relationship between Natural Ecosystem and Human Foods:  
A Case Study in Narathiwat, Thailand**

Since 1995, we conducted stable isotopic study at Narathiwat (N5° 44' - 6° 38', E101° 12' - 102° 5'), the southeast province of Thailand, to investigate carbon and nitrogen cycles in peat swamp forests and surrounding areas. Wide area of natural peat swamp forest had been destroyed to create paddy field in this province. Consequently, peat layer decreased and soil condition become acid-sulfate. Finally the destroyed area become secondary forest dominated only by *Melaleuca cauputi* and *Blechnum indicum* (Kyuma 1995). Natathiwat area is divided into hill site, alluvial plain, swamp, sandy plain, river and ground water pool (Fig.4). Various kinds of organic matters were collected mainly at the natural (ToDaeng) and secondary (Bacho) forests, and surrounding areas, then analyzed their stable isotope ratios. The ToDaeng swamp have been kept intact as a protected forest, while wide area of Bacho swamp already underwent a large scale development during 1970s to early 1980s (Kyuma 1995). In addition, we started the another research at the Narathiwat area since 1997. We collected human scarp hair and measured its carbon and nitrogen stable isotope ratios to evaluate the contribution of biological products from natural ecosystem as food resource for local people in Narathiwat area.

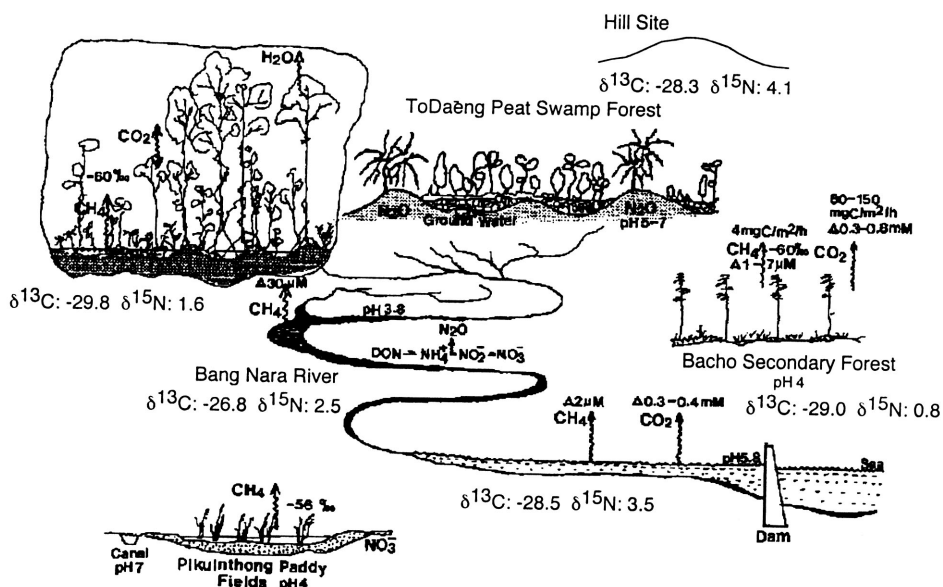

Fig. 4.  $^{13}\text{C}$  and  $^{15}\text{N}$  of sediments at Narathiwat watershed.

The results are summarized as follows.

- 1)  $\delta^{15}\text{N}$  values suggested that inorganic nitrogen in precipitation is major source for organisms at the forests and surrounding area at Narathiwat (Fig. 5). The effect of nitrogen fixation and  $\text{NH}_3$  volatilization was low in the area due to low pH (4-5) of the swamp water. Higher nitrogen isotope ratio at ToDaeng natural forest ( $\delta^{15}\text{N}$ ; ca. 2 ‰) suggested that denitrification activity was higher at ToDaeng than at Bacho secondary forest (ca. -5 - 0 ‰) (Fig.5).

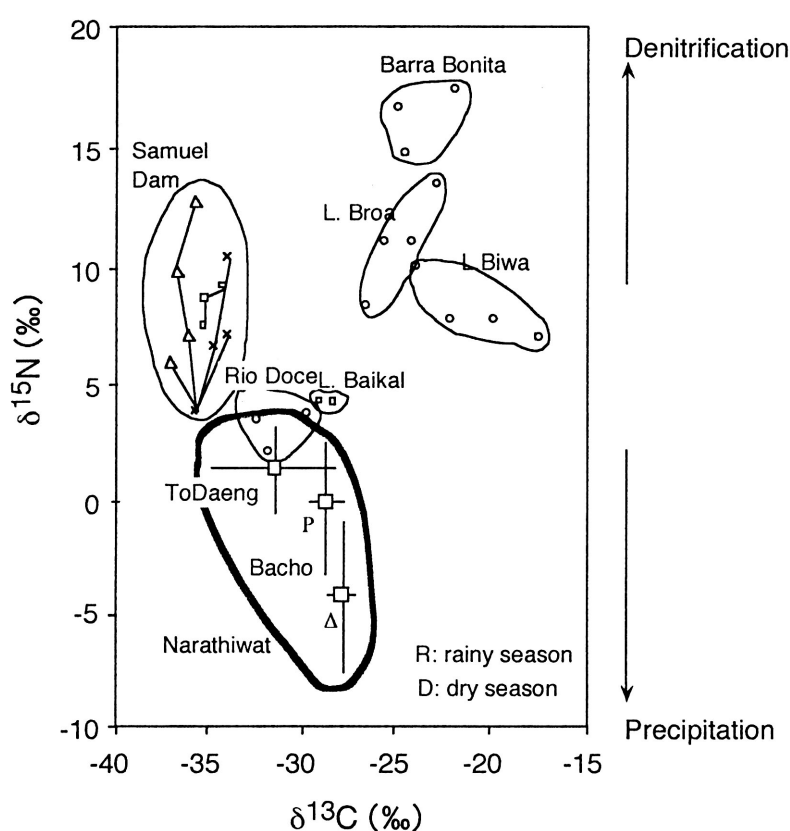

Fig. 5. Summary of  $\delta^{13}\text{C}$  and  $\delta^{15}\text{N}$  values of plant leaves collected at Narathiwat area and organic matters in various kinds of lacustrine ecosystems. Possible factors affecting isotope ratios of respective ecosystems are as follows: Barra Bonita: sewage water, L. Bira: allochthonous inputs of terrestrial plants from upper region, L. Biwa: denitrification, Samuel Dam: inflowing organic matter from upper region, Rio Doce: Steady state, L. Baikal: oxygen rich water, Narathiwat: precipitation.

- 2) Photosynthetic activity is higher at secondary forest ( $\delta^{13}\text{C}$ ; ca. -28 ‰) than at natural forest (ca. -32 ‰) (Fig.5). Fluctuation of  $\delta^{13}\text{C}$  at ToDaeng natural forest was affected primary by vertical depression of right intensity (Hanba *et al.*, 1996) and also plant species diversity. Vertical depression of  $\delta^{13}\text{C}$  of plant leaves correlated

with light intensity under no water stress. This pattern is widely observed in various kinds of forests (Hanba *et al.*, 1996). On the contrary the fluctuation at Bacho secondary forest was rather affected by difference of photosynthetic activity depend on leaf longevity, because species composition of plants was simple as mentioned above.

- 3)  $\delta^{15}\text{N}$  in soil organic matter at ToDaeng was lower than that at other tropical forest possibly due to lower turnover rate of nitrogen compared with other tropical forests (Fig. 6). That is, the swamp is under depletion of available nitrogen because of low mineralization of the peat materials. Assimilation of inorganic nitrogen with low  $\delta^{15}\text{N}$  that enters the system by atmospheric precipitation most probably caused the low  $\delta^{15}\text{N}$  in primary produced organic matters. The  $\delta^{15}\text{N}$  of organic matters in the Bacho swamp (reclaimed) are lower than those in the ToDaeng swamp (virgin) (Fig. 5). The difference probably reflected that N-availability (size of inorganic-N pool) was enlarged during dry season because of increased mineralization under aerobic condition (not water-logged).

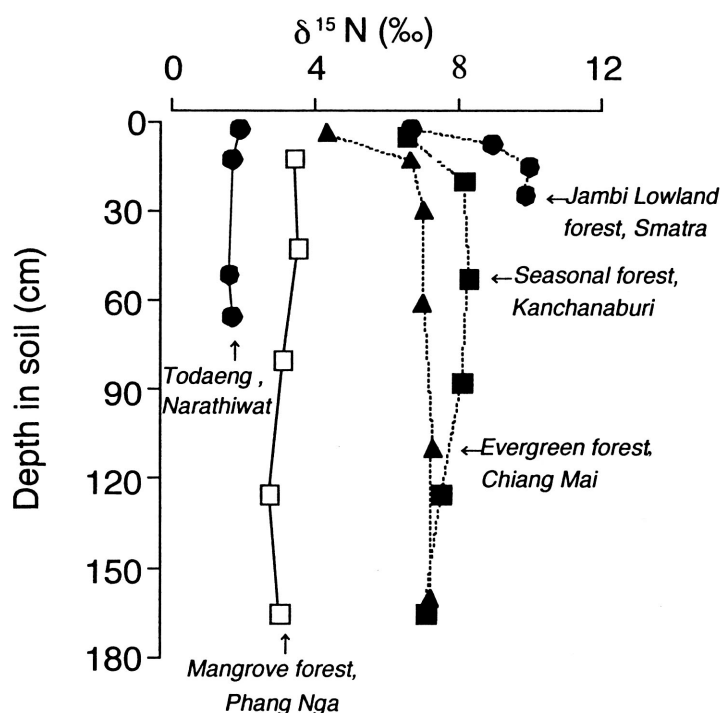

Fig. 6. Vertical profile of  $^{15}\text{N}$  of soil organic matter at different types of tropical forests.

- 4) Isotope values of human hair ( $\delta^{13}\text{C}$ ; ca. -19 ‰,  $\delta^{15}\text{N}$ ; 10.6 ‰) suggested that food resources for people in Narathiwat and surrounding area were not only products in the Narathiwat ecosystem but also those imported from other areas (Fig. 7).



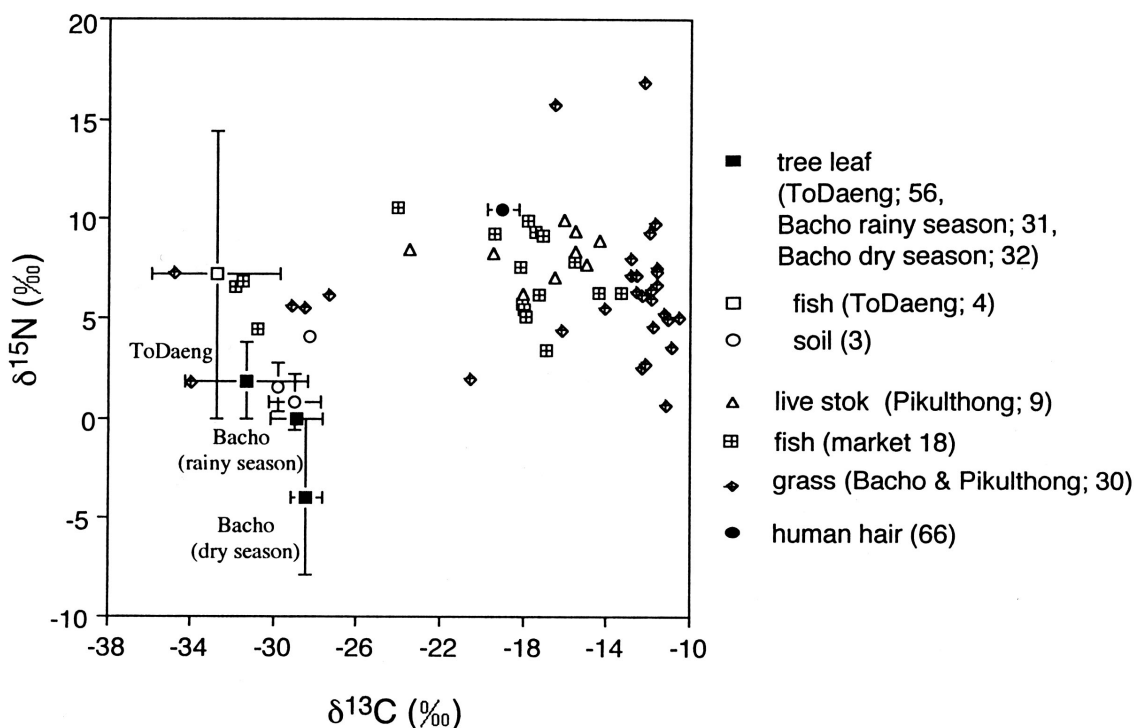

Fig. 7.  $\delta^{13}\text{C}$  and  $\delta^{15}\text{N}$  of human scarp hair and organic materials at Narathiwat. Number of samples is shown in parenthesis.

Stable isotope studies at Narathiwat mentioned above were conducted as a part of the research programme of “Creative Basic Research Studies on Development of Sustainable Biomass Production Techniques” by Ministry of Education, Science and Culture, Japan”.

### References

- DeNiro, M. J. and Epstein, S. 1978. Influence of diet on the distribution of carbon isotopes in animals. *Geochim. Cosmochim. Acta*, 42: 492-506.
- DeNiro, M. J. and Epstein, S. 1981. Influence of diet on the distribution of nitrogen isotopes in animals. *Geochim. Cosmochim. Acta*, 45: 341-351.
- Fry, B., Anderson, R.K., Entzeroth, L., Bird J. L. and Parker, P.L. 1984.  $^{13}\text{C}$  enrichment and oceanic food web structure in the northwestern Gulf of Mexico. *Contrib. Mar. Sci.*, 27: 13-47.
- Hanba, Y., Matsui, K. and Wada, E. 1996. Solar radiation affects modern tree-ring  $\delta^{13}\text{C}$ : observation at a cool-temperate forest in Japan. *Isotopes Environ. Health Stud.*, 32: 55-62.
- Kyuma, K. 1995. Climate, landform, and soil conditions of the Narathiwat Province as the background of the swamp forest project. In: Vijarnsorn, P. *et al.* (eds.), A Tropical Swamp Forest Ecosystem and Its Greenhouse Gas Emission, (Reports of a New Program for Creative Basic Research Studies of Global Environmental

- Change with Special Reference to Asia and Pacific Regions: Nodai Research Center, Tokyo Univ. of Agriculture) vol. II-1, pp. 9-16.
- Minagawa, M. and Wada, E. 1984. Stepwise enrichment of  $^{15}\text{N}$  along food chains: Further evidence and the relation between  $^{15}\text{N}$  and animal age. *Geochim. Cosmochim. Acta*, 48: 1135-1140.
- O'Leary, M. H. 1981. Carbon isotope fractionation in plants. *Phytochemistry*, 20: 553-567.
- Rau, G. H., Mearns, A. J., Young, D. R., Olson, R. J., Schafer, H. A and Kaplan, I. R. 1983. Animal  $^{13}\text{C}/^{12}\text{C}$  correlates with trophic level in pelagic food webs. *Ecology*, 64: 1314-1318.
- Sweeney, R. E., Liu, K. K. and Kaplan, I. R. 1978. Oceanic nitrogen isotopes and their use in determining the source of sedimentary nitrogen. In: Robinson, R. W. (ed.), *Stable Isotope in the Earth Science*, (New Zealand: DSIR Bulletin) vol. 20, pp. 9-26.
- Wada, E and Hattori, A. 1991. *Nitrogen in the Sea: Forms, Abundances and Rate Process*. CRC Press, Florida, 208pp.
- Wada, E., Mizutani, H. and Minagawa, M. 1991. The use of stable isotopes for food web analysis. *Critical Reviews in Food Science and Nutrition*, 30: 361-371.

## Mangrove Litter-Fall Studies at the PT Freeport Indonesia Project Area

Cecep KUSMANA<sup>1</sup>, Pratita PURADYATMIKA<sup>2</sup>, Yahya A. HUSIN<sup>2</sup>,  
Garry SHEA<sup>2</sup> and Darrell MARTINDALE<sup>2</sup>

<sup>1</sup> Faculty of Forestry, IPB Bogor 16001

<sup>2</sup> PT. Freeport Indonesia

### Abstract

Litter traps were used to estimate litter-fall production in two mangrove communities in the Ajkwa estuary; part of the PT Freeport Indonesia project area. The two communities studied included *Bruguiera gymnorrhiza* - *Camptostemon schultzei* - *Rhizophora apiculata* (Site 1) and *B. cylindrica* - *R. apiculata* (Site 2). The period of study was from February 16, 1998 to October 27, 1998 for Site 1 and February 25, 1998 to December 12, 1998 for Site 2. Total annual litter-fall for Site 1 and Site 2 was estimated at 800.78 g/(m<sup>2</sup> year) and 744.35 g/(m<sup>2</sup> year), respectively. For both communities, litter-fall consisted of leaves (61.5% of total litter production at Site 1 and 51.8% at Site 2), reproductive parts (20.5% at Site 1 and 11.1% at Site 2) and twigs (18.0% at Site 1 and 37.1% at Site 2). The monthly rate of total litter production at Site 1 displayed two peaks during the study period (a major peak in March and a minor one in October) while Site 2 showed only a single peak in February. Monthly rates of production for both leaf and twig litters at both sites peaked only once during the study period while rates of litter production from plant reproductive parts peaked twice. In both communities, the rate of twig litter production coincided with litter production from reproductive parts. During the sampling period, litter-fall rates varied substantially but were not significantly correlated with rainfall. However, the rate of twig litter production in both communities was significantly correlated with wind velocity.

**Key words:** Ajkwa estuary, community, litter-fall, litter trap, mangrove, rate of litter-fall, reproductive parts, twig.

### 1. Introduction

Organic material covering forest floors, commonly referred to as litter, is primarily composed of dead plant parts (including leaves, twigs and reproductive parts). Litter production is defined as the weight of all dead material (of both plant and animal origin) deposited on a given unit area of soil surface within a specified time period (Chapman, 1986). Estimations of abundance and composition of litter-fall are important to the study of nutrient cycling (Proctor, 1984), primary production (Ovington, 1962) and the structure and function of the ecosystem (Gaur and Pandey, 1978). Therefore, the study of quantitative aspects of litter-fall continues to be an important part of forest ecology (Proctor, 1984). However, rates of forest litter production around the world vary widely due to differences in community structure, stand age, geographical situation (altitude), and seasonal climatic changes (Tanner, 1980).

Mangrove swamps are thought to be highly productive communities (Lugo and Snedaker, 1974) and are recognized as an important source of detritus to marine and estuarine ecosystems (Snedaker, 1978) supporting a variety of aquatic organism (Odum and Heald, 1972). Snedaker (1978) also reported that litter-fall produced in mangroves enters the estuarine system, where it forms the basis for a complex food web. Despite

the likely importance of mangrove litter-fall to the aquatic ecosystem, little information exists regarding productivity in Indonesia (Soemodihardjo and Soerianegara, 1989).

The island of Irian Jaya contains one of the largest expanses of unmodified mangrove forests in the world. However, no recent data on the productivity of mangroves in this region have been published. The intention of this study was to provide baseline data on the input of organic matter from the mangrove communities into the surrounding coastal ecosystem; specifically to estimate monthly productivity and composition of litter-fall from mangroves in the Ajkwa river estuary within the PT. Freeport Indonesia (PTFI) project area.

## 2. Description of Study Area

### 2.1 PT Freeport Indonesia (PTFI) Project Area

The Contract of Work (COW) signed between the Government of Indonesia (GOI) and PTFI in 1991, granted PTFI two working areas defined as:

**a. Contract of Work Mining Area (COW A).** This area is approximately 100 km<sup>2</sup> and is the location of most mining activities. Activities include exploration, open-pit, and underground mining, ore processing (at the mill site) and mine overburden disposal.

**b. Contract of Work Project Area (COW B).** This area of approximately 2,890 km<sup>2</sup> connects the mining area in the north of the Arafura Sea in the south. Supporting facilities and infrastructure including Tembagapura, Ridge Camp, Kuala Kencana, Amamapare Port, Timika Airport and other areas situated in the COW Project Area.

PTFI Contract of Work Area (Mining Area and Project Area) is in the Mimika Baru District of the Mimika Administrative Regency.

### 2.2 Environment of Research Location

#### *Climate*

Fig. 1 presents monthly rainfall and temperature data collected in the study area from January to December, 1998.

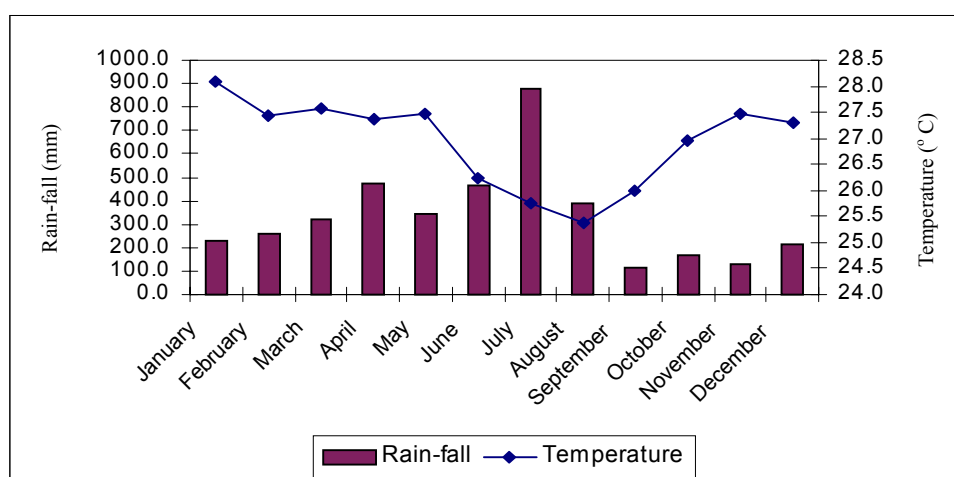

Fig. 1. Total monthly rainfall and mean monthly temperatures, PTFI Project Area, January to December, 1998.

The total annual rainfall in the study area was approximately 3,980.1 mm. Total monthly rainfall ranged from 114.0 mm in September to 876.5 mm in July. The Schmidt and Ferguson System (1951) classifies this climate as Type A (no dry month throughout the year). The mean monthly air temperature in this area ranged from 25.4°C in August to 28.1°C in February and mean monthly humidity ranged from 80% to 91%. Average monthly wind velocity in this area ranged from 2.02 m s<sup>-1</sup> in October and July, to 2.58 m s<sup>-1</sup> in December.

### **Soil**

The sites used for this study are situated within the Kajapah Land System and consist of inter-tidal swamps of mangrove and *Nypa* palm. Soils consist of recent fine alluvium (marine) or peat and are classified as Sulfaquents and Sulfihemists according to the USDA Great Soil Group System (USDA, 1975). Sulfaquents are permanently saturated, unweathered soils that become strongly acidified upon aeration. The soil texture is peat.

### **Geology**

The regional geology of the PT Freeport Area consists of both older sedimentary rocks and recent sedimentary material. This material is composed of rocks from the Buru formation consisting mainly of calcareous mudstone, shale, limestone, conglomerate, and occasionally beds of lignite coal. The material ranges from unconsolidated to relatively consolidated. This geological unit is usually found in gently sloping hills, however, in cleared areas with steep slopes the material is unstable and susceptible to landslides.

Fanglomerate and alluvial deposits are also found within the study area. Fanglomerate is a combination of conglomerate, sand and mud and is spread across the Timika lowlands and surrounding areas. The area stretching south to the coast is formed by alluvial and swamp deposits consisting of mud, sand, silt, peat and organic matter. This formation is largely unconsolidated with high permeability.

## **2.3 Vegetation**

Preliminary research conducted by Ellison (1997), reported five mangrove communities in the Ajkwa estuary:

- (1) **Seaward pioneer community (*Avicennia* – *Sonneratia* association)** - This community is located at lower elevations on accreting mud banks and inner bends of rivers. Community species include *Avicennia marina*, *A. officinalis*, *A. eucalyptifolia* and *Sonneratia caseolaris*;
- (2) ***Rhizophora stylosa* – *Bruguiera gymnorhiza* community** – This community grows in the south of the main Ajkwa estuary and on outer bends of rivers. Additionally, *R. apiculata* and *R. mucronata* may also occur in this community;
- (3) ***Bruguiera* – *Rhizophora* – *Xylocarpus* community** – This community is generally found at higher elevations on the inner bends of rivers. Within the study area, this community is located mainly in the north of the main Ajkwa estuary. Species identified in this community include *R. stylosa*, *R. mucronata*, *B. cylindrica*, *B. parviflora* and *X. mekongensis*;
- (4) ***Nypa fruticans* community** – This community is found on accreting banks (raised-land building by sedimentation) in northern mangrove areas; and
- (5) **Mixed mangrove forest community** – This community grows in brackish water

and consists of *R. apiculata*, *Heritiera littoralis*, *X. granatum*, *Pandanus* sp. and *N. fruticans*.

In general, the Ajkwa estuary is dominated by the *Bruguiera – Rhizophora – Xylocarpus* community, however, the *R. stylosa – B. gymnorhiza* community dominates the composition of the Minajerwy estuary.

### 3. Literature Review

Litter is defined as dead organic matter (of both plant and animal origin) overlying the forest floor. The rate of litter production can be defined as the weight of organic materials deposited on a given unit area of soil surface within a standard period of time (Chapman, 1986). The use of litter-fall traps is the most widely accepted method of measuring litter production (Newbould, 1967).

Pool *et al.* (1975) and Twilley *et al.* (1986) reported that mangroves with greater tidal activity and water turn-over generally have higher litter-fall rates than mangroves in stagnant water areas. Odum (1980) described the tides as an energy subsidy stimulating the net primary production of the intertidal wetlands. Similarly, Wharton and Brinson (1979) suggested that the water movement provides not only a source of silts and clays, but also a supply of nutrients and aeration for optimal growth.

Annual litter-fall rates of some mangrove forests are presented in Table 1. Generally, annual litter-fall rates in tropical mangrove forests are higher than that of sub-tropical mangroves. This difference may be attributable to differences in vegetation structure (Othman, 1989), climatic factors (Proctor, 1984), forest growth phase and soil fertility (Schaik and Mirmanto, 1985) and tidal activity and hydrologic condition (Twilley *et al.*, 1986). Maximum leaf-fall coinciding with periods of high rainfall is uncommon in the tropics, although periods of high litter-fall usually coincide with either high or low precipitation (Proctor *et al.*, 1983). The underlying factors causing seasonality in mangrove litter production appear to be complex. There is, however, little available evidence documenting the causes, although climatic factors have been suggested by some studies (Pool *et al.*, 1975; Sasekumar and Loi, 1983; Williams *et al.*, 1981). Seasonality in the phenological cycle of mangroves may be the result of a combination of many factors including environmental parameters, tree physiology and the ecological aspects of pollination and propagule dispersal (Duke *et al.*, 1984).

## 4. Methodology

### 4.1 Location and Time Period of Research

This study was conducted at two sites (Site 1 and Site 2) within mangrove communities of the Ajkwa estuary in the PTFI COW area (Figure 4.1). In 1998, permanent plots were constructed at the 2 sites for estimating the abundance and production rate of litter-fall. Litter was collected from February 16, 1998 until October 27, 1998 at Site 1 and from February 25, 1998 until December 12, 1998 at Site 2.

### 4.2 Sample Plots

At each sample site, two sample plots of 100 m × 100 m were established in a prominent mangrove forest in the study area. Furthermore, in each community, two permanent plots were established which were completely divided into sub-plots of 20 m × 20 m.

Magrove litter-fall studies at the PT Freeport Indonesia project area

Table 1. Litter production in mangrove forest communities throughout the world.

| No Location and mangrove community        | Litter fall component (g m <sup>-2</sup> year <sup>-1</sup> ) |   |                                 |                         |          | Reference                         |
|---|---|---|---------------------------------|-------------------------|----------|-----------------------------------|
|   | Leaf  | Reproductive organs (flower, fruit, etc.) | Woody materials (twig and bark) | Others                  | Total    |                                   |
| 1. Ohura Bay, Okinawa, Japan              |   |   |                                 |                         |          |                                   |
| <i>Kandelia candel</i>                    | 305.14 (43.2)   | 203.21 (28.8)                             | 165.05 (23.4)                   | 32.59 (4.6)             | 705.99   | Hardiwinoto <i>et al.</i> (1989)  |
| <i>K. candel-Bruguiera gymnorrhiza</i>    | 689.90 (64.3)   | 227.70 (21.2)                             | 121.30 (11.3)                   | 34.97 (3.2)             | 1,073.87 |                                   |
| <i>B. gymnorrhiza</i>                     | 566.60 (73.3)   | 101.10 (13.1)                             | 83.88 (10.8)                    | 21.25 (2.7)             | 772.80   |                                   |
| Mean                                      | 520.54 (61.2)   | 177.33 (20.8)                             | 123.41 (14.5)                   | 29.60 (3.5)             | 850.88   |                                   |
| 2. Iriomote Island, Okinawa               |   |   |                                 |                         |          |                                   |
| <i>Rhizophora mucronata</i>               | 279 (75.6)  | 76.6 (20.8)                               | 12.9 (3.5)                      | 0.2 (0.1)               | 368.7    | Kishimoto <i>et al.</i> (1987)    |
| <i>R. mucronata-Bruguiera gymnorrhiza</i> | 512.3 (38.7)  | 196.7 (26.4)                              | 31.6 (4.2)                      | 5.3 (0.7)               | 745.9    |                                   |
| <i>B. gymnorrhiza</i>                     | 572.8 (65.3)  | 197.4 (22.5)                              | 89.9 (10.2)                     | 17.7 (2.0)              | 877.8    |                                   |
| Mean                                      | 454.7 (68.5)  | 156.9 (23.6)                              | 44.8 (6.7)                      | 7.7 (1.2)               | 664.1    |                                   |
| 3. Middle Harbour, Australia              |   |   |                                 |                         |          |                                   |
| <i>Avicennia marina</i>                   | 458.2 (79)  | -   | -                               | 121.8 <sup>+</sup> (21) | 580      | Goulter and Allaway (1979)        |
| 4. Hinchinbrook Island, Australia         |   |   |                                 |                         |          |                                   |
| <i>Rhizophora apiculata-R. lamarckii-</i> |   |   |                                 |                         |          | Duke <i>et al.</i> (1981)         |
| <i>R. stylosa</i>                         | 551.15 (57.6)   | 240.90 (25.2)                             | 94.90 (9.9)                     | 69.35 ( 7.3)            | 956.30   |                                   |
| <i>Ceriops tagal</i>                      | 417.56 (58.1)   | 69.35 ( 9.6)                              | 56.94 (7.9)                     | 175.20 (24.4)           | 719.05   |                                   |
| <i>Bruguiera gymnorrhiza</i>              | 393.00 (49.4)   | 240.90 (30.3)                             | 99.77 (12.5)                    | 62.05 ( 7.8)            | 795.72   |                                   |
| <i>Avicennia spp.</i>                     | 600.43 (75.1)   | 12.78 ( 1.6)                              | 67.53 (8.5)                     | 118.63 (14.8)           | 799.37   |                                   |
| <i>B. parviflora</i>                      | 401.50 (40.5)   | 361.35 (36.4)                             | 96.73 (9.7)                     | 133.23 (13.4)           | 992.81   |                                   |
| <i>Sonneratia alba</i>                    | 386.90 (48.8)   | 167.90 (21.2)                             | 116.80 (14.8)                   | 120.45 (15.2)           | 792.05   |                                   |
| Mean                                      | 458.42 (54.4)   | 182.20 (21.6)                             | 88.78 (10.6)                    | 113.15 (13.4)           | 842.55   |                                   |
| 5. New Zealand                            |   |   |                                 |                         |          |                                   |
| <i>Avicennia marina</i> (tall mangrove)   | 562 (69.4)  | 100 (12.3)                                | 148 (18.3)                      | -                       | 810      | Woodroffe (1982)                  |
| <i>A. marina</i> (low mangrove)           | 272 (74.5)  | 9 ( 2.5)                                  | 84 (23.0)                       | -                       | 365      |                                   |
| Mean                                      | 417 (71)  | 54.5 ( 9.3)                               | 116 (19.7)                      | -                       | 587.5    |                                   |
| 6. Motupore Island, Papua New Guinea      |   |   |                                 |                         |          |                                   |
| <i>Rhizophora stylosa</i>                 | 1,162 (81.3)  | -   | -                               | 268 <sup>+</sup> (18.7) | 1,430    | Leach and Burgin (1985)           |
| 7. Phuket island, Thailand                |   |   |                                 |                         |          |                                   |
| <i>Rhizophora apiculata</i>               | 670   | NM  | NM                              | NM                      | 670      | Christensen (1978)                |
| 8. Fort Myers, SW Florida, USA            |   |   |                                 |                         |          |                                   |
| <i>Avicennia germinans</i>                | 209 (59.5)  | 142 (40.5)                                | -                               | -                       | 351      | Twilley <i>et al.</i> (1986)      |
| <i>A. germinans-Rhizophora mangle</i>     |   |   |                                 |                         |          |                                   |
| <i>Laguncularia racemosa</i>              | 547 (63)  | 321 (37)                                  | -                               | -                       | 868      |                                   |
| Mean                                      | 378 (62)  | 231.5 (38)                                | -                               | -                       | 609.5    |                                   |
| 9. Rookery Bay, SW Florida, USA           |   |   |                                 |                         |          |                                   |
| <i>Avicennia germinans</i>                | 355 (70.4)  | 149 (29.6)                                | -                               | -                       | 504      | Twilley <i>et al.</i> (1986)      |
| <i>A. germinans-Rhizophora mangle -</i>   |   |   |                                 |                         |          |                                   |
| <i>Laguncularia racemosa</i>              | 575 (76.6)  | 176 (23.4)                                | -                               | -                       | 751      |                                   |
| Mean                                      | 465 (74.1)  | 162.5 (25.9)                              | -                               | -                       | 627.5    |                                   |
| 10. Mgeny estuary, South Africa           |   |   |                                 |                         |          |                                   |
| <i>Bruguiera gymnorrhiza</i>              | 582.18 (67.44)  | 253.67 (29.39)                            | 27.38 ( 3.17)                   | -                       | 863.23   | Steinke and Charles (1984)        |
| <i>Avicennia marina</i>                   | 434.35 (60.71)  | 158.78 (22.20)                            | 122.28 (17.09)                  | -                       | 715.41   |                                   |
| Mean                                      | 508.27 (64.39)  | 206.22 (26.13)                            | 74.83 ( 9.48)                   | -                       | 789.32   |                                   |
| 11. Tabasco, Mexico                       |   |   |                                 |                         |          |                                   |
| <i>Avicennia germinans</i>                | 509.99 (83)   | 49.16 (8)                                 | 55.30 (9)                       | -                       | 614.45   | Lopez-Portillo and Ezeurra (1985) |
| 12. Malay Peninsula                       |   |   |                                 |                         |          |                                   |
| <i>Avicennia</i>                          | 569.40 (40.9)   | 536.55 (38.6)                             | 244.55 (17.6)                   | 40.15 (2.9)             | 1,390.65 | Sasekumar and Loi (1983)          |
| <i>Sonneratia</i>                         | 956.30 (66.8)   | 138.70 (9.7)                              | 270.10 (18.9)                   | 65.70 (4.6)             | 1,430.80 |                                   |
| <i>Rhizophora</i>                         | 1,080.40 (71)   | 129.94 (8.6)                              | 248.20 (16.3)                   | 62.05 (4.1)             | 1,520.59 |                                   |
| Mean                                      | 868.70 (60)   | 268.40 (18.5)                             | 254.28 (17.6)                   | 55.97 (3.9)             | 4,447.35 |                                   |
| 13. Matang, Malaysia                      |   |   |                                 |                         |          |                                   |
| <i>Rhizophora apiculata</i>               |   |   |                                 |                         |          | Gong <i>et al.</i> (1984)         |
| 5-year-old                                | 618 (88.8)  | 9 (1.3)                                   | 69 (9.9)                        | -                       | 696      |                                   |
| 10-year-old                               | 809 (82.0)  | 2 (0.2)                                   | 176 (17.8)                      | -                       | 987      |                                   |
| 15-year-old                               | 802 (80.0)  | 46 (4.6)                                  | 154 (15.4)                      | -                       | 1,002    |                                   |
| 20-year-old                               | 808 (78.5)  | 109 (10.6)                                | 112 (10.9)                      | -                       | 1,029    |                                   |
| 25-year-old                               | 844 (74.1)  | 185 (16.2)                                | 111 (9.7)                       | -                       | 1,140    |                                   |
| Virgin Jungle Reserve                     | 576 (75.5)  | 124 (16.2)                                | 63 (8.3)                        | -                       | 763      |                                   |
| Mean                                      | 742.8 (79.3)  | 79.2 (8.5)                                | 114.2 (12.2)                    | -                       | 936.2    |                                   |

Table 1. (Continued)

| No Location and mangrove community             | Litter fall component (g m <sup>-2</sup> yr <sup>-1</sup> ) |   |                                 |                            |          | Reference                         |
|--|---|---|---------------------------------|----------------------------|----------|-----------------------------------|
|  | Leaf  | Reproductive organs (flower, fruit, etc.) | Woody materials (twig and bark) | Others                     | Total    |                                   |
| 13. Matang, Malaysia                           |   |   |                                 |                            |          | Gong <i>et al.</i> (1984)         |
| <i>Rhizophora apiculata</i>                    |   |   |                                 |                            |          |                                   |
| 5-year-old                                     | 618 (88.8)  | 9 (1.3)                                   | 69 (9.9)                        | -                          | 696      |                                   |
| 10-year-old                                    | 809 (82.0)  | 2 (0.2)                                   | 176 (17.8)                      | -                          | 987      |                                   |
| 15-year-old                                    | 802 (80.0)  | 46 (4.6)                                  | 154 (15.4)                      | -                          | 1,002    |                                   |
| 20-year-old                                    | 808 (78.5)  | 109 (10.6)                                | 112 (10.9)                      | -                          | 1,029    |                                   |
| 25-year-old                                    | 844 (74.1)  | 185 (16.2)                                | 111 (9.7)                       | -                          | 1,140    |                                   |
| Virgin Jungle Reserve                          | 576 (75.5)  | 124 (16.2)                                | 63 (8.3)                        | -                          | 763      |                                   |
| Mean   | 742.8 (79.3)  | 79.2 (8.5)                                | 114.2 (12.2)                    | -                          | 936.2    |                                   |
| 14. Sarawak, Malaysia                          |   |   |                                 |                            |          | Othman (1989)                     |
| <i>Rhizophora mucronata-R. apiculata</i>       | 449 (78.5)  | -   | -                               | 123 <sup>+</sup> (21.5)    | 572      |                                   |
| 15. Pamanukan, West Java, Indonesia            |   |   |                                 |                            |          | Al Rasyid                         |
| <i>Rhizophora mucronata</i>                    | 623.42  | NM  | NM                              | NM                         | 623.42   | (1989)                            |
| <i>Avicennia spp.</i>                          | 635.19  | NM  | NM                              | NM                         | 635.19   |                                   |
| Mean   | 629.31  | NM  | NM                              | NM                         | 629.31   |                                   |
| 16. Muara Angke, Jakarta, Indonesia            |   |   |                                 |                            |          | Sukardjo                          |
| <i>Avicennia marina-A. alba</i>                | 614.04 (36.9)   | 572.20 (34.3)                             | 479.15 (28.8)                   | -                          | 1,665.39 | (1989)                            |
| <i>A. marina-Rhizophora mucronata</i>          | 515.79 (36.9)   | 480.64 (34.3)                             | 402.48 (28.8)                   | -                          | 1,398.91 |                                   |
| <i>R. mucronata-R. apiculata</i>               | 182.27 (36.9)   | 169.85 (34.4)                             | 142.23 (28.8)                   | -                          | 494.35   |                                   |
| Mean   | 437.37 (36.9)   | 407.56 (34.3)                             | 341.29 (28.8)                   | -                          | 1,186.22 |                                   |
| 17. Tanjung Apar, East Kalimantan, Indonesia   |   |   |                                 |                            |          | Sukardjo (unpublished report)     |
| <i>Rhizophora apiculata-Avicennia marina</i>   | 766.82 (36.9)   | 714.41 (34.3)                             | 598.51 (28.8)                   | -                          | 2,079.74 |                                   |
| <i>A. officinalis-A. marina</i>                | 1,062.67 (36.9)   | 990.25 (34.3)                             | 829.23 (28.8)                   | -                          | 2,882.15 |                                   |
| <i>Ceriops tagal-R. apiculata</i>              | 1,018.99 (36.9)   | 895.42 (32.4)                             | 849.28 (30.7)                   | -                          | 2,763.69 |                                   |
| Mean   | 949.49 (36.9)   | 866.69 (33.6)                             | 759.01 (29.5)                   | -                          | 2,575.19 |                                   |
| 18. Tritih, Cilacap, Indonesia                 |   |   |                                 |                            |          | Suwarno (1985)                    |
| <i>Rhizophora mucronata</i> (6-year-old)       | 658.32 (81)   | 28.08 (3.5)                               | -                               | 126.36 <sup>+</sup> (15.5) | 812.76   |                                   |
| 19. Saleh River, South Sumatera, Indonesia     |   |   |                                 |                            |          | Soerianegara <i>et al.</i> (1985) |
| <i>Sonneratia spp.</i>                         | -   | -   | -                               | -                          | 622.40   |                                   |
| <i>Sonneratia-Avicennia</i>                    | -   | -   | -                               | -                          | 1,255.51 |                                   |
| <i>Avicennia spp.</i>                          | -   | -   | -                               | -                          | 689.85   |                                   |
| <i>Rhizophora spp.</i>                         | -   | -   | -                               | -                          | 1,023.83 |                                   |
| <i>Bruguiera spp.</i>                          | -   | -   | -                               | -                          | 1,177.86 |                                   |
| Mean   | -   | -   | -                               | -                          | 953.89   |                                   |
| 20. Tiris Indramayu, West Java, Indonesia      |   |   |                                 |                            |          | Sukardjo (unpublished report)     |
| <i>Rhizophora apiculata-R. mucronata</i>       | 525.31 (40.70)  | 337.81 (26.18)                            | 427.38 (33.12)                  | -                          | 1,290.50 |                                   |
| 21. Talidandang Besar, East Sumatra, Indonesia |   |   |                                 |                            |          | Kusmana <i>et al.</i>             |
| <i>Bruguiera parviflora</i>                    | 758.75 (59.89)  | 263.57 (20.8)                             | 52.00 (4.11)                    | 192.62 (15.2)              | 1,266.94 | (1998)                            |
| <i>B. sexangula</i>                            | 704.16 (55.47)  | 309.03 (24.34)                            | 67.13 (5.29)                    | 189.16 (14.9)              | 1,269.48 |                                   |
| <i>B. sexangula-Nypa fruticans</i>             | 707.16 (64.53)  | 181.60 (16.58)                            | 53.04 (4.84)                    | 153.98 (14.05)             | 1,095.78 |                                   |
| Mean   | 723.36 (59.75)  | 251.40 (20.76)                            | 57.39 (4.74)                    | 178.59 (14.75)             | 1,210.74 |                                   |

Note: + = micellaneous including woody materials and reproductive organs

- = not reported

NM = not measured

Values in brackets indicate percentage of total litter

### 4.3 Measured Parameters

Parameters measured for this study included the diameters of trees greater than 10 cm as well as the production of litter from various tree components.



#### 4.4 Data Collection Procedure

Tree diameters were measured 10 cm above the highest prop roots for *Rhizophora* spp. and 10 cm above the buttress or 1.3 m above ground level (diameter at breast height, DBH) for all other species.

Litter production was measured by collection in litter-fall traps as described by Newbould (1967). For this study, 13 litter traps (opening 0.50 m<sup>2</sup>; depth-0.50 m), were suspended within each plot in the studied mangrove community. Traps were made from nylon mesh cloth (1 mm mesh size) and were suspended from tree branches above high-tide. All materials accumulated in the traps were collected once per week during the sampling period.

#### 4.5 Data Analysis

Estimates of litter-fall rates of various tree components were calculated using standard statistical procedures (Sokal and Rohlf, 1986). To analyse the effect of rainfall on litter-fall, individual litter components (leaves, reproduction organs, stems) and total litter in each month were correlated with monthly total rainfall. As effects of rainfall may not be immediate, monthly mean rates of litter-fall were also correlated with monthly rainfall for previous months using time-lag correlation.

### 5. Results and Discussion

#### 5.1 Forest Composition and Structure

Mangrove forest species composition and structure of research Site 1 is presented in Table 2.

Table 2. Mangrove species composition and structure of Site 1.

| No. | Plot   | Species                         | N (No./ha) | BA (m <sup>2</sup> /ha) | IVI (%) |
|-----|--------|---------------------------------|------------|-------------------------|---------|
| 1.  | Plot 1 | <i>Avicennia marina</i>         | 1          | 0.11                    | 2.10    |
|     |        | <i>Bruguiera cylindrica</i>     | 1          | 0.03                    | 1.87    |
|     |        | <i>Bruguiera gymnorrhiza</i>    | 235        | 17.31                   | 145.34  |
|     |        | <i>Camptostemon schultzii</i>   | 91         | 7.03                    | 74.90   |
|     |        | <i>Rhizophora apiculata</i>     | 47         | 8.85                    | 70.69   |
|     |        | <i>Rhizophora mucronata</i>     | 5          | 0.25                    |         |
|     |        | Total                           | 380        | 33.58                   |         |
| 2.  | Plot 2 | <i>Bruguiera gymnorrhiza</i>    | 242        | 16.53                   | 160.17  |
|     |        | <i>Camptostemon schultzii</i>   | 83         | 7.00                    | 79.87   |
|     |        | <i>Rhizophora apiculata</i>     | 42         | 5.46                    | 57.42   |
|     |        | <i>Xylocarpus australasicus</i> | 3          | 0.06                    | 2.55    |
|     |        |                                 |            | Total                   | 370     |

Note :  
 IVI = Importance Value Index  
 N = Density  
 BA = Basal Area

Based on data in Table 2, mangroves in Site 1 can be categorized as *B. gymnorrhiza* – *C. schultzii* – *R. apiculata* community. Seven species of mangrove trees were recorded within both sample plots. *B. gymnorrhiza*, *C. schultzii* and *R. apiculata* were considered dominant species while the other four species were minor contributors to the mangrove community. In this community, *B. gymnorrhiza* was the most dominant species with an IVI of 145.34% and 160.17% for plots 1 and 2, respectively. Densities

for this species were measured at 235 and 242 trees/ha at the two plots with basal areas of 17.31 m<sup>2</sup>/ha and 16.53 m<sup>2</sup>/ha.

The total density and basal area of trees measured in Plots 1 and 2 ranged from 370 (Plot 2) to 380 (Plot 1) trees/ha and 29.06 (Plot 2) to 33.58 (Plot 1) m<sup>2</sup>/ha, respectively. Consequently, major trees species comprised approximately 98% of both total density and basal area of the stand in this community. Physiognomically, the stand was formed by trees with a diameter ranging from 7.42 to 84.3 cm and a height of 5.17 m to 52.55 m forming a one continuous canopy layer.

Forest species composition and structure of research Site 2 are presented in Table 3.

Table 3. Mangrove species composition and structure of Site 2.

| No. | Plot   | Species                         | N (No./ha) | BA (m <sup>2</sup> /ha) | IVI (%) |       |  |
|-----|--------|---------------------------------|------------|-------------------------|---------|-------|--|
| 1.  | Plot 1 | <i>Avicennia marina</i>         | 11         | 0.62                    | 14.99   |       |  |
|     |        | <i>Bruguiera cylindrica</i>     | 322        | 11.20                   | 134.30  |       |  |
|     |        | <i>Bruguiera gymnorrhiza</i>    | 1          | 0.04                    | 1.48    |       |  |
|     |        | <i>Ceriops tagal</i>            | 1          | 0.01                    | 1.37    |       |  |
|     |        | <i>Diospyros maritima</i>       | 6          | 0.14                    | 5.12    |       |  |
|     |        | <i>Rhizophora apiculata</i>     | 188        | 9.47                    | 103.20  |       |  |
|     |        | <i>Rhizophora mucronata</i>     | 5          | 0.13                    | 6.03    |       |  |
|     |        | <i>Xylocarpus australisicus</i> | 1          | 0.01                    | 1.37    |       |  |
|     |        | <i>Xylocarpus granatum</i>      | 34         | 1.25                    | 32.13   |       |  |
|     |        | Total                           | 569        | 22.87                   |         |       |  |
| 2.  | Plot 2 | <i>Avicennia marina</i>         | 1          | 0.12                    | 1.93    |       |  |
|     |        | <i>Bruguiera cylindrica</i>     | 211        | 8.64                    | 103.09  |       |  |
|     |        | <i>Bruguiera gymnorrhiza</i>    | 1          | 0.03                    | 1.59    |       |  |
|     |        | <i>Diospyros maritima</i>       | 6          | 0.13                    | 8.54    |       |  |
|     |        | <i>Heritiera littoralis</i>     | 7          | 0.09                    | 8.18    |       |  |
|     |        | <i>Rhizophora apiculata</i>     | 311        | 16.98                   | 152.44  |       |  |
|     |        | <i>Xylocarpus granatum</i>      | 26         | 0.42                    | 24.62   |       |  |
|     |        |                                 |            | Total                   | 563     | 26.41 |  |

Note : IVI = Importance Value Index  
 N = Density  
 BA = Basal Area

The data in Table 3 suggests that the Site 2 mangrove community can be categorized as *Bruguiera cylindrica* – *Rhizophora apiculata* community. Total densities of trees in this community were estimated at 569 trees/ha (Plot 1) and 563 trees/ha (Plot 2). Basal areas were calculated at 22.87 m<sup>2</sup>/ha (Plot 1) and 26.41 m<sup>2</sup>/ha (Plot 2). A total of ten tree species were recorded in the sample plots. Among them, *B. cylindrica* and *R. apiculata* comprised more than 90% of the total stand density and basal area in this community. The average diameter and height of trees in both plots were 15.87 cm (range = 9.6 cm to 87.9 cm) and 22.65 m (range = 4.88 m to 56.56 m), respectively. The mangrove community in Site 2 was comprised of more tree species than Site 1. Site 2 contained denser stands of trees with smaller diameters than Site 1. Mangroves in Site 1 are frequently subjected to tides providing a continuous supply of silts, clays and nutrients as well as aeration for optimal tree growth. Stands in this community produced trees with larger diameters than at Site 2 owing to the tides functioning as an energy subsidy and stimulating net primary production of the intertidal wetlands (Odum, 1980). In terms of species richness, our results support Kusmana *et al.* (1998) who suggested

that species richness in mangrove forest communities increases with distance inland from the coast due to decreasing salinity.

Compared to mangrove forests in other locations in Indonesia (Table 4), mangrove communities in the study area are similar to the mangrove forests in Simpang Ulim – Aceh (Al Rasyid, 1983), Halmahera - Maluku (Komiya *et al.*, 1988), Banyuasin - South Sumatra (Yamada and Sukardjo, 1980), Tanjung Kasam – Riau (Sukardjo, unpublished report).

Table 4. Community types of some mangrove forests in Java and other islands in Indonesia.

| No                                | Location                        | Community type   | Species richness | Reference                         |
|-----------------------------------|---------------------------------|--|------------------|-----------------------------------|
| <b>A Java Island</b>              |                                 |  |                  |                                   |
| 1                                 | Cilacap                         | <i>Aegiceras corniculatus</i> - <i>Ficus retusa</i><br><i>Avicennia alba</i> - <i>Sonneratia alba</i><br><i>Rhizophora mucronata</i> - <i>Bruguiera cylindrica</i>                                     | 14               | Marsono (1989)                    |
| 2                                 | Ujung Karawang                  | <i>Avicennia marina</i> - <i>Aegiceras corniculatus</i>  | 9                | Djaja <i>et al.</i> (1984)        |
| 3                                 | Indramayu                       | <i>Avicennia marina</i> - <i>Avicennia alba</i>  | 9                | Sukardjo (1980)                   |
| 4                                 | Pulau Rambut                    | <i>Rhizophora mucronata</i> - <i>Rhizophora stylosa</i><br><i>Rhizophora mucronata</i><br><i>Scyphyphora hydrophyllacea</i> - <i>Lumnitzera racemosa</i>   | 13               | Kartawinata and Waluyo (1977)     |
| 5                                 | Pulau Dua                       | <i>Rhizophora stylosa</i> - <i>Rhizophora apiculata</i>  | 12               | Buadi (1979)                      |
| 6                                 | Baluran                         | <i>Rhizophora stylosa</i> - <i>Rhizophora apiculata</i>  | 16               | Indiarto <i>et al.</i> (1987)     |
| 7                                 | Grajagan                        | <i>Rhizophora apiculata</i> - <i>Avicennia</i> spp.  | 14               | Sukardjo, unpublished report      |
| 8                                 | Muara Angke                     | <i>Avicennia alba</i> - <i>Avicennia marina</i><br><i>Avicennia marina</i> - <i>Rhizophora mucronata</i>   | 11               | Kusmana (1983)                    |
| <b>B Other Indonesian Islands</b> |                                 |  |                  |                                   |
| 1                                 | Kangean Isles                   | <i>Rhizophora stylosa</i><br><i>Rhizophora apiculata</i><br><i>Ceriops tagal</i>   | 12               | Soemodihardjo, unpublished report |
| 2                                 | Tanjung Apar (East Kalimantan)  | <i>Rhizophora apiculata</i> - <i>Avicennia alba</i><br><i>Avicennia officinalis</i> - <i>Avicennia alba</i><br><i>Ceriops tagal</i> - <i>Rhizophora apiculata</i>                                      | 13               | Sukardjo, unpublished report      |
| 3                                 | Tanjung Kasam (Riau)            | <i>Xylocarpus granatus</i> - <i>Lumnitzera racemosa</i><br><i>Rhizophora apiculata</i> - <i>Xylocarpus granatus</i>  | 12               | Sukardjo, unpublished report      |
| 4                                 | Way Sekampung (lampung)         | <i>Avicennia</i> spp<br><i>Hibiscus tiliaceus</i> - <i>Pongamia pinnata</i>  | 14               | Sukardjo (1979)                   |
| 5                                 | Banyuasin (South Sumatera)      | <i>Avicennia alba</i><br><i>Rhizophora apiculata</i><br><i>Bruguiera gymnorrhiza</i> - <i>Rhizophora apiculata</i>   | 9                | Yamada and Sukardjo (1980)        |
| 6                                 | Tanjung Bungin (South Sumatera) | <i>Rhizophora apiculata</i> - <i>Nypa fruticans</i><br><i>Nypa fruticans</i> - <i>Rhizophora apiculata</i>   | 9                | Sukardjo <i>et al.</i> (1984)     |
| 7                                 | Talidandang Besar (Riau)        | <i>Bruguiera parviflora</i><br><i>B. sexangula</i><br><i>B. sexangula</i> - <i>Nypa fruticans</i>  | 8                | Kusmana and Watanabe (1991c)      |
| 8                                 | Gaung and Mandah Rivers (Riau)  | <i>Rhizophora apiculata</i> - <i>R. mucronata</i><br><i>Bruguiera parviflora</i> - <i>B. sexangula</i><br><i>Aegiceras corniculatus</i> - <i>Nypa fruticans</i>  | 7                | Al Rasyid (1984)                  |
| 9                                 | Central Sulawesi                |  |                  | Darnaedi and Budiman (1984)       |
| -                                 | Ranu                            | <i>Rhizophora apiculata</i> - <i>Ceriops tagal</i>   | 3                |                                   |
| -                                 | Lapangga                        | <i>Rhizophora apiculata</i> - <i>Ceriops tagal</i>   | 8                |                                   |
| -                                 | Matube                          | <i>Rhizophora mucronata</i>  | 3                |                                   |
| -                                 | Morowali                        | <i>Rhizophora apiculata</i>  | 5                |                                   |
| 10                                | Halmahera (Maluku)              | <i>Sonneratia alba</i><br><i>Bruguiera gymnorrhiza</i> - <i>Xylocarpus granatus</i><br><i>Rhizophora apiculata</i> - <i>Bruguiera gymnorrhiza</i><br><i>Nypa fruticans</i> - <i>Rhizophora stylosa</i> | 14               | Komiya <i>et al.</i> (1988)       |
| 11                                | Bone-bone (South Sulawesi)      | <i>Sonneratia alba</i> - <i>Rhizophora apiculata</i><br><i>Rhizophora mucronata</i><br><i>Bruguiera gymnorrhiza</i>  | 20               | Ahmad (1989)                      |
| 12                                | Simpang Ulim (Aceh)             | <i>Rhizophora apiculata</i> - <i>Bruguiera gymnorrhiza</i>   | 8                | Al Rasyid (1983)                  |

Values for species richness pertain to tree species.

Table 5 shows the density of trees with diameters greater than 10 cm as well as the species richness of trees in some virgin mangrove forests in Indonesia. Compared to mangrove forests in other regions, communities within the study area showed high species richness, similar to mangroves in Halmahera - Maluku. However, other studies of mangrove species in Irian Jaya have shown more species of mangroves than are found in our study area. For example, Prawiroatmodjo (unpublished report) recorded 14 species of mangroves in Teluk Bintuni - Irian Jaya. In terms of density, mangrove forests in the study area are most similar to mangrove communities in Halmahera – Maluku and Talidandang Besar – Riau.

Table 5. Densities and Species Richness Indices of trees with diameters greater than 10 cm for some virgin Indonesian mangrove forests.

| No. | Location                       | Density (ind./ha) | Species richness | Reference                        |
|-----|--------------------------------|-------------------|------------------|----------------------------------|
| 1.  | Tanjung Bungin, South Sumatera | 162 - 288         | 9                | Sukardjo and Kartawinata, 1979   |
| 2.  | Banyuasin, South Sumatera      | 187 - 448         | 9                | Yamada and Sukardjo, 1980        |
| 3.  | Gaung and Mandah Rivers, Riau  | 333               | 7                | Al Rasyid, 1984                  |
| 4.  | Tanjung Apar, East Kalimantan  | 80 - 528          | 13               | Sukardjo, unpublished report     |
| 5.  | Irian Jaya                     | 144 - 255         | 14               | Prawiroatmodjo, unpublished data |
| 6.  | Central Sulawesi               | 210 - 422         | 10               | Darnaedi and Budiman, 1984       |
| 7.  | Halmahera, Maluku              | 206 - 586         | 14               | Komiyama <i>et al.</i> (1988a)   |
| 8.  | Talidandang Besar, Riau        | 364 - 592         | 8                | Kusmana <i>et al.</i> (1992a)    |

## 5.2 Litter Production and its Components

Table 6 shows estimated annual litter production in mangrove communities in the study area.

Table 6. Estimated annual litter production of tree components in mangrove communities in the PTFI study area.

| Site | Mangrove Community   | Litter Components (g/(m <sup>2</sup> year)) |                                  |                                    |                                   |
|------|--|---|----------------------------------|------------------------------------|-----------------------------------|
|      |  | Leaf  | Reproductive Part                | Twig                               | Total                             |
| 1    | <i>Bruguiera gymnorrhiza</i> - <i>Comptostemon schultzei</i> - <i>Rhizophora apiculata</i> community | 492.61 ± 95.47<br>(CV = 58.14 %)            | 164.28 ± 31.63<br>(CV = 57.76 %) | 143.89 ± 68.35<br>(CV = 142.50 %)  | 800.78 ± 121.15<br>(CV = 45.39 %) |
|      | %  | 61.5  | 20.5                             | 18.0                               | 100                               |
| 2    | <i>Bruguiera cylindrica</i> - <i>Rhizophora apiculata</i> community                                  | 385.66 ± 59.59<br>(CV = 51.25 %)            | 82.91 ± 31.24<br>(CV = 124.99 %) | 275.78 ± 160.45<br>(CV = 192.96 %) | 744.35 ± 195.42<br>(CV = 78.76 %) |
|      | %  | 51.8  | 11.1                             | 37.1                               | 100                               |

Note: Value show average (x) ± SE  
CV = Coefficient of Variance

Annual litter production was estimated at 800.78 g/(m<sup>2</sup> year) from mangroves of Site 1 and 744.35 g/(m<sup>2</sup> year) from Site 2. At both sites, the leaves comprised more than 50% to the total litter. Monthly total litter production in both communities was highly variable (CV = 45 % to 79 %). It should also be noted that twig litter comprised a substantial proportion of total litter-fall production at Site 2.

Annual litter-fall production from Site 1 is higher than in Site 2. These results support the findings of Pool *et al.* (1975), Twilley *et al.* (1986) and Kusmana *et al.* (1998). Who reported that mangroves exposed to greater tidal activity and water turnover generally show higher litter-fall rates than mangroves in areas with stagnant water. Odum (1980) suggests that tides may function as an energy subsidy, stimulating production in intertidal wetlands. Tides have also been shown to provide silts and clays, as well as a supply of nutrients and aeration for optimal growth of mangroves (Wharton and Brinson, 1979).

Annual litter-fall rates in the study area lie within ranges previously reported for other mangrove populations (Table 1). Litter-fall rates in both study sites were lower than for similar mangrove communities in Hinchinbrook Island - Australia (Duke *et al.*, 1981), Saleh River - South Sumatera (Soerianegara *et al.*, 1985), and Talidandang Besar - Riau (Kusmana *et al.*, 1998). However, rates were higher than for mangrove communities studied in Iriomote island - Okinawa (Kishimoto *et al.*, 1987). Differences in the abundance of mangrove litter-fall in these regions, may be attributable to differences in vegetation composition and structure (Othman, 1989), climatic factors (Proctor, 1984), the phase of forest growth and soil fertility (Schaik and Mirmanto, 1985) as well as tidal activity and hydrologic condition (Twilley *et al.*, 1986).

### 5.3 Litter-fall Rate Pattern

#### *Rate of total litter-fall*

Fig. 2 shows monthly rates of total litter-fall in Site 1 and Site 2 mangrove communities. Total monthly litter-fall during the sampling period ranged from 1.27 g/(m<sup>2</sup> d) to 4.07 g/(m<sup>2</sup> d) in Site 1 and 0.65 g/(m<sup>2</sup> d) to 6.35 g/(m<sup>2</sup> d) in Site 2.

In Site 1, the monthly rate of total litter-fall was highest in March although a smaller peak was observed in October (Figure 2). However, in Site 2 the monthly rate of total litter-fall showed a single in February. There was no significant correlation between rainfall and rate of total litter-fall in both mangrove communities in the study area ( $r < 0.05$ ,  $n = 26$ ,  $p > 0.05$ ). Our results support other tropical studies, suggesting that maximum litter-fall coincides with both high and low periods of precipitation (Proctor *et al.*, 1983).

The difference in litter-fall rate between Site 1 and Site 2 may be the result of differences in vegetation composition and structure, tree physiological processes or tidal activity as reported by Othman (1989) and Twilley *et al.* (1986).

(A)

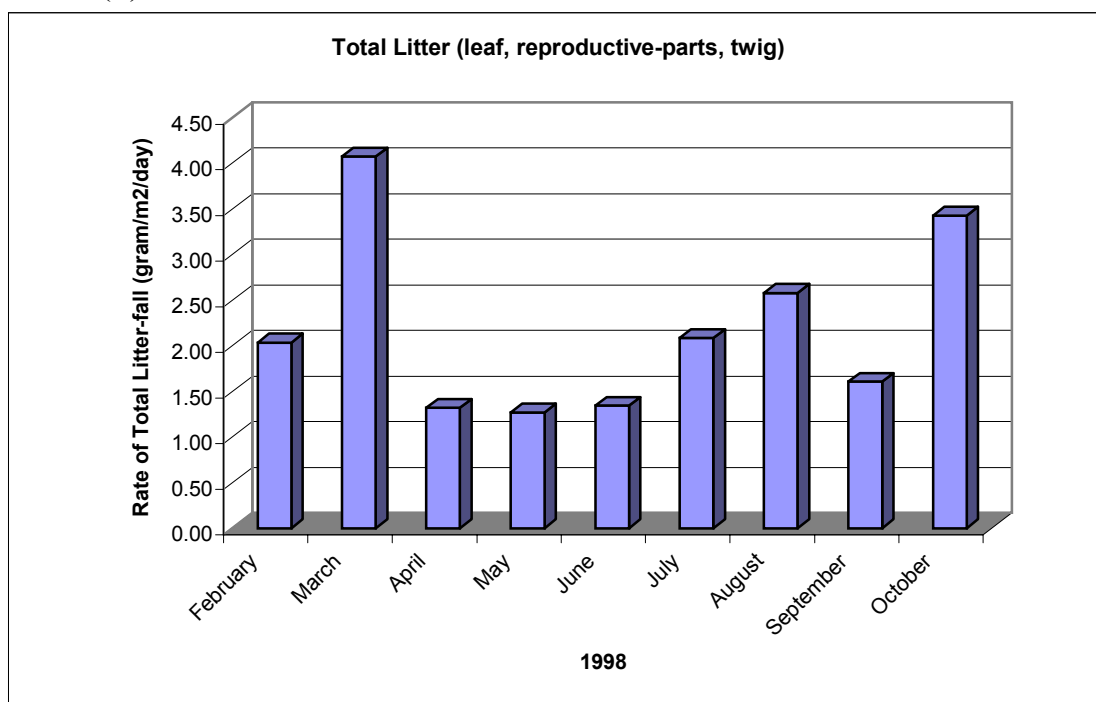

(B)

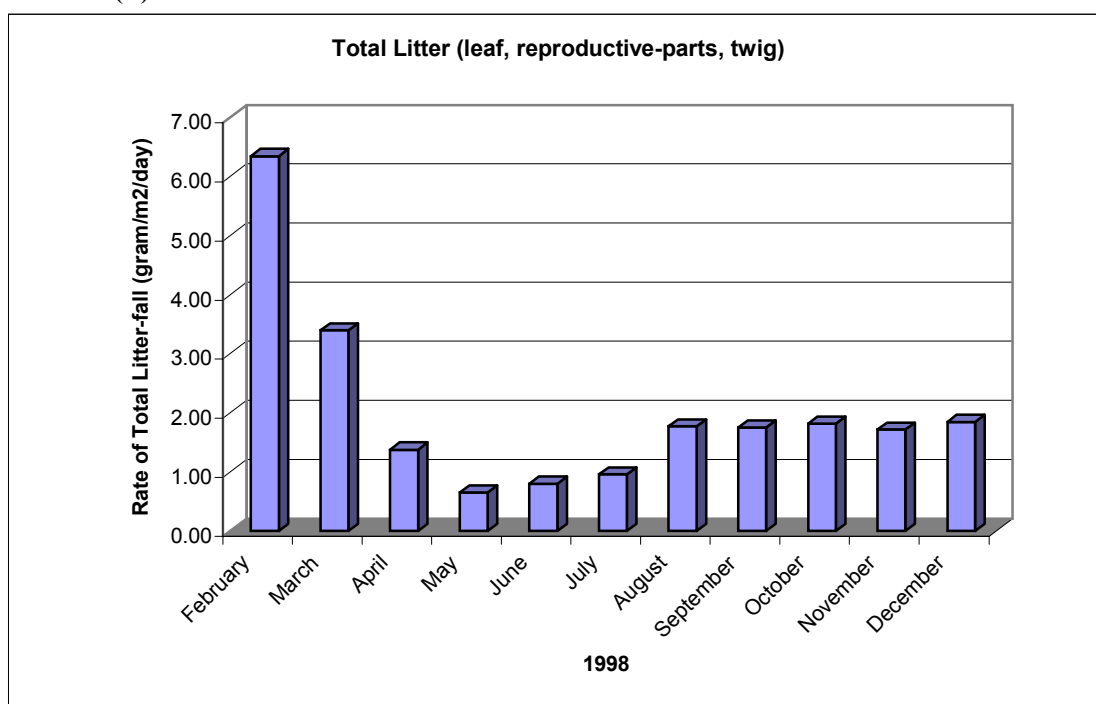

Fig. 2. Monthly rates of litter-fall for mangrove communities in research Site 1 (A) and Site 2 (B), PTFI Project Area, 1998

**Rate of leaf litter production**

Fig. 3 shows monthly rates of leaf litter production in mangrove communities in Site 1 and Site 2. The monthly rates ranged from 0.59 g/(m<sup>2</sup> d) (May) to 3.14 g/(m<sup>2</sup> d) (October) and 0.34 g/(m<sup>2</sup> d) (May) to 1.85 g/(m<sup>2</sup> d) (December) in the mangrove communities in Site 1 and Site 2, respectively. Both communities showed a general increase in monthly leaf production through the end of sample collection.

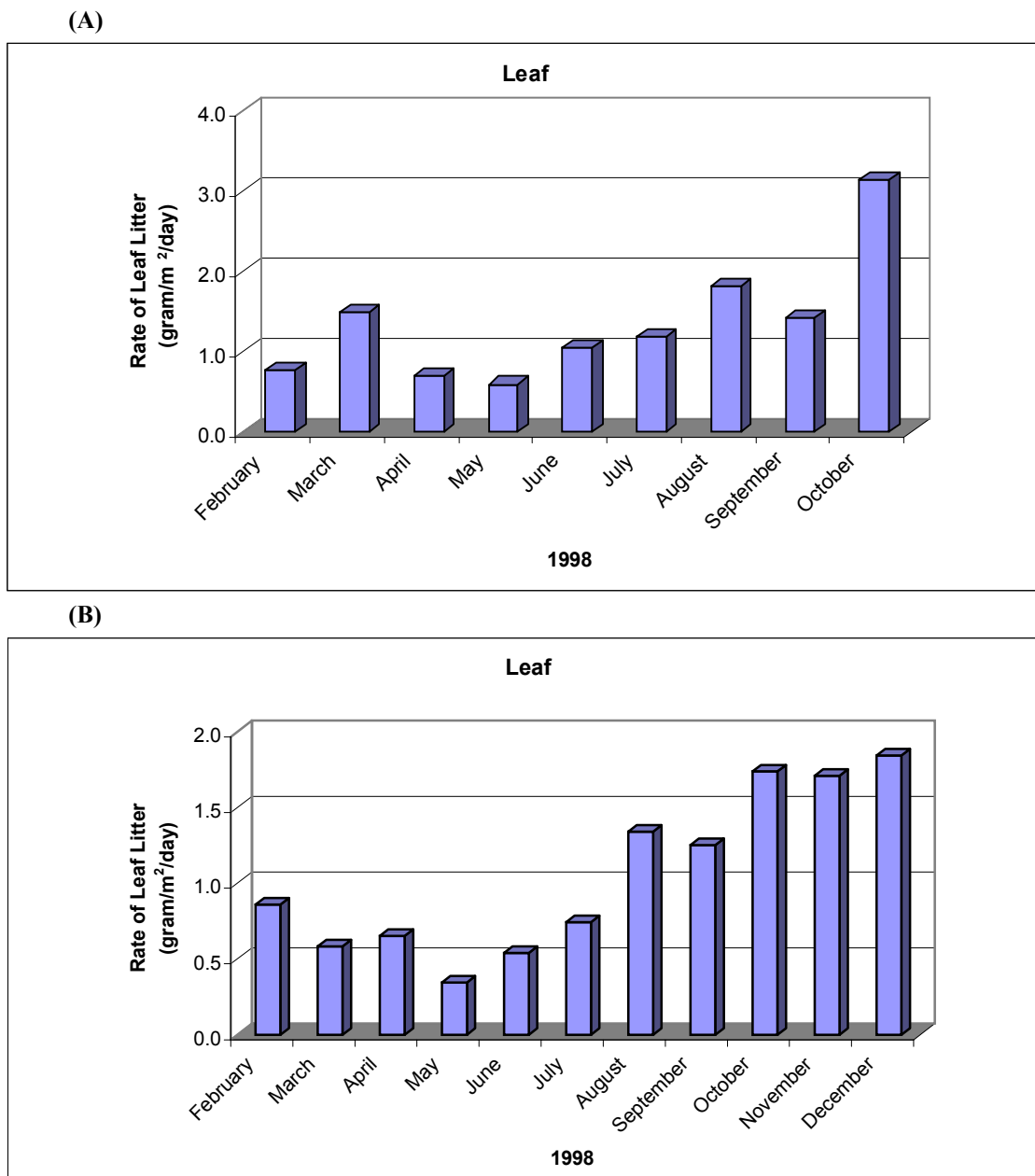

Fig. 3. The rate pattern of leaf litter of mangrove community in research Site 1 (A) and Site 2 (B)

As with previous studies conducted on litter-fall (Table 1), leaves were the major component of litter; therefore, the observed pattern of litter-fall production is attributable primarily to leaf litter. Monthly rates of leaf litter production varied widely throughout the collection period ( $CV > 50\%$ ) and no significant correlation existed between rainfall and rate of leaf litter-fall in both mangrove communities in the study area ( $r < 0.60$ ,  $n = 26$ ,  $p > 0.05$ ). This result suggests that maximum leaf litter production coinciding with periods of high rainfall is not common in the tropics, although peaks in leaf-fall production have been shown to coincide with either low or high rainfall (Proctor *et al.*, 1983).

Although the density of mangroves in Site 1 is lower than in Site 2, Site 1 produces higher amounts of leaf litter. Possible reasons for this discrepancy are: (1) mangrove community in Site 1 consists of trees with larger diameters than Site 2; (2) the mangrove community in Site 1 may produce more new leaves as an adaptation to high salinity conditions due to frequent inundation from tidal action; and (3) the exposure to tides at Site 1 possibly produces more optimal growth conditions.

Compared to other similar mangrove communities, the annual rate of leaf litter production in the PTFI study area is less than for mangroves in Talidandang Besar – Riau (Kusmana *et al.*, 1998). However, the rate is higher than for mangrove communities in Hinchinbrook island – Australia (Duke *et al.*, 1981) and Iriomote island – Okinawa (Kishimoto *et al.*, 1987). These differences may be attributable to differences in vegetation composition, climatic factors, tidal activity and hydrologic condition (Lugo and Snedaker, 1974; Twilley *et al.*, 1986).

#### ***Rate of reproductive parts litter***

Fig. 4 shows the monthly rates of litter production from plants reproductive parts in the study area.

The monthly rate of litter production from plant reproductive parts ranged from 0.13 g/(m<sup>2</sup> d) (June) to 0.71 g/(m<sup>2</sup> d) (August) for Site 1 and from 0.15 g/(m<sup>2</sup> d) (June) to 0.99 g/(m<sup>2</sup> d) (February) for Site 2.

Litter production from plant reproductive parts peaked in March at Site 1 and February at Site 2. Smaller peaks were observed in August at Site 1 and in September at Site 2. Production between February and October from mangrove reproductive parts showed the same general trend as leaf litter production. Our data support the findings of Duke *et al.* (1984) who reported a relationship between leaf litter and litter production from plant reproductive parts for mangroves in north-eastern of Australia. Other research on mangroves has suggested that the relationship between leaf litter and litter from plant reproductive parts may be influenced by the phenological cycles of mangroves (Duke *et al.*, 1984).

Production of litter from reproductive parts in the study area varied considerably between months ( $CV = 58\%$  to  $125\%$ ). However, no significant correlation ( $r < 0.40$ ,  $n = 26$ ,  $p > 0.05$ ) existed between the rate of production of litter from reproductive parts and rainfall.

Compared to similar mangrove communities in other regions, the rate of production of litter from mangrove reproductive parts in the study area is less than from mangrove communities in Hinchinbrook Island, Australia (Duke *et al.*, 1981). This difference in production is possibly the result of differences in forest structure, climate or habitat condition.



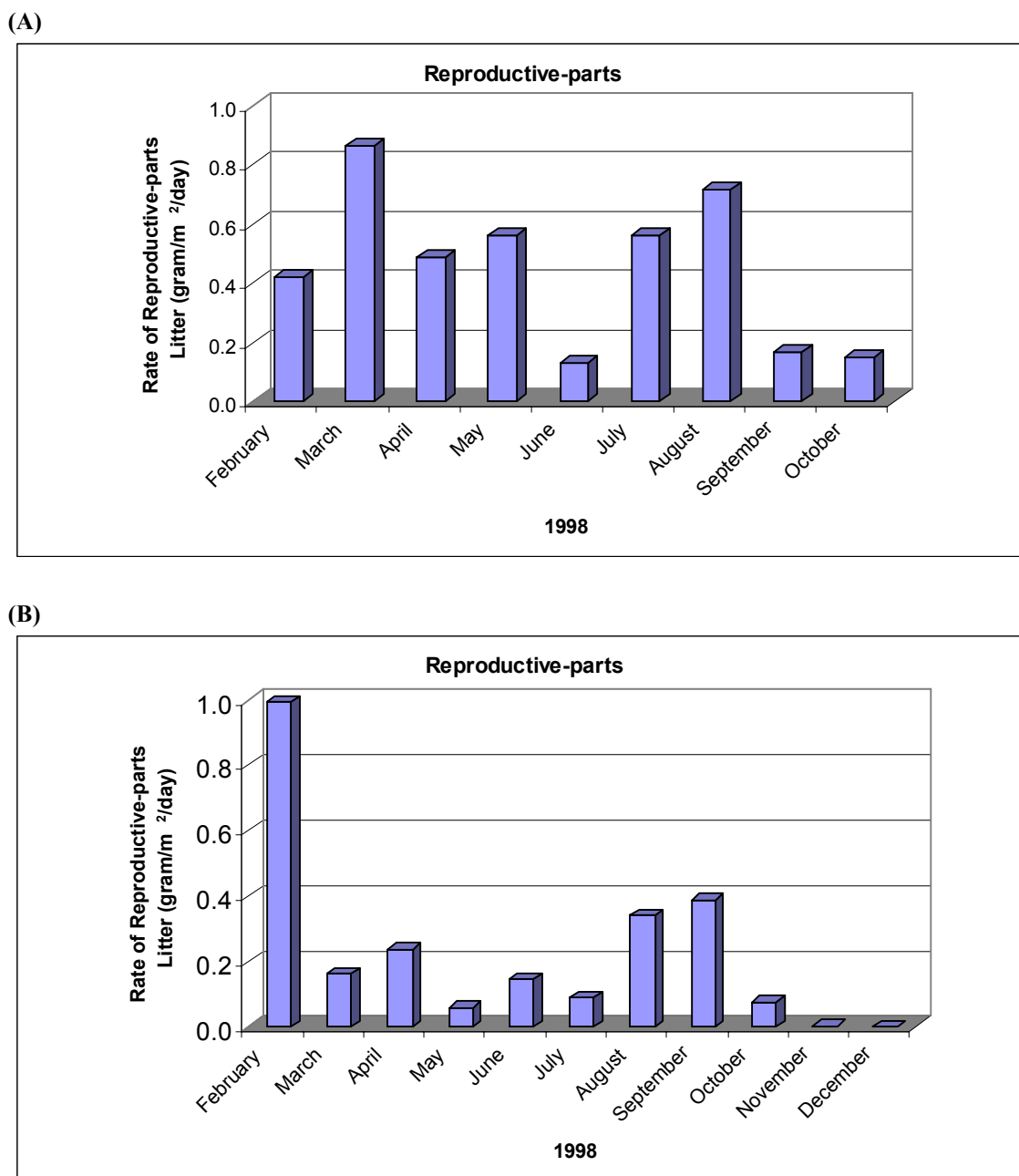

Fig. 4. The rate pattern of reproductive part litter of mangrove community in the research Site 1 (A) and Site 2 (B)

***Rate of twig litter production***

Twig litter rates for mangroves in the study area ranged from 0.12 g/(m<sup>2</sup> d) (September) to 1.73 g/(m<sup>2</sup> d) (March) at Site 1 and from 0.00 g/(m<sup>2</sup> d) (October and December) to 4.49 g/(m<sup>2</sup> d) (February) at Site 2. Monthly production of twig litter peaked in March at Site 1 and in February at Site 2 (Fig. 5).

Monthly production of twig litter showed a similar trend to litter production from reproductive parts suggesting that flower–fall may stimulate the shedding of twigs possibly due to decreasing physiological function of the twig after living flower buds are shed. This supports the results of Lopez-Partillo and Ezcurra (1985) and Kusmana *et al.* (1998), who reported marked seasonal patterns of woody litter production in mangrove forests in Tabasco, Mexico and Talidandang Besar-Riau, respectively.

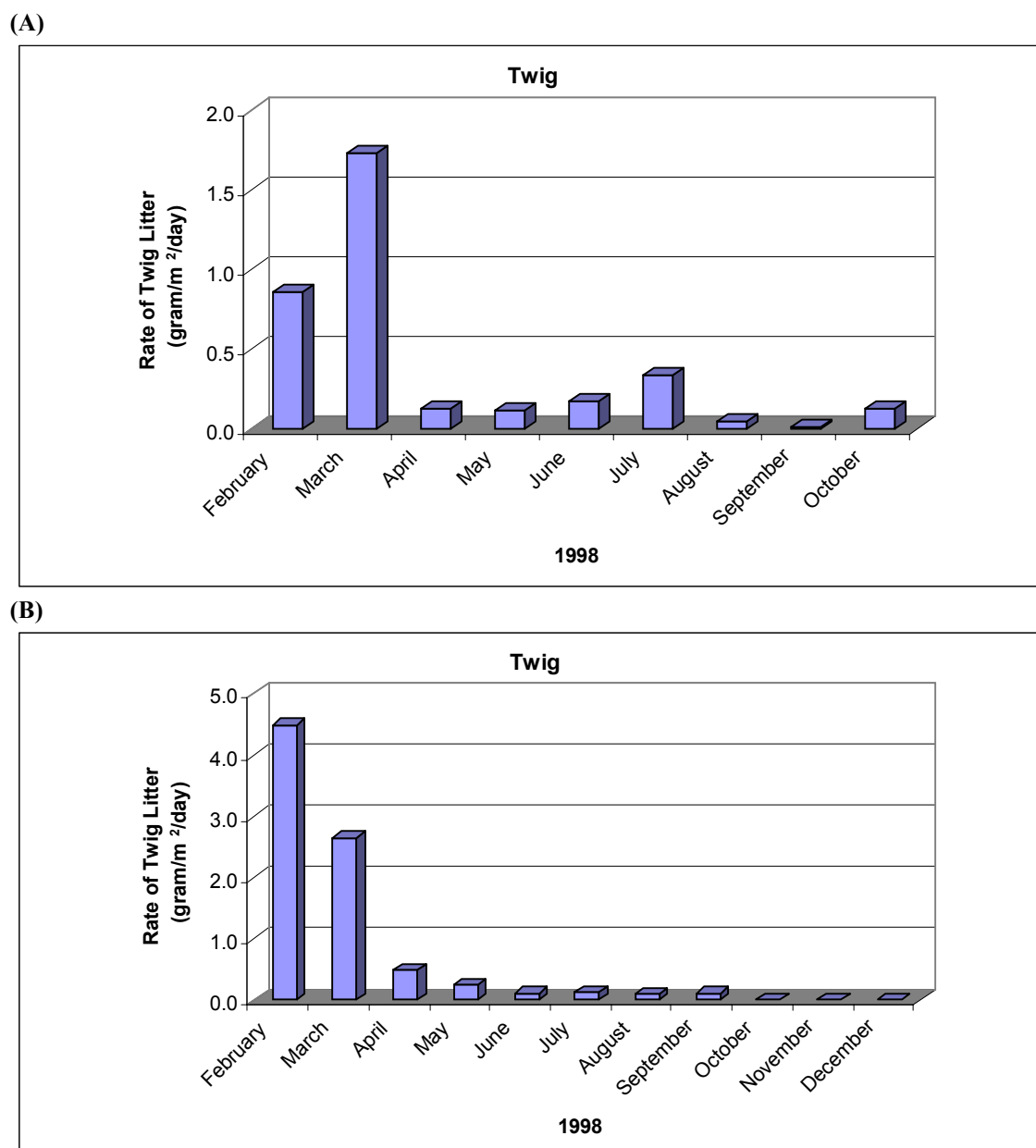

Fig. 5. The rate pattern of twig litter of mangrove community in the research Site 1 (A) and Site 2 (B)

During the litter collection period, the rate of twig litter production varied considerably (CV = 143% to 193%). Production rates were significantly correlated ( $r = 0.70$ ,  $n = 26$ ,  $p = 0.05$ ) to wind velocity, but not to rainfall ( $r < 0.30$ ,  $n = 26$ ,  $p > 0.05$ ). Higher wind velocity may be responsible for higher rates of twig litter production at Site 2 than Site 1 because mangrove at site 2 grow in the rather higher ground level and hence that is frequently subjected to strong wind.

The mangrove communities examined for this study have much higher twig litter rates than do other studied mangrove forests around the world (Table 1). This may be attributable to differences in vegetation composition and structure, phenological processes in relation to habitat condition, or climatic factors (wind velocity).

## 6. Conclusion

The total annual litterfall for site 1 and site 2 was estimated at 800.78 g/(m<sup>2</sup> year) and 744.35 g/(m<sup>2</sup> year), respectively. The monthly rate of total litter production at site 1 displayed two peaks during the study period (a major peak in March and a minor one in October) while Site 2 showed only a single peak in February. Monthly rates of production for both leaf and twig litters at both sites peaked only one during the study period while rates of litter production from plant reproductive parts peaked twice. During the sampling period, litter-fall rates varied substantially but were not significantly correlated with rainfall.

## References

- Ahmad, T. 1989. Potentialities of mangrove forest related to coastal aquaculture: A case study in Bone-bone, Luwu, South Sulawesi. In: Soerianegara, I., Zamora, P. M., Kartawinata, K., Umaly, R. C., Tjitrosomo, S., Sitompul, D. M. and Rosalina, U. (eds.), *Proceedings of Symposium on Mangrove Management: Its Ecological and Economic Consideration*, SEAMEO-BIOTROP, Bogor, pp. 287-299.
- Al Rasyid, H. 1983. Pengaruh penggunaan sistem silvikultur pohon induk terhadap perkembangan hutan payau Simpang Ulim, Aceh. Laporan Puslithut/FRDC Report No. 416: 8-30.
- Al Rasyid, H. 1984. Penilaian permudaan alam hutan mangrove antara S. Gaung dan S. Mandah, Riau. In: Soemodihardjo, S., Nontji, A. and Djamali, A. (eds.), *Prosiding Seminar II Ekosistem Mangrove*, MAB-LIPI, Jakarta, pp. 162-171.
- Al Rasyid, H. 1986. Jalur hijau untuk pengelolaan hutan mangrove Pamanukan, Jawa Barat. *Buletin Penelitian Hutan*, 475: 29-65
- Buadi. 1979. Hutan bakau di Pulau Dua, Teluk Banten, Jawa Barat. In: Soemodihardjo, S., Nontji, A. and Djamali, A. (eds.), *Prosiding Seminar II Ekosistem Mangrove*, MAB-LIPI, Jakarta, pp. 69-71.
- Chapman, S. B. 1986. Production ecology and nutrient budgets. In: Moore, P. D. and Chapman, S. B. (eds.), *Methods in Plant Ecology*, 2nd edn. Blackwell Scientific Publication, Oxford, pp. 1-59.
- Christensen, B. 1978. Biomass and primary production of *Rhizophora apiculata* Bl. in a mangrove in Southern Thailand. *Aquatic Botany*, 4: 43-52.
- Darnaedi, D. and Budiman, A. 1984. Analisis vegetasi mangrove Morowali, Sulawesi Tengah. In: Soemodihardjo, S., Nontji, A. and Djamali, A. (eds.), *Prosiding Seminar II Ekosistem Mangrove*, MAB-LIPI, Jakarta, pp. 162 - 171.
- Djaja, B., Sudargo, G. and Indrasuseno. 1984. Hutan mangrove di Tanjung Karawang

- Bekasi, Jawa Barat. In: Soemodihardjo, S., Nontji, A. and Djamali, A. (eds.), *Prosiding Seminar II Ekosistem Mangrove*, MAB-LIPI, Jakarta. pp. 156-161.
- Gong, W. K., Jin-Eong, O., Chee Hoong, W. and Dhanarajan, G. 1984. Productivity of mangrove trees and its significance in a managed mangrove ecosystem in Malaysia. In: Soepadmo, E., Rao, A. N. and MacIntosh, D. S. (eds.), *Proceedings of Asian Symposium on Mangrove Environment: Research and Management*, UNESCO, Paris, pp. 216-225.
- Goulter, P. F. E. and Allaway, W. G. 1979. Litter-fall and decomposition in a mangrove stand, *Avicennia marina* (Forsk.) Vierh., in Middle Harbour, Sydney. *Aust. J. Mar. Freshwater Res.*, 30: 541-546.
- Hardiwinoto, S., Nakasuga, T. and Igarashi, T. 1989. Litter production and decomposition of a mangrove forest at Ohura Bay, Okinawa. *Research Bulletins of the College Experiment Forests*, 46 (3): 577-594.
- Indiarto, Y., Prawiroatmodjo, S., Mulyadi and Kabinawa, I. N. 1987. Analisis vegetasi hutan mangrove Baluran, Jawa Timur. In: Soerianegara, I., Adisoemarto, S., Soemodihardjo, S., Hardjowigeno, S., Sudomo, M. and Ongkosongo, O. S. R. (eds.), *Prosiding Seminar III Ekosistem Mangrove*, MAB-LIPI, Jakarta, pp. 92-97.
- Kartawinata, K. and Waluyo, E. B. 1977. A Preliminary study of the mangrove forest on Pulau Rambut. *Mar. Res. Indon.*, 18: 119-129.
- Kishimoto, T., Miyajima, H., Nakasuga, T. and Baba, S. 1987. Zonation of mangrove forest (III) Litter-fall its seasonal change. *Trans. Mtg. Jap. For. Soc.*, 98: 301-302.
- Komiyama, A., Moriya, H., Prawiroatmodjo, S., Toma, T. and Ogino, K. 1988a. Forest as an ecosystem, its structure and function : 1. Floristic composition and stand structure. In: Ogino, K. and Chihara, M. (eds.), *Biological System of Mangroves: a Report of East Indonesia Mangrove Expedition 1986*, Ehime University, Ehime, pp. 85-96.
- Komiyama, A., Moriya, H., Prawiroatmodjo, S., Toma, T. and Ogino, K. 1988b. Forest as an ecosystem, its structure and function, 2. Primary productivity of mangrove forest. In: Ogino, K. and Chihara, M. (eds.), *Biological System of Mangroves: a Report of East Indonesia Mangrove Expedition 1986*, Ehime University, Ehime, pp. 85-96.
- Kusmana, C. 1983. Analisis vegetasi hutan mangrove Muara Angke, Teluk Jakarta. Skripsi sarjana Kehutanan, Fakultas Kehutanan, Institut Pertanian Bogor, Bogor.
- Kusmana, C. and Watanabe, H. 1991b. Zonation pattern of a mangrove forest in Riau, eastern Sumatra, Indonesia. *Rimba Indonesia*, XXVI (3-4): 13-18.
- Kusmana, C., Abe, K. and Watanabe, H. 1992a. Species composition and structure of a mangrove forest in East Sumatra, Indonesia. *Indon. J. Trop. Agric.*, 3(2): 67-77.
- Kusmana, C., Takeda, S. and Watanabe, H. 1998. Litter production of a mangrove forest in East Sumatra, Indonesia. *Indon. J. Trop. Agric.*, 8(3): 52-59.
- Leach, G. J. and Burgin, S. 1985. Litter production and seasonality of mangrove in Papua New Guinea. *Aquatic Botany*, 23: 215-224.
- Lopez-Portillo, J. and Ezcurra, E. 1985. Litter-fall of *Avicennia germinans* L. in one-year cycle in a mudflat at the laguna Mecoacan, Tabasco, Mexico. *Biotropica*, 17(3): 186-190.
- Lugo, A. E. and Snedaker, S. C. 1974. The ecology of mangrove. *Ann. Rev. Ecol. Syst.*, 5: 39-64.
- Marsono, Dj. 1989. Structure and composition of mangrove vegetation in Cilacap. In:

- Soerianegara, I., Zamora, P. M., Kartawinata, K., Umaly, R. C., Tjitrosomo, S., Sitompul, D. M. and Rosalina, U. (eds.), *Proceedings of Symposium on Mangrove Management: Its Ecological and Economic Consideration*, SEAMEO-BIOTROP, Bogor, pp. 172-180.
- Newbould, P. J. 1967. *Methods of Estimating the Primary Production of Forest*. IBP Handbook No. 2. Blackwell Scientific Publications, Oxford.
- Odum, E. P. 1980. The status of three ecosystem-level hypotheses regarding salt marsh estuaries : tidal subsidy, out welling, and detritus-based food chain. In: Kennedy, V. S. (ed.), *Estuarine Perspectives*. Academic Press, New York, pp. 458-495.
- Odum, E. P. and Heald, J. E. 1972. Trophic analyses of an estuarine mangrove community. *Bulletin of Marine Science*, 22: 671-738.
- Othman, S. 1989. The structure of vegetation and rate of litter production in a mangrove forest at Siar Beach, Lundu, Sarawak, East Malaysia. In: Soerianegara, I., Zamora, P. M., Kartawinata, K., Umaly, R. C., Tjitrosomo, S., Sitompul, D. M. and Rosalina, U. (eds.), *Proceedings of Symposium on Mangrove Management: Its Ecological and Economic Consideration: SEAMEO-BIOTROP, Bogor*, pp. 145-155.
- Ovington, J. D. 1962. Quantitative ecology and the woodland ecosystem concept. *Adv. Ecol. Res.*, 1: 103-192.
- Pool, D. J., Lugo, A. E. and Snedaker, S. C. 1975. Litter production in mangrove forests of Southern Florida and Puerto Rico. In: Walsh, G. E., Snedaker, S. C. and Teas, H. J. (eds.), *Proceedings of the International Symposium on Biology and Management of Mangrove*. Institute of Food and Agriculture Sciences, University of Florida, Gainesville, Florida, USA.
- Proctor, J. 1984. Tropical forest litterfall. I . Problems of data comparison . In: Sutton, S. L., Whitmore, T. C. and Chadwick, A. C. (eds.), *Tropical Rain Forest: Ecology and management*. Special Publication Series of the British Ecological Society No. 2. Blackwell Scientific Publication, London, pp. 267-273.
- Proctor, J., Anderson, J. M., Fogden, S. C. L. and Vallack, H. W. 1983. Ecological studies in four contrasting lowland rain forests in Gunung Mulu National Park, Sarawak. II. Litterfall, litterstanding crop and preliminary observation on herbivora. *J. Ecol.*, 71: 261 – 283.
- Sasekumar , A. and Loi, J. J. 1983. Litter production in three mangrove forest zones in the Malay Peninsula. *Aquatic Botany*, 17: 283-290.
- Schaik, C. P. van and Mirmanto, E. 1985. Spatial variation in the structure and litter-fall of a Sumatran rain forest. *Biotropica*, 17 (3): 196-204.
- Snedaker, S. C. 1978. Mangroves: their value and perpetuation. *Nature and Resources*, 14: 6-13.
- Soerianegara, I., Coto, Z., Suselo, T. B., Nainggolan, P. H. J., Supriyanto, Sumawidjaja, K., Rahardjo, S., Purwanto, Dj. and Adiwilaga, A. E. 1985. Ekologi produksi ekosistem mangrove sebagai salah satu dasar penentuan pola pemanfaatan daerah pantai. Kerjasama antara Pusat Penelitian dan Pengembangan Biologi Tropika, Institut Pertanian Bogor dengan Kantor Menteri Negara Kependudukan dan Lingkungan Hidup.
- Sokal, R. R. and Rohlf, F. J. 1986. *Introduction to Biostatistics*. 2nd edn. W. H. Freeman and Company, New York.
- Steinke, T. D. and Charles, L. M. 1984. Productivity and phenology of *Avicennia*

- marina* (Forsk.) Vierh. and *Bruguiera gymnorrhiza* (L.) Lam in Mgeny estuary South Africa. In: Teas, H. J. (ed.), *Physiology and Management of Mangroves*, W. Junk Publishers, The Hague, pp. 25-36.
- Sukardjo, S. 1979. Hutan payau di Kuala Sekampung Lampung Selatan, Sumatera. In Soemodihardjo, S., Nontji, A and Djamali, A. (eds), *Prosiding Seminar II Ekosistem Mangrove*, MAB – LIPI, Jakarta, pp. 59-68.
- Sukardjo, S. 1980. The Mangroves in the New Cimanuk Delta. Paper presented at the LIPI – UNO Joint Seminar on the Coastal Resources of the Cimanuk, West Java, Indonesia. Jakarta.
- Sukardjo, S. 1989. Litter-fall production and turnover in the mangrove forest in Muara Angke-Kapuk, Jakarta. In: Soerianegara, I., Zamora, P. M., Kartawinata, K., Umaly, R. C., Tjitrosomo, S., Sitompul, D. M. and Rosalina, U. (eds.), *Proceedings of Symposium on Mangrove Management: Its Ecological and Economic Consideration*, SEAMEO–BIOTROP, Bogor, pp. 129-143.
- Sukardjo, S. and Kartawinata, K. 1979. Mangroves forests of Banyuasin, Musi river estuary, South Sumatra. In: Srivastava, P. B. L., Ahmad, A. M., Dhanarajan, G. and Hamzah, I. (eds.), *Symposium on Mangrove & Estuarine Vegetation in Southeast Asia*. Biotrop Special Publication 10, pp. 61-77.
- Sukardjo, S., Kartawinata, K. and Yamada, I. 1984. The Mangrove Forest in Bungin river, Banyuasin, South Sumatra. In: Soepadmo, E., Rao, A. N. and MacIntosh, D. S. (eds.), *Proceedings of Asian Symposium on Mangrove Environment: Research and Management*, UNESCO, Paris, pp. 121-141.
- Suwarno. 1985. Produksi serasah hutan tanaman *Rhizophora mucronata* Lamck. Di hutan mangrove Cilacap. Skripsi Sarjana Kehutanan, Departemen Manajemen Hutan, Fakultas Kehutanan, Institut Pertanian Bogor, Bogor. 58 pp.
- Tanner, E. V. J. 1980. Litter fall in montane rain forest of Jamaica and its relation to climate. *J. Ecol.*, 68: 833-848.
- Twilley, R. R., Lugo, A. E. and Patterson-Zucca, C. 1986. Litter production and turnover in basin mangrove forest in Southwest Florida. *Ecology*, 67: 670-683.
- Wharton, C. H. and Brinson, N. M. 1979. Characteristics of southeastern river system. In: Johnson, R. R. and McCormick, J. F. (technical coordinator), *Strategies for Protection and Management of Floodplain Wetlands Other Riparian Ecosystem. United States Forest Services General Technical Report*, WO 12: 32-40.
- Woodroffe, C. D. 1982. Litter production and decomposition in the New Zealand mangrove, *Avicennia marina* var. *resinifera*. *New Zealand Journal of Marine and Freshwater Research*, 16: 179-188.
- Yamada, I and Sukardjo, S. 1980. Ecological study of mangrove and swamp forests in South Sumatra. In: Tsubouchi, Y., Ilyas, N., Takaya, Y. and Hanifah, A. R. (eds.), *South Sumatra Man and Agriculture*. The Center for Southeast Asian Studies, Kyoto University, Kyoto, Japan, pp. 1-34.

## **Vegetation Analysis of Suaq Balimbing Peat Swamp Forest, Gunung Leuser National Park-South Aceh**

**PURWANINGSIH and Razali YUSUF**

Research and Development Center for Biology, The Indonesian Institute of Sciences

### **Abstract**

Vegetation study was conducted in 1.6 ha plot of peat swamp forest at the Suaq Balimbing Research Station, in order to understand the forest structure and floristic composition. Within 1.6-ha plot, 44 species of trees and sapling belonging to 35 genera and 25 families were recorded. The *Gluta rengas* (rengas) was the most abundant tree species, followed by *Shorea palembanica* (meranti rawa), *Parinarium corymbosum* (resak), *Sandoricum emarginatum* (puin), *Garcinia celebica* (sigabu), *Eugenia sexangulata* (jambu), *Horsfieldia crassifolia* (bidarah), *Mangifera longipetiolata* (mangga hutan) and *Litsea gracilipes* (medang baru). On the other hand, for small tree (sapling) the *Garcinia celebica* was the most dominate among others species. The tree density was 806 /ha and most (80 %) of them were small trees (diameter <30cm). There are three canopy layers and most (60 %) of trees occupied stratum C (10-20 m high), and others 35 % and 5 % occupied stratum B (20-30 m high) and A (30-40 m high) respectively.

### **Introduction**

Gunung Leuser National Park (TNGL), which has been established in May 9, 1928, is the biggest conservation areas in Sumatra Island (Anonyms, 1994). The area (792,675 ha) administratively belongs to two provinces that are North Sumatra and Aceh. Provinces. Some forest type covers the park and one particular forest type is peat swamp forest can be found in Kluet District, South Aceh. A research station called the Suaq Balimbing Research Station has been established in this area in order to orangutan rehabilitation.

Although the area has declared as a research station, but forest destructions is still continuing and have resulted in some disturbed forest. Some parts of this area have changed to secondary growth and open areas that covered by grasses of Cyperaceae. This situation threatens the existence of orangutan because their habitat and sources of food such as *Mangifera petiolata*, *Tetramerista glabra*, *Sandoricum emarginatum*, *Garcinia celebica* and *Nesia altissima* might be decreasing in the future. So far little is known about the data and information on peat swamp forest vegetation of this area. The paper presented the results of the first step on ecological study of Suaq Balimbing peat swamp forest with special attention in the forest structure and floristic composition.

### **Study site**

Suaq Balimbing Research Station is a part of the Gunung Leuser National Park, which is located at South Kluet District, South Aceh. Geographically the Suaq Balimbing situated on 3°04' N and 97°25'E, with altitude of 15-20 m above sea level. The topography in general was plain except for several area was hilly. An alphabetically tract system was made within almost whole area in order to make easier for orangutan observation. For that reason a broad-trail 2 km long, from the camp to South direction has been made. The main vegetation type in this area is flooded peat swamp forest,

which overgrown by small buttresses-trees such as Myrtaceae, Clusiaceae and Anacardiaceae.

### Methods

A 1.6-ha (160m × 100m) permanent plot has been established in the Suaq Balimbing peat swamp forest, and was then divided into 160 sub-plots of 10m×10m. All trees (DBH > 10 cm) within each subplot were numbered with aluminium tag, measured and estimated their height. In addition another sub-plot of 5m × 5m has been made within each sub-plot of 10m × 10m, for sapling (2-10 cm) enumeration. The voucher specimens for each species were collected for further identification.

### Results and discussion

#### *Species composition*

In the 1.6-ha plot 44 species of tree (32) and sapling (40), which belong to 35 genera and 25 families were recorded (Table 1). The forest here is very poor in species compare to other peat swamp forest (Table 2). This is may related to the unfavorable habitat condition such as poor-nutrient soil and flooded.

Table 1. Density and basal area per hectare in research plot of Suaq Balimbing forest.

|         | Density<br>Ind./ha | Basal area<br>(m <sup>2</sup> /ha) | Number of<br>species | Number of<br>genera | Number of<br>families |
|---------|--------------------|------------------------------------|----------------------|---------------------|-----------------------|
| Trees   | 806                | 44.43                              | 32                   | 26                  | 18                    |
| Sapling | 3188               | 3.87                               | 40                   | 25                  | 19                    |
| Total   | 3994               | 48.30                              | 44                   | 35                  | 25                    |

Table 2. Number of species, density and basal area of some peat swamp forest in Indonesia

| Location              | Plot size<br>(ha) | Number of<br>species | Density<br>(tree /ha) | Basal area<br>(m <sup>2</sup> /ha) | Sources           |
|-----------------------|-------------------|----------------------|-----------------------|------------------------------------|-------------------|
| Suaq Balimbing (Aceh) | 1.6               | 32                   | 806                   | 44.43                              | -                 |
| Mansemat (Kalbar)     | 1.05              | 86                   | 698                   | 24.29                              | Siregar, 1999     |
| Selatai (Kalbar)      | 1.0               | 61                   | 513                   | 17.67                              | Sambas, 1994      |
| G.Palung (Kalbar)     | 1.0               | 122                  | 433                   | 28.03                              | Soedarmanto, 1994 |
| Tj. Puting (Kalteng)  | 1.0               | 96                   | 728                   | 43.01                              | Mirmanto, 1999    |
| Kuala Kampar (Riau)   | 0.24              | 28                   | -                     | -                                  | Mansur, 1999      |
| Kwalian (Riau)        | 0.24              | 33                   | -                     | -                                  | Anonym, 1996      |

Out of 18 families recorded, 5 of them were the most common families with family importance value (FIV) of greater than 20.0 (Table 3). The Anacardiaceae and Clusiaceae were dominant in terms of number of individuals, whereas Dipterocarpaceae and Meliaceae in basal area. On the other hand, the Lauraceae together with Anacardiaceae were dominant in terms of number of species.



Tabel 3. Number of species (NS), number of individual (D), basal area (BA= cm<sup>2</sup> /ha) and importance value of family in Suaq Balimbing forest plot

| Family           | NS | D      | BA        | FIV   |
|------------------|----|--------|-----------|-------|
| Anacardiaceae    | 3  | 236.25 | 174332.70 | 77.93 |
| Dipterocarpaceae | 1  | 73.13  | 74151.50  | 28.89 |
| Clusiaceae       | 2  | 90.00  | 25415.06  | 23.14 |
| Lauraceae        | 3  | 77.51  | 15698.65  | 22.53 |
| Meliaceae        | 2  | 53.76  | 34424.70  | 20.67 |
| Rosaceae         | 1  | 72.50  | 33891.21  | 19.75 |
| Myrtaceae        | 2  | 76.26  | 15940.80  | 19.30 |
| Myristicaceae    | 2  | 40.63  | 23742.90  | 16.64 |
| Theaceae         | 1  | 21.25  | 17683.72  | 9.74  |
| Apocynaceae      | 1  | 24.38  | 14678.21  | 9.45  |
| Dilleniaceae     | 1  | 26.25  | 9054.31   | 8.42  |
| Sterculiaceae    | 2  | 2.50   | 413.59    | 6.65  |
| Rubiaceae        | 2  | 1.88   | 254.03    | 6.54  |
| jangkang         | 1  | 3.13   | 2758.22   | 4.13  |
| sp-1             | 1  | 1.25   | 384.48    | 3.37  |
| Icacinaceae      | 1  | 1.25   | 203.93    | 3.33  |
| sp-3             | 1  | 0.63   | 441.79    | 3.30  |
| Moraceae         | 1  | 0.63   | 306.80    | 3.27  |
| sp.4             | 1  | 0.63   | 216.48    | 3.25  |
| Euphorbiaceae    | 1  | 0.63   | 141.86    | 3.24  |
| Fabaceae         | 1  | 0.63   | 107.52    | 3.23  |
| sp-2             | 1  | 0.63   | 76.70     | 3.22  |

Some 9 tree species in the forest plot were recorded with importance value of greater than 10.0 (Table 4). *Glutta renghas* (IV=79.15) was the most dominant tree species followed by *Shorea palembanica* (IV=36.27), *Parinarium corymbosum* (IV=25.91), *Sandoricum emarginatum* (IV=22.14), *Eugenia sexangulata* (IV=22.12), *Garcinia celebica* (IV=22.01), *Horsfieldia crassifolia* (15.94), and *Litsea gracilipes* (IV=12.29). The success of *Glutta renghas* to dominate forest here may be due to its potency to adapt in the unsuitable environment. This species was found in almost all the sub-plots, indicated by frequency value of 86.25%.

Processes of succession in this forest have been going well, indicated by some dominant tree species having a good regeneration on the sapling. The most dominant sapling species were *Garcinia celebica*, *Glutta renghas*, *Eugenia sexangula*, *Mangifera longipetiolata* and *Shorea palembanica* (Table 5). The *Garcinia celebica* is under canopy species, which usually with unpredictable flowering season. In addition some under canopy species were able to germinate their seed under close canopy condition (cf. Denslow, 1980). *Glutta renghas*, *Eugenia sexangulata*, *Mangifera longipetiolata* and *Shorea palembanica* on the other hand, were flowering season species and need small gap for their seed germination. Whitmore (1982) mentioned that the development of plant from seed to seedling and sapling is an important factor during regeneration of tropical rain forest.

Tabel 4. The density (D= trees/ha), basal area (BA= cm<sup>2</sup>/ha) and importance value (IV) of tree species in Suaq Balimbing forest plot

| No  | Family           | Species                         | D      | F     | BA        | IV    |
|-----|------------------|---------------------------------|--------|-------|-----------|-------|
| 1.  | Anacardiaceae    | <i>Gluta renghas</i>            | 213.75 | 86.25 | 158944.71 | 79.15 |
| 2.  | Dipterocarpaceae | <i>Shorea palembanica</i>       | 73.13  | 53.75 | 74151.50  | 36.27 |
| 3.  | Rosaceae         | <i>Parinarium corymbosum</i>    | 72.50  | 47.50 | 33891.21  | 25.91 |
| 4.  | Meliaceae        | <i>Sandoricum emarginatum</i>   | 53.13  | 40.00 | 34346.77  | 22.14 |
| 5.  | Myrtaceae        | <i>Eugenia sexangulata</i>      | 75.63  | 46.88 | 15877.01  | 22.12 |
| 6.  | Clusiaceae       | <i>Garcinia celebica</i>        | 67.50  | 45.63 | 20964.98  | 22.01 |
| 7.  | Myristicaceae    | <i>Horsfieldia crassifolia</i>  | 37.50  | 31.25 | 23023.16  | 15.94 |
| 8.  | Lauraceae        | <i>Litsea gracilipes</i>        | 46.25  | 23.75 | 8475.29   | 12.29 |
| 9.  | Apocynaceae      | <i>Alstonia spatulata</i>       | 24.38  | 20.63 | 14678.21  | 10.36 |
| 10. | Anacardiaceae    | <i>Mangifera longipetiolata</i> | 21.25  | 18.13 | 15016.64  | 9.56  |
| 11. | Theaceae         | <i>Tetramerista glabra</i>      | 21.25  | 15.00 | 17683.72  | 9.55  |
| 12. | Dilleniaceae     | <i>Dillenia puchella</i>        | 26.25  | 21.25 | 9054.31   | 9.45  |
| 13. | Clusiaceae       | <i>Garcinia dioica</i>          | 22.50  | 18.75 | 4450.08   | 7.46  |
| 14. | Lauraceae        | <i>Phoebe lanceolata</i>        | 20.63  | 16.88 | 3625.88   | 6.67  |
| 15. | Lauraceae        | <i>Cryptocarya crassinervia</i> | 10.63  | 9.38  | 3597.48   | 3.96  |
| 16. | Jangkang         | Jangkang                        | 3.13   | 3.13  | 2758.22   | 1.62  |
| 17. | Myristicaceae    | <i>Myristica</i> sp.            | 3.13   | 2.50  | 719.74    | 1.04  |
| 18. | Anacardiaceae    | <i>Camptosperma coriacea</i>    | 1.25   | 1.25  | 371.35    | 0.48  |
| 19. | Sterculiaceae    | <i>Sterculia oblongata</i>      | 1.25   | 1.25  | 210.34    | 0.45  |
| 20. | Icacinaceae      | <i>Platea excelsa</i>           | 1.25   | 1.25  | 203.93    | 0.45  |
| 21. | Sp-1             | sp-1                            | 1.25   | 0.63  | 384.48    | 0.36  |
| 22. | Sterculiaceae    | <i>Sterculia rubiginosa</i>     | 1.25   | 0.63  | 203.25    | 0.32  |
| 23. | Rubiaceae        | <i>Adina minutiflora</i>        | 1.25   | 0.63  | 143.58    | 0.31  |
| 24. | Sp-3             | sp-3                            | 0.63   | 0.63  | 441.79    | 0.30  |
| 25. | Moraceae         | <i>Ficus xyllophylla</i>        | 0.63   | 0.63  | 306.80    | 0.27  |
| 26. | Sp.4             | sp.4                            | 0.63   | 0.63  | 216.48    | 0.25  |
| 27. | Euphorbiaceae    | <i>Macaranga diepenhorstii</i>  | 0.63   | 0.63  | 141.86    | 0.23  |
| 28. | Rubiaceae        | <i>Gardenia anisophylla</i>     | 0.63   | 0.63  | 110.45    | 0.22  |
| 29. | Fabaceae         | <i>Dialium patens</i>           | 0.63   | 0.63  | 107.52    | 0.22  |
| 30. | Meliaceae        | <i>Disoxylum</i> sp.            | 0.63   | 0.63  | 77.93     | 0.22  |
| 31. | Sp-2             | sp-2                            | 0.63   | 0.63  | 76.70     | 0.22  |
| 32. | Myrtaceae        | <i>Eugenia lineata</i>          | 0.63   | 0.63  | 63.79     | 0.21  |

### Forest structure

Within the 1.6-ha plot, 1290 trees (DBH > 10 cm) were recorded or the tree density was 806 trees /ha with basal area of 44.43 m<sup>2</sup>/ha. These values were relatively higher than other peat swamp forests (Table 2), suggesting that some of trees were bigger in size. Out of all the trees recorded, 20 % of them with diameter of > 30 cm and represent of them were *Gluta renghas* (23%), *Shorea palembanica* (37%) and *Parinarium corymbosum* (24%).

The tree diameter distribution showed that 80 % of total tree recorded had diameter of less than 30 cm, similar to the common phenomenon in the tropical forests, which has been always experienced as their dynamic process (Ogawa *et al.*, 1965). Diameter distribution of some prominent species show that only *Gluta renghas* which is evenly distributed and with higher proportion in all the diameter classes. It could be expected that the species would remain dominant in the future, if there is no forest disturbance any more.

Tabel 5. The density (D= sapling /ha), basal area (BA= m<sup>2</sup> /ha) and importance value of sapling species in Suaq Balimbing forest plot

| No  | Species                         | Family           | BA/HA   | F   | D/HA | IV    |
|-----|---------------------------------|------------------|---------|-----|------|-------|
| 1.  | <i>Garcinia celebica</i>        | Clusiaceae       | 6393.97 | 103 | 613  | 49.43 |
| 2.  | <i>Gluta renghas</i>            | Anacardiaceae    | 7483.80 | 82  | 443  | 44.12 |
| 3.  | <i>Eugenia sexangulata</i>      | Myrtaceae        | 4882.37 | 96  | 403  | 37.99 |
| 4.  | <i>Mangifera longipetiolata</i> | Anacardiaceae    | 2554.82 | 72  | 280  | 24.94 |
| 5.  | <i>Shorea palembanica</i>       | Dipterocarpaceae | 3312.00 | 62  | 223  | 23.76 |
| 6.  | <i>Dillenia puchella</i>        | Dilleniaceae     | 1257.34 | 39  | 148  | 13.05 |
| 7.  | <i>Parinarium corymbosum</i>    | Rosaceae         | 1533.80 | 31  | 110  | 11.53 |
| 8.  | <i>Gynotroches</i> sp.          | Rhizophoraceae   | 1278.86 | 19  | 148  | 10.46 |
| 9.  | <i>Tetrameristra glabra</i>     | Theaceae         | 1512.40 | 21  | 95   | 9.68  |
| 10. | <i>Phoebe lanceolata</i>        | Lauraceae        | 1355.26 | 23  | 75   | 8.91  |
| 11. | <i>Eugenia cuprea</i>           | Myrtaceae        | 730.38  | 27  | 105  | 8.76  |
| 12. | <i>Litsea gracilipes</i>        | Lauraceae        | 863.98  | 21  | 65   | 7.06  |
| 13. | <i>Cryptocarya</i> sp.          | Lauraceae        | 591.86  | 23  | 65   | 6.62  |
| 14. | <i>Gardenia</i> sp.             | Rubiaceae        | 603.97  | 19  | 70   | 6.28  |
| 15. | <i>Horsfieldia crassifolia</i>  | Myristicaceae    | 800.79  | 18  | 55   | 6.18  |
| 16. | gar.2                           | Clusiaceae       | 892.70  | 13  | 35   | 5.13  |
| 17. | <i>Sterculia oblongata</i>      | Sterculiaceae    | 401.97  | 18  | 53   | 5.07  |
| 18. | <i>Sandoricum emarginatum</i>   | Meliaceae        | 552.41  | 14  | 45   | 4.70  |
| 19. | <i>Glochidion rubrum</i>        | Euphorbiaceae    | 401.81  | 12  | 30   | 3.57  |
| 20. | <i>Alstonia spatulata</i>       | Apocynaceae      | 365.09  | 9   | 23   | 2.84  |
| 21. | Gar.3                           | Clusiaceae       | 112.92  | 6   | 15   | 1.56  |
| 22. | <i>Dialium patens</i>           | Fabaceae         | 132.05  | 3   | 18   | 1.29  |
| 23. | Undet                           |                  | 92.64   | 3   | 8    | 0.87  |
| 24. | Undet                           |                  | 52.86   | 2   | 5    | 0.56  |
| 25. | <i>Macaranga triloba</i>        | Euphorbiaceae    | 125.66  | 1   | 3    | 0.54  |
| 26. | Undet                           |                  | 31.91   | 2   | 5    | 0.50  |
| 27. | <i>Platea excelsa</i>           | Icacinaceae      | 27.82   | 2   | 5    | 0.49  |
| 28. | Undet                           |                  | 18.24   | 2   | 5    | 0.47  |
| 29. | <i>Ficus</i> sp.1               | Moraceae         | 17.36   | 2   | 5    | 0.47  |
| 30. | Undet                           |                  | 64.50   | 1   | 5    | 0.46  |
| 31. | Undet                           |                  | 88.14   | 1   | 3    | 0.44  |
| 32. | Undet                           | Araliaceae       | 55.15   | 1   | 3    | 0.35  |
| 33. | Undet                           |                  | 34.64   | 1   | 3    | 0.30  |
| 34. | Undet                           |                  | 11.31   | 1   | 3    | 0.24  |
| 35. | Undet                           |                  | 10.39   | 1   | 3    | 0.24  |
| 36. | <i>Polyalthia sumatrana</i>     | Annonaceae       | 9.50    | 1   | 3    | 0.24  |
| 37. | <i>Xylopi ferruginea</i>        | Annonaceae       | 9.50    | 1   | 3    | 0.24  |
| 38. | <i>Semecarpus longifolius</i>   | Anacardiaceae    | 7.85    | 1   | 3    | 0.23  |
| 39. | Undet                           |                  | 7.85    | 1   | 3    | 0.23  |
| 40. | Undet                           |                  | 7.85    | 1   | 3    | 0.23  |

Tree height analysis have resulted in 3 canopy layers, i.e. lower layer (stratum C) occupied by 60% trees with heights of 10-20 m; stratum B (20-30 m) occupied by 35% of trees; and stratum A occupied by only 5% trees with heights of 30-40 m (Fig. 1). The

emergent trees represented by *Shorea palembanica* and *Parinarium corymbosum* reach up to 35 m, whereas *Gluta renghas* was dominant in stratum B.

Table 6 shows that there are 11 groups of species, and most (37.5 %) of them aggregated on sub-plot 20. This group consisted of prominent species i.e. *Gluta renghas*, *Litsea gracilipes*, *Parinarium corymbosum*, *Shorea palembanica* and *Eugenia sexangulata*, having similar distribution in each sub-plot. It can be expected that those species may have the same pattern in adaptation on the habitat. On the other hand some species such as *Cryptocarya crassinervia*, *Sterculia oblongata*, *Sterculia rubiginosa* and *Platea excelsa* were limited in distribution.

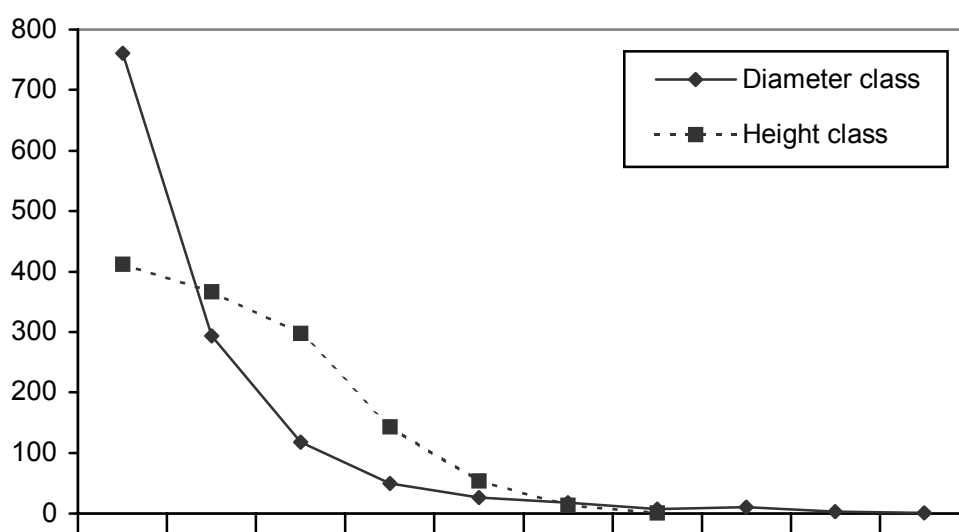

Fig. 1. Number of individuals in each diameter and height classes in Suaq Balimbing peat swamp forest, South Aceh

### Conclusions

Peat swamp forest in Suaq Balimbing Research Station could be said that it was poor in plant species. Out of all the tree species recorded *Gluta renghas* would be suggested to dominate in this area in the future. The human disturbances would decrease the width of the forest area or accelerate deforestation; therefore law enforcement and forest control must be intensified.

Vegetation analysis of a peat swamp forest in South Aceh

Table 6. Species Grouping in sub-plot at Suaq Balimbing, South Aceh

| Species                         | Sub-plot |    |    |    |    |    |    |    |    |    |    |    |    |    |    |    |    |    |    |    |
|---------------------------------|----------|----|----|----|----|----|----|----|----|----|----|----|----|----|----|----|----|----|----|----|
|                                 | 1        | 2  | 3  | 4  | 5  | 6  | 7  | 8  | 9  | 10 | 11 | 12 | 13 | 14 | 15 | 16 | 17 | 18 | 19 | 20 |
| <i>Gluta renghas</i>            | 17       | 12 | 21 | 28 | 16 | 17 | 12 | 20 | 28 | 15 | 11 | 11 | 12 | 20 | 10 | 24 | 16 | 19 | 19 | 14 |
| <i>Litsea gracilipes</i>        |          | 1  | 2  | 1  | 2  | 7  | 1  |    |    | 3  | 10 | 8  | 2  | 8  | 1  | 5  | 4  | 5  | 7  | 7  |
| <i>Parinarium corymbosum</i>    | 6        | 6  | 5  | 6  | 7  | 3  | 9  | 6  | 2  | 7  | 5  | 1  | 6  | 2  | 12 | 8  | 4  | 5  | 9  | 7  |
| <i>Shorea palembanica</i>       | 5        | 7  | 8  | 6  | 8  | 4  | 2  | 5  | 7  | 4  | 4  | 12 | 4  | 7  | 6  | 5  | 6  | 7  | 4  | 6  |
| <i>Eugenia sexangulata</i>      | 8        | 3  | 2  | 3  | 8  | 11 | 5  | 6  | 4  | 13 | 7  | 8  | 6  | 10 | 7  | 5  | 3  | 5  | 2  | 5  |
| <i>Alstonia spatulata</i>       |          | 4  | 1  | 2  | 1  | 1  |    | 1  | 1  | 3  | 1  | 4  | 1  | 4  | 4  | 3  | 1  | 2  | 1  | 4  |
| <i>Dillenia puchella</i>        | 1        | 4  | 1  | 2  | 2  |    | 3  | 5  | 3  |    | 4  |    | 4  | 2  | 1  | 2  | 2  | 1  | 1  | 4  |
| <i>Garcinia celebica</i>        | 2        | 5  | 1  | 5  | 9  | 5  | 5  | 8  | 5  | 10 | 5  | 6  | 2  | 3  | 11 | 6  | 4  | 12 | 2  | 2  |
| <i>Sandoricum emarginatum</i>   | 5        | 1  | 7  | 6  |    | 7  | 3  | 6  | 3  | 3  | 7  | 3  | 2  | 7  | 5  | 1  | 6  | 3  | 8  | 2  |
| Jangkang                        |          |    |    |    |    |    |    |    |    |    |    |    | 2  |    | 1  | 1  |    |    |    | 1  |
| Dehaasia                        |          |    |    | 1  |    |    |    |    | 3  |    | 1  | 4  | 2  |    |    | 1  | 2  |    |    | 1  |
| <i>Phoebe lanceolata</i>        | 1        |    |    | 2  | 3  | 1  | 1  | 2  | 2  | 1  | 1  | 2  | 4  | 2  | 1  | 1  | 4  | 1  | 3  | 1  |
| <i>Horsfieldia crassifolia</i>  | 5        | 3  | 4  | 5  | 5  | 4  | 5  | 2  | 2  | 2  | 5  | 1  | 2  | 4  | 1  | 2  |    | 4  | 4  |    |
| <i>Garcinia dioica</i>          | 1        | 4  |    | 3  |    | 1  | 2  | 1  | 1  | 7  | 1  | 2  | 2  | 4  | 2  | 2  | 1  |    | 2  |    |
| <i>Myristica</i> sp.            |          |    |    |    |    |    |    |    |    |    |    |    |    |    | 2  |    |    | 2  | 1  |    |
| <i>Mangifera longipetiolata</i> |          | 2  |    | 1  |    |    | 3  | 3  | 2  | 4  | 5  | 2  | 1  | 2  | 3  | 2  | 2  | 2  | 2  |    |
| <i>Adina minutiflora</i>        |          |    |    |    |    |    |    |    |    |    |    |    |    |    |    |    |    |    | 2  |    |
| <i>Tetrameristra glabra</i>     |          | 1  |    | 2  | 5  | 3  | 1  | 2  | 1  |    | 3  | 2  | 4  |    | 1  | 6  | 1  | 2  |    |    |
| <i>Macaranga diepenhorstii</i>  |          |    |    |    |    |    |    |    |    |    |    |    |    |    |    |    |    |    |    | 1  |
| undet-3                         |          |    |    |    |    |    |    |    |    |    |    |    |    |    |    |    |    |    |    | 1  |
| undet-4                         |          |    |    |    |    |    |    |    |    |    |    |    |    |    |    |    |    |    |    | 1  |
| undet-5                         |          |    |    |    |    |    |    |    |    |    |    |    |    |    |    |    |    |    |    | 1  |
| <i>Camposperma coriacea</i>     |          |    |    |    | 1  |    |    |    |    |    |    |    |    |    |    |    |    |    |    | 1  |
| undet-2                         |          |    |    |    |    |    |    |    |    |    |    |    |    |    |    |    |    |    |    | 1  |
| <i>Cryptocarya crassinervia</i> |          |    | 1  |    |    |    |    |    |    |    |    |    |    |    |    |    |    |    |    | 1  |
| <i>Sterculia oblongata</i>      |          |    |    |    |    |    | 1  |    | 1  |    |    |    |    |    |    |    |    |    |    |    |
| <i>Sterculia rubiginosa</i>     |          |    |    |    | 2  |    |    |    |    |    |    |    |    |    |    |    |    |    |    |    |
| <i>Ficus xyllophylla</i>        |          |    |    |    |    |    |    |    |    |    |    |    |    |    |    |    |    |    |    | 1  |
| <i>Gardenia anysophylla</i>     |          |    |    |    |    |    |    |    |    |    |    |    |    |    |    |    |    |    |    | 1  |
| undet-1                         |          |    |    |    |    |    |    |    |    |    |    |    |    |    |    |    |    |    |    | 1  |
| <i>Platea excelsa</i>           |          | 1  |    |    |    |    |    |    |    |    |    |    |    |    |    |    |    |    |    | 1  |
| <i>Dialium patens</i>           |          | 1  |    |    |    |    |    |    |    |    |    |    |    |    |    |    |    |    |    |    |
| <i>Disoxyllum</i> sp.           |          | 1  |    |    |    |    |    |    |    |    |    |    |    |    |    |    |    |    |    |    |
| <i>Eugenia lineata</i>          |          | 1  |    |    |    |    |    |    |    |    |    |    |    |    |    |    |    |    |    |    |

### References

- Anonym. 1994. *Kawasan Taman Nasional di Indonesia*. Direktorat Bina Kawasan Pelestarian Alam, Ditjen PHPA-Dephut: 161.
- Anonim, 1996. Laporan Pengkajian Masalah Pencadangan Areal untuk Budidaya Perkebunan Kelapa Sawit Atas Nama Inti Salim Group pada Kawasan Lindung Gambut di Kabupaten Bengkalis Propinsi Riau. TIM Pengkajian Departemen Kehutanan. Jakarta Oktober 1996.
- Denslow, J.S. 1980. Gap partiitoning among tropical rain forest trees. In: Ewel, J. (ed.), *Tropical Succession Supplement. Biotropica*, 12 (2): 47-55
- Ding Hou, 1978. Anacardiaceae. *Flora Malesiana : Spermatophyta*. Vol. 8: 395-548.
- Ogawa, H.; K. Yoda; K. Ogino; T. Shidei; D. Ratnawongso & C. Apasutaya, 1965. Comparative ecological study on three main types of forest vegetation in Thailand. I.: Structure and floristic composition. *Nature and life in S.E. Asia*, 4:13-48.
- Mansur, M. 1999. Analisis vegetasi hutan rawa gambut di Kabupaten Bengkalis dan Kampar, Propinsi Riau. *Prosiding Seminar Hasil-hasil Penelitian Bidang Ilmu Hayat*. pp.248-257.
- Mirmanto, E.; R. Polosakan and H. Simbolon, 1999. Penelitian ekologi hutan gambut di Taman Nasional Tanjung Puting, Kalimantan Tengah. Paper presented at the *Seminar Biodiversitas dan Pengelolaan Hutan Gambut secara Berkelanjutan*. Bogor, 12 Februari 1999.
- Sambas, E.N., S. Susiarti and S. Prawiroatmodjo, 1994. Struktur dan komposisi pohon hutan gambut di Kabupaten Ketapang, Kalimantan Barat. *Pros. Sem. Hasil Litbang SDH*. Puslitbang Biologi-LIPI, Bogor. pp 351-358.
- Siregar, M. & E.N. Sambas, 1999. Floristic composition of management of Mensemat Peat swamp Forest (MPSF) in Sambas, West Kalimantan. Paper presented at the *Internasional Symposium on Tropical Peatland Management*, 22-23 November 1999. Ciloto-Puncak, Indonesia.
- Soedarmanto, B. 1994 Fitososiologi hutan rawa gambut tropika di Taman Nasional Gunung Palung, Kalimantan Barat. *Skripsi* Fakultas Biologi, Universitas Nasional Jakarta.
- Whitmore, T.C. 1982. On pattern and process in forest. In: Newman, E.I. (ed.), *The Plant Community as Working Mechanism*. Blackwell, Oxford, pp. 45-59.

## Primary Production of a Heath (Kerangas) Forest in Lahei, Central Kalimantan

Kazuki MIYAMOTO<sup>1</sup>, Takashi KOHYAMA<sup>1</sup>, Eizi SUZUKI<sup>2</sup> and  
Herwint SIMBOLON<sup>3</sup>

<sup>1</sup> Graduate School of Environmental Earth Science, Hokkaido University

<sup>2</sup> Faculty of Science, Kagoshima University

<sup>3</sup> Research and Development Center for Biology-LIPI

### Abstract

We examined primary production of a heath forest, which establish on highly acidic and nutrient-poor sandy soil, in central Kalimantan. Biomass of two 1-ha plots was around 200 - 250 t/ha. Relative growth rate (RGR) of stand biomass and net production was considerably lower during 1997-1998 than during 1998 - 1999, indicating that low rain fall and hours of sunlight caused by El Nino strongly affect the productivity of the heath forest. Turn over time defined as a reciprocal of RGR of stand biomass were greatly shorter than that of a mixed dipterocarp forest in west Kalimantan. Nutrient-poor soil was likely to be related to these characteristics of the heath forest.

### Introduction

Kerangas forests are one of the most distinctive formation in Central Kalimantan, which occurs on highly acidic- and nutrient-poor sandy soils. Previous studies reported flora, soil characteristics and secondary succession about these forests. However, little is known about primary productivity and architectural characteristics of the forests so far. We attempted to reveal those characteristics of kerangas forests in terms of biomass, biomass allocation, growth and turn over by cutting various sized trees and using allometric relations between various pair of plant dimensions.

From 1997 to 1998, drought and haze pollution by El Nino occurred over Kalimantan. We examined the effect of insufficient rain fall and sunlight on primary productivity of the heath forest comparing primary production for El Nino period with that for non-El Nino period.

The present research addressed following questions: 1) What is the factors determining the productivity of the heath forest? 2) Are there any effects of El Nino on the productivity of the heath forest?

### Study Site and Method

We carried out field survey in the area about 3-4 km east from Kampung Babugus, Desa Lahei, Kacamatan Metagai, Kabupaten Kapuas. This area is characterized by peat swamp forests and kerangas forests. We established two 1-ha plots in this area (one in a kerangas forest (P1) and another in a peat swamp forest (P2)) in August 1997, and one more plot in heath forest (P4) in January 1998. In the heath forest, main tree species were *Cotylelobium lanceolatum*, *Shorea teysmanniana*, *Shorea platycarpa* (Dipterocarpaceae), *Calophyllum* spp. (Guttiferae), *Engelhardia serrata* (Juglandaceae), *Eugenia cf. klosii*, *Tristania obovata* (Myrtaceae) (Table 1). To observe annual growth of the forest, we measured girth at breast height (g.b.h.) for all trees with more than 15 cm g.b.h. in one kerangas plot (P4). For calculating parameters of allometric equations

to estimate primary production, we carried out clear felling in one of the subplots (10 m × 10 m) in P1. We cut various sized trees (from saplings with 4 m high to adults with 30 m high), then, measured and weighed above ground parts of these sample trees divided into three fractions (trunks, branches and leaves). In order to calculate dry weight of each sample tree, we collected small samples to be dried at 80°C in electric oven.

Table 1. Number and basal area (BA) of main species of a 1-ha plot (P1) in a heath (kerangas) forest. Only species with more than or equal to 2.0% in BA were shown except *Agathis borneensis*.

| Species (Local name)                  | Family           | Number of individuals | BA (m <sup>2</sup> )   | %     |
|---------------------------------------|------------------|-----------------------|------------------------|-------|
| <i>Cotylelobium lanceolatum</i>       | Dipterocarpaceae | 108                   | 4.4                    | 14.6  |
| <i>Shorea teysmanniana</i>            | Dipterocarpaceae | 58                    | 1.9                    | 6.3   |
| <i>Calophyllum</i> sp 1. (bingtangor) | Guttiferae       | 180                   | 1.9                    | 6.2   |
| <i>Shorea platycarpa</i>              | Dipterocarpaceae | 43                    | 1.3                    | 4.2   |
| <i>Engelhardtia serliata</i>          | Juglandaceae     | 12                    | 1.1                    | 3.6   |
| <i>Eugenia</i> cf. <i>klosii</i>      | Myrtaceae        | 79                    | 0.9                    | 3.1   |
| <i>Tristania obovata</i>              | Myrtaceae        | 55                    | 0.9                    | 2.9   |
| <i>Hopea gniffithui</i>               | Dipterocarpaceae | 163                   | 0.9                    | 2.8   |
| <i>Sindora leiocarpa</i>              | Leguminosae      | 77                    | 0.8                    | 2.7   |
| <i>Vatica umbonata</i>                | Dipterocarpaceae | 14                    | 0.8                    | 2.6   |
| <i>Garcinia rostrata</i>              | Guttiferae       | 87                    | 0.7                    | 2.4   |
| <i>Calophyllum pulcherrimum</i>       | Guttiferae       | 91                    | 0.7                    | 2.4   |
| <i>Calophyllum</i> sp2. (kupple naga) | Guttiferae       | 6                     | 0.6                    | 2.0   |
| <i>Agathis borneensis</i>             | Araucariaceae    | 18                    | 0.4 (1.3) <sup>†</sup> | 1.3   |
| Others                                |                  | 1142                  | 13.1                   | 42.9  |
| Total                                 |                  | 2133                  | 305                    | 100.0 |

<sup>†</sup> Sum of BA of living trees and stumps previously felled was shown in parentheses.

## Results

### *Size distribution pattern of the heath forest*

Fig. 1 shows d.b.h. size class distribution of the heath forest and the mixed dipterocarp forest stands. Every distribution showed a reversed -J shaped pattern. Frequency of small sized trees up to 20 cm was higher in the heath forest than in the mixed dipterocarp forest. No individuals was found in the d.b.h. class more than 70 cm in the heath forest, while trees distributed up to 158 cm in the mixed dipterocarp forest.

### *Architectural characteristics of the kerangas forest in allometry*

We employed expanded allometric equation to describe the Diameter - Height (DH) relationship of trees:

$$1/H = 1/AD + 1/H^* \quad (1)$$

where A and H\* are regression constants. This relation is an asymptote to projected maximum tree height H\*. Maximum tree height (H\*) in the heath forest was short



compared with that in the mixed dipterocarp forest. In small sized trees up to 10 cm in diameter at breast height (d.b.h.), however, trees in the heath forest were taller than those in the mixed dipterocarp forest. In fact, most tree species in the heath forest had slender trunks.

We employed simple allometric equation to describe the relations between the other pairs of tree dimensions (e.g. trunk dry weight - branch dry weight):

$$Y = aX^b \quad (2)\text{-a}$$

in log scale, the relations are shown by linear lines:

$$\ln Y = \ln a + b \ln X \quad (2)\text{-b}$$

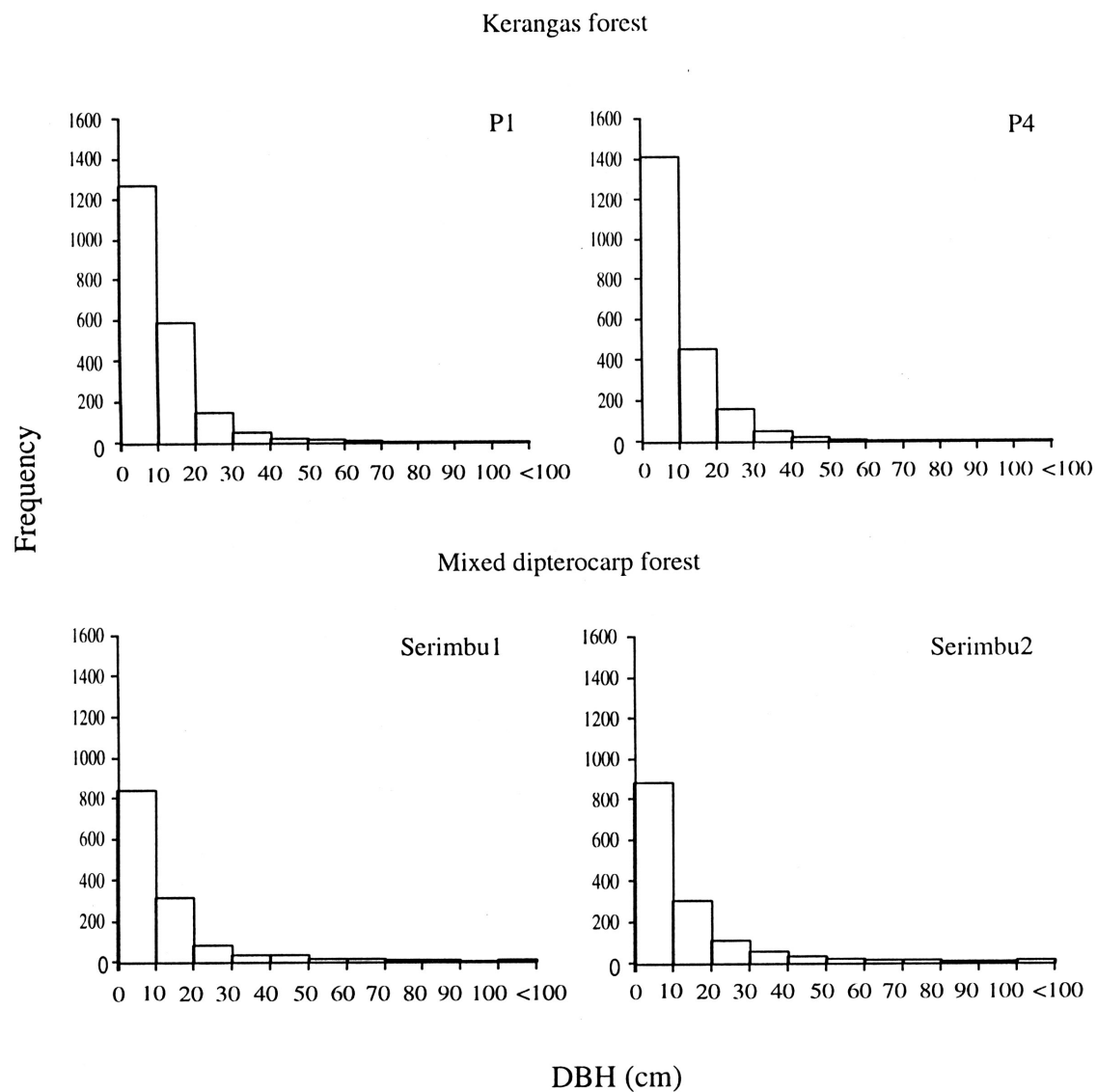

Fig. 1. Frequency distribution of DBH ( $\geq 5$  cm) of trees in 1-ha plots in the heath forest and the mixed dipterocarp forest.

where a and b are regression constants. In leaf dry weight (Wl) - stem and branch dry weight (Wsb) relation and leaf area (Al) - crown area (Ac) relation, significant differences were shown between the heath forest and the mixed dipterocarp forest in the regression constant b, which correspond to a slope of linear regression line in equation (2)-b ( $p < 0.005$ ). Whereas in Al - Wl relation, significant difference was shown in elevation ( $p < 0.001$ ).

#### ***Primary production of the heath forest***

Stand biomass of the heath forest was around 200 - 250 t/ha. These values were equivalent to a half of those of the mixed dipterocarp forests. We adopted a reciprocal of relative growth rate (RGR) of the stand biomass as a turn over time. The turn over time of two 1-ha plots during 1998-1999 were around a quarter of that of the mixed dipterocarp forest.

#### ***The effect of El Nino on the productivity of the heath forest***

There were remarkable differences in RGR of stand biomass and net production between before and after August 1998 both in P1 and P4. Especially in P1, RGR during 1997-1998 showed negative value. Significant difference in relative growth rate of d.b.h. (RDGR) was not found between two plots and in time-plot interaction, but within time (i.e., El-Nino year vs. non-El Nino year).

### **Discussion**

From the present result, it was obvious that the heath forest had lower biomass, shorter turn over time than the mixed dipterocarp forest. These characteristics of the heath forest appear to be partly due to unique DH relation and size distribution biased to small sized trees. Although occur in the same tropical lowland area as mixed dipterocarp forest, heath forests have slender trunks and short maximum tree height (around 30 m). These physiognomic features and productivity of the heath forest appear to be related to nutrient poor soil environment.

During 1997 to early 1998, rainfall was considerably lower than usual. Especially in 1997, only 2/3 of usual annual rainfall was recorded. In addition to that, hours of sunlight were remarkably short from July to September 1997 due to smoke by forest fire. Significant difference in RDGR between El Nino year and non-El Nino year indicates that insufficiency of rainfall and hours of sunlight during El Nino period strongly affected the growth of the heath forest stands. Further studies are needed to precisely evaluate the effect of El Nino on the forest productivity.

Primary production of a heath forest in Central Kalimantan

Appendix 1. Dimensions and plant mass of samples in a heath forest in Central Kalimantan, Indonesia.

| No | D0 (cm) | D0.1(cm) | D (cm) | Db (cm) | H (m) | HI (m) | Ws (kg) | Wb (kg) | Wl (kg) | W (kg)  | Ac (m <sup>2</sup> ) | Al (m <sup>2</sup> ) |
|----|---------|----------|--------|---------|-------|--------|---------|---------|---------|---------|----------------------|----------------------|
| 1  | 5.16    | 4.84     | 4.49   | 2.74    | 10.11 | 7.8    | 6.03    | 1.12    | 0.46    | 7.61    | 6.60                 | 4.19                 |
| 2  | 4.07    | 3.53     | 3.79   | 3.44    | 8.5   | 8.5    | 3.36    | 1.17    | 0.52    | 5.05    | 4.78                 | 5.32                 |
| 3  | 5.98    | 4.33     | 4.20   | 2.39    | 7.45  | 5.92   | 4.95    | 0.77    | 0.15    | 5.87    | 2.64                 | 2.56                 |
| 4  | 4.84    | 4.30     | 4.39   | 2.93    | 7.68  | 5.63   | 3.86    | 0.55    | 0.25    | 4.66    | 2.83                 | 1.85                 |
| 5  | 4.36    | 3.53     | 3.41   | 2.45    | 8.4   | 5.75   | 3.57    | 0.57    | 0.21    | 4.35    | 5.28                 | 1.30                 |
| 6  | 5.57    | 4.42     | 4.42   | 3.95    | 7.79  | 3.9    | 5.23    | 2.15    | 0.57    | 7.95    | 8.28                 | 5.49                 |
| 7  | 4.39    | 3.72     | 3.50   | 3.06    | 6.2   | 3.15   | 1.89    | 0.47    | 0.45    | 2.80    | 5.30                 | 3.42                 |
| 8  | 2.86    | 2.42     | 2.36   | 2.29    | 6.93  | 2.5    | 1.41    | 0.21    | 0.15    | 1.78    | 3.60                 | 1.42                 |
| 9  | 3.88    | 3.28     | 3.21   | 2.80    | 7.9   | 4.01   | 2.81    | 0.60    | 0.32    | 3.73    | 2.47                 | 2.62                 |
| 10 | 3.85    | 3.37     | 3.28   | 1.24    | 9.5   | 8.35   | 2.65    | 0.11    | 0.08    | 2.84    | 2.01                 | 0.63                 |
| 11 | 3.72    | 2.67     | 2.51   | 2.20    | 6.85  | 3.54   | 1.69    | 0.30    | 0.18    | 2.17    | 1.94                 | 1.78                 |
| 12 | 7.19    | 5.09     | 4.87   | 3.18    | 6.7   | 5.53   | 5.04    | 0.79    | 0.39    | 6.22    | 4.15                 | 1.93                 |
| 13 | 7.48    | 6.43     | 6.40   | 3.25    | 10.82 | 8.1    | 12.41   | 2.19    | 0.30    | 14.90   | 3.28                 | 2.72                 |
| 14 | 11.14   | 9.80     | 9.80   | 8.56    | 13.66 | 5.5    | 35.18   | 17.00   | 4.95    | 57.13   | 19.79                | 26.28                |
| 15 | 8.09    | 6.91     | 6.97   | 5.73    | 13.7  | 7.57   | 24.13   | 5.14    | 1.01    | 30.28   | 11.88                | 5.92                 |
| 16 | 6.24    | 5.09     | 4.97   | 3.12    | 7.1   | 4.95   | 4.24    | 0.88    | 0.90    | 6.02    | 3.80                 | 5.99                 |
| 17 | 8.21    | 7.67     | 7.67   | 5.83    | 13.6  | 7      | 23.60   | 4.50    | 1.62    | 29.72   | 6.33                 | 12.29                |
| 18 | 8.85    | 8.82     | 9.14   | 5.92    | 12.17 | 8      | 24.28   | 4.14    | 2.18    | 30.60   | 5.73                 | 8.39                 |
| 19 | 10.15   | *        | 8.66   | 5.12    | 14.78 | 9.85   | 26.71   | 2.23    | 1.04    | 29.98   | 3.58                 | 4.95                 |
| 20 | 9.49    | *        | 8.94   | 7.29    | 13.01 | 6.34   | 30.89   | 12.06   | 1.92    | 44.87   | 13.43                | 10.33                |
| 21 | 7.00    | 6.33     | 6.24   | 4.04    | 10.53 | 7.2    | 11.15   | 1.16    | 0.09    | 12.39   | 3.64                 | 0.73                 |
| 22 | 9.52    | 8.37     | 8.37   | 7.00    | 13    | 8.3    | 34.89   | 11.62   | 3.80    | 50.31   | 14.18                | 21.34                |
| 23 | 10.92   | 10.12    | 9.61   | 7.19    | 14.44 | 9.25   | 38.67   | 10.79   | 2.50    | 51.96   | 12.37                | 15.53                |
| 24 | 11.11   | 9.01     | 9.26   | 6.56    | 14.75 | 7.7    | 32.56   | 6.45    | 1.63    | 40.64   | 4.18                 | 11.49                |
| 25 | 9.17    | 7.67     | 7.64   | 4.11    | 16.26 | 10.2   | 25.73   | 1.95    | 1.03    | 28.71   | 8.34                 | 7.18                 |
| 26 | 12.61   | 9.87     | 9.93   | 8.94    | 15.6  | 7.25   | 53.17   | 17.68   | 6.09    | 76.93   | 10.41                | 40.73                |
| 27 | 8.18    | 6.53     | 6.33   | 4.46    | 11.6  | 5.53   | 15.51   | 3.22    | 0.90    | 19.62   | 7.79                 | 8.24                 |
| 28 | *       | 10.22    | 10.31  | 12.03   | 16.1  | 8.5    | 72.70   | 17.32   | 3.80    | 93.82   | 19.35                | 24.12                |
| 29 | 8.34    | 6.81     | 7.29   | 5.35    | 11.1  | 7.3    | 21.55   | 2.46    | 0.44    | 24.44   | 6.13                 | 3.82                 |
| 30 | 6.49    | 5.86     | 5.92   | 4.71    | 10.6  | 5.5    | 11.13   | 1.99    | 0.50    | 13.63   | 11.04                | 5.25                 |
| 31 | 7.10    | 5.89     | 5.70   | 3.12    | 9.75  | *      | 11.40   | 0.54    | 0.07    | 12.01   | 3.53                 | 0.61                 |
| 32 | 6.24    | 5.16     | 5.47   | 3.53    | 8.75  | 5.8    | 7.60    | 0.94    | 0.45    | 9.00    | 4.15                 | 3.75                 |
| 33 | 6.24    | 5.09     | 5.03   | 2.74    | 7.15  | *      | 7.47    | 0.04    | 0.02    | 7.53    | 1.51                 | 0.12                 |
| 34 | 5.06    | 4.77     | 4.74   | 2.39    | 11.2  | 8.1    | 6.04    | 0.24    | 0.12    | 6.40    | 3.29                 | 1.18                 |
| 35 | 5.09    | 4.33     | 4.49   | 3.85    | 10.6  | 6.4    | 7.12    | 0.96    | 0.43    | 8.51    | 4.34                 | 3.91                 |
| 36 | 4.39    | 2.83     | 2.83   | 2.51    | 8.3   | 3.12   | 2.08    | 0.67    | 0.33    | 3.08    | 4.14                 | 3.16                 |
| 37 | 6.24    | 5.19     | 5.19   | 4.17    | 10.8  | 6.4    | 9.97    | 2.02    | 0.82    | 12.82   | 4.32                 | 6.37                 |
| 38 | 3.50    | 2.99     | 3.06   | 2.10    | 7.45  | 5.05   | 2.24    | 0.44    | 0.32    | 2.99    | 3.14                 | 3.29                 |
| 39 | 4.36    | 3.82     | 3.60   | 2.93    | 10.13 | 5.8    | 4.65    | 0.59    | 0.27    | 5.52    | 2.72                 | 2.78                 |
| 40 | 5.00    | 4.46     | 4.65   | 1.59    | 9.95  | *      | 4.33    | 0.10    | 0.05    | 4.47    | 0.71                 | 0.54                 |
| 41 | 4.20    | 3.72     | 3.69   | 2.32    | 9.35  | 7.1    | 2.06    | 0.27    | 0.07    | 2.39    | 2.76                 | 0.64                 |
| 42 | 5.09    | 4.46     | 4.17   | 3.09    | 9.18  | 6.1    | 2.97    | 0.18    | 0.05    | 3.21    | 1.53                 | 0.43                 |
| 43 | 5.32    | 4.62     | 4.65   | 2.07    | 8.95  | 7.6    | 5.50    | 0.10    | 0.04    | 5.65    | 1.30                 | 0.31                 |
| 44 | 4.04    | 3.34     | 3.28   | 1.94    | 7.7   | 4.8    | 2.47    | 0.04    | 0.05    | 2.55    | 0.33                 | 0.37                 |
| 45 | 3.66    | 3.06     | 3.06   | 2.58    | 5.45  | 3.95   | 1.41    | 0.28    | 0.28    | 1.97    | 3.30                 | 2.52                 |
| 46 | 21.14   | 15.02    | 15.34  | 11.71   | 17.7  | 10     | 84.96   | 16.04   | 9.73    | 110.72  | 16.96                | 41.42                |
| 47 | 4.39    | 4.11     | 4.14   | 2.83    | 9     | 6.35   | 5.58    | 1.07    | 0.27    | 6.92    | 5.72                 | 1.49                 |
| 48 | 3.37    | 3.09     | 3.02   | *       | 6.7   | 3.45   | 2.04    | 0.64    | 0.28    | 2.96    | 4.10                 | 2.38                 |
| 49 | 21.29   | 18.24    | 19.10  | 14.51   | 21.5  | *      | 200.73  | 32.17   | 9.36    | 242.26  | 23.00                | 60.91                |
| 50 | 3.57    | 2.90     | 2.93   | 2.80    | 8.25  | 3      | 2.39    | 0.57    | 0.24    | 3.21    | *                    | 2.23                 |
| 51 | 6.62    | 5.03     | 4.93   | 3.66    | 8.1   | *      | 4.37    | 1.43    | 0.58    | 6.38    | 2.00                 | 3.05                 |
| 52 | 4.30    | 3.47     | 3.31   | 2.04    | 7.35  | 4.5    | 2.37    | 0.07    | 0.04    | 2.49    | 1.26                 | 0.40                 |
| 53 | 26.36   | 23.71    | 25.27  | 17.00   | 20.3  | 14.1   | 251.31  | 45.04   | 6.01    | 302.35  | 39.47                | 48.50                |
| 54 | 4.20    | 3.72     | 3.57   | 3.37    | 6.5   | 2.3    | 2.28    | 0.76    | 0.32    | 3.36    | 3.28                 | 2.10                 |
| 55 | 4.07    | 4.07     | 3.63   | 2.39    | 8.55  | 5.75   | 2.90    | 0.26    | 0.01    | 3.17    | 1.63                 | 0.11                 |
| 56 | 36.61   | 30.69    | 32.59  | 28.49   | 27.6  | 20     | 817.11  | 226.86  | 20.88   | 1064.85 | 37.92                | 108.80               |
| 57 | 43.23   | 34.19    | 37.15  | 28.17   | 27.8  | 22     | 936.06  | 280.99  | 12.03   | 1229.09 | 62.58                | 61.93                |
| 58 | 26.26   | 21.14    | 21.77  | 17.09   | 20.73 | 11.3   | 176.96  | 53.17   | 19.26   | 249.40  | 39.03                | 85.63                |
| 59 | 36.13   | 27.09    | 30.18  | 18.75   | 22.1  | 16.85  | 505.47  | 69.37   | 12.66   | 587.50  | 25.51                | 57.28                |

Abbreviations: D0, stem diameter at the ground level; D0.1, stem diameter at 1/10 of the tree height; D, stem diameter at breast height; Db, stem diameter at the lowest living branch; H, tree height; HI, height of the lowest living branch; Ws, stem dry weight; Wb, branch dry weight; Wl, leaf dry weight; W, aboveground total weight; Ac, crown area; Al, total leaf area; \*, No available record

**Part 5**  
**Peatland and Technology**

## Photosynthetically Active Radiation Transmittance within Alder (*Alnus japonica* Steud) Stand in Kushiro Mire

Bismart Ferry IBIE<sup>1</sup> and Hidenori TAKAHASHI<sup>2</sup>

Graduate School of Environmental Earth Science, Hokkaido University, Sapporo, Japan.

<sup>1</sup>E-mail: ferry@ees.hokudai.ac.jp, <sup>2</sup>E-mail: htaka@ees.hokudai.ac.jp

### Abstract

Photosynthetic photon flux density (PPFD) at three heights level within boreal alder stand from middle of summer to the early winter season of 1999 has been studied in Kushiro mire, Hokkaido-Japan. The tree density in study site was 3,036 ha<sup>-1</sup>, the mean of tree height was 5.82 m, mean of tree height at the crown base was 3.99 m, mean of canopy depth was 1.81 m, mean canopy coverage of each tree was 3.78 m<sup>2</sup> and tree canopies covered about 65% of total areas. The PPFD at 1.1 m height was about 27-31% of PPFD at 8.1m height. The daily PPFD of the alder stand on sunny day from the top canopy to the forest floor are also presented.

**Keywords:** alder, stand, PAR, transmittance, vertically, PPFD, attenuation, gap.

### Introduction

Hannoki or Japanese alder (*Alnus japonica* Steud) trees on protected forest area of Kushiro mire have homogeneous distributions both horizontally and vertically. Trees with homogenous vertical distribution will formed up several forest canopy layers, and in turn photosynthetically active radiation (PAR) from above canopy to forest floor will gradually attenuate. Because of its role in photosynthesis and other physiological processes, solar radiation between 400 and 700 nm (PAR) is one of the most important resources for plants (Gendron *et al.*, 1998). Vertical distribution of photosynthetic photon flux density (PPFD) is important in determining the ability of tree to profiteer light environments at every growth phases of each canopy layer.

This paper presents results of PPFD measured at three heights level of PAR within boreal alder stand from middle summer to early winter season of 1999.

### Materials and Methods

The study was conducted in a 0.0112-ha plot of hannoki stand of Kushiro Shitsugen National Park, Kushiro, Japan between 14 August 1999 and 9 November 1999. The measured tree variables were included: crown diameters, total tree height, crown depth and tree height at the crown base.

One sensor was mounted above the canopy on a 8.1 m and two other sensors were installed below the canopy on a 3.4 m and 1.1 m height, respectively. PAR were measured by using three LI-COR terrestrial radiation sensors, type SB model number LI-190 SB quantum sensor. At every 10 min, the PPFD of PAR was measured and computed using a-tree data loggers (KADEC-US). The data were calculated from 05:00 to 17:00 Japan Standard Time.

### Results and Discussion

Density and mean height of 13 live trees within the study plot were 3,036 trees ha<sup>-1</sup> and 5.80 ± 0.87 m. The mean tree height at the crown base was 3.99 ± 0.83 m, the crown depth was 1.81 ± 0.60 m. The stem diameter, crown diameter and the crown areas of trees were

$7.47 \pm 1.66$  m,  $2.11 \pm 0.62$  m and  $3.78 \pm 1.89$  m<sup>2</sup>, respectively. The understory plants consisted principally of grasses (distributed in clumps) and alder seedlings. The height of grasses was about 0.5-1.5 m.

The relationship between stems and crown diameters performed the following equation:  $Y=14.206 X^{1.335}$  ( $R^2 = 0.855$ ), hence the crown areas might be estimated through its stem diameters.

Within the alder trees, mean ratio of crown depth/radius of crown,  $H/R$  was 1.281 m; while percentage of forest floor coverage (ratio between vertical projection of the tree coverage and study plot areas),  $C_e$  was 65 %.

Figs. 1, 2 and 3 showed the hourly of PPFD transmittance at different levels on 16 and 17 September 1999, and vertical pattern of the PPFD transmittance on 16 and 17 September 1999, respectively. Those figures showed sigmoid shapes. Roujean (1999) reported the same shapes of the vertical distribution of PAR transmittance of old black spruce and old jack pine stand in boreal forest stands of Canada (Fig. 4). The incoming PPFD with the sensors at 1.1 m and 3.4 m height were, respectively, between 23-27% and 25-29% of the PPFD at 8.1m height. Therefore, the absorbed PPFD from 8.1m to 1.1m height and from 8.1m to 3.4 m height were 73-77% and 71-75%, respectively (Table 1). Tang (1996) has explained that the vertical gradient of light transmittance varies considerably in different canopy layers. In tropical broadleaf forests, a large proportion of light is absorbed in upper canopy layers. The uppermost layer usually comprises less than 20% of the upper canopy, but intercepts more than 70% of incident PPFD.

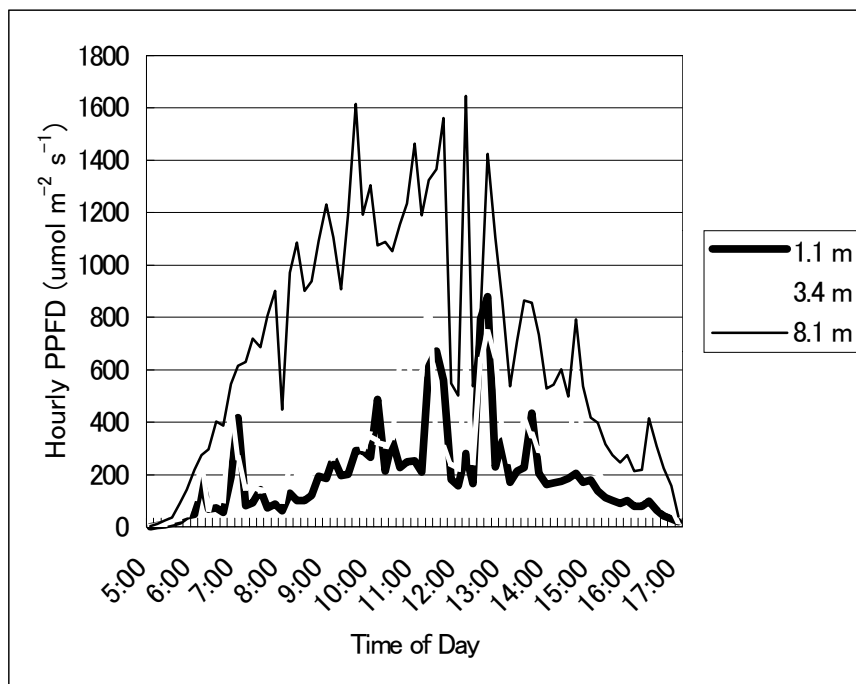

Fig. 1. Hourly PPFD transmittance at alder stands on 16 September 1999.

Photosynthetically active radiation within alder stand

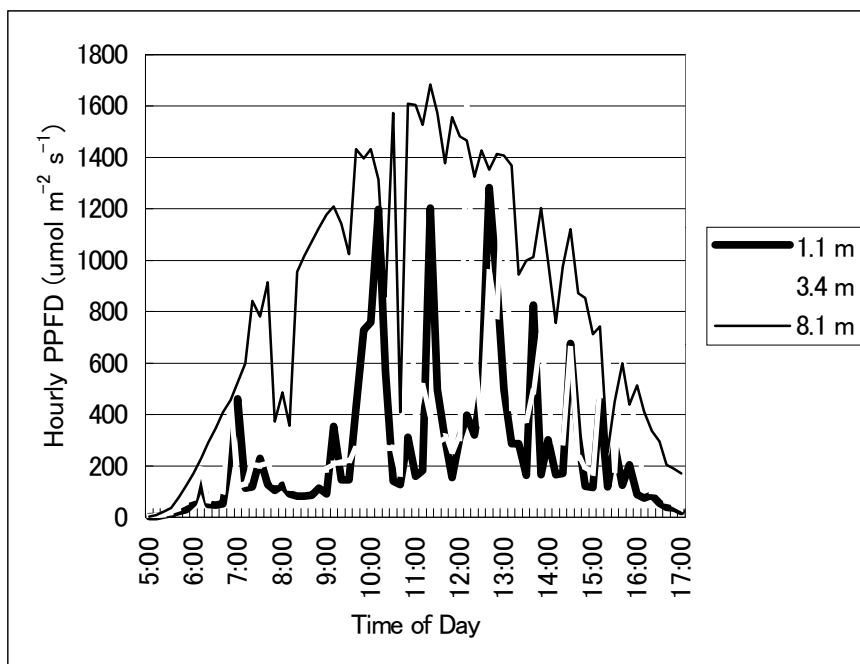

Fig. 2. Hourly PPFD transmittance at alder stands on 17 September 1999.

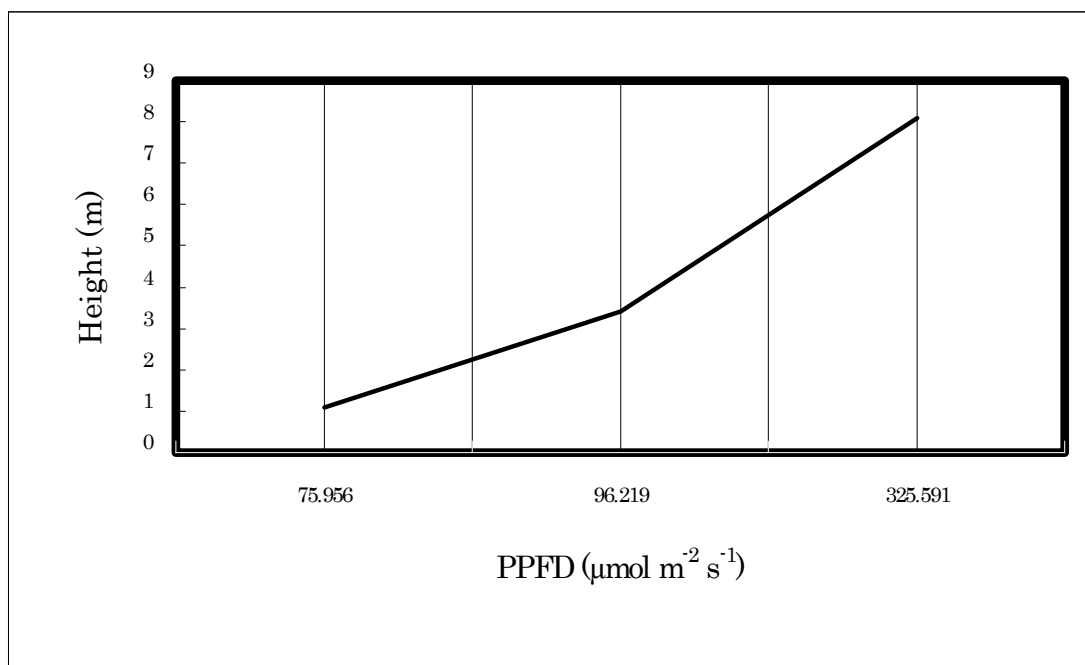

Fig. 3. The vertical pattern of PPFD (average value from 16-17 September 1999) within alder stands (range of tree height at crown base were between 3.16 m and 4.82 m).

Table 1. PPFD attenuation on alder stand.

| Date    | Layers | Height (m) | Sum PPFD<br>(mol m <sup>-2</sup> d <sup>-1</sup> ) | Ratio PPFD among layers (%) |            |            |
|---------|--------|------------|--|-----------------------------|------------|------------|
|         |        |            |  | layers 2/1                  | layers 3/1 | layers 3/2 |
| 160999  | 1      | 8.1        | 51.4   | 87.74                       |            |            |
|         | 2      | 3.4        | 19.4   |                             | 27.82      |            |
|         | 3      | 1.1        | 14.3   |                             |            | 73.71      |
| 170999  | 1      | 8.1        | 61.4   | 87.13                       |            |            |
|         | 2      | 3.4        | 22.8   |                             | 31.43      |            |
|         | 3      | 1.1        | 19.3   |                             |            | 79.62      |
| Average | 1      | 8.1        | 56.4   | 87.41                       |            |            |
|         | 2      | 3.4        | 21.1   |                             | 29.79      |            |
|         | 3      | 1.1        | 16.8   |                             |            | 88.74      |

Baldocchi *et al.*, (1984, in Botkin, 1993) reported that PAR was attenuated exponentially in an Oak-hickory forest at Oak Ridge National Laboratory. The same shape was documented by Yoda (1974, cited in Chazdon *et al.*, 1996) from the primary canopy at 30 m to the forest floor in Malaysia. Table 2 showed light variation below different plant canopies.

Table 2. Light variation below different plant canopies.

| No.                  | Location/Site  | Light (%)     | Source                            | Note                                       |
|----------------------|--|---------------|-----------------------------------|--|
| 1. Tropical region:  |  |               |                                   |  |
| a.                   | Tropical forest  | 0.2           | Yoda (1978) in Tang (1996)        | Mean daily PFD<br>May 1987- May<br>1988    |
| b.                   | Primary tropical wet forest,<br>Costa Rica:                |               | Rich <i>et al.</i> (1993)         |  |
|                      | 1. Gap   | 9-11          |                                   |  |
|                      | 2. Closed  | 2             |                                   |  |
| c.                   | Peat swamp forest,<br>Central Kalimantan                   | 5             | Takahashi & Miyasaka (1998)       | 1993-1996 (Mean)                           |
| 2. Temperate region: |  |               |                                   |  |
| a.                   | Broadleaf or in conifer<br>forests                         | 3-10<br>50-70 | Larcher (1995) in Tang (1996)     | Growing season<br>Winter season            |
| b.                   | Scot pine, Helsinki,<br>Southern Finland                   | 25            | Palva <i>et al.</i> (1998)        | 5 July-16 Oct.<br>1996, sunny day          |
| c.                   | <i>Argyrodendron peralatum</i> ,<br>Australian Rain Forest | 12.5          | Doley <i>et al.</i> (1988)        |  |
| d.                   | Pine Forest  | 15            | Hassika & Berbigier (1998)        | 5 July 1995-7 Aug.<br>1996, clear sky days |
| e.                   | Grass  | 1-≤ 4         | Tang <i>et al.</i> (1992); (1996) |  |



Relative height

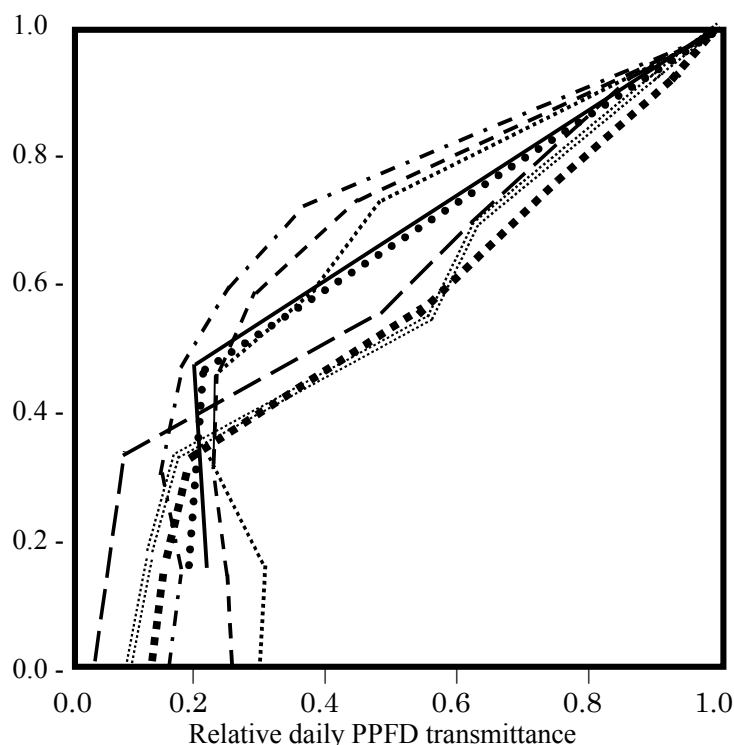

Fig. 4. Vertical pattern of the daily PPFD transmittance of alder plot on 16 September (straight line) and on 17 September 1999 (plus line). An old jack pine plot is also displayed for comparison, on 6 June (dotted line), 3 August (short dashed line) and 16 September 1994 (dashed dotted line). Then an old black spruce plot on 6 June (long dashed line), 3 August (double dashed line) and 16 September 1994 (bold dotted line) Roujen (1999).

Time series of the daily PPFD transmittance at 1.1 m, 3.4 m, and 8.1 m height are shown in Fig. 5, while Fig. 6 shows the ratio of PPFD at any different height of sensors. Fig. 5 showed that the daily PPFD at 8.1m are more variable than of at 3.4 m and 1.1 m. The PPFD values on the day of year 232 (20 August), 263 (21 September), 265 (23 September), 267 (25 September), 275 (3 October), 280 (8 October), 284 (12 October), 285 (13 October), 287 (15 October), 293 (21 October), 295 (23 October), 299 (27 October), 300 (28 October), 301 (29 October), 305 (2 November) are different compared with the PPFD values of the other days. This phenomenon might be caused by an overcast sky condition in which the flux to all direction are nearly uniform (Monteith and Unsworth, 1990) or due to these three sensors were installed in three different height but not at one vertical point. The mean daily PPFD at 8.1m was  $41.342 \pm 20.224 \text{ mol m}^{-2} \text{ d}^{-1}$  (ranged from 3.535 on 29 October 1999 to 88.137  $\text{mol m}^{-2} \text{ d}^{-1}$  on 4 August 1999). The mean daily PPFD at 3.4 m was  $16.894 \pm 8.203 \text{ mol m}^{-2} \text{ d}^{-1}$  (ranged from 1.885 on 29 October 1999 to 31.832  $\text{mol m}^{-2} \text{ d}^{-1}$  on 3 November 1999), while at 1.1 m was  $13.480 \text{ mol m}^{-2} \text{ d}^{-1} \pm 5.241$  (ranged from 2.403 on 22 October 1999 to 23.464  $\text{mol m}^{-2} \text{ d}^{-1}$  on 30 October 1999).

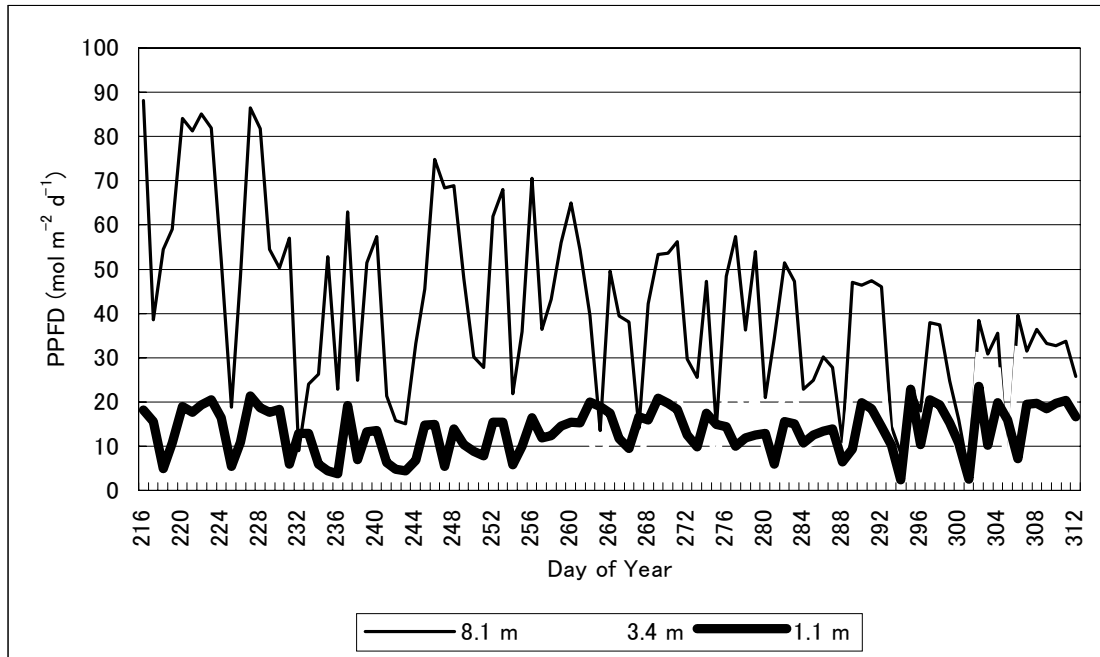

Fig. 5. Time series of the daily PPFD at three heights.

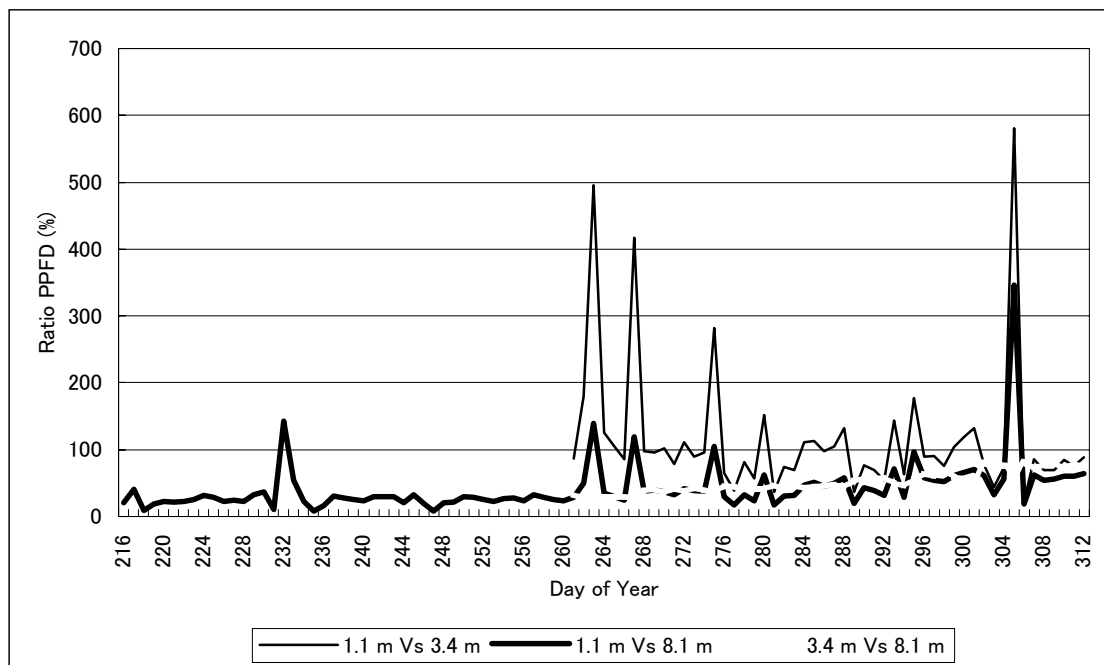

Fig. 6. Ratio of PPFD at different height.

### Synopsis and Future Prospects

Canopies of the alder trees covered about 65% of study site and the daily PPFD at the 1.1m above the ground level was between 27 and 31%. Since the values of PPFD at three different levels are greatly high, a study of PAR with shorter difference height levels and at difference of gap fractions in long-term periods are needed.

### Acknowledgements

The authors are very indebted to Mr. Yamada, Mr. Ishii, Mr. Isobe and Mr. Aswin for their cooperation during the field work.

### References

- Botkin, D. B. 1993. *Forest Dynamics an Ecological Model*. Oxford University Press. New York.
- Chazdon, R. L., Pearcy, R. W., Lee, D. W. and Fetcher, N. 1996. Photosynthetic responses of tropical forest plants to contrasting light environments. In: Mulkey, S. S., Chazdon, R. L. and Smith, A. P. (eds.), *Tropical Forest Plant Ecophysiology*. Chapman and Hall, New York, pp. 5-55.
- Gendron F., C. Messier and Commeau, P. G. 1998. Comparison of various methods for estimating the mean growing season percent photosynthetic photon flux density in forests. *Agric. and For. Meteorol.*, 92: 55-70.
- Hassika, P. and Berbigier, P. 1998. Annual cycle of photosynthetically active radiation in maritim pine forest. *Agric. and For. Meteorol.*, 90: 157-171.
- Monteith, J. L. and Unsworth, M. H. 1990. *Principles of Environmental Physics*. 2nd edn. Athanaeum Press Ltd.
- Palva, L., Garam, E., Siivola, E., Sepponen, R. and Hari, P. 1998. Quantifying spatial variability of photosynthetically active radiation within canopies using a multipoint measuring system. *Agric. and For. Meteorol.*, 92: 163-171.
- Rich, P. M., David B. C., Deborah A. C. and Steven F. O. 1993. Long-term study of solar radiation regimes in a tropical wet forest using quantum sensors and hemispherical photography. *Agric. and For. Meteorol.*, 65: 107-127.
- Roujean, J. L. 1999. Measurements of PAR transmittance within boreal forest stands during BOREAS. *Agric. and For. Meteorol.* 93: 1-6.
- Tang, Y., 1996. *Light in Plant Ecophysiology*. In: Prasad, M. N. V. (ed.), John Wiley and Sons Inc. New York.
- Takahashi, H. and Miyasaka, H. 1998. Micrometeorological aspects of tropical peat swamp forest and farmland in Central Kalimantan, Indonesia. In: *Environmental Conservation and Land Use Management of Wetland Ecosystem in Southeast Asia. Annual report and Proceedings for International Workshop 6-9 August 1997. Palangka Raya, Central Kalimantan, Indonesia. Core University Program Between Hokkaido University, Japan and R & D Center of Biology-LIPI, Indonesia.*

## Water Balance of a Peat Swamp Forest in the Upper Catchment of the Sebangau River, Central Kalimantan

Masayuki KAYAMA, Hidenori TAKAHASHI<sup>1</sup> and Suwido H. LIMIN<sup>2</sup>

<sup>1</sup>Graduate School of Environmental Earth Science, Hokkaido University, Sapporo, 060-0810 Japan

<sup>2</sup>Faculty of Agriculture, University of Palangka Raya, Central Kalimantan, Indonesia

### Abstract

Water balance determinants such as: gross rainfall, throughfall, stem flow, air temperature, solar radiation, ground water level and ground level, were measured in the peat swamp forest of upper catchment of the Sebangau River, Central Kalimantan from March 1998 to February 1999. Data indicated that the gross rainfall was 494.5mm, distributed into the throughfall 422.1mm (85.4% of gross rainfall), the stem flow, 8.1mm (1.6% of gross rainfall) and interception 64.3mm (13.0% of gross rainfall). Throughfall and stem flow in the forest had a good linear regression with the gross rainfall ( $R^2=0.95$  and  $0.81$  respectively). But, the stem flow had the threshold rainfall for flowing down the stem. The threshold rainfall was changed with dryness of the forest. The stem flow had a peak at latest 20 min after start of gross rainfall. Ground water level in the forest reacted sharply against rainfall. The deviation of ground water level before and just after the rainfall had a good linear regression with the effective amount of rainfall, defined as total of throughfall and stem flow. But the regression coefficient was different with the depth/height of ground water level. Daily evapotranspiration and run-off were estimated from the hourly data of ground water level in the forest. Water balance of the peat swamp forest from December 15th to February 7th was estimated by analyzing each parameter.

### Introduction

To better manage the forest resource, basic information on forest ecology and the inter-relating effects of the forest on the environment is essential. In the forest and wetland, ground water level and water movements are also very important as environmental determining factors. Some hydrological data have been reported from several areas, such as interception under the tropical rainforest Malaysia (Sinun *et al.*, 1992) and Amazon (Lloyd *et al.*, 1992), evapotranspiration at the secondary vegetation Amazon (Holscher *et al.*, 1997) and Australia (Farrington *et al.*, 1990), change characteristic of ground water level at several wetlands in Hokkaido island (Umeda and Inoue, 1984) and hydrological processes at subtropical rainforest Brazil (Fujieda *et al.*, 1997). But only a few hydrological information exist for the tropical peat swamp forest areas. Takahashi *et al.* (1997) have reported the characteristics of ground water level of an area in Central Kalimantan, however no information concerning hydrological processes. The present paper intends to clarify characteristics of hydrological processes in a tropical peat swamp forest with precious carbon storage.

### Study Site and Instrumentation

#### Study site and plot

The study was conducted in a peat swamp forest of upper catchment of the Sebangau River, 20km at southwest of Palangka Raya, capital city of Central Kalimantan, Indonesia or at 23°13' S and 113°54' E.

Plot 1B (observation point) is located within the marginal tall forest type, 1km

from the Sebangau River Base camp and Plot 2B is located inside forest 1km from Plot 1B. According to Rieley and Page (1995), numbers of tree plants in 0.15 ha of this area were 260-380 trees. The forest margin was consisted of many species such as: *Callophyllum hosei*, *Cambretocarpus rotundatus*, *Camptosperma coriaceum*. The tree height in each forest type were shift slightly from 10-20 m height in shrub areas into 40-45 m height in the tall tree forest type as advance inside the forest.

### Instrumentation

Gross rainfall was measured with a tipping-bucket raingauge (1 count is 0.5 mm) from March 1998 to February 1999, which was set at open area to avoid canopy. Throughfall was measured with a tipping-bucket raingauge (1 count is 1 mm) with a gutter of 3.6 mm length, from November 1998 to February 1999, which set up in the forest. Stemflow was collected with a half-section plastic tube as a channel collar to direct water down into a tipping-bucket raingauge (1 count is 0.5 mm) from November 1998 to February 1999. The stemflow water of other 6 trees, was directed down into plastic containers. Ground water level was measured with pressure transducer water gauge, and temperature was measured with a platinum resistance sensor from March 1998 to February 1999. Ground level was measured with a potential meter from September 1998 to February 1999. Every data is automatically recorded at every 60 min with a data logger (KADEC, made by KONA SYSTEM).

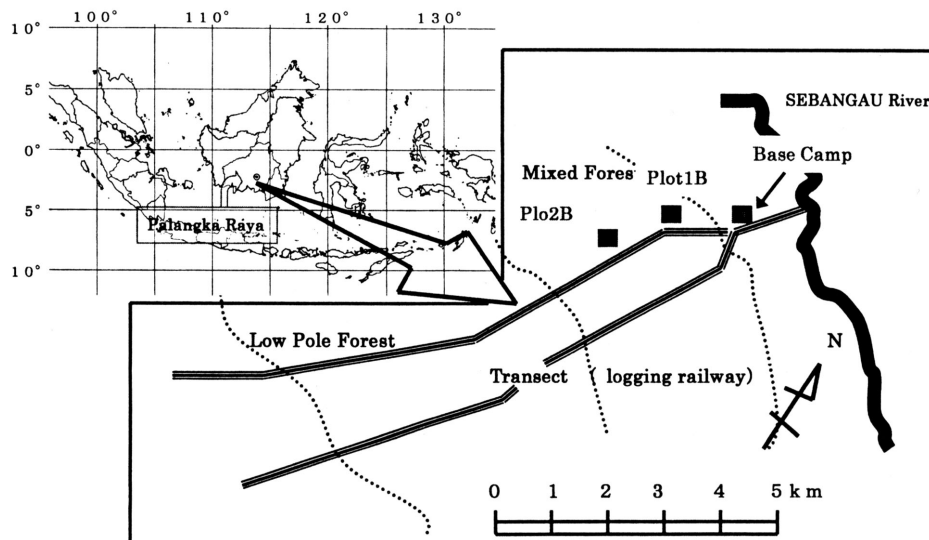
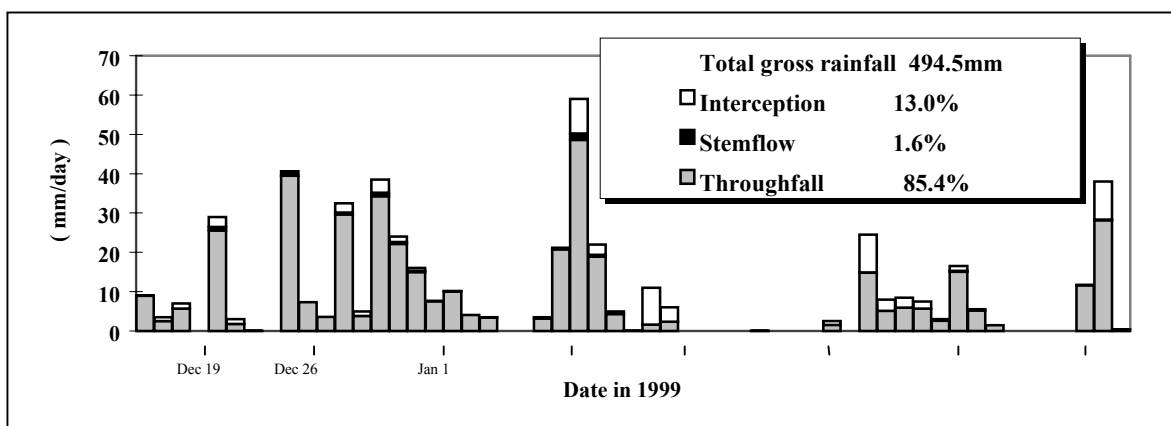

Fig. 1. Map of study site

## Results and Discussion

### Crown interception

The total amount of gross rainfall was 494.5 mm, the total throughfall, stemflow and interception were about 85.4%, 1.6% and 13.0% of total gross rainfall, respectively from Dec 15, 1998 to Feb 7, 1999 (Fig. 2). Equations in Fig. 3 indicated that the gross rainfall required initiating throughfall, while stemflow may exceed 2.46 mm and 0.49mm. It is said that the tropical rainforest is the most difficult forest type for measuring interception because of the spatial variability of throughfall and stemflow. Crown interception for several forest types at any place varies from 6.2% to 22.0% depending on forest type (Table 1). The value of interception in the study area was approximately the same as that in a natural secondary forest in Brazil, 12.4% (Castro *et al.*, 1983), slightly lower than in a tropical rainforest in Malaysia, 17.0% (Sinun *et al.*, 1992), but higher than in a logged forest in Kalimantan Indonesia, 6.2% (Asdak *et al.*, 1998).



**Fig. 2.** Daily change of gross rainfall, throughfall, stemflow and interception at Plot 1B in December 15, 1998 – February 7, 1999.

**Table.1.** Comparisons of gross rainfall,  $P_g$ , throughfall,  $P_t$ , stemflow,  $P_s$ , and rainfall interception loss,  $P_i$ , at any place, percentage means total amount of  $P_t$ ,  $P_s$  and  $P_i$  was percentage of total  $P_g$ , respectively.

| Site   | $P_g$ (mm) | $P_t$ (%) | $P_s$ (%) | $P_i$ (%) | Remark                            |
|--|------------|-----------|-----------|-----------|-----------------------------------|
| Peat swamp forest, Kalimantan Indonesia                    | 494.5      | 85.4      | 1.6       | 13.0      | 1998/12/16-1999/2/7               |
|  | 1465.5     | 77.5      | -         | -         | 1998/11/14-1999/4/3               |
| Tropical rainforest, unlogged                              | 2199       | 87.2      | 1.4       | 11.4      | Asdak <i>et al.</i> , 1998        |
| Kalimantan Indonesia, logged                               | 3563       | 93.5      | 0.3       | 6.2       | Asdak <i>et al.</i> , 1998        |
| Tropical rainforest, Sabah, Malaysia                       | -          | -         | 1.9       | 17.0      | Sinun <i>et al.</i> , 1992        |
| Amazonian rainforest, Brazil                               | -          | -         | -         | 9.0       | Lloyd <i>et al.</i> , 1988        |
| Secondary lowland tropical rainforest, West java Indonesia | -          | -         | -         | 21.0      | Calder <i>et al.</i> , 1986       |
| Secondary tropical rainforest, Brazil                      | -          | -         | -         | 12-20     | Franken <i>et al.</i> , 1990      |
| Natural Secondary forest, Vicosa Minas Gerais              | -          | 87.4      | 0.2       | 12.4      | Castro <i>et al.</i> , 1983       |
| Natural Secondary forest, Cunha Sao Paulo                  | -          | 82.8      | 1.1       | 16.1      | Fujieda <i>et al.</i> , 1997      |
| Cerradao forest, Sao Moronel Sao Paulo                     | -          | 80.5      | 2.9       | 16.6      | Leopoldo & Conte, 1985            |
| Reforestament forest, Rio de Janeiro                       | -          | 83.0      | -         | 17.0      | Coelho Netto <i>et al.</i> , 1986 |
| Terra Firme forest, Manaus Amazon                          | 2721       | 91.0      | 1.8       | 7.2       | Lloyd & Marques., 1988            |
| Terra Firme forest, Manaus Amazon                          | -          | 89.2      | 1.9       | 8.9       | Lloyd <i>et al.</i> , 1988        |
| Terra Firme forest, Manaus Amazon                          | -          | 81.8      | -         | 18.2      | Franken <i>et al.</i> , 1982      |
| Terra Firme forest, Manaus Amazon                          | -          | 77.7      | 0.3       | 22.0      | Franken <i>et al.</i> , 1982      |

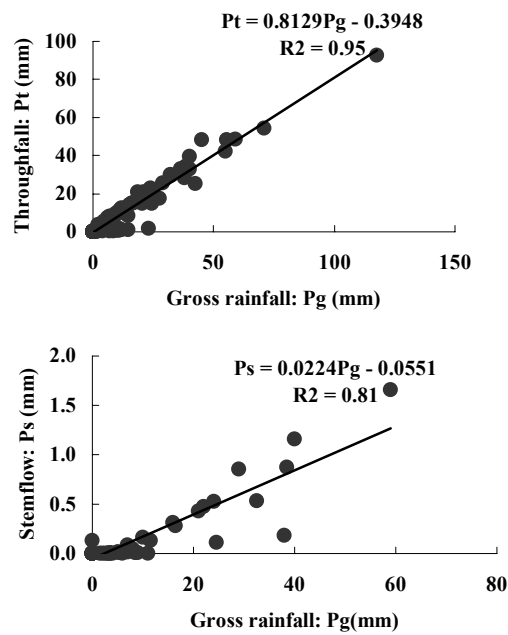

Fig. 3. Relationships between gross rainfall (Pg) with throughfall (Pt) and stemflow (Ps) at Plot 1B.

### Generating pattern of throughfall and stemflow

Fig. 4 shows volume of gross rainfall, throughfall and stemflow every 10 min. As it is shown, there is no time lag between the occurrence and the peak of gross rainfall and throughfall. On the other hand, the stemflow had a peak 20 min after the start of gross rainfall. But time lag of the occurrence and the peak between gross rainfall and stemflow showed three patterns: no time lag, 10 min, and 20 min. This variability was influenced by rain intensity, duration and bark condition.

### Response of ground water level to effective rainfall

Ground water level is sensitive to rain in the area. The relation between effective rainfall (Pe) and change of ground water level ( $\Delta h$ ) (Fig. 5) shows the change of ground water level response to effective rainfall. It is commonly accepted that the regression coefficient (Fig. 5) is high at reclaimed high-density peatland and low at natural peatlands. As a comparison, the regression coefficient was 2.2-2.6 at sphagnum peatland and 10 at bamboo grassland in wetland Sarobetu of Hokkaido (Umeda *et al.*, 1985).

### Relation between ground water level and runoff

Runoff was estimated from water balance equation;  $\Delta h = Pe - E + R$ , where,  $\Delta h$ , Pe, E and R are the change of ground water level, effective rainfall, evapotranspiration and runoff, respectively. The evapotranspiration was estimated from the graphical solution method (Umeda *et al.*, 1985). Fig. 6 shows the relation between estimated runoff and ground water level. The runoff processes changed at ground water level of about 0cm (ground surface). The runoff fluctuation is comparatively small below ground surface, but runoff increased as ground water level increased above ground surface.

Water-balance of a peat swamp forest in Central Kalimantan

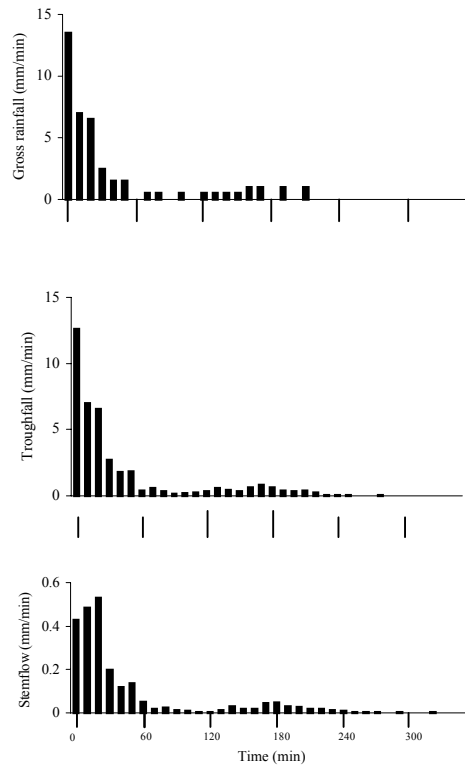

Fig. 4. Comparison of gross rainfall and stemflow every 10 min, 02:30-08:20 December 23, 1998.

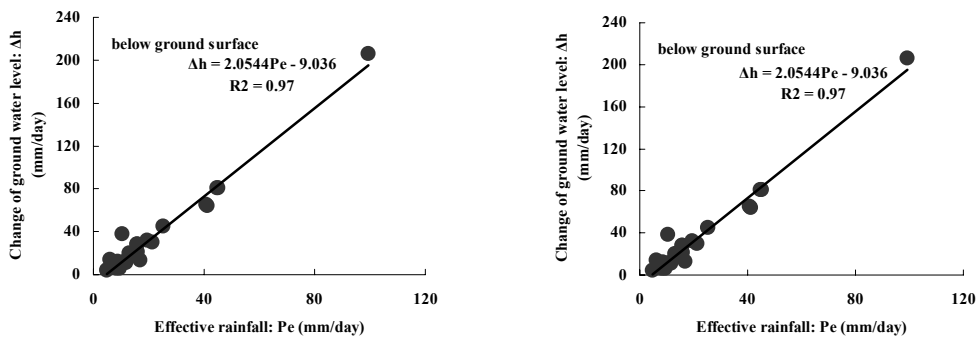

Fig. 5. Relationship between effective rainfall (Pe) and change of ground water level ( $\Delta h$ ) at Plot 1B.



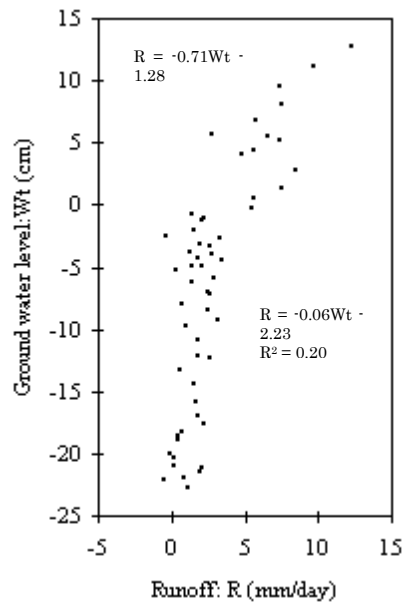

Fig. 6. Relation between ground water level (Wt) and runoff (R) during days without rainfall.

### Hydrological processes

The hydrological processes at Plot 1B of study site are illustrated schematically in Fig. 7 together with the percentage of hydrological elements estimated from field measurements and its analysis. The hydrological processes are summarized as follows. From Dec 16, 1998 to Feb 7, 1999, at first, the rate of gross rainfall was fixed 100%. About 1.7% of total gross rainfall drops on the tree surface as stemflow. About 85.1% of total gross rainfall passes through the canopy as throughfall. About 13.2% of total gross rainfall was intercepted by the canopy and returns directly to the atmosphere. Total of throughfall and stemflow, namely effective rainfall, is 86.8% of total gross rainfall reaches the forest floor, where it infiltrates and remains in the soil to feed subsurface flow and surface flow (inflow and outflow) or evapotranspiration. The runoff is 59.8% and, the evapotranspiration is 37.6% of gross rainfall. At the period of observation about two months, change of ground water storage was -48.4mm, and represented 10.0% of gross rainfall. To add to evaporation of 13.2% intercepted by the canopy, total evapotranspiration is 50.8% of total gross rainfall.

### Conclusions

Hydrological characteristics of peculiarity tropical peat swamp forest was made clear by this study such as distribution of gross rainfall, generating pattern of throughfall and stemflow, response of ground water level to effective rainfall and runoff processes, farther water balance. This information will become very important for change of ecosystem, water system and climate following forest fire, logging activity and development, and also forest management, preservation and restoration.

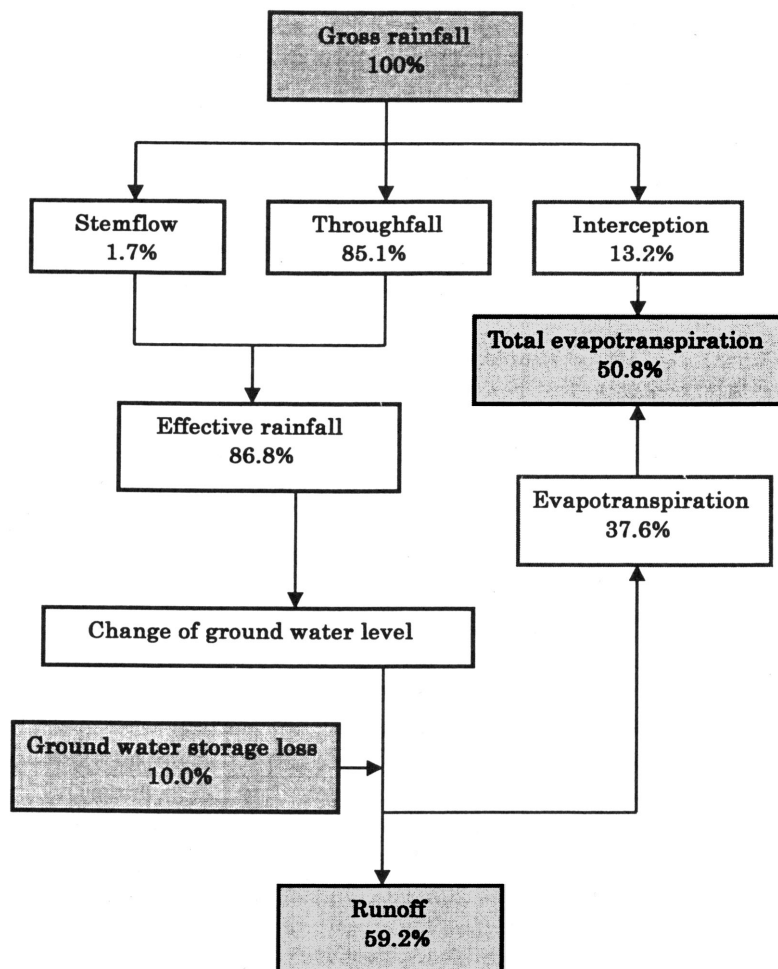

Fig. 7. Hydrological processes at Plot 1B in December 16, 1998 to February 7, 1999.

### References

- Asdak, C., Jarvis, P. G., Gardingen, P. van, and Fraser, A. 1998. Rainfall interception loss in unlogged and logged forest areas of Central Kalimantan, Indonesia. *Journal of Hydrology*, 206: 237-244.
- Farrington, P., Watson, G. D., Bartle, G. A. and Greenwood, E. A. N. 1990. Evaporation from dampland vegetation on a groundwater mound. *Journal of Hydrology*, 115: 65-75.
- Fujieda, M., Kudoh, T., Valdir de Cicco and de Calvarcho, J. L. 1997. Hydrological processes at two subtropical forest catchments: the Serra do Mar, Sao Paulo, Brazil. *Journal of Hydrology*, 196: 26-46.
- Holscher, D., T. D. de A. Sa, Bastos, T. X., Denich, M. and Folster, H. 1997. Evaporation from young secondary vegetation in eastern Amazon. *Journal of Hydrology*, 193: 293-305.
- Lloyd, C. R. 1988. Spatial variability of throughfall and stemflow measurements in Amazonian rainforest. *Agricultural and Forest Meteorology*, 42: 63-73.

- Rieley, J. O. and Page, S. E. (eds.) 1995. The ecology of environmental importance of the Peat Swamp Forest in the Sungai Sebangau catchment, Central Kalimantan, Indonesia. Report of the Kalimantan Peat Swamp Forest Research Project 1993-95. East Midland Environmental Consultants, Nottingham, UK.
- Takahashi, H., Yonetani, Y. and Miyasaka, H. 1997. Micrometeorological aspects of tropical peat swamp forest and farmland in Central Kalimantan, Indonesia. *Annual Report and Proceedings for International Workshop 6-9 August*.
- Umeda, Y. and Inoue, T. 1984. Ground water level and change of ground level in peatland. Agricultural Engineering Works Society of Japan, Hokkaido, Essentials, 33: 9-12.
- Umeda, Y., Shimizu, M. and Demura, M. 1985. Forming of Sarobetsu Peatland-Surface Forms on Peatland (II). *Journal of the Faculty of Agriculture Hokkaido University*, Vol. 15, Pt. 1: 28-35.

## **Polycyclic Aromatic Hydrocarbon (PAHs) in Central Kalimantan**

**Nori TANAKA, Siwat PONGPIAJUN, Shuniz TANAKA  
and Toshio IWAKUMA**

Graduate School of Environmental Earth Science, Hokkaido University,  
Sapporo, Japan

### **Abstract**

Little is known about the fate of PAHs such as pyrene (pyr) and benzo[a]pyrene (BaP), which are toxic and known as carcinogenic substances. They are emitted to the atmosphere by incomplete combustion of biomass and fossil fuels either as vapor or particulate matter. Previous laboratory studies revealed that enhanced apparent solubility of PAHs by association with humic acids (HAs). It suggests that humic substances (HSs) can promote mobility of PAHs in our environments. However, the study on PAH in our natural system is painfully little to evaluate the above speculation.

In this study, a novel analytical technique for analyzing PAH in natural water (cloud-point method) is applied for natural water analysis. This method allows pre-concentration of PAH and preservation by simple process on a research site. Then, the improved method was applied for the analysis in Central Kalimantan, Indonesia.

This study revealed PAHs distribution in tropical peat forest and allow to examine interaction of PAHs with HSs, pH, DOC, TOC, conductivity. The highest concentration of several nM of dissolved pyrene was found in Kahayan River water. The ground water has the lowest pyrene concentration as low as 10 pM. In southern part of Central Kalimantan, there is significant special variation in pyrene concentration and strong correlation of pyrene concentration to peat layer thickness was found.

The expected relation between HSs and PAHs was not found anywhere in Central Kalimantan natural water systems. No correlation between dissolved pyrene and DOC, TOC, pH and conductivity was apparent. Lastly, it is speculated that the most of pyrene in river and lake waters is not controlled by the association with HSs but it may be controlled by the particulate scavenging in the natural water system.

**Key words:** polycyclic aromatic hydrocarbon (PAHs), humic substances (HSs), Central Kalimantan, mobility

### **Introduction**

Polycyclic aromatic hydrocarbon (PAHs) is highly mutagenic and carcinogenic substances, which has four- and seven-benzene rings. The major sources are emission from burning biomass and fossil fuel combustion. After Einsenreich *et al.* (1981) and Poster and Baker (1996), PAHs can be scavenged easily by wet precipitation and then transferred in aquatic and soil environment. Soil as complex mixture of mineral and organic substances, it can be quite effective absorbent of PAHs. Therefore, it is believed that the most of PAHs can be trapped and immobile at the surface of soil. Humic substances (HSs) are widely distributed in our environment. The chemical nature of HSs was examined very intensively and found its ability to increase apparent water solubility of PAHs in water (Shinozuka *et al.*, 1987, 1991; Tanaka *et al.*, 1997). In this study, PAHs distribution in Central Kalimantan is surveyed and examined relation between PAHs and HSs in natural water system.

## Analytical Methods

### 1) PAHs in natural water

It is widely known that aqueous solution with certain surfactants exhibits the property of clear separation into two phases (Corti *et al.*, 1984). The surfactant-rich phase can concentrate certain water-insoluble chemical compounds such as PAHs.

#### *Cloud-Point pre-concentration*

Fifty ml of sample water was filtered through GF/C glass fiber filters and then, 5% of Triton X-114 surfactant solution was added into the water sample in a glass bottle. After vigorous shaking, the mixture was kept at 40°C for 5min. The mixture is separated into two aqueous phases. The about 48 ml of supernatant is removed from the bottle and subsequently added 3ml of acetonitrile.

#### *HPLC analysis*

PAHs in the acetonitrile solution is then analyzed with a high performance liquid chromatography with a fluorescence detector. The separation column for the study was GL-Science Intersil ODS-2 column. The used mobile phase for this analysis is the mixture of acetonitrile and water (75:25). The excitation wave length are 330 nm, 384nm and 384nm for pyrene, benzo[a]pyrene and benzo[ghi]pyrene, respectively. The detection wave lengths are 385 nm, 406 nm and 406 nm, respectively.

### 2) Humic acids in natural water

After the method recommended by Aji *et al.* (1998), humic acids concentration was determined. Fifty ml of water sample was filtered through 5A filter Paper (Toyo Roshi Co. Ltd.) and then 0.5 ml of 6M HCl and 1ml of 10% NH<sub>2</sub>OH-HCl are added. It is boiled for 5 minutes and then cooled at room temperature. The sample can be stored as is at this stage of the procedure. 0.5 M EDTA was added and subsequently adjusted pH to 10 by adding about 4 ml of 6M NH<sub>4</sub>OH. Finally, the total volume was adjusted to 50 ml. The absorption at 450nm was measured with a spectro-photometer.

### 3) TOC, DOC and TC analyses

By using Shimazu TOC-300 analyser, DOC, TOC and TC were analyzed. Unacidified and unfiltered sample was analyzed first for TC and then filtered unacidified and acidified sample was analyzed for TOC and DOC, respectively.

### 4) Water temperature, pH and DO

Water temperature and DO were measured in situ with a YSI Model 55 (Yellow Springs Instruments, USA). pH and specific conductivity were measured with a ES-14 (Horiba, Japan).

### 5) Sampling

From April 23 to May 13, 1999, Lake Tundai, Lake Sabuah and Lake Tahai were visited for sample collection. Water samples were collected by using a Niskin sampler from 3 to 4 water depths from the surface to the bottom of each lake. Those lakes are oxbow lakes and have several canals to the Kahayan River. Exchange of water between lake and river can be taking place more or less at each lake.

### Results and Discussion

In Table 1, pyrene concentrations in lakes and the Kahayan River waters are listed. Waters from the surface of canal and the Kahayan River have extremely high pyrene concentration as high as 1450 pM. In the Kahayan River, pyrene concentrations decreased toward river bottom while lakes have the minimum concentration at the middle water depth. Mean concentration of pyrene in lakes was 304 pM and the mean in the Kahayan River and the canal was 680 pM.

Table 1. The concentration of pyrene in natural waters

| Date   | Place           | Station | Depth, m | Pyrene, pM<br>(95% confidence limit) |
|--------|-----------------|---------|----------|--------------------------------------|
| 990506 | L. Takapan      | 1       | 0        | 209 ± 59                             |
| 990506 | L. Takapan      | 1       | 1        | 95 ± 61                              |
| 990506 | L. Takapan      | 1       | 2        | 77 ± 48                              |
| 990506 | L. Takapan      | 1       | 3        | 97 ± 64                              |
| 990506 | L. Takapan      | 1       | 5        | 141 ± 59                             |
| 990506 | L. Takapan      | 2       | 4        | 271 ± 53                             |
| 990506 | L. Takapan      | 3       | 5        | 132 ± 71                             |
| 990506 | L. Takapan      | 3       | 7        | 135 ± 62                             |
| 990506 | L. Takapan      | 4       | 5        | 142 ± 71                             |
| 990506 | L. Takapan      | 4       | 8        | 99 ± 65                              |
| 990508 | L. Sabuah       | 1       | 1        | 341 ± 145                            |
| 990508 | L. Sabuah       | 1       | 2        | 294 ± 133                            |
| 990508 | L. Sabuah       | 2       | 3        | 551 ± 134                            |
| 990508 | L. Sabuah       | 2       | 6        | 280 ± 109                            |
| 990508 | L. Sabuah       | 2       | 9        | 527 ± 108                            |
| 990508 | L. Sabuah       | 3       | 0        | 500 ± 101                            |
| 990508 | L. Sabuah       | 3       | 1        | 413 ± 108                            |
| 990508 | L. Sabuah       | 3       | 1.5      | 623 ± 103                            |
| 990508 | L. Sabuah       | 4       | 1        | 131 ± 65                             |
| 990508 | L. Sabuah       | 4       | 3        | 116 ± 83                             |
| 990508 | L. Sabuah       | 4       | 4        | 135 ± 91                             |
| 990510 | Canal in Garung | 3       | 0.5      | 1085 ± 131                           |
| 990510 | Canal in Garung | 3       | 1        | 1304 ± 95                            |
| 990510 | Kahayan R.      | 4       | 0        | 281 ± 131                            |
| 990510 | Kahayan R.      | 4       | 1        | 173 ± 101                            |
| 990510 | Kahayan R.      | 4       | 1.5      | 188 ± 123                            |
| 990510 | Kapuas R.       | 7       | 1        | 179 ± 70                             |
| 990510 | Kapuas R.       | 7       | 3        | 171 ± 87                             |
| 990512 | Kahayan R.      | 1       | 0        | 1447 ± 192                           |
| 990512 | Kahayan R.      | 1       | 3        | 781 ± 208                            |
| 990512 | Kahayan R.      | 1       | 6        | 485 ± 23                             |
| 990512 | Kahayan R.      | 2       | 0        | 1250 ± 181                           |
| 990512 | Kahayan R.      | 2       | 3        | 842 ± 269                            |
| 990512 | Kahayan R.      | 2       | 5        | 662 ± 100                            |
| 990513 | L. Tahai        | 2       | 0        | 666 ± 200                            |
| 990513 | L. Tahai        | 2       | 3        | 781 ± 170                            |
| 990513 | L. Tahai        | 2       | 5        | 539 ± 220                            |
| 990524 | L. Sunter       | 1       | 0        | 153 ± 110                            |
| 990524 | L. Sunter       | 1       | 2        | 270 ± 108                            |
| 990524 | L. Sunter       | 2       | 0        | 228 ± 58                             |
| 990524 | L. Sunter       | 2       | 2        | 117 ± 99                             |

In Table 2, water temperature, DO, pH, conductivity and redox potential were given. From water temperature profiles, weak stratification of lake water is identified in each lake. The water temperature of the Kahayan River was constant from the surface to the bottom, indicating strong vertical mixing. DO content in Lake Sabuah was as low as 0.07 ml/l in the bottom, suggesting anoxic condition in the bottom due to weak vertical mixing and strong microbial activities. Both lake and river waters are quite acidic. Observed pH values ranged 3.66 to 6.89. Vertical profiles of pH in observed lakes tend to have lower pH in the surface and it increases toward bottom. It is expected from the ground water input to those lakes, which is suggested from comparable oxygen isotope composition in the bottom layer of the lakes. Although there is substantial range in pH, certain correlation between PAHs and pH could not be found.

Table 2. Analytical results of natural waters in Central Kalimantan.

| Date   | Place           | Sample type | St. | Latitude<br>S | Longitude<br>E | Depth<br>m | W.T.<br>C | DO<br>mg/l | pH   | Conductivity<br>mS/m | ORP<br>mV | HA<br>ppm | TC<br>mmol C/l | DOC<br>mmol C/l | $\delta^{18}\text{O}$<br>‰ |
|--------|-----------------|-------------|-----|---------------|----------------|------------|-----------|------------|------|----------------------|-----------|-----------|----------------|-----------------|----------------------------|
| 990427 | L. Tundai       | lake water  | 1   | 2°12'30"      | 114°05'44"     | 0          | 30.6      | 1.95       | 5.00 | 3.70                 |           | 104       | 0.975          | 0.384           |                            |
| 990427 | L. Tundai       | lake water  | 1   | 2°12'30"      | 114°05'44"     | 0.5        | 30.6      | 1.05       | 5.14 | 2.83                 |           | 83        |                |                 |                            |
| 990427 | L. Tundai       | lake water  | 1   | 2°12'30"      | 114°05'44"     | 1          | 29.3      | 0.95       | 5.58 | 2.12                 |           | 69        |                |                 |                            |
| 990427 | L. Tundai       | lake water  | 1   | 2°12'30"      | 114°05'44"     | 1.5        | 29.0      | 0.82       | 5.82 | 1.87                 |           | 66        |                |                 | -8.543                     |
| 990427 | L. Tundai       | lake water  | 1   | 2°12'30"      | 114°05'44"     | 2          | 28.3      | 0.37       | 6.1  | 1.81                 |           | 50        | 0.743          | 0.368           | -8.644                     |
| 990427 | L. Tundai       | lake water  | 1   | 2°12'30"      | 114°05'44"     | 3          | 28.2      | 0.33       | 5.73 | 2.35                 |           | 55        | 0.795          | 0.403           | -8.591                     |
| 990427 | L. Tundai       | lake water  | 1   | 2°12'30"      | 114°05'44"     | 4          | 28.2      | 0.31       | 5.47 | 1.799                |           | 50        |                |                 |                            |
| 990427 | L. Tundai       | lake water  | 1   | 2°12'30"      | 114°05'44"     | 5          | 28.2      | 0.3        | 5.55 | 1.966                |           | 51        | 0.726          | 0.372           | -8.659                     |
| 990427 | L. Tundai       | lake water  | 1   | 2°12'30"      | 114°05'44"     | 6          | 28.1      | 0.27       | 6.43 | 1.727                |           | 32        | 0.547          | 0.227           | -8.65                      |
| 990427 | L. Tundai       | lake water  | 1   | 2°12'30"      | 114°05'44"     | 7          | 28.1      | 0.27       | 6.37 | 2.34                 |           | 35        | 0.581          | 0.259           | -8.596                     |
| 990427 | L. Tundai       | lake water  | 1   | 2°12'30"      | 114°05'44"     | 8          | 28.0      | 0.24       | 6.05 | 2.94                 |           | 48        | 0.699          | 0.384           | -8.65                      |
| 990427 | L. Tundai       | lake water  | 2   | 2°12'30"      | 114°05'44"     | 0          |           |            |      |                      |           |           |                | 0.529           | -8.205                     |
| 990427 | L. Tundai       | lake water  | 2   | 2°12'30"      | 114°05'44"     | 1.5        |           |            |      |                      |           |           |                |                 | -8.54                      |
| 990427 | L. Tundai       | lake water  | 2   | 2°12'30"      | 114°05'44"     | 3          |           |            |      |                      |           |           | 0.544          |                 | -8.549                     |
| 990427 | L. Tundai       | lake water  | 2   | 2°12'30"      | 114°05'44"     | 4          |           |            |      |                      |           |           |                |                 | -8.44                      |
| 990427 | L. Tundai       | lake water  | 2   | 2°12'30"      | 114°05'44"     | 6          |           |            |      |                      |           |           |                |                 | -8.557                     |
| 990427 | L. Tundai       | groundwater |     |               |                |            |           |            |      |                      |           |           |                |                 | -7.581                     |
| 990503 | Mentaya R.      | river water |     |               |                |            |           | 0          |      |                      |           |           | 0.388          |                 |                            |
| 990503 | Kangkiling      | groundwater |     | 1°58'20"      | 113°45'13"     |            | 28.9      |            | 5.27 | 2.17                 | 78        |           | 0.07           |                 | -7.821                     |
| 990503 | Kerangpangi     | groundwater |     | 1°53'24"      | 113°17'31"     | 7          | 29        |            | 4.63 | 1.91                 | 125       |           | 0.235          |                 | -6.339                     |
| 990503 | Dinas Perikanah | groundwater |     | 2°06'03"      | 112°55'26"     |            | 29.5      |            | 4.25 | 2.22                 | 143       |           | 0.243          |                 | -7.51                      |
| 990503 | Sala            | pond water  |     | 1°53'04"      | 113°24'07"     | 0          | 27.8      |            | 3.9  | 3.68                 | 159       |           | 1.345          | 1.03            |                            |
| 990503 | Hampangen       | pond water  |     | 1°53'23"      | 113°31'06"     | 0          | 28.2      |            | 4.86 | 3.02                 | 104       |           | 2.303          | 1.618           | -8.428                     |
| 990503 | Pundu           | groundwater |     | 1°58'18"      | 113°03'13"     | 0          | 27.3      |            | 5.13 | 8.11                 | 94        |           |                |                 | -7.617                     |
| 990503 | Katingan        | river water |     | 1°54'00"      | 113°22'25"     | 0          | 28.9      |            | 6.82 | 2.59                 | 1         |           | 0.399          |                 | -8.023                     |
| 990505 | Mentaya         | river water |     | 2°31'34"      | 112°57'32"     | 0          | 30.5      |            | 4.82 | 2.76                 | 111       |           |                |                 | -7.544                     |
| 990506 | L. Takapan      | lake water  | 1   | 2°08'26"      | 113°54'27"     | 0          | 29.1      | 1.29       | 4.51 | 1.571                | 131       | 50        | 0.701          |                 |                            |
| 990506 | L. Takapan      | lake water  | 1   | 2°08'26"      | 113°54'27"     | 1          | 27.6      | 0.55       | 4.55 | 1.55                 | 123       | 42        |                |                 | -8.211                     |
| 990506 | L. Takapan      | lake water  | 1   | 2°08'26"      | 113°54'27"     | 2          | 27.5      | 0.49       | 4.52 | 1.49                 | 120       | 43        |                |                 | -8.175                     |
| 990506 | L. Takapan      | lake water  | 1   | 2°08'26"      | 113°54'27"     | 3          | 27.5      | 0.49       | 4.58 | 1.481                | 119       | 39        | 0.686          | 0.36            | -8.236                     |
| 990506 | L. Takapan      | lake water  | 1   | 2°08'26"      | 113°54'27"     | 4          | 27.4      | 0.48       | 4.73 | 1.51                 | 114       | 45        | 0.709          |                 |                            |
| 990506 | L. Takapan      | lake water  | 1   | 2°08'26"      | 113°54'27"     | 5          | 27.4      | 0.48       | 4.84 | 1.48                 | 103       | 46        |                |                 | -8.174                     |
| 990506 | L. Takapan      | lake water  | 1   | 2°08'26"      | 113°54'27"     | 6          | 27.4      | 0.47       | 4.93 | 1.82                 | 101       |           |                |                 | -8.203                     |
| 990506 | L. Takapan      | lake water  | 2   | 2°08'20"      | 113°55'12"     | 0          | 28.3      | 3.34       | 5.51 | 1.65                 | 62        | 41        | 0.595          |                 | -8.427                     |
| 990506 | L. Takapan      | lake water  | 2   | 2°08'20"      | 113°55'12"     | 1          | 27.9      | 2.25       | 5.53 | 2.03                 | 64        | 37        | 0.593          | 0.356           | -8.33                      |
| 990506 | L. Takapan      | lake water  | 2   | 2°08'20"      | 113°55'12"     | 2          | 27.8      | 2.1        | 5.39 | 1.69                 | 71        |           |                |                 |                            |
| 990506 | L. Takapan      | lake water  | 2   | 2°08'20"      | 113°55'12"     | 3          | 27.8      | 2.04       | 5.39 | 1.678                | 72        |           |                |                 |                            |
| 990506 | L. Takapan      | lake water  | 2   | 2°08'20"      | 113°55'12"     | 4          | 27.8      | 2.1        | 5.65 | 1.687                | 57        |           |                |                 |                            |
| 990506 | L. Takapan      | lake water  | 3   | 2°08'28"      | 113°55'20"     | 0          | 29        | 0.95       | 5.22 | 1.521                | 82        | 39        |                |                 | -8.213                     |
| 990506 | L. Takapan      | lake water  | 3   | 2°08'28"      | 113°55'20"     | 1          | 28.2      | 0.52       | 5    | 1.818                | 95        |           |                |                 |                            |
| 990506 | L. Takapan      | lake water  | 3   | 2°08'28"      | 113°55'20"     | 5          | 27.7      | 0.54       | 5.11 | 2.1                  | 88        |           |                |                 |                            |
| 990506 | L. Takapan      | lake water  | 3   | 2°08'28"      | 113°55'20"     | 7          | 27.7      |            | 5.2  | 1.627                | 83        |           |                |                 |                            |
| 990506 | L. Takapan      | lake water  | 4   | 2°09'10"      | 113°54'29"     | 0          | 27.6      | 4.08       | 4.88 | 1.85                 | 98        | 37        |                | 0.544           | -8.228                     |
| 990506 | L. Takapan      | lake water  | 4   | 2°09'10"      | 113°54'29"     | 5          |           |            | 4.87 | 1.47                 | 101       |           | 0.667          | 0.419           | -8.309                     |
| 990506 | L. Takapan      | lake water  | 4   | 2°09'10"      | 113°54'29"     | 8          |           |            | 4.81 | 1.645                | 105       |           |                |                 | -8.234                     |
| 990508 | L. Sabuah       | lake water  | 1   | 2°02'14"      | 113°56'21"     | 0          | 31.4      | 2.86       | 5.85 | 3.3                  | 61        | 28        | 0.573          | 0.266           | -8.444                     |
| 990508 | L. Sabuah       | lake water  | 1   | 2°02'14"      | 113°56'21"     | 0.5        | 27.5      | 2.12       |      |                      |           | 30        | 0.571          | 0.298           | -8.535                     |
| 990508 | L. Sabuah       | lake water  | 1   | 2°02'14"      | 113°56'21"     | 1          | 27.2      | 1.8        | 5.6  | 2.84                 | 58        | 23        | 0.519          | 0.282           | -8.461                     |
| 990508 | L. Sabuah       | lake water  | 1   | 2°02'14"      | 113°56'21"     | 1.5        | 27        | 0.98       |      |                      |           | 35        | 0.586          | 0.255           | -8.421                     |
| 990508 | L. Sabuah       | lake water  | 1   | 2°02'14"      | 113°56'21"     | 2          | 26.9      | 0.46       | 5.59 | 2.93                 | 60        |           |                |                 |                            |
| 990508 | L. Sabuah       | lake water  | 1   | 2°02'14"      | 113°56'21"     | 2.5        | 26.8      | 0.21       |      |                      |           |           |                |                 |                            |
| 990508 | L. Sabuah       | lake water  | 1   | 2°02'14"      | 113°56'21"     | 3          | 26.7      | 0.12       | 5.78 | 4.93                 | 50        |           |                |                 |                            |
| 990508 | L. Sabuah       | lake water  | 1   | 2°02'14"      | 113°56'21"     | 3.5        | 26.6      | 0.14       |      |                      |           |           |                |                 |                            |

Table 2 (Continued)

| Date   | Place        |             | St. | Latitude<br>S | Longitude<br>E | Depth<br>m | W.T<br>C | DO<br>mg/l | pH   | Conductivity<br>mS/m | ORP<br>mV | HA<br>ppm | TC<br>mmol C/l | DOC<br>mmol C/l | $\delta^{18}\text{O}$<br>‰ |
|--------|--------------|-------------|-----|---------------|----------------|------------|----------|------------|------|----------------------|-----------|-----------|----------------|-----------------|----------------------------|
| 990508 | L. Sabuah    | lake water  | 1   | 2°02'14"      | 113°56'21"     | 4          | 26.5     | 0.15       | 5.76 | 3.7                  | 53        |           |                |                 |                            |
| 990508 | L. Sabuah    | lake water  | 2   | 2°03'23"      | 113°56'35"     | 0          | 31.2     | 4.14       | 5.9  | 2.76                 | 54        | 34        | 0.6            | 0.329           | -8.388                     |
| 990508 | L. Sabuah    | lake water  | 2   | 2°03'23"      | 113°56'35"     | 0.5        | 30.8     | 3.91       | 5.64 | 3.02                 | 58        | 29        | 0.559          | 0.341           | -8.459                     |
| 990508 | L. Sabuah    | lake water  | 2   | 2°03'23"      | 113°56'35"     | 1          | 27.6     | 1.74       | 5.7  | 2.28                 | 55        | 38        | 0.611          | 0.329           | -8.494                     |
| 990508 | L. Sabuah    | lake water  | 2   | 2°03'23"      | 113°56'35"     | 2          | 27.4     | 0.19       | 5.41 | 2.39                 | 71        | 37        | 0.669          | 0.38            | -8.442                     |
| 990508 | L. Sabuah    | lake water  | 2   | 2°03'23"      | 113°56'35"     | 3          | 26.9     | 0.11       | 5.51 | 4.4                  | 66        | 48        | 0.759          | 0.525           | -8.532                     |
| 990508 | L. Sabuah    | lake water  | 2   | 2°03'23"      | 113°56'35"     | 4          | 26.9     | 0.09       | 5.55 | 3.11                 | 64        |           |                |                 |                            |
| 990508 | L. Sabuah    | lake water  | 2   | 2°03'23"      | 113°56'35"     | 6          | 26.8     | 0.07       | 5.47 | 2.55                 | 64        |           |                |                 |                            |
| 990508 | L. Sabuah    | lake water  | 2   | 2°03'23"      | 113°56'35"     | 8          | 26.8     | 0.1        | 5.2  | 2.76                 | 83        |           |                |                 |                            |
| 990508 | L. Sabuah    | lake water  | 2   | 2°03'23"      | 113°56'35"     | 9          | 26.8     | 0.08       | 5.24 | 3.9                  | 79        |           |                |                 |                            |
| 990508 | L. Sabuah    | lake water  | 3   | 2°03'32"      | 113°55'53"     | 0          | 29.2     | 5.78       | 6.2  | 3.76                 | 43        | 32        | 0.401          | 0.188           | -8.667                     |
| 990508 | L. Sabuah    | lake water  | 3   | 2°03'32"      | 113°55'53"     | 1          | 27.5     | 5.41       | 6.17 | 3.08                 | 63        | 38        | 0.417          |                 | -8.74                      |
| 990508 | L. Sabuah    | lake water  | 3   | 2°03'32"      | 113°55'53"     | 1.5        | 27.4     | 5.37       | 6.13 | 2.8                  | 37        | 34        | 0.422          | 0.157           | -8.883                     |
| 990508 | L. Sabuah    | lake water  | 4   | 2°02'56"      | 113°55'36"     | 0          | 25       | 6.42       | 6.13 | 2.76                 | 5         | 32        | 0.429          |                 |                            |
| 990508 | L. Sabuah    | lake water  | 4   | 2°02'56"      | 113°55'36"     | 1          | 25       | 6.47       | 6.22 | 2.73                 | 35        |           | 0.437          | 0.145           | -8.815                     |
| 990508 | L. Sabuah    | lake water  | 4   | 2°02'56"      | 113°55'36"     | 3          | 25       |            | 6.24 | 2.37                 | 19        |           | 0.18           |                 | -8.839                     |
| 990508 | L. Sabuah    | lake water  | 4   | 2°02'56"      | 113°55'36"     | 4          | 25       |            | 6.22 | 2.57                 | 11        |           | 0.137          |                 | -8.853                     |
| 990510 | Nusa         | lake water  | 1   | 2°22'32"      | 114°08'33"     | 0.5        |          |            | 3.81 | 8.37                 | 165       |           | 2.264          |                 | -7.753                     |
| 990510 | Jabirren     | pond water  | 2   | 2°31'07"      | 114°11'14"     | 0          |          |            |      |                      |           |           | 0.758          | 0.49            | -8.484                     |
| 990510 | Jabirren     | groundwater | 2   | 2°31'07"      | 114°11'14"     | 4          |          |            |      |                      |           |           | 0.29           |                 | -8.366                     |
| 990510 | Garung       | river water | 3   | 2°38'09"      | 114°12'19"     | 0          |          |            | 3.68 | 9.36                 | 166       |           | 2.971          |                 | -7.333                     |
| 990510 | Garung       | river water | 3   | 2°38'09"      | 114°12'19"     | 0.5        |          |            | 3.78 | 7.88                 | 164       |           | 3.06           |                 | -7.327                     |
| 990510 | Garung       | river water | 3   | 2°38'09"      | 114°12'19"     | 1          |          |            | 3.66 | 8.11                 | 165       |           |                |                 |                            |
| 990510 | Garung       | river water | 4   | 2°40'22"      | 114°16'23"     | 0          |          |            | 5.61 | 1.733                | 57        |           | 0.595          | 0.274           | -8.294                     |
| 990510 | Garung       | river water | 4   | 2°40'22"      | 114°16'23"     | 1          |          |            | 5.68 | 2                    | 53        |           |                |                 |                            |
| 990510 | Garung       | river water | 4   | 2°40'22"      | 114°16'23"     | 2          |          |            | 5.72 | 1.82                 | 51        |           |                |                 |                            |
| 990510 | Pulang Pisau | pond water  | 5   | 2°47'15"      | 114°15'28"     | 0          |          |            |      |                      |           |           | 0.457          | 0.004           | -6.979                     |
| 990510 | Kapuas R.    | river water | 7   | 2°59'22"      | 114°22'06"     | 1          |          |            | 5.2  | 3.22                 | 78        |           | 0.489          |                 |                            |
| 990510 | Kapuas R.    | river water | 7   | 2°59'22"      | 114°22'06"     | 3          |          |            | 5.22 | 3.38                 | 81        |           | 0.521          | 0.298           | -8.534                     |
| 990510 | Kapuas R.    | river water | 7   | 2°59'22"      | 114°22'06"     | 5          |          |            | 4.83 | 3.22                 | 98        |           | 0.581          |                 | -8.495                     |
| 990512 | Kahayan R.   | river water | 1   | 2°11'29"      | 113°55'27"     | 0          | 27.2     | 4.53       | 5.21 | 2.58                 | 75        | 39        |                |                 | -9.124                     |
| 990512 | Kahayan R.   | river water | 1   | 2°11'29"      | 113°55'27"     | 1          | 27.2     | 4.58       | 5.4  | 1.813                | 72        | 39        |                |                 |                            |
| 990512 | Kahayan R.   | river water | 1   | 2°11'29"      | 113°55'27"     | 2          | 27.2     | 4.5        | 5.19 | 1.522                | 81        | 44        |                | 0.407           | -9.107                     |
| 990512 | Kahayan R.   | river water | 1   | 2°11'29"      | 113°55'27"     | 3          | 27.2     | 4.48       | 5.34 | 1.527                | 75        |           |                |                 |                            |
| 990512 | Kahayan R.   | river water | 1   | 2°11'29"      | 113°55'27"     | 4          | 27.2     | 4.36       | 5.48 | 1.492                | 76        |           |                |                 |                            |
| 990512 | Kahayan R.   | river water | 1   | 2°11'29"      | 113°55'27"     | 5          | 27.2     | 4.5        | 5.3  | 1.522                | 77        |           |                |                 |                            |
| 990512 | Kahayan R.   | river water | 1   | 2°11'29"      | 113°55'27"     | 6          | 27.2     | 4.59       | 5.31 | 1.517                | 76        |           |                |                 |                            |
| 990512 | Kahayan R.   | river water | 1   | 2°11'29"      | 113°55'27"     | 7          | 27.2     | 4.48       | 5.55 | 1.595                | 68        |           |                |                 |                            |
| 990512 | Kahayan R.   | river water | 2   | 2°06'01"      | 113°56'13"     | 0          | 27.2     | 5.72       | 6.31 | 1.9                  | 11        | 36        |                | 0.282           | -9.297                     |
| 990512 | Kahayan R.   | river water | 2   | 2°06'01"      | 113°56'13"     | 1          | 27.2     | 5.44       | 6.22 | 1.86                 | 15        | 42        |                |                 | -9.227                     |
| 990512 | Kahayan R.   | river water | 2   | 2°06'01"      | 113°56'13"     | 2          | 27.2     | 5.44       | 6.36 | 1.9                  | 22        | 46        |                |                 |                            |
| 990512 | Kahayan R.   | river water | 2   | 2°06'01"      | 113°56'13"     | 3          | 27.2     | 5.44       | 6.41 | 1.94                 | 24        |           |                |                 |                            |
| 990512 | Kahayan R.   | river water | 2   | 2°06'01"      | 113°56'13"     | 4          | 27.2     | 5.3        | 6.3  | 1.055                | 24        |           |                |                 |                            |
| 990512 | Kahayan R.   | river water | 2   | 2°06'01"      | 113°56'13"     | 5          | 27.2     | 5.32       | 6.25 | 2.62                 | 22        |           |                |                 |                            |
| 990513 | L. Tahai     | lake water  | 1   | 2°01'26"      | 113°46'34"     | 0          | 26.5     | 2.72       | 4.94 | 2.99                 | 103       | 37        | 0.612          |                 | -9.325                     |
| 990513 | L. Tahai     | lake water  | 1   | 2°01'26"      | 113°46'34"     | 1.5        | 26.4     | 2.48       |      |                      |           | 39        | 0.674          |                 |                            |
| 990513 | L. Tahai     | lake water  | 1   | 2°01'26"      | 113°46'34"     | 3          | 26.4     | 2.32       | 4.48 | 1.584                | 131       | 42        | 0.722          | 0.345           | -9.46                      |
| 990513 | L. Tahai     | lake water  | 1   | 2°01'26"      | 113°46'34"     | 5          | 26.4     | 2.46       | 4.85 | 0.784                | 115       |           |                |                 |                            |
| 990513 | L. Tahai     | lake water  | 2   | 2°01'16"      | 113°46'32"     | 0          | 29.2     | 3.87       | 4.8  | 1.528                | 99        | 38        | 0.592          |                 |                            |
| 990513 | L. Tahai     | lake water  | 2   | 2°01'16"      | 113°46'32"     | 3          | 26.5     | 2.61       | 4.64 | 1.679                | 114       | 36        | 0.587          |                 | -9.427                     |
| 990513 | L. Tahai     | lake water  | 2   | 2°01'16"      | 113°46'32"     | 5          | 26.5     | 2.62       | 4.68 | 1.654                | 113       | 55        | 0.662          |                 | -9.226                     |
| 990513 | L. Tahai     | lake water  | 3   | 1°56'12"      | 113°45'15"     | 0          | 26.3     | 2.85       | 4.61 | 1.582                | 117       |           | 0.632          |                 | 9.649                      |
| 990513 | L. Tahai     | lake water  | 3   | 1°56'12"      | 113°45'15"     | 3          | 26.2     | 2.65       | 4.6  | 1.724                | 117       | 40        | 0.693          |                 |                            |
| 990513 | L. Tahai     | lake water  | 3   | 1°56'12"      | 113°45'15"     | 5          | 26.2     | 2.66       | 4.62 | 1.702                | 116       | 37        | 0.7            |                 | -9.488                     |
| 990524 | L. Sunter    | lake water  | 1   | 6°08'31"      | 106°51'35"     | 0          | 30.5     |            | 6.43 | 0.879                | 91        |           | 2.047          | 0.192           | -4.806                     |
| 990524 | L. Sunter    | lake water  | 1   | 6°08'31"      | 106°51'35"     | 2          |          |            | 7.46 | 0.98                 | 252       |           | 1.953          | 0.188           | -4.904                     |
| 990524 | L. Sunter    | lake water  | 1   | 6°08'31"      | 106°51'35"     | 4          |          |            | 7.38 | 0.81                 | 253       |           | 1.903          | 0.18            | -4.869                     |
| 990524 | L. Sunter    | lake water  | 2   | 6°08'32"      | 106°51'26"     | 0          | 30.8     |            | 8.67 | 0.95                 | 36        |           | 2.113          | 0.259           | -4.84                      |
| 990524 | L. Sunter    | lake water  | 2   | 6°08'32"      | 106°51'26"     | 1          |          |            | 7.85 | 0.763                | 60        |           | 2.008          | 0.227           | -4.937                     |
| 990524 | L. Sunter    | lake water  | 2   | 6°08'32"      | 106°51'26"     | 2          |          |            | 7.72 | 0.99                 | -147      |           | 1.961          | 0.274           | -4.872                     |
| 990524 | L. Sunter    | lake water  | 2   | 6°08'32"      | 106°51'26"     | 3          |          |            | 7.46 | 0.99                 | -236      |           | 1.914          | 0.215           | -5.003                     |

In Table 3, pyrene concentration in the Kahayan River and in the other selected river in Europe are presented. It is obvious that the concentration range in the Kahayan River is the highest among them. The source of pyrene to the Kahayan River could be very intense and localized, because the highly elevated level of pyrene in the surface water and the spatial variability is also substantial.

Generally speaking, the observed concentration of pyrene in Central Kalimantan is



far less than its solubility in water, which is estimated three orders of magnitude higher than the highest observed value in this study. This clearly indicates that accumulation of pyrene does not occur in Central Kalimantan. The reason for that is whether input rate of pyrene is not enough to sustain high level of pyrene or there are some processes to reduce pyrene level such as particulate scavenging. The pyrene vs. humic acids showed no particular correlation (Fig. 1). This study, therefore, cannot identify enhancement in the solubility of pyrene in natural conditions.

Table 3. The concentration of pyrene in world river water

| Rivers             | Country   | Concentration [pM] | References               |
|--------------------|-----------|--------------------|--------------------------|
| Central Kalimantan | Indonesia | 97-1447            | This study               |
| Nitra River        | Slovakia  | 18                 | Aji <i>et al.</i> (1998) |
| Tormes River       | Spain     | 0.69               | Aji <i>et al.</i> (1998) |
| Seine River        | France    | 109                | Aji <i>et al.</i> (1998) |

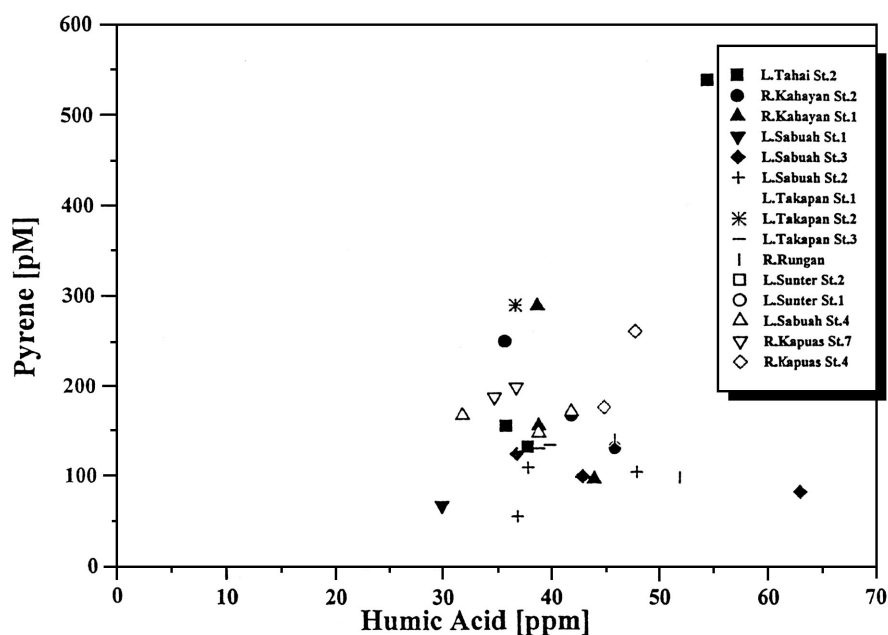

Fig. 1. Concentrations of humic acids and pyren in natural waters in Indonesia. Most water samples are taken in Central Kalimantan.

#### Acknowledgment

This research was made possible by many research staffs in Research and Development Center for Limnology, the Indonesian Institute of Sciences. Research staffs and graduate students of Palangka Raya University provided us unreserved assistance in laboratory and field expedition. Therefore, our appreciation is forwarded to their dedication and hopefully its privilege is continued.

### References

- Aji, H., Orima, M. and Kurashige, C. 1998. Study on polycyclic aromatic hydrocarbons measured by high performance liquid chromatograph. *Kankyou to Sokuteigijyutsu* 25(3): 17 (in Japanese).
- Corti, M. Minero, C. and Degiorgio, V. 1984. Cloud point transition in nonionic micellar solutions. *J. Phys. Chem.*, 88: 309.
- Einsenreich, S. J., Looney, B. B. and Thornton, J. D. 1981. Airborne organic contaminants in the Great Lakes ecosystem. *Environ. Sci. Technol.*, 15: 30.
- Poster, L. D. and Baker, J. T. 1996. Influence of submicron particles on hydrophobic organic contaminants in precipitation. 2. Scavenging of polycyclic aromatic hydrocarbon by rain. *Environ. Sci. Technol.*, 30: 349.
- Shinozuka, N., Lee, C. and Hayano, S. 1987. Solubilizing action of humic acid from marine sediment. *Sci. Total Environ.*, 62: 311.
- Shinozuka, N. and Lee, C. 1991. Aggregate formation of humic acids from marine sediments. *Marine Chemistry*, 33: 229.
- Tanaka, S., Oba, K. and Fukushima, M. 1997. Water solubility enhancement of pyrene in the presence of humic substances. *Anal. Chem Acta*, 337: 351.

## **River and Peatland Technology in the Sebangau River Basin**

**Tadaoki ITAKURA<sup>1</sup>, Harukuni TACHIBANA<sup>1</sup>, Hidenori TAKAHASHI<sup>2</sup>,  
Mitsuhiko KAMIYA<sup>3</sup>, Koken UTOZAWA<sup>3</sup>, Nyoman SUMAWIJAYA<sup>4</sup>,  
Inga TORANG<sup>5</sup>, Untung DARUNG<sup>5</sup>, Suwido H. LIMIN<sup>5</sup>  
and Suprihanto NOTODARMOJO<sup>6</sup>**

<sup>1</sup> Graduate School of Engineering, Hokkaido University, Sapporo, 060-8628 Japan,  
E-mail: itakura@eng.hokudai.ac.jp

<sup>2</sup> Graduate School of Environmental Earth Science, Hokkaido University, Sapporo,  
060-0810 Japan

<sup>3</sup> Hokkaido Institute of Technology, Sapporo, 006-0810 Japan

<sup>4</sup> Research and Development Center for Geotechnology, LIPI, Bandung, Indonesia

<sup>5</sup> University of Palangka Raya, Palangka Raya, Central Kalimantan, Indonesia

<sup>6</sup> Faculty of Civil Engineering, Bandung Institute of Technology, Bandung, Indonesia

### **Abstract**

Observation of the water stage and the discharge were carried out at Kya of the Sebangau River since August 1998. Runoff coefficient which is defined as the ratio, total amount of river flow/total amount of rain at the upper basin, was evaluated to be 0.31 for two months from Aug. 25 to Oct. 26, 1998.

The pH of the ground water in the peat land was low and the organic carbon existed at high concentration. The high concentration of phosphorus in the ground water of the Sebangau River basin was a distinctive feature of the woody peat land.

The number of the coliform group in the water of the Kahayan and the Sebangau Rivers were from 1,400 to 1,700. But the number was from 2,600 to 23,000 in the water at the Kerengbangkirai and Rambang Ports.

The coefficient of permeability in peat layer at Setia Alam, a marginal forest area decreased with depth and was  $8 \times 10^{-4}$  cm sec<sup>-1</sup> at the depth of 0.9 m and  $6.1 \times 10^{-4}$  cm sec<sup>-1</sup> at 1.6 m.

### **1. River hydraulics**

Observation of the water stage and the discharge were made at Kya of the Sebangau River. Fig. 1 shows a relationship between the water stage and the discharge at Kya. A tentative stage-discharge relationship (H-Q) can be described by Eq. (1).

$$Q=(1.7H+3.9)^2 \quad (1)$$

The discharge at Kya and the amount of daily rainfall at UNPAR are depicted in Fig. 2. The total amount of runoff,  $\Sigma Q'$  for 63 days (Aug. 25 – Oct. 26, 1998) was ;

$$\Sigma Q'=139.4 \times 10^6 \text{ m}^3$$

if the base flow was assumed to be  $10 \text{ m}^3 \text{ sec}^{-1}$ , the direct runoff,  $\Sigma Q$  was;

$$\Sigma Q=85.0 \times 10^6 \text{ m}^3$$

The total amount of rainfall,  $\Sigma R$  for the same 63 days at UNPAR was;

$$\Sigma R=460.5 \text{ mm}$$

If the drainage area at Kya of the Sebangau River,  $A$ , is assumed to be  $A=600 \text{ km}^2$ , and overall runoff coefficient,  $f$ , is evaluated as;

$$f = \frac{\sum Q}{A \sum R} = 0.31 \tag{2}$$

The runoff coefficient will be more in the rainy season. It is 0.4 – 0.9 in the Sarobetsu Mire in Hokkaido Japan. The lag of the discharge behind the rain fall is 1 –2 days.

A flood routing was performed for a runoff from Sep. 23, 1998 using a simple storage function method,

$$\frac{ds}{dt} = f \cdot r - q \tag{3}$$

$$S = kq^p \tag{4}$$

Table 1. The water stage and the discharge at Kya of the Sebangau River

| Date          | Stage<br>H (m) | Discharge<br>Q (m <sup>3</sup> /sec) | Remarks                |
|---------------|----------------|--------------------------------------|------------------------|
| Aug. 12, 1998 | 0.20           | 18.9                                 |                        |
| Sep. 20, "    | -0.05          | 14.3                                 |                        |
| Oct. 17, "    | 1.34           | 36.4                                 |                        |
| Dec. 18, "    | —              | 30.9                                 |                        |
| Jan. 17, 1999 | —              | 52.2                                 |                        |
| Feb. 26, "    | —              | 5.0                                  |                        |
| Mar. 23, "    | —              | 22.9                                 |                        |
| May 31, "     | —              | 17.8                                 |                        |
| Nov. 29, "    | 0.98           | 32.6                                 |                        |
| (Dec. 29, "   | 0.54           | 19.4)                                | cross section not sure |

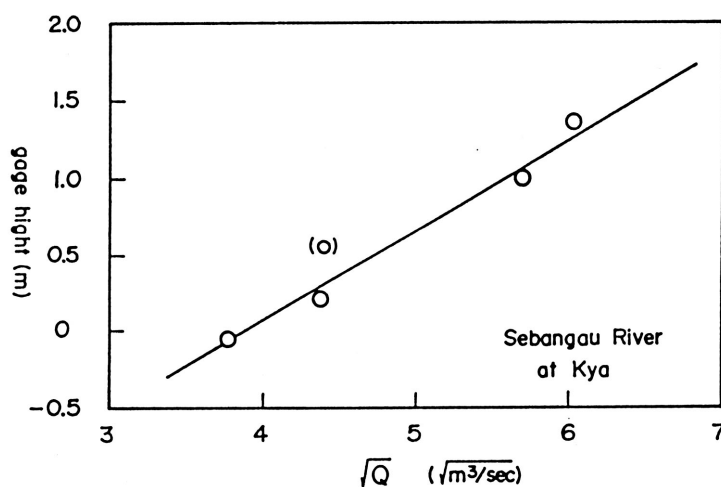

Fig.1. Relationship between water stage and discharge

Eq. (3) and Eq. (4) are the equation of continuity and the storage function, respectively. In which  $s$ : storage height of the basin,  $t$ : time,  $r$ : rainfall,  $q$ : discharge,  $f$ : runoff coefficient and  $k, p$ : coefficients.

Fig.3 shows the calculated discharges with several sets of coefficients compared to the observations. Although the observation of the decreasing stage of this particular runoff was not clear, a filtering effect seems to be predominate in this river basin and the runoff is highly non-linear.

The change of the bed of the river channel was observed at the cross section at Kya of the Sebangau River. The charge was 0.5 – 2.0 m during 2 months. But it is not sure that the change by the sediment transport or not. The change of the cross section is depicted in Fig.4.

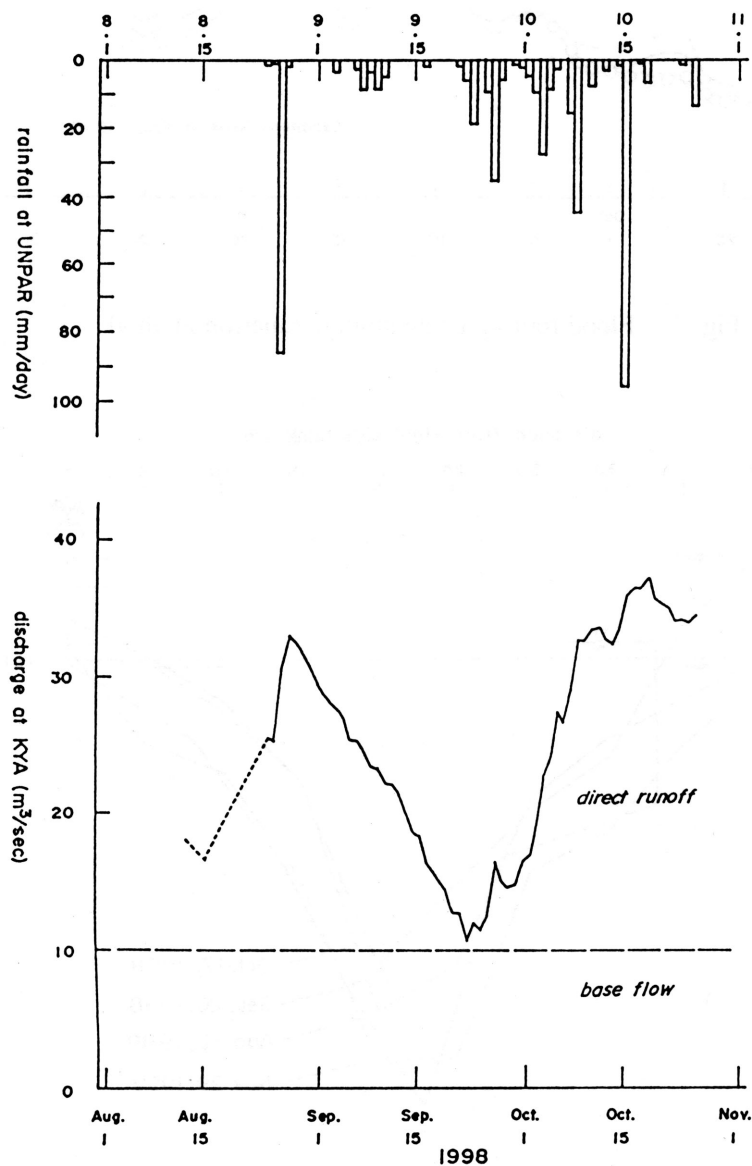

Fig. 2. Discharge and rainfall

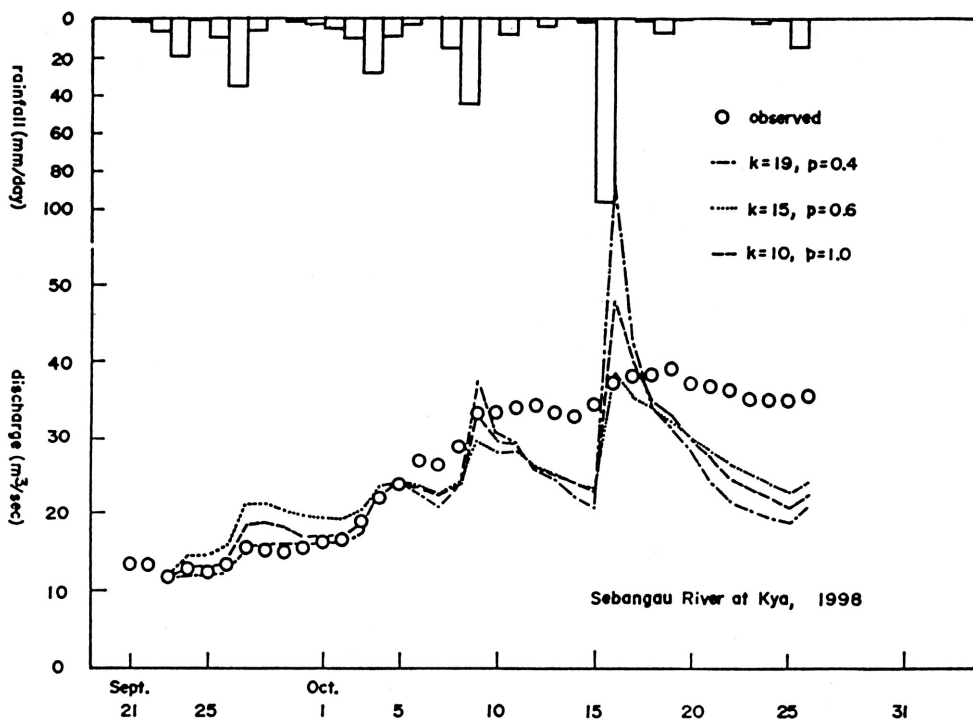

Fig. 3. Flood routing using storage function method

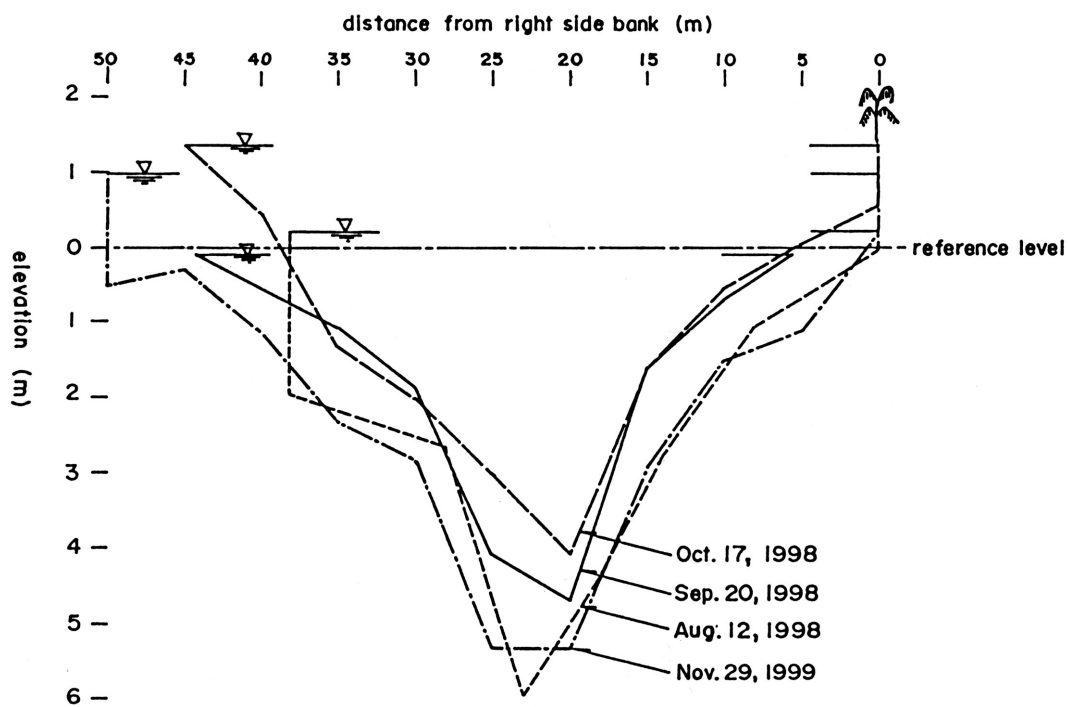

Fig. 4. Cross section at Kya

## 2. Quality of water

Observation of the quality of ground water and river water, and the characteristics of the peat were performed in the Sebangau River basin.

The pH of the ground water in the peat land was low and the organic carbon existed at high concentration. These characteristics are similar to that of the Sarobetsu Mire in Hokkaido, Japan.

On the other hand, the concentration of phosphorous of the ground water was higher in the Sebangau River basin and this is a distinctive feature of the woody peat land. The ground water of the peat land affects more the Sebangau River than the Kahayan River.

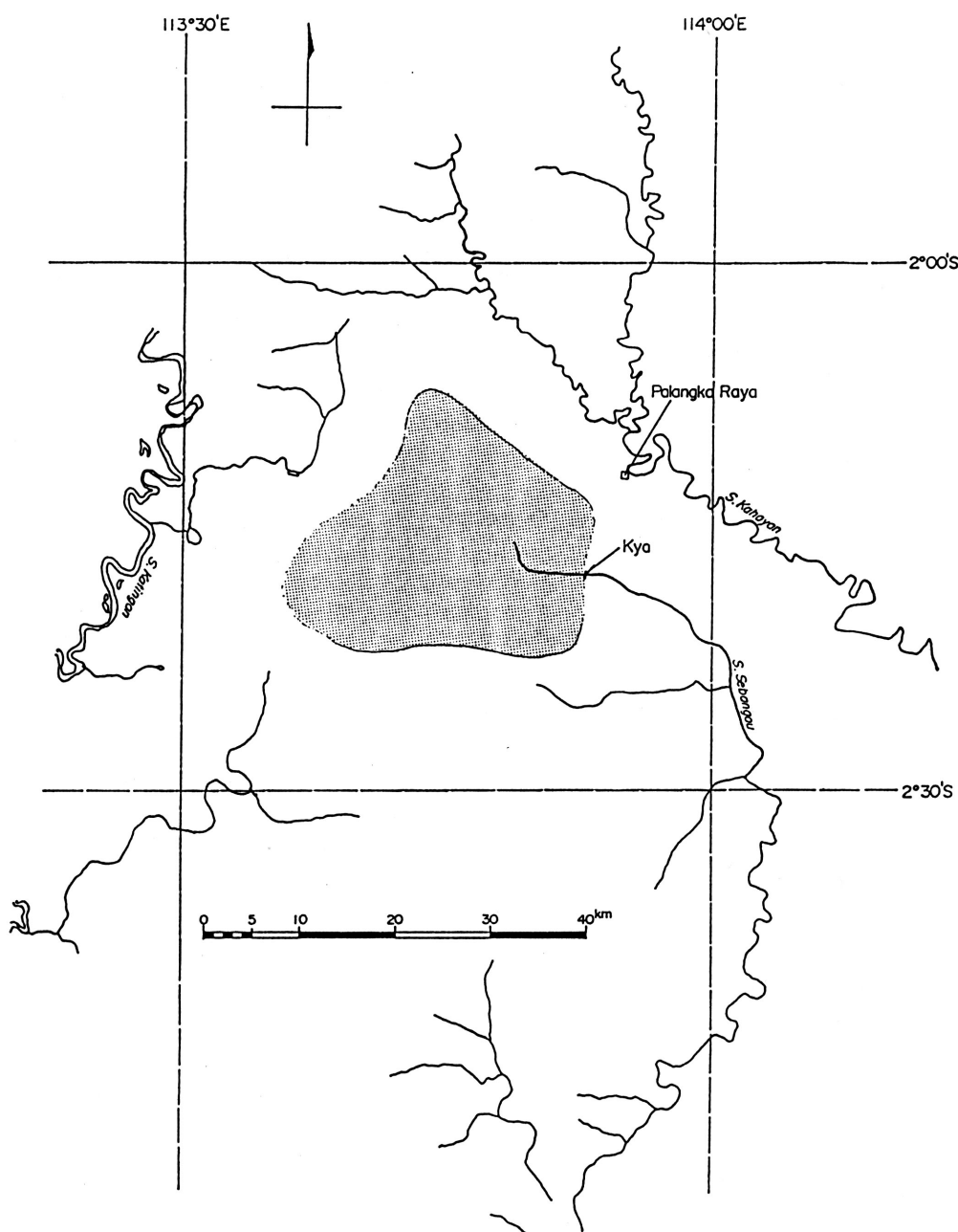

Fig. 5. Drainage basin of the Sebangau River at Kya. Drainage area = 600 km<sup>2</sup>

The water in the study area was less affected by the sea water for the concentration of the general inorganic components was low.

The C/N ratio of the peat soil existed in the ratio of 50 to 60, that is almost the same as the Sarobetsu Mire in Hokkaido, Japan.

### **3. Coliform Group in Ground Water and River Water**

The coliform group test which is one of the microbiological examination was carried out using simplified test paper. The results of the test were as follows;

- 1) The coliform group was hardly detected in the well water which was the ground water pumped up from a depth of 12 m.
- 2) The numbers of the coliform group in the water of the Kahayan River and the Sebangau River were within the range from 1,400 to 1,700 (average number of colonies/100 ml).
- 3) The number at the Kerengbankirai Port and Rambang Port were within the range from 2,600 to 23,000.

### **4. Physical Properties of Peat**

The field tests of peat were carried out at Setia Alam (not reclaimed land) and at Kalampangan (reclaimed land).

The ignition loss of Kalampangan, in which the content of mineral matter has increased due to the development of land use for farming, was lower than that obtained from Setia Alam. Due to the water drainage conducted at Kalampangan to prepare the land use for farming, the water content was also much lower at Kalampangan (about 20%) than at Setia Alam (more than 200%).

The coefficient of permeability at Setia Alam decreased with depth. It was  $8 \times 10^{-4}$  cm sec<sup>-1</sup> at the depth of 0.9 m and  $6.1 \times 10^{-4}$  cm sec<sup>-1</sup> at 1.6 m. These coefficients of permeability were large for the peat mire.

### **References**

- Itakura, T., Kuroki, M. and Mori, A. 1998. Erosion of bed rivers in peatland. In: *Proceedings of International Workshop on Environmental Conservation and Land Use management of Wetland Ecosystem in Southeast Asia*, pp.108-114.
- Tachibana, H., Nakamura, S., Saeki, H., Takahashi, H., Saito, H. and Minamide, M. 1999. Biological and chemical environment of Sarobetsu Mire affected by human activities. In: *Proceedings of the International Conference on Water, Environment, Ecology, Socio-economics and Health Engineering, Seoul National University*, pp. 368-378.
- Takahashi, H. and Yonetani, Y. 1995. Studies on microclimate and hydrology of peat swamp forest in Central Kalimantan. In: Rieley, J. O. and Page, S. E. (eds.), *Biodiversity and Sustainability of Tropical Peatland*, pp. 179-187.



## The Effects of Environmental Factors on Diurnal Changes of Ground Water Table in a Tropical Peat Swamp Forest

Hidenori TAKAHASHI<sup>1</sup>, Masayuki KAYAMA<sup>1</sup> and Suwido LIMIN<sup>2</sup>

<sup>1</sup> Graduate School of Environmental Earth Science, Hokkaido University  
Sapporo 060-0810, Japan, E-mail: htaka@ees.hokudai.ac.jp

<sup>2</sup> University of Palangka Raya, Central Kalimantan, Indonesia

### Abstract

Ground water level in a mire sometimes shows a step-like diurnal change with a large drop during daytime, which is mainly caused by evapotranspiration in the daytime. The change of ground water level usually include a component of gradual decrease with the seepage of ground water through a day. The components of seepage and evapotranspiration in the diurnal changes of ground water level were estimated from the long term record of ground water level in a peat swamp forest, the Sebangau River catchment, Central Kalimantan. The two data series of ground water level, June - October in 1997 and March - October in 1998 were used for this analysis.

The seepage rate in the forest were slightly changed from 5.6 to 1.3 mm day<sup>-1</sup> with depth of ground water table in 1998. But the seepage rate about 4.5 mm day<sup>-1</sup> in 1997 were larger than that in 1998, and have no big change with depth of ground water table. Surface flow in the forest also observed during rainy season in 1998. Decreasing rates of the water depth in the forest were changed from 25 to 12 mm day<sup>-1</sup> with depth of surface water.

The effective hourly deviation (EHD) of ground water level which was defined as the actual deviation of ground water level minus seepage component, was negative according to evapotranspiration in the daytime. The changes of the EHD during daytime followed roughly the changes of solar radiation with a lag of 1-2 h. The daily accumulated values of EHD have a good linear relation with daily total of solar radiation.

The EHD of ground water level became positive in early morning in some cases. The result indicates that ground water was supplied from the upper layer, the unsaturated subsurface and/or vegetation layers during night.

### Introduction

Ground water table in a tropical peat swamp forest is affected by several components of water balance in the forest, in and out flows, seepage, rain and evapotranspiration. The ratios of each component in a tropical peat swamp forest were studied by Kayama *et al.* (2000) in Central Kalimantan. Evapotranspiration from the peat swamp forest were estimated by the method using the diurnal change of ground water level (Takahashi *et al.*, 1997; Takahashi *et al.*, 1999, Kayama *et al.*, 2000), which was developed and applied by Umeda and Inoue (1985) for a boreal sphagnum peat swamp.

Diurnal pattern of changing ground water level was investigated by Godwin (1931) and a small rise of ground water level in the morning was found in a sphagnum peatland in England. Umeda and Inoue (1992) also studied on the phenomenon in a boreal sphagnum in Hokkaido Japan. They attributed the water flown from outside of the system. Tsuboya *et al.* (1997) studied about the phenomenon in relation to soil moisture behavior in a subsurface layer.

Takahashi *et al.* (1999) found the sap in vascular plants grown on the peatland flew downward during night and the change of ground water level coincided with it. They

estimated that the water which related to the small rise of ground water level in the mire amounted to 20% of daily evapotranspiration.

The purpose of this study is to make clear the diurnal changes of the effective ground water level with the effective hourly deviation of ground water level which was defined as the remains being removed the seepage component from actual hourly deviation.

### **Study Site and Methodology**

The tropical peat swamp forest selected for this study is situated in the NATURAL LABORATORY which was established in a forest on the upper catchment of River Sebangau, about 20 km from Palangka Raya. Observation point (Plot 1B) in the forest is located inside of designated “germ plasm” biodiversity conservation area in the marginal tall forest zone, 2 km from the river along the logging railway. The depth of peat near the plot is approximately 3 m (Rieley, 1997). The camp site is located at the edge of forest in the intermediate point between Plot 1B and the river.

Ground water levels at Plot 1B and Camp were measured with a pressure sensor (Druck Ltd, PDCR830) and a data logger (Kona System, Kadec-Mizu). Integrated solar radiation with 1 h interval were measured at the camp site and the climate observatory in the campus of University of Palangka Raya (UNPAR) with a solarimeter (Prede Co. Ltd., PC-100) and a data logger from September 1996 to September 1998. Precipitation was measured at the open area near Plot-1B with a tipping-bucket rain recorder and a data logger (Kona System, Kadec-PLS). Data from September 1997 to October 1999 were used for this analysis.

The seepage ratio of ground water level at the Plot 1B was estimated from a change of ground water level during night, 9 p.m. - 5 a.m., without rainfall. Effective hourly deviation (EHD) of ground water level was conducted from the remains of the actual hourly deviation of ground water level minus seepage ratio.

### **Results and Discussions**

#### ***General aspect of ground water level in a forest during the observation***

The annual pattern of rainfall in Central Kalimantan is determined by two main monsoon systems, a southeast dry monsoon and a northeast wet monsoon. Normally, the dry season start from July and finish in September in Central Kalimantan. But the El Nino event gives a large effect on the length and total amount of rainfall during the dry season. The dry season in 1997 was strongly affected by the large El Nino, which was one of the largest events in the 20th century. Rainfall became very few from the end of May and it continued until middle November in 1997 (Fig. 1). The total amount of rainfall from June to September was only 9.3 mm in 1997. It was quite small amount in comparison with 1092 mm of total rainfall from June to September 1998.

The ground water level during wet season in 1996/97 has kept in high condition, 10 - 20 cm above the ground surface. But the ground water level has started to lower with small amount of rainfall from June to September and reached to the lowest level, 98 cm below the ground surface on middle November, 1997. The ground water level has recovered with some amount of rainfall in November and December in 1997 but it was not so enough to keep it above the ground surface during wet season in 1997/98. The dry season in 1998 had so large amount of rainfall then ground water level fluctuated above and below the ground surface.

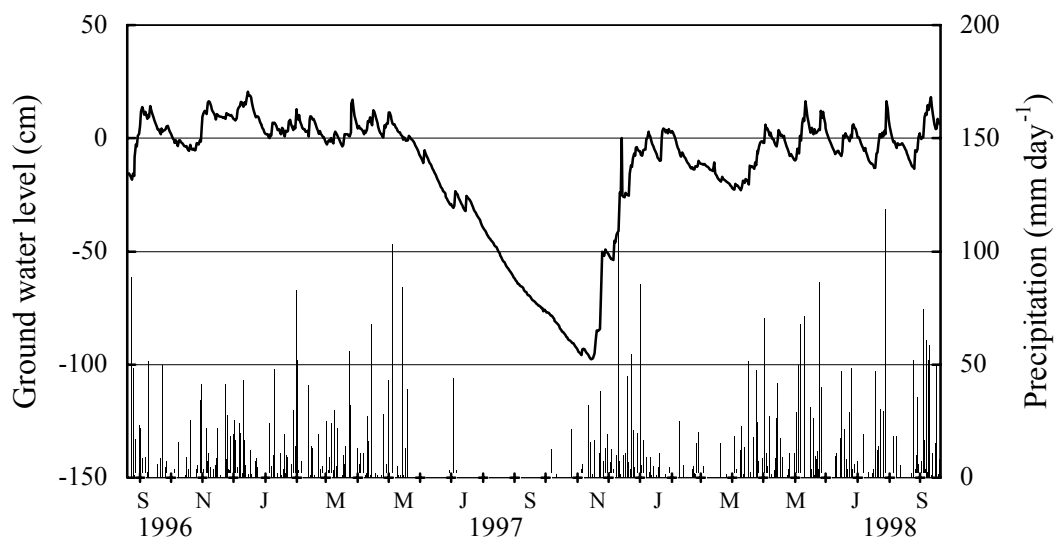

Fig. 1. Daily rainfall and ground water level change at Plot 1B during the observation.

#### ***Diurnal change of ground water level in a forest***

All hourly data of ground water level without rainfall from September in 1996 to September in 1998 were calculated as a deviation from the beginning of each day, 0 WIT (West Indonesian Time). The hourly deviation of ground water level from 0 WIT of each day was classified with the depth of ground water table into 7 layers, surface to 10 cm above the ground, surface to 10 cm below surface, 10 cm to 20 cm, 20 cm to 40 cm, 40 cm to 60 cm, 60 cm to 80 cm, and 80 to 100 cm below surface. The mean values of the deviation from 0 WIT were calculated and shown in Fig. 2.

The patterns of diurnal change of ground water level have some remarkable features with the flat period from 6 a.m. to 11 a.m., the sharp lowering from 11 a.m. to 6 p.m. and the gentle lowering from 6 p.m. to 5 a.m. of next morning. The seepage ratio which included the runoff and the real seepage to the deeper layer, were estimated from deviations of ground water level from 9 p.m. to 5 a.m. The seepage rates are different with the depth of ground water level, being very large above the ground and small below the ground as shown in Fig.3. The seepage rates between 10 cm to 30 cm of ground water level are different with the year of observation. The reasons of the difference are not clear but might be attributable to the dryness of the forest in 1997.

The seepage rates were changed during night. The seepage rates from 9 p.m. to 12 p.m. are larger than that from 1 a.m. to 5 a.m. (Fig.4). Some components should be considered for explanation of this phenomenon but could not make clear in this study. One possible reason of this phenomenon is loss of water has continued until midnight. And the other reason is water supply from upper layer start from very early morning.

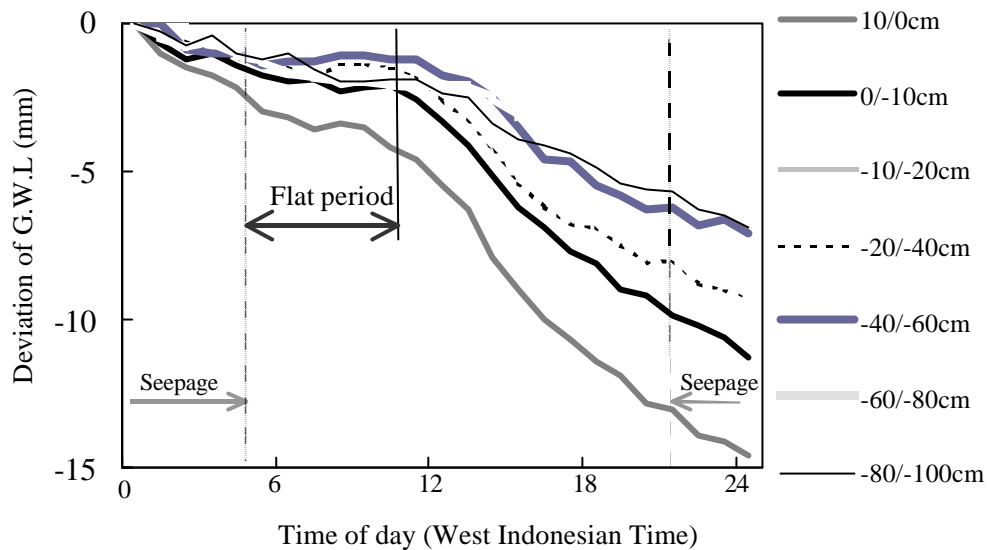

Fig. 2. Diurnal change of ground water level in different water level at Plot 1B.

#### ***Diurnal change of the effective hourly deviation of ground water level***

The effective hourly deviation (EHD) of ground water level defined as the actual deviation of ground water level minus seepage component. The seepage ratio calculated from the ground water level at 9 p.m. and 5 a.m. in the next morning were used in this analysis.

The diurnal changes of EHD of ground water level in Plot 1B show remarkable features with increasing, positive, of the EHD in ground water level from 3 a.m. to 11 a.m. at some levels of ground water table, 10 cm above the ground to ground surface, surface to 10 cm below the surface, 10 cm to 20 cm, 20 cm to 40 cm, 40 cm to 60 cm below the ground surface (Fig.5). And the decreasing of the EHD during daytime was also clear in these layer. But the daytime decreasing of EHD at the deeper level of ground water table such as 60 cm to 100 cm, are obscure because of weak solar radiation caused by dense haze in summer 1997 (Takahashi *et al.*, 1999).

The increase of the EHD of ground water level was observed in a boreal sphagnum mire, Hokkaido, Japan (Takahashi *et al.*, 1999). They found some simultaneous relationship between diurnal change of EHD of ground water and a sap flow in the vascular plants growing in the mire.

The tropical peat swamp forest also has such behavior in the EHD of ground water level. The decreasing, negative, in the EHD of ground water level were clearly caused by evapotranspiration from the forest in the daytime. But we could not find any reason for the increasing, becoming positive, in the EHD of ground water level. Some amount of water should be supplied from subsurface peat layer or plants, trees and grasses on the forest floor.

Diurnal changes of ground water table in a tropical peat swamp forest

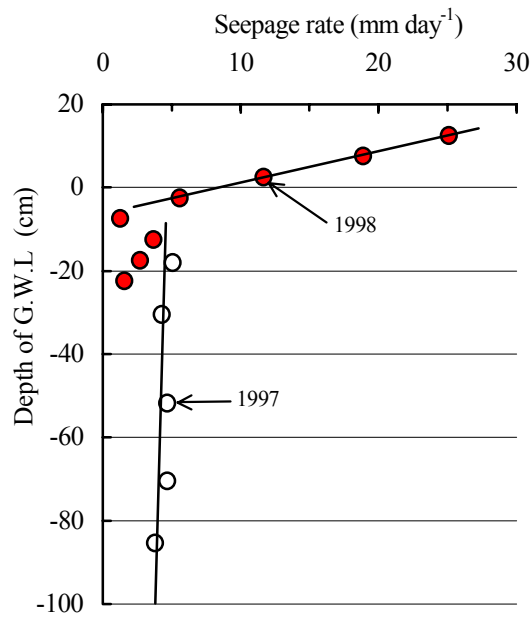

Fig. 3. Changes of seepage rate with ground water depth and year.

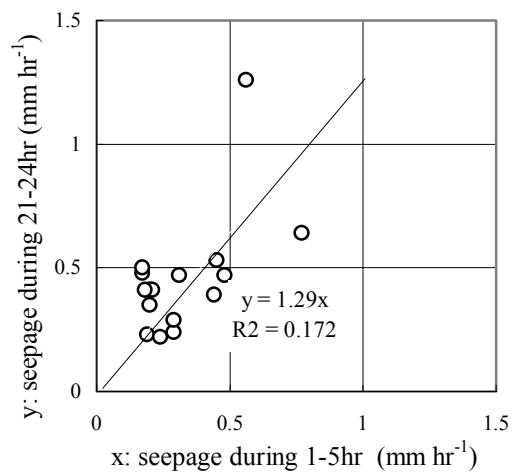

Fig. 4. Difference of seepage rate with time, 1-5 a.m. and 9-12 a.m.

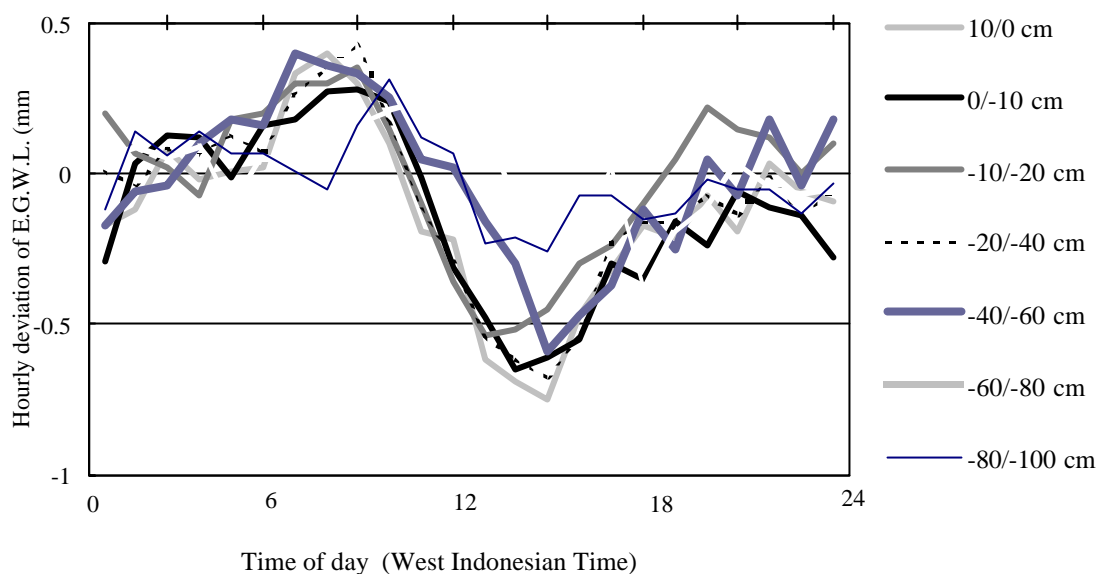

Fig. 5. Diurnal change of EHD of ground water level in different levels of ground water at Plot 1B.

Table 1. Daily total (mm) of minus and plus fraction in the diurnal change of E.G.L. in Plot 1B.

| Depth       | Plus | Minus | Plus/Minus |
|-------------|------|-------|------------|
| > 10 cm     | 2.57 | -7.26 | 0.35       |
| 10/0 cm     | 1.27 | -4.36 | 0.29       |
| 0/-10 cm    | 1.41 | -4.55 | 0.31       |
| -10/-20 cm  | 2.41 | -2.68 | 0.90       |
| -20/-40 cm  | 1.56 | -3.80 | 0.41       |
| -40/-60 cm  | 2.26 | -2.64 | 0.86       |
| -60/-100 cm | 0.99 | -1.40 | 0.71       |

Totals of daily minus deviation and plus deviation are calculated in each level of ground water and shown in Table 1. The ratios of the plus deviation against minus deviation are very large with a range from 0.29 to 0.90. The rate was 22% in a boreal sphagnum mire in Hokkaido Japan (Takahashi *et al.*, 1999). These values of the plus deviation are not so small that the more detail research are expected.

### Conclusions

A series of ground water level and rainfall in a tropical peat swamp forest was carried out at the NATURAL LABORATORY in Palangka Raya, Indonesia from September 1996 to September 1999. The effective hourly deviation (EHD) of ground water level was introduced to analyze the behavior of ground water movement in the forest. The results are concluded as follows,

1. The diurnal change of ground water table have remarkable feature with flat period in the morning, sharp lowering in the afternoon and gentle lowering during night.
2. The seepage rates which were calculated from the lowering ground water level between 9 p.m. to 5 a.m. next morning, changed largely with the depth of ground water level when the ground water level was higher than ground surface. But the rate did not changed largely when the ground water level was below the ground surface.
3. The EHD of ground water level have the plus deviation in the morning without rainfall. This phenomenon means some water supplied from upper layer of the ground water table.
4. The EHD of ground water level changed from plus to minus deviations around 11 a.m. according to evapotranspiration from the forest. This minus deviations are not clear when the ground water level was deeper than 60 cm from the ground surface, because solar radiation has become very small on these days.
5. The rate of the plus EHD of ground water level to the minus deviation were 30% to 90%. These values are not small to neglect them from the water balance in the forest.

#### References

- Kayama, M., Takahashi, H. and Limin, S. H. 2000. Water balance of a peat swamp forest in the upper catchment of Sebangau River, Central Kalimantan. In: *Proceedings of the International Symposium on Tropical Peatlands, Bogor, Indonesia, 22-24 November 1999*, pp. 299-306.
- Rieley, J. O., Page, P. E. and Limin, S. H. 1997. The peatland resource of Indonesia and the Kalimantan peat swamp forest research project. In: Rieley, J. O. and Page, S. (eds.), *Biodiversity and Sustainability of Tropical Peatland*, pp. 37-44.
- Takahashi, H. and Yonetani, M. 1997. Studies on microclimate and hydrology of peat swamp forest in Central Kalimantan, Indonesia. In: Rieley, J. O. and Page, S. (eds.), *Biodiversity and Sustainability of Tropical Peatland*, pp. 179-198.
- Takahashi, H., Ishihara T., Machimura, T. and Kurashige, Y. 1999. Effect of sap flow in plants on small rise of ground water level during night in a mire. *Abstracts for International Symposium on Chemical, Physical and Biological Process in Peat Soils*, pp. 55-56.
- Tsuboya, T., Takagi, K., Kurashige, Y. and Tase, M. 1997. Diurnal fluctuation in peat-water content in Saprobeta Mire, Hokkaido, Japan. *Jour. Japanese Association of Hydrological Sciences*, **27**: 129-141.
- Umeda, Y. and Inoue, T., 1985: The influence of evapotranspiration on the ground water able in peatland. *Jour. Faculty of Agriculture, Hokkaido University*, **62(2)**, 167-181.

## **Application of Remote Sensing and GIS to Monitor Peatland Multi-Temporal in Central Kalimantan**

**H.-D.V. BOEHM and F. SIEGERT**

Kalteng Consultants

Kirchstockacher Weg 2, 85635 Höhenkirchen near Munich, Germany  
Tel.: +49-8102-774848, Fax.: +49-8102-774850, Mobile: +49-170-3161199  
e-mail: viktorboehm@t-online.de; <http://www.rhc.at/kalteng>

### **Abstract**

The study area of this 180 km × 360 km sized project lays between the Java Sea and the Schwaner Mountains of Central Kalimantan with the Province Capital Palangkaraya in the center. The technologies of Remote Sensing (RS) and of a Geographical Information System (GIS) are applied for multi-temporal change detection of the biomass between 1991 and 1998 using the satellite images/data from LANDSAT TM5, ERS1 + 2, SPOT and NOAA-AVHRR. In this area the main tropical forest types are Peat Swamp Forest (PSF) near the flat coastal region stretching up to the north of Palangkaraya and Heath Forest in the north of Palangkaraya changing with Dipterocarp Forest in the higher altitudes up to the mountain region (Sieffermann *et al.*, 1988). The vegetation changes are processed for the time periods especially between 1991 and 1997 and between 1997 and 1998 with the huge fires in 1997 caused by the El Niño-Southern Oscillation (ENSO) event and man made fires.

The Government decided 1995 to convert Peatland into Paddy Fields by a one Million hectare project in the south of Palangkaraya. This project was unsuccessfully realised between 1996 and 1998 creating clear cuts and channels with more than 4000 km length into the PSF (Notohadiprawiro, 1998). The ecosystem was changed with the existing hydrology of the peatdomes and watersheds between the main rivers.

Several ground and aerial surveys (Boehm and Siegert, 1999) were performed for remote sensing verification between 1995 and 1999 using the tracks of a Global Positioning Sensor (GPS). By multi-temporal assessment of deforestation we found that the forest conversion between 1991 and 1997 was 16.3%, that equals to an average forest conversion rate of 2.7% per year. During the fire period the closed forest burned by 23.1% between May 1997 and March 1998 (LANDSAT TM analysis). It was found by the ERS analysis (images used before the fires until 10/97) that the burned area will be underestimated in the TM image by approx. 5.5%. This is because of the fast regrowth of vegetation (within 6 months, 10/97 and 3/98) in the area. A lot of Carbon was released during this period (Jaya *et al.* 2000, Page *et al.*, 2000).

The logging roads in the higher regions increased from 4419 km in 1991 to 6621 km in 1997 while the logging railways in the PSF changed from 7136 km in 1991 to 9406 km in 1997.

The main reasons of deforestation between 1991 and 1997 are:

- Logging operation, - Land clearing for small scale farming, and - Land clearing for plantations and between 1997 and 1998 the main reasons are: - Large scale land clearing for Mega rice project (MRP), - Man-made fires favoured by ENSO draught, and - Illegal logging operation. A professional EIA (Environmental Impact Assessment) study must be prepared for the new 2.8 Mha Kahayan, Kapuas, Barito (KaKaB) project before developing this additional area with its fragile soil.

### **Introduction**

Remote Sensing (RS) is a powerful tool to monitor the surface of the earth in different



spectral bands e.g. in the visible, in the infrared and the Radar-frequencies. The changes of the interesting areas can be easily detected over a time period. The Radar sensors in Satellites have the advantage to penetrate active the electro-magnetic rays through the clouds, while the passive optical sensors need a cloudfree or low cloud weather condition. Sensor-fusion increases the information level achieved by image processing.

For many projects a Geographical Information Systems (GIS) is used to store geocoded raster sensor data in different levels to show information's of tropical forests e.g. vegetation, soil, water bodies incl. hydrology, forest types, clear cuts, slash and burn, streets, rivers, channels, settlements, GPS-tracks, fires, animal habits, photos, video-clips etc.

In this presentation this tools are applied for tropical forest in Central Kalimantan where PSF grows in the wetlands north of the Java Sea. In that area a land-use conversion 1 Million ha (Mega)-Rice-Project (MRP) for rice cultivation including transmigration was started by the Indonesian government, in April 1996, with the digging of irrigation channels into the peat swamp. The development of an area of one million hectares in Central Kalimantan, situated between the Rivers Sebangau in the west, River Kahayan, River Kapuas and River Barito in the east and the Java Sea in the South was realised. The total area of impact is approx. 1.4 million ha for the Blocks A, B, C, D and E. The project faces hydrological problems of peat domes with a height up to 10m between the main rivers. Satellite-images of the heavy forest fires in autumn 1997 in Central Kalimantan have been processed too. During the 1997 ENSO event, the dry season spanned eight months from March to December, during which there was hardly any rainfall (Boehm, 1999; Boehm and Siegert, 1999; Siegert and Ruecker, 1999, Liew *et al.*, 2000, Siegert and Ruecker, 2000).

In the framework of the European Union project "Natural Resource Functions, Biodiversity and Sustainable Management of Tropical Peatlands" No.: ERB IC18-CT98-0260 and the TREES-project (Tropical Ecosystem Environment observation by Satellite): No. 14988-1999-05 F1EI ISP DE. this work is financed. Results will be presented of the MRP especially in the Dadahup area of Block A with processed LANDSAT TM, SPOT and ERS Radar images and aerial surveys in 1996, 1997, 1998 and 1999, as well as from several ground truth campaigns.

## **Materials and Methods**

### ***Data Processing***

Basic image processing was done using ENVI 3.2. Raw image files were imported into ENVI and bands 3, 4 and 5 were selected to produce a colour RGB image. Band assignment was 5,4,3 = RGB (red, green blue). Each channel was interactively contrast enhanced in a reference LANDSAT TM image (118-61, 1991) in order to maximise overall image contrast.

This band combination proved to be the best in this region. It allowed to separate more than 20 vegetation and land use classes. Using the result of a histogram analysis of the reference image the adjacent scene (LANDSAT TM 118-62, 1991) was adapted in contrast and colouring to the reference image. This procedure was applied to all LANDSAT TM scenes.

The two adjacent scenes were mosaiked using 15 ground control points in the overlapping image parts. Initially we used 4 BAKOSURTANAL map sheets (scale 1:50.000) for georeferencing. However the results were not convincing. Therefore we

used a set of more than 2000 GPS measurements (shp files) acquired during several ground and aerial surveys conducted in 1996, 1998 and 1999. GPS points were collected using the continuous track mode of the GPS acquiring measurements every 10s to 30s (aerial surveys) or 20s to 60s (ground surveys) (Fig. 1B).

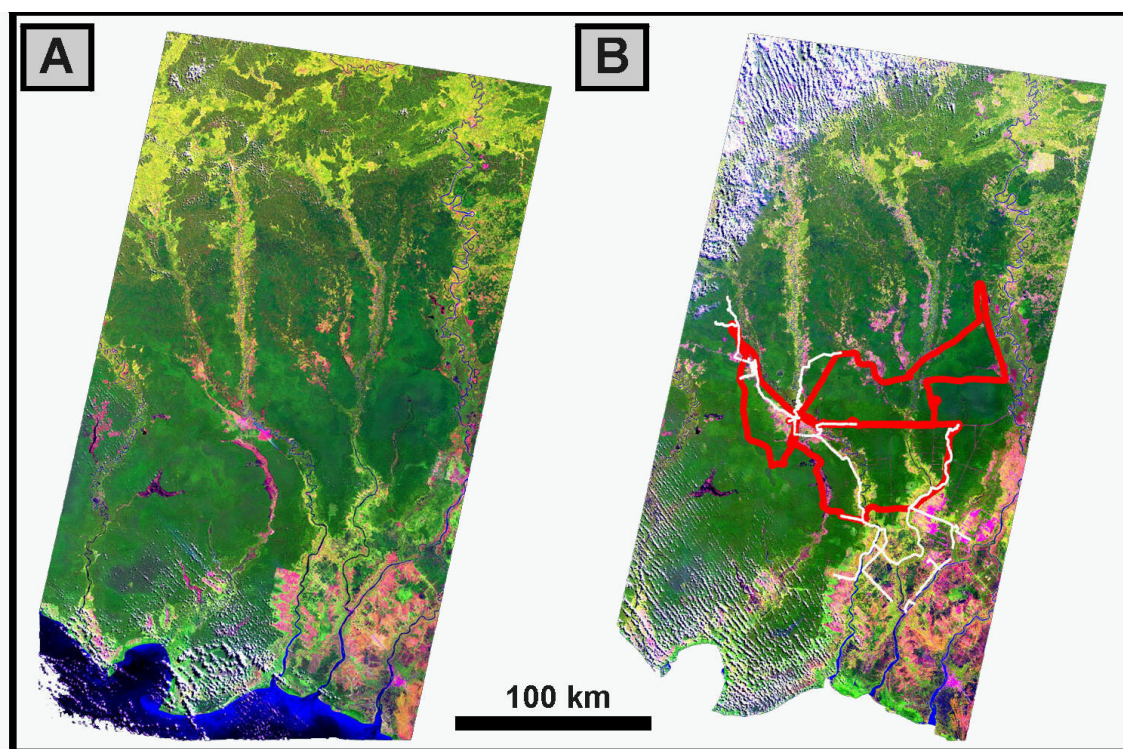

Fig. 1. Mosaiked TM images (118-61 and 62) of 30.6.1991 (A) and 29.5.1997(B). In (B) the GPS tracks of the 1998 ground (white) and aerial (red) surveys are shown. Peat swamp forests appear in dark green colours in the lower half of the image, heath forests in brownish colours, Dipterocarp forest in yellow-green in the northern area.

For georeferencing the enhanced, mosaiked LANDSAT TM reference image (118-62, 1991) was rotated by  $8.5^\circ$  clockwise before it was imported into ARCVIEW 3.2. In ARCVIEW the pixel size was set to 30 m. By using the ARCVIEW Image Scaler extension the image was then moved interactively into a position in which the GPS measurements matched unambiguous features like rivers, roads, channels etc. Thereby we achieved an accuracy of one pixel (30m) for most of the study area. The view was then projected as described in Table 1. The 1997 and 1998 LANDSAT TM scenes were registered to the reference image from 1991 in ENVI using 35 Ground Control points - GCP's (mean RMS smaller than 1).

### ***Test site description***

Indonesia has a large amount of tropical peat (between 17 and 27 Million ha), located mainly on the three islands Sumatra, Kalimantan and Irian Jaya (Anderson, 1983; Rieley and Page, 1995). Central Kalimantan contains about 3 Mha of peatland, which is

one of the largest joined tropical peatland areas world-wide. Approximately half of the study site (2 Mha) is covered by peatland that supports natural vegetation of peat swamp forest on top of peat that ranges from 0.5 m to more than 10 m thickness. Adjacent to the north there are large areas of heath forest, which grows on extremely nutrient poor siliceous soils. Further north typical lowland and hill Dipterocarp forest are found. Between 1991 and 1996 deforestation was related predominately to logging operations and land clearing along newly built roads.

Table 1. Map Information

|                                   |                   |           |
|-----------------------------------|-------------------|-----------|
| <b>Site</b>                       | 118-61 and 118-62 |           |
| <b>Geographic extent</b>          | lat (°N)          | long (°E) |
| TL                                | -0.57             | 113.73    |
| TR                                | -0.79             | 115.21    |
| BL                                | -3.10             | 113.18    |
| BR                                | -3.57             | 114.62    |
| <b>Map series used</b>            | not used          |           |
| <b>Projection type</b>            |                   |           |
| name                              | UTM               |           |
| ellipsoid *                       | GRS80             |           |
| datum                             | WGS84             |           |
| False easting                     | 500,000 m         |           |
| False northing                    | 0 m               |           |
| Zone                              | 49                |           |
| N or S                            | S                 |           |
| Central meridian                  |                   |           |
| Latitude of 1st standard parallel |                   |           |
| Latitude of 2nd standard parallel |                   |           |

This changed in 1996, when a programme of massive peatland conversion, the so-called Mega Rice Project (MRP) was initiated in Central Kalimantan with the aim of converting one million hectares of peatland to agricultural use. Between January 1996 and July 1998 over 4000 km of drainage and irrigation channels were constructed throughout the area designated for the MRP and forest clearance on this land was initiated. After removal of the commercial timber, the remaining tree debris was removed by means of fire as the cheapest, most readily available land clearance tool (Fig. 2). During the 1997 ENSO event, the dry season spanned eight months from March to December, during which there was hardly any rainfall. At the start of the dry season in 1997 fires were started in order to clear land. Many of these fires spread into forest areas where they burned with greater intensity.

The total area of impact is approx. 1.4 (exact 1,589,629 ha) million ha for the Blocks A: 314,311 ha; B: 161,282 ha; C: 449,172 ha; D: 144,684 ha, and E: 510,513 up to Buntok.

Palangkaraya has: 9,667 ha: The Pristine PSF between rivers Sebangau and Katingan in the East res. West and the Java Sea in the South and the villages Kasongan and Tangkiling in the North: 855,265 ha.

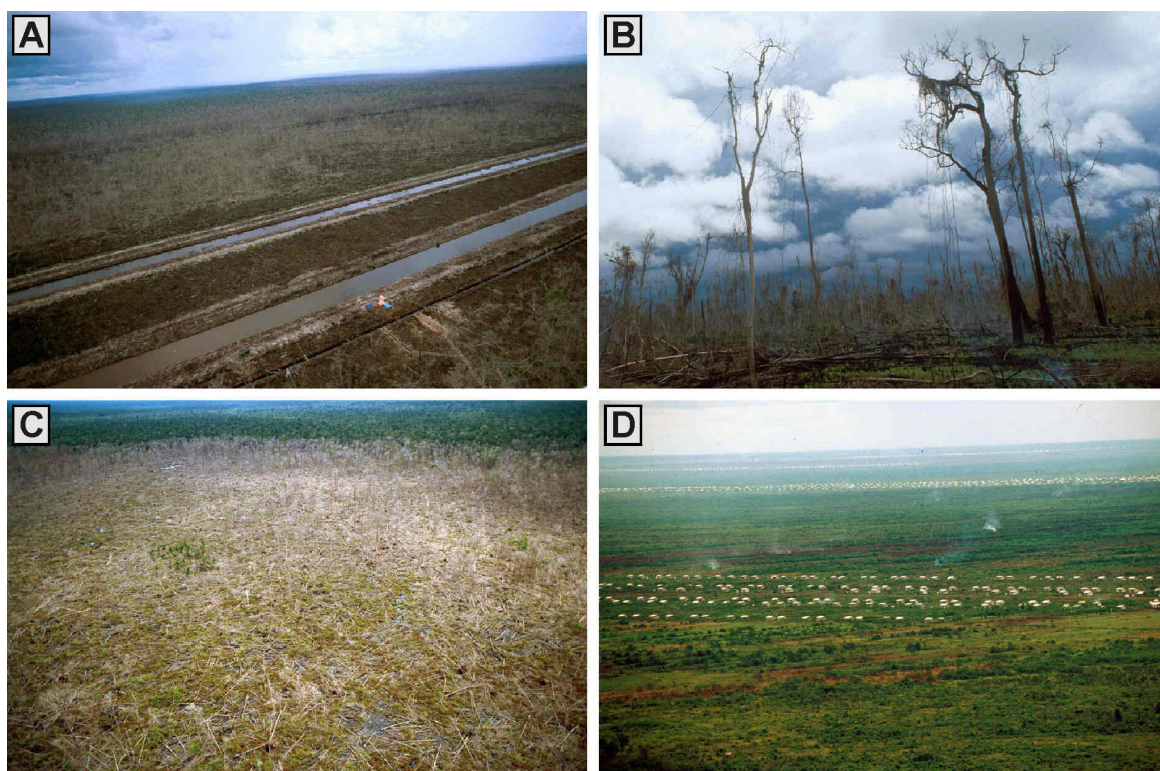

Fig. 2. Ground photographs of the study site in Central Kalimantan (A): Main irrigation canal near Palangkaraya. (B): Burned peat swamp forest. 100% of the biomass was killed by the fire, however substantial amounts of biomass remained unburned. (C): Aerial view of a burned scar. (D): Newly established Transmigration settlement on land cleared during the 1997 El Nino draught.

### ***Ground and aerial surveys***

Extensive ground surveys (see GPS tracks in ARCVIEW project) had been carried out prior to image interpretation in order to check land-use and vegetation (Boehm *et al.*, 1997; Notohadiprawiro, 1998). In the field we used a laptop computer in which the processed and georeferenced TM images (1991, 1997 and 1998) were stored. By connecting a GPS to the laptop we were able to ascertain our actual position in the georeferenced TM images at any time. Most importantly we were able to access specific areas which were ambiguous in the LANDSAT TM image. Post-fire ground-truthing was carried out both on foot and by low level aerial reconnaissance in April 1996, June and November 1998 and August 1999 to verify the existence and magnitude of burned scars.

### ***Classification procedure***

Image interpretation was done accordingly standard remote sensing procedures. The georeferenced image mosaics were visually interpreted on-screen using ARCVIEW 3.1. Interpretation was done at a resolution in order to comply with a final map scale of 1:100,000. Clouds, haze and non-overlapping areas were masked out. Area calculations were done with EXCEL 2000.



Classification of vegetation types was done according to ground knowledge. Table 2 shows how the classes were assigned to the TREES classification (Fig. 3).

Table 2. Classification of LANDSAT TM images

|                              |                         | Trees | Class No | Vegetation Land use          |
|------------------------------|-------------------------|-------|----------|------------------------------|
| <b>Natural forest</b>        | Closed                  | 1     | 7        | Medium peat                  |
|                              |                         |       | 8        | Low pole peat                |
|                              |                         |       | 9        | Tall peat                    |
|                              |                         |       | 13       | Heath forest                 |
|                              |                         |       | 16       | Dipterocarp                  |
|                              |                         |       | 20       | Heath peat forest            |
|                              |                         |       | 21       | Mangrove                     |
|                              | Open                    | 2     | 17       | Old logged dipterocarp       |
|                              |                         |       | 18       | New logged dipterocarp       |
|                              | Fragmented              | 3     | 3        | Freshwater swamp forest      |
|                              |                         |       | 10       | Degraded swamp forest        |
|                              |                         |       | 22       | Degraded mangrove            |
|                              | Undefined               | 4     |          |                              |
| <b>Plantations</b>           |                         | 5     | 24       | Agroforestry                 |
| <b>Forest regrowth</b>       |                         | 6     | 19       | Secondary forest             |
| <b>Non-forest vegetation</b> | Mosaics                 | 7     | 4        | Shifting cultivation         |
|                              |                         |       | 23       | Strongly degraded mangrove   |
|                              | Savannas and grasslands | 8     | 2        | Bushes, alang-alang          |
|                              |                         |       | 11       | Freshwater swamp (no forest) |
|                              |                         |       | 15       | Old fire scars               |
|                              | Agriculture             | 9     | 5        | Permanent farmland           |
| <b>Unvegetated</b>           |                         | 10    | 1        | Recent land clearance        |
| <b>Not visible</b>           |                         | 11    | 25       | Clouds                       |
| <b>No data</b>               |                         | 12    | 6        | Blackwater lake              |
|                              |                         |       | 12       | Water                        |
|                              |                         |       | 14       | Urban areas                  |

## Results and Discussion

### *Assessment of deforestation between 1991 and 1997*

Table 3 shows an overview of the changes, which occurred in a 6 years period between 1991 and 1997. The total area analysed was 5.1 Mha. Taken together 7% of the area were cloud covered (1991 and 1997).

The highest rate was observed for closed forest: 8.3% decrease over a period of 6 years. The second largest figure is a 4.4% increase of unvegetated areas, i.e. land clearing. There were also substantial decreases in open forest (-1.6%) and forest mosaics (-1.9%).

The overall forest conversion rate is obtained if all conversion processes which lead to forest degradation or conversion are summed up (also considering forest regrowth). The forest conversion between 1991 and 1997 was 16.3%, that equals to an average forest conversion rate of 2.7% per year.

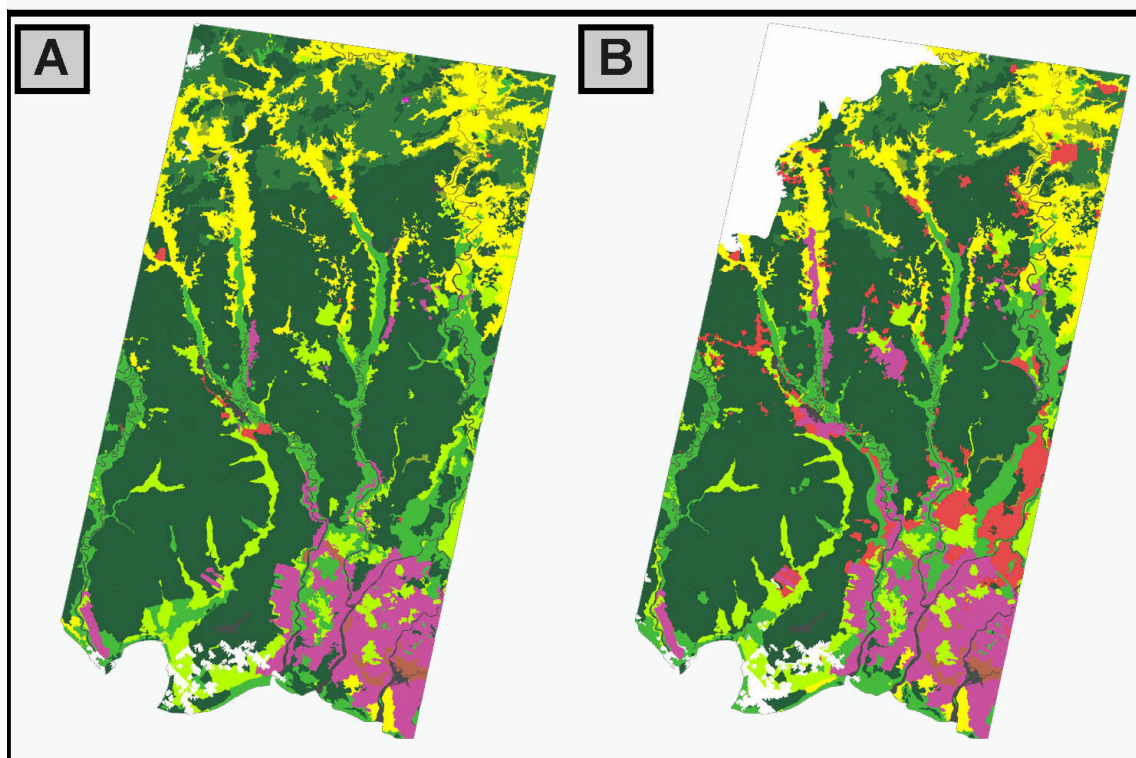

Fig. 3. Classification of the two TM mosaics of 1991 (A) and 1997(B). The colours indicate; dark green: closed forest; green: open, bright green: fragmented forests; brown-green: forest regrowth; yellow-green: grasslands; yellow: mosaics; red: unvegetated; purple: agriculture, brown: plantations; white: not visible in TM image.

Table 3. Overview of the changes between 1991 and 1997

| Class  | 1991, ha  | 1997, ha  | Change, ha | Change rate % |
|--|-----------|-----------|------------|---------------|
| Closed forest                                    | 2,659,921 | 2,231,239 | -428,682   | -8.3%         |
| Open forest                                      | 446,409   | 365,132   | -81,276    | -1.6%         |
| Fragmented forest                                | 515,773   | 494,471   | -21,303    | -0.4%         |
| Forest Undefined                                 | 0         | 0         | 0          | 0.0%          |
| Forest Plantation                                | 28,590    | 29,244    | 654        | 0.0%          |
| Forest regrowth                                  | 76,150    | 60,146    | -16,004    | -0.3%         |
| Mosaics  | 578,607   | 477,875   | -100,732   | -1.9%         |
| Grasslands, wood & shrub,<br>non forest regrowth | 381,959   | 354,900   | -27,059    | -0.5%         |
| Agriculture                                      | 349,305   | 408,606   | 59,301     | 1.1%          |
| Unvegetated                                      | 14,878    | 245,529   | 230,651    | 4.4%          |
| Not visible                                      | 59,912    | 441,829   | 381,917    | 7.4%          |
| No data  | 74,158    | 76,690    | 2,532      | 0.0%          |
| Total  | 5,185,661 | 5,185,661 | 0          | 0.0%          |

In order to be able to assess forest conversion processes in detail one has to know about the type of conversion. This becomes evident in the following change matrix (Table 4). For example closed forest was converted into unvegetated, open and fragmented forest and into grasslands.

Table 4. Change matrix 1991-1997.

| Scenc P/R                | 1997                       | Natural forest |           |                 |                | Planta-<br>tions | Forest | Non-forest vegetation        |          |                 | Unvege-<br>tated | Not<br>visible | No data | Total     |
|--------------------------|----------------------------|----------------|-----------|-----------------|----------------|------------------|--------|------------------------------|----------|-----------------|------------------|----------------|---------|-----------|
|                          |                            | Closed         | Open      | Frag-<br>mented | Unde-<br>fined |                  |        | Mosaics<br>and<br>grasslands | Savannas | Agricult<br>ure |                  |                |         |           |
| 1991                     |                            |                |           |                 |                |                  |        |                              |          |                 |                  |                |         |           |
| Natural Forest           | Closed                     | 2,209,789      | 60,190    | 69,960          | 0              | 0                | 1,258  | 8,564                        | 47,756   | 7,061           | 129,452          | 125,416        | 475     | 2,659,921 |
|                          | Open                       |                | 2 304,009 | 0               | 0              | 0                | 345    | 3,683                        | 109      | 0               | 13,160           | 124,943        | 156     | 446,409   |
|                          | Fragmented                 | 15,776         | 0         | 377,053         | 0              | 955              | 1,152  | 6,431                        | 31,896   | 19,406          | 57,139           | 5,218          | 748     | 515,773   |
|                          | Unidentified               | 0              | 0         | 0               | 0              | 0                | 0      | 0                            | 0        | 0               | 0                | 0              | 0       | 0         |
| Plantations              |                            | 0              | 0         | 0               | 0              | 28,050           | 0      | 0                            | 0        | 192             | 0                | 0              | 349     | 28,590    |
| Forest regrowth          |                            | 0              | 0         | 79              | 0              | 0                | 55,618 | 5,858                        | 0        | 432             | 3,121            | 10,922         | 119     | 76,150    |
| Non-forest<br>vegetation | Mosaics                    | 1,099          | 396       | 5,905           | 0              | 0                | 1,557  | 450,426                      | 3,293    | 4,446           | 8,441            | 102,254        | 791     | 578,607   |
|                          | Savannas and<br>grasslands | 2,695          | 0         | 38,335          | 0              | 0                | 215    | 1,347                        | 268,554  | 29,758          | 24,771           | 15,680         | 605     | 381,959   |
|                          | Agriculture                | 159            | 0         | 2,886           | 0              | 230              | 0      | 45                           | 282      | 341,112         | 3,743            | 0              | 846     | 349,305   |
| Unvegetated              |                            | 3              | 0         | 242             | 0              | 0                | 0      | 0                            | 3,008    | 5,738           | 5,395            | 490            | 1       | 14,878    |
| Not visible              |                            | 1,620          | 537       | 0               | 0              | 0                | 0      | 522                          | 0        | 442             | 307              | 56,078         | 407     | 59,912    |
| No data                  |                            | 96             | 0         | 10              | 0              | 10               | 0      | 999                          | 2        | 20              | 0                | 828            | 72,193  | 74,158    |
| Total                    |                            | 2,231,239      | 365,132   | 494,471         | 0              | 29,244           | 60,146 | 477,875                      | 354,900  | 408,606         | 245,529          | 441,829        | 76,690  | 5,185,661 |

### ***Assessment of deforestation between 1997 and 1998***

Major factor of deforestation between 1997 and 1998 were fires which destroyed large areas of forest and other vegetation types in Indonesia. At the start of the dry season in 1997 many fires were started in order to clear land of vegetation prior to planting crops and trees. Many of these fires spread into forest areas where they burned with greater intensity. In Central Kalimantan fires spread into peatland where both the surface vegetation and underlying peat were ignited.

To investigate the extent of the fire affected area and to assess affected vegetation types and fire impact we evaluated a LANDSAT TM scene acquired 6 months after the end of the fire season (Fig. 4). Using band combination 5,4,3 (RGB) fire scars were clearly visible in the LANDSAT TM image. Table 5 shows the results of this analysis.

As a comparison we used ERS-2 SAR images to assess the burned area (Boehm, 1999; Boehm and Siegert, 1999; Siegert and Ruecker, 1999, Liew et al., 2000, Siegert and Ruecker, 2000). It was found by the ERS analysis that the burned area will be underestimated in the LANDSAT TM image by approx. 5.5%. This is because of the fast regrowth of vegetation (within 6 months) in areas where already degraded vegetation types have been burned completely by the fires. Fig. 5B shows that substantial areas which have been burned as indicated by ERS-2 SAR (red-brown areas) and by NOAA-AVHRR hotspot data (Siegert and Hoffmann, 2000, provided by IFFM/GTZ, Samarinda) are not recognizable in the LANDSAT TM image (Fig. 5C).

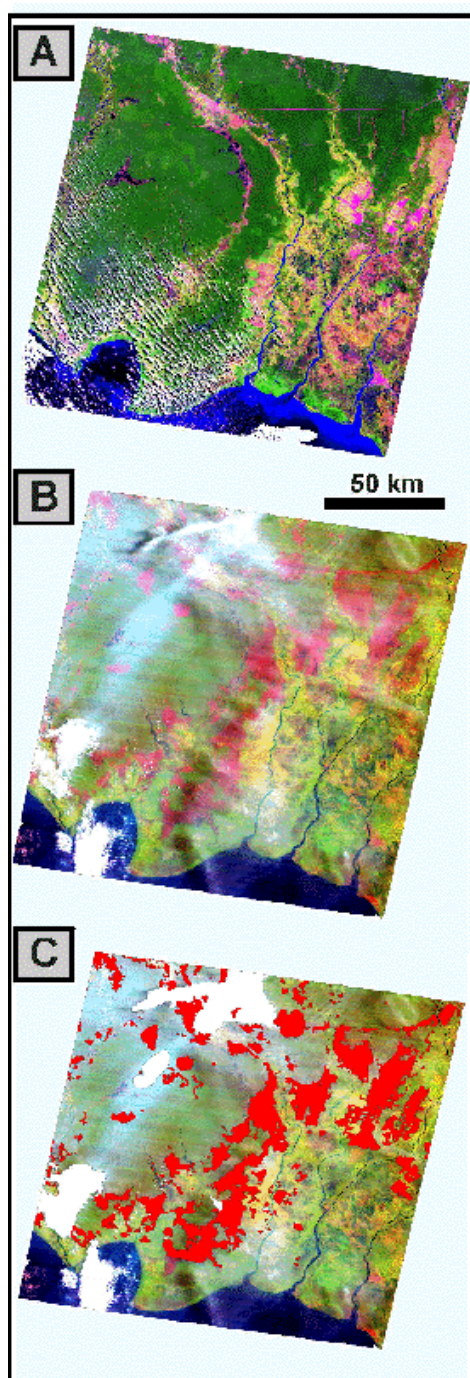

Fig. 4. LANDSAT TM image of 29 May 1997 (A) and 29 March 1998 (B). In (B) red colours indicate burned areas. (C) GIS layer of burned scars superimposed on TM image.

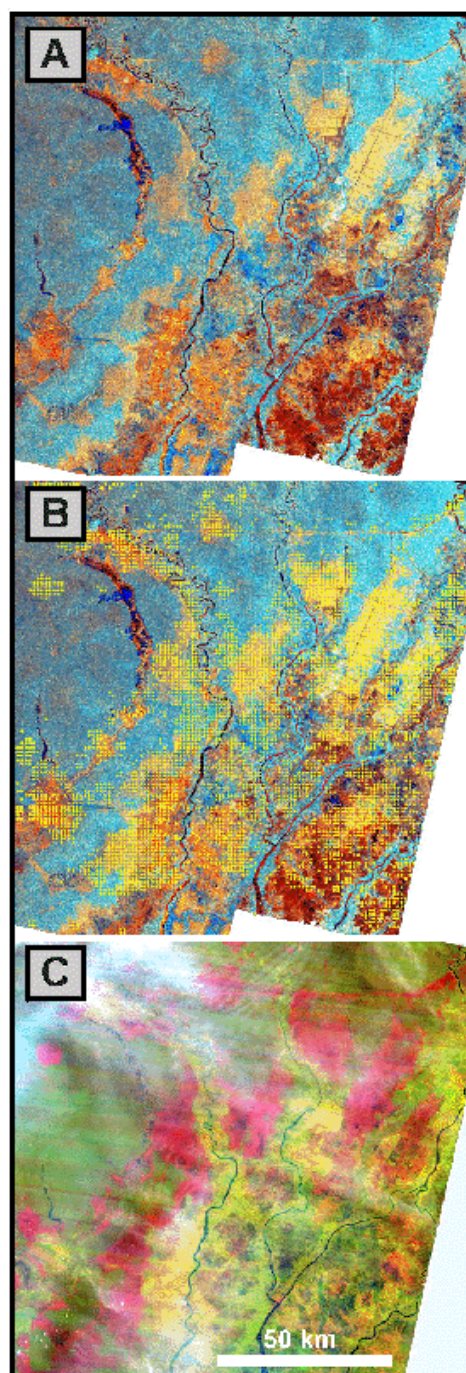

Fig. 5. (A) Multi-temporal ERS-2 mosaik of part of the study site before 1996/7 and after the fires 1997. Blue indicates unburned vegetation, orange to brown burned vegetation. (B) NOAA-AVHRR hotspots (yellow) acquired between August and October 1997 superimposed on multi-temporal ERS-2 mosaik. (C) Corresponding subset of the 29.3.1998 LANDSAT TM image. Note that substantial areas appear in green (unburned) although they have been burned as shown in (A and B).



Table 5. Burned areas and vegetation types processed by LANDSAT TM (118-62) analysis using the images from 5/1997 and 3/1998

| Trees class                                      | Clouds  |         |      | Burned area |      | Unburned area |       | Total area |     | Burned area |
|--|---------|---------|------|-------------|------|---------------|-------|------------|-----|-------------|
|  | ha      | ha      | %    | ha          | %    | ha            | %     | ha         | %   | %           |
| Closed forest                                    | 130,969 | 291,747 | 12.2 | 841,971     | 35.3 | 1,264,687     | 53.1  |            |     | 23.1        |
| Open forest                                      | 0       | 0       | 0.0  | 0           | 0.0  | 0             | 0.0   | 0          | 0.0 | 0.0         |
| Fragmented forest                                | 22,695  | 62,413  | 2.6  | 243,348     | 10.2 | 328,457       | 13.8  |            |     | 19.0        |
| Forest undefined                                 | 0       | 0       | 0.0  | 0           | 0.0  | 0             | 0.0   | 0          | 0.0 | 0.0         |
| Forest plantation                                | 0       | 1       | 0.0  | 13,222      | 0.6  | 13,222        | 0.6   |            |     | 0.0         |
| Forest regrowth                                  | 0       | 2,875   | 0.1  | 452         | 0.0  | 3,327         | 0.1   |            |     | 86.4        |
| Mosaics  | 237     | 450     | 0.0  | 715         | 0.0  | 1,402         | 0.1   |            |     | 32.1        |
| Grasslands, wood & shrub,<br>non forest regrowth | 8,927   | 47,793  | 2.0  | 182,062     | 7.6  | 238,782       | 10.0  |            |     | 20.0        |
| Agriculture                                      | 12,795  | 10,511  | 0.4  | 272,142     | 11.4 | 295,448       | 12.4  |            |     | 3.6         |
| Unvegetated                                      | 4,996   | 54,190  | 2.3  | 105,330     | 4.4  | 164,516       | 6.9   |            |     | 32.9        |
| Not visible                                      | 1,281   | 10,071  | 0.4  | 15,604      | 0.7  | 26,956        | 1.1   |            |     | 37.4        |
| No data  | 6,309   | 4,476   | 0.2  | 35,507      | 1.5  | 46,292        | 1.9   |            |     | 9.7         |
| Sum  | 188,210 | 484,526 | 20.3 | 1,710,353   | 71.8 | 2,383,089     | 100.0 |            |     | 20.3        |

### ***Logging roads and railways***

Fig. 6A shows the logging roads into the dry soil of heath forests and Dipterocarp forests in black for 1991 and in red for 1997. In the same Fig. 6A the logging rails into the PSF are shown in dark blue colour for 1991 res. blue for 1997, compare Table 6.

Fig. 6B has the same colours for the logging roads and logging rails as in fig. 6A, but here they are superimposed with the forest classification (dark green: tall peat swamp forest, green: medium peat swamp forest and bright green: low pole peat swamp forest, blue-green: logged over and intact heath forest, dark blue-green: logged over and intact Dipterocarp forest). As can be seen logging roads and railways were only established in valuable forest types (not in heath and low pole forest). The road network is especially dense in Dipterocarp forests.

Table 6. Change Detection of Logging roads and Logging railways between 1991 and 1997 of the study site.

|                       |         |                        |         |
|-----------------------|---------|------------------------|---------|
| Logging roads 1991    | 4419 km | Logging roads 1997:    | 6621 km |
| Logging railways 1991 | 7136 km | Logging railways 1997: | 9406 km |

### ***Causes for deforestation***

Satellite images from 1998 compared to those from 1997 and 1991 show quick conversion of Peat Swamp Forest areas into land use regions, some of which are left uncultivated. Roads and a system of irrigation channels with a total length of more than 4000km give loggers unprecedented access to cut every tree. After commercially viable trees have been cut, smaller ones of a diameter of 10 – 20 cm are not spared. Selective logging, although required by government law, is hardly observed. Countless floats transport timber over black-water lakes and along channels and rivers. Huge areas of ecologically damaged peat-landscape are visible from the air.

Draught and/or low water-table cause trees to die. Frequent fires give forests no time to recover and the tropical climate causes quick overgrowth by ferns and alang-alang etc. Most of the Kalteng fires in 1997/1998 were man-made. Huge amounts of stored carbon were released into the atmosphere. Peatland destruction is an irreversible process.

Between 1991 and 1997:

- Logging operation
- Land clearing for small scale farming
- Land clearing for plantations

Between 1997 and 1998:

- Large scale land clearing for Mega rice project (MRP)
- Man-made fires favoured by ENSO draught
- Illegal logging operation

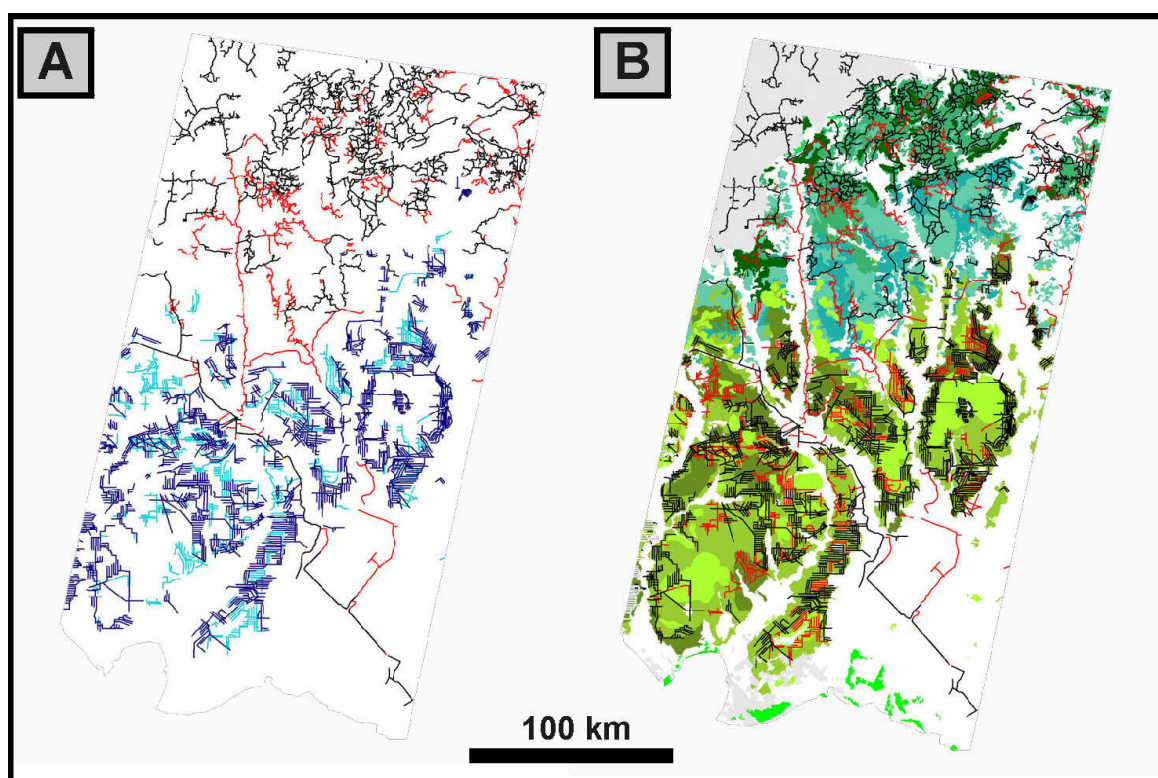

Fig. 6. A: Logging roads (black: 1991, red: 1997) and logging railways (dark blue: 1991, blue: 1997). B: Logging roads and logging railways superimposed on forest classification (dark green: tall peat swamp forest, green: medium peat swamp forest and bright green: low pole peat swamp forest, blue-green: logged over and intact heath forest, dark blue-green: logged over and intact Dipterocarp forest).

Fig. 7 shows a new geocoded SPOT image (41 km × 46 km) taken on 19 June 1999 from Block A of the MRP at Dadahup with the rivers Barito (green) and Mengkatip (black). The regrowth is ongoing between the new channels (light red colour) after the clear cuts and fires in 1997. Farmers observe new threats. Many mice are eating amounts of the rice. The SPOT image resolution is with 20 m per pixel high. Even houses and smaller channels can be made visible. The clouds are in white and the shadows in black colours. Below the splitting of rivers Barito and Kapuas Murung lies the island Pulau Petak that was developed some years before. On the right side of Barito also channels drain farmlands.

Fig. 8 shows a vegetation map from nearly the whole Block A based on the LANDSAT TM image from 1991. It includes the Lamunti and Dadahup region. The colours indicate different types of PSF, of bushlands and cultivated areas. The legend is: dark pink - clearings; light pink - shifting cultivation and farmland; pink - old fire scars; ochre - riverine ecosystem; green - medium PSF, blue green - low pole PSF; dark green - tall PSF; light blue - degraded swamp forest; purple - wetlands; light green - secondary PSF.

A digitised soil map is presented in Fig. 9 from the upper part of Block A. The soil map indicating the thickness of peat for Block A (digitised from Peta Penelitian Tanah dan Agroclimat). There is a clear correlation between peat thickness and agricultural activities, see figure 8 and ref. Jaya, 2000). Till 1997 there were no land clearings or shifting cultivation on thick peat. The peat thickness starts with 0 m at the rivers and reaches in the upper part up to 10 m and 12 m.

Tidal influenced areas in the south have a different soil content, e.g. pyrite (FeS<sub>2</sub>) (Purnomo, approx. 1990). Peaty soil contains a little bit of peat material. In the lower part of the figure 9 the tidal influences the irrigation and drainage channels to water the paddy fields near the Java Sea. Reclamation of tidal swamp area with acid sulphate soil is well known since many years. Short channels (handils) were dug by the Banjars, which are approx. 4km to 9km long and grouped left and right to rivers Sebangau, Kahayan, Kapuas and Barito. Water management system called "Fork-System" from Gadjah Mada University are approx. 12km long, with right and left ponds (reservoir) at the end; which were built in the 1980th to store and remove oxidation products. A gradient of fertility occurs along the primary, secondary, tertiary and quaternary channels, e.g. Pangkoh-Kahayan, Tabunganen-Barito, and Barambai-Barito. The tidal water quality are measured in pH-value, electric conductivity (EC in  $\mu\text{Si}/\text{m}$ ), sodium (Na<sup>+</sup>), chloride (Cl<sup>-</sup>), sulphate (SO<sub>4</sub><sup>2-</sup>) and magnesium (Mg<sup>2+</sup>) concentration; Na<sup>+</sup>, Cl<sup>-</sup>, SO<sub>4</sub><sup>2-</sup> may come from sea water and Mg<sup>2+</sup> from the soil.

Fig. 10A-F contains a gallery of aerial photos taken during the flights 11 April 1996 and 13 June 1998.



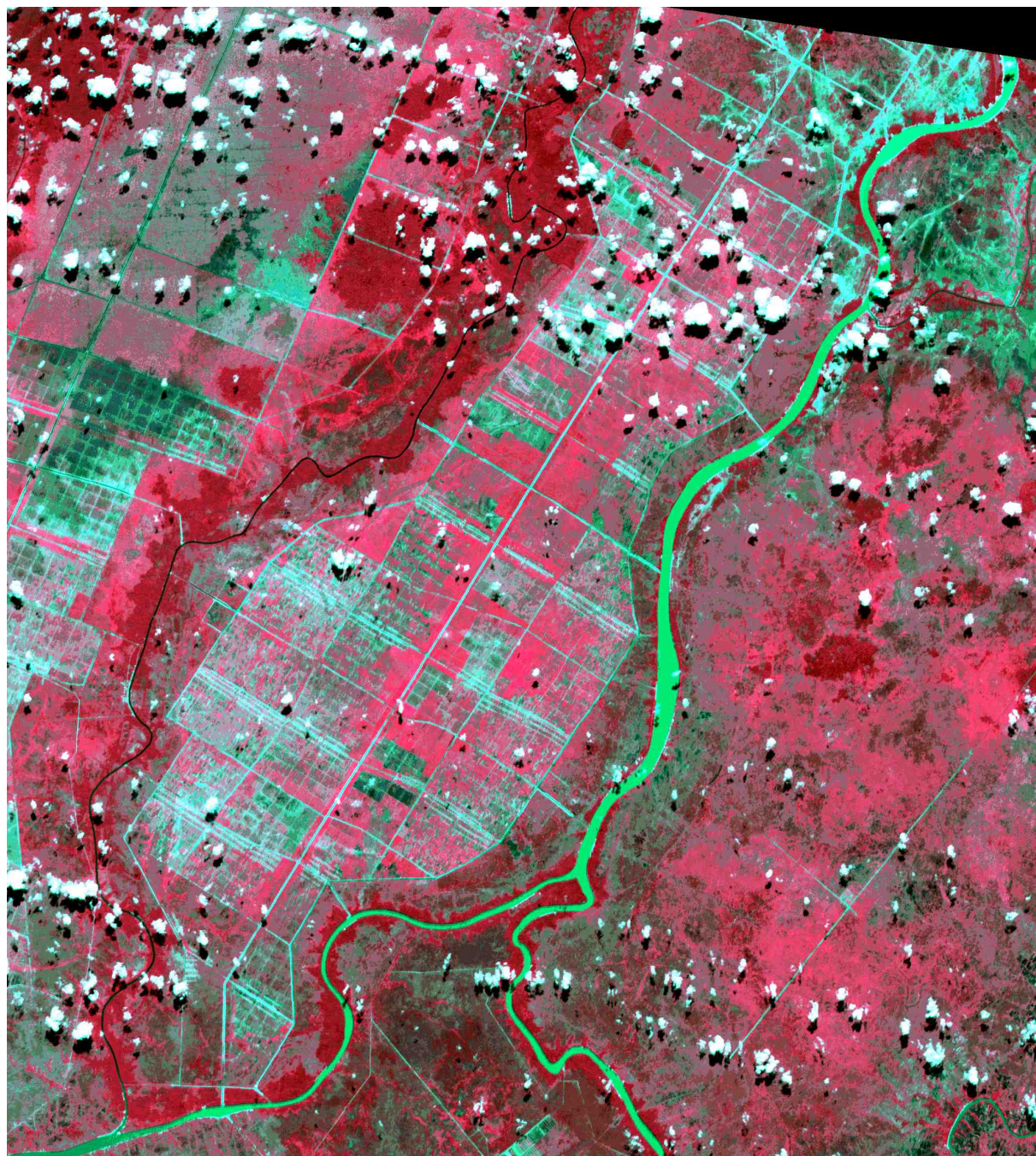

Fig. 7. SPOT image acquired on 19 June 1999 showing regrowth of secondary vegetation in bright red. The image shows with high resolution the MRP area in Block A at Dadahup area between rivers Mengkatip, left (black) and Barito, right (bright green). Transmigration settlements are resolved beside the channels. Red means vegetation and green cleared areas. The white and black areas indicate clouds res. shadows.



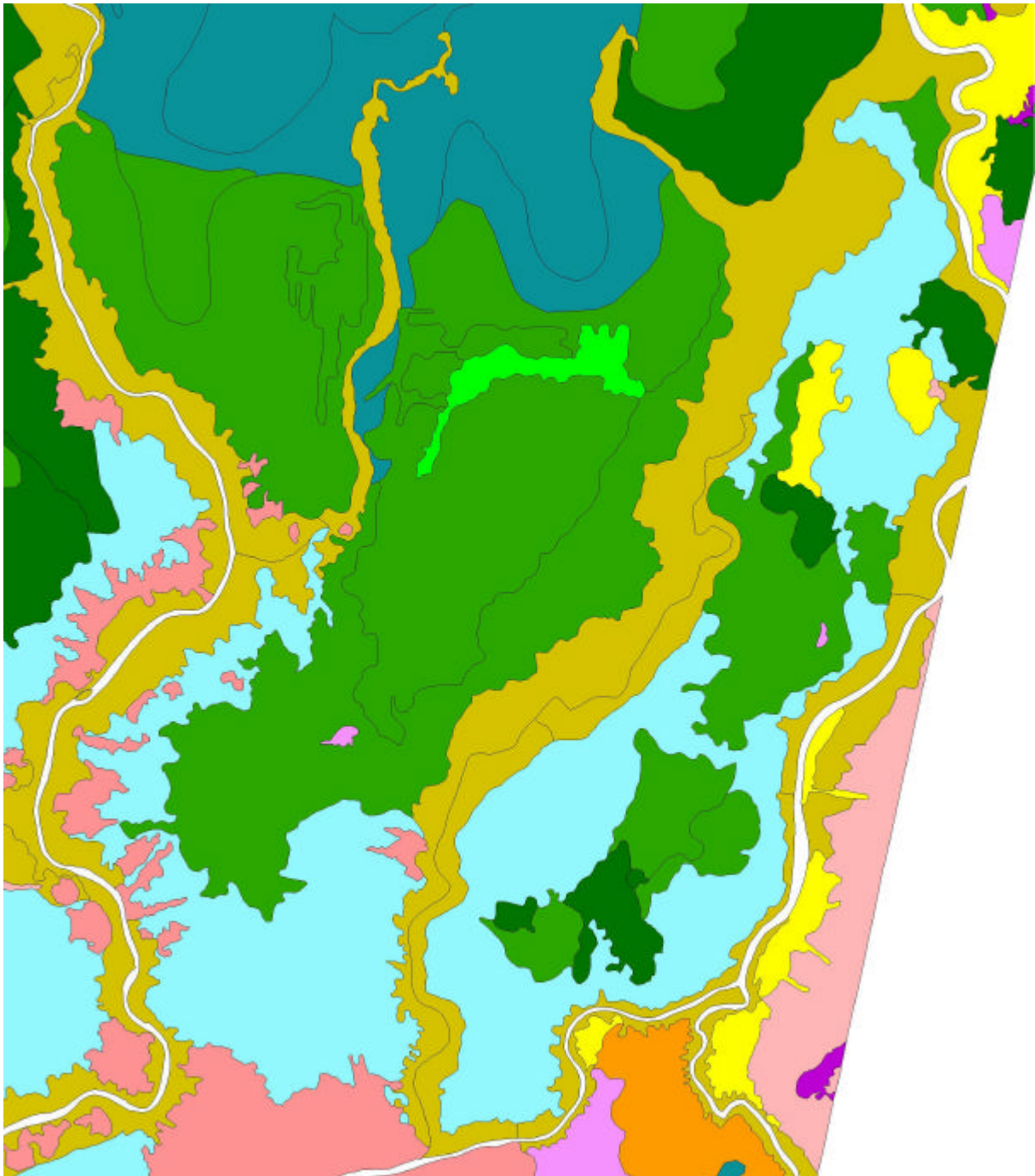

Fig. 8. Vegetation map from MRP- Block A with villages Lamunti and Dadahup between rivers Kapuas and Barito. The map based on the LANDSAT TM image from 1991. The legend is: dark pink - clearings; light pink - shifting cultivation and farmland; pink - old fire scars; ochre - riverine ecosystem; green - medium PSF, blue green - low pole PSF; dark green - tall PSF; light blue - degraded swamp forest; purple - wetlands; light green - secondary PSF.

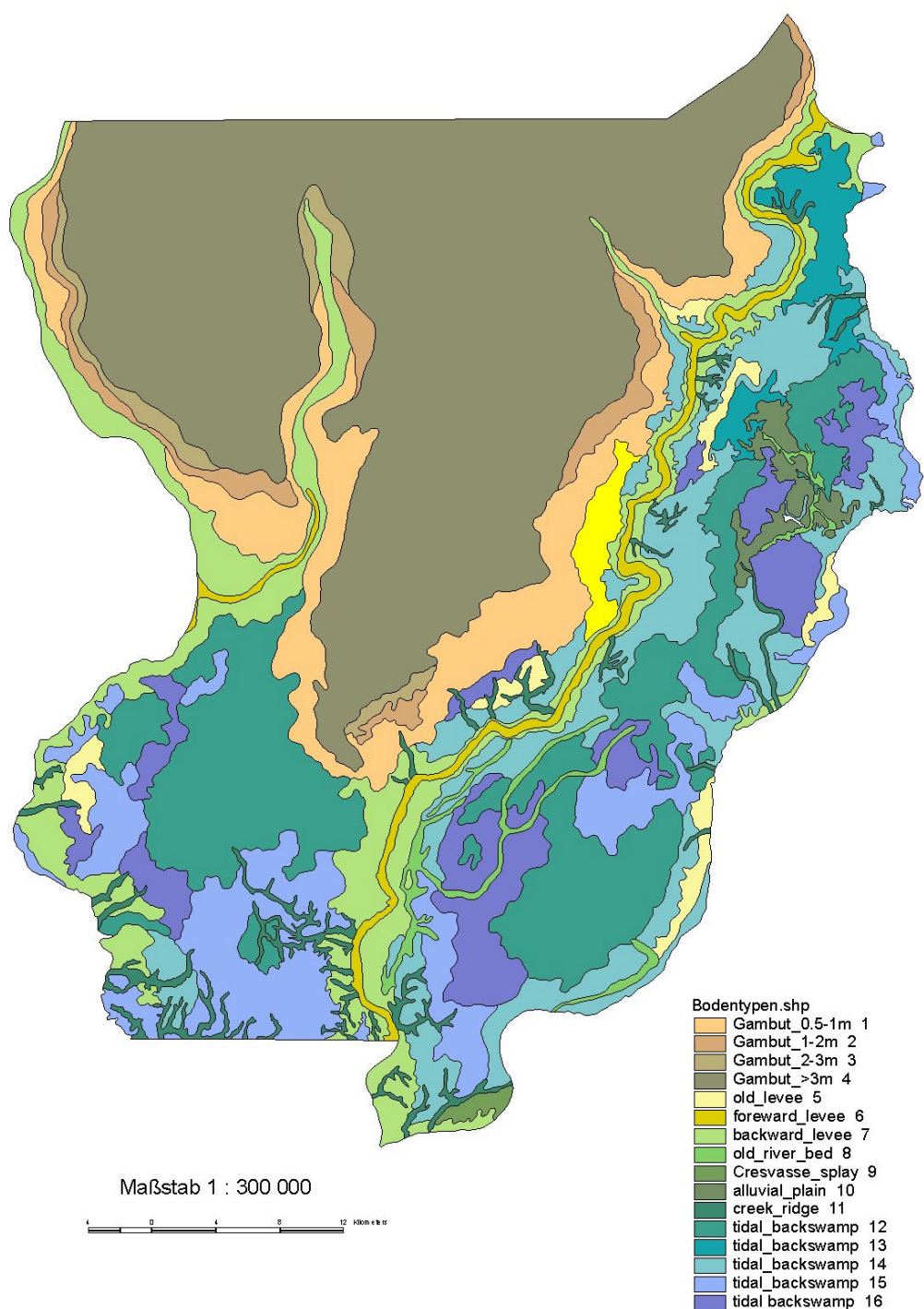

Fig. 9. Soil map from MRP- Block A with Dadahup and Lamunti. The soil map indicating the thickness of peat for Block A (digitised from Peta Penelitian Tanah dan Agroclimat). There is a clear correlation between peat thickness and agricultural activities, see Fig. 8 and ref. Jaya, 2000. Till 1997 there were no land clearings or shifting cultivation on thick peat.



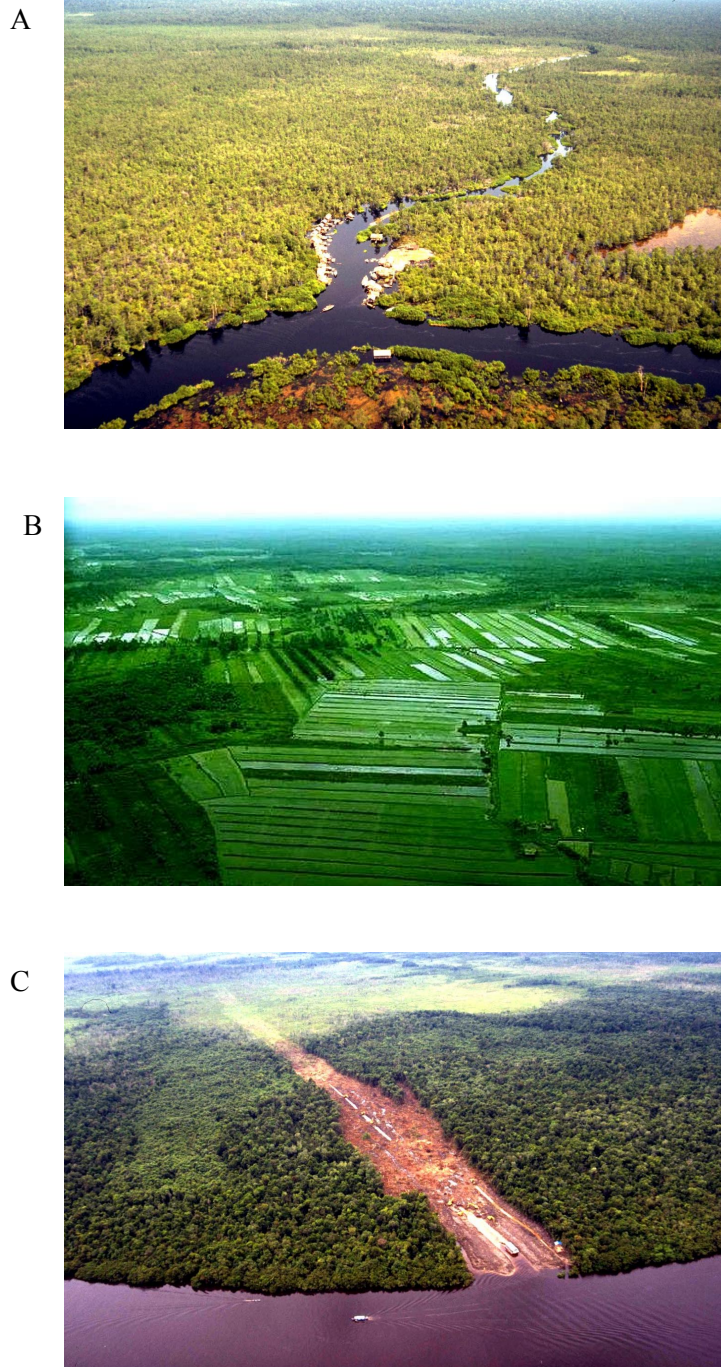

Fig. 10. Gallery of aerial photos.

(A) Pristine Peat Swamp Forest with black water at river Sebangau. Aerial photo taken on 11 April 1996; (B) Rice fields near river Kahayan in the south of the MRP where the tidal influence occur. Aerial photo taken on 11 April 1996; (C) Preparation work for a secondary channel into PSF of the Mega Rice Project at Lamunti, river Kapuas. Aerial photo taken on 11 April 1996.



Fig. 10. Gallery of aerial photos (continued).

(D) The double channel with black peat water at river Barito. Main sluices and secondary PSF is visible. Aerial photo taken on 13 June 1998; (E) Double channel crossing the black water river Mentangai. Without sluices no irrigation is possible. Burnt PSF is the result of ENSO effect combined with man made fires. Aerial photo taken on 13 June 1998; (F) Double channel with big sluices at river Kahayan. In the foreground is the black water river of Kalampangan Area leading into Kahayan. Aerial photo taken on 13 June 1998.



### Future Perspectives

There is a very high risk that most of the peat swamp forest resource will be destroyed within a very short period of time. NOAA-AVHRR hotspot data indicate that land clearing continues although the Government has stopped the MRP. Another major reason of forest degradation is illegal logging, which occurs all over the area with a strong increase since the economic crisis. Logging and the drainage of the peat swamp (by the canals) highly increases the risk of recurrent fires. Using hydrological models, current land use patterns and accessibility (logging roads and railways) may simulate the future development.

A bigger project of 2.8 million ha incl. the 1 million ha of MRP is released by presidential decree in the Kahayan, Kapuas, Barito (KaKaB) region of Central Kalimantan. This must be planned better and according to professional EIA (Environmental Impact Assessment).

### References

- Anderson, J.A.R. 1983. The tropical peat swamps of western Malesia. In: Gore, A.J.P. (ed.), *Mires: swamp, bog, fen and moor, B. Regional studies*. Elsevier, Amsterdam, pp. 181-199.
- Boehm, H.-D.V., Siegert, F., Rieley, J.O. and Limin, S. 1997. *Land use Planning and Environmental Monitoring in Kalimantan Using Remote Sensing Data*. published in Economic & Business Review Indonesia No. 279, August 20, 1997.
- Boehm, H.-D.V. and Siegert, F. 1999. *Interim Report of Aerial Surveys and Ground Truth campaigns in 1997 and 1998 in Central Kalimantan, Indonesia - Peat Swamp Forest, Mega-Rice-Project and Fires, 25.2.1999*, 49 pp. incl. 22 colour figures.
- Boehm, H.-D.V. and Siegert, F. 1999. Remote sensing verification by aerial surveys and ground truth campaigns 1997 and 1998 in Central Kalimantan, Indonesia - peat swamp forest, Mega-Rice-Project and fires. *Workshop on Tropical Forest and Remote Sensing, the Centre for Remote Imaging, Sensing and Processing, National University of Singapore, 5 March 1999*; CD is available from CRISP.
- Boehm, H.-D.V. and Siegert, F. 2000. Ecological impact of the one Million ha Rice Project in Central Kalimantan, Indonesia, using Remote Sensing and GIS Technology *Ambio*, (in prep).
- Jaya, A., Limin, S., Rieley, J.O. and Boehm, H.-D.V. 2000. Peat depth in Block C of Mega Rice Project, Central Kalimantan. prepared for the Millennium Wetland Event, Quebec 2000.
- Liew, S.C., Boehm, H.-D.V., Siegert, F., Kwoh, L.K., Padmanabhan, K., and Lim, H. 2000. Remote sensing and aerial survey of vegetation cover change in lowland peat swamp of Central Kalimantan during the 1997 fire. *Journal of Remote Sensing*, (in press).
- Notohadiprawiro, T. 1998. Conflict between problem-solving and optimising approach to Land use resources development policies - the case of Central Kalimantan wetlands. *Proceedings of Symposium of International Peat Society, Jyväskylä, Finland, 7 - 9 September, 1998*, pp. 14 – 24.
- Page, S.E., Rieley, J.O., Boehm, H.-D.V., Siegert, F. and Muhamad, N.Z. 2000. Impact of the 1997 fires on the peatlands of Central Kalimantan, Indonesia. prepared for the Millennium Wetland Event, Quebec 2000.
- Purnomo, E., Geling, S.M., and Someren, W.G.T. van approx.1990. Spatial and temporal

- variability of some chemical compositions of tidal irrigation water in an acid sulfate soil of South Kalimantan. Private communication. Paper No. 16 of Center for Tropical Acid Soil Studies (CTASS). (to be published).
- Rieley, J.O. and Page, S.E. 1995. *Biodiversity and Sustainability of Tropical Peatland*. Samara Publishing Limited, Tresaith, Cardigan UK.
- Sieffermann, G , Fournier, M., Truitomo, S., Sadelman, M.T. and Semah, A.M. 1988. Velocity of tropical peat accumulation in Central Kalimantan province, Indonesia (Borneo). *Proceedings of the 8th International Peat congress, Leningrad, USSR. Volume 1*. pp. 90-98.
- Siegert, F. and Ruecker, G. 1999. Evaluation of the 1998 forest fires in East-Kalimantan (Indonesia) using multitemporal ERS-2 SAR images. *Earth Observation Quarterly*, 61: 7-12.
- Siegert, F. and Hoffmann, A. 2000. The 1998 Forest fires in East-Kalimantan (Indonesia): A quantitative evaluation using high resolution, multitemporal ERS-2 SAR images and NOAA-AVHRR hotspot data. *Remote Sens. Environ.* (in press).
- Siegert, F. and Ruecker, G. 2000. Use of multitemporal ERS-2 SAR images for identification of burned scars in South-East Asian tropical rainforest. *Int.J.Rem.Sensing* (in press).

## **Infiltration Test on the Palangkaraya Peat**

**Nyoman SUMAWIJAYA**

Research and Development Center for Geotechnology - LIPI

### **Abstract**

To understand the effect of land use changes to infiltration capacity of the tropical peat land an infiltration test has been carried out using 'double-ring-infiltrometer' on the peat-land of Palangkaraya.

Some of the peat land in Palangkaraya and the surrounding area have been developed as agricultural land and settlement area. One experiment to mine peat has been done also by the Mining and Energy Department. Conversion of natural (forest covered) peat into agriculture land and mining land reduce infiltration capacity very significantly. At the natural peat land infiltration rate is >550 cm/hr at the first minute to about 10 cm/hr at the stable condition (constant rate), while for the agricultural land the infiltration rate ranges from 135 cm/hr to 26,6 cm/hr at the first minute and the constant infiltration rate ranges from 10 cm/hr to 3,6 cm/hr. The ex-mining area of peat was almost becoming impermeable; the infiltration rate is in the ranges of 10 cm/hr to 6,4 cm/hr at the early time and drop to 0.5 cm/hr – 0.2 cm/hr at its constant rate. This very low infiltration rate of the ex-mining area mostly caused by over-loading of the heavy equipment during the mining process.

### **Introduction**

Infiltration is the process of entry of water into the soil. There are three independent activities involve in the infiltration process: entry of water through the soil surface, storage within the soil, and transmission through the soil. When the water goes further into the deeper part of the geological formation; the process is called percolation. When the percolating water joints the groundwater body, recharge process occurs. Surface run off occurs when rainfall exceeds the infiltration capacity of the soil.

Infiltration capacity of a soil is affected by soil texture, morphology, and land use. Some minor factors influence soil infiltration capacity are: soil water content, soil and water temperature, turbidity of water, and rainfall intensity. Some developments have been made to some parts of Indonesian peat, mainly for agriculture, and oil palm plantation. In anticipating the effect of peat-land development to the hydrological condition of the area an infiltration test has been made to the Palangkaraya peat.

### **Description of the Study Site**

#### ***Location and land use***

The study area is located at Kalampangan village, about 17 km to the Southeast of Palangkaraya, the capital city of Central Kalimantan (Fig. 1). Part of the peat in the study area and the surrounding area have been converted from virgin forest into agricultural land and settlement since 1978. Farmers mostly cultivate corn, soya-bean, vegetable, and some tree crops like coconut, and fruit trees. One family works on about 2-ha land. All farming activities are done manually (without machinery) by conserving rain water (without irrigation water). They do make tertiary canal and field ditches (collectors), but the purpose of this canal is to drain the excess of precipitation water. From the field-ditches, water is directed into the tertiary canal and then flows to the

Kahayan river about 3 km to the north.

In 1985 to 1987 a pilot project of peat mining in an area of about 20 ha was carried out by the Mining and Energy Department in cooperation with Finland Government. About 10 cm to 30 cm of the upper layer of the peat has been taken from the area.

#### ***Peat type and thickness***

Palangkaraya peat is a tropical type peat which the deposition process is determined by combination of low laying topography, surplus rainfall, and low silt content of the river water (Radjagukguk, 1995). The study area is part of the peat deposit situated between the Sebangau and Kahayan River in Central Kalimantan.

Peat is brown to black in color, weak, moderate to strong decomposition (H3 – H8 of van Post scale). However wood content is high (up to 30%). Root and trunk with diameter more than 1 cm are easily identified in the field. Many times auger drilling fail to get targeted depth because of the presence of non-decomposed wood or root. Tree toes are still found at many locations. This peat also contains fine to medium, white to gray and brown sand (quartz sand). In the transition layer between peat and sand, the peat usually mix with gray clay and fine sand. Underlying the peat is quart sand and other weathering product of tertiary rock. Thickness of peat varies from place to place with the maximum thickness recorded was 6 m.

#### ***Climate and hydrology***

Climate of the area is classified as humid tropic with annual rainfall maximum 2,600 mm, whilst the monthly rainfall intensity varies from minimum 22 mm to a maximum 525 mm. Rainy season last from October to April while dry season last from May to September. The minimum temperature varies between 22°C to 24°C and the maximum temperature varies between 30°C to 35°C. Some times Palangkaraya area experience long drought with no rain for several months such in 1987 and 1991, 1994, and 1997.

Groundwater level is 0.25 to 1.5 m below ground surface during September (time of survey), but during the rainy season sometimes the study area is flooded. The nearest river to the study area is the Kahayan River, about 3 km to the northeast (Fig. 1) and the Sebangau River in the southwest of the area.

#### **Methodology**

Infiltration test was carried out using ‘double-ring-infiltrometer’ method. To do the test, first the inner ring of 15 cm width and 20 cm length is driven about 10 cm into the soil and then the outer ring of 30 cm diameter and 20 cm length is done in the same way. The inner ring is just inside the outer ring (the same center point). Water is applied into the outer and the inner ring until the water level is about 5 cm above the ground and maintained by continually supplying water from a graduated reservoir. By measuring the volume of water added into the inner ring per unit time, infiltration rate can be calculated. In the first minute, infiltration rate is very fast, and then sharply drop for about 3 to 5 min which is followed by gradual drop for 10 min or more. Measurement ceased after ‘constant’ rate is achieved.

Infiltration test on the Palangkaraya peat

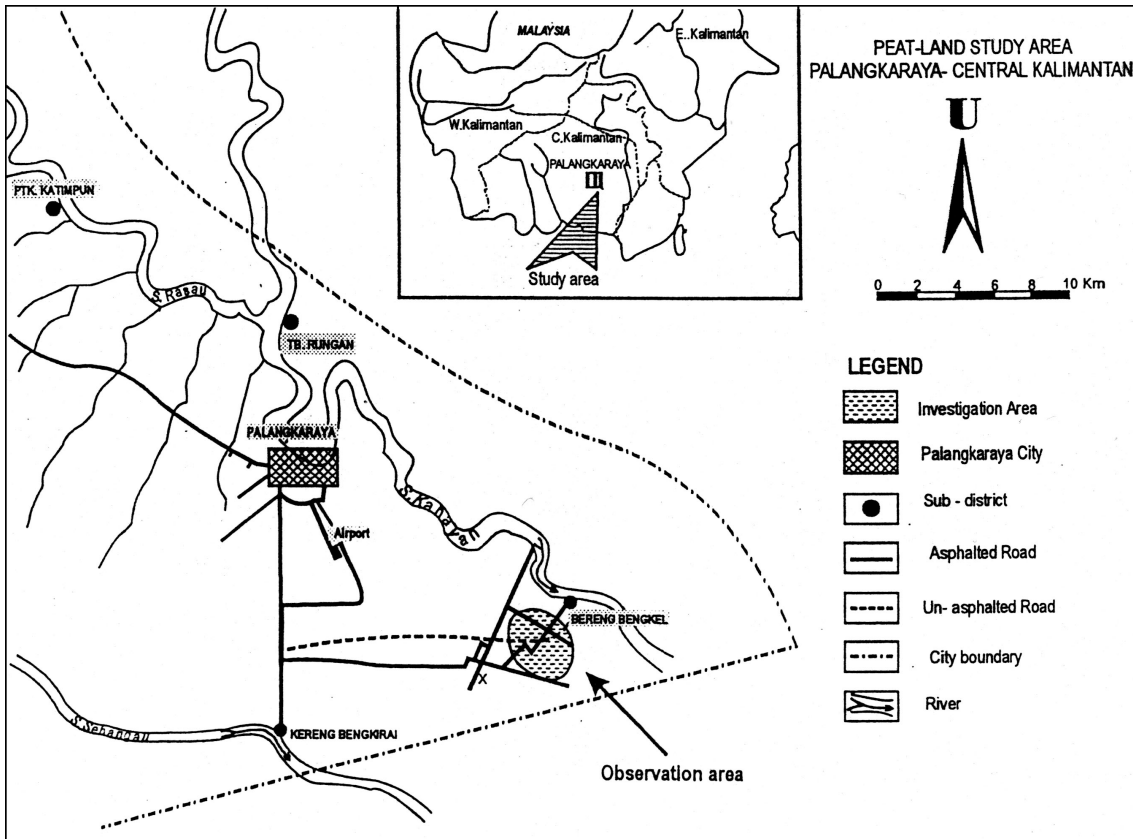

Fig. 1. Map of study location

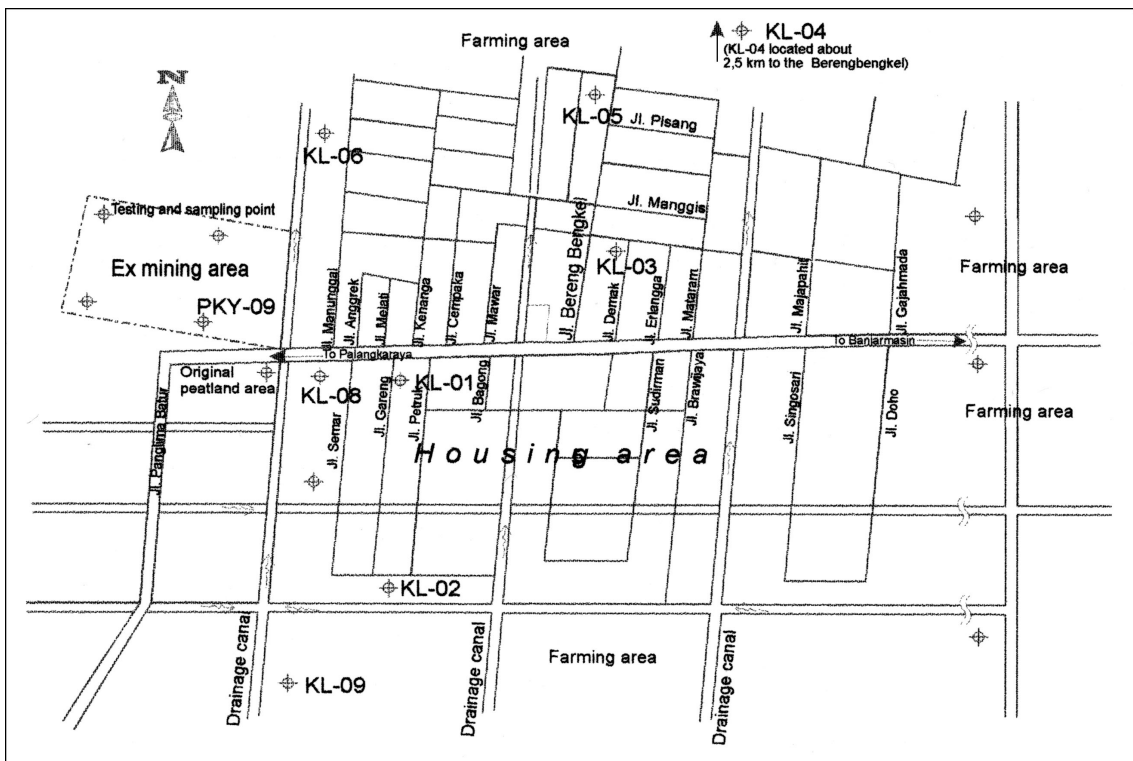

Fig. 2. Schematic location of infiltration test

### Result and Discussion

Detail location of the test point is shown in Fig. 2 and results of infiltration test in the form of graphic are shown on Fig. 3. From this infiltration test we can see that land use changes gives big effects on the infiltration rate/capacity of peat. The biggest change is on ex-mining area. The highest infiltration rate was measured in the virgin peat (550 cm/h at first minute — KL-08) whilst the lowest one was for the peat at the ex-mining area 6.4 cm/h at the first minute and 0.2 cm/h at the constant rate (PKY-09).

The big change of infiltration rate of ex-mining peat land is most possibly caused by the compression and consolidation of the peat by the heavy equipment during the mining process. To do mining first; canals of 0.5 m wide and about 0.75 m depth are constructed in every 20 m distant to lower the water table in the peat. As the water level drop, shrinkage process occurs in the peat. The shrinkage process follows by reduction of porosity and permeability, and so to the infiltration rate.

As mention before, the low bearing capacity of peat land is related to its high water content. With this hypothesis, reduction of shrinkage effect caused by compressive stress from heavy equipment during the mining process (with also reducing the effect to the infiltration capacity) can be done by applying good mining work practices. Mining work is carried out only when the bearing capacity of the peat is maximum with mean also minimum water content. By studying the relation of peat compressive strength and its water content we can define the most possible field water content of the peat with its maximum compressive strength. This study should include determination of hydraulic conductivity, ripeness of the peat, distance between two consecutive drainage canal, and depth of water table. One rule of thumb being applied by one peat mining in Perawang (Riau) is: when there is 5 mm rain in the working field, mining work stop for one day, if rainfall more than 10 mm, mining operation is stop for three days of no rain.

Big change of infiltration rate also occurs in the housing area. This change is considered bigger than the effect of converting mineral soil land. It is closely similar to clay characteristic. In the mineral soil, land use changes may give only physical effect of compaction and consolidation as the result of particle rearrangement. There is no particle breakdown effect in mineral soil but, for peat land conversion beside rearrangement of the particle there is chemical or biological process effect related to drainage. Draining peat mean reducing water content and on the same time oxygen circulation increase. By increasing input of oxygen decomposition process progress both biologically and chemically. Peat becoming more riper. The more ripe peat the finer its particle size and the less its hydraulic conductivity.

Conversion of forest (swamp-forest) peat into other land use types almost always preceded by the development or construction of drainage canal to lower the water level in the working area. The purpose of lowering water table is to improve the bearing capacity and increase oxygen circulation. The upper part of the peat will become dry or partly dry. If the peat over-dry, peat cannot fully recover its lost moisture on re-submergence or re-wetting process.

### Infiltration test on the Palangkaraya peat

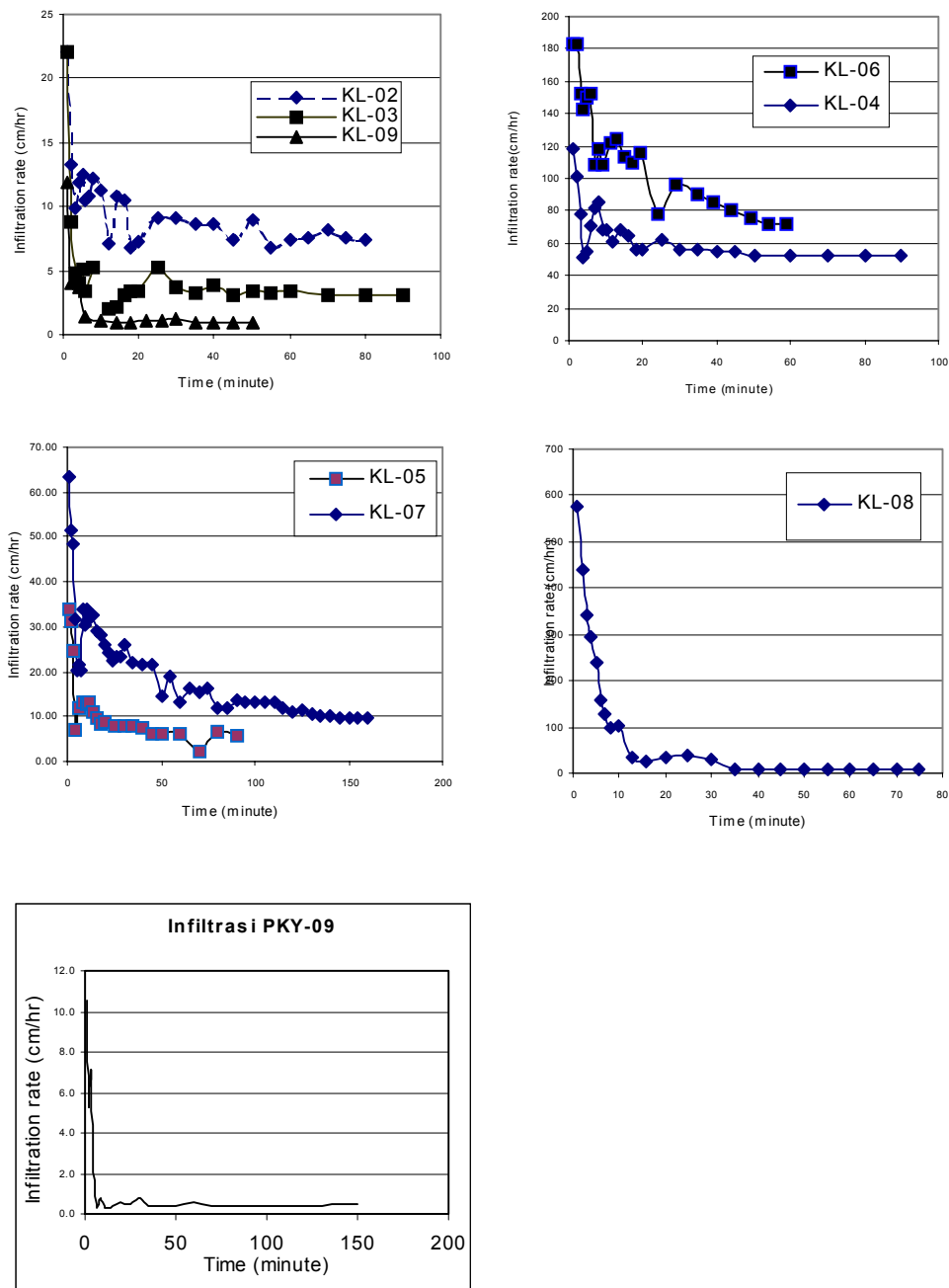

**Note on legend:**

- |   |   |
|---|---|
| KL-01: coconut plantation               | KL-07: peat land prepared for mining area |
| KL-02: tomato farming area              | KL-08: bushed covered peat                |
| KL-03: corn farming area                | KL-09: banana plantation on the back yard |
| KL-04: secondary forest on mineral soil | PKY-09: ex-mining area                    |
| KL-05: house farming                    |   |
| KL-06: abandone farming land            |   |

Fig. 3. Graphic of infiltration test data

This infiltration test data is not an exact or realistic data of infiltration capacity of the observed soil. The measured infiltration rate from infiltration test usually bigger than the natural infiltration rate. This higher infiltration rate can be caused by two reasons: during infiltration test supply of water was made continue and constant, whilst the natural rains fall is almost always varies along the rainfall duration. The second cause of higher infiltration rate during infiltration test is the positive hydraulic head. In the experiment (infiltration test), there is about 5 cm positive head caused by the impounded water column inside the ring. This hydraulic head is big enough to force the water to flow down. Whilst in the naturally infiltration process this positive head is not always possible.

Infiltration test data is only an indicative measure and distribution of infiltration capacity of the land/soil. However this test or data can be used to see the possible effect of land use changes to the infiltration capacity of a soil under consideration. Great care is needed in applying the infiltration test data in solving the real water problem in the field.

### Conclusion

1. Conversion of virgin peat into any type of land use give big effect of its infiltration capacity. The biggest change if infiltration occurs on conversion of peat land into mining land.
2. To minimize the effect of loading of heavy equipment during the mining process or other activities field work should be done only during the minimum possible water content of the field peat.
3. Detail study of infiltration capacity of the peat is needed in order to minimise the effect of peat land conversion the hydrology.

### References

- Djuwansah, M. and Sumawijaya, N. 1995. Aspek Lingkungan Pemanfaatan Sumberdaya Gambut di Indonesia, In: Arief, I. *Prosiding Temu Profesi Tahunan IV, Bandung 17 Juli 1995*.
- Hamming A.F.J., Subagio, K. and Vadari, T. 1990. Soil Permeability Aspect in Pulau Petak, Kalimantan, *Paper Workshop on Acid Sulphate Soils in the Humid Tropics, 20-22 November 1990, Bogor, Indonesia*.
- Hobbs N. B. 1986. Mire morphology and the properties and behavior of some British and foreign peats, *Quarterly Journal of Engineering Geology*, 19: 7-80.
- Notohadiprawiro, T. 1997. Twenty-five years experience in peatland development for agriculture in Indonesia. In: Rieley J. O. and Page, S. E. (eds), *Biodiversity and Sustainability of Tropical Peatlands*.
- Nugroho K., Gianinazzi, G. and Wijaya-Adhi, I.P.G. 1997. Soil hydraulic properties of Indonesian peat. In: Rieley J. O. and Page, S. E. (eds), *Tropical Peatlands*, Samara Publishing Limited, Cardigan.
- Radjagukguk, B. 1997. Peat soils of Indonesia: location, classification, and problems for sustainability. In : Rieley J. O. and Page, S. E. (eds), *Tropical Peatlands*, Samara Publishing Limited, Cardigan.
- Rieley J. O., *et al.* 1997. Tropical peat-lands: natural resource, characteristics and functions – problems for sustainable management, *Paper Presented at the*



*International Workshop on environmental Management of Wetland Ecosystem in South Asia, held in Palangkaraya, Central Kalimantan, Indonesia, 6-9 August 1997.*

- Sudibyakto. 1989. Pengujian Beberapa Model Infiltrasi Untuk Pendugaan Limpasan Permukaan Di Sub DAS Sayang, DAS Konto Hulu, Laporan Penelitian, DPP/SPP Fakultas Geografi UGM.
- Sumawijaya, N. 1996. Aspek Hidrologi Pada Pemanfaatan Lahan Gambut di Indonesia, In: Mudohardono D. *et.al* (eds), *Proseding Pertemuan Ilmiah Tahunan XXV Ikatan Ahli Geologi Indonesia, Bandung 11-12 Desember 1996.*
- Suparka *et.al.*, 1996. Peat in Indonesia : A dilemma of utilization and environmental impact. *International Symposium on Geology and Environment, Chiangmay, January 31st – February 2nd 1996.*
- Wilson, E.M. 1993. *Hidrologi Teknik*. Penerbit ITB, Bandung.

**Part 6**  
**Aquatic Environment**

## Ground Water Recharge in Central Kalimantan Deduced from Isotopic Hydrology

Nori TANAKA, Siwat PONGPIAJUN and Toshio IWAKUMA

Graduate School of Environmental Earth Science, Hokkaido University, Sapporo, Japan

### Abstract

From 1997 to 1999, various water samples were collected and analyzed for oxygen isotope composition in order to understand hydrology in Central Kalimantan. Rainwater, lake water, river water, and ground water from wells and peat ponds were collected during our expedition. Ground water was found to be isotopically lightest among the water samples and rain water samples collected in both dry and wet seasons were found to be heaviest of all, indicating that ground water has to be provided from the water supply other than the local precipitation. Isotope compositions of all other water samples including lake water and river water distributed between ground water and rain water, suggesting that those water formed from the mixing ground water and rain water. The most probable source of water for the ground water in Central Kalimantan is precipitation in the high mountainous area on the north of Central Kalimantan. Many mountains are with several thousand-meter elevations. The isotope composition in the precipitation in the area is expected to be substantially light because of so-called altitude effect on the isotope composition in precipitation. Rainwater *in situ* in Central Kalimantan recharges negligible amount of the ground water. Therefore, it is believed that protection in the northern mountain range is essential to maintain the ground water in high quality and quantity in Central Kalimantan.

**Key words:** Ground water, Kalimantan Indonesia, Isotope, Recharge, Protection of ground water.

### Introduction

In Central Kalimantan, there is vast peat land forest, which is subjected to recent development for food production for sustaining Indonesian growing population. Its devastation during the developments are widely known recently by the internationally recognized forest fire, which had been uncontrollable in 1997, partly due to exceptional dryness in the region due to El Nino Southern Oscillation. Biomass burning is common practice in this region but the extent is far more exceeded to its own capacity for the sustainability. Surface water in peat land like Central Kalimantan has unsuitable quality for drinking water and domestic use because of high organic contents and low pH. The ground water is, however, maintained somehow in pretty good conditions for human consumption. The ground water is, therefore, should be wisely managed for domestic consumption and irrigation. Although knowledge on the ground water hydrology is very essential for its usage in sustainable manner, little is known about recharge rates, locations and flow pattern. Clearing forest for agricultural development could lead to major change in hydrological feature as well as material balance in the region, including carbon, nutrients and soil. In order to avoid unrecoverable devastation to the ecosystems and the fresh water resources, we have to accumulate enough scientific knowledge to assess possible impacts induced by developmental activities. This study is conducted in part of Core University Program between Hokkaido University and R & D Center for Biology, LIPI, Indonesia sponsored by Japan Society for Promotion of Science (Tokura,

1998). Isotope compositions of easily accessible water bodies were surveyed for obtaining first grab of the hydrology in this region.

### Sampling and Analytical Methods

All samples for isotope analysis were listed in the Table 1 together with analytical results. The Kahayan River, major sampling location is shown in Fig. 1. Rainwater samples were collected in dry and wet seasons in Central Kalimantan, Bogor Botanical Garden in Bogor, and Cibinong, Java, Indonesia. Several lakes in southern and central part of Kalimantan were surveyed and 1998. Well water are collected at farmhouse at Tumbang Tahai, which has opened several years ago as new plantation near Palangka Raya. Stream waters and peat waters from boreholes after peat core collection at Lahei site were also analyzed for isotope composition. Samples are stored in polyethylene bottles or glass bottles in a cool place and transferred to Japan for the isotope analysis.

Five ml from each water sample was transferred in the bottles attached to the equilibrator on a mass spectrometer. Water samples in the bottles are evacuated once and filled with pure CO<sub>2</sub> gas and let equilibrated for 6 h in an isothermal water bath. Then, CO<sub>2</sub> gas was introduced into inlet of the mass spectrometer and analyzed for the isotope composition. All above process is automatically carried out and the equilibrator can handle 24 bottles at once. All process for 24 sample analyses will take about 12 h. The analytical precision is 0.03 ‰ for oxygen isotope analysis and 0.6 ‰ for hydrogen isotope analysis. Analytical results were given in a delta notation as ‰ deviation from the Vienna international isotope standard seawater (VSMOW) sample.

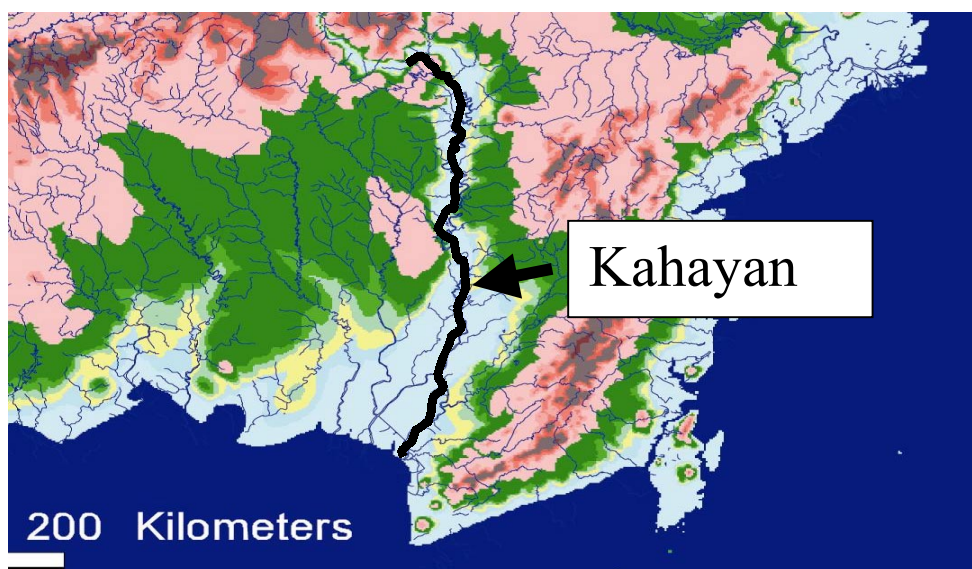

Fig. 1. Map of Central Kalimantan (Solid line represents Kahayan River)

### Results and Discussion

Analytical results were listed in Table 1 together with sample description. Isotope composition of natural water observed in the Kahayan River watershed were plotted

Table1. A list of samples and oxygen isotope composition

| Location      | Date    | Sample types.       | $\delta^{18}\text{O}_{\text{vsmow}}$ |
|---------------|---------|---------------------|--------------------------------------|
| Bogor         | 98/1/13 | Rain water          | -2.37                                |
| Cibinong      | 99/4/29 | Rain water          | -5.11                                |
|               | 99/5/21 | Rain water          | -3.66                                |
| Palangka Raya | 98/1/18 | Rain water          | -3.46                                |
|               | 98/9/11 | Rain water          | -2.30                                |
|               | 99/4/23 | Rain water          | -1.45                                |
|               | 99/4/25 | Rain water          | -1.79                                |
|               | 99/5/01 | Rain water          | -13.19                               |
|               | 99/5/09 | Rain water          | -6.99                                |
|               | 99/5/14 | Rain water          | -12.87                               |
| Tewah         | 99/4/25 | Rain water          | -1.49                                |
| Tamban Tahai  | 98/1/20 | Groundwater         | -7.06                                |
| G. Obos       | 98/9/17 | Groundwater         | -8.19                                |
| Bukit Batu    | 98/9/18 | Groundwater         | -8.54                                |
| Sampit        | 98/9/19 | Groundwater         | -7.66                                |
| Basarang      | 98/9/21 | Groundwater         | -7.04                                |
| Pulang Pisau  | 98/9/21 | Groundwater         | -7.68                                |
| Sepang Simin  | 99/4/25 | Groundwater         | -8.33                                |
| Bawan         | 99/4/26 | Groundwater         | -6.54                                |
| Tb. Posu      | 99/5/24 | Spring water        | -9.13                                |
| Tb. Marikoi   | 99/5/24 | Spring water        | -8.88                                |
| Tb. Maraya    | 99/5/24 | Spring water        | -8.94                                |
| Tb Miri       | 99/5/24 | Spring water        | -8.96                                |
| Penda Rangas  | 99/5/24 | Spring water        | -9.58                                |
| Tewah         | 99/5/25 | Spring water        | -8.81                                |
| Tanjungtung   | 99/5/25 | Spring water        | -8.99                                |
| Upunbatu      | 99/5/25 | Spring water        | -7.74                                |
| Goha          | 99/5/26 | Spring water        | -8.27                                |
| Palangka Raya | 99/5/28 | Spring water        | -8.77                                |
| Lahei         | 98/1/17 | Peat water          | -7.28                                |
| Baamang       | 98/9/19 | Peat pond water     | -6.60                                |
| Pundu         | 98/9/19 | Peat pond water     | -7.26                                |
| Kotabesi      | 98/9/19 | Peat pond water     | -6.12                                |
| Mintin        | 98/9/21 | Peat pond water     | -6.91                                |
| Garung        | 98/9/21 | Peat pond water     | -5.88                                |
| Lake Sabuah   | 98/2/22 | North 0 m depth     | -6.59                                |
|               | 98/2/22 | Central 0 m depth   | -6.37                                |
|               | 98/9/11 | Entrance 0 m depth  | -8.06                                |
|               | 98/9/11 | Central 0 m depth   | -7.68                                |
|               | 98/9/11 | Central 0 m depth   | -7.67                                |
|               | 98/9/11 | Central 0.5m depth  | -7.68                                |
|               | 98/9/11 | Central 1.5 m depth | -7.51                                |
|               | 98/9/11 | Central 2 m depth   | -7.93                                |
|               | 98/9/11 | Central 3 m depth   | -8.14                                |
| Lake Sembuluh | 98/2/25 | North 0 m depth     | -5.79                                |
|               | 98/2/25 | Central 0 m depth   | -5.51                                |
| Lake Rantep   | 98/9/11 | 0 m depth           | -7.90                                |
|               | 98/9/11 | 0.5 m depth         | -7.96                                |
|               | 98/9/11 | 1 m depth           | -8.23                                |
|               | 98/9/11 | 1.5 m depth         | -7.98                                |
|               | 98/9/11 | 2 m depth           | -8.04                                |

Table1 (continued)

| Location       | Date      | Sample types. | $\delta^{18}\text{O}_{\text{vsmow}}$ |
|----------------|-----------|---------------|--------------------------------------|
| Lake Tundai    | 98/9/15   | 0.5 m depth   | -7.10                                |
|                | 98/9/15   | 1 m depth     | -7.12                                |
|                | 98/9/15   | 1.5 m depth   | -7.15                                |
|                | 98/9/15   | 2 m depth     | -7.16                                |
|                | 98/9/18   | 2 m depth     | -6.94                                |
|                | 98/9/18   | 3 m depth     | -6.93                                |
|                | 98/9/18   | 4 m depth     | -7.01                                |
|                | 98/9/18   | 5 m depth     | -6.95                                |
|                | 98/9/18   | 6 m depth     | -6.98                                |
|                | 98/9/18   | 7 m depth     | -7.06                                |
| 98/9/18        | 8 m depth | -7.11         |                                      |
| Lahei          | 98/1/17   | Stream water  | -6.85                                |
| Tanjung Puting | 98/2/24   | Swamp water   | -5.45                                |
|                | 98/2/24   | River water   | -5.41                                |
|                | 98/2/24   | River water   | -5.46                                |
|                | 98/2/24   | River water   | -5.50                                |
| Kumai River    | 98/2/24   | River water   | -4.41                                |
| Kahayan River  |           |               |                                      |
| Tb. Maraya     | 99/4/24   | River water   | -8.81                                |
| Tb. Marikoi    | 99/4/24   | River water   | -8.61                                |
| Penda Rangas   | 99/4/24   | River water   | -8.67                                |
| Tb. Habaon     | 99/4/25   | River water   | -8.57                                |
| Kuala Kurun    | 99/4/25   | River water   | -8.33                                |
| Kampuri        | 99/4/26   | River water   | -8.52                                |
| Tb. Miwan      | 99/4/27   | River water   | -8.39                                |
| Palangka Raya  | 99/5/08   | River water   | -8.77                                |
| Palangka Raya  | 99/5/08   | River water   | -8.68                                |
| Pilang         | 99/11/26  | River water   | -8.66                                |
| Garong         | 99/11/26  | River water   | -8.60                                |
| Buntoi         | 99/11/26  | River water   | -8.30                                |
| Banunai        | 99/11/26  | River water   | -7.43                                |

against the distance from Palangka Raya city in Fig. 2. Rainwater samples collected in Palangka Raya in both wet and dry seasons ranged -1.45 to -3.46 ‰, showing heaviest isotope composition among examined natural waters. In Palangka Raya, extremely light oxygen isotope composition was observed (as low as -13 ‰) in dry season. However, it is obvious that the rain in dry season cannot penetrate into the soil due to low rainfall and fast evaporation in the dry season. The source for precipitation with such low oxygen isotope ratio is evapo-transpiration from local vegetation. Rainwater collected at Bogor in wet season was -2.37 ‰. Rainwater collected at Cibinong had -5.11 ‰. Ground waters collected at Palangka Raya, Tumbang Tahai, G. Obos, Bukit Batu, Sampit, Basarang, Tb Miri, Tb Marikoi, Tb Posu, Sepang Simin, Tewah, Penta Rangas, Goha, Tunjungtung, Upanbatu and Pulang Pisau ranged -7.04 to -8.54 ‰. River water from Kumai and Tanjung Puting were from -4.14 to -5.50 ‰. Upstream water of Kahayan River from Palangka Raya has -8.67 to -8.33 ‰. Downstream water from Palangka Raya were also found to have the comparable isotope composition to those at the upstream. Peat waters from peat ponds and others at Lahei, Baamang, Pundu, Mintin and Garung ranged -5.88 to -7.28 ‰. Lastly, lake waters from Sabuah, Sembuluh, Rantep and Tundai ranged -5.51

to -8.23 ‰. Lake waters analyzed were the most similar to the isotope composition of the ground water. Peat ponds have the next close value and river water has the closest value to the rainwater, although the value is still significantly lower than the rainwater (Table 2). Isotope data for rainwater is painfully limited in this area.

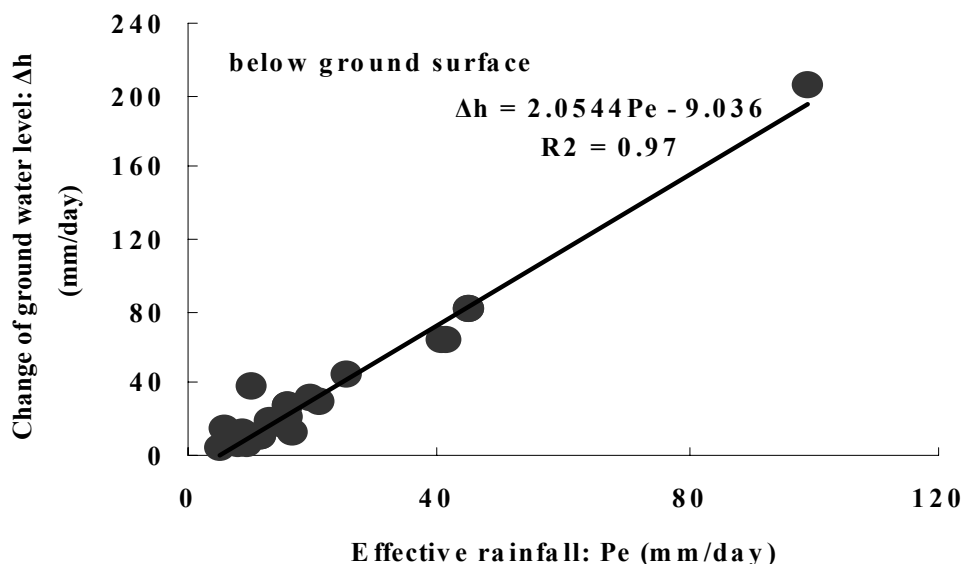

Fig. 2. Oxygen isotope composition of natural waters in the Kahayan River watershed, Central Kalimantan, Indonesia.

Table 2. Summary of oxygen isotope analysis in Kalimantan.

| Samples                 | Locations  | $\delta^{18}\text{O}_{\text{VSMOW}} (\text{‰})$ range |
|-------------------------|--|---|
| Rain water              | Palangka Raya, Bogor, Cibinong, Tewah  | -1.49~-5.11(4) <sup>1</sup>                           |
| River water             | Kumai(estuary), Tanjung Puting, Kahayan, Miri, Tb Miwan  | -4.14~-8.67(17) <sup>c</sup>                          |
| Peat ponds and leachate | Lahei, Baamang, Pundu, Kotabesi, Mintin, Garung  | -5.88~-7.28(7) <sup>1</sup>                           |
| Lake water              | Sabuah, Sembuluh, Rantep, Tundai   | -5.51~-8.23(34) <sup>1</sup>                          |
| Ground water            | Tb Tahai, G.Obos, Bukit Batu, Sampit, Basarang, Pulang Pisau, Tb Marikoi, Tb Miri, Tb Posu, Upanbatu, Tanjungtung, Tb Maraya, Sepang Simin, Goha, Palangka Raya, Penda Rangas, | -6.54~-9.58(18) <sup>1</sup>                          |

1: Number of samples are given in parentheses.

International Atomic Energy Agency (IAEA) has been collecting precipitation for isotopic analysis at two locations (Djakaruta, Java and Djajapura, Irian Jaya) since 1962. The averaged oxygen isotope composition of precipitation at Djakaruta (8 m a.s.l) from

1962 to 1987 obtained by weighting by the monthly rainfall is -5.6‰. Throughout the observation period from 1962 to 1987, No seasonal trend in isotope composition has been observed (IAEA, 1969-1990). According to Giggenbach (1992), the oxygen isotope compositions of rainwater at Keli Mutu, Merapi and Sirung ranged -4.0 to -5.1 ‰ (presented as pers. commun. with J. C. Varekamp and R. Freulen (1990)). The isotope composition clearly differs from values from our study. Although the value is not necessarily applicable in the Central Kalimantan, it can be speculated that there is a sampling bias due to limited number of samples in our study. Nevertheless, under considering all currently available data for oxygen isotope in rainwater in Indonesia, to our best knowledge, rainwater should be an end member with heaviest isotope composition among natural water in the Central Kalimantan. Obviously, it is highly desirable to obtain precipitation all year round in Central Kalimantan and analyzed for stable isotope soon. Post-depositional alternation in the isotope composition by lateral flow, evaporation, evapo-transpiration could make isotope composition heavier or no change. Consequently, there is no process which forces isotope composition isotopically lighter in the Central Kalimantan. It can be safely stated that the local precipitation never becomes isotopic composition in the ground water. It can be very clearly concluded that the ground water in the Central Kalimantan is not locally recharged at all and that main body of surface water in the Central Kalimantan is originated from ground water. Rainwater, therefore, in the Central Kalimantan should flows out possibly as surface flow or returns to the atmosphere through evapo-transpiration. Thick peat layer in Central Kalimantan is apparently preventing *in situ* ground water recharge in this area.

Then, what is the origin of the ground water? There are three possibilities; 1) fossil water, 2) remotely recharged rainwater and 3) local precipitation thermally altered by volcanic activity. Volcanic water vapor in Indonesia has been studied by Allard (1983) and was found oxygen isotope composition of +7.7 ‰, which is substantially heavier than the regular surface water in Indonesia. The oxygen isotope shift toward heavy isotopic composition of surface water in geothermal activities is well known phenomenon due to oxygen exchange between minerals and water. The effect is opposite one from what we expect. Therefore, the ground water cannot be the local precipitation altered by volcanic activity. The possibility for fossil water is easily denied because of abundant discharge of the ground water as lake and river waters. Annual precipitation in central Kalimantan is about 3,000 mm. Fossil origin water cannot maintain such discharge for a long period. Therefore, this can be easily denied. It is preferable for us to pick up remote recharge of the central Kalimantan ground water, possibly somewhere in Northern mountainous area. There is no observational proof whether the region can sustain enough groundwater recharge, since it is not known the precipitation rates in the region. However, from the observation in Yakushima, the precipitation rate in the high altitude in this Island could easily exceed more than couples of thousand millimeters per year. It is well known that the precipitation in high altitude has significantly lower isotope composition, which is called "elevation effect". Elevation effect is a kind of composite effect of temperature and distance from seashore, water vapor source region. The typical elevation effect in oxygen isotope is -0.2 to -0.5 ‰/100 m elevation (Waseda and Nakai, 1983). In order to achieve -3 to -5 ‰ shift in the oxygen isotope composition, the elevation effects for more than 1,000 m altitude is required. Mountains more than 1000 m elevation are located around Central Kalimantan, except southern area, opening



to the ocean. The dating of ground water and identification of active recharge area and rate are desirable for better managing ground water resources in the Central Kalimantan.

#### **Acknowledgment**

We appreciate for supports from University of Palangka Raya during our stay in Palangka Raya. Drs T. Kohyama, H. Takahashi, S. Limin and H. Simbolon assist us to access various locations around Palangka Raya. During Kahayan river expedition, Mr. Matling Torang of Palangka Raya University and Mr. Taruna of Department of Mining and Energy, Indonesia, accompanied us for assisting to find sampling locations, lodging and various information. The financial support for the expedition is from JSPS Core University Program LIPI-Hokkaido University, "Sustainable management in Tropical Rain Forest", which is in place in 1997. The Ministry of Education, Sport and Culture, Japan also provided our travel assistance in the expeditions.

#### **References**

- Allard, P. 1983 The origin of hydrogen, carbon, sulfur, nitrogen, and rare gases in volcanic exhalations: evidence from isotope geochemistry. In: Tazieff, H. and Sabroux, J.C. (eds.), *Forecasting Volcanic Event*, Elsevier, pp. 337-386.
- Giggenbach, W. F. 1992. Isotopic shifts in waters from geothermal and volcanic systems along convergent plate boundaries and their origin. *Earth & Planet. Sci. Lett.*, 113: 495-510.
- IAEA. 1969-90. *World Survey of Isotope Concentration in Precipitation, Environmental Isotope Data*. No.1- No. 9.
- Tokura, S. 1998. *Environmental Conservation and Land Use Management of Wetland Ecosystem in Southeast Asia, Annual Report and Proceedings for International Workshop, 6-9 August 1997, Palangka Raya, Central Kalimantan, Indonesia*, 221 pp.
- Waseda, S. and Nakai, N. 1983. Stable isotope composition in Central and Tohoku Japan, *Chikyuuikagaku*, 17: 83-91 (in Japanese)

## **Surface Water Quality in Central Kalimantan, Indonesia**

**Masaaki KURASAKI<sup>1</sup>, Dede Irving HARTOTO<sup>2</sup>, Takeshi SAITO<sup>3</sup>,  
Mika SUZUKI-KURASAKI<sup>4</sup> and Toshio IWAKUMA<sup>1</sup>**

<sup>1</sup> Department of Environmental Medicine and Informatics, Graduate School of Environmental Earth Science, Hokkaido University, Sapporo 060-0810, Japan

<sup>2</sup> Research and Development Center for Limunology, Indonesian Institute of Sciences, Kompleks LIPI-Cibinong, Cibinong-Bogor 16911, Indonesia.

<sup>3</sup> Department of Environmental Medicine, Hokkaido University Graduate School of Medicine, Sapporo 060-8638 Japan.

<sup>4</sup> Division of Biotechnology, Hokkaido College of High-Technology, Eniwa 061-1396 Japan

### **Abstract**

This study investigated water quality at total 13 sites in 4 rivers (Kapuas, Murung, Kahayan and Sebangau Rivers), 2 channels (Dadahup and Kelambangau), 1 lake (Lake Tundai) and 1 pond (for fish culture) in Central Kalimantan, Indonesia to assess as a base-line study of aquatic environment in Kalimantan. It was noted that the pH values of water samples from rivers except the Kahayan were low indicating that the river water maintained acidic condition. It is surprising that the water of Dadahup channel located in the region of one hundred million hector project showed pH 2.6 and 2.9. The acidic condition of the channel water was estimated to be caused by sulphonic ions, which was considered to be unsuitable for agriculture and drinking water. In sample water from Lake Tundai, lead concentration was higher than that of Japanese Environmental Standard. At a few sampling sites, the lead concentration from rivers also showed a high level. As in the Central Kalimantan, motorboats are utilized as an important public transportation measure, the fuel containing lead may cause lead pollution in these rivers and lakes. Other risk factors such as cadmium and mercury were scarcely detected at all the sampling sites. Further investigation will be needed to clarify the quality of the aquatic environment and effects of water quality on habitant health in Central Kalimantan in Indonesia.

### **Introduction**

In the world, river water has been used as drinking water, irrigation for agriculture and fish culture. In Central Kalimantan of Indonesia, the rivers also play important roles on traffic and economic activities. Guidelines for water reuse (WHO 1989) are controversial. Studies of the water quality are needed to test their validity. Cross-sectional studies of the impact of excreta use in aquaculture, and of waste water use in irrigation have been carried out in several countries. In South Kalimantan of Indonesia, Prihartono *et al.* (1994) reported that 37% of the households regularly or occasionally mix boiled with unboiled water for drinking, or use unboiled water alone. Blumenthal *et al.* (1992) described that in Indonesia, waste water/excreta was used but some health protection that measure existed did not have domestic exposure to pond water, whose quality was around forty times higher than the tentative WHO bacterial guideline for fishpond water. Sometime water reuse has caused the habitants to be infected with diseases. Cross *et al.* (1976) reported that 5.6% of 3,017 inhabitants in West Kalimantan were detected malaria infection.

On the other hand, it is well known that the haze has occurred by the slash-and-bun agriculture in Kalimantan. This fire is considered to influence aquatic ecosystem to ground water and peat water. The Kenyah Dayak in East Kalimantan, who migrated from

their mountainous homeland to a riverine village in the 1940s, have subsisted on slash-and-burn rice cultivation. To cope with rapidly increasing population, the villagers have not changed their farming practice to increase land productivity but instead have exploited fields in remote riverbanks, using motorized canoes (Abe *et al.*, 1995).

However there is little information of water quality in Central Kalimantan, Indonesia. From views of the information, in this study, in order to assess as a base-line study of aquatic environment, we assayed water quality of river, lake, channel in Central Kalimantan. The significance of the obtained results was discussed to elucidate the geographical distribution and the background levels of total trace elements in water environmental in Central Kalimantan.

## Materials and Methods

### *Sample collection*

Water from the rivers of Kapuas, Kahayan and Sebangau was collected on December 11-14, 1998. In addition, water samples of Tundai Lake, two channels and fish culture center were also collected to compare the water quality with river water. All water samples were stored in sterilized polypropylene conical tubes (Falcon, USA) (50 ml). Total number of the sampling sites was 13 sites as shown in Fig. 1. The GPS data of sampling sites are listed in Table 1.

Table 1 GPS data of water sampling sites

| Site No. | Site                        | Date              | Time (local) | Location |         |
|----------|-----------------------------|-------------------|--------------|----------|---------|
|          |                             |                   |              | long. °E | lat. °S |
| 1        | Murung River                | December 11, 1998 | 16:16        | 114.5996 | 2.7990  |
| 2        | Kapuas River                | December 12, 1998 | 8:32         | 114.3702 | 2.9148  |
| 3        | Kahayan River 1             | December 13, 1998 | 12:59        | 113.9204 | 1.6236  |
| 4        | Kahayan River 2             | December 13, 1998 | 14:55        | 113.9511 | 1.9372  |
| 5        | Sebangau River 1            | December 14, 1998 | 12:00        | 113.8519 | 2.3027  |
| 6        | Sebangau River 2            | December 14, 1998 | 13:15        | 113.9064 | 2.2978  |
| 7        | Channel Dadahup 1           | December 11, 1998 | 14:10        | 114.6208 | 2.6954  |
| 8        | Channel Dadahup 2           | December 11, 1998 | 14:42        | 114.6227 | 2.6949  |
| 9        | Channel Jembatan Kalamangan | December 14, 1998 | 16:12        | 114.0333 | 2.2887  |
| 10       | Lake Tundai 1               | December 12, 1998 | 11:33        | 113.9983 | 2.2111  |
| 11       | Lake Tundai 2               | December 12, 1998 | 15:32        | 114.0096 | 2.2084  |
| 12       | Lake Tundai 3               | December 12, 1998 | 16:01        | 114.0141 | 2.2327  |
| 13       | Fish culture pond           | December 11, 1998 | 16:10        | 114.3702 | 2.7587  |

### *Sample preparation and analysis*

The water temperature, conductivity and pH of the samples were measured immediately at each sampling point with a thermometer (Tanita model 5432, Japan), a pH meter (Shindengen, model pH boy-P2, Japan) and a specific conductivity meter (Iuchi model TDS-can3, Japan), respectively. For measuring anion concentrations, the water samples were filtered suction through a 0.45  $\mu\text{m}$  Millipore (USA) filter. The anion concentrations ( $\text{SO}_4^{2-}$  and  $\text{Cl}^-$ ) of the samples were determined with a high performance liquid chromatography (Hitachi HPLC system Lachrom, Japan) using an anion column (4.6  $\times$  50 mm) (Waters IC-Pak, USA). To determine metal contents in water samples, 5 ml of ultrapure analytical grade concentrated  $\text{HNO}_3$  (Tawa Chemical,

Japan) was added to 5 ml of the samples. After digestion of insoluble materials at 80°C for 12 hr, the contents of Mg, Co, Sn, Au, Cd, Pb, Hg, Fe, Cu and Zn in the water samples were analyzed with an inductively coupled plasma mass spectrometry (ICP-MS, Seiko SPQ-6500, Tokyo, Japan) as previously described (Hanada *et al.*, 1998). Furthermore Na, K and Ca contents of the samples were measured with a flame atomic absorption spectrophotometer (Hitachi model 180-80, Japan).

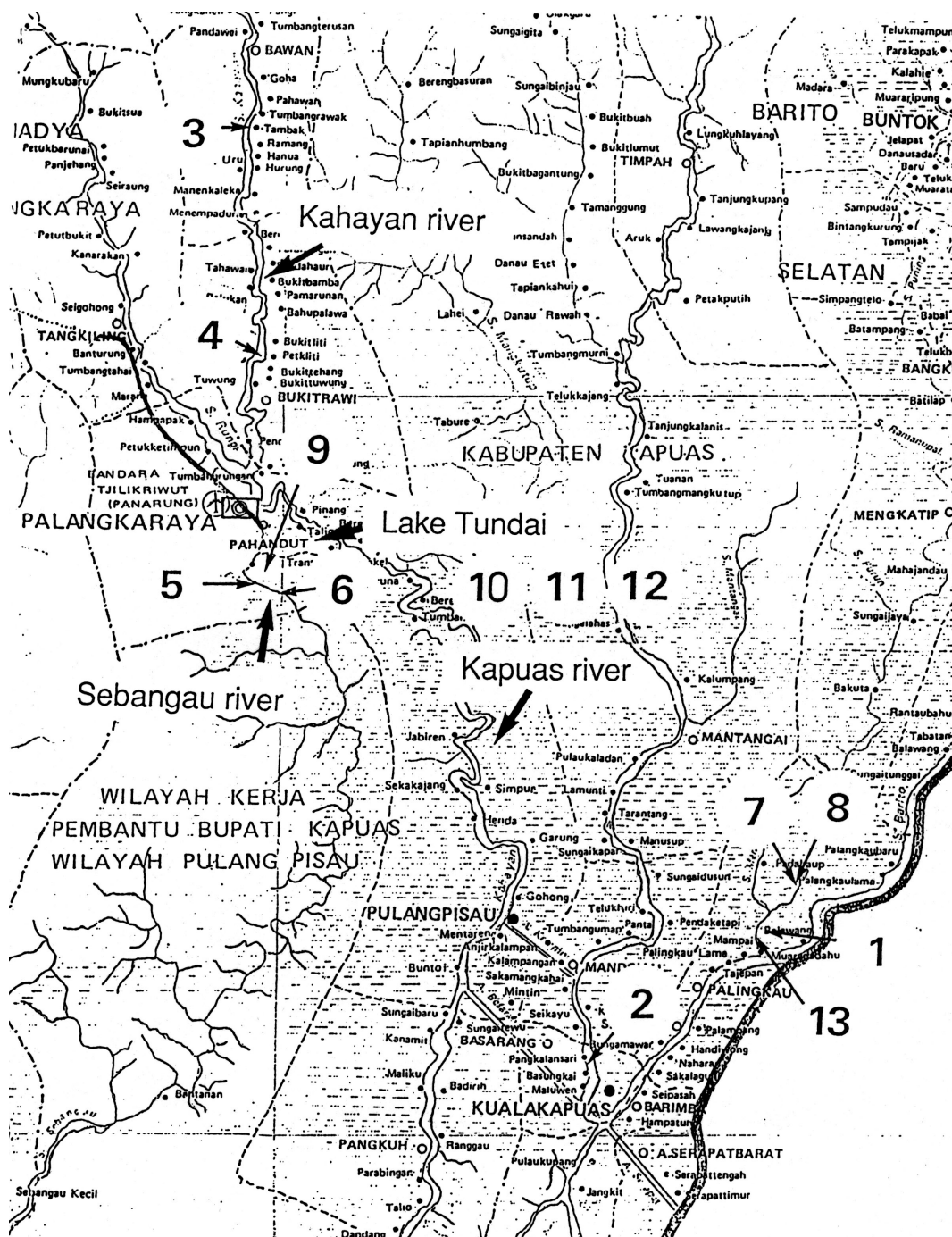

Fig. 1. Map of Central Kalimantan showing sampling locations

### Results and Discussion

The air temperature, water temperature, conductivity, pH and 2 anion ions ( $\text{SO}_4^{2-}$  and  $\text{Cl}^-$ ) concentrations of water samples from rivers, channels, lake and pond in Central Kalimantan are listed in Table 2. Metal concentrations (Mg, Co, Sn, Zn, Cu, Cd, Pb, Hg, Fe, Au, Na, K and Ca) of water samples from the respective sites are shown in Table 3.

Table 2. pH, conductivity and anion concentrations of waters from rivers, channels, lake and pond

| Site Site No.                   | Air temperature, °C | Water temperature, °C | Specific conductivity, $\text{mS m}^{-1}$ | pH  | $\text{SO}_4^{2-}$ $\text{mg l}^{-1}$ | $\text{Cl}^-$ $\text{mg l}^{-1}$ |
|---------------------------------|---------------------|-----------------------|---|-----|---------------------------------------|----------------------------------|
| 1 Murung River                  | 32.0                | 31.3                  | 10.0                                      | 4.8 | 24.9                                  | 0.8                              |
| 2 Kapuas River                  | 32.6                | 29.6                  | 6.0                                       | 4.2 | 10.7                                  | 0.8                              |
| 3 Kahayan River 1               | 33.1                | 30.8                  | 2.0                                       | 6.7 | N.D.                                  | 0.8                              |
| 4 Kahayan River 2               | 33.6                | 30.0                  | 2.0                                       | 6.6 | N.D.                                  | 2.0                              |
| 5 Sebangau River 1              | 32.8                | 28.8                  | 6.0                                       | 4.0 | N.D.                                  | 0.7                              |
| 6 Sebangau River 2              | 33.4                | 31.8                  | 5.0                                       | 3.9 | N.D.                                  | 0.7                              |
| 7 Channel Dadahup 1             | 34.0                | 31.0                  | 38.0                                      | 2.9 | 75.3                                  | 1.4                              |
| 8 Channel Dadahup 2             | 34.3                | 33.0                  | 61.0                                      | 2.6 | 110.0                                 | 6.2                              |
| 9 Channel. Jembatan Kalempangan | 32.1                | 30.8                  | 4.0                                       | 4.0 | N.D.                                  | 0.8                              |
| 10 Lake Tundai 1                | 35.0                | 30.3                  | 1.5                                       | 4.6 | 2.5                                   | 0.4                              |
| 11 Lake Tundai 2                | 35.8                | 34.6                  | 4.0                                       | 3.8 | N.D.                                  | 0.9                              |
| 12 Lake Tundai 3                | 35.0                | 31.0                  | 2.0                                       | 4.5 | 3.6                                   | 0.3                              |
| 13 Fish culture pond            | 32.0                | 34.1                  | 12.0                                      | 4.2 | 24.8                                  | 0.5                              |

N.D. means not detected

Table 3. Metal concentrations of waters from rivers, channels, lake and pond

| Site Site No.                   | Mg $\text{mg l}^{-1}$ | Co $\mu\text{g l}^{-1}$ | Sn $\mu\text{g l}^{-1}$ | Zn $\mu\text{g l}^{-1}$ | Cu $\mu\text{g l}^{-1}$ | Cd $\mu\text{g l}^{-1}$ | Pb $\mu\text{g l}^{-1}$ | Hg $\mu\text{g l}^{-1}$ | Fe $\mu\text{g l}^{-1}$ | Au $\mu\text{g l}^{-1}$ | Na $\text{mg l}^{-1}$ | K $\text{mg l}^{-1}$ | Ca $\text{mg l}^{-1}$ |
|---------------------------------|-----------------------|-------------------------|-------------------------|-------------------------|-------------------------|-------------------------|-------------------------|-------------------------|-------------------------|-------------------------|-----------------------|----------------------|-----------------------|
| 1 Murung River                  | 1.156                 | 2.46                    | 0.05                    | 15.03                   | 0.64                    | 0.014                   | 1.71                    | N.D                     | 117.2                   | N.D                     | 2.31                  | 3.27                 | 0.625                 |
| 2 Kapuas River                  | 0.492                 | 0.91                    | 0.11                    | 12.41                   | 1.57                    | 0.015                   | 0.96                    | N.D                     | 268.6                   | N.D                     | 1.94                  | 1.44                 | 0.431                 |
| 3 Kahayan River 1               | 0.581                 | 1.12                    | 1.90                    | 22.15                   | 3.42                    | 0.068                   | 5.23                    | N.D                     | 32.6                    | N.D                     | 2.27                  | 1.31                 | 1.228                 |
| 4 Kahayan River 2               | 0.477                 | 0.85                    | 0.09                    | 6.40                    | 2.71                    | 0.013                   | 2.09                    | N.D                     | 215.4                   | N.D                     | 2.23                  | 1.29                 | 1.161                 |
| 5 Sebangau River 1              | 0.040                 | N.D                     | 0.01                    | 1.50                    | 0.54                    | N.D                     | 0.09                    | N.D                     | 492.7                   | N.D                     | 0.45                  | 0.73                 | 0.139                 |
| 6 Sebangau River 2              | 0.059                 | 0.02                    | 0.01                    | 5.12                    | 0.66                    | 0.004                   | 0.41                    | N.D                     | 485.6                   | N.D                     | 0.75                  | 1.75                 | 0.200                 |
| 7 Channel Dadahup 1             | 2.225                 | 6.45                    | 0.13                    | 16.83                   | 1.50                    | 0.031                   | 0.33                    | N.D                     | 251.2                   | 0.01                    | 7.07                  | 4.47                 | 0.611                 |
| 8 Channel Dadahup 2             | 3.077                 | 10.13                   | 0.08                    | 39.69                   | 1.65                    | 0.028                   | 1.28                    | 0.29                    | 232.4                   | 0.01                    | 8.34                  | 7.20                 | 1.014                 |
| 9 Channel. Jembatan Kalempangan | 0.039                 | 0.02                    | 0.01                    | 2.76                    | 0.32                    | N.D.                    | 0.10                    | N.D                     | 487.3                   | N.D                     | 1.08                  | 1.96                 | 0.098                 |
| 10 Lake Tundai 1                | 0.314                 | 0.16                    | 0.05                    | 7.99                    | 1.57                    | 0.003                   | 11.48                   | N.D                     | 237.7                   | N.D                     | 1.42                  | 1.10                 | 1.028                 |
| 11 Lake Tundai 2                | 0.136                 | 0.10                    | 0.05                    | 5.75                    | 1.90                    | 0.015                   | 0.28                    | N.D                     | 447.8                   | N.D                     | 3.42                  | 1.18                 | 0.708                 |
| 12 Lake Tundai 3                | 0.235                 | 0.40                    | 0.13                    | 8.36                    | 1.47                    | 0.013                   | 0.76                    | N.D                     | 208.9                   | N.D                     | 1.27                  | 1.25                 | 1.194                 |
| 13 Fish culture pond            | 1.105                 | 2.22                    | 0.09                    | 13.49                   | 2.35                    | 0.012                   | 0.51                    | N.D                     | 340.7                   | N.D                     | 2.16                  | 2.61                 | 0.694                 |

N.D. means not detected

It was noted that the pH values of water samples from rivers except the Kahayan were low indicating that these river water maintained acidic condition. Usually it is considered that pH of river water should show a neutral range, about pH 6.5 to 8.0 to use the drinking water and irrigated water for agriculture (Yamagata, 1979). As shown in Table 2, it is surprising that the water of Dadahup channel (Sites 7 and 8) located in the

region of one hundred million hector planning showed pH 2.6 and 2.9. This channel has been used as an irrigation water for rice cultivation and a living water for habitants. From the analyses of anion ions, the acidic condition of the channel water was estimated to be caused by sulphonic ions (Table 2). The reasonable explanation regarding that the sulphonic ion has been accumulated in the water is still unclear. However we speculate that these acidic condition was occurred by the peat soil after slash-and-burn agriculture. As other remarkable features in the Dadahup channel, high specific conductivity (Table 2), high magnesium, cobalt and zinc concentrations and also high sodium and potassium concentrations (Table 3) were observed. There was no major differences of the other metal concentrations between Dadahup region and other regions including river and lake sites. The pH, conductivity, and sulphonic anion concentration of water samples from the Murung River and fish culture pond were shown the same tendency in comparison with that from Dadahup channel. These sites were thought to receive the influence of Dadahup channel, because the water from Dadahup flowed into near the sampling sites of the Murung River and this river water was incorporated into fish culture pond. In conclusion, from the data presented here the water relating to Dadahup channel is considered to be unsuitable for agriculture and drinking water. If the rice cultivation would be continued in this region, the water and soil should be neutralized using of alkali reagents for efficient rice cultivation and protecting inhabitant health.

In sample water from Lake Tundai (Site 10), lead concentration was higher than that of Japanese Environmental Standard (10 µg/l) (Global Environmental Forum, 1997). In a few sampling sites, the lead concentration from rivers also showed a high level, although the lead level is lower than that of Japanese Environmental Standard (Table 3). Recently Foo and Tan (1998) reported that hair from Singapore contained more mercury, but less cadmium and lead compared to hair from the islands of Indonesia. In Jakarta, Heinze *et al.* (1998) supposed that children attending schools in urban areas with high traffic density belonged a high risk group for lead poisoning. To evaluate lead pollution in each area, they collected soil samples and tap water. The mean blood lead concentration was higher in the central district than in the southern district ( $8.3 \pm 2.8$  vs.  $6.9 \pm 3.5$  µg/100 ml;  $p < 0.05$ ) in a total of 131 children. It is well known that lead poisoning may lead to anaemia, because activities of haem synthesis enzymes are inhibited by lead exposure. In the case of Jakarta, Heinze *et al.* (1998) presumed that from analyses of tap water and soil Indonesian children living in urban areas were receiving lead poisoning by increasing of automobile at increased risk for blood lead levels above the actual acceptable limit. The same speculation was also described by Soemantri *et al.* (1997).

In the Central Kalimantan, motorboats are utilized as an important public transportation measure. We also observed a great deal of traffic by motorboats in these rivers during the investigation period. The fuel containing lead might have caused the lead pollution in these rivers and lakes. The fuel should be changed to that without lead.

There were many miners to obtain alluvial gold in the Kahayan River. In the purification process of gold, mercury is widely used. Then we expected to detect mercury in the water sample from the Kahayan River. However no mercury was detected in all the samples except that from Dadahup Channel (Table 3). Mercury should be analyzed by using Parr bombs during acid digestion, because after heating mercury change to vapor. As in this study, we used open system for acid digestion, it was difficult to determine whether mercury was contaminated into water of the Kahayan River. Regarding mercury poisoning in Indonesia, there are several recent reports as follows. Burger and Gochfeld

(1997) reported on the concentration of heavy metals and selenium in the feathers of cattle egrets *Bubulcus ibis* that were examined from nesting and roosting sites in Bali and Sulawesi, Indonesia. Mercury and manganese concentrations were significantly higher in cattle egrets from Bali compared to Sulawesi, but otherwise there were no significant differences, and there were significant differences in lead, cadmium and mercury among the three egret species nesting on Bali. The cadmium and mercury concentrations related to size and trophic level (insectivorous cattle egrets had the lowest concentrations, fish-eating intermediate egrets had the highest concentrations). Nakagawa and Hiromoto (1997) described that total mercury and methyl mercury levels in hair of residents of Indonesia was lower than in residents of Japan, and that in Indonesia, no subjects had high levels of methylmercury in hair. However their total mercury levels in Indonesian are still higher than that in South Asian countries (Feng *et al.*, 1998). This finding suggested that the high total mercury levels observed in some residents of Indonesia reflected exposure to inorganic mercury.

Other risk factors such as cadmium were detected as low level in the all sampling sites in Central Kalimantan in comparison with the level of Japanese Environmental Standard (Table 3). Suzuki *et al.* (1980) found that Cadmium contents in 116 polished and unpolished rice samples produced in the Java Islands of Indonesia were determined to be  $0.040 \pm 0.042 \text{ mg kg}^{-1}$ . Considering the fact that Indonesians consume about 300 g of rice daily, the daily intake of Cd would exceed the tolerable limit proposed by the FAO/WHO and could cause slight chronic renal damage to the rice eaters. However in Central Kalimantan cadmium content in the rice grown using the water at the present sampling site was expected to be lower than that reported by Suzuki *et al.* (1980). Especially the Sebangau River, the concentration of metals showed adequate levels. However other rivers contained zinc and iron enough to use as drinking water. As only drinking water, total dietary intakes of zinc of the people from these rivers except Sebangau was estimated to be more than 20 mg/person, which was higher than the recommended dietary allowance of daily zinc intake from foods by the American standard diet (15 mg/person).

Prihartono *et al.* (1994) performed follow-up survey of the same households during 6 months to measure prevalence. The results of the study indicated that 97% of the households report that they regularly boil their drinking water. However, 37% of the households regularly or occasionally mix boiled with unboiled water for drinking, or use unboiled water alone. They concluded that the use of unboiled water was associated with higher rates of childhood diarrhoeas in the households studied. From the viewpoint of public health, non boiling water has carried risk of infection.

Two years' follow-up investigation of a hepatitis E virus (HEV) outbreak in West Kalimantan, Indonesia in 1991 was reported to investigate the epidemiology of epidemic HEV transmission. Overall, the prevalence of anti-HEV IgG among the 445 subjects (representing 127 households) was 59% (Corwin *et al.*, 1995). They described that use of river water for drinking and cooking ( $P < 0.001$ ) was associated with high prevalence communities (Blumenthal *et al.*, 1992). WHO (1989) guidelines can be tested using cross-sectional epidemiological studies which indicate that guidelines for restricted irrigation and for aquaculture may be around the right level. Mosquito species which intermediated malaria were reported to inhabit irrigated and rain-fed rice fields of North Sulawesi, Indonesia (Mogi *et al.*, 1995). The effect of irrigation system introduction on regional mosquito abundance cannot be evaluated by the enlarged surface water area

alone. Prevalence rates of malaria were consistent in the four villages in Irian Jaya, averaging 10% for infants, 50% for children 1-4 years of age, 35% for those 5-9 years old, 28% for those 10-14 years old, and 16% for adults (greater than 15 years old) (Anthony *et al.*, 1992). Changes in habitat quality and custom, expressed as the abundance per dip (index of density per unit water area), also need to be investigated to elucidate the risk of infection concerning water quality.

Further investigation will be needed to study the water environment and effects of water quality on habitant health in Central Kalimantan in Indonesia.

### Acknowledgements

The authors are gratefully indebted to Ms Sulastri, Aquatic Dynamics Division, Research and Development Centre for Limnology, and Mr. Suwido H. Limin, Faculty of Agriculture, University of Parangka Raya for their helpful advice and discussion, and for sampling of water.

### References

- Abe, T., Ohtsuka, R., Watanabe, M., Yoshida, M. and Futatsuka, M. 1995. Adaptation of the resettled Kenyah Dayak villagers to riverine environment in East Kalimantan: a preliminary report. *J. Hum. Ergol., (Tokyo)* 24: 33-36.
- Anthony, R. L., Bangs, M. J., Hamzah, N., Basri, H., Purnomo and Subianto, B. 1992. Heightened transmission of stable malaria in an isolated population in the highlands of Irian Jaya, Indonesia. *Am. J. Trop. Med. Hyg.*, 47: 346-356.
- Blumenthal, U. J., Abisudjak, B., Cifuentes, E., Bennett, S. and Ruiz-Palacios, G. 1991-92. Recent epidemiological studies to test microbiological quality guidelines for wastewater use in agriculture and aquaculture. *Public Health Rev.*, 19: 237-242.
- Burger, J. and Gochfeld, M. 1997. Heavy Metal and Selenium Concentrations in Feathers of Egrets from Baliand Sulawesi, Indonesia. *Arch. Environ. Contam. Toxicol.*, 32: 217-221.
- Corwin, A., Jarot, K., Lubis, I., Nasution, K., Suparmawo, S., Sumardiati, A., Widodo, S., Nazir, S., Orndorff, G. and Choi, Y. 1995. Two years' investigation of epidemic hepatitis E virus transmission in West Kalimantan (Borneo), Indonesia. *Trans R. Soc. Trop. Med. Hyg.*, 89: 262-265.
- Cross, J. H., Clarke, M. D., Cole, W. C., Lien, J. C., Partono, F., Djakaria, Joesoef, A. and Oemijati, S. P 1976. arasitic infections in humans in West Kalimantan (Borneo), Indonesia. *Trop. Geogr. Med.*, 28: 121-130.
- Feng, Q., Suzuki, Y. and Hisashige, A. 1998. Elements in the hair of South-east Asian islanders. *Sci. Total Environ.*, 209: 185-192.
- Foo, S. C. and Tan, T. C. 1998. Hair mercury levels of residents in China, Indonesia, and Japan. *Arch. Environ. Health*, 53: 36-43.
- Global Environmental Forum 1997. *Environmental data*. Kokin Syoin, Tokyo.
- Hanada, T., Isobe, H., Saito, T., Ogura, S., Takekawa, H., Yamazaki, K., Tokuchi, Y. and Kawakami, Y. Intracellular accumulation of thallium as a marker of cisplatin cytotoxicity in nonsmall cell lung carcinoma. *Cancer*, 83: 930-935.
- Heinze, I., Gross, R., Stehle, P. and Dillon, D. 1998 Assessment of lead exposure in schoolchildren from Jakarta. *Environ. Health Perspect*, 106: 499-501.



- Mogi, M., Memah, V., Miyagi, I., Toma, T. and Sembel, D. T. 1995. Mosquito (Diptera: Culicidae) and predator abundance in irrigated and rain-fed rice fields in north Sulawesi, Indonesia. *J. Med. Entomol.* 32: 361-367.
- Nakagawa, R. and Hiromoto, M. 1997. Geographical distribution and background levels of total mercury in air in Japan and neighbouring countries. *Chemosphere* 34: 801-806.
- Prihartono, N., Adisasmita, A., Costello, C., Damayanti, R., Prasetyo, S. and Syarif, S. 1994. Water preparation practices in south Kalimantan, Indonesia. *J. Diarrhoeal Dis. Res.*, 12: 279-286.
- Soemantri, A. G., Hapsari, D. E., Susanto, J. C., Rohadi, W., Tamam, M., Irawan, P. W. and Sugianto, A. 1997. Daily and weekly iron supplementation and physical growth of school age Indonesian children. *Southeast Asian J. Trop. Med. Public Health* 28 Suppl., 2: 69-74.
- Suzuki, S., Djuangshi, N., Hyodo, K. and Soemarwoto, O. 1980. Cadmium, copper, and zinc in rice produced in Java. *Arch. Environ. Contam. Toxicol.* 9: 437-449.
- Yamagata, N. (ed.) 1979. Standard values in Environment; a back ground on the basis of science. Japanese Chemical Association, Tokyo.

## **Relationship of Water Level to Water Quality in an Oxbow Lake of Central Kalimantan**

**Dede Irving HARTOTO**

Research and Development Center for Limnology- Indonesian Institute of Sciences,  
Kompleks LIPI Cibinong, Jl. Raya Jakarta Bogor Km 46, CIBINONG BOGOR 16911,  
Indonesia

Tel: +62 21-8757071, Fax: +62 21-8757076, E-mail: lhartoto@indo.net.id

### **Abstract**

Long-term monitoring of water quality was conducted in the oxbow Lake Takapan (50.42 ha), in the main river (Kahayan River) and its tributary (Rungan River) to clarify the relationships between water level and water quality parameters or between water quality of rivers and that of lake. Water level relative to bank overflow was measured daily and basic water quality parameters, such as dissolved oxygen, pH, water and air temperatures, conductivity, turbidity and oxidative reductive potentials (ORP) were measured five days a week between August 1996 to December 1997. Mean and 95% confidence limits of water level was  $-95.53 \pm 15.61$  cm, which indicated that most of the time the water level was below the bank overflow level. Means and 95% confidence limits of pH, dissolved oxygen, conductivity, turbidity, water temperature and ORP were  $5.31 \pm 0.08$ ,  $2.51 \pm 0.20$  mg/l,  $0.007 \pm 0.001$  mS/cm,  $60.92 \pm 6.23$  NTU,  $28.35 \pm 0.16$  °C,  $26.96 \pm 0.13$  °C and  $348.95 \pm 7.88$  mV, respectively. All water quality parameters except turbidity were significantly correlated with water level ( $p < 0.05$ ). With increasing water level, pH, water temperature, air temperature and dissolved oxygen decreased whereas conductivity and ORP tended to increase. The water quality of Lake Takapan was influenced by that of the inflowing Rungan River more significantly than the Kahayan River.

### **Introduction**

Oxbow lake is a surface water body that develops due to change in river watercourse in geological time scale. The occurrence of deposition and erosion zones are always found at the bend of the river course. If we observe the river water course from upstream to downstream, the deposition of eroded matters always located on the inner side of the bend and the scouring process could be observe in the outer side of the bend. Through the change of the strength of water flow in their maturity process, the river course may move to the different location nearby. As the consequence, it will leave a more or less lentic water body that has a variety of connections to the river. The lake basin usually of crescent shape resembles the bow on the back of an ox. The degree of connection of river water to the oxbow lake depends on the stage of river and the lake maturity. The combination of natural forces, in its turn determined the availability of spatial habitat resources for aquatic life especially the freshwater fishes. On the other hand, the form and structure of fish community are linked to habitat type (Barella and Petrere, 1994).

Oxbow lakes and related water bodies are important habitat types supporting inland water fishery production in Central Kalimantan (Hartoto, 1998). Oxbow lakes as the representative of the cut-off portion of meander bend in a floodplain system are known to sustain spatial resources for feeding, roaming and spawning of several fish species. The fishes that inhabit the oxbow lake are the white fishes, e.g., "ikan Pipih"

(=feather backs, *Notopterus notopterus*) and “Baung” (*Mystus nemurus*) and the blackfishes, e.g., “ikan Sepat” (=Goramis, *Trichogaster pectoralis*) and “Snake heads” (*Channa micropeltes*). The availability of habitat resources for river fishes in the oxbow lake depends on the water level relative to the bank overflow level. Usually, during the time of the long dry season, most of the white fishes change their mass body tissue (fat and protein) into generative material, such as ovaries (Hartoto, 1983). The fishes with the ripe gonad then wait for the environmental signals, such as the existence of pheromone, abundant food resources for the young and the petrochor as the trigger for the spawning process (Boyd, 1990). There is a question if in any case the water quality in the oxbow lake is always suitable, for at least temporarily sustain the fish life requirement. Experience show that the time of bank overflow is one of important phenomenon for the success of several fish species, since many oxbow lake dwelling fish species spawn, feed or take refuge in the lake in this period. Change in water level may alter the hydrological conditions such as exchange of water between the lake and adjacent rivers. In the above context, as initial step, the present study was aimed to reveal the relationship between water level and general water quality parameters based on the long-term monitoring in an oxbow lake.

## Materials and Methods

### Description of study site

This study is conducted in Lake Takapan, an ear shaped oxbow lake of 50.42 ha surface area that is located in Palangkaraya Municipality, Central Kalimantan (Fig. 1). The lake is classified as Oxbow Lake Type III, which at high water time receives water both from the main river (Kahayan River) and one of its tributaries (Rungan River) (Hartoto, 1998). Lake Takapan have two connecting channels with the Rungan River and one connecting channel with the Kahayan River. During the long dry season, the lake first lose its connection with the Kahayan River but always remain connected to the Rungan River through the channel at south of the lake. The maximum depth of the lake is more than 10 m at high water time. Lake Takapan and its vicinity are the fishing ground for more than 30 local fishers and many other fishers from other areas. This lake is also a fish-trading place for the fishers. In the vicinity of Lake Takapan there is one big spawning site for fishes (Lake Tabiri) well known to the fisher which serve as the refugia for the young fishes, spawning and nursery sites for the adult blackfishes such as the Climbing Perches (*Anabas testudineus*) and the Kissing Gouramis (*Helostoma temminckii*). The list of fish species recorded in this lake is up to 62 species, which is dominated by the Cyprinids (Hartoto, 1998).

### Water level monitoring

The monitoring site was located at Jelawat Research Station of Central Kalimantan Fishery Office, which lies near the southern connecting channel of the lake with the Rungan River. Water level was recorded at 06.00, 12.00 and 18.00 everyday from 24 August 1996 until 21 December 1997 (484 days) to the nearest 1 cm using a scaled staff gauge which was erected at the connecting mouth of the lake with the Rungan River. The average of the data at the three-observation times was then corrected with the level of bank overflow (0 m). Water levels below the bank overflow level were recorded with negative signs whereas those above the bank overflow level with positive signs.

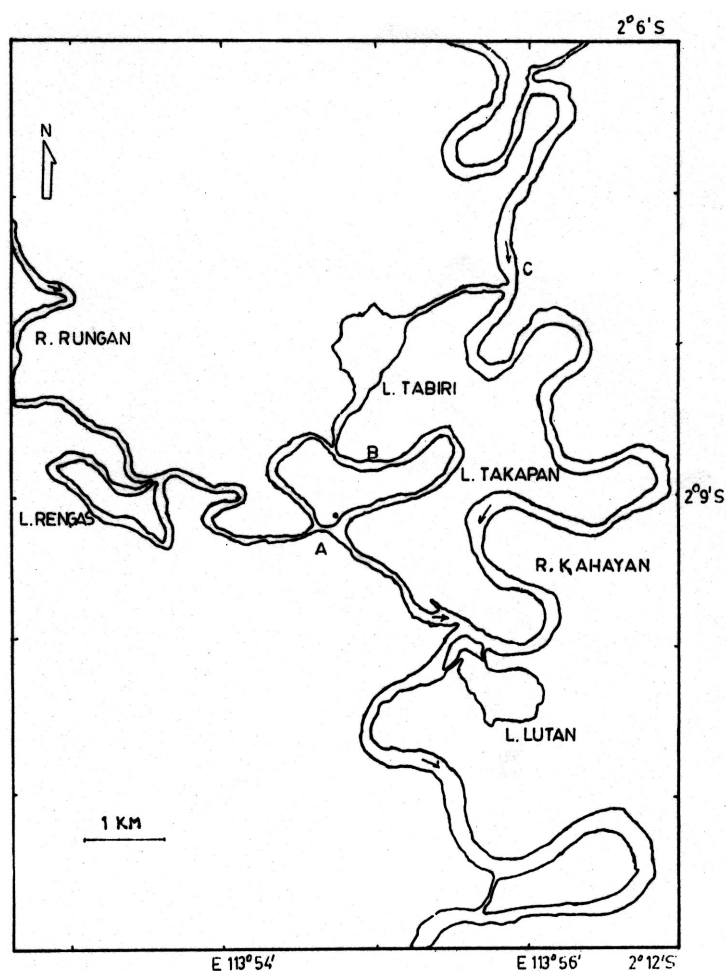

Fig. 1. Map of Lake Takapan and adjacent segment of the Rungan River and the Kahayan River.

### Water quality measurement

Air and water temperatures, pH, dissolved oxygen, conductivity and turbidity were measured using a HORIBA water quality checker. Oxidative reductive potentials (ORP) was measured with TRX-90 TOKO ORP meter. The water quality parameters at 1 m depth were measured in triplicate at Jelawat Research Station at 05.00 (sunrise), 15.00 (highest photosynthesis period) and 18.00 (sunset) Sunday through Thursday every week. Average values of nine (three by three) measurements were used for statistical analyses. To give an insight whether or not the water quality of the Kahayan River and the Rungan River influenced the lake water quality, a simultaneous monitoring of these three habitats was conducted on the same day in the Rungan River (Station A in Fig. 1), middle of Lake Takapan (Station B) and in the Kahayan River (Station C). At each station, a triplicate measurement of each parameter for a depth profile of 1-m intervals was collected 10 times between August 1996 to March 1997. A rain gauge was also installed at the station from October 1996 to December 1997.

### Data analysis

The data collected were plotted using Microsoft Excel 97 and analyzed statistically according to the methods described by Steel and Torrie (1967) with the aid of the MICROSTA Program.

## Results and Discussion

### Water level

The water levels in Lake Takapan were generally under the bank overflow level with mean and 95% confidence limits  $-110.96 \pm 14.56$  cm (Fig. 2). During the 484 observation days, only 157 days (32.4%) the water level was above the bank overflow level. In that period, the Central Kalimantan was in the time of long drought due to El Niño phenomenon. However Lake Takapan was always connected to the Rungan River through its southern connecting channel even at the period of lowest water.

The highest water level (+269 cm) was observed on 15 December 1996 and the lowest water level (-347 cm) occurred about 9 months later, on 3 September 1997. From the changes in monthly precipitation (Fig. 3), we can observe five consecutive months (June to October 1997) with very little rain although the total yearly rainfall (1,826 mm) between October 1996 to September 1997 was still high ( $> 1,500$  mm). This type of precipitation data was a characteristic of global climatic classification as tropical rain forest climate or monsoon wet tropical climate. The monthly average number of rainy days during the study period was 8.2 days and monthly average rainfall 149.6 mm.

The draw down in this oxbow lake was very high (6.16 m), which was calculated from the data in Fig. 2. From this, we can deduce that there are a lot of contraction and expansion in the size and the depth of the oxbow lake even though the time of the study was not an ordinary one.

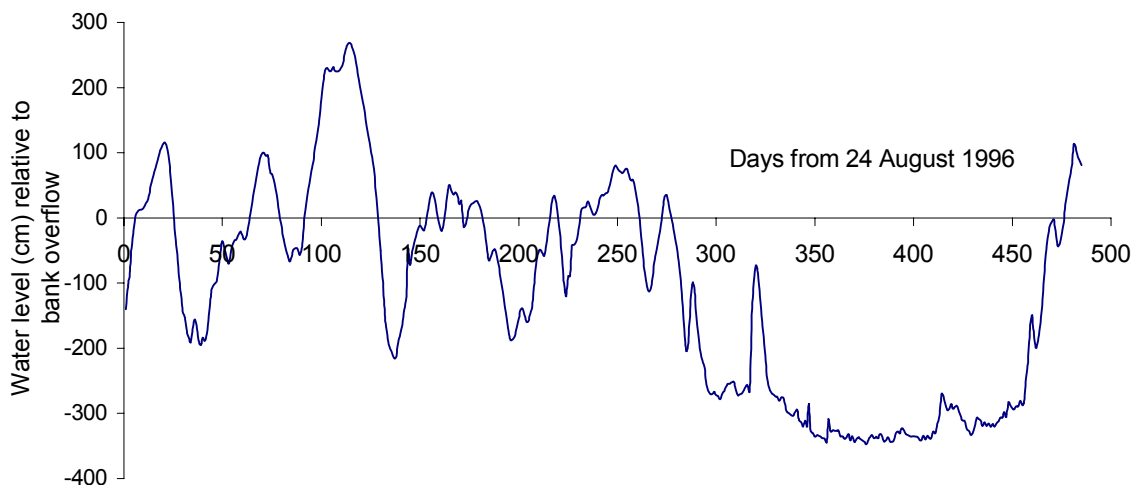

Fig. 2. Change in water level in Lake Takapan from 24 August 1996 until 21 December 1997

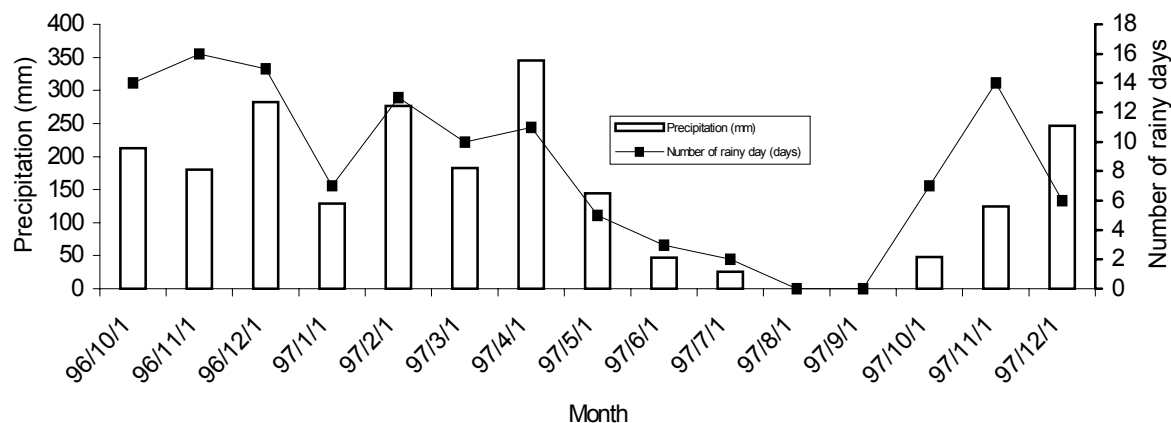

Fig. 3. Monthly precipitation and number of rainy days in Lake Takapan between October 1996 to December 1997

### Water quality

Water quality data were recorded for 226 days (46.7%), of which 82 days were taken at the time when the water level was above the bank overflow level. However the average water level during the days of water quality measurement was below the bank overflow level ( $-60.92 \pm 19.05$  cm,  $\pm 95\%$  confidence limits). Among the many physical, chemical and biological processes, three basic mechanisms have been identified to control surface water chemistry, i.e., precipitation, the nature of the bedrock and the evaporation-crystallization process (Gibbs, 1970).

The pH (Table 1) in the connecting channel of Lake Takapan was relatively low ( $5.31 \pm 0.08$ ) although it was always receiving water from the Rungan River. Lowest pH (4.47) observed on 2 December 1997 (at -91 cm), and the highest pH (6.95) on 4 November 1997 (at -315 cm). The pH values in this lake

Table 1. Mean and 95% confidence limits for general water quality parameters at the monitoring station in Lake Takapan

|                  | Parameters       |      |           |                      |               |                        |                      |          |
|------------------|------------------|------|-----------|----------------------|---------------|------------------------|----------------------|----------|
|                  | Water level (cm) | pH   | DO (mg/l) | Conductivity (mS/cm) | Turbidity NTU | Water temperature (°C) | Air temperature (°C) | ORP (mV) |
| Mean             | -60.92           | 5.31 | 2.51      | 0.008                | 60.9          | 28.4                   | 27.0                 | 348.9    |
| Confidence limit | 19.05            | 0.08 | 0.19      | 0.001                | 6.2           | 0.2                    | 0.1                  | 7.9      |
| n                | 226              | 226  | 212       | 226                  | 226           | 226                    | 226                  | 207      |

were comparable to pH values in limnetic swamp forest of Tasek Bera (4.45-6.10) (Ikusima *et al.*, 1982a) but lower than the pH range (5.4-6.5) of two major lakes, Tasek Beringin and Tasek Bungor in the Ulu Lepar Wetland systems in Malaysia (Khan, 1990). The low pH values of Lake Takapan meets the range of pH (4-7) for the characteristics of blackwater lakes classified by Rai and Hill in Payne (1965). Although the low pH may not be suitable for fish life (Boyd, 1990), the fish species in Lake Takapan seems to have already adapted to this situation.

Average dissolved oxygen concentration was also low as  $2.51 \pm 0.19$  mg/l, with the lowest value (0.61 mg/l) observed on 17 December 1997 (at 113 cm water level) after the period of very long drought. These dissolved oxygen values was quite similar to the oxygen level in limnetic part of Tasek Bera ranging between 1.01-3.15 mg/l (Ikusima *et al.*, 1982b). In the floodplain habitat of the river during the dry season, dissolved oxygen level usually links to several factors such as the size of water body, degree of thermal stratification, vegetation cover, phytoplankton growth and wind action. A higher number of cyprinid species are distributed in this area than the species with breathing organs, such as labyrinth and arborescent organs (Hartoto, 2000). Although they do not possess these organs cyprinid fish species seem to be capable of adapting to low dissolved oxygen water in other ways, e.g., having smaller dorsal oriented mouths and smaller heads and high blood affinity to oxygen (Lagler *et al.*, 1977; Welcome, 1979)

The mean conductivity in Lake Takapan was  $0.007 \pm 0.001$  mS/cm ( $\pm 95\%$  confidence limits). The lowest conductivity value (0.002 mS/cm) was observed on 15 January 1997 at -72 cm water level whereas the highest value (0.032 mS/cm) on 25 November 1997 nearly at the end of long drought period (at -165 cm). Similarly to the low pH range, low conductivity is also a characteristic of a blackwater lake in Amazon watershed according to Ray and Hill's classification. Low conductivity is common in blackwater lakes such as Tasek Bera where the value range between 0.0105-0.0230 mS/cm (Lim and Furtado, 1982).

The average turbidity was  $60.9 \pm 6.9$  NTU, with the lowest value (6 NTU) observed on 1 June 1997 at -96 cm water level and the highest value (232 NTU) on 12 December 1996 at the period (+ 238 cm). The average turbidity value was not so high but the range between the minimum and maximum values was large, which was probably due to the scouring effect of rain on some denuded forests loosening and washing some particles away from the forest floor, and carrying it as a part of surface run, which in the end might have increased the turbidity. There were in fact some denuded forest areas near Lake Takapan due to forest fire and timber cutting.

Average water temperature ( $28.4 \pm 0.2^\circ\text{C}$ ) was higher than the average air temperature ( $27.0 \pm 0.1^\circ\text{C}$ ). The lowest water temperature ( $24.6^\circ\text{C}$ ) was recorded on 3 December 1997 that coincided with the day of lowest air temperature ( $23.9^\circ\text{C}$ ). The highest water temperature ( $32.8^\circ\text{C}$ ) was observed on 28 September 1996 (at -156 cm water level) whereas the highest air temperature ( $29.7^\circ\text{C}$ ) was observed on 6 October 1996 (at -118 cm). This pattern revealed that there was a large temperature variation in this lake which in contrast to the lakes in Amazon basin where the water temperature is more stable at  $29 \pm 1^\circ\text{C}$ . A large variation ( $22-30^\circ\text{C}$ ) between the maximum and minimum temperatures within the upper water column is similarly observed in three lake systems in Rio Doce Valley Lakes in the southeast regions of Brazil (Henry *et al.*, 1997). Different from the climate in Lake Takapan, the climate near the Brazilian Lakes

is defined as semi humid tropical climate with 4 to 5 dry months (Tundisi, 1997). The degree of insolation, substrate composition, turbidity, ground-or rainwater inflows, wind and vegetation cover, can all influence the temperature of water in rivers and flood plain lakes (Welcome, 1979).

Oxidative reductive potential (ORP) in Lake Takapan was on average  $348.9 \pm 7.9$  mV, with the highest ORP values observed on 12 November 1996 when the water level was -32 cm. The lowest ORP level (248 mV) was observed on 30 August 1997 when the water level was low (at -337 cm) in the El Nino period. The ORP value is the index of the proportion of oxidized to reduced substances in the water. This fact means that although there were still some amount of oxidative materials, there were significant amounts of reduced substances during the present study. Possible source of the reduced substances might be aerosol materials originated from the haze produced by the forest fire, which have fallen onto the surface water. The present ORP values were lower than the range of ORP values (0.45-0.52 V) of oxygenated natural waters shown by Hutchinson (1957). In the pH range of Lake Takapan, according to the diagram described by Hem (1975), the oxidation-reduction condition of the lake was poised equilibrium at a value between -0.32 V to +0.89 V. In relation to sulfur species, the water of Lake Takapan cannot be classified as oxidized or reduced water. Most of the sulfur in the water was found as sulfate ion in the present pH range of 5.23-5.39.

#### **Relationship of water level and water quality**

The data in Table 2 indicate that turbidity is the only parameter under studied that not significantly correlated with the water level. Other general water quality parameters are significantly correlate to water level at  $\alpha = 0.05$ . The strongest correlation of water level is with pH, DO and water temperature. The contribution of variation of water level to variation of those parameters represented by  $r^2 = 0.504, 0.403$  and  $0.547$  for pH, DO and water temperature respectively. Probably there are other environmental factors beside water level that contribute to the variation of pH, DO and water temperature. As shown by the data in Table 3 and Table 4, the water temperature in Lake Takapan is significantly influenced by water temperature both in the Rungan River and the Kahayan River. The dissolved oxygen level in the lake is correlated to the pH of the Rungan River. The pH of Lake Takapan is changing in coincidence with the changing of pH in River Rungan. The limnological data of the Rungan River (Table 3) indicate that the river with its weak tea to black coffee color low pH can be grouped as blackwater river as classified by Sioli (1984). On the other hand, the Kahayan River with its ochre color water and 0.20-m Secchi disk transparency classified as whitewater river according to the same classification.

Increasing conductivity of the Rungan River tend to decrease the pH in Lake Takapan. The water of the Rungan River as a blackwater river with low pH contains a lot of negative ions, (measured by conductivity). Presumably, it constitutes mostly by negative hydrogen ion. An increase of conductivity in the Rungan River will contribute a lot of hydrogen ion to Lake Takapan, so as its consequence, lowering the pH. The statement on the pattern further supported by regression Eq. 7 in Table 4.



Table 2. Linear regression equations for the relationship between water level (WL) and various general water quality parameters in Lake Takapan

| No. | Equation of linear regression       | n   | R       | R <sup>2</sup> |
|-----|-------------------------------------|-----|---------|----------------|
| 1.  | Log pH = -0.0002 WL + 0.7082        | 226 | -0.720* | 0.504          |
| 2.  | Log DO = -0.0011 WL + 0.2635        | 212 | 0.634*  | 0.403          |
| 3.  | Log Conductivity = -0.0009WL-2.2852 | 226 | 0.399*  | 0.197          |
| 4.  | Log Turbidity = 0.0001WL +1.6638    | 226 | 0.059   | 0.003          |
| 5.  | Log WT = -0.00008 WL +1.4474        | 226 | -0.584* | 0.341          |
| 6.  | Log AT = -0.00003 WL + 1.428        | 226 | -0.227* | 0.052          |
| 7.  | Log ORP = 0.0003 WL + 2.5531        | 207 | 0.538*  | 0.290          |

\* Significant at 0.05 probability level

Table 3. Average values of water quality parameters in the middle of Lake Takapan, the Kahayan River and the Rungan River based on ten times simultaneous monitoring between August 1996 to March 1997

| Parameter                   | Lake Takapan | Rungan River | Kahayan River |
|-----------------------------|--------------|--------------|---------------|
| Water temperature (WT), °C  | 29.32        | 28.96        | 28.18         |
| Dissolved oxygen (DO), mg/l | 2.06         | 3.09         | 4.20          |
| pH                          | 4.75         | 4.72         | 5.48          |
| Conductivity(Con), mS/cm    | 0.006        | 0.005        | 0.014         |
| ORP, mV                     | 459.4        | 399.1        | 355.6         |
| Secchi depth, m             | 0.46         | 0.36         | 0.20          |
| Air Temperature (AT), °C    | 26.21        | 30.03        | 29.03         |
| Turbidity (Turb), NTU       | 41.1         | 70.8         | 148.5         |

Table 4. Regression equations for significant correlations between water quality parameters in the middle of Lake Takapan, the Kahayan River and the Rungan River based on ten times monitoring between August 1996 to March 1997

| No | Equation  | r        | r <sub>multiple</sub> <sup>2</sup> | R <sup>2</sup> <sub>partial</sub>   | F           |
|----|---|----------|------------------------------------|---|-------------|
| 1  | WT <sub>Takapan</sub> = -15.0200 + 1.52626 WT <sub>Rungan</sub>   | 0.6775*  | 0.4590                             |   | 5.939       |
| 2  | WT <sub>Takapan</sub> = 26.3512 + 0.0336Turb <sub>Rungan</sub>  | 0.8056*  | 0.6490                             |   | 11.09       |
| 3  | WT <sub>Takapan</sub> = 25.7828 + 258.6826Con <sub>Kahayan</sub>  | 0.7714*  | 0.5951                             |   | 8.82        |
| 4  | DO <sub>Takapan</sub> = -5.5350 + 1.7486pH <sub>Rungan</sub>  | 0.9239*  | 0.9612                             |   | 36.43       |
| 5  | pH <sub>Takapan</sub> = 0.5598 + 0.8788pH <sub>Rungan</sub>   | 0.9320*  | 0.8690                             |   | 19.91       |
| 6  | pH <sub>Takapan</sub> = 6.1355 - 299.5455Con <sub>Rungan</sub>  | -0.9016* | 0.8130                             |   | 13.04       |
| 7  | pH <sub>Takapan</sub> = 2.8697 - 161.5078Con <sub>Rungan</sub> + 0.5559pH <sub>Rungan</sub>                                 | 0.9940*  | 0.9880                             | r <sup>2</sup> Con = 0.9087<br>r <sup>2</sup> pH = 0.9087                                 | 86.20       |
| 8  | pH <sub>Takapan</sub> = 1.2240 - 0.0058Turb <sub>Rungan</sub> - 126.0268Con <sub>Rungan</sub> + 0.9741 pH <sub>Rungan</sub> | 1.000**  | 0.9999                             | r <sup>2</sup> Con = 0.9087<br>r <sup>2</sup> pH = 0.9087<br>r <sup>2</sup> Turb = 0.9930 | 3997.3<br>0 |
| 9  | Con <sub>Takapan</sub> = 0.0198 + 0.0839 pH <sub>Kahayan</sub>  | -0.8798* | 0.7740                             |   | 10.30       |

\* Significant at 0.05 probability level; \*\* Significant at 0.01 probability level

Eq. 8 in Table 4 indicated that higher turbidity in the Rungan River would decrease the pH of Lake Takapan. The pattern probably could be explained by the possibility that the material that composed the Rungan River turbidity was aquatic

humic substances. As already stated before, the change of water level in the lake did not influence turbidity of Lake Takapan, but probably the input of water from the Rungan River contributed much more to vary turbidity in Lake Takapan.

Weakest correlation was indicated by the relationship between water level in Lake Takapan and log conductivity and air temperature (Table 2). A great number of physical phenomena, such as evaporation, condensation, transpiration and the countless plant and animal activities are closely linked to air temperature (Salati and Marques, 1984). Eq. 6 in Table 2 shows that when the water level increased, the air temperature tended to decrease. This is probably because more water surface expose to the air and sun, and as the result, more forest canopy submerged under high water. Consequently, it will further accelerate the evaporation process that in turn will decrease air temperature.

pH tend to decrease with increasing water level (Fig. 4). Increasing water level means more inundated land in adjacent riparian systems of the oxbow lake and as its consequences there occurs more intense dissolution of acidic materials originated from organic matter decomposition. It is well understood that there is a lot of organic material in the floor of tropical swamp forest.

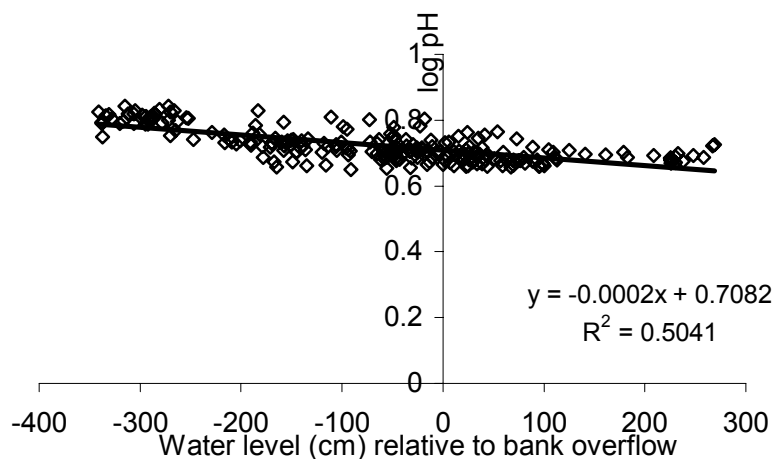

Fig. 4. Scatter diagram of relationship between water level and pH in Lake Takapan

Low water period is suspected to be the period of higher photosynthetic activity. This activity sustained by more concentrated nutrient due to the decrease in water volume and the settlement of dissolved organic matter such as aquatic humic substances to the sediment. The humic substances can absorb radiation in the UV and visible ranges (Thomas, 1997). Lake Takapan reported to have high humic acid concentration in the range of 23.05-361.91 mg/l (Hartoto and Yustiawati, 1999). This dissolved organic matter probably already settles to the bottom of the lake at the period when the water level was below the bank overflows level. This condition was suspected to be favorable for intensive photosynthesis that resulted in removal of carbon dioxide. The carbon dioxide removal, which is follow by consecutive carbonate accumulation and hydrolysis probably, can explain the increase of pH (Boyd, 1990).

Dissolved oxygen level and water temperature showed a similar pattern (Figs. 5 and 6) with the pH. The dissolved oxygen tend to decrease with increasing water level and oxygen depletion seems to occur when the water level was above the bank overflow level. This is probably due to high oxygen demand required for the decomposition of organic litter in the forest floor and increasing input of humic substances because wider land that was newly inundated. The land presumably contains a lot of peaty material that produced humic substances.

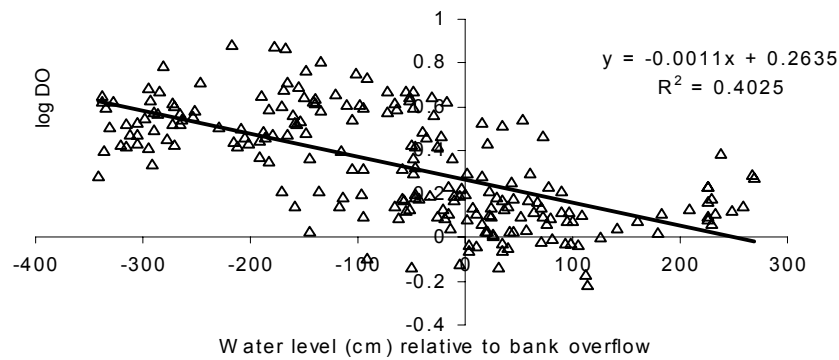

Fig. 5. Scatter diagram of relationship between water level and DO in Lake Takapan

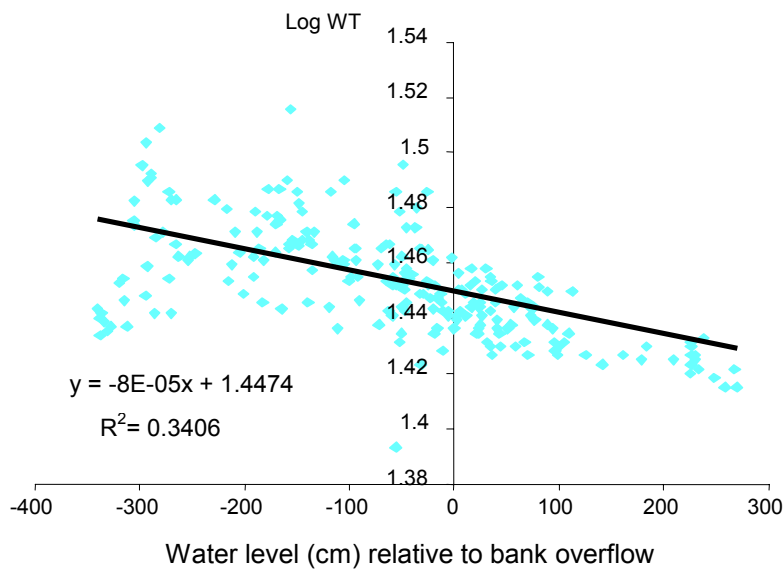
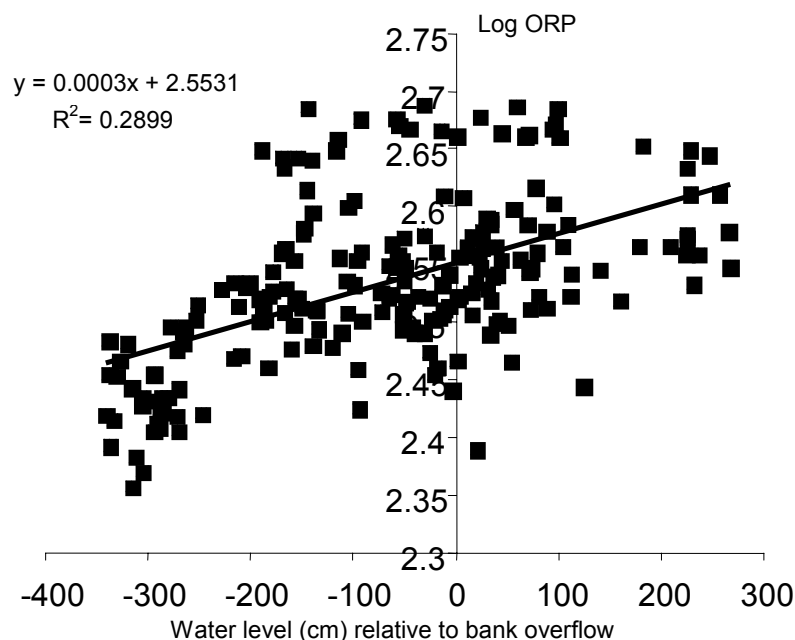

Fig. 6. Scatter diagram of relationship between water level and water temperature in Lake Takapan

Fig. 7 indicates that the ORP values tend to increase with increasing water level. The water level in the lake increased due to a higher input of relatively oxygenated river water through the Kahayan River (DO = 3.09 mg/l) and the Rungan River (DO = 4.20 mg/l) during the rainy season. Since the Kahayan River was connected to Lake Takapan

only at the period of high water level, it seems that the Rungan River have much more influence to the water quality of Lake Takapan (Tables 3 and 4).



ig. 7. Scatter diagram of relationship between water level and ORP in Lake Takapan

### Conclusion

In Lake Takapan, the variation of water quality parameters, such as pH, temperature, oxidative reductive potentials, dissolved oxygen and conductivity were significantly influenced by the fluctuation of water level relative to bank over flow height. Water quality of the Rungan River as one of the rivers that feed water to the lake affected Lake Takapan water quality more significantly than that of the Kahayan River.

### References

- Barella, W. and Petreire, M., Jr. 1994. The influence of environmental factors on fish community structure in the Jacare Oeoirá River, Brazil. In: Cowx, I.G. (ed), *Rehabilitation of Freshwater Fisheries*, Fishing News Books, pp. 161-170.
- Boyd, C. E. 1990. *Water Quality in Ponds for Aquaculture*. Alabama Agricultural Experiment Station. Auburn University, Alabama. USA. 482 pp.
- Corner, E. J. H. 1978. *The Freshwater Swamp Forest of South Johor and Singapore*. Botanic Gardens Parks & Recreation Department. Singapore. 265 pp.
- Gibbs, R. J. 1970. Mechanism controlling world water chemistry. *Science*, 170: 1088-1090
- Hartoto, D. I. 2000. An overview of some limnological parameters and management status of fishery reserve in Central Kalimantan. *Report of the Suwa Hydrobiological Station, Shinshu University*, 12: 49-74.
- Hartoto, D.I. and Yustiawati. 1999. Humic acid level at various type of inland water in Central Kalimantan. *Paper presented in Seminar on Tropical Peat Swamp Forest*,

- Bogor 12 February 1999. Research and Development Center for Biology-Indonesian Institute of Sciences (LIPI).
- Hem, J. D. 1970. *Study and Interpretation of the Chemical Characteristics of Natural Water. A review of chemical, geologic and hydrologic principles and processes that control composition of natural water, with methods for studying and interpreting chemical Analysis.* United States Government Printing Office. 663 p
- Henry, R., Tundisi, J. G., Calijuri, M. D. C. and de Ibanez, M. D. S. R. 1997. A comparative study of thermal structure, heat content and stability of stratification in three lakes. In: J.G. Tundisi and Saijo, Y. (eds.), *Limnological Studies on the Rio Doce Valley Lakes, Brazil.* Brazilian Academy of Sciences. Graftex Comunicado Visual. Brazil, pp. 69-81
- Hutchinson, G. E. 1957. *A Treatise on Limnology. Volume 1. Geography, Physics and Chemistry.* John Wiley & Sons, Inc. New York. 1015 p.
- Ikusima, I., Lim R.P. and Mizuno, T. 1982. pH and RpH. The Ecology of a Freshwater Swamp, In: Furtado, J.L. and Mori, S. (eds), *Tasik Bera. The Ecology of a Freshwater Swamp.* Dr. W. Junk Publishers. The Haque, Netherland, pp.83-85.
- Ikusima, I., Lim, R. P., Furtado, J. I. and Sato, O. 1982. dissolved gases: Oxygen and carbon dioxide in Tasik Bera. In: Furtado, J.I. and Mori, S. (eds), *Tasik Bera: The Ecology of a Freshwater Swamp.* Dr. Mari W. Junk Publishers. The Haque, Netherlands, pp. 76-83.
- Khan, N. 1990. *Preliminary assessment of the water quality and pollution threat at the Ulu Lepar Wetland System.* Asian Wetland Bureau Publication No 60. 30 pp.
- Lagler K.F., Barricade, J.E., Miller, R.R. and May Passino, D.R. 1977. *Ichthyology. 2nd edn.* John Wiley & Sons. 506 pp.
- Lim, R.P. and Furtado, J.I. 1982. Conductivity in Tasik Bera. In: Furtado, J.I. and Mori, S. (eds), *Tasek Bera. The Ecology of a Fresh Water Swamp.* Dr. Mari W. Junk Publishers. The Haque Netherland, pp. 86 - 88.
- Payne, A.I. 1986. *The ecology of Tropical lakes and Rivers.* JohnWiley & Sons, Inc. 301 pp.
- Salati, E. and Marques, J. 1984. Climatology of the Amazon Region. In: Sioli, H. (ed.), *The Amazon: Limnology and landscape ecology of a mighty tropical river and its basin.* Dr. W. Junk Publishers, Dordrechts. Netherlands, pp. 85-126.
- Sioli, H. 1984. The Amazon and its main affluent: Hydrography, morphology of the river course and river types. In: Sioli, H. (ed.), *The Amazon. Limnology and landscape ecology of a mighty tropical river and its basin.* Dr. W. Junk Publishers, Dordrechts. Netherlands, pp. 127-166.
- Thomas, J. D. 1997. The role of dissolved organic matter, particularly free amino acid and humic substances, in freshwater ecosystem. *Freshwater Biology*, 38: 1-36.
- Tundisi, J. G. 1997. Climate. In: Tundisi, J.G. and Saijo, Y. (eds.), *Limnological Studies on the Rio Doce Valley Lakes, Brazil.* Brazilian Academy of Sciences. Graftex Comunicado Visual. Brazil, pp. 7-11
- Welcomme, R.L. . 1979. *Fisheries ecology of floodplain rivers.* Longman Group Limited. London, 317 pp.

## **Limnological Characteristics of Lake Rengas Fishery Reserve in Central Kalimantan**

**AWALINA and Dede Irving HARTOTO**

RDC for Limnology, Indonesian Institute of Sciences  
Complex LIPI Cibinong, Jl. Raya Jakarta-Bogor km 46, CIBINONG-BOGOR 16911  
Tel: +62 21-8757071, Fax: +62 21-8757076

### **Abstract**

The present study, which was based on primary and secondary data collection, was aimed to reveal and to compile the limnological database of Lake Rengas Fishery Reserve (LRFR, A=33.33 ha), one of the 13 fishery reserves in Central Kalimantan. Lake Rengas ( $z_{\max} = 7$  m) is a Type II oxbow lake that receives water from the Rungan River. Fishery reserve which is located in the oxbow lake ideally should include ecologically important habitat types such as the river segment, the connecting channel and the pelagic part of the lake. The primary data collection in this study included the depth profile of several water quality parameters in many habitat types conducted at eight sampling times, at several sampling sites during 1996 to 1997. In addition the secondary data were collected from several publications related to the reserves.

The 95 % confidence intervals of limnological parameters for the lake were: water temperature  $27.51 \pm 0.31^{\circ}\text{C}$  (dry season) and  $27.39 \pm 0.04^{\circ}\text{C}$  (wet season), dissolved oxygen  $1.91 \pm 0.57$  mg/l (dry season) and  $2.47 \pm 0.25$  mg/l (wet season), pH  $4.40 \pm 0.13$  (dry season) and  $4.08 \pm 0.46$  (wet season), turbidity  $154.7 \pm 76.0$  NTU (dry season) and  $35.1 \pm 9.2$  NTU (wet season), oxidative reductive potentials  $376.1 \pm 31.8$  mV (dry season) and  $469.0 \pm 19.4$  mV (wet season) and conductivity  $8.7 \pm 2.2$   $\mu\text{S}/\text{cm}$  (dry season) and  $7.0 \pm 1.6$   $\mu\text{S}/\text{cm}$  (wet season). The relationship between depth and limnological parameters were mostly expressed by polynomial equations both in the lake and in the river.

The status of the water quality of LRFR was discussed based on the present results and other limnological parameters taken during the same period.

### **Introduction**

The existence of fishery reserves in Central Kalimantan; that is legitimated by the Republic of Indonesian Act Number 9 Year 1985 on Fishery; is very important to guarantee the natural availability of brood stock and fingerling. It is recorded that total area of inland water in Central Kalimantan is about 1,944,260 ha, that consists of peat swamps (80.7 %), and the rest are rivers and lakes. From 1988 to 1993 its reported that total average fish production was 23.3 kg/(ha year), currently is about 45,301,258 kg/year. Potentially the inland water of Central Kalimantan has fishery production of 130,000 tons/year. Economically, the estimated value of this commodity have value not less than 40 million US\$ per year (Hartoto, 2000). Fishery reserve or "Suaka perikanan" is used as conservation measures and management tools for fishery production. However, it is expected to function as an area for supplying the fingerlings and broodstock to the adjacent fishing ground and its vicinity.

Hartoto *et al.* (1998a) proposed the definition of fishery reserve as an inland water area that have a part where the fishes is prohibited to be caught by any method, at any time and by anyone. The fishery reserves managed to sustain or to increase production based on adjacent natural fish stock for the welfare of the fisher. There are thirteen

inland water fisheries known in Central Kalimantan Province. The existence of a fishery reserve is important to sustain the fish production based on natural stock in adjacent inland waters. Beside that, for Indonesian condition, the fishery reserve also can function as a social safety net since it also a source of income for ordinary fishers and other small stake holders. To develop a scientifically-based management practices, it is clear that detailed limnological information of fishery reserves is pre-requisite. Hartoto (2000) have already reported a general overview on some inland fishery reserves on Central Kalimantan. Evaluation of management status of LRFR show that the lake achieved the highest score (1.62) compared with other reserves in Central Kalimantan, even though it still belongs to the second class (or “Muda” Class) of management status.

Oxbow lakes in Central Kalimantan is important because most of the harvest fishery reserves are located in the oxbow lakes. From the viewpoint of fishery ecology, oxbow lakes are classified into three types. Lake Rengas is known as an oxbow lake that receives water from a tributary (Rungan River) of a main river (Kahayan River) and is classified as the type II oxbow lake (Hartoto, 2000). The objective of this study was to reveal the vertical profiles of some limnological parameters and its temporal variation in Lake Rengas. Other published parameters on any other aspect for Lake Rengas are also presented here as a compilation of available data.

### **Material and Methods**

Lake Rengas (surface area 33.33 ha) is located in Palangkaraya Municipality. It receives water from the Rungan River, a tributary of the Kahayan River. To understand temporal variation between seasons, water quality monitoring was conducted eight times, i.e., four times in the wet season (September, October, November 1996 and January 1997) and four times in the dry season (April, May, June and November 1997). Dissolved oxygen (DO), conductivity, pH, temperature, and turbidity were measured with Horiba Water Quality Checker. Oxidative reductive potentials (ORP) were measured using a TOKO ORP-meter TRX 90. The data were taken from the middle of Lake Rengas and the Rungan River segment. The maximum depth, and Secchi depth, were also measured at the same time.

Other parameters are also compiled from reports, such as nitrogen fractions (Hartoto and Awalina, 1999b), humic acids levels (Hartoto and Yustiawati, 1999), phosphorus finger prints (Yustiawati and Hartoto, phytoplankton community (Sulastri and Hartoto, 2000), heavy metals (Hartoto and Awalina, 1999a) and fish species and management status (Hartoto, 2000), in order to comprehend Lake Rengas limnology more holistically. The compilation was considered to be reasonable because all those parameters were sampled in coincidence with the data sampling for the present study.

The data collected was analyzed pictorially and statistically. The simple statistical analysis include descriptive statistics and regression analysis.

### **Results and Discussion**

#### **Depth profile of water quality**

Table 1 and Table 2 show the values of general water quality parameter of both in Lake Rengas and the Rungan River. Figs. 1 to 6 indicate the vertical profile of these parameters. The DO tended to be higher in the wet season than that in the dry season both in Lake Rengas and River Rungan (Table 2). This pattern began to develop at 1-m water depth, but in the surface layer, the dissolved oxygen in the dry season was always

higher than that in the wet season (Figs. 1 and 2). The pattern was probably due to the input of more oxygenated water from the river segment through the channel to Lake Rengas. Vertically, the DO seemed to be constant from the surface to the bottom in the wet season but on the contrary, it tended to decline with depth in the dry season.

The pH in the wet season tended to be lower than that in the dry season both in Lake Rengas and in the Rungan River. In both seasons, the average pH values in Lake Rengas tended to decrease with increasing water depth. On the contrary, in the Rungan River, the average pH values seemed to be constant from the surface layer to the bottom both in the dry and wet seasons (Figs. 1 and 2).

Table 1. Descriptive statistics of water quality parameters from Lake Rengas.

|                         | Limnological parameter |          |      |                     |         |                |
|-------------------------|------------------------|----------|------|---------------------|---------|----------------|
|                         | Water temperature, °C  | DO, mg/l | pH   | Conductivity, µS/cm | ORP, mV | Turbidity, NTU |
| a. Dry season           |                        |          |      |                     |         |                |
| Mean                    | 27.51                  | 1.91     | 4.40 | 8.7                 | 376.1   | 154.7          |
| Standard error          | 0.15                   | 0.28     | 0.06 | 1.0                 | 14.8    | 37.1           |
| Standard deviation      | 0.84                   | 1.53     | 0.35 | 5.5                 | 57.4    | 103.4          |
| 95% confidence interval | 0.31                   | 0.57     | 0.13 | 2.2                 | 31.8    | 76.0           |
| Median                  | 27.25                  | 2.20     | 4.41 | 6                   | 378.4   | 30.7           |
| Count                   | 30                     | 30       | 30   | 30                  | 15      | 30             |
| b. Wet season           |                        |          |      |                     |         |                |
| Mean                    | 27.39                  | 2.47     | 4.08 | 7.0                 | 469.0   | 35.1           |
| Standard Error          | 0.21                   | 0.12     | 0.09 | 0.6                 | 9.0     | 4.5            |
| Standard deviation      | 1.06                   | 0.49     | 0.46 | 3.0                 | 35.0    | 21.4           |
| 95% confidence interval | 0.44                   | 0.25     | 0.19 | 1.3                 | 19.4    | 9.2            |
| Median                  | 26.9                   | 2.55     | 3.98 | 6                   | 469.6   | 28             |
| Number of samples       | 25                     | 17       | 25   | 25                  | 15      | 23             |

Table 2. Descriptive statistics of water quality parameters for the Rungan River.

|                         | Limnological parameter |          |      |                     |         |                |
|-------------------------|------------------------|----------|------|---------------------|---------|----------------|
|                         | Water temperature, °C  | DO, mg/L | pH   | Conductivity, µS/cm | ORP, mV | Turbidity, NTU |
| A. Dry season           |                        |          |      |                     |         |                |
| Mean                    | 28.17                  | 3.33     | 4.71 | 6.48                | 426.0   | 101.0          |
| Standard deviation      | 0.85                   | 0.36     | 0.51 | 4.15                | 74.5    | 127.6          |
| Standard error          | 0.15                   | 0.07     | 0.09 | 0.75                | 19.2    | 22.9           |
| 95% confidence interval | 0.31                   | 0.13     | 0.19 | 1.52                | 41.3    | 46.8           |
| Median                  | 28.2                   | 3.52     | 4.47 | 4                   | 457.7   | 51.4           |
| Number of samples       | 30                     | 31       | 31   | 31                  | 15      | 31             |
| B. Wet season           |                        |          |      |                     |         |                |
| Mean                    | 27.28                  | 3.29     | 4.36 | 5.4                 | 497.9   | 33.8           |
| Standard deviation      | 0.80                   | 0.54     | 0.54 | 2.8                 | 33.06   | 11.1           |
| Standard error          | 0.22                   | 0.15     | 0.14 | 0.8                 | 10.5    | 3.07           |
| 95% confidence interval | 0.48                   | 0.33     | 0.32 | 1.7                 | 23.7    | 6.7            |
| Median                  | 27.1                   | 3.3      | 4.19 | 4                   | 513.5   | 32             |
| Number of samples       | 13                     | 13       | 13   | 13                  | 10      | 13             |



In Lake Rengas, that have maximum water depth around 1.0 to 1.5 m, the conductivity in the wet season was higher than that in the dry season. The conductivity in the wet season was lower than the values in the dry season at depths of 2-7 m (Figs. 3 and 4). The conductivity tended to increase vertically with increasing water depth in the dry season. In the wet season, on the other hand, the values tended to decrease with increasing depth (Fig. 3). In the Rungan River, the conductivity values were constant throughout the water column (0-5 m depths) in the dry season whereas in the wet season, the values tended to decrease at depths of 3-5 m (Fig. 4).

The water temperature tended to be constant vertically both in Lake Rengas and the Rungan River and in both seasons. No significant difference of temperature was observed between dry and wet seasons for Lake Rengas, but for the Rungan River the temperature was relatively lower in the wet season than in the dry season except at 4-5 m depths where temperatures did not differ between the two seasons (Figs. 3 and 4).

Turbidity seemed to be lower in the wet season than in the dry season both for Lake Rengas and the Rungan River. Vertical profile of turbidity was straight from the surface to the bottom in the wet season. On the contrary, the turbidity in the dry season for Lake Rengas was not constant and rapidly decreased between 4-5 m depths. Vertical profile of turbidity in the Rungan River was relatively more constant than in Lake Rengas, even though the turbidity was slightly decreased at 2-4 m depths and tended to increase near the bottom (Figs. 5 and 6).

Both in the pelagic part of Lake Rengas and in the Rungan River, the ORP values in the dry season were much higher than those in the wet season. It deserves to note here that in the dry season, the ORP averages of Lake Rengas pelagic habitat were quite higher than the average ORP in the Rungan River. The vertical pattern of ORP in dry season on both habitats were quite similar, which shown a tendency to increase at 0-1.5 m depths followed by rapid decrease at 2-7 m depths.

In the wet season the ORP values in Lake Rengas was constant only at 0-4.5 m depths and rapidly decreased at 5-7 m depths. Almost similar pattern was observed in the Rungan River in the wet season. The pattern was quite different where it seems to be more constant than ORP profile of the Lake Rengas pattern (Figs. 5 and 6).

### **Condition of water quality**

The water quality data for Lake Rengas and the Rungan River segment in both dry and wet seasons (Tables 1 and 2) were still good and met the requirement to support aquatic life (Boyd, 1990).

The average water temperature of the Lake Rengas was relatively high throughout the year, i.e.,  $27.51 \pm 0.84^\circ\text{C}$  for dry season (mean  $\pm$  SD) and  $27.39 \pm 1.06^\circ\text{C}$  for rainy season. The slight but insignificant difference of water temperature between these two seasons may appreciably be caused by the quantity of sunlight during the seasons. In this water temperature range phytoplankton productivity is relatively high (Boyd, 1990).

The average DO concentrations in the lake were  $1.91 \pm 1.53$  mg/L for the dry season and  $2.47 \pm 0.49$  mg/L for the wet season. The value in the dry season was the same as the average DO (1.90 mg/L) in Tasek Bera (Ikushima *et al.*, 1982). The low DO concentration in the oxbow lake might be caused by the high rate of oxygen consumption for decomposing organic matter originated from adjacent riparian forest systems (allochthonous natural debris) and also by the limited oxygen supply from the air.

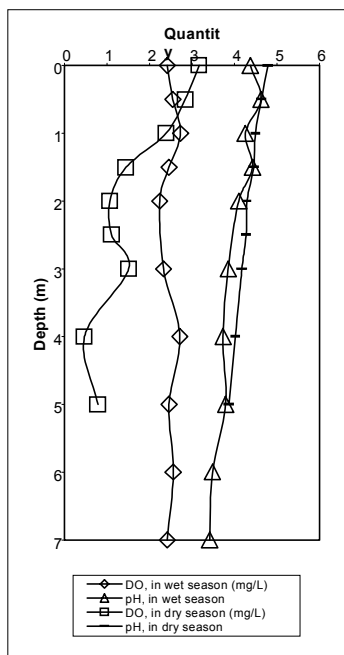

Fig. 1. Depth profiles of average pH and DO at the center of Leke Rengas.

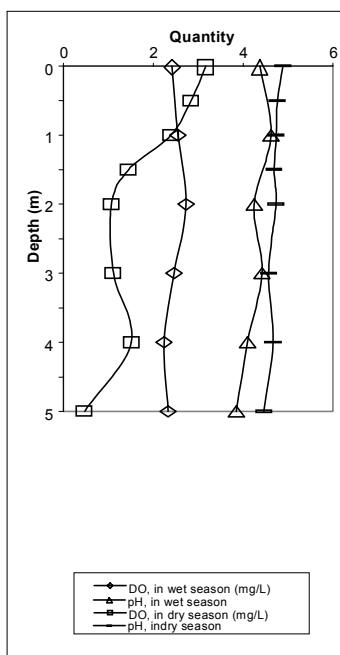

Fig. 2. Depth profiles of average pH and DO in the Rungan River.

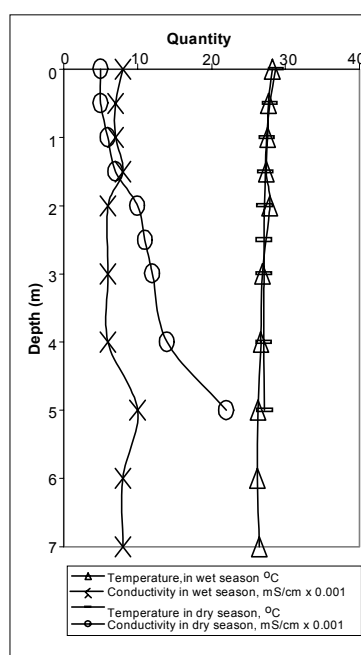

Fig. 3. Depth profiles of average temperature and conductivity at the center of Lake Rengas.

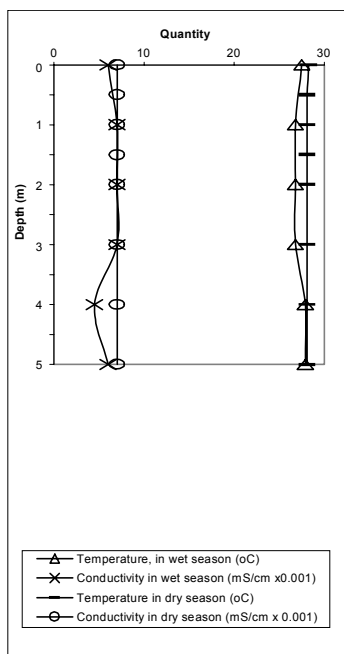

Fig. 4. Depth profiles of average temperature and conductivity in the Rungan River.

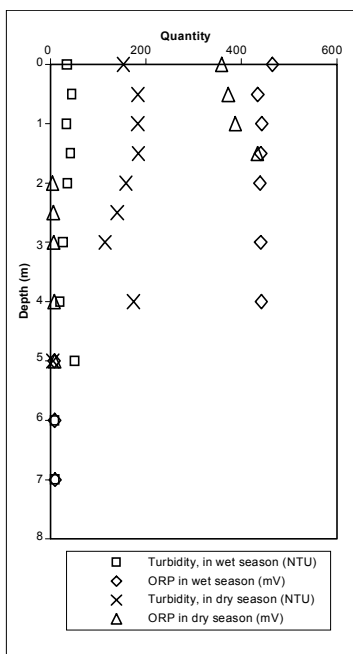

Fig. 5. Depth profiles of average turbidity and ORP at the center of Leke Rengas.

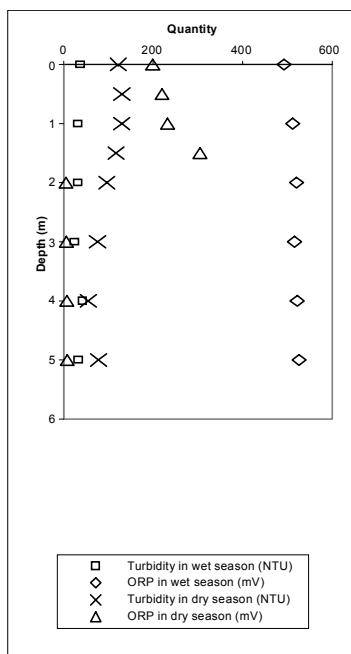

Fig. 6. Depth profiles of average turbidity and ORP in the Rungan River.

The average pH value in the lake was  $4.40 \pm 0.35$  for the dry season and  $4.08 \pm 0.46$  for the wet season. These values were similar to those in Tasek Bera (4.57-6.83, Ikusima *et al.*, 1982) and a freshwater swamp in Amazon basin (Sioli, 1967). Hartoto (1997) and Hartoto *et al.* (1998a) observed that many natural fish populations in black water in Kalimantan and Sumatra are adapted to low water pH. In Lake Rengas, pH value in the dry season tended to be higher than that in the wet season presumably due to the higher photosynthetic rate in the dry season, which finally resulted in higher pH. Photosynthesis affects pH through a mechanism of reduced  $\text{CO}_2$  and carbonates accumulation followed by hydrolysis that induces increase in pH (Boyd, 1990).

The average conductivity in the lake was  $8.7 \pm 5.5$   $\mu\text{S}/\text{cm}$  for dry season and  $7.0 \pm 3.0$   $\mu\text{S}/\text{cm}$  for wet season. Conductivity is low in freshwaters with very low ionic content according (Boyd, 1990). The average conductivity of water in several habitat types of Tasek Bera was  $14.2$   $\mu\text{S}/\text{cm}$  (Lim and Furtado, 1982). A similar value has been observed in Rio Doce Valley Lake system in Brazil by Mitamura and Hino (1997).

The average ORP in the lake was  $376.1 \pm 57.4$  mV for dry season and  $469.0 \pm 35.0$  mV for rainy season. Hartoto (2000) have reported that the ORP value observed in Lake Rengas is highest among the oxbow lakes in Central Kalimantan. Since ORP in oxygenated water is from 450 mV to 520 mV (Hutchinson, 1957), water of Lake Rengas might be more oxygenated in the wet season than in the dry season. This is probably because Lake Rengas contain higher concentrations of organic suspended matter in the dry season than in the wet season as indicated by turbidity which tended to be higher in the dry season ( $154.7 \pm 103.4$  NTU) than in the wet season ( $35.1 \pm 21.4$  NTU) (Table 1).

Regression equation of relationship between some limnological parameters and water depth (x) in Lake Rengas (both for the middle part and riverine segment) is presented in Table 3. Most of the relation of water temperature, DO, pH, Turbidity, Conductivity, ORP to water depth were polynomial respectively. So, its clear that relationship of each of limnological parameter to water depth is not only include one parameter but also other limnological parameters.

Table 3. Regression equation of relationship between some limnological parameters and water depth (x) in Lake Rengas.

| No.                             | Equation                                     | $r^2$  | R       | n  | Type of equation |
|---------------------------------|--|--------|---------|----|------------------|
| <b>a. Middle of Lake Rengas</b> |  |        |         |    |                  |
| 1                               | $\text{WT} = 0.0043x^2 - 0.491x + 28.299$    | 0.2320 | 0.482*  | 55 | Polynomial       |
| 2                               | $\text{DO} = 0.0237x^2 - 0.1221x + 3.3713$   | 0.0218 | 0.148   | 47 |                  |
| 3                               | $\text{pH} = 4.7663 e^{-0.0392x}$            | 0.2829 | 0.532*  | 55 | Exponential      |
| 4                               | $\text{Turb} = 49.109 e^{-0.1167x}$          | 0.0204 | 0.1438  | 53 |                  |
| 5                               | $\text{Cond.} = 0.216x^2 - 1.7641x - 6.4293$ | 0.0605 | 0.258   | 55 |                  |
| 6                               | $\text{ORP} = 7.9317x^2 - 6.9525x + 393.02$  | 0.2716 | 0.5212* | 30 | Polynomial       |
| <b>b. Rungan River Segment</b>  |  |        |         |    |                  |
| 7                               | $\text{WT} = 0.0349x^2 - 11.034x + 104.78$   | 0.0241 | 0.155   | 43 |                  |
| 8                               | $\text{DO} = 0.0373x^2 - 0.0394x + 2.905$    | 0.0927 | 0.305*  | 44 | Polynomial       |
| 9                               | $\text{pH} = 4.717 e^{-0.0184x}$             | 0.0677 | 0.260   | 44 |                  |
| 10                              | $\text{Turb.} = -11.034x + 104.78$           | 0.0244 | 0.156   | 44 |                  |
| 11                              | $\text{Cond} = -0.293x^2 + 1.162x + 5.809$   | 0.0398 | 0.199   | 44 |                  |
| 12                              | $\text{ORP} = -0.9706x^2 + 26.28x + 428.25$  | 0.1654 | 0.407*  | 25 | Polynomial       |

### Published limnological information on Lake Rengas

In order to comprehend the limnological characteristics of Lake Rengas more holistically, it is necessary to compile more information from any other published papers that are related to this lake. We add here those data which have been obtained at the same time as the present field research.

According to Hartoto (2000), average Secchi disk transparency is 0.51 m, average air temperature at sampling times is 26.4°C. The number of fish species is 52 of which Cyprinidae are dominant.

The average of nitrogen fractions have been reported as N-NO<sub>2</sub> 4.1 µg/l, N-NO<sub>3</sub> 1024.0 µg/l, N-NH<sub>3</sub> 225.2 µg/l, total N (TN) 5319.0 µg/l, total P (TP) 448.0 µg/l and TN/TP ratio 26. Ammonia content in this lake is the highest as compared with other types of oxbow lake in Central Kalimantan (Hartoto and Awalina, 1999b). It is also reported that Lake Rengas has phosphorus limiting growth factor, and N-NO<sub>2</sub>, N-NO<sub>3</sub>, N-NH<sub>3</sub> contents was still save concentration for aquatic life according to Boyd (1990).

Humic acid level in Lake Rengas has already been studied by Hartoto and Yustiwati (1999) as follows. Average content range 91.2-308.6 mg/l. The humic acid concentration of lotic habitat showed higher average (206.0 mg/L) than the average of lentic habitat (172.8 mg/l). This pattern is also found on Fe content as catalyst for organic material oxydation. Seemingly, this lake has a favorable condition for the production of humic acid that is recognized as one of the oxydized organic matter component.

Phosphorus is the external function that determines internal condition or productivity in natural inland waters. Hartoto *et al.* (1998b) proposed the utilization of the ratio of dissolved and particulate acid hydrolizable-P to Total P as an indicator for the dependency of an aquatic system to detritus, in terms of energy and material balance. This ratio than refer as the detritus dependency indicator. Yustiwati and Hartoto (1999) reported that in Lake Rengas the detritus dependency indicator dominated by dissolved acid hydrolizable-P which indicate that organic material decomposition occurs quite well.

Average concentrations of some heavy metals (Fe, Mn, Pb, and Hg) in water and sediment of Lake Rengas are 1.199 mg Fe/l, 0.027 mg Mn/l, 0.056 mg Pb/l, and 0.008 mg Hg/l for lake water while in sediment the average contents are 2045.7 mg Fe/kg dry weight, 110.5 mg Mn/kg dry weight, 10.74 mg Pb/kg dry weight, and 0.887 mg Hg/kg dry weight. Fe, Mn, and Pb, in Lake Rengas water is still within natural range but Hg in water and sediment exceeded the safe concentration (Hartoto and Awalina, 1999a).

Sulastri and Hartoto (2000) have reported that the average phytoplankton density in Lake Rengas is 3,254 individuals/l. *Chlorophyceae* is the common dominant genera in this lake. In the dry season the density was highest and the phytoplankton is dominated by the genes *Oocyst*. In the wet season the dominant genera were Chlorophyceae such as *Oedogonium* and *Trochisia*, and some genera belonging to the group of desmid such as *Closterium*, *Gonatozygon* and *Pleurotaenium*.

Hartoto (2000) have already conducted an evaluation on the management status of fishery reserve using a scoring method (Hartoto *et al.*, 1998b) of Lake Rengas. The result indicate that Lake Rengas had the highest average score (1.62) compared to other fishery reserve in Central Kalimantan. According to Evaluation criteria and Classification of inland water fishery reserve this average score is belong to "Muda" or Class II.

### References

- Awalina and Hartoto, D.I. 1999. Heavy metals pollution in rivers at Tanjung Puting National Park, Central Kalimantan. *Paper presented in Seminar on Tropical Peat Swamp Forest, Bogor 12 Februari 1999*. Puslitbang Biologi-LIPI.
- Boyd, C.E. 1990. *Water Quality in Ponds for Aquaculture*, Auburn University, Alabama, USA. 482 pp.
- Hartoto, D.I. 1997. Notes on limnological condition of Lake Loa Kang as fishery reserve and its potential as food supply habitat for Mahakam Freshwater Dolphin. In: *Rehabilitasi Lingkungan Perairan Danau Semayang, Kalimantan Timur*, by Tim Peneliti. Seri Laporan Pep-LIPI No.7. Puslitbang Ekonomi dan Pembangunan, Lembaga Ilmu Pengetahuan Indonesia, pp. 63-85.
- Hartoto, D. I. 2000. An overview of some limnological parameters and management status of fishery reserve in Central Kalimantan. *Report of the Suwa Hydrobiological Station, Shinshu University*, 12: 49-74.
- Hartoto, D .I. and Awalina. 1999a. Metals bioconcentration of freshwater fishes in Central Kalimantan as an evaluation criteria for management of inland water fishery reserve. *Paper presented in Seminar on Tropical Peat Swamp Forest, Bogor 12 Februari 1999*. Puslitbang Biologi-LIPI.
- Hartoto, D.I. and Awalina.1999b. Nitrogen fractions variation in some Oxbow Lakes of Central Kalimantan. *Paper presented in the Poster Session in Seminar of R&D Activities of RDCL, 1998-1999, Cibinong, 13 April 1999*.
- Hartoto, D. I. and Yustiawati.1999. Humic acid level at various type of inland water in Central Kalimantan. *Paper presented in Seminar on Tropical Peat Swamp Forest, Bogor 12 Februari 1999*. Puslitbang Biologi-LIPI.
- Hartoto, D. I., Sarnita, A. S., Sjafei, D .S., Awalina, Yustiawati, Sulastri, M. M. Kamal and Siddik, Y. 1998a. *Dokumen: Kriteria Evaluasi Suaka Perikanan Perairan Darat*. Paper presented in Research Development Center for Limnology Yearly Seminar, Bogor, April 1998.Pusat Penelitian dan Pengembangan Limnologi, Lembaga Ilmu Pengetahuan Indonesia. 51 p. (in Indonesian)
- Hartoto, D.I., Syawal, M.S. and Ridwansyah, I. 1998b. Phosphorus fingerprints of Lake Semayang. In: Lukman and Hartoto, D.I. (eds), *Rehabilitasi Lingkungan Perairan Danau Semayang, Kalimantan Timur*. by Puslitbang Ekonomi dan Pembangunan, LIPI, pp. 35-50.
- Hem, J.D. 1975. *Study and Interpretation of the Chemical Characteristics of Natural Water*. 2nd edition's Printing Office, Washington. 363 p .
- Hutchinson, G.E. 1957. *A Treatise on Limnology. Volume I. Geography, Physics and chemistry*. John Willey & Sons, New York, 1015 pp.
- Ikusima, I, Lim R.P. and Mizuno, T. 1982. pH and RpH Tasek Bera. The Ecology of Freshwater Swamp, In: Fortado, J.L. and Mori, S. (eds). *Tasek Bera: The Ecology of a Freshwater Swamp*. Dr. W. Junk Publishers, The Hague, pp. 83-85.
- Ikusima, I, Lim R.P, Furtado, J.I. and Sato, O. 1982. Dissolved gases Oxygen and carbon Dioxyde in Tasek Bera., In: Fortado, J.L. and Mori, S. (eds). *Tasek Bera: The Ecology of a Freshwater Swamp*. Dr. W. Junk Publishers, The Hague, pp. 76-83.
- Lim, R.P. and Furtado, J.I. 1982. Conductivity in Tasek Bera. In: Furtado, J.I. and Mori, S. (eds), *The Ecology of a Freshwater Swamp*. Dr. W. Junk Publishers, The Hague, pp. 86-88.

- Mitamura , O and Hino, K 1997. Distribution of biogeochemical constituents in the waters. In : Tundisi J.G. and Saijo, Y. (eds). *Limnological Studies on The Rio Doce Valley Lakes, Brazil*. Brazilian Academy of Sciences. Graftex communicado Visual. Brazil. pp 97-108.
- Sioli, H. 1967. Studies in Amazonian Waters. *Amazoniana*. 3 (Limnologia): 9-50.
- Sulastri and Hartoto, D. I. 2000. Comparative analysis of phytoplankton community in some inland water habitat of Central Kalimantan, Indonesia. *Report of the Suwa Hydrobiological Station, Shinshu University*, 12: 9-17.
- Yustiawati and Hartoto, D.I. 1999. Phosphorus nutrient finger prints of some inland water types in Central Kalimantan. *Paper presented in the Poster Session in Seminar of R &D Activities of RDCL, 1998-1999, Cibinong, 13 April 1999*.

## Distribution of Phytoplankton in Some Oxbow Lakes of Central Kalimantan

SULASTRI and D. I. HARTOTO

Research and Development Centre for Limnology,  
Indonesian Institute of Sciences  
Kompleks LIPI CIBINON, Jl. Raya Jakarta Bogor km 46,  
Cibinong-Bogor 16911, Tel: +62 21-8757071, Fax: +62 21-8757076  
E-mail: lastri@indo.net.id, lhartoto@indo.net.id

### Abstract

Oxbow lake is the backwater of the main channel remaining in communication with the main river and lentic, having many of the characteristic of floodplain lagoon. It was reported that usually rich of nutrient, giving rise to plankton bloom. Some studies reported that phytoplankton in backwater or oxbow lake are more abundant and scarce in the river system. This study was aimed to describe the distribution of phytoplankton in some oxbow lakes of Central Kalimantan, by analysis the density and composition of phytoplankton from some habitat types of the lake and river segment. Some water parameters and physical condition at each study site were also described. The study was conducted in Lakes Lutan, Takapan, and Rengas, as a part of Kahayan River system between 1996 to 1997. The result show that the phytoplankton density of Lake Lutan is highest in the middle of the lake with a total density of 3,495 individuals/l and the phytoplankton community was dominated by Euglenophyta group especially *Trachelomonas* and *Euglena*. While in Lake Takapan the highest density was found in the river habitat or Kahayan River segment with a total density of 3,337 individuals/l and the phytoplankton community was dominated by Chrysophyta and Chlorophyta especially *Navicula*, *Synedra*, *Tabellaria*, *Closterium* and *Spirogyra*. The highest density of phytoplankton in Lake Rengas is 2,948 individuals/l found in river habitat or Rungan River segment and the community was dominated by Cyanophyta group especially *Anabaena* and *Nostoc*. The difference of phytoplankton distribution in these three oxbow lakes is probably due to the difference of environmental conditions such as water quality and physical conditions such as morphological conditions. The relationship between some water quality and phytoplankton density was discussed.

### Introduction

An oxbow lake is a backwater of the main channel remaining in communication with the main river and lentic, having many of the characteristic of floodplain lagoons. There are usually rich nutrients, giving rise to phytoplankton blooms. Therefore an oxbow lake has an important role as a feeding site for river fishes. Some studies reported that phytoplankton are more abundant in backwater or oxbow lake and scarce in the river system (Welcome, 1979). The oxbow lake receives the water from the main river so that the condition of water quality, flora and fauna has also relationship to the condition of the main river. There are many types of oxbow lakes in central Kalimantan based on the morphology and channels connecting to the main river. The oxbow lakes in Central Kalimantan are of ecological and economical value for local people, since the oxbow lakes of the major rivers such as the Kahayan River are important fishing ground for local fisheries. Study from an ecological viewpoint of these types of aquatic system in

this area is still limited. While to manage these types of aquatic systems, a data base on their limnological condition is essential.

The present study analyzes the distribution of phytoplankton in some oxbow lakes of the Kahayan River system (Fig. 1). We compare phytoplankton densities and compositions at five sampling sites for each lake including inside the lake and river segment that have influence on the water in the lake.

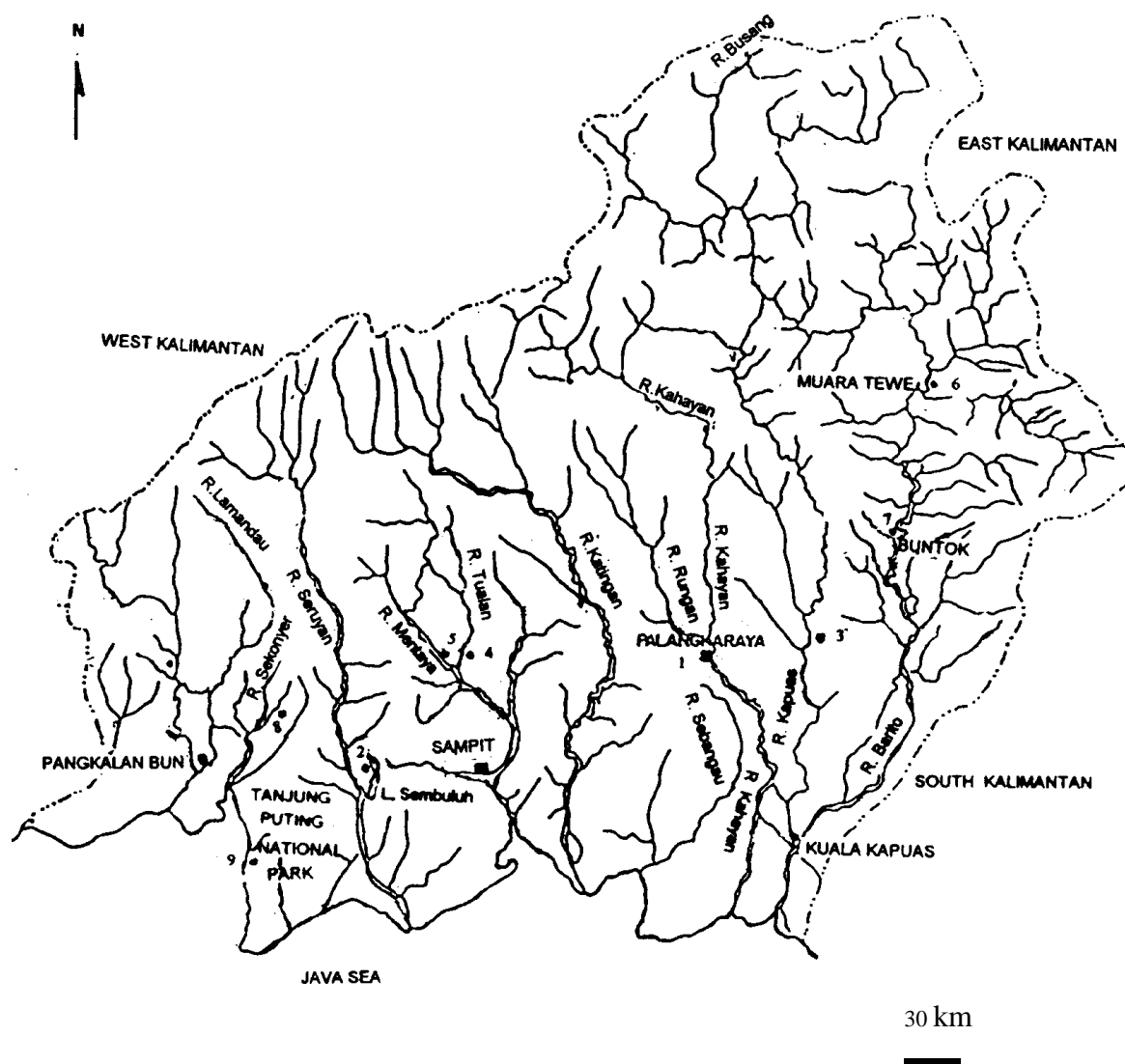

Fig. 1. Position of phytoplankton sampling sites in inland water of Central Kalimantan



### Materials and Methods

Study was conducted in Lake Lutan (Fig. 2), Takapan (Fig. 3) and Rengas (Fig. 4). The morphological, physical and chemical condition at each sampling site were presented in Table 1. Lake Lutan is the lowermost part of these three oxbow lakes in the Kahayan River system and receives the water from the main river or Kahayan River. Lake Takapan is the middle of these three oxbow lakes and receives the water from the Kahayan River and its tributaries. And Lake Rengas is the uppermost part of these three oxbow lakes in the Kahayan River system, receives the water from the Rungan River or the tributary of the Kahayan River.

Samples were taken from some habitat types (Table 2) in 1996 and 1997. To have representative data, the data was collected both water quality and phytoplankton at least four or five time at sampling site. Temperature, conductivity, transparency, depth, pH, dissolved oxygen were measured *in situ* using Horiba U-10 instrument. While other parameters like nutrients were analyzed in the laboratory. Phytoplankton samples were collected by composite from surface water to the bottom and passing 30 l of water through a plankton net number 25 (40  $\mu\text{m}$  mesh opening) then fixed in 1% Lugol's solution for taxonomical studies. The algal taxon was identified according to Prescott (1970), Scott and Prescott (1961). Quantitative analyses of phytoplankton were performed using modified Lackey drop microtransec method (Anonymous, 1977). Species diversity was calculated according to Shannon and Weaver (Odum, 1971). Correlation analysis between phytoplankton and water quality parameters was performed using a statistical software Microsta.

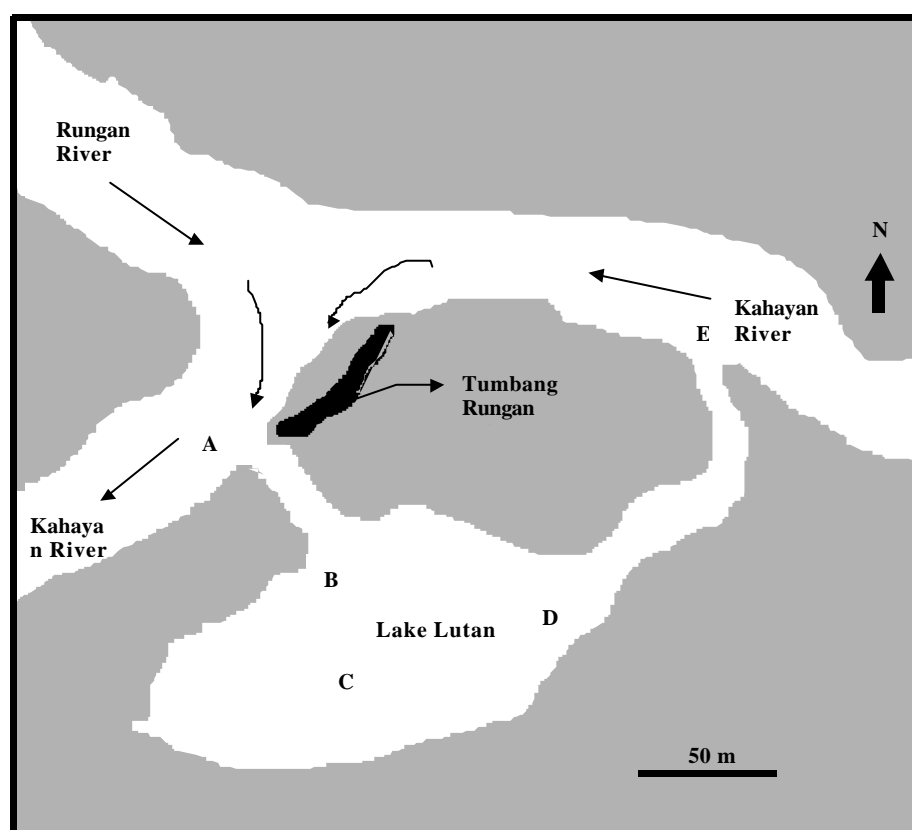

Fig. 2. Sampling sites in Lake Lutan

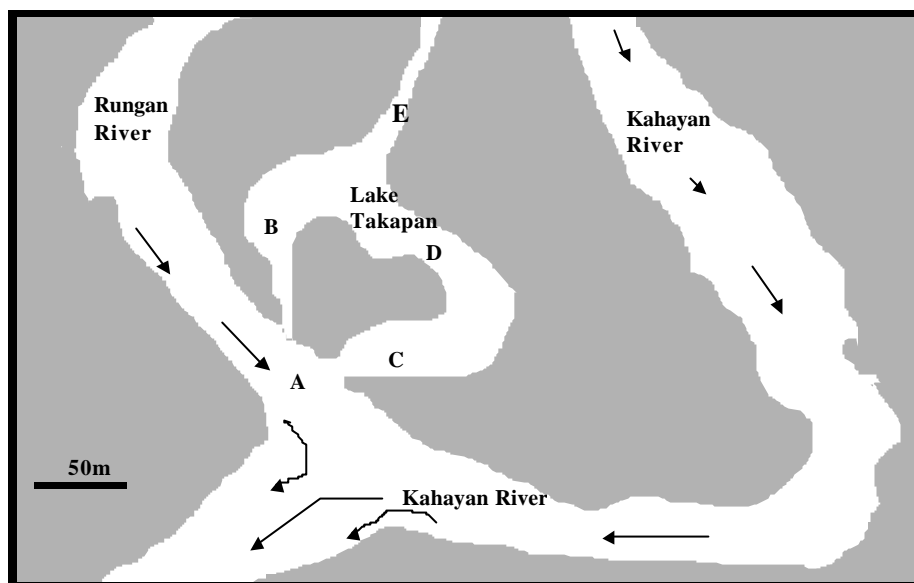

Fig. 3. Sampling sites in Lake Takapan

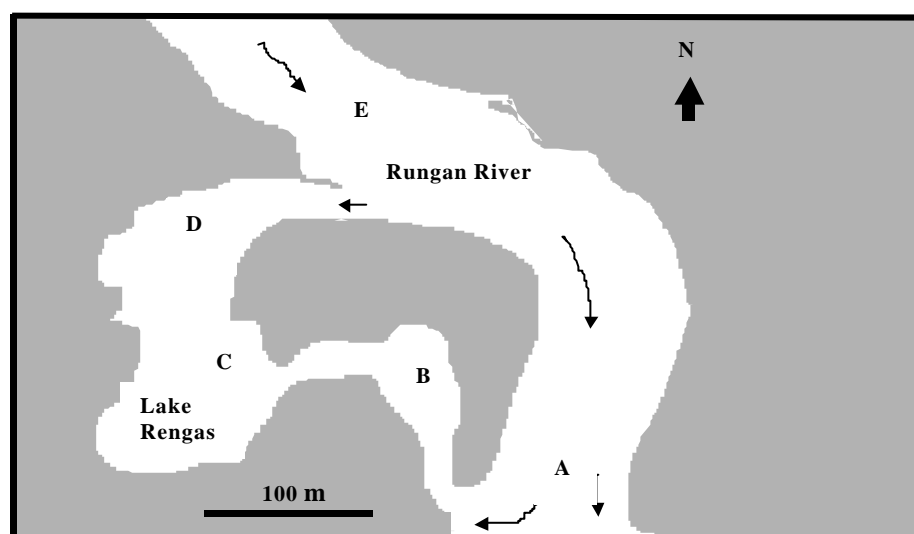

Fig. 4. Sampling sites in Lake Rengas

Table 1. The morphometric features of Lakes Lutan, Takapan and Rengas.

| Parameters                     | Lutan | Takapan | Rengas |
|--------------------------------|-------|---------|--------|
| Maximum area (ha)              | 7.0   | 50.4    | 35     |
| Maximum depth (m)<br>(pelagic) | 5.02  | 7.0     | 7.0    |
| Transparancy (cm)<br>(average) | 35.20 | 40.71   | 35.36  |
| Turbidity (NTU)<br>(average)   | 84.02 | 22.13   | 72.42  |

Table 2. Description of physical condition of sampling sites.

| No | Lake    | Code of site | Description of sampling site   |
|----|---------|--------------|--|
| 1. | Lutan   | A            | Kahayan River segment, in front of downstream inlet channel of lake Lutan.                           |
|    |         | B            | Part of Lake Lutan system, in front of downstream connecting channel                                 |
|    |         | C            | Middle of Lake Lutan   |
|    |         | D            | Part of Lake Lutan system, in front of the mouth of upstream connecting channel.                     |
|    |         | E            | Kahayan River segment, in front of upstream inlet channel of Lake Lutan.                             |
| 2  | Takapan | A            | Rungan River segment, at the mouth of inlet of lake  |
|    |         | B            | Part of the Lake Takapan system, near the northern inlet   |
|    |         | C            | Part of the Lake Takapan system, near the southern inlet.  |
|    |         | D            | Middle of the lake   |
|    |         | E            | Right junction of another inlet stream, flooded grass land, part of riparian system of Lake Takapan. |
| 3  | Rengas  | A            | Rungan River segment, in front of down stream inlet channel.   |
|    |         | B            | A segment of down stream connecting channel of Lake Rengas   |
|    |         | C            | Middle of the lake   |
|    |         | D            | A segment of upstream connecting channel of Lake Rengas.   |
|    |         | E            | Rungan River segment, in front of upstream inlet channel of Lake Rengas.                             |

### Results and Discussion.

Physico-chemical parameters at three oxbow lakes were presented in Fig. 5. The result showed that generally water temperature in the lake (sites B, C and D) either Lake Lutan, Takapan or Rengas is higher than in river habitat (sites A and E). It is probably due to shading by riparian vegetation along the river that cause the water temperature in the river habitat lower than in the lake system. While the dissolved oxygen (DO) content in these three oxbow lakes show that the value of oxygen content in river habitat is generally higher than in the lake system. It may be due to water current. The same pattern is also observed for conductivity and pH that generally value of these parameters in river habitat are higher than in lake system except conductivity value of Lake Rengas is higher in the middle of the lake. While the nutrient contents such as nitrate, nitrite, ammonia, total N and total P showed in variation condition at each sampling site. For example nitrite value in Lake Lutan and Rengas is higher in lake systems than in river habitats. While the highest value of total N in Rengas and Lake Lutan is the middle of the lake or at site C (Hartoto and Awalina, 1999; Yustiawati and Hartoto, 1999).

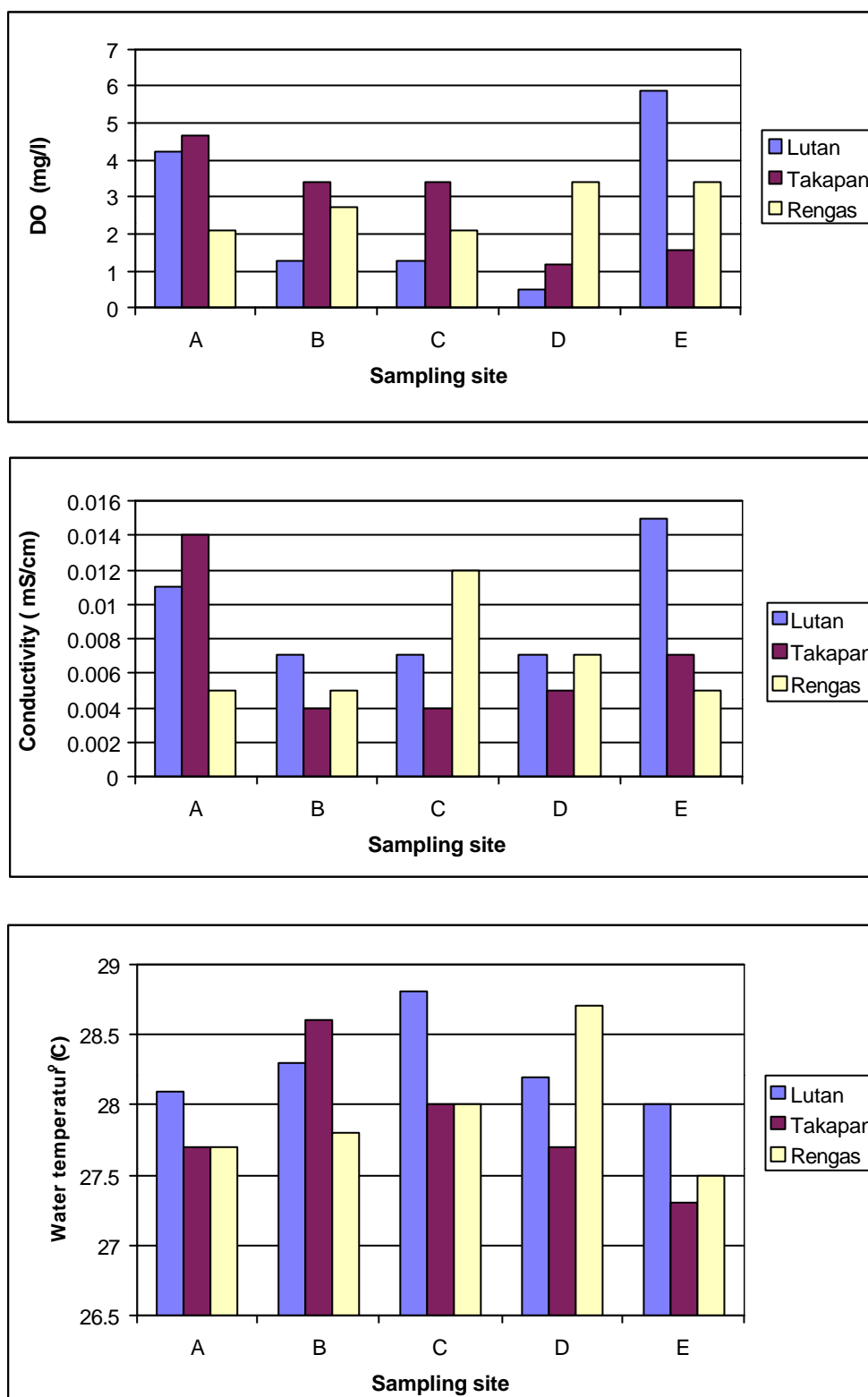

Fig. 5. Water quality of Lakes Lutan, Takapan and Rengas

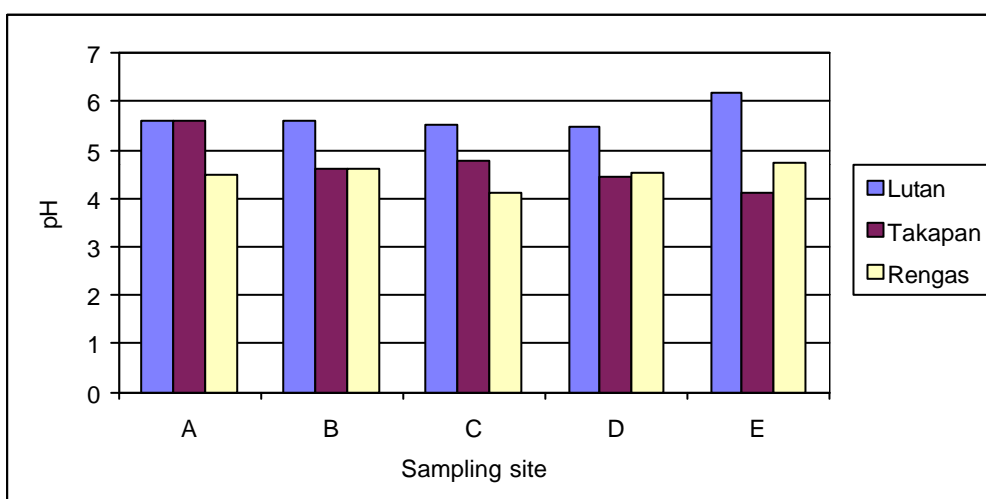
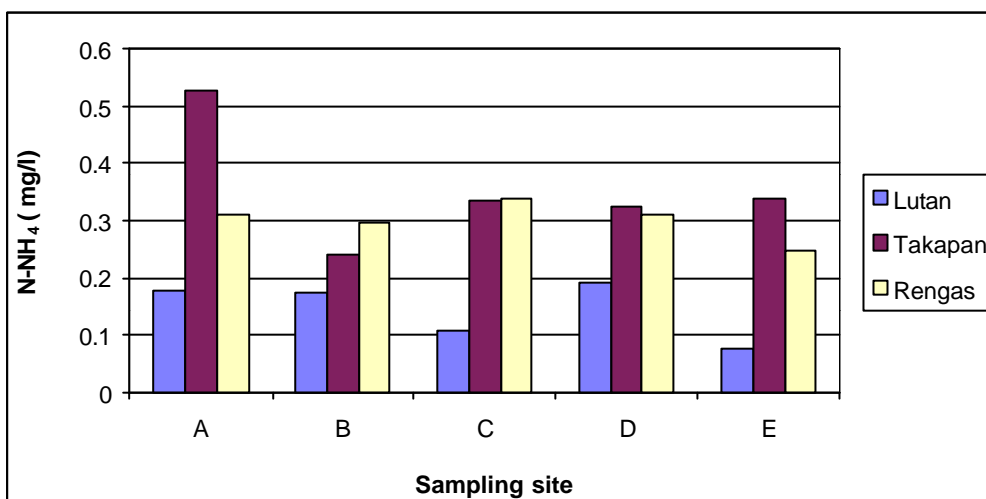
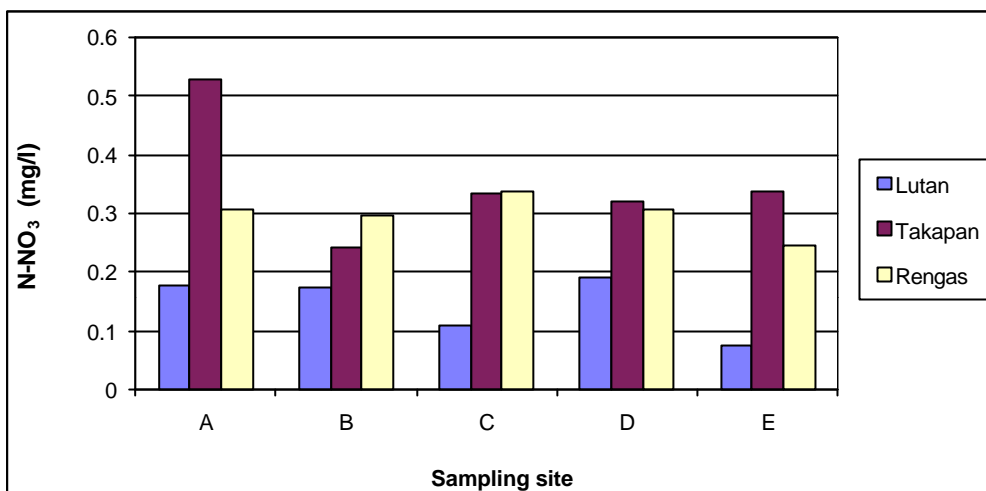

Fig. 5. Water quality of Lakes Lutan, Takapan and Rengas (continued)

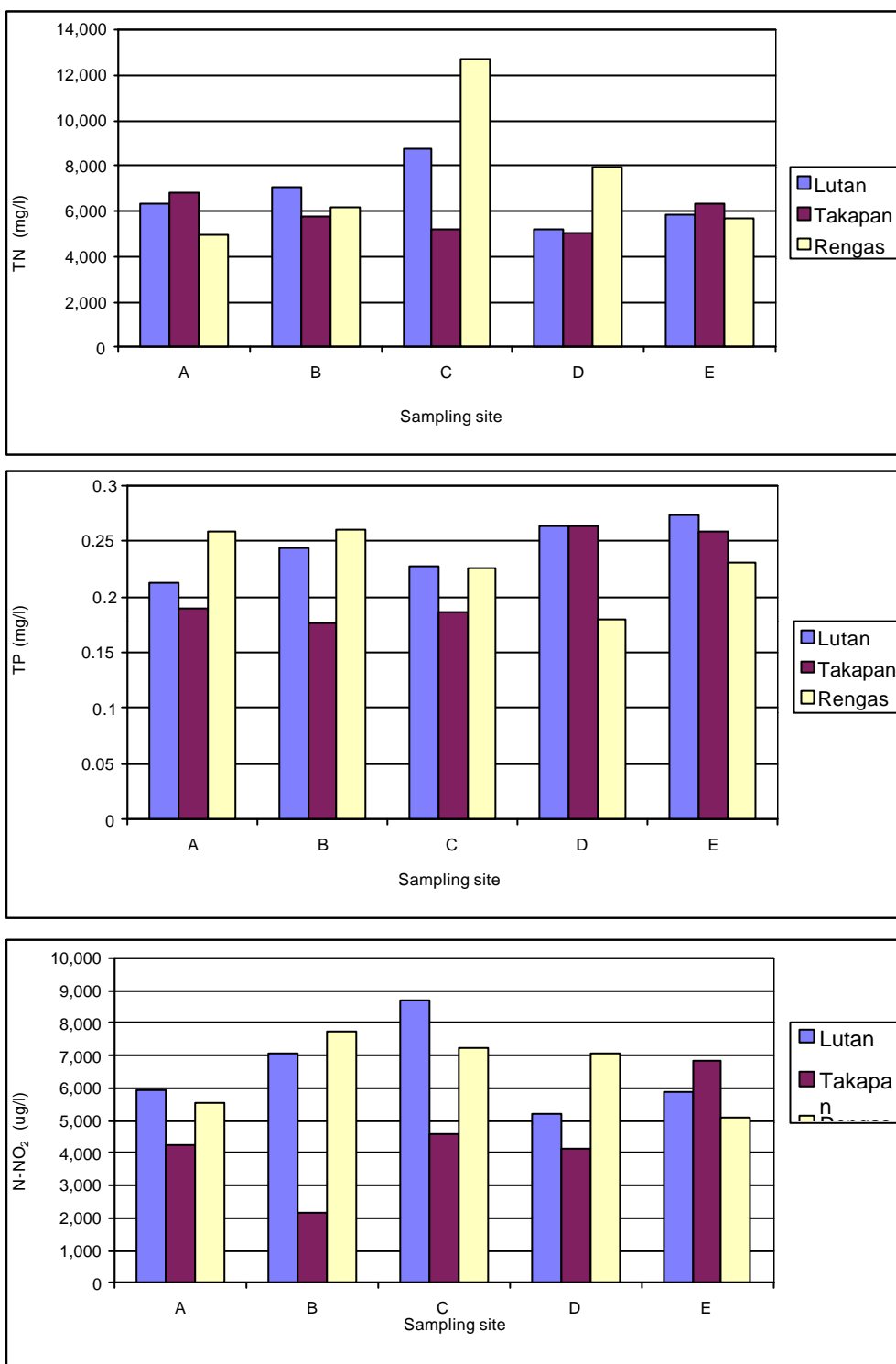

Fig. 5. Water quality of Lakes Lutan, Takapan and Rengas (continued)

Tabel 3. Average density (individuals/l) of phytoplankton in Lake Lutan

| Taxon group           | Sampling site |    |                             |     |               |
|-----------------------|---------------|----|-----------------------------|-----|---------------|
|                       | River habitat |    | Pelagic / oxbow lake system |     | River habitat |
|                       | A             | B  | C                           | D   | E             |
| <b>CHRYSOPHYTA</b>    |               |    |                             |     |               |
| <i>Actinocyclus</i>   | 46            | -  | 9                           | -   | 23            |
| <i>Asteronella</i>    | 152           | -  | -                           | -   | 28            |
| <i>Cyclotella</i>     | -             | -  | -                           | -   | 8             |
| <i>Diatoma</i>        | 56            | -  | 29                          | -   | 28            |
| <i>Eunotia</i>        | -             | 5  | -                           | -   | 5             |
| <i>Fragilaria</i>     | -             | -  | 23                          | -   | 55            |
| <i>Gomphonema</i>     | -             | -  | -                           | -   | 5             |
| <i>Meridion</i>       | 6             | -  | -                           | -   | -             |
| <i>Navicula</i>       | 34            | 42 | 92                          | -   | 89            |
| <i>Pinnularia</i>     | 9             | -  | -                           | -   | -             |
| <i>Surirella</i>      | 24            | -  | 9                           | 20  | 9             |
| <i>Synedra</i>        | 51            | -  | 28                          | 7   | 58            |
| <b>CHLOROPHYTA</b>    |               |    |                             |     |               |
| <i>Ankistrodesmus</i> | 189           | 14 | 5                           | -   | 14            |
| <i>Basycladia</i>     | 5             | 48 | 69                          | -   | 19            |
| <i>Chlamidomonas</i>  | -             | 7  | 345                         | -   | -             |
| <i>Cladophora</i>     | 94            | -  | 9                           | 7   | 154           |
| <i>Closterium</i>     | 266           | 55 | 75                          | 25  | 58            |
| <i>Cosmarium</i>      | -             | 14 | 97                          | 10  | 5             |
| <i>Desmidium</i>      | 5             | 7  | 5                           | -   | 9             |
| <i>Dermatophyton</i>  | 5             | -  | -                           | -   | 9             |
| <i>Euastrum</i>       | 5             | -  | -                           | -   | -             |
| <i>Genicularia</i>    | 19            | -  | -                           | -   | -             |
| <i>Gloeocystis</i>    | -             | -  | -                           | -   | 5             |
| <i>Gonatozygon</i>    | 50            | 28 | 106                         | 41  | 18            |
| <i>Ichthyocercus</i>  | -             | 7  | -                           | -   | -             |
| <i>Kirchneriella</i>  | -             | 14 | -                           | -   | -             |
| <i>Micrasterias</i>   | -             | 7  | -                           | -   | -             |
| <i>Oedogonium</i>     | 5             | -  | -                           | -   | -             |
| <i>Pediastrum</i>     | 6             | -  | -                           | -   | -             |
| <i>Penium</i>         | 6             | -  | -                           | -   | -             |
| <i>Pleurotaenium</i>  | 5             | 20 | 65                          | 20  | -             |
| <i>Rhizoclonium</i>   | -             | 28 | -                           | 14  | -             |
| <i>Sphaerocystis</i>  | -             | -  | -                           | -   | 5             |
| <i>Scenedesmus</i>    | 6             | -  | -                           | -   | -             |
| <i>Spirogyra</i>      | 5             | 14 | 14                          | 52  | 16            |
| <i>Tetraedron</i>     | -             | -  | -                           | -   | 8             |
| <i>Trochisia</i>      | 30            | 28 | 733                         | 176 | 35            |
| <i>Ulotrix</i>        | 22            | 7  | 18                          | -   | 14            |
| <i>Zygnema</i>        | -             | -  | -                           | 7   | -             |
| <b>CYANOPHYTA</b>     |               |    |                             |     |               |
| <i>Anabaena</i>       | 18            | 46 | 32                          | -   | -             |
| <i>Aphanocapsa</i>    | -             | 20 | -                           | 7   | -             |
| <i>Aphanizomenon</i>  | -             | 14 | -                           | -   | -             |
| <i>Coelosphaerium</i> | -             | 7  | -                           | -   | -             |
| <i>Hapalosiphon</i>   | -             | 62 | -                           | -   | -             |

Table 3 (continued)

| Taxon group                  | A     | B     | C     | D     | E     |
|------------------------------|-------|-------|-------|-------|-------|
| <i>Lyngbya</i>               | -     | -     | 5     | -     | -     |
| <i>Microcystis</i>           | -     | 35    | 18    | -     | 5     |
| <i>Nodularia</i>             | -     | -     | 5     | -     | -     |
| <i>Nostoc</i>                | 5     | -     | -     | -     | -     |
| <i>Oscillatoria</i>          | 33    | 35    | 18    | 41    | 23    |
| <i>Rivularia</i>             | -     | -     | -     | -     | 5     |
| <i>Spilurina</i>             | 37    | 14    | 18    | -     | 5     |
| EUGLENOPHYTA                 |       |       |       |       |       |
| <i>Euglena</i>               | 55    | 14    | 221   | -     | 61    |
| <i>Phacus</i>                | -     | -     | 414   | -     | 8     |
| <i>Trachelomonas</i>         | -     | 7     | 990   | 14    | -     |
| Total number (individuals/l) | 1249  | 599   | 3495  | 441   | 746   |
| Index of diversity           | 0.871 | 1.068 | 0.697 | 0.539 | 0.959 |

Table 4. Average density (individuals/l) of phytoplankton in Lake Takapan

| Taxon group            | Sampling site |     |                         |               |     |
|------------------------|---------------|-----|-------------------------|---------------|-----|
|                        | River habitat |     | Pelagic/<br>lake system | River habitat |     |
|                        | A             | B   |                         | C             | D   |
| CHRYSOPHYTA            |               |     |                         |               |     |
| <i>Cyclotella</i>      | 0             | 5   | 0                       | 0             | 0   |
| <i>Cymbella</i>        | 35            | 0   | 0                       | 0             | 35  |
| <i>Diatoma</i>         | -             | -   | 52                      | -             | -   |
| <i>Eunotia</i>         | 35            | 15  | 41                      | -             | -   |
| <i>Fragilaria</i>      | 84            | 0   | 41                      | 0             | 0   |
| <i>Gomphonema</i>      | -             | -   | 21                      | -             | -   |
| <i>Meridion</i>        | 118           | -   | -                       | -             | -   |
| <i>Navicula</i>        | 308           | 11  | 38                      | 17            | 83  |
| <i>Synedra</i>         | 851           | -   | 414                     | -             | -   |
| <i>Surirella</i>       | 49            | -   | -                       | 17            | -   |
| <i>Tabellaria</i>      | 278           | 36  | 392                     | -             | 276 |
| CHLOROPHYTA            |               |     |                         |               |     |
| <i>Actinastrum</i>     | 64            | -   | -                       | -             | -   |
| <i>Bambusina</i>       | -             | -   | 5                       | -             | -   |
| <i>Characium</i>       | -             | -   | 293                     | -             | -   |
| <i>Cladophora</i>      | 35            | -   | -                       | -             | -   |
| <i>Closterium</i>      | 428           | 106 | 64                      | -             | 110 |
| <i>Cosmarium</i>       | -             | 52  | 10                      | -             | -   |
| <i>Crucigenia</i>      | -             | 15  | 34                      | -             | -   |
| <i>Desmidium</i>       | -             | -   | 5                       | -             | -   |
| <i>Dictyosphaerium</i> | 23            | -   | -                       | -             | 23  |
| <i>Excentrosphaera</i> | -             | 31  | 17                      | 55            | -   |
| <i>Gonatozygon</i>     | 35            | 54  | 28                      | 10            | 55  |
| <i>Hyalotheca</i>      | -             | -   | 10                      | -             | -   |
| <i>Oedogonium</i>      | 35            | -   | -                       | -             | -   |
| <i>Oocystis</i>        | -             | 283 | -                       | -             | -   |
| <i>Ophiocytium</i>     | -             | 7   | -                       | -             | -   |



## Phytoplankton distribution in oxbow lakes of Central Kalimantan

Table 4 (continued)

| Taxon group                  | A     | B     | C     | D     | E     |
|------------------------------|-------|-------|-------|-------|-------|
| <i>Pediastrum</i>            | -     | -     | -     | -     | 28    |
| <i>Quadrigula</i>            | -     | -     | 35    | -     | -     |
| <i>Scenedesmus</i>           | -     | 15    | -     | -     | 62    |
| <i>Spirogyra</i>             | 511   | 11    | 41    | 7     | -     |
| <i>Staurastrum</i>           | 26    | -     | 10    | 19    | -     |
| <i>Trochisia</i>             | 241   | 5     | 133   | -     | 55    |
| <i>Ulotrix</i>               | 135   | 25    | 31    | -     | -     |
| <i>Stigonema</i>             | -     | 15    | 5     | -     | -     |
| <i>Xantidium</i>             | 23    | -     | -     | -     | -     |
| CYANOPHYTA                   |       |       |       |       |       |
| <i>Anabaena</i>              | -     | 111   | 22    | 10    | 78    |
| <i>Aphanocapsa</i>           | -     | -     | 52    | -     | 28    |
| <i>Chroococcus</i>           | -     | -     | -     | -     | 469   |
| <i>Dicothrix</i>             | -     | 70    | 37    | 14    | -     |
| <i>Lyngbya</i>               | 35    | -     | -     | -     | -     |
| <i>Microcystis</i>           | 69    | -     | -     | -     | 138   |
| <i>Nostoc</i>                | -     | 10    | 33    | -     | -     |
| <i>Oscillatoria</i>          | -     | 16    | 33    | -     | -     |
| EUGLENOPHYTA                 |       |       |       |       |       |
| <i>Euglena</i>               | 76    | 11    | 67    | -     | 5     |
| <i>Phacus</i>                | 35    | -     | -     | -     | 28    |
| <i>Trachelomonas</i>         | -     | -     | 17    | 10    | 7     |
| PYRROPHYTA                   |       |       |       |       |       |
| <i>Glenodinium</i>           | -     | -     | 14    | -     | -     |
| <i>Peridinium</i>            | 23    | -     | -     | -     | 7     |
| Total number (individuals/l) | 3337  | 904   | 1995  | 149   | 1487  |
| Index of diversity           | 0.824 | 0.687 | 0.902 | 0.563 | 0.666 |

Table 5. Average density (individuals/l) of phytoplankton in Lake Rengas.

| Taxon group         | Sampling site |     |                            |               |    |
|---------------------|---------------|-----|----------------------------|---------------|----|
|                     | River habitat |     | Pelagic/ oxbow lake system | River habitat |    |
|                     | A             | B   | C                          | D             | E  |
| CHRYSOPHYTA         |               |     |                            |               |    |
| <i>Actinocyclus</i> | 5             | -   | -                          | 14            | -  |
| <i>Asteronella</i>  | 24            | 124 | -                          | 156           | -  |
| <i>Centrtractus</i> | 20            | -   | -                          | -             | -  |
| <i>Cyclotella</i>   | 7             | 25  | -                          | 41            | -  |
| <i>Cymbella</i>     | -             | 5   | -                          | -             | 7  |
| <i>Diatoma</i>      | 58            | -   | -                          | -             | -  |
| <i>Eunotia</i>      | 20            | 58  | 20                         | -             | -  |
| <i>Fragilaria</i>   | -             | 20  | -                          | -             | -  |
| <i>Melosira</i>     | -             | 5   | -                          | -             | -  |
| <i>Meridion</i>     | -             | 20  | -                          | -             | -  |
| <i>Navicula</i>     | 7             | 72  | -                          | 7             | -  |
| <i>Surirella</i>    | 7             | 11  | -                          | 7             | -  |
| <i>Synedra</i>      | 25            | -   | -                          | 7             | -  |
| <i>Tabelaria</i>    | 118           | 43  | -                          | 7             | 55 |

Table 5 (continued)

| Taxon group                  | A     | B     | C     | D     | E     |
|------------------------------|-------|-------|-------|-------|-------|
| <b>CHLOROPHYTA</b>           |       |       |       |       |       |
| <i>Ankistrodesmus</i>        | 39    | -     | -     | 27    | -     |
| <i>Basicladia</i>            | 59    | -     | -     | 7     | -     |
| <i>Cladophora</i>            | -     | -     | 89    | -     | -     |
| <i>Chlamydomonas</i>         | -     | 5     | 55    | -     | 20    |
| <i>Closterium</i>            | 311   | 381   | 30    | 346   | 255   |
| <i>Cosmarium</i>             | 6     | -     | 30    | -     | -     |
| <i>Desmidium</i>             | -     | 9     | -     | 28    | -     |
| <i>Echinosphaerela</i>       | 20    | -     | -     | -     | -     |
| <i>Gonatozygon</i>           | 166   | 9     | -     | 89    | -     |
| <i>Kirchneriella</i>         | 20    | -     | 89    | 205   | 50    |
| <i>Microspora</i>            | -     | -     | -     | 82    | -     |
| <i>Oedogonium</i>            | -     | 20    | 35    | 574   | 30    |
| <i>Oocystis</i>              | -     | -     | -     | 7     | -     |
| <i>Pediastrum</i>            | 20    | -     | 30    | -     | 61    |
| <i>Rhizoclonium</i>          | -     | -     | 146   | 7     | -     |
| <i>Staurastrum</i>           | 20    | -     | 7     | 20    | -     |
| <i>Spirogyra</i>             | 9     | 23    | -     | 7     | 27    |
| <i>Stigeoclonium</i>         | -     | -     | -     | 82    | -     |
| <i>Trochisia</i>             | 87    | 63    | -     | 20    | -     |
| <i>Ulotrix</i>               | 43    | 54    | 87    | 110   | 124   |
| <b>CYANOPHYTA</b>            |       |       |       |       |       |
| <i>Anabaena</i>              | 680   | 31    | -     | 30    | 491   |
| <i>Aphanocapsa</i>           | -     | -     | -     | 41    | -     |
| <i>Asterocystis</i>          | -     | -     | -     | -     | 207   |
| <i>Chroococcus</i>           | -     | 6     | -     | -     | 20    |
| <i>Holopedium</i>            | -     | 5     | -     | -     | -     |
| <i>Lyngbya</i>               | -     | 5     | 48    | -     | 41    |
| <i>Microcystis</i>           | 98    | 20    | -     | -     | 386   |
| <i>Nodularia</i>             | -     | 6     | -     | -     | -     |
| <i>Nostoc</i>                | 32    | 6     | -     | 144   | 991   |
| <i>Oscillatoria</i>          | 114   | 7     | 20    | -     | 27    |
| <i>Spilurina</i>             | 20    | 13    | -     | -     | -     |
| <b>EUGLENOPHYTA</b>          |       |       |       |       |       |
| <i>Euglena</i>               | 57    | 13    | 7     | 30    | 7     |
| <i>Trachelomonas</i>         | 36    | -     | -     | -     | -     |
| <b>PYRROPHYTA</b>            |       |       |       |       |       |
| <i>Peridinium</i>            | 20    | -     | -     | -     | -     |
| Total number (individuals/l) | 2948  | 1026  | 693   | 2095  | 2799  |
| Index of diversity           | 0.674 | 0.771 | 0.719 | 0.768 | 0.597 |

The composition and the density of phytoplankton at each site sampling of Lake Lutan, Takapan and Rungan are presented in Tables 3, 4 and 5. While the total density taxonomical group is presented in Fig. 6. In Lake Lutan, Euglenophyta were found at higher density with *Trachelomonas* as the dominant species. Correlation analysis showed that Euglenophyta had positive correlation with the water temperature (Table 6). The highest density was found in pelagic zone that was also high of water temperature.

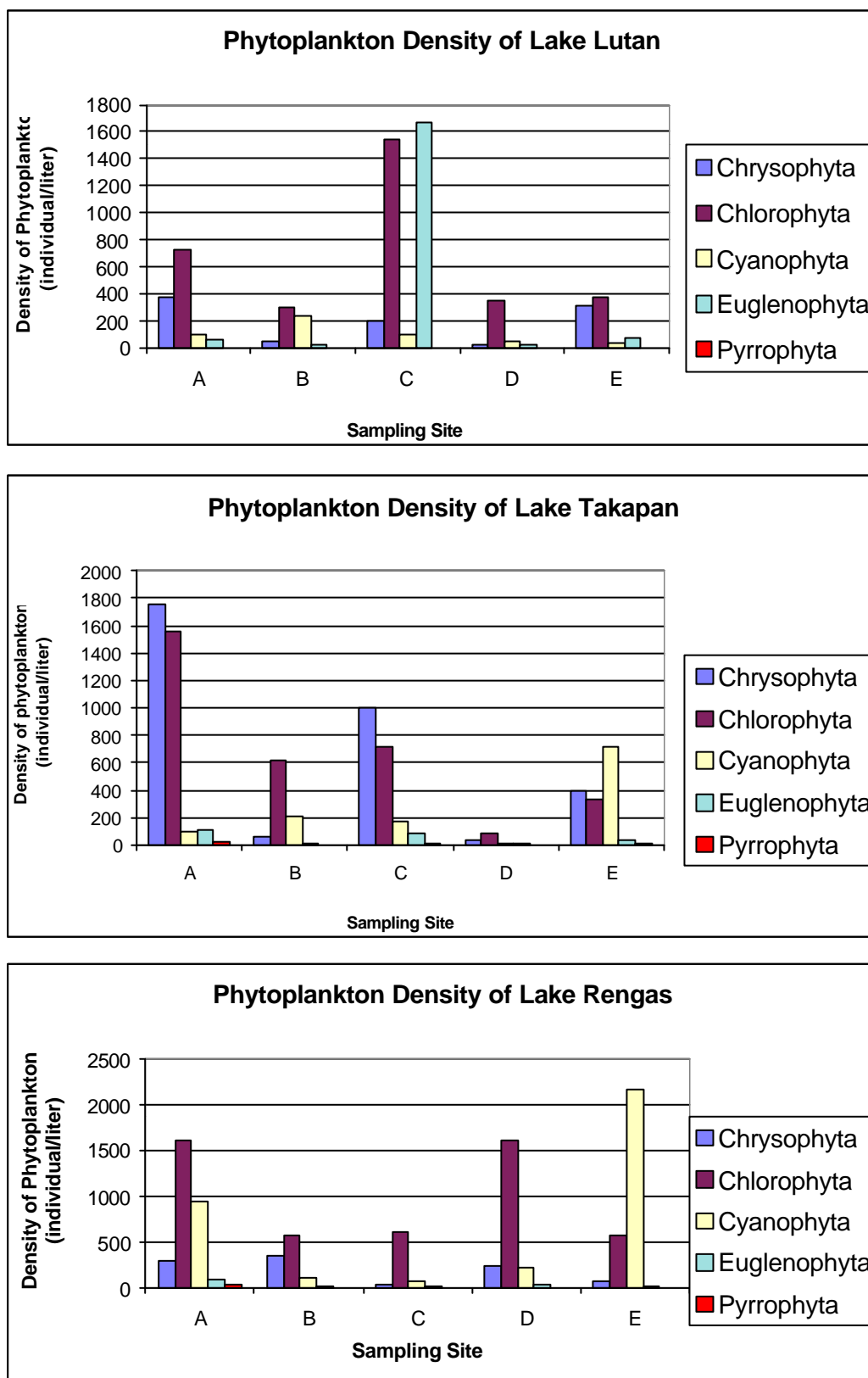

Fig. 6. Phytoplankton density of Lakes Lutan, Takapan and Rengas

Table 6. Regression analysis of phytoplankton and water quality parameters

| Phytoplankton versus water quality      | Equation of regression analysis                | R and F values        |
|---|--|-----------------------|
| 1. Lake Lutan                           |  |                       |
| Cyanophyta vs. N-NO <sub>3</sub>        | Cyano = -73.517 + 211.96 N-NO <sub>3</sub>     | R = 0.930, F = 170.8* |
| Euglenophyta vs. WT (water temperature) | Eugleno = -60672.8 + 2158.35 WT                | R = 0.922, F = 17.18  |
| Cyanophyta vs. N-NO <sub>2</sub>        | Cyano = 5362.25 - 714.01N-NO <sub>2</sub>      | R = 0.922, F = 17.23* |
| 2. Lake Takapan                         |  |                       |
| Chrysophyta vs. N-NH <sub>4</sub>       | Chryso = -1524.24 + 6163.96 N-NH <sub>4</sub>  | R = 0.890, F = 11.43* |
| Chlorophyta vs. pH                      | Chloro = 917.60 - 360.74 pH                    | R = 0.925, F = 17.98* |
| Diversity vs. N-NO <sub>3</sub>         | Diversity = -0.4246 + 1.1872 N-NO <sub>3</sub> | R = 0.890, F = 11.43* |
| 3. Lake Rengas                          |  |                       |
| Euglenophyta vs. WT                     | Eugleno = 2.5646 + 0.3278 WT                   | R = 0.989, F = 144.6* |
| Diversity vs. N-NO <sub>2</sub>         | Diversity = -3.8904 + 14.768 N-NO <sub>2</sub> | R = 0.929, F = 19.00* |

\* P&lt;0.05

Euglenophyta shows preference for high pH value (5.5 to 6.1) and is frequently associated with nutrient rich sites (Round, 1981; Mataloni and Tell, 1996). The water quality analysis shows that Lake Lutan has higher values of pH and nutrients especially nitrite than in Lake Takapan and Lake Rengas (Fig. 5). The high density of phytoplankton in Lake Lutan was found in the pelagic zone. The high density of Chrysophyta was found in river habitat or the Kahayan River segment.

In Lake Takapan, Chrysophyta were found in higher density with *Synedra* as the dominant species. The higher density of Chrysophyta was found in river habitat or the Kahayan River segment (site A). Study on African river reported that the main river was inhabited mainly desmids and diatoms (Welcome, 1979). It may be due to turbulence, some species like heavy desmids and diatoms can be resuspended in the river habitat. At site C as a part of the Lake Takapan also has higher density of Chrysophyta than two others sites (sites B and D). Site C is near the Kahayan River segment and received the water directly from the Kahayan River segment. Correlation and regression analyses show that Chrysophyta in Lake Takapan has positive correlation with ammonia (N-NH<sub>4</sub>). Species from group of Chlorophyta is dominated by *Closterium* and *spirogyra* that were also high in the Kahayan River segment (site A). *Closterium* is a group from desmid that was reported mostly inhabited river habitat.

In Lake Rengas the dominant phytoplankton is some species from Cyanophyta group, such as *Anabaena* and *Nostoc*. The other species which show high density are *Closterium* and *Oedogonium*, a group of Chlorophyta. The high density of Cyanophyta was observed in river habitat or segment of the Rungan Rver (sites A and C). In this way there is no significant correlation between the density of Cyanophyta and water quality parameters, although a study Mataloni and Guillermo (1995) have reported that Cyanophyceae show a preference for lower pH. In Lake Rengas the average value of pH is lower than Lakes Lutan and Takapan (Fig. 5).

Based on the total density of phytoplankton for each taxonomical group in these three lakes (Fig. 6), in Lake Lutan the highest density of phytoplankton was found at the middle of the lake while in Lake Takapan and Lake Rengas the highest density of phytoplankton were found in the river habitat or segment of the Kahayan and Rungan Rivers. This is due probably to the differences of morphology and water quality. Lake Lutan is shallower than other two lakes, which cause the faster nutrient turnover.

The diversity index value of phytoplankton in lake Lutan, Takapan and Lake Rengas are not difference clearly between oxbow lake system and river habitat.

### Conclusion

Dominant phytoplankton differed between Lakes Lutan, Takapan and Rengas. The dominant phytoplankton were Euglenophyta in Lake Rengas, Chrysophyta in Lake Takapan and Cyanophyta in Lake Rengas. It seemed that the water quality condition exerted an impact on the composition of phytoplankton, which was shown by correlation analyses of water quality and each group of these phytoplankton.

Based on the total density of phytoplankton, their distribution differed within lakes and rivers. The highest density of phytoplankton was observed in the pelagic zone in Lake Lutan while in Lakes Takapan and Rengas the highest density was observed in the river habitat. It was due probably to the differences of geomorphology and water quality condition.

### References

- Anonymous, 1975. *Standard Methods for the Examination of Water and Waste Water*. 14th edn. APHA-AWWA-WCR, 1-193 pp.
- Goldman, C. R. and Horne, A.J. 1983. *Limnology*. McGraw-Hill, London-Mexico-Sidney, 464 pp.
- Hartoto, D.I. and Awalina.1999. Nitrogen fractions variation in some oxbow lakes of Central Kalimantan. *Paper presented as Poster on Seminar on Limnological Research Activities 1998/1999, Research and Development Center for Limnology, Indonesian Institute of Sciences, Cibinong, 13 April 1999I*, 19 pp.
- Mataloni, G. and Tell, G. 1996. Comparative analysis of the phytoplankton communities of a plat bag from Tierra del Fuego (Argentina). *Hydrobiologia*, 325: 101-112.
- Odum, E.P. 1971. *Fundamentals of Ecology*. 3rd edn. W.B. Saunders, Philadelphia 574 pp.
- Prescott, G. W. 1963. *The Freshwater Algae*, W.M. Brown Company Publisher, 347 pp.
- Round, F.E. 1981. *The Ecology of Algae*. Cambridge University Press, London-New York-Melbourne-Sydney, 653 pp.
- Scott, A. M. and Prescott, G.W. 1961. *Indonesian Desmid*. *Hydrobiologia*. XVII. Acta Hydrobiologica Hydrographica et Trostistologica. Dr. W. Junk, Den Haag, 123 pp.
- Welcome, R.L. 1979. *Fisheries Ecology of Floodplain Rivers*. Longman, London-New York, 317 pp.
- Yustiawati and Hartoto, D. I. 1999. Phosphorus nutrient fingerprints of some inland water types in Central Kalimantan. *Paper presented as Poster on Seminar on Limnological Research Activities 1998/1999, Research and Development Center for Limnology, Indonesian Institute of Sciences, Cibinong, 13 April 1999*, 23 pp.

## Seasonal Changes of Phytoplankton Species in Relation to Environmental Factors in an Oxbow Lake of Central Kalimantan, Indonesia

Kumiko KUSAKABE<sup>1</sup>, Toshio IWAKUMA<sup>1</sup> and SULASTRI<sup>2</sup>

<sup>1</sup> Graduate School of Environmental Earth Science, Hokkaido university, Sapporo, Japan

<sup>2</sup> Research and Development Center for Limnology-LIPI, Cibinong, Indonesia

### Abstract

Dystrophic lakes are distributed widely in tropical region and it is generally assumed that desmids and diatoms are dominant and have low biomass. In the present study, phytoplankton and its vertical composition were observed and their biomasses were estimated in Lake Sabuah, Central Kalimantan, Indonesia during 8 May to 22 July 1999. Dominant species were *Cryptomonas* spp. and *Chlamydomonas* sp. from 8 May until 8 July and the density of *Chlamydomonas* sp. increased markedly. During the period from 8 to 22 July, densities of *Tabellaria* sp., *Synedra* sp. and *Gymnodinium* spp. increased. Total biomass of the phytoplankton ranged widely from 0.4 to 65.8 mgC/m<sup>3</sup> throughout the observation period. Biomass percentages of *Cryptomonas* spp. and *Chlamydomonas* sp. changed from 9.5% to 83.5% in the surface water during the observation period and the total biomass increased simultaneously with the dynamics. Biomasses of *Synedra* sp. and *Tabellaria* sp., which increased remarkably on 22 July, were 33.6% in the surface water. Most phytoplankton cells were distributed in the top 1.0 m of the water column throughout the observation period. Thus, vertical profile of phytoplankton agreed well with the depth of euphotic zone of 0.8-1.49 m.

### Introduction

The knowledge of aquatic organisms in Indonesia is still poor although there is information on the Mahakam River system in Kalimantan, the Musi River system and some lakes in Sumatra (Mizuno, 1980), attached algae in 5 lakes in Sumatra (Watanabe, 1987), a review on meteorology, hydrology, geographical features and aquatic systems of Indonesia (Rasi *et al.*, 1999), biological features of some lakes in Kalimantan (Sulastri, 1998). These studies didn't focus much on the succession of phytoplankton species, their biomass and vertical distribution, based on long-term surveys.

Dystrophic lakes are distributed widely in tropical region and it is generally assumed that desmids and diatoms are dominant in these lakes and have low biomass or density (Mizuno, 1980; Vegas-Vilarrúbia, 1995; Sulastri *et al.*, in press). In the meanwhile, there are a few studies which reports that flagellates appeared in certain lakes (Croome, 1988; Jorgen, 1998). In the past studies in Indonesia, phytoplankton samplings might have been conducted mainly with plankton net. Because of that, there were some cases in which small flagellates were possibly dropped out of the samples.

In the present study, phytoplankton and its vertical composition were observed using a sedimentation chamber and their biomasses were estimated.

### Study site

Surveys were conducted at Lake Sabuah that is located in the Kahayan River system in Central Kalimantan, Indonesia. Samples were taken at the central part (2°3'19"S, 113°56'37"E) of the lake (Fig. 1). The lake lies ca. 15 km north from Palangkaraya, the

capital city of Central Kalimantan, and has 0.61 km<sup>2</sup> surface area. This oxbow lake is connected to the Kahayan River via small channels. When the water level that is influenced mainly by precipitation is low, inflow from the Kahayan River decreases. Water color of the river is yellowish brown, whereas that of Lake Sabuah is black.

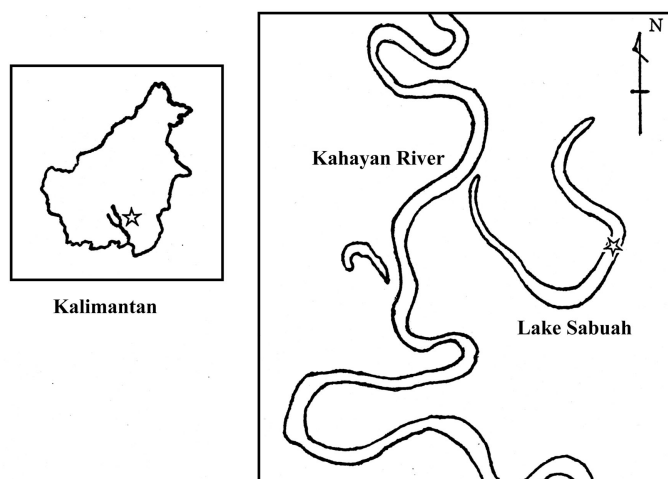

Fig. 1. Lake Sabuah in Central Kalimantan.

### Methods

Surveys were conducted at the central part of Lake Sabuah on 8 and 22 May, 8 June and 8 and 22 July 1999. Water depth was measured with an echo sounder (Furuno, Japan). Water temperature and concentration of dissolved oxygen were measured in situ with a DO meter (YSI Model 55, Yellow Springs Instruments, USA) at every 0.5 m from surface to bottom. Quantum flux density was measured at water depth of 0, 0.5, 1.0, and 1.5 m with an underwater quantum sensor (LI192S, LI-COR, USA) and as a reference an above-water quantum sensor (LI190S, LI-COR, USA) equipped with a data logger (LI-6000, LI-COR, USA). Water samples were taken from 6 depths (0, 0.5, 1.0, 2.0, 4.0, 8.0 m) using a 2-l Van-Dorn water sampler. Specific conductivity (SC) and pH were measured for the sampled water with a combined pH-SC meter (ES-14, Horiba, Japan).

Subsamples of lake water were taken to analyze phytoplankton, chlorophyll *a* and particulate organic carbon (POC).

For the analysis of phytoplankton species, 150-500 ml of lake water was sampled in a 500-ml polyethylene bottle and fixed with 1% Lugol's iodine solution. After phytoplankton were sedimented and concentrated in the laboratory, the supernatant was removed by siphoning. The sediments and some water were poured into 50-ml polyethylene bottle. Identification and enumeration of phytoplankton species were conducted using a Utermöhl chamber (20 ml) with inverted microscope (Nikon TMS, Japan). The length and width of predominant species were measured and the volume was calculated after Miyai *et al.* (1988). Thereafter, carbon content of the cell was calculated using a formula by Strathmann (1967). Biomass of predominant species was determined by multiplying cell density by carbon contents.

For the analysis of chlorophyll *a*, 100-400 ml of the water was passed through a grass fiber filter (Whatman GF/F, not precombusted). The filter was placed in a 15-ml

polypropylene centrifuge tube with 8 ml of pure methanol. After that, this tube was wrapped with aluminum foil and stored in a freezer until analysis. Later the tube was centrifuged at 3000 rpm for 20 min and absorbance of the supernatant was determined at 750 nm and 664 nm with a spectrophotometer (DU-65, Beckman, USA). Chlorophyll *a* concentration was calculated after Marker *et al.* (1980).

A subsample of 100-300 ml of the lake water was passed through a Whatman GF/F glass-fiber filter precombusted at 450°C for 3 h to analyze POC concentration. The filter was wrapped with aluminum foil and stored in a freezer until analysis. The filter was ground to powder and analyzed with an elemental analysis system (Vario EL, Germany).

## Results

### *Environmental factors*

Water depth changed from 8.9 to 10.8 m in the sampling period and it became the shallowest on 8 June 1999: the maximum difference of water depth was about 2.0 m during the observation period (Fig. 2).

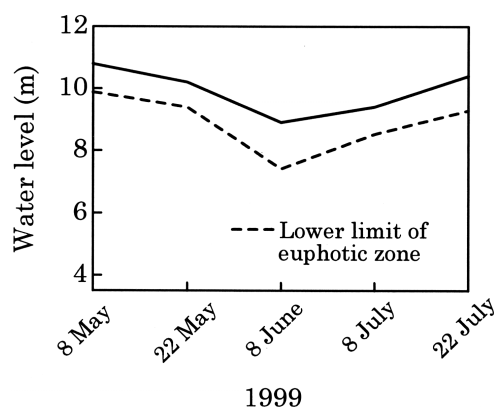

Fig. 2. Temporal changes of water level (m) and the depth of euphotic zone at the center of Lake Sabuah from 8 May to 22 June 1999.

Water temperature varied from 28.6 to 31.2°C in the surface water (0 m depth) and was the lowest on 22 July 1999. A distinct stratification was observed (1.3-3.6°C/m) within the top 1 m depth. Below 2 m depth, temperature gradient in the water column was small (Fig. 3a). Dissolved oxygen (DO) concentration changed from 1.34 to 4.60 mg/l in the surface water. The concentration was lowest on 8 June 1999. Except a slightly higher value on 22 July, DO concentration was less than 1.0 mg/l under the depth of 1.5 m. On 22 July, there were 2 DO peaks vertically in the water column (Fig. 3c). Specific conductivity (EC) varied from 2.47 to 4.27 mS/m in the surface water. The value was the highest on 8 June. The values decreased as it reached deeper sites in the column on 22 May and 8 June 1999. On other days, there were 2 peaks vertically in the water column. Especially the values were over 5.00 at the depth of 4.0 and 8.0m on 8 June (Fig. 3d).

Chlorophyll *a* concentration in the surface water ranged from 2.1 to 19.0 µg/l during the observation period. The concentration was highest on 8 July and on every sampling occasion the value decreased vertically to deeper depths (Fig. 4a). Concentrations of particulate organic carbon (POC) and particulate organic nitrogen (PON) in the surface water ranged from 0.78 to 1.92 mg/l and from 0.10 to 0.88 mg/l, respectively. Dynamic patterns of POC and PON were similar (Fig. 4b, c).



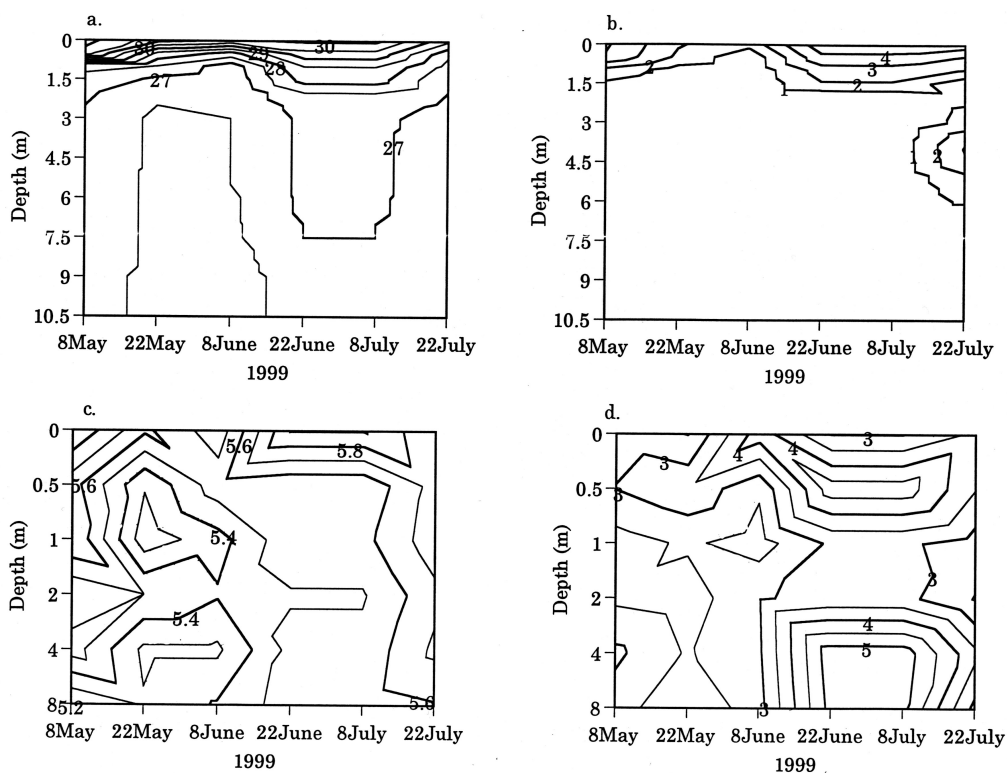

Fig. 3. Depth-time isopleths of environmental factors in Lake Sabuah from 8 May to 22 June 1999. a: water temperature ( $^{\circ}\text{C}$ ); b: dissolved oxygen concentration (mg/l); c: pH; d: specific conductivity (mS/m).

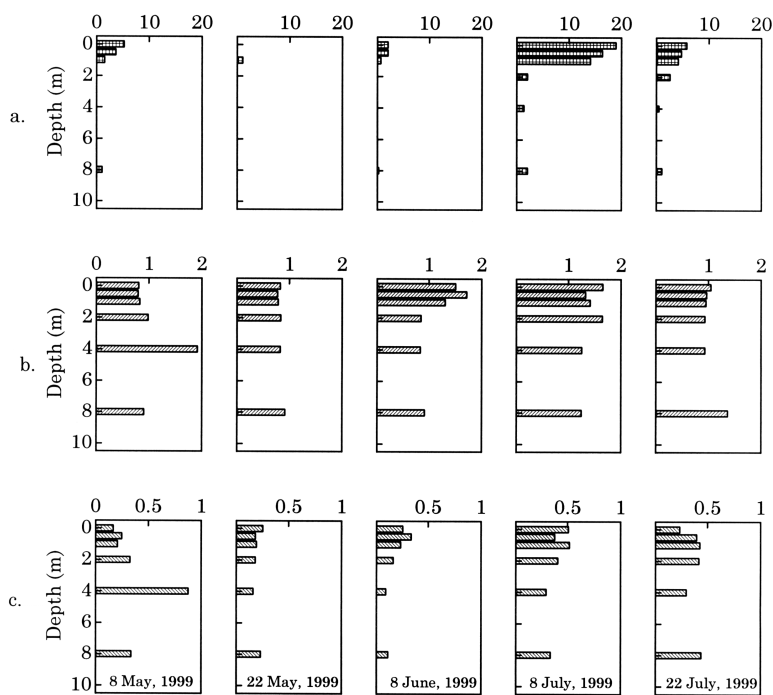

Fig. 4. Depth profile of concentration of (a) chlorophyll *a* ( $\mu\text{g/l}$ ), (b) POC (mg/l) and (c) PON (mg/l) in Lake Sabuah from 8 May to 22 June 1999.

*Phytoplankton*

Phytoplankton taxa appeared were mainly *Chroococcus* spp. (Cyanophyceae), *Tabellaria* sp., *Synedra* sp. (both Bacillariophyceae), *Gymnodinium* spp. (Dinophyceae), *Cryptomonas* spp. (Cryptophyceae), *Phacus* sp., *Trachelomonas* sp. (both Euglenophyceae) and *Chlamydomonas* sp. (Chlorophyceae). Dominant species were *Cryptomonas* spp. and *Chlamydomonas* sp. from 8 May until 8 July and the density of *Chlamydomonas* sp. increased markedly (Fig. 5a, b). Individual numbers of *Trachelomonas* sp. were stable throughout the time (Fig. 5c). *Chroococcus* spp. showed 3 different patterns of vertical profile throughout the sampling period: appearing only in the bottom layer, only in the surface layer and appearing both in the bottom and surface layers (Fig. 5d). During the period from 8 to 22 July, densities of *Tabellaria* sp., *Synedra* sp. and *Gymnodinium* spp. increased (Fig. 5e, f and g). *Phacus* sp. appeared only on 7 July with its cell density was maximum at the depth of 1.0 m (Fig. 5h).

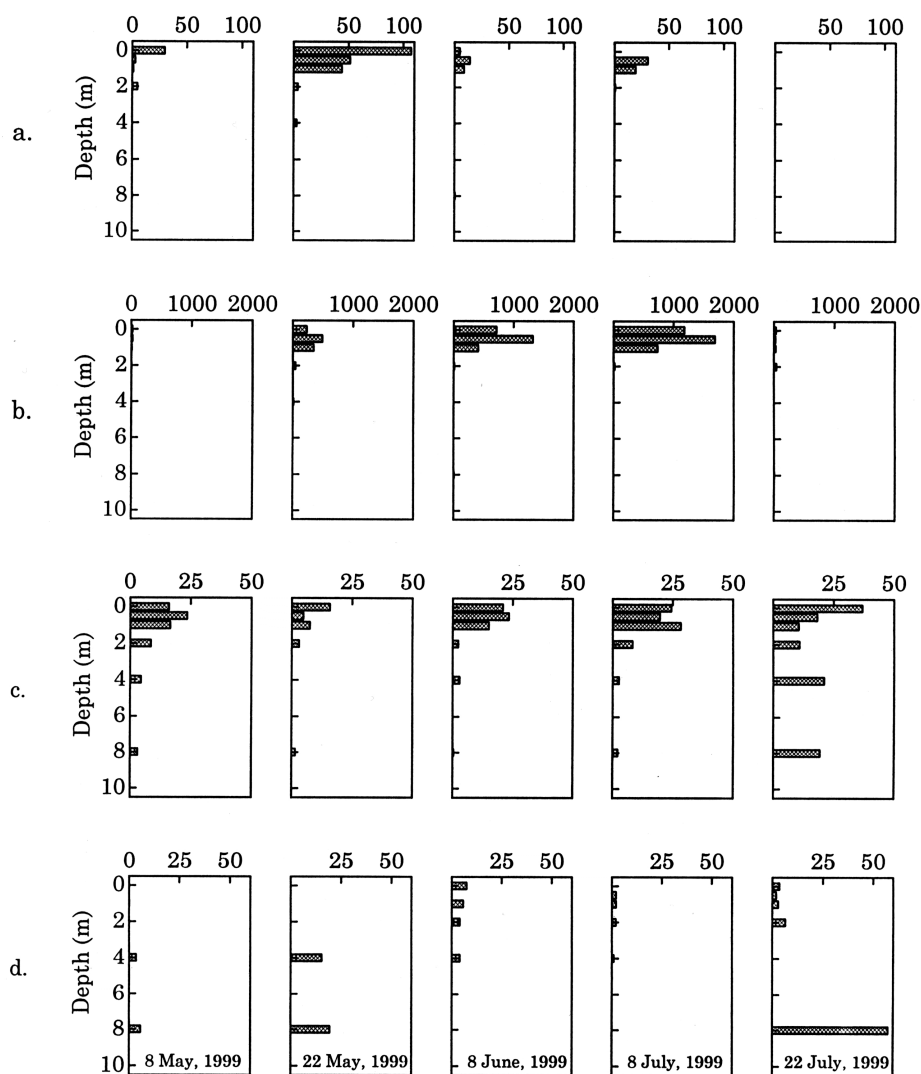

Fig. 5. Vertical distributions of phytoplankton in Lake Sabuah (inds./ml).  
 a: *Cryptomonas* spp.; b: *Chlamydomonas* sp.; c: *Trachelomonas* sp.; d: *Chroococcus* spp.;  
 e: *Tabellaria* sp.; f: *Synedra* sp.; g: *Gymnodinium* spp.; h: *Phacus* sp.

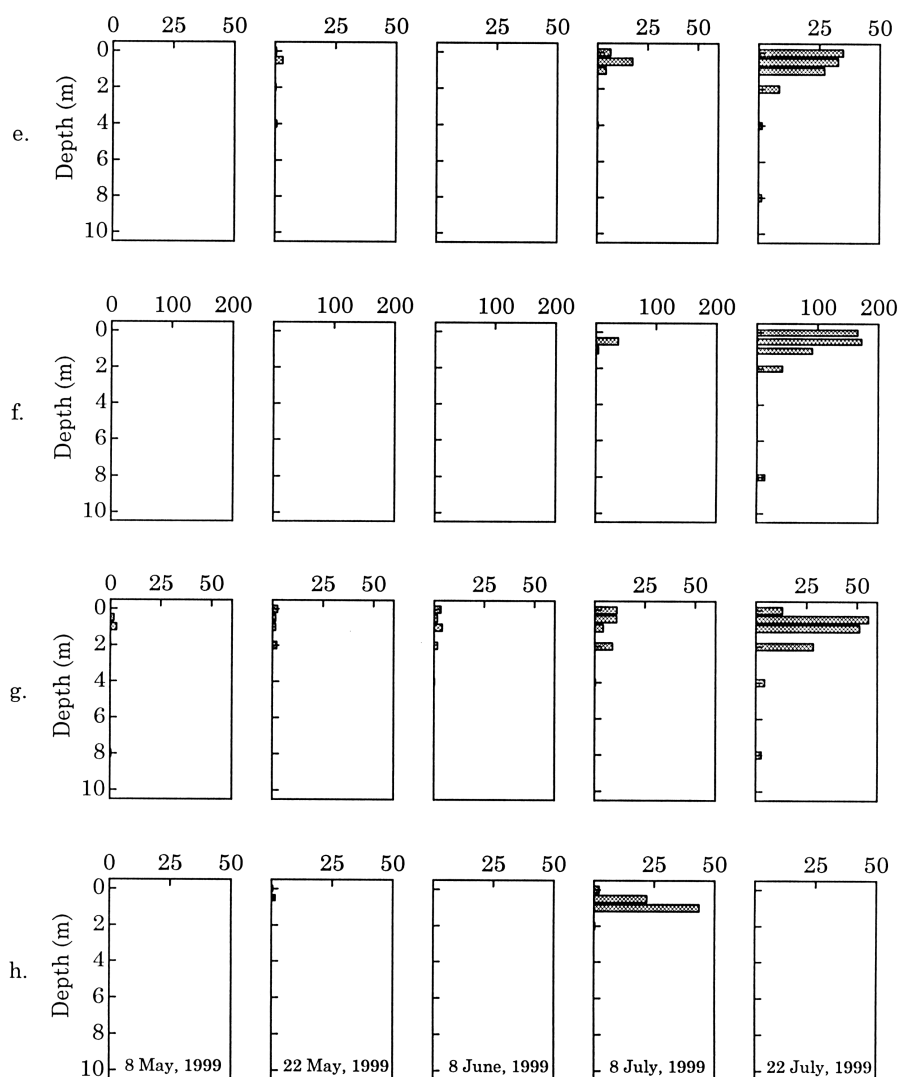

Fig. 5. (continued).

Average lengths of phytoplankton cells were 76.6-106.3  $\mu\text{m}$  for *Tabellaria* sp., 46.6-49.1  $\mu\text{m}$  for *Synedra* sp., 13.3-17.9  $\mu\text{m}$  for *Gymnodinium* spp., 16.7-24.1  $\mu\text{m}$  for *Cryptomonas* spp., 30.3  $\mu\text{m}$  for *Phacus* sp., 11.6-16.0  $\mu\text{m}$  for *Trachelomonas* sp. and 8.8-12.0  $\mu\text{m}$  for *Chlamydomonas* sp. Thus, *Tabellaria* sp., *Synedra* sp., *Cryptomonas* spp. and *Phacus* sp. were categorized as microplankton and *Gymnodinium* spp., *Trachelomonas* sp. and *Chlamydomonas* sp. were categorized as nanoplankton. Average cell volumes were 396.4-728.1  $\mu\text{m}^3$  for *Tabellaria* sp., 48.2  $\mu\text{m}^3$  for *Synedra* sp., 436.8-1605.0  $\mu\text{m}^3$  for *Gymnodinium* spp., 498.1-1113.4  $\mu\text{m}^3$  for *Cryptomonas* spp., 6462.0  $\mu\text{m}^3$  for *Phacus* sp., 575.4-1335.3  $\mu\text{m}^3$  for *Trachelomonas* sp. and 92.0-199.1  $\mu\text{m}^3$  for *Chlamydomonas* sp. (Fig. 6).

Total biomass of the phytoplankton ranged widely from 0.4 to 65.8  $\text{mgC}/\text{m}^3$  and the values were high in the surface layer (0-1.0 m depth) throughout the observation period. The biomass fluctuation in the surface water was influenced mainly by the dynamics of density of *Chlamydomonas* sp.: as the density became maximum (1693 inds./ml) at the depth of 0.5 m on 8 July, the value of biomass reached maximum (65.8  $\text{mgC}/\text{m}^3$ ) (Fig. 7).

Seasonal changes of phytoplankton in an oxbow lake of Central Kalimantan

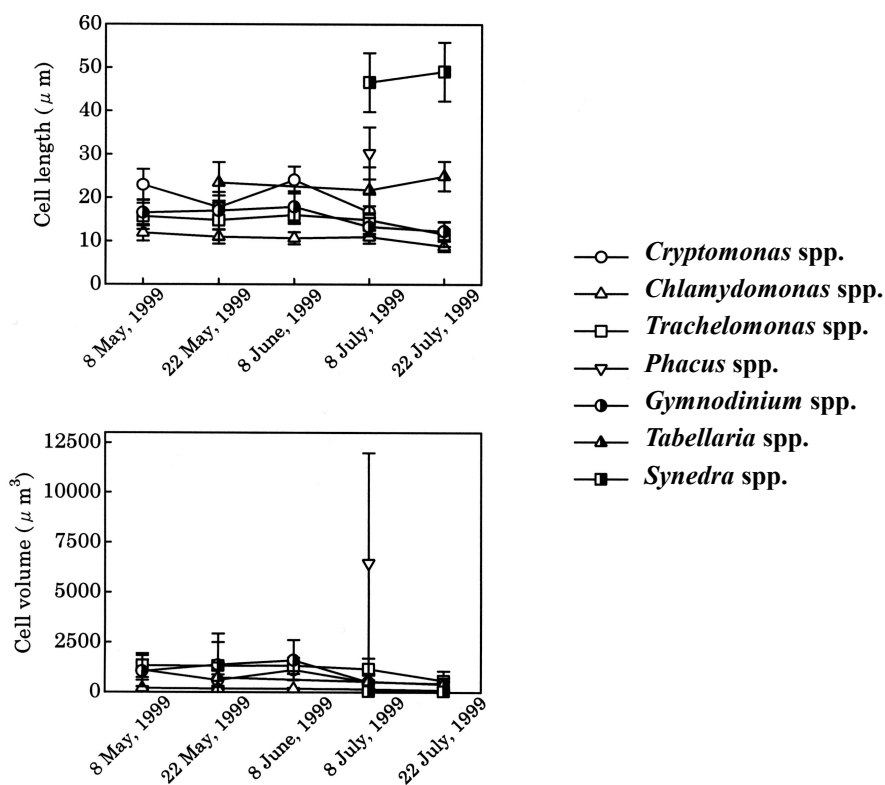

Fig. 6. Temporal changes of length ( $\mu\text{m}$ ) and volume ( $\mu\text{m}^3$ ) of phytoplankton cells in Lake Sabuah. A vertical bar indicates standard deviation.

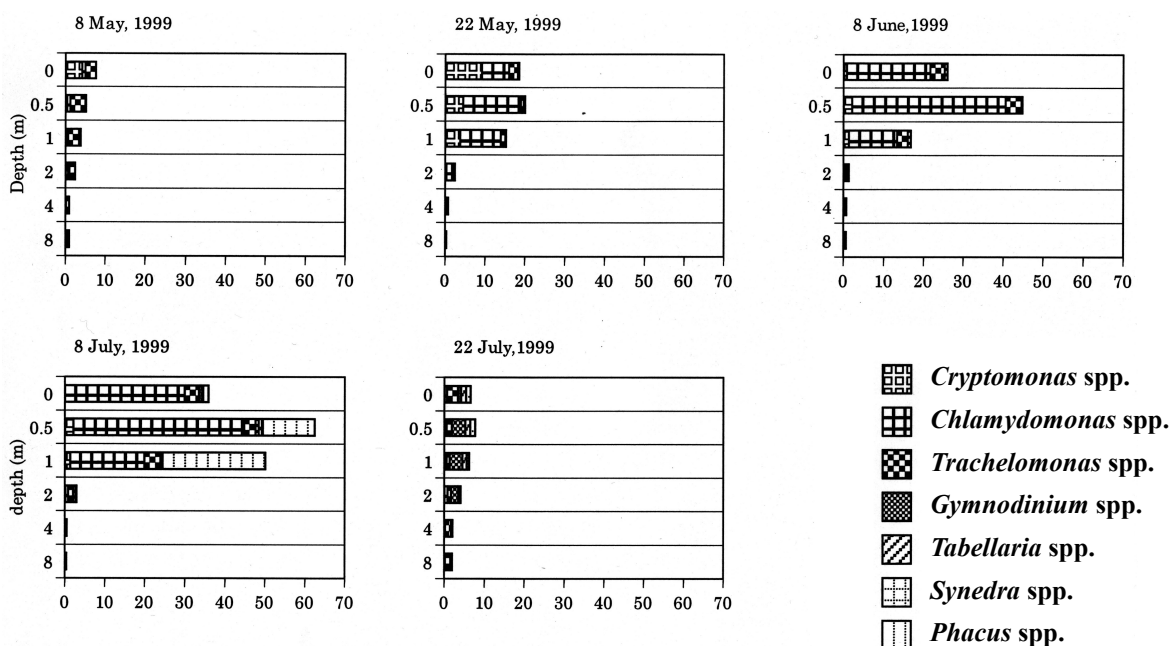

Fig. 7. Depth profile of biomass ( $\text{mgC}/\text{m}^3$ ) of dominant phytoplankton species.

Percentage compositions of phytoplankton taxa in terms of biomass are shown in Fig. 8. Percentage of *Cryptomonas* spp. and *Chlamydomonas* sp. biomass changed from 9.5% to 83.5% in the surface water during the observation period. Particularly it reached 93.9% at 0.5 m depth on 22 May. Biomass of *Trachelomonas* sp. occupied constant proportion throughout the water column from 8 May to 8 June. It became larger in the bottom layers on 8 and 22 June. Biomass of *Chroococcus* spp. tended to occupy large proportions in bottom layers. Biomass percentage of *Phacus* sp. was 53.2% at 1.0 m depth on 8 June. Biomasses of *Synedra* sp. and *Tabellaria* sp., which increased remarkably on 22 July, were 33.6% in the surface water (Fig. 8).

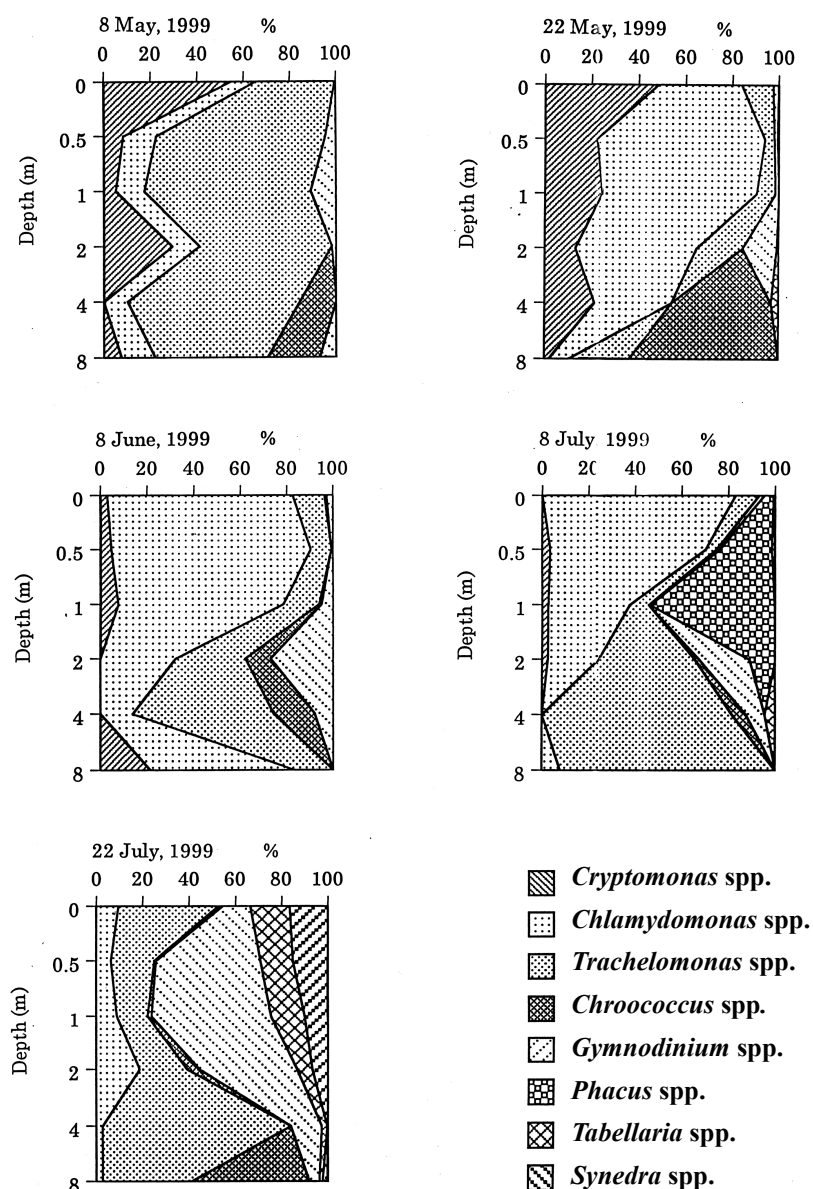

Fig. 8. Percentage composition of dominant phytoplankton species in terms of biomass from 8 May to 22 June 1999.

### Discussion

In dystrophic lakes, low pH, amounts of ions and humic substances affect phytoplankton. Humic substances absorb light quanta and bind with ion and phosphorus, which regulate light and nutrient availability of phytoplankton (Wetzel, 1990). The conditions and large fluctuation of water level, which are unique in tropical region, regulate occurrence pattern of phytoplankton species. In the present survey, the water level fluctuated widely and became shallowest on 8 June. The features of other environmental factors were very low DO concentrations, relatively acidic water as shown by pH and very low specific conductivity.

Flagellates were dominant and its individual number increased markedly before 8 June, whereas diatoms and dinoflagellates were dominant thereafter. When carbon contents of each phytoplankton were applied to obtain the amount of biomass, total biomass increased simultaneously with increasing flagellates' cell number. The percentage fraction in total phytoplankton biomass was 90.3% (0.5 m, 8 June). Even when the densities of diatoms increased, their proportion to the total biomass of phytoplankton was only 33.6% (0m, 22 June). This was due to the fact that their volumes were small and that the carbon contents were smaller than other phytoplankton. Biomass of *Chroococcus* spp. tended to occupy higher proportion among the phytoplankton biomass in the bottom layer.

A heavy precipitation (ca. 115 mm/d) was observed on 20 June at a meteorological station in the campus of the University of Palangkaraya (02°12'55"S, 113°54'00"E) (Takahashi, 2000). Therefore it was not clear that which factor (water level change or large precipitation) strongly affected the succession of phytoplankton. The depth of euphotic zone was the deepest on 8 June when the water depth was shallowest, which might be caused by lesser inflow from the main stream, the Kahayan River. After the heavy precipitation, the depth of euphotic zone decreased to 0.88 m. This might be caused by the increased water inflow from the Kahayan River, which carried dissolved and particulate organic substances from the watershed into the lake.

Flagellates which have motile ability and diatoms which sink slowly due to their slender needle-like shapes may be able to stay longer in the euphotic zone. The present study revealed that these algae became dominant in a humic oxbow lake in Kalimantan. However phytoplankton species that have been reported from Indonesian freshwaters were mainly desmids and diatoms (Sulastri, in press). Flagellates will also be found in other aquatic systems in the further study observing plankton for the intact water. More detailed and long-term phytoplankton research as well as the quantitative and qualitative survey of attached algae are necessary to elucidate how hydrological conditions and humic substances affect phytoplankton population.

### Acknowledgments

We are grateful for advises on the present study from Ir. Dede Irving Hartoto, Research and Development Center for Limnology, Indonesia. For staying and research at Palangkaraya, Central Kalimantan, Ir. Suwido H. Limin helped and supported us greatly. Miss Linda Wulandari, and Miss Yulintine, lecturer of University of Palangkaraya, Mr. Nor Radmann, Mr. Abdul Hafid, Mr. Pieth Haryono, Mr. Junus Sitorus, students at the University of Palangkaraya supported our sampling at the field. We also thank Mr. Imuh the boat driver.

### References

- Croome, R.L. and Tyler, P.A. 1988. Phytoflagellates and their ecology in Tasmanian polyhumic lakes. *Hydrobiologia*, 161, 245-253.
- Fittkau, E.J., Irmiler, U., Junk, J.W., Reiss, F. and Schmidt, G.W. 1975. Productivity, biomass, and population dynamics in Amazonian water bodies. *Amazonian Aquatic Systems*. pp 289-311. Springer-Verlag, New York.
- Hirose, H. and Yamagishi, T. 1977. Illustrations of the Japanese Fresh-Water Algae. . Uchida Rokakuho Publishing (in Japanese).
- Kristiansen, J. and Menezes, M. 1998. Silica-scaled Chrysophytes from an Amazonian flood-plain lake, Mussura Lake, northern Brazil. *Arch. Hydrobiol., Algological Studies*, 90: 97-118.
- Lehmusluoto, P., Machbub, B., Terangna, N., Achmad, F., Boer, L., Timotius, K.H. and Goeltenboth, F. 1999. Limnology in Indonesia from the legacy of the past to the prospects for the future. In: Wetzel, R.G. and Gopal, B. (eds.), *Limnology in Developing Countries*, International Association for Limnology, pp 119-234.
- Miyai, H., Mitsuzaki, K., Ogawa, K. and Sugihara, T. 1988 A simple method for the estimation of phytoplankton biomass based on cell morphology. *Bull. Plankton Soc. Jpn.*, 35: 121-126 (in Japanese).
- Mizuno, T. 1980. *Lakes and Forests in Southeast Asia*. Tokai University Press, Tokyo, 232 pp. (in Japanese).
- Nakano, K., Watanabe, T. and Usman, R. 1987. A fundamental study of overall conservation of terrestrial and freshwater ecosystems in a montane region of Western Sumatra: Vegetation, land-use, and water quality. *Memoirs of the Kagoshima University Research Center for the South Pacific*, 8: 87-124.
- Sulastri, Hartoto, D.I. and Sarnita, A. (in press) Comparative analysis of phytoplankton community in some inland habitat Central Kalimantan, Indonesia. In: *Proceedings of the International Symposium on Ecosystems in Borneo*.
- Strathmann, R.R. 1967. Estimating the organic carbon content of phytoplankton from cell volume or plasma volume. *Limnol. Oceanogr.*, 12: 411-418.
- Takaashi, H. 2000. Meteorological data at the weather station in University of Palangka Raya. *Environmental Conservation and Land Use Management of Wetland Ecosystem in Southeast Asia, Annual Report for April 1999-March 2000*, Graduate School of Environmental Earth Science of Hokkaido University, pp. 100-106.
- Takamura, N., Ishikawa, Y., Mikami, H., Mikami, H., Fujita, Y., Higuchi, S., Murase, H., Yamanaka, S., Nan-jyo, Y., Igari, T. and Fukushima, T. 1996. Abundance of bacteria, picophytoplankton, nanoflagellates and ciliates in relation to chlorophyll *a* and nutrient concentrations in 34 Japanese waters. *Jpn. J. Limnol.*, 57: 245-259.
- Vegas-Vilarrúbia, T. 1995. Distribution of the phytoplankton from the Guri Reservoir (Venezuela). *Hydrobiologia*, 310: 33-46.
- Wetzel, R.G. 1990. Land-water interfaces: Metabolic and limnological regulators. *Verh. Internat. Verein. Limnol.*, 24: 6-24.

## **Effects of Artificial Mixing of Surface and Bottom Waters and Lime Treatment on the Abundance and Primary Productivity of Phytoplankton in Lake Sabuah**

**Ardianor<sup>1</sup>, Enan M. Adiwilaga<sup>2</sup>, Hefni Effendi<sup>2</sup> and Fifi Widjaja<sup>2</sup>**

<sup>1</sup> Division of Aquatic Resources Management, Faculty of Agriculture, Palangka Raya University, Palangkaraya, Central Kalimantan, Indonesia.

<sup>2</sup> Faculty of Fisheries and Marine Science, Bogor Agricultural University, Bogor, West Java, Indonesia.

### **Abstract**

The objective of this research was to find out the effect of artificial turn over on primary productivity and abundance of phytoplankton in Lake Sabuah. Experiment was conducted in situ by constructing a series of transparent plastic bag-type enclosures for incubation of mixed bottom and surface water mass. These plastic enclosures were fixed to 2 floating rafts. The experimental design applied was complete randomize design (CRD) with one independent variable, percentage of bottom water to the total volume (500 l) of mixture of surface and bottom waters (0 %, 25%, 50%, and 75%) with 3 replications. Dependent variables were net primary productivity (NPP) and abundance of phytoplankton. A similar experiment was performed in which water's pH was increased to about 7 using limestone (CaCO<sub>3</sub>), as comparative experiment to the acid lake.

The artificial mixing of bottom water into surface layer water significantly increased the primary productivity of phytoplankton in both non-lime (F = 24.65) and lime (F = 7.79) treatments. Phytoplankton abundance was not affected significantly by the artificial mixing of bottom and surface waters. However, the average phytoplankton abundance on days 1 to 3 after the start of incubation was higher than the initial abundance at all the levels of mixing rates. The significant difference of dependent variables with different levels of mixing rates was attributed to the close relation between mixing rate and phosphorous concentration during incubation.

### **Introduction**

Lake Sabuah is an oxbow lake, which has low pH and quite high concentrations of iron (Fe) and orthophosphate (PO<sub>4</sub>-P) in the bottom water. According to Torang (1995) and Buchar (1998) productivity of phytoplankton in this lake is low (oligotrophic). Consequently, a research is needed to find out new information about how to increase productivity of phytoplankton in Lake Sabuah and to know the potential of it growth under artificial turn over or controlled conditions. Phytoplankton are important natural food due to their ability to synthesize inorganic matters to organic ones through photosynthetic mechanism.

Phytoplankton are microscopic plants that suspend in the water column. The production rate is primarily a function of light intensity, nutrient and temperature. In addition, the primary limiting nutrient for phytoplankton is phosphorous (in the form of PO<sub>4</sub>-P) (Goldman and Horne, 1983). A study conducted in 49 lakes of the United States has shown that phosphorous is limiting phytoplankton growth in 35 lakes, while nitrogen in 8 lakes (Miller *et al.*, 1974 in Boyd, 1990).

The precipitation of phosphate is controlled by redox potential and pH, and a pure



sodium phosphate solution will precipitate as iron phosphate ( $\text{FePO}_4$ ) upon an introduction of iron. This process can be shown to vary with the oxygen level and pH of the water (Goldman and Horne, 1983). In the epilimnion, if the pH is low and the oxygen concentration is quite high, phosphate is easily reacting with Fe, Al, and Ca forming chemical compounds, and slowly sink to the hypolimnion because of the heavy weights of the compounds. Under the oxygen-depleted (anoxic) condition in the bottom area, the chemical compounds of phosphorous metal-alkali (Fe, Al, and Ca) are separated by producing the soluble phosphorous (Wetzel, 1983). The anoxic condition around the bottom area is called “phosphorous trap” (Jorgensen and Vollenweider, 1989). Moreover, in the presence of stratified water column, phosphate is trapped in the hypolimnion. Thus, phosphorous is not available for primary production of phytoplankton in the epilimnion. It becomes available if a physical-process turnover occurs, which, however, rarely happens in the tropical region.

In an aquatic system management the turnover process may be caused artificially. Movement of the bottom water mass to the surface layer also cause a direct movement of abundant orthophosphate to the layer. In the present research, we examined the effect of artificial mixing of bottom water into surface water on the abundance and primary productivity of phytoplankton in Sabuah Lake. The abundance and primary productivity of phytoplankton was predicted to increase under adequate light intensity and higher  $\text{PO}_4\text{-P}$  concentrations, the latter of which would be caused by such mixing treatment.

Since the pH of Lake Sabuah is originally low, a similar experiment was performed in which water's pH was increased to about 7 using limestone ( $\text{CaCO}_3$ ) as comparative experiment to that in the acid lake. Conversely, the neutral-pH would be expected to give probability to phytoplankton growth.

The objective of this research was to clarify the effect of artificial mixing of bottom water into surface water and a lime treatment to primary productivity and abundance of phytoplankton in Lake Sabuah. It was expected to give information on the method of enhancing phytoplankton productivity in the oligotrophic Lake Sabuah and some other lakes with similar characteristics in the catchment area of the Kahayan River.

## Methods

### Study site and time

The study site was located in Lake Sabuah, Tuwung Baru Village, Central Kahayan District, Kapuas Regency of Central Kalimantan Province, about 17 km from Palangkaraya (Fig. 1).

Research was conducted about 4 months from February until May 1999. Primary productivity was measured by incubating lake water in situ as long as 6 h per day from 9:00 A.M. to 15:00 P.M. Lake water and plankton samples were collected at 9:00 A.M. for the analysis of chemical parameters and identification of plankton in the laboratory.

### Experimental design

#### *Field design*

The experiment was conducted by constructing a series of transparent plastic (thickness = 0.35 mm) bag-type enclosures for incubation of mixed bottom and surface waters. A total of these 24 enclosures each having an opening area of  $0.864 \text{ m}^2$  (enforced by wooden frame of  $1.44 \text{ m} \times 0.6 \text{ m}$ ) and 1 m depth were fixed to 2 floating rafts, where each length and width was  $8 \times 5 \text{ m}$ . Each of floating raft held 12 enclosures (Fig. 2).

**Factor design**

The experimental design applied was complete randomize design (CRD) with one independent variable: percentage of bottom water to the mixed volume of the bottom and surface waters, i.e., 0% (A, control), 25%(B), 50%(C) and 75%(D) of 500 l of lake water, with 3 replications. Dependent variables were net primary productivity (NPP) and abundance of phytoplankton.

Bottom water was introduced into each enclosure with an electric pump fitted with PVC pipe. The bottom end of the PVC pipe for water intake was set at 25-50 cm above lake bottom. The bottom water was mixed with the surface water in the enclosures according to the fixed mixing rates. After the mixing initial values of physic-chemical parameters and variables were measured.

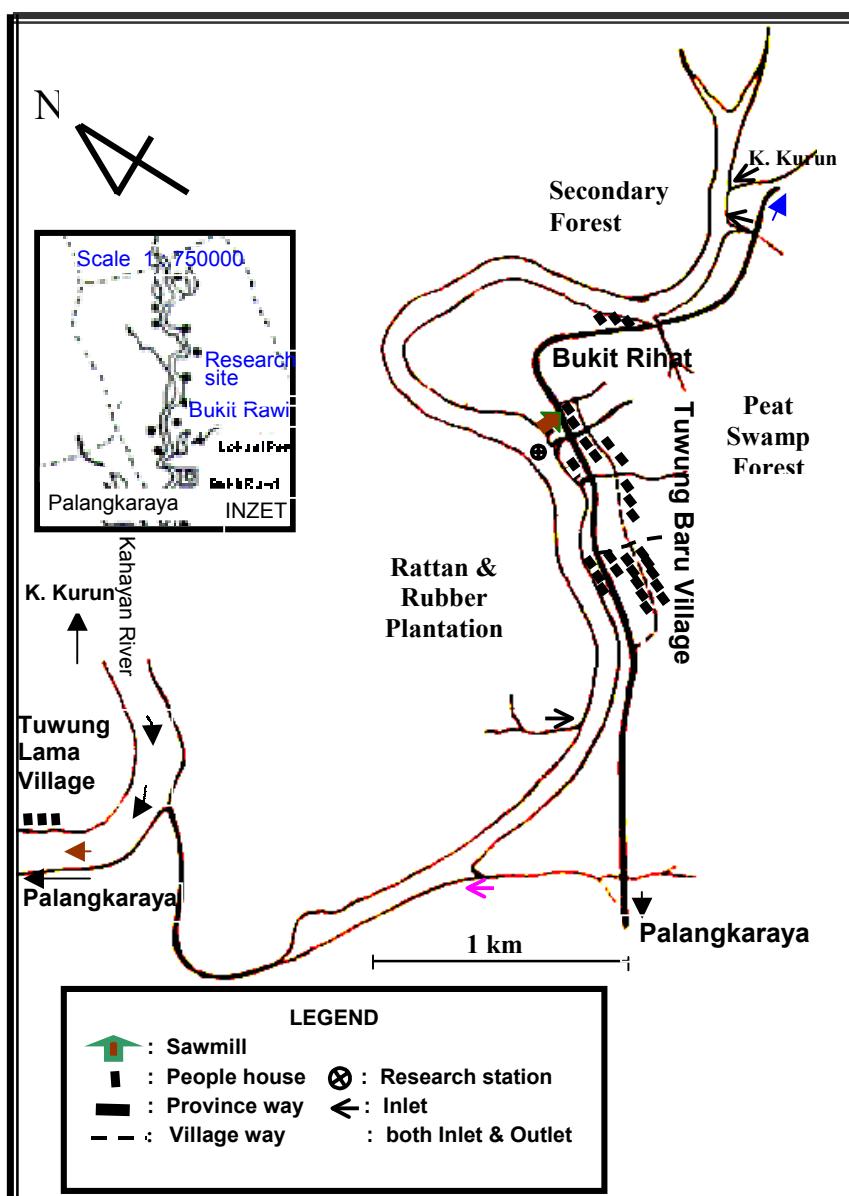

Fig. 1. Map of Lake Sabuah showing research station.



Fig. 2. Transparent plastic enclosures fixed to floating rafts.

The comparative treatment with lime ( $\text{CaCO}_3$ ) was conducted after mixing process. In the preliminary lime treatment, mixing rate was fixed at 50% (B).

#### ***Physico-chemical parameters***

Physico-chemical parameters were measured in the field or analyzed in the laboratory. The parameters and the methods of measurements or analysis are shown in Table 1. Initial parameters were taken for pH, DO, iron,  $\text{PO}_4\text{-P}$ , and plankton abundance.

Table 1. Methods of measurement or analysis of physico-chemical parameters.

| No. | Parameter                                 | Equipment /Method                   | Experiment       |
|-----|---|-------------------------------------|------------------|
| 1.  | Temperature                               | Thermometer/Expansion               | Supporting       |
| 2.  | Transparency                              | Secchi disk/Visual                  | Supporting       |
| 3.  | Light intensity                           | Lux meter/Potensiometer             | Supporting       |
| 4.  | pH  | pH meter/Potentiometer              | Supporting       |
| 5.  | Free- $\text{CO}_2$                       | Titrimetric/ Sodium carbonate       | Supporting       |
| 6.  | DO  | Test-kit and DO meter/Winkler       | Main/ Supporting |
| 7.  | Iron (Fe)                                 | AAS/Phenentrolone                   | Supporting       |
| 8.  | Orthophosphate ( $\text{PO}_4\text{-P}$ ) | Spectrophotometer/Stannous chloride | Main             |
| 9.  | Nitrate ( $\text{NO}_3\text{-N}$ )        | Spectrophotometer/Brucine           | Supporting       |
| 10. | Ammonia ( $\text{NH}_3\text{-N}$ )        | Spectrophotometer/Nesslerization    | Supporting       |

#### ***Primary productivity***

Net primary productivity (NPP,  $\text{mgC m}^{-3} \text{h}^{-1}$ ) was measured using the oxygen method (Wetzel and Likens, 1979), in which net photosynthetic activity per unit volume per time interval (period) was obtained by the concentration of oxygen in the light bottle

( $LB$ , ppm) minus the concentration in the initial bottle ( $IB$ , ppm) as follows:

$$NPP = \frac{[(O_2, LB) - (O_2, IB)] \cdot (1000)}{(PQ) \cdot (t)}$$

where  $t$  is incubation time (6 h);  $PQ$ , photosynthetic quotient (=1.2) (Strickland and Parsons 1968) and 1000, the conversion factor from liter to  $m^3$ .

### ***Phytoplankton abundance***

The phytoplankton samples was concentrated using centrifuge or centrifugation method (Thronsen, 1978). Phytoplankton in each concentrated sample of 3 ml were counted and identified under microscope. Phytoplankton cell density was determined using the Hardy's formula:

$$N = n \cdot \left( \frac{S}{a} \right) \cdot \left( \frac{1}{V} \right)$$

where  $N$  is the amount of phytoplankton ( $cells\ l^{-1}$ );  $n$ , the number of phytoplankton counted (cells);  $S$ , the volume of concentrated sample (=3 ml);  $a$ , the volume of a drop sample counted and identified under microscope ( $\varphi$  0.05 ml);  $V$ , the total volume of sample centrifuged (=2 l) (Hardy, 1939).

### **Data analyses**

Statistical analyses were ANOVA for dependent variables and regression-correlation for chemical parameters in relation to the factor (independent variable). If ANOVA result tended to show significant difference at 95% probability level ( $\alpha=0.05$ ), a polynomial regression analysis was performed. Computer programs used were SPSS and Minitab for Windows.

## **Results and Discussion**

### **Preliminary experiment**

#### ***Lime adjusting***

For 50% (B) of mixing rate, 37.24  $mg\ l^{-1}$  of  $CaCO_3$  was required to increase water's pH of each enclosure to about 7. Physico-chemical parameters at first day of preliminary experiment are shown in Table 2.

Table 2. Physico-chemical parameters of bottom and surface water mass in the preliminary experiment.

| Parameters                        | Bottom | Surface | Mixing rate of 50% |      |
|-----------------------------------|--------|---------|--------------------|------|
|                                   |        |         | Non Lime           | Lime |
| Temperature ( $^{\circ}C$ )       | 25.5   | 27.1    | 26.1               | 26.5 |
| pH                                | 5.67   | 6.26    | 5.61               | 5.76 |
| DO (ppm)                          | 0.00   | 3.7     | -                  | -    |
| Orthophosphate ( $PO_4$ -P) (ppm) | 0.098  | 0.047   | -                  | -    |
| Iron (Fe) (ppm)                   | 0.393  | 0.091   | -                  | -    |

**Day of monitoring**

Growth of phytoplankton was not directly increased after the artificial mixing. However, they were passing the adaptation phase from no optimum light, temperature and nutrient under the natural condition. Further, from the preliminary experiment the abundance of phytoplankton was shown to increase. Indeed, it was fixed on the 3rd day after mixing as primary (main) monitoring and the NPP and abundance of phytoplankton were measured.

**Treatment****Pre monitoring***Physico-chemical parameters*

Artificial mixing of bottom and surface mass was done at 6:30 to 16:00 of D(-2), continued to liming and sampling of plankton. Amount of lime (calcite) added to 0% (A) to 75%(D) was 13.72, 16.38, 17.37 and 19.02 g, respectively. Data for physico-chemical parameters are shown in Table 3. The difference were significant (bottom > surface) for all parameters particularly orthophosphate and iron, while the dissolved oxygen (DO) was vice versa.

Table 3. Physico-chemical parameters for bottom and surface waters.

| Parameters                                | Bottom      | Surface     |
|---|-------------|-------------|
| Temperature (°C)                          | 25.4 – 28.3 | 29.2 – 36.8 |
| pH  | 5.46        | 6.14        |
| DO (ppm)                                  | 0.46        | 3.72        |
| Free-CO <sub>2</sub> (ppm)                | 19.97       | 10.98       |
| Orthophosphate (PO <sub>4</sub> -P) (ppm) | 0.114       | 0.056       |
| Iron (Fe) (ppm)                           | 0.383       | 0.089       |

There was no correlation between water temperature and the mixing rate of bottom and surface waters (Fig. 3a). The pH, in particular on D (-2), showed significant correlation with the mixing rate. The pH decreased with increasing percentage of bottom water in the mixed water mass (Fig. 3b), due to the lower pH of bottom water than that of surface (see Table 3). However, no significant correlation was found for D (-1) and D (0) probably because of the buffer process within the enclosures.

Orthophosphate and iron concentrations of D (-2) to D (0) tended to increase with increasing percentage of bottom water in the mixed water mass (Figs. 3c, d). The correlation coefficient ranged between 0.86 and 0.99 (mostly significant except for orthophosphate (NL) at D (0), which was - 0.22) (Table 4).

**Phytoplankton abundance**

The phytoplankton abundances in the surface and bottom waters at the research station were 57 and 80 cells l<sup>-1</sup>, respectively. The average abundance of phytoplankton in the present study (74 cells l<sup>-1</sup>; Table 5) was higher than the reported values of 1.968 cells l<sup>-1</sup> (Torang, 1985) and 2.356 cells l<sup>-1</sup> (Buchar, 1998) in this lake (average of 5 stations). The difference was probably caused by difference in sampling times (or seasons): Torang and Buchar sampled in August to November (rainy season).

Enclosure experiments on the abundance and production of lake phytoplankton

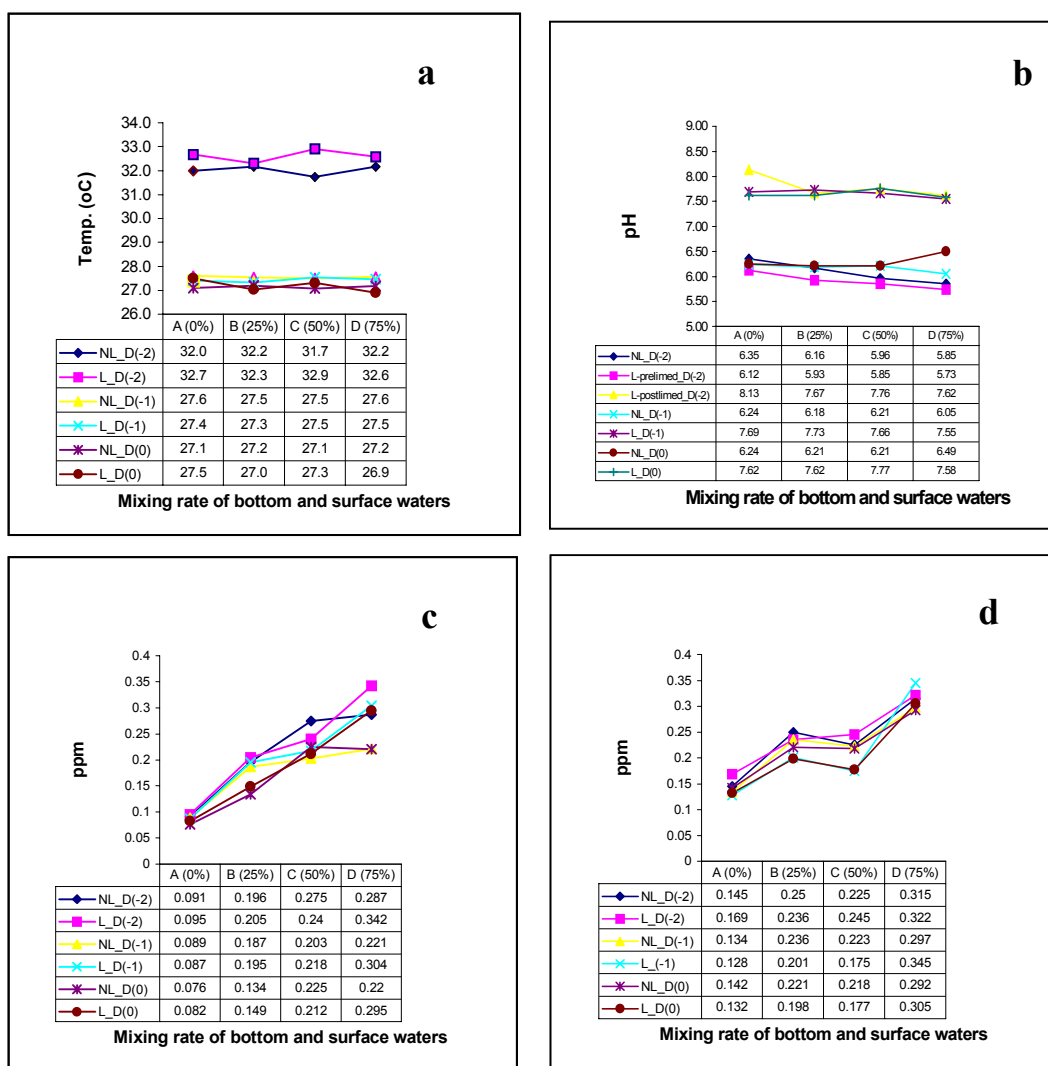

Fig. 3. Physico-chemical parameters of D (-1) to D (0) for non-lime (NL) and lime (L) treatments. a: Temperature; b: pH; c: Orthophosphate; d: Iron.

Table 4. Correlation of orthophosphate and iron (Y) to percentage of bottom water to mixed surface and bottom waters (X) in the pre monitoring.

| Date/day        | Parameters (Y) | Correlation coefficient | Equation |                       |
|-----------------|----------------|-------------------------|----------|-----------------------|
| 24-3-99/ D (-2) | NL             | Iron (Fe)               | 0.89     | $Y = 0.16 + 0.0019X$  |
|                 |                | PO <sub>4</sub> -P      | 0.95*    | $Y = 0.11 + 0.0027X$  |
|                 | L              | Iron (Fe)               | 0.96*    | $Y = 0.17 + 0.0019X$  |
|                 |                | PO <sub>4</sub> -P      | 0.98*    | $Y = 0.10 + 0.0031X$  |
| 25-3-99/ D (-1) | NL             | Iron (Fe)               | 0.91     | $Y = 0.15 + 0.0019X$  |
|                 |                | PO <sub>4</sub> -P      | 0.90     | $Y = 0.11 + 0.0016X$  |
|                 | L              | Iron (Fe)               | 0.86     | $Y = 0.12 + 0.0025X$  |
|                 |                | PO <sub>4</sub> -P      | 0.97*    | $Y = 0.10 + 0.0027X$  |
| 26-3-99/ D (0)  | NL             | Iron (Fe)               | 0.94     | $Y = 0.15 + 0.0018X$  |
|                 |                | PO <sub>4</sub> -P      | -0.22    | $Y = 13.63 - 0.1334X$ |
|                 | L              | Iron (Fe)               | 0.87     | $Y = 0.13 + 0.002X$   |
|                 |                | PO <sub>4</sub> -P      | 0.99**   | $Y = 0.08 + 0.0028X$  |

\*\*P<0.01 ; \* P<0.05; ; NL = Non-lime treatment; L = Lime treatment.

Table 5. Average of initial phytoplankton and zooplankton abundances.

| Treatment | Phytoplankton (cells l <sup>-1</sup> ) |      | Zooplankton (cells l <sup>-1</sup> ) |      |
|-----------|--|------|--------------------------------------|------|
|           | Non Lime                               | Lime | Non Lime                             | Lime |
| A (0%)    | 67                                     | 63   | 3                                    | 7    |
| B (25%)   | 60                                     | 73   | 13                                   | 13   |
| C (50%)   | 80                                     | 83   | 17                                   | 17   |
| D (75%)   | 83                                     | 83   | 20                                   | 30   |

## Main monitoring

### Physico-chemical parameters

Physico-chemical parameters on D (1) to D (3) correlated with the mixing rate of surface and bottom waters. Light is a main source of energy, and temperature as a controlling factor: these are not affected by the mixing rate of surface and bottom waters. Therefore phosphorous was probably increased by increasing percentage of the bottom water in the mixture of surface and bottom waters. On the other hand, nitrogen (N) was not increased significantly. Iron concentration increased significantly since it served as a controller of solubility of orthophosphate (Fig. 4a, b).

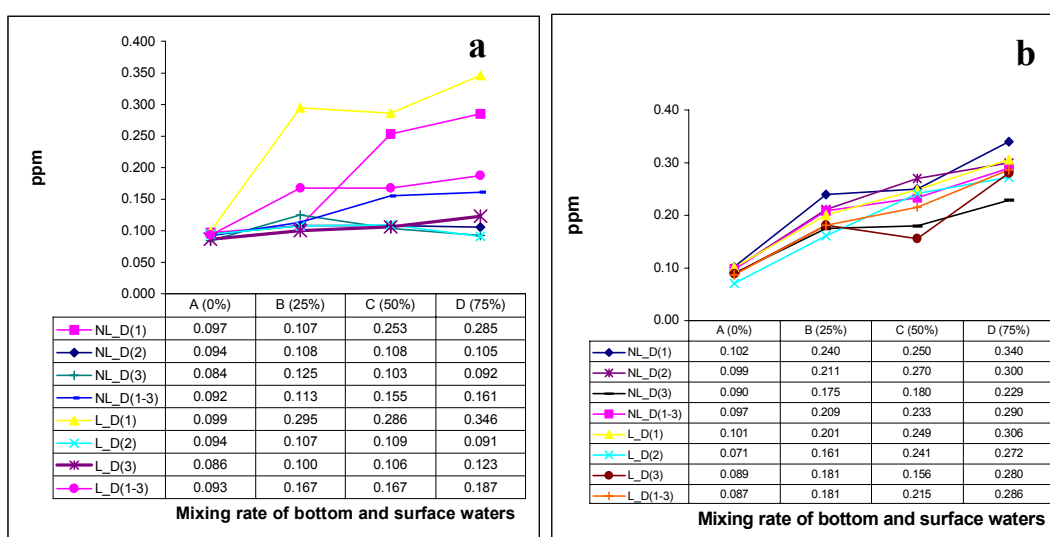

Fig. 4. Physico-chemical parameters of D (1) to D (3) for non-lime (NL) and lime (L) treatments. a: Orthophosphate; b: Iron.

Phosphorous (absorbed in the form of PO<sub>4</sub>-P) in fresh water is more limiting than nitrogen (absorbed in the form of ammonia, nitrate and N<sub>2</sub>) for phytoplankton due to their immobility.

Most data for phosphate and iron concentrations of D (1) to D (3) in non-lime (NL) treatment showed significant correlation with the mixing rate of surface and bottom waters. However, by the lime treatment, the correlation became insignificant (iron = linear correlation; phosphate = quadratic), indicating that a reaction might have

occurred among lime, orthophosphate and iron. Because of the difference in their concentrations (iron > orthophosphate), iron was still linear whereas orthophosphate had already been quadratic up to D (3) (Fig. 4a, b).

Table 6. Correlation between orthophosphate and iron (Y) and Percentage of mixed bottom and surface water (X) in the main experiment.

| Date/day             |    | Parameters (Y)     | Correlation coefficient | Equation                                      |
|----------------------|----|--------------------|-------------------------|---|
| 27-3-99/ D (1)       | NL | Fe                 | 0.95*                   | $Y = 0.12 + 0.0029X$                          |
|                      |    | PO <sub>4</sub> -P | 0.94                    | $Y = 0.079 + 0.0028X$                         |
|                      | L  | Fe                 | 0.98*                   | $Y = 0.11 + 0.0027X$                          |
|                      |    | PO <sub>4</sub> -P | 0.87                    | $Y = 0.14 + 0.003X$                           |
| 28-3-99/ D (2)       | NL | Fe                 | 0.96*                   | $Y = 0.10 + 0.0051X - 3.0 \times 10^{-5}X^2$  |
|                      |    | PO <sub>4</sub> -P | 0.97*                   | $Y = 0.094 + 0.0006X - 7.0 \times 10^{-6}X^2$ |
|                      | L  | Fe                 | 0.98*                   | $Y = 0.084 + 0.0027X$                         |
|                      |    | PO <sub>4</sub> -P | 0.99**                  | $Y = 0.093 + 0.0009X - 1.0 \times 10^{-5}X^2$ |
| 29-3-99/ D (3)       | NL | Fe                 | 0.94                    | $Y = 0.10 + 0.002X$                           |
|                      |    | PO <sub>4</sub> -P | 0.84                    | $Y = 0.09 + 0.0016X - 2.0 \times 10^{-5}X^2$  |
|                      | L  | Fe                 | 0.89                    | $Y = 0.09 + 0.002X$                           |
|                      |    | PO <sub>4</sub> -P | 0.98*                   | $Y = 0.086 + 0.0005X$                         |
| Avg. of D(1) to D(3) | NL | Fe                 | 0.96*                   | $Y = 0.12 + 0.0024X$                          |
|                      |    | PO <sub>4</sub> -P | 0.97*                   | $Y = 0.093 + 0.001X$                          |
|                      | L  | Fe                 | 0.86                    | $Y = 0.12 - 0.007 + 0.0002X^2$                |
|                      |    | PO <sub>4</sub> -P | 0.88                    | $Y = 0.097 + 0.0027X - 2.0 \times 10^{-5}X^2$ |

\* P<0.05; \*\* P<0.01; NL = Non-lime treatment; L = Lime treatment.

**Net primary productivity (NPP) of phytoplankton**

Artificial mixing of the bottom and surface water mass increased NPP that is shown by ANOVA of D (1) – D (3) for non-lime (F = 24.65) and lime (F = 7.79) treatments (Table 7).

Table 7. Analysis of variance for percentage (%) of bottom water to the mixture of surface and bottom waters and primary productivity (NPP).

| Time of day | F-value |        | Polynomials |   |
|-------------|---------|--------|-------------|---|
|             | NL      | L      | NL          | L |
| D1          | 1.89    | 33.06* | -           | L |
| D2          | 9.48*   | 13.28* | L           | Q |
| D3          | 15.20*  | 0.58   | L           | - |
| D1 – D3     | 24.65*  | 7.79*  | L           | L |

\* P < 0.05; L = linear; Q = quadratic; NL = Non-lime treatment; L = Lime treatment

A linear correlation was observed up to 75% of mixed water mass with  $r^2 > 0.8$  (Figs. 5a, b). The significant effect of mixing of water mass on NPP was caused by increasing of orthophosphate from 0% to 75% of mixing rate, with correlation coefficient of 0.84 – 0.99 for non-lime treatment and 0.87 – 0.99 for lime treatment.



According to Schindler (1978) maximum biomass is particularly limited by phosphorous supply in temperate lakes, conversely by nitrogen in marine systems. Thus, there is a significant correlation between phytoplankton biomass and phosphorous (Anderson *et al.* 1978) or phytoplankton biomass is affected by concentration of phosphorous in most of the lakes (Heyman and Lundgren, 1988).

In a tropical lake, Lago do Castanho, phosphate concentration in the hypolimnion is 0 to 0.46 g l<sup>-1</sup> (higher in the bottom), and commonly decrease in the epilimnion after turn over due to high rates of phytoplankton photosynthesis (Payne, 1986).

Under natural condition, turbulence (turn over) may increase trophic status because of the movement of sediment containing high concentration of phosphorous which will become available for the growth of phytoplankton in the epilimnion (Schubel, 1968; Anderson, 1972, 1978 in Peters and Cattaneo, 1984).

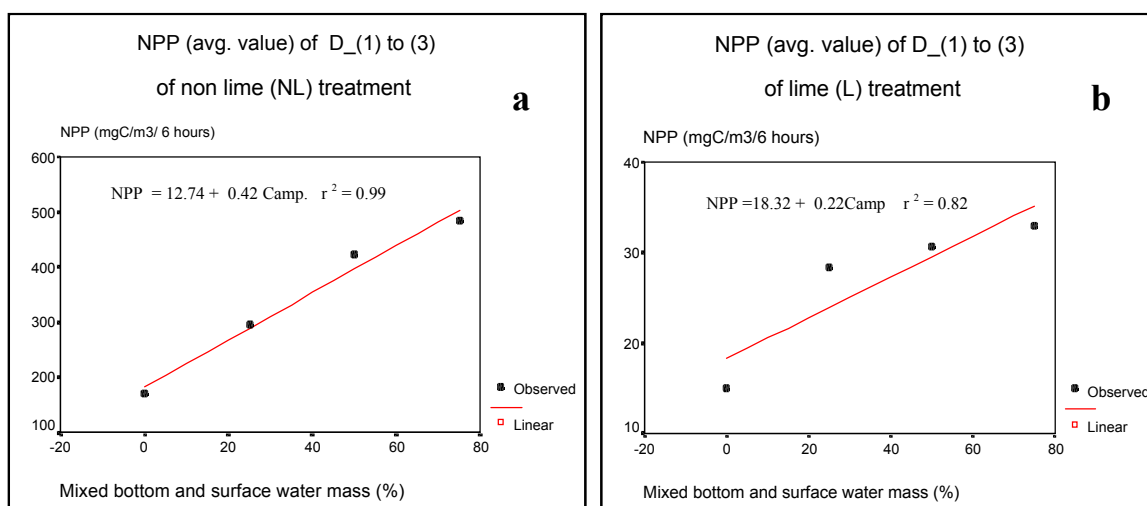

Fig. 5. Net primary productivity (NPP) averaged for D (1) to D (3) in relation to mixing rate of surface and bottom waters. a: non-lime (NL) treatment; b: lime (L) treatment.

### ***Abundance of phytoplankton***

A total of 30 phytoplankton genera were found consisting of 4 classes, viz. Bacillariophyceae (9 genera), Chlorophyceae (19 genera), Cyanophyceae (1 genus) and Eulenophyceae (1 genus). The dominant genus was *Tabellaria*.

Based on the ANOVA, the phytoplankton abundance was not significantly affected by the artificial mixing of bottom and surface waters (Table 8). However, the average phytoplankton abundance for 5 days of incubation was higher than the initial values at each level of mixing (Table 9). The significant correlation between dependent and independent variables was caused by a close relation between the levels of artificial mixing and the concentrations of phosphorous during incubation.

Both non-lime (NL) and lime (L) treatments caused high difference of abundance of phytoplankton as compared with the initial abundance (columns 6 and 7 in Table 9). Phytoplankton abundance increased up to the 3rd day of monitoring (D (3)) particularly for the mixing rate of 25% (B), 50% (C) and 75% (D).

Table 8. Analysis of variance for percentage (%) of bottom water to the mixture of surface and bottom waters and phytoplankton abundance.

| Time of Day    | F-value |       | Polynomials |   |
|----------------|---------|-------|-------------|---|
|                | NL      | L     | NL          | L |
| D1             | 1.68    | 0.47  | -           | - |
| D2             | 4.12*   | 5.74* | -           | L |
| D3             | 0.35    | 9.05* | -           | Q |
| Avg. of D1– D3 | 0.08    | 1.19  | -           | - |

\* P<0.05; L = linear; Q = quadratic; NL = Non Lime treatment; L = Lime treatment

Table 9. Comparison of phytoplankton abundance between initial value and the average of D (1) to D (3).

| Treatment | Abundance of phytoplankton (cell l <sup>-1</sup> ) |          |                  |          |                          |          |
|-----------|--|----------|------------------|----------|--------------------------|----------|
|           | Initial (after mixing)                             |          | Avg. of D1 to D3 |          | Avg. of D1toD3 – initial |          |
|           | Non Lime (NL)                                      | Lime (L) | Non Lime (NL)    | Lime (L) | Non Lime (NL)            | Lime (L) |
| 1         | 2  | 3        | 4                | 5        | 6                        | 7        |
| A (0%)    | 67   | 63       | 357              | 257      | 290                      | 149      |
| B (25%)   | 60   | 73       | 341              | 246      | 281                      | 173      |
| C (50%)   | 80   | 83       | 335              | 251      | 171                      | 168      |
| D (75%)   | 83   | 83       | 326              | 214      | 131                      | 131      |

The fact that the phytoplankton abundance did not differ significantly between non-lime and lime treatments (ANOVA) was not caused by insufficient nutrient (PO<sub>4</sub>-P) but possibly by grazing of zooplankton during incubation (Figs. 6a, b). It is also supported by the correlation coefficient between phyto- and zooplankton of -0.733 (NL) and 0.121 (L) and the regression in Figs. 7a and b. The dominant zooplankton species identified in the present study were cyclopid copepods which are reported as phytoplankton feeder (Pennak, 1978; Lewis, 1979; Goldman and Horne, 1983).

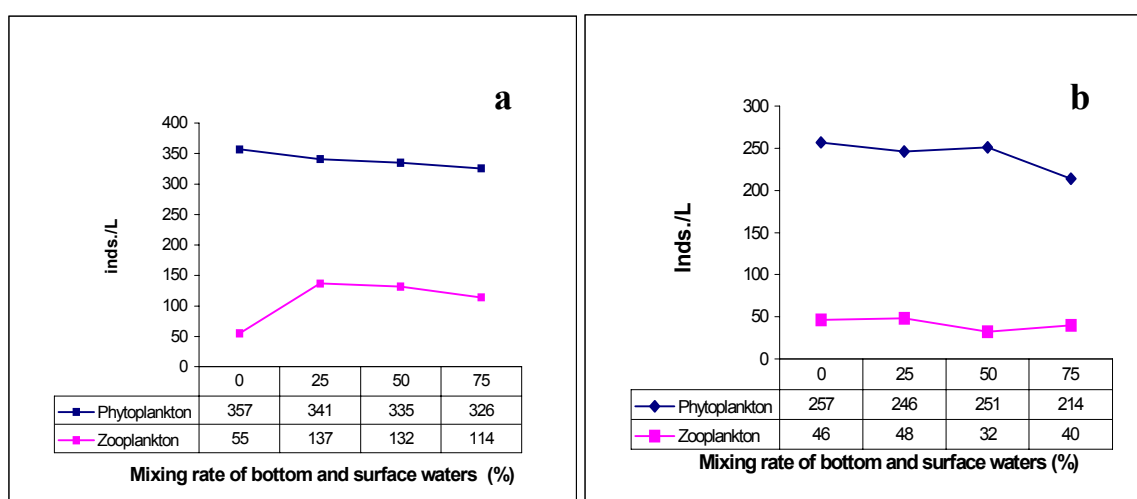

Fig. 6. Phytoplankton and zooplankton abundances averaged for D (1) to D (3) in relation to mixing rate of surface and bottom waters. a: non-lime (NL) treatment; b: lime (L) treatment.

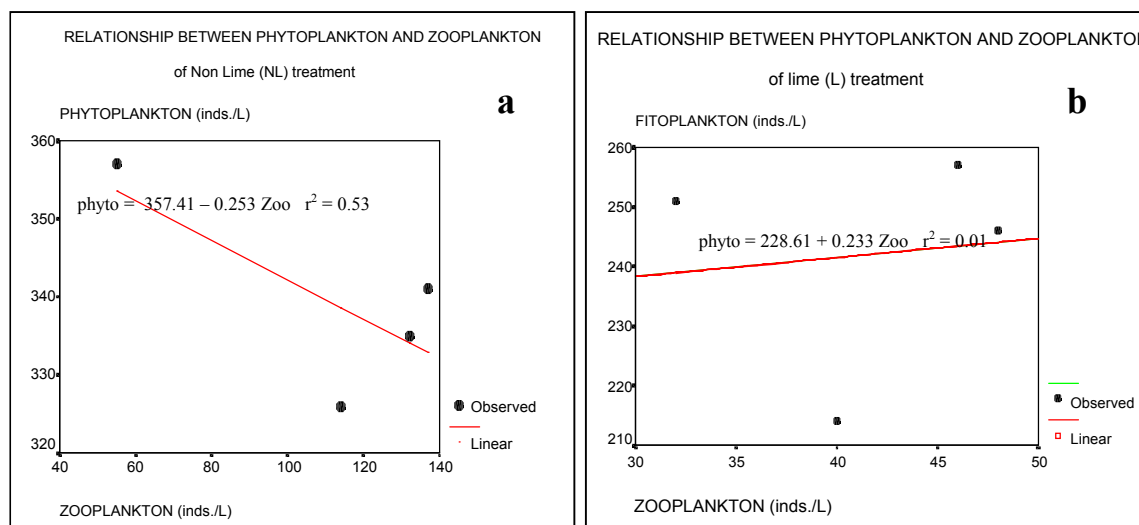

Fig. 7. Relationship between phytoplankton and zooplankton abundances. a: non-lime (NL) treatment; b: lime (L) treatment.

### Conclusion

According to the result, there can be concluded that artificially turn over of water mass from the bottom to the surface layer with different percentage of mixing may increase nutrient concentration, especially orthophosphate, so it could be able to support the increasing of primary productivity and abundance of phytoplankton within the surface water which is adequate of light.

### References

- Anderson, G., Berggren, H., Cronberg, C. and Gelin, C. 1978. Effect of planktivorous and benthivorous fish on organisms and water chemistry in eutrophic lakes. *Hydrobiologia*, 59: 9-15.
- Boyd, C. E. 1990. *Water Quality in Ponds for Aquaculture*. Alabama Agricultural Experimental Station, Auburn University, Alabama. USA.
- Buchar, T. 1998. Bioekologi Komunitas Ikan di Danau Sabuah. Tesis, Program Pascasarjana, Institut Pertanian Bogor (IPB), Bogor. Tidak dipublikasikan.
- Cole, G. A. 1983. *Textbook of Limnology. 3rd edn*. Waveland Press Inc, New York, USA.
- Connel, W. Des and Miller, G. J. 1995. Kimia dan Ekotoksikologi Pencemaran (alih bahasa : Yanti Koestor). Penerbit Universitas Indonesia, Jakarta.
- Goldman, C.R. and Horne, A. J. 1983. *Limnology*. McGraw-Hill, New York. USA.
- Heyman, U, and Lundgren, A. 1988. Phytoplankton biomass and production in relation to phosphorous: some conclusion from field study. *Hydrobiologia*, 170: 211 – 227.
- Jorgensen, S.E and Vollenweider, R. A. 1989. Guidelines of Lake Management. Principles of Lake Management Vol. 1. International Lake Environment Committee, United Nations Environmental Program, Shiga. Japan.
- Lewis, W. M. Jr. 1979. *Zooplankton Community Analysis: Studies on A Tropical System*. Springer-Verlag, New York, USA.

- Payne, A. I. 1986. *The Ecology of Tropical Lakes and Rivers*. John Willey and Sons, Chichester, New York, Toronto, Brisbane, Singapore.
- Pennak, R.W. 1978. *Fresh Water Invertebrates of the United States*. Jhon Wiley and Sons. Canada.
- Peter, R.H., and Cuttaneo, A. 1984. The effect of turbulence on phosphorous supply in a shallow bay of Lake Memphremagog. *Ver. Internat. Verein. Limnol.*, 22:185 – 189.
- Schilder, D. W. 1978. Factors regulating phytoplankton production and standing crop in the world's freshwater. *Limnology and Oceanography.*, 23: 86 – 93.
- Strickland, J. D. H. and Parsons, T. R. 1968. *A Practical Handbook of Sea Water Analysis. Bull. Fish. Res. Bd.*, Canada.
- Torang, I. 1995. Hubungan Antara Iluminasi dengan Kelimpahan dan Komposisi Jenis Fitoplankton. Tesis, Program Pascasarjana, Institut Pertanian Bogor (IPB), Bogor. Tidak dipublikasi.
- Wetzel, R. G. and Likens, G. E. 1979. *Limnological Analyses*. W.B. Sauders Company, Philadelphia, London, Toronto.
- Wetzel, R. G. 1983. *Limnology*. Second edition. CBS College Publishing, New York, USA.

## **Turnover Rate of Aquatic Macrophytes in the Irrigation Ponds around Lake Shinji and Lake Nakaumi, Japan**

**Hidenobu KUNII**

Research Center for Coastal Lagoon Environments, Shimane University,  
Matsue 690-8504, Japan. E-mail address: kunii@soc.shimane-u.ac.jp

### **Abstract**

This study was conducted to evaluate the temporal changes of the species composition of aquatic macrophytes and environmental variables in the irrigation ponds around Lake Shinji and Lake Nakaumi, Shimane Prefecture, Japan, during a relatively long period of time by comparing the data taken in 1980's and in 1990's. The results compared showed a drastic change in species composition in each pond and almost all the taxa exhibited appearance/disappearance patterns without significant environmental change during the period. Mean turnover rate of dominant 11 taxa, which showed more than 10% frequency of occurrence in 1980's, was estimated as 35.2%.

### **Introduction**

It is reported that there exist hundreds of thousands irrigation ponds in Japan and most of these ponds are artificial developed during sixteenth and nineteenth centuries with the development of rice field. During 1980s, the author studied the relation between aquatic macrophyte composition and water variables of 149 irrigation ponds around Lake Shinji and Lake Nakaumi and showed that (1) the macrophytes can be divided into 4 or 5 groups by using Detrended Correspondence Analysis (DCA) and chi-square test and (2) such variables as pH, electric conductivity, alkalinity, Ca, Mg, Na, K have significant relation with aquatic macrophyte composition while other variables (transparency, chlorophyll a content, reactive-P, total P, COD, Fe and ignition loss of bottom soil) have not (Kunii, 1991).

Lakes and ponds can be conceptualized as islands (Keddy, 1979; Browne, 1981), and it is very important to know the temporal changes in aquatic macrophyte composition in terms of the conservation and management of aquatic macrophytes. Ten years after this study, the author thus conducted to evaluate the temporal changes of the species composition of aquatic macrophytes and environmental variables in the irrigation ponds.

### **Site and Methods**

Present study was conducted at the irrigation ponds around Lake Shinji and Lake Nakaumi, Shimane Prefecture, Japan. Forty-five and 46 ponds, which were visited in 1984 and 1986, respectively, were visited again in the growth period of 1994 and 1996, respectively, and presence/absence data on each macrophyte were recorded and several environmental variables were measured in the field and/or analysed in the laboratory (cf. Table 2). For the detailed description of the study site and measurement, refer Kunii (1991). From these two time different data sets, comparisons were made to evaluate the temporal changes of the species composition of aquatic macrophytes and environmental variables. Here the author used turnover rate to express the dynamic equilibrium or the community stability of the macrophytes in ponds in terms of the island biogeography (see Diamond, 1969; Browne, 1981).

### Results and Discussion

Of the 37 species found in 1980s, 4 species (*Sparganium fallax*, *Vallisneria asiatica*, *Myriophyllum verticillatum* and *Eichhornia crassipes*) could not be found, while 2 species (*Potamogeton maackianus* and *Elodea nuttallii*) were newly found in 1990s (Table 1). As a result, total number of taxa found was 37 and 35 and average number of taxa per pond was 3.9 and 3.4, respectively, in 1980s and in 1990s.

Table 1. Temporal changes in floristic composition between 1980s and 1990s in 91 irrigation ponds, Shimane, Japan.

| Plant name                        | 1984+1986       |               | Newly found | Not found | Difference | 1994+1996       |               |
|-----------------------------------|-----------------|---------------|-------------|-----------|------------|-----------------|---------------|
|                                   | No. ponds found | Frequency (%) |             |           |            | No. ponds found | Frequency (%) |
| <i>Trapa</i> spp.                 | 51              | 56.0          | 6           | -9        | -3         | 48              | 53.9          |
| <i>Utricularia</i> spp.           | 34              | 37.4          | 8           | -13       | -5         | 29              | 32.6          |
| <i>Potamogeton octandrus</i>      | 35              | 38.5          | 4           | -16       | -12        | 23              | 25.8          |
| <i>Nymphaea tetragona</i>         | 27              | 29.7          | 2           | -9        | -7         | 20              | 22.5          |
| <i>Brasenia schreberi</i>         | 21              | 23.1          | 0           | -4        | -4         | 17              | 19.1          |
| <i>Ceratophyllum demersum</i>     | 15              | 16.5          | 6           | -5        | 1          | 16              | 18.0          |
| <i>Potamogeton fryeri</i>         | 18              | 19.8          | 3           | -7        | -4         | 14              | 15.7          |
| <i>Lemna paucicostata</i>         | 5               | 5.5           | 9           | -2        | 7          | 12              | 13.5          |
| <i>Hydrilla verticillata</i>      | 14              | 15.4          | 2           | -5        | -3         | 11              | 12.4          |
| <i>Spirodela polyrhiza</i>        | 8               | 8.8           | 4           | -1        | 3          | 11              | 12.4          |
| <i>Najas minor</i>                | 15              | 16.5          | 6           | -11       | -5         | 10              | 11.2          |
| <i>Myriophyllum oguraense</i>     | 19              | 20.9          | 0           | -10       | -10        | 9               | 10.1          |
| <i>Ottelia alismoides</i>         | 4               | 4.4           | 5           | -1        | 4          | 8               | 9.0           |
| <i>Egeria densa</i>               | 2               | 2.2           | 4           | 0         | 4          | 6               | 6.7           |
| <i>Myriophyllum ussuriense</i>    | 7               | 7.7           | 1           | -4        | -3         | 4               | 4.5           |
| <i>Eleocharis</i> sp.             | 7               | 7.7           | 3           | -6        | -3         | 4               | 4.5           |
| <i>Potamogeton distinctus</i>     | 5               | 5.5           | 0           | -1        | -1         | 4               | 4.5           |
| <i>Nymphoides indica</i>          | 5               | 5.5           | 0           | -1        | -1         | 4               | 4.5           |
| <i>Nymphaea</i> cv.               | 4               | 4.4           | 0           | 0         | 0          | 4               | 4.5           |
| <i>Blyxa echinosperma</i>         | 7               | 7.7           | 1           | -5        | -4         | 3               | 3.4           |
| <i>Najas graminea</i>             | 6               | 6.6           | 2           | -5        | -3         | 3               | 3.4           |
| <i>Limnophylla sessiliflora</i>   | 2               | 2.2           | 1           | 0         | 1          | 3               | 3.4           |
| <i>Nuphar japonica</i>            | 2               | 2.2           | 3           | -2        | 1          | 3               | 3.4           |
| <i>Nitella</i> spp.               | 17              | 18.7          | 1           | -16       | -15        | 2               | 2.2           |
| <i>Nelumbo nucifera</i>           | 3               | 3.3           | 0           | -1        | -1         | 2               | 2.2           |
| <i>Chara</i> spp.                 | 3               | 3.3           | 2           | -3        | -1         | 2               | 2.2           |
| <i>Potamogeton oxyphyllus</i>     | 1               | 1.1           | 2           | -1        | 1          | 2               | 2.2           |
| <i>Ricciocarpus natans</i>        | 1               | 1.1           | 2           | -1        | 1          | 2               | 2.2           |
| <i>Potamogeton maackianus</i>     | 0               | 0             | 2           | 0         | 2          | 2               | 2.2           |
| <i>Elodea nuttallii</i>           | 0               | 0             | 2           | 0         | 2          | 2               | 2.2           |
| <i>Potamogeton crispus</i>        | 5               | 5.5           | 0           | -4        | -4         | 1               | 1.1           |
| <i>Najas japonica</i>             | 2               | 2.2           | 1           | -2        | -1         | 1               | 1.1           |
| <i>Blyxa japonica</i>             | 2               | 2.2           | 1           | -1        | 0          | 1               | 1.1           |
| <i>Isoetes japonica</i>           | 2               | 2.2           | 1           | -2        | -1         | 1               | 1.1           |
| <i>Hydrocharis dubia</i>          | 1               | 1.1           | 0           | 0         | 0          | 1               | 1.1           |
| <i>Sparganium fallax</i>          | 2               | 2.2           | 0           | -2        | -2         | 0               | 0             |
| <i>Vallisneria asiatica</i>       | 1               | 1.1           | 0           | -1        | -1         | 0               | 0             |
| <i>Myriophyllum verticillatum</i> | 1               | 1.1           | 0           | -1        | -1         | 0               | 0             |
| <i>Eichhornia crassipes</i>       | 1               | 1.1           | 0           | -1        | -1         | 0               | 0             |
| Total no. of taxa found           | 37              |               |             |           |            | 35              |               |
| Average no. of taxa per pond      | 3.9             |               |             |           |            | 3.4             |               |

Almost all the taxa (37 out of 39 taxa) showed appearance/disappearance pattern (Fig. 1) and only *Nymphaea* cv. and *Hydrocharis dubia* showed no temporal change. While *Utricularia* spp., *Potamogeton octandrus*, *Najas minor* and *Myriophyllum oguraense* decreased drastically, *Lemna paucicostata* increased markedly. Mean turnover rate of dominant 11 taxa, which showed more than 10% frequency of occurrence in 1980s, was estimated as 35.2% (Fig. 2) without significant environmental changes (Table 2).

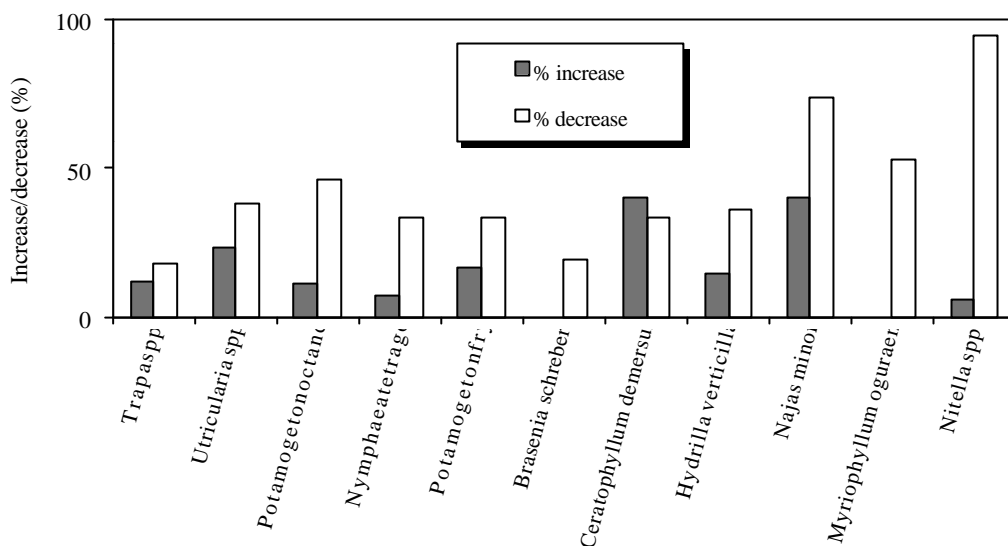

Fig. 1. Percent increase/decrease of dominant aquatic macrophytes during 10 years.

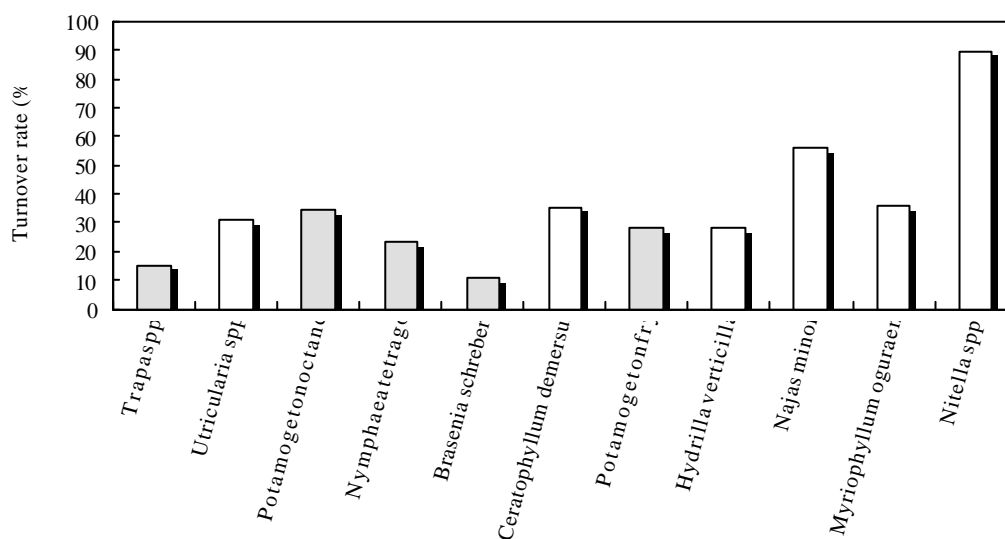

Fig. 2. Turnover rate of dominant aquatic macrophytes during 10 years. Hatched bars indicate floating-leaved and free-floating macrophytes.

Table 2. Comparison of some environmental variables between 1980s and 1990s.

| Variables                          | Years | Sample No. | Max.   | Min.  | Mean   | S.D.  | t-test |
|------------------------------------|-------|------------|--------|-------|--------|-------|--------|
| Water depth<br>(m)                 | 1980s | 77         | 6      | 0.3   | 1.9    | 0.95  |        |
|                                    | 1990s | 82         | 5.65   | 0.02  | 1.67   | 1.05  |        |
| Transparency<br>(m)                | 1980s | 76         | 3      | 0.3   | 1.14   | 0.57  | ***    |
|                                    | 1990s | 78         | 2.4    | 0.02  | 0.89   | 0.44  |        |
| pH                                 | 1980s | 89         | 9.1    | 4.5   | 6.67   | 0.58  |        |
|                                    | 1990s | 89         | 8.8    | 4.8   | 6.63   | 0.76  |        |
| E.C.<br>( $\mu$ S/cm)              | 1980s | 89         | 329    | 15    | 107    | 52.9  | **     |
|                                    | 1990s | 89         | 553    | 34    | 133.96 | 80.66 |        |
| COD<br>(KMnO <sub>4</sub> mg/l)    | 1980s | 89         | 22.12  | 3.16  | 11.02  | 4.46  | ***    |
|                                    | 1990s | 89         | 37.79  | 2.57  | 14.49  | 7.22  |        |
| PO <sub>4</sub> -P<br>( $\mu$ g/l) | 1980s | 85         | 80.2   | 0     | 2.65   | 8.79  |        |
|                                    | 1990s | 89         | 178.34 | 0     | 8.19   | 28.75 |        |
| Alkalinity<br>(meq/l)              | 1980s | 89         | 2.19   | 0     | 0.39   | 0.31  |        |
|                                    | 1990s | 89         | 11.4   | 0.03  | 0.56   | 1.22  |        |
| Chl.a<br>( $\mu$ g/l)              | 1980s | 83         | 163.07 | 0.58  | 14.45  | 21.31 | *      |
|                                    | 1990s | 88         | 526.94 | 0.67  | 32.89  | 71.97 |        |
| Ignition loss<br>(%)               | 1980s | 43         | 50.9   | 1.99  | 9.3    | 9.01  | ***    |
|                                    | 1990s | 70         | 27.45  | 7.1   | 15.04  | 4.52  |        |
| Na<br>(mg/l)                       | 1980s | 90         | 25.46  | 0     | 11.13  | 5.07  |        |
|                                    | 1990s | 89         | 41.21  | 4.13  | 11.34  | 5.02  |        |
| K<br>(mg/l)                        | 1980s | 91         | 5.7    | 0.23  | 1.85   | 1.03  |        |
|                                    | 1990s | 89         | 6.67   | 0.15  | 1.69   | 1.03  |        |
| Ca<br>(mg/l)                       | 1980s | 90         | 30.09  | 0.29  | 4.52   | 4.08  | **     |
|                                    | 1990s | 89         | 41.29  | 0.54  | 6.66   | 6.49  |        |
| Mg<br>(mg/l)                       | 1980s | 89         | 14.15  | 0.15  | 3.24   | 2.35  |        |
|                                    | 1990s | 89         | 15.06  | 0.49  | 3.79   | 2.99  |        |
| Mn<br>(mg/l)                       | 1980s | 90         | 1.16   | 0.01  | 0.17   | 0.18  |        |
|                                    | 1990s | 89         | 2.24   | 0     | 0.15   | 0.34  |        |
| Fe<br>(mg/l)                       | 1980s | 90         | 1.72   | 0     | 0.45   | 0.36  |        |
|                                    | 1990s | 89         | 5.91   | 0     | 0.31   | 0.75  |        |
| T-P<br>(mg/l)                      | 1980s | 44         | 0.031  | 0.006 | 0.015  | 0.006 |        |
|                                    | 1990s | 89         | 0.418  | 0.001 | 0.034  | 0.058 |        |
| T-N<br>(mg/l)                      | 1980s | -          | -      | -     | -      | -     |        |
|                                    | 1990s | 89         | 0.56   | 0     | 0.06   | 0.1   |        |
| DOC<br>(mg/l)                      | 1980s | -          | -      | -     | -      | -     |        |
|                                    | 1990s | 89         | 6.74   | 0.12  | 1.45   | 1.23  |        |
| Al<br>(mg/l)                       | 1980s | -          | -      | -     | -      | -     |        |
|                                    | 1990s | 89         | 14.28  | 0.65  | 3.9    | 2.39  |        |

\*,  $P < 0.05$ ; \*\*,  $P < 0.01$ ; \*\*\*,  $P < 0.001$

Temporal changes in aquatic macrophyte flora have also been observed in other regions in Japan (e.g. Nakamura, 1992; Shimoda, 1995; Kadono, 1998). Several possibilities concerning about the appearance/disappearance pattern of the aquatic macrophytes can be proposed; the artifact caused by overlooking of some plant species in each investigation, the change of environmental factors (e.g. eutrophication), the autogenous factor such as occasional germination of buried seeds/propagules, the allogenous factor such as seeds/propagules transportation by birds and so on.

Lakes and ponds can be conceptualized as islands (Keddy, 1979; Browne, 1981), and each population in each pond may be recognized as local population while that in whole



study area as metapopulation (Hanski, 1999). In terms of the conservation and management of aquatic macrophytes in the ponds, further studies and analyses are needed.

### References

- Browne, R. A. 1981. Lakes as islands: biogeographic distribution, turnover rates, and species composition in the lakes of central New York. *Journal of Biogeography*, **8**:75-83.
- Diamond, J. M. 1969. Avifaunal equilibria and species turnover rates on the Channel Islands of California. *Zoology*, **64**:57-63.
- Hanski, I. 1999. *Metapopulation Ecology*. Oxford University Press. 313p.
- Kadono, Y. 1998. Present status of wetland flora in Japan, with special reference to aquatic macrophytes. In: Peng, C. I. and Lowry, P. P. (eds.), *Rare, Threatened, and Endangered Floras of Asia and the Pacific Rim*. Institute of Botany, Academia Sinica Monograph Series No.16. pp.27-36.
- Keddy, P. A. 1976. Lakes as islands: the distributional ecology of two aquatic plants, *Lemna minor* L. and *L. trisulca* L. *Ecology*, **57**:353-359.
- Kunii, H. 1991. Aquatic macrophyte composition in relation to environmental factors of irrigation ponds around Lake Shinji, Shimane, Japan. *Vegetatio*, **97**:137-148.
- Nakamura, T. 1992. The present state of aquatic plants of irrigation reservoirs in Sakai City, Osaka Pref. *Bulletin of the Water Plant Society of Japan*, **48**:24-27 (in Japanese).
- Shimoda, M. 1995. Changes in aquatic vegetation and environment in irrigation ponds in the Saijo Basin, Hiroshima Prefecture, Japan. *Vegetation Science*, **11**:23-40 (in Japanese with English Abstract).

## **A Preliminary Study on the Dynamics of Zooplankton Community in Two Humic Lakes of Central Kalimantan**

**Sulmin GUMIRI<sup>1,2</sup>, Abdul HAFID<sup>2</sup>, Toshio IWAKUMA<sup>1</sup>,  
Ryo KOMATSU<sup>1</sup> and Kumiko KUSAKABE<sup>1</sup>**

<sup>1</sup> Graduate School of Environmental Earth Science, Hokkaido University, Japan

<sup>2</sup> Department of Aquatic Resources Management, The University of Palangka Raya,  
Indonesia

### **Abstract**

A 5 months study on zooplankton abundance was carried out in two humic oxbow lakes, Sabuah undergoing permanent isolation from the main river with occasional connection during high water level season and Tundai being open to the main river at both ends. Zooplankton abundance was higher in Lake Tundai than in Lake Sabuah. In both lakes, the highest peak occurred in May when the zooplankton community was dominated by copepod nauplii. In Lake Tundai, abundance of copepod nauplii was higher near inlet compared with the central area. Cladocerans and adult copepods were rare in Lake Sabuah, whereas in Lake Tundai cladocerans were the dominant group during August-September or low water level season. The difference in zooplankton communities was possibly caused by the difference in carbon concentrations (TC and DOC) induced by the different hydrological processes between the two oxbow lakes.

**Key words:** zooplankton, humic oxbow lake, hydrological condition, water quality

### **Introduction**

Although the knowledge of the structural components of tropical lakes and reservoir has expanded greatly over the past three decades, research on freshwater ecosystems in this region has mainly been directed toward describing species (Nilssen, 1984). This is also true for zooplankton community. For example: in tropical Asia, a comprehensive knowledge of systematic and distributions is available at least in half the country of the area (Dussart *et al.*, 1984) and the reviews on species and size composition of tropical freshwater zooplankton in Southeast Asia have been well documented (Fernando, 1980; Lai and Fernando, 1980; Fernando and Poyi, 1981; Idris and Fernando, 1981; Lim and Fernando, 1985). In Indonesia, however, zooplankton information is still not adequate enough (Lesmulo *et al.*, 1999) and its seasonal variation is little known.

Most information on the population dynamics of subtropical and tropical zooplankton is only available from studies conducted in American and African lakes. In most tropical lakes studied, zooplankton has a maximum abundance during period of July to December (Wyngaard, 1982; Twombly, 1983; Mangestou and Fernando, 1991), although the population peak period does not follow this phenomenon among different zooplankton taxa such as observed from two different lakes of North Ethiopia (Wodajo and Belay, 1984). Various factors have been argued to induce the pattern of seasonal abundance of tropical zooplankton, i.e., food availability, predation pressure and coupling of hydrological events in the lake. More studies are needed to verify this typical phenomenon and identify factors controlling population dynamics of tropical zooplankton.

The main objective of the present study was to examine the seasonal dynamics of zooplankton community in two humic lakes with different hydrological conditions to discuss possible mechanism underlying the changes of zooplankton abundance.

### Study Sites

The two subject lakes of the present study are located along the Kahayan River near Palangka Raya, the capital city of Central Kalimantan - Indonesia (Fig. 1). Lake Sabuah ( $2^{\circ}3'19''\text{S}$ ;  $113^{\circ}56'37''\text{E}$ ) is an oxbow lake located in ca. 15 km north of Palangka Raya city. The surface area of the lake is approximately  $1.2 \text{ km}^2$ . The lake undergoes permanent isolation from the Kahayan River during most period of the year and only occasionally connected with the river during high water level season. In rainy season the deepest point can be up to 14 m. Previous study indicated that this lake has a poor vertical mixing, the depth of euphotic zone is 0.76 m at the centre of the lake and the dissolved oxygen concentrations are very low under this euphotic depth, indicating that plankton and fish may inhabit the top 1 m of the lake water column (Iwakuma *et al.*, 2000).

Lake Tundai ( $2^{\circ}12'30''\text{S}$ ;  $114^{\circ}00'37''\text{E}$ ), is also an oxbow lake located ca. 10 km south of Palangka Raya city. Unlike Lake Sabuah, Lake Tundai is still open at both ends to the Kahayan River. A small tributary river namely the Jengahen River also flows into this lake. The surface area of the lake is approximately  $2.8 \text{ km}^2$  and the maximum depth of 11 m at the centre of the lake. An earlier observation on the limnological features of this lake indicated that in December the depth of euphotic zone in the northern inlet part was 0.88 m, and the dissolved oxygen concentration in the surface layer was lower near the inlet than that at the centre of the lake (Iwakuma *et al.*, 1999).

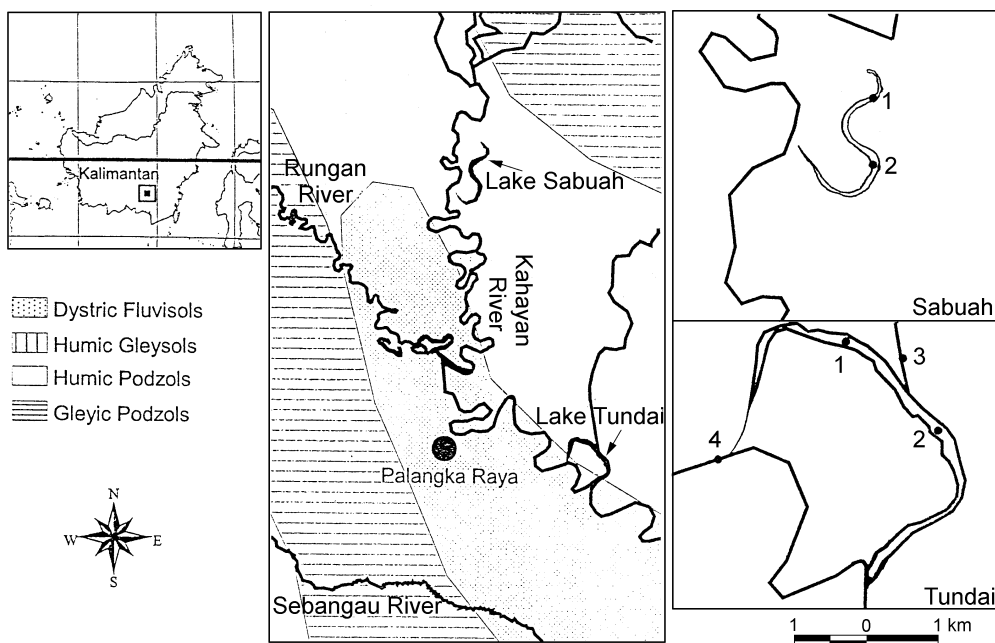

Fig. 1. Map of study sites in Lake Sabuah and Lake Tundai.

Lake Sabuah 1: Station near inlet; 2: Centre;

Lake Tundai 1: Station near inlet; 2: Centre; 3: Jengahen River; 4: Kahayan River.

### Material and Methods

Observation and sample collection were made during May-September 1999. Field measurement and sample collection were performed in two stations: near inlet and centre of both lakes. Observation and water sample collection were also performed for the Kahayan and Jengahen Rivers that connected to the Lake Tundai.

Environmental factors were measured monthly. Lake water level was measured using a water level gauge, set up at the shoreline near the centre of both lakes. Water temperature and dissolved oxygen concentration were measured in situ with a platinum resistor thermometer and an oxygen probe (YSI Model 55, Yellow Springs Instruments, USA). The measurement was made at 0.25 m and 0.5 m intervals from the surface to 1 m depth and from 1 m to the bottom. Specific conductivity and pH were measured at 0.5 m intervals with probes (HORIBA, Japan).

Water sample was collected at 0.5 m depth with a 3-l Van-Dorn water sampler for total carbon (TC) and dissolved organic carbon (DOC) analysis. For DOC analysis, a subsample of 500 ml of the water was passed through a glass fibre filter (Whatman GF/F). TC and DOC were determined for unfiltered and filtered waters, respectively, with a TOC analyser (TOC-500, Shimadzu, Japan).

Zooplankton were collected at the water surface of the stations near inlet and centre of the lake. Samples were collected using a 10-l plastic bucket. Twenty such collections (200 l) of surface water were filtered through a 40- $\mu$ m mesh plankton net and zooplankton were preserved in 4% sugar formalin solution. In the laboratory, three separate 1-ml sub samples were counted in a grid-marked counting slide at 50 $\times$  magnification and an average count was taken, following the procedure described by Eaton *et al.* (1995). Zooplankton were classified into five different groups: rotifers, cladocerans, copepod nauplii, copepodids, and adult copepods.

### Results

#### Lake Sabuah

##### *Environmental factors*

During the period of study, there was a considerable change of lake water level. The water level was high in May and June, then decreased sharply in July and it remained relatively stable at the lowest level until September. The difference between the highest and lowest water levels was 2.86 m (Fig. 2.)

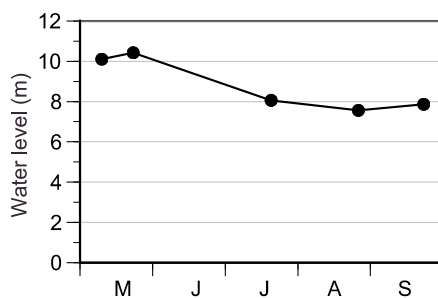

Fig. 2. Temporal change of water level in Lake Sabuah.

Water temperature was stratified at both stations and decreased sharply within the top 2 m depth. At both stations, dissolved oxygen (DO) concentrations increased with decreasing water level. DO concentrations decreased sharply within the top 2 m depth to less than 1mg/l, which coincided with the stratification of water temperature. The surface pH value varied between 4.9-6.2 at the station near inlet and between 5.6-6.0 at the centre of the lake. During low water level season, pH values increased slightly at the station near the inlet, whereas such values were relatively stable at the centre of the lake. Specific conductivity (SC) fluctuated between 1.5-5.9 mS/m at the station near inlet and between 2.5-6.5 mS/m at the centre of the lake (Fig. 3).

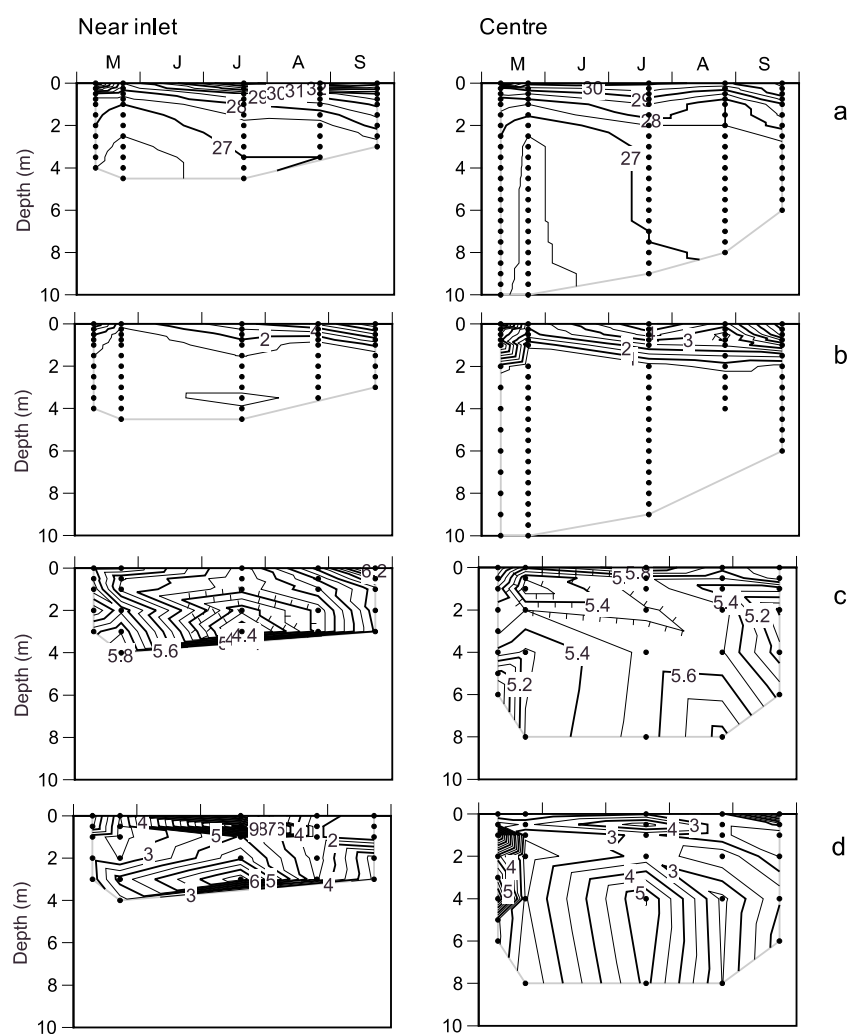

Fig. 3. Depth-time profiles of water quality parameters in Lake Sabuah.  
 a: Water temperature ( $^{\circ}\text{C}$ ); b: Dissolved oxygen concentration (mg/l); c: pH;  
 d: Specific conductivity (mS/m).

Total carbon (TC) and dissolved organic carbon (DOC) concentrations in the surface water fluctuated between 11.2-19.1 mg/l and 6.3-14.9 mg/l, respectively, at the station near inlet and between 7.6-17.9 mg/l and 4.4-13.6 mg/l, respectively, at the centre of the lake. The values were lowest in July (Fig. 4).

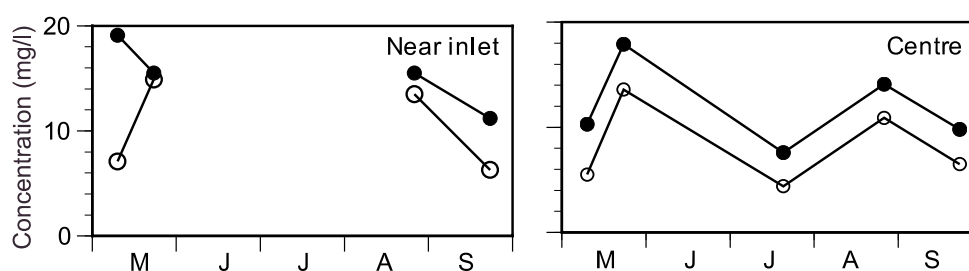

Fig. 4. Temporal changes of total carbon (TC, solid circle) and dissolve organic carbon (DOC, open circle) concentrations in the surface water of lake Sabuah.

### *Zooplankton abundance*

In general, total zooplankton density in Lake Sabuah was low with the maximum density of 6.5 individuals/l occurred during May at the station near inlet of the lake. Copepod nauplii was the dominant zooplankton group in this period. At the centre, the abundance of zooplankton community was extremely low throughout the study period. Cladocerans were nearly absent from the surface water of the lake (Table 1).

Table 1. Zooplankton abundance in Lake Sabuah (individuals/l).

|                 | Sampling date |        |         |           |              |
|-----------------|---------------|--------|---------|-----------|--------------|
|                 | 9 May         | 22 May | 18 July | 23 August | 19 September |
| Near inlet      |               |        |         |           |              |
| Rotifers        | 0.56          | -      | -       | -         | 0            |
| Cladocerans     | 0             | -      | -       | -         | 0            |
| Copepod nauplii | 5.83          | -      | -       | -         | 0            |
| Copepodids      | 0             | -      | -       | -         | 0.03         |
| Adult copepod   | 0.1           | -      | -       | -         | 0            |
| Total           | 6.49          | -      | -       | -         | 0.03         |
| Centre          |               |        |         |           |              |
| Rotifers        | 0.46          | -      | 0.03    | -         | 0            |
| Cladocerans     | 0             | -      | 0       | -         | 0            |
| Copepod nauplii | 0.4           | -      | 0.17    | -         | 0            |
| Copepodids      | 0             | -      | 0       | -         | 0.03         |
| Adult copepod   | 0             | -      | 0       | -         | 0.03         |
| Total           | 0.86          | -      | 0.20    | -         | 0.06         |

- : No data

## **Lake Tundai**

### *Environmental factors*

During the observed period, the water level of Lake Tundai decreased continuously. The difference between the maximum and minimum water levels was 3.3 m (Fig. 5).

Water temperature decreased sharply with depth in the top 1 m of the water column at both stations but the stratification was destabilized in July at the station near inlet. Surface water temperature increased with the decrease in water level in August-September. DO concentration increased with decreasing water level from May to September as with Lake Sabuah. However in contrast to Lake Sabuah, stratification of DO was not clear within the water column of Lake Tundai. The pH values decreased with the decrease of water level: the surface pH values decreased from 5.9 to 4.0 at the

station near inlet and from 4.2 to 4.0 at the centre of the lake. SC values increased with decreasing water level from May to September. The range of SC values in the surface water were 2.7-6.9 mS/m and 3.5-7.8 mS/m for the station near inlet and the centre of the lake, respectively (Fig.6).

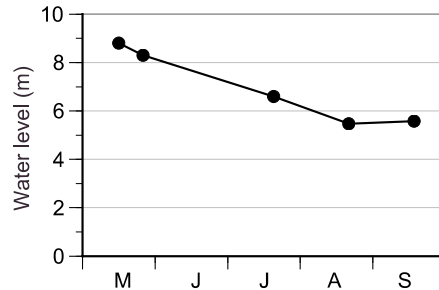

Fig. 5. Temporal change of water level in Lake Tundai.

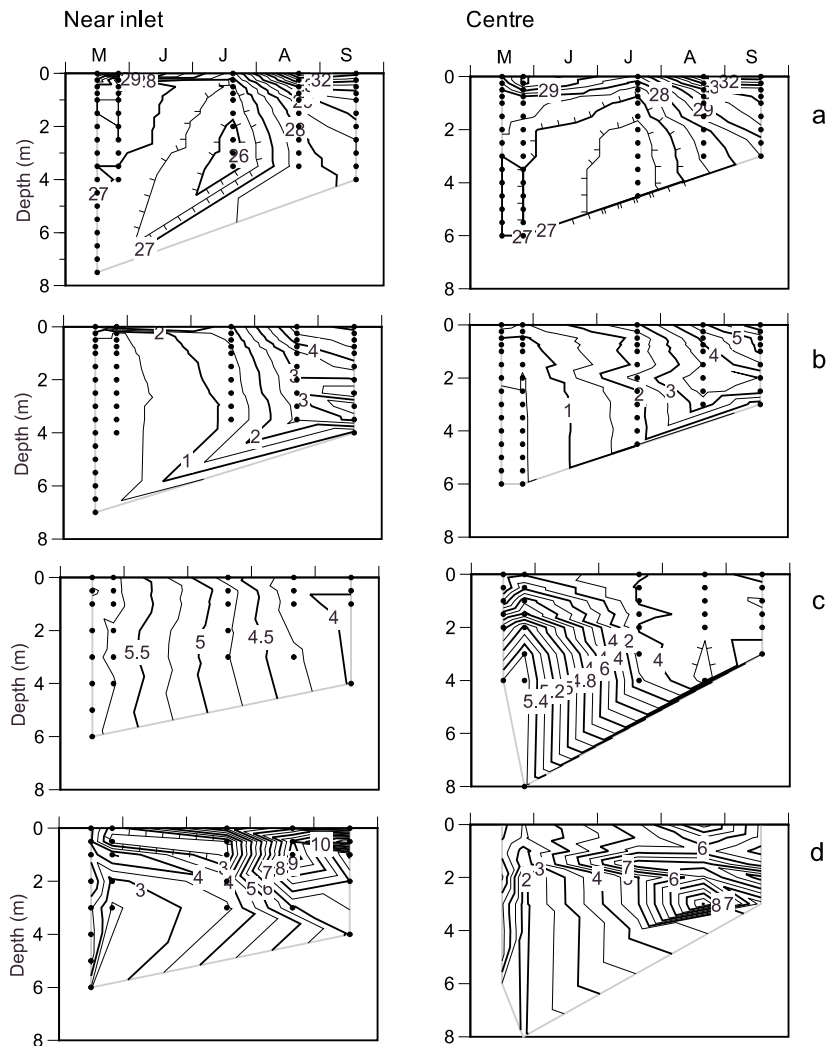

Fig. 6. Depth-time profiles of water quality parameters in Lake Tundai.  
a: Water temperature (°C); b: Dissolved oxygen concentration (mg/l); c: pH;  
d: Specific conductivity (mS/m).

TC and DOC concentrations also increased with the decrease of water level. At the station near inlet TC concentrations increased from 4.5 to 46.4 mg/l and DOC from 4.1 to 39.4 mg/l. At the centre of the lake, these values were relatively higher than the station near inlet varying between 31.1-44.5 mg/l for TC and 23.9-41.1 mg/l for DOC. The values also tended to increase with decreasing water level (Fig. 7).

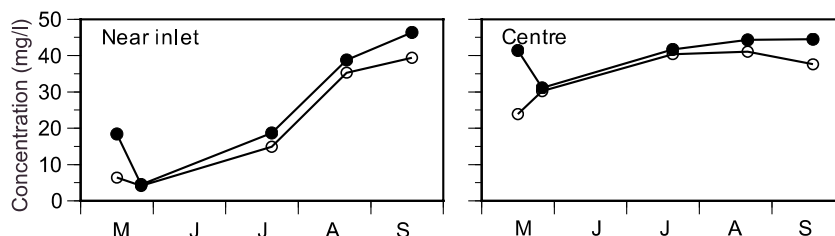

Fig. 7. Temporal changes of total carbon (TC, solid circle) and dissolve organic carbon (DOC, open circle) concentrations in the surface water of lake Tundai.

Water quality parameters changed considerably due to the influence of the Kahayan River that was connected to the lake both in upstream and downstream part of the lake, and also by a tributary river namely the Jengahen River that was connected continuously to the lake. These two rivers were different in their chemical characteristics. The Kahayan River was characterised by neutral pH and low TC and DOC, whereas the Jengahen River was characterised by low pH, and high TC and DOC. In high water level season the Kahayan River affected the water quality of Lake Tundai, whereas in low water level season, the lake water was controlled by the Jengahen River (Fig. 8).

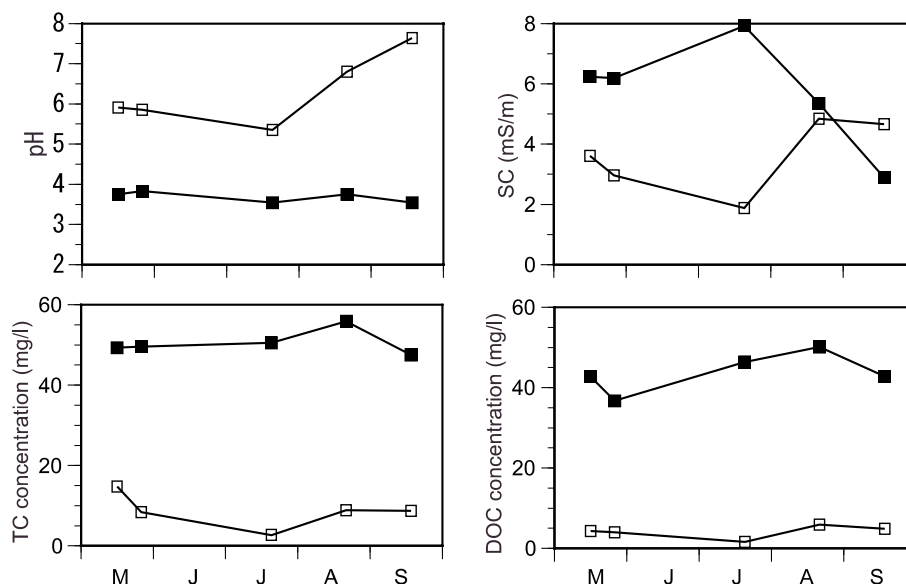

Fig. 8. Water quality of the Kahayan (open square) and the Jengahen Rivers (solid square).



**Zooplankton abundance**

The temporal patterns of total zooplankton abundance were similar between the station near inlet and centre of the lake. At both stations high total zooplankton densities occurred similarly in May and August. However there were different patterns for the temporal dynamics among main groups of zooplankters. In May, copepod nauplii was dominant at the station near inlet, whereas rotifers dominated the centre of the lake. In August, however, rotifers became the dominant zooplankton at the station near inlet, whereas at the centre the cladocerans became predominant, and in September this group was the only zooplankton inhabiting the water surface at the centre of the lake. Adult copepods were very rare at both stations (Table 2).

Table 2. Zooplankton abundance in Lake Tundai (individuals/l).

|                 | Sampling date |        |         |           |              |
|-----------------|---------------|--------|---------|-----------|--------------|
|                 | 14 May        | 22 May | 18 June | 23 August | 19 September |
| Near inlet      |               |        |         |           |              |
| Rotifers        | 4.67          | 0.83   | -       | 18.40     | 0.00         |
| Cladoceran      | 3.17          | 0.07   | -       | 1.47      | 1.00         |
| Copepod nauplii | 9.83          | 0.53   | -       | 2.23      | 0.07         |
| Copepodids      | 7.83          | 0.07   | -       | 0.13      | 0.07         |
| Adult copepods  | 0.17          | 0.03   | -       | 0.07      | 0.13         |
| Total           | 25.67         | 1.53   | -       | 22.30     | 1.27         |
| Centre          |               |        |         |           |              |
| Rotifers        | 14.00         | 4.67   | -       | 2.20      | 0.00         |
| Cladoceran      | 1.17          | 0.33   | -       | 21.33     | 13.67        |
| Copepod nauplii | 1.50          | 1.00   | -       | 0.07      | 0.00         |
| Copepodids      | 5.33          | 0.00   | -       | 0.07      | 0.00         |
| Adult copepods  | 0.83          | 0.33   | -       | 0.13      | 0.00         |
| Total           | 22.83         | 6.33   | -       | 23.80     | 13.67        |

- : No data

**Discussion**

In both Lake Sabuah and Lake Tundai the maximum zooplankton densities occurred in May at the station near inlet when the water level was high. However, the densities were considerably different. In Lake Sabuah the total zooplankton density was 6.49 individuals/l, whereas in Lake Tundai the maximum density was 25.65 individuals/l.

Another interesting finding was the occurrence and seasonal dynamics of rotifers and cladocerans in both lakes. In Lake Sabuah, these two groups were very rare and cladocerans were totally absent during low water period. In Lake Tundai, on the other hand, rotifers were very abundant, but their seasonal dynamics at both stations were oppositely different. At the station near inlet, rotifers tend to increase, whereas at the centre they tended to decline with the decrease of water level. Cladocerans were relatively stable at low densities at the station near inlet, but they increased considerably during low water level season at the centre.

The different abundance and seasonal dynamics of zooplankton community in Lakes Sabuah and Tundai may be explained by the following mechanisms.

The decrease of water level affected the water quality differently in both lakes. Since there is no influx river to Lake Sabuah, the decrease of water level might lead to the exposure of littoral zone and then increase the transparency especially in the near inlet of the lake. This, in turn, would affect the depth of light penetration into the water column and increase the difference between water temperatures and oxygen concentrations at the surface and 1 m depth. There was no clear effect of decreasing water level with the changing of pH values, SC, TC and DOC concentrations in this lake. However, by judging from the low TC and DOC concentrations, the low abundance of zooplankton in this lake in September might be related with the low supply of carbon (TC and DOC) from surrounding area of the lake due to the decrease of water level.

In Lake Tundai the hydrological mechanisms was slightly different. Due to its open connection with the Kahayan River and also by receiving water from the Jengahen River, the water quality of Lake Tundai was greatly affected by the contribution of water discharge from both rivers. During high water level season, water from the Kahayan River enters the lake from two different channels. During this period, the water quality at the station near inlet of the lake was greatly affected by the Kahayan River. As a result, the pH values were much higher and TC and DOC concentrations were much lower at the station near inlet than at the centre. When the inflow water from the Kahayan River decreased, the inlet channel dried up and the station near inlet was influenced mainly by the Jengahen River. This led to the decrease of pH and increase of EC, DO, TC and DOC at both stations near inlet and centre of the lake.

In lakes with significant allochthonous input of humic substances, two conceptually separate food chains come together: Jones (1992) described that in this combined food chain, phytoplankton and bacteria can be viewed as occupying the same trophic level which serve to mobilise, and to make available to higher trophic levels, energy which is otherwise unavailable, whether in a physical form (light) or a chemical form (dissolved organic matter, DOM). Many workers have reported several evidences that DOC is the main source of carbon for bacteria in humic lakes. Hessen (1992) observed that allochthonous DOC accounted for almost 90% of the carbon required to support bacterial growth in a small humic lake of Norway. This finding was supported by the laboratory culture experiment by Arvola and Tulonen (1998) who reported that the growth rates, cell numbers, and biomass of bacteria were substantially higher in the presence of DOM than in culture without DOM.

Many other workers also reported the linkages between organic carbon and zooplankton growth. In their earlier work, Hessen *et al.* (1990) reported that most of the carbon biomass of zooplankton was derived from detritus and bacteria, while phytoplankton accounted only for a minor fraction. The most recent work on this concept was done by Thouvenot *et al.* (1999) who observed that metazoan zooplankton especially cladocerans appeared to be the main consumers of bacteria.

In the present study we found that, over the whole study period, the TC and DOC concentrations in Lake Sabuah were considerably lower than that in Lake Tundai. Therefore, one possible factor that influenced the abundance of zooplankton community was the carbon (TC and DOC) concentration in both lakes.

The difference in physiological adaptations among zooplankton groups to the changing of water quality may affect the zooplankton community. Rotifers (*Keratella*,

*Polyarthra*) are often abundant in acidified lakes (Brönmark and Hansson, 1998), whereas a study in a eutrophic lake of Germany indicated that two *Daphnia* species could have different resistance to low oxygen concentration due to the difference in their ability in producing Haemoglobin (Sell, 1998). Judging from the above information, the successful colonization of rotifers at the station near inlet and cladocerans at the centre of Lake Tundai during low water level season, might be also induced by this physiological adaptation. Of course other factors such as food availability, predation pressure and competition among zooplankton should also be taken into account as factors affecting the seasonal dynamics of rotifers and cladocerans.

In conclusion, the present study showed that the difference in zooplankton abundance between Lake Sabuah and Lake Tundai could be attributed to the difference in carbon concentrations, e.g. TC and DOC, as an important source of energy in humic oxbow lakes. Hydrological conditions regulated the allochthonous input of carbon to these oxbow lakes resulting in different levels of carbon concentrations.

#### Acknowledgements

We would like to express our deep thanks to Mr. Suwido H. Limin and Mrs. Linda Wulandari of the University of Palangka Raya for assisting us in managing our research activities in Central Kalimantan, and also to Mr. Yunus Sitorus, Mr. Piet Haryono and Mr. Noor Radman, students of the same university, who assisted us in collecting the samples.

#### References

- Arvola, L. and Tulonen, T. 1998. Effects of allochthonous dissolved organic matter and inorganic nutrients on the growth of bacteria and algae from a highly humic lake. *Environ. Intern.*, **24**: 509-520.
- Brönmark, C. and Hansson, L. A. 1998. *The Biology of Lakes and Ponds*, Oxford University Press, Oxford.
- Dussart, B. H., Fernando, C. H., Tundisi, T. M. and Shiel, R. J. 1984. A review of systematics, distribution and ecology of tropical freshwater zooplankton. *Hydrobiologia*, **113**: 77-91.
- Eaton, A. D., Clesceri, L. S. and Greenberg, A. E. 1995. *Standard Methods for the Examination of Water and Wastewater*, 19th edn. American Public Health Association, Washington.
- Fernando, C. H. 1980. The species and size composition of tropical freshwater zooplankton with special reference to the oriental region (South East Asia). *Int. Revue ges. Hydrobiol.*, **65**: 411-426.
- Fernando, C. H. and Ponyi, J. E. 1981. The freeliving freshwater Cyclopoid Copepoda (Crustacea) of Malaysia and Singapore. *Hydrobiologia*, **78**: 113-123.
- Hessen, D. O., Andersen, T. and Lyche, A. 1990. Carbon metabolism in a humic lake: Pool sizes and cycling through zooplankton. *Limnol. Oceanogr.*, **35**: 84-99
- Hessen, D. O. 1992. Dissolved organic carbon in a humic lake: effects on bacterial production and respiration. *Hydrobiologia*, **229**: 115-123.
- Idris, B. A. and Fernando, C. H. 1981. Cladocera of Malaysia and Singapore with new records, redescription, and remarks on some species. *Hydrobiologia*, **77**: 233-256.

- Iwakuma, T., Hehanussa, P. E. et al. 1999. Aquatic ecosystems in Central Kalimantan (FY1998). In: *Environmental Conservation and Land Use Management o Wetland Ecosystems in Southeast Asia: Annual Report for April 1998-March 1999*. Hokkaido University and RDC for Biology-LIPI, pp. 165-189.
- Iwakuma, T. I. Ohtaka, A., Hartoto, D. I., Limin, S. H., Torang, I., Jaya, S. and Tanaka, N. 2000. Preliminary study on limnological features of lakes and rivers in the peat swamp area of Central Kalimantan. *Rep. Suwa Hydrobiol.*, **12**: 81-88.
- Jones, R. I. 1992. The influence of humic substances on lacustrine planktonic food chains. *Hydrobiologia*, **229**: 73-91.
- Lai, H. C. and Fernando, C. H. 1980. Zoogeographical distribution of Southeast Asian freshwater Calanoida. *Hydrobiologia*, **74**: 53-66.
- Lehmusluoto, P., Machbub, B., Terengna, N., Ahmad, F., Boer, L., Brahmana, S. S., Setiadji, B., Priadie, B., Timostius, K. H. and Goeltenboth, F. 1999. *Limnology in Indonesia - From the legacy of the past to the prospect for the future*. In Wetesel, R. G. and Gopal, B. *Limnology in Developing Countries*. Vol. 2. International Publications, New Delhi.
- Lim, R. P. and Fernando, C. H. 1985. A review of Malaysian freshwater Copepoda with notes on new records and little known species. *Hydrobiologia*, **128**: 71-89.
- Mangestou, S. and Fernando, C. H. 1991. Seasonality and abundance of some dominant crustacean zooplankton in Lake Awasa, a tropical rift valley lake in Ethiopia. *Hydrobiologia*, **226**: 137-152.
- Nilssen, J. P. 1984. Tropical lakes - functional ecology and future development: The need for a process-orientated approach. *Hydrobiologia*, **113**: 231-242.
- Wodajo, K. K. and Belay, A. 1984. Species composition and seasonal abundance of zooplankton in two Ethiopian Rift Valley lakes - Lake Abiata and Langano. *Hydrobiologia*, **113**: 129-136.
- Sell, A. F. 1998. Adaptation to oxygen deficiency: Contrasting patterns of haemoglobin synthesis in two coexisting *Daphnia* species. *Comp. Bioch. And Physiol. - Part A: Mol. & Integ. Physiol.*, **120**: 119-125.
- Thouvenot, A., Richardot, M., Debroas, D., and Devaux, J. 1999. Bacteriivory of metazooplankton, ciliates and flagellates in a newly flooded reservoir. *J. Plankton Res.*, **21**: 1659-1679.
- Twombly, S. 1983 Seasonal and short term fluctuations in zooplankton abundance in tropical Lake Malawi. *Limnol. Oceanogr.*, **28**: 1214-1224.
- Wyngaard, G. A., Elmore, J. L. and Cowell, B. C. 1982. Dynamics of a subtropical plankton community, with emphasis on the copepod *Mesocyclops edax*. *Hydrobiologia*, **89**: 39-48.

## **Diel and Seasonal Feeding Activities of Fishes in an Oxbow Lake of Central Kalimantan, Indonesia**

**Ryo KOMATSU<sup>1</sup>, Sulmin GUMIRI<sup>1,2</sup>, Dede Irving HARTOTO<sup>3</sup>  
and Toshio IWAKUMA<sup>1</sup>**

<sup>1</sup> Graduate School of Environmental Earth Science, Hokkaido University,  
Sapporo, Japan

<sup>2</sup> University of Palangka Raya, Palangka Raya, Indonesia

<sup>3</sup> Research and Development Centre for Limnology-LIPI, Cibinong, Indonesia

### **Abstract**

In Central Kalimantan, there are abundant fish species, which may be playing important roles in freshwater ecosystems. Food habit and the changes of diel and seasonal feeding activities of fishes were studied to elucidate their functional roles in a tropical lake ecosystem and to demonstrate how the fish communities are maintained. A total of 31 species of fishes were collected with gill nets, a scoop net (selambau), cast nets in Lake Tundai (lat. 2°12'30"S and long. 114°0'34"E, surface area 0.65 km<sup>2</sup>), an oxbow lake along the Kahayan River, in September 1998 or low water level season and in April-May 1999 or high water level season. *Cyclocheilichthys apogon* were caught during 1500 to 1800 including sunset and during 0300 to 0600 including sunrise in low water level season and caught at daytime in high water level season. They fed on Chironomidae larvae preferably in high water level season. *Mystus nemurus* and *Mystus nigriceps* were caught during nighttime or around 1800 and 0600. They fed on fishes in low water level season. The ratio of Chironomidae larvae among the stomach contents of 2 *Mystus* species increased in high water level season. *Trichogaster leerii* were caught abundantly during 1500 to 1800 and during 0300 to 0600. They fed on filamentous algae and detritus in high water level season. The ecology of fishes and interaction with the environment are discussed.

### **Introduction**

A large amount of fish catch has been reported for tropical peat swamp areas in Central Kalimantan, indicating that the abundance and production of fish species are also large in this region (Hartoto, 2000). These fishes are, without doubt, playing important roles in freshwater ecosystems and have large impacts on them (Horne and Goldman, 1994; Lampert and Sommer, 1997).

Freshwater environments in peat swamp areas of Central Kalimantan are characterized by high concentrations of dissolved organic matters which are the cause of brown water, low transparency and subsequent very low dissolved oxygen concentration (Iwakuma *et al.*, 1999). The ecological information on ecosystem function especially on the maintenance mechanism of fish communities is not always true for tropical waters although there have been some intensive studies on fish community structure (Ng and Kelvin; 1992; Peter *et al.*, 1994; Zakaria-Ismail and Lim, 1995), effect of food contents (Khan *et al.*, 1996), impacts of introduced animals on aquatic ecosystems (Ng *et al.*, 1993). The purpose of the present study was to analyze the food habit and the changes of diel and seasonal feeding activities of fishes to elucidate their functional roles in a lake ecosystem and to demonstrate how the fish communities are maintained.

### Study Area

Many oxbow lakes are located along the rivers flowing through tropical peat swamp areas in Central Kalimantan, Indonesia. Lake Tundai is a long and slender oxbow lake (lat. 2°12'30"S and long. 114°0'34"E, surface area 0.65 km<sup>2</sup>) still connected to the Kahayan River 20 km downstream of Palangka Raya City. We caught fishes in Lake Tundai (Fig. 1). The lake outlet at the southern tip is wide and deep enough to pass through easily by boat even in the low water level season. In high water level season, i.e., November-April, the forest surrounding the lake is inundated widely. Several channels where only a small boat can pass through are connecting the lake to the Kahayan River and another river. Water coming through these channels also inundates the forests. In low water level season, lake water is concentrated in the lake basin. The maximum observed fluctuation of water level was 3.4 m during September 1998-June 1999 (S. Gumiri, unpublished data). Since the water color is deep brown, the transparency in this lake is about 50 cm (R. Komatsu, unpublished data).

On the left bank of the lake, there is a village which is connected to other villages only by waterway. Observations and sampling were made near the village.

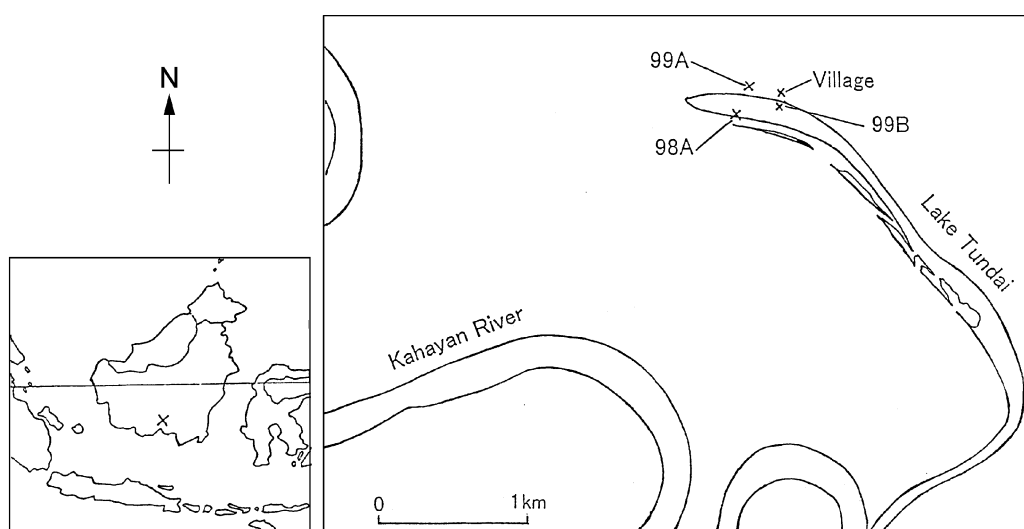

Fig. 1. Lake Tundai showing the location of sampling sites. Gill nets were set at site 98A along the right bank of the lake in September 1998. A scoop net (selambau), which we lent in April 1999, was set by local fisherman at site 99A in the flooded forest. Fishes were also collected with cast nets at site 99B in front of a village in May 1999.

### Methods

Freshwater fishes were caught in Lake Tundai in September 1998, when it was near the end of low water level season and April-May 1999, when it was near the end of high water level season.

In September 1998, fishes were caught with three gill nets of different depths and mesh sizes: 18 m long × 2 m deep with 50-mm opening mesh, 18 m long × 2 m deep with 2.5-mm opening mesh and 18 m long × 1.8 m deep with 1.5-mm opening mesh. Nets were set in parallel at Site 98A of the lake each extending from littoral zone to pelagic zone. The site was located near a forest and therefore some wood debris were on

the muddy bottom sediment. Since the water depth at this site was 0 m to ca. 2.3 m, almost all the lower ends of the nets touched the bottom. We set the nets at 1200 on 18 September 1998 and collected fishes 9 times every 3 h until 1500 on the following day.

In April and May 1999, we used a traditional big scoop net (selambau) ca. 10 m long  $\times$  5 m wide with 2" mesh opening at Site 99A. The 3 sides of the net were submerged to the bottom before each sampling occasion, left for 2-3 h and the net was pulled up quickly above the water to collect fish. The site was located alongside a watercourse for timber transportation from the marginal flooded forest to the lake during a high water level season. Water depth was ca. 2 m to 3 m and the bottom was covered with many wood and plant debris. We collected fishes 10 times at 1600 and 1800 on 29 April and thereafter every 3 h until 1740 on the following day. During 6-7 May we used 2 gill nets of different dimensions and mesh sizes: 11 m long  $\times$  1.5 m with 0.5" opening mesh and 18 m long  $\times$  2 m deep with 50-mm opening mesh. The nets were set at Site 99A at 1300 on 6 May 1999 and fishes were collected 9 times every 3 h from 1500 until 1500 on the following day. In addition, we collected fishes with cast nets in front of the village we stayed (Site 99B). Depth of water was between 0m to ca. 2.5m for this sampling. The bottom sediment was mud and the water surface was covered by many artificial materials, e.g., pillars of houses, floating huts, small boats etc. Fishes were collected 4 times at 1800 on 6 May and 0000, 0600, and 1200 on 7 May 1999. Each sampling was completed within 30 min. During 25-26 May 1999 fishes were collected again at Site 99B with the cast nets. We caught fishes 8 times every 3 h from 1200 on 25 May until 0900 on 26 May. Similarly, each sampling was completed within 30 min. Additional samplings using the cast net and gill nets were made off the village, pelagic zone and in the flooded marginal forest.

Fishes were killed with an excess amount of anesthesia MS222 (ethyl-3-aminobenzoate methanesulfonic acid salt) to avoid the vomiting of stomach contents soon after they were caught. And they were fixed and preserved in 10% formalin solution. To fix their internal organs and gut contents, 10% formalin solution was injected into the abdomen soon after they were killed. Total length, standard length, wet body weight and the wet weights of stomach and intestine contents of each individual were measured in the laboratory and ratio of stomach contents weight to body weight, i.e.,  $100 \times \text{stomach content weight (g)} / \text{body weight (g)}$ , were calculated. The quantitative analyses of the contents of gut were made according to a points method (Hynes, 1950). Stomach contents were identified under binocular microscope of 10-40  $\times$  magnification as fishes, prawns, Chironomidae, Anisoptera, Trichoptera, Hemiptera, insects other than them, unidentified insects, litter, algae, detritus and others. When sand or mud was found in gut contents, it was classified as detritus. Average ratio of each food items of stomach contents found from each species to body weight were calculated.

All the statistical analysis was performed using a statistical software (StatView, Hulinks Inc.).

## Results

### *Diel patterns of number of fish caught with nets*

In the present study we caught 504 individuals belonging to 14 species in September 1998, and 1115 individuals belonging to 26 species in April-May 1999 from Lake Tundai (Table 1).

Table 1. List of fishes caught in Lake Tundai with gill nets, cast nets and a scoop net.

| Species                            | Number of individuals |                  |
|------------------------------------|-----------------------|------------------|
|                                    | September 98          | April and May 99 |
| <i>Cyclocheilichthys apogon</i>    | 13                    | 111              |
| <i>Leptoburbus hoevenii</i>        | 10                    | 27               |
| <i>Luciosoma trinema</i>           |                       | 6                |
| <i>Osteochilus melanopleura</i>    | 15                    | 76               |
| <i>Osteochilus microcephalus</i>   |                       | 1                |
| <i>Osteochilus pentalineatus</i>   |                       | 5                |
| <i>Osteochilus schlegelii</i>      | 10                    |                  |
| <i>Osteochilus triporos</i>        |                       | 250              |
| <i>Parackela</i> spp.              |                       | 12               |
| <i>Puntius lineatus</i>            |                       | 48               |
| <i>Rasbora</i> sp.1                |                       | 61               |
| <i>Rasbora</i> spp.                |                       | 40               |
| <i>Thynnichthys polylepis</i>      |                       | 4                |
| <i>Mystus nemurus</i>              | 20                    | 14               |
| <i>Mystus nigriceps</i>            | 33                    | 10               |
| <i>Kryptopterus apogon</i>         |                       | 10               |
| <i>Kryptopterus limpok</i>         |                       | 12               |
| <i>Kryptopterus</i> sp.1           |                       | 9                |
| <i>Kryptopterus</i> spp.           | 3                     | 116              |
| <i>Ompok</i> sp.                   | 1                     |                  |
| <i>Wallago leerii</i>              | 1                     |                  |
| <i>Pseudentropius brachypterus</i> |                       | 35               |
| <i>Pangasius nasutus</i>           |                       | 5                |
| <i>Clarias meladerma</i>           |                       | 1                |
| <i>Parambassis macrolepis</i>      |                       | 1                |
| <i>Nandus nebulosus</i>            | 1                     |                  |
| <i>Pristolepis grooti</i>          | 15                    | 3                |
| <i>Helostoma temminckii</i>        | 39                    | 10               |
| <i>Trichogaster leerii</i>         | 339                   | 224              |
| <i>Trichogaster trichopterus</i>   | 4                     | 18               |
| <i>Macragnathus aculeatus</i>      |                       | 6                |
| Total                              | 504                   | 1115             |

Diel patterns of number of individuals caught with gill nets in Sep 1998 or low water level season was bimodal having peaks at the time interval 1500-1800 which included sunset and at the interval 0300-0600 which included sunrise. In these time intervals many species were also caught. Some differences were recognized in the diel patterns of number of individuals trapped among fish species. The patterns for dominant species are as follows: *Osteochilus melanopleura* was caught only during daytime, *Mystus nemurus* was caught mainly at the intervals 1500 to 1800 and 0300 to 0600 and most individuals of *Mystus nigriceps* were caught at the same time intervals as *M. nemurus*. *Helostoma temminckii* was caught mainly at time interval 0300-0600. Number of *Trichogaster leerii* caught was highest and they were caught mainly at intervals 1500-1800 and 0300-0600. Though the total number of *Cyclocheilichthys apogon* collected was not so large, they seemed to be caught mainly at intervals 1500-1800 and 0300-0600 (Fig. 2). A complete list of species collected at each sampling time interval with the gill nets is shown in Appendix 1.



Fish feeding activity in an oxbow lake of Central Kalimantan

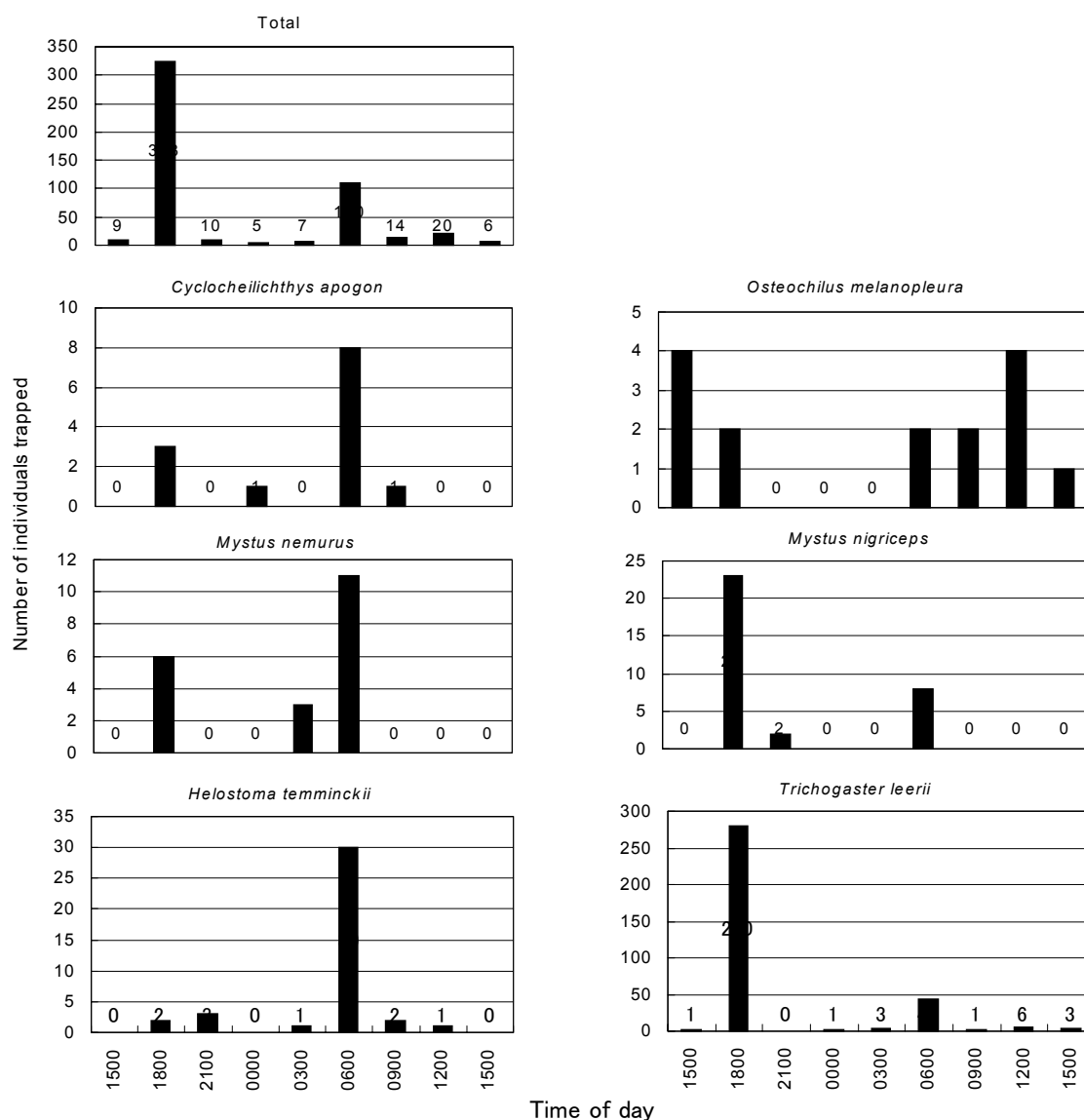

Fig. 2. Number of individuals caught with gill nets at site 98A in low water level season at several sampling occasions during 1200 of 18 September to 1500 of 19 September 1998. A figure by the column indicates number of individuals caught at each sampling time.

Diel pattern of number of individuals caught by scoop net (selambau) in April 1999 or high water level season was unimodal having single peak at 0600 which was due to the catch of predominant *Osteochilus melanopleura*. As for other species, although distinct peaks like in September 1998 were not found, some different patterns were found. *Cyclocheilichthys apogon* and *Leptoburbus hoevenii* were caught only at daytime. A large number of *Osteochilus melanopleura* were caught at 0600. Unlike September 1998, *Mystus nemurus* and *Mystus nigriceps* were not abundant but they were caught mainly during nighttime or around the sunrise at 0600. Only a small number of *Kryptopterus apogon* were caught mainly during nighttime. Other *Kryptopterus* spp. could not be collected enough to detect diel pattern. Furthermore because it was difficult to identify them correctly to species. The number of *Helostoma*

*temminckii* was also small but there was a pattern that they were caught mainly during daytime. Similarly *Trichogaster leerii* were caught only during daytime (Fig. 3). A complete list of species collected at each sampling time with the scoop net is shown in Appendix 2.

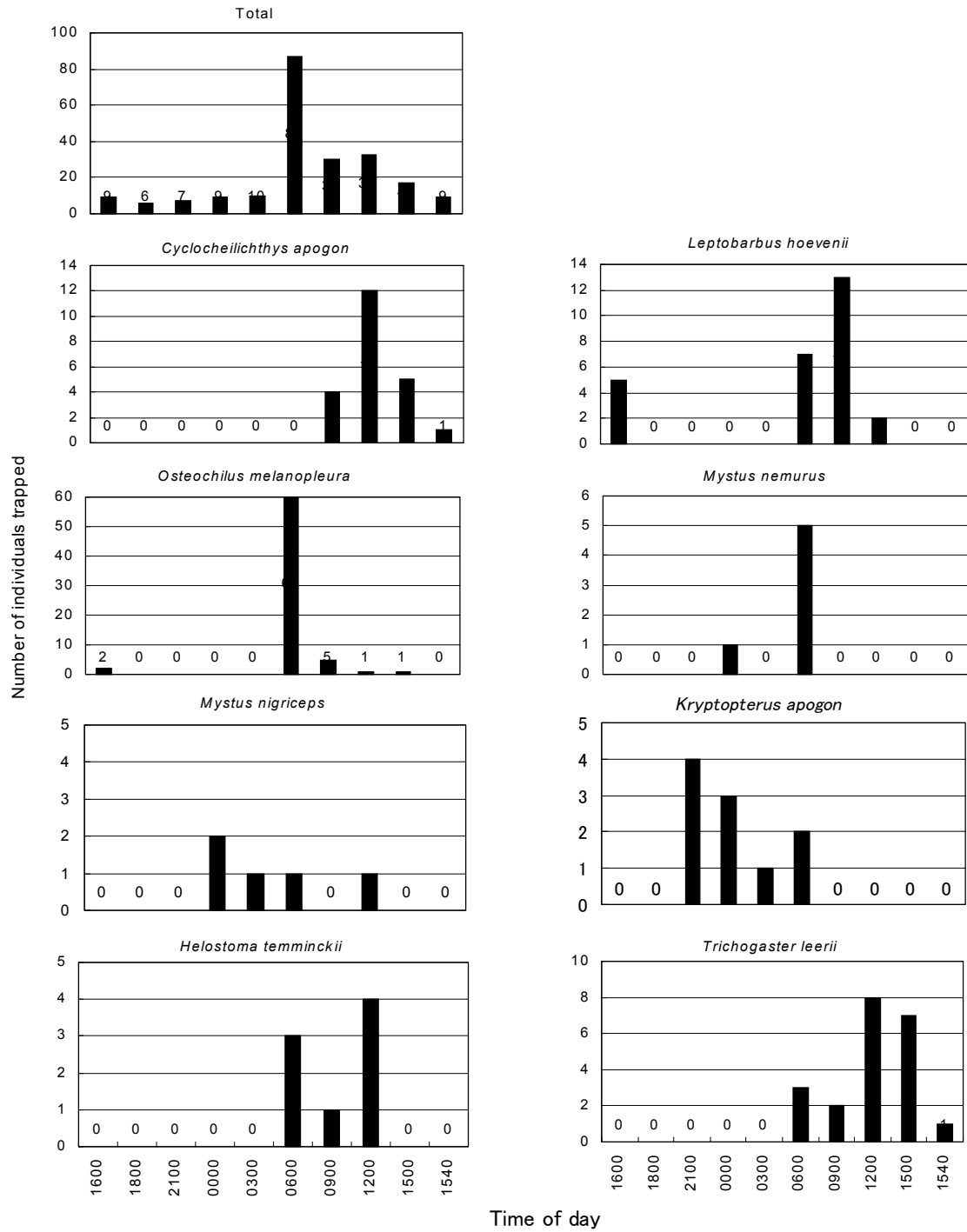

Fig. 3. Number of individuals caught with a scoop net (selambau) at site 99A in high water level season at several sampling times during 1600 of 29 April to 1740 of 30 April 1999. A figure by the column indicates number of individuals caught at each sampling time.

Fig. 4 shows the number of individuals caught by 2 gill nets in May 1999, or high water level season. Except for 1 individual of *Clarias meladerma* and *Macrognathus aculeatus*, all the fishes were caught with the gill net of smaller mesh size (0.5”). The sample consisted of small individuals of *Osteochilus triporos*, *Puntius lineatus*, *Rasbora spp.*, etc., of which *Osteochilus triporos* was most abundant (Appendix 3). They were not caught during nighttime but only during daytime.

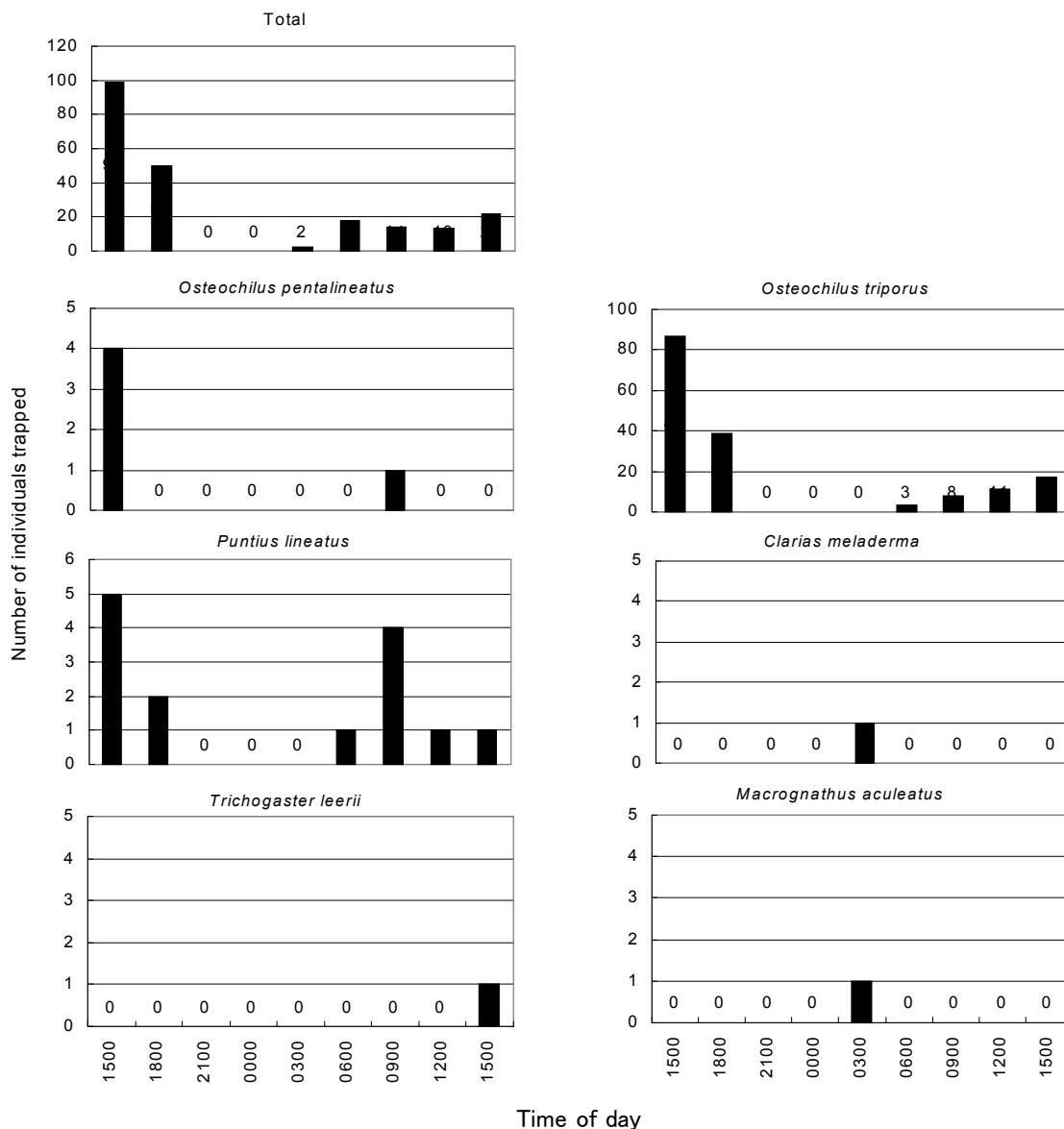

Fig. 4. Number of individuals caught with gill nets at site 99A in high water level season at several sampling times during 1200 of 6 May to 1500 of 7 May 1998. A figure by the column indicates number of individuals caught at each sampling time.

*Stomach contents*

All samples were caught with gill nets in September 1998. Some individuals had presumably been alive being trapped in the gill nets to a maximum of 3 h. This might have caused the stomachs of some individuals become empty. Individuals with empty stomachs therefore could not be judged that stomach contents had already been digested, vomited or empty from the beginning. Fortunately, stomachs of most individuals of *Mystus nemurus* and *Mystus nigriceps* were not empty. *M. nemurus* fed mainly on small fishes, with small amount of shrimps, aquatic insects, etc. *M. nigriceps* fed also on small fishes, aquatic insects (Hemiptera and Anisoptera larvae), etc. Since the samples collected with a scoop net (selambau) and cast nets in April-May 1999 were fixed immediately after the collection, percentage of stomach contents, food items and their average composition were calculated. Relatively many individuals of *Cyclocheilichthys apogon* were collected with a scoop net and cast nets both during daytime and nighttime. Many head capsules of Chironomidae larvae were found from their stomach contents. Many lumps of protein were also found, which seemed to be the remains of Chironomidae larvae crushed with the fish's pharyngeal teeth. Other items were small amount of aquatic insects, algae, etc. (Table 2).

Table 2. Food items found from the stomachs of *Cyclocheilichthys apogon*, *Mystus nemurus*, *Mystus nigriceps* and *Trichogaster leerii*. Average of ratio of each food items in stomach to body weight.

| Food items                 | <i>Cyclocheilichthys apogon</i> | <i>Mystus nemurus</i>  |                         | <i>Mystus nigriceps</i> |                         | <i>Trichogaster leerii</i> |
|----------------------------|---------------------------------|------------------------|-------------------------|-------------------------|-------------------------|----------------------------|
|                            | High water level season         | Low water level season | High water level season | Low water level season  | High water level season | High water level season    |
| Fishes                     |                                 | 2.98                   | 0.93                    | 0.24                    | 0.32                    |                            |
| Prawns                     |                                 | 0.064                  |                         |                         |                         |                            |
| Chironomidae larvae        | 0.044                           |                        | 0.372                   | 0.0078                  | 0.824                   | 0.0003                     |
| Chironomidae pupae         |                                 |                        | 0.0028                  |                         | 0.024                   |                            |
| Ceratopogonidae larvae     |                                 |                        |                         |                         |                         | 0.0038                     |
| Anisoptera larvae          |                                 | 0.044                  | 0.044                   | 0.028                   | 0.035                   |                            |
| Trichoptera larvae         |                                 |                        | 0.0067                  |                         | 0.0079                  |                            |
| Hemiptera adults           |                                 |                        | 0.016                   | 0.024                   | 0.0010                  |                            |
| Insects (all stages)       | 0.004                           |                        | 0.090                   | 0.024                   | 0.032                   |                            |
| Unidentified invertebrates | 0.132                           |                        |                         |                         |                         |                            |
| Animals                    |                                 |                        | 0.099                   | 0.029                   | 0.037                   |                            |
| Attached algae             | 0.0002                          |                        |                         |                         |                         | 0.088                      |
| Higher plants              | 0.0039                          |                        |                         |                         |                         |                            |
| Detritus                   |                                 |                        |                         |                         |                         | 0.105                      |
| Others                     | 0.015                           | 0.051                  | 0.035                   | 0.046                   | 0.101                   | 0.010                      |
| Total                      | 0.1991                          | 3.139                  | 1.5955                  | 0.3988                  | 1.3819                  | 0.2071                     |

Since almost all individuals of *Mystus nemurus* and *Mystus nigriceps* were caught around sunrise and nighttime, it was difficult to construct a figure of diel change in percentage of stomach contents for these species. Therefore the information on food

items and their ratio of each food items to body weight are shown in Table 2. A large amount of Chironomidae larvae were found with small fishes from the stomach of *Mystus nemurus*. Some other aquatic insects, e.g., Anisoptera larvae and Trichoptera larvae were also found. Likewise most of the stomach contents of *Mystus nigriceps* were Chironomidae larvae which were dwelling the lake bottom. A small amount of other aquatic insects were also found. *Trichogaster leerii* were caught mainly during daytime except for around at 0300.

The ratio of stomach contents weight to body weight did not show any distinct diel pattern: some fish had some contents in their stomach both during daytime and nighttime. However the value for daytime seemed to be higher than that for nighttime. At least individuals that had empty stomach were caught only at nighttime.

The fact that the stomach contents of *T. leerii* included sand and mud suggested that this species was detritus feeders. Many filamentous algae mainly *Zygonema* were also found from the stomach of *T. leerii*. During the nighttime, they were caught only at 0300 but almost all of their stomachs were empty. Except for some individuals caught around 0600 whose stomachs were empty, all the individuals caught during daytime had some contents in their stomachs (Fig. 5).

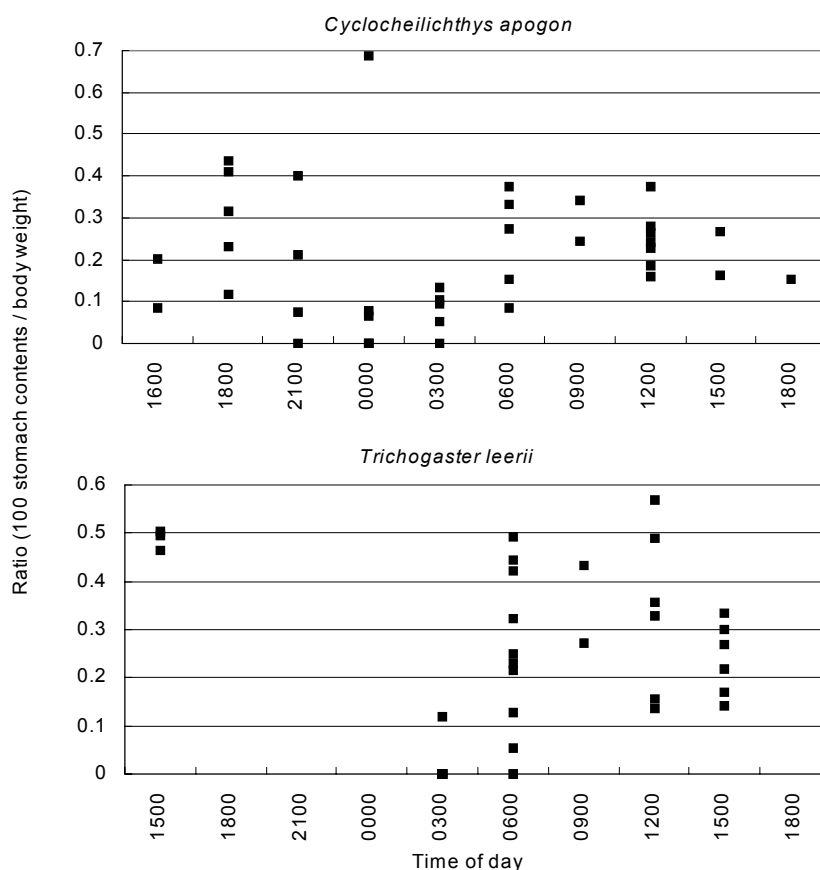

Fig. 5. Diel changes in the ratio of stomach contents weight to body weight for *Cyclocheilichthys apogon* and *Trichogaster leerii*.

### Discussion

A total of 31 species or taxa of fishes were caught from Lake Tundai in September 1998 and April-May 1999. For some taxa, individuals large enough for correct identification were not caught. There were species for which it was too difficult to investigate their gut contents. In the present study, we discussed on 4 dominant species, i.e., *Cyclocheilichthys apogon*, *Mystus nemurus*, *Mystus nigriceps* and *Trichogaster leerii*.

*C. apogon* belongs to Cyprinidae. In general, Cyprinidae fishes vary widely in their behavior, e.g., diurnal or nocturnal activity, which made them fit to respective environments. Similarly they have also various food habits, e.g., carnivorous, herbivorous or omnivorous habits. Let us first compare the number of individuals caught during a 24-h period between low water level season in September 1998 and high water level season in April 1999. *C. apogon* were caught mainly during 1500-1800 and 0300-0600 including sunset and sunrise in low water level season. In high water level season, however, they were caught during daytime. They seemed to have crepuscular activity in low water level season and change their behavior to diurnal in high water level season. Shiraishi *et al.* (1972) have studied freshwater fishes in Lake Bera using gill nets. They caught *C. apogon*, which is regarded as nocturnal in low water level season but its diel activity is not clear in high water level season. Maybe this fish have different behavior in other regions, or they moved actively also around sunset and sunrise and caught by gill net for nighttime.

Chironomidae larvae seemed to be eaten preferably by fishes during the high water level season. Furthermore the food item, unidentified invertebrates, seemed to consist mainly of crushed Chironomidae larvae, since fish of Cyprinidae crush their foods with their pharyngeal teeth. Therefore the main food item seems to be Chironomidae larvae during this season. This seemed to agree well with the result of Yap (1988). However this fish species is considered as a detritivore (Tan, 1972) or a carnivore (Inger & Chin, 1962). So they seemed to be able to change their food item according to the environmental condition. Also in this lake, they fed mainly on detritus in low water level season (T. Buchar, personal communication). *C. apogon* in lake Tundai may change their food items according to the seasons.

From the several 24-h observations during high water level season (29-30 April, 7-8 May, and 25-26 May 1999), feeding activity of fishes measured by the percentage of stomach content seems to decrease during nighttime. Although there was no significant difference in stomach contents among sampling times (Kruskal-Wallis test,  $P > 0.5$ ), a significant difference was detected between daytime (1500, 1800, 0600, 0900, 1200) and nighttime (2100, 0000, 0300) (Mann-Whitney U-test,  $P = 0.0007$ ). Individuals that had empty stomach were only caught at nighttime. Therefore they seem to feed more actively during daytime than nighttime in high water level season. Their diel activity reflected their feeding activity. Why they change their diel activity in low water level season remain unsolved although there are some plausible reasons such as change of food items, presence of predators, etc.

*Mystus nemurus* and *M. nigriceps* belong to Bagridae. In general, Bagridae fish are nocturnal and carnivorous. From the result of number of individuals caught by gill nets and a scoop net, they also seemed nocturnal or crepuscular. The main food items of *M. nemurus* were fishes in low water level season, but in high water level season, Chironomidae larvae became important food item rank with fishes. Ratio of fishes was still large, but most of it was due to amount of only 1 individual. The food items of *M.*

*nigriceps* were also fishes and some aquatic insects in low water level season, but in high water level season, their main food item was almost completely changed to Chironomidae larvae, a few number of which were found in low water level season. Comparing these 2 species, *M. nemurus* had stronger tendency of piscivory as is pointed out by Hartoto (in press). Why they switch their food items between high and low water level seasons? Lake water is concentrated in the narrow space in low water level season as compared with high water level season. Of course fishes are also concentrated in this narrow space which may enhance the predation by piscivores or increase of food for piscivores. In fact that, In high water level season, at first we set the gill nets used in low water level season, but only small number of fishes were caught. For reason, it is thought that density of fish was decreased in high water level season. Whether the availability of chironomid larvae as food items decreased or not in low water level season remain unsolved. Further studies are necessary on population dynamics Chironomidae larvae.

*Trichogaster leerii* belongs to Belontiidae. Individuals *T. leerii* were caught mainly during 1500-1800 and 0300-0600 which include sunset and sunrise, respectively, in low water level season. Especially during 1500-1800, a large number of them were caught. In high water level season, they were caught during daytime. Therefore they seem to have diurnal or crepuscular behavior. In fact they were observed during daytime when they were swimming in school in the pelagic zone of lake and they could be caught there. And when only one time we could catch them during nighttime, they made school and didn't move. So it is thought that they swim actively in school during daytime and rest in the littoral zone during nighttime. Maybe clear peaks in low water level season were made because they were caught when they moved actively in the littoral zone before or after resting in a big school. Fishes caught during three 24-h periods in high water level season, there is only one group of samples caught during nighttime. However almost all of their stomachs were empty and their percentage of stomach contents weight were different significantly in each sampling time (Kruskal-Wallis test,  $P=0.0001$ ) and between daytime and nighttime (Mann-Whitney U-test,  $P<0.0001$ ). Therefore it is thought that they have high activity in daytime including feeding behavior. They fed on filamentous algae like *Zygnema* and detritus. Some Ceratopogonidae larvae were found with filamentous algae, but they seemed to be eaten by chance. These filamentous algae might have been distributed in the littoral zone (Kusakabe *et al.*, 2000) and there are some more fish species feed on filamentous algae like *T. leerii*. Further study on the littoral zone is necessary.

It is clear that chironomid larvae are important food item for several fishes, e.g., *C. apogon*, *M. nemurus*, *M. nigriceps*, to maintain their population at least high water level season. However the food item most frequently appeared more *M. nemurus* and *M. nigriceps* were small fishes and other aquatic insects in low water level season. Possible reason is that it is difficult to prey upon small fishes in high water level season. In general, fishes spawn during high water level season in flooded forests. Piscivores like *M. nemurus* cannot prey fishes including their own juveniles easily. So it is thought that high water level season is also important for hatched juvenile fishes to avoid menace of predation and grow up. On the other hand, it is thought that low water level season is more important than high water level season for the piscivorous fishes. Because small prey fishes that hatched in high water level season are concentrated and prey condition become better than high water level season. For *C. apogon* high water level season

maybe better than low water level season. Also in low water level season, they feed mainly on detritus (T. Buchar, personal communication), which itself is not a good food item (Lemke and Bowen, 1998). High water level season when they feed on Chironomidae larvae seem to be better than low water level season. Moreover there is no benefit about food condition for them like piscivorous fishes in low water level season. And maybe competition in same species for prey is decreased in high water level season. *T. leerii* seemed to feed on also filamentous algae in low water level season (T. Buchar, personal communication). So high water level season is also better for them because there seems to be same benefits to *C. apogon* except for difference of food items. Eventually it is thought that not only forest around the lake but also phenomenon to repeat the flooding in the forest and disperse of lake in high water level season and decrease and concentration of the water in low water level season is important to maintain fish community and ecosystem.

### Acknowledgments

We thank Dr. Hery Harjono, Director of Research and Development Center for Limnology of the Indonesian Institute of Sciences, for providing permissions for research and bringing specimens to Japan, and to Ms. Sulastri of the same institute for suggesting important information and discussion. Thanks are also due to Mr Suwido H. Limin, Lecturer of the University of Palangka Raya for providing us laboratory facilities, Dr. Atushi Doi, Lecturer of the Center for Ecological Research, Kyoto University, and Mr. Tariono Buchar, Lecturer of the University of Palangka Raya for their assistance in the field and identification of fish species. Sincere gratitudes are due to Professor Yuji Sawara, Faculty of Agriculture and Life Science of Hirosaki University, for his advice. We thank Ms. Linda Wulandari and Ms. Yulintine, Lecturers of the University of Palangka Raya, Mr. Abdul Hafid, Mr. Alberto Simon, Mr. Junus Sitorus, Mr. Noor Radman, Mr. Pieth Haryono and Mr. Taufik, students at the University of Palangka Raya, for their assistance in the field, and to all the members of the Laboratory of Environmental Medicine and Informatics of Graduate School of Environmental Earth Science, Hokkaido University for their discussion.

### References

- Hartoto, D. I. 2000. An overview of some limnological parameters and management status of fishery reserve in Central Kalimantan. *Rep. Suwa Hydrobiol. Sta., Shinshu Univ.* 12: 49-74.
- Horne, A. J. and Goldman, C. R. 1994. *Limnology, 2nd edn.* McGraw-Hill, New York.
- Hynes, H. B. N. 1950. The food of fresh-water sticklebacks (*Gasterosteus aculeatus* and *Pygosteus pungitius*), with a review of methods used in studies of the food of fishes. *Journal of Animal Ecology.* 36-58
- Inger, R. F. and Chin, P. K. 1962. The freshwater fishes of North Borneo. *Fieldiana Zoology*, 45. Chicago Natural Museum, 268 pp.
- Iwakuma, T., Hehanussa, P. E. *et al.* 1999. Aquatic ecosystems in Central Kalimantan (FY 1998). In: *Environmental Conservation and Land Use Management of Wetland Ecosystem in Southeast Asia. Annual Report for April 1998-March 1999*, Hokkaido University and RDC for Biology-LIPI, 165-189
- Khan-M.-S., Ang, K.-J. and Ambak, M.-A. 1996. The effect of varying dietary protein level on the growth, food conversion, protein utilization and body composition of



- tropical catfish *Mystus nemurus* (C. and V.) cultured in static pond water system. *Aquatic Research*, 27: 823-829
- Kusakabe, K., Iwakuma, T. and Sulastrri. 2000. Biomass and abundance of phytoplankton in a tropical oxbow lake. In: *Proceedings of the International Symposium on Tropical Peatlands, Bogor, Indonesia, 22-24 November 1999*, pp. 413-422.
- Lampert, L. and Sommer, U. 1997. *Limnoecology: The Ecology of Lakes and Streams*. Oxford Univ. Press, New York-Oxford.
- Lemke, M. J. and Bowen, S. H. 1998. The nutritional value of organic detrital aggregate in the diet of fathead minnows. *Freshwater Biol.*, 39, 447-453
- Ng, P. K. L. and Lim, K. K. P. 1992. The conservation status of the Nee Soon freshwater swamp forest of Singapore. *Aquatic Conservation: Marine and Freshwater Ecosystem*, 2: 225-226
- Ng, P. K. L., Chou, L. M. and Lam, T. J. 1993. The status and impact of introduced freshwater animals in Singapore. *Biol. Conserv.*, 64: 19-24.
- Ng, P. K. L., Tay, J. B. and Lim, K. K. P. 1994. Diversity and conservation of blackwater fishes in Peninsular Malaysia, particularly in the North Selangor peat swamp forest. *Hydrobiologia*, 285: 203-218
- Shiraishi, Y., Mizuno, N., Nagai, M., Yoshimi, M. and Nishiyama, K. 1972. Studies on the diel activity and feeding habit of fishes at Lake Bera, Malaysia. *Jpn. J. Ichthyol.*, 19: 295-306 (in Japanese).
- Tan, L. W. 1972. Studies on the feeding biology of *Pristolepis fasciatus* Bleeker and *Cyclocheilichthys apogon Valenciennes*. B. Sc. (Hons) Thesis, Zoology Division, Sch. Biol. Sc., University of Malaya, Kuala Lumpur, Malaysia, 57pp.
- Yap, S.-Y. 1988. Food resource utilization partitioning of fifteen fish species at Bukit Merah Reservoir, Malaysia. *Hydrobiologia*, 157: 143-160
- Zakaria-Ismail, M and Lim, K-K-P., 1995 The fish fauna of Tasik Temengor and its tributaries south of Banding, Hulu Perak, Malaysia. *Malayan Nature Journal*, 48: 319-332.

Appendix 1. The time of sampling and number of fishes caught with gill nets at site 98A in low water level season during 1200 of 18 September to 1500 of 19 September 1998.

| from 1200 to 1500                |     | from 0300 to 0600                |     |
|----------------------------------|-----|----------------------------------|-----|
| Species                          | No. | Species                          | No. |
| <i>Leptobarbus hoevenii</i>      | 1   | <i>Cyclocheilichthys apogon</i>  | 8   |
| <i>Osteochilus melanopleura</i>  | 4   | <i>Osteochilus melanopleura</i>  | 2   |
| <i>Osteochilus schlegelii</i>    | 1   | <i>Helostoma temminckii</i>      | 30  |
| <i>Pristolepis grooti</i>        | 2   | <i>Pristolepis grooti</i>        | 3   |
| <i>Trichogaster leerii</i>       | 1   | <i>Trichogaster leerii</i>       | 44  |
|                                  |     | <i>Trichogaster trichopterus</i> | 3   |
| from 1500 to 1800                |     | <i>Mystus nemurus</i>            | 11  |
| Species                          | No. | <i>Mystus nigriceps</i>          | 8   |
| <i>Cyclocheilichthys apogon</i>  | 3   | <i>Wallago leerii</i>            | 1   |
| <i>Helostoma temminckii</i>      | 2   | from 0600 to 0900                |     |
| <i>Osteochilus melanopleura</i>  | 2   | Species                          | No. |
| <i>Pristolepis grooti</i>        | 3   | <i>Cyclocheilichthys apogon</i>  | 1   |
| <i>Trichogaster leerii</i>       | 280 | <i>Leptobarbus hoevenii</i>      | 1   |
| <i>Kryptopterus sp.</i>          | 2   | <i>Osteochilus melanopleura</i>  | 2   |
| <i>Mystus nemurus</i>            | 6   | <i>Osteochilus schlegelii</i>    | 2   |
| <i>Mystus nigriceps</i>          | 23  | <i>Helostoma temminckii</i>      | 2   |
| <i>Nandus nebulosus</i>          | 1   | <i>Pristolepis grooti</i>        | 5   |
| <i>Ompok sp.</i>                 | 1   | <i>Trichogaster leerii</i>       | 1   |
| from 1800 to 2100                |     | from 0900 to 1200                |     |
| Species                          | No. | Species                          | No. |
| <i>Leptobarbus hoevenii</i>      | 5   | <i>Leptobarbus hoevenii</i>      | 2   |
| <i>Helostoma temminckii</i>      | 3   | <i>Osteochilus melanopleura</i>  | 4   |
| <i>Mystus nigriceps</i>          | 2   | <i>Osteochilus schlegelii</i>    | 5   |
| from 2100 to 0000                |     | <i>Helostoma temminckii</i>      | 1   |
| Species                          | No. | <i>Pristolepis grooti</i>        | 2   |
| <i>Cyclocheilichthys apogon</i>  | 1   | <i>Trichogaster leerii</i>       | 6   |
| <i>Leptobarbus hoevenii</i>      | 1   | from 1200 to 1500                |     |
| <i>Trichogaster leerii</i>       | 1   | Species                          | No. |
| <i>Trichogaster trichopterus</i> | 1   | <i>Osteochilus melanopleura</i>  | 1   |
| <i>Kryptopterus sp.</i>          | 1   | <i>Osteochilus schlegelii</i>    | 2   |
| from 0000 to 0300                |     | <i>Trichogaster leerii</i>       | 3   |
| Species                          | No. |                                  |     |
| <i>Helostoma temminckii</i>      | 1   |                                  |     |
| <i>Trichogaster leerii</i>       | 3   |                                  |     |
| <i>Mystus nemurus</i>            | 3   |                                  |     |

Fish feeding activity in an oxbow lake of Central Kalimantan

Appendix 2. The time of sampling and number of fishes caught with a scoop net (selambau) at site 99A in high water level season during 1600 of 29 April to 1740 of 30 April 1999.

| 1600                            |     | 0900                               |     |
|---------------------------------|-----|------------------------------------|-----|
| Species                         | No. | Species                            | No. |
| <i>Leptoburbus hoevenii</i>     | 5   | <i>Cyclocheilichthys apogon</i>    | 4   |
| <i>Osteochilus melanopleura</i> | 2   | <i>Leptoburbus hoevenii</i>        | 13  |
| <i>Rasbora</i> sp.              | 1   | <i>Luciosoma trinema</i>           | 1   |
| <i>Kryptopterus</i> sp.         | 1   | <i>Osteochilus melanopleura</i>    | 5   |
| <hr/>                           |     | <i>Osteochilus triporos</i>        | 2   |
| 1800                            |     | <i>Pristolepis grooti</i>          | 1   |
| Species                         | No. | <i>Helostoma temminckii</i>        | 1   |
| <i>Kryptopterus</i> spp.        | 3   | <i>Trichogaster leerii</i>         | 2   |
| <i>Pangasius masutus</i>        | 3   | <i>Trichogaster trichopterus</i>   | 1   |
| <hr/>                           |     | <hr/>                              |     |
| 2100                            |     | 1200                               |     |
| Species                         | No. | Species                            | No. |
| <i>Kryptopterus apogon</i>      | 4   | <i>Cyclocheilichthys apogon</i>    | 12  |
| <i>Kryptopterus</i> sp.         | 1   | <i>Leptoburbus hoevenii</i>        | 2   |
| <i>Pangasius masutus</i>        | 1   | <i>Luciosoma trinema</i>           | 3   |
| <i>Macrogathus aculeatus</i>    | 1   | <i>Osteochilus melanopleura</i>    | 1   |
| <hr/>                           |     | <i>Osteochilus triporos</i>        | 1   |
| 0000                            |     | <i>Parackela</i> sp.               | 1   |
| Species                         | No. | <i>Mystus nigriceps</i>            | 1   |
| <i>Mystus nemurus</i>           | 1   | <i>Helostoma temminckii</i>        | 4   |
| <i>Mystus nigriceps</i>         | 2   | <i>Trichogaster leerii</i>         | 8   |
| <i>Kryptopterus apogon</i>      | 3   | <hr/>                              |     |
| <i>Kryptopterus limpok</i>      | 1   | 1500                               |     |
| <i>Kryptopterus</i> spp.        | 2   | Species                            | No. |
| <hr/>                           |     | <i>Cyclocheilichthys apogon</i>    | 5   |
| 0300                            |     | <i>Luciosoma trinema</i>           | 2   |
| Species                         | No. | <i>Osteochilus melanopleura</i>    | 1   |
| <i>Mystus nigriceps</i>         | 1   | <i>Osteochilus triporos</i>        | 2   |
| <i>Kryptopterus apogon</i>      | 1   | <i>Trichogaster leerii</i>         | 7   |
| <i>Kryptopterus limpok</i>      | 3   | <hr/>                              |     |
| <i>Kryptopterus</i> spp.        | 2   | 1740                               |     |
| <i>Pangasius masutus</i>        | 1   | Species                            | No. |
| <i>Macrogathus aculeatus</i>    | 2   | <i>Cyclocheilichthys apogon</i>    | 1   |
| <hr/>                           |     | <i>Kryptopterus</i> spp.           | 2   |
| 0600                            |     | <i>Pseudentropius brachypterus</i> | 5   |
| Species                         | No. | <i>Trichogaster leerii</i>         | 1   |
| <i>Leptoburbus hoevenii</i>     | 7   | <hr/>                              |     |
| <i>Osteochilus melanopleura</i> | 60  |                                    |     |
| <i>Mystus nemurus</i>           | 5   |                                    |     |
| <i>Mystus nigriceps</i>         | 1   |                                    |     |
| <i>Kryptopterus apogon</i>      | 2   |                                    |     |
| <i>Kryptopterus</i> spp.        | 4   |                                    |     |
| <i>Helostoma temminckii</i>     | 3   |                                    |     |
| <i>Trichogaster leerii</i>      | 3   |                                    |     |
| <i>Macrogathus aculeatus</i>    | 2   |                                    |     |

Appendix 3. The time of sampling and number of fishes caught with gill nets at site 99A in high water level season during 1500 of 6 May to 1500 of 7 May 1999.

| from 1200 to 1500                  |     | from 0300 to 0600                |     |
|------------------------------------|-----|----------------------------------|-----|
| Species                            | No. | Species                          | No. |
| <i>Osteochilus pentalineatus</i>   | 4   | <i>Osteochilus triporos</i>      | 3   |
| <i>Osteochilus triporos</i>        | 87  | <i>Puntius lineatus</i>          | 1   |
| <i>Puntius lineatus</i>            | 5   | <i>Rasbora</i> sp.               | 1   |
| <i>Rasbora</i> spp.                | 1   | <i>Kryptopterus</i> spp          | 13  |
| Unknown                            | 2   |                                  |     |
| from 1500 to 1800                  |     | from 0600 to 0900                |     |
| Species                            | No. | Species                          | No. |
| <i>Osteochilus triporos</i>        | 39  | <i>Osteochilus pentalineatus</i> | 1   |
| <i>Puntius lineatus</i>            | 2   | <i>Osteochilus triporos</i>      | 8   |
| <i>Rasbora</i> spp.                | 3   | <i>Puntius lineatus</i>          | 4   |
| <i>Kryptopterus</i> spp.           | 3   | <i>Rasbora</i> spp.              | 1   |
| <i>Pseudentropius brachypterus</i> | 2   |                                  |     |
| Unknown                            | 1   | from 0900 to 1200                |     |
| from 1800 to 2100                  |     | Species                          | No. |
| No fishes                          |     | <i>Osteochilus triporos</i>      | 11  |
| from 2100 to 0000                  |     | <i>Puntius lineatus</i>          | 1   |
| No fishes                          |     | <i>Rasbora</i> sp.               | 1   |
| from 0000 to 0300                  |     | from 1200 to 1500                |     |
| Species                            | No. | Species                          | No. |
| <i>Clarias meladerma</i>           | 1   | <i>Osteochilus triporos</i>      | 17  |
| <i>Macrognathus aculeatus</i>      | 1   | <i>Puntius lineatus</i>          | 1   |
|                                    |     | <i>Rasbora</i> spp.              | 3   |
|                                    |     | <i>Trichogaster leerii</i>       | 1   |

## **Concept for Sustainable Development of Local Fish Resource in Central Kalimantan**

**Matling TORANG and Tariono BUCAR**

Dept. of aquatic resources management,  
Faculty of Agriculture, The University of Palangka Raya - Indonesia

### **Abstract**

In Central Kalimantan, the total area of inland waters is approximately 2,267,800 ha. Most of these resources have long been recognized as important habitats for local freshwater fishes. These freshwater fishes are of high important for the local people as the main source of protein and the source of income for local fisherman. However, various human activities carried out in the waters body such as transportation, deforestation and illegally fishing practices have threaten these freshwater ecosystems. Local people have been affected by this habitat destruction.

Peat swamp is the dominant freshwater habitat in Central Kalimantan. This water body is characterized by a high water level fluctuation, browning water color, low transparency and low pH values. These special features lead to the specific characteristics of organisms including local fishes that occupy the habitat. Any environmental change such as the changing of microclimate, will affect the sustainability of this unique ecosystem.

In order to maintain local fish habitat, a management practice should be applied in Central Kalimantan. This could be done by formulating a government policy that can manage the exploitation of water resources in this region. The establishment of a conservation area will also be useful in maintaining local fish biodiversity. For this need, the local people have agreed to allocate their land at the upstream of the Sebangau River to be developed as the local fish conservation area. There is also a possibility to develop similar conservation area in other region of Central Kalimantan.

It is recommended that this sustainable development concept could be supported by establishing a research collaboration program among scientists either locally or internationally.

**Key words:** Local fish, aquatic resource, conservation, sustainable development.

### **Introduction**

Total area of Central Kalimantan province is 1,538,280,000 ha where inland water covers approximately 2,267,800 ha. This inland water consists of 323,500, 132,800 and 1,811,500 ha of rivers, lakes and swamps respectively (Anonymous, 1994). The huge areas of freshwater ecosystems indicate that this province has a high potential for the development of fisheries resources.

Traditionally, indigenous peoples of Central Kalimantan fulfill their need for protein by consuming local fishes caught from inland waters. For most people in this region, local freshwater fishes are more preferable than marine or introduced fishes. In order to maintain the sustainability of their need for local fish, local people apply traditional ways of maintaining the environment. For example, they always use simple and selective equipment for catching the fishes and they avoid to overexploiting their natural resources.

However, since few years ago there have been changes of inland waters condition in this region. The increase of population due to the immigration program lead to the

increase of human invasion to the natural resources as well as to the local people in this region. Various human activities either in the water body or in the catchment area of the water body have deteriorated the water quality and reducing the water production including local fishes. As a consequence, local people lost their natural resources either as a source of their food or the source of their income. Unfortunately, no one cares about this condition.

## **Environmental Condition**

### **A. Spread of Environment**

In the past, Central Kalimantan was covered by a dense tropical rain forest. People could easily collected good quality, high and big trees just from their surrounding forest. Many big rivers such as the Barito, Kapuas, Kahayan, Katingan, Mantaya, Pambuang, Kumai, Lamandau and Jelai flow from northern to southern part of the province. These rivers were always clear and unpolluted. At that time, the people of Central Kalimantan was very proud of these rivers due to its function in supporting their life such as for transportation, drinking water as well as the place where they can go for catching fishes.

At present, however, the condition has changed dramatically. Rivers discharge fluctuated considerably. During dry season the upstream villages could not be reached by water transportation, whereas during wet season flooding will occur in the area down stream of the rivers. River water is always turbid throughout the year and the local fishes have been hard to find in the river. This condition was caused by the change of the natural environment due to the two different causes: natural and man-made. The natural change usually occur slowly and in relatively small scale, whereas the man-made change could be massive and out of control. Now, huge area of bare land occur in Central Kalimantan due to the over exploitation of forest resources. One of extreme example could be seen in Bukit Batu area, 35 km from Palangka Raya City to the west. In the past this area was covered with a dense forest. Due to the over exploitation, the vegetation now has disappeared, and the area is completely open without any single big tree left. Other effects of deforestation practice are the lowering of ground water level and the increase of surface run-off or decreasing the infiltration of rainfall to the ground. During last ten years there has been an indication that microclimate has also changed in this region (based on Schmidt and Ferguson Climatic type).

There have been many environmental impacts of deforestation practice and climate change in this region. The worse forest fire in 1997 was an example. During the fire, all area was polluted by haze and smog for several months. Other impact occurred in disturbed peat swamp forest is the lowering of ground surface (subsidence). This impact is usually caused by the drainage of natural peatland for other purposes such as its conversion for public settlement or agricultural land. Such impact do not occur in a naturally peat swamp forest. This natural ecosystem usually support the existence of a high biodiversity either aquatic or terrestrial organisms including local fishes that are consumed by the local people. Therefore, the economical value of the lost of this natural ecosystem could not be counted precisely.

### **B. Water Properties**

The properties of a water body are influenced by both allochthonous and autochthonous factors. In other word, the present status of a water body reflects the present environmental condition both inside and surroundings of the water body. Therefore, any

changing of environmental condition surround a specific water body will lead to the changing of the properties of such water body. Followings are the general properties of water bodies in Central Kalimantan.

### ***1. Physical water properties***

#### ***a. Water flow***

Inland waters could be categorized into two different types: running water (lotic) and stagnant water (lentic). The ecological natures of these two are also different.

The general feature of peatland water in Central Kalimantan is the changing from a running water during rainy season to become a stagnant water in the dry season. During high water level many puddles occur in a peatland area. These puddles especially shallow water will be dried out with the decrease of ground water level during dry season. Another feature is the occurrence of various size of oxbow lakes along the river systems. These lakes also undergo the switch from lotic water during rainy season to become lentic water during dry season. In order word, during rainy season this water body possesses river system characteristics, whereas in dry season a lake characteristics will become apparent.

#### ***b. Water color***

Water color of inland peat waters always brown visual color. This color is influenced by the present of organic compounds soluble in the water (Matling, 1995). Therefore, this color is not an apparent color, means it can be reduced by filtering process. For example, the value of a natural peatland water could be reduced from 549 to 65 unit PtCo by filtering the water with ash and charcoal (Matling, 1995).

According to Cole (1983), the water color can be affected by dissolved organic matters as humic acid (humic substance) released from soil, peat, or sediment. After the oxidation of peat in dry season, the peat will be washed and washed into the water streams during rainy season, hence the water color will be affected to become browning in color. Due to their surrounding area, many oxbow lakes in Central Kalimantan have water color same as peat water. Similar color also occurs in several rivers such as the Kapuas and Sabangau rivers. There is also a black water color in this region such as in the Mantangai River (a tributary of the Kapuas River).

#### ***c. Transparency***

In general, water transparency in Central Kalimantan is relative low. For example in Kahayan River during August 1999 the transparency ranged only between 19.0 and 29.5 cm. This is due to the water color and turbidity. The major causes of water turbidity are the opening of catchment areas and gold mining activities either in the river body or its catchment area. From field observation conducted in April 1999, there were 1,904 units of gold mining in Kahayan water body spread out from Tumbang Miri village at the upstream to Palangka Raya city at the downstream. Each unit could dig up 5-10 m<sup>3</sup> river sediment, resulting approximately 14,280 m<sup>3</sup> along the Kahayan River weekly.

The water color in peat swamp area is slightly different. In this water body the color is mainly influenced by the release of organic substance from peatland. Water transparency could be up to 42.5 cm as measured in a natural peat swamp area (Matling 1999), and between 37.5 and 42.5 cm in Lake Sabuah which is affected by peat water from its surrounding area (Yulistatie, 1999).

#### *d. Water temperature*

Fluctuation of water temperatures in shallow waters are higher than those in deep waters. The temperature measured for inland peatland waters around Palangkaraya ranges between 24.9-37.9°C (Matling, 1999). The variance in temperature value is possibly due to the fact that it was measured only in surface water between 1200-1500PM. The depth of this natural peatland water ranged between 0.03-0.54 m. In deeper water such as in Lake Sabuah (12.5 m depth), water temperature ranged between 27.5-30.3°C (Yulistatie, 1999). Both types of water undergo similar process that changes from stagnant waters during dry season to be stream waters in rainy season. In the river body, on the other hand, the fluctuation of water temperature is not high. For example water temperature of the Kahayan River (Palangka Raya) in March and April 1999 ranged between 26.0-29.5°C (Indarti, 1999). This river water temperature is relatively constant throughout the year, as indicated by the values that ranged from 26.4-28.8°C in the same location in the Kahayan River during September 1999.

## **2. Chemical properties**

### *a. pH*

Generally, the freshwaters in low land area of Central Kalimantan have low pH values (Roberts, 1989). In Kahayan River, for example, the pH values ranged between 6.03-6.98 and in Lake Sabuah such values ranged from 5.69-6.05 (Torang, 1996). Under turn over mixing between bottom and surface waters in Lake Sabuah, the pH values ranged from 5.76-6.99 (Yulistatie, 1999). These values are much higher compared with peatland waters collected from puddles around Palangka Raya, that ranged from 3.60-4.97 (Matling, 1999) and 3.42-4.41 (Resistensi, 1998). Although the pH values are very low, many local fishes could be found easily in these puddles. Therefore, the unique feature of local fishes in Central Kalimantan is their ability to adapt and grow in acidic waters.

### *b. Dissolved oxygen*

Due to the decomposition of organic matters, the concentration of dissolved oxygen in peatland waters of Central Kalimantan is usually very low. In 1996, for example, the concentration in Lake Sabuah ranged from 3.86-4.79 ppm (Torang, 1996), whereas in 1999 such concentration ranged between 2.99 and 3.66 ppm (Yulistatie, 1999). At the bottom of the lake, the concentration decreased considerably up to 0.1 ppm. In the surface waters of puddles around Palangka Raya, the concentration ranged from 0.14 to 6.39 ppm (Matling, 1999).

Local fishes can adapt very well to this low concentration of dissolved oxygen. Their physiological adaptation to this hard environment is indicated by the presence of labyrinth on their breeding organ system.

## **Biotic Condition**

### **A. Community of Fishes**

Fish communities were studied in both Lake Sabuah during period of July to November 1996, and in Lake Tundai from March to August 1999. The identification of fish species was performed according to Weber and Beaufort (1916), Saanin (1984), Affandi *et al.* (1992) and Kottelat *et al.* (1993). In Lake Sabuah, local fishes consist of 5 orders, 17 families and 48 species (Table 1), whereas in Lake Tundai, collected fishes belong to 6 orders, 18 families and 44 species (Table 2).



Table 1. Fish species compositions at each location of Lake Sabuah from July to November 1996.

| Order                            | Family                        | Species                            | Common name               | Station                   |            |     |    |
|----------------------------------|-------------------------------|------------------------------------|---------------------------|---------------------------|------------|-----|----|
|                                  |                               |                                    |                           | I                         | II         | III | IV |
| Cypriniformes                    | Cyprinidae                    | <i>Cyclocheilichthys apogon</i>    | Puhing                    | +                         | +          | +   | -  |
|                                  |                               | <i>Oteochilus melanopleura</i>     | Kalabau                   | -                         | +          | -   | -  |
|                                  |                               | <i>Labiobarbus ocellatus</i>       | Masau                     | +                         | +          | +   | -  |
|                                  |                               | <i>Pontiopliter waandersi</i>      | Sanggalang                | -                         | +          | -   | -  |
|                                  |                               | <i>Parachela oxygastroides</i>     | Lalang                    | -                         | +          | -   | -  |
|                                  |                               | <i>Rasbora argyrotaenia</i>        | Seluang bulu              | +                         | +          | +   | -  |
|                                  |                               | <i>Leptobarbus hoeveni</i>         | Jelawat                   | +                         | +          | -   | -  |
|                                  |                               | <i>Thynnichthys thynnoides</i>     | Menangin                  | +                         | +          | +   | -  |
|                                  |                               | <i>Osteochilus hasselti</i>        | Nilem                     | +                         | +          | -   | -  |
|                                  |                               | <i>Thynnichthys polylepis</i>      | Mentukan                  | +                         | -          | -   | -  |
|                                  |                               | <i>Luciosoma trinema</i>           | Johar                     | -                         | +          | -   | -  |
|                                  |                               | <i>Barbichthys laevis</i>          | Kumkum                    | +                         | +          | -   | -  |
|                                  |                               | <i>Barbodes schwanefeldi</i>       | Salap                     | -                         | +          | -   | -  |
|                                  |                               | <i>Hampala macrolepidota</i>       | Adungan                   | +                         | +          | -   | -  |
|                                  |                               | <i>Osteochilus triporos</i>        | Banta                     | +                         | +          | -   | -  |
|                                  |                               | <i>Osteochilus pentalineatus</i>   | Tembayuk                  | +                         | +          | -   | -  |
|                                  |                               | <i>Osteochilus waandersi</i>       | Umpan-umpan               | -                         | +          | +   | -  |
|                                  |                               | <i>Puntius binotatus</i>           | Bunter                    | -                         | +          | -   | -  |
|                                  |                               | <i>Rotheichthys microlepis</i>     | Kenali                    | +                         | +          | -   | -  |
|                                  |                               | Perciformes                        | Cobitidae                 | <i>Botia macracanthus</i> | Ikan macan | -   | +  |
| <i>Botia hymenophysa</i>         | Langli                        |                                    |                           | -                         | +          | -   | -  |
| Mascembalidae                    | <i>Macrogathus aculeatus</i>  |                                    | Joli                      | -                         | +          | -   | -  |
|                                  | Belontiidae                   |                                    | <i>Trichogaster leeri</i> | Sepat iju                 | +          | +   | -  |
| <i>Trichogaster trichopterus</i> |                               |                                    | Sepat rawa                | +                         | +          | -   | -  |
| <i>Belontiidae hasselti</i>      |                               |                                    | Kapar                     | -                         | +          | -   | +  |
| Chandidae                        | <i>Parambassis wolffi</i>     |                                    | Ikan Kaca                 | +                         | +          | -   | -  |
| Chanidae                         | <i>Channa pleurophthalmus</i> |                                    | Kerandang                 | +                         | +          | -   | -  |
|                                  | <i>Channa melanopterus</i>    |                                    | Kehung                    | -                         | +          | -   | -  |
|                                  | <i>Channa striata</i>         |                                    | Gabus                     | -                         | +          | -   | +  |
|                                  | <i>Channa micropeltes</i>     |                                    | Toman                     | +                         | +          | -   | -  |
| Anabantidae                      | <i>Anabas testudineus</i>     |                                    | Betok                     | -                         | +          | -   | -  |
| Helostomatidae                   | <i>Helostoma temmincki</i>    |                                    | Tambakan                  | +                         | +          | -   | -  |
| Osphronemidae                    | <i>Osphronemus goramy</i>     |                                    | Gurami                    | +                         | +          | -   | -  |
| Luciocephalidae                  | <i>Luciocephalus pulcher</i>  | Tumbu ramer                        | -                         | +                         | -          | -   |    |
| Pristolepididae                  | <i>Pritolepsis grooti</i>     | Patung                             | +                         | +                         | -          | -   |    |
| Siluriformes                     | Siluridae                     | <i>Kryptopterus micronema</i>      | Lais junggang             | +                         | +          | +   | +  |
|                                  |                               | <i>Kryptopterus apogon</i>         | Lais timah                | -                         | +          | +   | +  |
|                                  |                               | <i>Kryptopterus schilbeides</i>    | Lais puith                | -                         | +          | -   | +  |
|                                  |                               | <i>Kryptopterus kryptopterus</i>   | Lais tunggul              | +                         | +          | +   | -  |
|                                  | Bagridae                      | <i>Mystus nigriceps</i>            | Sanggiringan              | +                         | +          | +   | +  |
|                                  |                               | <i>Mystus micracanthus</i>         | Baung                     | +                         | +          | +   | +  |
|                                  |                               | <i>Bagrichthys micranodus</i>      | Hinur                     | -                         | +          | -   | +  |
|                                  | Claridae                      | <i>Clarias batrachus</i>           | Lele                      | -                         | +          | -   | -  |
|                                  | Schilbidae                    | <i>Pseudotropius brachyopterus</i> | Nuanjang                  | -                         | +          | -   | -  |
|                                  |                               | <i>Pseudotropius moolenburghae</i> | Ikan riu                  | -                         | +          | -   | -  |
| Plegognathy                      | Tetraodontidae                | <i>Tetraodon immaculatus</i>       | Buntel pinnag             | -                         | +          | -   | -  |
|                                  |                               | <i>Tetraodon reticularis</i>       | Buntel kelapa             | -                         | +          | -   | -  |
| Osteoglossiformes                | Notopteridae                  | <i>Notopterus borneensis</i>       | Belida                    | +                         | +          | -   | -  |

+ : existing - : none

## B. Food Habit of Several Fish Species

The food habits of several fish species was analysed by referring to the Index of Preponderance (Natarajan and Jhingran, 1963; Effendie, 1979), whereas the stomach contents was identified according to Edmondson (1963) and Prescott (1970). The structure of fish community in Lake Sabuah and Lake Tundai was dominated by carnivorous fishes (Buchar, 1997, 1999), as presented in Table 3.

Table 2. Fish species compositions at each location of Lake Tundai from March to August 1999.

| Order                             | Family                       | Species                             | Common name                        | Station                      |               |     |   |
|-----------------------------------|------------------------------|-------------------------------------|------------------------------------|------------------------------|---------------|-----|---|
|                                   |                              |                                     |                                    | I                            | II            | III |   |
| Cypriniformes                     | Cyrinidae                    | <i>Osteochilus pentalineatus</i>    | Tembayuk                           | +                            | +             | -   |   |
|                                   |                              | <i>Osteochilus triporos</i>         | Banta                              | +                            | -             | +   |   |
|                                   |                              | <i>Osteochilus melanopleura</i>     | Kalabau                            | +                            | +             | +   |   |
|                                   |                              | <i>Rasbora</i> sp.                  | Saluang kahui                      | +                            | -             | -   |   |
|                                   |                              | <i>Rasbora argyrotaenia</i>         | Saluang balu                       | +                            | +             | +   |   |
|                                   |                              | <i>Cyclocheilichthys apogon</i>     | Puhing                             | +                            | +             | +   |   |
|                                   |                              | <i>Cyclocheilichthys heteronema</i> | Sabuluh                            | +                            | -             | -   |   |
|                                   |                              | <i>Cyclocheilichthys jantochir</i>  | Puhing kahui                       | -                            | +             | -   |   |
|                                   |                              | <i>Thynnichthys thynnoides</i>      | Menangin                           | +                            | -             | +   |   |
|                                   |                              | <i>Parachela oxygastroides</i>      | Lalang                             | +                            | -             | -   |   |
|                                   |                              | <i>Leptobarbus hoeveni</i>          | Jelawat                            | +                            | +             | +   |   |
|                                   |                              | <i>Labiobarbus ocellatus</i>        | Masau                              | +                            | -             | -   |   |
|                                   |                              | <i>Luciosoma trinema</i>            | Seluang juara                      | +                            | +             | +   |   |
|                                   |                              | <i>Puntius lineatus</i>             | Lauk tundai                        | +                            | -             | -   |   |
|                                   |                              | <i>Puntiopliter waandersi</i>       | Sanggung                           | +                            | +             | -   |   |
| Perciformes                       | Belontiidae                  | <i>Trichogaster leeri</i>           | Sepat hijau                        | +                            | +             | +   |   |
|                                   |                              | <i>Trichogaster tricopterus</i>     | Sepat rawa                         | +                            | -             | +   |   |
|                                   |                              | <i>Belontiidae hasellii</i>         | Kapar                              | +                            | -             | -   |   |
|                                   | Chandidae                    | <i>Parambasis wolffi</i>            | Ikan kaca                          | +                            | +             | +   |   |
|                                   | Chanidae                     | <i>Channa pleurophthalmus</i>       | Kerandang                          | -                            | -             | +   |   |
|                                   | Anabantidae                  | <i>Anabas testudineus</i>           | Betok                              | +                            | -             | -   |   |
|                                   | Helostomatidae               | <i>Helostoma temmencki</i>          | Tambakan                           | +                            | +             | +   |   |
|                                   | Luciocephalidae              | <i>Luciocephalus pulcher</i>        | Tumbu ramer                        | +                            | -             | -   |   |
|                                   | Pritolepididae               | <i>Pristolepis grooti</i>           | Patung                             | +                            | +             | -   |   |
|                                   | Nandidae                     | <i>Nandus nebolusus</i>             | Tatawun                            | +                            | +             | -   |   |
|                                   | Mascembalidae                | <i>Macrogathus aculeatus</i>        | Joli                               | +                            | -             | -   |   |
|                                   | Siluriformes                 | Siluridae                           | <i>Kryptopterus palembangensis</i> | Lais baji                    | +             | +   | + |
| <i>Kryptopterus apogon</i>        |                              |                                     | Lais junggang                      | +                            | -             | -   |   |
| <i>Kryptopterus macrocephalus</i> |                              |                                     | Lais hitam                         | +                            | -             | -   |   |
| <i>Kryptopterus limpok</i>        |                              |                                     | Lais kerak                         | +                            | -             | -   |   |
| <i>Kryptopterus</i> sp.           |                              |                                     | Lais nipah                         | +                            | -             | -   |   |
| <i>Kryptopterus parvanalis</i>    |                              |                                     | Lais bamban                        | +                            | +             | +   |   |
| <i>Kryptopterus schilbeides</i>   |                              |                                     | Lais putih                         | -                            | -             | +   |   |
| <i>Ompok hypophthalmus</i>        |                              |                                     | Lais Bantut                        | +                            | -             | -   |   |
| <i>Wallogo leeri</i>              |                              |                                     | Tapah                              | +                            | -             | -   |   |
| Pangsiidae                        |                              |                                     | <i>Pangasius micronema</i>         | Lawang                       | +             | +   | + |
| Bagiridae                         |                              |                                     | <i>Mystus nigriceps</i>            | Sanggiringan                 | +             | +   | + |
|                                   |                              |                                     | <i>Mystus nemurus</i>              | Baung                        | +             | +   | + |
| Claridae                          |                              |                                     | <i>Clarias meladerma</i>           | Lele                         | +             | -   | - |
| Schilbidae                        |                              |                                     | <i>Pseudotropius brachyopterus</i> | Ikan riu                     | +             | -   | - |
| Plegognathi                       |                              |                                     | Tetraodontidae                     | <i>Tetraodon reticularis</i> | Buntel kelapa | +   | - |
|                                   | <i>Tetraodon immaculatus</i> | Buntel pinang                       |                                    | -                            | +             | -   |   |
| Osteoglossiformes                 | Notopteridae                 | <i>Notopterus borneensis</i>        | Belida                             | +                            | -             | -   |   |
| Ostariophysii                     | Doiichthyidae                | <i>Doiichthys novae</i>             | Sapapirang                         | -                            | -             | +   |   |

+ : existing, - : none

Table 3. Food habit and trophic level status of several fish.

| Species                              | Groups of food |            |          |         |          |          |        |                    |               | Trophic level status |
|--------------------------------------|----------------|------------|----------|---------|----------|----------|--------|--------------------|---------------|----------------------|
|                                      | Aquatic plant  | Gastropoda | Nematoda | Insecta | Plankton | Detritus | Fishes | Crustacea (shrimp) | Insect larvae |                      |
| <i>Osteochilus pentalineatus</i>     | A              | -          | -        | -       | M        | S        | -      | -                  | -             | H                    |
| <i>Osteochilus triporos</i>          | A              | -          | -        | -       | M        | S        | -      | -                  | -             | H                    |
| <i>Osteochilus melanopleura</i>      | S              | -          | -        | -       | M        | A        | -      | -                  | -             | H                    |
| <i>Rasbora</i> sp.                   | -              | -          | A        | M       | M        | S        | -      | -                  | -             | C                    |
| <i>Rasbora argyrotaenia</i>          | -              | -          | A        | S       | M        | A        | -      | -                  | S             | C                    |
| <i>Cyclochheilichthys apogon</i>     | S              | -          | -        | -       | S        | M        | -      | -                  | -             | O                    |
| <i>Cyclochheilichthys heteronema</i> | S              | -          | -        | -       | S        | M        | -      | -                  | -             | D                    |
| <i>Cyclochheilichthys jantochir</i>  | A              | -          | -        | -       | S        | M        | -      | -                  | -             | D                    |
| <i>Thynnichthys thynnoides</i>       | S              | -          | -        | -       | M        | A        | -      | -                  | -             | H                    |
| <i>Parachela oxygastroides</i>       | -              | -          | A        | M       | S        | -        | -      | -                  | S             | C                    |
| <i>Leptobarbus hoeveni</i>           | M              | -          | -        | A       | M        | S        | -      | -                  | -             | H                    |
| <i>Labiobarbus ocellatus</i>         | -              | -          | -        | -       | M        | S        | -      | -                  | A             | H                    |
| <i>Luciosoma trinema</i>             | -              | A          | -        | S       | M        | A        | -      | -                  | -             | C                    |
| <i>Puntius lineatus</i>              | -              | -          | -        | A       | S        | M        | -      | -                  | A             | D                    |
| <i>Puntiopliter waandersi</i>        | S              | -          | -        | -       | M        | A        | -      | -                  | A             | O                    |
| <i>Trichogaster leeri</i>            | S              | -          | -        | -       | M        | A        | -      | -                  | -             | H                    |
| <i>Trichogaster trichopterus</i>     | S              | -          | -        | -       | M        | A        | -      | -                  | -             | H                    |
| <i>Belontiidae haseltii</i>          | -              | -          | A        | A       | M        | S        | -      | -                  | -             | C                    |
| <i>Parambassis wolfii</i>            | -              | A          | -        | S       | M        | -        | S      | -                  | -             | C                    |
| <i>Channa pleurophthalmus</i>        | -              | A          | -        | -       | -        | S        | M      | A                  | A             | Pr                   |
| <i>Channa melanopterus</i>           | -              | -          | -        | A       | -        | S        | M      | -                  | -             | Pr                   |
| <i>Channa striata</i>                | -              | -          | -        | A       | -        | S        | M      | A                  | -             | Pr                   |
| <i>Channa micropeltes</i>            | -              | A          | -        | -       | -        | -        | M      | S                  | -             | Pr                   |
| <i>Anabas testudineus</i>            | -              | -          | S        | A       | M        | S        | -      | -                  | A             | C                    |
| <i>Helostoma temminckii</i>          | S              | -          | -        | -       | M        | A        | -      | -                  | -             | H                    |
| <i>Luciocephalus pulcher</i>         | -              | -          | S        | A       | M        | -        | -      | -                  | A             | C                    |
| <i>Pristolepis grooti</i>            | -              | -          | A        | A       | M        | S        | -      | -                  | S             | C                    |
| <i>Nandus nebolus</i>                | -              | -          | A        | A       | M        | -        | -      | -                  | -             | C                    |
| <i>Macrogathus aculeatus</i>         | -              | -          | A        | M       | S        | A        | -      | -                  | -             | C                    |
| <i>Kryptopterus palembangensis</i>   | -              | -          | A        | S       | S        | -        | M      | -                  | A             | C                    |
| <i>Kryptopterus apogon</i>           | -              | A          | A        | -       | S        | -        | M      | -                  | -             | C                    |
| <i>Kryptopterus macrocephalus</i>    | -              | -          | A        | A       | M        | S        | -      | -                  | -             | C                    |
| <i>Kryptopterus limpok</i>           | -              | -          | -        | A       | M        | S        | A      | -                  | -             | C                    |
| <i>Kryptopterus</i> sp.              | -              | A          | -        | A       | M        | -        | S      | -                  | -             | C                    |
| <i>Kryptopterus parvanalis</i>       | -              | -          | -        | -       | S        | S        | M      | A                  | -             | C                    |
| <i>Kryptopterus hypophthalmus</i>    | -              | A          | -        | A       | M        | S        | -      | -                  | -             | C                    |
| <i>Wallago leeri</i>                 | -              | A          | -        | -       | -        | -        | M      | S                  | -             | Pr                   |
| <i>Pangasius micronemus</i>          | A              | -          | -        | -       | S        | M        | -      | -                  | -             | O                    |
| <i>Mystus nigriceps</i>              | -              | -          | -        | -       | S        | S        | M      | A                  | -             | C                    |
| <i>Mystus nemurus</i>                | -              | -          | -        | A       | -        | S        | M      | A                  | -             | Pr                   |
| <i>Pseudotropius brachypterus</i>    | -              | -          | -        | -       | M        | S        | -      | -                  | A             | C                    |
| <i>Tetraodon reticularis</i>         | -              | -          | -        | S       | M        | A        | A      | -                  | -             | C                    |
| <i>Tetraodon immaculatus</i>         | -              | -          | -        | S       | M        | A        | -      | -                  | A             | C                    |
| <i>Notopterus boornensis</i>         | -              | A          | -        | -       | -        | S        | M      | A                  | -             | C                    |
| <i>Osphronemos goramy</i>            | S              | -          | -        | A       | M        | S        | -      | -                  | -             | H                    |
| <i>Barbodes schwanenfeldii</i>       | A              | -          | A        | -       | M        | S        | -      | -                  | -             | O                    |
| <i>Barbichthys laevis</i>            | A              | -          | -        | -       | S        | M        | -      | -                  | -             | D                    |
| <i>Osteochilus hasselti</i>          | A              | -          | A        | -       | S        | M        | -      | -                  | -             | D                    |

Remarks: M = Main food (index of preponderance) (IP = 30%)

S = Supplement food (IP = 5 - 25%)

A = Added food (IP = 5%)

H = Herbivore

D = Detrivore

O = Omnivore

C = Carnivore

Pr= Predator

## **Concept for Sustainable Development**

### **A. Establishment of Conservation Area**

Having described water properties and its existing aquatic organisms, we can understand the relationship between various human activities and the deterioration of water quality in Central Kalimantan. It is urgently necessary to consider the establishment of conservation areas in order to sustain the natural resources in the region.

The establishment of the areas should be based on the result of a scientific ecological research. For this purpose, it is important to select undisturbed, safe and ecologically suitable areas. Two areas have been identified to be appropriate for conservation areas in Central Kalimantan. The first area located in the upstream of Sebangau River that is suitable for local fish conservation, and the second area is in the upstream of the Kahayan River (Sirat River and Lake Saribu) which is good for crocodile conservation (Tim Peneliti PPLH Unpar, 1999). There might be also other suitable sites in other part of the province.

This concept of the establishment of conservation area should be adapted to the ecological potential of the area. The most important priority should be addressed to protect the existence of the original organisms in the region. The introduction of new species from outsides should be avoided. A feasibility study and the formulation of a government regulation will be important steps in establishing the area. In addition, this idea should be also introduced to the local people in order to develop their awareness of the important of their natural resources in supporting human life.

### **B. Research Concepts**

As described previously, the sustainable concept should be based on the result of a scientific research. The research should be organized in a such a way, hence any short and small scale ecological researches could be integrated in broader concept and goals of long term research period with the main purpose to improve prosperity of people especially local community in Central Kalimantan. It is necessary to develop further a research institution that can manage and organize such research activities. The present CIMTROP that has long experience in ecological research, should be utilized, improved further and facilitated in order to achieve this sustainable development concept.

## **Conclusions**

1. The continuously rapid environmental change in Central Kalimantan should be paid attention to.
2. There is a need for an action to protect the natural resources and to prevent its rapid man-made deterioration.
3. Indigenous peoples of Central Kalimantan prefer local freshwater fish instead of sea fish and introduced fish for their consumption.
4. The sustainable development of resources of local fish by conserving their natural habitat could improve the prosperity of local people in Central Kalimantan.
5. The fish communities in Lake Sabuah and Lake Tundai are dominated by the family Cyprinidae, with the tropic level status dominated by carnivorous fishes.

### References

- Affandi, R., Sjafei, D.S., Rahardjo, M.F. and Sulistiono. 1992. *Iktiologi, Suatu Pedoman Kerja Laboratorium*. Departemen Pendidikan dan Kebudayaan Dirjen Pendidikan Tinggi PAU Ilmu Hayat IPB-Bogor. 344 pp.
- Ampera, C. 1990. Pengaruh Faktor-faktor Produksi terhadap Pendapatan Petani dan Usahatana Kacang Panjang (*Vigna unguiculata*) di WKPP Banturung Kecamatan Bukit Batu Tangkiling. Fakultas Non Gelar Teknolgi Universitas Palangkaraya (Thesis).
- Anonymous. 1994. *Laporan Tahunan 1993*. Dinas Perikanan Propinsi Daerah Tingkat I Kalimantan Tengah. Palangkaraya.
- Buchar, T. 1997. Bio-ekologi Komunitas ikan di danau Sabuah, Kabupaten Kapuas Propinsi Kalimantan Tengah. Tesis Pascasarjana. Institut Pertanian Bogor, 108 pp (MSc. thesis).
- Buchar, T. 1997. Kebiasaan Makan dan Relung makanan komunitas ikan di danau Sabuah. Fak. Pertanian Jurusan Perikanan, Universitas Palangkaraya. 81 pp.
- Buchar, T. 1999. Iktiofauna di danau Tundai Kodya Palangka Raya, Kalimantan Tengah. Fak. Pertanian Jurusan Perikanan, Universitas Palangkaraya. (in press).
- Cole, G.A. 1983. *Textbook of Limnology*. Waveland Press, Illinois, USA.
- Colwell, R.K. and Futuyama, D.J. 1971. On the measurement of niche breadth and overlap. *Ecology*, 52: 567-576.
- Effendie, M.I. 1979. *Metoda Biologi Perikanan*. Yayasan Dwi Sri Bogor, 112 pp.
- Edmonson, W.T. 1963. *Fresh Water Biology*. 2nd edn. John Wiley and Sons, New York, 1248 pp.
- Indarti, 1999. Pembesaran Benih Ikan Patin (*Pangasius* sp.) dalam Karamba di sungai Kahayan Pahandut Seberang Kecamatan Pahandut Kotamadya Palangkaraya. Jurusan Perikanan Fakultas Pertanian Universitas Palangkaraya (Thesis).
- Kottelat, M., Whitten, J.A., Kartikasari, S.N. and Wirjoatmojo. 1993. *Ikan Air Tawar Indonesia Bagian Barat dan Sulawesi*. Edisi Dwibahasa Inggris-Indonesia. Periplus Edition. Indonesia. 293 pp.
- Lukas. 1997. Pengamatan Waktu dan Jenis Ikan yang Tertangkap dengan Pukat Kantong (Tabing) di Muara Danau Rigei Kelurahan Tumbang Tahai Kecamatan Bukit Batu. Jurusan Perikanan Fakultas Pertanian Universitas Palangkaraya (Thesis).
- Matling. 1995. Penggunaan Arang dan Abu dalam Perbaikan Kualitas Fisik dan Kimia Air Gambut untuk Media Tumbuh Fitoplankton. Program Pascasarjana Institut Pertanian Bogor (MSc thesis).
- Matling. 1999. Laporan Hasil Pengamatan Terhadap Kualitas Air Rawa Gambut Pedalaman di Sekitar Palangkaraya. Jurusan Perikanan Fakultas Pertanian Universitas Palangkaraya.
- Natarajan, A.V and Jhingran, A.G. 1961. Index of preponderance, a method of grading the food elements in the stomach of fishes. *Ind. J. Fish.*, 8 (1): 54-59.
- Prescott, G. W. 1970. *The Fresh Water Algae*. 2nd edn. Wm. C. Brown Company Publishers. 348 pp.
- Purnamalita, 1997. Pengamatan Kegiatan Penangkapan Ikan yang Dilakukan oleh Nelayan di Danau Rigei Kelurahan Tumbang Tahai Kecamatan Bukit Batu. Jurusan Perikanan Fakultas Pertanian Universitas Palangkaraya (Thesis).
- Resistensi, M.D., 1998. Hubungan Curah Hujan dengan Kualitas Air Permukaan Rawa Gambut Pedalaman di Kecamatan Pahandut Kotamadya Palangkarayan. Jurusan

- Perikanan Fakultas Pertanian Universitas Palangkaraya (Thesis).
- Roberts, T.R. 1989. *The Freshwater Fishes of Westrn Borneo (Kalimantan Barat Indonesia)*. California Academy of Sciences, San Francisco.
- Saanin, H. 1984. *Taksonomi dan Kunci Identifikasi Ikan*. Cetakan ke dua. Jilid I dan II. Binacipta. Bandung. 520 pp.
- Tim Peneliti PPLH Unpar, 1999. Laporan Hasil Survey Buaya di Sei Sirat Kapuas Hulu. Pusat PPLH Universitas Palangkaraya.
- Torang, I. 1996. Hubungan Antara Illuminasi dengan Kelimpahan dan Komposisi Jenis Fitoplankton. Program Pasacasarjana Institut Pertanian Bogor (MSc thesis).
- Yulistatie. 1999. Pengaruh Percampuran Massa Air Dasar dan Massa Air Permukaan Terhadap Kelimpahan Fitoplankton di Perairan Danau Sabuah. Jurusan Perikanan Fakultas Pertanian Universitas Palangkaraya (Thesis).
- Weber, M and De Beaufort. 1916. *Fishes of Indo-Australian Archipelago. Vol. I-X*. E.J. Brill Ltd., Leiden. Holland.

**Part 7**  
**Human Dimensions**

## **Role of Peat Forest in the Banjarese Traditional Land Management (BTLM) System**

**Budi MULYANTO, Basuki SUMAWINATA, SUWARDI and  
Gunawan DJAJAKIRANA**

Department of Soil Sciences, Faculty of Agriculture, Bogor Agriculture University  
Jl Raya Pajajaran, Bogor-Indonesia, E-mail: soilpb@indo.net.id.

### **Abstract**

The role of peat forest on the paddy fields within the Banjarese Traditional Land Management system was studied in Karya Tani Village, Pulau Petak, South Kalimantan. Field observation and some laboratory analyses were done in order to understand the soil, including peat layers and water characteristics.

In the Banjarese Traditional Land Management system peat swamp forests in the upstream were conserved while paddy fields were established in the downstream. Converting the area with potential acid sulphate soils, such as peat swamp forests, into agriculture land by development of canal system would induced pyrite oxidation and cause the soils into extremely acid condition.

Soils of peat swamp forest are porous and retain water in very high amount; hence the peat swamp forests may act as water reservoir. The water from the peat swamp forest in the upstream may flush out the hazardous substances (produced by pyrite oxidation) in the paddy fields established at the down stream.

### **Introduction**

Indonesia has about 20 million ha of peat land spread over Sumatra (41.1%), Kalimantan (22.8%), Irian Jaya (23.8%), Sulawesi (1.6%), Halmahera and Ceram (0.5%). During the last 25 years, Indonesia has converted the peat lands in relatively very large area for some purposes (for agriculture land, energy, etc.), especially in Sumatra and Kalimantan. However all these efforts have less success due to lack or ignoring the knowledge of the characteristics of peat swamp forest of the tropical region and its eco-relationship with surrounding ecosystem.

Long time before the Indonesian government open the peat land in a very large scale, the Banjarese people of South Kalimantan have converted the wetland area, including peat land area into agricultural land in traditional manner. In land management system, they always consider the peat forest upstream as source of relatively fresher water for their agriculture land established in downstream. This paper intend to study the role of peat swamp forest on the paddy fields within the BTLM system

### **Material and Methods**

The study was conducted in Karya Tani village, Barito Kuala district, South Kalimantan (Fig. 1). The land management system that related to the agriculture practices was described based on the field observation and the history of the area development was recuperated by discussion with H. Anang, known as Kepala Parit. He was the group leader of the village establishment pioneers. Based on the description of land management system, a land-use cycle was set up.

Soil observation was carried out by augering the soil using a peat auger made by Eijlkamp up to more than 2 m depth. If possible soil pits were made to observe the



morphology of soil and the morphological characteristics were described in the field. Some soil samples were taken and packed with half PVC pipe and wrapped with plastic film. In addition the water samples were also taken for chemical analyses. Soil and water chemical analyses included pH, EC, K, Na, Ca, Mg, Fe and S.

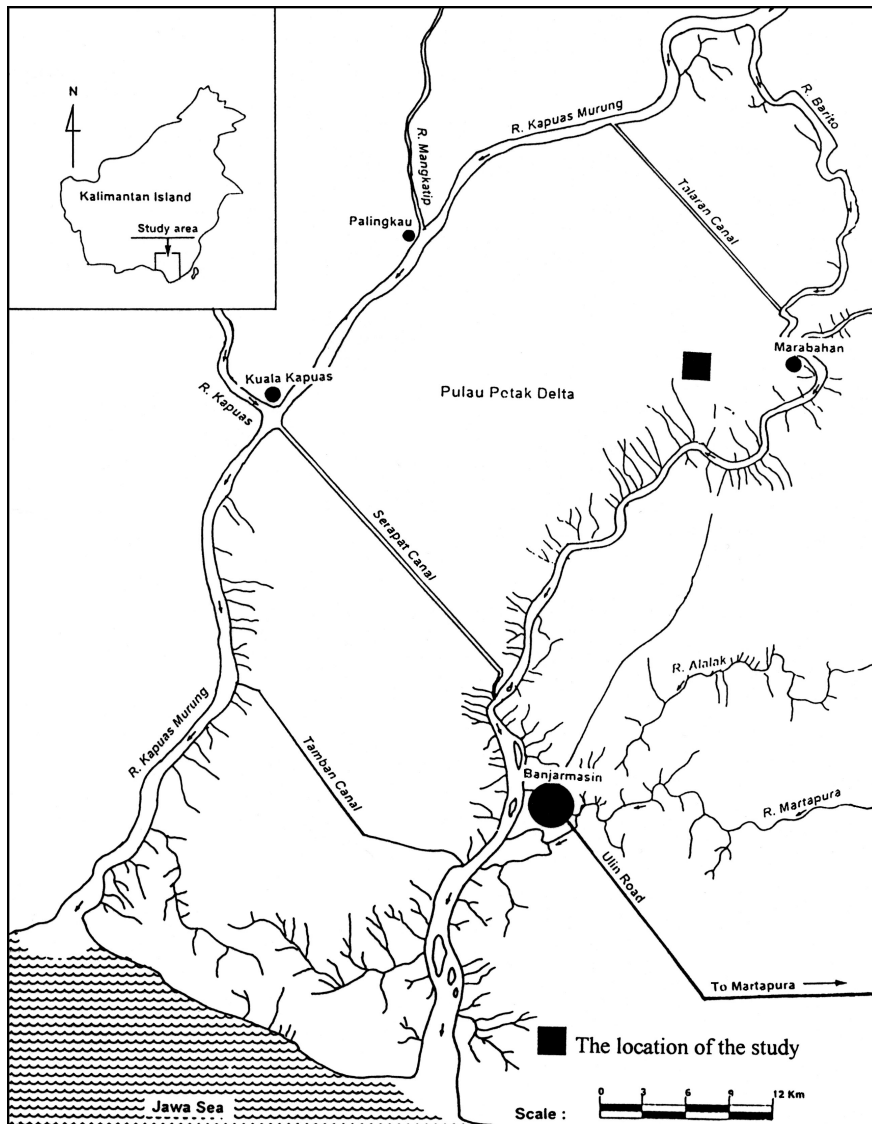

Fig. 1. The location of study area.

## Results and Discussion

### The Banjarese Traditional Land Management (BTLM)

Initially the Karya Tani area was covered by peat swamp forest as indicated by the pollen analyses of sediments taken from this area (Sumawinata, 1998). Due to shifting cultivation the primary swamp forests was gradually converted into secondary swamp forests dominated by *Gelam* (*Melaleuca* sp.).

The drainage system in this area includes narrow ditches (dug with hand called *handils*) as secondary canals set perpendicular to, and in the left and right directions of the primary canal (Fig 2). The distances between secondary canals are 27 depa (1 depa = 1.70 m). The lands between the secondary canals are divided into *kavelings*, called *keping*. Dimensions of *keping*s are  $33 \times 150 \text{ depa}^2$  and  $33 \times 135 \text{ depa}^2$  for the *keping*s facing to the primary and secondary canals respectively. In about 1985 the secondary canals were 8 rows, while at present have increased into 14 rows, means the expansion of the agriculture land is naturally in progress in expense of the *Gelam* forests (Mulyanto *et al.*, 1998).

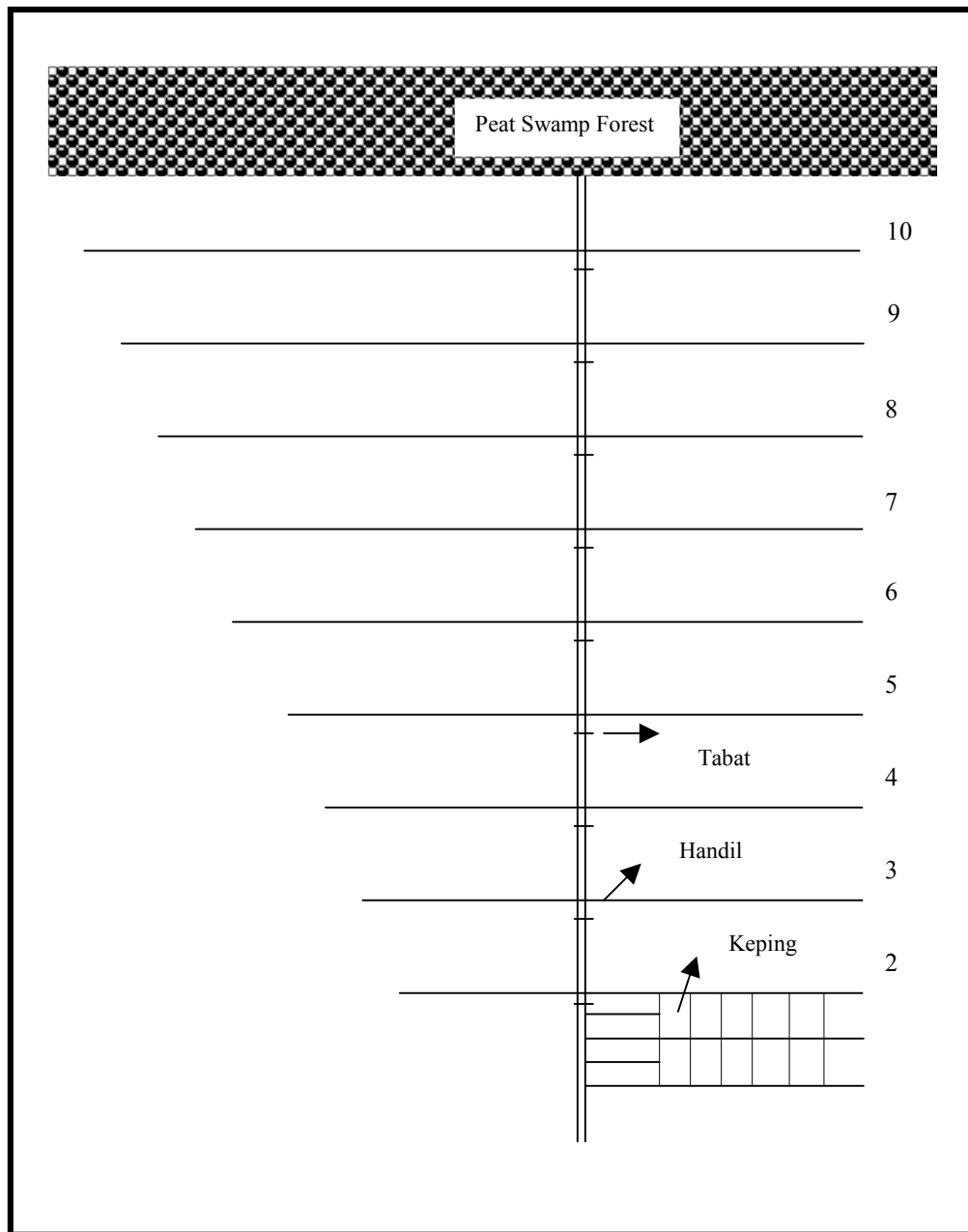

Fig. 2. The drainage system of the BTLM in the study area.

Canals drained out and control the water level for rice planting. The water level in the kavelings is controlled by *tabats* (simple water gates) either in the primary canal or in the secondary canals. In early November, when the rainy season starts, the water gates are kept open to leach out the acid substances produced in the rice fields during the dry period from the kavelings, and drained off through the primary canal. In the late of December the simple water gates are closed, the black water draining from the *Gelam* forest as well as the rainwater filled up the rice fields; further transplanting of the plant is started.

Land preparation of rice field in the peat land of BTLM is significantly different with the land preparation of the rice field in mineral soils. BTLM systems do not plow the soil but the Banjarese people prepared the land with very limited disturbance to the soil. The land preparation for the second seedbeds (*ampakan*) is carried out by cutting the grasses with *tajak* or *parang*, and allows grass litters to decompose. In that way, the soil is not disturbed because either *tajak* or *parang* cut the grasses about 1-2 cm above the soil surface. Further the land preparation is done step-by-step, and only as needed related to transplanting *ampakan* seedlings to the *lacakan*.

About 25 years after the Karya Tani Village establishment, the surrounding village has extended into a mosaic of several land covers. Present land covers of the areas were included: *Gelam* forest, a mixture of rice field and *Gelam* forest in the forest margin (row number 11 and 12), pure rice field (row number 8, 9, 10), a mixture of rice field and abandoned lands (row number 5, 6, 7) and abandoned lands (1, 2, 3, 4). This mosaic is an expression the sequences of land use cycle in a swampy area. The sequences of the land use cycle include a) forest and paddy field stage, b) climax paddy field stage, c) transition land use stage, d) abandoned stage. After the area is abandoned, the area will become secondary forest, mostly *Gelam* forest through natural succession. The stages of the land use cycle seem related to the change of soil characteristics as indicated by the difference of the vegetation composition. The abandoned area is mostly occupied by *Porum kudung* (*Eleocharis* sp.) grass. The change of soil characteristics is probably caused by the change of water table fluctuation in the soil, due to establishment of drainage system.

## **Characteristics of Peat Swamp Forests**

### ***Forest***

According to Van Wijk (1951) the studied area was covered by peat swamp forest. At present, the peat swamp forest in the studied area was replaced by secondary forest, dominated by *gelam* (*Melaleuca cajuputi*). Sumawinata (1998) reported that the peat swamp forest shrinkage significantly after about 50 years. This is due to conversion of forest into agriculture land by shifting cultivation. Abandoned agricultural land was then successively replaced by grasses, shrubs and secondary forests dominated by *gelam*.

The nearest primary peat swamp forest was found in Saka Lagun areas. According to Klepper *et al.* (1992) the peat swamp forests in Saka Lagun were consisted of 20 tree species, without any *gelam* (Table 1), completely difference with the secondary forest around Karya Tani Village. The peat layer in Saka Lagun (1.5-2 m) is deeper than of in Karya Tani (0.5-0.75 m). The existing of the peat forest is very significantly important for the agriculture system in surrounding such as the BTLM.

Table 1. Vegetation composition in the Saka Lagun areas (after Klepper *et al.*, 1992).

| No | Local name                      | Latin name                     |
|----|---------------------------------|--------------------------------|
| 1  | Mangkurangan (dominant species) | -                              |
| 2  | Basan                           | <i>Pandanus heliocopus</i>     |
| 3  | Tampuluh tuku                   | -                              |
| 4  | Papung                          | <i>Sandoricum</i>              |
| 5  | Kacapuri                        | <i>Diospyros korsthalsiana</i> |
| 6  | Banitan                         | <i>Polyalthia sp</i>           |
| 7  | Salumar                         | <i>Jackia ornata</i>           |
| 8  | Lampatatung                     | -                              |
| 9  | Tumulinah                       | -                              |
| 10 | Pak borong                      | -                              |
| 11 | Tangkolopo                      | <i>Eugenia spec.</i>           |
| 12 | Walak                           | -                              |
| 13 | Ayau                            | <i>Cryptocarya ferrea</i>      |
| 14 | Kalumpang                       | <i>Artocarpus sp.</i>          |
| 15 | Kandrih                         | <i>Semecarpus spec.</i>        |
| 16 | Ompah                           | <i>Semecarpus sp.</i>          |
| 17 | Kamurah                         | <i>Mastixia sp.</i>            |
| 18 | Kulur hutan                     | -                              |
| 19 | Unsit                           | -                              |
| 20 | Otak Udang                      | -                              |

### Soil

The thickness of peat layer in pulau Petak was about 1-2 m in the year 1930, and the age of the peat is about 1420-2000 years (Furukawa, 1994). The thickness of peat layer in Karya Tani varies in between 0-75 cm. In the area of paddy field the peat layer is 0-20 cm, while the peat in gelam forest is about (0.5-0.75 cm) (Fig 3).

Peat under gelam forest in the study area is black and at fibric-hemic ripening level. The peat contain organic fragment of various sizes. In several centimeter upper peat layers, the peat is hemic without wood fragments. The coarse fragments are mostly live roots of gelam tree. At layer below 20-cm depth the peat is fibric, contains some coarse wood and root fragments. Morphologically, peat is porous; consequently peat layer could retain water at enormous amount (200-500 %). Based on this condition, the peat forest in the upstream may act as water reservoir for the agriculture lands at the downstream.

Underlying peat layer is soil developed from mangrove swamp sediment, and contains pyrites ( $\text{FeS}_2$ ) in significant amount. The present of pyrite in the underlying peat layer has to be considered in the conversion of land use, because oxidation of pyrite can produce acid that causes deterioration of the soil environment.

Chemical characteristics of gelam forest and paddy field (Table 2) indicate that the c-organic content of the upper layer is higher than that of the paddy field due to decomposition of peat when the land use was changed from forest to rice field about ten years ago. This fact is parallel with the data of soil morphology. The iron content of the paddy field soil is relatively higher than that of peat forest. It caused by pyrite oxidation when the land was drained (Mulyanto *et al.*, 1999).

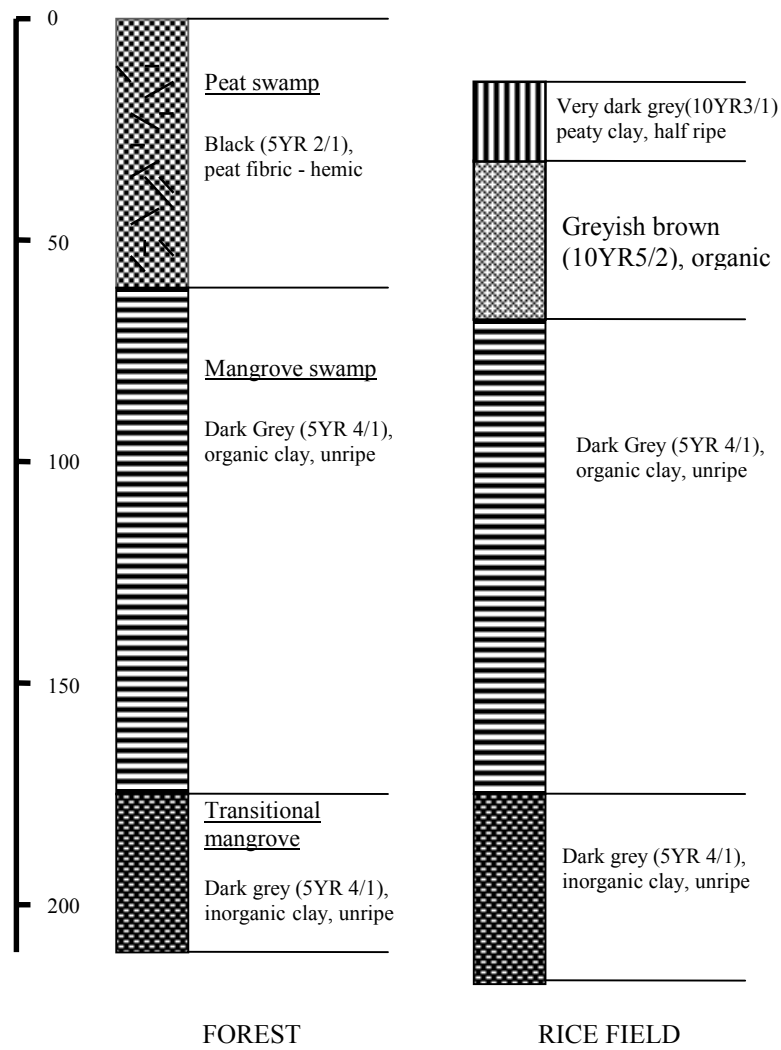

Fig. 3. Soil profiles of forest and rice field in the study area.

Table 2. Chemical data of soil in the study area.

| Depth<br>cm | pH<br>H <sub>2</sub> O | EC<br>μS/cm | C-org<br>% | Ca      | Mg    | Na   | K    | Total | CEC   | Fe<br>ppm |
|-------------|------------------------|-------------|------------|---------|-------|------|------|-------|-------|-----------|
|             |                        |             |            | me/100g |       |      |      |       |       |           |
| Forest      |                        |             |            |         |       |      |      |       |       |           |
| 0-25        | 4.64                   | 32.6        | 42.27      | 9.17    | 15.21 | 0.52 | 0.41 | 25.31 | 32.5  | 166.16    |
| 25-50       | 4.95                   | 42.1        | -          | -       | -     | -    | -    | -     | -     | -         |
| 50-75       | 5.65                   | 121.1       | 10.42      | 8.20    | 15.50 | 0.43 | 0.21 | 24.43 | 18.8  | 178.17    |
| 75-100      | 5.95                   | 194.5       | -          | -       | -     | -    | -    | -     | -     | -         |
| Rice Field  |                        |             |            |         |       |      |      |       |       |           |
| 0-25        | 4.43                   | 104.8       | 13.30      | 9.41    | 29.22 | 0.49 | 1.39 | 40.51 | 23.36 | 341.36    |
| 25-50       | 4.56                   | 124.2       | -          | -       | -     | -    | -    | -     | -     | -         |
| 50-75       | 5.34                   | 143.6       | 4.92       | 8.82    | 19.42 | 0.43 | 1.48 | 30.16 | 25.35 | 350.20    |
| 75-100      | 5.16                   | 115.0       | -          | -       | -     | -    | -    | -     | -     | -         |

**Water**

Characteristics of water of the peat forest and the paddy field are strongly different due to development of canal system in the BTLM (Table 3). The pH of water of the paddy field is much lower than that of peat forest. The low pH of the paddy field is related to the pyrite oxidation during water table at the lower level in the dry season. The pyrite oxidation causes the amount of Fe and S increase significantly leading to the formation of iron oxides and other minerals as expressed by red color of the canal wall. Besides low pH, the content of Mg and Na of the paddy field water is relatively higher than that of peat forest. It is probably related to the influence of the tidal activity, especially in dry season when the tidal water strongly influences the paddy field area.

Table 3. Chemical data of water in the study area

| Parameter | Rainy season |            | Dry season |            |
|-----------|--------------|------------|------------|------------|
|           | Forest       | Rice field | Forest     | Rice field |
| pH        | 5.4          | 2.9        | -          | -          |
| Mg (mg/l) | 0.96         | 2.28       | 4.35       | 14.50      |
| Ca (mg/l) | 0.20         | 0.20       | 0.18       | 1.18       |
| Na (mg/l) | 5.06         | 18.90      | 12.00      | 30.00      |
| K (mg/l)  | 1.56         | 4.29       | 4.50       | 4.50       |
| Fe (mg/l) | 0.56         | 2.80       | 3.25       | 5.29       |
| S (mg/l)  | 1.92         | 14.70      | -          | -          |

**Impact of Peat Forest to Paddy Fields**

Converting gelam forest into paddy field by opening up drainage system causes decomposition of peat as indicated by the lost of peat layer and formation of dark peaty clay /organic clay in the rice field. In addition, draining the fields would decrease ground water table and in turn induced oxidation of pyrites in mangrove swamp sediment. Pyrite oxidation produces acid as indicated by low pH and high EC both of soil and water and may decrease the productivity of paddy field.

In the BTLM system, the peat forest in the upstream may supply relatively fresher water (with higher pH and lower EC) into paddy fields. Since the peat forest in the upstream is still remain in sufficient wide, supply of fresher water for washing out the hazardous substances in water and soil the of rice fields at the downstream can be managed. According to the Kepala Parit (H. Anang), in the end of 1970, number of handils is only 8, and the rice production was about 2 tons per ha without fertilizer input. However, since the main canal has extended and the number of canals have increased up to 14 in the expense of peat forest, the production of paddy fields in handils no 1 - 4 were decreased and ultimately abandoned. This fact indicates that expanding the agriculture area in the expense of the peat forest will decrease the fresh water supply, and in turn decreased the rice field productivity. In that sense, the productivity of paddy field can only be maintained in the areas closer to the peat forest.

**Conclusions**

In the Banjarese Traditional Land Management system, the peat forest is always conserved in the upstream area, whereas the paddy fields are established in the downstream. Converting the area with potential acid sulphate soils into an agriculture

land by canal system development will induced pyrite oxidation, causes the agriculture land became extremely acid condition and dangerous to the crops, including rice.

Peat under forest such as gelam forest, with porous structure can retain water in very high amount; therefore the peat under the forests can act as water reservoir. The water from the peat swamp forest is essential to flush out the hazardous substances produced by pyrite oxidation. When the peat swamp forest in the upstream was conserved such as in the BTLM system, the rice productivity of peat soil fields established in the downstream may sustained relatively high even with only minimum fertilizer input.

### **Acknowledgement**

This research project was funded by the Ministry of Research and Technology and the National Research Council (No. 002/As.IV/RUT/1998) trough the RUT project.

### **References**

- Furukawa, H. 1994. *Coastal Wetlands of Indonesia: Environment, Subsistence and Exploitation*. Kyoto University Press. Japan. 219 pp.
- Klepper, O., Chairuddin, G., and Hatta, G. H. 1992. *Ecological Aspect of the Development of Acid sulphate Soils in the Humid Tropic*. AARD & LAWOO. 100 pp.
- Mulyanto, B., Sumawinata, B., Djajakirana, G. and Suwardi. 1999. Micromorphological characteristics of (potential) acid sulphate soils under Banjarese Traditional Land Management System. International Seminar on Toward Sustainable Agriculture Facing the 21 Century, 26-28 September, Lampung Indonesia.
- Sumawinata, B. 1998. Sediment of lower Barito basin in South Kalimantan: Fossil pollen composition. *Tonan Ajia Kenkyu*, 36(3): 1-24.
- Van Wijk, C. L. 1951. Soil survey of tidal swamp of South Borneo in connection with the agriculture possibilities. *Contr. Gen. Res. Sta.* No 123.

## **The Massive Exploitation of Peat Swamp Forest Potentiality has not Successfully Increased the Local People's Prosperity in Central Kalimantan**

**Suwido H. LIMIN and Patricia Erosa PUTIR**  
Faculty of Agriculture, University of Palangkaraya

### **Introduction**

The total area of forest in Central Kalimantan is approximately 15,356,400 ha (or 90% of the total area of Central Kalimantan). 2,651,724 ha, or 17,27% of the area above is still covered by peat soil, and also as the habitat of various forests which are having high economic values. Some of them are Ramin (*Gonystylus bancanus* Kurtz), Jelutung (*Dyera costulata*), Meranti Rawa (*Shorea* spp), and Gemor (*Alseodaphne* spp).

It is true that timber is the leading commodity of Central Kalimantan within the last three decades, as it has contributed the largest portion of Indonesian foreign exchange after oil and gas. The management of forest potentiality has been carried out by the owners of forest concession, which is legally arranged under the law of forestry along with its implementation guidelines. The decree of minister of Forestry number 485 /KPTS – II/ 1989, stated that the management of productive forest can be worked out by silviculture system, as known by “Tebang Pilih Tanam Indonesia (TPTI), selective cutting system. This method must be executed by every forest concession owner, which is clearly stated in the “**Rencana Karya Lima Tahun**” (RKLT) the five years work planning as well as in the “**Rencana Karya Tahunan (RKT)**, the annual work planning. The formulation of RKLT and the RKT is based on the survey finding in the field is aimed at regulating the cutting cycle within every forest concession. In this way, it is hoped that within a certain period of time (cutting cycle 35 years), the tree will have reached cutting criteria and could be exploited.

The establishment of various acts as well as their guidelines is aimed at maintaining sustainable production of forest. However, the application of those acts in the field seems to be inconsistent. The inconsistency of the law mentioned above is clearly proven. In many cases, the forest concession owners have broken the law as they exceeded the cutting limit as stated in the effective forest acts.

The condition of forest management as mentioned above has been going on for a long time and it will be going on and on in the future. This is due to the vested interest of the decision-makers. Consequently, illegal logging has proliferated all over Indonesia. Although illegal logging activities have been tolerated as what is going on up to the present, it is proven that illegal logging activities have not been successfully increased the prosperity of the local people.

### **Peat Swamp Forest Potentiality**

To describe the potentiality of peat swamp forest in Central Kalimantan, in the following parts the inventory findings done by the forest concession of PT Inhutani III (Ex PT. Sumber Alam Ramin) within the area of 600 ha in Kapuas Regency of Central Kalimantan (Table 1).



Table 1. The total number of tree (N, stem) and volume (V, m<sup>3</sup>) of some types of wood within peat swamp forest area of 600 ha in Kapuas Regency, Central Kalimantan

| Type of wood                        | Diametre class (cm) |        |         |          |         |          |         |          |        |           |
|-------------------------------------|---------------------|--------|---------|----------|---------|----------|---------|----------|--------|-----------|
|                                     | 20 - 29             |        | 30 - 39 |          | 40 - 49 |          | 50 - up |          | Total  |           |
|                                     | N                   | V      | N       | V        | N       | V        | N       | V        | N      | V         |
| 2                                   | 3                   | 4      | 5       | 6        | 7       | 8        | 9       | 10       | 11     | 12        |
| A. Protected wood<br>1. Jelutung    |                     |        | 37      | 36.42    | 48      | 77.69    | 15      | 41.84    | 100    | 155.95    |
| Total A                             |                     |        | 37      | 36.42    | 48      | 77.69    | 15      | 41.84    | 100    | 155.95    |
| B. Wood type allowed<br>for cutting |                     |        |         |          |         |          |         |          |        |           |
| 1. Meranti types                    | 104                 | 40.26  | 185     | 133.64   | 310     | 521.11   | 99      | 280.60   | 698    | 975.61    |
| a. Meranti Rawa                     | 67                  | 24.45  | 170     | 123.23   | 281     | 451.19   | 89      | 242.95   | 607    | 841.82    |
| b. Gerunggang                       | 115                 | 6.50   | 22      | 22.53    | 59      | 94.37    | 19      | 50.82    | 115    | 174.22    |
| c. Alau                             |                     |        |         |          |         |          |         |          |        |           |
| Total B1                            | 186                 | 71.21  | 377     | 279.40   | 650     | 1,066.67 | 207     | 574.37   | 1,420  | 1,991.65  |
| 2. Miscellaneous                    |                     |        |         |          |         |          |         |          |        |           |
| a. Mentibu                          | 155                 | 58.14  | 281     | 215.20   | 619     | 836.07   | 200     | 450.19   | 1,255  | 1,559.60  |
| b. Terentang                        | 67                  | 24.97  | 163     | 121.75   | 270     | 433.84   | 86      | 233.60   | 586    | 814.116   |
| c. Kapur Naga                       | 37                  | 12.85  | 74      | 60.37    | 127     | 204.64   | 40      | 110.19   | 278    | 388.41    |
| d. Ketiau                           | 15                  | 6.50   | 37      | 30.51    | 87      | 139.78   | 28      | 75.27    | 167    | 252.06    |
| e. Tanah-tanah                      | 37                  | 13.30  | 81      | 66.71    | 117     | 187.92   | 37      | 101.19   | 272    | 369.12    |
| Jumlah B2                           | 311                 | 115.76 | 636     | 494.90   | 1,220   | 1,802.25 | 391     | 970.44   | 2,558  | 3,383.35  |
| 3. Exclusive type                   |                     |        |         |          |         |          |         |          |        |           |
| a. Ramin                            | 1,079               | 641.84 | 2,527   | 1,689.48 | 3,609   | 6,957.96 | 1,173   | 3,746.59 | 8,388  | 13,035.87 |
| Total B3                            | 1,079               | 641.84 | 2,527   | 1,689.48 | 3,609   | 6,957.96 | 1,173   | 3,746.59 | 8,388  | 13,035.87 |
| Total B1, B2, B3                    | 1,576               | 828.81 | 3,540   | 2,463.78 | 5,479   | 9,826.88 | 1,771   | 5,291.40 | 12,366 | 18,410.87 |
| Total (A + B)                       | 1,576               | 828.81 | 3,577   | 2,500.20 | 5,527   | 9,904.57 | 1,786   | 5,333.24 | 12,466 | 18,566.82 |
| Average/ha                          | 3                   | 1.38   | 6       | 4.17     | 9       | 16.51    | 3       | 8.89     | 21     | 30.94     |
| Ramin volume (%)                    |                     | 4.92   |         | 12.96    |         | 53.38    |         | 28.74    |        | 100       |
| Total Ramin stem (%)                | 12.86               |        | 30.13   |          | 43.03   |          | 13.98   |          | 100    |           |

Source: Data PT. Inhutani III (ex. HPH PT. Sumber Alam Ramin)

Based on the data in the above table, Ramin type was found out to be more dominant, i.e., 13,035.87 m<sup>3</sup> or 70.21% of the volume of all type of wood (total 18,566.82 m<sup>3</sup>). From the above volume, it was known that 4.92% of trees having 20-29 cm, 12.96% of trees having 30-39 cm diameter, 53.38% of trees having 40-49 cm diameter and 28.74% of trees having > 50 cm. If the harvesting of Ramin is limited to those of having ≥ 40 cm in diameter, log production from the area of about 600 ha is approximately 10,704.55 m<sup>3</sup> (82.12%) or 4782 trees (57.01%).

### Forest Exploitation

#### Historical background and forest concession programmes

The exploitation of natural forest for production is carried out by providing the legal forest concession, which has been clearly stated in the government regulation, no: 21/1970. Silvicultural system being used is TPTI. This system is developed from the TPI, the selective cutting system (the Decree of Directorate General of Forestry Exploitation, No: 35/KPTS/DD/I/1972), which has been revised in 1980, and then later revised and being changed to the TPTI (according to the Decree of Minister of Forestry, No: 485/KPTS-II/1989). This was again revised in 1993 (according to the Decree of the Directorate General of Forest Exploitation, No: 151/KPTS/IV-BPHH/1993) about the guidelines for TPTI.

The system of TPTI is effectively used up to present. Every forest concession which has been provided operational right are designated to manage their forest concession based on the “Rencana Karaya Pengusahaan Hutan” (RKPH). Moreover every forest concession should make five year planning as well as annual work planning as the guidelines in executing their activities in the field.

Forest right which has been provided to the forest concession owners is aimed at gaining the socio-economic of forest, covering: a) the development of forest productivity, processing and marketing of forest product (in the effort of developing the domestic income, state foreign exchange, as well as meeting the need of the society: sufficient, and reasonable price), b) job expansion, even distribution of job opportunity, as well as business opportunity, c) enhancement of the prosperity of the people both within and surround the forest, d) development of energy supply by developing bio-mass energy generated from forest product.

Addressing ourselves to forest degradation caused by the malfunction forest concession, so that Indonesian Government through the decree of Minister of Forestry, No: 523/KPTS-II/1997, designated every forest concession owners to be more concern in forest conservation by involving the local community to hand in hand in managing the forest and enhancing the prosperity of the local people. This policy is widely known as the development of rural society surrounding the forest (PMDH).

#### **Forest concession contribution for the local communities**

The presence of a forest concession, however, often brings about difficult problems to the local society. In many cases as reported that the forest concessions have carried out their obligations and task, through forest concession for villages development programmes, which was considered to be fruitful to the development of the local communities. In fact, the forest concession’s contribution up to the present to the development of the local communities is meaningless if it is compared to the profit gained by the forest concession owners from the forest exploitation from time to time. It is true that there is a forest concession contributed the development of villages, by for examples: providing educational facilities, such as school building, religious facilities such as mosque and church, establishing “Village Cooperation Unit” (KUD), as well as the provision of school teaching staff. But those programmes were not managed in a sustainable manner. Therefore, there have been many of those facilities are not effective.

The establishment of inland road, which was at first promoted to be useful for breaking the isolation of remote areas, however, now is not effective. This is due to the characteristics of the roads developed. Inland roads in many cases were developed for the need of the company only. The assumption that the opening of market center by the presence of the forest concessions has not come to reality, and even those markets which have been available long before the presence of forest concession, could not be developed. A clear fact on this case is that the “**City of Pulang Pisau**”. Pulang Pisau was a place where 75% of timber production of Central Kalimantan produced. Now, this city has been a dead city.

With regard to the manpower employment, most of the forest concession owners recruited employees from outside Central Kalimantan, or they were supplied from the area where the owners of forest concession come from. If there were employees from the local communities, they were not able to stay for a long time. This was due to the lower wages paid. Besides, the Dayak people are not used to work as labors. The

management structure and personnel of the companies are used to pre-established long before they are operational in Central Kalimantan.

The description of the forest product of Central Kalimantan done by one of the forest concessions can be presented in the following table:

Tabel 2. Forest production within three years RKT

| Activities                   | Five Years Work Plan (RKL II) |               |               | Total RKL II | Average (m <sup>3</sup> /ha) |
|------------------------------|-------------------------------|---------------|---------------|--------------|------------------------------|
|                              | RKT 1995/1996                 | RKT 1996/1997 | RKT 1997/1998 |              |                              |
| Width (ha)                   | 350                           | 350           | 500           | 1.200        |                              |
| Production in m <sup>3</sup> | 11.447,90                     | 13.145,01     | 17.897,00     | 42.489,91    | 35,41                        |
| Meranti rawa                 | 2.195,35                      | 1.102,97      | 3.520,21      | 6.818,53     | 5,682                        |
| Nyatoh                       | 196,80                        | 783,86        | 1.767,02      | 2.747,68     | 2,289                        |
| Geronggang                   | 272,96                        | 965,48        | 2.448,56      | 3.687,00     | 3,073                        |
| Kapur naga                   | 299,09                        | 447,47        | 2.185,04      | 2.904,60     | 2,421                        |
| Perupuk                      | 166,83                        | 1.421,63      | -             | 1.588,46     | 1,324                        |
| Jelutung                     | -                             | 111,06        | -             | 111,06       | 0,093                        |
| Terentang                    | -                             | 1.540,47      | -             | 1.540,47     | 1,284                        |
| Keruing                      | -                             | 1.704,39      | 2.263,66      | 3.968,05     | 3,307                        |
| Pulai                        | 124,97                        | -             | -             | 124,97       | 0,104                        |
| Mentibu                      | 274,76                        | 2.045,83      | 2.440,87      | 4.761,46     | 3,967                        |
| Ramin                        | 7.917,14                      | 3.021,85      | 3.298,64      | 14.237,63    | 11,86                        |

Source: Data HPH PT. Gajah Seno Sakti

From Table 2 above, it is clear that forest product is dominated by Ramin species. It is the leading forest product of peat swamp forest in Central Kalimantan. If peat swamp forest in Central Kalimantan with the total area of approximately 2.7 million ha (which is mostly exploited) has been managed professionally, the whole area of peat swamp forest of Central Kalimantan would produce million cubic of wood. For example, especially Ramin based on the price about US\$ 150.00/m<sup>3</sup>, we could easily predict how much profit can be gained. However, so far the profit has been dominated by the forest concession owners, "the cukong", financial backer, or the illegal logging guarantors as well as the governmental personnel who keep protecting the companies. Whereas, casual logging workers, and illegal loggers were usually underpaid, this condition was indicated when there was a transaction between them. It is proven in many cases, that the casual logging workers or the illegal loggers were trapped in debt to the financial backers.

With regard to the number of HPH BINA DESA, in their form as HTI TRANS or HTI MURNi in Central Kalimantan, i.e. around 15 unit altogether, and the number of saw mill or band saw is about 128 units with their felling capacity is about 892,290 m<sup>3</sup>/year, 6 units of plywood industries with felling capacity licenses about 477,680 m<sup>3</sup>/year, 9 units of moulding/dowel with their felling capacity licenses about 137,800 m<sup>3</sup>/year, 315 units of wood processing industries, and plus 46 units of other active HPH, so that the presence of those facilities and companies should be able to support the local community to live sufficiently as well as the successful development of the local government. In contrast, with regard to the target of wood production of Central Kalimantan, which is stated formally 4 million m<sup>3</sup> per year, excluding the illegal

logging which might be more than that, in fact this amount of production has not significantly contributed the development of local communities as well as the local provincial government.

To give a clear description of the injustice in terms of timber trading up to present, for example within Sabangau river, Central Kalimantan, the price of timber, especially of Ramin or meranti species, the casual logging workers were paid Rp. 270,000/m<sup>3</sup>. These types of wood then was sold to the middlemen on the price not less than Rp. 1 million/m<sup>3</sup>, and in Surabaya, the price would reach Rp. 2 million/m<sup>3</sup>. From those figures, it is clear that there is a significant difference in price. The casual loggers could only gain gross profit as much as 13.5-27 %. Whereas financial backers could gain 73-86.5%, without hard working. This practice of wood trading, even if there is an increase in the timber production, it will remain unable to enhance the prosperity of the casual loggers, except to a certain group of society, the government personnel who keep guard the forest concession owners or the HPH.

### **The reactions from the local communities surrounding the forest concession**

Any effort done by the HPH to enhance the condition of local communities has not satisfied the need of the local communities. With respect to the concept that should have been worked out by the HPH, there would not be any poor local communities around the forest every forest concession. Therefore, Indonesian government through the governmental act, No: 41/1999, chapter 10, section 68, article 1, on the forestry. It is stated that the local communities dwelling around the HPH, have the right to live in safely within the well-preserved environment. In fact, this was not paid to the local communities. In practice, the right was not gained by the local communities because forest is remain belongs to the central authority (the authorized government personnel as well businessmen).

To this condition, there have been disappointments within the local communities. These disappointments among others have been firmly expressed in the National workshop on 12th April 1999 in Palangka Raya, which produced **Tambun Bungai and Sabangau Declaration**. This national workshop provided good opportunity for the local communities to express their ideas and opinions about the HPH where they lived. Through this workshop the local communities stated that those who lived around the HPH did not gain any meaningful advantages from the HPH (forest concessions). In contrast, if the local communities were caught cutting the forest around their villages, they were charged of illegal logging or at least threatened to be charged of legal action. This situation, as well the behavior of some authorities as mention above has made the local communities feel that they do not own the surrounding environment any more, although in fact they have for generation keep guarding the forest as their main livelihood.

The establishment of inland roads by the HPH, as one of the effort to break the remote areas isolation was only useful for the activities of the HPH. After all of the HPH have finished their project, there were many inland roads were made disfunctional, so that the local communities could not use them for any purposes. This condition is very ironic because the government has formally established policies on development of local communities. However, what had happened was something very contradicted.

Since the implementation of government act in the field did not satisfied the condition needed, peat swamp forest will become a very promising business for the

illegal loggers as well as for the businessmen. For this reason, peat swamp forest could not provide fresh air but as the best area for competition for forest felling by using various tools, such as axe, chainsaw, and even the best gambling area. This condition was not taken into account by the local communities because in fact the life of illegal loggers was not developed but gradually went down to the deep poverty.

For example, there were immigrants in Kalamangan, Bereng Bengkel told that they have been involved in illegal logging. Having involved in the illegal logging activities for about five months, however, they could not support their family needs. But even, in many cases, the financial backers did not pay their wages. Furthermore, they were trapped in debt. The local communities also stated that if they work as casual logging workers in the HPH, there is not any clear guarantee to support their family life. This is due to the low wages gained compared to the risk resulted from the work. Therefore, in enhancing the economic status of marginal communities, local price of any commodity including timber should be managed and increased, as well as wages. Some facts showed that local communities who have ever been involved and successfully as casual logging workers in 1975–1980, now realize that casual logging activities would not be dependable activities if they did and said in every thing honestly.

The presence of HPH has about negative impact more than positive impact. In this case Directorate General of Productive Forest, (Waskito Suryodibroto) stated that forest degradation within the HPH areas has reached 16.57 million ha out of 52 million productive forest. Thirty-two percent of this figure has been deforested during this last decade. This means that 3.24% or 4.5 million ha of forest destroyed every year. (Realitas, 1999). Other negative impact of deforestation on the socio-cultural aspect of the local communities, Alqadrie in Hasanuddin, 1996), stated that there have been much more negative impact of exploitation. In terms of negative impact with regard to socio-cultural life, it was begun by the recruitment of casual workers of the HPH from various areas. In this context, there have been much fighting, gambling, prostitution both openly and disguised practiced, the oppression of traditional law, and making the local communities as the main cause of deforestation.

Hasanuddin reported research finding by Wahana Lingkungan Hidup Indonesia (WALHI), that one of the main causes of the productive forest destruction was the low price of wood in the level of casual loggers. The low price of wood did not reflect the presence of opportunity costs and scarcity values of logs. The low price of wood in this case, has hampered the efficiency both in the logging areas (only 60%) and in the logging industries (only 50%). This also encouraged over investment in logging industries, and increased effective demand on natural wood. Consequently, there has been a wide gap with regard to the log supply. Based on the data from the Secretariat of Forest conservation collaboration (SKEPHI), it is known that fixed capacity of wood industry in Indonesia up to present has reached 40,000 million m<sup>3</sup>/year, where as log production has only reached 33 million m<sup>3</sup>/year, generated from the HPH (forest concession), IPK, (Wood utilization Licenses) HTI, (Industrial Forest Plantation) and “Hutan Rakyat” (Forest for people). Therefore, there has been a deficit of wood supply as much as 7 million m<sup>3</sup>/year. This gap has occurred due to the mismanagement of principle licenses for wood industries (Pulp paper and plywood), and wood processing industries (saw mill), carried out by the Department of Forestry and Plantation. In this case, there has not any certain regulation on the fixed capacity of wood industries. Consequently, if HPH is dominated by a certain department and particular companies,

those companies will have a wide freedom in forest felling, especially within the areas which are functionally changed for non-forestry. (Realitas, 1999).

### Conclusion

1. Peat Swamp Forest is an important habitat for various type of forest having high economic values. Some of them Ramin (*Gonystylus bancanus*), Jelutung (*Dyera costulata*), Meranti Rawa (*Shorea* spp), and Gemor (*Alseodaphne* spp). Ramin species are dominant, i.e. 70.21% of the total volume of all type of wood, or with average production as much as 30.94 m<sup>3</sup>/ha.
2. The proliferation of illegal logging from year to year, both those are organized by the HPH or individually practiced, peat swamp forest sustainability has been seriously threatened. As the logical consequence of mismanagement of forest in Indonesia up to present, the need for wood in the future could not be met by domestic supply, but imported from overseas countries.
3. Illegal logging which has been long practiced by the local communities is proven to be not promising income generation. In fact, within those community involving in both legal and illegal logging, there was much development.
4. Legal logging practiced by the HPH even if it has been regulated by various acts and practical guidelines, the implementation of those acts in the field has been very much contradicted to the local communities needs. Therefore, the presence of the HPH in Central Kalimantan has not brought about much contribution to the local communities surrounding the HPH, as well as to the acceleration of the development of Central Kalimantan.
5. The pattern of forest management which was practiced since 30 years ago is actually the main cause of deforestation and environmental degradation.
6. With regard to the useless of the HPH to the local communities or the unbalance contribution resulted from the forest exploitation returned back to the local government, it is worth considering the concept of selling the wood with out cutting the tree and the same time to implement credit carbon programmes.

### References

- Departement Kehutanan dan Perkebunan Kantor Wilayah Propinsi Kalimantan Tengah Palangka Raya. 1999. Laporan Tahunan Tahun 1998–1999 (Annual report of Forestry and Plantation Department of Central Kalimantan)
- Departemen Kehutanan dan Perkebunan Kantor wilayah Propinsi Kalimantan Tengah. Target dan Realisasi Rencana Karya Tahunan Pengusahaan Hutan Tahun 1999/2000 Propinsi Kalimantan Tengah sampai bulan September. 1999. (Target and the achievement of annual work plan of forest concessions in Central Kalimantan)
- Gajah Seno Sakti. 1999. Rencana Karya Lima Tahun Pengusahaan Hutan III (Tahun 2000–2005). PT. Gajah Seno Sakti Propinsi Kalimantan Tengah. (Five years work plan of Pengusahaan Hutan III, Central Kalimantan)
- Hasanuddin. 1996. Sistem Pengelolaan Hutan Produksi Lestari dalam Pengelolaan Hutan Lestari di Indonesia. Konsep Permasalahan dan Strategi menuju era ekolabel di hutan produksi, Jakarta.
- Realitas Media Indonesia (Daily Newspaper). 1999.

## **Rehabilitation of Devastated Peat Lands and Establishment of Sustainable Agro-systems through Buffer Zone Planning in Central Kalimantan**

**Mitsuru OSAKI<sup>1</sup>, Hanny WIJAYA<sup>2</sup>, Suwido Hester LIMIN<sup>3</sup>  
and Herwint SIMBOLON<sup>4</sup>**

<sup>1</sup> Faculty of Agriculture, Hokkaido University, Sapporo, Japan  
E-mail: mosaki@chem.agr.hokudai.ac.jp

<sup>2</sup> Faculty of Agricultural Technology, Bogor Agricultural University,  
Jalan Raya Pajajaran, Bogor, Indonesia E-mail: hazemi@indo.net.id

<sup>3</sup> Faculty of Agriculture, The University of Palangka Raya, Palangka Raya, Indonesia  
E-mail: suwido@palangkaraya.wasantara.net.id

<sup>4</sup> Research and Development Center for Biology, The Indonesian Institute of Sciences LIPI,  
Jalan Juanda 18, Bogor, Indonesia E-mail: herbogor@indo.net.id.

### **Abstract**

Tropical peat swamp areas have been considering as the key ecosystem for not only reserving bioresources and biodiversity, but also reducing carbon efflux owing to degradation of peat, stocking of carbon in forests, or controlling water balance. However, now, the peat swamp and wetland in tropical area face to the crisis of disappearance due to human impact, which is accelerated by recent abnormal and unusual global climate changes.

In Central Kalimantan (surrounding Palangka Raya), the native peat swamp forest locate between Sebangau River and Katingan River (Sebangau-Katingan Watershed), the abandoned, destroyed, and fire-damaged area locate between Sebangau River and Kahayan River (Sebangau-Kahayan Watershed), and intensive agriculture area locate between Kahayan River and Barito River (Kahayan-Barito Watershed). Recently we started the project on rehabilitation of devastated peat lands and establishment of sustainable agro-systems through buffer zone planning in Sebangau-Katingan Watershed. The following area are proposed as research belt zones:

1. Belt Zone Kalamangan (Inland peat area with sandy material sublayer) lies between both rivers of 10 km long, 10 km wide.
2. Belt Zone Pangkoh (Transitional peat with clay material sublayer) lies between both rivers of 30 km long, 10 km wide.

Instead of sustainable development of peat swamp, it is proposed that principal concept of this project are 1) to conserve the native peat swamp forests, 2) to rehabilitate and protect the destroyed, abandoned, and fire-damaged area in surrounding area of native forest, and 3) to reduce the human impact to surrounding area, to minimize the introduction of civil engineering works, and to establish the sustainable production system. Idea and strategy on this project will be presented in this symposium.

### **Introduction**

The lowland wetland area of Central Kalimantan shows extremely complicated and diversified ecological system. But with careful observation, it can be pointed out that the area seems to have gradient in many criteria such as soil type and distribution, vegetation, hydrological condition, and the land use that is the reflection of history of human activity in this area. Obviously, this tropical wetland area is the one and the only

of such an ecological system that can be found in the world. Such gradient is most apparent to be observed along a transect passing through an area from the large river stream to the interior part of peat swamp forest. For instance, the lower reach of the main river stream is highly effected by seawater, but the salinity declines with distance from the main stream. Soil distribution along the riverbank is mainly covered by alluvial soil forming a levee through deposition of silt contained in the river water. But, apart from the riverbank, the formation of peat soil is established where the thickness of peat increases toward the boundary of watershed. Prior to the development of the peat, however, the weathering, formation, and development processes of the underlying soil has long been occurring resulted in a sandy sublayer of the inland peatsoils and marine clay sediment sublayer of the coastal peatsoils. In some places, a pyretic sublayer in which an acid sulfate soil can be formed if the layer is oxidized accompanies the latter. As a resultant of all of these processes, the coastal and near river stream area is occupied by nutrient rich topogenous peatsoils and the inland area, which is dominant in Central Kalimantan, occupied by relatively poorer nutrient containing ombrogenous peatsoils.

In most tropical woody deep peat soils, it is well-known that micronutrient deficiencies are one of the major growth-limiting factors for crop cultivation (Tadano, 1985). Among the micronutrients, Cu, B and Zn appear to be the most deficient elements for crop growth in some tropical peat soils (Joseph *et al.*, 1970; Ng and Tan, 1974; Chew *et al.*, 1979; Nilnond *et al.*, 1987). Frequently, sterility becomes a serious problem in rice grown in deep peat soils and it was suggested that sterility was due to the lack of Cu or toxicity of phenolic compounds or the combined effect of both factors (Driessen, 1978). In peat soils, the growth of maize and tomato is extremely retarded and the yield is very low, and the sterility of barley and rice occurs in the no Cu application or B application (in only barley) (Ambak *et al.*, 1991).

In acid sulfate soil, nutritional factors limiting crop growth are considered to be as follows; (a) the extremely low pH condition of the soil, such as pH3.2, associated with a high Al concentration in the soil solution, is an important factor limiting crop growth before liming. Iron toxicity may be another important factor for low land rice under flooding, and (b) after liming, a low K level in the soil may be the primary limiting factor followed by low P and low N (van Breemen and Pons, 1978; Takai and Vijarnsorn, 1987).

#### **Outline of JSPS Core University Program in Agronomy Group**

The latitude of human activity also shows a gradient along the transect from the river bank to the interior peat swamp forest. People first inhabited the bank of large river because of its accessibility and soil fertility reasons. They gradually moved toward inland through and by making anjirs and handils for logging and starting permanently agricultural activities. Since then, population is growing and some more areas are needed as well. Nowadays, the frontier seems to move toward west direction, over-going into the watershed of Sungai Kahayan and Sungai Sebangau that are still relatively covered with forest.

In the JSPS Core University Program entitled "Environmental Management of Wetlands Ecosystems in Southeast Asia", the agricultural sciences group declared its research concept as follows:

- (1) to conserve the native peat swamp forests (subject I, conservation area),



- (2) to rehabilitate and protect the destroyed, abandoned, and fire-damaged area in surrounding area of native forest (subject II, protection area), and
- (3) to reduce the human impact to surrounding area, to minimize the introduction of civil engineering works, and to establish the sustainable production (subject III, sustainable production area). And from these points of view, it is requested to choose appropriate study area for this study.

It would be the best if the study area can cover the whole one watershed of relatively large river system and designate it as the research area, because such watershed seems to contain both extremely diversified ecosystem and agrosystem. However, to be realistic, it is quite difficult to set such large area as a research object because of implicated human activities that already established in the area, and also of difficulty in conserving the appropriate condition of research environments necessitated for the research study project.

By establishing the research area as belt zones connecting two large rivers, the Sungai Kahayan and the Sungai Sebangau, the above requirement of the research concept can be easily satisfied. And, it is scientifically justified that these belt zones should cover both the coastal and the inland peatland area. Since some places of these areas have long been established and cultivated for various agricultural commodities and other activities with various degree of success, the belt zones should cover those inhabited areas.

Based on the above-mentioned justifications, the following areas are proposed as research belt zones:

#### **Belt Zone A**

Covering an area lies between Sungai Kahayan and Sungai Sebangau of 10 km wide that passes through the formerly transmigration area Pangkoh, this belt zone is to represent the coastal peatland area with clay material sublayer.

#### **Belt Zone B**

Covering an area lies between Sungai Kahayan and Sungai Sebangau of 10 km wide that passes through the formerly transmigration area Kalampangan, this belt zone is to represent the inland peat area with sandy material sublayer.

Once these zones are established, meaning that the area is preserved and protected as a tropical peatland conservation area, the following phases of the research programs are proposed:

1. Phase I – the Baseline Study

Year 1 to 2

The results of this study will be used as a basic consideration in establishing the detail research programs and activities and their required experimental plots.

2. Phase II – the Implementation of the Detail Research Programs and Activities

Year 3 to 7

During this phase, the detail research programs integrating all related aspects are implemented. The goal of this phase is to establish a management practice that results in a better land functions and productivity as a sustainable ecological system of bio-production in Central Kalimantan's Peatlands. As a basic criterion, the management practice that will be chosen and established should results in a better

prosperity of the people with a minimum environment disturbances or even without any of them as far as possible. This will be achieved through a series of research activities that will be implemented based on a yearly basis of evaluation.

3. Phase III – the Implementation of the Action Research Programs  
Year 8 to 10

In this phase, the land management and practices established in the Phase II will be applied and improved accordingly to the research program area in a kind of participatory programs involving all the stakeholders, including farmers, extension workers, government officers, experts, etc. Based on the results of this phase, the establishment of a regional, national, and international networking on Sustainability of Ecological System of Bio-production in Tropical Wetlands will be proposed.

### References

- Ambak, K., Abu Bakar, Z. and Tadano, T. 1991. Effect of limiting and micronutrient application on the growth and occurrence of sterility in maize and tomato plants in Malaysian deep peat soil. *Soil Sci. Plant Nutr.*, 37: 689-698.
- van Breemen, N. and Pons, L. J. 1978. Acid sulfate soils and rice, In: *Soils and Rice*, IRRI Publication, IRRI, Los Banos, pp. 739-761.
- Chew, W.Y., Joseph, K.T. and Ramli, K. 1979. Influence of applied copper and other micronutrients on groundnuts (*Arachis hypogaea*) and sorghum (*Sorghum bicolor*) on Malaysian oligotrophic peat. *Trop. Agric.*, 56: 25-32.
- Driessen, P. M. 1978 : Peat soils. In: *Soils and Rice*, IRRI, Manila, pp. 763-779.
- Joseph, K.T., Hussein, S. and Williams, C.N. 1970. Assessing the nutrient status of a peat soil from the Klang area. *Malays. Agric. J.*, 47: 338-345.
- Ng, S.K. and Tan, Y.P. 1974. Nutritional complexes of oil palms planted on peat in Malaysia. I. Foliar symptoms, nutrient composition and yield. *Oleagineaux*, 29: 1-14.
- Nilnond, C., Pantanahiran, W. and Tadano, T. 1987. Evaluation of copper deficiency among micronutrients as a nutritional factor limiting crop growth in peat soil. In: Takai, Y. *et al.* (eds.), *Coastal and Inland Salt-Affected Soils in Thailand-Their Characteristics and Improvement*, Nodai Research Institute, Tokyo University of Agriculture, Tokyo.
- Tadano, T. 1985. Nutritional factors limiting crop growth in problem soils and crop tolerance to them. In: *Proceedings of International Seminar on Environmental Factors in Agricultural Production*, Thailand, pp. 329-345
- Takai, Y. and Vijarnsorn, P. 1987. In: Takai, Y. *et al.* (eds.), *Coastal and Salt-Affected Soils in Thailand. - Their Characteristics and Improvement*, Nodai Research Institute, Tokyo University of Agriculture, Tokyo, pp. 258-267.

## **Livelihood Role of Inland Floodplain Ecosystem for Local Community Related to Fisheries Commodity: A Review**

**Uras Tantulo PALIS**  
CIMTROP, UNPAR, Palangka Raya  
E-mail: Uras @mailcity.com

### **Abstract**

In Central Kalimantan the livelihood role of the inland floodplain ecosystem can be defined both economically and ecologically. Economically, this provides fish to the local community due to its role as a fish habitat, so it serves as a cheap nutrition sources to their life. Ecologically on the other hand it does not only act as sink for carbon through utilization of nutrient in the system by both aquatic and terrestrial plants but also plays a considerable role in the self-cleaning function of the system.

One of the methods applied by local fishermen to catch and culture the fish in the flooding area is called "beje". This is a kind of traditional method, which is constructed during dry season by digging small ponds or canals in area of flooding which follows the natural feature of the area.

The result of government policy for the development of area for agriculture and human settlements has clearly changed the nature of the system, which has severe effect on the fish biodiversity. The effects destabilize fish populations with a loss of species and a fall in productivity. The recent example is the failure of 1 Million-Hectare Mega Rice Project in which its implementation has destroyed the nature of the flooding area due to alteration of flood regime in the area. As a consequence severe effects have been occurred to the local people due to loss on their source of traditional livelihood including beje operation.

There is now a immediate requirement to identify more friendly way of utilization of the ecosystem without neglecting its function to the both local community and its related ecological system. To do so a wise use of the floodplain ecosystem by appreciating the traditional wisdom of the local people should be taken into consideration.

**Keywords:** Livelihood role, inland floodplain, local community, fisheries commodity

### **Introduction**

Floodplain ecosystem in Central Kalimantan is a part of large river system in which according to Welcomme (1994), the ecology of the system depends on the flood regime, which by seasonally inundating the floodplain, increases the food and space available to fish. During flooding time that usually takes 2 to 3 months, the water rises to overflow its river's bank and slowly extends over the floodplain to produce a massive increase in aquatic habitat. This condition, according to Bayley (1991), has accelerated recycling of nutrients as they enter solution and a burst of primary productivity follows with bloom of phytoplankton.

During drought time on the other hand, some area is completely dried but some low parts of the areas are remain in pools which are entirely disconnected with the main river. The former condition gives opportunity to the terrestrial plants to develop well through utilization of trapped nutrients in the soil that was formed during

flooding time. It supports the growth rate of terrestrial plant. The later condition on the other hand, due to limited water area, high temperature and dense of fish population are cause an extreme condition for the fish. Only certain fish species can stand on this condition like swamp fish which have developed some adaptation strategies (Welcomme, 1979).

As a natural ecosystem which has a function for increasing the aquatic habitat and enrich the aquatic system with the nutrients, the role of its system is very important to support the existence of the fish. Both functions provides more opportunity of fish to develop properly since it acts as a sheltered habitat used by fish for spawning, as nursery areas for fry and as habitat for adults (Page, 1999). In addition, most of fish species time their reproductive cycle and associated migrations to place the juveniles on the floodplain at this time of maximum food availability and shelter, and have developed a wide variety of breeding strategies to achieve this end. This role obviously has put a greater contribution to the capture fisheries on open inland water surface in which most of fish caught consumed by the local people.

The dependency of the local community on the aquatic resources in Central Kalimantan is considered high since these resources fulfills almost all of their daily life need. The water for instance has been utilized for drinking water and other activities like washing and bathing. Other importance is in term of yielding fish commodity, which are caught out from rivers, lakes and swamps areas of the Central Kalimantan province. Since this is considered as an important sources of nutrition for local community then it is very demanded due to cheap price of it compare to others commodity like cereal, beef, poultry, and again the fish can be easily caught out of the aquatic system using simple method. Table 1 indicates the fish is in a comparative list of average per capita consumption of calories and protein by commodity group 1993.

The importance of the fish as a nutrition source is also indicated by the number of fish consumed by the local people each year. In 1994 about 61,885.46 ton of the fish had been consumed by 1,501.326 people and this value had increased in 1995 become 64,630.10 ton which were consumed by 1,547,134 people, and 67,700.15 ton in 1998 which were consumed by 1,671,621 (note: The number of population in Central Kalimantan in 1997 were 1,685,535, Anonymous, 1998d.). Based on this figure the fish consumption in the Central Kalimantan tends to increase by 3.05% per year (Anonymous, 1998c).

Table 1. Comparative list of average per capita consumption of calories and protein by commodity group, 1993.

| Commodity group | National |         | Central Kalimantan |         |
|-----------------|----------|---------|--------------------|---------|
|                 | Calorie  | Protein | Calories           | Protein |
| Cereals         | 1210.42  | 23.26   | 1335.96            | 25.28   |
| Tubers          | 93.70    | 0.81    | 64.34              | 0.62    |
| Fish            | 40.14    | 7.26    | 73.13              | 13.82   |
| Meat            | 20.19    | 1.40    | 36.31              | 1.74    |
| Eggs and Milk   | 27.79    | 1.67    | 26.83              | 1.54    |
| Fruits          | 37.83    | 0.43    | 43.25              | 0.53    |

Source: Adapted after Anonymous, 1998.

Some problems have occurred in relation to the development of the area, which are mainly resulted from human activities like gold mining, logging activities and swamp reclamation for agriculture. Those activities have brought about devastation on the aquatic resources which in turn have led this negative implication to lowering the fisheries production in the area. This indication can be seen from number of fish production of inland open water that tends to decrease each year by 3.09% (Anonymous, 1998c). The cause of this trend has also resulted from fishing activity using dangerous method such as using poisoning chemical substances and electricity power that threatened the existence of fish population. An urgent action then should be formulated to measure the extent of effect, so a remedial action could be taken for better utilization of the floodplain ecosystem and its functions to the human being (local people).

This paper is aimed to highlight the important role of floodplain ecosystem as a main source of fish for local community and to provides a review of the characteristics of floodplain ecosystem including its contribution to the existence and development of fish biodiversity in Central Kalimantan.

### **Status of Floodplain Ecosystem in Central Kalimantan**

#### **Type of Floodplain**

Unlike low-land floodplains, in which most of the water level condition are affected by the tidal regime, inland floodplain ecosystem in Central Kalimantan on the other hand is dependent mainly in run-off from the rainfall over the river. Based on this, the classification of the floodplain in the region falls into up-land floodplain where the flood regime is uninfluenced by the tidal regime, and the drainage time goes on 24 hours (Chandrawidjaya, 1994).

The classification of the floodplain in Central Kalimantan ecosystem can also be defined according to MacKinnon *et al.* (1996) who defined that the swamp area which mostly flooded during rainy season is divided into two types, first rain-fed peat swamp forest and the second river fed freshwater swamp forest. Based on this type, the rain that feed peat swamp forest are nutrient poor due to lack on nutrient which are derived from rainfall and are caused by low soil pH and contain high pyrite substances. The river fed swamp forest in contrary is very rich with nutrient due to receive dissolved mineral nutrient from rivers flood waters (MacKinnon *et al.*, 1996). However their classification of peat swamp forest into first category seems not applicable to all peat-swamp forest since not all of the peat swamp areas are rain-fed sources but some of them are also exposed by the influences of the river's flood regime.

#### **Distribution and Extent**

In Indonesia, marshy flood area founds in Sumatra, Kalimantan and West Irian. These are located on the flat coastal alluvial plains and submerged and drained by numerous small rivers (Welcomme, 1979). Inland floodplains ecosystem in Central Kalimantan which consists of Freshwater swamp and peat swamp are widespread over alluvial soils that are flooded for long periods with freshwater (MacKinnon *et al.*, 1996). In Central Kalimantan alone the area covered is 1,812,000 ha of the total wetland area in Kalimantan. This is the largest part of total wetlands habitat (1,932,000 ha) of the area (Table 2). They are also associated with coastal swamps, inland lakes and huge

low-lying river basins, such as those of the Seruyan and Kahayan (MacKinnon *et al.*, 1996).

Table 2. Wetland habitats in Central Kalimantan

| Type of wetlands | Original area (ha) | Remaining area (ha) |
|------------------|--------------------|---------------------|
| Freshwater swamp | 1,880,000          | 940,000             |
| Peat swamp       | 996,000            | 872,000             |
| Mangrove forest  | 120,000            | 100,000             |
| Freshwater lakes | 20,000             | 20,000              |
| Total            | 3,016,000          | 1,932,000           |

Source: Adapted from MacKinnon *et al.* (1996).

The distribution and location of the floodplains ecosystem are mainly related with the existence of flooded area. In Central Kalimantan most of the flooded area are part or connected to the main river. Generally the areas are a low part of the region so they are most vulnerable to the flooding. There are 14 flooded areas in Central Kalimantan which cover an area of 58,647 ha. Upstream of Muara Teweh and Buntok have the largest area followed by upstream of Pangkuh, upstream of Palangka Raya and upstream of Kuala Kurun (Table 3). Those lowland areas such as Kuala Kapuas, upstream of Pangkuh and the Jelai River are flooded by the combination of high tide and river flood (Anonymous, 1998b).

Table 3. Location and extent of flooded area in Central Kalimantan, 1995

| Location   | Flooded area (ha) |
|--|-------------------|
| Muara Teweh upstream, Buntok                         | 12,800            |
| Kuala Kapuas   | 6,128             |
| Pangkuh upstream, Palangkaraya upstream, Kuala Kurun | 11,200            |
| Kasongan   | 10,700            |
| Sampit   | 6,400             |
| Telaga Pulang  | 5,746             |
| Arut River upstream                                  | 2,685             |
| Kotawaringin upstream                                | 2,388             |
| Jelai River  | 600               |
| Total  | 58,647            |

Source: Anonymous (1998).

### The Livelihood Role

The life of dayak people in Central Kalimantan have been much influenced by existing natural resources. By this reason high appreciation had been put to the natural resources by their ancient since they had realized that the consequences have to be bear if their natural resources are destroyed due to their own activities. In this perspective, they had exploited the natural resources carefully and in a limited number; it was done only to fulfill their daily life. This wise utilization of natural resources seems to be an important aspect of natural conservation.

Other than planting, fishing is one of their way that have been done to fulfill the need on food. Whilst animal husbandry is only done as a subsistence activity rather than commercial one. It is no wonder then the role of aquatic resources for supporting their life is very dominant. Fishing has been done intensively simply just because both the nature has provided it abundantly, and due to other alternative to provide protein to their family is difficult to find. Again, the fishing gear to catch the fish is simple and easy to operate.

### **Economic Role Related to Fisheries Commodity**

Economically, the livelihood role of floodplain ecosystem to the fisheries aspect can be distinguished both direct and indirectly. Directly, as the area of main fish producer, the fishing activity that is carried out commercially by the fishermen will affect the income contribution domestically to the region in term Gross Product Regional Domestic (GDRP). In 1997 the contribution from fishing activity in inland open water including floodplain area to the GDRP was amounted Rp 246,768,85 (about \$ 37) (Anonymous, 1998c). Although this contribution was not quiet significant, but if we assess the contribution indirectly which are related to the protein provision for the poor people, it will show how significant is the importance of this aspect. Fishing activity in this respective is mainly done as a subsistence activity, so they do not need to buy fish, and in turn reduces their expenditure on food. The capture fisheries in floodplain area of Dadahup village using beje for example had generated income amounted of Rp 2,000,000 per 17 m × 2 m area of beje (Epriyeni, 1997).

### **Number of Fisheries Household**

In the one hand the number of local people who works as part-timer fishermen is difficult to be defined. It is because their number always changes. This situation is understandable that since some of them are not permanently work as a fishermen. On the other side, in 1993 the number of full-timer fishermen who were categorized into fisheries household was 9,186. This number tend to decrease in 1995 become 4,373. But in 1997 the number was increase significantly to 9,867 (Anonymous, 1998c). The dynamic of fisheries household in Central Kalimantan can be seen from Table 3.

Aquaculture is now considered as an alternative method for producing fish. As shown in Table 4, the number of household that is engaged in this activity has significantly increased. "Karamba" (cage) are widely used to rear the fish which are situated along the Kahayan River adjacent to Palangka Raya city. This activity has

Table 4. The number of fisheries household in 1993-1997

| No.              | Year | Fisheries household |                             |             | Number |
|------------------|------|---------------------|-----------------------------|-------------|--------|
|                  |      | Marine fisheries    | Inland open water fisheries | Aquaculture |        |
| 1.               | 1993 | 4,044               | 9,186                       | 3,101       | 16,331 |
| 2.               | 1994 | 4,063               | 8,628                       | 3,655       | 16,346 |
| 3.               | 1995 | 4,373               | 4,373                       | 6,221       | 14,967 |
| 4.               | 1996 | 4,340               | 7,781                       | 8,772       | 20,893 |
| 5.               | 1997 | 4,476               | 9,867                       | 8,272       | 22,615 |
| Average increase |      | 2.62%               | 12.34%                      | 30.84%      | 9.87%  |

Source: Dinas Perikanan Tk. I Kalteng, 1998.

strongly supported by the local government since it is realized as an excellent alternative for generating income and food for the community.

### ***Fisheries Yields***

#### ***Fish species***

The fish caught out of floodplain area consists of both riverine species (white fish) and swamp species (black fishes). The former usually are caught at the beginning of the rainy season and at mid of the dry season where the water level begins to decrease. The later, however are mostly caught at the end of the dry season.

The fishing activity at the beginning of the rainy season is carried out during migration of the riverine species in relation to their sense in fulfilling their life cycle in the floodplain area for breeding activity. Whilst in the mid of the season, due to decrease in water level and change in water quality, the fish cannot stands on bad condition migrated backs to the river.

During the drawdown, when the water in the system is confined to the floodplains pools and the main river channels, severe condition of low dissolved oxygen, high temperature, crowding and reduced food availability prevail. In this condition only the fish which have developed adaptation strategies such as climbing perch (*Anabas testudineus*), snake head (*Chana striatus*), catfish (*Clarias* sp.) will remain. The condition in which only limited space and water available in the pools makes the fish is vulnerable caught by fishermen.

#### ***Fish production***

The fish commodity in Central Kalimantan is mainly resulted from marine and inland fisheries. Marine fish commodity is solely contributed from capture fisheries with production of 46,900.9 ton in 1994 and it had been increased become 50,027.1 ton in 1997 (Anonymous, 1998). The average increase was 3.78% per year. The fish's contribution of inland fisheries on the other hand resulted from various aquatic ecosystem such as river, lake and floodplain area, and are also comes from aquaculture. From inland capture fisheries, in 1994 the fish production was reached 42,253.2 ton in 1994 and this value had decreased to 39,444.9 in 1998 (Anonymous, 1998). The average decrease was 3.09 per year.

The fish caught from the floodplain area during dry season according to Sastroedaryo, 1981, are dominated by the swamp species such as snake head (*Chana striatus*) 33.9%; Climbing perch (*Anabas testudineus*) 14,3%; Sepat siam (*Trichogaster pectoralis*) 13.3%; Sepat rawa (*Trichogaster* sp.) 13.2%; Kapar (*Polycanthus hasselti*) 8.5%; Toman (*Channa micropeltes*) 7.9%; and Tambakan (*Helostoma teminckii*) 1.9%. The number of fish produced from floodplain ecosystem varied accordingly. Data observed by Muslim, 1997 in the floodplain area of Bakung Merang Village showed that the fish production were ranged between 20 – 300 kg per month during the fishing season, the fishing season in the flooding area is usually take place for 2 – 3 months period.

#### ***Capture Method***

Fishing activity in Floodplain area of Central Kalimantan can be defined as the traditional method since the equipment used are usually constructed using local



material such as bamboo and rattan plaited. Generally, they are passive in nature and in form of fishing traps which are adjusted to the floodplain characteristic. Most of them are aimed to catch the fish during their migration. The list of fishing gear used in floodplain ecosystem in Central Kalimantan can be seen in Table 5.

Table 5. Fishing gear used in Floodplain of Central Kalimantan

| Local Name/function | Common name        |
|---------------------|--------------------|
| Tempirai            | Vertical slit trap |
| Bubu/lukah          | Cylindrical trap   |
| Penggilar           | -                  |
| Serok               | Scoop net          |
| Rawai               | Long line          |
| Rengge              | Gill net           |
| Pancing             | Hook line          |
| Jala/lunta          | Cash net           |
| Hancau              | Lift net           |
| Tanguk              | Scoop              |
| Beje                | -                  |

One of traditional method applied by local fishermen to catch the fish is called “beje”. This method is applied by concerning the nature of fish behavior in response to the floodplain characteristic as explain before. A beje can cover about 2–5 ha of the floodplain area which is named as “Tatah Beje” by the local people.

According to Fatimah, 1995 beje is considered as a fishing apparatus which it is like fish pond in shape. The beje is constructed purposely in the area of floodplain in order to make easy the fishermen in catching and collecting the fish that are assemble in small area of the beje when the water level extremely decrease during dry season. While Hamid (1981) defined the beje as a ditch that is constructed in order to make a connection between the main river and the swamp areas. The size of the ditch is 1 to 2 m in width while the depth varies between 1 to 2 m. The main function of the beje according to Hamid 1981 is a trapping for the fish that are entering the beje during raining season when the water level rise. But different definition comes from Mangalik and Arifin (1994) who stated that the beje is not merely used as a method of catching the fish but also for culture facility. According to them, the fish culture can be carried out in the beje because the water is available whole year thus its amount is enough for one period of fish culture. And as a consequence, the fish will live and growth properly which in turn give an opportunity to breed and multiply in the beje area. Moreover, a certain method of fish culture by giving the fish either supplemented or artificial feed can be applied so that high rate of growth attained. Moreover Mangalik and Arifin (1994) confirmed that stocking fish seed into the beje can be carried out if it has been estimated that the remain of fish population in the beje is already lowered.

Traditionally beje only useful during dry season so that there is no special management apply on it. However if the beje is aimed to yield more fish continuously then development of a management system is a must. Of course, there should be a special attention given in order to run the management of the beje so much time must be consumed by the owner of the beje.

### **Ecological Role**

The ecological role of floodplain ecosystem related to fisheries aspect can be defined as an area for food sources for the fish. In this way, the role of higher vegetation as a sink mechanism of nutrient by locking up nutrients during the flood phase and returning them to the soil during dry season is very important. About 55% of allochthonous minerals (C, N and P) are trapped in the marshy area of floodplain in the form of biomass, debris and detritus (Rast and Ryding, 1989). Another important role of floodplain ecosystem is the function of self cleaning in terms of biotic nutrient filter. In this way, the rate of N and P absorbed by the higher plants amounted to 9.48 and 0.15 kg/(ha year), respectively (Richardson *et al.*, 1982). It is clear that the ecological function of the floodplain ecosystem will give a significant contribution to the aquatic productivity, therefore to the fish productivity of the floodplain area.

### **Some Problems Facing for Future Development**

At this time, the tension on the fisheries resources as a consequence of human activities is going on heavily. Logging activities, gold mining, land reclamation for agriculture, utilization of pesticide for wood preservation for instance have been and will continuously be sources for quality degradation of the aquatic ecosystem. It is realized that along with the increase in human population those activities will become stronger in the future, which implies that more basic need will be demanded. For this reason, there should be an effort formulated not only merely to overcome the negative impact of human activities in one side but also to fulfill the need of people without causing a negative implication on the environment on the other side.

### **Logging Activity**

The activity related to logging activities whether illegal or not are common conducted in Central Kalimantan. Although there is data on it available but it is certainly that the effect of its can be directly or indirectly affected the fish's habitat and to the fish themselves. Directly, it affects the fish biodiversity and its related aquatic component when the water temperature rise due to no tree's canopy remains to shade the aquatic system. This has also cause increase in penetration of the sunlight in to the water (higher light intensity occurs) which have caused negative effect on the existence of phytoplankton including its abundance, distribution and diversity. The logging and related activities in adjacent areas of forested watersheds can adversely affect aquatic life (McCool *et al.*, 1986). This has destroyed the riparian vegetation which shades stream and provide bank stability, overhead cover, food for fishes (by insect drift) and allochthonous input to support the aquatic system (Moring *et al.*, 1994). On the other side, it has indirectly affected the fish biodiversity by increasing in the soil abrasion which have led increase in water turbidity. This high turbidity can cause the decrease in penetration of the light into the water and also can cause clogging to the fish larvae.

The sediment loading during flooding time will change bed structure of floodplain which in turn change on ecostructure of benthos fauna. This also cause change on flow regime which will affect the ecology function of floodplain ecosystem including the migration pattern of fish. Alteration of flood regime is also tending to block the main river channel, disconnect the floodplain and reduce ecosystem diversity. In this case, the fish production tends to decrease due to reduction in the aquatic area and drop in the water level due to shallow process.

Pesticides are also widely utilized for log/wood preservation. After used the waste of this activity are directly discarded to the river, as a result the pesticide will enter and be accumulated into sediment and due to microorganism activity they are engaged into food web including the fish. Thus, it might have a negative effect to human health if the fish already contaminated by the pesticides are eaten.

### **Peat Swamp Reclamation**

One of the projects in Central Kalimantan called 1 Million-Hectare Mega Rice Project has been well known to cause negative effect to the environment including to the aquatic resources. In this case the construction of the canal by digging and cutting enormous peat forest have changed not only terrestrial habitat but also the peat swamp function as a fish habitat. Soil leaching from the open acid soil has lowered the water pH between 2.84–3.32 (Anonymous, 1999). Its effect was that no fish could stand on this aquatic condition. Another important effect of this project was that fisheries commodity was lost of the traditional beje operation. Seemingly, the canals construction which cross over the area has cut the connection between beje and the main river, so that water from the river during flooding time could no more inundate the floodplain where the beje existed (Epriyeni, 1998).

### **Gold Mining**

On the one hand, bad condition of Indonesian economic combined with falling in the exchange rate of Indonesian Rupiah to the American dollar have led increasing in gold prices. Both aspects seem to act as a trigger factor for some people in Central Kalimantan turn their work into the gold mining. They are not only mining the gold on the land but also in almost all the catchment areas of 11 main rivers. According to Tim PPLH Unpar (1997), along the Kahayan River alone there had been  $\pm 5,838$  gold miners who had engaged in this activity. Unfortunately, in carrying out of their activities, they do not take into consideration of its negative effect on the aquatic environment. In order to separate the gold from other substances mercury is used. At the end of this process the waste mercury is simply discarded into the river. This obviously have cause water pollution of the heavy metal. Based on the research by Tim PPLH Unpar (1997), the mercury was found from the water sample in some area of the Kahayan River ranging from 0.001–0.081 mg/l. This value is above the level permitted for drinking water, i.e. 0.001 mg/l.

In aquatic environment, inorganic mercury (Hg) can be converted by microorganism into *methyl mercury* that is considered to be dangerous and this form of mercury is easy absorbed by the human body. Some 95% of the methyl mercury is absorbed by the gut, and most of it retained and accumulated in the body, and less than 1% can be excreted. In the food web the mercury concentration tends to increase due to accumulation process. In higher tropic level the concentration is higher than the lower tropic level (Mason, 1993). But even a low level mercury concentration can have dangerous effect on the human being. The dangerous effect of mercury can be clinically observed on blood of adult people on level of 0.2–0.5  $\mu\text{g/ml}$  and mercury concentration in the human body as much as 0.5–0.8 mg/kg (WHO, 1976). But for the people who eat fish from the aquatic system contaminated by mercury, the level mentioned above could be possibly exceeded (Mason, 1993). The poisonous effect of mercury is dominated by neurological disturbances (Mason, 1993).

### Conclusion

The natural resources of floodplain ecosystem in Central Kalimantan is considered as a huge potency for the local people. Other than its high economic value as an area that produces the fish for the local people, but also its important ecological role on keeping balance between the terrestrial and aquatic ecosystems.

The contribution of floodplain ecosystem to the existence of fisheries activity is very significant through its ecological role as a nutrient trap, nursery ground for small or adult fishes and fish breeding ground: all of those role are in turn enriching the fish biodiversity whether in the floodplain area itself or in the connected river. As a consequence, it is also increasing the fish yield by the fishermen.

Regarding the traditional fishing activity in the floodplain area, there should be an effort done to the improvement of fishing ability while taking into consideration the carrying capacity of the existence of the aquatic ecosystem. The beje fisheries as an wise alternative might be developed in the area by modifying beje, so it is not only acting as a fish trap but also as a culture facility. But in its operation, the modified beje should be constructed by following the nature of floodplain ecosystem. It also should be avoided to clear the land by cutting the tress and other plants in the area during its construction.

There have been heavy tensions on the fisheries resources in the floodplain area and its related rivers as a result of human activities. The activities in the future certainly will be continued and will act as main sources for fisheries degradation in the area. It is no wonder then the fisheries resources will be extinct in the future along with the degradation of the floodplain ecosystem and other related aquatic ecosystems. An immediate action then is necessary to be done to avoid this prediction coming true in the future.

### References

- Anonymous. 1998a. The Development Study on Comprehensive Regional Development Plan For The Western Part of Kalimantan (SCRDP-Kaltengbar). Draft Final Report. Pacific Consultants International. International Development Center of Japan. Sector Plan 2. Vol. 5.
- Anonymous. 1998b. The Development Study on Comprehensive Regional Development Plan For The Western Part of Kalimantan (SCRDP-Kaltengbar). Draft Final Report. Pacific Consultants International. International Development Center of Japan. Sector Plan 1. Vol. 4.
- Anonymous. 1998c. Potensi Daerah Dan Kebijaksanaan Pembangunan di Kalimantan Tengah. Pemerintah Daerah Tingkat I Kalimantan Tengah. 58 pp.
- Anonymous. 1998d. Evaluasi Pembangunan Lima Tahun (PELITA) VI Sub Sektor Perikanan Kalimantan Tengah Tahun 1994/1995 – 1998/1999. Pemerintah Daerah Tingkat I Kalimantan Tengah. Dinas Perikanan, 45 halaman.
- Anonymous. 1999. Laporan Antara Studi Implementasi RKL-RPL Proyek Pengembangan Lahan Gambut Kalimantan Tengah Anggaran 1999/2000. Departemen Pendidikan dan Kebudayaan Universitas Palangka Raya. Lembaga Penelitian Pusat Penelitian Lingkungan Hidup.
- Burrows, I.G. and Whitton, B.A. 1983. Heavy metals in water, sediments and invertebrates from a metal-contaminated river free of organic pollution. *Hydrobiologia*, 106: 263-273.

- Bayley, P.B. 1991. The food pulse advantage and the restoration of river floodplain systems. *Regul. Rivers*, 6 (2): 75-86.
- Conner, W. H. and Day, J.W., Jr. 1982. The ecology of forested wetlands in the south eastern United States. In: Gopal, B. *et al.* (eds.), *Wetlands. Ecology and Management*. National Ins. Ecol. and Inter. Sci. Publ. New Delhi. pp. 69-88.
- Chandrawidjaya, R., 1994. Karakteristik Dan Pola Perilaku Perairan Rawa di Kalimantan Selatan
- Fatimah, S. 1995. Beje Sebagai Alat Tangkap. *Harian Banjarmasin Post*.
- Hamid, A., 1981. Tatah Beje. Prosiding Seminar Perikanan Perairan Umum. Pusat Penelitian dan Pengembangan Perikanan. Jakarta.
- Kazantzis, G., 1980. Mercury. In: Waldron, H.A. (ed.), *Metals in the Environment*, Academic Press, London, pp. 221-261.
- MacKinnon, K., Hatta, G., Halim, H. and Mangalik, A., 1996. *The Ecology of Kalimantan. The ecology of Indonesia Series. 3rd Volume*. Periplus Edition, 681 pp.
- Mangalik, A. and Arifin., S, 1994. Pengembangan Budidaya Ikan Di rawa Sungai Buluh, Kabupaten Hulu Sungai Utara. Pusat Penelitian Unlam Banjarbaru. 11 pp.
- Mason, C.F., 1993. *Biology of Freshwater Pollution, 2nd edn*. Longman Scientific & Technical. Copublished in the United States with John Wiley & Sons, Inc., New York. 339 pp.
- McCool, S. F., Benson, R. E., and Ashor, J. L. 1986. how the public perceives the visual effect of timber harvesting: an evaluation of interest group preferences. *Env. Manage.*, 10: 385-391.
- Moring., J. R., Garmon, G. C. and Mullen, D. M. 1994. Effects of logging practices on fishes in streams and techniques for protection: a review of four studies in the United States. In: Cowx, I.G. (ed.), *Rehabilitation of Freshwater Fisheries*, Hull International Fisheries Institute, University of Hull, U.K., Fishing News Books, pp. 194-206.
- Muslim. 1997. Pengelolaan dan Pemanfaatan Perairan Rawa Melalui Tehnik Beje di Desa Bakung Merang Kelurahan Panarung Kotamadya Palangkaraya. Departemen Pendidikan Dan Kebudayaan, Universitas Palangkaraya, Fakultas Pertanian, Jurusan Perikanan, Program Studi Manajemen Sumberdaya Perairan. 29 pp.
- Piotrowski, J.K. and INSKIP, M.J. 1981. *Health Effects of Mercury*. MARC Report 24. Chelsea College, London.
- Page, S.E. 1999. *The Natural Resource Functions of Tropical Peatlands*. Department of Biology, University of Leicester, Leicester.
- Richardson, C. J., Tilton, D. T., Kadlec, J.A., Chamie, J. P. M and Wentz, W. A. 1978. Nutrient dynamics of northern wetlands ecosystem In: Good *et al.* (eds.), *Freshwater Wetlands*. Academic Press. New York. pp. 217-242.
- Sudjana, M. A., 1984. *Metode Statistika*. tarsito, Bandung. 487 pp.
- Tim Peneliti Unversitas Palangka Raya. 1993. Laporan Akhir Studi Program Pengembangan Wilayah Terpadu Bagi daerah Kritis, Minus Dan Terpencil DiKecamatan Kamipang, Kabupaten Kotawaringin Timur, Kalimantan Tengah. Kerjasama Antara Universitas Palangka Raya Dengan Bappeda Propinsi Daerah Tingkat I, Kalimantan Tengah.

- Tim Studi PPLH Unpar. 1997. Laporan Hasil Studi Identifikasi Dampak Lingkungan Penambangan Emas Tanpa Ijin (PETI) Pada DAS Kahayan Yang Meliputi Kecamatan Kahayan Tengah, Banama Tingan, Sepang, Kurun, Tewah, Dan Kahayan Hulu Utara Kabupaten Daerah Tingkat II Kapuas. Kerjasama Antara Proyek Pembinaan, Pengembangan Dan Penyuluhan Usaha Pertambangan Tersebar di Enam Kabupaten/Kotamadya Daerah Tingkat II dengan Pusat Penelitian Lingkungan Hidup (PPLH) Universitas palangkaraya.
- Welcomme, R.L., 1979. *Fisheries Ecology of Floodplain Rivers*. Longman, London and New York. 313 pp.
- Welcomme., R.L. 1994. The status of large river habitats. In: Cowx, I.G. (ed.), *Rehabilitation of Freshwater Fisheries*. Hull International Fisheries Institute, University of Hull, U.K. Fishing News Books, pp. 11-20.

## **Socio-Economic Values of Wetlands for Dayak Community in Central Kalimantan**

**Tampung N. SAMAN<sup>1</sup> and Suwido H. LIMIN<sup>2</sup>**

<sup>1</sup> Department of English of Education, Faculty of Education and Teacher Training,  
University of Palangkaraya

<sup>2</sup> Department of Agriculture, University of Palangkaraya

### **Abstract**

Central Kalimantan Province has not only been covered by primary and secondary thick freshwater but also by tropical peat swamp forests. The soil of Central Kalimantan is poor. It is only 8% of the Central Kalimantan soil is alluvial where mostly traditional rice cultivation have been long practiced. This degradation is believed as the effect of excessive forest felling through government programs, which have been implemented since the beginning of 1970. This condition has been made worse and intensified by the 1 Million hectares rice project (PLG) in 1996, and also the newest but controversial forest policies: "Forest for people", and legal forest felling licenses (IPK).

The largest Dayak groups include the Iban and the Ngaju of Central Kalimantan, lived along the river banks (a part of wetland ecosystems) and earned their life from the traditional rice shifting cultivation, "berladang" as their main subsistence for generations.

Central Kalimantan is dominated by natural wetlands. They are covering more than 19.61% of the total Central Kalimantan area. The main wetlands habitats in Central Kalimantan are fresh-water swamp, peat swamp, mangrove forest, beach vegetation and freshwater lakes. The values of wetlands to the indigenous people of Central Kalimantan, the Dayak cannot be underestimated as they have been the main source of their livelihood, especially for traditional rice shifting cultivation, secondary forest and non-forest product and traditional fisheries.

As the result of the extensive natural resources exploitation in Central Kalimantan, including the conversion of wetlands for agriculture, the local Dayak Community, have been facing many complicated socio-economic problems: job opportunity, scarcity of natural resources as their main livelihood, the humiliation and ignorance of their traditional right.

Reacting to these problems, the local traditional leaders of Dayak seek for the best solution. They have declared that they strongly support any effort in natural conservation where by the main livelihoods of the indigenous people can be maintained and developed in the future.

### **Introduction**

Central Kalimantan province is the third largest province in Indonesia; 15,380,000 ha, or more or less as large as one and a half time of Java and Madura islands. This part of Borneo island has been well-known by its tropical rain forest, which is up to 1993, 84% of this area was still covered by both primary and secondary forest which mainly freshwater and peat swamp forests, around the rivers of Kahayan, Seruyan, Sebangau, Mentaya (Rampai, 1993). But now the percentage of these forest areas is of course substantially reduced mainly because of the extensive forest cutting and land clearing by both legal and illegal logging for new transmigration program and the implementation of the 1 Million hectare Mega Rice Project in January 1996 and new forestry policies: "**Forest for people**" by providing more legal licensees (IPK), for

forest felling, i.e. 777,180 ha. Now in Central Kalimantan, there has not any conversion forest left, and the deficit of conversion forest is about 777,000 ha (Tim Realitas, 1999).

In terms of soil type, the result of research conducted by JICA 1998: D12-2, shows that Kalimantan's soils including Central Kalimantan are poor. It is only 8% of the Central Kalimantan soil is alluvial soil where mostly traditional rice cultivation was practiced. This might be true as the result of extensive and unplanned forest and other natural resources exploitation. This fact is very discouraging because Central Kalimantan used to be very rich in terms of its Natural Resources as reflected in this quotation (Kusni and Rukiah, 1999):

Central Kalimantan was characterized by thick, green tropical rain forest, impenetrable by the sunlight; big and small rivers with abundant freshwater fish; fertile soil where even wooden stick could grow easily became a tree, and the sky above it was crowded by various birds from early morning until night. Its natural resource was so rich that it could provide every thing for the people.

Therefore, 500 years ago the largest Dayak groups include the Iban and the Ngaju of Central Kalimantan, who mostly lived along the riverbanks, have been very knowledgeable in utilizing wetland ecosystem as a part of the main resources of their livelihood. Dayak swidden farmers have accumulated knowledge and skills of land and forest management (Sasaki, 1998). Dayak people are mainly traditional shifting cultivators of hill rice, within the areas, where they could find out mineral soil and alluvial plains along the main rivers of Kahayan, Kapuas, Barito, Katingan, and Sebangau rivers, with a short cropping regime and a longer fallow (5-20 years) to allow fertility to recover. (MacKinnon *et al.*, 1996). In many ways including in cultivating the soil (berladang), they were very much dependent on the natural systems and signs. For example, they could tell when there would be rainy or dry seasons (common indicators in shifting rice cultivation) by looking at the position of the moon ("bulan bunter", "bulan monos"), the stars ("bintang patendu"), winds and other natural signs, such as thunder storms, the sound of animals, etc. (see also Sellato, 1989b and Harrisson, 1960 in MacKinnon *et al.*, 1996). So that hundreds years ago and up to 1970s natural phenomena were predictable. With regard to the wetlands utilization, they have learnt that what they call "LUWAU", the peat land "NAPU", the ever-wet land areas have never been good for rice cultivation. So that they had neither cultivated nor exploited peat land in the inland areas for rice planting. However, they very well understand that this has been the characteristic of the soil in Central Kalimantan, and as well as they understand that this type of soil provides much livelihood either in terms of forest or water resources. Therefore, at the same time, they have been very much dependent on those natural resources: water and peat swamp forest and non-forest resources. For this reason, they have their own concepts on living harmoniously with the natural resources: "***Ruwan Penyang Hinje Simpei, Ruwan Tingang Kampungan Renteng, Ruwan Lamiang Tusukan Samben***". (Declaration of Bumi Tambun Bungai 1999) This can simply be translated as: We are the Dayak, who live and earn life in Bumi Tambun Bungai, Central Kalimantan as the owner of the abundant natural resources will always think and act wisely in utilizing it so as the life will go along harmoniously with the nature." It is true because the natural resources of Central Kalimantan have provided the needs of Dayak to live happily and prosperous. This culture of Dayak has been very effective until the beginning of 1970. Up to the late 1970s, even if Dayak people lived in the remote areas in the upstream of the Kahayan River, for example, they had never



suffered from hunger. This was due to at this time almost every Dayak family had their own “LOSOK PAREI”, barn of rice, where they stored rice supply enough for more than two years resulted from once rice harvesting. At that time every Dayak family undertaking traditional shifting cultivation with only once a year harvesting time. However, when the sectoral government programs including, **land clearing for big scale plantation, transmigration, logging concessions and other government jumping projects such as livestocks, and fisheries** were executed by the beginning of 1970, forest and other natural resources were extensively exploited. This resulted in significant decrease in local people’s subsistence areas and great ecological problems. Therefore, everything including the weather: dry and rainy seasons and flood were unpredictable, and at the same time traditional shifting cultivation of Dayak society in lowland and wetland ecosystems hardly ever harvested successfully. It has been even worse because the above government programs have never contributed revenues to raise the welfare of the indigenous community. Therefore, the whole life style and the culture of Dayak in Central Kalimantan have accordingly changed very much. The changes viewed from many aspects, have been very fatal, not only to the Dayak community (not limited to those group who are traditional shifting cultivators but also to those who are civil servants) within Central Kalimantan but also to the whole world since they mostly affected the ways people earn their lives and as well as the ways perceive the natural resources where their livelihood generated. Since traditional shifting cultivation is no longer effective, most of traditional shifting cultivators of Dayak community have changed their ways of earning life i.e., by illegal logging, and traditional gold mining, etc. These two sectors have been very intensive, as they are very promising. In fact they are fully aware that these natural exploitation are hazardous to the whole ecosystems including their lives, but they act indifferently as they have learnt that the “outsiders” have been greedily exploited their livelihood through the legal logging concessions, why could not they? So that they have to compete with them in any ways they could.

Now since the ecosystems have been very much exploited, that the traditional farmers of Dayak have nothing in their barns. This group of communities now has lost their livelihood. Consequently, under this condition, there have been many social problems occurred within the local society and the outsiders, the forest concessions and gold-mining owners. This will surely increase complicated and serious socio-economic problems in Central Kalimantan in the coming years.

With regard to those problems, recently, there is a greater attention addressed to wetland ecosystems, especially tropical peat land in Central Kalimantan since it has been extensively exploited and converted for agriculture, the rice project. This paper reviews the socio-economic values of wetlands in Central Kalimantan.

### **Central Kalimantan’s Wetlands**

Generally the major habitats of Kalimantan are wetlands, covering more than 10 million ha, or it is about 20% of Kalimantan’s land mass (MacKinnon and Artha 1981 in MacKinnon *et al.*, 1996). Where as in fact, the whole area of Central Kalimantan’s lowland is dominated by a naturally ever-wet, partially inundated, water catchment and floodplains for the rivers from the peripheral mountain ranges. In the everwet environment of a tropical floodplain, the fallen leaves and dead wood of vegetation do not decompose completely, accumulating to form a substrate of organic debris, called peat (Rijksen, 1999).

Central Kalimantan's wetlands are also characterized by freshwater regulated by lake and rivers systems (11 main rivers and 33 tributaries, and 20,000 freshwater lakes), peat swamp regulated by rain systems (with rain falls 129 mm in average/year), and coastal mangroves regulated by tidal systems (Kalimantan Tengah Dalam Angka, 1997). In this case Central Kalimantan's wetlands are interchangeably wetted and dried. There is about 19.64% the area of Central Kalimantan are wetlands. The rivers of Kapuas, Mahakam, and Barito in Central Kalimantan have been the extensive floodplains with associated swamps and lakes system. Central Kalimantan wetlands habitats can be described in Table 1.

Table 1. Wetlands habitats in Central Kalimantan

| Type             | Original area (ha) | Remaining area (ha) | Area included in reserves (ha) | Percent protected |
|------------------|--------------------|---------------------|--------------------------------|-------------------|
| Freshwater swamp | 1,880,000          | 940,000             | 78,000                         | 4.1               |
| Peat swamp       | 996,000            | 872,000             | 98,000                         | 9.8               |
| Mangrove forest  | 120,000            | 100,000             | 11,000                         | 9.1               |
| Beach            | ?                  | ?                   | -                              | -                 |
| Vegetation       |                    |                     |                                |                   |
| Freshwater lakes | 20,000             | 20,000              | -                              | -                 |
| Total            | 3,016,000<br>100%  | 1,932,000<br>64%    | 187,000<br>6.2%                |                   |

Source : MacKinnon *et al.* (1996)

Natural wetlands provide people, either directly or indirectly, with an enormous range of advantages: staple food plants, commercial timbers, fertile grazing lands, support for inland and coastal fisheries, flood control, breeding ground for waterfowl and fuel from peat. These hidden values are rarely quantified. They are often overlooked in regional development plans. The same is true in the case of Central Kalimantan Development plans, which have been very seriously damaging wetland ecosystems.

As well as to the sustainable ecosystems, natural wetlands are extremely valuable to the local Dayak community. They are the main livelihood sources that guarantee their existence in this global world. So that the sustainable and integrated management of the wetland ecosystems is the key terms that should be taken into account in the development program of Central Kalimantan. For the local community this is the matter of survival. In the following parts, the indigenous people's livelihood: traditional shifting rice cultivation, harvesting secondary forest product, and traditional fisheries are reviewed in general.

### **The Indigenous People's Livelihood**

For the indigenous people of Central Kalimantan, natural wetlands are the main livelihood. Therefore they have been very dependent on these natural resources. In this context, wetland resources have been used in various methods for various uses. The followings are the most common uses and have been long practiced:

**a) Traditional Shifting Rice Cultivation (Ladang berpindah)**

The traditional shifting rice cultivation is not only the cultural and economic cornerstone of Dayak peoples, but it has been the main subsistence activity. Shifting rice cultivation is especially important in Central Kalimantan as rice is the source of all life. There is around 30% of the population in Central Kalimantan involved in shifting cultivation (MacKinnon *et. al.*, 1996). And according to Sasaki (1998) there are more than 900,000 house members in Central Kalimantan are related to swidden agriculture.

The cycle of cultivation usually starts in May by slashing of the undergrowth, then felling of the trees. Then fields are burned in August by using wise and ritual traditional method which is well known as “TATAS METHOD”, and also by following wind direction, where by fire could not spread out to the other areas. After the land is cleared, in September the rice is sown in traditional ways by the so called “TUGAL” system, i.e., by making many holes using wooden sticks and carried out by many men followed by the equal number of women who put the seeds of rice into the holes. In this way the whole activity is very cost effective. Generally harvest time is around February the following year, during the short dry season.

But the history of traditional rice cultivation in Central Kalimantan, since late 1970s up to present time have been characterized by failures. This is due to two interchangeable extreme dry and rainy seasons. In 1997, traditional rice cultivation was totally failed due to extended draught and fires. This year, starting from mid-October 1999, the whole area of river-side especially Katingan, Rungan and Kahayan rivers have been totally flooded, and the lowland areas within the ex-PLG project are threaten by flood. So that there is no hope for the local and traditional farmers to harvest their paddy crop because 100% of their “ladangs” have been destroyed by severe strong flow flood (Kapos, 2 November 1999).

**b) Harvesting Secondary Forest Product:**

Harvesting minor forest products brings incomes and employment to local communities. The income of the Dayak people in Central Kalimantan is not only generated from paddy cultivation but also resulted from harvesting secondary forest product, cash crops such as damar, jelutong latex, natural rubber, honey, hunting, gemor, fresh water fish, rattan. Since these income generations were cultivated by simple and traditional ways, i. e., aimed at satisfying the very limited subsistence level of needs, the natural ecosystems were not disturbed. The following table shows some common secondary forest product as cash crops in Central Kalimantan.

From the table above, rattan was the leading secondary forest product in Central Kalimantan. However, the local price for this product has not been in a good prospective. Other products such as Jelutong latex and gemor went down. Especially for Jelutong product decreased by approximately 37.76% on average during this last four years. According to some local people interviewed informally, this was not due to the heavy forest felling for big scale plantation and forest fire in 1997, but also the methods used in harvesting it was not in sustainable manners, i.e., by felling the tree. The same is true with edible nest, this product was totally collapsed since 1997 until now. According to local people the price of this product now is in good prospective, the best quality reaches Rp. 10,000,000/kg. Where as honey of wild bees have been totally lost. Actually the presence of wild bees producing honey has a very strong collaborative relationship with the traditional rice cultivation. Bees help pollination process paddy

flowers.

In addition, Central Kalimantan's forests like other Borneo's forest, are rich in wild and or cultivated edible fruit trees including various kinds of mangoes (*Mangifera*), mangosteen (*Garcinia mangostana*) (which is also a favorite fruit of both Queen Victoria and wild orangutans) (MacKinnon in MacKinnon *et al.*, 1996), rambutans (*Nephelium*), durian (*Durio*), langsung (*Lansium*) and rambai (*Baccaurea*) (MacKinnon *et al.*, 1996).

Furthermore, there are also locally well-known typical wild and edible fruit trees of Central Kalimantan. For examples, such as "tongkoi", "paken" belonging to *Durio* species, "kasturi" and "rarawa" belonging to *Mangifera casturi* species, "manamun", and "katiau" belonging to *Nephelium* species, and "mangkahai" and the most delicious is "banturung" of jack fruit type. These fruits are also important nutrients for the local Dayak communities. So the importance of secondary forest products for indigenous can not be underestimated.

Table 2. Common secondary forest product in Central Kalimantan

| Types of non-forest products                 | Unit  | Production realization |            |              |           |            |
|--|-------|------------------------|------------|--------------|-----------|------------|
|  |       | 1994/1995              | 1995/1996  | 1996/1997    | 1997/1998 | 1998/1999  |
| Rattan                                       | Tone  | 5,436.51               | 10,912.98  | 12,321.43    | 8,948.837 | 12,000.216 |
| Rattan Manau                                 | Piece | 56,380.000             | 405,384.00 | 570,338.00   | 217.825   | 1,083.093  |
| Damar  | Tone  | 447.525                | 1,064.93   | 208.00       | 725.000   | 412.736    |
| Gaharu wood                                  | Tone  | 53.66                  | 62,02      | 0.145        | 0.005     | -          |
| Jelutong latex<br>( <i>Dyrea costulata</i> ) | Tone  | 249.87                 | 151.44     | 171.00       | 54.000    | 19.000     |
| Kulit Gemor                                  | Tone  | 2,983.00               | 1,567.74   | 952.55       | 233.000   | 362.736    |
| Sarang burung/<br>Edible nests               | Tone  | 1.42                   | 1.34       | 0.028        | -         | -          |
| Madu Hutan /Honey                            |       | NA                     | NA         | NA           | NA        | NA         |
| Pasak Bumi<br>( <i>Eurycoma longifolia</i> ) | Tone  | -                      | -          | -            | 2.000     | -          |
| Sirap  | Piece | -                      | 770,000.00 | 2,234,500.00 | 61.040    | 350.040    |
| Kemedangan                                   | Tone  | -                      | -          | -            | -         | 138.010    |
| Biji Tengkwang                               | Tone  | -                      | 312.00     | 0.11         | -         | -          |

Source: Adopted from Laporan Tahunan Departemen Kehutanan dan Perkebunan-Kantor Wilayah Propinsi Kalimantan Tengah, 1998/1999

### c) Traditional fisheries

To the local Dayak community in Central Kalimantan, fish is very important protein sources. It is the main-source of animal protein for them. Fish consumption per capita is higher in Kalimantan than in any other part of Indonesia, three times greater than in Java (Birowo, 1979 in MacKinnon *et al.*, 1996). Fish consumption per capita, per year in Central Kalimantan reached 40.08 kg in 1998 (Evaluasi Pembangunan Lima Tahun-Sub Sektor Perikanan Kalimantan Tengah, 1994-1999).

In Central Kalimantan there are two types of fisheries: "Perikanan Laut", sea fisheries, and "Perikanan Darat", inland fisheries. The development of those fisheries can be explained in Table 3.

It is clear from Table 3 that freshwater fisheries were less developed. Marine fisheries generated 53.64% of the total fish product whereas inland and fresh water

fisheries did only 46.35%. This seems very illogical condition as Central Kalimantan fresh water fisheries resources are greater than marine fisheries.

Table 3. Fisheries Development in Central Kalimantan

| No. | Type of fisheries                            | 1993            | 1994            | 1995            | 1996            | 1997            | Average increase (%) |
|-----|--|-----------------|-----------------|-----------------|-----------------|-----------------|----------------------|
| 1.  | Perikanan Laut /Marine fisheries             | <u>43,221.6</u> | <u>46,900.8</u> | <u>48,233.9</u> | <u>50,542.8</u> | <u>50,027.1</u> | 3.78                 |
| 2.  | Perikannan darat/Inland fisheries            | <u>44,812.7</u> | <u>45,339.1</u> | <u>44,498.9</u> | <u>45,466.1</u> | <u>43,231.6</u> | 0.85                 |
|     | a.Perikanan Perairan Umum/Inland open waters | 44,812.7        | 42,253.2        | 41,773.5        | 42,265.8        | 39,444.9        | 3.09                 |
|     | b.Budidaya/Freshwater aquaculture            | -               | 3,085.9         | 2,725.4         | 3,200.3         | 3,786.7         | 8.02                 |
|     | - Ponds                                      | -               | 2,84.7          | 2,95.0          | 3,05.0          | 4,08.4          | 13.64                |
|     | - Cage/Floating net                          | -               | 2,794.2         | 2,412.1         | 2,865.3         | 2,936.3         | 2.53                 |
|     | - Sawah paddy                                | -               | 4.0             | 8.3             | 16.5            | 192.0           | 423.31               |
|     | - Brackishwater ponds                        | -               | 3.0             | 10.0            | 13.5            | 250.0           | 673.40               |
|     | Total production                             | 88,034.3        | 92,239.9        | 92,731.8        | 96,008.9        | 93,258.7        | 1.49                 |

Source: Evaluasi Sub-sektor perikanan Kalimantan Tengah, 1998

Some traditional fisheries in Central Kalimantan are: “hempeng” “beje”, tambak, keramba or “jaring apung” are called inland fisheries.

Those livelihoods of indigenous people have been threaten to extinct since the development programs launched especially of those transmigration, logging concessions, and the Big Scale of Private Plantation programs including 1 Million hectare Mega Rice Project, which have been resulted in the most serious multi dimensional problems for Central Kalimantan Province. The threat is not only those, but the ambitious, and unworkable KAPET DAS KAKAB project, the legal license provision of forest felling (in many cases, are given to non-local people) and the newest forestry policies: “forest for people” are the most fatal to the sustainability livelihood of the local people in Central Kalimantan. The followings are some of socio and cultural-economic problems, which have been emerged.

### Socio-Ecomic Problems

Since the natural resources have been extensively exploited mainly through the sectoral government programs mentioned above, there have been many socio-economic problems widespread in Central Kalimantan. Here are the main problems:

#### a) Less access to Job opportunity

At the beginning, the local people thought that the government’s development programs in plantation, logging concession and transmigration sectors are of great benefit for them, as they would provide more job opportunities. On the contrary, and in fact, only the “new comers”, the workforce from outside were recruited to work in the program, especially the transmigrants themselves. The local people have been ignored on the reasons that the they were lack of skills and uneducated (Limin, 1999) All of the owners

of forest concessions, gold mining are from outside. The cultivation of forest resources and gold mining in Central Kalimantan has put the local people in a difficult position, they are passive spectators (Nasir, 1999). For example, many forest concessions operated within the area of Sandung Tambun and Upun Batu, Central Kalimantan, did not employ the local work force but recruited human resources from outside Kalimantan (Usop *et al.*, 1994) and (Awan, in Kapos Maret, 1999). Under this condition the local people were in the cross section of the roads. Furthermore, the number of ad hoc government's program like logging concession, big scale private plantation companies and the new forestry policies have been intensified from time to time. Whereas the traditional activities, such as traditional shifting cultivation and as well as the areas for this activity has been reduced sharply. This condition can simply be described in the following figure:

**Volume of traditional activities of local community      Volume of Government's project**

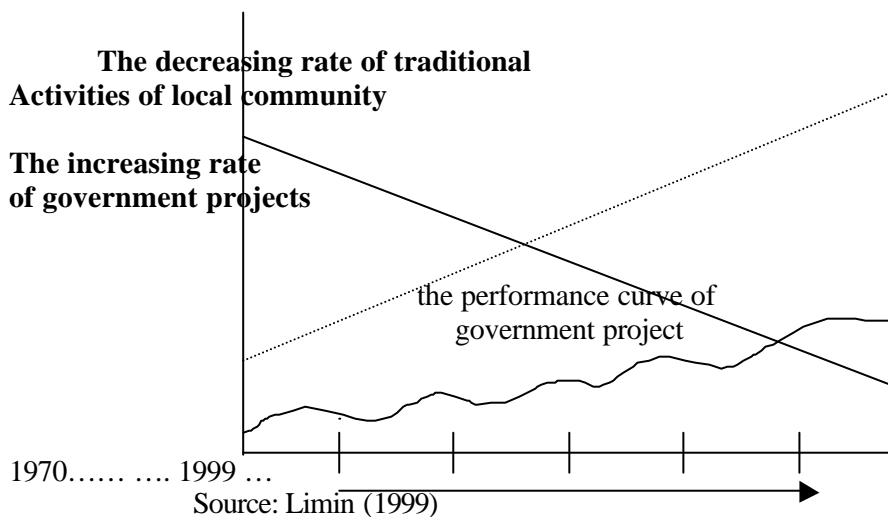

This has changed the whole ways of their life. They would never go back to their former job as traditional shifting cultivators. This is because, on the one hand, the ecosystems and the whole nature, which used to facilitate traditional shifting cultivation, have totally changed. They are not friendly anymore, the weather is not predictable, the water resources have been destroyed and polluted, lands and the forest resources as their livelihood have been so limited. On the other hand, those people, especially the young generation of local people are not ready to face the difficult life. Furthermore, young local people are from economically weak families, so that they have less opportunity in education, therefore many of them could not get any job in government sectors. So what are they earning and where are they going for life? In this way, the local people have been systematically marginalized (Kusni and Rukiah, 1999).

**b) Loss of livelihood source and lack of accessibility to natural resources use**

As time goes on and government programs have been implemented and expanded, the local community has now been in great difficulty. This is not only due to the excessive forest and land exploitation but also due to the extended forest concession

given that covering the whole area of Central Kalimantan, leaving no area for the traditional activities of local community. It has been the fact that the local community, who cut the tree for their own construction materials, around their villages, are often charged by legal action, because they were accused to have stolen the tree of certain forest concession. It is even more ironic that the local community have to go down to the capital city of Central Kalimantan, Palangka Raya, which took 3 up to 6 h by speed boat or 10–20 h by motor boat, to get wood plunk material for coffin. This condition has gradually made the local community not only lost their trust to the government and its policies, but also their responsibility to the natural resources.

In addition, gold mining as practiced by PT. Ampalit Mas Perdana and PT Indo Muro Kencana, have no real contribution to the local community around the area. A research team from Palangka Raya University has reported that there have been a serious socio-economic gap between the local society and those are the employment of this company. Inside the area is equipped with sophisticated facilities; electricity, telecommunication system. Where as out-side, the surrounding villages have been neglected and live in the dark, with out electricity. The local community has been forbidden to traditionally mine gold, where they used to do so as their main income (Limin, 1999). Further more, the totally failed Mega Rice Project (PLG) in the area of the Kahayan, Kapuas and Barito Rivers, in 1996, has its own story. The story was expressed by Yetsi Ronjan, one of the traditional leaders of Dayak Ngaju at Dadahup village, he said he still remember how the Governor, Warsito Rasman expelled people from the area of the project. The governor said: “the PLG project is the development project, so who ever hampers the project is a communist (the PKI)”(Tempo, 1999). It is true that the local community within the area of PLG, around the mouth of the Kapuas River, have for generations harvested rattan and fish from traditional fisheries ponds (beje). In this area long before the project commenced, one person could gather 8 to 10 tones per ha of rattan plantation or it was equal to Rp. 500,000/ton, and Rp.300,000 per fish pond (beje)/harvesting, which was harvested twice a year. But now this is an old story, because the PLG project has destroyed all of those livelihoods of the local community, the Dayak (The Guardian, 18 February 1999).

### **c) Economically trapped.**

The lifestyles of the local community, the Dayak, have been particularly relax, and there has not much competition among them. This is commonly assumed that the local people have been so far pampered by the abundant natural resources in the past: by getting down to the river, in a moment they could catch enough fish, gold, and a few steps from home, they could harvest vegetable. Where as from traditional rice cultivation they could get enough rice for one or two years ahead supply. In this way, the local people did not have to work hard for earning life (Rukiah and Kusni, Kapos, July 1999). They felt there was no need to save for future needs. And market places were not developed, so that there had been few of local people as traders. In one case, they have been traditionally formed as hopeless producers and buyers or the consumers. Since most of the local people lived in the remote areas, in the upstream of the rivers, with poor transportation infrastructures, which by it was very difficult to reach either in the dry or rainy seasons.

This condition has affected the whole aspect of their life. So that they had less access to the market places, to technology, to education and as well as to information.

This condition has also been used effectively by the outsiders, forest concession owners, including traders from South Kalimantan, either directly or indirectly to take the advantage. For example, those traders have been very clever, they have very well understood that the local people were in a very weak position. Therefore, they have the biggest role in determining the prices of goods and services as they wish. For examples, on the one hand, the price of rice, sugar, vegetable oil and so on can be 300–400% higher than in the market places in Palangka Raya.

On the other hand, the price of local commodity: rubber, rattan, jelutong latex is much lower. From an interview with the local community, it was found out that the price of jelutong latex produced by local, farmers is Rp. 250,000 per quintal (100 kg), but the middle traders sell them to exporters on much more higher: Rp. 2,500,000. The same is true with rattan and the other forest products and services. Casual logging workers get paid Rp. 40,000/day (2.82 pounds), and independent logger get Rp. 190,000 for a cubic meter of ramin or red meranti. Where as the middle man gets four times as much in Jakarta (The Guardian, 18 February 1999). Further more, since the beginning of 1990s, rattan prices dropped to half of the previous price level, due to the export ban of semi-processed rattan canes. So that many swidden farmers in Central Kalimantan shifted their efforts to rubber cultivation. Recently, rubber price has been very low, therefore, many people turned to traditional, but naturally unfriendly small-scale gold mining (SCRDP–Kaltengbar, 1998). There are approximately 1904 units of water pump machines have been used for extracting gold along the Kahayan River alone. In this case, the local communities have been placed only as the potential market of nine consumptive necessity goods. Having done an in depth study on the socio-economic and cultural aspects of the local people in Pulang Pisau, (Central Kalimantan), Sjarkowi (1999), described Pulang Pisau, which used to produce 75% of Kalimantan timber production, looks like a dead city, indicating not even a single sign of economic development. Consequently, in terms of economy and geography, the local communities, especially those who totally dependent on the natural resource base, have been trapped into a highly dependency.

#### **d) Legal oppression of local tradition, culture and customary rights**

The centralized government of “*orde baru*” has been the main source of many socio-cultural and economic problems in every province of Indonesia, including the province of Central Kalimantan. During this regime, every traditional and customary institution, such as “*lembaga damang*” has been totally destroyed and amalgamated into governmental institutions. Therefore, those institutions were unable to function as they were used to be, i.e, as the important tools for conveying ideas and leading the indigenous people to harmonious life within the community. Cultural values were also oppressed, for example, by integrating the indigenous religion of Dayak, “*Agama Kaharingan*” with Hindu. Without this integration, the Kaharingan people would not get any legalization in Indonesia (Kusni and Rukiah, 1999).

In terms of traditional land right and customary right, the local people have established their right on a certain land area around their villages, and along the river banks, either in the high land or in the low land areas in Central Kalimantan, since the first time they made a swidden of primary forest land. Their children and other relatives on certain conditions can inherit the land ownership. Therefore, community members know well which land belongs to whom. In many cases, fruit trees or other useful trees



planted by the person designated as the mark of the land ownership. This has been confirmed by a regent, Badrus sapani in Kuala Kapuas regency in 1953. Some of the confirmed customary rights are:

- 1). The customary right (“hak ulayat adat”) as far as 5 km<sup>2</sup> from the left and right sides of the river or as far as the sound of “gong” is heard.
- 2). The customary right on main source of livelihood (“hak tanggungan, hak rutan pantung, hak anak sungai, hak danau, hak beje, hak andil tatas, hak panggul, sapinang sapukang, hak bahu huma hak petak rutan dan hak pahewan”). These customary rights have been established within the local community of Dayak for generations (Siun, 1999).

However, as the government project was introduced for natural resources extraction or land development over the territories of the indigenous communities, the situation have totally changed. In this case, the local traditional and customary land right of Dayak became powerless and overlooked by the government policies.

It is clearly stated in the national constitution of Indonesia, established in 1945, that land, water and natural resources are controlled by the government and are utilized for the interest of the public. Although local customary rights to land and natural resources have been acknowledged in the Basic Agrarian Law of 1960, the utilization of such customary right must not disturb the national and state interest concerning land and natural resources development. In fact, according to Article 10 of the Basic Agrarian Law of 1960, it is clearly stated As well that it is necessary for a person to get rights to agricultural land to actively or exploit by himself or herself on the appropriate methods, and permanently used. With regard to this Law, there are two problems have been facing by the local community: firstly, they just did not realized about this law. Secondly, since the indigenous shifting cultivation is composed of two main characteristics, opening forest for cropping and forest fallow, the indigenous swidden farming can not meet the condition to get formal land rights, because it is not permanent land use. This condition even worse at present time. The implementation of the new forestry policy on the forest extraction, “Forest for people”: the Decree of the minister of Forestry and Plantation number 677/1998/HPHKM. This decree can only allow the forest utilization by the society through many conditions, one of them through a business management called cooperation. Once again the local communities, the Dayak have not well informed with this kind of organization since their traditional customary institutions have been long destroyed and disfunctional. In fact, there are many logging concession owners and other informal institutions, from outside Central Kalimantan designated forest concession in Central Kalimantan (Tim Realitas 1999).

### **What Do the Indigenous People Want?**

With regard to those problems mentioned above, the local people simply need to be secure both in terms of socio-economic and as well as cultural and natural ecosystem aspects. This means that those aspect should be developed integrated methods, with out neglecting one of them.

With respect to the regional development methods which are being implemented now in Central Kalimantan, many experts are questioning with skepticism on their success. Related to the sustainability of the regional income and as well as the indigenous people’s livelihood, and examining the implication of the newest policy in the forestry department, Nasir (1999) stated that the new policy on forestry which is

called “ forest for people”, however, have legally facilitated great opportunity for serious forest felling. This of course have resulted in great loss of original regional income (PAD), and as well as loss of the livelihood of the indigenous communities in Central Kalimantan. This must not be allowed to happen in the future.

Further more, according to a comprehensive study done by JICA and BAPPENAS in 1998, that if the logging operations and oil palm plantation development are continued at the present pace, Kalimantan’s natural power on which the local people rely for economic activities would broken. And due the exhaustion of timber of timber resources ... in five years, the timber production from timber concession areas will decrease by 30% in Central Kalimantan. By 2018, the timber concession areas in both provinces, West and Central Kalimantan will be no longer productive. This means that the original regional income (PAD) of Central Kalimantan, on which the provincial government heavily relies, will not be very promising to support the coming total regional autonomy.

Addressing those problems, Center for International Co-operation in Management of Tropical Peatland (CIMTROP) at the University of Palangka Raya, Central Kalimantan, academics from various universities and institutions including non-governmental organization from both overseas and domestic, and as well as the local and traditional leaders of “adat in Central Kalimantan on 12-15 April 1999, have produced a declaration called “Declaration of Bumi Tambun Bungai” in Central Kalimantan, through a deliberate discussion. Some important points that clearly expressing the local people’s concern that should be taken into account in managing the land and forest use so as to minimize socio-economic problems are quoted as follows:

### **Article 2.**

2.1. The utilization of Central Kalimantan’s natural resources should be based on:

2.1.1. Carrying capacity of the natural resources and ecosystem of Central Kalimantan. i.e., by a comprehensive, and wise consideration on many factors of local environment such as land, water, forest and as well as wildlife and their functions.

2.1.2. Ways of life of the indigenous people: For example, traditional farming on dry land and wet land must be developed based on the wise tradition which have been proven to be effective, productive and as well as naturally friendly.

2.2. Traditional ownership of the local people on the natural resources which have been passed for generations, must be taken into account in every development program of Central Kalimantan.

2.3. Any symbols indicating our ancestor’s belief must be appreciated and preserved within every format of development program and its execution.

2.4. Every planning and process of development program of Central Kalimantan must involve the local society so as to result in the most appropriate and acceptable and feasible programs.

### **Article 3.**

The local government of central Kalimantan must pass a particular policy on natural resources management so that the welfare and prosperity of the local people can be improved. This can be carried out by:

- a. developing both basic and advanced industries for handling the leading commodity within the area;

- b. regulating reasonable basic price rate for local commodity within the local producer level;
- c. empowering the local people to be able to wisely use their natural resources;
- d. providing proper privilege to the local people to own a certain width piece of land so that there will be a wide areas, enough for undertaking traditional economic activities;

**Article 4.**

Forest Concessions and Industrial forest concessions must be reduced, on the reasons that: 1) in fact the whole area of Central Kalimantan has been allocated for the forest concessions. 2) since the presence of the forest concessions and forest concessions for industrial plant in Central Kalimantan, the local people have never gained substantial contribution from those forest concessions. Instead, as the result of those programs, there have been many socio-economic problems arisen: loss of livelihood, natural resources degradation and last but not least cultural degradation.

In addition to those points, through Kalimantan Peat Swamp Research Project (KPSFRP) a very important facility, the Natural Laboratory for Peat Swamp Forest in Central Kalimantan, has been formally established in 9 July 1999. The main aims of this laboratory are:

- a. providing international natural facility as a museum of ecological components and scientific study
- b. Facilitating research and conservation, as the technology source on peat and peat swamp forest, and as well as facilitating science and technology transfer among experts which is needed for development acceleration both in terms of human and natural resources.
- c. Facilitating scientific as well as eco-tourism and conservation area that brings about positive contribution for the local people and government, through wise and sustainable management of potential natural resources as the main livelihood of the indigenous people.

The existence of this natural laboratory has been acknowledged to the local society through a meeting on 5 September 1999 at the Base Camp of LAHG Sebangau. The most important point expressed by the local communities, and strongly agreed by the management of this laboratory, is that the laboratory should be developed and managed not only for natural conservation but also for the sustainability of their livelihoods, such as jelutung latex, gemor, fresh swamp fisheries, and others.

**References**

- Conservation of the Sebangau Water Catchment Area in Central Kalimantan. 1999. A project proposal for the preparatory phase of an integrated conservation and development project to conserve the Sebangau watercatchment area in its original state: The Golden Ark Association, CIMTROP and AIDEnvironment.
- Declaration of Tambun Bungai (12 April 1999)
- Evaluasi Pembangunan Lima Tahun-Sub Sektor Perikanan Kalimantan Tengah. 1998. Dinas Perikanan Propinsi Daerah Tingkat 1 Kalimantan Tengah.
- Kalimantan Tengah Dalam Angka. 1997. Propinsi Kalimantan Tengah
- Kume, T., Sasaki, H. and Yoshinobu N. 1998. Discussion Paper No. 12. Goals of Regional development for Kalimantan: back to Basics, the sustainability of the

- “Kalimantan System”. *The Development Study on Comprehensive Regional development Plan for the Western and Central Part of Kalimantan SCRDP Kaltengbar*. Japan International Cooperation Agency (JICA), National Development Planning Agency (APPENAS) The Government of the Republic of Indonesia: Pacific Consultant International, International Development Center of Japan, Technical Report 2, D 12-2.
- Kusni, J.J. and Rukiah S. 1999. Marjinalisasi Masyarakat Dayak. Local daily Newspaper: *Kalteng Pos*, July 30, 1999, p.6.
- Laboratorium Alam Hutan Gambut (LAHG): Hasil Pertemuan antara Pengelola LAHG dengan Masyarakat Kereng Bangkirai dan Sekitarnya, tanggal 5 September 1999 di Base Camp LAHG Sebangau Tentang Tujuan dan Fungsi Pembangunan LAGH.
- Laporan Tahunan Departemen Kehutanan dan Perkebunan. 1998/1999: Kantor Wilayah Propinsi Kalimantan Tengah.
- Limin, Suwido H. 1999. Pengalaman dan Persepsi di Daerah Tentang Pengembangan Masyarakat: Suatu Tinjauan di Daerah Kalimantan Tengah.
- MacKinnon, K., Hatta, G., Halim and Mangalik A. 1996. *The Ecology of Kalimantan. Singapore: Periplus Editions*.
- Nasir, Darmae. 1999. Eksploitasi Sumberdaya Hutan dan Tambang Kemanakah Uangnya? Palangka Raya: CIMTROP UNPAR.
- Nasir, darmae. 1999. “Kesesambungan Pendapatan Kalteng: Antara Pemerintah daerah dan Masyarakat Lokal dari potensi SDA” in *Kalteng Pos*. (Sabtu 24 Juli 1999).
- Rampai, Kiwok D. 1993. Upacara Traditional dalam kaitannya Dengan Peristiwa Alam dan Kepercayaan daerah Kalimantan Tengah. Departemen Pendidikan dan Kebudayaan Direktorat Jenderal Kebudayaan Direktorat Sejarah dan Nilai Traditional: Nilai-Nilai Budaya Kalimantan Tengah.
- Sasaki, H. 1998. Discussion Paper No.4. The Place of swidden Farmers (Shifting Cultivators) in regional development of Kalimantan. The JICA Study SCRDP-Kaltengbar. *The Development Study on Comprehensive Regional Development Plan for the Western and Central Kalimantan. (SCRDP – Kaltengbar)* Japan International Cooperation Agency (JICA), National Development Planning Agency (BAPPENAS). The Government of the Republic of Indonesia: Pacific Consultant International, International Development Centre of Japan. Technical Report 2, D4-3.
- Siun. 1999. “Eksistensi Hak Ulayat Dalam Perspektif Negara Hukum Indonesia (2): Ketika Kompensasi Adil Diakali” in *Kalteng Pos*. (Rabu 1 September 1999).
- Sjarkowi, Fachrurrozie. 1999. Determinan Ekonomi Lingkungan Dalam Upaya Pelestarian Manfaat Ekosistem Lahan Rawa Gambut Tropik. (unpublished).
- Tempo. 1999. Edisi 6 -12 April 1999. pp. 39-48.
- The Guardian. 1999. February 18, 1999. pp. 7-9.
- Tim Realitas. 1999. Media Indonesia. “Merusak dengan IPK”.
- Usop, KMA.M., *et al.* 1994. Laporan Akhir: Penelitian Pengembangan Desa Tertinggal Ditinjau Dari Pendekatan Sosial Budaya. Pusat Penelitian dan Pengkajian Kebudayaan Dayak Universitas Palangka Raya dan BAPPEDA Propinsi Dati I Kalimantan Tengah.

## **Problems on Developing Ruminants Livestock in Inland Peat of Central Kalimantan**

**Robertho Imanuel ADEN**

Faculty of Agriculture, University of Palangka Raya, Palangka Raya, Indonesia

### **Introduction**

This writing is aimed at stimulating ideas and discussions and as well as solutions from the participants of symposium on the development of ruminants livestock in inland peat in Central Kalimantan.

### **Problems Encountered by the Ruminants Livestock in Inland Peat in Central Kalimantan**

The main characteristics of ruminant livestock product in Central Kalimantan are the lower meat product. This is due to many important factors in ruminant livestock development, which in fact has not been paid proper attention to and improvement. Those factors are: 1) The quality of grass for feed stuff is very poor, and as well as the lack of farmers on the development of the grass feed stuff. 2) The local indigenous people of Central Kalimantan have not been used to raise ruminant livestock, such as cows, goats, sheep and buffaloes. Even if there are some people raising those livestock, they run in small scale and traditionally. 3) Lack of extension staff for livestock in giving explanation and providing practice about ruminants livestock, and as well artificial insemination, and as well lack of training on techniques of grass for feed stuff. 4) The complex condition of peat land, having high acidity and less fertile. This requires high input and high cost. 5) Low demand of meat (ruminant livestock in Central Kalimantan Tengah), firstly caused by the higher price of meat, reaching Rp.28,000-30,000/kg. This resulted in only a certain group of society who could afford for it. 6) Another reason of low product of meat is due to the less number of livestock, and many of the livestock were utilized as helping workforce. 7) There has not been enough research on the resources structure of livestock and the farmers' objectives of keeping livestock in small-scale and mixed farming scheme, which is generally practiced in Asian countries. Having examined the seven factors above, I try to present data as one of the main important factors in developing ruminant livestock, that is grass feed stuff which is available in Central Kalimantan (Table 1).

From the above table it is known that these types of grass planted in peat areas are within the District Cempaga, Baamang and Katingan. There is not any datum about the type of soil used for planting grass. From the available data only Barito Selatan is known to have produced 50 ton/(ha year), and it is not specified from any particular district.

From a direct formal interview with the Regional Livestock Department of Central Kalimantan, there has not been any complete record on grass feed production, therefore, it is not known the real potential of Central Kalimantan on the production of grass feed stuff. The main reason for not recording the data is classical: "no budget available". At the same time I was informed that the activity of planting grass feed stuff was not done by giving any treatment or input to the land used.

Table 1. Grass feed stuff of livestock under supervision of Regional Livestock Department of Central Kalimantan (ha).

| No.         | Regency/Municipality | District             | Area (ha) | Type of grass   |
|-------------|----------------------|----------------------|-----------|---|
| 1.          | Kotawaringin Barat   | Kumai                | 5.54      | King grass  |
|             |                      | Arut Selatan         | 4.34      | King grass  |
| 2.          | Kotawaringin Timur   | Danau Sembuluh       | 0.6       | Rumput Gajah ( <i>Pennisetum purpureum</i> )                |
|             |                      | Cempaga              | 0.5       |   |
|             |                      | Hanau                | 0.25      |   |
|             |                      | Tewang               | 0.25      |   |
|             |                      | Parenggean           | 5.75      |   |
|             |                      | Baamang              | 14        |   |
|             |                      | Katingan             | 5.75      |   |
|             |                      | Mentaya Hulu         | 7.50      |   |
|             |                      | Mentaya Hulu Selatan | 0.25      |   |
|             |                      | Mentaya Hulu Utara   | 0.25      |   |
|             |                      | Ketapang             | 0.25      |   |
| Pulau Haman | 0.5                  |                      |           |   |
| 3.          | Palangka Raya        | Pahandut             | 2         | King grass and Rumput Gajah ( <i>Pennisetum purpureum</i> ) |
| 4.          | Kapuas               | Kahayan Hilir        | 0.75      |   |
|             |                      | Maliku               | 2         |   |
|             |                      | Pandih Batu          | 1         |   |
| 5.          | Barito Selatan       | Bentot               | 0.50      |   |
|             |                      | Tamiang              | 0.50      |   |
|             |                      | Sababilah            | 3         |   |
|             |                      | Pamangka             | 1         |   |

Source: Regional Livestock Department of Central Kalimantan, 1997

From the points expressed above, it is clear that another constraint that hamper the development of ruminant livestock and grass feed stuff in Central Kalimantan, i.e., lack of government's concern in providing substantial support.

Furthermore from the interview, it is known that the number of cows slaughtered per day is 20 cows. While in the municipality of Palangka Raya, 10 cows are slaughtered/day. In the case, Central Kalimantan requires about 7300 cows per year, while the municipality needs 3650 cows per annum.

To satisfy the need for meat as estimated above, the local producers from Pangkoh, Kapuas District have produced approximately 20%. While 80% of the need is met by the outsiders, from Madura Island of East Java Province.

The price of meat in the municipality of Palangka Raya is moving around Rp.28,000-30,000/kg. If it is converted into US dollars, it is about \$ 4.5/kg.

Up to this point I have examined that the potential for ruminant livestock production has not been exploited. Based on the fact, this sector has a very good prospective either as an important source of animal protein or as the potential income generation for provincial government in facing the coming full autonomy.

So far the development of ruminant livestock and grass feed stuff is not studied well in Central Kalimantan. This condition is believed to be resulted from the lack of the government's concern and poor human resources and as well as lack of well-planned project of livestock development in Central Kalimantan.

### **Conclusion**

1. There is an urgent need to carry out a comprehensive research on various kinds of grass feed stuff, such as "Rumput Gajah" (*Pennisetum purpureum*), and *Setaria spacelata*, within the area of inland peat. The limited food resource will be the main constraint in livestock production.
2. There should be a research on the development of grazing field for livestock by shifting grazing fields. This technique is important to guarantee the availability of grass feed during the year. This method should be introduced to the local society through a well-planned project.
3. There should be a research on farming system by fully utilizing the available human resources so as to produce the high level productivity of peat land at lower cost. In this way, the farmers and animal husbandry will be able to develop a mixed cultivation business, which is applicable to a large-scale livestock raising, such as cow raising.

### **Reference**

Dinas Peternakan Tingkat I Propinsi Kalimantan Tengah (Regional Livestock Department of Central Kalimantan). 1997, 1999.

# Appendix



## List of Participants

| No. | Name                       | Affiliation   |
|-----|----------------------------|---|
| 1   | ADACHI, Yu                 | Faculty of Agriculture, Hokkaido Univ., Japan                                 |
| 2   | AMBAK, Kamarudin           | Malaysian Research and Development Institute, Johor, Malaysia                 |
| 3   | ARDIANOR                   | Department of Aquatic Resources Management, Univ. of Palangka Raya, Indonesia |
| 4   | ARTININGSIH, Typuk         | RDC for Biology-LIPI, Bogor, Indonesia  |
| 5   | ASTUTI, Dwi                | RDC for Biology-LIPI, Bogor, Indonesia  |
| 6   | AWALINA                    | RDC for Limnology-LIPI, Cibinong, Indonesia                                   |
| 7   | BOEHM, H.-D.V.             | Kalteng Consultants, Germany  |
| 8   | BUCHAR, Tariono            | Aquatic Resources Management, Univ. of Palangka Raya, Indonesia               |
| 9   | CHA, Joo Young             | Nakagawa Experiment Forest, Hokkaido Univ., Japan                             |
| 10  | CHAIRUL                    | RDC for Biology-LIPI, Bogor, Indonesia  |
| 11  | DJUWANSAH, M. Rahman       | RDC for Geotechnology-LIPI, Bandung, Indonesia                                |
| 12  | EROSA, Patricia            | University of Palangka Raya, Indonesia  |
| 13  | GAFFAR, Eddi Zulkarnaini   | RDC for Geotechnology-LIPI, Bandung, Indonesia                                |
| 14  | GUMIRI, Sulmin             | Graduate School of Environmental Earth Science, Hokkaido Univ., Japan         |
| 15  | HADI, Abdul                | Faculty of Horticulture, Chiba Univ., Japan                                   |
| 16  | HARAGUCHI, Akira           | Faculty of Science, Niigata Univ., Japan                                      |
| 17  | HARDININGSIH, Hardiningsih | RDC for Biology-LIPI, Bogor, Indonesia  |
| 18  | HARJONO, Hery              | RDC for Limnology-LIPI, Cibinong, Indonesia                                   |
| 19  | HARTOTO, Dede Irving       | RDC for Limnology-LIPI, Cibinong, Indonesia                                   |
| 20  | HASEGAWA, Toshihiro        | Faculty of Agriculture, Hokkaido Univ., Japan                                 |
| 21  | HASHIDOKO, Yasuyuki        | Faculty of Agriculture, Hokkaido Univ., Japan                                 |
| 22  | HIDAYATI, Nuril            | RDC for Biology-LIPI, Bogor, Indonesia  |
| 23  | HIGASHI, Seigo             | Graduate School of Environmental Earth Science, Hokkaido Univ., Japan         |
| 24  | HIRAKAWA, Kazuomi          | Graduate School of Environmental Earth Science, Hokkaido Univ., Japan         |
| 25  | HOESEN, Djadja Siti Hazar  | RDC for Biology-LIPI, Bogor, Indonesia  |
| 26  | IBIE, Bismart, Ferry       | Graduate School of Environmental Earth Science, Hokkaido Univ., Japan         |
| 27  | IMANUEL, Robertho          | University of Palangka Raya, Indonesia  |
| 28  | INOUE, Takashi             | Faculty of Agriculture, Hokkaido Univ., Japan                                 |
| 29  | INUBUSHI, Kazuyuki         | Faculty of Horticulture, Chiba Univ., Japan                                   |
| 30  | ISTOMO                     | Faculty of Forestry, Bogor Agricultural Univ., Indonesia                      |
| 31  | ITAKURA, Tadaoki           | Faculty of Engineering, Hokkaido Univ., Japan                                 |
| 32  | IWAKUMA, Toshio            | Graduate School of Environmental Earth Science, Hokkaido Univ., Japan         |
| 33  | JAMAL, Juliasri            | RDC for Biology-LIPI, Bogor, Indonesia  |
| 34  | JAMAL, Yahya               | University of Palangka Raya, Indonesia  |
| 35  | JUNE, Tania                | Bogor Agricultural Univ., Indonesia   |
| 36  | KAHONO, Sih                | RDC for Biology-LIPI, Bogor, Indonesia  |
| 37  | KANO, Yoshio               | Tokyo Univ. of Agriculture & Technology, Japan                                |
| 38  | KASIM, Ernawati            | RDC for Biology-LIPI, Bogor, Indonesia  |
| 39  | KAYAMA, Masayuki           | Graduate School of Environmental Earth Science, Hokkaido Univ., Japan         |
| 40  | KOBAYASHI, Shigeo          | Center for International Forestry Research, Indonesia                         |

| <b>No.</b> | <b>Name</b>             | <b>Affiliation</b>   |
|------------|-------------------------|--|
| 41         | KOHYAMA, Takashi        | Graduate School of Environmental Earth Science, Hokkaido Univ., Japan          |
| 42         | KOMATSU, Ryo            | Graduate School of Environmental Earth Science, Hokkaido Univ., Japan          |
| 43         | KRAMADIBRATA, Kartini   | RDC for Biology-LIPI, Bogor, Indonesia   |
| 44         | KUNII, Hidenobu         | Research Center for Coastal Lagoon Environments, Shimane Univ., Japan          |
| 45         | KURASAKI, Masaaki       | Graduate School of Environmental Earth Science, Hokkaido Univ., Japan          |
| 46         | KUSAKABE, Kumiko        | Graduate School of Environmental Earth Science, Hokkaido Univ., Japan          |
| 47         | KUSUMANA, Cecep         | Faculty of Forestry, Bogor Agricultural Univ., Indonesia                       |
| 48         | LAYUNIYATI              | University of Palangka Raya, Indonesia   |
| 49         | LIMIN, Suwido H.        | University of Palangka Raya, Indonesia   |
| 50         | MAKALEW, Anna Maria     | Agriculture, Indonesia   |
| 51         | MANSUR, Muhamad         | RDC for Biology-LIPI, Bogor, Indonesia   |
| 52         | MATSUBARA, Takeshi      | College of Cross-Cultural Communication & Business, Shukutoku Univ., Japan     |
| 53         | MELLING, Lulie          | Department of Agriculture, Sarawak, Malaysia                                   |
| 54         | MIRMANTO, Edi           | RDC for Biology-LIPI, Bogor, Indonesia   |
| 55         | MOGEA, Johannes Palar   | RDC for Biology-LIPI, Bogor, Indonesia   |
| 56         | MULYANTO, Budi          | Faculty of Agriculture, Bogor Agriculture Univ., Indonesia                     |
| 57         | MURNINGSIH, Tri         | RDC for Biology-LIPI, Bogor, Indonesia   |
| 58         | NAIOLA, Beth Paul       | RDC for Biology-LIPI, Bogor, Indonesia   |
| 59         | NAKAHARA, Osamu         | Faculty of Agriculture, Hokkaido Univ., Japan                                  |
| 60         | NAPITUPULU, Rostiati NR | RDC for Biology-LIPI, Bogor, Indonesia   |
| 61         | NISHI, Norio            | Graduate School of Environmental Earth Science, Hokkaido Univ., Japan          |
| 62         | NUYIM, Tanit            | Princess Sirindhorn Peat Swamp Forest Research & Nature Study Center, Thailand |
| 63         | OKAZAKI, Masanori       | Tokyo Univ. of Agriculture & Technology, Japan                                 |
| 64         | OSAKI, Mitsuru          | Faculty of Agriculture, Hokkaido Univ., Japan                                  |
| 65         | PALIS, Uras Tantulo     | University of Palangka Raya, Indonesia   |
| 66         | PANGGABEAN, Gilmour     | RDC for Biology-LIPI, Bogor, Indonesia   |
| 67         | PARTOMIHARDJO, Tukirin  | RDC for Biology-LIPI, Bogor, Indonesia   |
| 68         | POLOSAKAN, Ruddy        | RDC for Biology-LIPI, Bogor, Indonesia   |
| 69         | PONGPIAJUN, Siwat       | Graduate School of Environmental Earth Science, Hokkaido Univ., Japan          |
| 70         | PURWANINGSIH            | RDC for Biology-LIPI, Bogor, Indonesia   |
| 71         | PURWANINGSIH, Sri       | RDC for Biology-LIPI, Bogor, Indonesia   |
| 72         | RADJAGUKGUK, Bostang    | Soil Science, Faculty of Agriculture, Gajah Mada Univ., Indonesia              |
| 73         | RAHAJOE, Joeni S.       | Graduate School of Environmental Earth Science, Hokkaido Univ., Japan          |
| 74         | RAHAYU, Sri Hartin      | RDC for Biology-LIPI, Bogor, Indonesia   |
| 75         | RISWAN, Soedarsono      | RDC for Biology-LIPI, Bogor, Indonesia   |
| 76         | SAEFUDIN                | RDC for Biology-LIPI, Bogor, Indonesia   |
| 77         | SAIM, Achmad            | RDC for Biology-LIPI, Bogor, Indonesia   |
| 78         | SAMAN, Tanpung N.       | University of Palangka Raya, Indonesia   |
| 79         | SAMBAS, Edi Nasriadi    | RDC for Biology-LIPI, Bogor, Indonesia   |
| 80         | SATYA, Ika Atman        | RDC for Limnology-LIPI, Cibinong, Indonesia                                    |
| 81         | SHIBUYA, Masato         | Faculty of Agriculture, Hokkaido Univ., Japan                                  |

| <b>No.</b> | <b>Name</b>           | <b>Affiliation</b>  |
|------------|-----------------------|---|
| 82         | SHIMADA, Sawahiko     | Graduate School of Environmental Earth Science, Hokkaido Univ., Japan         |
| 83         | SIREGAR, Mustaid      | RDC for Biology-LIPI, Bogor, Indonesia  |
| 84         | SUDIANA, I Made       | RDC for Biology-LIPI, Bogor, Indonesia  |
| 85         | SUGIARTO, Arwan       | RDC for Biology-LIPI, Bogor, Indonesia  |
| 86         | SUHERMAN, Dadan       | RDC for Geotechnology-LIPI, Bandung, Indonesia                                |
| 87         | SULANDARI, Sri        | RDC for Biology-LIPI, Bogor, Indonesia  |
| 88         | SULASTRI              | RDC for Limnology-LIPI, Cibinong, Indonesia                                   |
| 89         | SULIASIH              | RDC for Biology-LIPI, Bogor, Indonesia  |
| 90         | SULISTIO, Joko        | RDC for Biology-LIPI, Bogor, Indonesia  |
| 91         | SUMAWIJAYA, Nyoman    | RDC for Geotechnology-LIPI, Bandung, Indonesia                                |
| 92         | SUZUKI, Hitoshi       | Graduate School of Environmental Earth Science, Hokkaido Univ., Japan         |
| 93         | SYARIF, Fauzia        | RDC for Biology-LIPI, Bogor, Indonesia  |
| 94         | TACHIBANA, Harukuni   | Faculty of Engineering, Hokkaido Univ., Japan                                 |
| 95         | TAKAHASHI, Hidenori   | Graduate School of Environmental Earth Science, Hokkaido Univ., Japan         |
| 96         | TAKAYA, Yuichiro      | Yamagata University, Japan  |
| 97         | TAMAI, Yutaka         | Faculty of Agriculture, Hokkaido Univ., Japan                                 |
| 98         | TANAKA, Noriyuki      | Graduate School of Environmental Earth Science, Hokkaido Univ., Japan         |
| 99         | TAWARAYA, Keitaro     | Faculty of Agriculture, Yamagata Univ., Japan                                 |
| 100        | TERAZAWA, Minoru      | Faculty of Agriculture, Hokkaido Univ., Japan                                 |
| 101        | TOKURA, Seiichi       | Graduate School of Environmental Earth Science, Hokkaido Univ., Japan         |
| 102        | TORANG, Matling       | Department of Aquatic Resources Management, Univ. of Palangka Raya, Indonesia |
| 103        | TRIANA, Evi           | RDC for Biology-LIPI, Bogor, Indonesia  |
| 104        | TSUJI, Hiroyuki       | Graduate School of Environmental Earth Science, Hokkaido Univ., Japan         |
| 105        | TUAH, Sehat Jaya      | Faculty of Agriculture, Hokkaido Univ., Japan                                 |
| 106        | USUP, Aswin           | University of Palangka Raya, Indonesia  |
| 107        | UTAMI, Nanda          | RDC for Biology-LIPI, Bogor, Indonesia  |
| 108        | UTAMI, Ning Wikan     | RDC for Biology-LIPI, Bogor, Indonesia  |
| 110        | UTOSAWA, Kohken       | Hokkaido Institute of Technology, Japan                                       |
| 111        | WIDAWATI, Sri         | RDC for Biology-LIPI, Bogor, Indonesia  |
| 112        | WIDJAJA, Elizabeth A. | RDC for Biology-LIPI, Bogor, Indonesia  |
| 113        | YAMAKAWA, Keisuke     | Chiba University, Japan   |
| 114        | YONEBAYASHI, Koyo     | Faculty of Agriculture, Kyoto Prefectural Univ., Japan                        |
| 115        | YOSHIHARA, Teruhiko   | Faculty of Agriculture, Hokkaido Univ., Japan                                 |
| 116        | YULINERY, Titin       | RDC for Biology-LIPI, Bogor, Indonesia  |
| 117        | YUSTIAWATI            | RDC for Limnology-LIPI, Cibinong, Indonesia                                   |
| 118        | YUSUF, Razali         | RDC for Biology-LIPI, Bogor, Indonesia  |
| 119        | ZEIN, M. S. A         | RDC for Biology-LIPI, Bogor, Indonesia  |