

E-DAT industryIP67 Einbaufansch

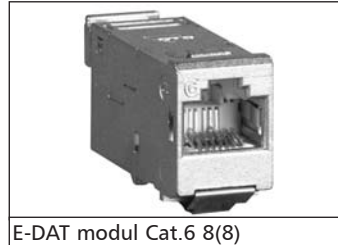

Einbaufansch



E-DAT modul Cat.6 8(8)

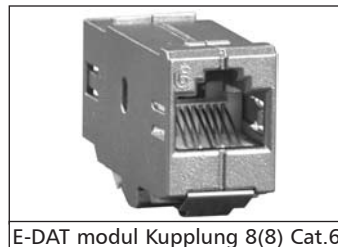

E-DAT modul Kupplung 8(8) Cat.6

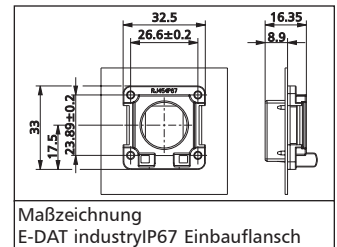

Maßzeichnung
 E-DAT industryIP67 Einbaufansch

- Erfüllt in gestecktem Zustand Schutzart IP67
- Steckgesicht gemäß IEC 61076-3-106 (Variante 6)
- Anschlusseinheit für eine 8-polige RJ45-Buchse
- einfache, zeitsparende Montage
- Anschluss handelsüblicher RJ45-Stecker möglich (kein IP-Schutz)
- Bauform EBK geeignet für Keystone-Module, Keystone-Kupplungen und UTP modul
- Bauform EBM geeignet für E-DAT modul Cat.6, E-DAT modul Kupplung 8(8) Cat.6, E-DAT modul Kupplung 8(8) 90° Cat.6, UAE modul Cat.5e und UAE modul Cat.6
- Gegenplatte aus stabilem Zinkdruckguss
- IP67-Verschlussdeckel unverlierbar
- incl. Einbaudichtung
- Abmaße ca. 33 x 33 mm

Ausführung	Bestell-Nr.
E-DAT industryIP67 EBM, Einbaufansch für E-DAT modul ohne Montageset	1309413003-E
mit Montageset	1309413203-E
E-DAT industryIP67 EBK Einbaufansch für Keystone-Module, Keystone-Kupplungen und UTP modul ohne Montageset	1309413103-E
mit Montageset	1309413303-E
Montageset (optional)	13094130-E
E-DAT modul Cat.6 8(8)	130910-I
E-DAT modul Kupplung 8(8) Cat.6	1309A0-I
E-DAT modul Kupplung 8(8) 90° Cat.6	1309A1-I
UAE modul Cat.5e 8(8)	130908-I
UAE modul Cat.6 8(8)	130909-I
UTP modul Cat.6 8(8)	130A10-I

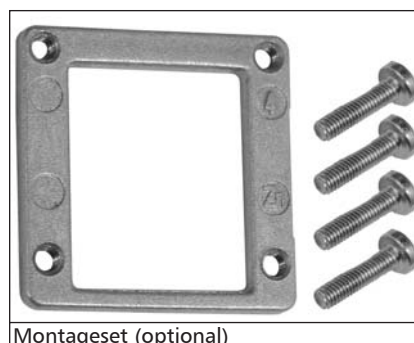

Montageset (optional)

NEU

E-DAT industryIP67 Mounting Flange



Mounting Flange

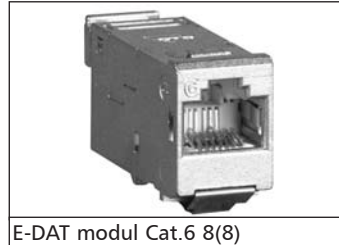

E-DAT modul Cat.6 8(8)

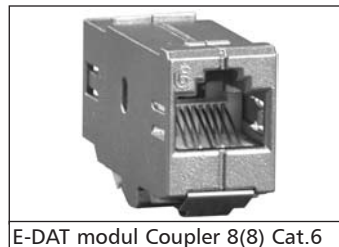

E-DAT modul Coupler 8(8) Cat.6

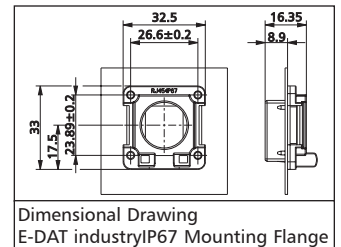

Dimensional Drawing
 E-DAT industryIP67 Mounting Flange

- Meets protection rating IP67 when plugged
- Connector face per IEC 61076-3-106 (variant 6)
- Termination unit for one 8 pole RJ45 jack
- Easy time saving installation
- Allows termination of standard RJ45 plugs (no IP protection)
- EBK version suitable for Cat. 5e keystone coupler and UTP modul
- EBM version suitable for E-DAT modul Cat.6, UAE modul Cat.5e and UAE modul Cat.6
- Solid zinc die cast counter plate
- Captive IP67 sealing cap
- Incl. mounting gasket
- Exterior dimensions about 33 x 33 mm

Version	Part Number
E-DAT industryIP67 EBM mounting flange for E-DAT modul without mounting kit	1309413003-E
with mounting kit	1309413203-E
E-DAT industryIP67 EBK mounting flange for keystone modules, keystone couplers and UTP modul without mounting kit	1309413103-E
with mounting kit	1309413303-E
Mounting kit (optional)	13094130-E
E-DAT modul Cat.6 8(8)	130910-I
E-DAT modul Coupler 8(8) Cat.6	1309A0-I
E-DAT modul Coupler 8(8) 90° Cat.6	1309A1-I
UAE modul Cat.5e 8(8)	130908-I
UAE modul Cat.6 8(8)	130909-I
UTP modul Cat.6 8(8)	130A10-I

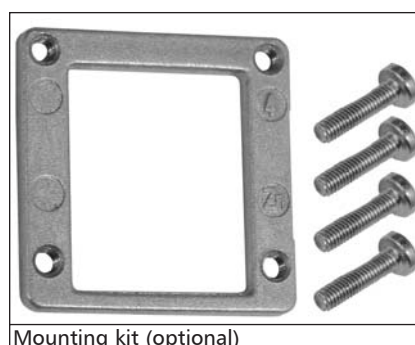

Mounting kit (optional)

NEW