

DOE Bioenergy Technologies Office (BETO) 2023 Project Peer Review

MICROCHANNEL REACTOR FOR ETHANOL TO N-BUTENE CONVERSION

April 4, 2023

SDI – Emerging and Support Technologies

Presenter: Matthew Coblyn, Oregon State University

Project PI: Brian Paul, Oregon State University



LanzaTech





1 - Approach: Motivation for ATJ Processing

PNNL co-developed Alcohol-to-Jet Process (ATJ)

- DOE-BETO goal to enable SAF production of 35 billion gallons per year by 2050.
- ATJ is regarded as one of the most promising technologies for scaled production of SAF.
- LanzaTech/ LanzaJet is commercializing earlier ATJ process technology developed at PNNL.



October 2018 Virgin Atlantic flight using low-carbon fuel from LanzaTech/ LanzaJet biorefinery in Georgia using technology co-developed with PNNL.

Differentiators versus current ATJ

- **Capital savings:** eliminates dehydration step
- **Energy savings:** combines endothermic and exothermic reactions
- Potential for **co-products** from ethanol enabled with new multifunctional catalysts

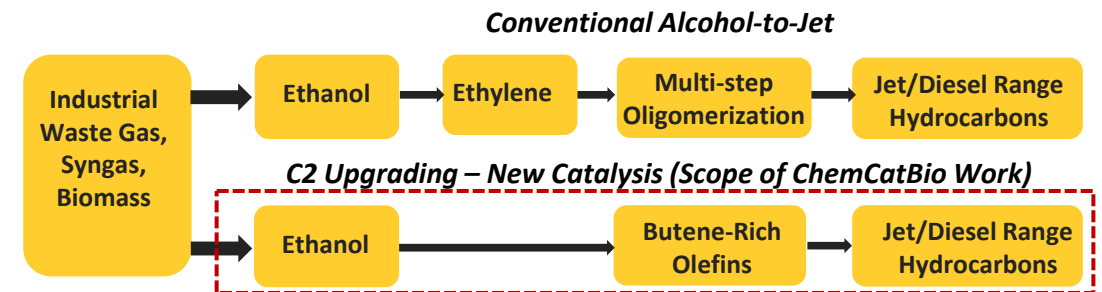

US Patent 10,647,625
US Patent 10,647,622

ACS Catal. 2020, 10, 18, 10602–10613
ChemCatChem 2020, 12, 1-11



1 – Approach: Motivation for Microchannel Technology

- Here we focus on demonstration for the **scale-up** of the **catalyst technology**
- Scale-up uses **microchannel reactors**, enabling further **process intensification** and **modularity**

- **Scale up by numbering up**, quickening time to market and reducing risk
- Leverages recent advances in **additive manufacturing (lowering reactor costs)**

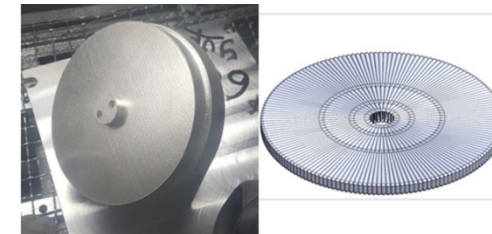
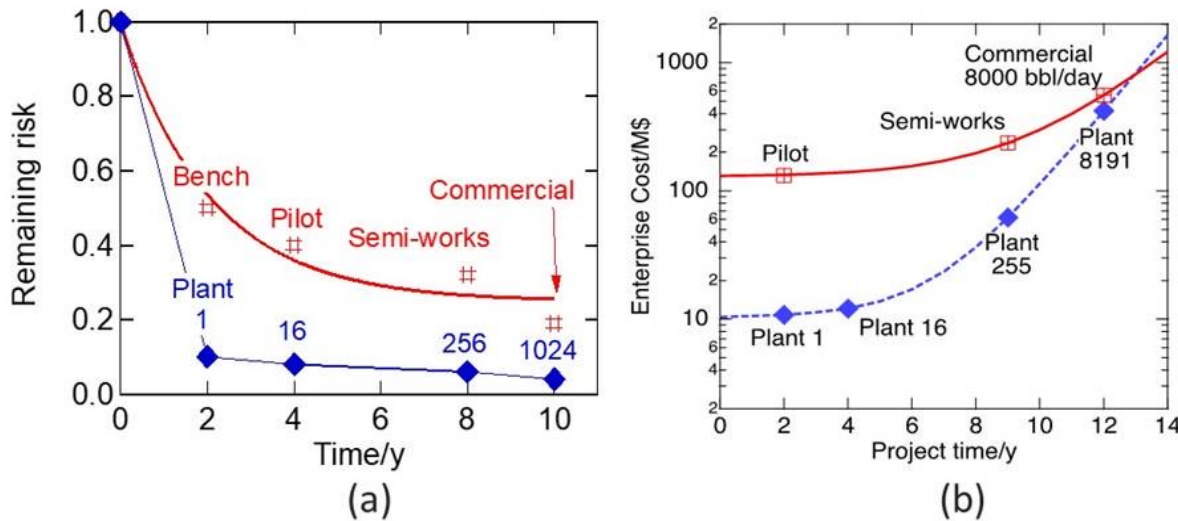

Microchannel reactors increase efficiency and reduce cost of biofuel/chemical production; amendable at the scale of biomass

Figure: (a) risk-reduction, and (b) enterprise cost models for numbering up and conventional scaling



1 – Approach: Project Objectives

BP	Objectives
1	<ul style="list-style-type: none">• Verify PNNL bench scale results for ethanol conversion
2	<ul style="list-style-type: none">• Design, fabricate, and demonstrate subscale microchannel reactor prototype unit (that scales up by numbering up).• Demonstrate a functional catalyst substrate, to be integrated with the reactor vessel during additive manufacturing, with sufficient surface composition, surface area, porosity, and adhesion to support catalyst loading and reactor operation necessary for ethanol conversion.
3	<ul style="list-style-type: none">• Demonstrate scalability by numbering to 0.15 LPM fermentation-derived ethanol for 500 hours of operation.• Evaluate the potential with TEA to achieve a \$3.0/GGE jet blendstock, and through LCA to achieve a 60% reduction in CO₂ emissions relative to conventional technology.<ul style="list-style-type: none">• Use manufacturing cost models to evaluate potential benefits of additive manufacturing methods• Perform a Technology to Market analysis to evaluate applicability to LanzaTech’s ethanol commercial platform and market viability



1 – Approach: Go/No-Go Decision Points

	Decision	Criteria
 Oct 2021	BP1 - Confirm benchmark data and assumptions provided in the application.	Benchmark/baseline data are replicated (90% ethanol conversion, 80% selectivity to olefins, 55% to C3+ olefins, over PNNL catalyst).
 Jan 2023	BP2 - Evaluate reactor design and fabrication to be used for scaled reactor demonstration.	1) Successful single-channel reactor (< 5 g catalyst i.e. “bench scale”) performance (>80% ethanol conversion, >80% selectivity to butene-rich olefins; 350-450°C, 100-200 psig, 0.5-2.0 gEtOH/gcat/hr); 2) A reactor design that meets the above metrics at 0.15 L/min ethanol scale; 3) Manufacturing cost models and TEA that supports the system level cost targets.



2 – Progress and Outcomes: BP1 G/NG Verification

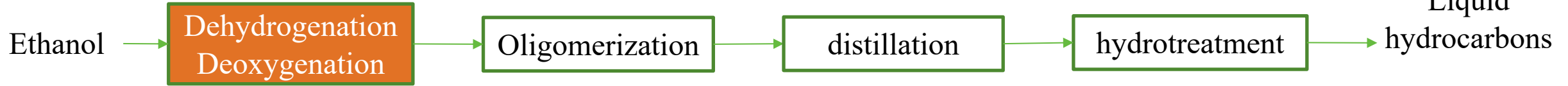

- In BP1 PNNL replicated bench scale **powder catalyst** experiment for ethanol-to-butene conversion from proposal
- 1-step conversion over PNNL Catalyst
- Performance target: **80% total olefin selectivity** at 90% ethanol conversion.
- Good agreement in conversion and product selectivity between two runs ✓

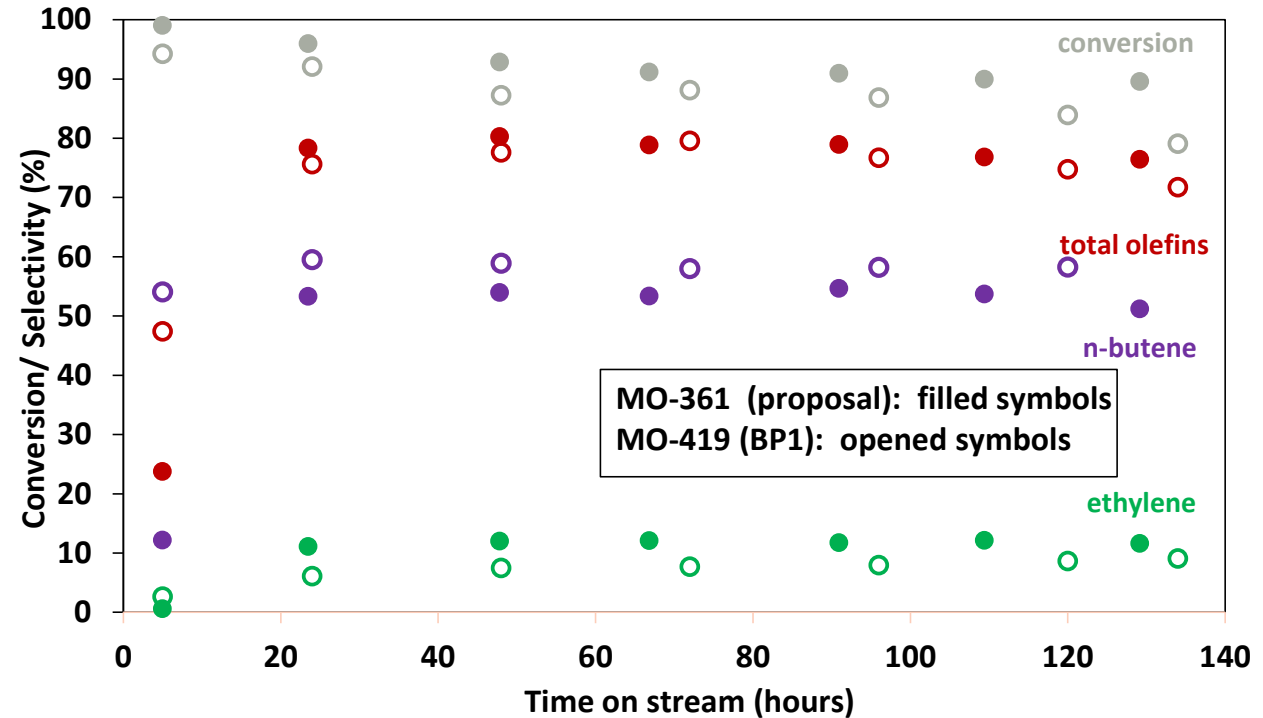

400°C, 100 psig, 1.8 hr⁻¹; Feed = 11 mol% EtOH in H₂ (0.0385 ml/min EtOH + 120 sccm H₂); Catalyst = 2.0 g (PNNL powder catalyst)



2 – Progress and Outcomes: Single Channel Reactor - “Baseline Reactor”

Engineered catalyst using baseline approach

- In BP2, PNNL replicated catalyst performance of powder catalyst data when using **engineered catalyst** in **single channel reactor** testing.
- PNNL **baseline reactor** approach utilizes single channel reactors fabricated and loaded with vendor-provided **foam inserts** that are wash-coated with catalyst
 - Engineered catalysts with dimensions: 5 mm x 5 mm x 4.5 in

Powder PNNL Catalyst Washcoated on
FeCrAlY foam

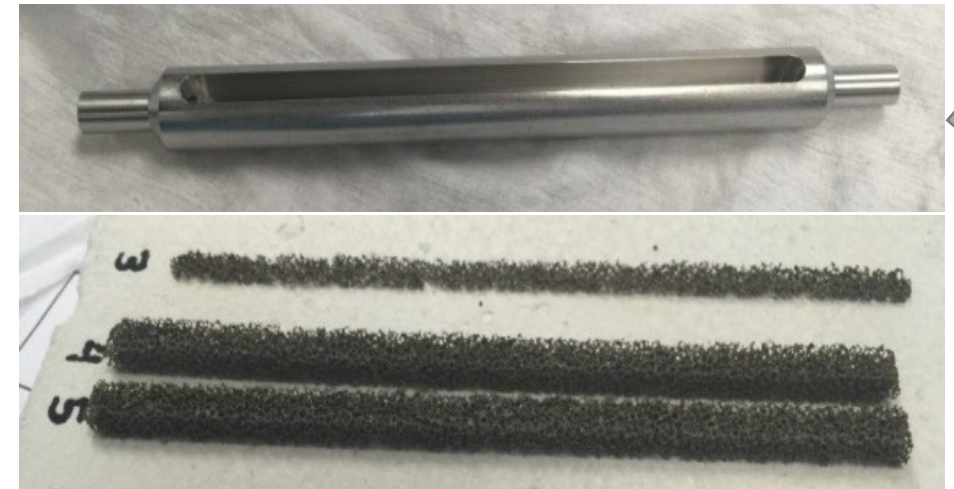

FeCrAlY Foam Inserts



2 – Progress and Outcomes: Reactor Performance

Single Channel Reactor - "Baseline Reactor" Results

Ethanol Conversion

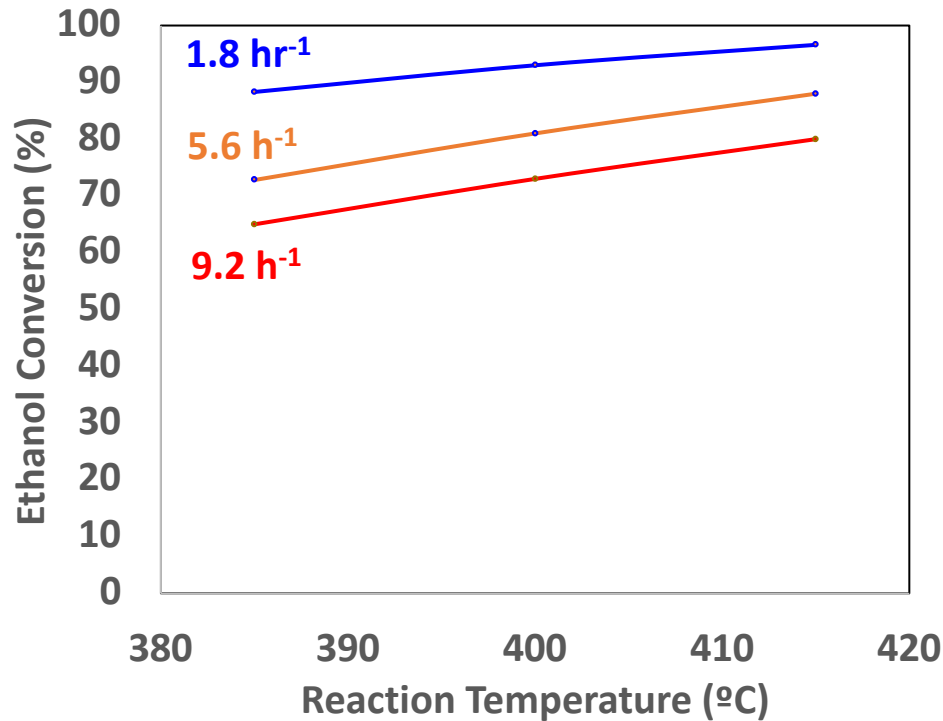

Product Selectivity

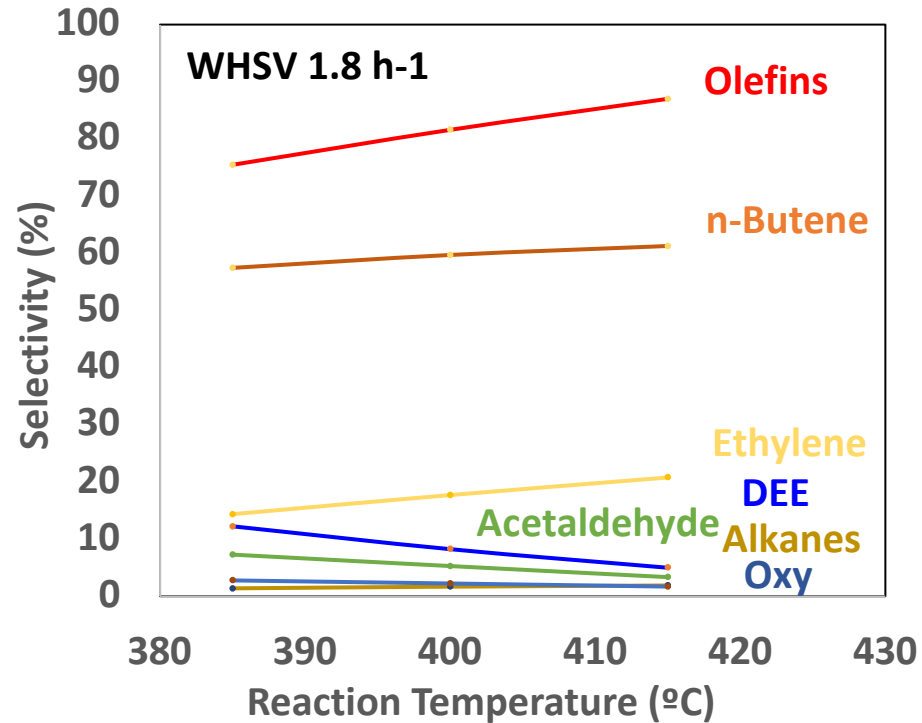

- 0.5 g catalyst wash coated on FeCrAlY Foam
- Feed: Ethanol = 10.9 mol%, H₂=89.1 mol %
- 100 psig (varied temperature and WHSV)

- Single channel reactor performance favorable and matched well with BP1 powder catalyst data (MO-419)
- Ethanol conversion > 80% and olefin selectivity > 80% target achieved (400°C, 100 psig, 1.8 hr⁻¹)
- Catalyst performance data also obtained for kinetics modeling and reactor design

G/NG Criteria #1: Successful **single-channel reactor** (< 5 g catalyst i.e. "bench scale") performance (>80% ethanol conversion, >80% selectivity to butene-rich olefins; 350-450°C, 100-200 psig, 0.5-2.0 gEtOH/gcat/hr) ✓



2 – Progress and Outcomes: Kinetic Modeling

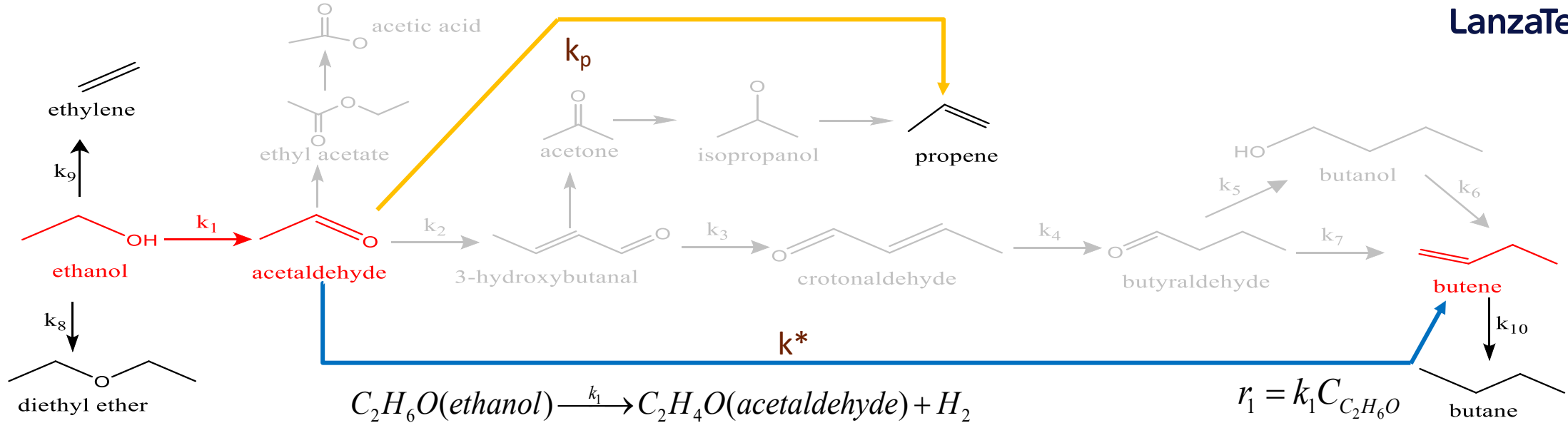

Kinetic model developed using single channel data for reactor design purpose

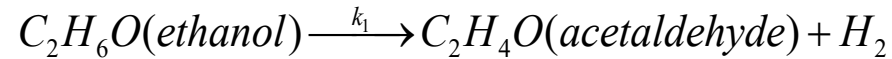

$$r_1 = k_1 C_{C_2H_6O}$$

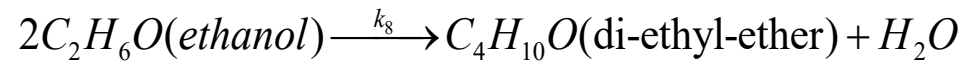

$$r_8 = k_8 C_{C_2H_6O}$$

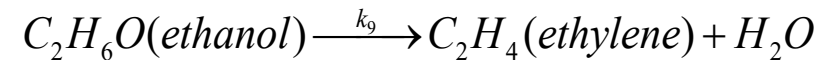

$$r_9 = k_9 C_{C_2H_6O}$$

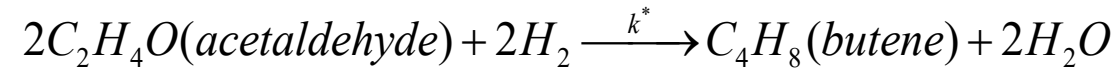

$$r_* = k^* C_{C_2H_4O}$$

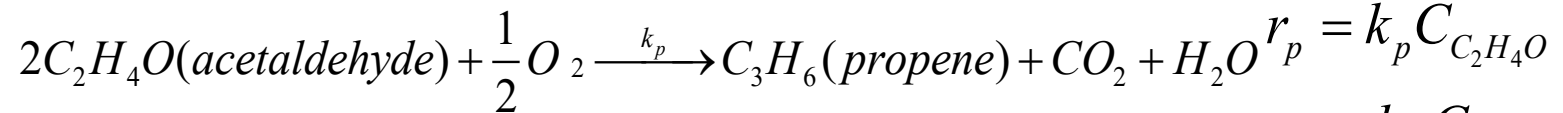

$$r_p = k_p C_{C_2H_4O}$$

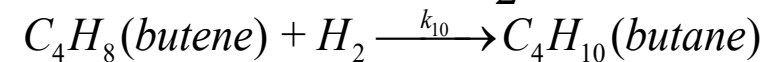

$$r_{10} = k_{10} C_{C_4H_8}$$



2 – Progress and Outcomes: Kinetic Modeling

Model Validation - Experimental and Model results compare well (single channel FeCrAlY data, 415°C)

$$k = Ae^{\frac{-E_a}{RT}}$$

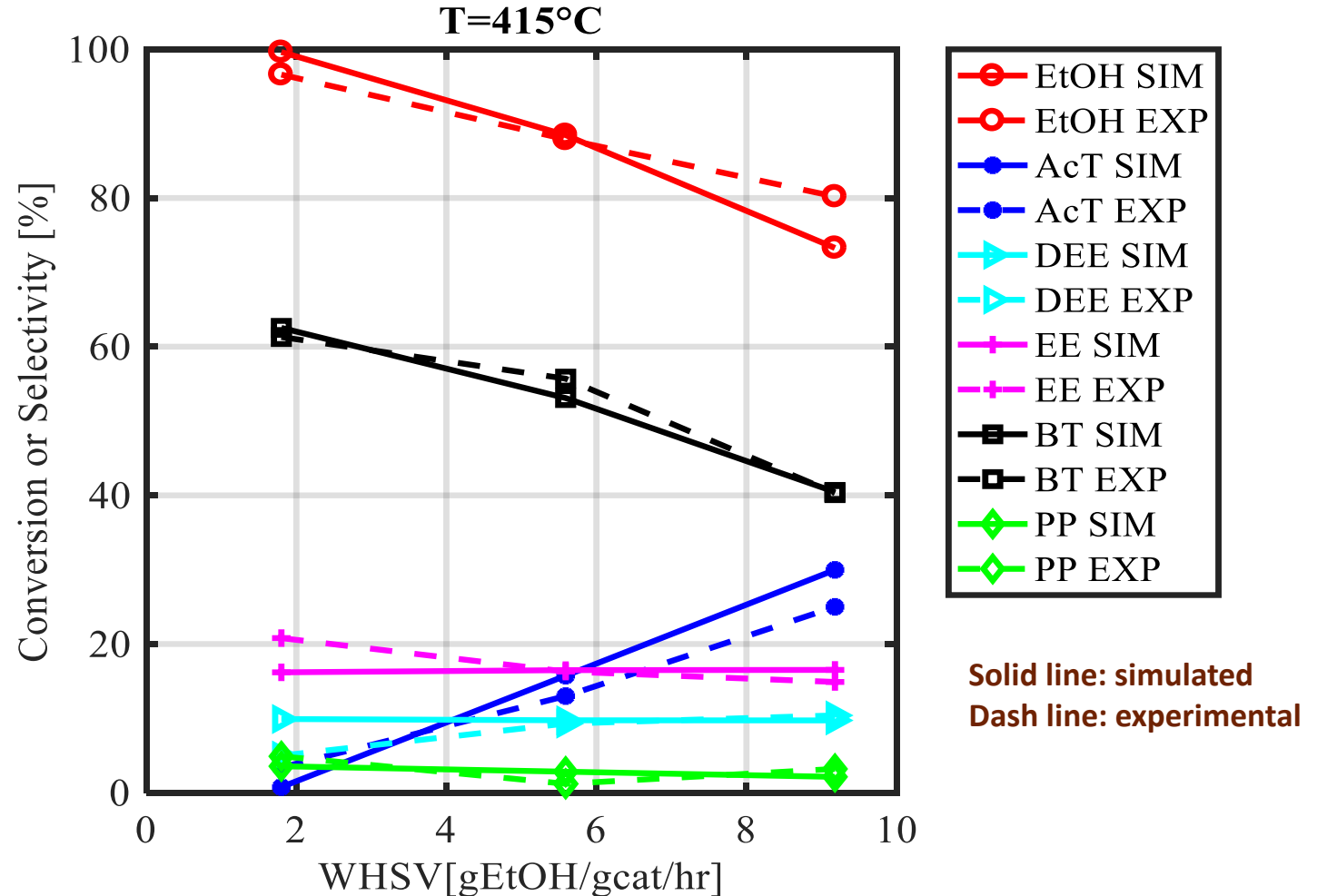



2 – Process and Outcomes: Reactor Modeling & Reactor Design

Demonstration Scale Reactor Design

- Reactor modeling of design meets the BP2 metrics (80/80) at 0.15 L/min ethanol scale

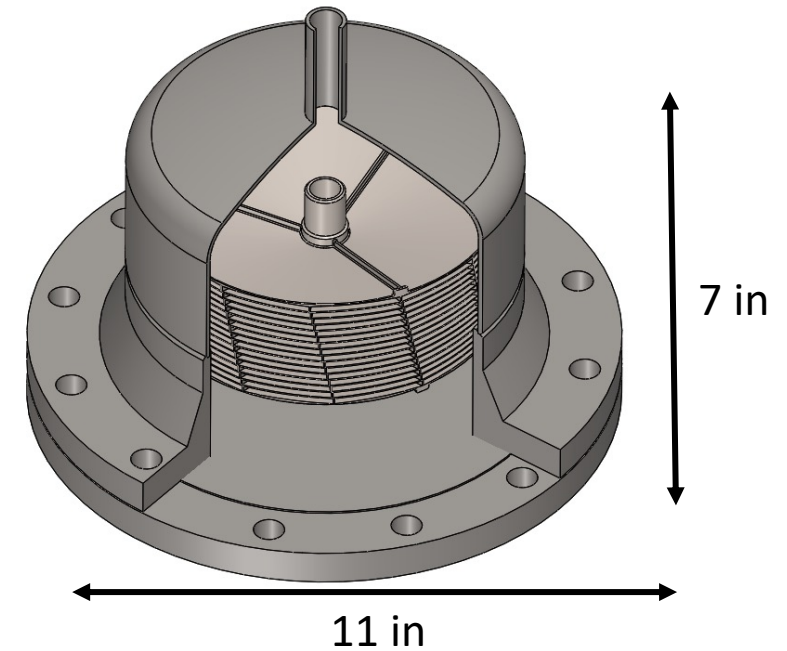
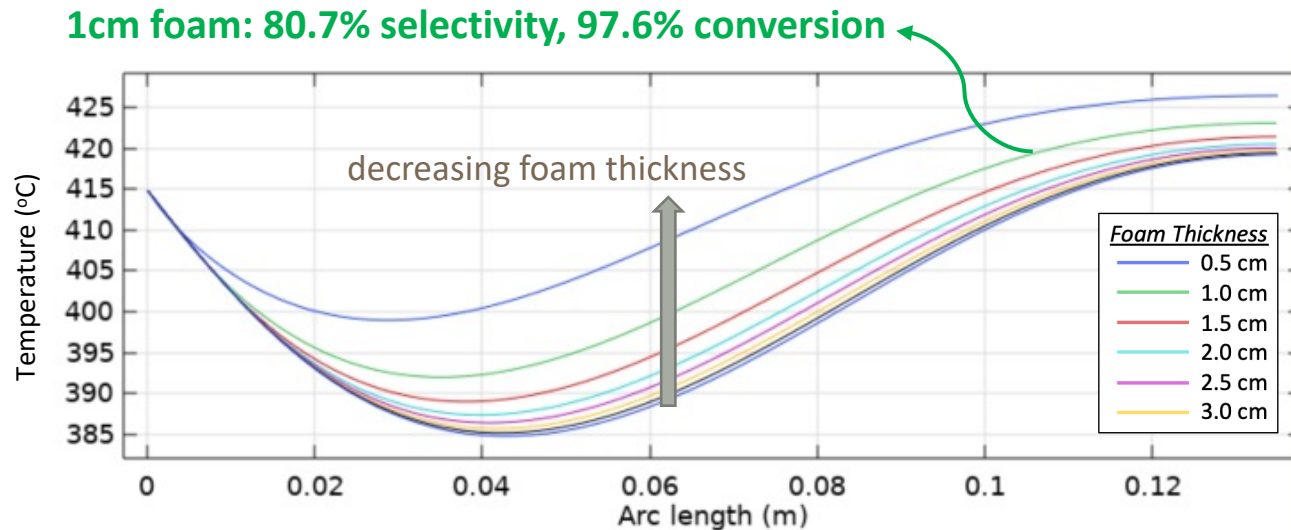

- G/NG Criteria #2:** Successful reactor design that meets the above metrics (80% selectivity/80% conversion) at 0.15 L/min ethanol scale
- Can be scaled up by numbering up to commercial scale.





2 – Progress and Outcomes: Process Modeling and TEA

Costs Derived from System-level TEA

Cost	Value (2016 \$)	Notes
Reactor (total installed cost)	\$32.0 million	Assumes adiabatic reactor operation and external heat exchangers

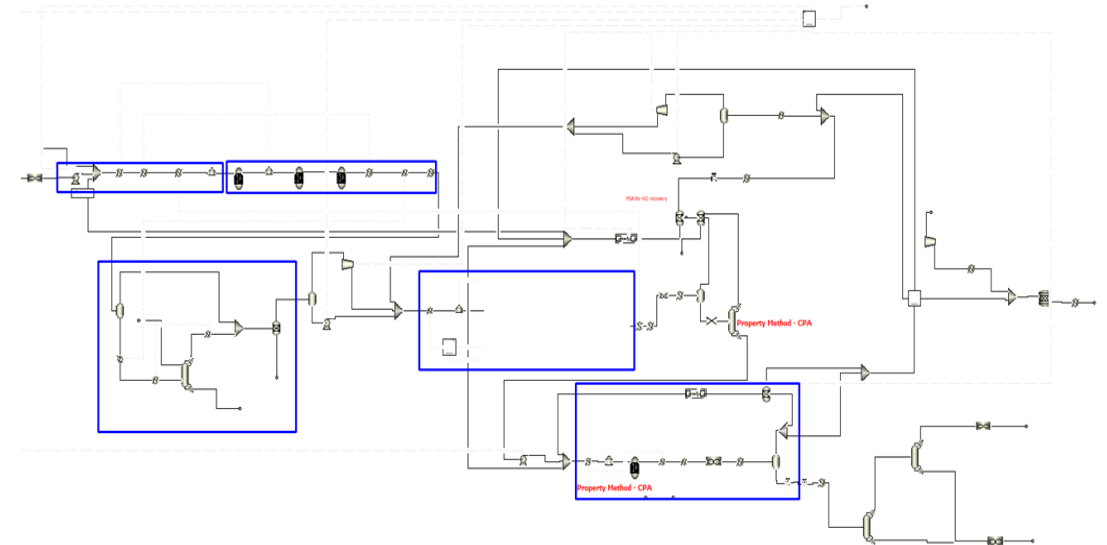

Reactor cost target required to meet \$3.00/GGE cost target, with no butene side product sales (Stretch Goal)



2 – Progress and Outcomes: Process Modeling and TEA

Catalyst

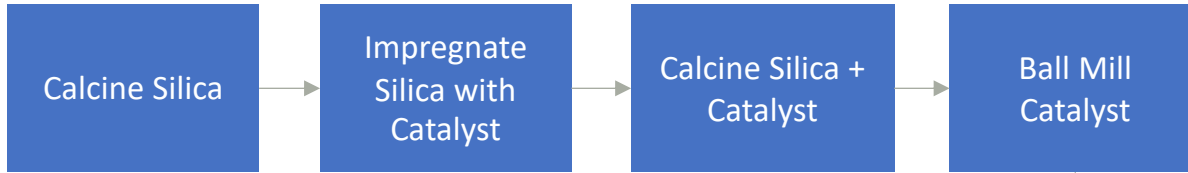

Catalyst Insert

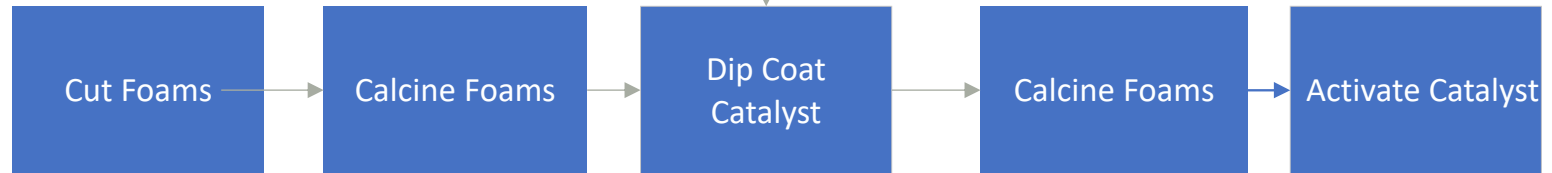

Reactor Shell

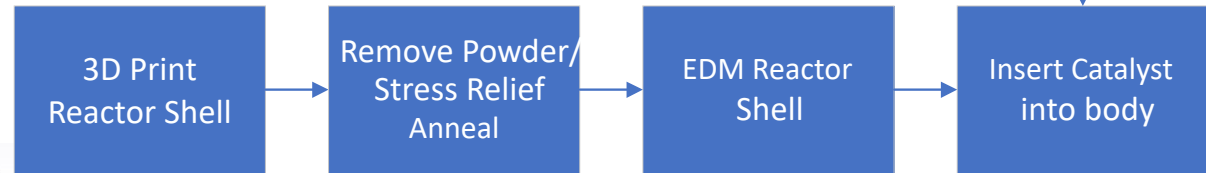

Reactor

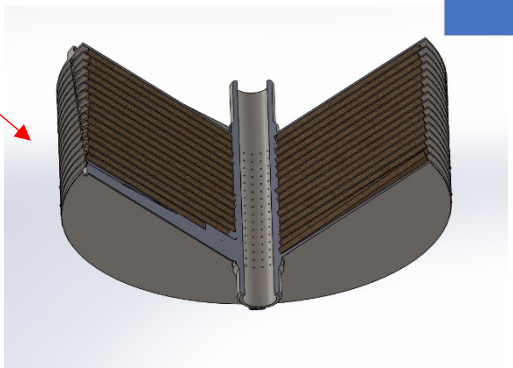
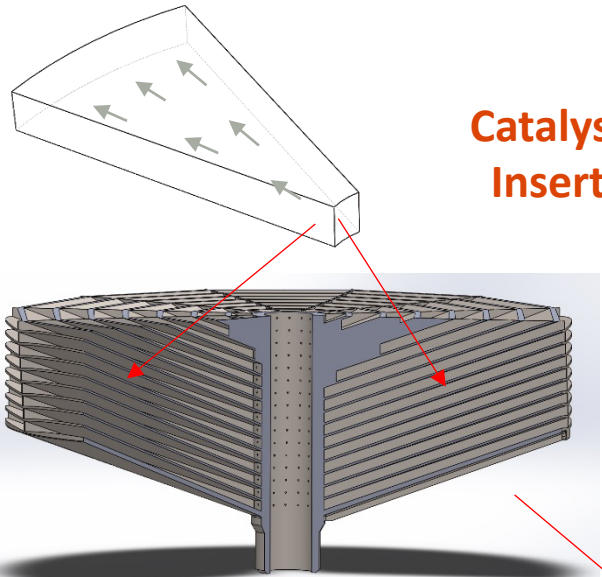



2 – Progress and Outcomes: Commercial Scale Reactor Design

Baseline Production-Scale Reactor

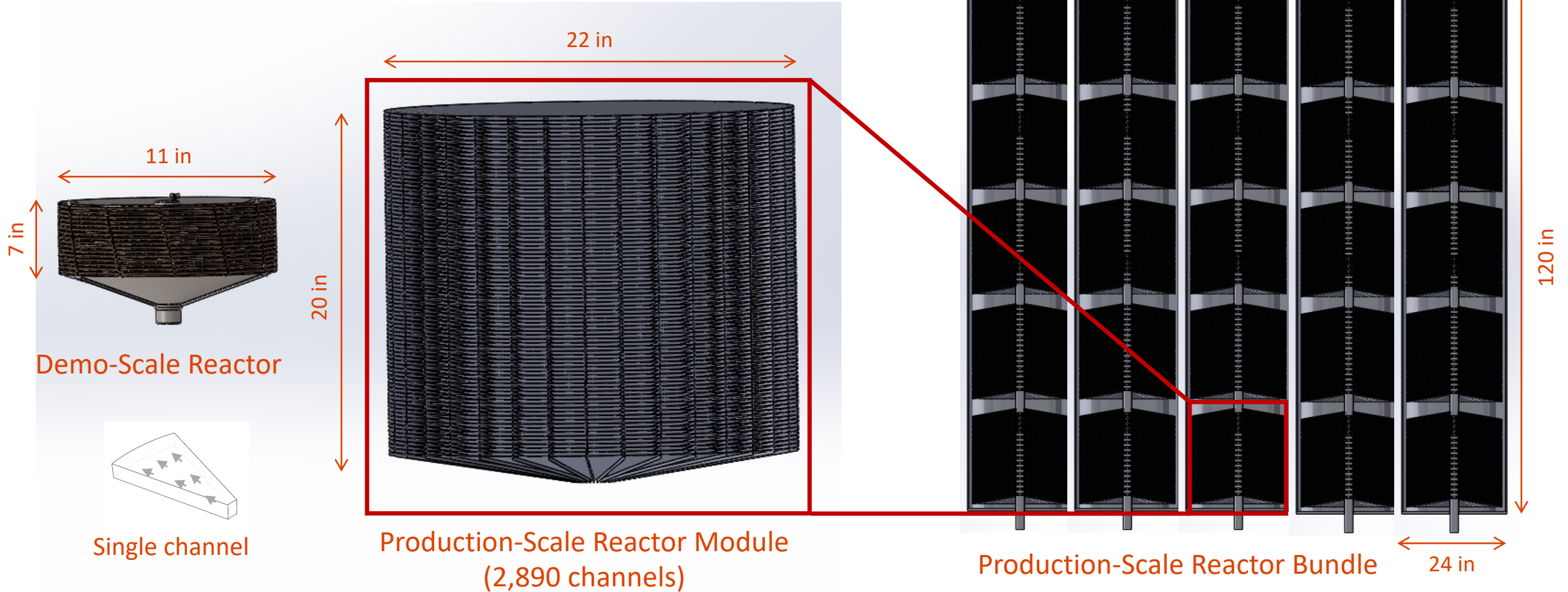



2 – Progress and Outcomes: Reactor Fabrication Cost Analysis

Baseline Reactor Results

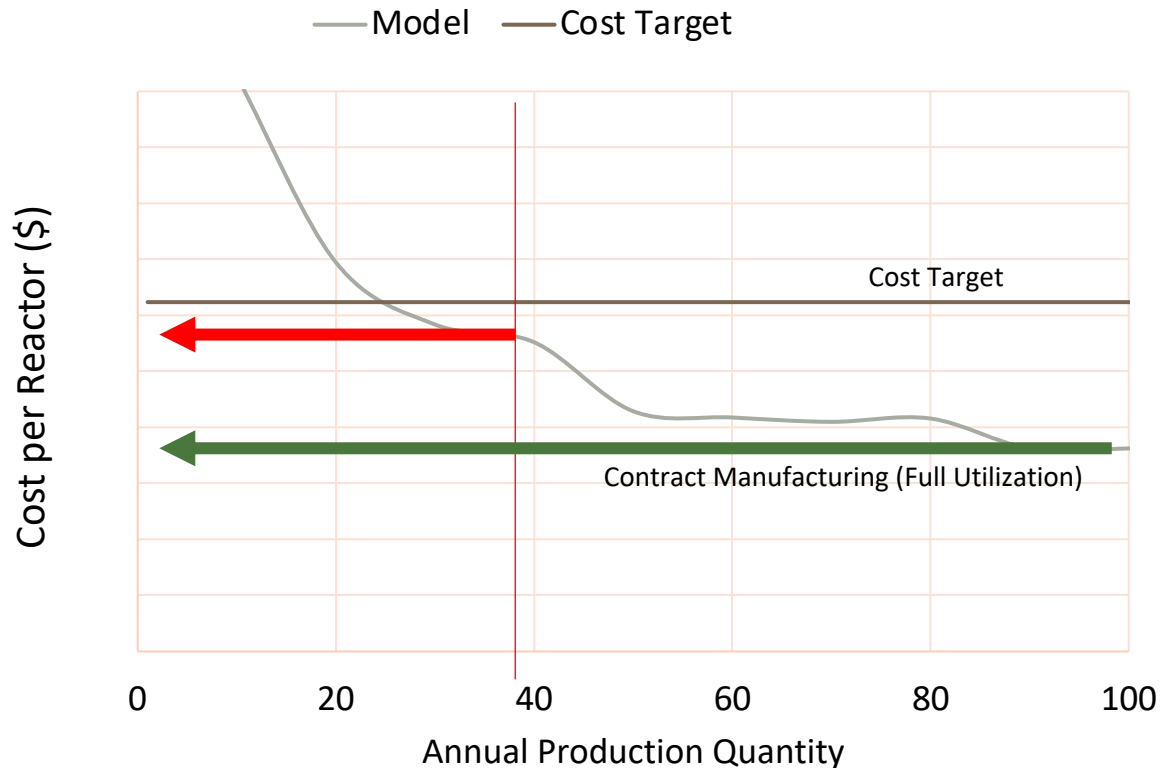

Breakout of Cost Categories

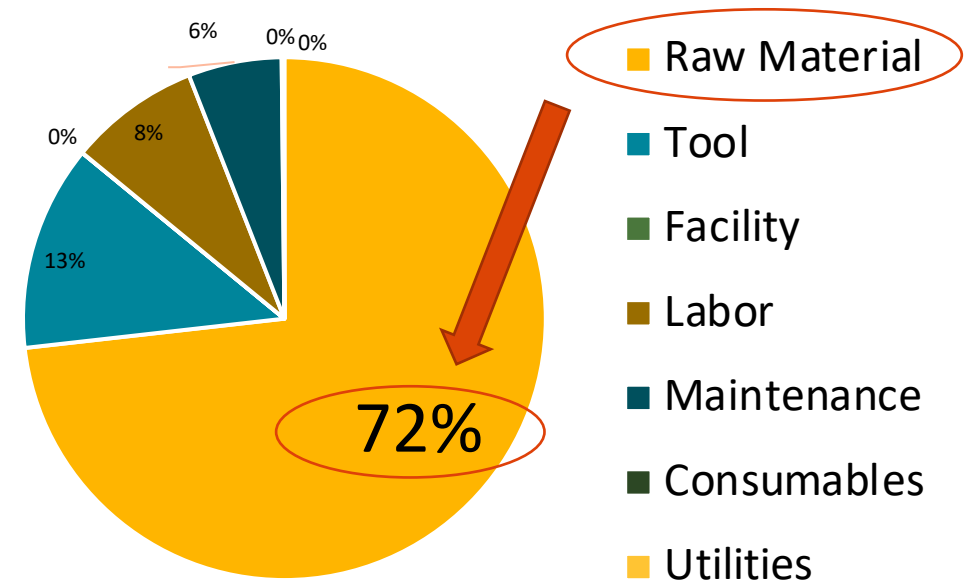

G/NG Criteria #3: Manufacturing cost models and TEA that supports the system level cost targets





2 – Progress and Outcome: Additive Manufacturing of Advanced Reactors

Advanced Reactors Improve Economics

Reactor	Approach	Risk/ Benefit	Lead
Baseline	Baseline manufacturing	Low-risk	PNNL
Advanced Reactor 1	Laser Powder Bed Fusion (LPBF) in SS + in-situ coating	High-risk, Better economics	OSU
Advanced Reactor 2	Hybrid Laser Directed Energy Deposition (LDED) in FeCrAlY + in-situ coating	High-risk, Better economics	OSU

	Qty	Differential
Total Reactor Equipment Cost	38	
Baseline Reactor	38	-3%
Advanced Reactor 1	38	-48%
Advanced Reactor 2	54	-30%



2 – Progress and Outcome: Advanced Reactor Proof-of-Concept

SS foam - after treatment, catalyst wash coating, and hydrothermal testing



Hydrothermal conditions: 20% steam @400C/100psi
466 sccm (0.2 m/s), 24 hrs

Treated stainless steel (SS) foam

OSU printed FeCrAlY
1.0 mm pore size - top view

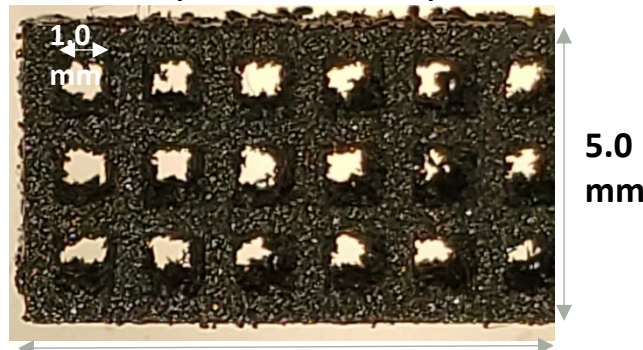

12.2 mm (0.5 in)

OSU-printed FeCrAlY lattice structure

Single Channel Catalytic Performance

Reactor Type	Catalyst Foam Substrate (from vendor)	Conversion (%)	Selectivity (mol C%)	
			Total Olefins	Butene
Baseline Reactor	FeCrAlY (50 ppi)	93.0	81.5	59.7
Advanced Reactor #1	Treated SS (60 ppi)	88.0	78.1	64.8

Engineered catalyst substrates coated with 0.5 g of active catalyst formulation (2 foams X 5 X 5 X 114 mm). Conditions = 400°C, 1.8 hr⁻¹, 100 psig, Feed = 11 mol% ethanol in H₂.

Single Channel Catalytic Performance

Reactor Type	FeCrAlY Foam Source	Conversion (%)	Selectivity (mol C%)	
			Total Olefins	Butene
Baseline Reactor	Vendor Provided	54.4	69.9	33.5
Advanced Reactor #2	OSU Printed	58.2	57.9	46.8

Engineered catalyst substrates coated with 0.2 g of active catalyst formulation (1 foam: 5 X 5 mm). Reactor length = 25.4 mm. (400°C, 100 psig, WHSV EtOH = 4.5 hr⁻¹, 11 mol% ethanol in H₂).



3 – Impact: Improvement to State-of-the-Art

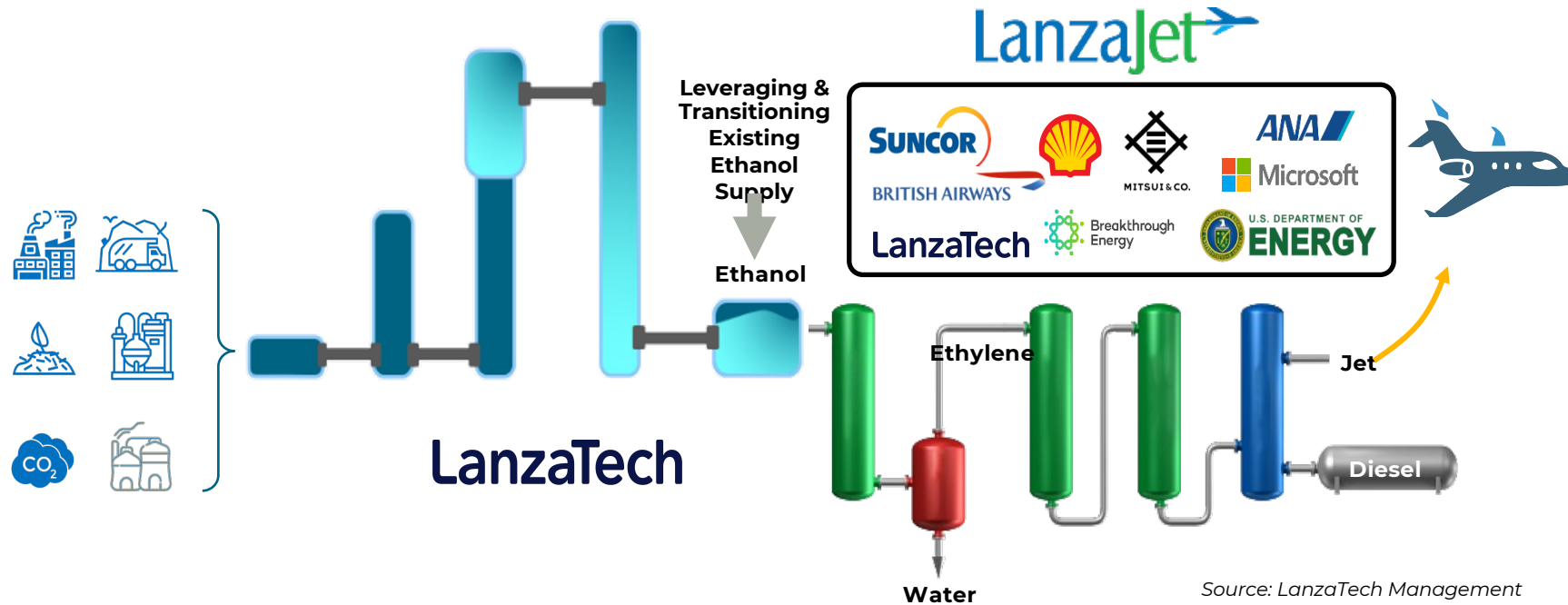

LanzaJet Deployment Plans

- 100 MGPY by 2025
- 10 MGPY Demo Plant Under Construction at Freedom Pines, GA
- 4 x 30 MGPY Plants on the horizon
- Portfolio of Projects Developing Around the Globe

Source: LanzaJet.com

Source: LanzaTech Management

Microchannel reactor opens up the opportunity to reduce the number of reactors and allow the production of smaller, modular process units that can allow distributed production of SAF using the PNNL/LanzaTech (LanzaJet) Process



3 – Impact: Spin-out to Commercial Engagement Projects

Process Intensification

Microscale-based Chemical Processing

- Extremely short characteristic times of transport in microscale architecture.
- High surface to volume ratio



- *Short Residence Times*
- *Improved Conversion and Selectivity*
- *Improved Energy Efficiency*

Modular Chemical Manufacturing

- *Scale-up through numbering-up of microchannels in a reactor and reactors in a module.*



- *Predictable, faster scale-up process*
- *Leverage economies of scale in reactor manufacturing*
- *Faster to market and scale production to demand*

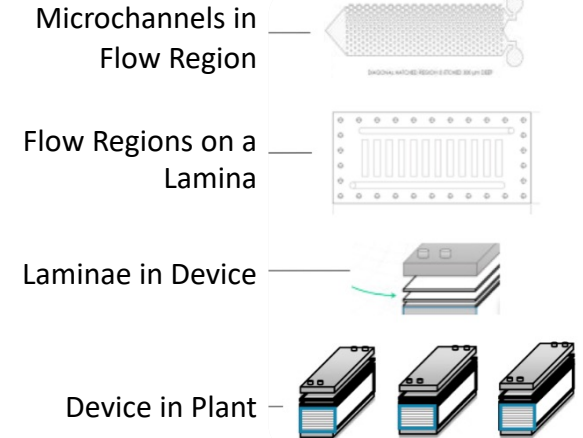

Example of multiples levels of numbering-up in a microscale-based LLE separator. (Summerville, et al. Procedia Manufacturing, 2020)

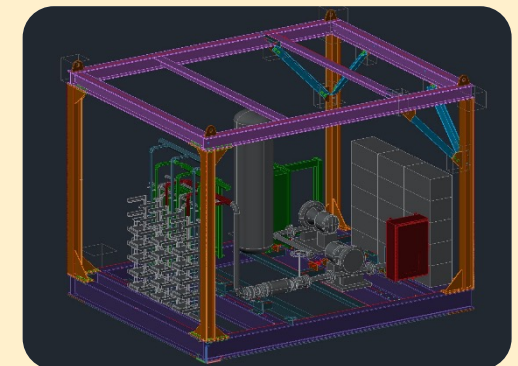

Modular Plant Example. (RAPID MCPI Bootcamp, 2019)



Summary

Project Goal:

- Develop new catalytic pathway for **direct ethanol to n-butene-rich olefins**, providing control over jet and diesel blendstocks and co-products, to enable distillate MFSP of \$3.00/GGE and >70% GHG emission reduction.
- Scale up using advanced process intensified and modular microchannel reactor technology.

Approach:

- Collaborative approach across academia, national laboratory, and leading bioenergy company targeting key challenges around new processing chemistry and scale-up.
- Setting state-of-the-art ethanol conversion for process intensification & high C efficiency
- Co-products can reduce costs, diversity product offerings

Progress and Outcomes:

- Ethanol to butene catalyst formulation verified suitable for scale up.
- Engineered catalyst developed that will **enable scale up** using microchannel reactor architecture.
- New engineered substrate developed that will be feasible in advanced reactor system not employing separate catalyst inserts.
- Proof of concept established for **3-D printed substrate** with multi-metal components and **demonstrated suitable conversion** with addition of catalyst.
- Kinetics and reactor modeling led to design of scaled reactor system that is projected to hit demonstration scale capacity target

Impact:

- Cost advantage potential to current state of technology ATJ processing
- Developing new fabrication methods that will **reduce capital costs** for modular processing systems
- Modularity enables **quicker time to market, reduced upfront risk**
- Tech transfer with industry



Quad Chart Overview

Timeline

- *Project start: October 2020*
- *Project end: February 2025*

Project Goal

Develop a new ethanol-to-n-butene conversion platform that will save cost and energy for the current alcohol-to-jet fuel process being developed by LanzaTech.

End of Project Milestone

- Demonstrate **scalability** at 0.15 LPM fermentation-derived ethanol for ≥ 500 hours with ≥ 100 continuous hours of operation, $\geq 80\%$ ethanol conversion and $\geq 80\%$ selectivity to olefin intermediates.
- **TEA** and **LCA** supporting targets of \$3.0/GGE jet blendstock with a 60% reduction in CO2 emissions relative to conventional technology.
- **Market analysis** showing applicability of the reactor for LanzaTech and **market viability assessment**.

	FY22 Costed	Total Award
DOE Funding	<i>OSU/LT: \$453,857 PNNL: \$254,640</i>	<i>OSU/LT: \$2,050,000 PNNL: \$1,950,000</i>
Cost Share	<i>\$145,153</i>	<i>\$1,000,000</i>

Funding Mechanism

DE-FOA-0002203, FY20 Topic Area 1: Scale-Up of Bench Applications (SCUBA)

TRL at Project Start: 3
TRL at Project End: 5

Project Partners

Oregon State University / Pacific Northwest National Laboratories / LanzaTech



Acknowledgements

Oregon State University

Brian Paul

Goran Jovanovic

Somayeh Pasebani

Chih-hung Chang

Matthew Coblyn

Kwangtae Son

Fuqiong Lei

Hsin-Mei Kao

Saereh Mirzababaei

Mitra Abbasi

Mark Rice

Maria Wright

LanzaTech

Ralph Gillespie

Michelle Kocal

Laurel Harmon

Brian Vicente

Rohit Kalvakaalva

PNNL

Robert Dagle

Johnny Saavedra Lopez

Patrick McNeff

Richard Zheng

Austin Winkelman

Mike Hubbard

Bioenergy Technologies Office

Mark Shmorhun

Liz Moore

Umakanta Jena



Oregon State
University



LanzaTech

Questions?

- Presenter: Matthew Coblyn, coblynm@oregonstate.edu
- Project PI: Brian Paul, brian.paul@oregonstate.edu



Publications, Presentations, and Technology Transfer, and Industry Partnerships

Industry Partnerships

LanzaTech

ONADDITIVE

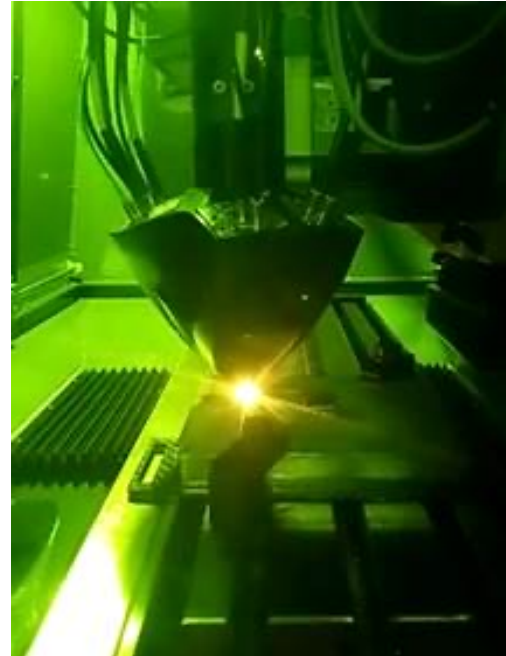

OSU is working with OnAdditive to produce a state-of-the-art hybrid LDED machine tool that will be used in advanced reactor development. The tool offers the potential to further reduce capital costs while providing a faster time-to-market.



Comments from Peer Reviews and Highlights from Go/No-Go Reviews

- This is the first peer review for this project.
- Highlights from previous Go/No-Go Reviews
 - BP1 Go/No-Go – excerpts from report by ICF, September 30, 2021
 - *The objective of the verification was to verify PNNL bench scale catalysis results with a previous experiment (MO-361) for ethanol conversion, C3+ olefin selectivity and total olefin selectivity.*
 - *Based on the overall results of the verification testing we are of the opinion that the OSU/PNNL/LT catalytic conversion verification has demonstrated the technical readiness to move to Budget Period 2.*
 - BP2 Go/No-Go
 - *Positive feedback received from DOE program team and ICF engineers at Go/No-Go meeting held January 31, 2023 at PNNL.*
 - *Final Go/No-Go report pending.*



Oregon State
University

Extra Slides



**Pacific
Northwest**
NATIONAL LABORATORY

LanzaTech



1 – Approach: Risks and Mitigation

Three Approaches to Reactor Fabrication

Baseline Satisfies the BP2 Go/No-Go Milestone

Risk Description	Reactor	Approach	Risk/ Benefit	Process
Fabrication costs may be too high to hit overall cost target	Baseline	Baseline manufacturing	Low-risk	Insert catalyst-coated FeCrAlY foam into a reactor vessel produced by additive manufacturing
Performance unknown	Advanced Reactor 1	Laser Powder Bed Fusion (LPBF) in SS + in-situ coating	High-risk, Better economics	Integrate stainless steel catalyst scaffold into reactor vessel during additive manufacturing and coat with catalyst afterwards
Performance unknown	Advanced Reactor 2	Hybrid Laser Directed Energy Deposition (LDED) in FeCrAl + in-situ coating	High-risk, Better economics	Integrate FeCrAl catalyst scaffold into reactor vessel during additive manufacturing and coat with catalyst afterwards