

US DEPARTMENT OF ENERGY

# Quadrennial Technology Review

---

# Technology Assessments

1	Introduction.....	1-3
1.1	Nature of the Assessments.....	1-3
1.2	Timeline and Deliverables.....	1-5
2	Vehicle Efficiency.....	2-11
2.1	Internal Combustion Engines.....	2-12
2.2	Lightweighting and Aerodynamics.....	2-23
3	Vehicle Electrification.....	3-35
4	Alternative Hydrocarbon Fuels.....	4-49
5	Building and Industrial Efficiency.....	5-70
5.1	Building Efficiency.....	5-71
5.2	Industrial Efficiency.....	5-89
6	Grid Modernization.....	5-106
6.1	Grid Infrastructure.....	5-107
6.2	Grid Storage.....	5-121
6.3	Grid Measuring, Modeling, and Control.....	5-131
7	Clean Power.....	7-149
7.1	Carbon Capture and Storage.....	7-150
7.2	Concentrating Solar Power.....	7-161
7.3	Fuel Cells for Distributed Generation.....	7-174
7.4	Geothermal.....	7-183
7.5	Nuclear Power.....	7-190
7.6	Solar Photovoltaics.....	7-199
7.7	Water Power.....	7-211
7.8	Wind.....	7-221

## 1 Introduction

This document contains the 17 technology assessments (TAs) that were carried out as part of the Department of Energy's (DOE's) Quadrennial Technology Review (QTR). These are meant to be accessible summaries of the techno-economic aspects (e.g., current deployment, historical pace of progress) and research and development (R&D) opportunities in the most important energy technologies or systems. Collectively, these assessments support the analysis and judgments of the *Report on the QTR*, available at [www.energy.gov/qtr](http://www.energy.gov/qtr).

The *Report on the QTR* developed portfolio principles to apply to these 17 technologies to prioritize energy R&D over the next five years. Its recommendations therefore rest upon the more detailed understanding of individual technologies. Similarly, the 17 TAs should play an important role when technology programs articulate R&D priorities to guide their activities. The TAs can help decision makers speak from a common framework, fact base, and set of analyses.

These TAs will serve a number of audiences. Policymakers in Congress, DOE, and other federal and local officials can use them when assessing options for energy policy and technology R&D. Scientists and technology leaders can use them to inform decisions on what R&D to pursue: whether they pursue priorities identified in the assessments or breakthroughs that alter the view of a technology's future. Similarly, the assessments provide industry with a structured landscape of technology areas—helping companies place their own R&D priorities in broader context. Finally, constituent groups focused on particular industries or policy goals can use these assessments to inform their interests within a broad context.

### 1.1 Nature of the Assessments

The following points are important in reading and using these TAs:

The TAs **are not program plans or policy or funding recommendations**. While they outline certain research needs and opportunities for risk reduction, they are not statements of the Department's intended investments. Activities that DOE supports are subject to a number of considerations, including budgets and evolving technology landscapes. The principles discussed in the *Report on the QTR* will be considered as DOE makes future investment decisions.

Given the diversity of topics the TA's cover, they are **not fully uniform in style, format, or content**. Furthermore, the TAs are **descriptive, not prescriptive**. In general, they include a discussion of the current state of the technology, including the historical pace of development in terms of cost, performance, and deployment, and the current state of the industry—in the United States and the world. They then describe the future potential of the technology: a summary of published views on technical headroom to improve cost and performance, including a view of key R&D opportunities; a summary of agreements and disagreements among major published roadmaps; and a summary of non-technical factors that would impact the pace of technology progress. Finally, the TAs include a summary of DOE's history, accomplishments, and role.

The **cost analyses of the TAs are not based on a single set of metrics and assumptions**. As identified in the *Report on the QTR*, the Department needs to develop a strong internal capability in techno-economic and policy analysis to support its energy R&D strategy. The Department needs a professional group that can integrate the major functions of technology assessment and cost analysis, program planning and evaluation, economic-impact assessments, industry studies, and energy and technology policy analysis. Such a group would harmonize assumptions across technologies and make the analyses transparent in order to inform future QTRs.

Our grouping of technologies among the TAs is necessarily imperfect. As a result, **the TAs are clusters of interrelated assessments**, all of which should be considered to get a complete view. In characterizing the energy technologies, we have focused on individual components. For an integrated view of the systems these technologies comprise, please consult the *Report on the QTR*.

The TAs are **not meant to be advocacy documents**. Energy is plagued by technological advocacy, wherein each particular technology in turn is presented as “the solution.” Yet no technology—at present or in the future—can do it all, so an appreciation of the broader context or capabilities of technologies that are competing to provide the same service is vital. These assessments have attempted to avoid advocacy and consistently balance optimism with realism, in part through relevant techno-economic data. And in citing the latter, we have tried to provide context within which to judge claims. The size of the energy sector can produce big numbers, which we also express as fractions of the relevant scale.

We have **avoided projections of deployment**. Potential materiality is certainly an important factor in judging technologies, and technology improvements can certainly facilitate deployment. However, market and regulatory conditions are even more important factors, and these are largely beyond the purview of DOE.

The TAs are largely not new technical and performance analyses. Rather, they **rely upon published external assessments** to the greatest extent possible. As such, they do not include the Administration’s analysis of these external assessments. The National Research Council’s *America’s Energy Future*<sup>1</sup> reports have been an important resource in that regard.

The TAs **do not cover all energy technologies**. Among the technologies excluded are those sufficiently mature to not warrant significant DOE R&D support (e.g., gas turbines). Equally omitted are immature technologies that cannot have material impact within two decades (e.g., nuclear fusion). DOE investment in immature yet high-reward technologies is important, but cannot substitute for energy technology activities that more immediately address urgent energy challenges.

In accordance with the *Report on the QTR*, the TAs **include brief descriptions of DOE’s role** in each technology area. There are three categories of DOE activities in energy technology:

---

<sup>1</sup> National Academies of Science, National Academies of Engineering, National Research Council. (2009). *America’s Energy Future*. Washington, DC.

- **Capability:** Pre-competitive R&D and fundamental engineering research creates a depth of knowledge about new and incumbent energy technologies, harnessing the capability of the national laboratories and universities and strengthening those capabilities in our private-sector partners.
- **Informational:** Information collected, analyzed, and disseminated by DOE shapes the policies and decisions made by other governmental and private-sector actors.
- **Targeted Initiatives:** Targeted initiatives bring goal-driven, coordinated efforts to bear throughout the research, development, and demonstration process to help prove technologies for adoption by the private sector.

Operating in any of these modes, DOE has a unique ability to convene energy-sector participants from the public and private sectors and coordinate their efforts. We also have opportunities to leverage the globalization of innovation, capital, and markets by engaging international partners in energy technology development and deployment.

## 1.2 Timeline and Deliverables

Consistent with the QTR project plan approved in late January 2010, DOE initiated the QTR’s TA activities in early March 2010. After the QTR core team organized the clean-energy landscape into 17 areas, 12 teams conducted these 17 assessments. A total of 135 assessment team members were drawn from the DOE program offices and the national laboratories (Table 1).

Each of the teams was responsible for three deliverables in each assessment:

- **A scoping document** that mapped the full landscape of technical pathways in each area. Pathways that had both sufficient data for assessment and the potential to have significant impact on national energy challenges were in scope. The scoping documents also noted those promising technologies with insufficient data.
- **A team presentation** at one or more of the five QTR strategy-specific workshops. These presentations provided immediate and interactive feedback on the team’s interim product from thought-leaders in industry, academia, and the non-profit sectors.
- The **TA** included in this document.

Each TA was reviewed in three phases. First, all members of each technology team had the opportunity to review all other TAs. Next, several members of the QTR team (Shouvik Banerjee, Megan Chambers, Avi Gopstein, Michael Holland, Asa Hopkins, Cynthia Lin, and Laurel Miner) reviewed the assessments, normalizing content and providing context. Finally, the TAs were sent to independent energy experts for external peer review.

### Technology Assessment Teams (Team leads are in **bold**)

DOE-QTR Technology Teams			
Strategy	Technology Team	Member	Organization
Transportation Efficiency	Internal Combustion Engine	<b>Gurpreet Singh</b>	DOE - EERE

**Prepublication Copy—Subject to Further Editorial Correction**

		Eric Rohlfig	DOE - SC
		David Shum	ARPA-E
		George Muntean	PNNL
		Johney Green	ORNL
		Bob Carling	SNL
Transportation Efficiency	Lightweighting and Aerodynamics	<b>Ed Owens</b>	DOE - EERE
		<b>Jerry Gibbs</b>	DOE - EERE
		Dave Warren	ORNL
		Kambiz Salari	LLNL
		Tom Wenzel	LBNL
		Austin Brown	NREL
Transportation Electrification	Electrification (Storage, Powertrain, Grid Integration)	<b>Pat Davis</b>	DOE - EERE
		<b>Dave Howell</b>	DOE - EERE
		<b>Sunita Satyapal</b>	DOE - EERE
		David Danielson	ARPA-E
		Linda Horton	DOE - SC
		Ann Schlenker	ANL
		Claus Daniel	ORNL
		Tom Wunsch	SNL
		Ahmad Pesaran	NREL
		Brenda Garcia-Diaz	SRNL
		Venkat Srinivasan	LBNL
		Romesh Kumar	ANL
Transportation Alt. Fuels	Production and Conversion	<b>Paul Bryan</b>	DOE - EERE
		<b>Zia Haq</b>	DOE - EERE
		Jonathan Burbaum	ARPA - E
		Jarad Daniels	DOE - FE
		Alison Goss Eng	DOE - EERE
		Martin Keller	ORNL
		Blake Simmons	SNL
		Kenneth Kern	NETL
		Tom Foust	NREL
		Adam Bratis	NREL
		Ted Krause	ANL
		Michael Wang	ANL
		Seth Snyder	ANL

**Prepublication Copy—Subject to Further Editorial Correction**

		Jonathan Male	PNNL
		Mike Thompson	PNNL
		Tom Tarka	NETL
		Sam Tam	DOE - FE
		Kevin Stork	DOE - EERE

Stationary Efficiency	Building Efficiency (Systems and End Uses)	<b>Roland Risser</b>	DOE - EERE
		<b>Tony Bouza</b>	DOE - EERE
		<b>Philip Farese</b>	NREL
		Colin McCormick	DOE - EERE
		David Shum	ARPA-E
		Bing Liu	PNNL
		Paul Matthews	LBNL
		Paul Torcellini	NREL
		Amir Roth	DOE - EERE
		Michael McCabe	DOE - EERE
		Ravi Prasher	ARPA-E
		Jerry Simmons	SNL
		James McMahon	LBNL
		Ed Vineyard	ORNL
Dane Christensen	NREL		

Stationary Efficiency	Industrial Efficiency	<b>Isaac Chan</b>	DOE - EERE
		<b>Joe Cresko</b>	DOE - EERE
		<b>Jamie Link</b>	DOE - EERE
		Aimee McKane	LBNL
		Richard Doctor	ANL
		Peter Fuhr	ORNL
		Phil Farese	NREL
		Tim Theiss	ORNL
		Osman Eryilmaz	ANL
		Ron Ott	ORNL
		Eric Masanet	LBNL

Power Generation	Solar Photovoltaic and Concentrating Solar Power	<b>Ramamoorthy Ramesh</b>	DOE - EERE
		<b>Marie Mapes</b>	DOE - EERE
		<b>Jesse Gary</b>	DOE - EERE
		Robert Margolis	NREL
		Ryne Raffaele	NREL

**Prepublication Copy—Subject to Further Editorial Correction**

		Mike Pelin	ANL
		Mark Mehos	NREL
		Ben Kroposki	NREL

Power Generation	Wind, Geothermal, Water, and Fuel Cells for Distributed Generation	<b>JoAnn Milliken</b>	DOE - EERE
		<b>Mark Higgins</b>	DOE - EERE
		<b>Rajesh Dham</b>	DOE - EERE
		<b>Tien Nguyen</b>	DOE - EERE
		Doug Hollett	DOE - EERE
		Fort Felker	NREL
		Trudy Forsyth	NREL
		Jose Zayas	DOE - EERE
		Walt Musial	NREL
		Daniel Laird	SNL
		Mike Sale	ORNL
		Brendan Smith	ORNL
		Bob Thresher	NREL
		Dave Stinton	ORNL
		Mike Penev	NREL
Tom Williams	NREL		
Charlie Visser	NREL		

Power Generation	Nuclear, Carbon Capture and Storage, and Natural Gas	<b>Jarad Daniels</b>	DOE - FE
		<b>Matt Crozat</b>	DOE - NE
		Peter Balash	DOE - FE
		Jay Braitsch	DOE - FE
		Darren Mollot	DOE - FE
		Kenneth Kern	DOE - FE
		Sikander Khan	DOE - FE
		Chris Nichols	DOE - FE
		John Wimer	DOE - FE
		Matt Bowen	NE
		Philip Finck	INL
		Mike Goff	INL
		Marianne Walk	SNL
		Paul Kalb	BNL
		Steve Zinkle	ORNL
		Harold McFarlane	INL
Madhava Syamlal	NETL		



**Prepublication Copy—Subject to Further Editorial Correction**

		Bryan Morreale	NETL
		Curt Oldenburg	LBNL

Grid	Infrastructure and Power Electronics (Bulk System Physical Infrastructure, Hardware, and Planning)	<b>Bill Parks</b>	DOE - OE
		<b>Kerry Cheung</b>	DOE - OE
		David Meyer	DOE - OE
		Rajeev Ram	ARPA-E
		Jay Caspary	SPP
		Mike Ingram	TVA
		Juan Torres	SNL
		Carl Imhoff	PNNL
		Tom King	ORNL
		Tom Baldwin	INL
		Tom Schneider	NREL

Grid	Measuring, Modeling, and Control (Information Technology, System Operation and Optimization, Microgrid Control)	<b>Gil Bindewald</b>	DOE - OE
		<b>Carol Hawk</b>	DOE - OE
		Charlton Clark	DOE - EERE
		Jeff Dagle	PNNL
		Joe Gracia	ORNL
		Joe Eto	LBNL
		Terry Oliver	BPA
		Jianhui Wang	ANL
		Dave Corbus	NREL

Grid	Energy Storage (Temporal Flexibility)	<b>Hank Kenchington</b>	DOE - OE
		<b>Imre Gyuk</b>	DOE - OE
		<b>Kerry Cheung</b>	DOE - OE
		Mark Johnson	ARPA-E
		Ross Guttromson	SNL
		Landis Kannberg	PNNL

The TAs have been reviewed in draft form by individuals chosen for their diverse perspectives and technical expertise. The purpose of this independent review was to provide candid and critical comments that assisted the QTR team in making the TAs as sound as possible. The following individuals reviewed one or more of the TAs:

**Terry Boston**, PJM Interconnection  
**Marilyn Brown**, Georgia Institute of Technology  
**James Degraffenreidt, Jr.**, WGL Holdings, Inc.

**Paul Dimotakis**, California Institute of Technology  
**Hamid Elahi**, General Electric  
**Robert Fri**, Resources for the Future

**David Goldstein**, Natural Resources Defense Council

**Charles Goodman**, Tulane University

**James Katzer**, Iowa State University

**Mark Lauby**, North American Electricity Reliability Corporation

**Nate Lewis**, California Institute of Technology

**Franklin Orr**, Stanford University

**Tom Overbye**, University of Illinois, Urbana-Champaign

**Jeffrey Peterson**, New York State Energy Research & Development Authority

**Per Peterson**, University of California at Berkeley

**William Powers**, Ford Motor Company, Retired

**Michael Ramage**, Exxon Mobile Research and Engineering Company, Retired

**Burt Richter**, SLAC National Accelerator Laboratory

**Maxine Savitz**, Honeywell, Retired

**Chris Somerville**, University of California at Berkeley

**Dan Sperling**, University of California at Davis

**Carl Weinberg**, Weinberg Associates

**Bob Williams**, Princeton University

**Kurt Yeager**, Electric Power Research Institute

This report is being disseminated by DOE. As such, the document was prepared in compliance with Section 515 of the Treasury and General Government Appropriations Act for Fiscal Year 2001 (Public Law 106-554), as well as information quality guidelines issued by the Department. Further, this report could be considered "influential scientific information," as the term is defined in the Office of Management and Budget's Information Quality Bulletin for Peer Review (Bulletin). This report has been peer reviewed pursuant to section II.2 of the Bulletin.

## 2 Vehicle Efficiency

The assessments in this chapter form the technical base for *Improving Vehicle Efficiency*, a strategy detailed in the corresponding chapter of the *Report on the Quadrennial Technology Review (QTR)*. Improving vehicle efficiency is the most effective short-term route to reduce liquid fuel consumption, and today's technologies allow new vehicles to be twice as efficient as those they replace. This chapter discusses internal combustion engines, lightweighting, and aerodynamics; however, there are a number of other technologies that can improve vehicle efficiency. For more information, see the following reports published by the National Academies of Science and National Research Council: *America's Energy Future*,<sup>1</sup> *Assessment of Fuel Economy Technologies for Light-Duty Vehicles*,<sup>2</sup> and *Technologies and Approaches to Reducing the Fuel Consumption of Medium- and Heavy-Duty Vehicles*.<sup>3</sup>

While each technology is presented here with a standalone assessment, the associated opportunities to impact the energy system are fully understood only within the context of an integrated framework that spans energy resource, supply, delivery, and consumption. The *Report on the QTR* presents an integrated framework of the energy system and contains the systems discussions that tie together these individual assessments.

The technology assessments in the *Vehicle Efficiency* chapter include:

- Internal Combustion Engines
- Lightweighting and Aerodynamics

## 2.1 Internal Combustion Engines

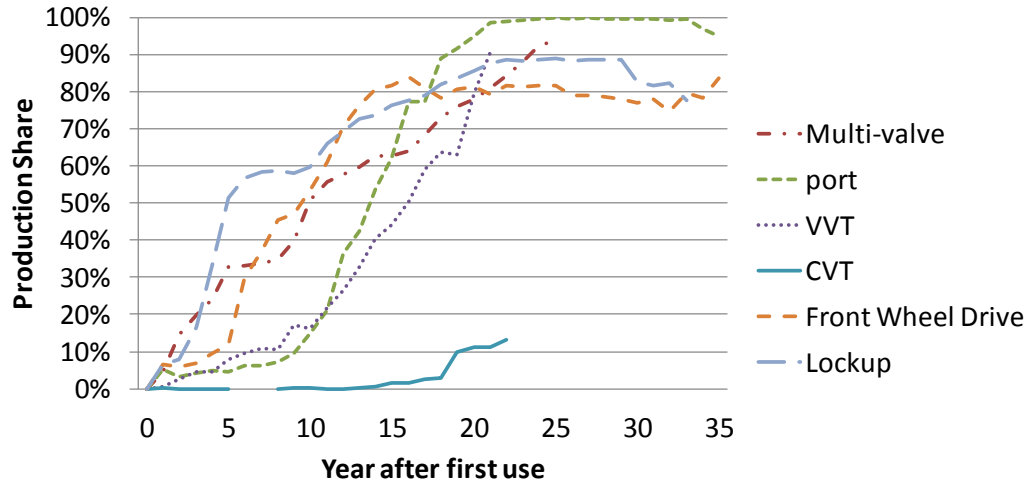
Current internal combustion engines (ICEs) offer outstanding drivability and reliability at a low cost; they are able to use natural gas and biofuels, such as ethanol (more than 12 billion gallons in 2010) or biodiesel. Over the last 30 years, ICE emissions of criteria pollutants<sup>4</sup> have been reduced by more than 99%, while performance has increased. ICEs are expected to maintain significant market share for many years in conventional vehicles, hybrid electric vehicles, and plug-in hybrid electric vehicles. Integrating electric hybrid powertrains with advanced engines will enable operation at higher efficiencies for additional fuel savings.

Although ICE technology is more than a century old, there remain substantial opportunities to improve engine efficiency and reduce emissions. Innovations in combustion, emission controls, fuel and air controls, and turbomachinery have maintained or improved fuel economy, even as vehicle size and weight have increased. Further improvements will be driven by industry compliance with increasing fuel economy standards through 2016<sup>5</sup> and beyond.<sup>6</sup> Technical opportunities for increased engine efficiency apply to a range of light-duty gasoline engines, light-duty diesel engines, and heavy-duty diesel engines.

Engine efficiency has improved as a result of reducing energy losses due to throttling, heat transfer, friction, exhaust energy, and unburned fuel. There are a number of technologies that have led to these energy-loss reductions. In a 2011 National Research Council (NRC) report,<sup>7</sup> Tables S.1 and S.2 (pp. 2–3) list more than 30 light-duty vehicle technologies—a mix of which can be implemented in the near term—including information about their effectiveness to improve vehicle fuel economy and estimates of technology costs in 2009 dollars. Similarly, a 2010 NRC report<sup>8</sup> conducted a review of technologies for medium- and heavy-duty vehicles that could be implemented in the near term to improve fuel economy.

While all gasoline vehicles sold in the United States operate with stoichiometric combustion (needed for emission control by the now universal three-way catalyst), higher-efficiency lean-burn gasoline engines are entering non-U.S. markets with less stringent emissions regulations. Lean-burn gasoline engines could also enter the U.S. market without increasing criteria pollutants by building upon recent advances in after-treatment technologies for diesel engines.

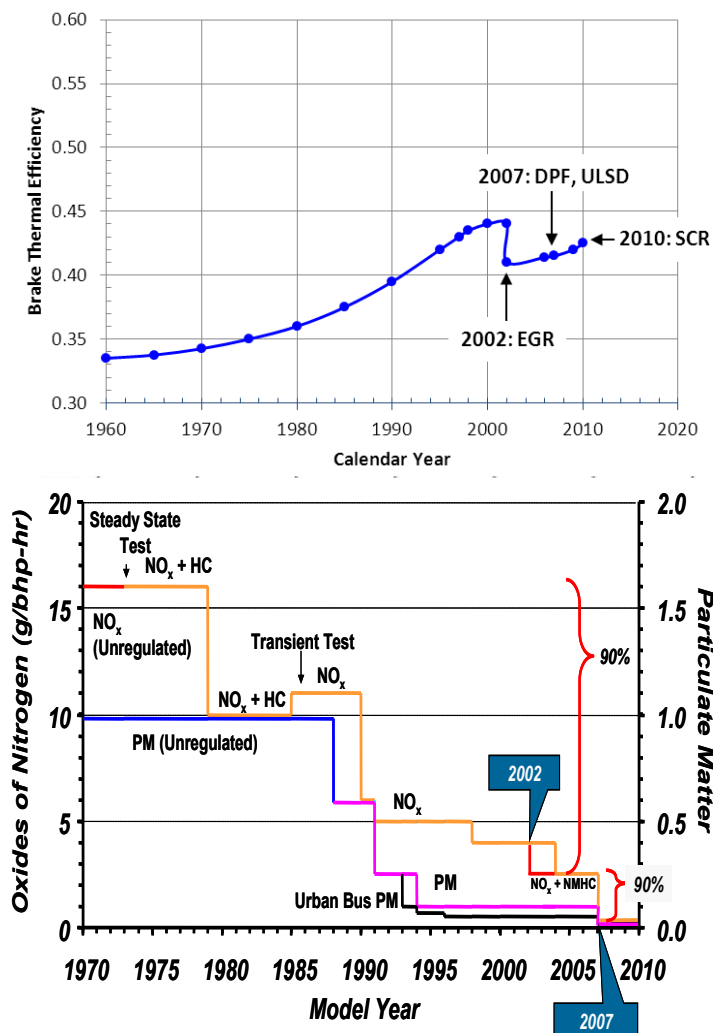
Prepublication Copy—Subject to Further Editorial Correction



**Figure 1. Car Engine Technology Penetration after First Significant Use** VVT = variable valve timing, CVT = continuously variable transmission. Source: U.S. Environmental Protection Agency. (2010). Light-Duty Automotive Technology, Carbon Dioxide Emissions, and Fuel Economy Trends: 1975 through 2010. Page 69, Figure 28. (EPA-420-R-10-023). Washington, DC. Accessed at <http://www.epa.gov/otaq/cert/mpg/fetrends/420r10023.pdf>

The time it takes for market penetration of light-duty engine technologies varies widely—it can take 3–5 years for individual manufacturers to integrate a new technology into their fleet, 5–15 years to penetrate industry-wide (Figure 1), and decades to penetrate the majority of the vehicle fleet. Since the invention and adoption of the three-way catalyst for emission control in the early 1970s (made possible only by implementation of unleaded gasoline), conventional engine efficiency has increased at a steady rate with some variation due to new emissions or fuel economy regulations. Regulation-accelerated deployment of advanced catalysts and the new Corporate Average Fuel Economy (CAFE) standards are expected to similarly drive deployment of other efficiency technologies.

Diesel engines are also well-suited for light-duty vehicle applications, offering an improvement in fuel economy. Diesel engines can achieve 20%–30% higher fuel economy than conventional gasoline engines; they account for nearly 50% of new car sales in Europe.<sup>9</sup> Diesel engines re-entered the U.S. passenger vehicle market in 2006 following engine innovations and ultra-low sulfur diesel fuel, which enabled the machinery to achieve required emission levels. However, diesel penetration in the U.S. light-duty vehicle market has been small, primarily due to the additional cost of the engine and emission control components, as well as the price of diesel fuel. In addition, there is a misperception that emissions from modern diesel engines have disproportionately adverse health impacts when compared to other engine technologies, which limits penetration.



**Figure 2. Historical Progress in Heavy-Duty Engine Efficiency and the Challenge of Simultaneous Emissions Reduction** DPF = diesel particulate filter. ULSD = ultra-low sulfur diesel. EGR = exhaust gas recirculation. SCR = selective catalytic reduction. HC = hydrocarbons. NMHC = non-methane hydrocarbons. PM = particulate matter. (top) Adapted courtesy of Detroit Diesel Corporation. (2009). Dearborn, Michigan: Directions in Engine-Efficiency and Emissions Research Conference. Accessed at [http://www1.eere.energy.gov/vehiclesandfuels/pdfs/deer\\_2009/session5/deer09\\_kalish.pdf](http://www1.eere.energy.gov/vehiclesandfuels/pdfs/deer_2009/session5/deer09_kalish.pdf)

(bottom) Source: 21<sup>st</sup> Century Truck Partnership. (2006). *Roadmap and Technical White Papers*. (21CTP-0003). Page 11, Figure 1.2. Washington, DC: Department of Energy, Office of Energy Efficiency and Renewable Energy. Accessed at [http://www1.eere.energy.gov/vehiclesandfuels/pdfs/program/21ctp\\_roadmap\\_2007.pdf](http://www1.eere.energy.gov/vehiclesandfuels/pdfs/program/21ctp_roadmap_2007.pdf)

Heavy-duty diesel is the primary engine for commercial vehicles because of its high efficiency and outstanding durability. However, increasingly stringent emission standards over the last decade restrained efficiency gains while emissions were reduced by more than 95% (Figure 2). As regulations for nitrogen oxides (NO<sub>x</sub>) and particulate matter emissions stabilized in 2010, further gains in efficiency are now seen as achievable.

Historically, efficient heavy-duty engine technologies have been quickly adopted by the commercial heavy truck fleet where fuel economy and fuel costs are major concerns and vehicle lifetime is shorter. At the level of an individual manufacturer, technologies can typically be implemented across a range of

engine models within one year. Nationally, technologies developed for the Class 8 market (e.g., long-haul tractor-trailers) are typically implemented in three years or less. These technologies quickly penetrate into the Class 6 and Class 7 markets (e.g., delivery trucks, buses) because of the similarity of the vehicle classes.

### 2.1.1 Current Industry

With the exception of sharp declines in 2008 and 2009, energy consumption in the transportation sector has grown over the last several decades. This growth is partly due to an increase in miles driven, but is also the result of expanding market share for light trucks, which has limited improvements in CAFE for the overall fleet. The price of fuel is also an important economic factor that affects the number of miles driven by the current fleet, as well as consumer choices that determine the future fleet. The current state of the light-duty and heavy-duty vehicle industries is summarized in a recent market report.<sup>10</sup>

### 2.1.2 Technology Potential

The maximum efficiency of the slider-crank architecture that dominates current engines can be doubled to about 60% if cost is not a constraint.<sup>11</sup> This could double the fuel economy of passenger vehicles and increase heavy vehicle fuel economy by more than 40%. However, commercially achievable fuel economies are constrained not only by basic chemistry and physics, but also by factors such as cost, consumer driving needs and comfort, and environmental regulations. Practical engine efficiencies will depend heavily on the targeted transportation sector; the cost-sensitive commercial trucking sector and its high rate of fuel use results in thermal efficiencies for heavy-duty engines that can be as much as 10% higher than light-duty engines.

Near-term options to improve fuel economy were outlined in two recent NRC reports.<sup>12</sup> Some of the options considered to have the most potential include: (a) lean-burn combustion; (b) homogeneous-charge compression ignition (HCCI); (c) variable compression ratio (VCR); (d) waste heat recovery; and (e) improved particulate and NO<sub>x</sub> aftertreatment. The Department of Energy (DOE) believes that these technologies have the potential to contribute to fuel economy improvements of 25%–40% for passenger vehicles and 20%–30% for commercial vehicles.<sup>13</sup> Estimates of potential improvements afforded by these technologies vary and are not necessarily additive. Further, these technologies must be cost competitive to make a business case for market introduction if their benefits are to be realized. Cost estimates for these technologies vary greatly.<sup>14</sup> The success of the combustion and emission control technologies is particularly impacted by, or dependent upon, the chemical and physical properties of fuels. This interdependence needs to be understood, and preferably exploited, to capture efficiency gains.

#### **(a) Lean-Burn (stratified charge) Combustion**

Lean-burn combustion refers to a spark ignition (SI) engine operating with more air than is required to burn the fuel. The lean-burn engine with the greatest fuel-efficiency potential is the stratified-charge, lean-burn engine. In this type of engine, fuel is directly injected into the cylinder and timed so that a stratified, but combustible, fuel-air mixture occurs near the spark plug at the time of spark. The amount

of fuel injected is used to control the power rather than restricting the intake air flow, as is done in the Port-fuel-injected (PFI) SI engines that are dominating the road today.

These engines—which are primarily for automotive and light truck applications—will operate on current gasoline and gasoline/ethanol blends. Moreover, this combustion approach is compatible with the industry trend toward engine downsizing and turbo-charging. All major automotive engine producers are investigating this technology because of its fuel-efficiency potential. Engines of this type have been produced in the past; however, only two (Mercedes and BMW) are in production today, and they are only being produced for the European market.

The lean-burn technology will be more expensive than a 2009 baseline PFI-SI engine, but will most likely cost less than a 2010 emission-compliant diesel engine. Primary cost drivers include the need for lean NO<sub>x</sub> emission control technology and increased fuel injection system and control system costs. The principal barriers to this technology are inadequate understanding of the combustion system; lack of accurate computational models for rapidly developing, robust lean-burn combustion systems; and the need for low-cost NO<sub>x</sub> and particulate emission control technology for lean-burn combustion systems.

#### **(b) Homogeneous-Charge, Compression Ignition Combustion**

HCCI refers to the general class of compression ignition, low-temperature combustion (LTC) strategies for engines. These range from LTC strategies that are more appropriate for diesel-like fuels (often called diesel LTC) to strategies that are more appropriate for gasoline-like fuels (most commonly called HCCI). Like lean-burn combustion engines, LTC compression ignition engines operate with a high air-to-fuel ratio, and they control power through the amount of fuel injected. There is also long-term potential for even greater efficiency when using gasoline or dual fueling with gasoline and diesel fuel.<sup>15</sup>

All major light-duty and heavy-duty engine producers are investigating this technology because of its fuel-efficiency potential and prospect for reducing emission control requirements relative to a high-efficiency diesel engine. General Motors and Daimler have built vehicles with prototype HCCI engines. Heavy-duty companies are widely employing higher fuel-injection pressures, advanced fuel-injection strategies, and exhaust-gas recirculation to force some of the fuel that was injected to burn under LTC conditions, thus minimizing engine out emissions.

LTC technologies will be more expensive than a 2009 baseline PFI-SI engine, but will most likely cost less than a 2010 emission-compliant diesel engine. Primary cost drivers relative to the PFI-SI will be associated with the control system, with fuel injection system and emission control system adding additional costs. Principal barriers include the need for improved understanding of LTC combustion that will allow operation and control over the full speed range; lack of accurate computational models for rapidly developing, robust LTC combustion systems; and the potential need for unburned hydrocarbon and carbon monoxide exhaust aftertreatment technology for lower-temperature exhaust gases.

#### **(c) Variable Compression Ratio**



VCR could increase efficiency and improve emissions by better matching the compression ratio to engine speed/power demands. For example, medium- to high-load operation in SI gasoline engines requires a sub-optimal spark timing to avoid engine knock. The ability to adjust the compression ratio would allow for more efficient spark timing over a wider operating range. Estimated efficiency improvements are 2%–6% for light-duty and heavy-duty applications.<sup>16</sup> The ability to adjust compression ratio on the fly also expands fuel flexibility by better matching compression and fuel properties. Another important application of VCR technology is enabling advanced combustion modes. For example, the sensitivity of HCCI combustion to in-cylinder charge conditions makes control of compression ratio necessary to enable and sustain HCCI combustion over a wider range of speed/load demands.

This technology has been, and continues to be, investigated by engine companies, automobile companies, suppliers, and research institutions with both light-duty and heavy-duty vehicles. Approaches to VCR include using variable valve systems to control the effective compression ratio and new mechanisms to adjust the swept volume of the cylinder. VCR has many material, design, and durability challenges due to the harsh environment and cyclic loading on the piston, connecting rod, and crank shaft.

#### **(d) Waste Heat Recovery**

Substantial improvements in engine efficiency will require a reduction in thermal-energy losses. With less than half of the fuel energy converted to useful work in a modern engine, there are opportunities to improve engine efficiency through the recovery of pressure and thermal energy. Technologies under investigation include turbo-compounding, organic Rankine cycles, and thermoelectric generators. Turbo-compounding has been commercialized to a limited extent in heavy-duty vehicles, but will require further development for more widespread use. The other two technologies have not been commercialized for the conversion of waste heat to shaft or electrical power. All of these technologies have challenges related to packaging, cost, weight, and drive-cycle matching. The usage patterns of heavy-duty vehicles make them a good match for waste heat recovery.

#### **(e) Improved Particulate and NO<sub>x</sub> Aftertreatment**

Particulate and NO<sub>x</sub> aftertreatment are required to ensure that current, advanced fuel-efficient engines can meet emission regulations. Aftertreatment technology is an essential part of the overall engine system. Any effort to improve the overall efficiency of this system must address the performance of the emissions controls. Specifically, improvements in aftertreatment effectiveness allow the base engine to be tuned into higher thermal-efficiency operation. Optimal fuel efficiency can be attained only through coordinated development of both components. Advanced aftertreatment technologies are new versions of catalytic converters that control pollution in the oxygen-rich exhaust system of lean engines; these catalysts are similar for both light-duty and heavy-duty vehicles.

Research needs are twofold: (1) catalysts to cost effectively reduce particulate, NO<sub>x</sub>, carbon monoxide, and hydrocarbons with minimal impact on fuel efficiency that are intimately integrated with the engine system; and (2) advancements in catalysts to address changing exhaust conditions created by new, renewable/alternative fuels and new, fuel-efficient engine designs. Current catalyst technologies that

meet existing regulations contain high levels of expensive platinum group metals, which raise total vehicle costs.

Basic research and unique scientific tools can advance combustion research in a variety of ways. Light-based examination of combustion phenomena helps provide the insight and data necessary to advance engine combustion technologies. X-rays of varying intensity produced at light sources enable investigation of combustion chemistries and dynamics over very short timeframes. X-ray-based capabilities, such as photoionization mass spectrometry, have validated combustion theory by confirming the existence of predicted chemical intermediates and enhanced understanding of the chemical mechanisms for engine combustion. Similarly, quantitative characterization of fuel spray and imaging of combustion in real engines under full engine speed and load have allowed manufacturers to improve component designs from fuel injectors to particulate filters. Longer wavelength lasers allow for real-time investigation of engine-based combustion kinetics and exhaust stream particulate matter. In combination with a large set of specially designed optically accessible engines and high-pressure engine combustion simulators, such laser-based and optical diagnostics allow for investigation of the science behind advanced engine combustion approaches, such as stratified-charge ignition or HCCI.

Beyond photon examination, particles like neutrons enable non-destructive characterization and imaging of operating engines and components. Synthesis, modeling, and characterization of catalysts can be used to advance the state of exhaust emissions abatement technology for diesel- and gasoline-engine platforms.

### 2.1.3 Breakthrough Technologies

Advancing engine technology to improve automobile fuel economy by more than 50% and heavy-duty fuel economy by more than 30% will require industry to accelerate its pursuance of multiple product development cycles, even as it explores innovative designs. The co-evolution of fuels adds additional complexity and opportunities and further highlights the need for efficient product development. Design processes that over-rely on “build and test” prototype engineering are too slow. These challenges present a unique opportunity to marshal U.S. leadership in science-based simulation to develop new capabilities in predictive computational design and predictive simulation to enhance engine performance. Predictive computational design and simulation tools will shrink engine development timescales, reduce development costs, and accelerate time to market.

A potential breakthrough engine design is a free-piston HCCI concept that uses a linear-motion piston that is not connected to a crankshaft, but rather coupled to a rebound device (e.g., another opposed combustion chamber); it produces electricity for a hybrid electric vehicle via a linear alternator.<sup>17</sup> An electronically controlled VCR optimizes combustion phasing based on the fuel utilized and intake air/engine temperature. Data from single-shot, free-piston experiments demonstrated a thermal efficiency of around 56%. Work on a continuous-running research engine would begin to quantify efficiencies achievable. Such a design could also find application in distributed power generation.

Other breakthrough technologies could capture and use waste heat in the vehicle. Thermoelectric generators can convert engine waste heat directly to electricity to power vehicle auxiliary loads and

accessories. With “zonal” or disbursed thermoelectric heating, ventilation, and air conditioning, the vehicle occupants can be cooled more directly than by cooling the whole cabin, thus providing a more energy-efficient alternative to currently used mobile air conditioners. Thermoelectric heating, ventilation, and air conditioning is a direct current system that can easily convert from cooling the vehicle to heating the vehicle. Over the next five years, production prototype first-generation thermoelectric generators, integrated with engine and electrical systems to augment a scaled-down alternator, are expected to be tested and evaluated to quantify real-world fuel economy improvements. A second-generation thermoelectric generator that uses better performing thermoelectric materials could eliminate the alternator entirely and improve the fuel economy of a passenger vehicle by 5%–7%. Such technologies could also be used for energy harvesting in the stationary sector.

#### 2.1.4 Assessment of Gaps

Technological barriers to the development of more efficient ICEs include the following:

- Inadequate understanding of fundamentals of in-cylinder combustion/emission-formation processes and inadequate capability to accurately simulate them, as well as incomplete understanding and predictive capability for exploiting or accommodating the effects of fuel composition.<sup>18</sup>
- Lack of cost-effective emissions control to meet Environmental Protection Agency standards for oxides of nitrogen and particulate matter emissions at smaller penalty in fuel economy.
- Incomplete fundamental understanding of, and insufficient practical experience with, new catalyst materials and processes for lean-burn engine emission control.
- Lack of integrated computational models that span engine and emission control processes with vehicle loads to predict vehicle fuel economy improvements.
- Lack of effective engine controls to maintain robust lean-burn combustion for boosted, down-sized engines.
- Inadequate durability of new emission control systems for engines operating in novel combustion regimes that need to perform effectively for 120,000 miles in passenger vehicles and 435,000 miles for heavy-duty engines.
- Lack of actual emissions data on pre-commercial and future combustion engines (for evaluation of potential health impacts and unintended consequences).
- Lack of thermoelectric-based devices for waste heat recovery. Challenges include improving properties of thermoelectric materials, producing such materials at scales and in forms necessary for automotive applications, and validating performance in automotive environments (e.g., durability).
- High cost of more efficient ICE technologies (LTC engines are expected to be more expensive than conventional gasoline engines; thermoelectric devices add cost that must be offset by benefits).

#### 2.1.5 Past DOE Activities

DOE started pursuing engine research and development (R&D) in 1975 when it supported R&D that improved the original catalytic converters, as well as the first use of lasers to visualize the combustion process and emissions formation in an operating engine.

DOE funding for advanced engine R&D has been relatively constant over the past decade, ranging from \$40–\$60 million per year. Some of DOE’s accomplishments<sup>19</sup> in light- and heavy-duty engine R&D include:

- Providing tools and knowledge that have helped engine manufacturers improve heavy-duty diesel efficiency by 4%–5% since 2002, as well as heavy-duty engine manufacturers meet 2007 regulations that required a 90% reduction in particulate matter emissions<sup>4</sup> and a more than 50% reduction in NOx emissions. Sandia National Laboratories developed a system of laser and optical diagnostics for optical engine experiments that allows researchers to view and measure detailed combustion processes and emissions formation as they occur in real time. These experiments, combined with new models of combustion, provided a new understanding of the combustion and emissions formation process in a diesel engine that differs significantly from the previous picture.
- Spearheading the development of clean-diesel technologies for passenger vehicles in the 1990s that met Environmental Protection Agency 2009 Tier 2 Bin 5 standards as early as 2000, while also boosting fuel economy to 30% better than comparable gasoline-powered vehicles. DOE funded three competitively selected, cost-shared projects with diesel engine companies and partnered with passenger car original equipment manufacturers (OEMs) and their suppliers to develop diesel engines for light trucks.
- Supporting the development of industry-standard engine design software. The KIVA family of modeling software was developed by Los Alamos National Laboratory in collaboration with other national laboratories, universities, and industry. It is now used by all engine manufacturers in their engine-design processes. Using this software with data from the optical engine experiments, Cummins was able to reduce the development time and cost of its high-efficiency 2007 ISB 6.7-L engine by 10%–15%.
- Supporting catalyst development that helped enable that same Cummins ISB 6.7-L engine to enter the commercial market in 2007, meeting the 2010 emission standards. R&D collaboration between Cummins, the company’s catalyst manufacturer Johnson Matthey, and national laboratory scientists used DOE’s national scientific facilities to identify and address problems of catalyst deactivation. This work enabled the first U.S. introduction of a new catalytic emission control technology, concurrent with the deployment of the high-efficiency engine.
- Establishing databases for fundamental reaction mechanisms and deactivation processes in new emission control technologies for high-efficiency, lean-burn gasoline and diesel engines. DOE’s collaboration with industry and university partners in the Cross-Cut Lean Exhaust Emissions Reduction Simulation project has identified promising emissions aftertreatment technologies. The collaboration also performed fundamental and applied R&D that was aimed at making these simpler and less costly than current technologies. Car manufacturers use the large Cross-Cut Lean Exhaust Emissions Reduction Simulation compilations of combustion and emissions data in their commercial product development.
- Developing engine and emission control technologies in joint DOE/industry research efforts that were adopted by all major engine manufacturers, which enabled them to meet the 2007 heavy-duty emissions standards without efficiency losses.

In addition to these successes, DOE research showed that specific engine technologies were unpromising. Sufficient cost and performance data were acquired to show that, at the time, the following had no clear efficiency and cost advantages, did not meet criteria pollutant standards, or both, for motor-vehicle applications.

- Steam (Rankine cycle) engines (1960s)
- Stirling engines (1970s to early 1990s)
- Gas turbines (1970s to early 1990s)
- Rotary engines (1980s)
- Two-stroke engines (1980s to 1990s)
- Adiabatic engines (1980s to early 1990s).

These judgments are revisited as technologies and needs evolve.

### 2.1.6 DOE Role

DOE's R&D roles have been to:

- Facilitate development of precompetitive technical knowledge base through investments in fundamental and applied R&D
- Undertake mid- to long-term pre-competitive research
- Provide access to unique national laboratory expertise and facilities
- Help create a national consensus on R&D areas of common public and private interest
- Enable public-private partnerships to integrate R&D into industrially useful design tools.

DOE has set the following fuel efficiency demonstration targets for its activities on passenger and commercial vehicles:

- By 2015: demonstrate engine efficiency improvements that advance the fuel economy of light-duty gasoline engines by 25% and light-duty diesel engines by 40%, compared to the baseline 2009 gasoline vehicle.
- By 2015: improve heavy-truck engine thermal efficiency to 50% with demonstration in commercial vehicle platforms. This would be about a 20% improvement over current engine efficiency.
- By 2018: further increase the thermal efficiency of a heavy-truck engine to 55%, which would be about a 30% improvement over current engines.

Today, DOE supports a portfolio of engine activities that spans fundamental research, applied technology development, and technical support for technology maturation and deployment.<sup>20</sup> Basic R&D in combustion chemistry, fluid dynamics, advanced laser diagnostics, and combustion model development supports applied R&D work.

Leveraging unique, world-class theoretical and experimental capacity, major research facilities at the national laboratories accelerate industry and university R&D by providing capabilities that are too costly for users to support on their own. Experimental capabilities relevant to the ICE span from broadly used

scientific platforms, such as light and neutron sources, to technology specific capabilities, such as engine combustion test beds.

Coupling simulation with experimental validation allows the Department to improve predictive models for the complex physics of ICEs, where improved models can accelerate the design of cleaner, more efficient engines.

## 2.2 Lightweighting and Aerodynamics

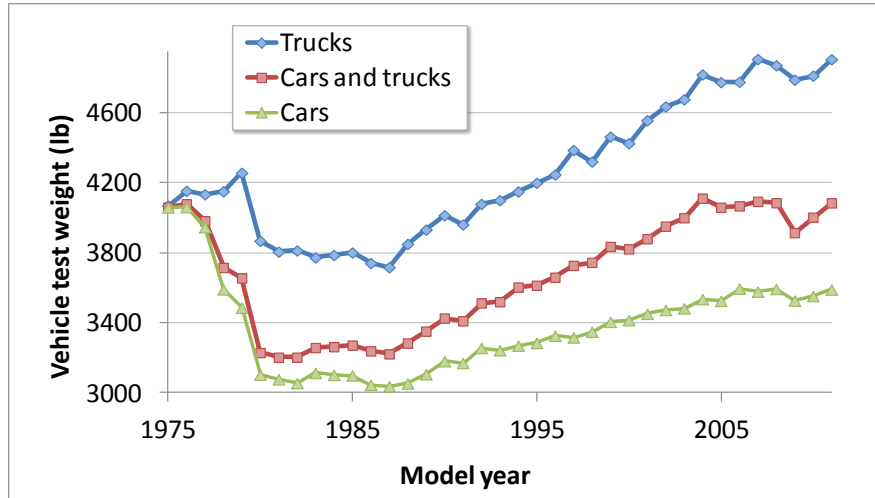
Vehicle weight and aerodynamics are two major determinants of fuel economy beyond engine efficiency. Rolling resistance, which is related to vehicle weight, is the dominant energy-loss mechanism at low speeds, while aerodynamics is the dominant mechanism at high speeds.

Lighter weight can significantly reduce a vehicle's fuel consumption at all speeds. For example, a 10% reduction in the weight of an ICE vehicle can improve fuel economy some 6%–8%.<sup>21</sup> Weight reduction in hybrid electric vehicles and plug-in hybrid electric vehicles can similarly increase electric range or overall vehicle efficiency. The benefits of lightweighting apply to all vehicle size classes, including heavy-duty trucks.

Aerodynamic drag is primarily a function of vehicle speed, frontal area, and coefficient of drag. As vehicle frontal area increases, aerodynamics at common highway speeds (60–70 miles per hour) has an increasing impact on transport efficiency to the point where more than 65% of usable engine output for Class 8 trucks is used to overcome aerodynamic drag.<sup>22</sup> Improving the aerodynamics of these vehicles could reduce their fuel consumption by up to 15%.<sup>23</sup> There are smaller benefits to improving the aerodynamics of passenger cars, light trucks, and sports utility vehicles due to their lower average speeds, smaller frontal area, and better aerodynamic efficiency of current designs.

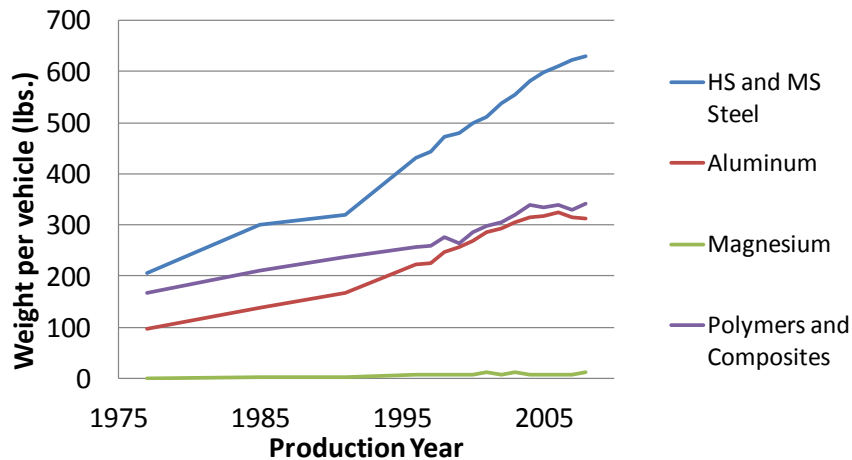
### 2.2.1 Lightweighting

Following the fuel shortages and price spikes of the 1970s and 1980s, as well as the initial regulatory CAFE standards for light-duty vehicle fuel economy, average new car weights declined rapidly from about 4,000 pounds to about 3,100 pounds. These weight reductions were achieved as manufacturers downsized models and introduced new materials, such as high-strength steel and lightweight plastics, that allowed for reduced thickness of metals in body structures. Following the plateau of CAFE standards in 1985, the market shifted toward larger and heavier vehicles. Additionally, manufacturers responded to increasing safety standards by introducing roll-over and side-impact structural reinforcements. These trends, as seen in Figure 3, have continued through 2010, and average new passenger car weights have increased from their minimum of 3,100 pounds in 1987 to about 3,600 pounds in 2010. In spite of this trend for increasing vehicle weight, today's passenger car has better fuel economy than its 1987 counterpart.



**Figure 3. Average Light-Duty Vehicle Weight, 1975–2009** Environmental Protection Agency. (2012). *Light-Duty Automotive Technology and Fuel Economy Trends: 1975 Through 2011*. (EPA-420-R-12-001a). Washington, DC. Accessed at <http://www.epa.gov/otaq/cert/mpg/fetrends/2012/420r12001a.pdf>

As shown in Figure 4, production vehicles have used increasing amounts of advanced materials since 1970: aluminum has increased by 84%, magnesium by 33%, high-strength steel by 77%, and composites by 70%. These materials, used in today’s cars, reduce weight by 10%.<sup>24</sup>



**Figure 4. Trends of Lightweight Materials Use in Vehicles** For the most part, these materials replace iron or mild-steel. Sources: Wards Communications. (2010). *Ward's Motor Vehicle Facts and Figures, 2010*, Detroit, MI. Department of Energy. (2004). "Average material consumption for a domestic vehicle." *Vehicle Technologies Program Fact of the Week*. Washington, DC. Accessed at [http://www1.eere.energy.gov/vehiclesandfuels/facts/2004/fcvt\\_fotw310.html](http://www1.eere.energy.gov/vehiclesandfuels/facts/2004/fcvt_fotw310.html)

### 2.2.1.1 Current Lightweighting Technology

Today’s average passenger car weighs 3,600 pounds (including passengers)<sup>25</sup> and consists of the following materials: 54% iron or mild steel, 9.7% first-generation high-strength steel, 9.4% aluminum, 7.2% plastic, 4% glass, and 1% magnesium; the remaining 15% is a mixture of copper, paint, carpeting, padding, insulation, and rubber.<sup>26</sup> The average selling price of a new car is about \$28,000,<sup>27</sup> or about \$8/pound: raw materials cost about \$0.60/pound, manufacturing and processing costs are about \$4.50/pound, and the remaining costs are shipping, OEM profit, and dealer mark-up.



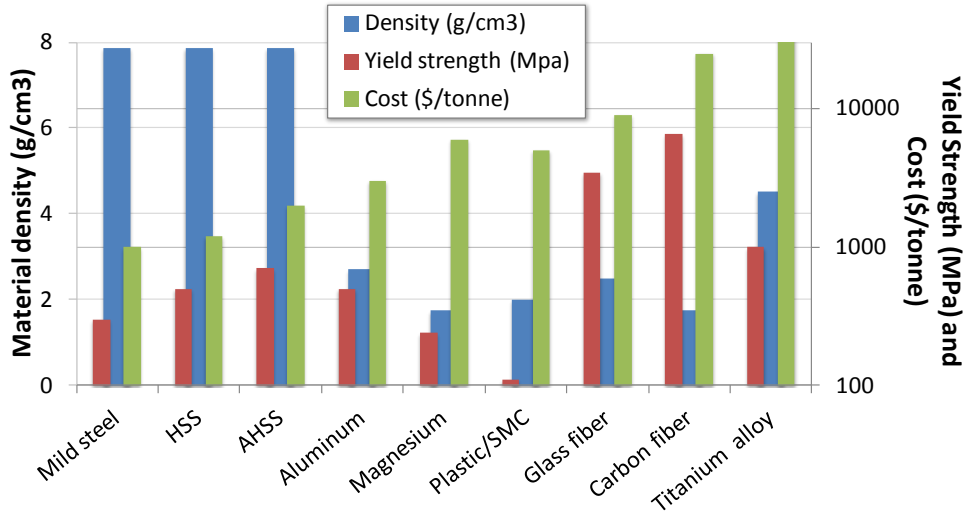
Light trucks and vans typically weigh 4,600 pounds<sup>28</sup> and have a different architecture (body-on-frame versus unibody) and material make-up relative to passenger cars. Heavy-duty trucks typically weigh 18,000 pounds, use a body-on-ladder-frame architecture, and are designed to carry very heavy loads.<sup>29</sup> The material make-up of heavy trucks is significantly different than that of light-duty vehicles, but their selling price is still about \$8.00/pound.

A passenger car's weight is distributed across four major component groups:<sup>30, 31</sup>

- **Body 32.6%:** The body consists of the body-in-white, closures (doors and hoods), windows, fenders, and bumpers. It is the primary structure enclosing the passenger compartment and provides primary crash protection; it links the cabin to the suspension and powertrain. Today's bodies are typically about 62% mild steel, 23% high-strength steel, 12% glass, and a mix of other materials.
- **Chassis 18.1%:** The chassis is the interface between the vehicle and the road. The chassis includes the suspension, steering, and brakes, along with tires and wheels. Today's vehicle chasses are typically about 85% cast iron and steel, 10% rubber, 3% aluminum, and a mix of other materials.
- **Powertrain 28%:** The powertrain consists of the engine, transmission, driveline, axles, exhaust system, starter battery, and fuel system. Today's vehicle powertrain is typically about 53% mild steel and cast iron and 33% cast aluminum, with the balance being a mixture of lead, fluids, plastic, and rubber.
- **Interior 12.5%:** The vehicle interior includes seats, air conditioning, instrument panel, center console, carpeting, and other components like sound systems. Today's vehicle interiors are about 50% plastics and 30% mild steel, with the remainder being a mix of aluminum, magnesium, rubber, cloth, and numerous electronic devices.

Today's vehicles are designed to make optimal use of commercial materials available to meet stringent cost, strength, weight, and durability requirements based on vehicle operational parameters and consumer preference.

Several commercially available materials, if able to meet cost and manufacturability targets, could be used for further vehicle lightweighting. These include carbon fiber composites, sheet aluminum, cast magnesium, and titanium. They are used in the aerospace industry, where cost targets are up to an order of magnitude higher, and production rates are several orders of magnitude lower than those of the automotive industry (see Figure 5).



**Figure 5. Materials Density, Strength, and Cost** Adapted with permission from Lutsey, Nicholas P. (2010). *Review of Technical Literature and Trends Related to Automobile Mass-Reduction Technology*. (Research Report UCD-ITS-RR-10-10). Page 9, Figure 7. Davis, CA: Institute of Transportation Studies, University of California, Davis. Accessed at [http://pubs.its.ucdavis.edu/publication\\_detail.php?id=1390](http://pubs.its.ucdavis.edu/publication_detail.php?id=1390)

There are a number of improved materials under development that may have application in vehicle lightweighting if technical, performance, manufacturing, and cost targets can be achieved. These materials include: next-generation high-strength steel (sheet), high-performance cast steel/iron, sheet magnesium, high-performance cast magnesium, high-performance cast aluminum, low-cost automotive-grade carbon fiber, hybrid carbon/glass fiber composites, and low-cost titanium. Most of these materials are being developed and tailored to meet automotive requirements and have cost targets up to 50% less than commercially available aircraft-grade materials. A comparison of these materials’ properties, costs across a range of different components, and lightweighting potential relative to mild steel is shown in Table 1.

**Table 1. Material Properties, Cost, and Lightweighting Potential Relative to Mild Steel** Powers, W. (2000). “Automotive Materials in the 21st Century.” *Advanced Materials Process*. 157:38-44.

Material	Density (g/cm <sup>3</sup> )	Strength/Density	Modulus/Density	Cost	Mass Reduction Potential
		<b>Relative to Steel</b>			
<b>Mild Steel</b>	7.87	1.00	1.00	1.0	0%
<b>High-Strength Steel</b>	7.87	1.86	1.00	0.90–1.20	10%
<b>Adv High-Strength Steel</b>	7.87	3.00	1.00	0.80–1.50	10%–28%
<b>Gen III High-Strength Steel</b>	7.87	7.00	1.00	1.00–2.00	15%–30%
<b>Ceramics</b>	3.90	0.70	3.05	1.50–3.00	10%–30%
<b>Sheet Molding Compound</b>	1.10–1.90	4.39	1.16	0.50–1.50	20%–30%
<b>Glass Fiber Composites</b>	1.40–2.40	4.74	5.75	0.90–1.50	25%–35%
<b>Plastics</b>	0.90–1.50	0.82	0.08	0.70–3.00	20%–50%
<b>Aluminum</b>	2.70	3.95	1.02	1.30–2.00	30%–60%
<b>Titanium</b>	4.51	4.73	0.98	1.50–10.00	40%–55%

<b>Metal Matrix Composites</b>	1.90–2.70	5.41	35.28	1.50–3.0	50%–65%
<b>Magnesium</b>	1.74	3.66	1.02	1.50–2.5	30%–70%
<b>Carbon Fiber Composites</b>	1.00–1.60	20.9	5.41	1.50–5.0	50%–70%

**2.2.1.2 Technology Potential**

Industry experts have indicated that lightweighting activities should focus on minimizing vehicle weight while maintaining vehicle utility, size, and crash-safety performance. Industry and technical experts have projected that, by 2050, there is the potential to lightweight passenger cars between 20%–50%,<sup>32</sup> resulting in fuel economy improvements between 15%–40%, respectively. The potential to lightweight light trucks and vans has been estimated to be 15%–50%, resulting in fuel economy improvements of 12%–40%.<sup>33</sup> It has also been estimated that the freight efficiency of heavy trucks can be improved by up to 50% through a combination of lightweighting, aerodynamic drag reduction, and powertrain efficiency improvements.<sup>23</sup> Because of the difference in architectures, production rates, operational requirements, and cost tolerances between cars, light trucks, vans, and heavy-duty trucks, each vehicle class may provide different opportunities to accelerate deployment of particular lightweighting materials.

For maximum future vehicle lightweighting, each of the component groups discussed above must contribute to the weight reduction. An analysis by the 2011 Materials Roadmapping Workshop of the technical potential for lightweighting passenger cars out to 2050 is shown in Table 2. This analysis indicates a pathway to weight reduction that will require the vehicle body weight to be reduced by 65%, the chassis/suspension to be reduced by 55%, the powertrain to be reduced by 40%, and the interior to be reduced by 35%.<sup>34</sup> Each of the four component groups has different physical requirements and will therefore require a different mix of engineering approaches and lightweighting materials. While cost is a significant determinant of technology deployment, cost targets are application-dependent.

**Table 2. Timeline to Achieve Technical Potential for Lightweighting Conventional Passenger Cars** Department of Energy. *Summary Report from the 2011 Advanced Materials Roadmapping Workshop (in draft)*. Detroit, MI. March 8–10, 2011.

Component Group	% weight reduction				
	2020	2025	2030	2040	2050
<b>Body</b>	35%	45%	55%	60%	65%
<b>Powertrain</b>	10%	20%	30%	35%	40%
<b>Chassis/Suspension</b>	25%	35%	45%	50%	55%
<b>Interior</b>	5%	15%	25%	30%	35%
<b>Completed Vehicle</b>	<b>20%</b>	<b>30%</b>	<b>40%</b>	<b>45%</b>	<b>50%</b>

Table 3 shows the lightweighting potential of various materials for different component groups, a description of current uses, and technical hurdles for lightweighting applications. Although Table 1 shows that titanium and metal matrix composites are among those materials with the greatest potential for weight reductions, the material properties and present manufacturability of many of these same materials limit their applicability. Other materials, such as carbon fiber composites, could substantially reduce weight in a number of applications.

**Table 3. Vehicle Materials, Technical Hurdles, and Applications** “Baseline” means the historic or primary material used in vehicles.

<b>Material</b>	<b>Current Applications</b>	<b>Projected Applications</b>	<b>Technical Status and Hurdles</b>
<b>Cast Iron</b>	Powertrain and suspension	Same	Baseline for medium- and heavy-duty (HD) engines: advanced HD engine requirements may exceed material properties
<b>Mild Steel</b>	Body, suspension, chassis, powertrain, and interior	Same	Baseline material
<b>High-Strength Steel</b>	Body, suspension, chassis, and interior	Same	Deployed, represents 9% of vehicle mass
<b>Adv High-Strength Steel</b>	Limited body, suspension, chassis, and interior	Body, suspension, chassis, and interior	In demonstration, on track for deployment
<b>Gen III High-Strength Steel</b>	Early development	Body, suspension, chassis, and interior	In alloy development, strength requirements, manufacturability, and cost
<b>Ceramics</b>	Very limited powertrain	Limited powertrain	Material properties, manufacturability, cost
<b>Sheet Molding Compound</b>	Limited body and interior	Body and interior	In deployment; manufacturability, cost
<b>Glass Fiber Composites</b>	Limited body and interior	Limited body and interior; bridging technology for low-cost carbon fiber	Manufacturability and cost
<b>Plastics</b>	Interior	Same	Is currently widely deployed
<b>Aluminum - Sheet</b>	Limited body and interior	Body and interior	Early deployment; manufacturability and cost
<b>Aluminum - Cast</b>	Powertrain and suspension	Same	Extensive use in light-duty engines; advanced engine requirements may exceed material properties
<b>Titanium</b>	Very limited powertrain and suspension	Powertrain and suspension	Material properties, materials supply, manufacturability, cost
<b>Metal Matrix Composites</b>	Limited powertrain and suspension	Powertrain and suspension	Material properties, manufacturability, cost
<b>Magnesium - Sheet</b>	Early development	Body and interior	Material properties, materials supply, manufacturability, cost
<b>Magnesium - Cast</b>	Interior	Body, suspension, chassis, powertrain, and interior	Material properties, materials supply, manufacturability, cost
<b>Carbon Fiber Composites</b>	Very limited body and interior	Body, suspension, chassis, powertrain, and interior	Material properties, manufacturability, cost

While there is clear agreement that components using lightweight materials must meet existing safety requirements and OEM durability obligations, there is divergence on the cost targets that range from cost equivalence with the displaced conventional material to directly linking the value of displacing a pound in the vehicle to the current price of gasoline. There is consensus that the cost target for lightweighting will vary greatly (order of magnitude) from one component to another. It is clear that vehicle lightweighting becomes more commercially viable as the price of gasoline and demand for high fuel economy increase.

The approach to weight reduction in passenger cars is not to attempt to manufacture an existing design with substitute materials. Rather, efficient lightweight designs require a systems approach that redesigns the vehicle to take advantage of the unique attributes of specific lightweight materials. Each component of the vehicle will have different materials requirements.

- **Body:** The lightweighting approach here is to use very high-strength sheet materials around the passenger compartment; lightweight sheet materials for enclosures (doors, trunk lid, hood); and a mixture of materials that provide strength, energy absorption, and lightweight in the crush zones. Benefits will occur over a series of steps as newer materials become technologically validated and economically viable. Advanced high-strength steel, Gen III high-strength steel, aluminum, and glass fiber composites are anticipated to play critical roles in achieving lightweighting goals to 2030. Carbon fiber composites, magnesium, advanced aluminum, and lightweight glazings are expected to be required to achieve long-term technical targets.
- **Suspension and Chassis:** The lightweighting approach here is to use very high-strength sheet materials at the corner suspensions; lightweight high-strength cast materials at brakes; and a mixture of materials that provide strength, energy absorption, and lightweight at the engine and rear cradles. Advanced high-strength steel, aluminum, and glass fiber composites are anticipated to play critical roles in achieving near-term lightweighting goals to 2030. Carbon fiber composites, magnesium, aluminum, and titanium are expected to be required to achieve long-term technical targets.
- **Interior:** Gen III high-strength steel, aluminum, magnesium, plastics, and glass fiber composites are anticipated to play critical roles in achieving near-term lightweighting goals. Carbon fiber composites, magnesium, aluminum, and plastics are expected to be required to achieve long-term technical targets.
- **Powertrain:** Many of these components require substantial strength, high fatigue endurance, and high temperature tolerance. A key approach to lightweighting here is to increase the specific power density and efficiency of

#### Integrated Computational Materials Engineering

Integrated computational materials engineering (ICME) is the optimization of a design (material, shape, and manufacturing method) that combines material models and data from different length scales (atoms up to bulk) and the processing history of the component or system. By integrating models for structure, processing, and performance across multiple processing steps, ICME enables optimization of product characteristics that are often difficult to relate, such as cost, chemistry, and structural performance. ICME is viewed as a promising method to accelerate materials research, improve design innovation, and reduce the cost of new product development. While the potential benefits of ICME are quite positive, considerable development is necessary. Computationally efficient models capable of crossing length scales have only been demonstrated for specific problems; empirically derived material properties limit the ability to explore beyond experimentally validated parameters; informatics and data integration tools in the materials community are far behind other fields such as biology. Preliminary ICME work is focused on solving industrially relevant materials problems. This will provide proof-of-concept and establish a baseline for continued improvement.

the engine. This will require materials with properties beyond current materials' strength and thermal-performance limitations. High-performance cast steels, compacted graphite iron, cast aluminum, and magnesium are anticipated to play critical roles in achieving near-term lightweighting goals. Advanced cast iron/steel, advanced cast aluminum, compacted graphite iron, metal matrix composites, aluminum, ceramics, titanium, and carbon fiber composites are expected to be necessary to achieve aggressive, long-term technical targets.

Several materials contained in the body and suspension and chassis have major impacts on long-term objectives: carbon fiber composites, magnesium, aluminum, and titanium. Some of the associated vehicle technologies also face additional technical hurdles as the operating parameters of the vehicle push traditional materials beyond their current physical properties.

Beyond surmounting technical hurdles, manufacturers will need modeling and design tools that incorporate the properties of multiple materials into a single vehicle structure. Multi-materials' vehicle structures will need advanced joining techniques that address the strength requirements of the joint while mitigating any undesired interactions or property differences between the joint materials. Recycling these complex vehicle systems will also challenge OEMs and recyclers as they try to minimize the production costs by recycling materials back to high-value products.

Lightweight materials compete with existing steel manufacturing methods that produce parts rapidly and inexpensively. Most new materials will require new processing equipment, often displacing millions of dollars of serviceable equipment. As materials meet their technical targets, each OEM will evaluate their cost effectiveness relative to the OEM's objectives, consumer preferences, and likely consumer payback based on the projected price of fuel. These internal analyses by OEMs will likely result in ad-hoc, early adoption of materials until these technologies are fully mature and can achieve their maximum market potential. A multi-material portfolio that can address near-, mid-, and long-term materials needs can mitigate deployment risks associated with a heterogeneous marketplace.

### 2.2.2 Aerodynamics

The objectives of vehicle aerodynamics are to reduce drag for improved vehicle efficiency, decrease wind noise, and prevent undesirable lift and side forces that could cause aerodynamic instability at high speeds. In some cases, it is also important to generate downward aerodynamic forces to improve traction and cornering abilities. Vehicle aerodynamics is typically studied using computer modeling and simulations and wind tunnel testing.

At highway speeds, more than 50% of usable engine output goes to overcome aerodynamic drag.<sup>35</sup> The drag force varies as the square of speed, resulting in significantly more power being needed to overcome drag at higher speeds.

Passenger car designers over the past decades have substantially improved aerodynamics to attain higher speeds and improved efficiency; however, heavy vehicles (trucks) have not followed that path. Since the basic configuration of a Class 8 tractor-trailer has not changed in decades, there is significant room for improvements in aerodynamics and energy efficiency. However, these improvements may face regulatory and operational constraints.<sup>36</sup>

### 2.2.3 DOE Accomplishments

DOE has maintained a materials research portfolio that is focused on addressing key issues that confront lightweighting. Materials developed through this research contribute to the continually improving benchmark for material properties and costs. In 2000, the potential of some of these technologies was demonstrated in the final product of the Partnership for a New Generation of Vehicles,<sup>37</sup> in which OEMs used advanced materials to reduce the weight of a midsize passenger car by 20%–31%; however, those technologies did not meet cost targets for commercialization at that time.

DOE's technical advances have helped overcome some of the hurdles to advanced materials commercialization. Examples of DOE work to accelerate the development of lightweight materials and parts include:

- Super plastic forming of aluminum, a low-cost process for forming sheet aluminum<sup>38</sup>
- Structural composite pickup truck beds using preform and liquid molding processes developed to reduce production costs<sup>39</sup>
- Carbon fiber body-in-white with a goal of 60% weight-reduction potential<sup>40</sup>
- Composite floor pan and processing methods for targeted use of composites realized a 33% weight savings<sup>41</sup>
- Design optimization of cast components demonstrated a 65% weight-reduction potential using advanced casting processes and lightweight metals<sup>42</sup>
- Magnesium engine cradle with a 35% weight reduction relative to aluminum<sup>43</sup>
- Rear cradle using advanced high-strength steel demonstrated a 28% weight reduction with cost neutrality.<sup>44</sup>

In these examples, the weight reduction or weight reduction potential has been determined or estimated in comparison to a baseline industry component at the time the work was performed.

### 2.2.4 DOE ROLE

DOE's primary roles in vehicle lightweighting are in convening and providing capabilities in the basic and fundamental engineering sciences. The Department leverages industrial partnerships to establish R&D priorities<sup>45</sup> that serve shared interests and advance the state of knowledge of novel material technologies. The Department's strong materials science capabilities underpin efforts to better understand and address fundamental engineering science challenges related to the joining of dissimilar materials and corrosion resistance. Integrated computational materials engineering is an emerging discipline in which DOE is striving to leverage its capabilities in modeling and simulation and materials science to accelerate development of materials and manufacturing processes to help enable more rapid transformation of transportation technologies.<sup>46</sup>

DOE efforts to improve vehicle aerodynamics emphasize the advancement of tools for modeling and simulation. Because vehicle aerodynamic improvement is design-specific, DOE focuses on developing general tools and techniques that can speed up the design process, minimize physical testing requirements, and reduce process costs.

- 
- <sup>1</sup> National Academies of Science. (2010). *Real Prospects for Energy Efficiency in the United States*. Washington, DC: The National Academies Press.
- <sup>2</sup> National Research Council. (2010). *Assessment of Technologies for Improving Light-Duty Vehicle Fuel Economy*. Washington, DC: The National Academies Press.
- <sup>3</sup> National Research Council. (2010). *Technologies and Approaches to Reducing the Fuel Consumption of Medium- and Heavy-Duty Vehicles*. Washington, DC: The National Academies Press.
- <sup>4</sup> U.S. Environmental Protection Agency. (2010). *Our Nation's Air: Status and trends through 2008*. (EPA Publication No. EPA-454/R-09-002). Research Triangle Park, NC.
- <sup>5</sup> U.S. Environmental Protection Agency, U.S. Department of Transportation. (2010). *Light-Duty Vehicle Greenhouse Gas Emission Standards and Corporate Average Fuel Economy Standards; Final Rule*. Washington, DC: Federal Register. Accessed at [http://www.nhtsa.gov/staticfiles/rulemaking/pdf/cale/CAFE-GHG\\_MY\\_2012-2016\\_Final\\_Rule\\_FR.pdf](http://www.nhtsa.gov/staticfiles/rulemaking/pdf/cale/CAFE-GHG_MY_2012-2016_Final_Rule_FR.pdf)
- <sup>6</sup> U.S. Environmental Protection Agency, U.S. Department of Transportation. (2011). *2017-2025 Model Year Light-Duty Vehicle GHG Emissions and CAFE Standards: Supplemental Notice of Intent*. Washington, DC: Federal Register. Accessed at [http://www.nhtsa.gov/staticfiles/rulemaking/pdf/cale/SNOI\\_2\\_for\\_2017on-09Aug11.pdf](http://www.nhtsa.gov/staticfiles/rulemaking/pdf/cale/SNOI_2_for_2017on-09Aug11.pdf)
- <sup>7</sup> National Research Council. (2010). *Assessment of Technologies for Improving Light-Duty Vehicle Fuel Economy*. Washington, DC: The National Academies Press.
- <sup>8</sup> National Research Council. (2010). *Technologies and Approaches to Reducing the Fuel Consumption of Medium- and Heavy-Duty Vehicles*. Washington, DC: The National Academies Press.
- <sup>9</sup> U.S. Department of Energy. (2010). *Fact #644: October 11, 2010 – Share of Diesel Vehicle Sales Decline in Western Europe*. Accessed at [http://www1.eere.energy.gov/vehiclesandfuels/facts/2010\\_fotw644.html](http://www1.eere.energy.gov/vehiclesandfuels/facts/2010_fotw644.html)
- <sup>10</sup> U.S. Department of Energy, Vehicle Technologies Program. (2011). *2010 Vehicle Technologies Market Report* (ORNL-TN-2011/28836). Oak Ridge, TN. Accessed at [http://www1.eere.energy.gov/vehiclesandfuels/pdfs/2010\\_vt\\_market\\_rpt.pdf](http://www1.eere.energy.gov/vehiclesandfuels/pdfs/2010_vt_market_rpt.pdf)
- <sup>11</sup> Oak Ridge National Laboratory. (2010). *Report on the Transportation Combustion Engine Efficiency Colloquium Held at USCAR, March 3-4, 2010*. (ORNL/TM-2010/265). Oak Ridge, TN. Accessed at [http://feerc.ornl.gov/pdfs/Stretch\\_Report\\_ORNL-TM2010-265\\_final.pdf](http://feerc.ornl.gov/pdfs/Stretch_Report_ORNL-TM2010-265_final.pdf)
- <sup>12</sup> National Research Council. (2010). *Assessment of Technologies for Improving Light-Duty Vehicle Fuel Economy*. Washington, DC: The National Academies Press.
- National Research Council. (2010). *Technologies and Approaches to Reducing the Fuel Consumption of Medium- and Heavy-Duty Vehicles*. Washington, DC: The National Academies Press.
- <sup>13</sup> U.S. Department of Energy. (2010). *Vehicle Technologies Program Multi-Year Program Plan 2011-2015*. Washington, DC. Accessed at [http://www1.eere.energy.gov/vehiclesandfuels/pdfs/program/vt\\_mypp\\_2011-2015.pdf](http://www1.eere.energy.gov/vehiclesandfuels/pdfs/program/vt_mypp_2011-2015.pdf)
- <sup>14</sup> For a more detailed discussion on cost-estimate methodologies for light-duty vehicle fuel economy, see *Assessment of Technologies for Improving Light-Duty Vehicle Fuel Economy*, National Research Council, 2010.
- <sup>15</sup> The ideal fuel specifications for LTC are presently unknown. However, it is known that—in the lab—fuel efficiency can be enhanced even more; for example, by dual fueling with E85 and diesel fuel or biodiesel, thus indicating further long-term potential for fuel(s) designed specifically for LTC.
- <sup>16</sup> National Research Council. (2010). *Assessment of Technologies for Improving Light-Duty Vehicle Fuel Economy*. Table 8.1. Washington, DC: The National Academies Press.
- <sup>17</sup> Van Blarigan, P. (2011). *Free-Piston Engine*. [Presentation at the 2011 Vehicle Technologies Annual Merit Review]. Washington, DC.
- <sup>18</sup> For more information on this and other basic research needs of ICEs, see: U.S. Department of Energy. (2007). *Basic Research Needs for Clean and Efficient Combustion of 21st Century Transportation Fuels*. Washington, DC. Accessed at [http://science.energy.gov/~media/bes/pdf/reports/files/ctf\\_rpt.pdf](http://science.energy.gov/~media/bes/pdf/reports/files/ctf_rpt.pdf)
- <sup>19</sup> U.S. Department of Energy. (2009). *Advanced Combustion Engine R&D: Goals, Strategies, and Top Accomplishments*. (DOE/GO-102009-2762). Washington, DC. Accessed at [http://www1.eere.energy.gov/vehiclesandfuels/pdfs/adv\\_combustion\\_goals.pdf](http://www1.eere.energy.gov/vehiclesandfuels/pdfs/adv_combustion_goals.pdf)



- <sup>20</sup> Individual companies enter into a cooperative R&D agreement with a national lab that has special expertise to help address a particular technology barrier to their application of a specific breakthrough. Technology maturation stage is when the company further develops the technology before it is ready for deployment.
- <sup>21</sup> National Research Council. (2010). *Assessment of Technologies for Improving Light-Duty Vehicle Fuel Economy*. Washington, DC: The National Academies Press.
- <sup>22</sup> National Academies of Science. (2010). *Real Prospects for Energy Efficiency in the United States*. Washington, DC: The National Academies Press.
- <sup>23</sup> National Research Council. (2010). *Technologies and Approaches to Reducing the Fuel Consumption of Medium- and Heavy-Duty Vehicles*. Washington, DC: National Academy Press. Accessed at [http://www.nap.edu/catalog.php?record\\_id=12845](http://www.nap.edu/catalog.php?record_id=12845)
- <sup>24</sup> Based on a 4,065 pound (lb) car using 310 lbs of aluminum, 12 lbs of magnesium, 630 lbs of high-strength steel, and 340 lbs of composites and plastics, assuming all materials replaced steel.
- <sup>25</sup> U.S. Environmental Protection Agency. (2009). *Light-Duty Automotive Technology, Carbon Dioxide Emissions, and Fuel Economy Trends: 1975 Through 2009*. (EPA420-R-09-014). Ann Arbor, MI. Accessed at <http://www.epa.gov/oms/cert/mpg/fetrends/420r09014.pdf>
- <sup>26</sup> Hall, J.N. (Speaker). (2011). *Evolution of Advanced High Strength Steels in Automotive Application*. Accessed at <http://www.autosteel.org/~media/Files/Autosteel/Great%20Designs%20in%20Steel/GDIS%202011/20%20-%20Jody%20Hall%20-%20Evolution%20of%20Advanced%20High-Strength%20Steels%20in%20Automotive%20Applications.ashx>
- <sup>27</sup> U.S. Federal Trade Commission. (2009). *Facts for Consumers*. Accessed at [www.ftc.gov/bcp/edu/pubs/consumer/autos/aut11.shtm](http://www.ftc.gov/bcp/edu/pubs/consumer/autos/aut11.shtm).
- <sup>28</sup> U.S. Environmental Protection Agency. (2009). *Light-Duty Automotive Technology, Carbon Dioxide Emissions, and Fuel Economy Trends: 1975 Through 2009*. (EPA420-R-09-014). Ann Arbor, MI. Accessed at <http://www.epa.gov/oms/cert/mpg/fetrends/420r09014.pdf>
- <sup>29</sup> Davis, S.C., et al. (2010). *Transportation Energy Data Book: Edition 29*. Oak Ridge, TN: Oak Ridge National Laboratory. Accessed at <http://info.ornl.gov/sites/publications/files/Pub24318.pdf>
- <sup>30</sup> Stodolsky, F., Vyas, A., and Cuenca, R. (1995). *Lightweight Materials in the Light-Duty Passenger Vehicle Market: Their Market Penetration Potential and Impacts*. (ANL/ES/CP-84474). Argonne, IL: Argonne National Laboratory.
- Bjelkengren, C. (2008). *The Impact of Mass Decoupling on Assessing the Value of Vehicle Lightweighting* (LFEE 2008-05 Report). Cambridge, MA: Massachusetts Institute of Technology. Accessed at <http://hdl.handle.net/1721.1/44384>
- <sup>31</sup> Lotus Engineering, Inc. (2010). *An Assessment of Mass Reduction Opportunities for a 2017-2020 Model Year Vehicle Program*. Ann Arbor, MI.
- <sup>32</sup> National Academies of Science. (2010). *Real Prospects for Energy Efficiency in the United States*. Washington, DC: The National Academies Press.
- Lotus Engineering, Inc. (2010). *An Assessment of Mass Reduction Opportunities for a 2017-2020 Model Year Vehicle Program*. Ann Arbor, MI.
- Lutsen, N., (2010). *Review of technical literature and trends related to automobile mass-reduction technology*. (Report UCD-ITS-RR-10-10). Davis, CA: University of California Davis. Accessed at [http://www.arb.ca.gov/msprog/levprog/leviii/meetings/051810/2010\\_ucd-its-rr-10-10.pdf](http://www.arb.ca.gov/msprog/levprog/leviii/meetings/051810/2010_ucd-its-rr-10-10.pdf)
- <sup>33</sup> Lutsen, N. (2010). *Review of technical literature and trends related to automobile mass-reduction technology*. (Report UCD-ITS-RR-10-10). Davis, CA: University of California Davis. Accessed at [http://www.arb.ca.gov/msprog/levprog/leviii/meetings/051810/2010\\_ucd-its-rr-10-10.pdf](http://www.arb.ca.gov/msprog/levprog/leviii/meetings/051810/2010_ucd-its-rr-10-10.pdf)
- <sup>34</sup> U.S. Department of Energy, Vehicle Technologies Program. *Heavy-Duty Vehicles Materials Technical Roadmap*. Washington, DC. (REPORT FORTHCOMING)
- U.S. Department of Energy, Vehicle Technologies Program. *Light-Duty Vehicles Materials Technical Roadmap*. Washington, DC. (REPORT FORTHCOMING)
- <sup>35</sup> National Academies of Science. (2010). *Real Prospects for Energy Efficiency in the United States*. Washington, DC: The National Academies Press.

- 
- <sup>36</sup> U.S. Department of Energy. (2009). *Research and Development Opportunities for Heavy Trucks*. Washington, DC. Accessed at [http://www1.eere.energy.gov/vehiclesandfuels/pdfs/truck\\_efficiency\\_paper\\_v2.pdf](http://www1.eere.energy.gov/vehiclesandfuels/pdfs/truck_efficiency_paper_v2.pdf)
- <sup>37</sup> National Research Council. (2001). *Review of the Research Program of the Partnership for a New Generation of Vehicles: Seventh Report*. Washington, DC: The National Academies Press. Accessed at [http://books.nap.edu/openbook.php?record\\_id=10180&page=2](http://books.nap.edu/openbook.php?record_id=10180&page=2)
- <sup>38</sup> U.S. Department of Energy, Vehicle Technologies Program. (2009). *FY 2009 Progress Report for Lightweighting Materials*. p. 2–57. Washington, DC.
- <sup>39</sup> National Research Council. (2001). *Review of the Research Program of the Partnership for a New Generation of Vehicles: Seventh Report*. p. 59. National Academy Press: Washington, DC.
- <sup>40</sup> U.S. Department of Energy, Vehicle Technologies Program. (2010). *FY 2010 Progress Report for Lightweighting Materials*. p. 3–13. Washington, DC.
- <sup>41</sup> U.S. Department of Energy, Vehicle Technologies Program. (2011). *FY 2011 Progress Report for Lightweighting Materials*. p. 4–3. Washington, DC.
- <sup>42</sup> US AMP. (2008). *AMD 601 High Integrity-Magnesium Automotive Components (HI-MAC)*. Slide 11. Washington, DC. Accessed at [http://www1.eere.energy.gov/vehiclesandfuels/pdfs/merit\\_review\\_2008/lightweight\\_materials/merit08\\_mccarty\\_9.pdf](http://www1.eere.energy.gov/vehiclesandfuels/pdfs/merit_review_2008/lightweight_materials/merit08_mccarty_9.pdf)
- <sup>43</sup> U.S. Department of Energy, Vehicle Technologies Program. (2005). *FY 2005 Progress Report for Automotive Lightweighting Materials*. p. 58. Washington, DC. Accessed at [http://www1.eere.energy.gov/vehiclesandfuels/pdfs/alm\\_05/2g\\_osborne.pdf](http://www1.eere.energy.gov/vehiclesandfuels/pdfs/alm_05/2g_osborne.pdf)
- <sup>44</sup> U.S. Department of Energy, Vehicle Technologies Program. (2009). *FY 2009 Progress Report for Lightweighting Materials*. p. 5–61. Washington, DC.
- <sup>45</sup> See, for instance: <http://www1.eere.energy.gov/vehiclesandfuels/technologies/materials/index.html>
- <sup>46</sup> National Research Council. (2008). *Integrated Computational Materials Engineering: A Transformational Discipline for Improved Competitiveness and National Security*. Washington, DC. Accessed at [http://www.nap.edu/catalog.php?record\\_id=12199](http://www.nap.edu/catalog.php?record_id=12199)

### 3 Vehicle Electrification

The assessment in this chapter forms the technical base for *Electrifying the Vehicle Fleet*, a strategy detailed in the corresponding chapter of the *Report on the Quadrennial Technology Review (QTR)*. Electrification (whether partial or full) provides fuel diversification beyond drop-in hydrocarbons and therefore mitigates economy-wide impacts of oil price volatility. Electrification is more viable for light-duty than heavy-duty vehicles.

While each technology is presented here with a standalone assessment, the associated opportunities to impact the energy system are fully understood only within the context of an integrated framework that spans energy resource, supply, delivery, and consumption. The *Report on the QTR* presents an integrated framework of the energy system and contains the systems discussions that tie together these individual assessments.

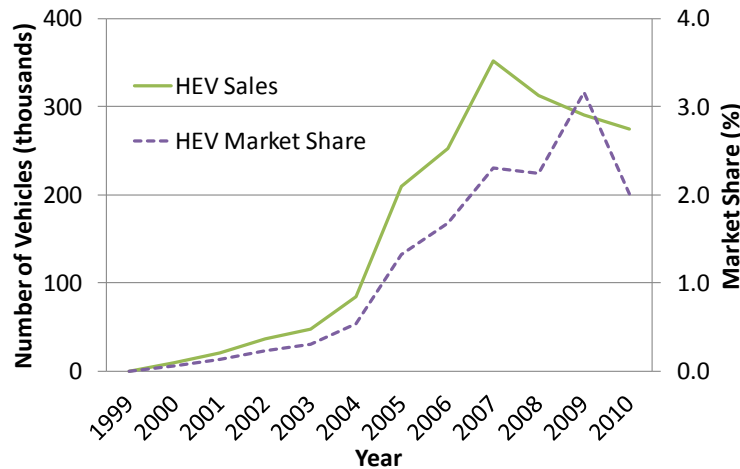
### 3.1.1 Introduction

Degrees of electrification range from mild and strong hybrid electric vehicles (HEVs), through plug-in hybrid electric vehicles (PHEVs), to battery-powered all-electric vehicles (AEVs<sup>1</sup>) and fuel cell electric vehicles (FCEVs).

#### 3.1.1.1 Electrification Technology Adoption

Though petroleum presently powers over 90% of the Nation’s transportation, electric and fuel cell vehicles have been on American roads for decades. At the beginning of the 20th century, 34% of automobiles in New York, Chicago, and Boston<sup>2</sup> were powered by electricity; fuel cells vehicles were first demonstrated in the 1960s.<sup>3</sup> However, neither technology has penetrated the contemporary market significantly due largely to cost, performance, and infrastructure challenges.

Three types of electric-drive vehicles are at different stages of technical maturity and market penetration: conventional HEVs, grid connected PHEVs and AEVs, and FCEVs. HEVs, first commercially introduced in 1999, now account for 3% of new light-duty vehicle sales (see **Error! Reference source not found.****Error! Reference source not found.****Error! Reference source not found.**Figure 6). More than 2 million HEVs have been sold in the United States,<sup>4</sup> and more than 40 hybrid makes and models were available in 2011.<sup>5</sup>



**Figure 6. U.S. HEV Sales History** HEV sales are calendar year sales. HEV market share calculated against total light-duty vehicle model year sales. Sources:

Alternative Fuels and Advanced Vehicles Data Center. (2011). *Table: Light-Duty Vehicles Sold in the U.S.* Washington, DC: Department of Energy, Office of Energy Efficiency and Renewable Energy. Accessed at [http://www.afdc.energy.gov/afdc/data/docs/ldv\\_sales.xls](http://www.afdc.energy.gov/afdc/data/docs/ldv_sales.xls)

Alternative Fuels and Advanced Vehicles Data Center. (2011). *Table: HEV Sales by Model.* Washington, DC: Department of Energy, Office of Energy Efficiency and Renewable Energy. Accessed at [http://www.afdc.energy.gov/afdc/data/docs/hev\\_sales.xls](http://www.afdc.energy.gov/afdc/data/docs/hev_sales.xls)

HEV powertrains are 5%–50% more efficient than traditional powertrains, depending on the degree of hybridization, the size of the battery, power electronics, and electric motor components, and the driving conditions. Micro-hybrids using lead-acid batteries that provide only start/stop capability, but no regenerative braking, have incremental costs of several hundred dollars, while PHEVs can have an

incremental cost of more than \$10,000. HEVs are roughly \$2,500 more expensive than comparable conventional vehicles.<sup>6</sup>

Grid-connected vehicles (PHEVs and AEVs) have recently come to market and manufacturers are expanding vehicle availability and consumer options. The Tesla Roadster, with a range greater than 200 miles, was the first production AEV to use lithium-ion batteries, and more than 1,500 cars have been sold since 2008. Tesla stopped production of the luxury Roadster in 2011 and is planning to bring the Model S to market by 2012. In 2010, General Motors (GM) delivered the first mass produced PHEV (Chevy Volt) and Nissan delivered the first mass produced AEV (Nissan Leaf). Through February 2012, about 9,000 Chevy Volts and 11,000 Nissan Leafs have been sold in the United States. None of these is currently cost-competitive with comparable conventional vehicles.

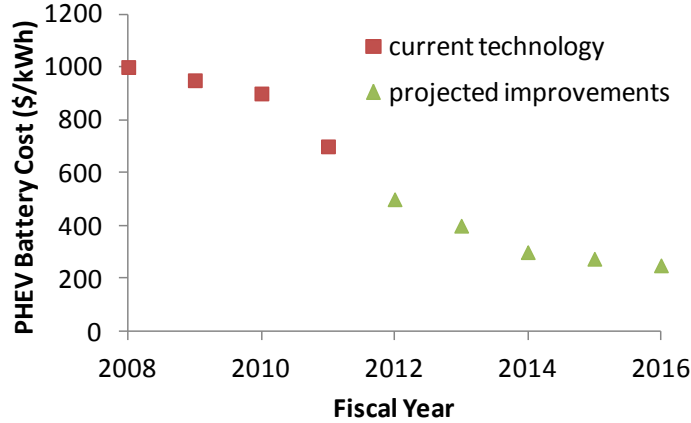
The Department of Energy (DOE) estimates that auto manufacturers would be able to domestically produce, subject to market conditions, more than one million PHEVs and AEVs by 2015.<sup>7</sup> Electric drive vehicles have the potential to eventually be a large share of the light-duty fleet, as well as some share of the urban heavy-duty fleet. Projections of market penetration rates vary widely, ranging from less than 10% in 2050 to 90%–95% in 2050.<sup>8</sup>

Fuel cell vehicles (including 155 FCEVs built by GM, Ford, Mercedes, and Hyundai) have been tested through 3 million miles of road travel. Industry and DOE are learning from the operating data from these FCEVs and approximately 60 U.S. hydrogen fueling stations. In 2009, seven of the world's leading automakers issued a joint Letter of Understanding<sup>9</sup> in support of commercial introduction of fuel cell vehicles from 2015 onward and anticipated—subject to a variety of prerequisites and conditions—that a “few hundred thousand units” could be commercialized around the world over the initial products' life cycles, although this is equivalent to less than 0.1% of new vehicle sales projected over that timeframe.

### 3.1.2 Batteries

Battery cost and performance are key determinants of the economics and utility of electric drive vehicles, as batteries are a significant fraction of electric vehicle costs today. Research, improved manufacturing processes, and advances in consumer electronics reduced lithium-ion battery costs from \$1,000 per kilowatt hour (kWh) in 2008 to roughly \$650/kWh today, as estimated by projection to high-volume manufacturing, using a peer reviewed cost model (**Error! Reference source not found.****Error! Reference source not found.**Figure 7).<sup>10</sup>

Historic milestones in the progress of battery technology include nickel/metal hydride batteries in the 1990s, which helped pave the way for HEVs, and lithium-ion batteries, first introduced for consumer products in 1990 and now used in most AEVs.



**Figure 7. DOE Estimates of PHEV Battery Cost** Current technology costs are modeled at a production level of 100,000 units per year. DOE uses a standardized battery cost model developed in partnership with the U.S. Advanced Battery Consortium available at [http://www.uscar.org/guest/article\\_view.php?articles\\_id=143](http://www.uscar.org/guest/article_view.php?articles_id=143). Projected technology costs are based on DOE achieving its technical targets and are modeled using BatPaC,<sup>11</sup> available at <http://www.cse.anl.gov/batpac/>

### 3.1.2.1 Technology Potential

Battery technology is far from its theoretical limit. In the near term, within existing lithium-ion technology, battery energy density could be as much as doubled by high-capacity cathode materials, higher-voltage electrolytes, and the use of silicon or tin-based intermetallic alloys to replace graphite anodes.

There is potential to improve battery storage technology and reduce costs from about \$1,000/kWh in 2008 to \$300/kWh by 2014, based on useable energy at the battery pack level, at a modeled annual production rate of 100,000 units (**Error! Reference source not found.****Error! Reference source not found.****Error! Reference source not found.**Table 4).

**Table 4. Performance Requirements and Potential Costs of Electric Drive Vehicle Batteries**

Energy Storage Goals <sup>a</sup>	HEV	PHEV	AEV	FCEV
Equivalent Electric Range, miles	<1	10–40	200–300	330
Discharge Pulse Power (10 seconds), kilowatts (kw)	25–45	38–50	80–120	80
Regenerative Pulse Power (10 seconds), kW	20–25	25–30	40	N/A
Cold Cranking Power at -30°C (2 seconds), kW	5–7	7	N/A	5–7
Available Energy, kWh	0.3–0.5	3.5–11.6	40–60	100 <sup>b</sup>
Calendar Life, years	15	10+	10+	15
Cycle Life, cycles	300,000 shallow cycles	3,000–5,000 deep cycles	1,000 deep cycles	1,500 ¼ tank to full
System Weight, kilograms	40–60	60–120	300	230 <sup>d</sup>
System Volume, liters	32–45	40–80	133	200 <sup>d</sup>
Operating Temperature Range,	-30–52	-30–52	-40–85	-30–52

Celsius				
Production Cost at 100,000 units/year <sup>c</sup>	N/A	\$270/kWh	\$150/kWh	\$33/kWh <sup>d</sup>
Met in production vehicle	Met in demonstration vehicle	Met in lab	Not met	

<sup>a</sup> As indicated, many of these metrics have been met in production or demonstration vehicles, but not at the cost goals.

<sup>b</sup> Based on total net power from 5.0 kg H<sub>2</sub> fuel cell system at 60% conversion efficiency (lower heating value).

<sup>c</sup> Costs are for usable capacity.

<sup>d</sup> Fuel cell system targets include fuel cell (\$30/kWh), H<sub>2</sub> storage (\$12/kWh), and all ancillary components (i.e., valves, regulators, mounting brackets, insulation, added cooling capacity, and/or other balance-of-plant components), excluding any hybrid battery or ultracapacitor.

These performance requirements were established in partnership with U.S. automakers<sup>12</sup> and are reviewed and revised as necessary to reflect changing market conditions.<sup>13</sup> Battery performance projections were developed using component modeling and simulation tools and hardware-in-the-loop simulations. They reflect the typical operation of a battery under standard drive cycles and are consistent with external technical assessments.<sup>14</sup> For example, batteries must be able to accommodate the power necessary to charge in a time compatible with consumer needs. Electric vehicles with longer electric ranges, and therefore batteries with higher capacity, will require higher power charging.

### 3.1.2.2 R&D Opportunities: Batteries

Near-term applied research and development (R&D) should focus on lithium-ion batteries, including the development of cells using high-voltage (5V) and/or high-capacity (>300mAh/g) cathodes; alloy or lithium metal anodes; lithium/air and lithium/sulfur systems; and high-voltage and solid-polymer composite electrolytes. While lithium-ion batteries are currently used in electric vehicles, improvements are needed in thermal stability, deep-discharge cycle life, and cost.<sup>15</sup> Additional research is required to develop additives that prevent overcharging, additives that form a good interface between the electrode and the electrolyte for improved life and fast charge capability, and electrolyte formulations and additives for low-temperature operation. As batteries become larger, abuse-tolerance becomes more of a concern and enhanced thermal management becomes more important.

Nanoscale materials and architectures are important for electrical energy storage. There are also synergies between electrical energy storage materials and hydrogen storage materials, such as metal hydrides. Such materials can have superior performance in high pulse discharge, recharge power, and low-temperature operation. New diagnostic tools and techniques will be required to investigate these materials.

Battery recycling will be important as battery use grows because it both recovers high-value materials, providing cost savings and conserving finite resources, and avoids the costs and environmental concerns associated with battery disposal. Future activity is needed to develop battery recycling technology, improving the efficiency and cost effectiveness of current recycling processes, enhancing recycling processes to recover more materials, and restoring or refurbishing partially spent batteries to approach new-battery performance levels. Future research should address potential electric vehicle battery

secondary use. Information on battery end-of-life performance should be collected, second-use applications evaluated, and testing conducted to assess the suitability of used batteries for secondary use.

Advanced battery prototyping can move new battery technologies closer to market by improving understanding of their behavior in simulated drive conditions. The design and development of pre-production battery prototypes provides valuable data that would assist in driving down battery cost through optimization of battery cell and pack designs.

Battery materials and cell manufacturing could benefit from incorporating automated and metrological methods into existing processes.

Development of advanced, computer-aided engineering tools could accelerate design cycles, reduce the number of prototypes needed, reduce battery development cost, and provide a competitive advantage to U.S. original equipment manufacturers (OEMs), suppliers, and battery manufacturers.

Basic research needs for electrical energy storage and for hydrogen and fuel cells have also been identified.<sup>16</sup>

Improved technical approaches for developing standards for battery design, performance ratings, commonality in labeling, and safety would further strengthen the industry.

### 3.1.3 Fuel Cells

Fuel cells convert the chemical energy in fuels, such as hydrogen or natural gas, directly into electricity. They do so without combustion by combining the fuel with oxygen from the air in an electrochemical cell. The only local product when hydrogen is used, besides electricity and heat, is water vapor—with no other emissions from the vehicle. However, commercial production of hydrogen is currently solely from fossil fuels.

In an FCEV, the fuel cell stack (the “stack,” composed of a number of individual cells) converts a fuel to electricity to power the electric motor. A small battery is typically included to provide additional power and take advantage of regenerative braking. FCEVs can be refueled in a few minutes, can be used for a wide range of vehicle sizes, and can achieve a driving range of more than 300 miles. However, the cost of fuel cells and the availability of a hydrogen production, distribution, and fueling infrastructure are major barriers. There are also additional technical barriers to FCEV deployment, including on-board hydrogen storage density, use of precious metal catalysts, and durability.

Fuel cell characteristics depend on the electrolyte used (e.g., phosphoric acid, molten carbonate, solid oxide, alkaline, and polymer electrolyte membrane fuel cells) and of these, the most widely used fuel cell in current prototype automotive applications is the polymer electrolyte membrane fuel cell. This is primarily due to their low-temperature operation (roughly 80°C), which allows for rapid start up and shut down and the good transient response required for a range of automotive operating conditions.



### 3.1.3.1 R&D Opportunities: Fuel Cells

The Department believes that continued R&D could possibly reduce fuel cell costs by an additional 40%,<sup>17</sup> while doubling durability.<sup>18</sup> This would make the total ownership costs (vehicles + fuel + maintenance) of FCEVs comparable to those of other advanced vehicle technologies. To enable these improvements, innovations are required to reduce fuel cell catalyst loading and to reduce the cost and improve the durability of high-temperature membranes, bipolar plates, and membrane electrode assemblies with high proton conductivity. The 50%–60% efficiency of fuel cell systems can be improved and future work in hydrogen storage packaging could improve practical ranges to more than 400 miles.<sup>19</sup>

Studies estimate that \$2–\$4 per gallon of gasoline equivalent (or “gge,” roughly equal to 1 kilogram (kg) of hydrogen) is required for FCEVs to be competitive.<sup>20</sup> Reforming natural gas is the most mature and lowest cost method to produce hydrogen; it is used to produce over 90% of the 9 million tons of merchant hydrogen annually in the United States (equivalent in energy capacity to about 7% of today’s U.S. gasoline consumption). R&D has advanced the state of hydrogen production from distributed natural gas so that it could be technically possible to achieve high-volume production costs of approximately \$3/gge.<sup>21</sup> Documents provided by industry during the *Report on the QTR* process have indicated a more realistic high-volume cost of \$7/kg over the near term.<sup>22</sup>

Production of hydrogen from renewable sources (biomass, algae, solar, etc.) offers lower greenhouse gas emissions, but is less mature and more costly at present; there are also serious scaling issues in some of these sources. A primary R&D need to enable photoelectrochemical hydrogen production is to develop materials with the appropriate bandgap to both absorb sunlight and electrolyze water in a single device, rather than relying on electrolysis. Biological approaches require fundamental research in a number of areas, such as direct water splitting using microalgae or cyanobacteria and optimization in photosynthesis through genetic engineering of chlorophyll and efficient light utilization.

Hydrogen delivery research is needed to enable low-cost materials for high-capacity tube trailers and pipelines that are not susceptible to hydrogen embrittlement. Compressor and liquefaction technologies are also required to enable high-pressure (700 bar) refueling and efficient, high energy density liquid delivery. Additional long-term R&D is required to develop metal hydrides, sorbents, and chemical carriers that can store hydrogen at low pressures with maximum energy density and specific energy, while near-term needs include carbon fiber research to reduce the cost of high-pressure tanks.

Novel approaches to addressing the infrastructure challenge include combined heat, hydrogen, and power (poly-generation or tri-generation) concepts using a high-temperature methane-powered fuel cell to provide both power and heat for buildings, as well as hydrogen for FCEVs.

The DOE roadmap includes additional activities in manufacturing R&D, technology validation, safety, codes and standards, and systems analysis.<sup>23</sup> Although transportation fuel cells have different requirements than stationary fuel cells, there are synergies in cost reduction that would benefit both applications. Increasing use of polymer electrolyte membrane fuel cells for other applications, such as backup power or small-scale combined heat and power, could improve manufacturing learning and help drive down the cost of automotive fuel cells.

The Department’s perspective on FCEV pathways and costs<sup>24</sup> was developed through numerous workshops and technical team meetings through the U.S. DRIVE government-industry partnership, which stands for *Driving Research and Innovation for Vehicle efficiency and Energy sustainability*; it is consistent with external assessments.<sup>25</sup> Specific technical requirements developed by U.S. DRIVE are shown in **Error! Reference source not found.****Error! Reference source not found.****Error! Reference source not found.**Table 5.

**Table 5. Projected Requirements for Fuel Cell Development**

Characteristic	2010 Status	2017 <sup>26</sup>
Energy efficiency @ 25% of rated power	59%	60%
Power density	400 W/L	650 W/L
Specific power	400 W/kg	650 W/kg
Production cost at high volumes	\$50/kW	\$30/kW
Durability with cycling	2,500 hours	5,000 hours

Two other key requirements are onboard hydrogen storage density of 7.5% by tank weight and hydrogen fuel cost of \$2–\$4/gge, dispensed to the vehicle.

**3.1.3.2 Factors that Affect Market Prospects**

Widespread adoption will depend on the cost and durability fuel cells, low-cost and compact hydrogen storage systems, and the availability of a hydrogen infrastructure. While Japan and Germany have announced plans for up to 1,000 hydrogen stations,<sup>27</sup> market penetration in the United States has been focused in California where plans call for up to 40 hydrogen stations funded primarily through state and industry activities. Industry plans in February 2009 included projections of approximately 50,000 FCEVs in California by the 2018 timeframe,<sup>28</sup> or some 0.2% of the current California light-duty vehicle fleet, although deployments in the few years since publication have already fallen significantly behind initial projections.<sup>29</sup>

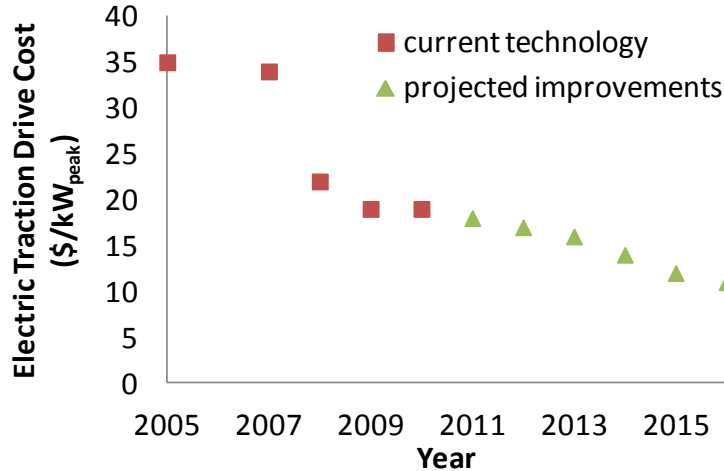
**3.1.4 Electric Motors and Power Electronics**

Because today’s electric propulsion components add significant cost to electric drive vehicles (e.g., \$2,000 for a 100 kilowatt (kW) system not including the battery pack), R&D is needed to decrease cost, weight, volume, and improve thermal management of power electronics (inverters and capacitors) and electric motors. One issue with today’s technology is the rare earth metals required in permanent magnet motors, which are popular because of their high power density, specific power, and efficiency. Current production of rare earth metals is concentrated in China. Limited supply and sustained high costs of rare earth metals could impact the commercial viability of electric drive systems.

While electric drive systems are more than 90% energy efficient, there are still opportunities to reduce cost, weight, and volume, while increasing efficiency and ensuring a domestic supply chain. R&D is needed on advanced packaging, enhanced reliability, and improved manufacturability.

The recent cost history of electric traction drives is shown in **Error! Reference source not found.****Error! Reference source not found.****Error! Reference source not found.**Figure 8. DOE projected the cost of an

electric drive system (not including the battery pack) that can deliver 55 kW of peak power for 18 seconds and 30 kW of continuous power, as estimated in high-volume manufacturing, will decrease from \$22/kW in 2008, to \$12/kW (\$7/kW for the motor) in 2015, and \$8/kW (\$4.70/kW for the motor) in 2020, while meeting performance requirements for power density, efficiency, and lifetime.



**Figure 8. Electric Drive Cost** This figure is a ground-up cost estimate based on proprietary data and cost models developed by an industry OEM.

The projection of potential pathways and costs (**Error! Reference source not found.****Error! Reference source not found.****Error! Reference source not found.**Table 6) was developed through numerous workshops with industry experts and stakeholders (e.g., automakers, component suppliers, university researchers) and is consistent with external assessments.<sup>30</sup>

**Table 6. DOE Technical Targets for Electric Traction System**<sup>31</sup>

	2010	2015	2020
Cost, \$/kW	<19	<12	<8
Specific power, kW/kg	>1.06	>1.2	>1.4
Power density, kW/L	>2.6	>3.5	>4.0
Efficiency (10%-100% speed at 20% rated torque)	>90%	>93%	>94%

### 3.1.4.1 R&D Opportunities: Electric Motors and Power Electronics

The opportunities in power electronics R&D are inverters and motors (permanent magnet and non-permanent magnet), Direct Current-to-Direct Current converters, Silicon Carbide/Gallium Nitride components, low-cost permanent magnet materials, high-temperature capacitors, advanced thermal systems, and motor control systems to meet future passenger vehicle hybrid systems requirements. Work in these areas will address the performance requirements for vehicle electrification, including utilizing power electronics to provide plug-in capability by integrating the battery charging function into the traction drive, thereby reducing electric propulsion system cost.

Other key areas of focus are capacitor dielectric material development, wide bandgap materials, and semiconductor power electronics packaging R&D. Extending beyond the transportation sector, advances in these areas can benefit a wide range of energy applications.

Reducing the need for rare earth materials in electric motors is a key R&D priority.<sup>32</sup> Specifically, near-term research will seek to reduce the amount of rare earth materials in current-generation magnets and to improve the performance of motor technologies that do not require permanent magnets.

### 3.1.5 Advanced Technologies

In addition to the technologies and roadmaps discussed above, several disruptive, breakthrough pathways for vehicle electrification can be imagined. These early-stage opportunities have not produced sufficient cost and performance data to be evaluated against the more developed pathways, but deserve further consideration for their significant potential.

**Table 7. Technology Opportunities for Vehicle Electrification**

Technology	Description
Lithium-metal and metal-air batteries (e.g., Lithium/air, Lithium/Sulfur)	Batteries that utilize metallic lithium anodes and/or air cathodes. These offer a potential 10× improvement in energy density and 5× improvement in cost over today’s lithium-ion batteries.
Rare-earth-free magnets and electric motors	Electric motors with magnetic materials that do not contain rare earths—either through non-rare earth magnet materials or new designs. These could reduce motor cost by 75% with no loss in performance.
Platinum-free fuel cells	Eliminating platinum or other precious metals could reduce the cost of automotive fuel cell stacks by one-third.

### 3.1.6 DOE History and Accomplishments

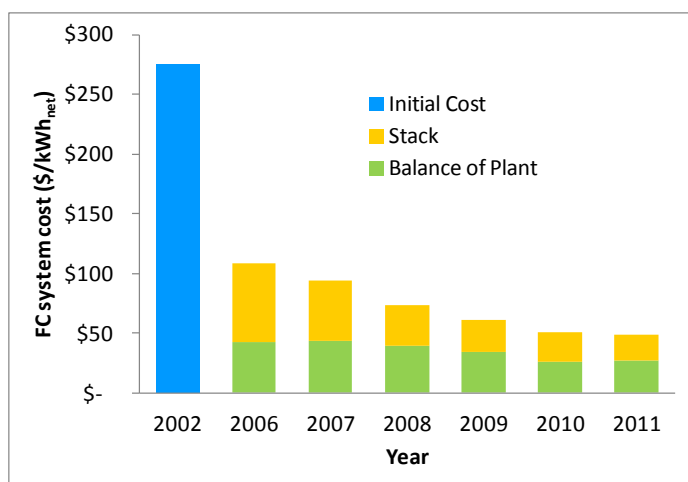
The Department’s battery investments have yielded many advances, some of which have been adopted by industry. These include:

- DOE-sponsored R&D created the nickel/metal-hydride battery technology upon which the batteries used in the Toyota Prius and many other HEVs are in part based upon.<sup>33,34</sup>
- Unique lithium-metal oxide electrode materials were developed at Argonne National Laboratory<sup>35</sup> and have subsequently been licensed by GM and LG Chem Power for use in the Chevrolet Volt,<sup>36</sup> with additional licenses to materials suppliers BASF, Toda America, and Envia Systems.
- Lithium-ion battery technology developed in part with DOE funding at Compact Power, Inc. (now named LG Chem Power) is being used in GM’s Chevrolet Volt; also selected for the upcoming Ford Focus AEV battery.<sup>37</sup>
- HEVs on the market from BMW and Mercedes are using lithium-ion technology developed under projects with Johnson Controls-Saft, a company supported by DOE and industry through the U.S. Advanced Battery Consortium.<sup>38</sup>
- Eaton announced that it would use batteries from LG Chem Power for future Eaton hybrid drive heavy vehicles,<sup>39</sup> while Johnson Controls-Saft began supplying lithium-ion battery packs to Azure Dynamics for electric delivery vans built on the Ford Transit Connect platform.<sup>40</sup>

- A123 Systems, started with the help of a DOE Small Business Innovation Research grant, will supply lithium-ion batteries for the Fisker Karma electric vehicle.<sup>41</sup>

Over the past decade, DOE has invested approximately \$150 million per year in R&D of transportation fuel cells, along with work on hydrogen production, delivery, and storage technologies. That investment has helped produce more than 300 patents and 30 commercial technologies, primarily early market applications and components.<sup>42</sup> Examples include fuel cell catalysts and membrane technologies used by suppliers such as 3M, DuPont, and BASF.

By focusing on reducing the amount of platinum catalyst in fuel cells and improving power densities, R&D supported by DOE in conjunction with industry has helped reduce fuel cell cost in the last few years—more than 80% since 2002, from \$275/kW<sup>43</sup> to approximately \$50/kW today, based on projections of costs to high-volume manufacturing (**Error! Reference source not found.****Error! Reference source not found.****Error! Reference source not found.**Figure 9).<sup>44</sup>



**Figure 9. Modeled Fuel Cell System Cost at 500,000 Units (80 kW) per Year** Modeled costs are based on an analysis of state-of-the-art components demonstrated at the laboratory scale and on projection to high-volume manufacturing. Source: Hydrogen and Fuel Cell Technologies Program. (2011). *DOE Hydrogen Program Record: Fuel Cell Systems Cost—2011*. (Record #11012). Washington, DC: Department of Energy. Accessed at [http://www.hydrogen.energy.gov/pdfs/11012\\_fuel\\_cell\\_system\\_cost.pdf](http://www.hydrogen.energy.gov/pdfs/11012_fuel_cell_system_cost.pdf)

DOE-funded efforts in the last 5 years have contributed to more than doubling the durability of automotive fuel cell systems operating under real-world conditions.<sup>45</sup> A partnership of automobile and energy companies with DOE has also demonstrated 24 hydrogen stations and 155 FCEVs on the road, traveling more than 3 million miles.

Innovations coming from the R&D of pre-competitive technologies have been transferred to and implemented by industry partners as a business case has developed for these technologies through the U.S. DRIVE public-private partnership.<sup>46</sup> For example, advances in lithium-ion battery technology developed under the partnership have been transferred to the U.S. battery manufacturing facilities supported under the American Recovery and Reinvestment Act of 2009.

### 3.1.7 DOE Role

In vehicle electrification, DOE is expanding beyond the capability and informational roles to targeted initiatives. In addition to the fundamental engineering science and materials capabilities that the Department commits to electric vehicle R&D, DOE is pursuing an ambitious technical goal for batteries and electric drives, working with industry and academic partners toward that goal. In addition, DOE is using its convening power to bring together major standards-setting organizations, battery manufacturers, and automotive OEMs to speed the development and adoption of these standards. DOE continues to support basic and fundamental engineering research in these areas through diverse funding mechanisms from individual grants to Energy Frontier Research Centers to the batteries hub.<sup>47</sup>

In small-scale fuel cells for vehicles, DOE is focused on its informational and capability roles. As with batteries and electric powertrains, DOE's convening power brings together stakeholders across the fuel cell industry, from fuel cell manufacturers to automotive OEMs to hydrogen suppliers.

---

<sup>1</sup> We use the term "all-electric vehicle," or AEV, for vehicles that carry no chemical fuel, but derive all of their primary energy from the electrical grid.

<sup>2</sup> Sulzberger, C. (2004). "An Early Road Warrior: Electric Vehicles in the Early Years of the Automobile." *IEEE Power & Energy Magazine*. 2(3):66-71.

<sup>3</sup> Hakim, D. (2002). "An Electrovan, Not an Edsel." *New York Times*. New York, NY. Accessed at <http://www.nytimes.com/2002/11/17/business/private-sector-an-electrovan-not-an-edsel.html?pagewanted=all&src=pm>

<sup>4</sup> Ward, J., and Davis, S. (2011). *2010 Vehicle Technologies Market Report*. Washington, DC: Department of Energy. Accessed at [http://www1.eere.energy.gov/vehiclesandfuels/pdfs/2010\\_vt\\_market\\_rpt.pdf](http://www1.eere.energy.gov/vehiclesandfuels/pdfs/2010_vt_market_rpt.pdf)

<sup>5</sup> U.S. Department of Energy. (2011). "Compare Hybrids Side-by-Side." Washington, DC. Accessed at [http://www.fueleconomy.gov/feg/hybrid\\_sbs.shtml](http://www.fueleconomy.gov/feg/hybrid_sbs.shtml)

<sup>6</sup> Oak Ridge National Laboratory. (2012) *2011 Vehicle Technology Market Report*. (ORNL/TM-2012/016). Oak Ridge, TN. Accessed at [http://cta.ornl.gov/vtmarketreport/pdf/2011\\_vtmarketreport\\_full\\_doc.pdf](http://cta.ornl.gov/vtmarketreport/pdf/2011_vtmarketreport_full_doc.pdf)

<sup>7</sup> U.S. Department of Energy. (2011). *One Million Electric Vehicles By 2015, February 2011 Status Report*. Washington, DC. Accessed at [http://www1.eere.energy.gov/vehiclesandfuels/pdfs/1\\_million\\_electric\\_vehicles\\_rpt.pdf](http://www1.eere.energy.gov/vehiclesandfuels/pdfs/1_million_electric_vehicles_rpt.pdf).

<sup>8</sup> Low estimate from Robert Lutz: Terlep, S. (2010). "GM Exec: Hybrids unlikely to take more than 10% of US market." *Market Watch*. Accessed at <http://www.marketwatch.com/story/gm-exechybrids-unlikely-to-take-more-than-10-of-us-market-2010-02-13>

High estimate from Electrification Coalition. (2009). *Electrification Roadmap*. Washington, DC.

Electric Power Research Institute and Natural Resources Defense Council. (2007). *Environmental Assessment of Plug-In Hybrid Electric Vehicles*. Atlanta, GA, and Washington, DC.

National Academy of Sciences. (2009). *Real Prospects for Energy Efficiency in the United States*. The National Academies Press. Washington, DC.

<sup>9</sup> Daimler, Ford, GM/Opel, Honda, Hyundai/KIA, the Alliance Renault/Nissan, Toyota. (2009). "Letter of Understanding on the Development and Market Introduction of Fuel Cell Vehicles." Accessed at [http://www.cleancaroptions.com/Auto\\_OEM\\_letter\\_on\\_FCEVs.pdf](http://www.cleancaroptions.com/Auto_OEM_letter_on_FCEVs.pdf)

<sup>10</sup> Current technology costs are modeled at a production level of 100,000 units per year. The Department of Energy uses a standardized battery cost model developed in partnership with the U.S. Advanced Battery Consortium, which is available at [http://www.uscar.org/guest/article\\_view.php?articles\\_id=143](http://www.uscar.org/guest/article_view.php?articles_id=143)

<sup>11</sup> For more information about BatPaC, see: Nelson, P. A., Gallagher, K. G., Bloom, I., and Dees, D. W. (2011). *Modeling the Performance and Cost of Lithium-Ion Batteries for Electric Drive Vehicles*. (ANL-11/32). Argonne, IL: Argonne National Laboratory. Accessed at <http://www.ipd.anl.gov/anlpubs/2011/10/71302.pdf>

<sup>12</sup> United States Council for Automotive Research. "Energy Storage System Goals." Accessed on February 2, 2012 at [http://www.uscar.org/guest/article\\_view.php?articles\\_id=85](http://www.uscar.org/guest/article_view.php?articles_id=85)

- 
- <sup>13</sup> U.S. Department of Energy. (2010). *Vehicle Technologies Program Multi-Year Program Plan 2011-2015*. Washington, DC. Accessed at [http://www1.eere.energy.gov/vehiclesandfuels/pdfs/program/vt\\_mypp\\_2011-2015.pdf](http://www1.eere.energy.gov/vehiclesandfuels/pdfs/program/vt_mypp_2011-2015.pdf)
- <sup>14</sup> America's Energy Future and the International Energy Agency's *Technology Roadmap for Electric and Plug-in Hybrid Electric Vehicles*.
- <sup>15</sup> National Research Council. (2011). *Assessment of Fuel Economy Technologies for Light-Duty Vehicles*. Washington, DC. Available at [http://www.nap.edu/catalog.php?record\\_id=12924](http://www.nap.edu/catalog.php?record_id=12924)
- <sup>16</sup> U.S. Department of Energy. *BES Workshop on Basic Research Needs for Electrical Energy Storage (EES)*, April 2–4, 2007; *Basic Research Needs for the Hydrogen Economy*, May 13–15, 2003.
- <sup>17</sup> The Department of Energy target for fuel cell cost is \$30 per kilowatt in 2017, a 40% decrease from the 2011 cost of \$49 per kilowatt.
- U.S. Department of Energy. (2011). *Fuel Cell Technologies Program Accomplishments Fact Sheet*. Washington, DC. Accessed at <http://www1.eere.energy.gov/hydrogenandfuelcells/pdfs/accomplishments.pdf>
- <sup>18</sup> McKinsey & Company/EU Powertrain Coalition. (2010). "A portfolio of power-trains for Europe: A fact-based analysis. The role of Battery Electric Vehicles, Plug-in Hybrids and Fuel Cell Electric Vehicles." Exhibit 21. Accessed at [http://www.europeanclimate.org/documents/Power\\_trains\\_for\\_Europe.pdf](http://www.europeanclimate.org/documents/Power_trains_for_Europe.pdf)
- <sup>19</sup> Wipke, K., et al. (2009). "Evaluation of Range Estimates for Toyota FCHV-adv Under Open Road Driving Conditions," Savannah River Site, SC. National Renewable Energy Laboratory and Savannah River National Laboratory. (SRNS-STI-2009-00446). Accessed at [http://www1.eere.energy.gov/hydrogenandfuelcells/pdfs/toyota\\_fchv-adv\\_range\\_verification.pdf](http://www1.eere.energy.gov/hydrogenandfuelcells/pdfs/toyota_fchv-adv_range_verification.pdf)
- <sup>20</sup> U.S. Department of Energy. (2011). "Hydrogen Threshold Cost Calculation." Washington, DC. Accessed at [http://www.hydrogen.energy.gov/pdfs/11007\\_h2\\_threshold\\_costs.pdf](http://www.hydrogen.energy.gov/pdfs/11007_h2_threshold_costs.pdf)
- <sup>21</sup> Assumes widespread deployment of 500 fueling stations per year and production of 1,500 kilograms per day at each station.
- National Renewable Energy Laboratory. (2006). "Distributed Hydrogen Production from Natural Gas," Golden, CO. (NREL/BK-150-40382). Accessed at [www.hydrogen.energy.gov/pdfs/40382.pdf](http://www.hydrogen.energy.gov/pdfs/40382.pdf);
- <sup>22</sup> Ex parte communications received by the *Report on the QTR* team from Air Products and Chemicals, Inc. on April 18, 2011. Available at <http://energy.gov/downloads/qtr-ex-parte-communications>
- <sup>23</sup> U.S. Department of Energy. (2007). *Fuel Cell Program Multi-Year Research Development and Demonstration Plan*. Washington, DC. Accessed at <http://www1.eere.energy.gov/hydrogenandfuelcells/mypp/index.html>
- <sup>24</sup> U.S. Department of Energy. (2007). *Fuel Cell Program Multi-Year Research Development and Demonstration Plan*. Washington, DC. Accessed at <http://www1.eere.energy.gov/hydrogenandfuelcells/mypp/index.html>
- U.S. Department of Energy. (2009). *Fuel Cell System Cost for Transportation - 2008 Cost Estimate*. Washington, DC. Accessed at <http://www.hydrogen.energy.gov/pdfs/45457.pdf>
- U.S. Department of Energy. (2004). *Fuel Cell Roadmap*. Washington, DC. Accessed at [http://www1.eere.energy.gov/vehiclesandfuels/pdfs/program/fuel\\_cell\\_roadmap.pdf](http://www1.eere.energy.gov/vehiclesandfuels/pdfs/program/fuel_cell_roadmap.pdf)
- <sup>25</sup> Hydrogen Technology Advisory Committee. (2010). *2010 Annual Report of the Hydrogen and Fuel Cell Technology Advisory Committee*. Washington, DC. Accessed at [http://www.hydrogen.energy.gov/pdfs/2010\\_htac\\_annual\\_report.pdf](http://www.hydrogen.energy.gov/pdfs/2010_htac_annual_report.pdf)
- National Research Council. (2008). *Transitions to Alternative Transportation Technologies - A Focus on Hydrogen*. Washington, DC: National Academies Press. Accessed at [http://www.nap.edu/catalog.php?record\\_id=12222](http://www.nap.edu/catalog.php?record_id=12222)
- National Research Council. (2010). *Review of the Research Program of the FreedomCAR and Fuel Partnership: Third Report*. Washington, DC: National Academies Press. Accessed at [http://www.nap.edu/catalog.php?record\\_id=12939](http://www.nap.edu/catalog.php?record_id=12939)
- <sup>26</sup> U.S. DRIVE. (2012). *Target Tables from the U.S. Drive Fuel Cell Technical Team Technology Roadmap*. Washington, DC. Accessed at <http://www.uscar.org/guest/teams/17/U-S-DRIVE-Fuel-Cell-Tech-Team>
- <sup>27</sup> International Partnership for Hydrogen and Fuel Cells. (2010). *2010 Hydrogen and Fuel Cell Global Commercialization & Development Update*. Berlin, Germany. Accessed at [http://www.iphe.net/docs/Resources/IPHE\\_FINAL\\_SON\\_press\\_quality.pdf](http://www.iphe.net/docs/Resources/IPHE_FINAL_SON_press_quality.pdf)



- 
- <sup>28</sup> California Fuel Cell Partnership. (2009). *Hydrogen Fuel Cell Vehicle and Station Deployment Plan*. West Sacramento, CA. Accessed at <http://www.fuelcellpartnership.org/hydrogen-fuel-cell-vehicle-and-station-deployment-plan>
- <sup>29</sup> Initial projections called for 370 FCEVs deployed in California by the end of 2010, as well as 712 FCEVs by the end of 2011.
- <sup>30</sup> National Research Council. (2010). *Review of the Research Program of the FreedomCAR and Fuel Partnership: Third Report*. Washington, DC: National Academies Press. Accessed at [http://www.nap.edu/catalog.php?record\\_id=12939](http://www.nap.edu/catalog.php?record_id=12939)
- The Electrification Coalition. (2009). *Electrification Roadmap: Revolutionizing Transportation and Achieving Energy Security*. Washington, DC.
- Energy and Environmental Analysis, Inc. (2007). *Technology and Cost of MY 2007 Toyota Camry HEV*. Arlington, VA. (ORNL/TM-2007/132).
- Fessler, R. R. (2011). *Assessment of Motor Technologies for Traction Drives of Hybrid and Electric Vehicles*. Washington, DC: Department of Energy. (ORNL/TM-2011/73).
- <sup>31</sup> United States Council for Automotive Research. (2010). *Electrical and Electronics Technical Team Roadmap*. Washington, DC. Accessed at [http://www1.eere.energy.gov/vehiclesandfuels/pdfs/program/eett\\_roadmap\\_12-7-10.pdf](http://www1.eere.energy.gov/vehiclesandfuels/pdfs/program/eett_roadmap_12-7-10.pdf).
- <sup>32</sup> U.S. Department of Energy. (2011). *Critical Materials Strategy*. Washington, DC. Available at [http://energy.gov/sites/prod/files/DOE\\_CMS2011\\_FINAL\\_Full.pdf](http://energy.gov/sites/prod/files/DOE_CMS2011_FINAL_Full.pdf)
- <sup>33</sup> Ruegg, T. (2008). *Linkages of DOE's Energy Storage R&D to Batteries and Ultracapacitors for Hybrid, Plug-InHybrid, and Electric Vehicles*. TIA Consulting, Inc. and 1790 Analytics LLC: Washington, DC. Accessed at [http://www1.eere.energy.gov/ba/pba/pdfs/vehicle\\_energy\\_storage\\_r\\_and\\_d\\_linkages.pdf](http://www1.eere.energy.gov/ba/pba/pdfs/vehicle_energy_storage_r_and_d_linkages.pdf)
- <sup>34</sup> EV World. (2002). "Texaco Ovonic Battery Systems Announces Award of Contract Under the FreedomCar Initiative." Richerster Hills, MI. Accessed at <http://evworld.com/news.cfm?newsid=2568>
- <sup>35</sup> U.S. Patents 6,677,082 (2001); 6,680,143 (2001); and 7,135,252 (2006). *Lithium metal oxide electrodes for lithium cells and batteries*.
- <sup>36</sup> General Motors. (2011). "GM and LG Chem Sign Deal with Argonne to Use Advanced Battery Material for Next Gen Chevy Volt." Accessed at <http://gm-volt.com/2011/01/07/gm-and-lg-chem-sign-deal-with-argonne-to-use-advanced-battery-material-for-next-gen-chevy-volt/>
- <sup>37</sup> Ford. (2010). "Ford Selects Compact Power as Lithium-Ion Battery Pack Supplier for Ford Focus Electric on Sale in 2011." Dearborn, MI. Accessed at [http://media.ford.com/article\\_display.cfm?article\\_id=32959](http://media.ford.com/article_display.cfm?article_id=32959)
- <sup>38</sup> U.S. Department of Energy. (2008). *Energy Storage Research and Development: 2008 Vehicle Technologies Program Annual Progress Report*. Washington, DC. Accessed at [http://www1.eere.energy.gov/vehiclesandfuels/pdfs/program/2008\\_energy\\_storage.pdf](http://www1.eere.energy.gov/vehiclesandfuels/pdfs/program/2008_energy_storage.pdf)
- <sup>39</sup> Eaton. (2010). "Eaton Selects LG Chem Subsidiary to Supply Battery Technology for Hybrid Power Systems; Battery Cells to be Manufactured in Holland, Mich." Holland, MI. Accessed at [http://www.eaton.com/Eaton/OurCompany/NewsEvents/NewsReleases/CT\\_288654](http://www.eaton.com/Eaton/OurCompany/NewsEvents/NewsReleases/CT_288654)
- <sup>40</sup> Ford. (2010). "Michigan Gov. Granholm Hails Collaboration by Ford, Azure Dynamics, Johnson Controls-Saft and AM General to Deliver New Ford Transit Connect Electric." Oak Park, MI. Accessed at [http://media.ford.com/article\\_display.cfm?article\\_id=33278](http://media.ford.com/article_display.cfm?article_id=33278)
- <sup>41</sup> A123 Systems. (2010). "A123 Systems Signs Multi-Year Battery System Supply Agreement with Fisker Automotive." Watertown, MA. Accessed at <http://ir.a123systems.com/releasedetail.cfm?ReleaseID=437662>
- <sup>42</sup> Pacific Northwest National Laboratory. (2010 and 2011). *Pathways to Commercial Success: Technologies and Products Supported by the Fuel Cell Technologies Program*.
- <sup>43</sup> [http://www.hydrogen.energy.gov/pdfs/5005\\_fuel\\_cell\\_cost.pdf](http://www.hydrogen.energy.gov/pdfs/5005_fuel_cell_cost.pdf)
- <sup>44</sup> U.S. Department of Energy. (2011). *FY 2010 Progress Report for the DOE Hydrogen Program*. (DOE/GO-102011-3178). Washington, DC.
- <sup>45</sup> Fuel Cell Technologies Program. (2012). Accomplishments Fact Sheet. Accessed at <http://www1.eere.energy.gov/hydrogenandfuelcells/pdfs/accomplishments.pdf>
- Fuel Cell Technologies Program. Multi-Year Research, Development and Demonstration Plan. Accessed at <http://www1.eere.energy.gov/hydrogenandfuelcells/mypp/index.html>



<sup>46</sup> Driving Research and Innovation for Vehicle Efficiency and Energy Sustainability, formerly the FreedomCAR and Fuels Partnership.

<sup>47</sup> U.S. Department of Energy. (2012). “Opportunity: Energy Innovation Hub-Batteries and Energy Storage.” Washington, DC. Accessed at <https://www.fedconnect.net/FedConnect/?doc=DE-FOA-0000559&agency=DOE>

## 4 Alternative Hydrocarbon Fuels

The assessment in this chapter forms the technical base for *Deploying Alternative Hydrocarbon Fuels*, a strategy detailed in the corresponding chapter of the *Report on the Quadrennial Technology Review (QTR)*. Liquid hydrocarbon fuels will remain important to the transportation sector for the foreseeable future. This technology assessment describes the pathways to producing non-crude-derived hydrocarbon fuels.

While each technology is presented here with a standalone assessment, the associated opportunities to impact the energy system are fully understood only within the context of an integrated framework that spans energy resource, supply, delivery, and consumption. The *Report on the QTR* presents an integrated framework of the energy system and contains the systems discussions that tie together these individual assessments.

Petroleum-derived gasoline and diesel are the primary fuels for transportation, both domestically and globally. While efficiency and electrification can reduce light-duty vehicle dependence on oil, other segments of the transportation sector (e.g., heavy-duty vehicles, airplanes, and civilian ships) will continue to require the energy density of liquid fuels. Alternative (non-crude-derived) liquid fuels for these markets are therefore necessary to further reduce greenhouse gas (GHG) emissions. Feedstocks and conversion pathways that generate diesel and jet fuels may therefore have greater long-term significance than gasoline substitutes. Feedstocks for alternative fuels include both fossil fuels (i.e., natural gas and coal) and biomass (e.g., sugar- and starch-based crops, crop residues, woody biomass, plant-derived lipids). All alternative fuels have significant barriers related to energy density, cost of production, infrastructure compatibility, materiality of impact, and/or ease of transport and use.

Brazil and the United States lead the world in production of biofuels (primarily ethanol). Several other countries have developed ethanol programs, including China, India, Canada, Thailand, Argentina, Australia, Colombia, and European Union member countries.<sup>1</sup> Global ethanol fuel production was some 22.5 billion gallons in 2010,<sup>2</sup> roughly 10% of global gasoline consumption by volume. This level of production allows reliable estimates of feedstock costs, cost of production, fuel characteristics, and GHG emissions.

In 2010, the United States produced 13 billion gallons of ethanol from corn grain, an 800% increase from 2000.<sup>3</sup> That production accounted for 10% by volume (7% by energy) of motor gasoline consumption. A more modest rate of increase in ethanol production from corn grain is expected over the next 10 years.<sup>4</sup> Biodiesel produced from oilseed crops peaked in 2008 at 691 million gallons (some 1% of diesel consumption) and declined to 315 million gallons in 2010.<sup>5</sup>

Other alternative hydrocarbon fuels currently deployed include compressed natural gas (CNG), propane, and liquid petroleum gas; however, these fuels supply less than 0.2% of the energy used by the transportation sector, the majority of which is in fleets.

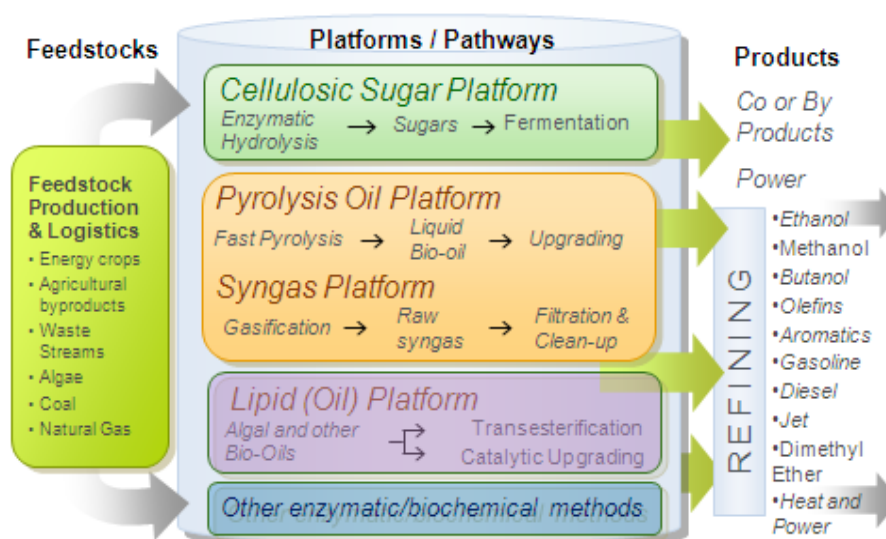
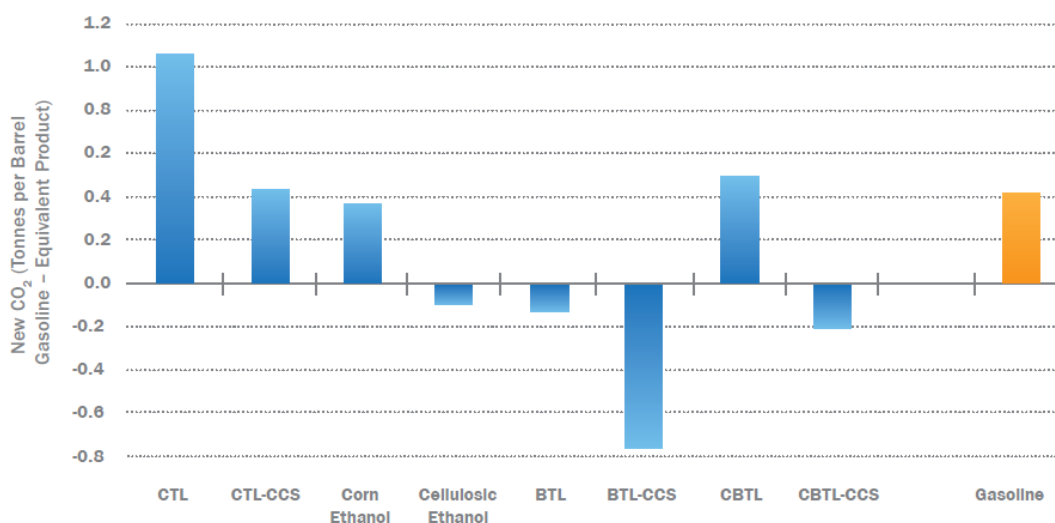


Figure 10. Summary of Feedstocks, Pathways, and Products for Alternative Hydrocarbon Fuels

Alternative hydrocarbon fuels comprise a wide variety of molecular structures, including alcohols and other oxygenates, as well as drop-in hydrocarbons. These fuels can be made from a wide variety of carbon sources. Conversion pathways include enzymatic and thermochemical, among others (Figure 10). The cost of producing alternative fuels is dependent on feedstock price (including production, processing, and transportation), conversion, and distribution (including potential infrastructure changes).

Certain fuel characteristics, including GHG intensity and domestic provenance, are determined by the feedstock. Although oil resources of differing quality have unique lifecycle carbon characteristics,<sup>6</sup> the U.S. Environmental Protection Agency has established a baseline for conventional fuel GHG intensity.<sup>7</sup> In general, biomass-based fuels typically have lower carbon intensity than fossil-based fuels (Figure 11). Recent analyses have indicated that certain alternative fossil-based fuels coupled with carbon sequestration technologies could approach carbon intensities similar to their petroleum-derived counterparts; however, these studies are based on models and assumptions that have not been validated in commercial facilities and therefore may not be realistic for actual operation.<sup>8,9</sup>



**Figure 11. Lifecycle Carbon Emissions for Various Transportation Fuels** The GHG emissions from some alternative fuels are less than those from conventional fuels, while others are higher. The production and extraction of feedstocks also have environmental impacts. CTL = coal-to-liquids, CCS = carbon capture and storage, BTL = biomass-to-liquids, CBTL = coal-and-biomass-to-liquids. There are many analyses for lifecycle carbon emissions from transportation fuels available, each with a unique perspective. This was adapted from *America's Energy Future Panel on Alternative Liquid Transportation Fuels*. (2009). p. 250. Washington, DC: National Academy of Sciences, National Academy of Engineering, National Research Council. Accessed at [http://www.nap.edu/openbook.php?record\\_id=12620&page=250](http://www.nap.edu/openbook.php?record_id=12620&page=250)

Biofuels made from the sugars, starches, lipids, and lignocellulosic components of biomass can serve as substitutes for petroleum-based fuels. Renewable biological feedstocks include grains, oilseeds, sugars, perennial grasses, energy crops, agricultural and forestry residues, municipal solid waste, and algae. Biofuels conversion processes based on these feedstocks vary significantly in their technical maturity, economics, potential materiality, and production infrastructure required. Comprehensive analyses of biomass feedstock production, cost, and technologies can be found elsewhere.<sup>10</sup>

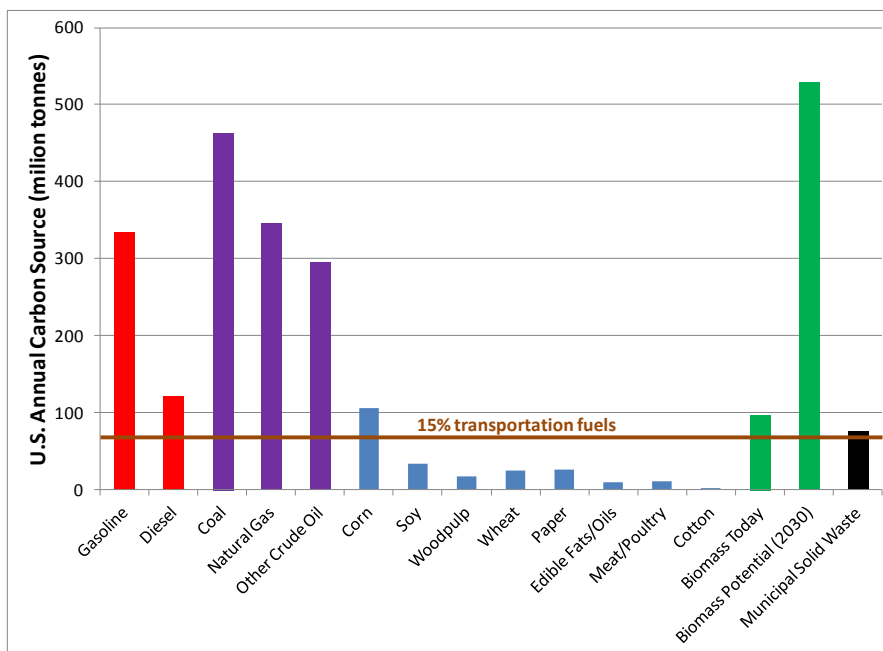
The social, economic, and environmental effects of domestic biofuels have been mixed. Diverting corn, soybean oil, or other food crops to biofuel production could induce competition between food, feed, and fuel, but increases in crop price have helped to revive rural economies. On a global scale, high commodity prices are expected to accelerate clearing of rain forest and savanna.

Sustainably produced biomass might provide additional benefits beyond GHG emission reduction, such as lowering the risk of forest fire (by removing excess combustible biomass), increasing crop yield (by harvesting otherwise wasted corn stover), reducing the need for landfills (by using municipal solid waste), and restoring wildlife habitat (by reestablishing diverse prairies for growing dedicated fuel crops). However, any direct conversion of natural ecosystems into cropland to accommodate dedicated biofuel crops could threaten those ecosystems and incur losses of biomass and soil carbon to the atmosphere that exceed associated GHG savings. In addition, removing biomass and crop residues could increase soil erosion and deplete soil carbon reserves, ultimately affecting water entry, retention, runoff, nutrient cycling, productivity, and other critical functions. Therefore, a systems approach is required for sustainable biomass production to ensure that it has a low impact on global food, feed, and fiber production, and to make sure that addressing the biofuel problem does not aggravate other challenges.<sup>11</sup> More comprehensive analyses of the social, economic, and environmental impacts of expanded biomass feedstock production are available elsewhere.<sup>12</sup>

The energy needs of the transportation sector are significant. The masses of coal and natural gas used today are comparable to that of petroleum, while the availability of biomass feedstock is small by comparison. One estimate of potential sustainable biomass production by 2030 is more than 1 billion tons annually.<sup>13</sup> Since 1 billion tons of biomass could produce about 60 billion gallons of fuel, or 1/4 of current U.S. consumption,<sup>14</sup> biofuels could have a material impact on the nation's fuel supply.

The carbon flows of various feedstocks in the United States are a convenient, albeit imperfect, gauge for their significance in the economy, as all alternative hydrocarbon fuels must contain carbon. Figure 12 shows annual U.S. carbon content in various substances. Gasoline and diesel fuels contain 450 million tonnes (Mt) of carbon. To have a substantial impact on oil consumption (say at the level of 15% or more), a non-oil feedstock containing at least 70 Mt of carbon is required, assuming 100% conversion efficiency, as illustrated by the brown line.<sup>15</sup> Among other fossil fuels, the carbon flow in today's coal use is of sufficient scale, natural gas is somewhat smaller (350 Mt), and other fossil fuel streams are smaller yet. Using these feedstocks for transportation fuels would require either diverting that flow from current uses (power and heat generation) or increasing resource production.

Among the agricultural sources, there is about 100 Mt of carbon content in the annual, edible U.S. corn crop, which would enable it to displace as much as 20% of transportation fuels if most other uses were curtailed; the other agricultural streams are far too small to be material. Municipal waste,<sup>16</sup> if fully exploited, could reach the 15% threshold. There is currently about 100 Mt of carbon from biomass supplying the energy sector. As described above, recent estimates of 1 billion tons of potential annual sustainable biomass production, which is equivalent to about 500 Mt carbon, could make a difference. Increasing the production of biomass feedstocks to these levels would have direct and indirect environmental impacts, ranging from residue removal to land-use change.



**Figure 12. Annual U.S. Carbon Flows (in MtC).** As shown by the height of the brown line, some 70 Mt of carbon in non-oil feedstocks would be required to replace 15% of current transport fuels if no carbon were lost in the conversion process. Existing technologies are about 50% efficient at converting feedstock to fuel.<sup>17</sup>

The molecular composition and associated characteristics (e.g., infrastructure compatibility, energy density) of a fuel are determined by the conversion pathway. This assessment focuses on liquid hydrocarbon fuels and is organized according to three conversion pathway categories: biochemical, thermochemical, and “other.” Gaseous hydrocarbon fuels, such as CNG and propane, are mature technologies with principal challenges related to infrastructure. Detailed discussions of those technologies have been published elsewhere.<sup>18</sup>

Fuels generated by the three conversion pathways could displace, or at least supplement, the petroleum-derived gasoline, diesel, and jet fuel that dominate the domestic and global markets. The three pathways and their feedstock resources differ in their technological maturity, economics, and lifecycle GHG emissions.

Prior to 2012, there were two key policy drivers associated with biofuel production: the Renewable Fuel Standard (RFS) and the Volumetric Ethanol Excise Tax Credit. To stimulate U.S. biofuels production, Congress initiated an expanded RFS program, referred to as RFS2, as a component of the Energy Independence and Security Act of 2007. The RFS2 set a goal of 36 billion gallons per year of renewable transportation fuels by 2022, of which a maximum of 15 billion gallons may be corn ethanol and a minimum of 21 billion gallons will be advanced biofuels.<sup>19</sup> The Volumetric Ethanol Excise Tax Credit was a tax incentive (\$0.45/gallon) for ethanol blenders that ended in December 2011.

Without mandates, deployment of alternative fuels depends on their cost relative to the petroleum-derived incumbents with which they compete. Cellulosic or algal fuels must also overcome other challenges, including high construction costs for demonstrations and first-of-a-kind commercial facilities;

lack of financing options; and technical, environmental, and safety requirements at scale. As the scale of biofuels production increases, so do concerns related to land use, biodiversity, and water availability.

As with biomass-derived fuels, the military and aviation communities have expressed interest in the ability of synthetic fuels produced from coal, biomass, and natural gas to replace petroleum-derived fuels. Various military and commercial aircraft have been tested and certified to use blends of up to 50% synthetic fuels and 50% petroleum-derived fuels. Because the Energy Independence and Security Act of 2007 prohibits the federal government from purchasing alternative fuels whose use results in greater lifecycle GHG emissions than petroleum-derived fuels, coal will be suitable as a feedstock only if it is blended with biomass and if it incorporates carbon capture and storage (CCS) in the conversion process.

#### **4.1.1.1 Biomass Feedstock Processing**

To enable widespread commercialization of advanced biofuels, biomass feedstock processing technologies must be commercially available, cost competitive, and sustainable. Opportunities to address these challenges include research on feedstock genetics and agronomy, the material properties of biomass, and sustainable harvesting. Other opportunities include development of quality and monitoring processes; improved systems for storage, material handling, and transportation; and integration and scale-up of components into processing systems. Algal feedstock processing presents its own set of challenges that it must overcome, many of which are the same barriers faced by other feedstock processing.

In 2011, the Department of Energy (DOE) estimated that processing corn stover, a possible feedstock for biochemical conversion, would cost \$37.80/dry ton if state-of-the-art technology were commercially scaled. Processing woody biomass, a more likely feedstock for thermochemical pathways, was estimated to cost \$67.50/dry ton at the 2010 state of technology.<sup>20</sup> The Department projected potential cost reductions to \$35/dry ton and \$47/dry, respectively, by 2012.

Lipid feedstocks that are currently used to produce biodiesel, including soybean oil, are not considered advanced feedstocks. However, conventional biodiesel conversion technologies, such as the upgrading and isomerization of waste grease fats, could be adapted to advanced sources of lipids, including algae.

#### **4.1.2 Biochemical Methods**

Biochemical conversion entails breaking down biomass to make the plant carbohydrates available for conversion into simple sugars, which can then be converted into biofuels using microorganisms and other catalysts. Cell walls are tough and complex structures that include long, strong, linear chains of sugars called cellulose and amorphous multi-sugar chains called hemicellulose. Biomass' resistance to chemical breakdown ("recalcitrance") must be overcome to access the sugars that can be, in turn, converted into fuels. Approaches include a combination of pretreatment, acid or enzymatic hydrolysis, and sugar conversion to alcohols or hydrocarbons; although, the diversity of feedstocks and the need to address substrate-specific issues does not allow for a single approach to biochemical conversion.

The pretreatment process breaks down hemicellulose into a mixture of soluble five- and six-carbon sugars and separates cellulose from lignin. This step makes the remaining cellulose more accessible for later enzyme hydrolysis,<sup>21</sup> increasing its speed and productivity.<sup>22</sup> A large number of pretreatment

options are available,<sup>23</sup> with each being suited to particular combinations of feedstocks and downstream conversion processes.<sup>22</sup>

Hydrolysis, also termed saccharification, is the process by which the cellulose is broken down into five- and six-carbon sugars using either enzymes or acids,<sup>21</sup> which often takes days.<sup>24</sup>

Following hydrolysis, the released sugars are converted into fuel. This is often accomplished through biological processing (e.g., fermentation) to create alcohol fuels such as ethanol or butanol. Chemical or catalytic conversion can replace or supplement fermentation to convert hydrolysis products directly into desired fuel types. Although fermentation has been used for food and beverage production for millennia, chemical conversion of sugars into non-alcohol fuels is a newer, developing science. Commercial processes have not yet been developed that can achieve all of the desired parameters, including process efficiency, feedstock utilization, cost, sustainability, and finished product characteristics.<sup>25</sup> Table 8 shows estimates of current conversion costs for corn starch and corn stover.

**Table 8. Conversion Costs (in 2007 dollars)**

	\$/gallon of fuel
Conventional corn starch to ethanol	\$0.75 <sup>26</sup>
Biochemical corn stover to ethanol	\$1.95 <sup>27</sup>

Note: Conventional ethanol plant costs can vary widely. The cost given here is for a 100 million gallon per year nameplate capacity facility that operates at 110% capacity<sup>28</sup> and was built in 2007. The plant produces 2.8 gallons of ethanol and 16.5 pounds of distillers dried grain per bushel of corn. Carbon dioxide is not captured. Assumed capital costs were \$1.97/gallon of nameplate capacity. Capital and operating costs (primarily natural gas) are included, but the cost of feedstock is excluded to compare conversion technologies on a purely technology basis.

Biochemical corn stover to ethanol costs include all capital and operating costs for Nth plant with 2010 state of technology. Feedstock costs were left out to enable technology comparison.

Most data on advanced biofuels come from laboratory and pilot-scale operations. More than 35 domestic biorefineries for cellulosic biomass are being designed or are in construction, many with federal financial support.<sup>29</sup> Three commercial-scale facilities (one each in Denmark, Finland, and Singapore) are in operation and six commercial-scale biorefineries are expected to begin production in the United States in 2013 or 2014. These pioneer facilities will drive down cellulosic biofuel production costs through learning, process optimization, and technology improvements. Lessons learned will also reduce risk for future biofuels deployments.

Emerging pathways that use current products as intermediates toward the conversion of higher-value end products could enable production of cost-effective, drop-in biofuels. These could include repurposing a corn ethanol refinery to convert isobutanol to butenes to diesel or jet fuel; conversion of clean sugars or starches to renewable jet fuel and diesel; conversion of methanol or ethanol to gasoline; and hydrolysis of pulp mills waste to provide clean, lower-cost, cellulosic-based sugars for drop-in fuel conversion.



#### 4.1.2.1 Technology Headroom

Based on the current availability of feedstocks, DOE estimates that more than 400 million tons of biomass could be sustainably harvested in the United States each year. By 2030, this could increase to as much as 1 billion tons annually.<sup>30</sup> This estimate does not include potentially significant sources of non-terrestrial biomass, such as algae.<sup>31</sup>

Technology barriers in biochemical conversion include biomass variability and recalcitrance, pretreatment chemistry and costs, enzyme production costs and loading, cleanup/separations, catalyst development, process integration, and biochemical/thermochemical interfaces. Of these barriers, the greatest potential for overall conversion cost improvement lies in pretreatment (which mitigates the impacts of biomass variability and recalcitrance and can improve enzyme costs and loading), saccharification (which affects enzyme costs and loading), and fermentation (which affects separations and cleanup barriers).<sup>32</sup>

Analysis is underway to determine the headroom for technologies related to the production of gasoline, diesel, and jet fuel.<sup>33</sup>

#### 4.1.2.2 Breakthrough Technologies

There are a number of high-risk technologies still in their infancy that have the potential to transform biofuels. Table 9 summarizes these, along with an indication of hoped-for technical characteristics that, if achieved on a pilot scale by 2015, could justify continued research and development (R&D) interest.

**Table 9. Potential Biofuel Breakthroughs**

Technology	Description
Sugar-Utilization or Biotransformation Catalysts	Develop organic/inorganic catalysts that utilize biomass intermediates (e.g., carbohydrates, lipids, proteins, acids) to produce green gasoline/jet/diesel, biochemicals, or intermediates thereof via biochemical conversion processes. These fuels have energy densities at least 33% higher than ethanol.
Thermochemical Intermediates-Upgrading Catalysts	Develop catalyst breakthroughs, which are integral to production of gasoline/diesel/jet and products from biomass because they enable upgrading of biomass-intermediates (e.g., bio oils, synthesis gas, mixed oxygenates) created by thermochemical conversion routes.
Uniform-Format Solid Feedstock Supply System <sup>34</sup>	Develop the ability to convert a diverse, low-density, perishable feedstock resource into an aerobically stable, dense, uniform-format, cost-effective, bulk-solid resource that can enter the existing agricultural bulk-solid commodity infrastructure.
Multipurpose and High-Performance Biomass Feedstocks	Develop genetically tractable energy crops with metabolic pathways that are enhanced or modified for production of renewable chemicals and commercial enzymes.

#### 4.1.3 Thermochemical Methods

Although thermochemical processes have been known for almost a century, they are not widely deployed commercially. Carbon is fungible; there are well-established thermochemical techniques to

take carbon from one form (feedstock) and convert it into another (product), breaking or making carbon-carbon bonds and appending or removing hydrogen or oxygen.

Thermochemical processes either convert a feedstock directly to a liquid fuel, or they convert a feedstock to a synthesis-gas intermediate (i.e., syngas—a mixture of hydrogen and carbon monoxide) that is then catalytically converted to fuels and/or chemicals. The former process is known as direct liquefaction, and the latter process is called indirect liquefaction, which is based on gasification. Thermochemical processes can be applied to coal, biomass, a combination of coal and biomass, or natural gas. While there is some potential for incremental technical improvements, the greatest hurdles to deployment of this technology are economic, not technical. Compared to other conventional methods for producing fuels, thermochemical conversion has both higher production and capital costs. Several facilities of this type have been built in other countries (see below), and industry is therefore well poised to deploy should economic conditions warrant.

Research opportunities in the thermochemical pathway for biofuels include biomass feedstocks tailored for gasification and pyrolysis systems, pyrolysis of biomass and bio-oil stabilization, syngas cleanup and conditioning, catalysts for fuel synthesis and intermediate upgrading, sensors and controls, and thermochemical process integration. Of these, the greatest potential for improvement lies in syngas cleanup and catalysis.<sup>35</sup>

#### 4.1.3.1 Indirect Liquefaction

After gasification, impurities like sulfur are removed and the syngas is converted into an ultra-clean transportation fuel via catalytic synthesis (most commonly using the Fischer-Tropsch (F-T) process). Globally, indirect liquefaction facilities that use F-T synthesis produce more than 370,000 barrels per day (bpd) of liquid fuels and specialty chemicals, which is about 0.4% of global liquid fuels production. Newer F-T facilities use natural gas as the feedstock for gasification; older facilities use coal. Syngas can also be converted to methanol and then to gasoline via the Mobil process. From 1985 to 1996, there was a plant in New Zealand using the Mobil process that had a production capacity of 14,500 bpd. While indirect liquefaction is a mature technology for converting coal and gas to liquids, incorporating biomass into these processes would require significant research, development, and demonstration.

The majority of thermochemical conversion R&D conducted in recent years has focused on the indirect liquefaction pathway. Table 10 shows the current state of these technologies.

**Table 10. Current State of Technology for Producing Liquid Fuels Through Gasification**

Pathway	Maturity	Global Deployment (largest facility)	Opportunities for R&D
Gas-to-Liquids (GTL)	Commercially deployed	210 kbpd (140 kbpd) <sup>36</sup>	Limited
Coal-to-Liquids (CTL)	Commercially deployed	163 kbpd (160 kbpd) <sup>37</sup>	Incremental changes
Coal- and Biomass-to-Liquids (CBTL)	Not yet demonstrated	Not deployed	Step changes

The United States presently has no major domestic facilities in operation for the production of synthetic fuel from coal and natural gas. Currently operating commercial and demonstration facilities are primarily located in Qatar, South Africa, Malaysia, and China.

Four gas-to-liquids (GTL) facilities worldwide produce more than 200,000 bpd of liquid fuels, lubricants, and specialty chemicals: two in Qatar (which began production in 2005 and 2011), one in South Africa, and one in Malaysia. Qatar accounts for more than 80% of the total production, and its facilities employ the latest technologies. These plants have been built to monetize stranded gas. GTL can be viewed as a commercial, but not fully mature, technology.

Three coal-to-liquids (CTL) facilities operate worldwide. A high-temperature F-T 160,000 bpd indirect liquefaction facility in Secunda, South Africa, was commissioned in the late 1970s. A 24,000 bpd CTL facility in Inner Mongolia, China, began production in 2010; the first commercial-scale direct liquefaction plant built in more than 60 years. Finally, an indirect liquefaction, methanol-to-gasoline (MTG) demonstration plant in Shanxi Province, China, began production in 2009.

Table provides a summary of the current technology status and costs of the different pathways for thermochemical conversion of biomass, natural gas, and coal. Although none of the operating facilities currently employ CCS, the cost of the CTL and coal and biomass to liquids (CBTL) pathways shown includes those costs. Using current technology, thermochemical conversion costs for woody biomass to ethanol via gasification would be about \$2.50/gasoline gallon equivalent<sup>38</sup> (\$1.65/gallon) at scale (2,000 tonnes/day).

**Table 11. CTL, CBTL, and GTL Pathways, Costs, and Technology Status**

National Energy Technology Laboratory. (2011). *Production of Zero Sulfur Diesel Fuel from Domestic Coal: Configuration Options to Reduce Environmental Impact*. Morgantown, WV.

National Energy Technology Laboratory. (2010). *Baseline Analysis of Sub-Bituminous Coal and Biomass to Gasoline (Indirect Liquefaction via Methanol Synthesis)*. DOE/NETL-40/092310. Morgantown, WV.

Memorandum from David Gray, Noblis, Inc., April 25, 2011.

	Pathway	Installed Capital Cost (\$/daily barrel)	Crude Oil Equivalent Price <sup>39</sup>	\$/gal Petroleum-Product Equivalent Price <sup>40</sup>	Technology Status
CTL w/ CCS	F-T	\$130,000–\$150,000	\$97/barrel (bbl)	\$2.80 <sup>41</sup>	Not yet demonstrated
CBTL w/ CCS (15 wt% switchgrass)	F-T	\$140,000–\$160,000	\$106/bbl	\$3.00 <sup>41</sup>	Not yet demonstrated
GTL	F-T	\$70,000–\$90,000	\$80–\$120/bbl <sup>42</sup>	\$2.30–\$3.40 <sup>43</sup>	Commercial
CTL w/ CCS	MTG	\$140,000–\$160,000	\$101/bbl	\$2.70 <sup>44</sup>	Not yet demonstrated

Note: All costs are 2010 estimates of Nth plants expressed in 2009 dollars, with the exception of the MTG cost estimate, which is expressed in 2007 dollars.

Current studies suggest that<sup>45</sup> GTL can be economically viable at crude oil prices above \$80–\$120/barrel (bbl), while CTL with CCS can be viable at crude oil prices above \$97/bbl. The large capital outlays associated with CTL, CBTL, and GTL facilities—normally built at 50,000 bpd or greater to maximize

economies of scale—present a significant risk to potential investors, especially given oil price volatility. At the capital cost shown in Table 11, a 150,000 bpd CTL with CCS plant is a \$14 billion bet that crude prices will average above \$97/bbl over the amortization period.

Because gasification produces relatively pure carbon dioxide (CO<sub>2</sub>) streams, the incremental costs of CCS in a CTL or GTL process are only those of compression, transportation, and storage. The incremental cost of sequestering CO<sub>2</sub> captured at indirect liquefaction facilities in a geologic formation is less than \$0.12/gallon of diesel.<sup>46</sup>

Advanced gasification technologies already in development could cumulatively reduce the crude oil break-even prices for CTL/CBTL systems by 25%.<sup>47</sup> These technologies include warm gas cleanup/desulfurization; advanced turbines with higher firing temperature and capacity to improve efficiency and economy of scale; ion-transfer membrane for oxygen production to reduce capital costs; chemical looping integrated with the F-T system to reduce capital costs and increase conversion of carbon in coal to fuels; and compact gasification technologies, which can reduce cost and oxygen consumption.

A DOE scoping study identified opportunities to achieve an 11% cost reduction at the pilot scale by 2022, which would enable F-T-based CTL with CCS systems to be commercially viable at a crude oil price of \$86/bbl and CBTL<sup>48</sup> with CCS systems viable at \$94/bbl (2009 dollars).<sup>49</sup> The study projected that commercial viability at crude-oil-equivalent prices of \$73/bbl (CTL with CCS) and \$80/bbl (CBTL with CCS) might be technically feasible by 2025. Advanced gasification technologies could also be applied to the CTL with CCS process for gasoline production, potentially enabling wholesale gasoline costs as low as \$2/gallon by 2025.

To date, no detailed public analysis on the benefits of integrating advanced technologies into GTL systems has been done; however, modest cost reductions of 3%–6% by 2020 appear likely. These could reduce wholesale diesel prices to \$2.20–\$3.20/gallon at natural gas prices of \$5–\$10/one million British thermal unit, respectively.

CTL, CBTL, and GTL systems would benefit from: (1) the system-level integration of state-of-the-art technologies, (2) the demonstration of facilities that integrate state-of-the-art technologies with carbon sequestration, and (3) the pursuit of advanced R&D that could dramatically reduce the costs of these systems. More information about CCS is contained in the *Carbon Capture and Storage* technology assessment.

#### 4.1.4 Direct Liquefaction

Direct liquefaction involves the application of high pressure, high temperature, and a hydrogen source to coal, with or without biomass, in the presence of a catalyst. This technology pathway, which was developed with assistance from the U.S. government in the late 1970s and early 1980s, produces a crude-petroleum-like product that can be refined into transportation fuels. While direct liquefaction has recently been demonstrated in China at the 24,000 bpd scale, no facilities have been proposed domestically. As a less mature technology, cost and performance benchmarks for direct liquefaction are not well-established. Because of chemical differences in the feedstocks, the process to convert coal

directly to liquids (direct liquefaction) is different from those that convert biomass directly to liquids (pyrolysis or other liquefaction techniques). Pyrolysis and other liquefaction processes result in liquid bio-oil intermediates that are catalytically upgraded to fuels and/or refinery-ready intermediate streams. Pyrolysis of biomass is currently more expensive than gasification, with an estimated conversion cost of woody biomass to gasoline or diesel of \$5/gallon.<sup>50</sup>

#### 4.1.5 Algae and Other Conversion Pathways

Conversion of non-edible oils (e.g., from algae) and other hybrid approaches (e.g., fermentative conversion of syngas or catalytic conversion of sugars) leverage various combinations of biochemical, catalytic, and thermochemical technologies. Algae have long been cultivated for high-value products like pharmaceuticals. There is potential for material algae production and processing for fuels, but there are significant challenges in production and harvesting efficiencies and cost. The basic resources required for large-scale cultivation of algae for fuel production are land with suitable topography, climate, and sunlight; water of acceptable quality and abundance; and concentrated sources of CO<sub>2</sub>. Many of the challenges related to algal biofuel production are engineering matters associated with how and where to grow the algae to achieve needed productivity. For example, closed photobioreactors can substantially lower the risk of culture contamination and the amount of water used, but capital costs of such systems are high. Technologies for developing algal strains with desirable traits for biofuel production include classical strain improvement, metabolic engineering, and synthetic biology. In addition, it is imperative to gain a better understanding of the environmental impacts of water use and disposal.<sup>51</sup>

The current minimum selling price for algal diesel via open pond-photo bioreactor is \$8.70–\$18.00/gasoline gallon equivalent.<sup>52</sup>

#### 4.1.6 Natural Gas and Propane

Natural gas is already a significant alternative fuel in some applications, such as transit buses in the United States. It offers the potential for fuel cost savings, reduced dependence on oil, and decreased CO<sub>2</sub> and other engine emissions. The barriers to natural gas deployment include limited availability of CNG refueling stations and CNG vehicles, as well as limited vehicle range.

Fuels that are not fungible with gasoline and diesel fuels require new fueling infrastructure; fleet vehicles offer the most attractive opportunities due to the associated captive fleet fueling infrastructure. Natural gas vehicles (NGVs) are appearing in fleets of buses, refuse trucks, drayage trucks, and taxis.<sup>53</sup> Worldwide, there are approximately 11 million NGVs. In the United States, there are approximately 100,000 NGVs in use, the vast majority of which are medium- and heavy-duty vehicles.<sup>54</sup> NGVs comprise about 4% of the heavy-duty vehicle fleet. About 20% of transit buses in use (and 20% of new buses) are fueled by natural gas.

Greater market penetration of NGVs would require increased natural gas production. Satisfying 50% of current light-duty vehicle energy needs would increase natural gas demand by 30% (see Figure 13 in the *Report on the QTR*). Widespread penetration would also require considerable investment in natural gas

fuel stations—today, there are roughly 160,000 retail fueling stations in the United States,<sup>55</sup> but only 890 natural gas stations,<sup>56</sup> not all of which are publically accessible.

Table 12 summarizes the current costs associated with CNG fueling stations at a scale comparable to that of a retail gasoline fueling station.<sup>57</sup> Such a natural gas (CNG or liquefied natural gas [LNG]) fueling station is estimated to have a capital cost of up to \$2 million.<sup>58</sup>

**Table 12. Estimated Costs of Natural Gas Fueling Station Components**

Component	Cost
Electric Compression Cost (estimated at 1kWh/gge)	\$0.09–\$0.15/gge
Maintenance/Repair/Service Fund	\$0.15–\$0.35/gge
Capital Amortization of Equipment	\$0.35–\$0.65/gge

There are relatively few LNG fueling stations because they are generally considered to be only for heavy-duty commercial vehicles. The cost of LNG fueling stations is approximately \$20,000–\$25,000 per truck serviced.<sup>59</sup>

Globally, propane is the most widely used alternative fuel. Outside of the United States, propane—or liquefied petroleum gas—is commonly referred to as “autogas” when used as an automotive fuel. According to Energy Information Administration estimates, roughly 147,000 propane vehicles<sup>60</sup> operate in the United States and use 130 million gasoline-equivalent gallons of propane fuel a year<sup>61</sup> (which is a bit more than 0.1% of total gasoline use), while there are more than 14.5 million propane-fueled vehicles worldwide.<sup>62</sup> Propane vehicles in the United States are primarily used in fleet or rural (e.g., farming) applications. Propane fueling stations, the most abundant of all alternative fuels, are unevenly distributed around the country.

Virtually all propane is produced as a co-product of natural gas processing or an oil refinery product. The world supply of liquefied petroleum gas grew steadily during the 2000–2008 period, from about 200 million tons in 2000 (about 6.2 million bbl/day) to 239 million tons (7.7 million bbl/day) in 2008.

**4.1.6.1 Future Drivers and Directions**

The greatest need for innovation within the natural gas pathway is fueling infrastructure improvements. A market is beginning to develop for LNG long-haul trucks. If the current price differential between natural gas and diesel fuel persists, as many believe is probable, LNG infrastructure will likely expand through private investment. The development of this market will primarily depend on sharing the operating cost benefit (i.e., lower natural gas price relative to diesel price) among the various market participants (i.e., trucking fleets, fueling station owners, and natural gas suppliers).

CNG, which is mainly used in heavy-duty vehicles, would be more viable as a light-duty vehicle fuel if low-cost home refueling appliances and bi-fuel gasoline-CNG vehicles were available to address consumer convenience concerns. Improved on-board gas storage—such as practical adsorbents, conformable CNG fuel tanks, or cheaper and lighter LNG tanks—could improve the viability of NGVs by extending the vehicle range.

Finally, as with all alternative vehicle technologies, more variety in original equipment manufacturer-integrated vehicle platforms and lower vehicle price premiums would encourage potential buyers of NGVs. This is particularly true for light-duty personal vehicles because consumers pay less attention than do commercial users to total cost of ownership relative to purchase price.<sup>63</sup> Vehicle resale value is also a consumer consideration.

#### 4.1.7 DOE History and Accomplishments

##### 4.1.7.1 Biochemical Methods

From the 1970s to the present, DOE has invested more than \$3.7 billion (including more than \$900 million in American Recovery and Reinvestment Act of 2009 funds) in a variety of research, development, and demonstration programs covering the areas of biofuels (particularly cellulosic ethanol), biomass feedstocks, and bio-based products. Funding for this program has varied, with the bulk coming since 2005. The majority of DOE's support has been for the development of biofuels technologies that do not depend on food crop feedstocks. DOE has provided analysis of the lifecycle impact of corn ethanol in comparison to fossil fuels and cellulosic biofuels.

DOE-supported basic research includes genomics-based systems biology and work on the principles of catalyst design and catalytic transformations of biomass for the production of cellulosic biofuels. This research is led by three Bioenergy Research Centers.<sup>64</sup> Development work has focused on improving engineering and process technologies, such as prehydrolysis, saccharification, fermentation, tar reforming, and fuel synthesis. In recent years, DOE has expanded its activities beyond alcohol fuels to renewable diesel, jet fuels, and gasoline.

DOE has developed industry-academia-laboratory consortia (such as the National Advanced Biofuels Consortium) to bridge the R&D gap between basic research and integrated demonstration and deployment activities. These are strategic partnerships to achieve technical improvements that reduce cost and risk in large-scale demonstrations. R&D efforts are focused on both individual process steps and integrated process development. Industrial partners have played an integral part in the development of commercial products, such as enzyme packages (for hydrolysis of biomass to sugars) and catalysts (for bio-oil upgrading, fuel synthesis, and syngas processing).

DOE is supporting the design, construction, and operation of 14 pilot-scale, 9 demonstration-scale, and 6 commercial-scale biorefinery projects that will produce a variety of biofuels, including ethanol; butanol; and renewable gasoline, diesel, and jet fuel. More information about the DOE-sponsored integrated biorefineries is available.<sup>65</sup>

##### 4.1.2 Thermochemical Conversion

CTL research began in the late 1920s at the U.S. Bureau of Mines, but didn't ramp up until after World War II when German synthetic fuels technologies were tested and expanded upon. In 1948, **liquid fuels laboratories and pilot plants—for both direct and indirect liquefaction—were completed.** This research continued through the 1970s, including work that was focused on both the fundamentals of CTL technologies and gasification technologies. Gasification constitutes a majority of the costs of indirect liquefaction.



Catalyst development and gas cleanup was the focus of thermochemical research in the 1980s and 1990s, which expanded to include GTL. Early in the 1980s, DOE provided a loan guarantee for the construction of the coal-fed Great Plains Gasification facility in North Dakota. The facility produces syngas from coal at a scale sufficient to produce 50,000 bpd of synthetic fuels. Its products include synthetic natural gas, ammonia, and numerous specialty chemicals. The CO<sub>2</sub> from the process is captured and sold for enhanced oil recovery and permanent carbon sequestration in Saskatchewan, Canada. Over the past decade, research efforts have focused on the effects of impurities on various catalysts, the performance of new process configurations, and the integration of new technologies into CTL systems.

DOE accomplishments in this area include:

- Demonstration of three large-scale, direct coal liquefaction (DCL) technologies and extensive research of other DCL technologies at bench and pilot scales. A DCL pilot plant in China is based on these processes. DOE is working with the Chinese DCL plant to better characterize the environmental impacts of DCL.
- Development and commercial-scale demonstration of a liquid-phase methanol reactor, which can be used to improve the MTG process, especially if coal is the feedstock.
- Involvement in the development of a process for the conversion of coal to methanol to gasoline.
- Development, demonstration, and commercialization of gasification technologies required for the indirect liquefaction pathway.

#### **4.1.2.1 Other Alternative Fuels**

Algal biofuels research is a subject of DOE's longer-term R&D.<sup>66</sup> Four separate algal consortia, representing more than 60 academic, industry, and national laboratory organizations, focus on a variety of advanced algal biofuels production technologies.<sup>67</sup>

In addition to algal biofuels research, DOE funds R&D for other advanced research concepts, such as fuels from sunlight and breeding plants that are better able to capture and convert solar energy.<sup>68</sup> DOE has funded R&D on natural gas as a transportation fuel since 1992, though funding levels have varied widely. In 1998, the interagency Partnership for a New Generation of Vehicles terminated light-duty vehicle work, partly because of the then-high natural gas prices. Heavy-duty vehicle work continued through the early 2000s, tapering off as projects reached completion. DOE also supported work over roughly the same time period on conformable and low-weight natural gas tanks for vehicles, vehicle platform integration, and fueling infrastructure (including renewable natural gas use at landfills).

DOE has not invested significantly in propane vehicle technology, largely because it is mature and propane has not been positioned as an on-road fuel.

#### **4.1.3 DOE Role**

The Department's roles in alternative hydrocarbon fuels are as diverse as the fuels themselves. DOE does not have a significant technical role in corn ethanol processes, but instead fulfills an informational role by conducting analysis of the lifecycle impact of corn ethanol in comparison to fossil fuels and cellulosic biofuels.



DOE supports both informational and capability activities for advanced biofuels. For example, data from DOE- and USDA-funded integrated biorefineries and loan guarantee recipients helps investors better estimate the risk involved with biorefinery projects. The Integrated Biorefinery Research Facility at the National Renewable Energy Laboratory provides industry partners with the opportunity to operate, test, and develop their own biorefining technology and equipment. DOE supports basic R&D capabilities in biofuels through its Bioenergy Research Centers—team-based, multi-institutional centers that focus on innovative research to achieve the basic science breakthroughs needed to develop sustainable and effective methods of producing cellulosic biofuels.

The Department's role in alternative fossil fuels, such as CTL, GTL, CBTL, and CNG, is also primarily to provide information and basic research capability. DOE assesses technology opportunities to improve the viability of CNG and LNG for long-haul trucks, including hybrid electrification, storage volume, engine efficiency, waste heat recovery, and aerodynamics. In addition, the Department supports analysis of the carbon intensity of the extraction, transport, and processing of various fossil fuels for transportation applications.

---

<sup>1</sup> International Energy Agency. (2011). *Technology Roadmap—Biofuels for Transport*. Paris, France. Accessed at [http://www.iea.org/papers/2011/biofuels\\_roadmap.pdf](http://www.iea.org/papers/2011/biofuels_roadmap.pdf)

<sup>2</sup> Global Renewable Fuels Alliance. (2010). "Global ethanol production to reach 85.9 billion litres in 2010: Global Renewable Fuels Alliance releases 2010 biofuels production forecast." Toronto, ON. Accessed at [http://www.globalrfa.org/pr\\_032110.php](http://www.globalrfa.org/pr_032110.php)

<sup>3</sup> Renewable Fuels Association. (2011). *2011 Ethanol Industry Outlook*. Washington, DC. Accessed at <http://www.ethanolrfa.org/page/-/2011%20RFA%20Ethanol%20Industry%20Outlook.pdf?nocdn=1>

<sup>4</sup> Perlack, R. D., and Stokes, B. J. (Leads), U.S. Department of Energy. (2011). *U.S. Billion-Ton Update: Biomass Supply for a Bioenergy and Bioproducts Industry*. (DOE/EE-0363). Oak Ridge, TN: Oak Ridge National Laboratory.

<sup>5</sup> National Biodiesel Board. (2010). "Estimated US Biodiesel Production by Calendar Year." Accessed at [http://www.biodiesel.org/pdf\\_files/fuelfactsheets/Estimated\\_Production\\_Calendar\\_Years\\_05-10.ppt](http://www.biodiesel.org/pdf_files/fuelfactsheets/Estimated_Production_Calendar_Years_05-10.ppt)

<sup>6</sup> National Energy Technology Laboratory. (2008). *Development of Baseline Data and Analysis of Life Cycle Greenhouse Gas Emissions of Petroleum-Based Fuels*. Pittsburgh, PA. (DOE/NETL-2009/1346). Accessed at <http://www.netl.doe.gov/energy-analyses/pubs/NETL%20LCA%20Petroleum-based%20Fuels%20Nov%202008.pdf>

<sup>7</sup> U.S. Environmental Protection Agency. (2009). *EPA Lifecycle Analysis of Greenhouse Gas Emissions from Renewable Fuels*. Washington, DC. (EPA-420-F09-024). Accessed at <http://www.epa.gov/otaq/renewablefuels/420f09024.pdf>

<sup>8</sup> Noblis. (2011). *Production of Zero Sulfur Diesel Fuel from Domestic Coal: Configurational Options to Reduce Environmental Impact*. Falls Church, VA. (Contract GS-10F-0189T-Order DE-NT0005816). (REPORT FORTHCOMING)

<sup>9</sup> National Energy Technology Laboratory. (2011). *Cost and Performance Baseline for Fossil Energy Plants; Volume 4: Coal-to-Liquids via Fischer-Tropsch Synthesis*. Pittsburgh, PA. (DOE/NETL-2011-1477). (REPORT FORTHCOMING)

<sup>10</sup> Perlack, R. D., and Stokes, B. J. (Leads), U.S. Department of Energy. (2011). *U.S. Billion-Ton Update: Biomass Supply for a Bioenergy and Bioproducts Industry*. (DOE/EE-0363). Oak Ridge, TN: Oak Ridge National Laboratory.

National Academy of Sciences, National Academy of Engineering, National Research Council. (2009). *America's Energy Future Panel on Alternative Liquid Transportation Fuels*. Washington, DC: National Academies Press. Accessed at [http://www.nap.edu/openbook.php?record\\_id=12620&page=250](http://www.nap.edu/openbook.php?record_id=12620&page=250)

National Research Council. (2011). Renewable Fuel Standard: Potential Economic and Environmental Effects of U.S. Biofuel Policy. Washington, DC. Accessed at [http://www.nap.edu/catalog.php?record\\_id=13105](http://www.nap.edu/catalog.php?record_id=13105)

<sup>11</sup> National Academy of Sciences, National Academy of Engineering, National Research Council. (2009). *America's Energy Future Panel on Alternative Liquid Transportation Fuels*. Washington, DC: National Academies Press. Accessed at [http://www.nap.edu/openbook.php?record\\_id=12620&page=250](http://www.nap.edu/openbook.php?record_id=12620&page=250)

<sup>12</sup> National Academy of Sciences, National Academy of Engineering, National Research Council. (2009). *America's Energy Future Panel on Alternative Liquid Transportation Fuels*. Washington, DC: National Academies Press. Accessed at [http://www.nap.edu/openbook.php?record\\_id=12620&page=250](http://www.nap.edu/openbook.php?record_id=12620&page=250)

National Research Council. (2011). Renewable Fuel Standard: Potential Economic and Environmental Effects of U.S. Biofuel Policy. Washington, DC. Accessed at [http://www.nap.edu/catalog.php?record\\_id=13105](http://www.nap.edu/catalog.php?record_id=13105)

<sup>13</sup> Perlack, R. D., and Stokes, B. J. (Leads), U.S. Department of Energy. (2011). *U.S. Billion-Ton Update: Biomass Supply for a Bioenergy and Bioproducts Industry*. (DOE/EE-0363). Oak Ridge, TN: Oak Ridge National Laboratory.

<sup>14</sup> A dry tonne of biomass can be converted to about 90 gallons of ethanol, or about 60 gallons of gasoline equivalent.

Humbird, D., et al. (2011). *Process Design and Economics for Biochemical Conversion of Lignocellulosic Biomass to Ethanol*. (NREL/TP-5100-47764). Golden, CO: National Renewable Energy Laboratory.

<sup>15</sup> Note that this assumes 100% carbon efficiency in converting from feedstock to fuel; existing conversion technologies are about 50% efficient.

<sup>16</sup> Municipal solid waste consists of everyday items we use and then throw away, such as product packaging, grass clippings, furniture, clothing, bottles, food scraps, newspapers, appliances, paint, and batteries. Some of this waste, such as food scraps and newspapers, would double-count carbon flows on the supply side.

#### <sup>17</sup> Coal

The United States consumed 1,000 million short tons of coal in 2009.

<http://www.eia.gov/totalenergy/data/annual/txt/ptb0701.html>

Carbon content of coal is approximately 51%. <http://www.eia.gov/todayinenergy/detail.cfm?id=2670>

#### Natural Gas

The United States used 22.839 trillion cubic feet of natural gas in 2009.

<http://www.eia.gov/dnav/ng/hist/n9140us2A.htm>

Carbon content of natural gas (assuming 100% methane CH<sub>4</sub>) is 15 g C per cubic feet NG. Based on 122 pound CO<sub>2</sub>/1,000 cubic feet NG. <http://cdiac.ornl.gov/pns/faq.html>

#### Gasoline

U.S. supply of gasoline was 3,284 million barrels in 2009.

[http://www.eia.gov/dnav/pet/pet\\_cons\\_psup\\_dc\\_nus\\_mbbl\\_a.htm](http://www.eia.gov/dnav/pet/pet_cons_psup_dc_nus_mbbl_a.htm)

Carbon content in gasoline is 2,421 grams carbon per gallon. Code of Federal Regulations (40 CFR 600.113).

<http://www.epa.gov/otaq/climate/420f05001.htm#calculating>

#### Diesel

U.S. supply of diesel is 1,038 million barrels/year (Distillate Fuel Oil: 15 ppm and under Sulfur).

[http://www.eia.gov/dnav/pet/pet\\_cons\\_psup\\_dc\\_nus\\_mbbl\\_a.htm](http://www.eia.gov/dnav/pet/pet_cons_psup_dc_nus_mbbl_a.htm)

Carbon content in diesel is 2,778 grams carbon/gallon.

<http://www.epa.gov/otaq/climate/420f05001.htm#calculating>

#### Other Crude Oil

The United States consumed 6,851 million barrels of crude in 2009.

[http://www.eia.gov/dnav/pet/pet\\_cons\\_psup\\_dc\\_nus\\_mbbl\\_a.htm](http://www.eia.gov/dnav/pet/pet_cons_psup_dc_nus_mbbl_a.htm)

Crude is 85% carbon by weight (<http://cdiac.ornl.gov/pns/convert.html>). Subtract gasoline and diesel carbon.

#### Corn

U.S. supply of corn was 13,091,862,000 bushel in 2009.

[http://www.nass.usda.gov/Statistics\\_by\\_Subject/result.php?2A34ECC7-2E42-3883-BF81-9AEFA12F396E&sector=CROPS&group=FIELD%20CROPS&comm=CORN](http://www.nass.usda.gov/Statistics_by_Subject/result.php?2A34ECC7-2E42-3883-BF81-9AEFA12F396E&sector=CROPS&group=FIELD%20CROPS&comm=CORN)

Carbon content of dry corn is 32%. <http://www.bio.net/bionet/mm/plantbio/1993-August/001498.html>

#### Paper

U.S. supply of paper was 87,632 thousand tons in 2008.

[www.census.gov/compendia/statab/2010/tables/10s0859.xls](http://www.census.gov/compendia/statab/2010/tables/10s0859.xls)

Carbon content of paper is similar to woodpulp (29% carbon content).

<http://www.sou.edu/envirostudies/Gutrich5.pdf>

#### **Soy**

U.S. supply of soy was 3,359,011,000 bushels in 2009.

[http://www.nass.usda.gov/Statistics\\_by\\_Subject/result.php?9D5F2C2B-331F-31F9-99E9-EE8D69415D1C&sector=CROPS&group=FIELD%20CROPS&comm=SOYBEANS](http://www.nass.usda.gov/Statistics_by_Subject/result.php?9D5F2C2B-331F-31F9-99E9-EE8D69415D1C&sector=CROPS&group=FIELD%20CROPS&comm=SOYBEANS)

Soy is 13% moisture by weight, and the carbon content of dry soy is 42.6%. <http://www.grains.org/conversion-factors>

#### **Woodpulp**

U.S. supply of woodpulp was 57,964 thousand tons in 2008.

[www.census.gov/compendia/statab/2010/tables/10s0859.xls](http://www.census.gov/compendia/statab/2010/tables/10s0859.xls)

Carbon content of woodpulp is about 29% (range 23%–35%). <http://www.sou.edu/envirostudies/Gutrich5.pdf>

#### **Wheat**

U.S. supply of wheat was 2,218,061,000 bushels in 2009.

[http://www.nass.usda.gov/Statistics\\_by\\_Subject/result.php?739ECD5D-4641-3D15-AA41-E64A5856106E&sector=CROPS&group=FIELD%20CROPS&comm=WHEAT](http://www.nass.usda.gov/Statistics_by_Subject/result.php?739ECD5D-4641-3D15-AA41-E64A5856106E&sector=CROPS&group=FIELD%20CROPS&comm=WHEAT)

Carbon content of wheat is about 46%. <http://biomassmagazine.com/articles/5317/codigesting-crop-residues>

#### **Edible Fats/Oils**

U.S. supply of edible fats and oils was 26,442 million pounds in 2008.

<http://usda.mannlib.cornell.edu/usda/ers/89002/2009/index.html>

Carbon content of soybean oil is 77%. [http://www.biodiesel.org/pdf\\_files/fuelfactsheets/Weight&Formula.PDF](http://www.biodiesel.org/pdf_files/fuelfactsheets/Weight&Formula.PDF)

#### **Meat/Poultry**

U.S. supply of livestock was 72,942,000,000 pounds in 2009.

[http://www.nass.usda.gov/Statistics\\_by\\_Subject/result.php?A295F1C9-B063-3B13-8A6B-0FF11AE25ED1&sector=ANIMALS%20%26%20PRODUCTS&group=LIVESTOCK&comm=LIVESTOCK%20TOTALS](http://www.nass.usda.gov/Statistics_by_Subject/result.php?A295F1C9-B063-3B13-8A6B-0FF11AE25ED1&sector=ANIMALS%20%26%20PRODUCTS&group=LIVESTOCK&comm=LIVESTOCK%20TOTALS)

U.S. supply of poultry was 41,787,000,000 pounds in 2009.

[http://www.nass.usda.gov/Statistics\\_by\\_Subject/result.php?A5C4E649-B4FB-3770-B69E-C886FCF83259&sector=ANIMALS%20%26%20PRODUCTS&group=POULTRY&comm=POULTRY%20TOTALS](http://www.nass.usda.gov/Statistics_by_Subject/result.php?A5C4E649-B4FB-3770-B69E-C886FCF83259&sector=ANIMALS%20%26%20PRODUCTS&group=POULTRY&comm=POULTRY%20TOTALS)

Carbon content of flesh is about 18%. <http://www.daviddarling.info/encyclopedia/E/elbio.html>

#### **Cotton**

U.S. supply of cotton was 5,850,000,000 pounds.

[http://www.nass.usda.gov/Statistics\\_by\\_Subject/result.php?D93C704C-D0F7-3A06-AC27-5FE78C79A5F9&sector=CROPS&group=FIELD%20CROPS&comm=COTTON](http://www.nass.usda.gov/Statistics_by_Subject/result.php?D93C704C-D0F7-3A06-AC27-5FE78C79A5F9&sector=CROPS&group=FIELD%20CROPS&comm=COTTON)

Carbon content of cotton fiber is 42%. <http://cottontoday.cottoninc.com/Sustainability-About/Life-Cycle-Inventory-Data-For-Cotton/Life-Cycle-Inventory-Data-For-Cotton.pdf>

#### **Biomass**

The United States currently uses 214 million dry tons of biomass for fuels. *U.S. Billion-Ton Update*, Table ES1.

<http://www.ascension-publishing.com/BIZ/Billion-Ton-2.pdf>

Carbon content of bioenergy feedstocks is about 45%. [http://bioenergy.ornl.gov/papers/misc/energy\\_conv.html](http://bioenergy.ornl.gov/papers/misc/energy_conv.html)

#### **Biomass Potential**

The United States could produce 1,046–1,305 million dry tons in 2030 (averaged to 1,175).

*U.S. Billion-Ton Update*. <http://www.ascension-publishing.com/BIZ/Billion-Ton-2.pdf>

#### **Municipal Solid Waste**

The United States produced 243 million short tons of municipal solid waste in 2009.

<http://www.epa.gov/waste/nonhaz/municipal/index.htm>

Carbon content of municipal solid waste is about 34% by weight. [http://www.ipcc-nggip.iges.or.jp/public/gp/bgp/5\\_3\\_Waste\\_Incineration.pdf](http://www.ipcc-nggip.iges.or.jp/public/gp/bgp/5_3_Waste_Incineration.pdf)

- <sup>18</sup> National Academy of Sciences, National Academy of Engineering, National Research Council. (2009). *Liquid Transportation Fuels From Coal and Biomass: Technological Status, Costs, and Environmental Impacts*. Washington, DC: National Academies Press. Accessed at [http://www.nap.edu/catalog.php?record\\_id=12620](http://www.nap.edu/catalog.php?record_id=12620)
- <sup>19</sup> Advanced biofuel is defined as a renewable fuel other than ethanol derived from corn starch and for which lifecycle GHG emissions are at least 50% less than the gasoline or diesel fuel it displaces. The EPA can grant waivers for these mandates. For example, acknowledging the lack of U.S. capacity to produce adequate volumes of cellulosic biofuels, EPA reduced the required annual volumes of cellulosic biofuels from the original statutory goal of 100, 250, and 500 million gallons per year (MGY) in 2010, 2011, and 2012 to 6.5 MGY, 6.6 MGY, and 8.65 MGY, respectively.
- Energy Independence and Security Act of 2007 § 202.
- <sup>20</sup> For stover, includes harvesting, storage, transport, and preprocessing and plant receiving. For woody biomass, includes harvesting, landing preprocessing, transport, and receiving.
- U.S. Department of Energy. (2011). *Biomass Multi-Year Program Plan*. Washington, DC. Accessed at [http://www1.eere.energy.gov/biomass/pdfs/mypp\\_april\\_2011.pdf](http://www1.eere.energy.gov/biomass/pdfs/mypp_april_2011.pdf)
- <sup>21</sup> U.S. Department of Energy. (2009). *Biochemical Conversion Platform Review Report: An Independent Evaluation of Platform Activities for FY2008 and FY2009*. Washington, DC. Accessed at [http://www.obpreview2011.govtools.us/review/documents/OBP\\_BC-Conversion\\_Platform\\_Review\\_Report\\_EERE\\_Standard\\_Cover%20%28FINAL\\_V1%29.pdf](http://www.obpreview2011.govtools.us/review/documents/OBP_BC-Conversion_Platform_Review_Report_EERE_Standard_Cover%20%28FINAL_V1%29.pdf)
- <sup>22</sup> National Academy of Sciences, National Academy of Engineering, National Research Council. (2009). *Liquid Transportation Fuels From Coal and Biomass: Technological Status, Costs, and Environmental Impacts*. Washington, DC: National Academies Press. Accessed at [http://www.nap.edu/catalog.php?record\\_id=12620](http://www.nap.edu/catalog.php?record_id=12620)
- <sup>23</sup> Kazi, F. K., et al. (2010). *Techno-Economic Analysis of Biochemical Scenarios for Production of Cellulosic Ethanol*. (NREL/TP-6A2-46588). Golden, CO: National Renewable Energy Laboratory. Accessed at <http://www.nrel.gov/docs/fy10osti/46588.pdf>
- <sup>24</sup> Humbird, D., et al. (2011). *Process Design and Economics for Biochemical Conversion of Lignocellulosic Biomass to Ethanol: Dilute-Acid Pretreatment and Enzymatic Hydrolysis of Corn Stover*. (NREL/TP-5100-47764). Golden, CO: National Renewable Energy Laboratory.
- <sup>25</sup> U.S. Department of Energy. (2011). *Biomass Multi-Year Program Plan*. Washington, DC. Accessed at [http://www1.eere.energy.gov/biomass/pdfs/mypp\\_april\\_2011.pdf](http://www1.eere.energy.gov/biomass/pdfs/mypp_april_2011.pdf)
- <sup>26</sup> Urbanchuck, J. (2010). *Current State of the U.S. Ethanol Industry*. Washington, DC: Department of Energy. Accessed at [http://www1.eere.energy.gov/biomass/pdfs/current\\_state\\_of\\_the\\_us\\_ethanol\\_industry.pdf](http://www1.eere.energy.gov/biomass/pdfs/current_state_of_the_us_ethanol_industry.pdf)
- Table 4 (p. 5-2) provides cost estimates for total production cost and feedstock costs. The \$0.75 estimate was derived by calculating the operating costs (Total cost per gallon – Feedstock cost per gallon = Operating cost) and adding the amortized capital costs (assumed to be \$0.15 based on a standard amortization of assumed nameplate capital costs of \$1.97).
- <sup>27</sup> Humbird, D., et al. (2011). *Process Design and Economics for Biochemical Conversion of Lignocellulosic Biomass to Ethanol*. (NREL/TP-5100-47764). Golden, CO: National Renewable Energy Laboratory. Accessed at <http://www.nrel.gov/biomass/pdfs/47764.pdf>
- Table 41 (p. 82) provides estimates for total MESP, as well as feedstock, enzyme, and non-enzyme conversion costs. The conversion costs were calculated by adding the enzyme and non-enzyme portions of the conversion costs from the 2010 SOT column of the table.
- <sup>28</sup> The analysis is based on a plant designed and built to a given nameplate capacity in 2007. Since then, improvements in technology and operations enable production levels greater than 100% of that nameplate capacity. We report nameplate capacity because it is what the capital costs are based on. We also report total (actual) capacity in support of operating costs.
- <sup>29</sup> U.S. Department of Energy, Biomass Program. “Integrated Biorefineries.” Washington, DC. Accessed at [http://www1.eere.energy.gov/biomass/integrated\\_biorefineries.html](http://www1.eere.energy.gov/biomass/integrated_biorefineries.html)
- <sup>30</sup> Perlack, R. D., and Stokes, B. J. (Leads), U.S. Department of Energy. (2011). *U.S. Billion-Ton Update: Biomass Supply for a Bioenergy and Bioproducts Industry*. (DOE/EE-0363). Oak Ridge, TN: Oak Ridge National Laboratory.

- <sup>31</sup> Wigmosta, M. S., Coleman, A. M., Skaggs, R., Huesemann, M. H., and Lane, L. J. (2011). "National microalgae biofuel production potential and resource demand." *Water Resources Research*. 47: Article No. W00H04 (13 April 2011).
- <sup>32</sup> U.S. Department of Energy. (2011). *Biomass Multi-Year Program Plan*. (DOE/EE-0405). Washington, DC. Accessed at [http://www1.eere.energy.gov/biomass/pdfs/mypp\\_april\\_2011.pdf](http://www1.eere.energy.gov/biomass/pdfs/mypp_april_2011.pdf)
- <sup>33</sup> U.S. Department of Energy. (2011). *Biomass Multi-Year Program Plan*. (DOE/EE-0405). Washington, DC. Accessed at [http://www1.eere.energy.gov/biomass/pdfs/mypp\\_april\\_2011.pdf](http://www1.eere.energy.gov/biomass/pdfs/mypp_april_2011.pdf)
- <sup>34</sup> Hess, J. R., Kenney, K. L., Park Ovard, L., Searcy, E. M., and Wright, C. T. (2009). *Uniform-Format Solid Feedstock Supply System: A Commodity-Scale Design to Produce an Infrastructure Compatible Bulk Solid from Lignocellulosic Biomass*. (INL/EXT-08-14752). Idaho Falls, ID: Idaho National Laboratory. Accessed at <http://www.inl.gov/bioenergy/uniform-feedstock>
- Tumuluru, J. S., Wright, C. T., Hess, J. R., and Kenney, K. L. (2011). "A review of biomass densification systems to develop uniform feedstock commodities for bioenergy application." *Biofuels, Bioproducts and Biorefining*. 1932-1031. Accessed at <http://dx.doi.org/10.1002/bbb.324>
- <sup>35</sup> U.S. Department of Energy. (2011). *Biomass Multi-Year Program Plan*. (DOE/EE-0405). Washington, DC. Accessed at [http://www1.eere.energy.gov/biomass/pdfs/mypp\\_april\\_2011.pdf](http://www1.eere.energy.gov/biomass/pdfs/mypp_april_2011.pdf)
- <sup>36</sup> The Shell Pearl GTL plant in Qatar produces 140,000 bpd, while smaller plants in Qatar (Sasol's Oryx plant), Malaysia (Shell's Bintulu plant), and South Africa (PetroSA's Mossel Bay plant) contribute the balance.
- <sup>37</sup> The Sasol Secunda plant in South Africa produces 160,000 bpd and is the only commercial CTL plant in operation. Two plants in China (one in Inner Mongolia and another in Shanxi Province) contribute the balance.
- <sup>38</sup> Anex, R. P., et al. (2010). "Techno-economic comparison of biomass-to-transportation fuels via pyrolysis, gasification, and biochemical pathways." *FUEL*. 89(1):S29-S35. doi:10.1016/j.fuel.2010.07.015.
- <sup>39</sup> Crude oil price at which the facility is economically viable and can meet its 12% Internal Rate of Return on Equity.
- <sup>40</sup> Gasoline or diesel price at which the facility is economically viable and can meet its 12% Internal Rate of Return on Equity.
- <sup>41</sup> National Energy Technology Laboratory. (2011). *Production of Zero Sulfur Diesel Fuel from Domestic Coal: Configuration Options to Reduce Environmental Impact*.  
At natural gas prices ranging from \$5–\$10/mm Btu, and assuming a 10% Capital Charge Factor.
- <sup>42</sup> Memorandum from David Gray, Noblis, Inc., April 25, 2011.
- <sup>43</sup> National Energy Technology Laboratory. (2010). *Baseline Analysis of Sub-Bituminous Coal and Biomass to Gasoline (Indirect Liquefaction via Methanol Synthesis)*. (DOE/NETL-40/092310). Morgantown, WV.
- <sup>44</sup> Tarka, T. J., Shah, V., et al. (2011). *Cost and Performance Baseline for Fossil Energy Plants, Volume 4: Coal-to-Liquids via Fischer-Tropsch Synthesis*. (DOE/NETL-2011/1477). Morgantown, WV: National Energy Technology Laboratory.
- White, C., and Gray, D. (2011). *Production of Zero Sulfur Diesel Fuel from Domestic Coal: Configurational Options to Reduce Environmental Impact*. Morgantown, WV: National Energy Technology Laboratory.
- <sup>45</sup> Tarka, T. J., et al. (2009). *Affordable, Low-Carbon Diesel Fuel from Domestic Coal and Biomass*. (DOE/NETL-2009/1349). Morgantown, WV: National Energy Technology Laboratory. Accessed at <http://www.netl.doe.gov/energy-analyses/pubs/CBTL%20Final%20Report.pdf>
- <sup>46</sup> Internal DOE analysis performed by the National Energy Technology Laboratory, May 5, 2011.
- <sup>47</sup> Converted using the Fischer-Tropsch process with 15% biomass to 85% coal.
- <sup>48</sup> Internal DOE analysis performed by the National Energy Technology Laboratory, May 5, 2011.
- <sup>49</sup> U.S. Department of Energy. (2011). *Biomass Multi-Year Program Plan*. (DOE/EE-0405). Washington, DC. Accessed at [http://www1.eere.energy.gov/biomass/pdfs/mypp\\_april\\_2011.pdf](http://www1.eere.energy.gov/biomass/pdfs/mypp_april_2011.pdf)
- <sup>50</sup> National Academy of Sciences, National Academy of Engineering, National Research Council. (2009). *Liquid Transportation Fuels From Coal and Biomass: Technological Status, Costs, and Environmental Impacts*. Washington, DC: National Academies Press. Accessed at [http://www.nap.edu/catalog.php?record\\_id=12620](http://www.nap.edu/catalog.php?record_id=12620)
- <sup>51</sup> Davis, R., et al. (2011). "Techno-economic analysis of autotrophic microalgae for fuel production." *Applied Energy*. 88(10):3524-3531. doi:10.1016/j.apenergy.2011.04.018.

- 
- <sup>53</sup> The Clean Vehicle Education Foundation estimates there are approximately 3,000 natural gas refuse haulers, 2,800 natural gas school buses, and 16,000–18,000 medium-duty NGVs (such as airport shuttles and delivery vans). Honda has sold light-duty CNG vehicles since 2007, and other OEMs have recently offered new models. Argonne National Laboratory. (2010). *Natural Gas Vehicles – Status, Barriers, Opportunities*. (ANL/ESD/10-4) p.7–8. Argonne, IL. Accessed at [http://www.afdc.energy.gov/afdc/pdfs/anl\\_esd\\_10-4.pdf](http://www.afdc.energy.gov/afdc/pdfs/anl_esd_10-4.pdf)
- <sup>54</sup> NGV Communications Group. <http://www.ngvgroup.com>
- <sup>55</sup> Energy Information Administration. “Other FAQs about Gasoline.” Washington, DC. Accessed at <http://www.eia.gov/tools/faqs/faq.cfm?id=25&t=10>
- <sup>56</sup> U.S. Department of Energy. (2011). “Alternative Fueling Station Total Counts by State and Fuel Type.” Washington, DC. Accessed at [http://www.afdc.energy.gov/afdc/fuels/stations\\_counts.html](http://www.afdc.energy.gov/afdc/fuels/stations_counts.html)
- <sup>57</sup> Argonne National Laboratory. (2010). *Natural Gas Vehicles – Status, Barriers, Opportunities*. (ANL/ESD/10-4). p.7–8. Argonne, IL. Accessed at [http://www.afdc.energy.gov/afdc/pdfs/anl\\_esd\\_10-4.pdf](http://www.afdc.energy.gov/afdc/pdfs/anl_esd_10-4.pdf)
- <sup>58</sup> [http://www.pnl.gov/main/publications/external/technical\\_reports/PNNL-19745.pdf](http://www.pnl.gov/main/publications/external/technical_reports/PNNL-19745.pdf)
- <sup>59</sup> Westport Innovations, Inc. Presentation at the Northwest Gas Association Meeting. March 18, 2011.
- <sup>60</sup> Energy Information Administration. (2011). “Estimated Number of Alternative Fueled Vehicles in Use in the United States, by Fuel Type, 2005–2009.” *Alternatives to Traditional Transportation Fuels*. Washington, DC. Accessed at [http://www.eia.gov/renewable/alternative\\_transport\\_vehicles/pdf/attf\\_V1.pdf](http://www.eia.gov/renewable/alternative_transport_vehicles/pdf/attf_V1.pdf)
- <sup>61</sup> Energy Information Administration. (2011). “Estimated Consumption of Vehicle Fuels in the United States, by Fuel Type, 2005–2009.” *Alternatives to Traditional Transportation Fuels*. Washington, DC. Accessed at [http://www.eia.gov/renewable/alternative\\_transport\\_vehicles/pdf/attf\\_c1.pdf](http://www.eia.gov/renewable/alternative_transport_vehicles/pdf/attf_c1.pdf)
- <sup>62</sup> World LP Gas Association. “Autogas Consumption, Vehicles, and Dispensing Sites.” *Key Autogas Data*. Neuilly-sur-Seine, France. Accessed at <http://www.worldlpgas.com/gain/key-autogas-data>
- <sup>63</sup> National Academy of Sciences. (2009). *Real Prospects for Energy Efficiency in the United States*. p.127. Washington, DC: The National Academies Press.
- <sup>64</sup> See <http://science.energy.gov/bes/efrc/>
- <sup>65</sup> See [http://www1.eere.energy.gov/biomass/integrated\\_biorefineries.html](http://www1.eere.energy.gov/biomass/integrated_biorefineries.html) and <http://obpreview2011.govtools.us/IBR/>
- <sup>66</sup> U.S. Department of Energy. (2010). *National Algal Biofuels Technology Roadmap*. Washington, DC. Accessed at [http://www1.eere.energy.gov/biomass/pdfs/algal\\_biofuels\\_roadmap.pdf](http://www1.eere.energy.gov/biomass/pdfs/algal_biofuels_roadmap.pdf)
- <sup>67</sup> See <http://www.naabb.org/>; <http://asulightworks.com/research-centers/sabc/>; <http://algae.ucsd.edu/index.html>; and <http://cellana.com/>
- <sup>68</sup> For example, the Joint Center for Artificial Photosynthesis. Find more at <http://solarfuelshub.org/>



## 5 Building and Industrial Efficiency

The assessments in this chapter form the technical base for *Improving Building and Industrial Efficiency*, a strategy detailed in the corresponding chapter of the *Report on the Quadrennial Technology Review (QTR)*. Increasing energy efficiency provides a net economic advantage by decreasing energy expenditures for the same level of service. Improving building and industrial energy efficiency will enhance U.S. economic competitiveness while reducing environmental impacts.

While each technology is presented here with a standalone assessment, the associated opportunities to impact the energy system are fully understood only within the context of an integrated framework that spans energy resource, supply, delivery, and consumption. The *Report on the QTR* presents an integrated framework of the energy system and contains the systems discussions that tie together these individual assessments.

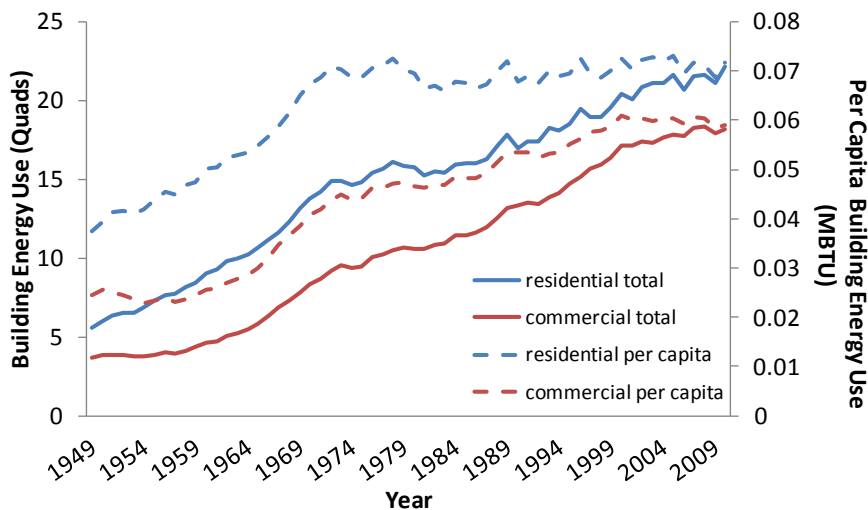
The technology assessments in the *Building and Industrial Efficiency* chapter have been organized alphabetically and include:

- Building Efficiency
- Industrial Efficiency

## 5.1 Building Efficiency

After losses in generating and delivering electricity, about 11 Quads of fossil fuels and 9 Quads of electricity were consumed in buildings in 2009. That energy was principally used for heating, ventilation, and air conditioning (HVAC); lighting; water heating; and electronics. Electricity accounts for 40% and 53% of site energy use in residential and commercial buildings, respectively; fuels for heating and cooking comprise the balance. Commercial buildings use 75% more energy per square foot than residential buildings.<sup>1</sup> There are ample opportunities to improve the energy efficiency in buildings—through improved components, as well as better design and operation of the building as a system.

U.S. residential and commercial building energy use has increased continuously since the 1950s (Figure 13). However, per capita building energy use (Figure 13) has slowed since the 1970s. Many factors influence these trends, including the pace of economic growth, structural shifts in the U.S. economy, and demographic changes.



**Figure 13. Residential (blue) and Commercial (red) Building Primary Energy Use (solid lines) and Per Capita Primary Energy Use (dotted lines) Since the 1950s** Sources: Energy Information Administration. (2011).

“Population, U.S. Gross Domestic Product, and Implicit Price Deflator, 1949-2010.” *Annual Energy Review*.

Washington, DC. Accessed October 2011 at

<http://www.eia.gov/totalenergy/data/annual/showtext.cfm?t=ptb1501>; Energy Information Administration.

(2011). “Energy Consumption Estimates by Sector, 1949-2010.” *Annual Energy Review*. Washington, DC. Accessed

October 2011 at <http://www.eia.gov/totalenergy/data/annual/showtext.cfm?t=ptb0201a>

The factors related to energy efficiency include:

- **State and Federal Appliance Standards:** Introduced into law in 1987, federal appliance standards reduced U.S. appliance electricity use by 2.5% (1.3 Quads) in 2000, by a projected 6.9% (3.1 Quads) in 2010, and by 9.1% (5.2 Quads) in 2020.<sup>2</sup>
- **Technology Development:** In the past three decades, public and private research and development (R&D) has introduced many energy-saving products into the marketplace, including electronic ballasts and compact fluorescent lighting. For example, some of the Department of Energy’s (DOE’s) most successful R&D programs are estimated to have



cumulatively saved the nation about 5 Quads of primary energy by 1999, a net economic benefit of around \$30 billion.<sup>3</sup>

- **Multiple Efforts:** Additional policies and actors at the local, state, and federal levels have contributed to reducing energy consumption, tax credits, Energy Efficiency Resource Standards, building codes, a broad set of utility incentives, and activities by non-government organizations.

Building construction and renovation industries account for less than 10% of U.S. gross domestic product (GDP).<sup>4</sup> In 2007, residential and commercial building renovations were valued at \$450 billion, and new building construction was valued at \$785 billion. Appliances and equipment is a \$166 billion industry in the United States.<sup>5</sup> Given the size and relatively large energy use, as explained above, there is significant interest in the potential of reducing energy use in buildings. For example, a number of recent reports have surveyed the potential for building energy efficiency in the U.S. economy. Among these are *Real Prospects for Energy Efficiency in the United States* from the National Academy of Sciences,<sup>6</sup> *Unlocking Energy Efficiency in the U.S. Economy* from McKinsey & Company,<sup>7</sup> and *Energy Future: Think Efficiency* from the American Physical Society.<sup>8</sup> However, multiple barriers hinder adoption of cost-effective technologies. Although a comprehensive analysis of these barriers is beyond the scope of this assessment, examples include:

- **Market Failures:** Fragmentation of suppliers and customer base, incomplete or poor communication of information (e.g., specific appliance operating cost) to consumers, and principal-agent disconnects between the parties that select equipment (i.e., landlords, contractors, builders) and those who pay the energy bills (i.e., tenants, building owners/operators). The latter are commonly known as “split incentives.”
- **Short-Term Consumer Decision Making:** Focus groups show that when considering only costs, consumers demand payback periods far shorter than the service life of the equipment (e.g., 1–1.5 year paybacks for high-efficiency HVAC systems).<sup>9</sup> Consumers accept longer payback periods when non-energy benefits beyond efficiency are considered, as in the case of the comfort, health, and productivity benefits of modern HVAC equipment.
- **Long Equipment Lifetimes:** Refrigerators, water heaters, and HVAC equipment have 10–20 year lifetimes that slow deployment of newer technologies.<sup>10</sup> This is especially true for HVAC equipment; studies have estimated median heat pump service life at close to 20 years.<sup>11,12</sup>
- **Embedded Infrastructure:** Deployed infrastructure (e.g., lighting fixtures and dimmers, HVAC ducts) designed for old technology is suboptimal for newer technologies, thereby limiting adoption and benefits of modern equipment.

### 5.1.1 Policy Context

Federal, state, and local government influence building energy efficiency in four ways: R&D, codes, standards, and market priming. Standards, codes, and market priming are discussed briefly here, while the remainder of the Building Efficiency technology assessment focuses on technology R&D.

**Appliance and Equipment Standards:** DOE develops test procedures and minimum efficiency standards for residential appliances and commercial equipment.

**Building Codes:** Building energy codes and standards are adopted and enforced by individual states, though some counties have building energy standards that exceed statewide standards. They are often based on model energy codes and standards developed by industry groups with support from DOE. Model energy codes were established by the Energy Conservation and Production Act of 1976, in which codes are "designed to achieve the maximum practicable improvements in energy efficiency."

**Market Priming:** Governments have used a number of mechanisms to ease technology deployment by reducing non-technical barriers to adoption. Some of the most significant activities of this type include:

- **Retrofitting Existing Residential Buildings:** DOE's Weatherization and Intergovernmental and Better Buildings Programs both deploy commercially available energy efficiency measures, including air sealing, insulation, and efficient HVAC equipment to low-income and other homes. These activities have laid the groundwork for further deployment by establishing "best practices" in the industry.
- **Guidelines and Certification:** DOE's Weatherization Assistance Program, in conjunction with experts and professionals in the residential energy efficiency market, has set the standard for how work will be performed in homes and what knowledge and abilities workers require to perform the various tasks by developing the Workforce Guideline for Home Energy Upgrades. This effort is complemented by a training accreditation and worker certification initiative to standardize the workforce, improve service delivery, and increase the confidence for consumers investing in energy efficiency.
- **Training Curricula:** The Weatherization Assistance Program has developed standardized training curricula for the classroom, as well as hands-on instruction to improve skills and maintain quality output.
- **Retrofitting Existing Commercial Buildings:** Similarly, the recently launched Better Buildings Initiative seeks to reduce total commercial building energy consumption by 20% by 2020 (about 4 Quads per year).
- **New Buildings:** Various initiatives, including the building codes program, Building America, and model building designs, seek to improve the way new buildings are built. These measures have their greatest effects in the long term due to the long lifetime of existing buildings.

- **Ratings:** Ratings like ENERGY STAR® and Leadership in Energy and Environmental Design allow builders to distinguish themselves from their competitors through the energy efficiency of their products. Home Performance with ENERGY STAR and various private, local, and state-level programs retrofit existing buildings to improve their efficiency.
- **Mandatory Energy Performance Disclosure:** Several states have enacted policies that require the rating and disclosure of energy performance of public, commercial, or residential buildings.<sup>13</sup>

### 5.1.2 Appliance and Equipment Efficiency

Despite the availability of cost-effective energy-saving technologies, today's appliances, equipment, and lighting systems consume more energy than necessary. Deploying technologies that are commercially available today, as well as those that would be available with low-risk R&D over the next two decades could reduce total building-related energy consumption by 40% (17.4 Quads per year).<sup>14</sup>

This assessment is divided between end-use-specific emerging technology R&D (which tends to be what manufacturers can commercialize in under 10 years), crosscutting research (which tends to have a 10–20 year horizon), and longer-term breakthrough R&D.

In order to determine the scope of this assessment, we started with a top-down frame that split building end use into eight major categories. We then evaluated the latest thinking to determine the current consumption and future technical potential in those categories. Opportunities for technology improvements are shown in Table 3. These include:

- Modernizing HVAC systems
- Advancing lighting technology
- Improving water heating
- Addressing miscellaneous electric loads
- Advancing refrigeration technology
- Reducing laundry energy consumption
- Exploring innovative cooking appliances
- Optimizing dishwashing appliances.

**Table 7. Technology Opportunities for End-Use Technologies**

		End Uses to Address							
		HVAC	Water Heating	Lighting	Refrigeration	MELs	Laundry	Cooking	Dishwashing
<b>Near-Term Emerging Technology</b>		-Cold-climate heat pump -Integrated HP	-“CO <sub>2</sub> ” HP -Gas absorption heat pump	Solid state (i.e., LEDs)	-Linear & variable speed compressors -System improvements		Various	Various	Various
<b>Crosscutting technologies</b>	<b>Insulation</b>	X	X		X	X	X	X	X
	<b>Heat Exchangers</b>	X	X	X	X	X		*	
	<b>Motors</b>	X	X		X	X	X	*	X
	<b>DC Equipment</b>	*	*	X	*	X	*	*	*
	<b>Working Fluids</b>	X	X		X		*		
	<b>Cascading &amp; Storage</b>	X	X		X		X		
<b>Breakthrough R&amp;D</b>		-Moisture transport membranes -Indirect evaporative -Liquid desiccants		Multi-photon phosphors	-Thermo-acoustic and magnetic -Solid state technology -Sterling cycle -Absorption & adsorption	OLED displays		Non-thermal cooking	

“X” Indicates applicability

“\*” Indicates limited applicability

Gray boxes indicate few opportunities

**5.1.2.1 End-Use R&D**

HVAC, lighting, water heating, and plug loads total 87% of the 34 Quads of primary energy consumption that has well-identified end uses.

**Table 8. Summary of Energy Consumption and Savings Potential with Major End Uses**

End Use	Technology Opportunities	Today’s Energy Use (Quads)	DOE Assessment of Possible Technical Reduction
<b>HVAC</b>	<ul style="list-style-type: none"> <li>• Combustion heating</li> <li>• Cold-climate heat pumps</li> <li>• Integrated heat pumps</li> <li>• Ground-source heat pumps</li> </ul>	15	10%–60%
<b>Lighting</b>	<ul style="list-style-type: none"> <li>• Solid state</li> <li>• Outdoor lighting advances</li> <li>• Sensors and controls</li> </ul>	5.4	70%–90%
<b>Water Heating</b>	<ul style="list-style-type: none"> <li>• Electric heat pump water heaters (HPWH)</li> <li>• Gas absorption HPWH</li> <li>• Solar water heating</li> <li>• Demand reduction</li> </ul>	3.7	50%–75%
<b>Miscellaneous Electric Loads</b>	<ul style="list-style-type: none"> <li>• Energy management controls</li> <li>• Standby power reduction</li> <li>• Component improvements</li> </ul>	5.7	50% <sup>15</sup>
<b>Refrigeration</b>	<ul style="list-style-type: none"> <li>• “Max tech” appliance could yield ~40% energy savings<sup>16</sup></li> </ul>	2.6	20%–40%
<b>Cooking</b>	<ul style="list-style-type: none"> <li>• Induction cook tops</li> <li>• Dual cavity ovens</li> <li>• Low-emissivity heating elements</li> </ul>	0.83	10%–50%

	<ul style="list-style-type: none"> <li>• Increased microwave oven use</li> </ul>		
<b>Laundry</b>	<ul style="list-style-type: none"> <li>• Reduced hot water use</li> <li>• Improved machine efficiency</li> <li>• Reduced drying need</li> </ul>	0.74	40%–70%
<b>Dishwashing</b>	<ul style="list-style-type: none"> <li>• Advanced hydraulics</li> <li>• Sorption-assisted drying</li> <li>• Improved food filters</li> <li>• Efficient motors</li> <li>• Advanced controls</li> </ul>	0.28	35%–50%

**Heating and Cooling:** These applications represent 15 Quads of energy consumption in buildings, and DOE believes that they offer 10%–60% energy savings. There is modest opportunity to significantly improve the efficiency of conventional combustion space heating technologies, such as gas-fired furnaces and boilers. For example, increasing the Annual Fuel Utilization Efficiency from the current stock-weighted value of 0.81 to the maximum technology of 0.98 would save 0.86 Quads of energy per year and provide corresponding environmental benefits. There are few technological hurdles to achieve these gains; furnaces and boilers with Annual Fuel Utilization Efficiencies greater than 0.95 are widely commercialized. Non-combustion technologies that potentially offer far greater energy savings include:

- **Cold Climate Heat Pumps:** Improve air-source heat pumps to operate at higher efficiencies under cold ambient temperature conditions; this technology could reduce space heating and cooling energy in Northern climate residences and small commercial buildings. Research opportunities include multi-stage vapor compression systems, improved icing controls, and adequate data reporting to enable simulations that accelerate product development. This technology can also improve efficiencies of refrigeration systems for frozen food.
- **Integrated Heat Pump:** Develop prototype systems to cut energy consumption for space heating, cooling, and water heating combined by 44%–60%. These pursue two-speed air source, variable speed air source, and variable speed ground-source heat pump technologies.
- **Ground-Source Heat Pump:** Improved ground coupling, reduced drilling costs, and improved analyses and opportunity assessments can lead to lower first costs and broader consumer adoption.
- **Air-Conditioning-Only Systems** can be improved through variable speed vapor compression technologies (including roof-top units and scroll compressors in commercial applications).

**Lighting:** Though currently responsible for 5.4 Quads of annual energy use, advanced lighting technologies are developing to reduce lighting energy consumption.<sup>17</sup> DOE believes that they could technically reduce lighting energy consumption by 70%–90%. Transitioning from the incandescent light bulb to compact fluorescent to solid-state lighting (SSL) in homes, and retrofitting low-efficiency T12 and T8 fixtures with high-efficiency T5 and SSL fixtures in commercial buildings can achieve significant savings.

In 2010, the average efficacy of lighting installed in the United States was 58 Lumens per Watt (Lm/W).<sup>18</sup> DOE targets for light-emitting diode (LED) luminaire efficacy are 139 Lm/W by 2015 and 202 Lm/W by 2020.<sup>19</sup> If these targets are achieved, due to the increased penetration of LED lighting, by 2020

consumers could reduce lighting energy consumption by 19%, a reduction of about 1.3 Quads of primary energy per year.<sup>20</sup> Manufacturers are designing luminaires for SSL with greater light utilization; improving SSL compatibility with control systems could further reduce consumption. Additional opportunities include:

- Replacing standard high-intensity discharge lamps with induction technology lamps to reduce energy use in large-area indoor and outdoor lighting applications.<sup>21</sup>
- Deploying occupancy and photo sensors, and integrating these controls with daylighting.<sup>1</sup>
- Reducing the cost of organic light-emitting diodes, which are even more energy efficient than semiconductor-based LEDs.

**Water Heating:** This end use is responsible for 3.7 Quads of primary energy use. Modern technologies, advanced distribution systems, and advanced controls offer greater savings than the simple technologies developed in the late 19th and early 20th centuries. Demand reduction through water-conserving fixtures and appliances offers additional energy and water savings.

DOE believes that several technologies can lead to 50%–75% end-use savings.<sup>22</sup> Energy consumption can be reduced by electric heat pump water heaters with benefits most clearly available in cooling-dominated Southern climates. Current research focuses on developing heat pump water heaters that use gas absorption or carbon dioxide (CO<sub>2</sub>) as the refrigerant. These technologies have the potential to reduce energy consumption by 40%–50% (gas absorption) or 70% (CO<sub>2</sub> refrigerant) and reduce emissions from refrigerant release. In appropriate regions of the country, solar water heating could reduce demand by another 50% or more, for a 70%–85% reduction in total primary energy demand for water heating.<sup>23</sup> Improved water heating controls, such as temperature setbacks or demand recirculation systems, could provide additional savings.

**Miscellaneous Electric (i.e., plug) Loads:** Plug load<sup>24</sup> energy consumption, which currently accounts for 5.7 Quads, is growing faster than any other equipment segment driven by electronics, such as personal computers, televisions and set-top boxes, and office equipment.<sup>25</sup> Scenario-based projections have estimated that technologies could reduce miscellaneous electric loads energy consumption by 50%.<sup>26</sup> Crosscutting energy-savings technologies include energy management controls (at the appliance and chip level), standby power reduction, and component improvements (e.g., broadly deploying technologies to extend battery life). Replacing the current stock of electronics with best-on-market could increase efficiency by 10%–15%; engineering new products with best-available components and practices would be an even larger improvement. Organic light-emitting diodes display technology has the potential to reduce energy use by 50%–70%. Automated control systems provide real-time feedback to help realize savings. For example, grid-responsive, user-friendly control systems that provide feedback along with real-time, remote diagnostics could deliver large energy savings; one study found that such systems could reduce individual residential electricity use by 4%–12%.<sup>27</sup>

---

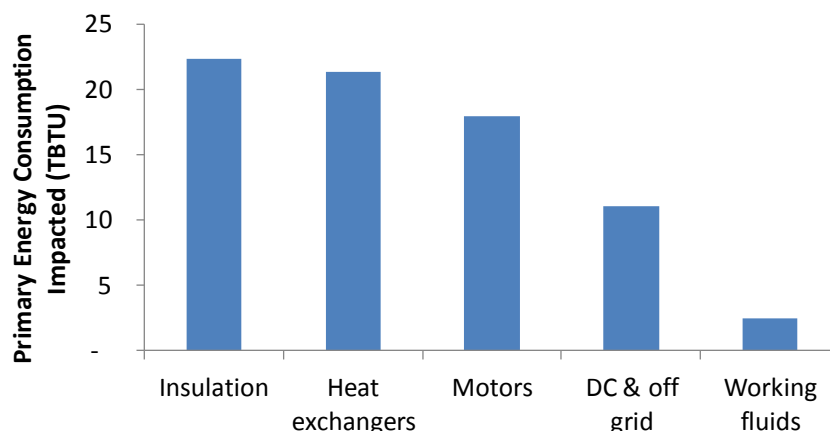
<sup>1</sup> For example, see:

Pacific Northwest National Laboratory. (2011). *Preliminary Scoping Report on Nanolens Coatings for Daylighting Applications*. (PNNL-20520). Richland, WA.

**Other Appliances:** The remaining end uses of refrigeration, laundry, cooking, and dishwashing also offer cost-effective technology-related opportunities to improve energy efficiency; these uses total some 4.4 Quads of primary energy.

- **Refrigeration:** While there are multiple approaches to reduce refrigerator energy consumption, no single commercialized device uses them all. Aggregating these into a “max tech” appliance would yield approximately 40% energy savings, reducing energy use to roughly half of the maximum permitted by new federal standards. Among the technologies and practices that could be incorporated are efficient compressor systems (linear, variable speed, and/or separate cold food/freezer compressors), optimized refrigerant (and air) temperatures, top-mounting condensing coils, vacuum-insulated panels, better gasket seals, adaptive defrosting and anti-sweat heaters, improved heat exchangers, and direct current (DC) fan motors.<sup>28</sup>
- **Cooking:** DOE estimates that, in aggregate, four strategies could reduce the primary energy consumption of cooking by 10%–50%.
  - Switch to induction cook tops and dual cavity ovens.
  - Increase the thermal efficiency of electric household ovens from 12.7% to 23% with low-emissivity heating element designs to provide 50% energy savings.<sup>29</sup>
  - Develop combined infrared-microwave technology to allow use of efficient microwave ovens for baking with no loss in quality.<sup>30</sup> However, this hybridization requires changes to the typical kitchen infrastructure.<sup>31</sup>
- **Laundry:** Recent technical advances offer significant energy-savings potential;<sup>32</sup> DOE believes there is technical potential for a 40%–70% reduction in laundry-related energy consumption. For example, Consortium for Energy Efficiency-tier 2 washers provide 43% energy savings<sup>33</sup> over the current standard. An additional 50% can be achieved through low-temperature detergents, advanced fill controls, and water recirculation techniques to reduce hot water use; advanced agitation techniques<sup>34</sup> and high-efficiency motors<sup>35</sup> to improve machine efficiency; and higher washer spin speeds, modulating gas dryers, heat pump dryers,<sup>36</sup> improved drum insulation, and waste heat recovery to reduce drying energy.
- **Dishwashing:** DOE believes that there is technical potential to reduce dishwashing energy consumption by 35%–50%. The Super-Efficient Home Appliances Initiative, adopted in August 2009,<sup>37</sup> is currently promoting energy-efficient dishwashers that use 17% less electricity and 35% less water than the federal minimum. Over 20% additional energy savings can be achieved with other technologies, including advanced hydraulics,<sup>38</sup> sorption assisted drying,<sup>39</sup> improved food filters, efficient motors, and advanced controls.<sup>40</sup>

### 5.1.2.2 Crosscutting Technologies



**Figure 14. Five Crosscutting Technologies that Have the Potential to Impact Energy Consumption** Energy cascading and storage is not included in this figure because there is no available estimate of savings potential. Source: Department of Energy analysis using 2010 residential and commercial building energy consumption data from the Energy Information Administration. (2011). *Annual Energy Review 2011*. Washington, DC: Department of Energy. Accessed at <http://www.eia.gov/forecasts/aeo/data.cfm>

Several material breakthroughs would provide significant performance benefits in multiple energy end uses; the following are the most significant. Figure 14 shows the annual primary energy consumption that could be affected by improvements in these crosscutting technologies.

**Insulation:** Insulation is ubiquitous in both building envelopes and equipment/appliances. Technical headroom includes increasing thermal insulation per unit thickness through advanced foams, nanotechnology, or vacuum-insulating panels.

**Heat Exchangers:** Heat exchangers are used in refrigeration, heating, air conditioning, and nearly every application that generates waste heat (e.g., computing), consuming 21 Quads (53%) of building energy consumption. Advancing heat exchanger materials to be cheaper, lighter, stronger, and more conductive could double the heat transfer coefficient to provide 0.7 to 1.1 Quads of annual energy savings.<sup>41</sup> Additional advances include improvements to heat exchanger and fan design (e.g., whale fins) to increase efficacy with existing materials.

**Motors:** Motors account for an estimated 20%–40% of building-related electric use (8.5 Quads of primary energy) and 40%–50% of U.S. electricity use (approximately 18 Quads of primary energy).<sup>42</sup> They are used in fans, pumps, compressors, and other assemblies in a vast number of appliances. The energy-savings potential depends on application; in aggregate, improved motors could reduce total U.S. electricity consumption by 12% or more through three approaches:<sup>43</sup>

- **Variable Speed Motors:** These could save 30%–50% more energy than their single-speed counterparts in various applications, including compressors, pumps, blowers, dishwashers, refrigerators, and air-conditioning systems.
- **Permanent Magnet Motors:** Replacing induction motors with permanent magnet and variable reluctance motors could provide additional savings, especially for small motors. These designs



are about 15% better than today's average induction motor and 5% better than the practical limit for induction motors.

- **Material Improvements:** Using today's premium materials, motors can be more than 96.2% efficient;<sup>44</sup> superconducting materials, amorphous steel, or other material advances could achieve efficiencies of 98.0%–99.5%, but could require considerable research to be cost effective.

**DC and Off-Grid Equipment:** Items using DC-based technology, such as modern-day electronics, efficient fluorescent and LED lighting, and motors, are a large and growing part of the electrical load. They currently total 11 Quads (28% of building-related energy consumption).<sup>45</sup> Crosscutting breakthroughs that could improve efficiency include:<sup>46</sup>

- **Eliminating DC-AC-DC Conversion:** With the expected deployment of onsite photovoltaics and plug-in electric vehicles, the advantages of using DC power directly increase the benefits of a building-wide DC bus system. Standards are under development to facilitate this transition. Solar-assisted cooling equipment offers one attractive application as power generation and cooling load are synchronized and direct-DC operation can improve efficiency.
- **Expanding the Use of Low-Power Circuits:** The energy-saving integrated circuits and circuit designs used in portable electronics could be expanded to consumer electronics not traditionally focused on energy efficiency because they are not limited by battery life.
- **Improving Power Conversion Efficiency:** There are multiple approaches to improve power conversion efficiency, each offering up to 3% improvement for a total of more than 5% improvement at nearly zero cost.<sup>47</sup>
- **Designing Advanced Semiconductor Materials:** To reduce energy consumption and waste heat generation.

**Working Fluids:** Today's air conditioners, refrigerators, and heat pumps use compression cycle technology with high Global Warming Potential (GWP) working fluids. Advanced refrigeration technologies could both provide energy savings and eliminate these working fluids. U.S. emissions of high GWP gasses represent more than 135 million metric tons CO<sub>2</sub> equivalent,<sup>48</sup> equal to 2.4% of U.S. energy-related CO<sub>2</sub> emissions. Refrigerant manufacturers are therefore developing new low GWP refrigerants, such as hydrofluoroolefins (HFOs), to meet new international regulations. For example, a Life Cycle Climate Performance analysis on the refrigerant HFO-1234yf<sup>49</sup> shows it could remove 5.2 to 5.9 million metric tons CO<sub>2</sub> equivalent on a global basis by the year 2017 if used in all new vehicle air-conditioning.<sup>50</sup> This impact can be increased if HFO-R1234yf or refrigerant blends with HFO components, or if other low GWP refrigerants are used in residential and commercial air conditioning and refrigeration. The transition to low GWP refrigerants requires addressing chemical stability, flammability, and toxicity. It is worth noting that the compression cycle modification necessary to accommodate non-HFC working fluids can simultaneously improve cycle efficiency.

**Energy Cascading and Storage:** Energy cascading is the process of using the waste heat from one process as the energy source for another. It can be integrated with distributed energy generation to minimize wasted energy.

### **5.1.2.3 Breakthrough Technologies**

Innovative technologies can transform the way energy is used for services. These opportunities tend to be higher risk, face additional barriers to development and deployment, and have a longer time horizon until impact; however, they can represent a “step-change” in energy consumption, economic feasibility, and/or American competitiveness. The timing and impact of these benefits are naturally difficult to predict. Innovative technologies under consideration or being researched include:

- **Improved Dehumidification, Latent, and Sensible Cooling** approaches and materials, including moisture transport membranes (ideally dynamically controlled) and liquid desiccants. Significant savings, on the order of 50%–90%, are possible for technologies optimized for specific climates and applications.<sup>51</sup>
  - **Non-Vapor Compression (VC) Cycle Refrigeration** technologies can improve efficiencies for refrigeration and HVAC application. These can be characterized by their theoretical Carnot efficiency, current state of development, developmental barriers, and current level of activity.<sup>52</sup> Thermoacoustic and magnetic cooling are most likely to compete with vapor compression,<sup>53</sup> and they could provide up to 30% improvement if they achieve their thermodynamic limits. Other candidates include solid-state technology (magnetocalorics, thermoelectrics, thermoelastic, thermoionic, and thermotunneling), gas-based cycles (e.g., Stirling cycle), and alternative cycles (absorption, adsorption, and Vuilleumier cycles).<sup>54</sup> Though some are commercially available today, research is needed to develop materials and improve engineering to make these systems compact.
- **Multi-Photon Phosphors** could provide an alternative to SSL and offer slightly higher efficacy if successful.
- **Broadly Applicable Nanotechnology** advances could provide significant, but difficult-to-quantify benefits through advanced material properties such as high-*k* dielectrics or high energy density storage.

### 5.1.3 Buildings as Systems

Building system integration includes designing buildings to incorporate component operations, deploying integrated control systems, and operating and maintaining the building using those systems.<sup>55</sup> It requires an iterative approach to reducing internal loads, controlling heat gain and loss through the envelope, refining building design, sizing and selecting HVAC equipment, and designing and integrating operating systems. All of these elements together comprise systems integration: they incorporate architectural design, engineering, and building use to meet building needs efficiently without compromising occupant safety or health.

Residential and commercial buildings can be designed and operated to improve comfort and safety while reducing their lifecycle cost and environmental impact through enhanced efficiency. An integrated approach to building design and operation can provide energy savings that exceed 50% in new buildings and 30% in retrofit applications.<sup>56</sup> Some whole-building techniques even show 80% savings over current designs.<sup>57</sup>

Capturing those savings requires developing strategies to set goals, designing buildings (ideally from the outset) to meet those goals, and managing construction and operation to accomplish those goals. Strategies include:

- **Reduce Internal Loads through Systems Integration:**<sup>58</sup> Efficiency of individual appliances and pieces of equipment are covered in the companion technology assessment. However, the expected appliance and equipment thermal load fundamentally affects building design.
- **Improve the Building Envelope:** The envelope, especially thermal insulation, is typically thought to provide only protection from the environment. Considering the envelope as an integrated component that manages solar heating gains, lighting, and ventilation can create energy efficiency and occupant health and comfort benefits.
- **Deploy Sensors, Controls, and Software:** These modern components should be properly integrated into a building's operation to automate systems, improve use of building information and occupant behavior, improve operations through retro- and continuous- commissioning, and leverage connection to the smart grid.
- **Whole-Building Energy Modeling** is a critical enabling component of whole-building integration to minimize energy use and provide accurate and transparent predictions of energy performance. Further, with well-collected national data, it allows identification of technology gaps to better prioritize research, development, and deployment activities.

#### 5.1.3.1 Systems Integration

A systems integration approach faces diverse barriers that arise from the existing building design and construction process. The current design and construction process decomposes the creation of a building into a large number of small steps, each with experts who advise on their particular component. Most buildings are assembled component-wise with fragmented decision making and responsibility. Therefore, many of the inefficiencies in modern buildings are system integration failures.

The integrated design process recognizes that reliable, high-performance designs require all relevant stakeholders and experts to discuss and resolve problems collectively. This has to begin early in the process, with appropriate decision-support tools available to evaluate the impacts of any proposed changes. Integrated design leverages advances in Building Information Modeling with new energy modeling for fast, responsive decision making. It extends the value of this process to include construction, commissioning, and handoff of the building, and then continues with operations and facility management. Because the benefits of system integration are not as easily quantifiable as those of individual appliance engineering, communicating its value is difficult.

**Design Guides:** The Advanced Energy Design Guides, inspired by successful designs of actual buildings, use energy models to “pre-calculate” solutions applicable to commercial buildings. They have had broad market appeal with high recognition among practitioners and benefits estimate for hundreds of buildings.<sup>59</sup>

**Building Performance Labeling:** Benchmarking and disclosing the energy performance of buildings can improve understanding of the costs and benefits of efficiency and raise awareness of and demand for high-performance buildings to “prime the market.” The Environmental Protection Agency has shown that labeling can be successful with appliances through its ENERGY STAR<sup>60</sup> program. Benchmarking and labeling programs like ENERGY STAR® and Leadership in Energy and Environmental Design are voluntary, but they have high awareness and brand recognition among consumers. Many cities and states have mandated energy benchmarking and disclosure for all commercial buildings.<sup>61</sup>

### **5.1.3.2 Building Envelopes**

Building envelopes impact every element of building habitation. Energy lost through building envelopes accounts for 13% of U.S. primary energy, costing consumers more than \$230 billion (\$700 per person per year).<sup>62</sup>

Envelope and windows industries have historically had very slow product development and implementation cycles. Despite its higher lifecycle cost, single pane glass is still sold in Southern markets while double pane low e-glass has taken more than two decades to reach the existing buildings market. Stud walls (i.e., 2×4) with cavity insulation are still the norm, and conventional asphalt shingles on roof trusses continue to dominate the construction market; these technologies have gone almost unchanged since World War II.

There are solutions that can save 20%–50% of that energy in existing buildings and, when coupled with other technologies, even more in new buildings or at times of equipment replacement and home improvement. Considering the envelope as an integrated component that manages solar heating gains, lighting, and ventilation, can provide additional benefits such as energy storage, superior task lighting, and improve indoor environmental quality. For example, the effective use of daylighting can reduce lighting energy consumption by 20%–60%, and the envelope can be designed so the building collects and stores energy.<sup>63</sup>

Improving building envelopes is complicated by the variety of climates in the United States and the differences in approach for new and existing buildings. Technical opportunities and efforts underway include:

- **Advanced Roofing Designs:** R&D proceeds on a number of next-generation attic and roofing technologies,<sup>64</sup> including durable white roofs, “cool color” low-emissivity roofing, above sheathing ventilation, radiant barriers, phase change materials,<sup>65</sup> and increased deployment of conventional insulations to raise roof insulation levels to climate-appropriate levels as high as R-60<sup>66</sup> or more.
- **Highly Insulating and Dynamic Windows:** Highly insulating windows require low thermal conductivity (i.e., R-values of 5–10), low infiltration, and climate-appropriate infrared emissivity. Cost-effective R-5 highly insulating windows were commercialized in 2010. Dynamic control of optical properties can manage summer solar gain and optimize winter gain to make windows a net provider of energy.
- **Wall and Basement Building Retrofits:** Cost reduction of building retrofits can be achieved through improved installation techniques and business models of conventional insulation (e.g., “drill-and-fill,” exterior foam sheathing). Demonstration efforts focus on exterior insulation fitting systems that can yield R-values of 40–60.
- **Highly Insulating Wall and Basement Approaches for New Buildings:** New building codes will likely draw on technologies previously mentioned, as well as advanced approaches to framing and manufactured homes.
- **Daylighting Research:** Properly designed buildings can bring in high-quality light to reduce electricity consumption through integration with daylighting controls. Continued efforts focus on daylighting components for active light control; daylight solutions for deep perimeter zones in commercial buildings; double-skinned, ventilated façades; dynamic shading, and 3-D window products.

Envelopes can also solve or introduce occupancy issues; research areas include:

- **Moisture:** As the building enclosure becomes more efficient, moisture control issues must also be addressed to ensure that moisture does not collect in building components and cause durability or health problems.
- **Indoor Environmental Quality:** In addition to reducing energy, efficient building designs can also improve occupant comfort and health. Detecting and eliminating building pollutants, including radon, combustion by-products, and chemicals (e.g., volatile organic compounds), remains an important area of research.<sup>67</sup>

### ***5.1.3.3 Building Sensors, Controls, and Diagnostics***

Building sensors, controls, and diagnostics can maximize the value of other building components and systems. High-performance buildings require reliable and standardized communications, information technology infrastructure, and protocols at both the component and whole-building level. Controls can be integrated through computerized building management systems that optimize energy use and

interface with energy systems through a modernized grid. Buildings that use these systems can have lower maintenance and energy costs, better thermal comfort, and improved indoor air quality.<sup>68</sup>

The limited penetration of whole-building instrumentation<sup>69</sup> can be explained, in part, by the historically high cost of wiring and configuration, calibration and stability concerns, and the uniqueness of each building. With recently developed wireless technologies, improved sensors, and powerful and flexible software and computer systems, many of these barriers can be overcome. Wireless sensor networking<sup>70</sup> may provide low-cost, low-power, and reliable networks that can lower total ownership cost and improve building performance. Four potential benefits of sensors, controls, and software can now be realized:

- **System Automation:** Device-level or whole-building sensors and controls can provide energy savings, increased convenience and operational simplicity, and decreased maintenance costs. Successful examples include inactivity-based timers, occupancy sensing, daylighting controls, and whole-home automation. For example, electric “plug load” use only decreases by 30%–40%<sup>71</sup> when buildings are unoccupied; full instrumentation could improve this reduction to more than 90%.<sup>72</sup>
- **Improved Data Use:** Reliable, timely, and easy-to-understand information facilitates informed decisions about energy conservation. Even systems that currently collect large datasets fail to translate this data into actionable information. Energy information systems can better inform facilities operators and help them achieve expected performance.<sup>73</sup> They allow for rigorous energy analyses that include normalization, standards-based calculations, anomaly detection, and forecasting. Some are exploring simplified approaches to expand such tools to homes.<sup>74</sup> Advanced billing information can also be a tool here. Providing more detailed and frequent usage information to homeowners through accepted channels, such as energy bills, can also reduce energy consumption, with at-scale deployment reductions of 1.5%–3.5%<sup>75</sup> in household electricity use.
- **Commissioning and “Re-Tuning:”** Poor operation of commercial buildings wastes energy; buildings need regular tune-ups and quality checks to sustain peak energy performance and ensure that they are being operated according to design intent after construction. This sensor-enabled process of commissioning or “re-tuning” can provide significant energy savings and extend equipment life at a very low cost. A study of commissioning projects in more than 600 buildings nationwide showed median whole-building energy savings of 16% and 13% in existing buildings and new construction, respectively, with median payback times of 1.1 and 4.2 years, respectively.<sup>76</sup> Similarly, re-tuning large commercial buildings enabled by energy management and control systems can reduce HVAC energy use by 5%–20%.<sup>77</sup>
- **Smart Grid:** Dynamic information exchange between the electrical system and the building can improve the overall efficiency and reduce the cost of the power system. These benefits are realized by moving building loads from “on-demand” usage to intelligent usage, a shift made possible by building energy storage (thermal or electric) and flexible, interactive appliances (e.g., demand-managed air-conditioning, time-delayed dishwashing cycles). Significant infrastructure

investment in both the grid and buildings is needed to capture such benefits. A necessary prelude to this type of investment is standardization.<sup>78</sup>

#### **5.1.3.4 Data-Enabled Building Modeling**

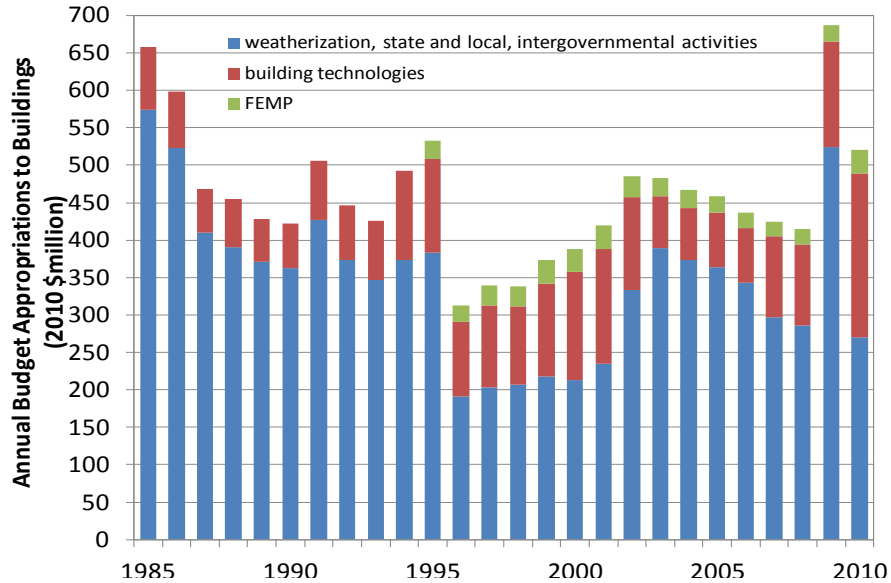
Whole-building modeling, involving “engines” and “applications,” can improve the accuracy of building system performance predictions. “Engines” deal with the numerical analysis of building physics and mechanical systems, while applications model usage scenarios, such as building design, building operation, or building portfolio analysis for code development. “Applications” are the user interface and other software that use the core physics the engines provide.

Historically, the focus has been on engine development (first DOE2 and then EnergyPlus) with smaller investments in testing and validation; only recently has there been a focus on user interfaces. A building energy modeling software would be enabled by the development of standards and interoperability for both model input and model output data; collecting and publishing repositories of component, system, and building models; and automated model acquisition and calibration research.

The view of buildings as systems continues to be challenged by a dearth of data. The Residential Energy Consumption Survey, the Commercial Buildings Energy Consumption Survey, and other databases, such as the California Commercial End-Use Survey, are critical data resources; although, they lack metered end-use energy data and system and operational characteristics. The ENERGY STAR portfolio manager tool provides generalized information for some building types. Other tools may be developed for niche applications (e.g., specialty building types or tools for a specific region or market segment). Sharing data on measured energy performance would enable innovation in building performance, as well as in tool development.

#### **5.1.4 DOE History and Accomplishments**

Building and appliance-related work in DOE ranges from emerging technologies through technology validation and market development to standards and analysis. Deployment activities in the form of weatherization are the largest part of building-related spending, averaging \$275 million annually from 2001 to 2010.<sup>79</sup> Over the past decade, building technology funding has more than tripled, increasing from \$59 million to \$219 million (Figure 15).



**Figure 15. Historical Funding of DOE Building and Appliance Programs.** Sources: (1985–2002) Current Congressional Appropriations from DOE CFO, Office of Budget; (2003–2008) DOE EERE Budget Office ([http://www1.eere.energy.gov/ba/pba/budget\\_archives.html](http://www1.eere.energy.gov/ba/pba/budget_archives.html)); (2009–2010) 2011 FY11 Congressional Budget for DOE EERE ([http://www1.eere.energy.gov/ba/pba/pdfs/fy11\\_budget.pdf](http://www1.eere.energy.gov/ba/pba/pdfs/fy11_budget.pdf)). Converted to 2010 \$million using consumer price index from the Department of Labor, Bureau of Labor Statistics (<ftp://ftp.bls.gov/pub/special.requests/cpi/cpi.txt>).

Together, equipment standards, the \$30 million Golden Carrot Award from the Super Efficiency Refrigerator Program, and the ENERGY STAR program reduced the energy consumption of residential refrigerators by 70% between 1974 and 2006, even as the average retail price decreased by 40% between 1980 and 2006 and capacity increased by 15%.<sup>80</sup>

Recent accomplishments include:

- Legislation and standard rulemakings completed between 1987 and 2010 reduced primary energy use by 3 Quads (about 3%) in 2010, a cumulative energy consumption reduction over that period of 26 Quads.<sup>81</sup> These rulemakings are projected to save another 126 Quads between 2010 and 2070, with annual energy savings peaking at nearly 5 Quads between 2020 and 2025.
- Codes adopted and implemented between 1990 and 2008 provide more than \$3 billion per year in annual cost savings through more than 0.25 Quads of annual energy savings.<sup>82</sup> In 2011, DOE-sponsored proposals passed into model energy codes to achieve 30% energy savings in residential and commercial buildings compared to a 2006 baseline.<sup>83</sup>
- Completing 13 standards since January 2009. These are estimated to save consumers hundreds of billions of dollars over the next two decades.
- Demonstrating advanced SSL technologies: a small-form factor LED light source of 350 lm at 80 lm/W; deep green LEDs achieving peak internal quantum efficiency of 50%; and commercial, high-power white LEDs delivering 121 lm/W (a typical 100 W incandescent bulb is 17 lm/W).
- Supporting research that inspired a commercialized hybrid water heater that is 50% more energy efficient than the traditional 50 gallon electric resistance water heater.



### 5.1.5 DOE Role

The Department's role in building energy efficiency lies primarily in its informational and R&D capability activities. Since the primary barriers to increasing building efficiency are largely non-technical, the availability of high-quality information to a wide range of decision makers affects deployment of building technologies. In addition, the diversity of both technologies and stakeholders involved in building efficiency makes it difficult to gather the information critical to technology development and deployment. There is a great lack of data about how and how much energy is used in buildings. The Department's Energy Information Administration conducts the Residential Energy Consumption Survey and the Commercial Buildings Energy Consumption Survey, which are critical to providing information to decision makers.

DOE collaborates with industry groups to develop model energy codes and design guides that provide valuable direction in the design and construction of new buildings. Further, DOE is currently rolling out a home energy score tool, which also informs development of a national standard for commercial building rating and labeling. The commercial labeling scheme takes into account the building envelope, mechanical and electrical systems, and major energy-using equipment.

DOE also maintains base research capabilities in building efficiency. The Department's modeling and simulation, materials science, and fundamental engineering science capabilities help advance building efficiency technologies. Furthermore, the Department's Greater Philadelphia Innovation Cluster Energy Innovations Hub<sup>84</sup> not only performs R&D, but also demonstrates and assesses efficiency technologies. The Department's regulatory authority to set efficiency standards for appliances serves an informational role. Building on its R&D capability and through stakeholder engagement, DOE sets baseline efficiency for many household and commercial appliances.

## 5.2 Industrial Efficiency

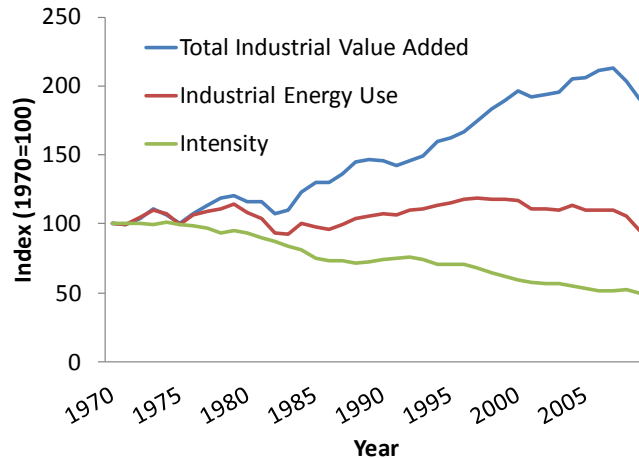
### 5.2.1 Industrial Materials and Processes

The U.S. industrial base is diverse, with about two-thirds of end-use energy<sup>85</sup> being consumed by energy-intensive industries, including chemicals, forestry products, petroleum refining, iron and steel, glass, aluminum, metal-casting foundries, and cement.<sup>86</sup> It also includes a wide array of manufacturing operations that convert raw materials into finished products—from the foods we eat to the infrastructure that surrounds us. In 2009, manufacturing accounted for 11% of GDP and directly employed 12 million people,<sup>87</sup> supplied 57% of U.S. exports,<sup>88</sup> and produced nearly 20% of the world's manufacturing value added.<sup>89</sup>

The industrial sector uses about one-third of U.S. primary energy. It is the most diverse sector, both in the types of energy services required and in the mix of energy sources that provide those services. Industrial energy use results in significant CO<sub>2</sub> emissions from combustion of fuels, and industrial processes generate a range of other greenhouse gases, such as nitrous oxide, methane, halons, and others with high GWP. In 2006, U.S. industry accounted for approximately 28% of total energy-related CO<sub>2</sub> emissions.<sup>90</sup> Industrial greenhouse gas emissions can be reduced significantly through changes in energy use, development of new materials, and improvement of process efficiencies.

Over the past two decades, as U.S. manufacturing has faced growing global competition and market pressures, production technology has advanced at different rates across different industrial subsectors. This is due to differences in the rate of product innovation, whether technology improvements require new manufacturing processes, and product commoditization, among others. For example, technological advance is relatively rapid in automotive, semiconductors, and electronics industries, and relatively slow in the steel and cement industries. In general, energy-intensive heavy industries are mature and slower to adopt technological innovation due in part to large sunk capital; for example, equipment changeovers can take from 20–50 years in these industries and require significant capital investment.<sup>91</sup>

Today's manufacturing sectors must continually improve productivity and efficiency to remain competitive. The new, efficient manufacturing plants built in developing economies compared to the older domestic manufacturing base adversely affect U.S. competitiveness. Between 1980 and 2009, U.S. industrial energy intensity (Quads/\$GDP) fell nearly 50% as the structure of industry changed, new technologies were deployed, and firms improved the efficiency of their operations (Figure 16).



**Figure 16. U.S. Industrial Output, Energy Consumption, and Intensity from 1980 to 2009** Sources: Energy Information Administration. (2010). *Annual Energy Review*. Washington, DC: U.S. Department of Energy. Accessed at [http://www.eia.gov/totalenergy/data/annual/pdf/sec2\\_9.pdf](http://www.eia.gov/totalenergy/data/annual/pdf/sec2_9.pdf);

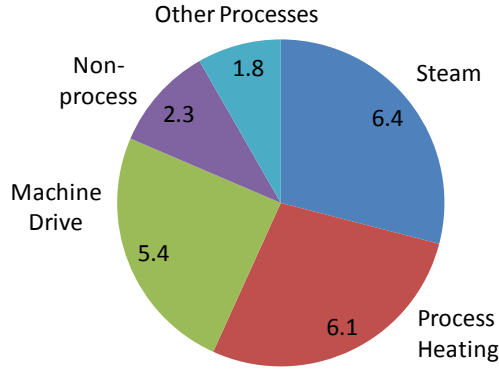
Bureau of Economic Analysis. *GDP by Industry*. Washington, DC: U.S. Department of Commerce. Accessed at [http://www.bea.gov/industry/gdpbyind\\_data.htm](http://www.bea.gov/industry/gdpbyind_data.htm).

The steel industry provides an example of reductions in energy intensity that resulted, in part, from new technology. For example, advances in electric arc furnace technology and the development of thin-slab casting helped the steel industry greatly expand the use of scrap steel. Adoption of electric arc furnace and other technology improvements were largely responsible for a decrease in steel industry energy intensity from about 58 million British thermal units (MBtu)/ton in 1950 to 50 MBtu/ton in 1975 to about 12 MBtu/ ton in recent years.<sup>92</sup>

### 5.2.1.1 Technology Status

The industrial sector is highly diverse, using thousands of processes to produce tens of thousands of products. However, energy use can be characterized by several key systems, with thermal processes dominating, as shown in Figure 17. Motor systems constitute the largest industrial use of energy for non-thermal processes.

Steam is produced in boilers for applications that range from process use to cogeneration (combined heat and power, or CHP). Electricity is used to drive machines, such as pumps, fans, compressors, and materials-handling equipment. Energy is also used for space heating and lighting. Where economically feasible, recovery systems capture waste heat for beneficial uses, such as material preheating or steam generation.



**Figure 17. Industrial Primary Energy Use (Quads)** Industrial primary energy use is dominated by thermal processes. Note: Approximately half of the energy required to generate steam use is additionally attributable to process heating energy demand. Source: Manufacturing Energy and Carbon Footprint Analysis on select energy-intensive industries, based on MECS data. Energy Information Administration. (2009). *2006 Manufacturing Energy Consumption Survey*. Washington, DC: Department of Energy. Accessed at <http://www.eia.gov/emeu/mecs/mecs2006/2006tables.html>; Industrial Technologies Program. (2011). Washington, DC: Department of Energy. Accessed at <http://www1.eere.energy.gov/industry/rd/footprints.html>

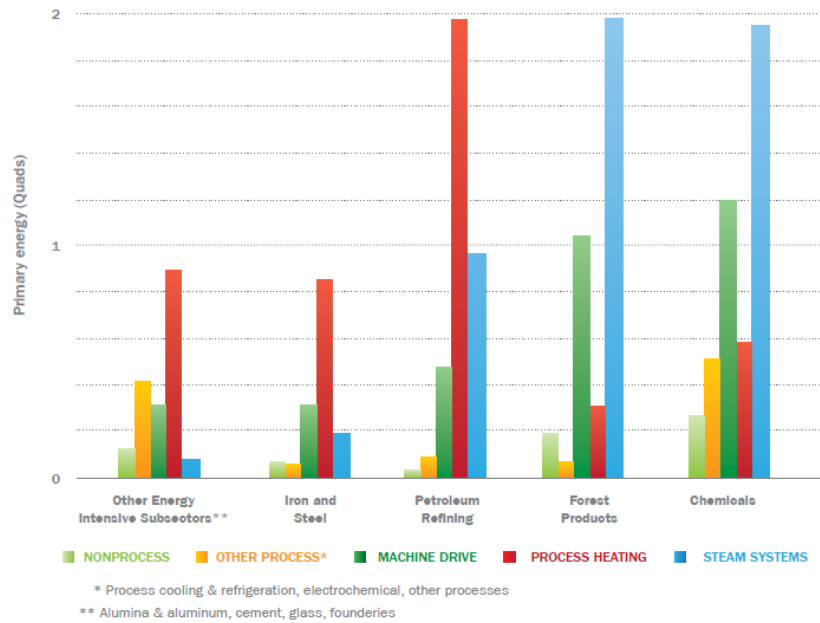
Figure 18 shows the crosscutting nature of important energy delivery systems for energy-intensive manufacturing sectors. These systems include:

- **Steam Systems (6.4 Quads)** provide energy for process heating (3.2 Quads), machine drives (0.4 Quad), and buildings HVAC (0.2 Quad), with conversion and distribution losses comprising the balance (2.6 Quads). That energy includes steam production and generation losses on manufacturing sites from conventional boilers (2.1 Quads<sup>8</sup>) and CHP systems (3.1 Quads<sup>8</sup>), as well as offsite steam production and losses (1.2 Quads<sup>8</sup>). Common end-use equipment that uses steam includes heat exchangers, turbines, fractionating towers, strippers, and chemical reaction vessels. Industrial boiler efficiency can be improved by innovations, such as high-intensity heat transfer; high-efficiency, low-emission burners; intelligent control systems; efficient preheating; flame radiation; and other enhancements.
- **Process Heating (6.1 Quad)** requires approximately 5 Quads of mostly fossil fuels and 1.1 Quads of electricity (comprising 0.75 Quad of generation and distribution losses and 0.38 Quad of useful energy). When including the 3.2 Quads of steam used for processes heat, more than 9.3 Quads of energy is used for process heating.<sup>93</sup> Common process heating systems include furnaces, ovens, heat exchangers, digesters, evaporators, kilns, dryers, and melters. This equipment is used for separation and reactor preheating, evaporation, curing, drying, agglomeration, sintering, forming, smelting, and other specialized heating processes. Energy losses occur from system or box losses, which may include radiation and convection losses; insulation losses; wall, door, or opening losses; or cooling losses. Losses also occur through flue or exhaust gases.
- **Machine Drive Systems (5.42 Quads)** used throughout manufacturing account for more than 5.17 Quads of primary energy producing electricity (3.42 of losses and 1.75 of useful energy);<sup>8</sup> 0.25 Quad of mostly fossil fuel; and 0.64 Quad of steam use (0.26 of losses and 0.38 of useful energy).<sup>8</sup> In many cases, efficiency can be improved by upgrading the motor (e.g., variable speed

drives, high-efficiency motor). The efficiency of common motor systems, such as pumps, fans, compressed air, and material-handling systems, can also be increased by system optimization.

- **Other Uses (4.4 Quads)** include non-process energy and other process energy. Non-process energy (2.26 Quads) includes buildings HVAC and lighting, other facility support, and onsite transportation; additionally, 0.32 Quad of steam energy (0.13 of losses and 0.19 of useful energy) support building HVAC. Other process energy (1.82 Quads) includes electro-chemical processes, process cooling, and refrigeration. There are diverse opportunities to decrease energy consumption, including next-generation processes and heat pump systems.

Any industry that has both electrical and thermal requirements could potentially benefit from CHP. The higher efficiency inherent to CHP combined with the benefits of onsite power generation, which eliminates transmission and distribution losses, reduces primary energy use and lowers greenhouse gas emissions. Overall efficiencies of 70% or higher are achievable by generating electricity and producing useful thermal energy from a single fuel source (natural gas, coal, oil, and alternative fuels). This thermal energy can be used for direct process applications, or it can be used indirectly to produce steam, hot water, hot air for drying, refrigeration, or chilled water for process cooling. CHP generally consists of a prime mover, a generator, a heat recovery system, and electrical interconnection equipment configured into an integrated system.



**Figure 18. Energy Use by Industrial System by Industry Subsector** \* Process cooling & refrigeration, electrochemical, other processes. \*\*Alumina & aluminum, cement, glass, foundries. Source: Manufacturing Energy and Carbon Footprint Analysis on select energy-intensive industries, based on MECS data. Energy Information Administration. (2009). *2006 Manufacturing Energy Consumption Survey*. Washington, DC: Department of Energy. Accessed at <http://www.eia.gov/emeu/mecs/mecs2006/2006tables.html>;

Industrial Technologies Program. (2011). Washington, DC: Department of Energy. Accessed at <http://www1.eere.energy.gov/industry/rd/footprints.html>

CHP systems are typically identified by their technology types (“prime movers”), which include reciprocating engines, combustion or gas turbines, steam turbines, microturbines, and fuel cells. Waste heat CHP systems recover energy from hot exhaust for conversion into electricity through a Rankine power cycle. Steam is most often used in Rankine cycles and in industrial applications to generate power from operations with hot exhaust gases, such as coke oven batteries and cement kilns. Lower temperatures often found in heat recovery applications allow other working fluids, such as hydrocarbons, to be used as well. Low-quality recovered heat can be used for a variety of applications, from absorption cooling to food processing.

CHP is already an important resource for the United States—there is 85 gigawatts of CHP capacity at more than 3,600 industrial and commercial facilities, which represents approximately 8% of current U.S. generating capacity and more than 12% of annual power generation.<sup>94</sup> CHP can be utilized in a variety of applications that have significant, and coincident, power and thermal loads. Eighty-eight percent of existing CHP capacity is found co-located with or in industrial applications, providing power and steam to energy-intensive industries, such as chemicals, paper, refining, food processing, and metals manufacturing. Countries such as Denmark and the Netherlands have a much higher percentage of their total power supplied by CHP (50% and 30%, respectively) than the United States. A 2008 Oak Ridge National Laboratory study indicated that the potential exists in the United States to more than double existing CHP capacity, increasing CHP’s contribution to 20% of total generation by 2030, which would save an estimated 5.3 Quads of fuel annually.<sup>95</sup>

Although CHP is a mature technology, market deployment is impeded by technical and investment challenges.<sup>96</sup> Improper installation or lack of coordination between developers and utilities in CHP planning and installation can result in grid operation technical complications. Improvements in the energy and environmental performance of CHP and thermal energy recovery technologies are needed to lower capital costs. Increasing fuel flexibility of combustion systems with no degradation of emissions profile, performance, reliability, availability, maintainability, and durability will reduce operating costs and the impacts of fuel price volatility.

Using alternative fuels requires modifications to a CHP system’s prime mover for acceptable levels of performance, emissions, durability, and ease of maintenance. It also requires investment in fuel gathering, handling, treatment, and storage equipment, which often adds a parasitic load to the system. All of these elements affect the lifecycle cost/benefit analysis. Finally, capital cost reductions in CHP systems can be made with better integration of major subsystems into packages. This is particularly valuable in the mid- to small-size CHP market. System designs that incorporate intelligent controls, sensors, and facility energy management systems with generation and heat recovery technology would offer value.

#### ***5.2.1.2 Market Potential***

Transformational developments in next-generation manufacturing concepts can enable revolutionary advances in energy efficiency and carbon abatement. This includes innovating the next generation of processes and materials with lower embodied energy and lifecycle costs for all manufactured products.

Innovative enabling technologies for energy-efficient and low CO<sub>2</sub>-equivalent emission products and processes can take advantage of developments in sensors and controls, catalysis, nanotechnology, micro-manufacturing, and reducing the GWP of industrial gases. As shown in Table , there can be substantial improvement over the next decade at negative cost.

**Table 15 Opportunity for Energy Efficiency Savings between 2010 and 2020 for Investments that Are Net Present Value Positive.**

Sector	Primary Energy Savings	Payback Time	Investment Required (2009 \$)	Savings Achieved (2009 \$)	Scope of Potential Opportunity
Manufacturing and Other Industrial	5 Quad/year	2.4 years	\$113 billion	\$442 billion	330,000 establishments

Source: McKinsey. (2009). *Unlocking Energy Efficiency in the U.S. Economy*.<sup>97</sup>

Several studies have evaluated the potential for both cost-effective energy efficiency improvements and opportunities to advance current state-of-the-art technology toward practical energy minimums. For example, one study estimated that the industrial sector can reduce energy use by 18% by 2020 with existing technologies and net present value-positive investments (i.e., energy cost savings resulting from technologies financed with loans would yield positive cash flow).<sup>98</sup> On a primary energy basis, this study estimated 2.1 Quads in cost-effective available savings in 2020 from energy support systems, including steam, motors, and buildings, and an additional 0.9 Quads available through increased industrial CHP adoption; available savings from specific industrial processes were estimated to be an additional 2.9 Quads. The National Academies has also surveyed a range of studies, which estimated the savings potential from deployment of existing and emerging technologies to be 4.9 to 7.7 Quads by 2020, inclusive of the potential for CHP.<sup>99</sup>

The Energy Information Administration currently projects a 54% increase in industrial shipments between 2009 and 2035 in the AEO2011 reference case, but only projects a 25% increase in industrial primary energy consumption during this time.<sup>100</sup> Energy consumption growth is moderated by a shift in the mix of output and improvements in energy efficiency. Overall energy intensity in the industrial sector declines by 19% in the reference case. Also of note from the Energy Information Administration is a side case where industrial technology is “frozen” at current levels—in this case, industrial consumption (outside of refining) is projected to be 2.66 Quads higher than the reference case in 2035, highlighting the impact of expected future technology development.<sup>101</sup>

### 5.2.1.3 Technology Potential

Because the opportunity for industrial energy efficiency is diverse, it is difficult to assess comprehensively. The efficiency potential for ubiquitous adoption of existing state-of-the-art technologies and best practices, as well as the potential for advanced technologies that have yet to be fully developed, is shown in Table . The energy consumption with known, yet unrealized technology opportunities are considered the practical minimum, while physical laws dictate the theoretical minimum.

**Table 16. Average, State-of-the-Art, and Potential Improvements for Major Industrial Subsectors**

Industrial Subsector	Average 2008 <sup>a</sup>		Energy Use		
	Total Energy	Energy Intensity	State of the Art (SOTA)	Practical Minimum <sup>b</sup>	Theoretical Minimum <sup>b</sup>
	Quad	(mbtu/\$)	Quad (%)	Quad (%)	Quad (%)
Chemicals <sup>102</sup>	6.9	30	5.7 (18)	2.0 (71%)	0.82 (88%)
Pulp & Paper <sup>103</sup>	2.2	14	1.6 (26)	1.3 (39%)	1.2 (43%)
Petrol Refining <sup>104</sup>	3.9	18	2.8 (30)	2.4 (38%)	1.1 (71%)
Iron & Steel <sup>105</sup>	1.5	20	1.2 (22)	1.1 (39%)	0.71 (53%)
Aluminum <sup>106</sup>	0.4	13	0.34 (12)	0.11 (72%)	0.06 (84%)
Glass <sup>107</sup>	0.2	9	0.14 (34)	0.01 (52%)	0.01 (61%)
Cement	0.4	54	0.30 (30) <sup>c</sup>	N/A	N/A

<sup>a</sup>AEO<sup>108</sup>; <sup>b</sup>DOE Industrial Technologies Program Bandwidth Studies<sup>102,103,104,105,106,107</sup>; <sup>c</sup>IEA data<sup>109</sup>; N/A: not available.

Other analyses identify cost-effective potential energy savings of 4.9 to 7.7 Quads per year by 2020, a reduction of 14%–22% from the AEO2010 industrial baseline.<sup>110</sup>

Recent reports discussing industrial efficiency include:

Energy Materials Blue Ribbon Panel. (2010 and 2011). *Linking Transformational Materials and Processing for an Energy-Efficient and Low-Carbon Economy: Creating the Vision and Accelerating Realization*. Warrendale, PA: The Minerals, Metals, and Materials Society. 2010 Report accessed at <http://energy.tms.org/docs/pdfs/VisionReport2010.pdf>. 2011 report accessed at [http://energy.tms.org/docs/pdfs/Opportunity\\_Analysis\\_for\\_MSE.pdf](http://energy.tms.org/docs/pdfs/Opportunity_Analysis_for_MSE.pdf).

National Academy of Sciences. (2009). *Real Prospects for Energy Efficiency in the United States*. The National Academies Press. Washington, DC. Accessed at [http://www.nap.edu/catalog.php?record\\_id=12621](http://www.nap.edu/catalog.php?record_id=12621)

Science and Technology Policy Institute. (2010). “The White Papers on Advanced Manufacturing Questions.” Washington, DC. Accessed at <http://www.whitehouse.gov/sites/default/files/microsites/ostp/advanced-manuf-papers.pdf>

International Energy Agency. (2007). *Tracking Industrial Energy Efficiency and CO2 Emissions*. Paris, France. Accessed at [http://www.iea.org/textbase/nppdf/free/2007/tracking\\_emissions.pdf](http://www.iea.org/textbase/nppdf/free/2007/tracking_emissions.pdf)

#### 5.2.1.4 Next-Generation Manufacturing Processes

Highly efficient processing can be achieved by reducing and integrating process steps; developing alternative, low-energy pathways; and developing entirely new processes and unit operations.

Technology areas that are expected to have large energy benefits across a variety of industries include:

- **Reactions and Separations:** New technologies with improved energy efficiency and process intensification applicable to a wide range of industries, such as oil refining, food processing, and chemical production. Examples include separation processes that rely on high-performance membranes and catalysts.
- **Waste Heat Minimization and Recovery:** Technology advances in ultra-efficient steam production, high-performance furnaces, and innovative waste heat recovery that contribute to sustainability, reduced water use, and a lower energy footprint.
- **Advanced Forming and Fabrication Technology:** Allows for the manufacture of components in near-final form, limiting post-processing of components, which lessens required materials and energy input.



- **Biomimetic Processing:** New production systems that mimic the low-emission, low-temperature fabrication of living systems. Replacement of traditional processing routes in areas such as chemical catalysis and polymer manufacturing could enable lower energy usage and carbon emissions.
- **Alternatives to High-Temperature Processing:** Improvements in producing/recovering materials that exploit lower-energy or non-thermal alternatives to conventional, high-temperature processing technologies. Examples include water-based selective extraction of critical materials from low-grade ores, processes relevant to obsolete electronic equipment and waste landfills, and low-temperature / high-efficiency chemical or electrochemical processes.
- **Sensors and Process Control:** Sensors and process controls would lead to highly automated processes with efficient, intelligent feedback control through continuous monitoring and diagnosis. Sensors are used for inferential controls, real-time and nondestructive sensing and monitoring, wireless technology, and distributed intelligence.
- **Motors and Drive Systems:** A next generation of motor and drive improvements is on the horizon, including motors with high-temperature superconducting materials. Superconductors can be used to increase the magnetic field in a motor, thereby dramatically reducing motor size, weight, and energy losses.

Electrolytic processing of titanium powder is one example of order-of-magnitude reduction in energy use that is achievable through low-temperature processing (as discussed in the *Report on the QTR*).<sup>111</sup> Selective heating of composite parts is a second example of the energy savings that have been demonstrated using next-generation processes. More efficient is electromagnetic heating that can be tailored to the susceptibility of materials. By putting energy only where it is needed, a manufacturer can selectively heat the composite part; alternatively, the thin face of the die can be selectively heated. In both cases, the entire autoclave does not need to be heated, which significantly reduces energy use. While energy savings is an important factor, this type of selective electromagnetic heating can enable other advantages over traditional thermal processes, including highly controllable heating rates, bulk volumetric heating, reduced processing time, improved yield, and smaller equipment footprint.<sup>112</sup>

#### 5.2.1.5 Next-Generation Materials

Next-generation materials could achieve order-of-magnitude improvements (e.g., extend service life tenfold) in products and components via unprecedented materials properties, reducing embedded energy. These materials and associated production technologies can reduce energy use, costs, and pollution, and also improve product quality. With the manufacture of new energy technologies growing, it may be important to develop substitutes for a range of critical materials (e.g., magnetic materials containing rare earth elements used in electric motors, phosphors used in SSL).

Some examples of next-generation materials categories that could reduce energy consumption across the economy include the following. For a more comprehensive list, see the vision report of the Energy Materials Blue Ribbon Panel.<sup>113</sup>

- **Lightweight Materials:** For example, inexpensive, high-performance carbon fibers.
- **High-Performance, Low-Cost Heat Transfer Materials:** For example, low-cost titanium.

- **Functional Coatings and Interfaces:** For example, coatings and thin films that provide functional surface interactions, enabling a new generation of smart products.
- **Thermal and Degradation Resistant Materials:** Materials with extended lifespan at higher temperatures can improve productivity, reduce or eliminate plant down time, and reduce energy intensity.
- **Critical Materials:** Critical materials are used directly in products (e.g., photovoltaics, LEDs, and alloying compounds), as well as in process steps (e.g., platinum catalysts or palladium and rhodium electrodes). Several approaches include finding new sources of such materials, discovering ways to reduce content of such critical elements in existing components, and identifying new compositions and approaches that do not rely on them. For example, technologies that decrease the cost of separating critical elements from recycle streams and ores, in some cases requiring next-generation process technologies.
- **Bio-Materials; Bio-Products:** Materials derived from renewable biomass resources can replace petrochemical precursors and feedstocks. Today, more than 90% of key organic chemicals are derived from petroleum feedstocks.<sup>114</sup> Product examples include packaging, polymers, engineered plastics, and resins that can be blended with traditional plastics to increase recyclability. Direct use of biomass can include wood fibers for textiles, and composites produced from nanocrystalline cellulose for aerospace applications.
- **Materials for Harsh Environments:** High-performance materials, such as ceramics, engineered polymers, and metallics, can operate in extreme environments.
- **Amorphous Materials:** Bulk amorphous (non-crystalline) metallic materials have achieved combinations of mechanical properties that improve performance (strength, wear, and corrosion) at a low cost compared to those of comparable conventional alloys. Amorphous magnetic materials can directly impact energy consumption, such as by reducing hysteresis and eddy current losses in motor cores.

#### *5.2.1.6 Policy Context and Market Barriers*

National and state policies can impact the deployment of efficient industrial technologies and projects. For example, motor efficiency standards first passed in the Energy Policy Act of 1992 helped transform the marketplace for high-efficiency motors, resulting in significant energy savings. As a result of these standards, motor manufacturers created the voluntary labeling program NEMA Premium, which is backed by the National Electrical Manufacturers Association. Motor standards have been recently strengthened by the Energy Independence and Security Act of 2007.

The Energy Independence and Security Act of 2007 also included incentives for recovering industrial waste energy, improving data center energy efficiency, and deploying CHP. Limited data is available to assess the effectiveness of these measures.

National and state policies, ranging from tax policy to environmental and permitting regulations, also impact technology deployment. Tax credits designed to encourage technology adoption can be limited by other tax policies, such as tax credit ceilings or depreciation rules. Environmental regulations, such as

the Clean Air Act, have improved industrial energy efficiency in order to reduce criteria pollutants from the combustion of fuels.

A recent McKinsey & Company report<sup>115</sup> outlined some of the key barriers to development and adoption of energy-efficient technologies in the industrial sector. Among these barriers are:

- Competition between energy efficiency improvements and many other corporate priorities for limited capital
- Low awareness of the benefits and applications for more efficient technologies, especially among top management
- Adverse view of higher-risk transformational technology projects
- Constraints on procurement/ distributor availability
- Transaction barriers that include space constraints and business disruption.

Similar barriers, in addition to tax codes/depreciation rules and regulatory requirements, have been noted in other studies.<sup>116</sup>

### 5.2.2 DOE History and Accomplishments

The Federal Non-Nuclear Energy Research and Development Act of 1974 established The Industrial Energy Conservation Program in 1975 to improve industrial energy efficiency through R&D on high-risk, innovative technologies. The program was further shaped by the Department of Energy Organization Act of 1977. Subsequent DOE activities addressed both the basic process industries (industry-specific technologies) and process peripherals (crosscutting technologies). The Energy Analysis and Diagnostic Center program was instituted at universities throughout the country to provide energy audits for small- and medium-sized manufacturers who lacked internal expertise in energy efficiency, as well as training for engineering students in energy efficiency practices.

As global competition increased in the 1980s, projects emphasized productivity, capital efficiency, and quality, in addition to energy efficiency. With growing environmental regulations, industrial waste reduction and pollution prevention also became part of the R&D portfolio, as did fuel flexibility. By 1994, investments were focused on the most energy-intensive industries, working with the private sector to identify the precompetitive technologies critical to future success.

More recently, DOE partnered with industry to reduce industrial energy use, carbon emissions, and waste, while also boosting productivity and economic competitiveness. It does so through R&D, as well as technical assistance activities that enable industrial subsectors to improve their energy efficiency.

The Department has supported more than 600 separate R&D projects that have produced more than 200 commercial technologies. In addition to direct energy savings, industry has also benefitted from improved productivity, reduced resource consumption, decreased emissions, and enhancements to product quality associated with these technological advances. In addition, many projects have expanded basic knowledge about complex industrial processes and have laid the foundation for developing future energy-efficient technologies.

Beyond R&D, DOE provides tools, training, assessments, and technical assistance to help industrial plants identify process improvement opportunities with near-term payback. Since their inception in 1976, the Industrial Assessment Centers have conducted more than 15,000 assessments, resulting in more than 100,000 recommendations with an average payback period of about one year and implementation rate of about 50%.<sup>117</sup>

An important DOE goal is to foster improved energy management across industry by establishing scalable mechanisms to identify, deploy, certify, and reward effective industrial energy management practices and individuals. DOE does this by helping to develop tools and protocols to enable industry to measure and manage energy usage and by promoting education and hands-on training for a new generation of energy management engineers (Industrial Assessment Centers and university-based consortia that focus on precompetitive manufacturing R&D).

---

<sup>1</sup> These averages hide wide variation by size, climate, and building type, as well as by occupancy and use; there can be up to a 10:1 difference between “similar” buildings.

Energy Information Administration. (April 2011). “Residential Sector Key Indicators and Consumption, Reference Case.” *Annual Energy Outlook 2011*. Washington, DC. Accessed at <http://www.eia.gov/oiaf/aeo/tablebrowser/#release=AEO2011&subject=0-AEO2011&table=4-AEO2011&region=0-0&cases=ref2011-d020911a>

Energy Information Administration. (April 2011). “Commercial Sector Key Indicators and Consumption, Reference Case.” *Annual Energy Outlook 2011*. Washington, DC. Accessed at <http://www.eia.gov/oiaf/aeo/tablebrowser/#release=AEO2011&subject=0-AEO2011&table=5-AEO2011&region=0-0&cases=ref2011-d020911a>

<sup>2</sup> National Academy of Sciences. (2009). *Real Prospects for Energy Efficiency in the United States*. The National Academies Press. Washington, DC.

<sup>3</sup> National Research Council. (2001). *Energy Research at DOE: Was It Worth It?* Washington, DC: The National Academies Press. Accessed at [http://www.nap.edu/catalog/10165.html?onpi\\_newsdoc071701](http://www.nap.edu/catalog/10165.html?onpi_newsdoc071701)

<sup>4</sup> U.S. Department of Energy. (2010). “Value of New Building Construction Relative to GDP, by Year (\$2009 Billion).” *Buildings Energy Data Book*. Washington, DC. Accessed at <http://buildingsdatabook.eren.doe.gov/ChapterIntro1.aspx>

<sup>5</sup> In 2007, major appliances, HVAC, and commercial refrigeration was \$60 billion; lighting manufacturing was \$14 billion; and electronics (other than appliances) was \$92 billion.

<sup>6</sup> National Academy of Sciences. (2009). *Real Prospects for Energy Efficiency in the United States*. Washington, DC: The National Academies Press.

<sup>7</sup> Grenade, H.C., et al. (2009). *Unlocking Energy Efficiency in the U.S. Economy*. Washington, DC: McKinsey & Company. Accessed at [http://www.mckinsey.com/Client\\_Service/Electric\\_Power\\_and\\_Natural\\_Gas/Latest\\_thinking/Unlocking\\_energy\\_efficiency\\_in\\_the\\_US\\_economy.aspx](http://www.mckinsey.com/Client_Service/Electric_Power_and_Natural_Gas/Latest_thinking/Unlocking_energy_efficiency_in_the_US_economy.aspx)

<sup>8</sup> American Physical Society. (2008). *Energy Future: Think Efficiency*. Washington, DC. Accessed at <http://www.aps.org/energyefficiencyreport/report/aps-energyreport.pdf>

<sup>9</sup> Goetzler, W. (2010). “Air Conditioning Market and Technology Trends.” *ARPA-E BEETIT presentation*. Arlington, VA: Navigant Consulting.

<sup>10</sup> Research & Markets. (2011). *U.S. Appliance Industry: Market Value, Life Expectancy, & Replacement Picture for 2005-2012*. Dublin, Ireland.

<sup>11</sup> Lovvorn, N. (2001). *Heat Pump Life in Alabama - Revisited*. Electric Power Research Institute. Palo Alto, CA.

<sup>12</sup> Pientka, K. (1987). Heat Pump Service Life and Compressor Longevity in a Northern Climate. *ASHRAE Trans.* 93(1):1087-1101.

- <sup>13</sup> Institute for Market Transformation. (2012). *Building Energy Performance Benchmarking and Disclosure*. Washington, DC. Accessed at <http://www.imt.org/rating>
- <sup>14</sup> National Academy of Sciences. (2009). *Real Prospects for Energy Efficiency in the United States*. The National Academies Press. Washington, DC.
- <sup>15</sup> Roth, K., et al. (2007). *Residential Miscellaneous Electric Loads: Energy Consumption Characterization and Savings Potential*. Cambridge, MA: TIAX LLC.
- <sup>16</sup> Desroches, L.-B., and Garbesi, K. (2011). *Max Tech and Beyond*. (LBNL-4998E). Berkeley, CA: Lawrence Berkeley National Laboratory. Accessed at <http://efficiency.lbl.gov/drupal.files/ees/MTAB%20Final%20LBNL%20Report.pdf>
- <sup>17</sup> U.S. Department of Energy. (2011). *Solid-State Lighting Research and Development: Multi Year Program Plan*. Washington, DC. Accessed at [http://apps1.eere.energy.gov/buildings/publications/pdfs/ssl/ssl\\_mypp2011\\_web.pdf](http://apps1.eere.energy.gov/buildings/publications/pdfs/ssl/ssl_mypp2011_web.pdf)
- <sup>18</sup> U.S. Department of Energy. (2012). *2010 U.S. Lighting Market Characterization*. Washington, DC. Accessed at <http://apps1.eere.energy.gov/buildings/publications/pdfs/ssl/2010-lmc-final-jan-2012.pdf>
- <sup>19</sup> U.S. Department of Energy. (2011). *Solid-State Lighting Research and Development: Multi Year Program Plan*. Washington, DC. Accessed at [http://apps1.eere.energy.gov/buildings/publications/pdfs/ssl/ssl\\_mypp2011\\_web.pdf](http://apps1.eere.energy.gov/buildings/publications/pdfs/ssl/ssl_mypp2011_web.pdf)
- <sup>20</sup> U.S. Department of Energy. (2012). *Energy Savings Potential of Solid-State Lighting in General Illumination Applications*. Washington, DC. Accessed at [http://apps1.eere.energy.gov/buildings/publications/pdfs/ssl/ssl\\_energy-savings-report\\_jan-2012.pdf](http://apps1.eere.energy.gov/buildings/publications/pdfs/ssl/ssl_energy-savings-report_jan-2012.pdf)
- <sup>21</sup> U.S. Department of Energy. (2004). *Technical Support Document: Energy Efficiency Program for Commercial and Industrial Equipment: High-Intensity Discharge Lamps Analysis of Potential Energy Savings*. Washington, DC.
- Navigant Consulting. (2005). *U.S. Lighting Market Characterization Volume II: Energy Efficient Lighting Technology Options*. Washington, DC.
- <sup>22</sup> For example, see: Baxter et al. (2005). "Residential Heat Pump Water Heater (HPWH) Development Status - USA." *Proceedings of the 8th IEA Heat Pump Conference*. Las Vegas, NV.
- <sup>23</sup> Cassard, H., Denholm, P., and Ong, S. (2011). *Break-Even Cost for Residential Solar Water Heating in the United States: Key Drivers and Sensitivities*. (TP-6A20-48986). Golden, CO: National Renewable Energy Laboratory.
- <sup>24</sup> Example miscellaneous plug loads include home electronics, computer, televisions, networking equipment, set-top boxes, printers, and small kitchen appliances.
- <sup>25</sup> Residential MELs include categories: color televisions and set-top boxes, personal computers and related equipment, and other uses; commercial MELs include categories: office equipment (PC) and office equipment (non-PC).
- Energy Information Administration. (2011). "Residential Sector Key Indicators and Consumption" and "Commercial Sector Key Indicators and Consumption." *Annual Energy Outlook 2011*. Washington, DC: Department of Energy. Accessed at <http://www.eia.gov/oiaf/aeo/tablebrowser/>
- <sup>26</sup> Roth, K., et al. (2007). *Residential Miscellaneous Electric Loads: Energy Consumption Characterization and Savings Potential*. Cambridge, MA: TIAX LLC.
- <sup>27</sup> Ehrhardt-Martinez, K., Donnelly, K. A., and Laitner, J. A. (2010). *Advanced Metering Initiatives and Residential Feedback Programs*. Washington, DC: American Council for an Energy-Efficient Economy.
- <sup>28</sup> Desroches, L.-B., and Garbesi, K. (2011). *Max Tech and Beyond*. (LBNL-4998E). Berkeley, CA: Lawrence Berkeley National Laboratory. Accessed at <http://efficiency.lbl.gov/drupal.files/ees/MTAB%20Final%20LBNL%20Report.pdf>
- <sup>29</sup> Shaughnessy, B. M., and Newborough, M. (2000). "Energy performance of a low emissivity electrically heated oven." *Applied Thermal Engineering*. 20:813–830.
- <sup>30</sup> Sumnu, G., Sahin, S., and Sevimli, M., (2005). "Microwave, infrared, and infrared-microwave combination baking of cakes." *Journal of Food Engineering*. 71(2):150-155.
- <sup>31</sup> Personal Communications: Omar Abdelaziz, Scott Welham, and David Najewicz. January 5, 2011. Appliance Park, Louisville, KY 40225.
- <sup>32</sup> U.S. Department of Energy. (2009). *Energy Conservation Standards Rulemaking Framework Document for Residential Clothes Washers*. Washington, DC.

- <sup>33</sup> Consortium for Energy Efficiency. (2009). *Residential Home Appliance Strategic Plan*. Boston, MA.
- <sup>34</sup> MDI. (2006). "Get Ready for the next wave of energy-efficient washers." *Machine Design International*. 78(11):34–37.
- <sup>35</sup> Teschler. (2008). Motors move toward more efficiency. *Machine Design International*. p. 74-78.
- <sup>36</sup> Heat pumps will save the most energy in cooling-dominated Southern climates.
- <sup>37</sup> Consortium for Energy Efficiency. (2009). *Super-Efficient Home Appliances Initiative Appliance Strategic Plan*. Boston, MA. Accessed at <http://www.cee1.org/resid/seha/seha-plan.php3>
- <sup>38</sup> Dries, J. (2008). Improving dishwasher efficiency. *Appliance Magazine*. Accessed at <http://www.applianceMagazine.com>
- <sup>39</sup> Heibler, H., and Laevemann, E. (2009). "Large energy savings by sorption-assisted dishwasher." 5<sup>th</sup> *International conference on Energy Efficiency in Domestic Appliances and Lighting (EEDAL'09)*. Berlin, June 16–18. Accessed at <http://www.eedal.eu/index.php?id=11575>,
- <sup>40</sup> Consortium for Energy Efficiency. (2009). *Super-Efficient Home Appliances Initiative Appliance Strategic Plan*. Boston, MA. Accessed at <http://www.cee1.org/resid/seha/seha-plan.php3>
- <sup>41</sup> Westphalen, D. R. (2006). "Heat transfer enhancement." *ASHRAE Journal*. 48(4):68-71.
- <sup>42</sup> Wade, P., and Brunner, C. U. (2011). "Energy-Efficiency Policy Opportunities for Electric Motor-Driven Systems." *Energy Efficiency Series*. Paris, France.
- <sup>43</sup> Desroches, L.-B., and Garbesi, K. (2011). *Max Tech and Beyond*. (LBNL-4998E). Berkeley, CA: Lawrence Berkeley National Laboratory.
- <sup>44</sup> A NEMA Premium 4-pole 200 HP enclosed motor is 96.2% efficient; motor efficiency varies with motor power and speed, among other factors.
- <sup>45</sup> Calculated as the sum of Lighting, Color Televisions and Set-Top Boxes, Personal Computers and Related Equipment, Office Equipment (PC), and Office Equipment (non-PC).  
Energy Information Administration. (2011). "Residential Sector Key Indicators and Consumption, Reference Case." *Annual Energy Outlook 2011*. Washington, DC.  
Energy Information Administration. (2011). "Commercial Sector Key Indicators and Consumption, Reference Case." *Annual Energy Outlook 2011*. Washington, DC
- <sup>46</sup> Garbesi, K., Vossos, V., and Shen, H. (2011). *Catalog of DC Appliances and Power Systems*. Lawrence Berkeley National Laboratory. Berkeley, CA.
- <sup>47</sup> Desroches, L.-B., and Garbesi, K. (2011). *Max Tech and Beyond*. (LBNL-4998E). Berkeley, CA: Lawrence Berkeley National Laboratory.
- <sup>48</sup> U.S. Environmental Protection Agency. (2011). *2011 U.S. Greenhouse Gas Inventory Report*. Washington, DC. Accessed at <http://epa.gov/climatechange/emissions/usinventoryreport.html>
- <sup>49</sup> R-1234yf offers similar thermophysical properties.
- <sup>50</sup> U.S. Environmental Protection Agency. (2011). *Presidential Green Chemistry Challenge Awards Program: Summary of 2011 Award Entries and Recipients*. Washington, DC.
- <sup>51</sup> For example: Bill Scanlon. (2010). "Energy Saving A/C Conquers All Climates." National Renewable Energy Laboratory. Boulder, CO.
- Desroches, L.-B., and Garbesi, K. (2011). *Max Tech and Beyond*. (LBNL-4998E). Berkeley, CA: Lawrence Berkeley National Laboratory.
- <sup>52</sup> Brown, D., Dirks, J., Fernandez, N., and Stout, T. (2010). *The Prospects of Alternatives to Vapor Compression Technology for Space Cooling and Food Refrigeration Applications*. Pacific Northwest National Laboratory. Richland, WA. Accessed at [http://www.pnl.gov/main/publications/external/technical\\_reports/PNNL-19259.pdf](http://www.pnl.gov/main/publications/external/technical_reports/PNNL-19259.pdf)
- <sup>53</sup> Thermoacoustic and magnetic technologies look relatively attractive because many working prototypes have already been built, the development barriers appear moderate, and the potential efficiencies are medium to high.
- <sup>54</sup> Fisher, S. (2000). *Not-In-Kind Technologies for Residential and Commercial Unitary Equipment*. Oak Ridge National Laboratory. Oak Ridge, TN.



- <sup>55</sup> Issues including integrating the building into grid operations, integrating building designs and financing into urban planning issues, and integrating building optimization into policy decisions are beyond the scope of this document.
- <sup>56</sup> Griffith, B. T. (2007). *Assessment of the Technical Potential for Achieving Net Zero-Energy Buildings in the Commercial Sector*. National Renewable Energy Laboratory. Golden, CO.
- American Society of Heating, Refrigerating and Air-Conditioning. (2011). *Advanced Energy Design Guides*. Retrieved May 5, 2011, from ASHRAE: [www.ashrae.org/aedg](http://www.ashrae.org/aedg)
- Office of Energy Efficiency and Renewable Energy. (2010). *Commercial Buildings Initiative: Commercial Building Partnerships*. Retrieved May 5, 2011, from EERE: [http://www1.eere.energy.gov/buildings/commercial\\_initiative/building\\_partnerships.html](http://www1.eere.energy.gov/buildings/commercial_initiative/building_partnerships.html)
- National Renewable Energy Laboratory. (2011). *NREL: Sustainable NREL - Research Support Facility*. Retrieved May 5, 2011, from NREL: [http://www.nrel.gov/sustainable\\_nrel/rsf.html](http://www.nrel.gov/sustainable_nrel/rsf.html)
- Office of Energy Efficiency and Renewable Energy. (2011). *Building Technologies Program: Building America*. Retrieved May 5, 2011, from EERE: [http://www1.eere.energy.gov/buildings/building\\_america/](http://www1.eere.energy.gov/buildings/building_america/)
- <sup>57</sup> Lovins, A. (2005). *Energy End-Use Efficiency*. Snowmass, CO: Rocky Mountain Institute.
- <sup>58</sup> Often improved HVAC performance is considered after solar gain and envelope improvements.
- <sup>59</sup> Energy Center of Wisconsin. (2010). *Evaluation Of The Market Impact Of The Advanced Energy Design Guides*. ASHRAE.
- <sup>60</sup> U.S. Environmental Protection Agency. (2009). *ENERGY STAR® and Other Climate Protection Partnerships, Annual report*. Washington, DC.
- <sup>61</sup> Institute for Market Transformation. (2011). *Building Energy Transparency: A Framework for Implementing U.S. Commercial Building Energy Rating & Disclosure Policy*. Washington, DC. Accessed at [http://www.buildingrating.org/Building\\_Energy\\_Transparency\\_Implementation\\_Report](http://www.buildingrating.org/Building_Energy_Transparency_Implementation_Report)
- <sup>62</sup> Calculated by applying percentage of building energy lost through the envelope from Buildings Energy Data Book to energy used for heating and cooling in Annual Energy Outlook and applying energy prices from State Energy Data System:
- U.S. Department of Energy. (1998). "2.1.15 Aggregate Residential Building Energy Loads as of 1998." *Buildings Energy Data Book*. Washington, DC.
- U.S. Department of Energy. (1998). "3.1.12 Aggregate Commercial Building Energy Loads as of 1998." *Buildings Energy Data Book*. Washington, DC.
- Energy Information Administration. (2011). "Residential Sector Key Indicators and Consumption, Reference Case." *Annual Energy Outlook 2011*. Washington, DC.
- Energy Information Administration. (2011). "Commercial Sector Key Indicators and Consumption, Reference Case." *Annual Energy Outlook 2011*. Washington, DC
- Energy Information Administration. (2009). "Primary Energy, Electricity, and Total Energy Price Estimates, 2009." *State Energy Data System*. Washington, DC.
- <sup>63</sup> Brambley, M. R., et al. (2005). *Advanced Sensors and Controls for Building Applications: Market Assessment and Potential R&D Pathways*. (PNL-15149). Richland, WA: Pacific Northwest National Laboratory. Accessed at [http://www.pnl.gov/main/publications/external/technical\\_reports/pnnl-15149.pdf](http://www.pnl.gov/main/publications/external/technical_reports/pnnl-15149.pdf)
- <sup>64</sup> Research includes applications for new and existing buildings in the residential and commercial sectors. Research considers both steep- and low-slope roofs and hot, moderate, and cold climates.
- <sup>65</sup> Walls and insulation materials can be designed to provide temporary thermal storage and optimize building load profiles relative to critical utility peaks and grid-connected renewable electric generation. There are multiple technologies to increase the thermal storage occurring naturally in buildings, including commercial ice storage systems and phase-change materials. These technologies offer limited benefits (i.e., under 0.5 Quad/year even if adopted by all buildings).
- <sup>66</sup> R-value is a measure of thermal resistance. A typical 4-inch-thick wall with fiberglass insulation may have an R-value of 12 (<http://coloradoenergy.org/procorner/stuff/r-values.htm>).
- <sup>67</sup> Budnitz, J., Berk, J., Hollowell, C., Nazaroff, W., Nero, A., and Rosenfeld, A. (1979). "Human disease from radon exposures: the impact of energy conservation in buildings." *Energy Build.* 2:209-215.

- <sup>68</sup> Brambley, M.R., et al. (2005). *Advanced Sensors and Controls for Building Applications: Market Assessment and Potential R&D Pathways*. (PNNL-15149). Richland, WA: Pacific Northwest National Laboratory. Accessed at [http://www.pnnl.gov/main/publications/external/technical\\_reports/pnnl-15149.pdf](http://www.pnnl.gov/main/publications/external/technical_reports/pnnl-15149.pdf)
- <sup>69</sup> For example, of the 64.7 Bft<sup>2</sup> of non-mall commercial floor space, only 15.6 Bft<sup>2</sup> has an energy management control system used for HVAC.
- Energy Information Administration. (2006). "Table B41. Cooling Equipment, Floorspace for Non-Mall Buildings, 2003." *Commercial Buildings Energy Consumption Survey*. Washington, DC: Department of Energy. Accessed at [http://www.eia.gov/emeu/cbecs/cbecs2003/detailed\\_tables\\_2003/2003set8/2003pdf/b41.pdf](http://www.eia.gov/emeu/cbecs/cbecs2003/detailed_tables_2003/2003set8/2003pdf/b41.pdf)
- <sup>70</sup> The ZigBee Alliance, an association of companies, is pursuing these goals through ZigBee technologies, which conform to a global communications protocol and digital radio frequency standard.
- <sup>71</sup> Hart, R., Mangan, S., and Price, W. Eugene Water & Electric Board. (2004). "Who Left the Lights On? Typical Load Profiles in the 21<sup>st</sup> Century." Washington, DC: American Council for an Energy-Efficient Economy. Accessed at <http://www.aceee.org/proceedings-paper/ss04/panel07/paper08>
- <sup>72</sup> Torcellini, P., Pless, S., Deru, M., Griffith, B., Long, N., and Judkoff, R. (2006). Lessons Learned from Case Studies of Six High-Performance Buildings. (NREL/TP-550-37542).
- <sup>73</sup> Granderson, J., Piette, M., Ghatikar, G., Price, P. (2009). Building Energy Information Systems: State of the Technology and User Case Studies. Technical report. (LBNL 2899E). Lawrence Berkeley National Laboratory.
- <sup>74</sup> 'Hohm' (<http://www.microsoft-hohm.com/>) uses a home electricity monitor to transmit real-time energy consumption data wirelessly to the home computer.
- <sup>75</sup> Navigant Consulting. (2011). *Evaluation Report: OPOWER SMUD*. Chicago, IL.
- OPOWER. (2010). *Overview | OPOWER*. Retrieved May 5, 2011, from OPOWER: <http://www.opower.com/Results/Overview.aspx>
- <sup>76</sup> Mills, E. (2009). *Building Commissioning: A Golden Opportunity for Reducing Energy Costs and Greenhouse-Gas Emissions*. Lawrence Berkeley National Laboratory. Berkeley, CA.
- <sup>77</sup> Pacific Northwest National Laboratory. (2010). *PNNL Building Re-tuning*. Richland, WA. Accessed May 2011, from <http://www.pnnl.gov/buildingretuning/index.stm>
- <sup>78</sup> National Institute for Standards and Technology. (2011). *Integrating Building Automation Systems with a Smart Utility Grid Project*. Gaithersburg, MD.
- <sup>79</sup> U.S. Department of Energy. (2010). "Refrigerator-Freezer Sizes and Energy Factors (Shipment-Weighted Averages)." *Buildings Energy Data Book*. Accessed at <http://buildingsdatabook.eren.doe.gov/TableView.aspx?table=5.7.5><http://buildingsdatabook.eren.doe.gov/TableView.aspx?table=5.7.5>
- Association of Home Appliance Manufacturers. *Major Appliance Fact Book* (published annually; data from 2006 and earlier editions). Washington, DC.
- <sup>80</sup> U.S. Department of Energy. (2010). "Refrigerator-Freezer Sizes and Energy Factors (Shipment-Weighted Averages)." *Buildings Energy Data Book*. Accessed at <http://buildingsdatabook.eren.doe.gov/TableView.aspx?table=5.7.5>
- Association of Home Appliance Manufacturers. *Major Appliance Fact Book* (published annually; data from 2006 and earlier editions). Washington, DC.
- <sup>81</sup> Meyers, S., Williams, A., and Chan, P. (2011). *Energy and Economic Impacts of U.S. Federal Energy and Water Conservation Standards Adopted From 1987 Through 2010*. (LBNL-5291E). Berkeley, CA: Lawrence Berkeley National Laboratory.
- <sup>82</sup> Belzer, D.B., McDonald, S.C., and Halverson, M.A. (2010). *A Retrospective Analysis of Commercial Building Energy Codes: 1990 – 2008*. (PNNL-19887). Richland, WA: Pacific Northwest National Laboratory.
- <sup>83</sup> American Society of Heating, Refrigerating and Air-Conditioning Engineers. (2011). *Advanced Energy Design Guides*. Accessed May 5, 2011, from ASHRAE: [www.ashrae.org/aedg](http://www.ashrae.org/aedg)
- <sup>84</sup> Greater Philadelphia Innovation Cluster for Energy-Efficient Buildings. <http://gpichub.org/http://gpichub.org/>
- <sup>85</sup> End-use energy, also referred to as site energy, is directly consumed by end users, and primary energy is site energy plus the energy consumed in the production and delivery of electricity, natural gas, fuel oil, etc. Except where noted, this technology assessment expresses energy in terms of primary energy data, which is



important for understanding broader environmental and policy issues, such as carbon emissions from energy sources.

- <sup>86</sup> Energy Information Administration. (2009). *An Updated Annual Energy Outlook 2009 Reference Case Reflecting Provisions of the American Recovery and Reinvestment Act and Recent Changes in the Economic Outlook*. Washington, DC. Accessed at <http://www.eia.gov/oiaf/servicerpt/stimulus/index.html>
- <sup>87</sup> U.S. Department of Commerce, Bureau of Economic Analysis. (2011). *Gross Domestic Product (GDP) by Industry Data*. Washington, DC. Accessed at [http://www.bea.gov/industry/gdpbyind\\_data.htm](http://www.bea.gov/industry/gdpbyind_data.htm)
- <sup>88</sup> The Manufacturing Institute. (2009). *The facts about modern manufacturing*. Washington, DC. Accessed at [http://www.nist.gov/mep/upload/FINAL\\_NAM\\_REPORT\\_PAGES.pdf](http://www.nist.gov/mep/upload/FINAL_NAM_REPORT_PAGES.pdf)
- <sup>89</sup> United Nations National Accounts Main Aggregates Database. (2010). *GDP and its breakdown at current prices in US Dollars*. New York, NY: United Nations. Accessed at <http://unstats.un.org/unsd/snaama/dnllist.asp>
- <sup>90</sup> Energy Information Administration. (2009). *Emissions of Greenhouse Gases in the United States 2009*. Washington, DC. Accessed at [http://www.eia.gov/environment/emissions/ghg\\_report/pdf/tbl7.pdf](http://www.eia.gov/environment/emissions/ghg_report/pdf/tbl7.pdf)
- <sup>91</sup> University of Texas at Austin, Oak Ridge National Laboratory, and the American Institute of Chemical Engineers. (2005). *Hybrid Separations/Distillation Technology: Research Opportunities for Energy and Emissions Reduction*. Accessed at [http://www1.eere.energy.gov/industry/chemicals/pdfs/hybrid\\_separation.pdf](http://www1.eere.energy.gov/industry/chemicals/pdfs/hybrid_separation.pdf)
- <sup>92</sup> The National Academies. (2010). *Real Prospects for Energy Efficiency in the United States*. Washington, DC: The National Academies Press. Accessed at [http://www.nap.edu/catalog.php?record\\_id=12621](http://www.nap.edu/catalog.php?record_id=12621)
- <sup>93</sup> U.S. Department of Energy, Industrial Technologies Program. (2006). *Manufacturing Energy and Carbon Footprint*. Washington, DC: Energetics, Inc. Accessed at [http://www1.eere.energy.gov/industry/pdfs/mfg\\_footprint.pdf](http://www1.eere.energy.gov/industry/pdfs/mfg_footprint.pdf)
- <sup>94</sup> Oak Ridge National Laboratory. (2008). *Combined Heat and Power: Effective Energy Solutions for a Sustainable Future*. (ORNL/TM-2008/224). Oak Ridge, TN. Accessed at [http://www1.eere.energy.gov/industry/distributedenergy/pdfs/chp\\_report\\_12-08.pdf](http://www1.eere.energy.gov/industry/distributedenergy/pdfs/chp_report_12-08.pdf)
- <sup>95</sup> Oak Ridge National Laboratory. (2008). *Combined Heat and Power: Effective Energy Solutions for a Sustainable Future*. (ORNL/TM-2008/224). Oak Ridge, TN. Accessed at [http://www1.eere.energy.gov/industry/distributedenergy/pdfs/chp\\_report\\_12-08.pdf](http://www1.eere.energy.gov/industry/distributedenergy/pdfs/chp_report_12-08.pdf)
- <sup>96</sup> The National Academies. (2010). *Real Prospects for Energy Efficiency in the United States*. Washington, DC: The National Academies Press. Accessed at [http://www.nap.edu/catalog.php?record\\_id=12621](http://www.nap.edu/catalog.php?record_id=12621)
- <sup>97</sup> McKinsey & Company. (2009). *Unlocking Energy Efficiency in the U.S. Economy*. Washington, DC. Accessed at [http://www.mckinsey.com/en/Client\\_Service/Electric\\_Power\\_and\\_Natural\\_Gas/Latest\\_thinking/Unlocking\\_energy\\_efficiency\\_in\\_the\\_US\\_economy.aspx](http://www.mckinsey.com/en/Client_Service/Electric_Power_and_Natural_Gas/Latest_thinking/Unlocking_energy_efficiency_in_the_US_economy.aspx)
- <sup>98</sup> McKinsey & Company. (2009). *Unlocking Energy Efficiency in the U.S. Economy*. Washington, DC. Accessed at [http://www.mckinsey.com/en/Client\\_Service/Electric\\_Power\\_and\\_Natural\\_Gas/Latest\\_thinking/Unlocking\\_energy\\_efficiency\\_in\\_the\\_US\\_economy.aspx](http://www.mckinsey.com/en/Client_Service/Electric_Power_and_Natural_Gas/Latest_thinking/Unlocking_energy_efficiency_in_the_US_economy.aspx)
- <sup>99</sup> The National Academies. (2010) *Real Prospects for Energy Efficiency in the United States*. Washington, DC. Accessed at [http://www.nap.edu/catalog.php?record\\_id=12621](http://www.nap.edu/catalog.php?record_id=12621)
- <sup>100</sup> U.S. Energy Information Administration. (2011). *Annual Energy Outlook*. Washington, DC. Accessed at [http://www.eia.gov/forecasts/aeo/pdf/0383\(2011\).pdf](http://www.eia.gov/forecasts/aeo/pdf/0383(2011).pdf)
- <sup>101</sup> U.S. Energy Information Administration. (2011). *Annual Energy Outlook*, Table D2. Washington, DC. Accessed at [http://www.eia.gov/forecasts/aeo/pdf/0383\(2011\).pdf](http://www.eia.gov/forecasts/aeo/pdf/0383(2011).pdf)
- <sup>102</sup> U.S. Department of Energy. (2006). *Chemical Bandwidth Study*. Washington, DC. Accessed at [http://www1.eere.energy.gov/manufacturing/industries\\_technologies/chemicals/pdfs/chemical\\_bandwidth\\_report.pdf](http://www1.eere.energy.gov/manufacturing/industries_technologies/chemicals/pdfs/chemical_bandwidth_report.pdf)
- <sup>103</sup> U.S. Department of Energy. (2006). *Pulp and Paper Industry Energy Bandwidth Study*. Washington, DC. Accessed at [http://www1.eere.energy.gov/manufacturing/industries\\_technologies/forest/pdfs/doe\\_bandwidth.pdf](http://www1.eere.energy.gov/manufacturing/industries_technologies/forest/pdfs/doe_bandwidth.pdf)
- <sup>104</sup> U.S. Department of Energy. (2006). *Energy Bandwidth for Petroleum Refining Processes*. Washington, DC. Accessed at [http://www1.eere.energy.gov/manufacturing/industries\\_technologies/petroleum\\_refining/pdfs/bandwidth.pdf](http://www1.eere.energy.gov/manufacturing/industries_technologies/petroleum_refining/pdfs/bandwidth.pdf)

- 
- <sup>105</sup> U.S. Department of Energy. (2006). *Steel Industry Energy Bandwidth Study*. Washington, DC. Accessed at [http://www1.eere.energy.gov/manufacturing/industries\\_technologies/steel/pdfs/steelbandwidthstudy.pdf](http://www1.eere.energy.gov/manufacturing/industries_technologies/steel/pdfs/steelbandwidthstudy.pdf)
- <sup>106</sup> U.S. Department of Energy. (2007). *U.S. Energy Requirements for Aluminum Production*. Washington, DC. Accessed at [http://www1.eere.energy.gov/manufacturing/industries\\_technologies/aluminum/pdfs/al\\_theoretical.pdf](http://www1.eere.energy.gov/manufacturing/industries_technologies/aluminum/pdfs/al_theoretical.pdf)
- <sup>107</sup> U.S. Department of Energy. (2006). *Industrial Glass Bandwidth Analysis*. Washington, DC. Accessed at [http://www1.eere.energy.gov/manufacturing/industries\\_technologies/glass/pdfs/industrial\\_bandwidth.pdf](http://www1.eere.energy.gov/manufacturing/industries_technologies/glass/pdfs/industrial_bandwidth.pdf)
- <sup>108</sup> Energy Information Administration. (2009). *An Updated Annual Energy Outlook 2009 Reference Case Reflecting Provisions of the American Recovery and Reinvestment Act and Recent Changes in the Economic Outlook*. Washington, DC. Accessed at <http://www.eia.gov/oiaf/servicerpt/stimulus/index.html>
- <sup>109</sup> International Energy Agency. (2007). *Tracking Industrial Energy Efficiency and CO<sub>2</sub> Emissions*. Paris, France.
- <sup>110</sup> The National Academies. (2010). *Real Prospects for Energy Efficiency in the United States*. Washington, DC: The National Academies Press. Accessed at [http://www.nap.edu/catalog.php?record\\_id=12621](http://www.nap.edu/catalog.php?record_id=12621)
- <sup>111</sup> Oak Ridge National Laboratory. (2011). *Internal Analysis Report*. Oak Ridge, TN.
- <sup>112</sup> The National Academies. (1994). *Microwave Processing of Materials*. Washington, DC: The National Academies Press. Accessed at [http://www.nap.edu/openbook.php?record\\_id=2266&page=3](http://www.nap.edu/openbook.php?record_id=2266&page=3)
- <sup>113</sup> Energy Materials Blue Ribbon Panel. (2010). *Linking Transformational Materials and Processing for an Energy Efficient and Low-Carbon Economy: Creating the Vision and Accelerating Realization*. Washington, DC: Department of Energy. Accessed at <http://energy.tms.org/Docs/pdfs/VisionReport2010.pdf>
- <sup>114</sup> U.S. Department of Energy and U.S. Department of Agriculture. (2005). *Biomass as a Feedstock for Bioenergy and Bioproducts Industry: The Technical Feasibility of a Billion Ton Annual Supply*. (DOE/GO-102995-2135). Washington, DC. Accessed at [http://feedstockreview.ornl.gov/pdf/billion\\_ton\\_vision.pdf](http://feedstockreview.ornl.gov/pdf/billion_ton_vision.pdf)
- <sup>115</sup> McKinsey & Company. (2009). *Unlocking Energy Efficiency in the U.S. Economy*. Washington, DC. Accessed at [http://www.mckinsey.com/en/Client\\_Service/Electric\\_Power\\_and\\_Natural\\_Gas/Latest\\_thinking/Unlocking\\_energy\\_efficiency\\_in\\_the\\_US\\_economy.aspx](http://www.mckinsey.com/en/Client_Service/Electric_Power_and_Natural_Gas/Latest_thinking/Unlocking_energy_efficiency_in_the_US_economy.aspx)
- <sup>116</sup> American Council for an Energy-Efficient Economy. (2009). "Barriers to energy efficiency investments and energy management in the U.S. industrial sector." Washington, DC. Accessed at [http://www.aceee.org/files/pdf/fact-sheet/ACEEE-Barriers\\_to\\_industrial\\_EE\\_10-20-09.pdf](http://www.aceee.org/files/pdf/fact-sheet/ACEEE-Barriers_to_industrial_EE_10-20-09.pdf)
- The National Academies. (2010). *Real Prospects for Energy Efficiency in the United States*. Washington, DC: The National Academies Press. Accessed at [http://www.nap.edu/catalog.php?record\\_id=12621](http://www.nap.edu/catalog.php?record_id=12621)
- <sup>117</sup> U.S. Department of Energy. (2012). "ARC Implementation Rates." *Industrial Assessment Centers Database*. Washington, DC. Accessed May 2012 at <http://iac.rutgers.edu/database/arclmpRate/>

## 6 Grid Modernization

The assessments in this chapter form the technical base for *Modernizing the Grid*, a strategy detailed in the corresponding chapter of the *Report on the Quadrennial Technology Review (QTR)*. The Nation needs an electrical grid that is adaptable, secure, reliable, resilient, and can accommodate changing loads, generation technologies, and operating business models. The *Report on the QTR* focused on the subset of technical issues most relevant to the Department’s research and development capabilities and strategy, not on larger grid modernization policies and barriers.

While each technology is presented here with a standalone assessment, the associated opportunities to impact the energy system are fully understood only within the context of an integrated framework that spans energy resource, supply, delivery, and consumption. The *Report on the QTR* presents an integrated framework of the energy system and contains the systems discussions that tie together these individual assessments.

The technology assessments in the *Grid Modernization* chapter include:

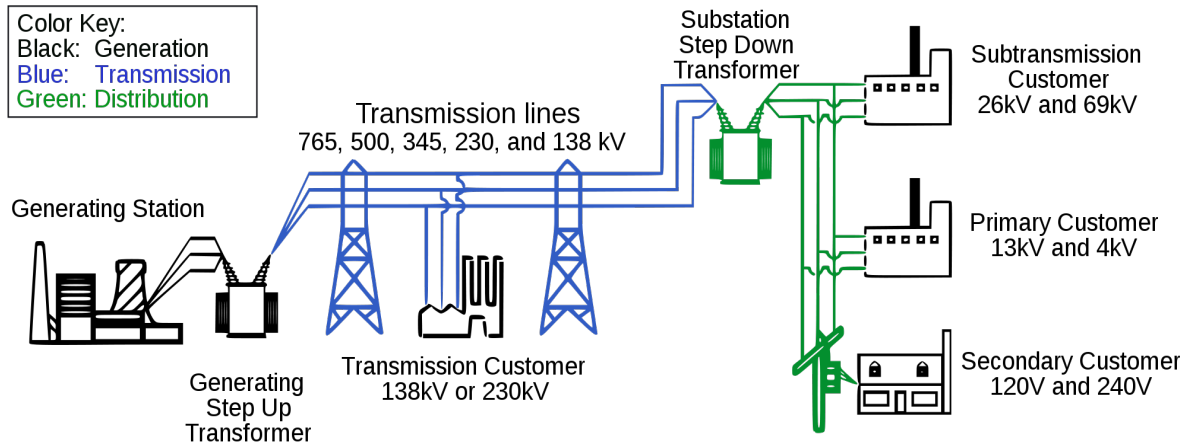
- Grid Infrastructure
- Grid Storage
- Grid Measuring, Modeling, and Control

## 6.1 Grid Infrastructure

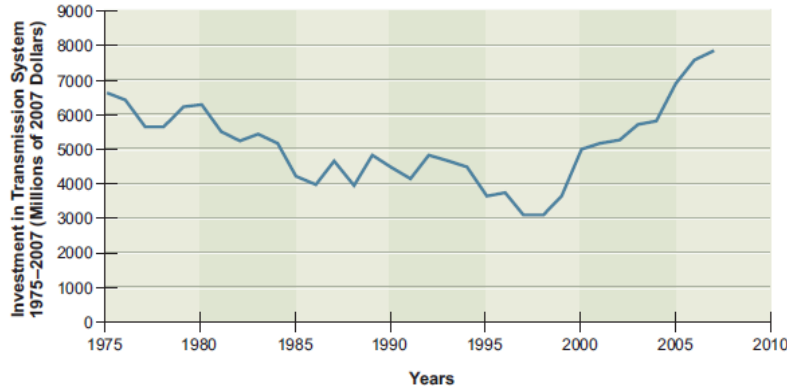
### 6.1.1 Context

Electrification of the United States was a major cornerstone of the economic development and prosperity of the post-WWII era and has since become an essential service to virtually every household and business in the nation. As described in *Modernizing the Grid* in the *Report on the QTR*, today's power transmission and distribution grid is technically adequate for providing basic electrical services. But, as described in the *Report on the QTR*, the grid will become increasingly stressed as the technologies that generate and consume power continue to evolve. Current operational and business models are still adapting to the more segmented, less regulated conditions that exist today and are expected for the future. The mix of old and new technologies within the system adds to the stress caused by increased demand and changing operations that adversely affects reliability and power quality. Overcoming these stresses requires innovations to enable new functions and capabilities while ensuring reliability, adequacy, and security. This section reviews technical opportunities to improve the grid's physical infrastructure, while the other assessments examine technologies in grid storage, and measurements, modeling, and control.

The physical system of the U.S. grid includes 180,000 miles of high-voltage transmission lines, 11 million miles of distribution lines, and 15,000 generators that are owned by 3,170 utilities and serve over 143 million customers across North America. There are also 15,000 transmission substations and 60,000 distribution substations that form the major "nodes" of this system.<sup>1</sup> Figure 19 is an illustrated representation of the grid's major components and their connectivity. The regulatory, market, and business structures that influence innovations in the grid are directly impacted by federal, state, regional, and local issues, adding to its complexity.

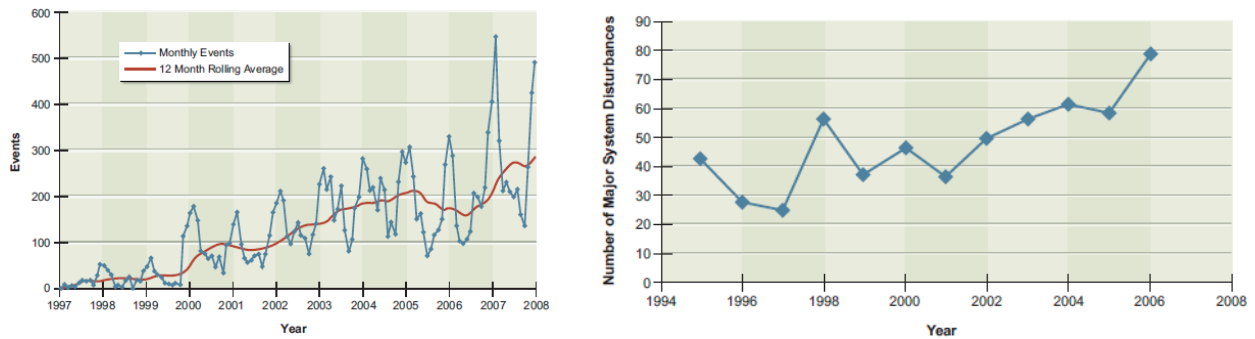


**Figure 19. Simplified Schematic Showing Major Elements of the Electric Grid** Source: U.S.–Canada Power System Outage Task Force. (2004). *Final Report on the August 14, 2003 Blackout in the United States and Canada: Causes and Recommendations*. Page 5. Accessed at <http://www.ferc.gov/industries/electric/industryact/reliability/blackout/ch1-3.pdf>



**Figure 20. Investment in Transmission Systems (1975–2007)** Transmission investment by integrated and stand-alone transmission companies. The investor-owned regulated utilities’ data cover only 80% of the transmission system. All investment is shown in 2007 dollars. Data were adjusted as necessary using the Handy-Whitman index of Public Utility Construction Costs. Source: Adapted with permission from The National Academies. (2009). *America’s Energy Future: Technology and Transformation*. Page 570, Figure 9.5 (1975–2003 from EEI, 2005; 2000–2007 from Owens, 2008). Washington, DC: National Academies Press. Accessed at <http://www.nap.edu/catalog/12091.html>

Overall, today’s grid has components that are aging and operating closer to the edge of reliability. Slow demand growth and overbuilding in the 1970s and 1980s allowed the annual investment in the grid to decrease over the last quarter of the 20th Century (Figure 20) without significant capacity issues. However, by 2007, electricity demand had expanded by about 30% (to about 4 trillion kilowatt hours [kWh])<sup>2</sup> relative to 1990, stressing local distribution systems. Despite the upturn in annual investment since 2000 (Figure 20), the number of line congestion events and disturbance events continues to rise (Figure 21). Within this context, today’s system loses about 7% of the electricity generated (300 billion kWh annually) to inefficiencies.<sup>3</sup> Nonetheless, the U.S. transmission and distribution system, recognized by the National Academy of Engineering as the most significant engineering accomplishment of the 20th century<sup>4</sup>, has been exceptionally reliable and driven economic vitality over the last century.



**Figure 21. (Left) Transmission Loading Relief Events** The number of transmission loading relief events is not an outage measure; it is the number of times a congestion limit is reached. Although this measure has been used to characterize transmission reliability, congestion limits can be reached purely for market reasons. **(Right) Major Transmission System Disturbances Reported to North American Electric Reliability Corporation.** Disturbances include electric service interruptions, unusual occurrences, demand and voltage reductions, public appeals, fuel supply problems, and acts of sabotage that can affect the reliability of the bulk electric systems. Source: Adapted with permission from The National Academies. (2009). *America’s Energy Future: Technology and Transformation*. Washington, DC: National Academies Press. Accessed at <http://www.nap.edu/catalog/12091.html>

Today’s electric infrastructure and its major components were designed for efficiency, reliability, ease of operation, and consumer benefit at minimum cost. Going forward, the system must continue to meet these requirements while supporting the integration of renewable generation and the deployment of electric vehicles, meeting the higher power-quality demands of digital devices, and enabling consumer participation in electricity markets.

Past operational methods and system components are increasingly inadequate for a modernizing grid. Rapid advances in information technology, material science, and computational capabilities are creating opportunities to address the many challenges facing the grid.

### **6.1.2 Framing the Assessment**

Table 9 frames the key components of the grid broken down by the five levels of the legacy delivery system. “Generation” refers to bulk generators. “Transmission” refers to step-up power transformers, extra-high voltage lines, direct current interties between interconnections, and wholesale electricity markets. “Substation” refers to the major “nodes” of the transmission system, including the interface with the distribution system at distribution substations. “Distribution” refers to distribution feeders, pole transformers, and distribution lines. “End-use” refers to billing meters and beyond, in other words, the load within residential and commercial buildings and industrial complexes. Each of these levels has challenges associated with grid modernization, as well as crosscutting technical and non-technical issues.

Table 97. Key Elements and Challenges Facing the Grid

	Generation	Transmission	Substation	Distribution	End-Use
<b>Key Elements of Legacy System</b>	Pumped Storage, Breakers, Switches, Controllers	Transformers, Extra-High Voltage Lines, Towers, Arrestors, Converters	Transformers, Breakers, Switches, Arrestors, Flexible Alternate Current Transmission Systems (FACTS) Devices	Transformers, Lines, Utility Poles	
	Communications Hardware and Software, Operational and Planning Models and Platforms, Limited Supervisory Control and Data Acquisition (SCADA), Limited Wide-Area Control Systems and Wide-Area Monitoring Systems				
<b>Key Additional Elements of a Modernized System</b>	Converters	High-Voltage Direct Current Lines, Fault Current Limiters, Phasor Measurement Units (PMUs)	Converters, Fault Current Limiters, PMUs	Alternating Current/Direct Current Lines, Arrestors, Controllers, Converters, Fault Current Limiters, Breakers, Switches	Converters, Breakers, Switches, Controllers
	Communications Hardware and Software, Information Technology, Operational and Planning Models and Platforms, SCADA, Limited Wide-Area Control Systems and Wide-Area Monitoring Systems, Sensors and Advanced Metering Infrastructure, Storage				
<b>Systems Level Challenges</b>	Renewable Integration, Changing Generation Mix	Increasing Capacity, Congestion on Lines, Under Utilization	Increased Data Flow, Two-Way Power Flow, Microgrids	Two-Way Power Flow, Vehicle Electrification, Distributed Generation, Microgrids	Demand Response, Energy Management Systems, Distributed Generation

This section assesses the grid’s physical system: the infrastructures and components that control, transmit, and convert electricity and powerflow. Storage and crosscutting elements of the system are covered in other assessments.

### 6.1.3 Technical Roadmaps

A key objective of this assessment is to develop a framework that organizes the physical components of the grid and facilitate better understanding of potential investments in new grid technologies. This is a more fundamental discussion than in most of the other technical assessments, which summarize well-established roadmaps. Table lists key infrastructure components grouped by their functionality and denotes the basic services they will need to maintain, the new services that they can enable, and crosscutting technologies that can directly impact their performance. Some services have more value to the end-user, while others have more value to system operators. Towers and poles have been left out of the table due to their passive nature.

Table 10. Key Components and the Services They Provide, Along with Crosscutting Technologies

	X-Formers	Cables & Conductors	Power Converters	FACTS & Controllers	Switches & Breakers	Arresters & Limiters
<b>Basic Services</b>						

Delivery	X	X	X			
Efficiency	X	X	X	X		
Reliability			X	X	X	X
<b>New Services</b>						
Bulk Renewable Generation		X	X	X		
Distributed Generation			X	O	O	O
Electric Vehicles	O	X	X	O	O	O
Power Quality	O		O	O		
Optimization	O		O	O	O	
Resiliency	O		O	O	X	O
Complex Loads (Distributed Renewables, Microgrids)	O		O	O	O	O
<b>Crosscuts</b>						
Dielectrics & Insulators	X	X	X	X	X	X
Power Electronics	O		X	X	O	O
Magnetics	X		X	X		
Wires	X	X				X
Cooling/Thermal Management	X	X	X	X		X

**X = near-term application, O = future application**

A Brattle Group study<sup>5</sup> in 2008 estimated the cost of grid modernization over the next 20 years to be \$233 billion in the transmission system and \$675 billion in the distribution system. These values are consistent with an Electric Power Research Institute (EPRI) study<sup>6</sup> conducted in 2002, which estimated a cost of \$225 billion in transmission and \$640 billion in distribution. The EPRI study also reported that basic expansion of the system to meet growing loads and replace aging components would cost \$175 billion in transmission and \$470 billion in distribution. The difference between these estimates (\$50 billion in transmission and \$170 billion in distribution over 20 years) provides an estimate of the incremental cost of enabling new functionalities and capabilities.

EPRI estimates the benefits to society from the incremental investment in modernization would be about \$640–\$800 billion over the next 20 years.<sup>7</sup> They also estimated that blackouts and service interruptions, which are generally related to distribution failures and power quality respectively, cost the U.S. economy \$80–\$100 billion annually. Line congestion, inefficiencies (the system loses about 2% in transmission and 5% in distribution), and underuse of assets also have direct economic costs. On the other hand, it is difficult to estimate the economic growth that would arise from new markets, services, and business models. Some potential benefits from grid modernization may be difficult to monetize, such as improving safety and security, or a cleaner environment. As distributed generation technologies become less expensive, there will be more power generation on the distribution grid, which will necessitate protection and control of two-way power flows.



#### 6.1.4 Infrastructure and Power Electronic Components

Infrastructure and power electronic components interact with the physical flow of electricity and power. Historically, transformers, power lines, switches, and breakers have been sufficient. Advanced components such as Flexible Alternating Current Transmission Systems (FACTS) devices, controllers, and other power electronics can improve flexibility, enable new functions, and enhance current capabilities. Legacy components can also be retrofitted and redesigned to provide desired capabilities. This section summarizes roadmaps for key components of the grid's physical system. In general, these components would benefit from improved performance and reduced cost.

Opportunities in the electric power system include capabilities that

- Enable informed participation of customers
- Accommodate diverse generation and storage options
- Provide increased resiliency to disturbances, attacks, and natural disasters
- Provide the power quality commensurate for a range of needs
- Optimize asset utilization and operating efficiency
- Enable the introduction of new products, services, and markets.

##### 6.1.4.1 Towers and Poles

Towers and poles support the above ground-conductors in the transmission and distribution networks. Towers transport power from distant generators to load centers. Utility poles are prevalent in most distribution grids, except in dense urban centers, where underground cables distribute power.

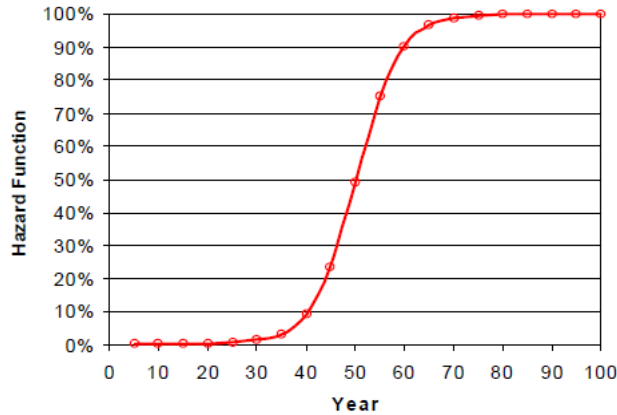
In regard to centralized power generation, towers will be needed for transmission of power generated far from load centers. (Distributed and on-site generation do not have the need for long-distance transmission.) Towers must be strong to withstand impacts of severe weather events. Design improvement allows better use of limited rights-of-way and potentially lessens the visual footprint. The value of these innovations has not been fully assessed.

New composite materials that are stronger and lighter, as well as analysis of new structural designs, could improve towers and poles. Europe leads in tower and pole design and materials. Bonneville Power Administration has developed software to develop stronger and more efficient tower designs, saving costs through reduced material use.

##### 6.1.4.2 Power and Distribution Transformers

Transformers change the voltage of electricity, increasing voltage to transmit power efficiently over long distances and decreasing it for final delivery to end users. Power transformers are located at generating plants and substations, while distribution transformers are located in residential and commercial areas. Most manufacturing for these components has moved abroad, resulting in long order lead times. Standardization of transformer designs would shorten lead times and reduce the required inventory of spare transformers. Power transformers cost millions of dollars, while distribution transformers cost \$5,000–\$15,000 depending on rating.

As transmission and distribution networks integrate in a modernizing grid, the performance requirements and operational characteristics of transformers will evolve. They must maintain high reliability and efficiency (99.5%–99.7%) while accommodating two-way power flows, higher temperatures and operating voltages, and more reactive loads (electric vehicles, light-emitting diode [LED] lights, etc.). The average age of the U.S. transformer fleet is 40 years—approaching their expected operational lifetime (Figure 22).<sup>8</sup> There is potential to decrease transformer weight, significantly easing siting, increasing fault current capabilities for reliability, and enabling safe two-way flow of power to improve grid flexibility.<sup>9</sup>



**Figure 22. Potential Hazard of Failure versus Transformer Age** Source: Bartley, William H. *Analysis of Transformer Failures*. (2003). Presented at the International Association of Engineering Insurers 36th Annual Conference, Stockholm, 2003. Page 7, Figure 3. Hartford, CT: The Hartford Steam Boiler Inspection & Insurance Co. Accessed at [http://www.imia.com/library\\_imia\\_papers.php](http://www.imia.com/library_imia_papers.php)

Research pathways include applied materials research in core materials for higher flux to reduce transformer weight, improved insulators for operating at higher temperatures and voltages, low-loss wires for improved windings for increased efficiency, and cost-effective thermal management that can handle overloading or enable high-temperature superconducting cables (HTSC). Protection schemes, material ratings, and controls are several factors that need to be addressed in future transformer designs to accommodate two-way power flows. Early demonstrations of advanced transformers with multi-functional capabilities are underway. Solid state transformers that leverage advances in power electronics will provide voltage and volt-ampere reactive (VAR) support for power quality, while transformers with embedded sensors for equipment diagnostics and real-time performance assessment will help identify and respond to disturbances.

### 6.1.4.3 Cables and Conductors

Cables and conductors carry and deliver electricity. Overhead conductors are mainly used with towers. High-voltage direct-current (HV-DC) technology has become more prominent in usage because it is more efficient and cost-effective for transmitting large amounts of power [ $>500$  megawatts (MW)] over long distances ( $>300$  miles).<sup>10</sup> These components are considered mature and have price ranges between \$0.1–\$4.0 million/mile depending on rating, type, and terrain. Underground cables, which have lower voltages, are used in urban centers where real-estate costs, safety concerns, and aesthetics restrict the

use of overhead lines. Underground cables are also used where overhead lines are hard to locate or when environmental impacts are a concern.

Advanced cables and conductors can have both higher power densities, which enable them to accommodate the growth in electrical demand in limited rights-of-way, and lower losses, to efficiently access remote energy resources. Reconductoring, the process of using advanced cables to increase capacity in existing corridors, has been the preferred solution. Reduced line sag (which can lead to safety hazards and power failures when cables contact other objects), increased ampacity (the maximum amount of electrical current a conductor can carry), longer lifetimes, and better thermal management can handle higher operating temperatures, severe weather events, and the mechanical and electrical stresses of high power densities. There is potential for enhanced cables and conductors that have up to five times the capacity<sup>11</sup> and an installed cost comparable to today's technologies.

Research pathways include applied materials research and advanced cable and conductor concepts for the development of extra-high voltage/HV-DC lines, enhanced underground cables, high-temperature low-sag cables, high-phase order cables, and HTSC. These innovations require parallel developments in associated technologies, such as new transformers for high-phase order cables and cryogenic coolers for HTSC. Other innovations, such as embedded self-healing and diagnostics, can improve disturbance response, while coatings to reduce corrosion and icing can extend lifetimes.

#### **6.1.4.4 Power Converters**

Power conversion systems change high power electric from direct current to alternating current (inverters) and alternating current to direct current (rectifiers). These components are used in a wide range of applications and are particularly critical for wind and solar photovoltaic electrical generation, grid-scale storage, electric vehicle charging, and HV-DC usage. Power converters can also allow power routing with multi-terminal HV-DC stations, VAR control and voltage support for more reactive loads, and frequency response to ensure system stability.

These components enable the connection of asynchronous systems through HV-DC interties, allowing power transfer between the three major U.S. interconnections. Power converters are considered mature, but still suffer from inefficiencies, high costs, and rated voltage/current limitations. Conversion systems comprise a large portion of HV-DC substation price (\$250–\$500 million/unit<sup>12</sup>), thus limiting the wide-scale deployment of HV-DC. While high-voltage alternating-current (HV-AC) substation costs \$10–\$60 million,<sup>13</sup> HV-AC line inefficiencies make them less economic over long distances.

There is potential for HV-DC power converters with improved system efficiencies, improved reliability, and significantly lower costs.<sup>14</sup> Basic research on wide band-gap semiconductor materials can improve the next generation transistors and thyristors to reduce power converter price. Improvement of Silicon Carbide (SiC) and Gallium Nitride (GaN)-on-Silicon processing to enhance material quality for device reliability is a promising research and development (R&D) area. New functions and capabilities can be added to existing power converter designs that help modulate oscillatory dynamics and provide VAR control for voltage support. Thermal management and cooling of these power systems and embedded sensors are other potentially important R&D topics.

#### **6.1.4.5 FACTS Devices and Controllers**

FACTS devices provide enhanced power transfer capabilities and controllability that help alleviate line congestion and increase asset utilization. This family of components can control line impedances, terminal voltages, and voltage angles quickly and effectively to improve dynamic system behavior and enhance system stability. They can also provide VAR support and frequency response historically provided by other controllers (such as synchronous condensers). The introduction of high voltage systems for inter-regional exchanges spurred the development of high-power FACTS devices. Deployment of these technologies have been limited over the past 30 years due to costs and reliability issues, used only where space and siting constraints make traditional solutions impractical. FACTS devices include universal power flow controllers, static synchronous compensator, static VAR compensators, and many others.

There is a need for increased control and flexibility to manage more reactive loads (e.g., LED lighting, electric vehicles) and to mitigate the lack of system inertia and primary frequency response associated with high penetration of intermittent renewable generation. Greater deployment of distributed generation, the use of microgrid technologies, and increased customer participation in electricity markets will require power flow controllers on the distribution grid. In addition to improved components, R&D can explore controller designs and development for use in the distribution system. FACTS devices could provide VAR support significantly faster than current technologies and with lowered system costs through improved power electronic devices.<sup>15</sup>

FACTS devices will benefit from applied materials research for their constituent transistors and thyristors. Research on distributed static series compensators and distributed series reactance modules that can be clipped onto wires to control their impedance can be built upon to develop new controllers.

#### **6.1.4.6 Switches and Breakers**

Switches and breakers are protective technologies, which include network interrupters, sectionalizers, and reclosers, used to separate and isolate sections of the grid during a disturbance. Automated switches help restore power after a fault and can provide load control and voltage regulation. Circuit breakers interrupt the current that flows during a fault. These technologies are considered mature, but are very expensive; circuit breakers can cost a few million dollars.

A modernized grid will likely include two-way power flows, more complex operations, higher voltages, direct current circuits, and advanced distribution systems. As more HV-DC circuits are deployed, HV-DC protection devices will be needed. However, there are no cost-effective mechanisms that force the current to zero for an HV-DC circuit breaker, without which, arcing and contact wear degrade reliability.<sup>16</sup> Cost-effective and enhanced insulators can improve current switches and breakers for HV-AC circuits, while new materials may be needed to develop a HV-DC breaker. Research on power electronic devices and materials can also be leveraged for solid-state switches.

#### **6.1.4.7 Arresters and Current Limiters**

Arrestors and current limiters protect equipment such as converters, transformers, and FACTS in the event of faults, lightning strikes, or other grid interruptions by redirecting, dissipating, or limiting surge

currents. This family of devices has an important role in the security and reliability of the grid. The value of these protective functions has not been fully assessed. Increased use of critical components and power electronics would raise susceptibility to electric fault currents. The expected growth in distributed generation, community storage, and electric vehicles could produce significantly larger fault currents than previously experienced on the distribution system. The key challenge for innovation in this area is the development of reliable and cost-effective devices that can handle the larger currents that may occur.

Materials research could lead to improved insulators that can withstand greater currents and voltages. Other materials research offers opportunities to improve current limiters since surge currents increase wire resistance.

### **6.1.5 Crosscutting Technologies**

Crosscutting technologies include materials and subcomponents that can provide benefits to many infrastructure and power electronic components (see Table ) as the grid moves towards higher voltages or currents, experiences increased strain from severe weather and thermal fluctuations, and handles faster operations with complex electronics.

#### **6.1.5.1 Dielectrics and Insulators**

Dielectrics and insulators are used in overhead lines, transformers, underground cables, circuit breakers, and many other components. Virtually every electrical device on the grid needs dielectrics or insulators to isolate the current-carrying segments from ground and to provide mechanical support while being able to withstand the high voltages involved. Dielectrics and insulators can be gases (such as sulfur hexafluoride), liquids (such as oils), or solids (such as ceramics and plastics), all with different properties and different applications. Failures in dielectric or insulator materials can lead to costly power outages, loss of equipment, and loss of service.

Materials innovations could improve mechanical, thermal, electrical, and lifetime properties of dielectrics and insulators. New materials such as smart materials and nanocomposites that can self-heal or provide new functionalities could transform this space.

#### **6.1.5.2 Power Electronics**

Transistors and thyristors are the building blocks of power electronic systems, so their cost and performance limits the deployment of power converters and FACTS devices. Cost-effective power electronic devices with higher voltage/current limits, improved efficiencies, increased reliability, and higher operating temperatures are needed. Wide band gap semiconductors such as GaN, SiC, Zinc Oxide, and diamond have significant potential for advanced devices. Today, the most promising materials for near-term applications are SiC and GaN, which have breakdown voltages ~50 and ~30 times higher than silicon respectively.<sup>17</sup> While diamond is still very early in development as a semiconductor, it has over 500 times the breakdown voltage of silicon.<sup>18</sup> The U.S. Department of Energy (DOE) has set goals of developing GaN on Silicon devices that operate at 5 kilovolts (kV) and 15 amps (A) within 5 years, and SiC switches that can operate at 20 kV, 100 A, temperatures greater than 200°C, and switching frequencies of 20 kilohertz (kHz).<sup>19</sup>

Power electronics would be improved through basic materials research, the exploration of new device architectures, processing methodologies, thermal management, and device packaging. Improved materials will increase the reliability and fundamental limits of the devices, whereas new architectures, thermal management, and packaging will improve the devices operational performance.

#### **6.1.5.3 Wires**

Wires and conductor materials are the building blocks of the conductors and cables that transmit electricity, as well as the windings for transformers. Higher strength-to-weight ratios, improved high-temperature strength, improved electrical and thermal conductivity, and lower losses are desirable for wires. Fundamental materials research can lead to innovation in this space.

#### **6.1.5.4 Cooling/Thermal Management**

Technologies such as cryogenic coolers and high-temperature packaging will be necessary to dissipate the heat generated by the higher power densities of a modern grid. Materials degrade at their temperature limits, possibly resulting in permanent component failures. Most grid components are cooled passively today, which can be a hazard in extreme weather conditions. Mechanical cooling has contributed to system reliability, but requires improvements in the costs and performance. Active and passive cooling innovations will make systems more resilient to thermal issues. Reliable and rugged refrigeration systems are necessary for the use of superconducting components.

#### **6.1.5.5 Magnetics**

Magnetic materials are used in transformers and power electronics. Fundamental materials research to improve magnetic properties (high flux, high coercivity), increased operating temperatures, and lower losses will impact grid components. Improved magnetics can lead to smaller and lighter transformers and power electronics.

### **6.1.6 Non-Technical Barriers**

Many of the technologies that could improve efficiency and operations of the grid are constrained by non-technical issues. Technological innovation, system operation, and overall performance of the electric grid are intricately linked to the system's market, policy, and regulatory structures.

#### **6.1.6.1 Systems Integration and Demonstration**

Systems integration and demonstration are crucial for the deployment and adoption of new technologies because the industry is risk averse and sensitive to changes. Utility involvement in this process is critical to the success of new technologies and the new services they can provide. Systems-oriented demonstrations enable understanding, ensuring that various grid technologies won't adversely impact one another. Well-designed demonstrations provide valuable information for the research community, as well as the cost and performance data needed to inform regulators and legislators. Below are key technology issues and demonstrations that could advance grid modernization.

**Interoperability Framework and Standards:** With the rapid advances in technologies that will interact on the grid, standards are necessary to provide a framework to guide interoperability. This multi-stakeholder activity includes activities from the federal government,<sup>20</sup> to the private sector, to nonprofit and standards organizations.

**Distributed Energy Resources:** Increasing use of distributed generation, energy management systems, and distributed resources present operational challenges and technology issues. The complex interactions between these technologies on the distribution/regional level can provide valuable insight into the grid as a whole. Deployment of distributed generation at scale will depend on understanding how these technologies will impact the grid on all levels, from a circuit to a region. Various studies have explored these issues,<sup>21,22</sup> and through American Recovery and Reinvestment Act of 2009 (ARRA) funding, additional demonstration projects have been initiated that integrate several distributed technologies.

**Advanced Metering Infrastructure (AMI) and Demand Response:** The use of AMI and dynamic pricing to provide demand response requires the evaluation of consumer reactions to price signals. Understanding consumer behavior and the aggregated impact of this distributed resource is important to guide future developments. The ARRA-funded AMI deployment is an opportunity to collect data and information on how this technology can work in practice and at scale. Benefits derived from this technology will be evaluated and disseminated to interested stakeholders. The unprecedented scale of this demonstration required close coordination with suppliers, utilities, and regulators.

**Microgrids:** Microgrids turn a set of localized distributed energy resources and loads into a single entity. This entity has the ability to connect and disconnect from the grid when necessary, such as during a fault or when load shedding is desired. While disconnected, a microgrid can operate autonomously to provide energy to the loads. Seamless separation and reconnection from the grid has not yet been demonstrated and evaluated for safety and efficacy. The grid components and technologies that will be needed to form a microgrid require demonstration.

#### **6.1.6.2 Planning and Policy Support**

The electric industry is comprised of numerous stakeholders with different priorities, business models, and jurisdictions. Addressing the policy, market, regulation, siting, permitting, and planning issues that involve these various stakeholders in conjunction with technology development and deployment are important to grid modernization. The industry currently uses multiple models and tools that may result in divergent conclusions.

**System Architecture:** Accurate assessment of the optimal combination of infrastructure assets, locally and nationally, is important to ensure affordable and reliable electricity. Exploring the costs and benefits of on-shore vs. off-shore technologies, overhead vs. underground transmission, two-way communication and control, hybrid AC/DC circuits, HV-DC backbones, and other system architectures are important for modernization. Advanced topologies such as high-frequency DC links and the use of HV-DC within interconnections to boost transfer capacity are gaining attention and require evaluation.

**Stakeholder Coordination:** The organic evolution of the electric grid and the varying perspectives of its stakeholders have made it difficult for entities to work seamlessly together. The issues facing the grid require collaboration and coordination between numerous stakeholders to arrive at technical, market, and policy solutions in a timely and cost-effective manner. Collaborative long-term analysis and planning for the Eastern, Western, and Texas electricity interconnections will provide a comprehensive look



across each of the three transmission interconnections to assess transmission needs for future scenarios. This will help states, utilities, grid operators, and others prepare for grid modernization.<sup>23</sup>

**Markets and Regulations:** Markets and regulations drive how certain grid technologies are used and implemented. Accurate and unbiased techno-economic reasoning for incentives, cost-allocation, pricing schemes, market changes, and technology choices is valuable to decision makers and legislators who are tasked with formulating policies. Many existing statutes and regulatory requirements (e.g., permitting and cost-minimization) strongly impact current planning practices, while new regulations and policies could unintentionally change grid planning.

**Environmental Considerations:** Changes in the generation mix and the adoption of new technologies have led to some environmental concerns. Issues such as water usage and waste management of generation, ecosystem impacts of transmission, and land-usage of renewable resources impact grid planning and policies.

### 6.1.7 DOE History and Accomplishments

In the 1980s and 1990s, DOE grid infrastructure technology investments were generally about \$20–\$30 million annually, the majority of which was dedicated to HTS. In the 2000s, they increased to around \$40–\$70 million annually. DOE’s major grid technology successes include the introduction of wide area visualization tools for the transmission level and the development of phasor measurement units (PMUs). Component-level technical successes included the development of fault current limiters. There was also some success with Smart Wire modules and aluminum conductor composite reinforced advanced conductors. ARRA funded the deployment of PMUs and made a major push to demonstrate storage, although this represents a modest subset of grid infrastructure technologies. In the past year, the Advanced Research Projects Agency – Energy (ARPA-E) has targeted projects in grid infrastructure technologies.

The HTS program received the majority of DOE funding for grid infrastructure technologies from 1987 through 2010. Funding ranged from \$12–\$22 million annually for the first 13 years, increasing to \$20–\$50 million annually from 2000–2010, about \$640 million over the course of the program. The program developed HTS materials and devices for a wide variety of applications, with an emphasis on underground cables. This program concluded with the successful demonstration of HTS technology in the Long Island Power Authority’s installation of the world’s highest rated HTS cable (138 kV).

After the 2003 Northeast blackout, the U.S. Secretary of Energy and the Canadian Minister of Natural Resources were appointed to chair the joint U.S.-Canada Power System Outage Task Force. That Task Force was assigned the responsibility of investigating the outage to determine the cause, as well as why it was not contained. A secondary task was to develop recommendations to reduce the possibility of future outages and to reduce the scope of any that did occur. Three working groups were created comprising of state and provincial representatives, federal employees, and contractors to address the two tasks. The final Blackout Report<sup>24</sup> was released in April 2004 identifying the cause of the blackout and listing 46 recommendations. These recommendations guided DOE R&D direction such as cybersecurity and the deployment of PMUs.



### 6.1.8 DOE Role

Public comments and technology roadmaps<sup>25</sup> indicate that non-technical barriers could slow grid modernization, and DOE has a role in providing information to decision makers who can address those barriers. DOE is well placed to convene multiple parties to achieve collaborations, discussions, and planning for the future grid. DOE also serves as a valuable resource for the collection and dissemination of unbiased grid technology performance and cost information.

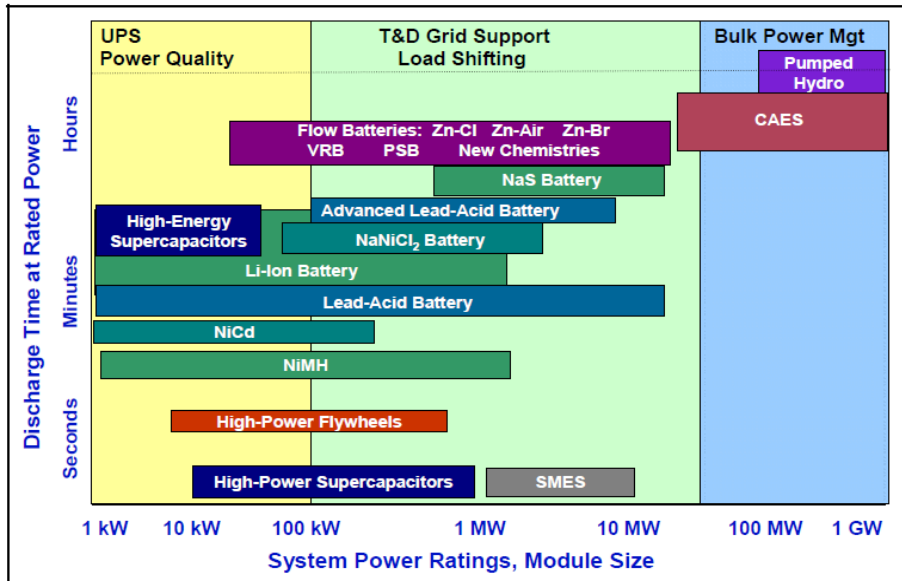
The Department possesses unique capabilities in materials discovery and design for high-voltage and high-temperature control of electricity, including wide bandgap semiconductors. The Department also has a unique set of integrated testbed capabilities, such as the National Supervisory Control and Data Acquisition (SCADA) Test Bed Program at Idaho National Laboratory,<sup>26</sup> that allow for verification, validation, and prediction of in situ device performance for new grid infrastructure technologies.

## 6.2 Grid Storage

### 6.2.1 Context

Grid storage can facilitate the transformation of the U.S. energy system and the modernization of the electrical grid. Storage technologies can provide balancing services to support renewable generation, reduce or mitigate electrical outages, and defer transmission and distribution upgrades. Additionally, storage can support the deployment of electric vehicles and will play a role in the evolving smart grid.

Systems that store energy for later use can extend and optimize the grid’s operating capabilities, especially in integrating variable renewable generation. Grid storage and other operational strategies, like demand response,<sup>27</sup> can provide valuable grid services that span a broad range of power, energy, and discharge times. Figure 23 shows the power, corresponding discharge times, and grid services provided by various storage technologies. Power quality services, including frequency regulation, requires response times in seconds to minutes, while transmission and distribution (T&D) grid support (load shifting, peak management, and bridging power services) operates on minutes to hours. Frequency regulation is required to maintain system stability, while power quality services mitigate the brief outages and disturbances that cost the U.S. economy more than \$80 billion annually.<sup>28</sup> Load shifting and peak management provide the ramping services needed to accommodate the diurnal cycles in load, and can also help defer transmission and distribution upgrades. Bridging power provides reliability by balancing against the short-term intermittency of some renewable sources. Finally, bulk power management has timescales of hours and is mainly used for energy arbitrage.



**Figure 23. Classification of Energy Storage Technologies by Power, Discharge Times, and Primary Grid Service Role** Power is a measure of how quickly energy can be released, while discharge times give a measure of how much energy can be supplied at a given power level. Credit: Rastler, D., et al. (2010). *Electricity Energy Storage Technology Options: A White Paper Primer on Applications, Costs and Benefits*. (Report #1020676). Page ES-7, Figure ES-6. Palo Alto, CA: Electric Power Research Institute. Accessed at [http://my.epri.com/portal/server.pt?Abstract\\_id=00000000001020676](http://my.epri.com/portal/server.pt?Abstract_id=00000000001020676)

The technologies in Figure 23 also have secondary applications beyond those shown. For example, the Bonneville Power Administration has used pumped storage hydropower (PSH) for load shifting and, in

some cases, power quality services. However storage technologies are generally optimized around the performance requirements and economics of a single application and might therefore be suboptimal for secondary applications.

In 2010, a DOE-funded multi-stakeholder workshop on grid storage identified five primary applications spanning the key service areas characterized in Figure 23. Table summarizes those grid applications and highlights the performance and cost targets needed to make each economically viable. Due to differences in cost and performance, most storage technologies are optimized to a primary application—although some have the potential for use in several applications.

**Table 11. Grid Application Performance and Cost Metrics with Targets** Nexight Group. (2010). *Electric Power Industry Needs for Grid-Scale Storage Applications*. p. 13. Albuquerque, NM. Accessed at [http://energy.tms.org/docs/pdfs/Advanced\\_Materials\\_for\\_SEES\\_2010.pdf](http://energy.tms.org/docs/pdfs/Advanced_Materials_for_SEES_2010.pdf)

<b>Grid Application</b>	<b>Purpose</b>	<b>Key Performance Targets</b>
Balancing Area and Frequency Regulation (short duration)	<ul style="list-style-type: none"> <li>Reconciles momentary differences between supply and demand within a given area</li> <li>Maintains grid frequency</li> </ul>	Service Cost: \$20/MW per hour
		System Lifetime: 10 years
		Discharge Duration: 15 minutes to 2 hours
		Response Time: < 1 sec
		Roundtrip Efficiency: 75%–90%
Renewables Grid Integration (short duration)	<ul style="list-style-type: none"> <li>Offsets fluctuations of short-duration variation of renewables generation output</li> </ul>	Capacity: 1–20 MW
		System Lifetime: 10 years
		Response Time: 1–2 seconds
		Roundtrip Efficiency: 75%–90%
Transmission and Distribution Upgrade Deferral and Substitution (long duration)	<ul style="list-style-type: none"> <li>Delays or avoids the need to upgrade transmission and/or distribution infrastructure using relatively small amounts of storage</li> <li>Reduces loading on existing equipment to extend equipment life</li> </ul>	Cost: \$500/kWh
		Capacity: 1–100 MW
		System Lifetime: 10 years
		Discharge Duration: 2–4 hours
		Reliability: 99.9%
Load Following (long duration)	<ul style="list-style-type: none"> <li>Changes power output in response to the changing balance between energy supply and demand</li> <li>Operates at partial output or input without compromising performance or increasing emissions</li> <li>Responds quickly to load increases and decreases</li> </ul>	Capital Cost: \$1,500/kW or \$500/kWh for 3 hour duration
		Operations and Maintenance Cost: \$500/MWh
		Discharge Duration: 2–6 hours
Electric Energy Time Shift (long duration)	<ul style="list-style-type: none"> <li>Stores inexpensive energy during low demand periods and discharges the energy during times of high demand (often referred to as arbitrage)</li> <li>Accommodates renewables generation at times of high grid congestion by storing energy and transmitting energy when there is no congestion</li> </ul>	Capital Cost: \$1,500/kW or \$500/kWh
		Operations and Maintenance Cost: \$250–500/MWh
		Discharge Duration: 2–6 hours
		Response Time: 5–30 minutes
		Roundtrip Efficiency: 70%–80%

A storage option’s economic viability depends on the value of the services that it provides compared to competing solutions. Bulk power management is most cost-effective with wide spreads in peak and off-peak electricity prices, while load shifting and peak management are most cost-effective when line congestion drives up the cost of electricity. Aside from technical challenges, factors such as siting, market structures, safety, policies, and operational paradigms all impact the economics of storage options. Ultimately, the true value of grid storage and temporal flexibility will depend highly upon local system needs.

### 6.2.2 Current State of the Technology

Grid storage technologies have been in various stages of development over the past 120 years; PSH is the most mature for these applications. Figure 24 shows the worldwide installed capacity of storage technologies, including commercial plants and demonstrations. Worldwide stationary storage capacity is expected to grow from 127 gigawatts (GW) today (some 3% of generating capacity), to more than 400 GW in 2030, with approximately half of that growth forecast to use batteries.<sup>29</sup>

In 2003, the United States cycles 2.5% of its electricity through storage, while Europe and Japan cycled 10% and 15% respectively.<sup>30</sup> Most of this capacity is PSH, which comprises 99% of the world’s storage capacity. There are currently 22 GW of installed PSH in the United States (some 2% of generating capacity), while an additional 25 GW is in development, but faces significant siting and permitting barriers.<sup>31</sup> Other available technologies include Compressed Air Energy Storage (CAES) and Sodium Sulfur (NaS) batteries. Globally, 400 MW of CAES have been installed and operational for over 20 years at two facilities, one of which is in the United States.<sup>32</sup> ARRA funding initiated the design and development of an additional 450 MW in the United States.<sup>33</sup> There are 330 MW of NaS batteries installed worldwide, primarily in Japan. The installed capacity of NaS batteries is expected to grow to 606 MW in 2012.<sup>34</sup> Other storage technologies presented in Figure 24, such as flywheels and redox flow batteries (RFB), are currently only deployed in small-scale demonstrations, but have significant technical headroom.

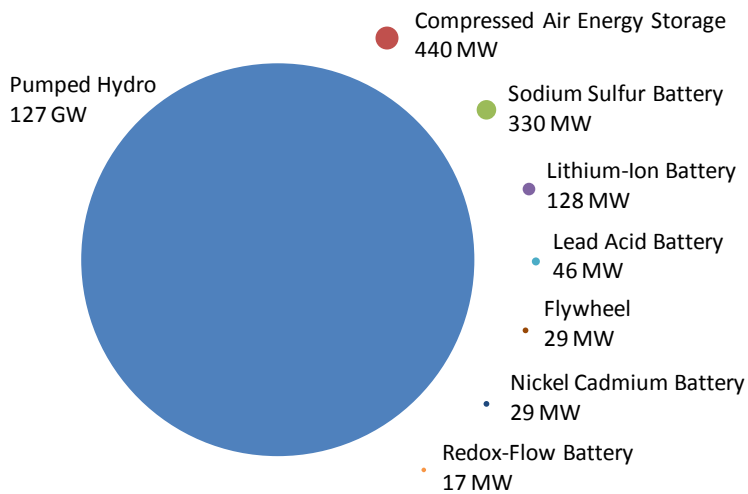
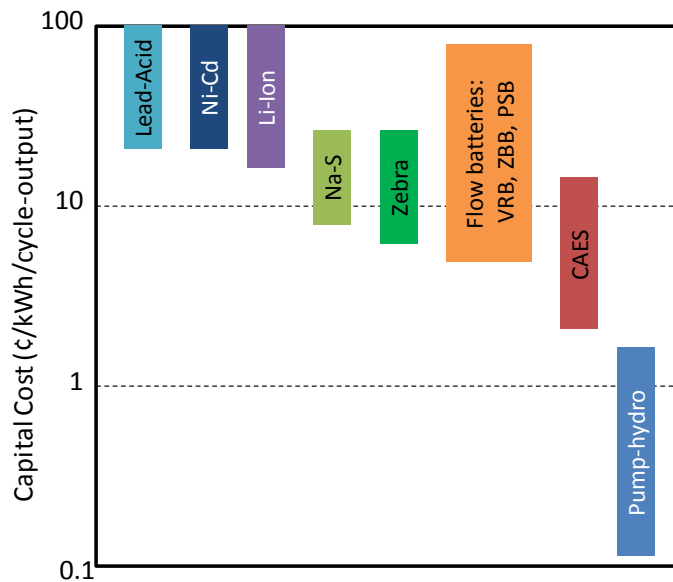


Figure 24 Installed Worldwide Grid Energy Storage Capacity Source: Rastler, D., et al. (2010). *Electricity Energy Storage Technology Options: A White Paper Primer on Applications, Costs and Benefits*. (Report #1020676). Page ES-3,

Figure ES-1. Palo Alto, CA: Electric Power Research Institute. Accessed at [http://my.epri.com/portal/server.pt?Abstract\\_id=00000000001020676](http://my.epri.com/portal/server.pt?Abstract_id=00000000001020676)

China Energy Storage Alliance. (2012). “CNESA Industry Trends 2012-03”. Beijing, China. Accessed at <http://www1.cnesa.org/do/bencandy.php?fid=110&id=1129>

The recent increases in renewable energy generation have spurred interest in storage technologies to provide grid services. Though not essential to renewable energy integration, storage technologies provide a way to maximize the use of variable power generated by renewable sources. Figure 25 shows the range of capital costs for various storage options in cents/kWh, normalized by their deep-discharge cycle-life and efficiency. Most battery grid storage options are currently too expensive and have limitations in efficiency, durability, cycle life, and other important metrics. Broad deployment of grid-scale storage requires improving the cost and performance of multiple technologies.



**Figure 25. Normalized Capital Cost for Bulk Energy Management of Grid Storage Technologies** Electricity Storage Association. Accessed at [http://www.electrictystorage.org/technology/storage\\_technologies/technology\\_comparison](http://www.electrictystorage.org/technology/storage_technologies/technology_comparison)

Advanced PSH is used primarily for peak shifting and diurnal energy management for renewable generation, but can also provide ancillary services. PSH facilities in the United States owe much of their existence to the need in the 1970s and 1980s for alternatives that were less expensive than oil and more flexible than nuclear. In contrast, newer PSH projects require pump-turbine and motor-generator technology that can provide ancillary services to power systems and are justified by the value of those services.

Technology classes for PSH facilities installed worldwide include traditional synchronous-speed pump-turbine units, advanced hydraulic feedback units with modulated output, variable speed PSH units,<sup>35</sup> and extremely fast-response ternary pump-turbine units that can swing hundreds of megawatts of capacity on sub-minute timescales. The U.S. PSH fleet includes only synchronous-speed integrated pump-turbine technology. Hydraulic feedback units with modulated output, variable speed PSH units, and extremely fast-response ternary pump-turbine units provide enhanced flexibility and services with only marginal

increases in capital and operating costs.<sup>36</sup> Most PSH facilities in the United States were built between 1965 and 1985 and have a generating capacity greater than 500 MW, with the largest facilities having individual units approaching 500 MW and total capacity exceeding 2,000 MW.<sup>37</sup> Modern pump-turbine and motor-generator designs achieve greater than 90% peak efficiency in both the pumping and generating modes for storage-cycle efficiency above 80%.<sup>38</sup> For more information about the technical headroom and barriers to PSH, see the *Water Power* technology assessment.

This assessment focuses on energy storage technologies such as batteries that have the potential for broad deployment and substantial technical headroom and scalable operational concepts, like demand response.

### 6.2.3 Technical Roadmaps

Several DOE roadmaps<sup>39</sup> address grid-scale storage with significant agreement on the technology potential and pathways forward. The DOE energy storage planning document establishes a roadmap for energy storage systems, whereas the other two roadmaps focus on the fundamental material innovations needed. The performance and cost of energy storage technologies depend strongly on the materials used and are the targets of basic R&D. Development of advanced materials, processing techniques, and methods to incorporate new materials into devices are needed to reach performance and cost targets. Relevant work includes basic materials research, exploration of advanced electrochemical combinations, solid state ionics, improved membranes and seals, use of new nanomaterials, and development of novel cell stack designs. New developments in crosscutting technologies such as advanced control systems, power electronics, and thermal management would facilitate effective deployment of storage technologies; those elements are covered in greater detail in the other grid technology assessments.

### 6.2.4 Technology Potential

**Lead-Acid Batteries:** Conventional lead-acid batteries are a mature technology with large retail sales and extensive use in vehicles.<sup>40</sup> Several small-scale demonstrations of the use of lead-acid batteries for grid-scale storage around the world were conducted worldwide in the 1980s, and a 250 kW project was funded by DOE in the early 1990s. However, the use of this technology for grid-scale applications has been limited by weight, volume, cycle-life limitations, and reliability issues arising from the traditional chemistry.

Lead-carbon batteries are the most significant technological opportunity for this technology family. Research on lead-carbon battery technologies,<sup>41</sup> similar to prototypes funded through ARRA,<sup>42</sup> has shown the potential for an order of magnitude improvement in cycle-life durability at manufacturing costs comparable to conventional lead-acid batteries. Such a development would dramatically reduce the levelized capital costs.

R&D in this space could improve cycle-life (from the commercially available 1,000 cycles and demonstrated 8,000 cycles to 10,000 cycles).<sup>43</sup> Generic research agendas that could address issues from maintenance requirements to high-voltage operation have been suggested, although specific technical targets have not been identified.<sup>44</sup> A firm understanding of the lead-carbon electrode and the modified

chemistry can move this space. Lighter weight and higher voltages will broaden the utility and applications of this technology.

**Lithium-Ion Batteries:** Lithium-ion technology is considered mature for consumer electronics, with production volumes of 10–12 gigawatt hours (GWh) a year, but it has not been used extensively for grid applications<sup>45</sup>. Present lithium-ion technology is poorly suited to bulk energy services because of its short deep-cycle life, thermal management and safety issues, and high material costs. However, the power densities and fast response times offered by lithium-ion batteries make them well suited for frequency regulation, and the high energy densities make them very attractive for electric and hybrid vehicle applications.

Manufacturing volumes of lithium-ion batteries are projected to reach 35 GWh annually by 2015, primarily driven by vehicle applications.<sup>46</sup> As a result, secondary use of vehicle batteries for grid storage applications is now under consideration. Early trials of multi-MW systems are underway for commercial service and demonstrations in frequency regulation markets.<sup>47</sup> Also, portable/transportation-derived designs have been adapted for stationary deployment. In total, there are now 50MW of grid connected lithium-ion batteries, with additional capacity under construction.

Further R&D can help increase deep discharge cycle-life, reduce costs, and improve the safety of this technology. Enhanced system understanding, improved packaging designs, and new materials can move the technology forward. Up to a two-fold reduction in total systems costs (from \$1,000/kWh) in approximately 5 years<sup>48</sup> and a five-fold increase in cycle-life (from 1,000) could be achieved from these innovations.

**Sodium Batteries:** Sodium-based battery technologies are attractive for their high efficiency and their use of abundant, low-cost sodium. Their primary challenges are high operating temperatures (up to 350°C depending on the Na-conducting membranes) and relatively high system costs.<sup>49</sup> Conventional NaS systems are considered mature, with significant deployment primarily in Japan.<sup>50</sup> The DOE co-funded the first U.S. installation of this technology in 2002.<sup>51</sup> More advanced configurations using Sodium-Nickel Chloride (Na-NiCl<sub>2</sub>) chemistry (referred to as ZEBRA) are also nearing commercialization. Despite the relative maturity of these technologies, issues remain with system costs, reliability, durability, and performance. Safety concerns also inhibit the wide market penetration of older generations of this technology. The high operating temperatures raise issues of thermal management, material selection, and system life, which can increase costs and lower reliability.

Applied materials R&D can drive down operating temperatures to improve durability and safety. Lower temperatures can open the door to new system designs and material selection for lower costs and enhanced performance.<sup>52</sup>

**Flow Batteries:** Flow batteries are essentially regenerative fuel cells that store electricity in the liquid electrolyte instead of in the electrodes. Therefore, they can be designed to optimize power delivery and energy storage capacity separately. This family of technologies is relatively immature, with limited deployment around the world. While a variety of redox couples are possible, the most mature is the all-vanadium RFB, which can have a life of 10,000 or more cycles at 100% depth-of-discharge.<sup>53</sup> Zinc-

Bromine (Zn/Br) and Zinc-Chloride (Zn/Cl) RFBs are less mature, but are in the early stages of demonstration. Iron-Chromium (Fe/Cr) and Zinc-Air RFB chemistries are generally less well-developed but are attractive due to the potential for very low system costs. Technical challenges associated with these technologies include controlling the transfer of active chemical species across the separating membrane, improving the durability and stability of membranes and electrolytes, and increasing the ion concentrations in the electrolytes. Improved stack architectures can also help improve performance and reliability, while improved hydraulic subsystems can reduce costs, increase durability, and ensure safety.

Further R&D can help develop new chemistries, increase charge densities of the electrolyte, and address other pressing technical issues to further develop this promising technology. DOE believes it is possible to double energy densities (from 20 Wh/kg), double power densities (from 50 mW/cm<sup>2</sup>), improve efficiencies (from 70%), and halve costs (from \$500/kWh).<sup>54</sup>

**Compressed Air Energy Storage:** CAES is a commercially available, utility scale, bulk electricity storage technology that uses high-pressure air as a storage medium. Large-scale, airtight storage volumes can be developed in geologic formations such as underground salt domes and saline aquifers. In conventional CAES, stored compressed air is released through a modified gas turbine that uses approximately one-third the natural gas of a conventional turbine, making CAES a hybrid storage/generation technology. Conventional CAES is considered a fairly mature technology, based on well proven gas-turbine technology and with two plants operating for over two decades.<sup>55</sup> Two additional CAES plants are under development following ARRA funding to demonstrate the viability of CAES in different geologic environments.<sup>56</sup> Research is ongoing into adiabatic CAES that does not require natural gas combustion.

**Electrochemical Capacitors:** Some storage applications, including frequency regulation and power quality, prioritize power delivery over energy capacity; high-performance electrochemical capacitors are well suited here. Electrochemical capacitors are currently expensive, and their electrolytes are not optimized for high-voltage grid applications.<sup>57</sup> Further R&D can lead to the development of new materials for electrodes and electrolytes in supercapacitors. Improved materials can lower costs and raise the operating voltages of capacitors to make them more applicable for high power grid services.

**Flywheel Storage:** Flywheels are also well-suited for applications requiring high power. Flywheels have demonstrated very rapid response times, deep discharge cycles, and are very efficient (over 90% round-trip).<sup>58</sup> Their power densities are 5–10 times greater than batteries, with a very long cycle-life estimated to be over 100,000. However, flywheels suffer from low energy densities and high system costs.<sup>59</sup> Through ARRA, DOE has funded several multi-MW demonstrations of flywheel technology for frequency regulation.<sup>60</sup>

R&D in flywheel designs, along with new materials for the hub (the spinning mass), can raise the efficiency, lower system costs, and improve reliability. It may be possible for costs of flywheels to be reduced eight-fold from the current \$2,000/kW.<sup>61</sup>

Potential headroom for the battery technologies assessed in this section is summarized in Table .



**Table 20. Summary of Battery Storage Technologies’ Current Performance and Technical Headroom** Each battery storage technology has different design, structure, and operation, which limit their application for certain grid services. Metrics cited here are used to reflect those most important to their applications.

Technology	Metric	Current	Headroom
Lead-Carbon Batteries <sup>62</sup>	Cycle life	3,000 cycles	10,000 cycles
	Energy density	25-40 Wh/kg	70 Wh/kg
Lithium-Ion Batteries <sup>63</sup>	Cycle life	1,000–4,000 cycles	5,000 cycles
	Costs	\$1,000/kWh	\$500/kWh
Sodium Batteries <sup>64</sup>	Power density	100 W/kg	Mature
	Energy density	150–240 Wh/kg	Mature
	Costs	\$550/kWh	Mature
Flow Batteries <sup>65</sup>	Power density	50 mW/cm <sup>2</sup>	100 mW/cm <sup>2</sup>
	Energy density	10–20 Wh/kg	40 Wh/kg
	Costs	\$500/kWh	\$250/kWh

**Emerging Technologies and Breakthroughs:** There are a number of high-risk technologies that could transform grid-scale storage, but are currently in their infancy. Table lists those emerging technologies and breakthroughs, along with an indication of technical milestones that, if achieved, could justify continued R&D interest.

**Table 12. Breakthrough Technologies**

Breakthroughs	Description
Ambient Temperature Sodium-Based Batteries	Operation at ambient temperature will simplify the design and thus costs; sodium is low cost and more abundant compared to lithium
Nitrogen-Oxygen Batteries	Highest energy density by using N <sub>2</sub> and O <sub>2</sub> as anode and cathode; using ambient materials will be safe and low cost
Metal-Air Batteries	Low-cost metal negative electrode and positive air electrode for large energy capacity and low costs; can offer 10× energy density of Li-ion
Advanced Flow Batteries	New electrolyte chemistries, stack/cell designs, and electrode materials can reduce costs (2× with zinc-iron to <\$150/kWh)
Liquid Metal Batteries	Uses liquid metals for electrodes and molten salt as electrolyte; can have 10× current of high-end batteries
Next-Gen Lithium-Ion Batteries	Improved component materials will lower costs and improve safety; replace cobalt in cathode with manganese; replace electrolyte with solid polymeric material; higher energy densities with nano silicon-carbon composite electrode
Advanced Flywheels	Will have high energy density instead of just high power; incorporate new fiber and nano-materials into rotor composite for increased speed and energy density; hubless designs with magnetic nanoparticles can also increase strength

### 6.2.5 Policy Context

Grid-scale storage can help ensure system integrity with a generating mix that has a higher fraction of renewable energy resources. However, current market structures fail to capture value across the multiple services (Table 19) that many storage technologies can provide. That deficiency, combined with market and policy uncertainty in how to treat storage institutionally (e.g., Is it a generator? Can it sell

wholesale? Retail? Who regulates it?), has slowed innovation in, and the deployment of, grid-scale storage technologies.

### 6.2.6 Barriers

Energy storage technologies face a number of barriers to widespread deployment beyond the challenges in meeting performance and cost targets. These barriers include:

- **Market Structures:** Markets do not address or value storage and many of the services it can provide.
- **Limited Large-Scale Demonstrations:** Many storage technologies lack the performance data from real-world, large-scale demonstrations needed to inform utilities and regulators.
- **Lack of Standards and Models:** There is little effort to develop the necessary standards for comparative evaluation of storage technologies and models for use by grid planners.
- **Stakeholder Understanding:** Benefits of storage have not been established, clearly articulated, or communicated to key stakeholders.

Storage technologies require more performance data from real-world, large-scale demonstrations before they can be deployed widely.<sup>66</sup> Many of the current testing sites for storage cannot accommodate grid-scale systems, nor do they reflect real-world conditions.<sup>66</sup> This limits the size, scale, and fidelity of simulations that can be used to evaluate device cost, efficiency, durability, reliability, and safety. Testing and demonstration of various technologies in multiple applications and regions across the country are the foundation for data and analysis that will support commercialization. Information from existing demonstration projects (such as those funded by ARRA) can provide a firm foundation for the technologies demonstrated.

Today's analysis tools and models do not adequately incorporate grid storage and the services that it can provide. This limitation hampers R&D, as well as stakeholder understanding of storage and its benefits. Analysis of market and policy structures with validated models and tools enable the changes necessary for the commercial development and deployment of storage. System planners and engineers also need to understand how to compare storage technologies accurately against other supply, delivery, and demand-side options. The lack of testing standards and simulation models prevents cross-evaluation and the development of accurate performance specifications for energy efficiency, cost, and other key attributes.<sup>66</sup>

### 6.2.7 DOE History and Accomplishments

DOE development and demonstration funding for grid-scale energy storage ranged from \$2–\$4 million annually from 2005–2009 and was \$13.6 million in Fiscal Year 2010; funding has increased again to about \$20 million starting in 2011. ARRA provided \$185 million for the development and demonstration of grid-scale storage. These funds encouraged an additional \$585 million cost-share investment by the private sector to further develop and demonstrate these technologies.

DOE also supports basic and applied materials research and novel chemistries for grid-scale storage, partially through six Energy Frontier Research Centers.<sup>67</sup>

### 6.2.8 DOE Role

DOE's focus in grid storage is on its R&D capability and informational role. Building on existing capabilities ranging from modeling and simulation to testbeds, and leveraging data from large-scale storage demonstration projects funded by ARRA, DOE is uniquely positioned to measure, validate, and disseminate performance information for grid-integrated storage technologies.

The Department's scientific and experimental capabilities allow it to develop testing protocols for large-scale energy storage and standards for technology validation. By developing the analytic tools necessary to assess and predict value and service as a function of operation and location, the Department helps quantify the benefits of storage under various operating conditions and provide this information so that industry and regulators alike can fully assess the value of deployed storage capacity. The Department also lends its R&D capability to technical issues related to lead carbon, mixed electrolyte, and metallic, ionic, liquid-flow battery R&D to increase energy density, cycle life, and cost-effectiveness.

## 6.3 Grid Measuring, Modeling, and Control

“Software” has been an important part of electric grid operations and planning since the 1960s when the increasing complexity of the physical transmission system began to require models, algorithms, and operating tools. These tools improved understanding of the system and helped ensure reliable service while delivering electricity to consumers at the lowest cost. By design, the approach was compartmentalized along the operational and jurisdictional boundaries that characterized the electric system at the time. The grid was managed very conservatively—with wide operating margins and significantly under-utilized assets—because of limitations in the underlying sensing, communication, and computing technologies then available.

Today, “smart grid” technologies are moving toward dynamic optimization of the grid, from generators all the way to the customer. Deploying smart grid technologies can produce data of unprecedented quality and quantity, on all aspects of grid operations. As various stakeholders—generators, grid operators, consumers—exploit those data to understand, control, and forecast aspects of the grid in real-time, the electric power system will develop an unprecedented level of flexibility.

Smart grid technologies can address evolving challenges that include variable generation from renewable resources; uncertainty in load profiles resulting from distributed generation, demand response, and plug-in electric vehicles; reduced generation and transmission margins; evolving opportunities for, and valuation of, ancillary services; and cybersecurity. Such capabilities will allow economically optimal accommodation of changing generation and load, while supporting the affordability, power quality, and reliability required by consumers. However, this growing overlay of information technology on grid operations and control will require greater focus on security to mitigate the threat of cyber intrusion by those with nefarious intent.

Innovation along three pathways will facilitate this transformation:

- **Measurement and Controls:** Acquiring, sharing, and (real-time) processing of data throughout the electric system
- **Communications and Security:** Enabling a secure, resilient information backbone
- **Modeling and Analysis:** System understanding (primarily off-line) to support better grid operations, planning, markets, and policy making.

### 6.3.1 Measurement and Controls<sup>68</sup>

Improved awareness of, and control over, the grid system and its many components is central to a future smart grid. The ability to acquire, process, and act upon data will improve asset utilization, allow system operation closer to thermal, voltage and stability limits, and improve reliability. Enhanced real-time monitoring, operator awareness, adaptive relaying/protection, and automated network switching are important underlying capabilities.

#### 6.3.1.1 Context

Operating an electric grid requires continuous and real-time matching of energy supply with energy demand. Today’s U.S. electric system is operated by adjusting generator output to meet constantly changing system loads and responding immediately to system contingencies (with occasional re-

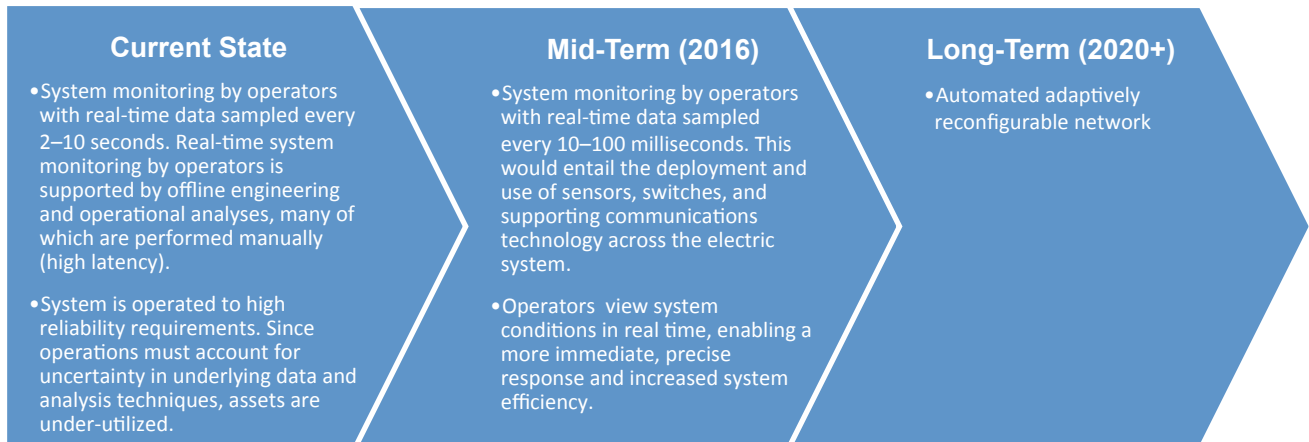
configuration of the transmission network). The approach is predicated on little to no control over electricity demand, so that generators alone must respond to changes.<sup>69</sup> This has been the operational paradigm since the inception of the utility industry in the late 1800s. Control is achieved through local control and monitoring system conditions (e.g., from energy management and SCADA systems) conveyed to a central control center, where a combination of automated controls and human decision making ensures system reliability at reasonable cost.

Today, the primary monitors of electric grid elements are current sensors (current transformers) and voltage sensors (voltage transformers and potential transformers). The SCADA system, which monitors current flow through lines, transformers, and other components into delivery points, typically makes measurements every 2 to 6 seconds. While that sampling rate has proven adequate for steady-state operations, it is insufficient to understand (or even detect<sup>70</sup>) the details of transient phenomena with timescales of milliseconds (one 60 Hz cycle is 16 milliseconds).<sup>71</sup>

Demand response has been used by some utilities for over 20 years to provide cost-effective temporal flexibility.<sup>72</sup> Interruptible contracts for commercial entities and industry, as well as direct load control schemes to manage residential water heating and air conditioning loads, have been very effective in peak-shifting. Other demand response programs being explored require AMI and dynamic pricing to allow customers to respond voluntarily to price signals.

The value and potential of this technology has not been fully assessed.

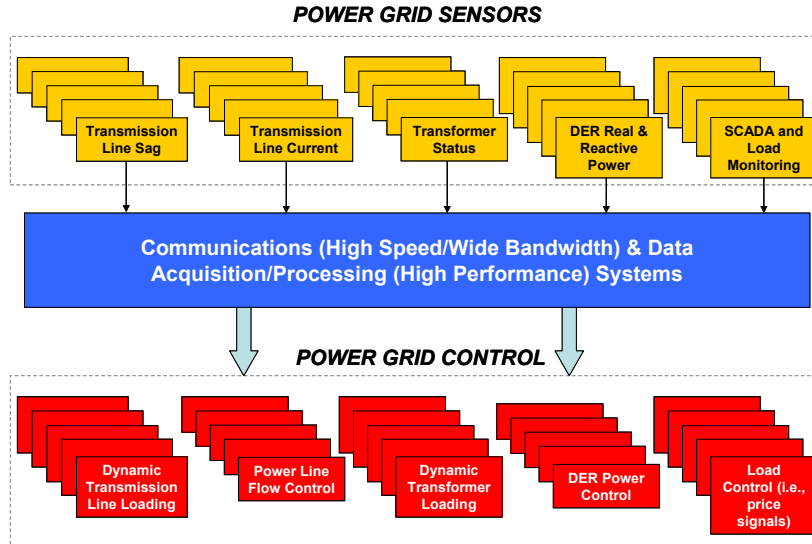
### 6.3.1.2 Trends and Technology Potential



**Figure 26. Pathway for Grid Modeling and Control** Note that some mid-term technologies are already employed by some operators.

Attributes of today’s operating methods include: (1) limited communication and sharing of operational data and system models across the broader community, (2) operational procedures and controls that are optimized to local needs/benefits rather than the broader system, (3) inaccurate system models, (4) poor communication between planning and operations models, and (5) reliance on offline (lengthy, non-real-time) analysis to set operating limits. The latter impacts the pace of innovation and the consumer’s ability to co-optimize their behavior/processes (in the case of large industry). A sensor network (such as the one shown in Figure 27) that provides time-synchronized dynamic data over the entire grid (e.g.,

voltages, currents, power flows, equipment performance, and weather) is a key enabler of the future grid’s real-time measurement and control system.<sup>73</sup> Although the private sector will continue to refine these sensors as applications evolve, the underlying sensor technologies are not expected (or needed) to evolve significantly.

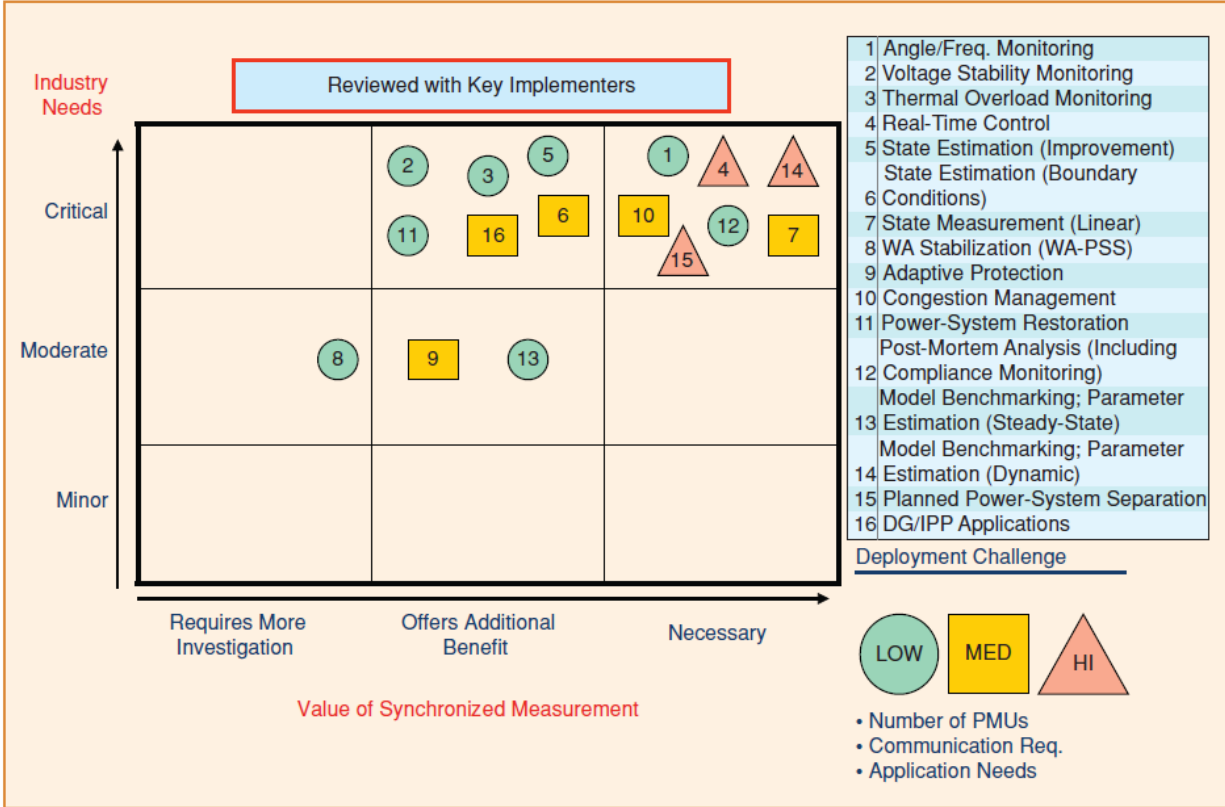


**Figure 27. Example of Sensors as an Enabling Technology for the Control of the Future Grid** Oak Ridge National Laboratory. (2004). *Advanced Sensors for Grid Modernization: White Paper on Issues and Benefits*. Oak Ridge, TN.

GPS time-synchronization technology allows temporally precise measurements of voltage, current, and frequency, typically sampled at 10 Hz (for GridEye Frequency Disturbance Recorders) to 30 Hz (for PMUs).<sup>74</sup> Sampling rates are expected to rise to 120 Hz as the new PMU infrastructure comes online.<sup>75</sup> While today the GridEye and PMU data are used for post-event analysis, the technology is suitable for matching energy supply and demand in real time, providing insights (through more dynamic measurement) critical to system stability.

Beyond 120 Hz, sampling is the digital fault recorder domain, with sampling rates up to 8 kHz.<sup>76</sup> Integrating and harmonizing datasets across the various time resolutions into a consolidated toolkit will create a unified view of the system, with insights into the instantaneous behavior of the grid, the generators, and the loads.

Through the Smart Grid Investment Grant program, DOE is supporting the deployment of more than 800 PMUs across the Nation—a five-fold increase of the presently installed base.<sup>77</sup> That network will provide time-synchronized information at the transmission level across entire interconnections. The primary need now is for advanced software tools and platforms that can fully exploit the information that will soon become available from this network. Today’s PMU-based applications have focused on wide-area monitoring and forensic analysis of grid disturbances,<sup>78</sup> while future applications will likely include real-time control of wide-area networks,<sup>79</sup> automatically and dynamically balancing supply side variability with demand side flexibility (see Figure 28).



**Figure 28. Phasor-Based Applications** Adapted with permission from: Novosel, D., Madani, V., Bhargava, B., Vu, K., and Cole, J. (2008). Dawn of the Grid Synchronization. Page 58, Figure 9. IEEE Power & Energy Magazine, Volume 6, Issue 1. Can be purchased from [http://ieeexplore.ieee.org/xpl/freeabs\\_all.jsp?arnumber=4412940](http://ieeexplore.ieee.org/xpl/freeabs_all.jsp?arnumber=4412940)

**Table 22. Opportunities for Technology Improvement**

Area	Action
Sensor Deployment including phasors (after ARRA)	Expand, as necessary, sensor network to enhance situational visibility and to improve system flexibility
Control Methodologies and Protection Schemes	Demonstrate concepts that enable automated controls for transmission and demand response and that increase transmission system throughput
Operator Tools	Develop and demonstrate phasor-based technology platforms for real-time operations and power system planning, such as inter-area oscillation detection and voltage stability monitoring
Deployment/Adoption of Tools and Methodologies	On an ongoing basis, adopt emerging real-time tools and platforms that analyze electric system data and can maintain reliability by balancing (dynamically and automatically) demand-side flexibility and supply-side variability
Data Sharing	Establish a method for sharing data across the electric system and its various stakeholders
Standards	Facilitate the adoption of interoperability standards

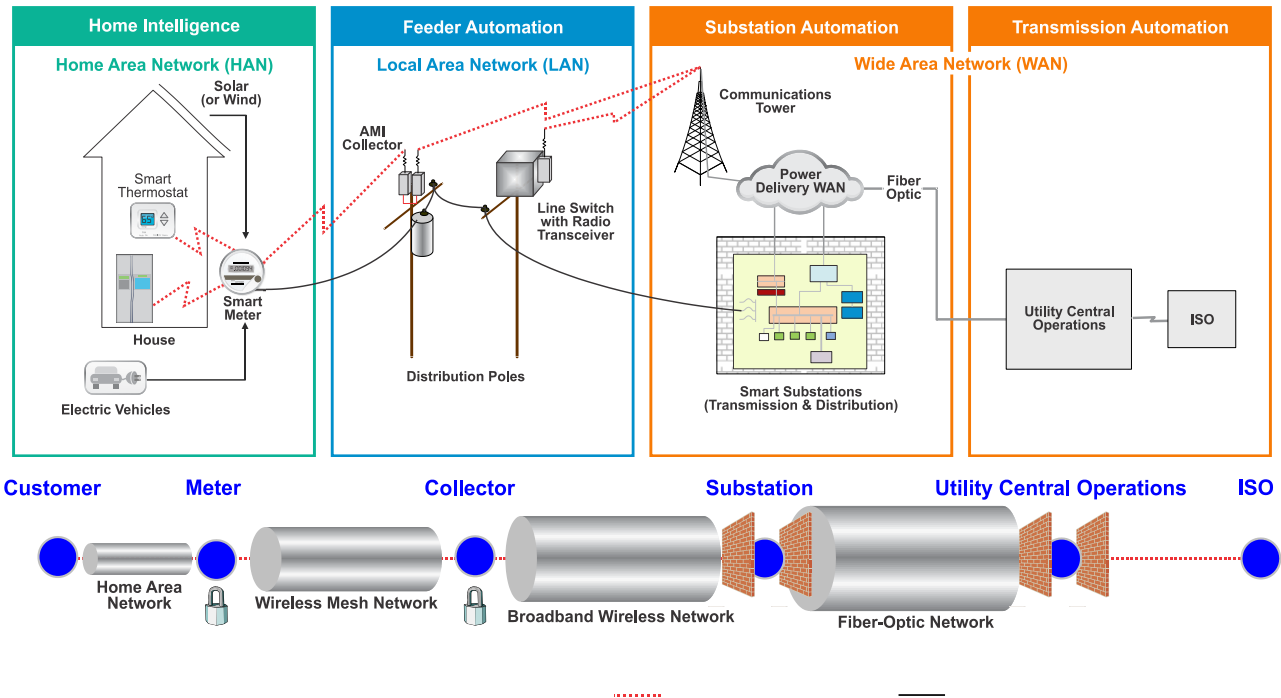
### 6.3.2 Communications and Security

In 2005, energy owners and operators, in collaboration with DOE, developed a technology strategy for better securing energy control systems going forward. The resulting *Roadmap to Secure Control Systems*

*in the Energy Sector (2006)*<sup>80</sup> lays out a vision to research, develop, deploy, and maintain energy delivery systems that can survive an intentional cyber assault without the loss of critical function. Updated in 2011 as the *Roadmap to Achieve Energy Delivery Systems Cybersecurity*,<sup>81</sup> it provides the strategic framework developed by industry through this effort.

Cybersecurity for energy delivery systems has emerged as one of the Nation’s most serious grid modernization and infrastructure protection issues. Intelligence reports indicate that cyber adversaries are becoming increasingly targeted, sophisticated, and better financed. The Stuxnet worm—designed to attack a specific control system—underscores the seriousness of targeted cyber attacks on energy control systems. The *Roadmap* acknowledges that the energy sector must research, develop, and deploy new cybersecurity capabilities faster than adversaries can launch new attack tools and techniques. With so many vital services and critical infrastructures interconnected with energy systems, a large-scale cyber attack could disrupt power and cause cascading failures, affecting the economy and public safety of large communities. Operational reliance (and automatic system controls) based on real-time data, such as GPS technology, reinforces the need to address potential cybersecurity vulnerabilities—assuring the signal is bona fide and always available when needed.

In addition to sensors and controls, the future grid will require wide bandwidth, high-speed, and secure communications. Current smart grid communication technologies and protocols are evolving from legacy devices using serial links to routable and wireless communications. Cybersecurity and privacy protections become more important as data availability and consumer engagement increase.



**Figure 29. Representative Communications Architecture** AMI = automated metering infrastructure, ISO = independent system operator.

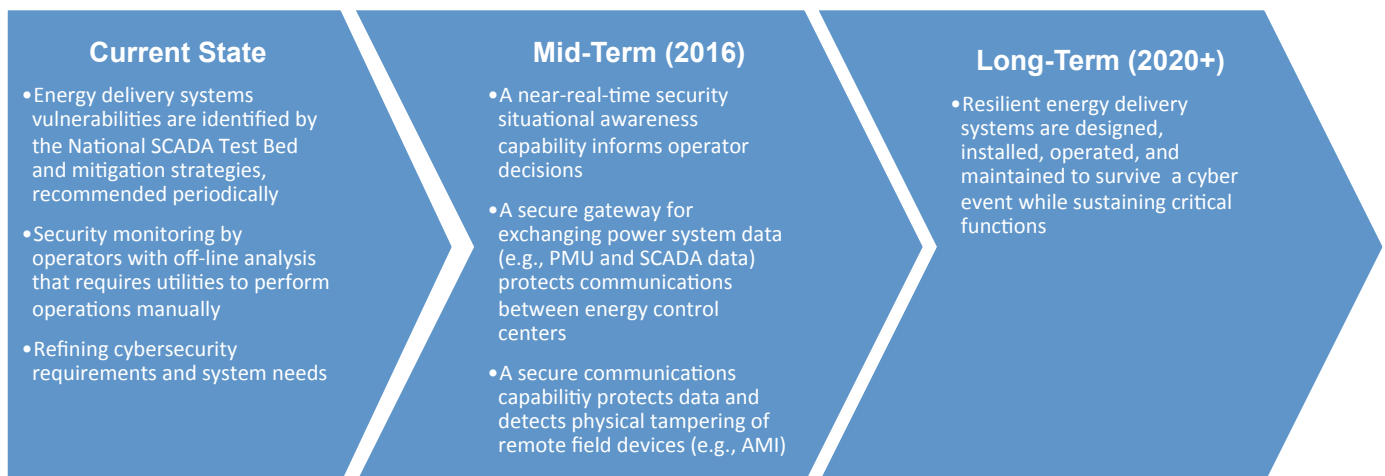


Figure 29 illustrates notional communications architecture. Energy control systems are uniquely designed and operated to control real-time physical processes that deliver continuous and reliable power to support national and economic security. The computers and networks that control our Nation’s power grid are very different from those on our desks in several important ways.

- Energy delivery system communications must be fast. Data communications in substations require responses within 4 milliseconds for protective relaying, while wide-area situational awareness of transmission lines requires communications within a second. A cascading power failure might be prevented by changing the path of power flows within a tenth of a second.
- Energy delivery system computers and networks must always be available. They cannot be patched or upgraded without extensive testing and validation, normally planned weeks or months in advance, to ensure that the change does not jeopardize power system operations. Often the vendor’s warranty for these systems prevents the change from being implemented at all. Energy delivery systems include decades-old legacy components with limited computation and bandwidth. As these legacy devices perform their function well, there is no immediate business case to replace them, but they were designed decades ago when the Internet did not exist and cybersecurity was not a central concern.
- Energy delivery systems have predictable communication patterns and predictable behavior, so they can be designed to allow only expected actions and deny others. In contrast desktop cybersecurity measures are designed to allow any actions not explicitly denied. Energy delivery systems require complex access controls, including secure remote access for maintenance and operations support. Multiple workers need different levels of access to the same device, and these access needs can change depending on operating mode. Most importantly, access controls must never jeopardize system availability, which could create problems during an emergency response. Energy delivery systems have critical components that are widely distributed across extensive territories, and are, by necessity, located outdoors, where they could be vulnerable to physical tampering. Finally, control systems security involves ensuring the timely and proper operation of cyber-physical devices (e.g., opening a digital relay or changing settings on transformers). Thus, cyber attacks on control systems can cause physical damage to expensive electric grid components like generators that can take months to replace.<sup>82</sup>

### 6.3.2.1 Trends and Technology Potential

Figure 30. Pathway for Security and Communications



In 2011, a partnership of energy infrastructure cybersecurity leaders from government and industry developed the *Roadmap to Achieve Energy Delivery Systems Cybersecurity*, which outlines a strategic framework to design, install, operate, and maintain energy delivery systems that can survive an intentional cyber assault without the loss of critical function.

The updates of the *Roadmap* included:

**Changing Landscape:** New infrastructure components and the increased use of mobile devices in energy infrastructure environments introduce new digital vulnerabilities and additional physical access points. New applications such as managing energy consumption involve new stakeholders (e.g., retail service providers, energy and financial market traders, industrial, commercial, and residential consumers) and require protection of private customer and energy market information. The roadmap has a broad focus on energy delivery systems, which include control systems, smart grid technologies, and the interface of cyber and physical security—where physical access to system components can impact cybersecurity.

**Advancing Threat Capabilities:** Energy delivery systems are vulnerable to cyber attack and the threat is real. Adversaries have pursued progressively destructive means to exploit flaws in system components, telecommunication methods, and common operating systems found in modern energy delivery systems with the intent to infiltrate and sabotage them.

**Building on Successes and Addressing Gaps:** *Roadmap* update participants identified the following new priorities: enhancing vulnerability disclosure between government, researchers, and industry; optimizing the limited time and resources of stakeholders through innovative partnerships; improving the metrics of progress; and addressing gaps to further advance cybersecurity technologies.

**Emphasizing a Culture of Security:** While regulations or standards can be used to raise security baselines, a focus on compliance alone will not produce resilient energy delivery systems. A culture focused on security that permeates the sector is needed. Social and human factors are particularly important because cybersecurity is a sensitive issue in which trust and careful stewardship are paramount. Sustaining a secure and resilient energy infrastructure will not be possible without people trained in developing and implementing the best available security policies, procedures, and technologies tailored to the energy delivery systems operational environment.

Critical future activities fall primarily into two themes: (1) building trusted systems from un-trusted components, and (2) achieving system resiliency by maintaining critical functions in the midst of a cyber event/incident. Because the threat landscape is constantly evolving, the energy sector security posture must also evolve dynamically. Privacy protection of customer energy-usage data is of the utmost importance. Greater access to system data will be required as the electricity consumer becomes an integrated part of the control system. Advanced data collection, communication, and information sharing capabilities are being rigorously secured to protect energy-consumer privacy. In addition, diverse types of energy-sector data—financial and operational—travel across smart grid communications links, are owned by different parties, and have different security requirements.

A strategic research focus into tailored trustworthy spaces fits naturally within the smart grid cybersecurity arena where diverse data with differing cybersecurity priorities travel together in multi-party data streams. As the type and context of data change, cybersecurity solutions capable of real-time responses that balance confidentiality, integrity, and availability become more valuable. As an example, cybersecurity protections in place during normal operations may be dynamically tailored to the needs of emergency responders.

Many entities have an interest in smart grid standards and interoperability work. Progress along the path of standardization and interoperability is accelerating and increasingly measurable. The Smart Grid Interoperability Panel (SGIP), a public-private partnership coordinated by the National Institute of Standards and Technology, published its first interoperability framework and roadmap in 2010, which identified key standards and gaps that required attention, as well as the evolution plan of the SGIP and a testing and conformance program. Version 2 of this framework has been recently published, marking progress to date and setting new goals.<sup>83</sup> SGIP is also assembling a catalog of standards that will encompass, over time, relevant standards measured against common criteria such as cybersecurity, architectural position, and openness.

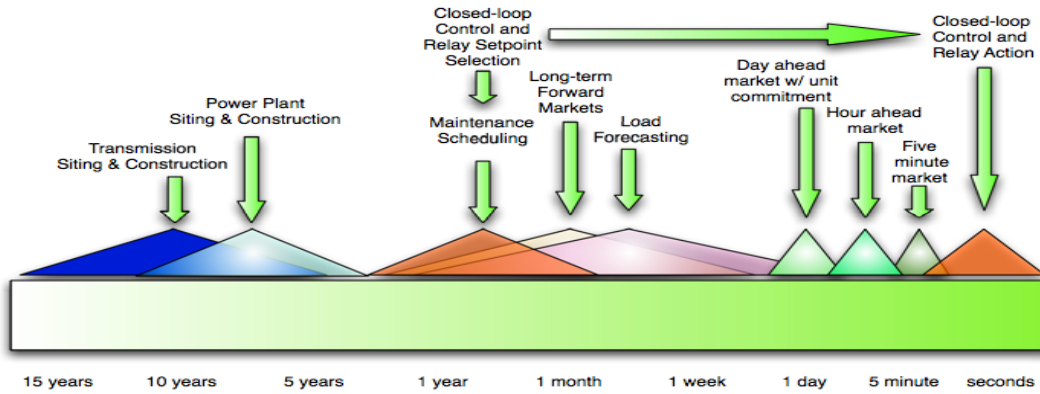
Outside of the SGIP, the GridWise Architecture Council is working to create an Interoperability Maturity model that will be a practical benchmarking and goal-setting tool for organizations across the smart grid. In addition, the North American Electric Reliability Corporation Smart Grid Task Force has provided a comprehensive *Reliability Considerations from Integration of Smart Grid* report and a follow-on Cybersecurity working group evaluating pathways for harmonizing and coordinating common practices, regulations, and standards. Furthermore, in 2011, the National Science and Technology Council outlined unifying policy strategies that would enable a smart grid.<sup>84</sup>

### 6.3.3 Modeling and Analysis

Integrating large amounts of variable generation, mass deployment of plug-in vehicles, and actively engaged end-users will all increase temporal and spatial uncertainty in grid operations. Market structures to attract and retain new sources of firming generation add additional modeling and analysis requirements. Innovative high-fidelity real-time modeling and simulation tools will be required for better grid operations, planning, and policy support.

#### 6.3.3.1 Context

Modeling and analysis of electric systems and markets cover both physical and behavioral (i.e., human) processes. These processes have different time scales and geographic scopes (Figure 31).



**Figure 31. Time Scales Over Which Various Processes in Electric System and Markets Operate** Source: Graphic by C. DeMarco. Presented at the Computational Needs for the Next Generation Electric Grid Proceedings: April 19-20, 2011. Ferris, M. (2011). *White Paper: Coupled Optimization Models for Planning and Operation of Power Systems on Multiple Scales*. Page 2-2. Madison, WI: University of Wisconsin-Madison.

There is limited potential for human interactions on the shortest time scales (seconds). Modeling and analysis here is focused on understanding the physical characteristics of the electric system and the actions of automatic controls. Human decision making has a more significant role on longer time scales, so that modeling and analysis of human decision making figures prominently in understanding how the electric system and markets perform.

Long-standing classes of modeling and analysis tools, listed from the shortest to longest time scales, include:

- The Electro-Magnetic Transients Program for the very shortest time scales of micro- to milliseconds. These are applied to both high-voltage transmission and low-voltage distribution systems.
- Dynamic simulation tools for the high-voltage transmission system for time scales of milliseconds to seconds.
- Positive sequence (i.e., balanced three phase) load flow tools for steady-state conditions on the transmission system.
- Single and multi-area generation unit-commitment and dispatch simulation tools that seek to minimize the total production cost of meeting aggregated customer demands on an hourly or sub-hourly basis, while respecting transmission limits (with varying treatments of the dynamic nature of these limits) and simulating contingencies.
- Optimal generation (and, to a lesser extent, transmission) expansion planning tools that look ahead a decade or more.

The basic algorithms underlying all of these models were developed in the 1960s and early 1970s. These models capture the economic dispatch of the electrical system and match generation and load, while adhering to the underlying physical constraints associated with power flow (e.g., Kirchoff's laws).

Over the past two decades, computing speeds and resources have increased impressively, allowing more computationally intensive programs. The power industry has begun to apply state-of-the-art optimization techniques in its operation and planning processes. Widely used optimizers have achieved

dramatic performance improvements.<sup>85</sup> Although challenges remain in solving extra-large-scale problems with existing modeling and computing techniques, many regional system operators like Pennsylvania New Jersey Maryland Interconnection have begun to use more advanced mix-integer programming-based planning tools. Mix-integer programming-based tools replace traditional Lagrangian relaxation-based tools in a number of application software products, ranging from capacity market, day-ahead market, and reliability commitment to time-coupled, real-time dispatch.<sup>86</sup> In addition, over the last decade, DOE has invested heavily in the development of advanced optimization solvers and has investigated related opportunities in advanced grid modeling and simulation.<sup>87</sup>

### 6.3.3.2 Trends and Technology Potential

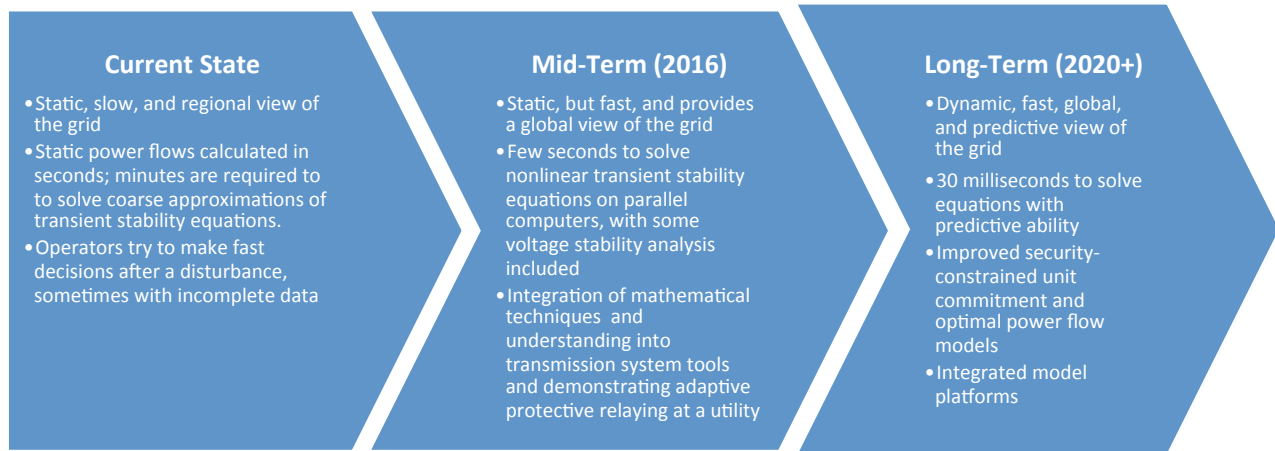


Figure 32. Pathway for Modeling and Analysis

Since these modeling and analysis tools were first introduced, the electricity industry has experienced three major changes that stress the current suite of modeling and analysis tools:

- **Structural:** In regions where there are markets, transmission and generation are no longer planned and operated on an integrated basis; market forces, not utility planners, determine the location and types of new generation that will be built. Optimal generation expansion tools do not adequately capture these decisions. Institutional mechanisms for coordinating planning of new (especially, inter-regional) transmission are in their infancy, with many unresolved issues (such as cost-allocation and siting). The current generation of unit-commitment and dispatch tools that minimize production cost cannot represent competitive wholesale electricity markets. Simultaneously, many parts of the United States still operate vertically integrated utilities, so market-based solutions must co-exist with more traditional company structures.
- **Resource:** Growing generation from variable renewable sources requires transmission from remote sites that cannot be modeled traditionally, as policy, rather than techno-economic, constraints are dominant. Variable renewable generation also presents new and unfamiliar operational challenges that cannot be captured in the hourly time step of current simulation tools.
- **Technology:** The traditional assumption of fixed or price-inelastic loads inherent in some planning tools is no longer appropriate. Customers are becoming empowered to make decisions

that will influence how the grid is operated in response to either price or control signals in near real time.

Traditional metrics for computational research (such as time to solution or size of problem) are of lesser importance in advancing grid modeling and analysis. Some key challenges are more basic and reflect the difficulty in capturing phenomena, such as (a) competitive suppliers in wholesale electricity markets; (b) millions of consumers (and their smart grid appliances, building and process controls) responding to dynamic prices or dispatch commands; and (c) electricity generators responding to uncertain future national energy and environmental policies.

From the perspective of maintaining system reliability, the business case for modeling and analysis improvements will continue to hinge on the requirements set by mandatory reliability rules. Changes in these rules will have direct implications for the modeling and analysis capabilities that industry will be expected to employ. For example, the “N-1” philosophy—where the system is managed so that operation can continue through any single potential outage—has served the industry very well,<sup>88</sup> but assigns every potential outage the same likelihood of occurring. Risks could be better managed, and assets better prioritized, by assigning probabilities to the various contingencies. Reliability rules depend on advances in modeling and simulation techniques to support potential rules such as “N-k”—or multiple outage—contingency analysis criteria.

Over the last several years, DOE has held workshops to bring together the mathematics, computation, and power system communities, along with industry and software tool developers. These venues play an important role not only in improving the tools themselves, but also in ensuring that the research is addressing emerging problems with solutions that the industry can use effectively. This philosophy extends further to the role of operator simulation environments as a platform for validation of the impact of the tools and techniques on decision-making processes. Decision support, cognitive task analysis, and visualization (i.e., human factors side of planning and operations) will be important to the effective implementation of new tools and models.

Emerging areas for future electric system and market modeling and analysis research include:

- Coordinating generation and transmission expansion. Challenges include: long lead times for transmission compared to generation, the lumpiness of both transmission and generation assets, the enabling role that transmission can play in creating new markets for generation, and the difficulty of representing the investment decisions in competitive markets.
- Integration of variable renewable generation. Integration presents both steady state and transient stability challenges due to the inherent variability and uncertainty of renewable generation output in combination with operator decision making (including operator errors) in starting up generation and managing ancillary services.
- Aggregate behavior of electricity consumers responding to dynamic prices or dispatch signals from grid operators. Challenges include the multitude of decision-making criteria/objectives and capabilities of consumers, the many types (and latencies) of information that will inform these decisions, and the degree of automation and/or sophistication of the technologies through which these decisions will be translated into actions.

- Framework for data integration. State estimators, SCADA, SynchroPhasor measurements, dynamic models of the system, and simulation programs co-exist, but they are not fully integrated into operational or planning models. Data integration will improve system model accuracy through model verification/tuning.
- Operator interface. Effective tools must take into account how they are used by grid operators, and should provide decision support, cognitive task analysis, and visualization.

All of these areas are opportunities for research.

#### 6.3.4 DOE Role

The Department's role in grid software is focused on informational and convening authorities. Recent deployments of advanced and time-synchronized sensing devices and the availability of high-speed data communications systems also point to the importance of DOE's capabilities in modeling, simulation, and cybersecurity.

Leveraging the PMU, smart meter, and other high-quality data acquisition device deployment activities under ARRA, the Department is cataloging, validating, and widely disseminating data, while respecting security, privacy, and business sensitivity limitations. The Department has unique capabilities to analyze complex systems—including developing and validating models—supported by world-leading high-performance computing facilities. DOE applies that capability to improving grid models for more effective grid operation and planning. The Department convenes the power industry and the high-performance computing community to share knowledge and resources, advancing the industry's understanding of the technical opportunities for the next generation analytic toolsets.

In its role as a convener, the Department strengthens approaches to transmission planning through proactive support of stakeholders in their broad set of regional planning activities. The Department is continuing to develop capabilities in modeling and analytics to support stakeholders as they develop long-term regional policies and plans.

DOE's extensive capabilities in information security and computing are valuable assets for the power grid community in the development of cybersecurity technologies and best practices. The federal emphasis on smart grid interoperability standards is on collaboration, acceleration, interoperability, stakeholder balance, technical coexistence, and engagement.

---

<sup>1</sup> The National Academies. (2009). *America's Energy Future: Technology and Transformation*. Washington, DC: National Academies Press.

- 
- <sup>2</sup> The National Academies. (2009). *America's Energy Future: Technology and Transformation*. Washington, DC: National Academies Press.
- <sup>3</sup> Energy Information Administration. (2011). *How much electricity is lost in transmission and distribution in the United States?* Washington, DC. Accessed at <http://www.eia.gov/tools/faqs/faq.cfm?id=105&t=3>
- <sup>4</sup> National Academy of Engineering. (2003). *Greatest Engineering Achievements of the 20<sup>th</sup> Century*. Washington, DC. Accessed at <http://www.greatachievements.org/?id=2949>
- <sup>5</sup> Transforming America's Power Industry: The Investment Challenge 2010-2030. (2008). Referenced from The National Academies. (2009). *America's Energy Future: Technology and Transformation*. Washington, DC: National Academies Press.
- <sup>6</sup> Power Delivery System of the Future: A Preliminary Study of Costs and Benefits. (2004). Referenced from The National Academies. (2009). *America's Energy Future: Technology and Transformation*. Washington, DC: National Academies Press.
- <sup>7</sup> Electric Power Research Institute. (2004). *Power Delivery System of the Future: A Preliminary Study of Costs and Benefits*. Palo Alto, CA.
- <sup>8</sup> Bartley, W. (2003). *Analysis of Transformer Failures*. Hartford, CT: The Hartford Steam Boiler Inspection and Insurance Co.
- <sup>9</sup> Oak Ridge National Laboratory. (2003). "A White Paper: Materials Research and Development for Electric Transmission and Distribution: What Could Make a Difference?" Oak Ridge, TN.
- <sup>10</sup> Oak Ridge National Laboratory. (2005). *Power Electronics for Distributed Energy Systems and Transmission and Distribution Applications*. (ORNL/TM-2005/230). Oak Ridge, TN.
- <sup>11</sup> U.S. Department of Energy. (2005). "GridWorks Multi-Year Plan." Washington, DC. Archived at <http://sites.energetics.com/gridworks/>
- <sup>12</sup> Oak Ridge National Laboratory. (2005). *Power Electronics for Distributed Energy Systems and Transmission and Distribution Applications*. (ORNL/TM-2005/230). Oak Ridge, TN.
- <sup>13</sup> Oak Ridge National Laboratory. (2005). *Power Electronics for Distributed Energy Systems and Transmission and Distribution Applications*. (ORNL/TM-2005/230). Oak Ridge, TN.
- <sup>14</sup> Oak Ridge National Laboratory. (2005). *Power Electronics for Distributed Energy Systems and Transmission and Distribution Applications*. (ORNL/TM-2005/230). Oak Ridge, TN.
- <sup>15</sup> Oak Ridge National Laboratory. (2005). *Power Electronics for Distributed Energy Systems and Transmission and Distribution Applications*. (ORNL/TM-2005/230). Oak Ridge, TN.
- <sup>16</sup> Oak Ridge National Laboratory. (2003). "A White Paper: Materials Research and Development for Electric Transmission and Distribution: What Could Make a Difference?" Oak Ridge, TN.
- <sup>17</sup> Oak Ridge National Laboratory. (2005). *Power Electronics for Distributed Energy Systems and Transmission and Distribution Applications*. (ORNL/TM-2005/230). Oak Ridge, TN.
- <sup>18</sup> Oak Ridge National Laboratory. (2005). *Power Electronics for Distributed Energy Systems and Transmission and Distribution Applications*. (ORNL/TM-2005/230). Oak Ridge, TN.
- <sup>19</sup> U.S. Department of Energy. (2011) *Power Electronics Research and Development Program Plan*. Washington, DC.
- <sup>20</sup> National Institute on Standards and Technology. (2010). *NIST Framework and Roadmap for Smart Grid Interoperability Standards, Release 1.0*. Gaithersburg, MD.
- <sup>21</sup> National Renewable Energy Laboratory. (2008). *Renewable Systems Interconnection: Executive Summary*. (NREL/TP-581-42292). Golden, CO. Accessed at <http://www.nrel.gov/docs/fy08osti/42292.pdf>
- <sup>22</sup> U.S. Department of Energy. (2008). *Solar Energy Grid Integration System – ES Program Concept Paper*. Washington, DC. Accessed at [http://www1.eere.energy.gov/solar/pdfs/segis\\_concept\\_paper.pdf](http://www1.eere.energy.gov/solar/pdfs/segis_concept_paper.pdf)
- <sup>23</sup> U.S. Department of Energy and Federal Energy Regulatory Commission. (2009). *Memorandum of Understanding Between U.S. Department of Energy and Federal Energy Regulatory Commission*. Washington, DC.
- <sup>24</sup> U.S.-Canada Power System Outage Task Force. (2004). *Final Report on the August 14, 2003 Blackout in the United States and Canada*. Washington DC: Department of Energy. Accessed at <https://reports.energy.gov/>
- <sup>25</sup> International Energy Agency. (2011). *Smart Grids Technology Roadmap*. Paris, France. Accessed at [http://www.iea.org/papers/2011/smartgrids\\_roadmap.pdf](http://www.iea.org/papers/2011/smartgrids_roadmap.pdf)
- Electricity Advisory Committee. (2009). *Keeping the Lights on in a New World*. Washington, DC. Accessed at [http://energy.gov/sites/prod/files/oeprod/DocumentsandMedia/adequacy\\_report\\_01-09-09.pdf](http://energy.gov/sites/prod/files/oeprod/DocumentsandMedia/adequacy_report_01-09-09.pdf)



- 
- U.S. Department of Energy. (2004). *National Electric Delivery Technologies Roadmap*. Washington, DC. Accessed at <http://energy.gov/oe/downloads/national-electric-delivery-technologies-roadmap-transforming-grid-revolutionize>
- Electric Power Research Institute. (2003). *Electricity Technology Roadmap*. Palo Alto, CA. Accessed at <http://mydocs.epri.com/docs/CorporateDocuments/StrategicVision/Roadmap2003.pdf>
- <sup>26</sup> Idaho National Laboratory. (2012). “National SCADA Test Bed Program.” Idaho Falls, ID. Accessed at <http://www.inl.gov/scada/>
- <sup>27</sup> See the *Report of the QTR* for a more extensive discussion of demand response and the role it plays in the system.
- <sup>28</sup> Electric Power Research Institute. (2004). *Power Delivery System of the Future: A Preliminary Study of Costs and Benefits*. Palo Alto, CA.
- <sup>29</sup> Boston Consulting Group. (2011). *Revisiting Energy Storage*. Boston, MA. Accessed at <http://www.bcg.com/documents/file72092.pdf>
- <sup>30</sup> Key, Kamath, Mears, and Gotschall. (2003). *EPRI-DOE Handbook of Energy Storage for Transmission and Distribution Applications*. Electric Power Research Institute. Palo Alto, CA. Report No. 1001834, p. 1-1. Accessed at <http://www.sandia.gov/ess/publications/ESHB%201001834%20reduced%20size.pdf>
- <sup>31</sup> Electricity Advisory Committee. (2011). *Energy Storage Activities in the United States Electricity Grid*. p.3. Washington, DC. Accessed at [http://energy.gov/sites/prod/files/oeprod/DocumentsandMedia/FINAL\\_DOE\\_Report-Storage\\_Activities\\_5-1-11.pdf](http://energy.gov/sites/prod/files/oeprod/DocumentsandMedia/FINAL_DOE_Report-Storage_Activities_5-1-11.pdf)
- <sup>32</sup> Nexight Group. (2010). *Electric Power Industry Needs for Grid-Scale Storage Applications*. p. 9. Albuquerque, NM. Accessed at [http://energy.tms.org/docs/pdfs/Advanced\\_Materials\\_for\\_SEES\\_2010.pdf](http://energy.tms.org/docs/pdfs/Advanced_Materials_for_SEES_2010.pdf)
- <sup>33</sup> U.S. Department of Energy. (2010). *Grid Storage Report: Report to Congress*. Washington, DC.
- <sup>34</sup> Electric Power Research Institute. (2010). *Electricity Energy Storage Technology Options: A White Paper Primer on Applications, Costs, and Benefits*. Report No. 1020676. Palo Alto, CA. Accessed at [http://www.electricitystorage.org/images/uploads/static\\_content/technology/resources/ESA\\_TR\\_5\\_11\\_EPRIS\\_storageReport\\_Rastler.pdf](http://www.electricitystorage.org/images/uploads/static_content/technology/resources/ESA_TR_5_11_EPRIS_storageReport_Rastler.pdf)
- <sup>35</sup> Suul, J. A. (2009). “Variable Speed Pumped Storage Hydropower Plants for Integration of Wind Power in isolated Power Systems.” *Renewable Energy*. T.J. Hammons (Ed.). Accessed at [http://www.intechopen.com/source/pdfs/9345/InTech-Variable\\_speed\\_pumped\\_storage\\_hydropower\\_plants\\_for\\_integration\\_of\\_wind\\_power\\_in\\_isolated\\_power\\_systems.pdf](http://www.intechopen.com/source/pdfs/9345/InTech-Variable_speed_pumped_storage_hydropower_plants_for_integration_of_wind_power_in_isolated_power_systems.pdf)
- <sup>36</sup> *Pumped Storage Hydropower: Summary Report on a Summit Meeting Convened by Oak Ridge National Laboratory, the National Hydropower Association, and the Hydropower Research Foundation*. Meeting held in Washington, DC, on September 20–21, 2010. Accessed at <http://www.esd.ornl.gov/WindWaterPower/PSHSummit.pdf>
- <sup>37</sup> Energy Information Administration. (2009). “Form EIA-860, “Annual Electric Generator Report,” – Generator (Existing) File.” Washington, DC. Accessed at <http://www.eia.gov/cneaf/electricity/page/capacity/existingunitsbs2008.xls>
- <sup>38</sup> Electric Power Research Institute. (2010). *Electricity Energy Storage Technology Options: A White Paper Primer on Applications, Costs, and Benefits*. p. 4–2. Report No. 1020676. Palo Alto, CA. Accessed at [http://www.electricitystorage.org/images/uploads/static\\_content/technology/resources/ESA\\_TR\\_5\\_11\\_EPRIS\\_storageReport\\_Rastler.pdf](http://www.electricitystorage.org/images/uploads/static_content/technology/resources/ESA_TR_5_11_EPRIS_storageReport_Rastler.pdf)
- <sup>39</sup> U.S. Department of Energy. (2011). *Energy Storage Program Planning Document*. Washington, DC. Accessed at [http://energy.gov/sites/prod/files/oeprod/DocumentsandMedia/OE\\_Energy\\_Storage\\_Program\\_Plan\\_February\\_2011v3.pdf](http://energy.gov/sites/prod/files/oeprod/DocumentsandMedia/OE_Energy_Storage_Program_Plan_February_2011v3.pdf)
- U.S. Department of Energy. (2010). *Advanced Materials and Devices for Stationary Electrical Energy Storage Applications*. Washington, DC. Accessed at [http://energy.gov/sites/prod/files/oeprod/DocumentsandMedia/AdvancedMaterials\\_12-30-10\\_FINAL\\_lowres.pdf](http://energy.gov/sites/prod/files/oeprod/DocumentsandMedia/AdvancedMaterials_12-30-10_FINAL_lowres.pdf)

- Basic Energy Science Advisory Committee. (2010). *Science for Energy Technology: Strengthening the Link between Basic Research and Industry*. Washington, DC: Department of Energy. Accessed at [http://science.energy.gov/~media/bes/pdf/reports/files/set\\_rpt.pdf](http://science.energy.gov/~media/bes/pdf/reports/files/set_rpt.pdf)
- <sup>40</sup> Electric Power Research Institute. (2003). *EPRI-DOE Handbook of Energy Storage for Transmission and Distribution Applications*.
- <sup>41</sup> Fernandez, M., Valenciano, J., Trinidad, F., and Munoz, N. (2010). "The use of activated carbon and graphite for the development of lead-acid batteries for hybrid vehicle applications." *Journal of Power Sources*. Vol. 195(14):4458-4469.
- <sup>42</sup> Nexight Group. (2010). *Advanced Materials and Devices for Stationary Electrical Energy Storage Applications*. p. 18. Albuquerque, NM. Accessed at [http://energy.tms.org/docs/pdfs/Advanced\\_Materials\\_for\\_SEES\\_2010.pdf](http://energy.tms.org/docs/pdfs/Advanced_Materials_for_SEES_2010.pdf)
- <sup>43</sup> Fernandez, M., Valenciano, J., Trinidad, F., and Munoz, N. (2010). "The use of activated carbon and graphite for the development of lead-acid batteries for hybrid vehicle applications." *Journal of Power Sources*. Vol. 195(14):4458-4469.
- <sup>44</sup> Nexight Group. (2010). *Advanced Materials and Devices for Stationary Electrical Energy Storage Applications*. p. 19. Albuquerque, NM. Accessed at [http://energy.tms.org/docs/pdfs/Advanced\\_Materials\\_for\\_SEES\\_2010.pdf](http://energy.tms.org/docs/pdfs/Advanced_Materials_for_SEES_2010.pdf)
- <sup>45</sup> Electric Power Research Institute. (2010). *Electricity Energy Storage Technology Options: A White Paper Primer on Applications, Costs, and Benefits*. Report No. 1020676. p. 4–17 and 4–18. Palo Alto, CA. Accessed at [http://www.electricitystorage.org/images/uploads/static\\_content/technology/resources/ESA\\_TR\\_5\\_11\\_EPRIS\\_storageReport\\_Rastler.pdf](http://www.electricitystorage.org/images/uploads/static_content/technology/resources/ESA_TR_5_11_EPRIS_storageReport_Rastler.pdf)
- <sup>46</sup> Electric Power Research Institute. (2010). *Electricity Energy Storage Technology Options: A White Paper Primer on Applications, Costs, and Benefits*. Report No. 1020676. p. 4–17 and 4–18. Palo Alto, CA. Accessed at [http://www.electricitystorage.org/images/uploads/static\\_content/technology/resources/ESA\\_TR\\_5\\_11\\_EPRIS\\_storageReport\\_Rastler.pdf](http://www.electricitystorage.org/images/uploads/static_content/technology/resources/ESA_TR_5_11_EPRIS_storageReport_Rastler.pdf)
- <sup>47</sup> "AES Wind Generation and AES Energy Storage Introduce AES Laurel Mountain." *Power Engineering*. November 16, 2011. Accessed at <http://www.power-eng.com/news/2011/11/1535632055/aes-wind-generation-and-aes-energy-storage-introduce-aes-laurel-mountain.html>
- <sup>48</sup> Nexight Group. (2010). *Electric Power Industry Needs for Grid-Scale Storage Applications*. p. 21. Albuquerque, NM. Accessed at [http://energy.tms.org/docs/pdfs/Advanced\\_Materials\\_for\\_SEES\\_2010.pdf](http://energy.tms.org/docs/pdfs/Advanced_Materials_for_SEES_2010.pdf)
- <sup>49</sup> Nexight Group. (2010). *Electric Power Industry Needs for Grid-Scale Storage Applications*, p. 25–28. Albuquerque, NM. Accessed at [http://energy.tms.org/docs/pdfs/Advanced\\_Materials\\_for\\_SEES\\_2010.pdf](http://energy.tms.org/docs/pdfs/Advanced_Materials_for_SEES_2010.pdf)
- <sup>50</sup> Electric Power Research Institute. (2010). *Electricity Energy Storage Technology Options: A White Paper Primer on Applications, Costs, and Benefits*. Report No. 1020676. p. 4–9 and 4–10. Palo Alto, CA. Accessed at [http://www.electricitystorage.org/images/uploads/static\\_content/technology/resources/ESA\\_TR\\_5\\_11\\_EPRIS\\_storageReport\\_Rastler.pdf](http://www.electricitystorage.org/images/uploads/static_content/technology/resources/ESA_TR_5_11_EPRIS_storageReport_Rastler.pdf)
- <sup>51</sup> Key, Kamath, Mears, and Gotschall. (2003). *EPRI-DOE Handbook of Energy Storage for Transmission and Distribution Applications*. Electric Power Research Institute. Palo Alto, CA. Report No. 1001834. p. 8-1. Accessed at <http://www.sandia.gov/ess/publications/ESHB%201001834%20reduced%20size.pdf>
- <sup>52</sup> Nexight Group. (2010). *Advanced Materials and Devices for Stationary Electrical Energy Storage Applications*. p. 25–28. Albuquerque, NM. Accessed at [http://energy.tms.org/docs/pdfs/Advanced\\_Materials\\_for\\_SEES\\_2010.pdf](http://energy.tms.org/docs/pdfs/Advanced_Materials_for_SEES_2010.pdf)
- <sup>53</sup> Raster, D. (2010). *Electricity Energy Storage Technology Options: A White Paper Primer on Applications, Costs, and Benefits*. Palo Alto, CA: Electric Power Research Institute. Accessed at [http://www.electricitystorage.org/images/uploads/static\\_content/technology/resources/ESA\\_TR\\_5\\_11\\_EPRIS\\_storageReport\\_Rastler.pdf](http://www.electricitystorage.org/images/uploads/static_content/technology/resources/ESA_TR_5_11_EPRIS_storageReport_Rastler.pdf)
- <sup>54</sup> Li, et al. (2011). "Large-Scale Energy Storage: A Stable Vanadium Redox-Flow Battery with High Energy Density for Large-Scale Energy Storage." *Advanced Energy Materials*. Vol. 1(3):394-400. Accessed at <http://onlinelibrary.wiley.com/doi/10.1002/aenm.201100008/abstract>
- <sup>55</sup> Parformack, P. W. (2012). *Energy Storage for Power Grids and Electric Transportation: A Technology Assessment*. Washington, DC: Congressional Research Service. Accessed at <http://www.fas.org/sgp/crs/misc/R42455.pdf>
- <sup>56</sup> U.S. Department of Energy. (2010). *Grid Storage Report: Report to Congress*. Washington, DC.

- <sup>57</sup> Nexight Group. (2010). *Electric Power Industry Needs for Grid-Scale Storage Applications*, p. 29. Albuquerque, NM. Accessed at [http://energy.tms.org/docs/pdfs/Advanced\\_Materials\\_for\\_SEES\\_2010.pdf](http://energy.tms.org/docs/pdfs/Advanced_Materials_for_SEES_2010.pdf)
- <sup>58</sup> Electric Power Research Institute. (2010). *Electricity Energy Storage Technology Options: A White Paper Primer on Applications, Costs, and Benefits*. Report No. 1020676. p. 4–15. Palo Alto, CA. Accessed at [http://www.electricitystorage.org/images/uploads/static\\_content/technology/resources/ESA\\_TR\\_5\\_11\\_EPRIS\\_torageReport\\_Rastler.pdf](http://www.electricitystorage.org/images/uploads/static_content/technology/resources/ESA_TR_5_11_EPRIS_torageReport_Rastler.pdf)
- <sup>59</sup> Nexight Group. (2010). *Electric Power Industry Needs for Grid-Scale Storage Applications*. p. 33. Albuquerque, NM. Accessed at [http://energy.tms.org/docs/pdfs/Advanced\\_Materials\\_for\\_SEES\\_2010.pdf](http://energy.tms.org/docs/pdfs/Advanced_Materials_for_SEES_2010.pdf)
- <sup>60</sup> Electricity Advisory Committee. (2011). *Energy Storage Activities in the United States Electricity Grid*. Washington, DC. Accessed at [http://energy.gov/sites/prod/files/oeprod/DocumentsandMedia/FINAL\\_DOE\\_Report-Storage\\_Activities\\_5-1-11.pdf](http://energy.gov/sites/prod/files/oeprod/DocumentsandMedia/FINAL_DOE_Report-Storage_Activities_5-1-11.pdf)
- <sup>61</sup> Nexight Group. (2010). *Electric Power Industry Needs for Grid-Scale Storage Applications*. p. 34. Albuquerque, NM. Accessed at [http://energy.tms.org/docs/pdfs/Advanced\\_Materials\\_for\\_SEES\\_2010.pdf](http://energy.tms.org/docs/pdfs/Advanced_Materials_for_SEES_2010.pdf)
- <sup>62</sup> Nexight Group. (2010). *Advanced Materials and Devices for Stationary Electrical Energy Storage Applications*. p. 17. Albuquerque, NM. Accessed at [http://energy.tms.org/docs/pdfs/Advanced\\_Materials\\_for\\_SEES\\_2010.pdf](http://energy.tms.org/docs/pdfs/Advanced_Materials_for_SEES_2010.pdf)
- Fernandez, M., Valenciano, J. Trinidad, F., and Munoz, N. (2010). “The use of activated carbon and graphite for the development of lead-acid batteries for hybrid vehicle applications.” *Journal Power Sources*. 195(14):4458–4469.
- Electric Power Research Institute. (2010). *Electricity Energy Storage Technology Options: A White Paper Primer on Applications, Costs, and Benefits*. Report No. 1020676. p. 4–7. Palo Alto, CA. Accessed at [http://www.electricitystorage.org/images/uploads/static\\_content/technology/resources/ESA\\_TR\\_5\\_11\\_EPRIS\\_torageReport\\_Rastler.pdf](http://www.electricitystorage.org/images/uploads/static_content/technology/resources/ESA_TR_5_11_EPRIS_torageReport_Rastler.pdf)
- Yang, Z., Zhang, J., Kintner-Meyer, M. C. W., Lu, X., Choi, D., Lemmon, J. P., and Liu, J. (2011). “Electrochemical Energy Storage for a Green Grid.” *Chemical Reviews*. 111(5):3577–3613. Accessed at <http://energyenvironment.pnnl.gov/ei/pdf/Chemical%20Reviews.pdf>
- <sup>63</sup> Electric Power Research Institute. (2010). *Electricity Energy Storage Technology Options: A White Paper Primer on Applications, Costs, and Benefits*. Report No. 1020676. p. 4–17. Palo Alto, CA. Accessed at [http://www.electricitystorage.org/images/uploads/static\\_content/technology/resources/ESA\\_TR\\_5\\_11\\_EPRIS\\_torageReport\\_Rastler.pdf](http://www.electricitystorage.org/images/uploads/static_content/technology/resources/ESA_TR_5_11_EPRIS_torageReport_Rastler.pdf)
- Nexight Group. (2010). *Electric Power Industry Needs for Grid-Scale Storage Applications*. p. 21. Albuquerque, NM. Accessed at [http://energy.tms.org/docs/pdfs/Advanced\\_Materials\\_for\\_SEES\\_2010.pdf](http://energy.tms.org/docs/pdfs/Advanced_Materials_for_SEES_2010.pdf)
- Yang, Z., Zhang, J., Kintner-Meyer, M. C. W., Lu, X., Choi, D., Lemmon, J. P., and Liu, J. (2011). “Electrochemical Energy Storage for a Green Grid.” *Chemical Reviews*. 111(5):3577–3613. Accessed at <http://energyenvironment.pnnl.gov/ei/pdf/Chemical%20Reviews.pdf>
- <sup>64</sup> Nexight Group. (2010). *Advanced Materials and Devices for Stationary Electrical Energy Storage Applications*. p. 25–28. Albuquerque, NM. Accessed at [http://energy.tms.org/docs/pdfs/Advanced\\_Materials\\_for\\_SEES\\_2010.pdf](http://energy.tms.org/docs/pdfs/Advanced_Materials_for_SEES_2010.pdf)
- Electric Power Research Institute. (2010). *Electricity Energy Storage Technology Options: A White Paper Primer on Applications, Costs, and Benefits*. Report No. 1020676. p. 4–9. Palo Alto, CA. Accessed at [http://www.electricitystorage.org/images/uploads/static\\_content/technology/resources/ESA\\_TR\\_5\\_11\\_EPRIS\\_torageReport\\_Rastler.pdf](http://www.electricitystorage.org/images/uploads/static_content/technology/resources/ESA_TR_5_11_EPRIS_torageReport_Rastler.pdf)
- Yang, Z., Zhang, J., Kintner-Meyer, M. C. W., Lu, X., Choi, D., Lemmon, J. P., and Liu, J. (2011). “Electrochemical Energy Storage for a Green Grid.” *Chemical Reviews*. 111(5):3577–3613. Accessed at <http://energyenvironment.pnnl.gov/ei/pdf/Chemical%20Reviews.pdf>
- <sup>65</sup> Nexight Group. (2010). *Electric Power Industry Needs for Grid-Scale Storage Applications*. p. 29. Albuquerque, NM. Accessed at [http://energy.tms.org/docs/pdfs/Advanced\\_Materials\\_for\\_SEES\\_2010.pdf](http://energy.tms.org/docs/pdfs/Advanced_Materials_for_SEES_2010.pdf)
- Li, et al. (2011). “Large-Scale Energy Storage: A Stable Vanadium Redox-Flow Battery with High Energy Density for Large-Scale Energy Storage.” *Advanced Energy Materials*. Vol. 1(3):394–400. Accessed at <http://onlinelibrary.wiley.com/doi/10.1002/aenm.201100008/abstract>

- Yang, Z., Zhang, J., Kintner-Meyer, M. C. W., Lu, X., Choi, D., Lemmon, J. P., and Liu, J. (2011). "Electrochemical Energy Storage for a Green Grid." *Chemical Reviews*. 111(5):3577–3613. Accessed at <http://energyenvironment.pnnl.gov/ei/pdf/Chemical%20Reviews.pdf>
- <sup>66</sup> Nexight Group. (2010). *Electric Power Industry Needs for Grid-Scale Storage Applications*. Albuquerque, NM. p. 23. Accessed at [http://energy.tms.org/docs/pdfs/Electric\\_Power\\_Industry\\_Needs\\_2010.pdf](http://energy.tms.org/docs/pdfs/Electric_Power_Industry_Needs_2010.pdf)
- <sup>67</sup> <http://science.energy.gov/bes/efrc/centers/external-efrc-websites/>
- <sup>68</sup> Controls "Hardware" is discussed in the *Grid Components* technology assessment.
- <sup>69</sup> There are a few instances where system operators can centrally control loads through demand response, such as ERCOT's load resource program (<http://www.ercot.com/services/programs/load/vlrp/index>).
- <sup>70</sup> North American Electric Reliability Corporation. (2010). *Real-Time Application of Synchrophasors for Improving Reliability*. p. 9. Washington, DC. Accessed at [https://www.naspi.org/site/StaticPDF/resource/rapir\\_final\\_20101017.pdf](https://www.naspi.org/site/StaticPDF/resource/rapir_final_20101017.pdf)
- <sup>71</sup> Midwest ISO. (2010). *Synchrophasor Integration into Planning and Operational Reliability Processes*. Carmel, IN. Accessed at <https://www.midwestiso.org/layouts/MISO/ECM/Redirect.aspx?ID=28862>.
- <sup>72</sup> U.S. Department of Energy. (2006). *Benefits of Demand Response in Electricity Markets and Recommendations for Achieving Them*. p. 36. Washington, DC. Accessed at <http://eetd.lbl.gov/ea/ems/reports/congress-1252d.pdf>.
- <sup>73</sup> Oak Ridge National Laboratory. (2004). "Advanced Sensors for Grid Modernization: White Papers on Issues and Benefits." Oak Ridge, TN.
- <sup>74</sup> Oak Ridge National Laboratory. *Grid Eye Fact Sheet*. Oak Ridge, TN. Accessed at <http://www.ornl.gov/sci/electricdelivery/pdfs/GridEye%20Fact%20Sheet.pdf>
- <sup>75</sup> For more information on synchrophasor infrastructure, see the North American SynchroPhasor Initiative at <https://www.naspi.org/>
- <sup>76</sup> For example, see the Schweitzer Engineering Laboratories, Inc. SEL-421 Protection and Automation System: <http://www.selinc.com/SEL-421/>
- <sup>77</sup> U.S. Department of Energy. *SmartGrid.gov*. Accessed at <http://www.smartgrid.gov/>
- <sup>78</sup> U.S. Department of Energy and Federal Energy Regulatory Commission. (2006). *Steps to Establish a Real-Time Transmission Monitoring System for Transmission Owners and Operators within the Eastern and Western Interconnections: A Report to Congress Pursuant to Section 1839 of EPACT 2005*. Washington, DC. Accessed at [http://energy.gov/sites/prod/files/oeprod/DocumentsandMedia/final\\_1839.pdf](http://energy.gov/sites/prod/files/oeprod/DocumentsandMedia/final_1839.pdf)
- <sup>79</sup> North American Electric Reliability Corporation. (2010). *Real-Time Application of Synchrophasors for Improving Reliability*. p. 9. Washington, DC. Accessed at [https://www.naspi.org/site/StaticPDF/resource/rapir\\_final\\_20101017.pdf](https://www.naspi.org/site/StaticPDF/resource/rapir_final_20101017.pdf)
- <sup>80</sup> Energetics Incorporated. (2006). *Roadmap to Secure Control Systems in the Energy Sector*. Washington, DC: U.S. Department of Energy, U.S. Department of Homeland Security. Accessed at <http://www.cyber.st.dhs.gov/docs/DOE%20Roadmap%202006.pdf>
- <sup>81</sup> Energy Sector Control Systems Working Group. (2011). *Roadmap to Achieve Energy Delivery Systems Cybersecurity*. Washington, DC: U.S. Department of Energy. Accessed at <http://energy.gov/oe/downloads/roadmap-achieve-energy-delivery-systems-cybersecurity-2011>
- <sup>82</sup> Office of the National Counterintelligence Executive. (2011). *Foreign Spies Stealing U.S. Economic Secrets in Cyberspace: Report to Congress on Foreign Economic Collection and Industrial Espionage, 2009–2011*. Washington, DC. Accessed at [http://www.dni.gov/reports/20111103\\_report\\_fecie.pdf](http://www.dni.gov/reports/20111103_report_fecie.pdf)
- North American Electric Reliability Corporation. *Critical Infrastructure Protection Program*. Washington, DC. Accessed at <http://www.nerc.com/page.php?cid=6|69>
- Energy Sector Control Systems Working Group. (2011). *Roadmap to Achieve Energy Delivery Systems Cybersecurity*. Washington, DC: U.S. Department of Energy. Accessed at [http://energy.gov/sites/prod/files/Energy%20Delivery%20Systems%20Cybersecurity%20Roadmap\\_finalweb.pdf](http://energy.gov/sites/prod/files/Energy%20Delivery%20Systems%20Cybersecurity%20Roadmap_finalweb.pdf)
- <sup>83</sup> U.S. National Institute for Standards and Technology. (2011). *NIST Framework and Roadmap for Smart Grid Interoperability Standards, Release 2.0 DRAFT* (Posted for Public Comment via Federal Register Notice,

October 25, 2011). Washington, DC. Accessed at <http://collaborate.nist.gov/twiki-sggrid/bin/view/SmartGrid/IKBFramework>

- <sup>84</sup> National Science and Technology Council. (2011). *A Policy Framework for the 21st Century Grid: Enabling Our Secure Energy Future*. Washington, DC: Executive Office of the President. Accessed at <http://www.whitehouse.gov/sites/default/files/microsites/ostp/nstc-smart-grid-june2011.pdf>
- <sup>85</sup> IBM ILOG CPLEX Optimizer Performance Benchmarks. Accessed at <http://www-01.ibm.com/software/integration/optimization/cplex-optimization-studio/cplex-optimizer/cplex-performance/#improvements>
- <sup>86</sup> Ott, A. L. (2010). "Evolution of Computing Requirements in the PJM Market: Past and Future." *2010 IEEE Power & Energy Society General Meeting*. p. 1–4.
- <sup>87</sup> U.S. Department of Energy. (2009). *Computational Issues and Challenges of the 21st Century Power System*. Technical Workshop Results. Gaithersburg, MD.
- <sup>88</sup> U.S.-Canada Power System Outage Task Force. (2004). *Final Report on the August 14, 2003 Blackout in the United States and Canada*. p. 7. Washington DC: Department of Energy. Accessed at <https://reports.energy.gov/>

## 7 Clean Power

The assessments in this chapter form the technical base for *Deploying Clean Electricity*, a strategy detailed in the corresponding chapter of the *Report on the Quadrennial Technology Review (QTR)*. Deployment of clean electricity will reduce emissions of greenhouse gasses and other pollutants that lead to smog, cause acid rain and haze, impact human health, and increase the risks of climate change. Developing and manufacturing clean electricity technologies will create jobs and strengthen U.S. economic competitiveness.

While each technology is presented here with a standalone assessment, the associated opportunities to impact the energy system are fully understood only within the context of an integrated framework that spans energy resource, supply, delivery, and consumption. The *Report on the QTR* presents an integrated framework of the energy system and contains the systems discussions that tie together these individual assessments.

The technology assessments in the *Clean Power* chapter have been organized alphabetically and include:

- Carbon Capture and Storage
- Concentrating Solar Power
- Fuel Cells for Distributed Generation
- Geothermal
- Nuclear Power
- Solar Photovoltaics
- Water Power
- Wind Power



## 7.1 Carbon Capture and Storage

Fossil fuels currently dominate U.S. and global electricity generation and total energy supply,<sup>1</sup> with coal and natural gas fueling 70% of U.S. electricity generation. U.S. fossil-fuel-based electricity generation and industrial processes emit 3.5 billion tonnes of carbon dioxide (CO<sub>2</sub>) into the atmosphere every year,<sup>2</sup> more than 10% of the global total.<sup>3</sup> Carbon capture and storage (CCS) is one of the primary options to reduce CO<sub>2</sub> emissions from fossil fuels, although variations among modeling assumptions (such as the future costs of gas and CCS) lead to somewhat different energy mixes. Long-term planning for increased penetration of intermittent renewables is often based upon natural gas backup, a paradigm that will persist for the foreseeable future. Recent developments for the production of shale gas give the United States vast natural gas resources that, when converted to reserves, could have a major impact on the world's energy balance.

“Business as usual” forecasts, such as those shown in Table , suggest that coal-fueled electricity generation could continue to grow for at least the next 25 years. CCS technologies present an opportunity to produce affordable, clean electricity from more than 15% of the more than 3,000 gigawatts of electric energy (GWe) of global coal-fueled electricity expected by 2035.<sup>4</sup> The development of lower-cost CCS is especially important for reducing potential greenhouse gas (GHG) emissions from coal-rich developing countries, such as China and India. Those nations currently rely on coal for more than 70% of electricity and are unlikely to limit their rapid domestic economic development by reducing coal-fired generation.<sup>5</sup> Recent International Energy Agency analysis suggests that eliminating CCS from the available mix of low- or zero-carbon technologies could increase by 70% the overall costs to reduce CO<sub>2</sub> emissions to 2005 levels by 2050.<sup>6</sup>

**Table 23. Projected Global Coal Generation Capacity** International Energy Agency. (2010). 2010 World Energy Outlook. Paris, France.

	Coal Generation Capacity (GWe)			2008–2050 % increase
	2008	2020	2035	
<b>United States</b>	334	353	348	4
<b>India</b>	84	201	441	425
<b>China</b>	563	1,011	1,540	174
<b>World</b>	1,514	2,184	3,056	102

CCS technology can also be applied to natural gas combustion, alternative fuels production, and biomass combustion. For alternative fuels production, CCS can reduce CO<sub>2</sub> emissions from any hydrocarbons-to-liquids process, such as coal-to-liquids and gas-to-liquids. CCS technology integrated with biomass-based combustion processes, such as co-firing coal with biomass, could result in net negative lifecycle CO<sub>2</sub> emissions. For more information on alternative transportation fuels, see the Alternative Hydrocarbon Fuels technology assessment and the *Report on the QTR*.

### 7.1.1 Current Status of Technology

CCS is a three-step process that includes capture and compression of CO<sub>2</sub> from power plants or industrial sources; transport of the captured CO<sub>2</sub>; and permanent and safe storage of that CO<sub>2</sub> in

geologic formations, such as deep saline formations, oil and gas reservoirs, and unmineable coal seams. The three dominant approaches to CO<sub>2</sub> capture are post-combustion from flue gas, post-combustion using oxyfuel, and pre-combustion using gasification. Technologies exist for all three components of CCS:

**Separation and Capture:** CO<sub>2</sub> has been captured from industrial gas streams since the 1930s using a variety of approaches to separate it from other gases. These processes are used in the natural gas industry to produce pipeline quality natural gas<sup>7</sup> and to produce food- and chemical-grade CO<sub>2</sub>. However, commercially available CO<sub>2</sub> separation processes are currently too costly for power applications.

**Transport:** The history of transporting CO<sub>2</sub> via pipelines in the United States spans nearly 40 years. The United States transports some 72 million tons of CO<sub>2</sub> annually<sup>8</sup> through 4,100 miles of existing CO<sub>2</sub> pipelines.<sup>9</sup>

**Storage:** Globally, four commercial carbon sequestration facilities with 25 cumulative years of experience inject CO<sub>2</sub> into deep geologic formations and apply a suite of technologies to monitor and verify that the CO<sub>2</sub> remains sequestered. Industry experience in subsurface CO<sub>2</sub> injection has also been accumulated over several decades via enhanced oil recovery (EOR) activities. The Department of Energy (DOE) estimates that there are hundreds of years of available storage resource in geologic formations in North America.<sup>10</sup>

Estimates of the Nth plant incremental costs<sup>11</sup> of new coal-fired plants with CCS relative to new pulverized coal (PC)-fired plants typically range from \$60–\$85/tonne of CO<sub>2</sub> avoided. Approximately 70%–90% of that cost is associated with capture and compression.<sup>12</sup>

According to the Global CCS Institute's Report, *The Global Status of CCS: 2010*:

- In 2010, there were 234 active or planned CCS projects around the world and across a range of technologies, project types, and sectors. Seventy-seven of these projects are large-scale integrated projects (LSIPs),<sup>13</sup> of which, eight are in operation, four are in execution, and the remaining 65 are in various stages of planning.
- The eight LSIPs in operation, as well as the four in execution are linked to the oil and gas sector: they either capture CO<sub>2</sub> in natural gas processing or inject CO<sub>2</sub> for EOR. There are 42 LSIPs in development planning in the power generation sector, 2 iron and steel projects, 1 cement project, and 1 pulp and paper project.
- Most LSIPs are in developed countries (notably the United States, Europe, Canada, and Australia), with a few in emerging markets like China.
- Separate pre- or post-combustion capture technologies have attained greater deployment than LSIPs, especially in the power industry. There are four proposed demonstrations of CO<sub>2</sub> capture using oxyfuel combustion.

Though CCS technologies exist, the scaling and integration of CCS with power generation has not yet been demonstrated. Scale-up of existing CCS processes for use with coal or natural-gas-based power



generation poses significant technical, economic, and regulatory challenges. CCS technology challenges associated with scaling and integration are discussed in detail in the August 2010 *Report of the Interagency Task Force on Carbon Capture and Storage*.

### 7.1.2 Historical Pace of Development and Market Diffusion

Although CO<sub>2</sub> capture is new to coal-based power generation, removal of CO<sub>2</sub> from industrial gas streams is not a new process (see callout box). Gas absorption processes that use chemical solvents to separate CO<sub>2</sub> from gas streams containing 3%–25% of the chemical compound have been in use since the 1930s, particularly in the natural gas industry and to produce food- and chemical-grade CO<sub>2</sub>.<sup>14</sup> In the 1950s and 1960s, gas adsorption processes were developed to separate CO<sub>2</sub> from gas streams associated with hydrogen production (in oil refineries), nitrogen separation, and dehydration. In the 1970s and 1980s, gas separation membranes were developed for EOR (oil/gas separation) and natural gas processing applications.

While the processes developed by these industries are relevant to coal plants, they are typically implemented at a smaller scale and at a very high cost per ton of CO<sub>2</sub>. There are five commercially operating facilities that capture CO<sub>2</sub> at scales relevant to electricity generation (i.e., more than 1 million tonnes of CO<sub>2</sub> per year). The largest (a natural gas processing operation in Wyoming) captures 3.6 million tonnes per year.<sup>15</sup> However, it is unclear how transferable the experience with natural gas processing is to separation of power plant flue gases, as the two gas feeds have very different chemical compositions.

Industry has safely stored CO<sub>2</sub> since the 1970s at scales relevant to power generation in the context of enhanced EOR. The long atmospheric lifetime of CO<sub>2</sub> requires confinement times of more than a century (leak rates of less than 1% per year) if CCS is to be an effective mitigating technology. While there are no direct measurements currently guaranteeing this level of integrity, there is circumstantial evidence supporting it.<sup>16</sup>

There is also international experience with storing CO<sub>2</sub>. Since 1996, about 1 million tonnes of CO<sub>2</sub> per year—about one-third of the CO<sub>2</sub> emitted by an average 500–megawatt (MW) coal plant—have been injected into the Sleipner reservoir off the coast of Norway. CO<sub>2</sub> that is produced along with natural gas is separated on the production platform and re-injected into a

The licensing history of the Econamine FG process—a technology that removes carbon dioxide (CO<sub>2</sub>) from oxygen-rich streams—is a good example of past applications of CO<sub>2</sub> removal technologies. Prior to 1999, 25 facilities were built with CO<sub>2</sub> capture capacities ranging from 635–365,000 tonnes per year using this process. Three were coal-fired applications that captured 600–1,600 tonnes of CO<sub>2</sub> per year. The captured CO<sub>2</sub> from these facilities was used for enhanced oil recovery and urea production, as well as in the food and beverage industry. The markedly different amounts captured for these facilities reflect the fact that they were built to serve a specific commercial market for CO<sub>2</sub>. Other amine-based processes (e.g., ABB/Lummus) were implemented at similar capture rates during this period. By comparison, a single 550 megawatt net output coal-fired power plant capturing 90% of the emitted CO<sub>2</sub> will need to separate 3–5 million tonnes of CO<sub>2</sub> per year. Scaling-up these existing processes represents a significant technical challenge and a potential barrier to widespread commercial deployment in the near term.

sandstone formation at a depth of about 1,000 meters below sea level to prevent venting the gas to the atmosphere.<sup>17</sup>

Injection of CO<sub>2</sub> enhances oil production by some combination of re-pressurizing the reservoir, invading zones not swept by injected water, and by creating mixtures of oil and CO<sub>2</sub> in the subsurface that can efficiently displace more oil. Typical productivity estimates range from 2–4 barrels of oil produced via EOR per tonne of CO<sub>2</sub> (i.e., about two atoms of carbon produced for each atom of carbon injected).<sup>18</sup> Although some features of CO<sub>2</sub> storage may differ from EOR operations, these activities have developed many of the reservoir management and operational tools needed for large-scale CO<sub>2</sub> injection and storage.

Approximately 60 million tonnes of CO<sub>2</sub> (0.8% of U.S. emissions) are injected in the United States each year for EOR, produced with the oil, captured, and then re-injected.<sup>19</sup> These are large-scale operations, with some injecting millions of tonnes of CO<sub>2</sub> per year, and some having already accumulated (stored) tens of millions of tonnes. As of year-end 2010, there were 114 CO<sub>2</sub>-EOR projects within the United States producing 272,000 barrels of oil per day.<sup>20</sup> Because of its limited scale, EOR as the storage mechanism for carbon cannot significantly reduce national emissions. Still, EOR's main benefit is to enhance the economics of early projects to allow demonstration and reduction of CCS costs.<sup>21</sup>

### 7.1.3 Technology Potential

One long-term goal for CCS technology is at least 90% capture and safe storage at electricity costs of \$62/megawatt hour (MWh), which approaches today's supercritical PC plant cost without CCS (\$59/MWh).<sup>22</sup> This requires the development of advanced, lower-cost CCS technologies using different types of coals and storing CO<sub>2</sub> in a variety of geologic settings.

In capture, while major technology thrusts associated with advanced solvents, solid sorbents, and membranes have made significant progress, these pathways are not expected to reach cost and performance characteristics that support overall CCS goals until around 2015. Goals for post-combustion and oxyfuel CCS are a cost premium of 35% relative to a conventional supercritical PC plant, and the goal for pre-combustion CCS is a cost premium of 10% relative to integrated gasification combined cycle.<sup>23</sup>

Research and development (R&D) programs can help reduce project uncertainty, decrease technology cost, and improve plant performance. Building on the separate demonstration of CO<sub>2</sub> capture and CO<sub>2</sub> storage technologies, the focus of CCS R&D is to:

- Demonstrate the operation of current CCS technologies integrated at a scale necessary to prove safe and reliable capture and storage.
- Develop improved CO<sub>2</sub> capture component technologies and advanced power generation technologies to significantly reduce the cost of CCS.

There are technical challenges associated with CCS integration and scale at all steps in the process. For CO<sub>2</sub> capture, these include maintaining adequate gas and/or liquid flow distribution in the larger absorption and regeneration reactors required for power plant applications. For commercial-scale, coal-based power plants, challenges include the energy penalty arising from high capture and compression

auxiliary power loads and the impacts of flue gas contaminants on the CO<sub>2</sub> capture system. For storage, demonstration at scale is needed to ensure the effectiveness of monitoring, verification, and accounting tools, all of which are important components of managing a geologic storage project and ensuring that the CO<sub>2</sub> plume and associated pressure front are moving through the subsurface as predicted. In addition, the potential of multiple commercial projects in a particular basin creates a new set of concerns (e.g., brine displacement, overlap of pressure fronts, spatial variation in depositional environments, etc.) that cannot be effectively evaluated with models and small-scale tests. One challenge for CO<sub>2</sub> integration with power production is accommodating cycling as the plant follows load.

First-generation CCS plants can operate at cost premiums of about 80% for coal or 45% for natural gas, when compared to new construction of similarly fueled generation without CCS.<sup>24</sup> Note that the cost per ton of CO<sub>2</sub> avoided is significantly higher for a natural gas combined cycle (NGCC) plant compared to a supercritical PC plant because of the low concentration of CO<sub>2</sub> in the NGCC plant flue gas. However, this same low concentration makes the cost per megawatt hour lower for NGCC.

The most promising second-generation technologies for coal plants would reduce this premium to around 22%, while integrated gasification fuel cells hold considerably more promise. Table is based on detailed engineering analysis and simulations carried out by the National Energy Technology Laboratory, which are documented in a series of studies available on the laboratory’s website.<sup>25</sup>

**Table 24. Estimates of Cost of Electricity (COE) Increases for Three CCS Technology Generations** National Energy Technology Laboratory Baseline and Pathway Studies. Links include [http://www.netl.doe.gov/energy-analyses/baseline\\_studies.html](http://www.netl.doe.gov/energy-analyses/baseline_studies.html) and <http://www.netl.doe.gov/energy-analyses/refshelf/PubDetails.aspx?Action=View&PubId=284>

	COE Increase vs. Current SCPC Plants w/o CCS		
<b>New Coal Plant Type with CCS</b>	<b>Generation 1</b>	<b>Generation 2</b>	<b>Transformational</b>
Super Critical Pulverized Coal (SCPC)	\$48/MWh (81%)	\$21/MWh (35%)	
Oxy-Combustion	\$37/MWh (63%)	\$21/MWh (35%)	
Integrated Gasification Combined Cycle	\$47/MWh (79%)	\$13/MWh (22%)	
Integrated Gasification Fuel Cell	n/a	\$14/MWh (23%)	<\$3/MWh (<5%)
	COE Increase vs. Current NGCC Plants w/o CCS		
<b>New Gas Plant Type with CCS</b>	<b>Generation 1</b>	<b>Generation 2</b>	<b>Transformational</b>
Natural Gas Combined Cycle (NGCC)	\$27/MWh (46%)		

R&D on second-generation technologies applicable to PC and gasification-based power plants might reduce the cost of CCS by more than half compared to first-generation technologies. R&D focusing on conventional PC plants addresses the technical barriers associated with acceptance and implementation of CCS technologies that can retrofit today’s existing coal plants. Of particular interest are the energetics (operating temperatures, regeneration), process size (capacity, permeability), product purity (selectivity), and material stability (thermal, chemical, and mechanical robustness) associated with capture technologies, including solvents, sorbents, and membranes.

Oxy-combustion is a PC option that simplifies the capture process, but is more expensive than gasification-based technologies because it requires far more oxygen. Different approaches are under investigation for reducing the cost of oxygen, such as introduction of an oxygen transport membrane, as well as R&D on oxy-combustion flame characteristics, burner, and coal-feed design. Analysis of the interactions between oxy-combustion products and boiler materials is necessary to the development of low-cost and efficient oxy-combustion power plant systems.

Gasification-based power generation is far less mature than PC technology, but is believed by many<sup>26</sup> to be the pathway leading to the most cost-effective CCS options. One R&D pathway focuses on power plants that use oxygen instead of air in the gasifier and convert coal into a gas stream consisting of CO<sub>2</sub> and hydrogen. CO<sub>2</sub> is separated before the hydrogen is combusted to generate electricity and, as a result, is referred to as “pre-combustion capture.” The relatively high pressure and concentration of the CO<sub>2</sub> in the gas stream reduce the cost of capturing and compressing the CO<sub>2</sub>. However, electricity from first-generation integrated gasification combined cycle plants without CCS is estimated to cost about 30% more than conventional PC plants.<sup>27</sup> Oxygen, typically obtained via air separation, is a significant component of this increased cost. R&D is focusing on reducing this cost, as well as key advances in several other major plant components (e.g., turbine, gas cleanup).

Demonstration of commercial-scale CCS coal plants could be initiated in the mid-2010s, which could enable industry to deploy commercial-generation plants beginning in the 2020s.<sup>28</sup>

Several monitoring techniques are currently available for CO<sub>2</sub> and/or brine leak detection. These can mainly be divided into techniques that focus on (1) atmospheric, surface, or near-surface detection; and (2) deep subsurface for the purposes of early leak detection. Research needs for near-surface monitoring technologies are to improve sensitivity of detection and/or increase the range of applicability so that very large areas can be covered more efficiently and cost effectively. Research needs for deep subsurface technologies include increased detection sensitivity, improved techniques for interpretation of signals to account for subsurface heterogeneity, and integration of signals from multiple monitoring tools.

#### 7.1.4 Consistency with Other CCS Roadmaps

A number of groups have developed CCS roadmaps, including the following:

- Carbon Sequestration Leadership Forum<sup>29</sup>
- International Energy Agency<sup>30</sup>
- Coal Utilization Research Council/Electric Power Research Institute<sup>31</sup>
- America’s Energy Future<sup>32</sup>
- Massachusetts Institute of Technology.<sup>33</sup>

These roadmaps generally agree on the R&D areas that should be pursued, milestones, and that 2020–2030 is a desirable timeframe for achieving cost-effective, commercially viable CCS. One difference is that some roadmaps (e.g., Coal Utilization Research Council/Electric Power Research Institute, International Energy Agency) provide detail on the demonstrations that would be needed in order to reach Nth plant cost for advanced CCS technology.

### 7.1.5 Policy Context and Deployment Barriers

In 2010, the President’s Interagency Task Force on Carbon Capture and Storage (Task Force) found that there are no insurmountable technological, legal, institutional, or other barriers that prevent CCS deployment. The Task Force found the lack of comprehensive climate change legislation to be the key barrier to CCS deployment; without a carbon price and appropriate financial incentives for new technologies, there is no framework for investment in CCS technology.<sup>34</sup>

Significant federal incentives for early deployment of CCS are in place, including tax credits and loan guarantees. Today, many CCS projects are being planned by the private sector in anticipation of requirements to reduce GHG emissions. The foremost economic challenge to these projects is ongoing policy uncertainty regarding the value of GHG emissions reductions.

Even with financial support, legal and regulatory uncertainties hinder the development of CCS projects. The Environmental Protection Agency (EPA) has taken significant steps to address regulatory uncertainty of carbon storage. In late 2010, EPA promulgated the Underground Injection Control Class VI injection well manual, which created a regulatory regime for siting, construction, operation, closure, and post-closure site care for CO<sub>2</sub> injection wells, and established monitoring requirements for CO<sub>2</sub> plumes.<sup>35</sup> They concurrently promulgated Subparts RR and UU of the GHG reporting rule, which create a scheme for reporting CO<sub>2</sub> sequestration to EPA. Finally, EPA is developing a rule to address the relationship between CCS and the Resource Conservation and Recovery Act. A major regulatory hurdle was overcome with the promulgation of regulations consistent with the Safe Drinking Water Act.<sup>36</sup>

The Task Force identified a range of views concerning potential long-term liabilities (i.e., those arising after closure of a CO<sub>2</sub> storage site) and the extent of potential impacts on widespread deployment. Many states planning CCS projects are taking steps to address long-term liabilities associated with geologic storage of CO<sub>2</sub>. The Task Force’s preliminary assessment is that the existing federal and state legal framework should be adequate for at least an initial group of 5 to 10 commercial-scale projects. However, because of divergent views on the topic and limited time to analyze a complex set of underlying issues and drivers, additional analysis is needed to determine the most appropriate legal or regulatory structures for addressing potential long-term liabilities associated with widespread deployment.

Aggregation of pore space and associated property rights are also important for CCS projects. Historically, pore space issues have been handled by states. Several states are taking actions to address aggregation of pore space for geologic storage on private lands.<sup>37</sup>

Public awareness and support are critical to the development of new energy technologies and are widely viewed as vital for CCS projects. Whether the public will support or oppose commercial-scale CCS projects is largely unknown, and the public’s reaction may be project-specific. Integration of public information, education, and outreach efforts throughout the lifecycle of CCS projects will help identify key issues, foster public understanding, and build trust between communities and project developers.

Many of these barriers will be addressed through improved monitoring technologies and processes, as discussed in the *Technological Potential* section above.

### 7.1.6 Factors that Affect Market Prospects

Driving down the cost of CCS will require successful R&D. A value for carbon mitigation will ultimately be needed for commercial viability of CCS technology. In the event that carbon mitigation value is established, CCS will need to compete with other low-carbon technologies in the market.

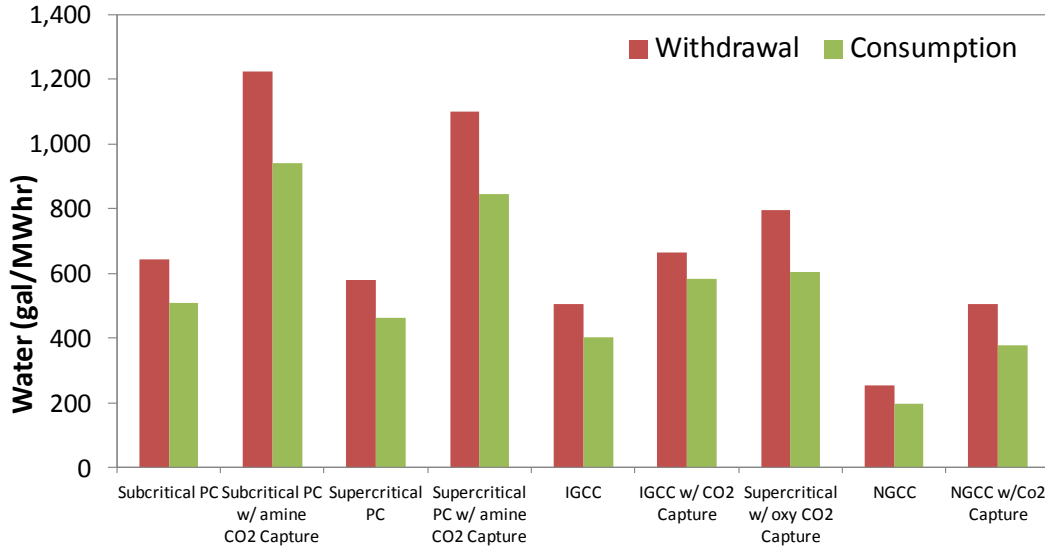
In light of current and projected high oil prices, EOR may provide a market for CO<sub>2</sub> captured from power generation, thereby reducing the level of support needed to demonstrate CCS. Currently, about 50 million tonnes per year of naturally occurring CO<sub>2</sub> from underground reservoirs is used for EOR, with another 10 million tonnes supplied by natural gas processing facilities.<sup>38</sup> The CO<sub>2</sub> is geographically limited, and costs are mostly associated with infrastructure for CO<sub>2</sub> transport (approximately \$5–\$15/tonne<sup>39</sup>). Other sources of CO<sub>2</sub> are ammonia and natural gas processing, which can produce CO<sub>2</sub> at \$15–\$30/tonne. The EOR market could potentially grow to 300 million tonnes per year at \$40/tonne CO<sub>2</sub> and \$85/barrel oil<sup>40</sup>—this is a modest market compared to the current U.S. CO<sub>2</sub> emissions of about 5.5 billion tonnes per year.<sup>41</sup> When injected for EOR, some of the CO<sub>2</sub> is permanently sequestered, while the remaining CO<sub>2</sub> is produced with the oil. That CO<sub>2</sub> is typically captured and reinjected so that all of the CO<sub>2</sub> is eventually permanently stored in the reservoir.

The installation of new, higher-efficiency power plants—configured to be capture-ready—would provide plants that could be retrofitted within 10 years from coming online, well before the construction of greenfield sites. The estimated capital cost premium for a capture-ready PC plant is roughly \$450/kilowatt (kW), while an integrated gasification combined cycle plant would incur an additional \$130/kW to be capture-ready.<sup>42</sup>

CO<sub>2</sub> storage tests are required to develop best practices and a better understanding of overall risk. Public acceptance is an important factor, especially with subsurface technology like CO<sub>2</sub> storage.

The need for significant expansion of CO<sub>2</sub> pipelines is sometimes cited as an infrastructure concern; however, the pipeline requirements associated with aggressive CCS deployment scenarios are not inconsistent with past natural gas pipeline experience.<sup>43</sup>

Adoption of currently available CCS technology for fossil-fueled power plants can increase water use and competition for water supplies. Amine-based, post-combustion carbon capture technologies are extremely water-intensive and can double the water consumption and withdrawal associated with fossil power production (Figure 33). However, the advanced pre-combustion CCS technologies based on coal gasification that may be available in the 2020s will have lower water requirements.



**Figure 33. Relative Water Usage for New PC and IGCC Plants** Estimates based on recirculating cooling technologies. Source: National Energy Technology Laboratory. (2010). *Estimating Freshwater Needs to Meet Future Thermoelectric Generation Requirements: 2010 Update*. (DOE/NETL-400/2010/1339). Page 27, Figure 12. Morgantown, WV. Accessed at [http://www.netl.doe.gov/energy-analyses/pubs/2010\\_Water\\_Needs\\_Analysis.pdf](http://www.netl.doe.gov/energy-analyses/pubs/2010_Water_Needs_Analysis.pdf)

### 7.1.7 Breakthrough CCS Technologies

Integrated gasification fuel cell systems and chemical looping are breakthrough technologies that could be available by 2030. The integrated gasification fuel cell system includes a high-efficiency, solid-oxide fuel cell that is fueled by high methane syngas. The efficient electrochemical energy conversion in the fuel cell allows for a net plant efficiency of 50%–60% (higher heating value, or HHV, basis), the lower value for an atmospheric fuel cell system and the higher value for a more advanced pressurized system. Additionally, the fuel cell system provides separation of CO<sub>2</sub> as a natural part of operation, greatly simplifying CO<sub>2</sub> capture. Further advantages of the integrated gasification fuel cell system include minimal water use and no nitrogen oxide or sulfur oxide emissions. Continued R&D on power density improvement, reliability enhancement, and cost reduction is required to meet the projected cost of electricity target, which is comparable to today's supercritical PC without CCS. The 5-year goal is to scale current 10 kilowatt of electric energy (kWe) test cells to 250 kWe and complete at least 5,000 hours of operation. The ultimate goal is to enable the manufacture of highly efficient, multi-megawatt, coal-fueled solid-oxide fuel cells power generation systems with greater than 99% CO<sub>2</sub> capture.<sup>44</sup>

Chemical looping involves the use of a metal oxide or other compound as an oxygen carrier to transfer oxygen from the air to the fuel. This combustion process produces a highly concentrated stream of CO<sub>2</sub> and water, eliminating the need for an air separation unit or subsequent CO<sub>2</sub> capture. Some versions of chemical looping can also be used to produce hydrogen. R&D is needed to improve oxygen carrier properties, optimize solids handling and process design, optimize process heat integration, and lower capital and operating cost. The durability and economics of an oxygen carrier that can be reused for an extended period of time may be demonstrated in 5 years.

Breakthrough technologies for characterizing subsurface geologies and phenomena applicable to CO<sub>2</sub> storage would lessen the uncertainty surrounding long-term storage. One example is continuous active



source seismic monitoring to achieve ultra-high resolution subsurface maps. Another is deployment of large arrays of tiny, wireless sensors or “motes” that have the potential to monitor geophysical/geochemical properties in a package of centimeter-scale or less. Dedicated field tests and associated modeling and monitoring could rapidly increase understanding of key geophysical and geochemical phenomena pertinent to energy technologies and also provide opportunities to answer the fundamental questions that may inhibit their large-scale implementation. A collective approach could accelerate subsurface technology breakthroughs well beyond current non-integrated approaches.

In addition to geologic storage, other carbon storage options have been described, although the costs of these options are unknown. The first is deep ocean storage, where CO<sub>2</sub> is injected directly into the deep ocean, whereby the injected CO<sub>2</sub> would remain sequestered until the surface and deep waters mix and CO<sub>2</sub> concentrations equilibrate with the atmosphere. The second is mineral carbonization, which involves converting CO<sub>2</sub> to solid inorganic carbonates, such as CaCO<sub>3</sub> (limestone), using chemical reactions.

### 7.1.8 DOE History and Accomplishments

The Department’s efforts in CCS have focused on basic materials research for carbon capture, reservoir characterization for sequestration, and technology demonstration.

Examples of progress in novel compounds include:

- The development of an ionic liquid that exhibits 40 times more CO<sub>2</sub> solubility than previous ionic liquids.
- Advances in oligomeric solvents that could reduce the cost for post-combustion CCS.<sup>45</sup>

Founded in 2003 through a competitive DOE funding announcement, the Regional Carbon Sequestration Partnership is comprised of seven partnerships that span 43 states, 4 Canadian provinces, and more than 400 organizations, including non-governmental organizations. The program is being implemented in three phases, with the initial phases resulting in:

- Completion of 18 small-scale field tests throughout the United States. In aggregate, these tests injected more than 1.22 million metric tons of CO<sub>2</sub> in various types of geologic reservoirs, including saline, depleted oil field, and unmineable coal seams. This effort contributed to the development and publishing of a series of best practices manuals in seven key areas related to CO<sub>2</sub> storage.<sup>46</sup>
- Release of the third edition of the Carbon Sequestration Atlas of the United States and Canada,<sup>47</sup> which provides estimates of potential CO<sub>2</sub> storage resources that have been determined by a peer-reviewed methodology and applied consistently across the Regional Carbon Sequestration Partnerships.

Up to eight integrated first-generation CCS demonstrations funded under the Clean Coal Power Initiative and American Recovery and Reinvestment Act of 2009 (ARRA) are expected to be operational around the mid 2010s. These demonstrations will primarily focus on integrating technologies to achieve reliable operation.



The National Carbon Capture Center, partially supported by DOE, commissioned the Post-Combustion Capture Center to support development of multiple post-combustion CO<sub>2</sub> capture technologies at several scales.

#### 7.1.9 DOE Role

The Department's roles in CCS are primarily informational and R&D capability. Initiatives such as the Regional Carbon Sequestration Partnership serve both of these roles by establishing a base of knowledge about the technical challenges, risks, and opportunities of carbon sequestration, and sharing that knowledge with stakeholders. The Department also uses its fundamental engineering science and materials science capabilities to develop technologies that could drive down the cost of CCS. In addition, the Department leverages information gathered from existing CCS demonstrations to disseminate data and analyses to stakeholders.

The Regional Carbon Sequestration Partnerships is a government-industry cooperative effort responsible for developing guidelines for the most suitable technologies, regulations, and infrastructure needs for CCS in different regions of the United States and Canada. These activities demonstrate how safe CO<sub>2</sub> storage plays an important role in providing information for policy makers and regulators.

## 7.2 Concentrating Solar Power

### 7.2.1 Current Status of Technology and Industry

At the end of 2010, nearly 1,200 MW of concentrating solar power<sup>48</sup> (CSP) capacity was in operation worldwide (about 0.1% of total capacity), with 508 MW in the United States (about 0.05% of total capacity). At the same time, nearly 2,600 MW of CSP was under construction globally, the majority of which is in the United States and Spain.<sup>49</sup> CSP primarily serves the wholesale power market at utility-scale, while photovoltaic (PV) systems can be both at utility-scale and behind the meter.

CSP technologies convert sunlight into thermal energy, which is used to generate electricity. As with other thermoelectric power technologies, plant efficiency increases with temperature. CSP's thermal inertia can provide stability in plant output during slight changes in solar irradiation, such as when a cloud passes overhead. Because CSP uses thermal energy, it can also incorporate thermal energy storage (TES) or fossil-fuel backup/hybridization for stability, dispatchability, and increased duration of energy output. These attributes allow CSP plants to operate much like fossil fuel power systems.

The United States has nearly 7,500 gigawatts (GW) of total resource capacity for CSP generation in seven Southwestern states.<sup>50</sup> This total is being refined by the joint DOE-Bureau of Land Management Programmatic Environmental Impact Statement, designed to identify the best practices for locating utility-scale solar plants.

### 7.2.2 Historical Pace of Market Diffusion

At the end of 2008, 430 MW of grid-tied CSP capacity was in commercial operation worldwide, more than 95% of which was in the southwestern United States.<sup>51</sup> Most of the capacity additions during 2009–2010 were in Spain, and at the end of 2010, Spain accounted for about 57% of all global CSP capacity.<sup>52</sup>

Worldwide, CSP is seeing a resurgence of interest, especially in the United States, Spain, the Middle East and North Africa region, Australia, China, and India. That interest has been driven by greater demand for renewable energy, government-supported R&D, and improved economics through technology advancements and policy initiatives. Since 2007, multiple utility-scale plants have been built and almost 12 GW of capacity were under construction or under contract worldwide during 2010.<sup>53</sup> Of this total, almost 10 GW were CSP plants with signed power purchase agreements under development in the southwest United States.<sup>54</sup>

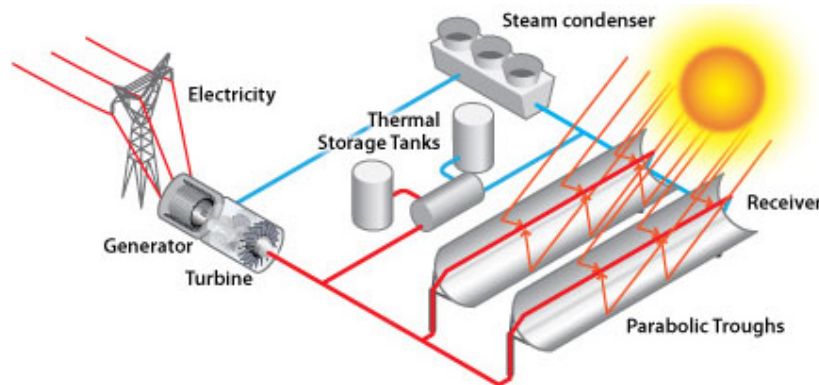
### 7.2.3 Current Status of CSP Technology

There are four major pathways in CSP technology: parabolic trough, linear Fresnel, power tower (also called central receiver), and dish/engine (Table ). All of these technologies convert sunlight into thermal energy, which then drives an engine. The first three have been demonstrated in hybrid configurations with fossil fuel technologies and/or adapted to use TES to provide operating flexibility and greater reliability. With troughs or power towers, the choice of wet, dry, or hybrid cooling systems can influence water use, cycle performance, and cost.

**Table 25. Major CSP Technologies<sup>55</sup>**

<b>Technology</b>	<b>Temp.</b>	<b>Design Efficiency<sup>56</sup></b>	<b>Annual Avg. Efficiency<sup>57</sup></b>	<b>Capacity Factor without Storage and Solar Multiple of One<sup>58</sup></b>
Parabolic Trough	390°C	25%	13%–15%	25%
Linear Fresnel	350°C	20%	8%–10%	25%
Power Tower	565°C	20%	14%–18%	20%
Dish/Engine	800°C	30%	20%–22%	25%

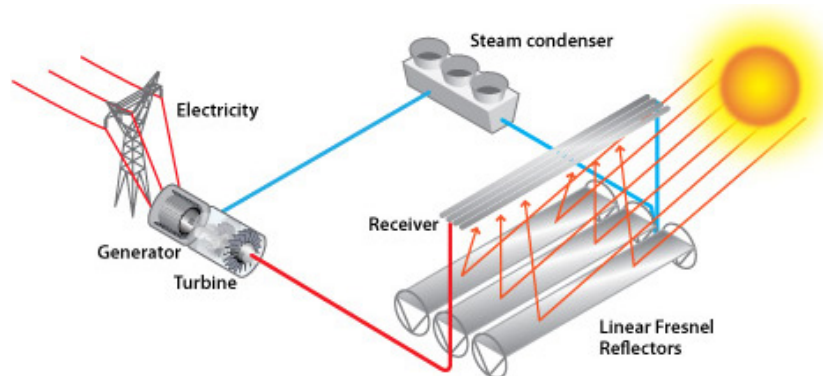
**Parabolic Trough Technology** was first commercialized in 1984 and accounts for 96% of global CSP deployment.<sup>59</sup> Parabolic trough power plants consist of large fields of mirrored parabolic trough collectors; a heat-transfer fluid (HTF)/steam-generation system; a power system, such as a Rankine steam turbine/generator; and optional TES and/or fossil-fuel-fired backup systems (Figure 34). They have a footprint of approximately 5 acres/MW without TES and 8 acres/MW with TES (a 1,500 MW plant would therefore occupy a square plot some 2 miles on a side).<sup>60</sup> The oil currently used as the HTF thermally degrades at 400°C, so these systems operate between 250°C–400°C.<sup>61</sup> They generally have a concentration ratio (collector aperture divided by receiver diameter; higher concentration ratios allow the receiver to achieve higher working temperatures) of 50 and use 1-axis tracking to follow the sun. The current design-point solar-to-electric efficiency—the net efficiency in the ideal case when the sun is directly overhead—for a parabolic trough plant ranges from 24%–26%, and the overall annual average conversion efficiency is about 13%–15%.<sup>62</sup>



**Figure 34. Parabolic Trough System** Courtesy of: National Renewable Energy Laboratory. (1996). *Linear Concentrator Solar Power Plant Illustration*. Washington, DC: Department of Energy. Accessed at [https://www.eeremultimedia.energy.gov/solar/graphics/linear\\_concentrator\\_solar\\_power\\_plant\\_illustration](https://www.eeremultimedia.energy.gov/solar/graphics/linear_concentrator_solar_power_plant_illustration)

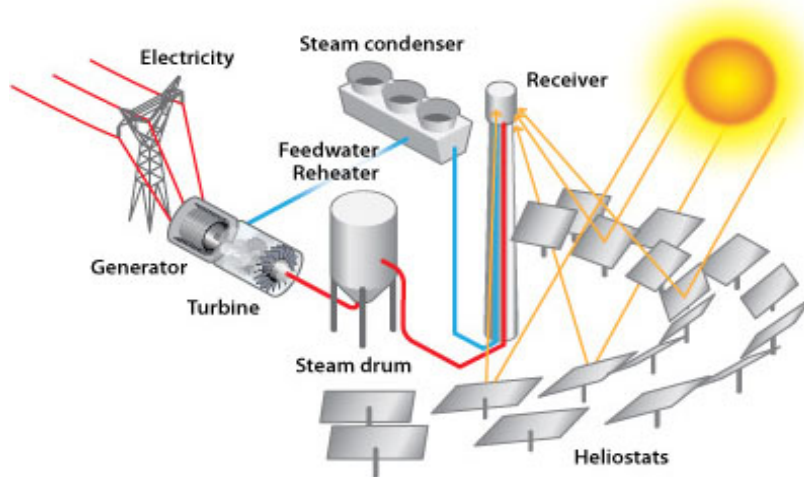
**Linear Fresnel Reflectors** approximate the parabolic shape of a traditional trough collector with long, ground-level rows of flat or slightly curved reflectors that reflect the solar rays up onto an overhead linear receiver (Figure 35). Flat reflectors and fixed receivers require lower capital costs compared to a traditional trough-based plant, but are less efficient on a solar-to-electricity basis. Recently, superheated steam at about 380°C has been demonstrated in a Linear Fresnel Reflector plant, and there are

proposals for producing steam at 450°C.<sup>63</sup> Because Linear Fresnel Reflectors are in the demonstration phase of development, their cost relative to parabolic troughs is unknown.



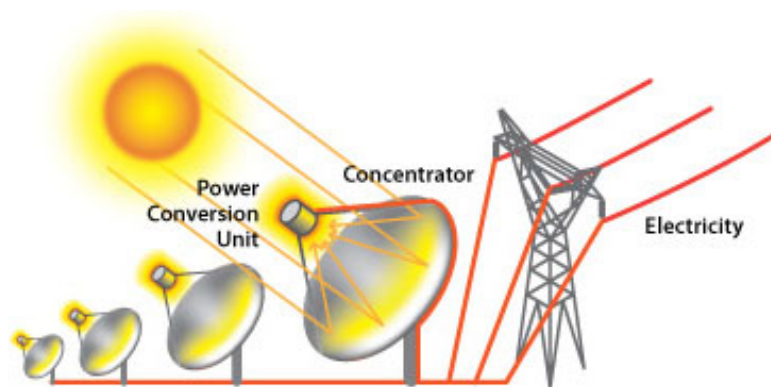
**Figure 35. Linear Fresnel System** Courtesy of: National Renewable Energy Laboratory. (2000). *Linear Fresnel Power Plant Illustration*. Washington, DC: Department of Energy. Accessed at [https://www.eeremultimedia.energy.gov/solar/graphics/linear\\_fresnel\\_power\\_plant\\_illustration](https://www.eeremultimedia.energy.gov/solar/graphics/linear_fresnel_power_plant_illustration)

**Power Tower Technology** accounts for 3% of global CSP capacity and is in the demonstration to early-commercialization stage of development.<sup>64</sup> Power tower systems use a field of 2-axis tracking collectors (heliostats) to reflect sunlight onto a central receiver; a large power tower plant can require anywhere from several thousand to more than one hundred thousand heliostats, each under computer control (Figure 36). This technology uses a Rankine or Brayton Cycle for power conversion. Most, but not all, power tower designs have a slightly larger footprint than an equivalent trough plant. Power towers have a concentration ratio of 500–1,500 suns and can achieve higher temperatures than other CSP technologies. Power tower designs currently use either molten salt as an HTF to move energy from the receiver to the steam generator, or to produce steam directly in the receiver. Both systems can operate at slightly less than 600°C. Because of their higher operating temperatures, power towers can achieve higher-efficiency and lower-cost TES compared to today's trough technology. The heliostat field can constitute about 50% of the plant cost, making it important to optimize heliostat design. The annual average solar-to-electric conversion efficiency of a power tower is about 14%–18%, with direct-steam towers slightly higher than molten-salt towers. The design-point efficiency is about 20%.



**Figure 36. Power Tower System** Courtesy of: National Renewable Energy Laboratory. (1996). *Concentrating Solar Power Tower Plant Illustration*. Washington, DC: Department of Energy. Accessed at [https://www.eeremultimedia.energy.gov/solar/graphics/concentrating\\_solar\\_power\\_tower\\_plant\\_illustration](https://www.eeremultimedia.energy.gov/solar/graphics/concentrating_solar_power_tower_plant_illustration)

**Dish/Engine Systems** were first demonstrated in the 1980s. They use a parabolic dish concentrator with an engine on each dish, instead of central steam generators like other CSP technologies. Dish systems currently use one of three engines: kinematic Stirling, free-piston Stirling, or Brayton turbine-alternator based (Figure 37). Although some companies are exploring TES, current dish/engine systems cannot use thermal storage because electricity is generated at each receiver instead of at a central steam turbine generator. Some dish/engine technology can be installed on relatively uneven land—with 5% or higher slope—reducing the cost of site preparation for new projects. Dish/engine systems use the least water of CSP technologies because they use closed loop cooling systems (similar to an automobile engine) and don't use a steam cycle. Dish/Stirling systems have demonstrated the highest recorded design-point solar-to-electric efficiency (31.4%) and have an estimated annual conversion efficiency in the low 20% range.<sup>65</sup>



**Figure 37. Dish/Engine System** Courtesy of: National Renewable Energy Laboratory. (1996). *Solar Dish/Engine Power Plant Illustration*. Washington, DC: Department of Energy. Accessed at [https://www.eeremultimedia.energy.gov/solar/graphics/solar\\_dishengine\\_power\\_plant\\_illustration](https://www.eeremultimedia.energy.gov/solar/graphics/solar_dishengine_power_plant_illustration)

**TES Systems** allow CSP systems to dispatch power beyond the daytime hours. Normally, incorporating TES is accompanied by increasing the size of the collector area to produce excess thermal energy during the day that can be put into the TES system for later use. The additional capital cost required to

incorporate TES is offset by increased operational hours. The most common thermal storage design is currently a two-tank molten-salt system. To store thermal energy, heat is transferred to the salt storage media. When the stored heat is needed, the system runs in reverse, transferring heat from the salt storage media. This type of thermal storage system is currently in commercial operation in Spain<sup>66</sup> and will soon be operational in the United States.

As the operating temperature of the storage medium increases, the amount of heat transferred to and from the medium also increases. Likewise, as the operating temperature increases, less of the storage medium is necessary to transfer the same amount of heat. This significant reduction in storage-material mass and the associated reduction in costs make it possible to economically add higher TES capacities. However, at least for the near term, most troughs and towers will likely be built with low levels (6 hours or less) of storage or none at all since electricity demand, and therefore value, is highest during the day and early evening. Still, higher levels of thermal storage may improve the economics of some projects; for example, 300 MW of the current CSP fleet include up to 7.5 hours of storage, and systems with up to 15 hours of storage are under construction.<sup>67</sup>

Storage can not only lower a CSP plant's levelized cost of electricity (LCOE), but also adds value by decreasing variability, increasing predictability, and providing firming capacity.<sup>68</sup> CSP plants with TES can bid into ancillary services and capacity markets where they exist to realize additional revenue. Even in the absence of explicit markets, CSP with TES can improve resource planning and help system planners and operators maintain grid reliability.

**HTFs** currently include molten nitrate salt, steam, synthetic oil, air, hydrogen, and helium. For power towers, the current state-of-the-art HTF, a 60/40 mixture of  $\text{NaNO}_3/\text{KNO}_3$ , is only capable of operating up to a temperature of about 600°C. Above this temperature, the nitrates degrade into nitrites, affecting performance. Other common fluids used as HTFs are not thermally stable at 600°C, have too high of a melting point, contain rare materials, or are gases with high-pressure requirements for necessary thermal transport rates.

### **7.2.3.1 Current Costs**

The estimated direct capital costs for building a 100–400 MW CSP plant today are about \$4,000–\$8,500/kW. The upper end of the range reflects plants with TES, whereas the lower end includes no-TES troughs, direct-steam generation towers, and dish/engine systems. Plant capacity factors extend from 20%–28% for plants with no TES and 40%–50% for plants with 6.0–7.5 hours of TES.<sup>69</sup> Larger amounts of TES and higher capacity factors are technically viable, but subject to project economics. The LCOE varies greatly depending on the location, values of key financing terms, available financial incentives, and other factors. For locations in the southwestern United States, the LCOE is currently about 19¢/kilowatt hour (kWh).<sup>70</sup>

One of the most recent utility-scale CSP plants built in the United States is the Nevada Solar One parabolic trough plant, which came online in 2007 at a reported cost of about \$4,100/kW (cost of \$266 million, capacity factor of approximately 23%, and nominal 64 MW capacity).<sup>71</sup> Several trough plants

similar in size have been built in Spain, including the Andasol plants that include TES; however, those project costs have not been disclosed.

**7.2.3.2 Manufacturing and Supply Chain**

The CSP supply chain is largely domestic. Most, if not all, materials needed to build a CSP plant can be found in the United States. However, substantial increases in the manufacturing capacity of CSP components will be required to meet a significant increase in CSP deployment. CSP plants require a number of components; some are similar to other industrial components and others are unique to the industry. Power block components and systems are mature and well-understood technologies, and thermodynamic power cycles currently used with CSP are more-or-less conventional and can be found elsewhere in the power generation industry. There may be R&D opportunities in automating the manufacture and installation of solar field components, which must be mass-produced and installed in large numbers.

**7.2.4 Technology Potential**

Assuming fixed financial inputs, the LCOE of a CSP plant can be reduced in two ways: (1) by lowering capital or operation and maintenance (O&M) costs, and (2) by increasing annual performance. The capital equipment for a CSP plant involves solar components (e.g., solar collector field, heat-transfer piping, and TES system) and more-or-less conventional thermodynamic power-cycle components (e.g., pump, turbine, and generator). The O&M cost per megawatt hour, of which staff is the largest contributor, decreases with an increase in plant size or co-location of multiple units.<sup>72</sup>

The operating temperature of a CSP plant is a major driver of conversion efficiency, and therefore system efficiency. Table shows the current, theoretical, and target operating temperatures for three CSP technologies. Linear Fresnel systems would be similar to parabolic trough values.

**Table 26. Current, Theoretical, and Target Operating Temperatures for CSP Systems** Based on: Kaltschmitt, M., Streicher, W., and Wiese, A. ed. (2007). "Renewable Energy: Technology, Economics and Environment." New York, NY: Springer.

	Parabolic Trough	Power Tower	Dish/Engine
Current concentration	~40	~800	~3,000
Maximum theoretical concentration	~215	~45,300	~45,300
Current operating temperature (°C)	~390	~565	~800
Maximum theoretical temperature (°C)	~1,120	~5,080	~5,080
DOE 2020 Target temperature (°C)	~500–600	~600–950	~800–1000

Reduced capital cost will be a consequence of manufacturing and installation scale-up, as well as technology advancements through R&D aimed at cost reduction and performance improvements. A number of component- and system-level advancements are currently being pursued, which generally can be classified into five subsystems: solar field, HTF, TES, cooling technology, and power block.<sup>73</sup>



Power towers may have the highest potential for cost reduction due to their combination of high optical concentration, high temperature, ease of TES integration, and ability to scale over a wide range of capacities.

The solar collector field (materials plus labor) represents the single largest capital investment in a CSP plant and, as such, represents the greatest potential for LCOE reduction among capital equipment costs. The key to reducing solar field costs is reducing the cost of the collector support structure, reflectors, and receivers.

For commercial parabolic trough systems, the maximum operating temperature is limited by the HTF. The maximum practical concentration ratio possible coupled with the lowest practical heat loss from the receiver tubes suggest an upper temperature limit of approximately 500°C for parabolic trough systems. Water/steam and molten-salt HTFs can be used at this temperature; however, there are concerns with the freezing temperature of molten salts, as well as a need for salt-compatible components. In contrast, molten salt and direct steam are currently used as the HTFs in power tower systems that operate at temperatures near 565°C. This is possible because of the considerably smaller amount of piping required for the HTF in a tower system. Owing to higher concentration ratios associated with tower systems as compared with parabolic troughs, operating temperatures of 1,000°C or higher may be feasible, depending on the medium used for the HTF.

The current CSP power block for trough, Fresnel, and power tower systems uses many conventional steam Rankine cycle components. It consists of a steam generator that feeds a subcritical Rankine cycle with reheat. The main cost-reduction potential in the current power block is correlated to increased size. The next-generation power cycle is likely to be the supercritical steam Rankine cycle because it readily exists at commercial, utility-scale fossil plants. Operating at temperatures above 650°C may require advanced cycles, such as supercritical CO<sub>2</sub> Brayton or Air-Brayton, which could provide high thermodynamic efficiencies compared to a traditional Rankine cycle. Regardless of the power-cycle design, achieving the greatest cost reduction will require significant decreases in collector costs, while also minimizing optical efficiency losses. It is essential to remove material weight from the solar field while maintaining adequate wind-load rigidity and optical accuracy. The primary cost components of heliostats include the reflector module, support structure and pylon, drive systems, wiring, and manufacturing infrastructure. Proposed improvements include polymeric or thin-glass reflectors, anti-soiling coatings to maintain reflectivity while decreasing O&M costs, novel structures with significantly reduced material content, low-cost drives with wireless field controls, and highly automated manufacturing and installation procedures.

The development and testing of new solar receiver designs and materials will be necessary to accommodate the deployment of advanced, high-temperature power cycles. Air-Brayton systems running at temperatures of 1,000°C and higher may require volumetric receivers or designs with secondary concentrators; such designs are currently being investigated as part of the European Solugas project. Although supercritical CO<sub>2</sub> systems will run at lower temperatures (600°C–800°C), they will still require analysis of compatible materials and receiver designs for high-pressure CO<sub>2</sub> systems. Selective receiver tube surface coatings that maintain high absorptivity while minimizing emissivity and are stable



at high temperatures in air are needed for new receiver designs. Initial research suggests that candidate materials may be found among those originally investigated for trough receiver coatings.

Last, as temperatures are increased and new HTFs are deployed, TES systems will need to advance in order to maintain the relatively high efficiency and low cost of current CSP TES systems. Supercritical steam and CO<sub>2</sub> are compatible with thermocline and two-tank storage concepts, but salts with stability and low corrosivity at the proposed higher temperatures may be required. Air-Brayton cycles would benefit from low-cost, solid-phase storage media or other novel TES concepts.

Significant work is required to improve the accuracy of global resource potential measurements. Highly accurate data on direct normal irradiance is critical to the deployment of CSP plants, as are the availability of reliable, sub-hourly, and sub-km datasets. Most solar resource data is satellite-based and several kilometers in resolution. Currently, there are only a few dozen quality, ground-based solar measurement stations operating in the United States, and only a subset of these stations have been operating long enough to provide accurate information on the inter-annual variability and long-term trend of the solar resource.

Table provides a summary of R&D opportunities for CSP cost reduction.

**Table 27. CSP Technology Development Areas**

Subsystem	Pathways
Solar Field	<ul style="list-style-type: none"> <li>• Polymeric and thin-glass front-surface reflectors</li> <li>• Anti-soiling coatings and low-to-no H<sub>2</sub>O cleaning</li> <li>• Low-cost drives</li> <li>• Accurate controls</li> <li>• Optimized support structure</li> <li>• Autonomous power and control</li> <li>• Automated manufacturing</li> <li>• Rapid installation, minimal site prep</li> <li>• Mass production</li> </ul>
Power Plant / Balance of Plant	<ul style="list-style-type: none"> <li>• High-efficiency power cycles</li> <li>• Combined cycle configurations</li> <li>• High-temperature heat exchangers</li> <li>• High-temperature hardware/instrumentation</li> <li>• Modular plant designs</li> <li>• Operation and maintenance optimization</li> </ul>
Solar Receiver	<ul style="list-style-type: none"> <li>• High-temperature materials</li> <li>• Solar selective coatings</li> <li>• Alternative designs</li> </ul>

Thermal Storage	<ul style="list-style-type: none"> <li>• High-temperature storage concepts</li> <li>• Molten-salt additives</li> <li>• Advanced, low-cost heat transfer fluids</li> <li>• Single-tank configurations</li> <li>• Chemical storage concepts</li> <li>• Corrosive-resistant, high-temperature hardware</li> </ul>
-----------------	--

#### 7.2.4.1 SunShot Initiative

In 2011, DOE launched the SunShot Initiative, a collaborative national initiative to make solar energy cost competitive with other forms of energy by the end of the decade. The SunShot target is for CSP to reach \$0.06/kWh, including 14 hours storage by 2020—a value that would make CSP competitive with base-load coal plants. This stretches further than the projected improvement developed by DOE in 2009 of \$0.09/kWh by 2020, and requires advanced CSP technological improvements and breakthroughs beyond previous estimates.<sup>74</sup>

Table outlines current and future CSP costs<sup>75</sup> based on the DOE roadmap exercises and a hypothetical combined-cycle power tower for the more aggressive cost-reduction SunShot case. Costs for 2010 are estimated based on a 100-MW parabolic trough plant with no TES, while the costs for 2015 are based on a 250-MW parabolic trough plant with 6 hours of TES and a 100-MW molten-salt power tower plant with 6 hours of TES. After 2015, salt-HTF trough and tower systems are assumed to be proven technologies with expanding deployment that leads to reduced costs via learning and manufacturing volume. The 2020 tower roadmap case is based on a 150-MW molten-salt HTF tower with a supercritical steam power cycle at 650°C. The SunShot case requires more aggressive performance improvements and cost reductions than assumed by the roadmap cases and is based on a 200-MW supercritical CO<sub>2</sub> power tower.<sup>76</sup> That level of cost reductions likely includes an increase in system efficiency by moving to higher-temperature operation (i.e., maximizing power-cycle efficiency) without sacrificing efficiency elsewhere in the system (i.e., minimizing optical and thermal efficiency losses). Likewise, reducing the cost of the solar field and developing high-temperature TES compatible with high-efficiency, high-temperature power cycles are critical to driving costs down further. The primary source of efficiency gains is the development and implementation of advanced power cycles, with the leading candidates for CSP applications being supercritical CO<sub>2</sub> Brayton and Air-Brayton power cycles.

**Table 13. Current and Projected Costs and Performance Estimates for CSP Trough and Tower Technologies**  
 Department of Energy. (2012). *SunShot Vision Study*. Washington, DC. Performance and cost values generated using the National Renewable Energy Laboratory’s System Advisor Model, available at <https://www.nrel.gov/analysis/sam/>

Case	2010 Trough	2015 Trough Roadmap	2015 Tower Roadmap	2020 Trough Roadmap	2020 Tower Roadmap	2020 Aggressive SunShot Target
<b>Design Assumptions</b>						
Technology	Oil-HTF Trough	Oil-HTF Trough	Salt Tower	Salt-HTF Trough	Salt Tower	Supercrit CO <sub>2</sub> combined cycle Tower
Solar Multiple	1.3	2.0	1.8	2.8	2.8	2.7
TES (hours)	-	6	6	12	14	14
Plant Capacity (MW, net)	100	250	100	250	150	200
Power Cycle Gross Efficiency	0.377	0.356	0.416	0.397	0.470	0.550
Cooling Method	wet	dry	dry	dry	dry	dry
<b>Cost Assumptions</b>						
Site Preparation (\$/m <sup>2</sup> )	20	20	20	20	20	10
Solar Field (\$/m <sup>2</sup> )	295	245	165	190	120	75
Power Plant (\$/kW)	940	875	1,140	875	1,050	880
HTF System or Tower/Rcvr (\$/m <sup>2</sup> or \$/kW <sub>th</sub> )	90	90	180	50	170	110
Thermal Storage (\$/kWh <sub>th</sub> )	-	80	30	25	20	14
Contingency	10%	10%	10%	10%	10%	10%
Indirect (% of direct costs + contingency)	17.6%	17.6%	17.6%	17.6%	17.6%	13%
O&M (\$/kW-yr)	70	60	65	50	50	40
<b>Performance and Cost</b>						
Capacity Factor	25.3%	42.2%	43.1%	59.1%	66.4%	66.6%
Total Installed Cost (\$/kW)	4,500	7,870	5,940	6,530	6,430	3,770
LCOE (c/kWh, real) [SunShot financial assumptions]	20.4	19.4	14.4	11.6	9.8	6.0

### 7.2.5 Factors that Affect Market Prospects

Financing presents a significant hurdle to the commercialization of new and existing CSP technologies. The size and term of capital expenditure for CSP (a 100-MW plant currently requires \$400–\$800 million, depending on storage)<sup>77</sup> are inappropriate for venture capital. CSP projects largely use first-of-a-kind technology and are therefore viewed as too risky for traditional project finance.

Project financing can be aided by modularity of the technology. Dish/engine systems are modular, with systems built to scale to meet the needs of each individual project site, potentially satisfying loads from kilowatt to gigawatt. This scalability makes dish/engine technology applicable for both distributed and utility-scale generation.

CSP demonstrations typically range between 1–10 MW. Most CSP projects in Spain are 50 MW, a size driven by policy rather than technical optimization. Based on a technical optimization, the optimal size of a CSP plant is approximately 150–250 MW.<sup>78</sup>

Obtaining permits, access to the grid, and access to water and gas networks for backup adds time, cost, and uncertainty to project development. For CSP plants with wet cooling, the significant water consumption can present both a logistical and sustainability challenge. Dry and hybrid cooling can reduce CSP water consumption substantially, although these systems can increase cost and reduce efficiency compared to wet cooling. CSP plants also require a relatively large plot of land; for example, a 100-MW project requires almost 1 square mile of land.<sup>79</sup> This land must be selected in a way that minimizes environmental and ecological effects. A wide range of habitats, plant and animal species, and cultural and economic activities could be affected by widespread solar development, particularly in the southwestern United States.

Electricity demand centers are often situated long distances from the best CSP resources, requiring access to or the build out of long-distance transmission lines.<sup>80</sup> Most transmission lines in the Southwest are already at or near full capacity, making access to transmission difficult.

### 7.2.6 DOE History and Accomplishments

Federal funding for CSP began in 1974 with National Science Foundation support for power tower system studies, followed by construction of the National Solar Thermal Test Facility at the Sandia National Laboratories. In 1979, two engineering prototype parabolic trough modules were assembled at Sandia National Laboratories to provide a documented indication of the performance potential of parabolic trough solar collectors. This demonstration provided a baseline for glass reflector technology and set a near-term performance goal for the collector manufacturing industry. Over the next several years, a number of other trough systems were developed, primarily for industrial process heat and irrigation pumping applications. However, emphasis subsequently shifted to focus solely on power production. R&D from the late 1970s to the mid 1980s improved trough technology to the point where Luz International first commercialized CSP in the 1980s with the Solar Energy Generating Systems (SEGS)—nine parabolic trough plants in the Mojave Desert of southern California, totaling 354 MW. The SEGS facilities were completed in 1991. Sandia was involved in the testing and evaluation of developmental and commercial trough collector hardware, with the SEGS plants in California leveraging much of this work. Sandia worked with the SEGS III-VII plants at Kramer Junction, California, throughout the 1990s to reduce O&M costs.

As a more recent example, DOE began funding R&D for advanced trough collector design projects in 2007. Solar Millennium's design has been built and tested through a DOE award at a 1-MW test loop at

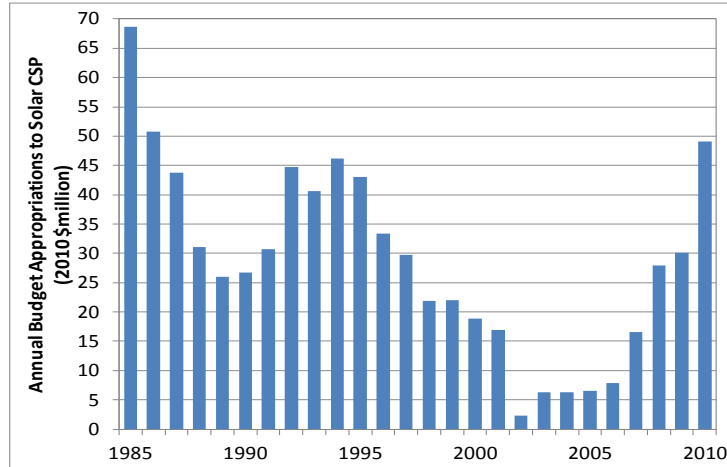
the SEGS plants in California. Abengoa Solar's design has been built and tested at the 1-MW Cameo project in Colorado.

Power tower development can also be traced through DOE-funded activities. Solar One—a joint undertaking of the Department, Southern California Edison Company, Los Angeles Department of Water and Power, and California Energy Commission—was a 10-MW water-steam power tower built in Barstow, California, between 1979 and 1981. Solar One was instrumental in helping to prove that power tower technology is effective, reliable, and practical for utility-scale generation. It operated from 1982 to 1988 and ultimately achieved 96% availability during hours of sunshine. In the 1990s, the Solar One steam-receiver plant was redesigned into a power tower plant named Solar Two, which employed a molten-salt receiver and TES system. The change from steam to a molten-salt working fluid was made largely due to the ease of integrating a highly efficient (about 99%) and low-cost energy storage system into a molten-salt plant design. The project was developed by DOE with a consortium of utilities led by Southern California Edison. Solar Two operated from 1996 to 1999 and helped validate nitrate salt technology and reduce the technical and economic risks of power towers, which is critical to CSP power tower commercialization. Solar One was a precursor to commercial direct steam power tower projects. Similarly, Solar Two served as a precursor to commercial molten-salt power tower projects with molten-salt thermal storage. Furthermore, the molten-salt storage validated at Solar Two has been commercially deployed at parabolic trough plants.

As for dishes, early DOE-funded work was carried out through the Jet Propulsion Laboratory in Pasadena, California, and later transferred to Sandia National Laboratories. Throughout the 1970s and 1980s, several dish/engine prototypes and hardware (e.g., concentrators, receivers, engines, transport, storage, and controls) were developed and tested. These experiments demonstrated the technical readiness of dish systems in electric power and process heat applications. Dish/electric modules based on Rankine-, Stirling-, and Brayton-cycle technology were explored. DOE has worked with industry to improve the reliability of the dish engine, primarily the Stirling engine, and is presently working on concepts to enable the technology to store energy.

Linear Fresnel technology has primarily been developed in Europe and Australia; DOE has had limited involvement to date.

DOE funding for CSP technologies has varied greatly since its first year of funding in 1974 (see Figure 38).



**Figure 38. Historical DOE Funding for CSP Technologies.** Sources: (1985–2000) Current Congressional Appropriations from DOE CFO, Office of Budget; (2000–2002) DOE CFO, Office of Budget (<http://www.cfo.doe.gov/budget/02budget/es/solar.pdf>); (2003–2008) DOE EERE Budget Office ([http://www1.eere.energy.gov/ba/pba/budget\\_archives.html](http://www1.eere.energy.gov/ba/pba/budget_archives.html)); (2009–2010) 2011 FY11 Congressional Budget for DOE EERE ([http://www1.eere.energy.gov/ba/pba/pdfs/fy11\\_budget.pdf](http://www1.eere.energy.gov/ba/pba/pdfs/fy11_budget.pdf)). Converted to 2010 \$million using consumer price index from the Department of Labor, Bureau of Labor Statistics (<ftp://ftp.bls.gov/pub/special.requests/cpi/cpi.txt>).

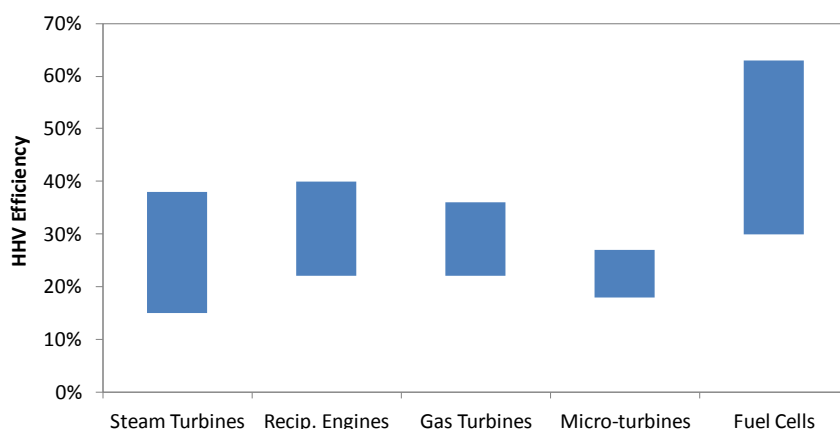
### 7.2.7 DOE Role

DOE’s role in CSP is expanding beyond R&D capability, convening, and informational to targeted initiatives. This means that, in addition to the fundamental engineering science and materials capabilities that the Department commits to CSP R&D, DOE has announced an ambitious technical goal—less than \$4/watt (W)—and will work with industry and academic partners toward that goal. This initiative, called SunShot, focuses on the installed system as a whole, including both technical and non-technical costs. For non-technical costs, areas of DOE focus include partnering with other federal and state entities to perform a programmatic environmental impact statement, identifying suitable federal land for utility-scale solar project development, and identifying best locations for new transmission corridors.

## 7.3 Fuel Cells for Distributed Generation

### 7.3.1 Current Status of Technology

Fuel cells for distributed generation have low emissions (60% reductions compared to coal power and 22% compared to a natural gas combined-cycle central station<sup>81</sup>), high electrical efficiency (greater than 60% of low heating value in select cases,<sup>82</sup> see Figure 39), nearly silent and vibration-free operation, potential to increase direct current (DC) power system reliability,<sup>83</sup> low maintenance, and the ability to use an existing natural gas fuel supply, as well as biogas, hydrogen, and other fuels. Global distributed fuel cell capacity is 100–150 megawatts of electric energy (MWe), including about 50 MWe operating in the United States (some 0.005% of total generating capacity). The market is small, but it is rapidly growing (increasing annually by 27% between 2008 and 2010<sup>84</sup>) as capital costs have approximately halved over the past 5 years.<sup>85</sup>



**Figure 39. Efficiency of Various Distributed Generation Technologies.** HHV = high heating value. No combined cycle assumed. Source: Environmental Protection Agency. (2008). *Catalog of CHP Technologies*. Table III of Introduction on page 7. Washington, DC. Accessed at [http://www.epa.gov/chp/documents/catalog\\_chptech\\_full.pdf](http://www.epa.gov/chp/documents/catalog_chptech_full.pdf)

Many of the first applications of distributed fuel cells have been in markets that require high reliability: data centers, telecommunications towers, emergency response and life support systems, and national defense and homeland security applications. Notably, these applications also have high load factors (i.e., require near-constant power), which justify the capital expense of fuel cells.

Costs of fuel cells for distributed generation are more than \$4,500/kW today. Greater penetration of the commercial and residential markets requires that capital and installation costs fall to less than \$2,000/kWe and durability (i.e., useful lifetime of the fuel stack) increase by at least 50%.<sup>86</sup> To date, fuel cells have been built at relatively low volumes, which has contributed to their high cost. Technology improvements, economies of scale, and advanced manufacturing techniques offer the potential for significant cost reductions.

Target capital costs for fuel cells using natural gas are several fold greater than those of a natural gas combined-cycle plant (projected to be less than \$1,200/kW with carbon capture and storage, or less than \$600/kW today without CCS for a 560-MW<sub>net</sub> power plant).<sup>87</sup> However, fuel cell systems are

expected to compete with microturbines to supply the distributed generation market if the installed cost is reduced below \$2,000/kWe. Microturbines with combined heat and power (CHP) have an installed cost of \$2,400–\$3,000/kW (compared to current \$5,000–\$6,500/kW installed costs for fuel cells with CHP).<sup>88</sup> Since they compete with residential power prices rather than wholesale prices, distributed generation systems can be economic with higher LCOE than utility-scale systems.

Distributed generation technologies can reduce peak electrical demand and congestion on the grid and provide local CHP for residential, commercial, and industrial applications. High-temperature waste heat from fuel cells can also be used to power absorption chillers and reduce the energy used to cool buildings. Verizon, for example, installed more than 1.4 MW of fuel cells to provide reliable power, as well as heating and cooling for one of its telecommunications centers.<sup>89</sup>

Natural gas and biogas from sources such as wastewater treatment plants and landfills are already available as fuels. The development of low-carbon fuels (e.g., hydrogen from biomass or microbial pathways) would reduce fuel cell GHG emissions even further.

Fuel cells used for CHP can provide heat and power more efficiently (70%–90% total efficiency on a lower heating value basis),<sup>90</sup> while avoiding the losses involved in electricity transmission and distribution.

The ability of fuel cells to follow load changes varies with fuel cell technology and system design. In general, lower-temperature systems are able to respond more quickly to transient power demands. For instance, polymer electrolyte membrane fuel cell (PEMFC) systems for automotive applications can transition from 10%–90% of rated power in less than 1.5 seconds.<sup>91</sup> Low-temperature PEMFC systems for small-scale CHP applications can transition from 10%–90% of rated power in less than 10 seconds. Higher-temperature systems are less capable of rapid response, with solid oxide fuel cells (SOFCs) currently achieving 5 minutes for 10%–90% transients.<sup>92</sup>

The major types of distributed generation fuel cells are described in Table .

**Table 29. Characteristics of Commercially Available Stationary Fuel Cell Types for Distributed Generation** “e” percentage is the efficiency of electricity generation only, CHP percentage is the efficiency from combining electricity production with waste heat use.

Fuel Cell Type	Operating Temperature	Efficiency	Unit Capacity	Fuel Stack Lifetime (hours)	Characteristics
Phosphoric Acid (PAFC)	150°C–200°C	40% e <sup>-</sup> 90% CHP	0.4 MW	80,000	Load following between 50%–100% of rated capacity
Molten Carbonate (MCFC)	600°C–700°C	>45% e <sup>-</sup> >85% CHP	0.35– 2.80 MW	40,000	Ammonia and carbon monoxide tolerant
Polymer Electrolyte Membrane (PEMFC)	50°C–100°C	40% e <sup>-</sup>	<1 MW	20,000–40,000	Most relevant for residential and light commercial CHP
Solid Oxide	700°C–900°C	50%–60%	<1 MW	20,000	Ammonia and carbon



(SOFC)		e <sup>-</sup>			monoxide tolerant
--------	--	----------------	--	--	-------------------

Beyond the need to reduce cost, there are specific technical challenges for each of these technologies (see Table ).

**Table 30. Technical Challenges for Fuel Cell Platforms.** PAFC = phosphoric acid, MCFC = molten carbonate, PEMFC = polymer electrolyte membrane, SOFC = solid oxide fuel cells

	PAFC	MCFC	PEMFC	SOFC
Low power density	x	x		
Short stack lifetime		x	x	x
Cost/complexity of manufacturing	x	x		x
Requirement for contaminant removal from fuel stream	x	x	x	x
Costly catalysts	x		x	
Poor transient response				x

There are fuel cell systems that are a cross between PEMFCs and phosphoric acid fuel cells (PAFCs), which have similar operation to PAFCs, but with a polymer-phosphoric acid electrolyte (such as BASF's gel-type polybenzimidazole). These would allow for enhanced performance and higher tolerance to carbon monoxide impurities in the fuel when operating in the 130°C–180°C range.

Advanced manufacturing techniques for fuel cells include membrane and electrode fabrication; online automated measurement tools for characterization, sampling, and testing; and advanced bonding processes for high-temperature membrane electrode assemblies.

Another potential application of fuel cell and hydrogen technologies is the storage of electricity, the need for which is likely to grow along with intermittent renewable generation. For example, solar or wind electricity can power electrolyzers that split water into hydrogen and oxygen. However, electrolysis will not be cost effective until efficiencies greatly improve. Hydrogen and/or oxygen can be stored and converted back to electricity using fuel cells or fuel cells combined with turbines. Reversible fuel cells can operate in either electrolyzer or fuel cell mode.

The global market for fuel cells in all applications grew to approximately \$500 million in 2009,<sup>93</sup> most of which was for distributed generation fuel cells. Approximately 15,000 fuel cells were shipped in 2010, which was about double the number in 2008.<sup>94</sup> U.S. manufacturers account for roughly 40% of the global production of fuel cells on a megawatt basis.<sup>95</sup>

### 7.3.2 Historical Pace of Development and Market Diffusion

The capital costs of some fuel cell stacks for distributed generation have come down by approximately 50% over the past 5 years.<sup>96</sup> The number of non-automotive fuel cells sold annually by U.S. manufacturers has increased by a factor of 5 from 2005 (see Table ). The United States, South Korea, Germany, and Japan are the fuel cell market leaders (see Figure 40). As of 2008, there were 13 MW of PEMFCs installed in the United States, including 10 MW for backup power.<sup>97</sup>

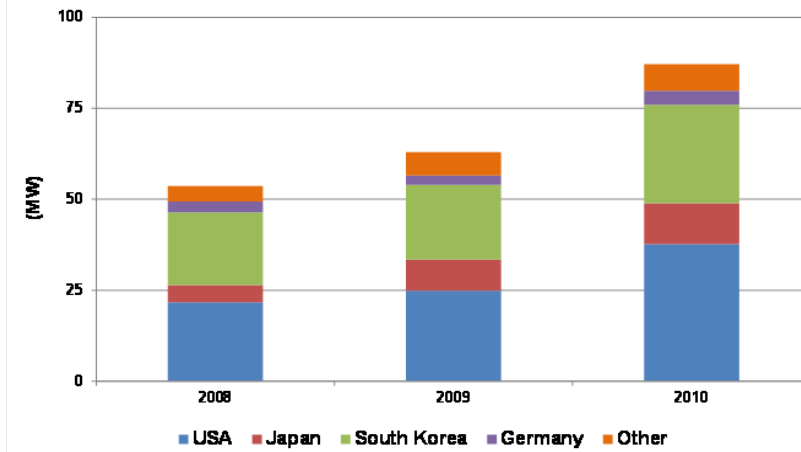


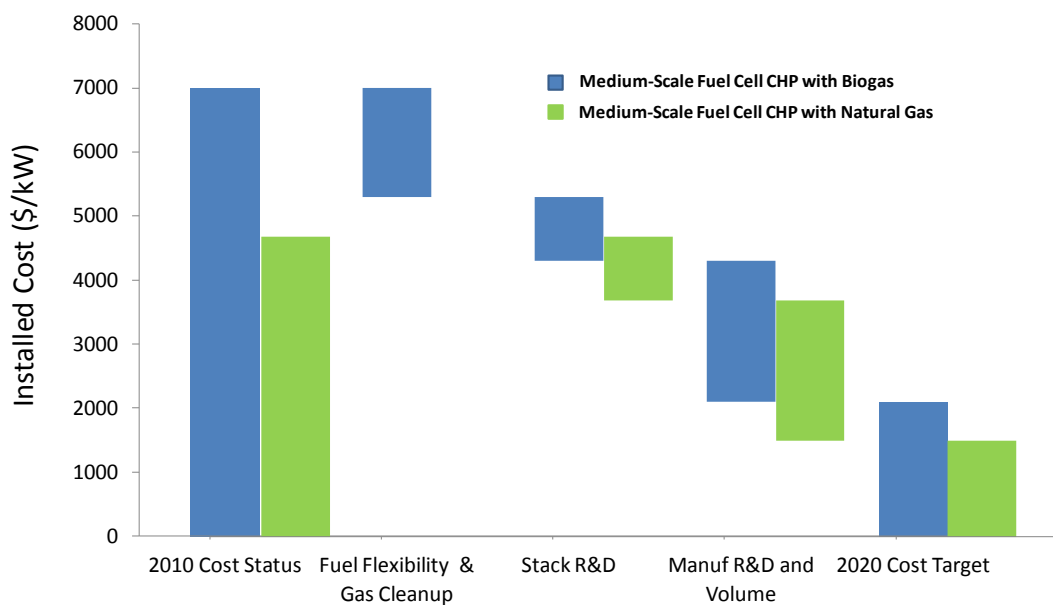
Figure 40. Fuel Cell Shipments in Major Countries (including exports). Adapted with permission from Pike Research ([www.pikeresearch.com](http://www.pikeresearch.com)).

Table 14. Estimated Production of Non-Automotive Fuel Cells by U.S. Manufacturers Compiled by Oak Ridge National Laboratory from information provided by manufacturers, annual reports, and other published sources.

	2005	2006	2007	2008	2009	2010
<b>Polymer Electrolyte Membrane Fuel Cells (PEMFC) (5 kW equivalent units)</b>						
PEMFC Material Handling	0	0	123	211	477	803
PEMFC Backup Power	135	158	219	435	894	1,221
PEMFC Combined Heat and Power	71	71	71	71	71	250
<b>Larger Non-PEMFCs</b>						
PAFC (400 kW equivalent units)	10	10	10	10	50	75
MCFC (MWs)	6	5	12	24	32	32

### 7.3.3 Technology Roadmap

There is significant room to improve the cost and performance of fuel cells. Fuel cells for distributed generation cost more than \$4,500/kW today. Roadmaps developed in consultation with industry suggest that there are no clear pathways below a first cost of \$2,000/kW for molten carbonate fuel cells (MCFCs) or PAFCs.<sup>98</sup> However, roadmaps developed by DOE that take into account cost reduction through increased production volumes and innovative R&D have identified paths to reduce installed costs to approximately \$2,100/kW for systems operating on biogas and \$1,500/kW for systems operating on natural gas (Figure 41).<sup>99</sup>



**Figure 41. DOE Cost-Reduction Potential Through 2020.** Analysis by the Department of Energy’s Fuel Cell Technologies Program. (2011). Washington, DC.

Figure 41 shows the cost-reduction potential for a fuel cell with the capability to use either natural gas or biogas. Currently, the biogas option for operating a fuel cell system includes a \$2,200–\$2,600/kW increase in installed cost for gas cleaning with existing technology.

At this time, reliable cost information for SOFCs is not available; however, estimates of \$8,000/kW have been reported.<sup>100</sup> In 2010, an independent panel judged that factory costs for small-scale SOFC systems could be reduced from \$1,300–\$4,500/kW to \$1,000–\$2,000/kW by 2020.<sup>101</sup>

There are several opportunities to achieve this technical potential. Reducing platinum content by 50% would reduce costs by roughly 3% for both PAFCs and PEMFCs.<sup>102</sup> Improved manufacturing methods could bring costs down by at least 10% for PEMFCs and PAFCs. Industry experts believe that R&D could increase durability by 50%–100% for certain fuel cells (PEMFC, MCFC, SOFC), which would reduce the cost of electricity by more than 10%.<sup>103</sup>

Some R&D opportunities include:

- Developing improved catalysts and electrolytes
- Identifying degradation mechanisms and approaches for mitigating their effects
- Characterizing and optimizing transport phenomena to improve cell and stack performance
- Investigating and quantifying effects of impurities on performance
- Developing low-cost, durable system balance-of-plant components
- Developing advanced manufacturing and diagnostics technology
- Developing innovative concepts for fuel cell technologies.

### 7.3.4 Potential Improvements

Table and 33 show potential improvements for fuel cells used in CHP applications. PEMFCs (up to 10 kWe for individual homes) are assumed to use natural gas, whereas larger systems for commercial and apartment buildings (MCFCs and PAFCs) are assumed to use either natural gas or biogas. These potential improvements are driven by the requirement to compete with incumbent technologies and based on an assessment of cost-reduction potential that is founded on cost engineering models and stakeholder feedback. These improvements, based on learning curve models, may not occur by 2020 if manufacturing volumes do not reach the assumed 100 MW per year.<sup>104</sup>

**Table 15. Costs of Fuel Cell CHP System**

	(\$/kWe)		
	2011	2015	2020
<b>Natural Gas</b>	4,600	3,000	1,500
<b>Biogas</b>	6,800	4,100	2,100

**Table 16. Levelized Cost of Electricity**

	From Fuel Cell CHP (¢/kWh)		
	2011	2015	2020
<b>Natural Gas</b>	17	12	7.9
<b>Biogas</b>	21	14	8.8

*Costs do not include federal and state incentives.*

*Natural gas prices from the Annual Energy Outlook 2011 (commercial rates).*

*Biogas prices assumed equal to natural gas prices.*

### 7.3.5 Near-Term Research Opportunities

The four major fuel cell pathways have different operating characteristics that make them suitable for different applications. For example, MCFCs and SOFCs are best for applications where high efficiency is desired, while PAFCs are more suitable for applications where the longest possible lifetime is required, and PEMFCs are desirable in applications where the fastest possible startup is required. Fuel type and quality, requirements for cogeneration of heat and/or hydrogen, and requirements for reliability and availability will also determine the best technology in a given application. Continued development may eventually allow one or more of these technologies to capture a more significant market share.

Key distributed generation R&D that is required includes tailoring electrode structures to increase power density, reduce polarization losses, improve durability, and reduce the amount of precious metal catalysts. Industry and DOE analyses have shown that both the fuel cell stack and balance-of-plant have significant headroom.<sup>105</sup> The following activities are therefore important:

- Conducting research on fuel cell stack components (such as catalysts, electrodes, interconnects, and electrolytes)
- Improving manufacturing processes (reducing cost, number of parts, and time of assembly) and developing advanced diagnostics that can quickly identify defective components on assembly lines
- Investigating new materials, new architectures, and operating conditions for low- and high-temperature fuel cells, or new structures and/or morphologies for existing materials.

The development of low-cost, durable, high-performance balance-of-plant components and subsystems is a critical element of distributed generation fuel cells.

### 7.3.6 Factors that Affect Market Prospects

Small distributed generation fuel cell systems have simpler and streamlined interconnection fees, standby/backup charges, engineering review, and contracting requirements. Presently, the “soft costs” for a small system are the same as that for larger systems (e.g., greater than 2 MWe).<sup>106</sup>

For large and small distributed generation systems, there are uncertainties regarding the cost of additional liability insurance, the rate at which excess distributed generation electricity can be sold to the grid, and the rate charged by the utility for standby/backup.

### 7.3.7 Breakthrough Technologies

Several innovative technologies have the potential to dramatically improve fuel cell performance at a lower cost. These technologies are early in the development phase, sufficiently out of the commercial mainstream to be viewed as “high-risk and high-return” R&D investments. Existing public and private sector R&D endeavors of this sort include:

**Reversible Fuel Cells:** Reversible fuel cells (such as reversible SOFCs) can improve the integration of intermittent renewable generation and could enable a smarter grid. However, the performance of this technology in the electrolyzer mode needs to be made more stable, and its ability to handle transients needs to be improved. The degradation mechanisms need to be understood, and novel materials for cells and stack must be developed, along with novel stack designs.

**Durable Ultra-Low Platinum Group Metal Catalysts:** The high cost of platinum group metal catalysts in PEMFCs and PAFCs drives the need to minimize their use. Innovative concepts with very low platinum group metal content are being studied with advanced theoretical and computational methods to understand and engineer new catalysts and catalyst layers, to investigate catalyst-support interactions and their effects on durability and mass activity, and to test and characterize new materials.

**Innovative Hydrogen Storage and Delivery Technologies:** Full commercialization of hydrogen fuel cells will require advances in technologies for storing hydrogen. Storage requires very high pressures, low temperatures, or material-based processes (as opposed to high-pressure storage, for example, using controllable low-pressure adsorbants) to be stored in a compact container. Research is ongoing to increase filling and discharge rates, improve pressure and temperature management, and achieve cost-effective packaging into integrated systems. Additional research is needed for larger-scale material production and handling methods.

### 7.3.8 Deployment Barriers

Fuel cells are currently competitive in niche applications, such as emergency backup power and distributed generation in California. In addition to the state of the technology, certain institutional and economic barriers, such as non-uniform codes and standards and the lack of public awareness and understanding of the technologies, impact the competitiveness of fuel cells.

The recent growth of the stationary fuel cell market has been facilitated by the federal investment tax credit of \$3,000/kW (or 30%, whichever is lower) of the capital cost for a fuel cell system, as well as by additional incentives in states such as California. Fuel cells can be competitive in regions where natural gas prices are low and electricity prices are high. More recently, Section 1603 of the tax code has provided grants (cash payments) in lieu of tax credits, which allows entities that do not pay substantial taxes (and hence don't benefit from a tax credit) to obtain incentives equivalent to the investment tax credit.

State policies with respect to CHP will also affect the deployment of fuel cells. These policies include energy efficiency resource standards and renewable portfolio standards (RPS). Thirteen states have portfolio standards that include CHP, using both renewable fuels and fossil fuels such as natural gas. There are no standard methods to compute the energy efficiency contribution of CHP for RPS purposes.

### 7.3.9 DOE History and Accomplishments

DOE has supported the development of PEMFCs, PAFCs, MCFCs, and SOFCs for more than three decades, helping to enable their commercial introduction. Fuel cells have been demonstrated with a variety of fuels, including hydrogen, pipeline natural gas, propane, bio-gas derived from landfills and waste water treatment plants, and fuel from coal gasification.

DOE's efforts have focused on the R&D of materials, stack components, balance-of-plant subsystems, and integrated fuel cell systems, targeting lower cost and enhanced durability, with an emphasis on the science and engineering at the cell level and on integration and component interactions at the system level. To complement R&D, DOE has also conducted demonstrations to verify the performance of pre-commercial technologies. These demonstrations have involved multiple types of fuel cells and a variety of applications, ranging from small residential, backup power, or portable systems to hundreds of kilowatts for buildings or industrial processes. DOE also identifies strategic opportunities to grow early markets for fuel cells and has directly assisted in commercial and near-commercial fuel cell system deployment in these markets through ARRA.

DOE achievements related to distributed generation fuel cells include:

- Reduced the cost of gas diffusion layers by more than 50% for PEMFCs.<sup>107</sup>
- Demonstrated the potential for 25% reduction in costs through a novel, three-layer membrane electrode assembly (MEA) manufacturing process.<sup>108</sup>
- Demonstrated more than 11,000 hours of durable, kilowatt-scale SOFC operation in 2011—more than double the 2010 durability of 4,500 hours.<sup>109</sup>
- Provided technical assistance, project development, and data collection support to several federal agencies, including assistance with early adoption demonstrations by the Department of Defense, the Federal Aviation Administration, and the U.S. Postal Service.<sup>110</sup>
- Deployed more than 800 fuel cell systems in emergency backup power, material handling, and CHP applications through \$42 million in ARRA funds, matched by \$54 million in cost-share.<sup>111</sup>

Over the past 11 years, DOE has invested approximately \$95 million in fuel cell R&D for small-scale distributed generation, at about \$5–\$10 million per year (\$42 million of ARRA funding not included). In addition, a significant portion of the work on automotive fuel cells is applicable to PEMFCs for distributed generation. Some of the R&D on hydrogen storage, production, and delivery technologies is applicable to distributed generation. Finally, market transformation activities and a portion of other crosscutting activities (e.g., safety, codes, and standards; systems analysis; and outreach) are applicable to fuel cells for power generation.

In recent years, emphasis has shifted from PEMFC research to include other types of fuel cells, with a portfolio of technology-neutral, application-driven activities. In addition, R&D on the balance-of-plant of fuel cells (components other than the fuel cell stack; e.g., the gas cleanup system, reformer, process control system, heat exchangers, water management system, and power conditioning section) has started to receive increasing attention for both low-temperature and high-temperature technologies.

#### **7.3.10 DOE Role**

DOE maintains mostly informational and R&D capability activities related to fuel cells. For example, the Department's core capabilities in materials science enable R&D activities related to improving fuel cell materials. The Department uses its informational role to help develop codes and standards related to fuel cells and fuels for both transportation and stationary applications.

## 7.4 Geothermal

### 7.4.1 Current Status of Technology

Geothermal technology emits few GHGs and is one of the few renewable energy technologies that can provide base-load power absent of energy storage. Geothermal resources range from shallow ground to hot water to rock that is located several miles below the earth's surface. Technologies designed to use this resource base fall under two primary categories: power production and energy efficiency.

Geothermal power production uses wells to access naturally occurring heat within the earth to produce steam to drive turbines and generate electricity. The United States first generated geothermal electricity in the 1960s with the development of the Geysers geothermal field. The United States is the world leader in power production from geothermal resources; although, the 3.2 GWe total installed capacity<sup>112</sup> generated less than 0.4% of the Nation's electricity in 2009.<sup>113</sup>

The domestic resource for geothermal power generation can be divided into conventional hydrothermal, enhanced geothermal systems (EGS), and low-temperature categories. The estimated domestic resource for conventional hydrothermal power production is 30 GWe, with 5–10 GWe that could be developed in the near term.<sup>114</sup> The EGS resource is potentially large but uncertain, with estimates ranging from 500 GWe<sup>115</sup> to 16,000 GWe,<sup>116</sup> although, the practically recoverable resource is certain to be significantly less, as is the case with all energy sources. Low-temperature geothermal energy is defined as heat obtained from the geothermal fluid in the ground at temperatures of 300°F or less. These resources are typically used in direct-use applications, such as district heating, greenhouses, fisheries, mineral recovery, and industrial process heating. However, some low-temperature resources can be harnessed to generate electricity. There is, as yet, no reliable assessment of the low-temperature geothermal resource; therefore, it has not been included in this assessment.

Geothermal energy is also used in energy efficiency applications. Ground-source (or geothermal) heat pump (GHP) systems heat and/or cool buildings using the constant temperature of the shallow subsurface to extract or reject heat. GHP systems use 23%–44% less electricity than conventional air-source heat pumps and can lower GHG emissions.<sup>117</sup> Less common direct-use applications for geothermal heat include district and space heating, greenhouse and aquaculture, spas and laundries, and wood drying and food dehydration. Currently, more than 12.6 GW<sub>t</sub> of geothermal energy (0.3 Quad annually) is used for energy efficiency or direct-use applications, 84% of which is for GHP systems.<sup>118</sup>

### 7.4.2 Historical Pace of Development and Market Diffusion

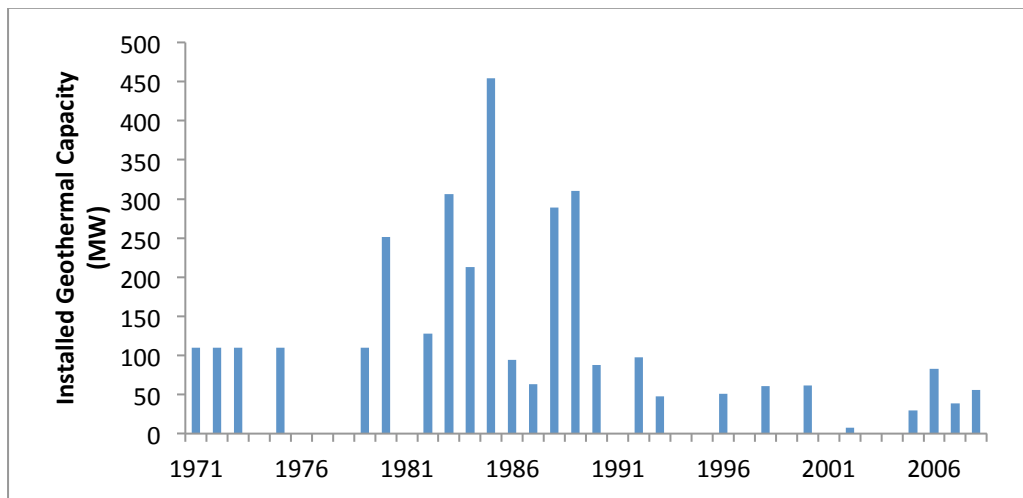
The Geysers 11-MWe plant in California, commissioned in 1960, is the oldest geothermal power facility in the United States. The late 1970s marked the beginning of two decades of high growth for the geothermal industry, as shown in Figure 42. Government R&D and legislative policies, including the Public Utility Regulatory Policies Act, are cited by the geothermal industry as having an impact on market growth through the 1980s.<sup>119</sup> This specific act provided a simple approach to contracting a power sales agreement to utilities, and the mandated rates available in the agreements were sufficient to support a reasonable return on investment for the project developers.

Industry growth has stagnated from the mid-1990s, likely due to the increasing cost of finding and



developing new geothermal prospects. Early development focused on the lowest-risk geothermal areas (i.e., those with obvious surface manifestations) and resources with the highest economic value due to size, temperature, brine chemistry, and more. Once these low-cost resources had been developed, discovery and confirmation of other resources became much more challenging. The marginal economics of remaining known resources and the decline of new resource discovery ultimately limited industry’s ability to deploy new geothermal generating capacity.

There are a number of technical and policy barriers to broader deployment of geothermal power in the United States. These include the high upfront cost of exploration and drilling, as well as their associated risk, and the need to find new resource areas for development. Unlike other renewable energy sources, such as wind and solar, a geothermal resource is not confirmed until a well is drilled into the reservoir, which costs millions of dollars.<sup>120</sup> Currently, the exploration success rate for identifying a hydrothermal resource is only around 35%,<sup>121</sup> leaving upfront costs for early development and associated risk as the primary deterrent for rapid development. The current low success rate for discovering geothermal resources is a major barrier to expanding the utilization, efficiency, and understanding of geothermal systems. The high upfront risk and cost deters investors and developers from exploring unknown areas, which hinders the industry’s already limited knowledge of geothermal systems and why they occur. The consequences of this are significant, as the ability to accurately identify potential geothermal resources and increase utilization depends on the exploration of currently uninvestigated locations.



**Figure 42. Initial Year of Operation of Current U.S. Geothermal Capacity<sup>112</sup>** The figure does not include development prior to 1971 (e.g., Geysers) or geothermal facilities that were retired prior to 2008. Source: Energy Information Administration. (2008). *Existing Electric Generating Units by Energy Source*. Form EIA-860. Washington, DC: Department of Energy. Accessed at <http://www.eia.gov/cneaf/electricity/page/capacity/existingunitsbs2008.xls>

### 7.4.3 Current Industry

Conventional hydrothermal resources are primarily found in the western United States, as are most of the industry players. Over the past 5 years, the industry has added 0.365 GWe capacity.<sup>122</sup> Approximately 0.75 GWe of new geothermal plants are in the drilling and construction phase.<sup>122</sup>

Direct-use projects are usually small and developed by individuals or private companies to utilize geothermal heat. There are 20 district heat projects in the United States, all of which are operated by municipalities.<sup>123</sup> Shipments of GHP have grown at a rate of 23% annually<sup>124</sup> between 2004 and 2009 and account for approximately 84% of the direct-use market, while other direct-use applications have remained static.

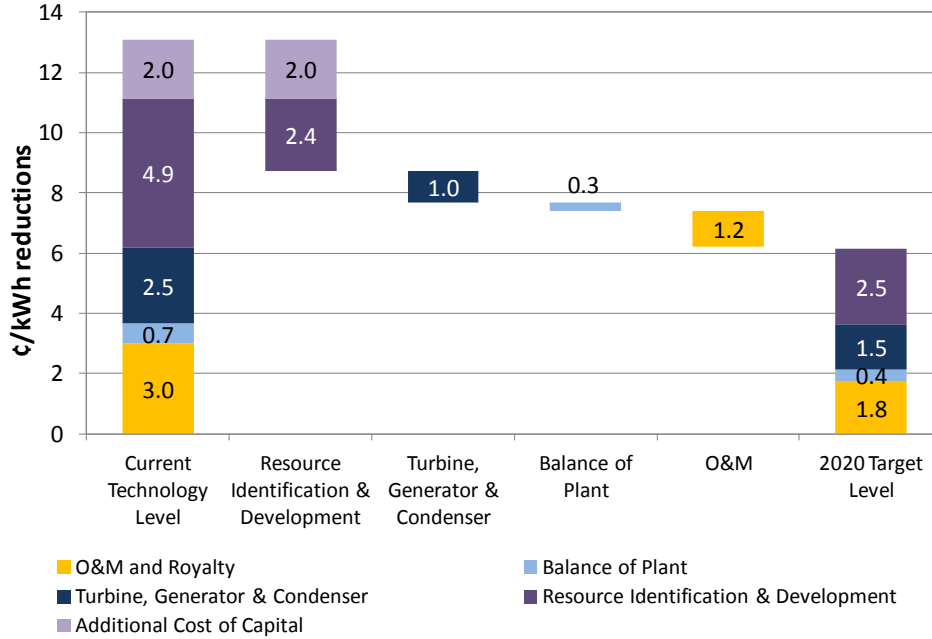
#### 7.4.4 Technology Potential

Key areas for geothermal technology development include:

- Applied R&D targeting exploration and drilling in geothermal environments, the high-cost and high-risk areas of current geothermal projects.<sup>125</sup>
- R&D to develop and manage geothermal reservoirs, including EGS in the long term.
- Innovative technologies to reduce the cost of energy conversion and system components.
- Shared information on technology development across the geothermal community.

Innovative exploration technologies are needed to increase exploration success rates.<sup>126</sup> They include improved, non-invasive geophysical techniques, such as remote sensing and improved geochemical survey methods that incorporate advanced reaction transport models and geomicrobiological influences. Innovation in data processing is also making exploration surveys more effective. By jointly inverting several geophysical datasets, scientists can yield higher-fidelity results. Opportunities also lie in technology transfer from the oil and gas industry, as a number of exploration methods that have been successfully applied there could possibly be adapted for use in geothermal with further R&D (e.g., advanced seismic).

Figure 43 shows a cost analysis for undiscovered hydrothermal, as well as scenarios for reducing LCOE. Currently, LCOE for EGS is significantly higher than it is for undiscovered hydrothermal. Cost elements for both undiscovered hydrothermal and EGS include the high cost of drilling and the high cost of capital, which is due in part to resource uncertainty. Power plant and O&M improvements are largely the role of industry. For undiscovered hydrothermal resources, technologies are needed that lower the cost and risk of exploration to reduce the number of holes drilled, thereby reducing the cost of capital. For EGS reservoir modeling and engineering and well-completion, technologies are R&D opportunities.



**Figure 43. DOE Estimates of Cost Elements and Cost-Reduction Scenario for LCOE from Undiscovered Hydrothermal Resources** The 2020 cost assumes the following reductions: Cost reduction of 50% in exploration and drilling, 50% in O&M, and 40% in power plant; one-year reduction from permitting time; and cost of capital reduction of 7% for all development stages (reduced from 15%–30% during resource identification and development). The reduction in upfront cost of capital is due to the reduction in the cost and risk of exploration. Source: Analysis by the Department of Energy’s Geothermal Technologies Program. (2011). Washington, DC.

#### 7.4.5 High-Risk Technology Breakthroughs

EGS offers the opportunity to use CO<sub>2</sub> as the subsurface HTF rather than water. This approach could remove the need for a source of water at the geothermal power facility and thereby expand the geography of siting options. The potential efficiency and cost advantages of this approach could improve the economics relative to water-based EGS.

#### 7.4.6 Factors that Affect Market Prospects

There are a number of issues surrounding land leasing and permitting of geothermal sites, including differences in how individual states view geothermal resources (i.e., mineral versus water), duplication in permitting requirements between state and federal regulatory agencies, and lack of continuity between state and federal regulations (e.g., split estates or geothermal leases on both federal and state land).

The current regulatory environment is complex and time-consuming. Specific regulatory challenges facing the geothermal sector can include a general lack of familiarity with hydrothermal and EGS development; the need to implement new protocols for issues such as induced seismicity; overlap and coordination issues between regulatory bodies; prioritization of geothermal regulatory filings relative to other permitting processes; and the need for separate regulatory approvals for each of several steps in the exploration through development process. In total, these factors can combine to make the regulatory process up to 50% of the total timeline from exploration start to first production.

Near-term market prospects require exploration risk reduction. For the long term, lower drilling costs are needed. Market prospects for EGS could be affected by the risk associated with induced seismicity. Industry, academic groups, and DOE acknowledge the need for safety protocols to address induced seismicity, but see the risk as manageable with further research and technology development.<sup>127</sup> Other environmental impacts, including ground water use and contamination, are discussed in depth elsewhere.<sup>128</sup>

Because drilling is often required to validate technologies and models, geothermal R&D project costs tend to be higher than other renewable energy projects.

#### 7.4.7 DOE History and Accomplishments

DOE's work in geothermal technologies has focused on four broad areas: exploration, drilling technology, geothermal reservoir engineering, and energy conversion.

**Exploration:** Exploration efforts have helped the geothermal industry find and delineate new geothermal resources. This was accomplished through collaboration with the United States Geological Survey (USGS) to complete regional and national resource assessments,<sup>115</sup> as well as a number of programs to cost-share exploration and drilling activities. R&D aimed at developing improved exploration techniques helped develop the best practices employed by industry today. The Department's exploration activities have played a significant role in the growth of geothermal power generation in the late 1980s.<sup>129</sup>

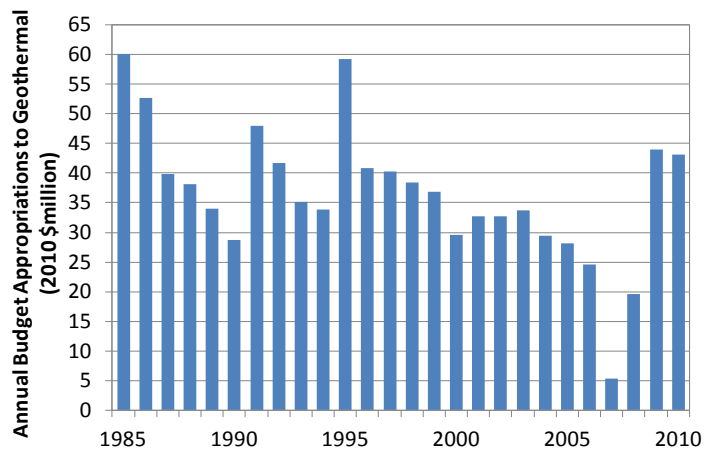
**Drilling Technology:** The cost of drilling and well completion together can constitute 30% or more of the total cost of a geothermal power plant. To reduce these costs, DOE-funded research areas have included improving drill bits, detecting and mitigating lost circulation, high-temperature instrumentation, and better communications with the downhole environment. These efforts have resulted in R&D 100 Awards and technology transfer agreements in areas that include polycrystalline diamond compact drill bit wear code, high-temperature (up to 300°C) unshielded electronics and logging tools, high-performance cement, and diagnostics-while-drilling systems.

**Geothermal Reservoir Engineering:** One example of a reservoir engineering effort is the Fenton Hill project, which focused on trying to create an EGS reservoir from "hot dry rock," and ran from the late 1970s until the early 1990s. Many key learnings regarding rock stimulation had their origin in this project. Fenton Hill provides key technical and operational lessons learned that are being leveraged in current demonstration projects, and will be incorporated into future test sites.

More recently, DOE has made investments to develop and validate technologies to exploit the EGS resource. Projects focus on high-temperature tools, reservoir fracture network characterization, advanced stimulation technologies, predictive modeling for fracture stimulation and induced seismicity, the use of supercritical CO<sub>2</sub> as a geofluid, development of integrated modeling approaches to the thermo-hydro-mechanical-chemical system, improvement of tracers and tracer interpretation models, and several pilot-scale demonstration projects. These projects constitute the majority of global EGS activities and are providing critical information in a variety of geologic settings.

**Energy Conversion:** DOE-supported energy conversion R&D has been aimed at reducing the cost of power generation through improved efficiency and reduced equipment costs. Projects of this type include developing longer-lasting materials that are able to withstand corrosive brines, engineering more efficient conversion cycles and more robust systems that are capable of handling time-varying ambient conditions, developing advanced condenser systems, and focusing on hybrid wet/dry cooling. This body of work has lowered the temperature of geothermal resource that can be developed economically.

DOE geothermal funding peaked in 1981 (at about \$150 million) and has been relatively stable (at less than \$50 million per year) since the mid 1980s, with two notable exceptions: (1) the program was nearly cancelled in Fiscal Year 2007, and (2) the \$368.2 million in ARRA funding received in 2009 (Figure 44, ARRA funds not included).



**Figure 44. Annual DOE Budget for Geothermal R&D Sources:** (1985–2002) Current Congressional Appropriations from DOE CFO, Office of Budget; (2003–2008) DOE EERE Budget Office ([http://www1.eere.energy.gov/ba/pba/budget\\_archives.html](http://www1.eere.energy.gov/ba/pba/budget_archives.html)); (2009–2010) 2011 FY11 Congressional Budget for DOE EERE ([http://www1.eere.energy.gov/ba/pba/pdfs/fy11\\_budget.pdf](http://www1.eere.energy.gov/ba/pba/pdfs/fy11_budget.pdf)). Converted to 2010 \$million using consumer price index from the Department of Labor, Bureau of Labor Statistics (<ftp://ftp.bls.gov/pub/special.requests/cpi/cpi.txt>).

A recent Blue Ribbon Panel of geothermal experts<sup>130</sup> convened by DOE provided recommendations for new program structures. The panel recommended a focus on regional reconnaissance to characterize known geothermal resources, exploration technologies to lower the cost and increase the success rate of confirming undiscovered resources, and EGS. The panel was not enthusiastic about low-temperature and co-produced resources due to the absence of technology challenges, the low quality of those resources, and the lack of industry interest.

#### 7.4.8 DOE Role

DOE’s roles in geothermal technology are informational, R&D capability, and convening. The Department has substantial capabilities in subsurface science that can benefit the industry. Further, the Department contributes valuable information to the geothermal field through resource characterization.

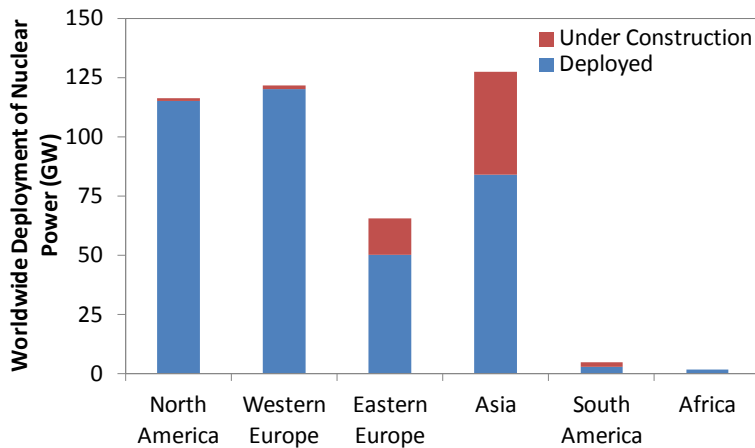
DOE reservoir engineering efforts focus on developing:

- Technologies to more effectively operate and manage geothermal resources already under production.
- Techniques for establishing the physical and chemical properties of reservoir rocks and fluids.
- Site-specific case studies of reservoir behavior in different geological environments. Efforts to date include developing geothermal reservoir simulators that improve understanding of geothermal resources and their response to utilization for electricity generation.

## 7.5 Nuclear Power

### 7.5.1 Status of Technology

Nuclear energy currently produces 14% of the world’s electricity<sup>131</sup> and has been in commercial operation since 1954. Twenty-nine countries operate 440 nuclear power plants with a total capacity of 374 GWe (some 8% of total installed capacity<sup>132</sup>). Sixty-five additional units are under construction, which will take the global capacity to 437 GWe.<sup>133</sup> The majority of nuclear power plants in operation are in North America and Europe, but most of the near-term growth is expected in Asia, as shown in Figure 45. More than 60 additional countries have approached the International Atomic Energy Agency, expressing interest in nuclear power. The agency anticipates that about 15 of these emerging nuclear nations will deploy new reactors over the next decade or two. Several of these new entrants have already committed to construction, although it remains unclear how the recent nuclear accident in Fukushima, Japan, will affect these plans.



**Figure 45. New Nuclear Construction Primarily in Asia.** Source: International Atomic Energy Agency. (2011). *Power Reactor Information System Database*. Vienna, Austria. Accessed at <http://www.iaea.org/programmes/a2/>

The United States produces more nuclear energy than any other nation, operating 104 reactors that have a total capacity of 101 GWe.<sup>134</sup> Although this is only 10% of total U.S. electric generation capacity, these reactors produce 20% of total U.S. electricity, as their average capacity factor exceeds 90% compared to 20%–65% for non-nuclear generators. The Nuclear Regulatory Commission (NRC) recently approved combined construction and operating licenses for 4 new nuclear reactors, docketed applications for 16 additional nuclear units, and docketed applications for 24 additional new nuclear units.<sup>135</sup> The Westinghouse AP-1000, which features passive safety systems, has been certified by the NRC and licensed for construction at the Vogtle site. While all U.S. reactors that are either in operation or being considered for deployment are variants of the light water reactor (LWR) technology, approximately 13% of today’s global nuclear capacity is in non-LWRs.<sup>136</sup>

### 7.5.2 History

DOE’s predecessor agency, the Atomic Energy Commission, laid the foundation for commercial nuclear energy development and then partnered with industry in deploying first-of-a-kind reactor technology. The Shippingport Atomic Power Station began service in 1957 as the first commercial U.S. nuclear-

generating plant. While the pressurized water reactor technology selected for submarine propulsion provided an advantage for initial commercial deployment, the Atomic Energy Commission also developed another successful LWR technology—the boiling water reactor. Research efforts in the 1950s and 1960s included other reactor technologies, such as sodium graphite, fast breeder, and high-temperature systems. These did not find immediate acceptance, but are being reinvestigated in today's Generation IV programs.

Nuclear construction expanded greatly in the 1970s. A total of 42 GWe of capacity entered commercial operation in the decade; another 57 GWe of capacity was ordered during the 1970s, but would not enter service until later. At the peak of deployment (1974–1976), 23 reactors with a combined 20 GWe of capacity were brought online in three years.<sup>137</sup> The 1979 accident at Three Mile Island led to a series of regulatory and design changes that extended the construction time of many projects underway at that time. The combination of high construction costs and mediocre operational performance during the 1980s, combined with slower-than-expected growth in electricity demand, resulted in no new orders of Generation II plants.

Beginning in the late 1980s and continuing through the 1990s, the operational performance of the nuclear fleet improved dramatically. Capacity factors rose from less than 60% to around 90% by 2000, where they have remained since.<sup>138</sup> Such efficient operation of depreciated capital assets with low fuel and operating costs led to a wave of license renewals that allowed the reactors to operate beyond their initial 40-year license horizon. However, commercial interest in construction of a new generation of nuclear power plants remains tempered, largely due to high capital costs and low natural gas prices.

From early in the development of commercial nuclear power, the safe storage and disposal of used fuel and radioactive waste was recognized as a critical need. The NRC was given the responsibility of assuring that used fuel would be managed safely, while the task of R&D for the “backend” of the nuclear fuel cycle became the purview of DOE. In 1982, the Nuclear Waste Policy Act<sup>139</sup> delegated responsibility to DOE to “manage and dispose of high-level radioactive waste and spent nuclear fuel in a manner that protects health, safety, and the environment; enhances national and energy security; and merits public confidence.” Early research was devoted to determining the suitability of various potential geologic repository environments. Amendments to this act in 1987 terminated these studies, and Congress mandated the decision to build the first U.S. spent fuel and high-level nuclear waste repository deep beneath Yucca Mountain in Nevada.<sup>140</sup> Subsequently, it was determined that Yucca Mountain was not a workable option, and in 2010 the Administration terminated the project along with the associated Office of Civilian Radioactive Waste Management.<sup>141</sup>



### 7.5.3 Current Industry

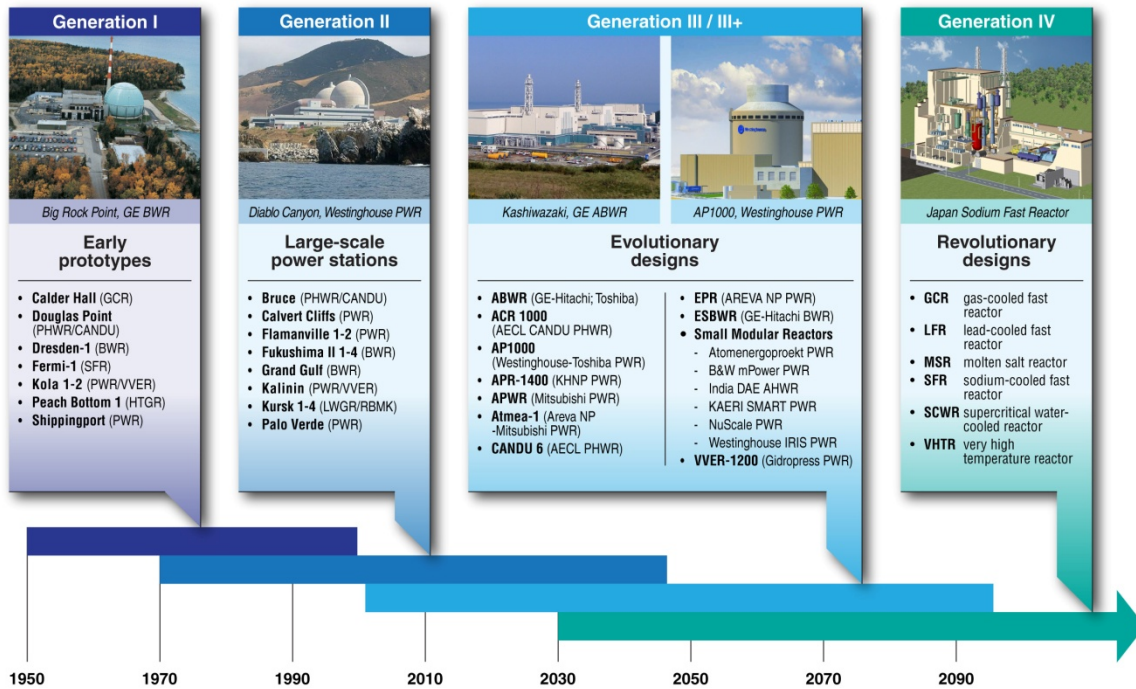


Figure 46. Generation Classification of Nuclear Power Plants Courtesy of Idaho National Laboratory.

Figure 46 depicts the four generations of deployed and proposed nuclear reactors. Almost all nuclear power plants deployed today are second generation. Timelines at the bottom of the figure are notional, as the pace of development varies significantly across different countries.

The NRC regulates commercial nuclear power plants through licensing, inspection, and enforcement of its requirements. The NRC responds when new information becomes available that is relevant to reactor security—as following September 11, 2001—and to reactor safety—as has occurred with the accident in Fukushima, Japan, in March 2011. The NRC also grants early site permits, design certifications, and licenses to construct and operate new nuclear plants. The process takes multiple years for the well-understood LWR technology, and even longer for more exotic designs. If new nuclear technologies are to be deployed, the NRC must be confident that these systems will not pose unacceptable risks to the public.

### 7.5.4 Roadmap

#### 7.5.4.1 Current Fleet

The oldest of the current fleet of reactors entered service in 1968; more than 100 additional reactors followed. These reactors were given 40-year operating licenses and were rated for a maximum generating capacity based upon then-current understanding of what would ensure safe operation with adequate margin. As operational experience grew and technological improvements were incorporated, reactor operators applied to the NRC to increase their power and/or to renew their operating licenses for an additional 20 years. If this process of uprating and renewing is to continue, the technical understanding underpinning those decisions must continue to improve.

To date, 68 of the 104 current reactors have received 20-year license renewals, and an additional 31 applications are either currently under review by the NRC or expected to be so in the future.<sup>142</sup> Similarly, the NRC has allowed 6 GWe of uprates since 1977<sup>143</sup> and expects applications for an additional 3 GWe.<sup>144</sup> Approval of these uprate requests would increase nuclear generation by about 3%.

While the current fleet has already seen significant uprates and lifetime extension, there could be more. An optimistic estimate, based on preliminary modeling and assuming a significant number of power uprates that could each add 7%–20% to the capacity of a reactor, would be a total of 10 GWe of uprates beyond the current plants.<sup>145</sup> A similarly optimistic view of license renewals, assuming the additional round of renewals follows the pattern of the first renewals with widespread interest and acceptance by the NRC, would be for all of the current reactors to receive, at minimum, a single 20-year renewal, and for 75 of them to receive a second renewal that would allow an extension of the reactors' operational life to 80 years.

There is a generally attractive business case for increasing the capacity or extending the life of existing reactors because the capital expense of initial construction has already been repaid. The additional investment that is likely required for a life extension or capacity uprate (less than \$1,500/kW<sup>146</sup>) is much smaller than the cost of building a new nuclear plant (about \$6,000/kW<sup>147</sup>), and is less than the cost of many competing generation technologies.

The principal technical barrier to extending or uprating reactors is demonstrating that structural materials in nuclear power plants will safely withstand extended service.<sup>148</sup> The NRC will evaluate these requests based upon a strong scientific understanding of the expected behaviors of the reactor systems over time, and reactor operators will only apply for uprates and license renewals if they are confident that the NRC will approve the safety case.

Applications for uprates and life extension for plants beyond 40 years have traditionally been based on empirical approaches. For example, material samples placed in the reactors can be used to validate predictions of neutron radiation damage. Empirical methods become less adequate beyond 60 years, as more complex aging mechanisms affect a broader variety of materials and components.<sup>149</sup> A science-based predictive approach will likely be needed to address these issues, where R&D will bring understanding of the fundamental phenomenology of aging and degradation mechanisms.

Advanced LWR fuels development for the current fleet focuses primarily on enhanced accident tolerance. For example, fuel clad with materials that can safely reach higher temperatures would better withstand accident conditions, such as those faced at Fukushima.<sup>150</sup> Research in new instrumentation and control mechanisms will provide more information about reactor conditions and help enable control strategies to further optimize operations and manage off-normal conditions. Improving risk-informed methodologies to characterize safety margins and predictive computational techniques in normal, degraded, and accident operations are important research goals.

#### **7.5.4.2 Generation III/III+**

Generation III plants incorporate evolutionary improvements in the technologies used in currently deployed LWRs. These improvements can include passive safety features and modular construction

techniques. Generation III systems include reactors from Westinghouse, GE-Hitachi, Areva, Mitsubishi, and Toshiba.<sup>151</sup> DOE supported the development of Generation III technologies through its Advanced Light Water Reactor program in the 1980s and 1990s.<sup>152</sup> The subsequent Nuclear Power 2010 program cost-shared the licensing and finalization of the designs, as well as applications for early site licenses by utilities.

The first Generation III reactors constructed were Advanced Boiling Water Reactors that entered commercial service in Japan in 1996; two more followed within the last decade. Other Generation III reactors are under construction in China, Japan, Taiwan, Finland, and France.<sup>153</sup> The NRC has recently authorized construction to begin on the first U.S. Generation III project.<sup>154</sup>

The designs for the first set of Generation III plants to be built in the United States are mature and largely fixed; significant alterations would likely require a new NRC review, which could delay deployment. These designs would be improved upon in successive waves of deployment that incorporates lessons learned from the initial projects, as well as subsequent technological advances. The development of advanced computational methodologies could increase confidence in operational and during-accident behaviors, facilitate licensing activities, and help optimize future designs. Development of new materials and fabrication techniques, such as new welding methods for major reactor components and construction methods such as steel/concrete composites, could also reduce future capital and operational costs.

Investment costs are the most significant challenge to building these new nuclear plants. Because no Generation III reactors have been constructed in the United States to date, estimates of their cost have varied broadly. A 2009 report from the National Academies set the range of overnight costs<sup>155</sup> between \$3,000/kW and \$6,000/kW.<sup>156</sup> Overnight costs are the starting point to determine the amount of investment needed to bring the plant into operation. Factoring in financing costs and the effects of cost escalation, the total investment cost can be about 50% more than the overnight cost, with long-timeline or high-risk projects being higher. Construction costs for new reactor designs in Japan and Korea dropped by 25%–30% after 4–5 units were built.<sup>157</sup>

Altogether, the total investment for a typical large new reactor design is estimated to be about \$10 billion.<sup>158</sup> That sum is a challenge even for larger U.S. nuclear utilities, which typically have annual revenues under \$15 billion.<sup>159</sup> A second factor will be safety concerns among stakeholders, especially in light of the recent events in Fukushima, Japan. Finally, improved interim storage solutions and long-term disposal of used fuel and radioactive waste will impact decisions on deployment of these and all future commercial nuclear reactors.

#### **7.5.4.3 LWR Small Modular Reactors**

Several U.S. companies are developing small modular reactor (SMR) concepts and designs based on traditional LWR technology, but with significant modifications to improve safety and security. These designs range from less than 50 MWe to more than 200 MWe, compared to the greater than 1,000 MWe for Generation II and III reactors. The proposed designs would use natural circulation and passive cooling to further enhance safety in a station black-out scenario, such as the situation that recently

occurred in Japan. Compared with current large reactors, LWR SMRs will have less piping, simpler safety systems, and less fuel per reactor.<sup>160</sup> Underground siting of the reactors should increase intrinsic security and minimize personnel costs to maintain a secure plant, while at the same time providing seismic safety advantages. Factory fabrication and standardized siting could bring down cost and improve quality while enabling multiple units to be deployed at a single site.

SMRs could help address the financing issue caused by the large upfront capital cost of conventional reactors and mitigate the risk of cost overruns and schedule delays. The projected smaller initial capital outlay means that SMRs are not necessarily “bet the company” propositions. However, the economics of SMRs are still uncertain. To the extent that overruns and delays depended upon how the large reactors are built, the SMR approach removes some of those concerns.

A handful of SMRs are in the early stages of design in the United States; there are also proposals from other nations, notably South Korea.<sup>161</sup> The cost target is to be economically competitive with large LWRs, although the first-of-a-kind units are not expected to achieve that goal.<sup>162</sup> Many issues will factor into whether SMRs are able to achieve cost-competitiveness. In particular, the economics of factory fabrication will need to be considered against the economies of scale of larger reactor designs. Factory construction is expected to minimize the challenges and costs of nuclear-quality workmanship in a field setting. The modular approach builds directly on the U.S. Navy’s experience with modular construction techniques in its submarine builds, which dramatically reduced labor hours and defects. From the perspective of a utility, these attributes would mean that the reactor vendor could have a shorter schedule, may be less vulnerable to potential delays, and may be able to offer firmer price guarantees to the purchaser.

These systems use the same fuel cycle as the current fleet of large LWRs. There are also technical issues that remain to be solved for SMRs, such as developing a well-established technical basis for regulation. For example, the cost and complexity of operating an SMR plant may be reduced if multiple reactors are controlled from a single control room, but the staffing requirements for such a concept need to be evaluated by the NRC. Similarly, the appropriate size of a security force may need to be evaluated in light of SMR plant characteristics, such as underground siting and other issues.<sup>163</sup> Less radioactive material in each reactor core could translate into a smaller emergency planning zone, expanding the range of feasible sites.

Any reactors built in the United States would require both NRC design certification and first-mover utilities that are willing to apply for a license to build and operate these plants.

There may also be R&D that could advance manufacturing technology generic to SMR designs, such as new welding techniques. The fabrication of SMRs may, to some degree, need to draw on new or advanced manufacturing technologies that are in use in other areas, such as military systems, that have yet to be applied to nuclear reactors. Of particular interest in design-related research is advanced materials to improve corrosion and non-normal event performance and, in the longer term, make certain designs more compact. Development of advanced computational methodologies will be very helpful in better understanding and exploiting passive safety features.

#### 7.5.4.4 *Generation IV*

Generation IV nuclear systems use very different technologies than the LWR nuclear-generating stations of Generation II and III, and they also require much more R&D before they would be commercially viable. Some Generation IV systems may be able to simultaneously address the sustainability, safety, economic, and nonproliferation issues that hinder expanded nuclear deployment.

A broad international consortium called the Generation-IV International Forum<sup>164</sup> provides an arrangement under which advanced nuclear technology nations collaborate on R&D activities for six categories of systems. Of these concepts, two are nearer term:

A **Very High-Temperature Reactor** would operate at much higher temperatures than current nuclear technology, producing electricity with a greater thermodynamic efficiency, as well as process heat for many industrial applications.<sup>165</sup> A very high-temperature reactor would require new structural materials to increase operating temperatures from the currently achievable 700°C to the target of 1,000°C.<sup>166</sup> U.S. high-temperature reactor R&D has focused on gas-cooled reactors as a source of electricity and process heat. These reactors could provide a non-GHG-emitting source of energy, but must compete with the economics of natural gas combustion,<sup>167</sup> which is expected to remain lower than historic norms due to growing unconventional gas production.<sup>168</sup>

The **Sodium-Cooled Fast Reactor** is one of three fast neutron-spectrum reactor concepts being investigated by international partners in Generation IV, primarily for fuel-cycle optimization.<sup>169</sup> Cost reduction is a major focus for sodium-cooled fast reactor development because these systems are expected to be even more capital-intensive than current LWR technology. France plans to construct a prototype reactor in the 2020–2025 timeframe; the Russian Federation is moving at a somewhat faster pace; and the Indian nuclear program plans construction of five 500-MWe units by 2020 in order to develop an industrial base.<sup>170</sup> The United States has built and operated experimental sodium-cooled fast reactors at Idaho National Laboratory and Hanford, neither of which is currently in use.

R&D applicable across many of the Generation IV approaches includes high-performance materials compatible with the proposed coolant types and capable of extended service at elevated temperatures; new fuels and cladding capable of irradiation to high burnup and resistant to the type of fuel damage experienced at Three Mile Island and Fukushima-Daiichi; and advanced heat delivery and energy conversion systems for increased efficiency of electricity production.

#### 7.5.4.5 *Used Fuel Management Technologies*

Some 60,000 tonnes of commercial-used fuel is currently stored in either water pools or dry casks, primarily at U.S. reactor sites that are in operation or shut down; an additional 2,000 tonnes is generated each year.<sup>171</sup> The once-through fuel cycle—where used uranium fuel is removed from the reactor, stored for some period of time, and then directly disposed into a repository—is the Nation's current process for managing used nuclear fuel.

In January 2010, the Secretary of Energy convened a Blue Ribbon Commission on America's Nuclear Future to conduct a comprehensive review of policies for managing the backend of the nuclear fuel cycle, including alternatives for storage, processing, and disposal. The Commission's final report<sup>172</sup>

recommendations include developing a new process to site disposal and consolidated storage facilities; initiating the search for a new geologic disposal facility; establishing consolidated interim storage locations to remove used fuel from reactor sites; reorganizing how the government performs these functions and how they are financed; and continued exploration for improved technologies for waste management. Many of these recommendations will require new legislation to implement.

Management of used fuel has both near-term and long-term components. Research on extending dry cask storage supports the continued operation of today's reactors and provides confidence that used fuel from new reactors can be managed effectively.

Some key factors that will affect the final choice of fuel cycles include economics, nuclear waste management, resource utilization, safety, security, environmental impacts, technical maturity, and proliferation risks. In the unexpected event that uranium supplies become scarce, interest in fuel cycles that more efficiently use uranium may grow.

There are two technical classes of long-term management of civilian nuclear waste: direct disposal and recycling. Direct disposal of spent fuel requires packaging, transportation, and disposition in a repository. Recycling approaches would remove useful elements from spent fuel for subsequent reuse in reactors; they would also require packaging, transportation, and disposition of wastes in a repository. Recycling approaches are more complex than direct disposal. Any specific approach has unique technical challenges and economic issues that will be considered and clarified as a long-term path forward is developed.<sup>173</sup>

Most waste management options would benefit from advanced fuels for improved performance with respect to burnup and radiation damage. For approaches that incorporate some form of recycling, many significant technical, economic, and proliferation hurdles will need to be overcome. Separations approaches would need to be improved upon beyond the current systems that only extract uranium and plutonium. For example, advanced fuels would be needed to hold all of the elements intended for recycle and to ensure that these fuels perform as predictably and reliably as current uranium fuels. Full recycle, including the minor actinides, creates additional challenges because the fuel fabrication must be performed remotely in hot cells. Waste forms will be needed to immobilize all of the elements that will be disposed.

Any waste management option will require storage of used nuclear fuel; one or more well-characterized geological disposal facilities will be needed for disposal of nuclear wastes. R&D on storage is already ongoing. Research will be needed to understand how key radioactive elements move in the environment near any potential geologic disposal facility and how such geologies may evolve over the hundreds of thousands of years needed for high-level waste disposal. The work characterizing Yucca Mountain is a foundation for such research, as will be similar work on other domestic and international geologies.

#### **7.5.5 Research Breakthroughs**

A number of high-risk technologies with the potential to improve the safety, efficiency, and cost of nuclear power are being investigated.

**Table 34. Technology Opportunities for Nuclear Power**

Technology	Description	Challenges
Silicon Carbide LWR Fuels	The zirconium cladding of LWR fuel can produce hydrogen in some accident scenarios. Silicon carbide fuels would improve safety while enabling more energy to be extracted.	Lack of mature fuel design concept with qualified joining techniques.
Molten Salt Coolants	These coolants are efficient for transporting heat from the reactor core at high temperatures. Molten salt systems may also facilitate the use of thorium fuels as well.	Proof of principle compatibility with structural materials systems.
Uranium Recovery from Seawater	Uranium is abundant in the oceans at very low concentrations. If it could be economically recovered, then concerns about uranium scarcity would no longer influence fuel-cycle decisions.	State-of-the-art technology still far from meeting necessary technical and economic targets.
TRISO (Tristructural-Isotropic) Fuel	TRISO particle fuel was developed for high-temperature gas-cooled reactors, but has other potential applications. The fuel is potentially much safer than current LWR fuel under upset conditions.	Complete qualification, including performance validation, of fuel would be required if it were to be adopted commercially.

**7.5.6 DOE Role**

DOE and its predecessor, the Atomic Energy Commission, have had a long history in the development of commercial nuclear power technologies. While the Atomic Energy Commission’s approach was to build large-scale demonstration facilities, DOE’s model focuses on R&D applicable across a broad range of nuclear energy technologies.

DOE is a leader in applying the capabilities of high-performance computing to create science-based predictive models for nuclear technologies. The Consortium for Advanced Simulation of LWRs Hub is applying these capabilities to LWRs.<sup>174</sup> One focus of the Consortium is corrosion residual unidentified deposit formation, which is important for extending fuel lifetime and ensuring fuel reliability. That understanding can then be incorporated into predictive tools that will allow plant operators and regulators to estimate failure probabilities of diverse components.

With its experts and facilities, the Department provides capabilities to the nuclear community. DOE maintains the world’s largest test reactor for fuel and material irradiation. It also maintains testing capabilities for irradiated fuels that support fuel-cycle R&D activities. R&D built upon these capabilities could lead to new technologies that improve the safety and reliability of existing nuclear power plants.

DOE is implementing a technical support program to help accelerate the commercialization of SMR technology through a competitive cost-share program to support industry teams of reactor vendors and utilities on engineering related to design and licensing of LWR-based SMRs for deployment in the United States.<sup>175</sup> Further, DOE has already started to engage the NRC on regulatory issues unique to SMRs.

DOE is responsible for long-term management of used nuclear fuel, an issue critical to the long-term sustainability of current or future nuclear technology. Through ongoing R&D, the Department develops technical information that could help winnow down the broad set of fuel-cycle options to those worthy



of further technical development, when needed, and provides information necessary for future decision-making.

## 7.6 Solar Photovoltaics

### 7.6.1 Current Status of Technology and Industry

In 2010, global PV capacity increased by 16.6 GW (30% annual increase) to 40 GW (1% of global capacity) and generated 0.3% of global electricity.<sup>176</sup> In 2011, the United States installed almost 2 GW of capacity, reaching a total of approximately 4 GW,<sup>177</sup> which generated 0.03% of U.S. electricity in 2010.<sup>178</sup>

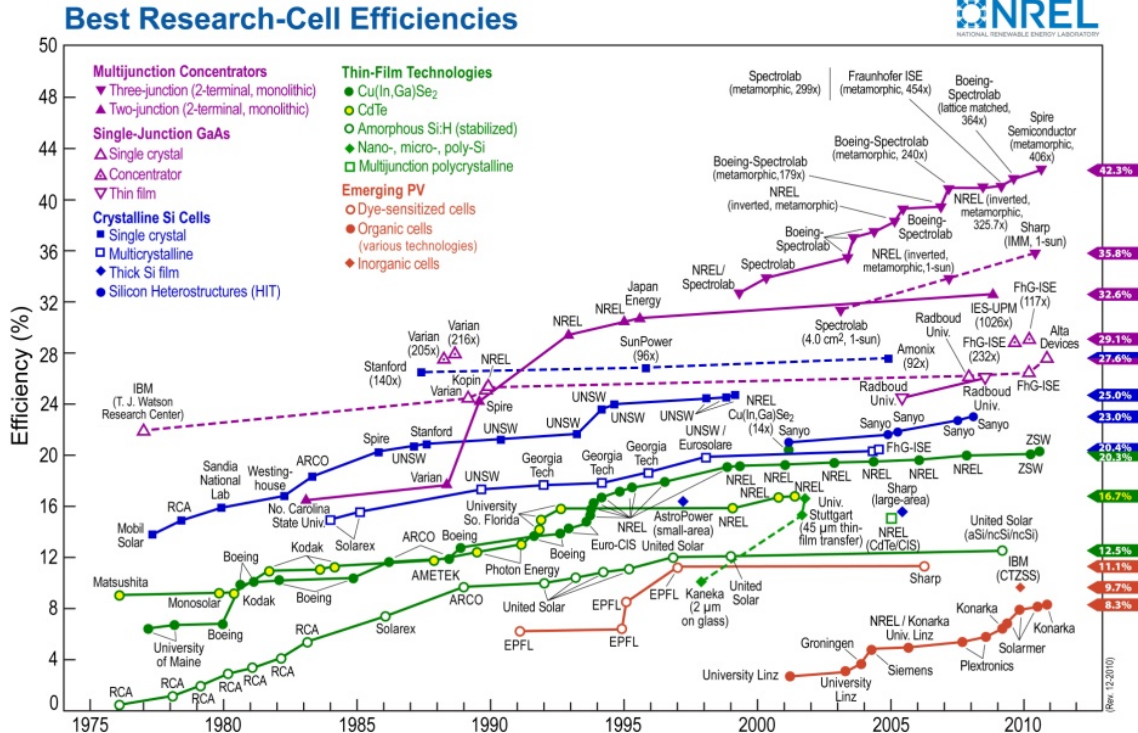
In 2010, the U.S. solar industry was \$6 billion.<sup>179</sup> At the state level, California represented 32% of new capacity in 2010 compared to 49% in 2009, indicating stronger growth in other states.<sup>180</sup> Historically, residential and commercial applications have dominated the U.S. PV market. However, deployment of utility-scale PV has grown from nearly zero in 2006 to one-third of PV capacity installed in 2010.<sup>181</sup>

Innovations across the three module technologies covered in this review—crystalline silicon (c-Si), thin-film materials (e.g., cadmium telluride [CdTe], copper indium gallium selenide [CIGS], amorphous silicon [a-Si]), and concentrating PV—continue to drive down costs through improved cell efficiency and manufacturing processes. Each technology has relative advantages and disadvantages, meaning that no single module technology is likely to dominate the entire market in the future.

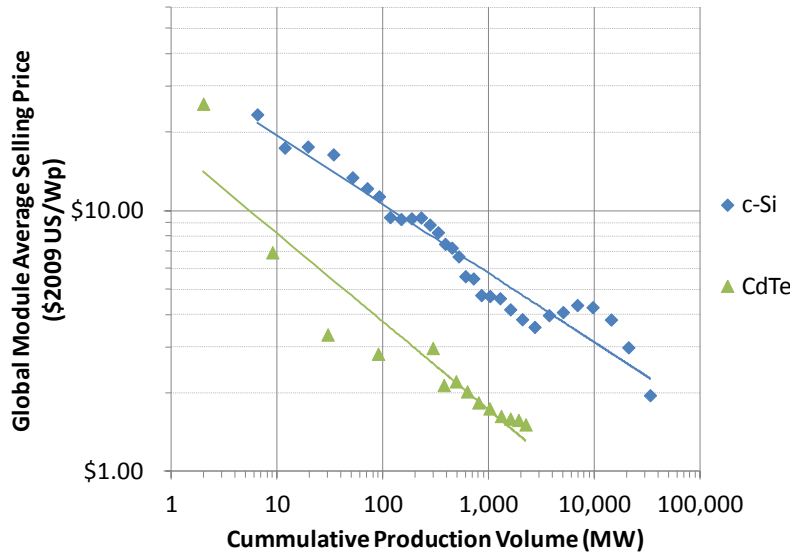
### 7.6.2 Historical Pace of Technology Development

Over the past couple of decades, R&D has led to a steady increase in the efficiency of PV cells. Increases in efficiency not only improve overall system performance, but when coupled with declining module costs over time, also drive reductions in cost per watt. Since the mid-1970s, laboratory efficiency has increased from about 13% to 25% for c-Si, from about 6% to 20.3% for CIGS, from about 9% to 16.7% for CdTe, from about 1% to 12.5% for a-Si, and from about 16% to 42% for multi-junction concentrating cells (Figure 47). U.S. scientists have been leaders for much of this improvement. However, opportunities remain to close the gap between industry production efficiencies and research efficiencies.





**Figure 47. Best Research-Cell Efficiencies for PV** Improvements in cell efficiencies driven by advancements in material science and semiconductor processing. The highest-efficiency research cell was achieved in 2010 in a multi-junction concentrator, at 42.3% efficiency. Source: National Renewable Energy Laboratory. (2011). *Best Research-Cell Efficiencies*. Golden, CO. Accessed at [http://www.nrel.gov/ncpv/images/efficiency\\_chart.jpg](http://www.nrel.gov/ncpv/images/efficiency_chart.jpg)



**Figure 48. Solar PV Experience Curves** Leading Technologies: Crystalline Silicon (c-Si), Cadmium Telluride (CdTe) Source: (CdTe) Sources: Adapted by the Department of Energy from (CdTe) First Solar Earnings Presentation, SEC Filings; (c-Si) Navigant, Bloomberg NEF, National Renewable Energy Laboratory internal cost models.

Since the 1970s, engineering and manufacturing scale have been bringing down manufacturing costs. Historically, for every doubling of cumulative production capacity, the PV industry has experienced a 16%–20% reduction in cost. In turn, the price of PV modules has declined significantly; the price of c-Si

modules has fallen from \$3.80/watt peak ( $W_p$ ) in 1999<sup>182</sup> to \$1.95/ $W_p$  in 2010,<sup>183</sup> reaching \$1.05/W in the fourth quarter of 2011.<sup>184</sup> The price of thin-film modules has fallen from \$3/ $W_p$ , reaching a spot price of \$0.85/ $W_p$  in the fourth quarter of 2011.<sup>185</sup>

Even with reduction in costs to date, roadmaps agree that there are significant improvement opportunities in both the near and long term.

### 7.6.3 Pathways for PV Technologies

Three categories of PV cells are used in today's commercial PV modules: c-Si, thin films, and multi-junction PV. The c-Si category, which includes monocrystalline and multicrystalline PV cells, dominates the global market, accounting for about 86% of globally manufactured PV in 2010. These cells produce electricity via c-Si semiconductor material derived from highly refined polysilicon feedstock. Thin films have the second largest market share, accounting for 13% of shipments in 2010.<sup>186</sup>

Silicon, the base material of c-Si cells, is a highly abundant benign raw material with well-understood physical properties. The cost of refined silicon is a significant contributor to overall manufacturing costs. Monocrystalline cells, made of single silicon crystals, are more efficient than multicrystalline cells, but they are more expensive to manufacture.

Thin-film PV technology produces electricity via extremely thin layers of semiconductor material made of CdTe, CIGS, a-Si, or copper indium diselenide (CIS). Thin-film technology uses very little active material and has a relatively inexpensive fabrication process, which can make it less expensive on average than crystalline technologies on a dollar per watt basis. CdTe is the most common thin-film technology. CIGS technology is transitioning from pilot-scale to full-scale production as a number of new manufacturing facilities are coming online. CIGS theoretical efficiency is similar to wafer-based silicon, although the current industry average and best lab cell are significantly lower. There are also some issues pertaining to toxicity and availability of materials, though they are generally believed to not be as significant as with CdTe. Roadmaps include the possibility of using more abundant and benign materials.

a-Si modules, a subset of thin-film PV, are non-crystalline and developed by deposition technologies that use significantly less Si than wafer-based modules, although their efficiency (approximately 8%) is significantly lower. In addition, the cost of manufacturing a-Si is high relative to its efficiency. a-Si can be manufactured with a flexible form factor and has been demonstrated as a potential building integrated PV product, although this niche is also being targeted by CIGS manufacturers.

Multi-junction cells use multiple layers of semiconductor material (from group III and V elements of the periodic table of chemical elements) to absorb and convert more of the solar spectrum into electricity than is converted by single-junction cells. Current multi-junction cell efficiencies are above 40%. Combined with light-concentrating optics, known as concentrating photovoltaics (CPV), and sophisticated sun-tracking systems, these cells have demonstrated the highest sunlight-to-electricity conversion efficiencies of any PV technologies; however, the cells have a higher cost per watt than c-Si and thin film technologies, to date. Currently, multi-junction cell technology is scaling from pilot to full-scale production.

#### 7.6.4 Reliability, Risk, and LCOE

The current industry norm for warranty lifetime is 25 years, with some going up as high as 30 years. A long lifetime is critical to reducing the LCOE, and reliability testing is critical to understanding the warranty and financing risks. Since c-Si technology has been under development for more than 30 years, failure mechanisms are well understood and reliability tests are well documented for this pathway. The failure mechanisms for thin-film technologies are moderately understood; although the recent reliability results for current technology (glass-glass sealed packaging) are quite good, more work needs to be done to verify testing protocol and long-term reliability prediction. The first lifetime tests for concentrating PV systems are being undertaken, predominantly in the United States and Spain. Maintaining research in reliability testing is especially critical as the technologies and their manufacturing processes continue to evolve.

Thin-film, c-Si, and concentrating PV technologies perform differently, depending on environmental conditions. For example, humid environments tend to expose weaknesses in thin-film encapsulates. However, at high temperatures, thin-film technologies tend to perform closer to their rated power than crystalline technologies. Concentrating PV requires more direct sunlight, while non-concentrating PV takes advantage of diffuse and direct light.

#### 7.6.5 Balance of System

Balance of System (BOS) comprises the non-module, non-inverter components and procedures required to produce a complete PV system. “Hardware” BOS elements include such items as support structures (including trackers), mounting hardware, wiring, racking, and monitoring equipment. “Soft” BOS elements include system design and engineering, customer and site acquisition, installation, permitting, interconnection, inspection, financing, contracting, and local regulatory costs.

For fixed-axis utility-scale systems based on standard silicon modules, non-hardware BOS costs account for roughly 30% percent of installed prices today.<sup>187</sup> Nevertheless, significant variation can exist due to site and project specific parameters, including local regulatory costs, site preparation requirements, regional wage rates, system architecture, and proximity to transmission infrastructure. Increased module efficiency reduces BOS costs on a per watt basis by requiring less land, racking hardware, and installation labor.

There are BOS differences between utility-scale and distributed PV applications. Utility-scale PV is typically ground-mounted, while distributed PV is roof-mounted. Depending on localized factors, rack mounting can be used for both ground-mounted and roof-mounted systems. However, land requirements, along with greater permitting and siting regulatory compliance, are BOS elements unique to utility-scale PV.

*Tracking the Sun III*, a review of installed PV costs in the United States by Lawrence Berkeley National Laboratory, shows that implied BOS costs<sup>188</sup> fell by \$2.5/W (40%) from 1998–2009.<sup>189</sup> Please note that for the purposes of the analysis, the inverter was also included in BOS, along with such items as mounting hardware, labor, permitting and fees, shipping, overhead, taxes, and installer profit. Average installed cost varied by as much as 63% across countries in 2009 (\$4.70/W in Germany versus \$7.70/W

in the United States).<sup>190</sup> With average prices for both modules and inverters varying by significantly less, local factors included in soft BOS (e.g., permitting requirements, labor rates, and sales tax exemptions) strongly influence PV system costs.

### 7.6.6 R&D Opportunities

Table and Table highlight PV research opportunities by technology and value chain component.

**Table 17. PV R&D Opportunities by Technology**

Pathway	R&D Opportunity
c-Si	<ul style="list-style-type: none"> <li>• Development of thinner or kerfless wafers</li> <li>• Development of electroplating methodologies that solve adhesion problems</li> <li>• Development of laser-based techniques to allow for improvements in device manufacturing</li> </ul>
a-Si	<ul style="list-style-type: none"> <li>• Development of an organic/a-Si device architecture to increase device efficiency via up-conversion</li> <li>• Development of a nanocrystalline-Si/amorphous-Si device architecture to exploit hot carrier collection for increased efficiency</li> <li>• Development of an organic/a-Si device architecture, without a p-n junction, to increase device efficiency</li> </ul>
CdTe	<ul style="list-style-type: none"> <li>• Development of transparent conductive oxides with high conductivity, transparency, and environmental stability</li> <li>• Improvement of alternative superstrates that provide low Fe glass transparency</li> <li>• Improvement of continuous, all dry processing, substrate approach (roll-to-roll)</li> <li>• Increased photocurrent generation</li> </ul>
CPV	<ul style="list-style-type: none"> <li>• Declined mirror cost through reduction in material inputs (e.g., stainless steel) and development of non-metal reflectors (e.g., polymers and emissive nanoparticles)</li> <li>• Increased module efficiency through improved triple junction and novel 4+ junction modules</li> <li>• Advanced computer algorithms and sensing materials to improve tracking systems</li> </ul>
CIS/CIGS	<ul style="list-style-type: none"> <li>• Development of a highly efficient, wide bandgap CIS/CIGS technology</li> <li>• Development of alternative electron collection layers</li> </ul>

**Table 18. PV R&D Opportunities by Value Chain Component**

Value Chain Component	R&D Opportunity
Module	<ul style="list-style-type: none"> <li>• Increase efficiency through high <math>V_{oc}</math> (open-circuit voltage), <math>I_{sc}</math> (short-circuit current), and FF (fill factor) while reducing recombination</li> <li>• Reduce raw material inputs to decrease manufacturing costs</li> <li>• Develop earth abundant absorbers for thin films</li> <li>• Develop solution-deposited metal oxides for back contacts for thin films</li> <li>• Improve transparent conducting oxides to decrease losses from series resistance</li> <li>• Reduce module costs through manufacturing scale-up</li> <li>• Develop passivation techniques to allow for use of lower-cost metals as contacts</li> </ul>
Inverter	<ul style="list-style-type: none"> <li>• Increase reliability and lifetime</li> <li>• Reduce losses from string mismatch with advancements in power monitoring</li> </ul>
Hardware BOS	<ul style="list-style-type: none"> <li>• Streamline hardware integration through innovations in building integrated PV</li> <li>• Facilitate the development of new building code language that will enable safe, low-cost, high-reliability designs</li> </ul>
Soft BOS	<ul style="list-style-type: none"> <li>• Facilitate development of model codes and standards that offer improved effectiveness in</li> </ul>

	<p>supporting PV deployment while ensuring safety, reliability, and performance by developing new solar power generation models to evaluate protocols for grid interconnection and safe and reliable equipment operation</p> <ul style="list-style-type: none"> <li>• Develop IT solutions to support the solar industry in working with authorities that have jurisdiction, support local jurisdictions in streamlining permitting process, and provide transparency to the solar industry as a whole</li> <li>• Investigate and communicate policy and regulatory barriers, as well as utility business and operational challenges acting as barriers that limit the size of the U.S. solar market</li> </ul>
--	---

**7.6.6.1 Resource Potential**

The U.S solar resource suitable for PV is both excellent and geographically widespread; across the United States, the solar resource ranges over approximately 1,000–2,500 kWh/m<sup>2</sup>/yr. Germany, which currently has the world’s largest installed PV capacity, has a solar resource comparable to that of Alaska on an annual basis. The total U.S. land area suitable for PV, including rooftops, is significant and is not expected to limit PV deployment. In addition, the fact that PV can be installed on dedicated land, commercial rooftops, or residential rooftops creates significant technical potential for both large-scale and distributed PV installations.

**7.6.6.2 Technology Potential**

In 2010, DOE held workshops with industry and other stakeholders to develop a roadmap to reach the goal of \$1/W installed price of utility-scale PV systems, \$1.25/W for commercial systems (200 kW), and \$1.50/W for residential (5 kW) systems by 2017.<sup>191</sup> Because the PV module is only one of the factors in installed system price, these goals require innovation on the installed system as a whole, including technical and non-technical barriers to installing and integrating solar energy into the grid.

**Pathways for Cost Reduction:** Module production costs vary by technology and manufacturer. For example, while cost leaders for c-Si modules have cited prices as low as \$1.05/W, this manufacturing cost is not representative of all manufacturing processes, products, and financial assumptions.<sup>192</sup> Typical module prices in 2010 were about \$2/W.<sup>193</sup> In order to increase deployment of PV technology, the industry will not only need to dramatically reduce module cost, but also reduce costs across the entire PV value chain (inverters, hardware BOS, soft BOS). A combination of advancements, ranging from manufacturing processes to installation, is required to achieve significantly reduced installed system costs.

Key barriers to advancing PV performance and cost declines can be characterized into two areas: cost drivers (materials, fabrication, and quality control) and efficiency improvements (short-circuit current, open-circuit voltage, and fill factor). For c-Si cells, decreasing manufacturing costs through reduced raw material inputs (i.e., thinner or kerfless wafers) will be a main driver of PV cost reduction. Additional cost reductions can be achieved through the use of alternate, lower-cost contact materials, as well as through improved quality control. Concurrently, increasing the efficiency of commercial cells will also reduce cost over time.

For thin films, manufacturing cost reduction can be achieved through lower-cost substrates, more abundant materials, and increasing roll-to-roll processing speed. Alongside improvements in

manufacturing, efficiency gains will be achieved through several pathways, such as the use of higher band gap buffer layers, monolithic integration, and improved transparent conducting oxides. Future improvements to CPV technologies will involve the ability to maintain high device efficiencies with even higher levels of sunlight concentration and concomitant higher temperatures. For BOS, cost reduction can be achieved through advancements such as building integrated PV that requires less hardware and mounting, as well as streamlining permitting processes. Continued R&D, coupled with declines in soft costs spurred by market barrier reduction, is expected to enable wide-scale PV adoption (Table ).

**Table 37. PV Cost Drivers and Pathways to Cost Reduction with the Greatest Potential by Technology**

Technology	Drivers	Cost Reduction Potential	Technical Risk	Pathways
c-Si	Wafers	High	Medium	Thinner or kerfless wafers, continuous CZ, or epitaxial film approaches
	Contact Materials (Ag and Al paste)	High	Low	New pastes and/or deposition methods with lower cost Earth abundant materials
CIGS	Materials cost and availability (Indium, selenium, cadmium)	High	Medium	Thinner layers or replacement with Earth abundant and benign materials (e.g., CZTS, ZnS, ...)
	Transparent Conductors	High	Low	ITO alternative materials and/or deposition methodologies
	Large scale spatial uniformity and improved throughput with same or lower cost of capital	High	Medium	Improved In-situ metrology, thermal control, and elimination of chemical bath CdS
CdTe	Glass cost, thermal properties, and transparency	High	Medium	Alternative superstrate approach that provides low Fe glass transparency (currently \$8.5 /m <sup>2</sup> vs \$2.5/m <sup>2</sup> for soda lime) or alternative substrate approach.
	Transparent Conductive Oxides/Buffer Layers	High	Medium	Develop TCO with high conductivity, transparency, environmental stability (i.e, AZO, FTZrO, ...)
	In-line step processing for better throughput	Medium	Low	Continuous, all dry processing, substrate approach (roll-to-roll)
Multi-Junction	High cost of single crystal substrates (GaAs, Ge)	High	Medium	Metamorphic growth on Si, direct deposition on foil, lift-off and regrowth/substrate reuse

**7.6.6.3 Power Electronics**

Power electronics include inverters—which convert DC electricity produced by the PV module into alternating current electricity used by the grid—and transformers—which step the electricity up to the appropriate voltage. These are often combined into a single integrated device and referred to as the inverter. Specific power electronics strategies include the following:

- Increase inverter efficiency (from 95% to greater than 98%), reliability (from a 10- to 20-year lifetime<sup>194</sup>), and improve module peak power management.
- Replace traditional electrolytic capacitors and magnets with high-frequency, solid-state circuits and use advanced magnetic materials to reduce size and cost and increase operational lifetime.



- Integrate wires and components to minimize electrical connections. Integrate micro-inverters into modules, thereby reducing installation effort, maximizing system power output, and achieving further cost reductions through mass production.

#### **7.6.6.4 Emerging PV Options**

A number of other PV technologies with the potential for improved efficiency, durability, and cost over current technologies—frequently referred to as third-generation PV—are being developed, but have associated technical risks. Dye-sensitized solar cells, which use dye molecules adsorbed onto a nanostructured substrate and immersed in a liquid or gel electrolyte to absorb solar radiation, have demonstrated laboratory efficiencies as high as 12%. Organic solar cells, based on polymers or small molecules with semiconductor properties, have demonstrated laboratory cell efficiencies above 8%; organic modules have the potential for low-cost manufacturing using existing printing and lamination technologies.<sup>195</sup> Quantum dots—nanospheres with physical properties similar to both semiconductors and molecules—absorb solar radiation at multiple frequencies, but they have not yet been used to produce efficient PV cells.

Challenges to the commercialization of these technologies include the stability of the materials against oxygen and water ingress, which could potentially be overcome by developing improved, cost-effective encapsulants. Alternatively, for organic solar cells, materials exist that are stable in air and can be deposited under a small vacuum or in a solution. Further R&D is needed to improve the efficiency of materials for these emerging technologies.

#### **7.6.6.5 Factors that Affect Market Prospects**

Even when technical issues are addressed, companies commercializing new PV technologies must address significant market challenges, including both manufacturing scale-up and demonstration of product reliability. The scale-up of manufacturing requires significant investment capital—amounts larger than typical venture capital and at risk levels higher than traditional equity or debt financing. In addition, validation of new PV technologies to reduce risk may require testing of standard products by an independent third party for 1 to 2 years.

To enable greater grid penetration by solar technologies, real and perceived risks to grid operations and stability need to be addressed. These include:

- Impacts on voltage and current flows, voltage regulation, reactive power flow, and system protection
- Integrating variable and uncertain solar generation into grid operations and planning
- Unfamiliarity of grid operators with PV system designs and their operating characteristics
- Inadequate accounting of capacity and energy valuation from variable renewable energy and energy storage technologies in traditional utility rates and costing methods
- Risk and uncertainty that surrounds predicting the availability of solar resource on a small-time and spatial scale.

For more information about energy storage, see the *Grid Storage* technology assessment.

Hardware and soft BOS costs—independent of module technology costs—must also be reduced to enable market growth for PV. Companies face high soft BOS costs when deploying systems, including complex and varied permitting and interconnection processes, along with barriers such as access to transmission lines for utility-scale systems. Other market barriers include interconnection or net metering caps, legal restrictions on financing mechanisms, and siting restrictions.

The economics of solar PV are aided by the fact that PV generation peaks at the same time as electricity demand; as a result, its price is highest. Reaching ‘grid parity’ with conventional electricity generation will not occur at one particular point in time, but will instead occur at differing price points across the United States. Indeed, in areas with high solar resource and high electricity prices, residential solar PV electricity is currently at parity with conventional electricity.<sup>196</sup>

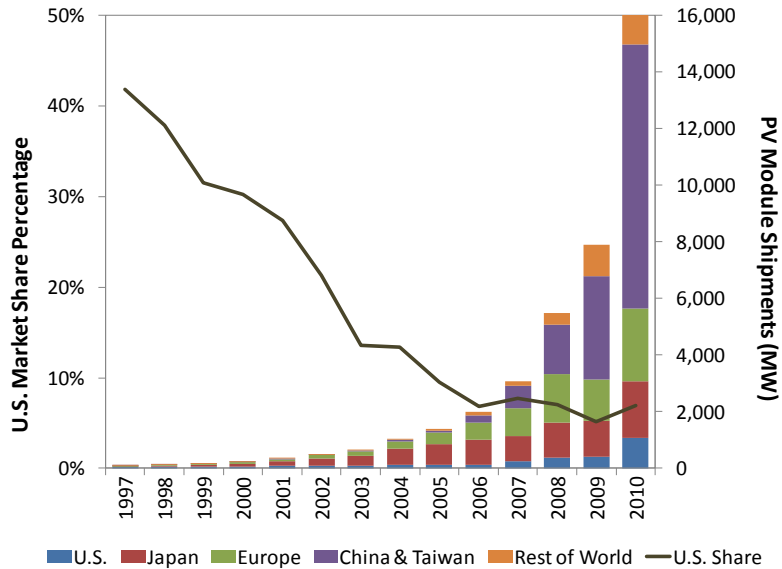
The traditional consumer of electricity generation equipment is a company dedicated to generating and selling electricity. Although this is sometimes the consumer of PV systems, the consumer base is much broader and includes all electricity consumers—both at the household and company level. For some of these non-traditional consumers who are used to buying electricity on a monthly basis, financing the upfront investment of buying electricity-generating equipment can potentially be challenging.

PV technologies use a number of materials that could be subject to shortages or demand-driven price increases at high production levels, including tellurium, indium, selenium, gallium, germanium, ruthenium, copper, silver, and molybdenum; the biggest concerns are tellurium and indium. One or more of the following strategies could help avoid potential material shortages for any of the PV technologies: increased efficiency (using less material per delivered watt); reduced material use through thinner layers; improved process utilization and in-process recycling; recycling at the end of module life; increased efficiency and amount of ore extraction and refining; and shift to materials that are more abundant. For more information, see the DOE Critical Materials Strategy.<sup>197</sup>

#### **7.6.7 Market and Policy Context**

In 2000, the United States accounted for 30% of global PV shipments, but then lost market share over the next decade—first to Japan, then to Germany, and finally to China and Taiwan.<sup>198</sup> In 2010, China and Taiwan accounted for 53% of global PV shipments.<sup>199</sup>





**Figure 49. U.S. Solar PV Market Share** Source: Adapted with permission from Navigant Consulting. (2011). *Photovoltaic Manufacturer Shipments, Capacity & Competitive Analysis 2010/2011*. Original report can be purchased from [http://www.navigant.com/~media/site/downloads/energy/manufacturer\\_shipments\\_report.ashx](http://www.navigant.com/~media/site/downloads/energy/manufacturer_shipments_report.ashx)

In the 1980s, U.S. and global PV demand was dominated by off-grid applications, typically very small systems with installed capacities measured in hundreds of watts. During the late 1990s, grid-connected systems—with installed capacities measured initially in kilowatts and later in megawatts—began dominating global demand. As this transition occurred, system cost declined significantly owing to a combination of R&D advances and economies of scale on the production and installation sides. In the United States, the transition to a market dominated by grid-connected systems occurred slightly later, driven by state and federal incentives.

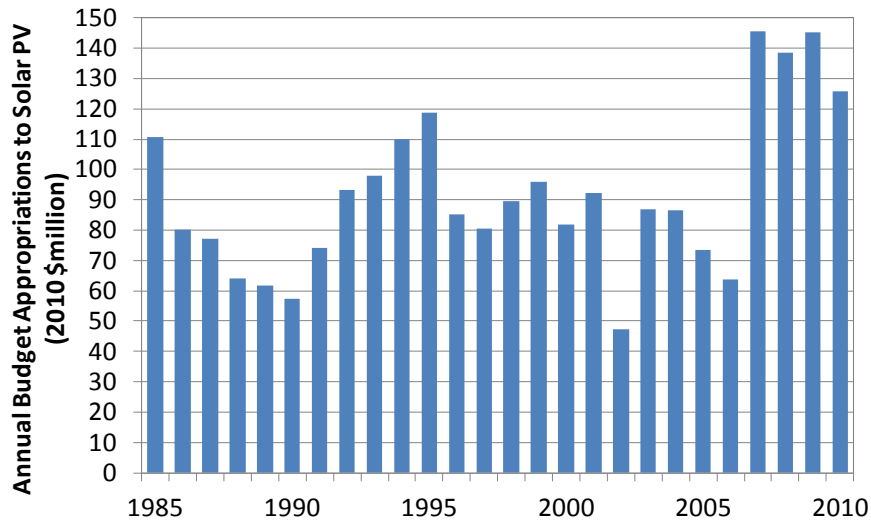
Two of the major federal policies impacting PV installations are the 30% investment tax credit and the 5-year accelerated depreciation (modified accelerated cost-recovery schedule). At the state and local levels, policies impacting PV include net-metering and interconnection rules, regulations regarding third-party financing models, RPS, performance-based incentives, and tax benefits.<sup>200</sup>

Historically, California has been the strongest state market for PV. The California Solar Initiative, enacted in December 2005, provides solar rebates for California consumers that are customers of investor-owned utilities. California continues to encourage solar and other renewable energy technologies through various policies, including a strong RPS, a diverse portfolio of incentives, and utility involvement. Other U.S. markets that have grown significantly during the past few years are Arizona, Colorado, New Mexico, New Jersey, New York, and Nevada. In 2010, California represented 28% of new installations, with 16 states installing more than 10 MW<sub>DC</sub> of PV.<sup>201</sup>

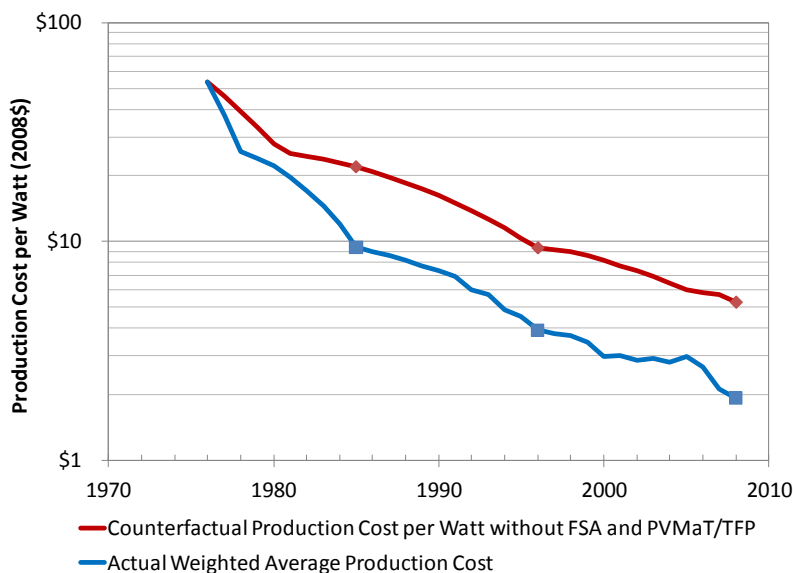
### 7.6.8 DOE History and Accomplishments

Since 1975, investments made by the Department (see Figure 50), along with direct DOE-industry partnerships, have made significant contributions to the development of PV technology and markets. These investments include those that were made under four major programs—Flat-Plate Solar Array

Project (1975–1985), PV Manufacturing Technology Project (1991–2008), Thin-Film PV Partnerships (1994–2008), and Measurement, Characterization, and Reliability R&D (1975–present). According to a retrospective benefit-cost evaluation, DOE investments of cost sharing, technical expertise, and technology infrastructure greatly contributed to declining production costs—without these investments, module cost per watt in 2008 (2008 dollars) would have been slightly more than \$5, as opposed to the actual cost of nearly \$2<sup>202</sup> (see Figure 51). Similarly, DOE investments have accelerated the introduction of warranties (currently 25 years) into the marketplace.



**Figure 50. Historical DOE Solar PV Budget** Sources: (1985–2000) Current Congressional Appropriations from DOE CFO, Office of Budget; (2000–2002,) DOE CFO, Office of Budget (<http://www.cfo.doe.gov/budget/02budget/es/solar.pdf>); (2003–2008) DOE EERE Budget Office ([http://www1.eere.energy.gov/ba/pba/budget\\_archives.html](http://www1.eere.energy.gov/ba/pba/budget_archives.html)); (2009–2010 excluding 2009 ARRA funds) 2011 FY11 Congressional Budget for DOE EERE ([http://www1.eere.energy.gov/ba/pba/pdfs/fy11\\_budget.pdf](http://www1.eere.energy.gov/ba/pba/pdfs/fy11_budget.pdf)). Converted to 2010 \$million using consumer price index from the Department of Labor, Bureau of Labor Statistics (<ftp://ftp.bls.gov/pub/special.requests/cpi/cpi.txt>).



**Figure 51. Annual and Counterfactual PV Module Production Cost per Watt Curves (2008\$).** Counterfactual analysis provides an estimate of the circumstances that would have prevailed had a new policy or policy change not been introduced. These analyses help to retroactively attribute causality to a specific program or initiative. Source: RTI International (Alan C. O'Connor, Ross J. Loomis, and Fern M. Braun). (2010). *Retrospective Benefit-Cost Evaluation of DOE Investment in Photovoltaic Energy Systems*. Washington, DC: Department of Energy. Accessed at [http://www1.eere.energy.gov/solar/pdfs/pv\\_evaluation.pdf](http://www1.eere.energy.gov/solar/pdfs/pv_evaluation.pdf)

Along with the above contributions, DOE-funded laboratories have made continuous improvements in cell efficiencies across technologies (see Figure 47).

The DOE Solar PV Subprogram launched at least five research initiatives between 1975 and 2009, all of which entailed the formation of direct contractual relationships between DOE and companies to advance solar PV technology. More than 160 different companies have participated in DOE PV partnerships. Many of the established DOE-industry partnerships have resulted in patents and publications, in addition to prototype devices, systems, processes, test data, and demonstrations.<sup>203</sup>

#### 7.6.9 DOE Role

The Department is not only investing in informational and capability activities for solar PV, but is also investing in targeted initiatives. The SunShot initiative is a good example of this. Through SunShot,<sup>204</sup> the Department has set ambitious goals (\$1/W utility, etc.) and is leading a coordinated effort to meet those goals. The Department is partnering with industry and academia to support promising technologies across the supply chain toward achieving the goals. In addition, DOE maintains core capabilities in applied R&D on PV technologies, including testing facilities.

## 7.7 Water Power

There are two major ways to convert water power into electricity: conventional hydropower (CH) and a range of emerging marine and hydrokinetic (MHK) technologies. This assessment treats them separately.

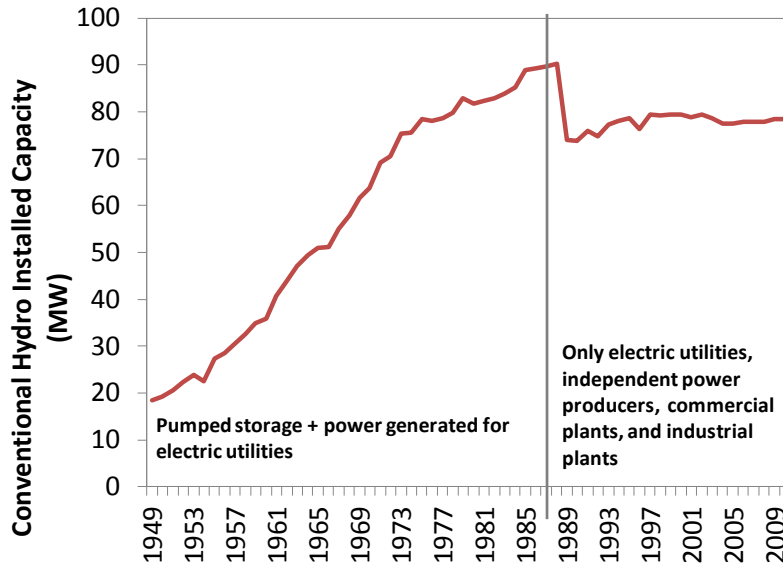
### 7.7.1 Conventional Hydropower and Pumped Storage Hydropower

The total installed capacity of U.S. hydropower facilities is approximately 100 GW, including 78 GW of conventional and 22 GW of pumped storage hydropower (PSH; for more information about PSH, see the *Grid Storage* technology assessment). In 2009, hydropower accounted for nearly 8% of U.S. net generating capacity and more than 60% of the Nation's renewable electricity generation.<sup>205</sup> In 2009, hydropower accounted for 7% of U.S. electricity generated. For more information about PSH, see the *Grid Storage* technology assessment.

The Corps of Engineers and Bureau of Reclamation operate and maintain 21.6 GW and 15.1 GW of installed hydropower capacity, respectively. Energy produced at these federal facilities is marketed by four power marketing administrations: Bonneville, Western, Southwestern, and Southeastern. The Tennessee Valley Authority operates, maintains, and markets energy produced from 5.4 GW of installed hydropower capacity. Investor-owned utilities, state utilities, and local public utilities own, operate, and market the remaining 57 GW. Installation costs for much of this capacity have been amortized over historical production. Overnight capital costs are highly site-specific. An Energy Information Administration estimate for a reference plant is overnight capital cost of approximately \$3,100/kW<sup>206</sup> and LCOE of \$0.08/kWh;<sup>207</sup> O&M costs ranged from \$4.7–\$9.7/MWh over the time period of 1999 to 2009.<sup>208</sup>

In 2008, hydropower accounted for just over 16% (3,288 terawatt hours [TWh])<sup>209</sup> of worldwide generation; it was approximately 21% of capacity (723 GW) in 2010.<sup>210</sup> As of 2006, China is the largest producer of hydroelectricity (431 TWh per year), followed by Canada (352 TWh per year), Brazil (345 TWh per year), and the United States (289 TWh per year). Norway is a leader among developed nations in using CH to meet the country's electricity needs, generating 98.9% from hydropower in 2006. Many nations with developing economies, including Bhutan, Mozambique, and Paraguay,<sup>211</sup> rely on hydropower to provide more than 99% of their electricity due to the availability of the resource and limited demand.

Figure 52 illustrates the slowing of U.S. capacity growth since the 1970s. Worldwide hydroelectricity production growth has occurred largely in Asia and Latin America in the last 40 years.<sup>212</sup>



**Figure 52. U.S. Installed Capacity of Conventional Hydropower, 1950–2010** Source: Energy Information Administration. (2011). *Annual Energy Review 2011, Table 8.11a Electric Net Summer Capacity: Total (All Sectors), 1949-2010*. Washington DC: Department of Energy. Accessed at <http://www.eia.gov/totalenergy/data/annual/showtext.cfm?t=ptb0811a>

Hydropower projects are currently under construction in about 80 countries. Several nations, including China, India, Iran, and Turkey, are undertaking large-scale hydropower development programs.

#### 7.7.1.1 Hydropower Deployment in the United States

In the 1700s, Americans used mechanical hydropower extensively for milling and pumping. The first U.S. hydroelectric power plant opened on the Fox River near Appleton, Wisconsin, in 1882. Niagara Falls was the first American site developed for major hydroelectric generation and remains a source of electric power today. By the early 1900s, hydroelectric power accounted for more than 40% of the Nation’s generation. In the 1940s, hydropower provided about 75% of all the electricity consumed in the West and Pacific Northwest and about one-third of total U.S. electrical energy.<sup>213</sup> With the rise of other generation technologies, hydropower’s share has slowly declined and today provides about 7% of the Nation’s electricity.

The early hydroelectric plants were DC stations built to power arc and incandescent lighting from about 1880 to 1895. The advent of the electric motor spurred demand and hydroelectric design rapidly changed, with deployment of a wide variety of plant styles between 1895 and 1915.<sup>214</sup> Hydroelectric plant design became fairly standardized after 1920. The Nation’s soaring electricity demand drove rapid expansion in hydropower generation capacity. Between 1921 and 1940, CH capacity in the United States tripled and almost tripled again between 1940 and 1980.<sup>215</sup> Since 1980, the development of new hydropower has slowed due to the high cost of sustainable hydropower development compared to other generation sources, increased regulation, competing uses of water, and public concerns about the environmental effects of hydroelectric dams; however, there is potential for further expansion through modernizing existing hydropower facilities, new technologies, and adding generation to existing non-powered dams.

### **7.7.1.2 Status of the Technology**

Modern hydropower turbine-generators have mechanical-electrical efficiencies greater than 92%.<sup>216</sup> Innovations in metal alloys, mechanical bearing design, and lubrication technologies allow the machines to run reliably and efficiently. However, there are increasing demands for dispatch flexibility—operation significantly above or below design flow rates and pressures, and increased frequency of stops and starts—with uncertain impacts on O&M costs and reliability. In anticipation of increasing deployment of wind and solar power, hydroelectric industry stakeholders are beginning to study the linkages between increased dispatch flexibility and O&M costs.<sup>217</sup>

Just over half of U.S. hydropower capacity is Francis turbine technology (fixed-blade, shrouded water wheel), which exhibits a relatively steep tradeoff between dispatch flexibility and efficiency and operating costs.<sup>218</sup> Auto-aerating Francis turbine technology, which can mitigate water quality (dissolved oxygen) deficiencies in water releases, is available from multiple turbine equipment vendors. Outcomes of first- and second-generation aerating technology have been successful thus far, but limited to upgrades of major facilities by large electric utilities that have been able to accommodate the risks and incremental costs of the new technology. Francis turbines are generally assumed to be unsuitable as a fish passage alternative.

Kaplan turbine technology (adjustable blade propeller) provides roughly one-fifth of U.S. hydropower capacity.<sup>219</sup> Kaplan turbines provide dispatch flexibility with relatively minor decreases in efficiency. However, Kaplan technology is applicable primarily to large rivers with low-to-moderate hydraulic head (typically 100 feet or less). A limited number of advanced “fish-friendly” Kaplan turbines have been successfully deployed on the Columbia River (Washington), but the site-specific and species-specific costs of verifying “fish-friendliness” have limited application to large federal operators and public utilities that can accommodate the technical and financial risks. The mechanical and hydrodynamic complexity of adjustable blade designs has stymied the development of auto-aerating technology for Kaplan turbines, although such technology would have application if it was available as an alternative to more expensive water quality improvement technology.

Small hydropower facilities use a variety of turbine technologies. High-head, low-flow sites generally find lowest-cost using Pelton turbine technology (water jets drive the turbine at atmospheric pressure) or other medium-to-high head technology without the need for new dam construction. At the other extreme, new low-head, low-power sites must use higher-cost and/or lower-efficiency turbine-generator technologies, and require relatively expensive civil works to guide water into powerhouses and through large diameter, high-cost, low-speed turbines.

### **7.7.1.3 Future Deployment Potential**

The Electric Power Research Institute (EPRI) has estimated as much as 60 GW of new hydropower could be developed.<sup>220</sup> In comparison, updated resource assessments by DOE’s Water Power Program estimate that development of new CH assets can occur across four classes, which are listed here in approximate order of increasing cost:

- 16 GW of new capacity through expansion or upgrade at existing hydropower facilities<sup>221</sup>

- 12.6 GW of new capacity through the addition of hydropower facilities at non-powered dams<sup>222</sup>
- Harvesting unused energy within constructed waterways and water distribution systems
- Developing new hydropower sites.

The resource potential across the United States at undeveloped sites is more than 100 GW<sup>223</sup>; however, developing most of this potential is contingent on significant capital investment, as well as other factors such as the availability of advanced turbine and environmental mitigation technologies.

#### *7.7.1.4 Technology Potential*

There are opportunities to reduce hydropower LCOE through better water utilization and reduced technology costs. The Energy Information Administration estimates that capital costs for a new reference hydropower plant are approximately \$3,100/kW.<sup>224</sup> However, hydropower costs are highly site-dependent and can range from more than \$5,000/kW for very low-head projects<sup>225</sup> to less than \$1,500/kW<sup>226</sup> for modernization of existing sites. Advances in water utilization will require new machine designs and materials that provide generation and capacity reliably and sustainably over wider operating ranges, with more intense duty cycles. New and improved environmental mitigation technologies would enable hydropower facilities to use more of the water in rivers, rather than being required to bypass flows. Advanced control and decision support systems for powerhouses would improve overall long-term system efficiencies.

Technology costs can be reduced through advances in construction, manufacturing, and materials that will decrease capital and maintenance costs for hydropower equipment and civil structures. In particular, development of modular technology for in-stream civil structures and electrical interconnection would reduce those costs for small hydropower deployment. Continued evolution of environmental mitigation technologies would reduce their costs and uncertainties and increase stakeholder acceptance, with the potential for dramatic reductions in licensing and compliance costs for new and upgrading facilities. These opportunities are currently under intense study as the Department initiates formal technology roadmapping development.<sup>227</sup>

The major factors driving future deployment, particularly of small and low-head hydropower facilities, will likely be cost and environmental performance. Costs are generally higher for lower-head hydropower installations because greater flow is required to achieve a given capacity. This increases the turbine runner size, which raises the direct costs of manufacturing and transporting the runner, as well as structural and construction costs.

Environmental performance can also raise cost because mitigation technologies and strategies, such as the bypass of flow for fish passage, are necessary for environmental sustainability. The absence of widely-applicable, accepted, low-risk, low-cost environmental mitigation technologies is a critical factor in the stagnation of hydropower capacity growth over the last two decades.

How changing hydrologic patterns might affect future deployment is described in detail elsewhere.<sup>228</sup> For example, droughts have decreased the generating performance of the top 10 hydropower-generating U.S. states by 1%–28% in recent years (2007–2009) compared to their historical averages.

#### 7.7.1.5 *Factors that Affect Market Prospects*

Federal and non-federal hydropower assets employ the same technologies and can benefit equally from technology innovation. However, the financial incentive and regulatory structure that determines the improvement feasibility and timing is different. Technology improvements at non-federal assets result from investment decisions of owners who, as for-profit entities, prioritize energy production over competing uses and therefore must implement improvements dictated by licensing requirements. Hydropower technology improvements at the Corps of Engineers and Bureau of Reclamation facilities result from a complex set of factors, including the business objectives of power marketing administration customers and the authorized and appropriated budgets of the Corps and Reclamation. Hydropower production is not typically identified as the top priority for capital investments and water management policy.

The major deployment challenges facing the CH industry are related to technology risk and financial risk. Additional challenges involve non-technical barriers, such as uncertain power resource characterization, regulatory risk, environmental risk, and public acceptance.

- **Capital Costs:** High capital costs and long payback period; lack of capital for technology upgrades, enhancing or adding CH generation; statutory exclusion from renewable energy markets; licensing costs and time for very small hydropower projects are large relative to other costs, making initial explorations for sites risky.
- **Technology Risk:** Lack of data on cost and performance of advanced technologies (e.g., small hydropower, advanced PSH, fish-friendly, and aerating turbines).
- **Resource Characterization:** Water power resource characterization is inadequate to fully understand the deployment potential.
- **Public Acceptance:** Project development can raise concerns about potential impacts on species diversity; alternative land uses, such as recreation and farming; and property values.
- **Regulatory Risk:** Risk in not attaining licenses reduces early investment for new development; exposure to reopening existing Federal Energy Regulatory Commission licenses during upgrades that can require additional studies and mitigation.
- **Environment and Siting Risk:** Difficulty of evaluating non-monetary benefits (ecosystem restoration); uncertainty of impacts and the need for new mitigation and environmental protection.

Environmental considerations and regulatory requirements are important factors in new deployment of CH technology.<sup>229</sup> Minimizing environmental impacts in recent years has resulted in generation and capacity reductions.

#### 7.7.2 *Marine and Hydrokinetic Technologies*

MHK technologies convert wave, tidal, ocean current, river in-stream, ocean thermal, and salinity-gradient power into electricity. These emerging technologies have potential to provide a low-carbon energy supply for many regions of the United States, including the following:



- Ocean wave energy along the Pacific coast (from Point Conception, California, to Alaska) and Hawaii.
- Ocean tidal hydrokinetic energy in East and West Coast locations that have narrow passageways between a bay and the ocean (e.g., Western Passage Maine, East River New York, Admiralty Inlet Washington, Golden Gate San Francisco, and multiple locations in Alaska).
- Open-ocean current hydrokinetic energy off the Atlantic Southeast coast.
- River hydrokinetic energy in most states.

Preliminary estimates indicate that the total MHK resource could potentially supply some 10% of the U.S. demand for electricity, though many factors—such as electrical transmission capabilities, economic viability, environmental concerns, and socio-economic considerations—may impose additional limits onto these resources that substantially alter full development potential.<sup>230</sup> Much of the U.S. population lives near the coast, and ocean wave or tidal current technologies will be located close to these load centers, potentially reducing overall transmission needs. Compared to more variable renewable energy sources, ocean thermal, in-stream current, and ocean current resources have the potential to provide relatively constant energy, while tidal energy benefits from resource predictability. However, as in all generating technologies, many factors beyond resource potential will ultimately determine deployment and impact, most notably cost and scale. LCOE is currently too high for MHK technologies to be competitive, and there is uncertainty in the extent to which costs can be reduced and potential resources could be exploited.

**7.7.2.1 Current Status**

Globally, installed tidal capacity is about 530 MW, nearly 500 MW of which is from two facilities (one in France and one in Korea). Capacity of devices that do not utilize reservoirs is only 5 MW worldwide.<sup>231</sup> The current installed wave energy capacity is about 3 MW worldwide. These figures are one-millionth the scale of total worldwide generating capacity of 4 TW. No ocean thermal energy conversion devices are deployed worldwide, and salinity gradient energy converters are only at a laboratory scale.<sup>232</sup>

The MHK industry is clearly a nascent industry, comprising only 0.005% of global capacity. While a handful of projects are deployed now at varying scales, there are no full-scale, multiple-device commercial deployments. Europe, particularly the United Kingdom, is leading the development of MHK technologies. Technology development in the United States is accelerating, but requires assessment of technical and economic viability. More than 40 different MHK technologies are being pursued in the United States, with individual devices ranging from 10 kW to approximately 1 MW. DOE maintains an online technology database of devices being developed worldwide;<sup>233</sup> they number in the hundreds.

MHK activity has increased during the past 5 years. The number of companies engaging in the industry, as well as patent applications filed and patents issued have increased substantially each year since 2008.<sup>234</sup> A number of MHK prototype and pilot-scale devices have been installed.

**Table 38. Description of MHK Technologies**

<i>Wave Technologies</i>	
<b>Absorbers</b>	The movement of a buoy relative to the ocean floor with the rise and fall of waves is

	converted to electrical energy through a linear or rotary generator.
<b>Attenuators</b>	The relative motion of the device (when oriented parallel to the incoming wave) drives a generator as the wave passes.
<b>Oscillating Water Columns</b>	A partly submerged structure ('collector'), which is open to the sea below the water surface so that it contains a column of water. Air is trapped above the surface of the water column. As waves enter and exit the collector, the water column moves up and down and acts like a piston on the air, pushing it back and forth. The air is channeled toward a turbine and forces it to turn. The turbine is coupled to a generator to produce electricity.
<b>Overtopping Devices</b>	Waves lift water over a barrier, which fills a reservoir that is drained through a hydro-turbine. Similar to low-head hydropower facilities, as they convert the potential energy of the elevated water to generate power.
<b>Inverted Pendulum Devices</b>	The surge motion of waves rotates a large, hinged paddle back and forth. This motion drives hydraulic pumps that then drive electrical generators.
<b><i>Tidal, Ocean, and River Current Technologies</i></b>	
Tidal, ocean, and river current turbines convert the kinetic energy in flowing water into electricity in the same manner a wind turbine uses the kinetic energy in wind.	
<b>Axial-Flow Turbines</b>	Two or three blades mounted on a horizontal shaft form a rotor; the kinetic motion of the water current creates lift, causing the rotor to turn driving a mechanical generator. These turbines must be oriented in the direction of flow. There are shrouded and open rotor models.
<b>Cross-Flow Turbines</b>	While similar to axial-flow turbines, cross-flow turbines, however, can operate with flow from multiple directions without reorientation. These turbines typically have two or three blades mounted along a vertical or horizontal shaft to form a rotor.
<b>Articulated Oscillating Hydrofoil Generators</b>	The flow of water produces lift or drag of an oscillating part transverse to the flow direction, which can be induced by a vortex, the Magnus effect, or by flow flutter.
<b><i>Tidal Barrage</i></b>	
Tidal barrage converts potential energy to electrical energy by allowing large reservoirs to fill during high tide and then releasing the water through CH turbines during low tide. This technology is not being considered for application in the United States due to detrimental environmental effects.	
<b><i>Ocean Thermal Energy Conversion (OTEC)</i></b>	
OTEC uses the potential energy difference between warm, surface seawater and colder, deep seawater that could be used to generate electricity. Open-cycle technologies use the warm surface ocean water as the working fluid, which is drawn into a vacuum vessel that causes the working fluid to vaporize, driving a turbine. Closed-cycle OTEC uses a working fluid, such as ammonia, that boils at a lower temperature than water. The ammonia is vaporized by the warm surface water, which drives a turbo generator.	
<b><i>Salinity Gradient</i></b>	
Salinity gradient power generation uses the potential energy available when saltwater and freshwater mix. Osmotic pressure drives the freshwater through the membrane to the saltwater side, increasing the pressure and the flow in the saltwater channel of the module. The high-pressure, higher-flow rate channel is then passed through a turbine to produce electricity.	

**7.7.2.2 Technology Potential and Innovations**

As MHK technology is nascent, it is likely that significant opportunities to improve cost and performance exist, although the extent is not known at this time. It is expected that costs will be reduced over time by a combination of factors, including the following:

- R&D on MHK components and systems.
- MHK design refinement through extended testing and advanced modeling and simulation.

- Economies of scale through deployments of multiple devices instead of the current, predominantly singular device deployments.
- Advances in production methods as developers shift toward larger production runs.
- Refinement of O&M and capital expense estimates after extended testing of full-scale devices.

Devices must survive the harsh marine environment and maximally extract energy from the resource. R&D of MHK can leverage some past investments in wind technology, offshore oil and gas expertise, and the accumulated knowledge in naval architecture. In some cases, project sites are extremely harsh environments and have forced innovation in device deployment and recovery methods. The high density of water (800 times denser than air) means that there can be significant energy transfer to the device, but device developers are challenged to ensure that this occurs in a controlled manner.

Most of the innovation in the sector is focused on refining existing devices and improving design tools, performance prediction, and cost modeling methods to move from proof of concept to a commercializable device. The following areas have shown the most recent development:

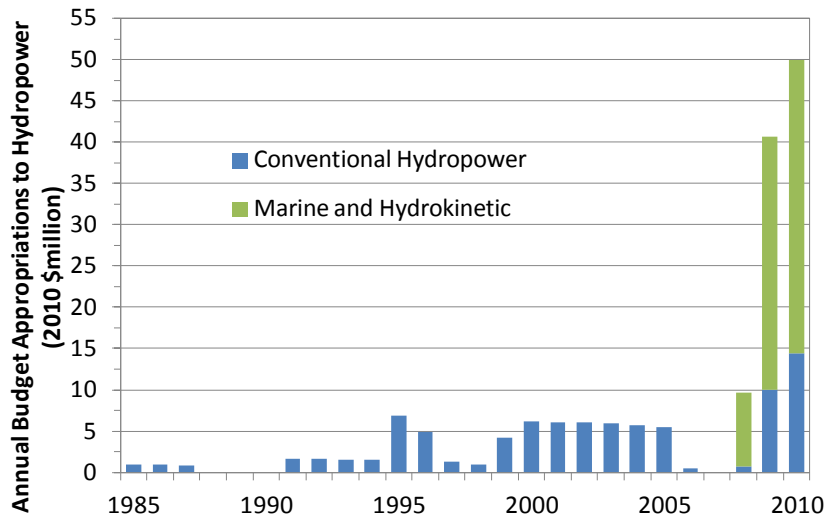
- **Computational Codes:** There has been significant innovation in the development and adaptation of computational design tools to model fluid flow. Refinements of existing computational fluid dynamics codes (many developed by the wind industry) can support the next generation of MHK devices. An emergent area is using advanced modeling tools to predict the performance of an array of devices, both the interactions among devices and the environmental impacts of the array.
- **Innovative Power Take-Offs:** Power take-off (PTO) is a broad category of MHK device components that convert mechanical motion to electrical energy. Some PTOs are intermediaries that convert oscillating motion to rotary motion that is suitable for a conventional generator, and some are integral to the device. Improvements in PTO efficiency directly impact the power output, reliability, and cost of MHK devices. Several R&D efforts for PTO are underway, ranging from direct-drive, rotary designs to the use of magnetostrictive alloys. Reverse magnetostriction offers the possibility of converting the strain on MHK mooring tethers directly into electricity with no moving parts.
- **Manufacturing:** MHK devices today are produced only in small numbers, and developers are actively pursuing techniques and design methods that will support the cost-effective production of multiple devices. Tools and techniques developed at composite boat builders, national laboratories, and in other industries are helping to accelerate that process. Developers are beginning to tap into automotive manufacturing expertise to ascertain the production scalability of their designs. Many have also used rapid prototyping to accelerate the design process.

To move into commercialization, the MHK industry needs to reduce technology risk related to performance uncertainties for each technology.

### 7.7.3 DOE History and Accomplishments

#### 7.7.3.1 Conventional Hydropower

DOE’s involvement with the hydropower industry dates back to the late 1970s and a Small Hydropower Demonstration Program that was established as part of a growing focus on renewable energy. DOE’s early focus was on small hydropower technology assessment, resource assessment, and analyses of environmental and policy issues. In 1993, emphasis of DOE’s hydropower activities began to shift toward enabling new turbine technologies that would reduce environmental impacts to make the hydropower industry more competitive. That work was temporarily halted in 2006 when program funding was zeroed out, but it was restarted in 2008 (Figure 53).



**Figure 53. Annual DOE Budget for Water Power Sources:** (1985–2002) Current Congressional Appropriations from DOE CFO, Office of Budget; (2003–2008) DOE EERE Budget Office ([http://www1.eere.energy.gov/ba/pba/budget\\_archives.html](http://www1.eere.energy.gov/ba/pba/budget_archives.html)); (2009–2010) 2011 FY11 Congressional Budget for DOE EERE ([http://www1.eere.energy.gov/ba/pba/pdfs/fy11\\_budget.pdf](http://www1.eere.energy.gov/ba/pba/pdfs/fy11_budget.pdf)). Converted to 2010 \$million using consumer price index from the Department of Labor, Bureau of Labor Statistics (<ftp://ftp.bls.gov/pub/special.requests/cpi/cpi.txt>).

Some of DOE’s recent accomplishments include:

- Installation and testing of an advanced, fish-friendly Kaplan turbine that has both energy and environmental benefits (14% more energy with a 3% increase in water-use efficiency, plus fish mortality of less than 3%) at the Wanapum project.<sup>235</sup>
- Installation and testing of new turbine designs that increase dissolved oxygen concentrations in an energy-efficient manner at the Osage project.<sup>236</sup>
- Development of an innovative runner with combined energy (greater than 90% conversion efficiency<sup>237</sup>) and environmental benefits (less than 2% fish mortality) called an Alden turbine.<sup>238</sup>

#### 7.7.3.2 Marine and Hydrokinetic

The Energy Policy Act of 2005 authorized DOE to conduct research on all water power technologies, and the Energy Independence and Security Act of 2007 called for DOE to establish a program of research,

development, demonstration, and commercial application activities to expand MHK renewable energy production.

The United States Marine Hydrokinetic Renewable Energy Technology Roadmap<sup>239</sup> is focused primarily on scientific and technical steps to overcome barriers to the widespread use of MHK technologies. Europe has MHK expertise and the U.S. roadmap is aligned with similar roadmapping efforts that have been conducted internationally.<sup>240</sup> The U.S. Technical Advisory Group of the International Electro-technical Commission Technical Committee TC-114 assists in the development of international standards for the MHK industry.

DOE has developed a diverse MHK portfolio. In 2010, DOE awarded more than \$37 million over 3 years to accelerate the technological and commercial readiness of MHK technologies. Twenty-seven cost-shared projects were funded, ranging from concept studies and component design research to prototype development and in-water device testing. National assessments of wave, tidal, ocean current, ocean thermal, and in-stream hydrokinetic resources have also been funded. Three national test centers have been established that will allow machine developers to efficiently test devices in a realistic environment.

DOE has provided technical support or funding to a number of deployed or proposed U.S. projects, including the following:

- Wave energy converter in Puget Sound, Washington, controlled remotely from Corvallis, Oregon.<sup>241</sup>
- River in-stream turbine in the Mississippi River (Louisiana) (40 kW)<sup>242</sup>
- The proposed Admiralty Inlet Pilot Tidal Project .

The data generated through these demonstrations will illuminate the viability of these technologies and pathways for cost reduction.

#### 7.7.4 DOE Role

DOE's contributions in CH center on resource characterization and information dissemination, as well as a capability role for fundamental engineering related to reducing environmental impacts. DOE's role in MHK focuses on informational and convening activities. For example, the Department is supporting the introduction of a multi-national data-sharing effort that will leverage the current MHK development work in the European Union, and is also pursuing bi-lateral data-sharing agreements with Canada (another leader in MHK). In addition, DOE is building a broad understanding of these emerging MHK technologies and facilitating rapid innovation and engineering development. DOE is also leveraging its convening ability to address barriers to industry collective action.

## 7.8 Wind

Global wind power capacity today exceeds 197 GW,<sup>243</sup> some 4% of total generating capacity. China leads the world with more than 44 GW installed, followed by the United States where more than 40 GW of wind power generates 2.3% of the Nation’s electricity.<sup>244</sup> Wind power’s potential for providing 20% of American electricity has been evaluated by DOE as a technically and economically feasible scenario.<sup>245</sup> Higher penetrations would be possible if grid transmission and integration barriers could be overcome. A 2007 report prepared for the American Wind Energy Association found technical potential of 8,000 GW of land-based resource and 4,000 GW of offshore resource, although actual deployments will be significantly less.<sup>246</sup> The highest-quality U.S. wind resources are concentrated in the Midwest and offshore.<sup>247</sup>

### 7.8.1 Current Status of Technology

Wind turbine technology has evolved into three major technology pathways, each at a different stage of maturity and deployment (Table ).

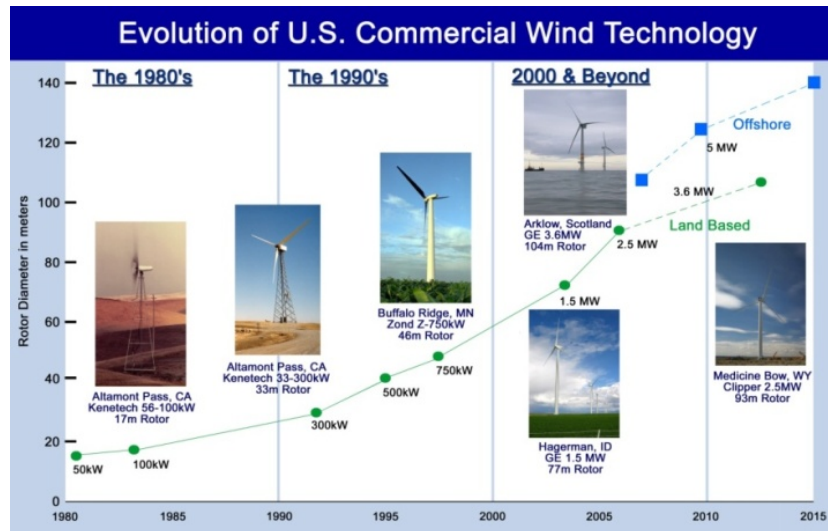
**Table 19. Major Wind Pathways**

	Global Deployment	Installed Costs (price of electricity <sup>248</sup> )	Turbine Size (plant size)	Siting Factors
<b>Land-Based</b>	98% of world’s wind power, 35 GW installed in 2009	\$2,120/kW <sup>249</sup> (\$61/MWh <sup>250</sup> )	100 kW-3 MW (varies)	Wind resource and grid access
<b>Fixed-Bottom Offshore</b>	3 GW, 97% of which is in Europe	\$4,250/kW <sup>251</sup> (\$270/MWh) <sup>252</sup>	2-5 MW (100-400 MW)	Wind resource quality, proximity to load centers
<b>Floating Platform Offshore</b>	No commercial installations	Unknown	Unknown	Significant wind resource (>3,000 GW) in deep water

Historically, two factors have driven down the cost of electricity from land-based and offshore turbines: larger systems (which provide economies of scale) and improved energy capture. Taller towers and larger rotors provide access to better winds and more energy, thereby increasing both resource availability and capacity factor (capacity factor, the ratio of average power produced to rated capacity, is typically about one-third for wind installations<sup>253</sup>). Improved turbine energy conversion efficiency has also helped increase annual energy production and capacity factor. These same scaling principals and efficiency improvements are applicable to existing technology to further reduce costs. An integrated systems perspective of the entire wind plant that could improve overall performance and mitigate intra-array effects will be necessary to fully realize this potential.

Floating platform offshore wind has two potential benefits: providing access to significant resources (greater than 3,000 GW) in deep water, and allowing mass production of turbine platforms independent of bathymetry and foundation design.

Small wind turbines (1–100 kW) can be deployed for distributed generation. There is about 175 MW of small wind power in the United States.<sup>254</sup> The United States is the world leader in small wind systems, with two-thirds (about 18 MW) of the turbines sold globally in 2009 having been manufactured by U.S. companies.<sup>255</sup> Since small wind is unlikely to be material by 2030 due to economics and quality of the distributed resource, it is not addressed in this technology assessment. However, many of the technology innovations discussed in this assessment are applicable to small-scale wind.



**Figure 54. Evolution of Wind Technology** Turbines have steadily increased in size and rated capacity. Source: Department of Energy. (2008). 20% Wind Energy by 2030. (DOE/GO-102008-2567). Washington, DC.

LCOE for wind technologies is higher than current average electricity prices, though in various settings wind technologies are economically competitive without subsidies.<sup>256</sup> Unfortunately, there are no good data available on the cost of electricity of deployed wind projects; all data are the price paid by utilities, which is depressed by federal and state subsidies. Both land and offshore wind technologies have potential for LCOE reductions through technology development to improve the economics of wind energy.<sup>257</sup> Wind technologies must also overcome various financial, regulatory, and public acceptance barriers. The principal technology cost drivers include:

- Installed capital cost of the wind plant system.
- Plant capacity factor and related system annual energy production.
- O&M costs and component reliability.
- Perceived financial risk, including performance and energy delivery potential.

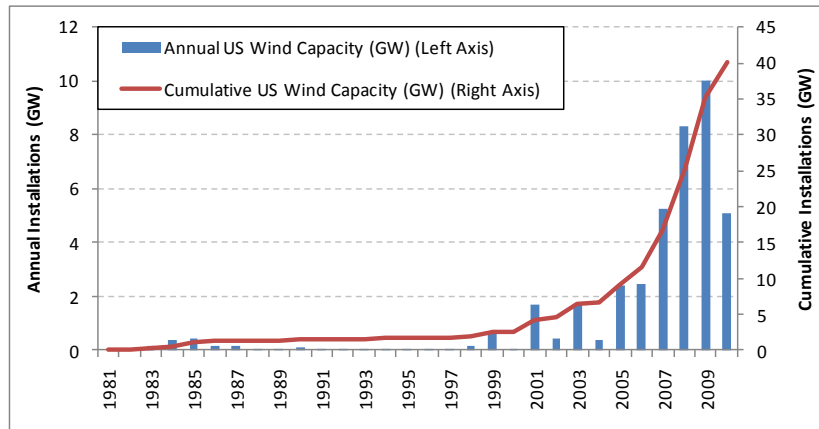
Specific technology improvement options addressing LCOE reduction and market barriers for the land and offshore pathways are examined in the sections below.

## 7.8.2 Historical Pace of Development and Market Diffusion

Global wind power capacity grew by 22% in 2010, with 38.3 GW in new installations comprising a \$65 billion industry.<sup>258</sup> In the United States, the wind industry installed just over 5 GW of new capacity, comprising a \$10 billion industry. Installations in 2010 were half that in 2009 due to lower wholesale

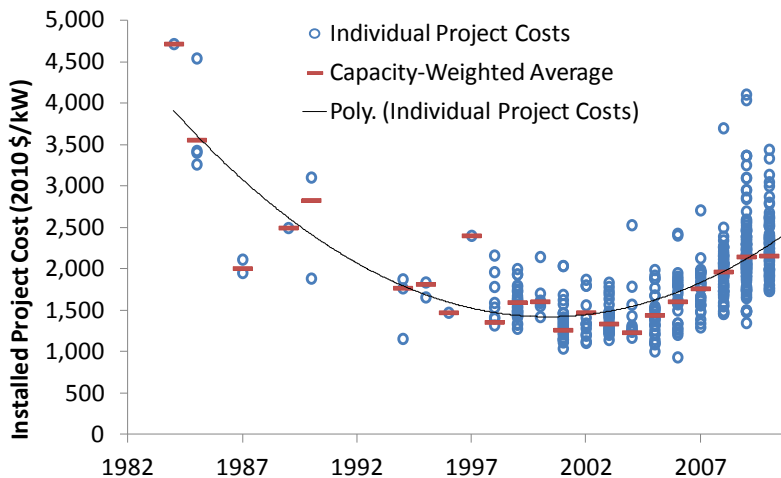
electricity prices and a depressed demand for electricity.<sup>259</sup> Since 2006, the U.S. wind industry has grown at an average annual rate of more than 36%.<sup>260</sup> An estimated 71% of U.S. wind power capacity has come online since 2006; 94% has come online since 2000 (Figure 55).<sup>261</sup> Texas is the state leader in installed wind power capacity, with nearly one-quarter of the U.S. fleet (10,085 MW).<sup>262</sup>

The domestic content of U.S. installations grew from 15% in 2006 to an estimated 61% in 2009. In addition, the United States has begun modest export of turbines and components to neighbors in the Western Hemisphere and to China.<sup>263</sup> Today's expanding U.S. wind manufacturing capacity consists of OEM nacelle and drivetrain assembly plants, OEM and tier-one blade and tower manufacturers, and lower-tier component manufacturers.



**Figure 55. Annual Installed Wind Capacity and Total Installed Wind Capacity in the United States** Source: Wisler, R., and Bolinger, M. (2010). *2009 Wind Technologies Market Report*. Page 3, Figure 1. Washington, DC: Department of Energy. Accessed at <http://eetd.lbl.gov/ea/ems/reports/lbnl-3716e.pdf>

The installed cost of wind power fell steadily from more than \$3,000/kW in the mid-1980s to \$1,200–\$1,400/kW in the early 2000s due to technical and manufacturing improvements, and then rose again to roughly \$2,100/kW in 2009 (Figure 56).<sup>264</sup> The average installed costs are expected to decline in the near future due to greater supply and an easing of commodity and energy prices.





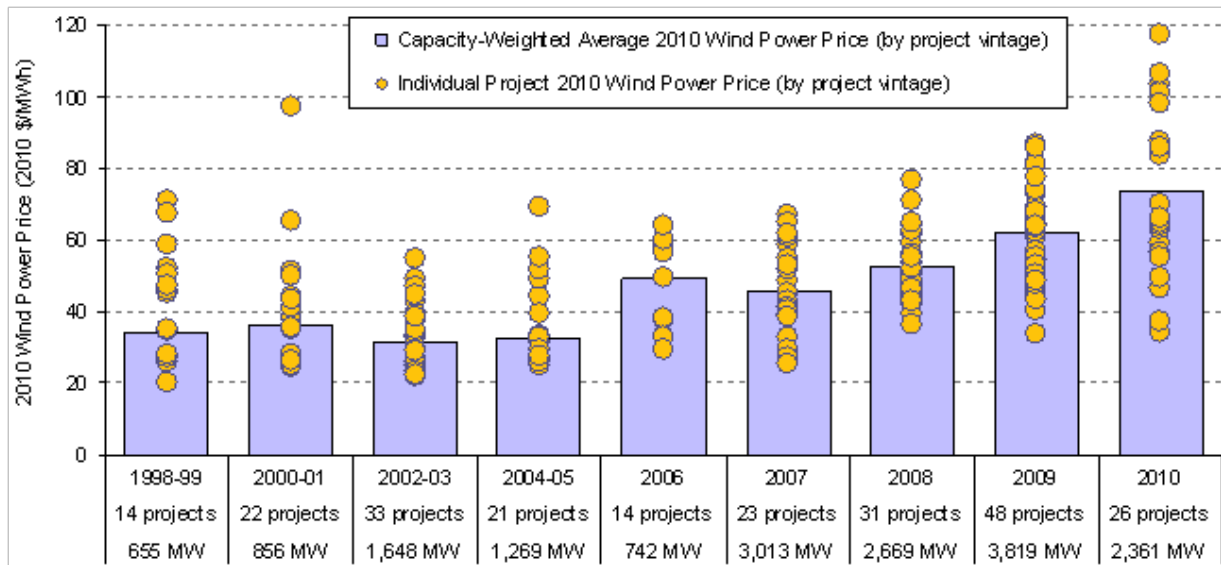
**Figure 56. Installed Cost (\$/kW) for Land-Based Wind Installations** Source: Wisner, R., and Bolinger, M. (2011). *2010 Wind Technologies Market Report*. Page 47, Figure 28. Washington, DC: Department of Energy. Accessed at <http://www1.eere.energy.gov/wind/pdfs/51783.pdf>

The factors that drove up the capital cost of wind installations in 2008—higher commodity prices, a relatively weak dollar and reliance on European supply, supply/demand constraints, and increased labor costs—eased in 2010. Insufficient transmission access in the best wind resource areas has also forced developers into lower wind resource classes, raising the cost of energy.

Installed costs for fixed-bottom shallow offshore wind plants have historically been 50%–100% higher than installed costs for land-based wind facilities, and were roughly \$4,000/kW in 2010. Data for proposed U.S. and European projects suggest shallow offshore installed capital costs will not decrease in the near future.<sup>265</sup> Comparable data for deep water floating technology does not yet exist. Offshore wind installation costs have also been driven upward by increased siting complexity. Limited offshore installation and operational experience demands higher construction and operation risk premiums.<sup>266</sup>

U.S. land-based wind costs for projects completed in 2010 appear to be similar to 2009. However, the most recent trends indicate cost reductions on the order of 25% for projects to be built 1 to 2 years into the future.<sup>267</sup> These cost reductions result from increased domestic content (which helps to hedge against exchange rate fluctuations), build-out of new manufacturing capacity, slowing demand for wind turbine equipment, and greater competition in wind turbine supply.

The price of electricity from wind projects in the first half of the decade ranged from \$30–\$40/MWh, while projects completed more recently have ranged from \$20–\$90/MWh (Figure 57). The price of electricity is based on many factors, including regional differences in wind resource, installation and development costs, wholesale electricity prices, demand for renewable energy associated with state policies, and applicable federal and state subsidies.<sup>268</sup>

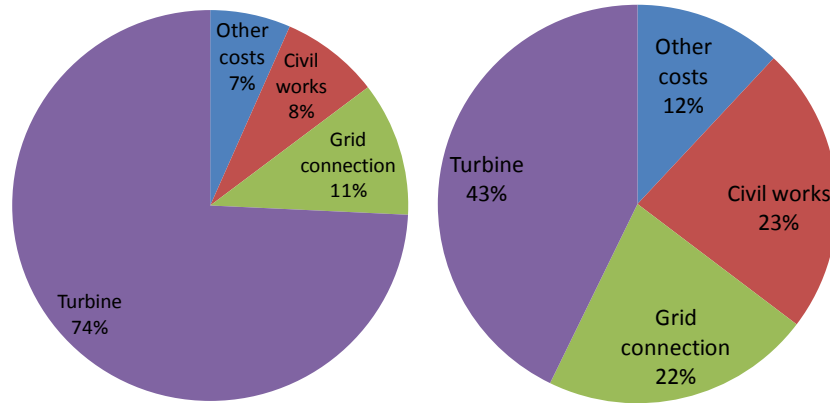


**Figure 57. Wind Power Price (\$/MWh)** Bars show the capacity-weighted average wind power price paid by utilities by project vintage. Yellow circles show individual project wind power price. Prices are depressed by applicable

federal and state subsidies. Source: Wiser, R., and Bolinger, M. (2011). *2010 Wind Technologies Market Report*. Page 39, Figure 21. Washington, DC: Department of Energy. Accessed at <http://www1.eere.energy.gov/wind/pdfs/51783.pdf>

### 7.8.3 Current Industry in the United States and the World

Wind turbines are only part of the overall capital costs associated with wind farms (Figure 58). The related BOS hardware and support infrastructure represents a greater portion of the overall wind plant cost drivers for offshore deployment.



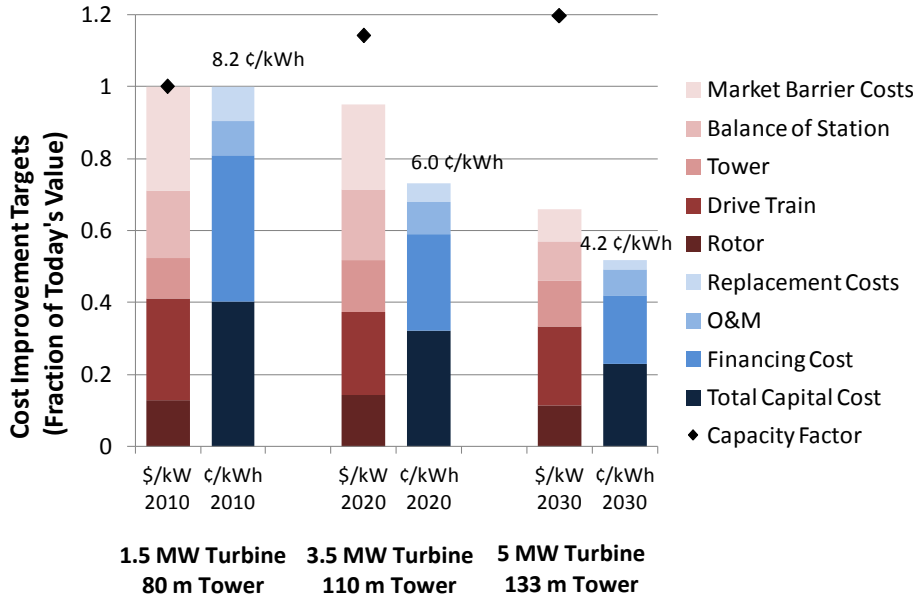
**Figure 58. Capital Cost of Land-Based (left) and Offshore (right) Wind Power by Component** Source: Wiser, R., et al. (2011). Chapter 7: Wind Energy. In *IPCC Special Report on Renewable Energy Sources and Climate Change Mitigation*. Page 66, Table 7.4. [O. Edenhofer, R. Pichs-Madruga, Y. Sokona, K. Seyboth, P. Matschoss, S. Kadner, T. Zwickel, P. Eickemeier, G. Hansen, S. Schlömer, C. von Stechow (eds)]. Cambridge, United Kingdom, and New York, NY, USA: Cambridge University Press. Accessed at <http://srren.ipcc-wg3.de/report>

The principal materials used in wind turbines include steel, copper, fiberglass, carbon fiber, and polymer resins, while turbine foundations are primarily concrete. The industry has identified potential issues in the availability of fiberglass and carbon fiber, the latter being relatively costly.<sup>269</sup> Similarly, increased demand for permanent magnets, used in many industrial applications, has created some concern about the reliable availability and cost of rare earth permanent magnets used in wind generators.<sup>270</sup>

### 7.8.4 Technology Potential

The installed costs of land-based wind power are expected to decline by as much as 25%–35% over the next two decades, even as stronger, longer blades and towers will be needed for increasingly larger systems.<sup>271</sup> For the less mature offshore industry, installed costs are expected to decline by 9%–44% by 2030.<sup>272</sup> At the same time, performance for both land-based and offshore wind is expected to continue to improve. In combination, these changes will increase energy capture, lower capital costs, and improve reliability, all of which lower the cost of electricity.

Figure 59 shows technical targets for the LCOE of land-based wind energy that the Department believes are feasible though increased capacity factor and decreased capital costs.



**Figure 59. Potential Decrease in Land-Based Turbine Costs (red bars), LCOE (blue bars), and Associated Increase in Capacity Factor (black diamonds).**<sup>273, 274</sup> Source: Internal Department of Energy Wind and Water Program Strategic Analysis, as part of roadmapping analysis.

The private sector, in part supported by DOE, continues to conduct R&D efforts that could reduce the LCOE of both land-based and offshore wind power. Activities to achieve significant LCOE reduction are sorted into three primary pathways, each with specific research objectives:

- Next-Generation Wind Turbine Component Development:** Developing larger light-weight turbine architectures (larger rotors, taller towers) that reduce overall mass (cost) and provide access to better resource and improved systems performance (capacity factor). Innovations in wind turbine components can improve energy capture and performance. Component material improvements (cost, strength, weight, fatigue) can facilitate turbine scaling and improve reliability. Research opportunities include development and validation of next-generation drivetrain and rotor concepts; integrated active rotor control for load mitigation; adaptive controls; integrated health monitoring; and advanced sensor systems.
- Wind Plant Production and Underperformance:** Next generation of advanced modeling capability will be better able to evaluate wind plant performance and provide operational information for control and dispatch of power that will have a direct impact on current underperformance issues. Vital to these efforts is a shift in approach, from turbine-level performance to a plant-wide, systems-level perspective. Research opportunities include the use of advanced modeling and computational capabilities to predict intra-array flow dynamics and to assess impacts on macro and micro climatology and facilitate complex terrain installations, large multiple arrays, and optimized siting; design tools to assess wind turbine design and performance as an integrated subsystem; grid modeling simulation to address dynamic stability and penetration effects from intermittency; and forecasting tools to provide high confidence projections of resource and power production.

- **Wind Plant Reliability:** Reliability innovations can lead to significant reductions in O&M costs and levelized replacement costs for large, expensive components, such as blades, gearboxes, and generators. O&M and replacement costs can be particularly significant for offshore wind plants. Research opportunities include damage and defect surveys to characterize problems in the field; studies to determine how defects affect the strength and life of wind turbine components; validation of failure analysis models; real-time performance monitoring, including gearbox and blade reliability, reliability and operational database failure and maintenance tracking, development of active condition monitoring systems for rotors, drivetrains, power conversion systems, as well as adaptive controls research to maximize power production while minimizing detrimental loads; and collection of industry-wide reliability, availability, and maintainability data.

Deep water floating platform technology has the greatest potential to reduce offshore costs, open significant wind resources, and overcome visual public acceptance barriers that limit onshore and shallow-water projects. Significant innovation is required in several technologies for floating platform architectures to achieve commercial viability. These innovations, many of which are equally applicable to land and shallow-water systems, are technically challenging but have the potential to drastically reduce LCOE. The greatest technical challenges in offshore innovation include:

- **Lightweight Turbine Architectures:** Floating offshore platforms will require lightweight turbines designed for the marine environment and accommodating unique logistics, installation, and maintenance requirements.<sup>275</sup> Every kilogram removed above the water line reduces the subsurface mass needed to achieve buoyancy by 5–6 kilograms. The principal technical challenge in making floating technology viable is stability of a lightweight, dynamically soft turbine mounted on a floating platform and subjected to coupled wind and wave loading.
- **Installation Vessels and Techniques:** Installation, operation, and maintenance in a marine environment are major technology considerations. In many marine operations, dockside construction and assembly is about four times more expensive than factory construction and assembly, and marine operations are eight times more expensive than land-based operations. Hardware options requiring minimal marine assembly, the development of specific installation vessels, enhanced installation techniques, component longevity, and performance options reducing on-station maintenance and replacement will likely be more costly than what is used in land-based systems.
- **Condition Monitoring:** O&M is a major cost driver (about 20% LCOE) for shallow-water systems already deployed in Europe due to the harsh marine operating environment and access windows limited by weather and sea conditions;<sup>276</sup> deep water floating systems will likely have even more stringent access limitations. Advanced condition system monitoring must be developed and implemented to limit maintenance trips and facilitate reductions in O&M. More thorough remote monitoring systems are needed for rotors, drivetrains, and power electronics, as well as the associated assessment technologies for predictive failure and maintenance.

### 7.8.5 Summary of Roadmap Agreements and Disagreements

The United States and European Union have different wind energy goals and objectives, although both project substantial future power generation from wind. For example, the International Energy Administration published a Wind Technology Roadmap in December 2009,<sup>277</sup> describing projected contributions for wind power worldwide through 2050, along with actions required to achieve those projections. The International Energy Administration projects some 2,700 TWh per year of wind energy generated by 2030, providing some 9% of worldwide electricity. In comparison, DOE has evaluated wind power's potential for providing 20% of American electricity as a technically and economically feasible scenario.<sup>278</sup>

### 7.8.6 High-Risk Technology Breakthroughs

Several innovative technologies that are radical departures from conventional approaches are being investigated. These technologies are early in the development and demonstration phases at the prototype scale R&D investments. Existing public and private sector R&D endeavors of this sort include:

**Wind Turbine Augmenter/Diffuser Technologies:** Recent advances in turbine augmentation technology can overcome the limitations of diffuser technologies. Shrouded or ducted rotor technologies to enhance wind turbine performance were initially proposed in the 1950s. Shrouds were designed to increase the turbine inlet to exit area ratio and reduce the exit pressure, thereby increasing the mass flow through the rotor inlet. A theoretical two-to-three fold improvement in performance is possible but has not been field validated. Performance discrepancies are due to flow separation from the shroud when the turbine turns with changes in wind direction. Augmenting rotor wake through integrated diffuser design mitigates these separation effects. Potential advantages include achieving a two-to-three fold improvement in energy capture and minimizing wake dispersion and coherency effects. Anticipated technical challenges remain the weight and thrust loading of the shroud, key drivers of total cost of energy when scaled to multi-megawatt platforms.

**Active Blade Control Technologies:** Active blade augmentation to control aerodynamic performance includes a wide range of well-documented technologies that have been used in aerospace applications. Most common are actuators (e.g., flaps, spoilers, etc.) to change the airfoil shape to achieve a specific performance objective. Another approach is flow augmentation for similar performance changes without physical manipulation of the blade geometry. High-pressure air directed through slots along the blade alters blade performance characteristics. This technology can be used to enhance aerodynamic performance to overcome design constraints. For example, large blades (greater than 80 meters) have blade widths that exceed acceptable transportation envelopes. Similarly, using a thick cross section for large blades is less aerodynamically efficient. Active blowing control can overcome aerodynamic performance degradation. Anticipated technical challenges include design life, duty cycle, maintaining active control systems, and the potential for increased aeroacoustic noise.

**Airborne Power Generation Technologies:** Aerospace architectures (e.g., wing and helicopter unibody structures, rotors, flight controls, etc.) used to collect energy at altitude, connected through a power cable tether. Advantages of these technologies include order of magnitude reduction in system mass by eliminating foundation and tower support infrastructure; scalability to multi-megawatt architectures;

access to significantly improved wind resources aloft; and rapid deployment potential both on and offshore. Anticipated technical challenges and opportunities include addressing fatigue, critical structural design constraints, improved LCOE through lower-cost composites, longevity and design life, OEM and potential aviation deployment barriers, and safety concerns.

### 7.8.7 Deployment Barriers

Key barriers to the domestic deployment of wind power include:

- **Transmission Access and Availability:** Lack of transmission access and necessary infrastructure, such as offshore installation vessels, drives wind deployment to lesser quality resources, thereby increasing the cost of electricity. Sites for projects deployed in 2008 averaged a Class III resource, continuing a downward trend over the past decade (Figure 60). Research opportunities focus on providing the information necessary to improve system-wide planning and include grid integration studies to assess technical solutions to wind resource variability, assessments of offshore infrastructure needs and costs, and conceptual design studies. A more detailed discussion of transmission and integration issues can be found elsewhere.<sup>279</sup>
- **Siting and Environmental Barriers:** Proposed sites for wind farms often face opposition based upon wildlife impacts, civilian and military radar interactions, and competing land/sea use. The construction and operation of wind power facilities can have real or perceived negative impacts on wildlife, radar, and other land and ocean uses, and these concerns may become more significant as the footprint of wind energy expands. These risks are not always fully understood, nor have methods for mitigating these impacts been demonstrated. Options to reduce these risks, whether perceived or actual, include research on reducing radar interference and acoustic signature; risk mitigation for wildlife and other environmental impacts; and better understanding interactions of wind farms with other industries, such as agriculture (land-based) and navigation (offshore). Public acceptance concerns related to these barriers could be addressed by increased availability of objective information and decision tools on wind energy to stakeholders and policymakers, direct and indirect technical support to state and local governments, and scientific research on issues of public concern.
- **Cost of Electricity:** Wind power is more expensive than traditional fossil fuel generation. Costs due to wind's variable output may increase with its greater penetration. Policies like the Production Tax Credit and RPS at the state and federal level affect the cost of electricity. Uncertainty about the existence and stability of these policies affects wind deployment.
- **Manufacturing Capability:** Improvements in manufacturing processes to minimize material inputs and waste could reduce costs and improve industry production efficiency. Opportunities include researching advanced materials and manufacturing process, as well as workforce development, especially for manufacturers and those involved in wind power implementation, such as installers, operators, and technicians.

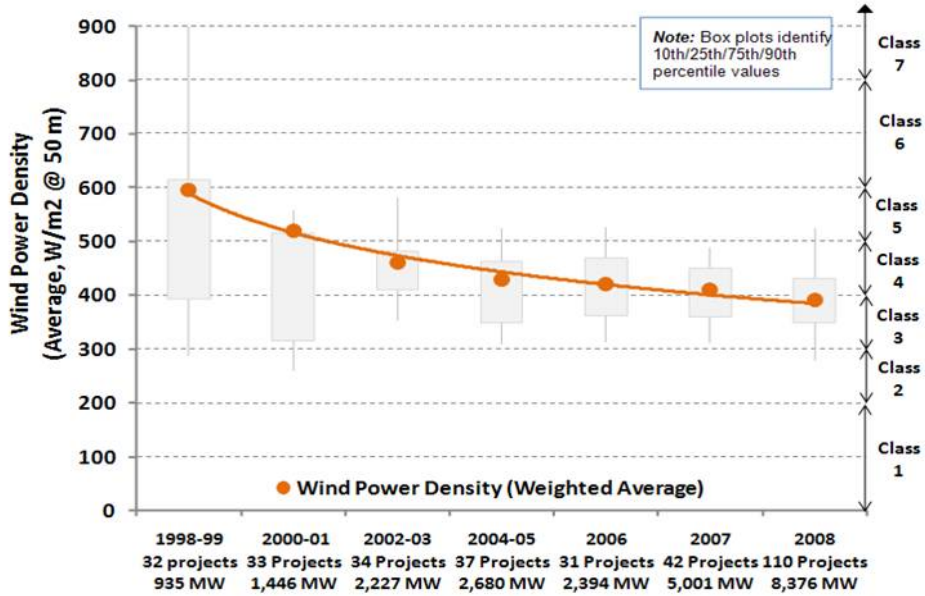


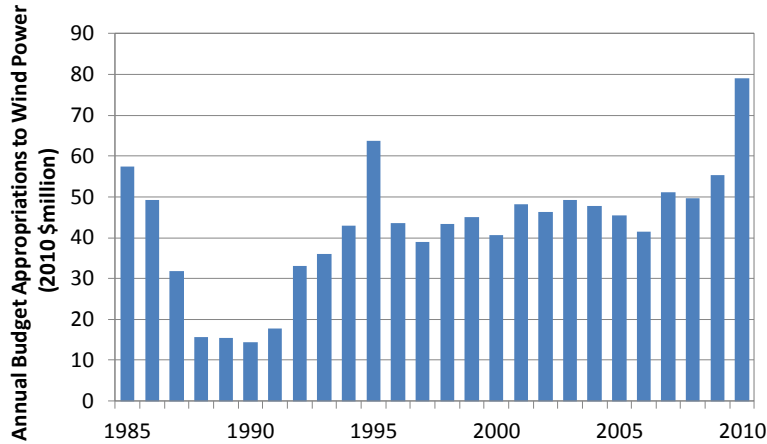
Figure 60. Wind Power Density of Installed Plants by Project Vintage Source: Wisner, R., and Bolinger, M. (2011). *2010 Wind Technologies Market Report*. Page 39, Figure 21. Washington, DC: Department of Energy. Accessed at <http://www1.eere.energy.gov/wind/pdfs/51783.pdf>

Potential issues that will warrant more attention at higher wind power penetration include the following:

- Possible impacts to micro- and macro-climatology from large turbine arrays. Micro- and macro-climatology impacts are potential alterations of the atmospheric boundary layer resource by the presence of a large multi-array wind farm. Micro effects include alterations to the flow at wind plant dimensional scales and below; effects include the inter-array flow field changing power production, turbine loads, and individual turbine wakes, impacting subsequent turbines aligned in multiple arrays. Micro also refers to the aggregated wake effect downstream of a farm that may impact agriculture, including surface humidity and temperature. Macro effects include impacts from multiple large wind farms, including changes in circulation patterns, precipitation patterns, and valuation of the wind energy resource when impacted by upstream wind farms.
- National and regional power forecasts, dispatch and integration strategies for accommodating more intermittent and variable power sources on the grid, deeper analysis and understanding of operational constraints, and associated government regulatory roles and responsibilities.<sup>280</sup>

### 7.8.8 DOE History and Accomplishments

Annual inflation-adjusted DOE wind R&D funding peaked in the late 1970s at \$160 million, fell sharply in the late 1980s to \$15 million, and remained near \$40–\$50 million a year from 1996 through 2008, before increasing in recent years (Figure 57).



**Figure 61. DOE Wind Energy R&D Budget.** Sources: (1985–2002) Current Congressional Appropriations from DOE CFO, Office of Budget; (2003–2008) DOE EERE Budget Office ([http://www1.eere.energy.gov/ba/pba/budget\\_archives.html](http://www1.eere.energy.gov/ba/pba/budget_archives.html)); (2009–2010) 2011 FY11 Congressional Budget for DOE EERE ([http://www1.eere.energy.gov/ba/pba/pdfs/fy11\\_budget.pdf](http://www1.eere.energy.gov/ba/pba/pdfs/fy11_budget.pdf)). Converted to 2010 \$million using consumer price index from the Department of Labor, Bureau of Labor Statistics (<ftp://ftp.bls.gov/pub/special.requests/cpi/cpi.txt>).

Notable technology contributions resulting from this investment include modeling and early-phase R&D, as well as technology evaluation and demonstration activities.<sup>281</sup>

**Modeling and Early-Phase R&D:**

- Measurements of the wind turbulence field and development of stochastic models. Established a causal relationship between atmospheric turbulence and turbine failure and provided fast and efficient methods for numerical simulation of turbulence in design codes (1980–present).
- Development and validation of numerous structural, aerodynamic, and controls codes used extensively by industry in the design and development of innovative technology and commercial architectures (1990s–present).
- Turbine blade and rotor material characterization and analytical modeling. Creation of a composites materials database used extensively by industry for blade and rotor design (1990s–present).
- Development of the first integrated tool for modeling offshore deep water floating platform structures (barge, spar buoy, tension leg platform), incorporating coupled hydrodynamic and aeroelastic response to atmospheric turbulence and wave interaction called HydroDYN. This model is becoming the standard tool in modeling innovative offshore concepts and designs (2005–present).

**Technology Evaluation and Demonstration:**

- Development and demonstration of the first multi-megawatt wind turbines (1980s).
- Co-location of field, dynamometer, and blade test facilities with a national engineering center dedicated to advanced technology and model development at the National Wind Technology Center (1996).
- Validated emerging turbine design performance (1990s).



- Through technology development programs (e.g., WindPact, Low Wind Speed Turbine), aided industry's development and demonstration of larger commercial wind turbines that could reach higher wind regimes and achieve greater energy capture (1995–2006).
- Established the global benchmark dataset for codes validation of turbine aerodynamics and wakes via the Unified Aerodynamics Experiment field and measurement campaigns, which were conducted at the National Wind Technology Center in conjunction with full turbine testing at a National Aeronautics and Space Administration wind tunnel (1990s).

### 7.8.9 DOE Role

DOE's primary roles in wind power focus on R&D capability and information. The Department has core scientific and technical capabilities for wind resource characterization, modeling of intra-array flow dynamics, analytic tool development for wind forecasting, and materials science. These capabilities allow DOE to lend its basic and fundamental engineering science resources to precompetitive solutions to challenges to wind power production. For example, the Department's National Wind Technology Center provides unique testing capabilities to help industry partners develop and refine turbine designs. The Department also provides valuable informational resources to various stakeholders through reports like *20% Wind Energy by 2030*.<sup>282</sup> Furthermore, DOE works with the Department of Interior to remove barriers to siting wind projects, providing information to stakeholders on the costs and benefits of wind power projects.<sup>283</sup>

---

<sup>1</sup> Energy Information Administration. (2011). "Total Energy Supply, Disposition, and Price Summary, Reference Case." *Annual Energy Outlook*. Washington, DC. Accessed at <http://www.eia.gov/oiaf/aeo/tablebrowser/#release=AEO2011&subject=0-AEO2011&table=1-AEO2011&region=0-0&cases=ref2011-d020911a>

<sup>2</sup> Energy Information Administration. (2011). "Growth of Carbon Emissions Slows in Projections." *Annual Energy Outlook*. Washington, DC. Accessed at [http://www.eia.gov/forecasts/aeo/MT\\_emissions.cfm#carbon](http://www.eia.gov/forecasts/aeo/MT_emissions.cfm#carbon)

<sup>3</sup> Energy Information Administration. (2011). "Total Carbon Dioxide Emissions from the Consumption of Energy." *International Energy Statistics*. Washington, DC. Accessed November 2011 at <http://www.eia.gov/cfapps/ipdbproject/IEDIndex3.cfm?tid=90&pid=44&aid=8>

<sup>4</sup> International Energy Agency. (2010). *Energy Technology Perspective 2010*. Paris, France.

<sup>5</sup> Energy Information Administration. (2011). "China." *Country Analysis Brief*. Accessed at <http://www.eia.gov/countries/cab.cfm?fips=CH>

Energy Information Administration. (2011). "India." *Country Analysis Brief*. Accessed at <http://www.eia.gov/countries/cab.cfm?fips=IN>

<sup>6</sup> International Energy Agency. (2008). *CO<sub>2</sub> Capture and Storage*. p. 16. Paris, France. Accessed at [http://www.iea.org/textbase/nppdf/free/2008/CCS\\_2008.pdf](http://www.iea.org/textbase/nppdf/free/2008/CCS_2008.pdf)

<sup>7</sup> The gas produced from a well can have more than 20% carbon dioxide, which must be separated and removed before the hydrocarbons are transported in a pipeline.

<sup>8</sup> National Energy Technology Laboratory. (2011). *Improving Domestic Energy Security and Lowering CO<sub>2</sub> Emissions with "Next Generation" CO<sub>2</sub>-Enhanced Oil Recovery (CO<sub>2</sub>-EOR)*. (DOE/NETL-2011/1504). Morgantown, WV. Accessed at [http://www.netl.doe.gov/energy-analyses/pubs/NextGen\\_CO2\\_EOR\\_06142011.pdf](http://www.netl.doe.gov/energy-analyses/pubs/NextGen_CO2_EOR_06142011.pdf)

- <sup>9</sup> Interstate Oil and Gas Compact Commission. *A Policy, Legal, and Regulatory Evaluation of the Feasibility of a National Pipeline Infrastructure for the Transport and Storage of Carbon Dioxide*, p. 21. Oklahoma City, OK. Accessed at <http://www.iogcc.state.ok.us/Webpages/iogcc/Images/PTTF%20Final%20Report%202011.pdf>
- <sup>10</sup> National Energy Technology Laboratory. (2010). *Carbon Sequestration Atlas of the United States and Canada – Third Edition*. Morgantown, WV. Accessed at [http://www.netl.doe.gov/technologies/carbon\\_seq/refshelf/atlasIII/index.html](http://www.netl.doe.gov/technologies/carbon_seq/refshelf/atlasIII/index.html)
- <sup>11</sup> “Nth plant” costs assume that several plants using the same technology have already been built and are operating. In other words, the assumption reflects a future in which a successful industry has been established with many operating plants.
- <sup>12</sup> Drawn from p. 5 of the following report. Comparing Case 1 (76.3 mills/kWh) to the capture Case 2 (105.6 mills/kWh), the additional 29.3 mills/kWh cost increase in the capture scenario includes 5.2 mills/kWh for transmission, storage, and monitoring of carbon dioxide, with the remaining 82% of the cost increase attributed to capture and compression.
- National Energy Technology Laboratory. (2010). *Cost and Performance Baseline for Fossil Energy Plants Volume 1: Bituminous Coal and Natural Gas to Electricity*. (DOE/NETL-2010/1397). Morgantown, WV. Accessed at [http://www.netl.doe.gov/energy-analyses/pubs/BitBase\\_FinRep\\_Rev2.pdf](http://www.netl.doe.gov/energy-analyses/pubs/BitBase_FinRep_Rev2.pdf)
- <sup>13</sup> An ‘integrated’ carbon capture and storage (CCS) project links together the whole CCS chain of capture, transport, and storage of carbon dioxide (CO<sub>2</sub>) with a scale of 1 million metric tonnes per annum or greater of CO<sub>2</sub> captured and stored.
- <sup>14</sup> Interagency Task Force on Carbon Capture and Storage. (2010). *Report of the Interagency Task Force on Carbon Capture and Storage*. Washington, DC. Accessed at <http://www.fe.doe.gov/programs/sequestration/ccstf/CCSTaskForceReport2010.pdf>
- <sup>15</sup> Interagency Task Force on Carbon Capture and Storage. (2010). *Report of the Interagency Task Force on Carbon Capture and Storage*. Washington, DC. Accessed at <http://www.fe.doe.gov/programs/sequestration/ccstf/CCSTaskForceReport2010.pdf>
- <sup>16</sup> Interagency Task Force on Carbon Capture and Storage. (2010). *Report of the Interagency Task Force on Carbon Capture and Storage*. Washington, DC. Accessed at <http://www.fe.doe.gov/programs/sequestration/ccstf/CCSTaskForceReport2010.pdf>
- <sup>17</sup> Intergovernmental Panel on Climate Change. (2005). *IPCC Special Report on Carbon Dioxide Capture and Storage*. New York, NY. Accessed at <http://www.ipcc-wg3.de/publications/special-reports/.files-images/SRCCS-WholeReport.pdf>
- <sup>18</sup> Kinder Morgan. (2006). *Permian Basin Overview*. Houston, TX. Accessed at [http://www.pacificcorp.com/content/dam/pacificcorp/doc/Environment/Stakeholder\\_Groups/CORP\\_Permian\\_Basin\\_overview\\_Kinder\\_Morgan\\_10\\_25\\_06.pdf](http://www.pacificcorp.com/content/dam/pacificcorp/doc/Environment/Stakeholder_Groups/CORP_Permian_Basin_overview_Kinder_Morgan_10_25_06.pdf)
- <sup>19</sup> Dipietro, P., Melzer, S., Kuuskraa, V., and Balash, P. (June 2011). “The Role of Underground CO<sub>2</sub> Accumulations in the Emergence of CO<sub>2</sub> Enhanced Oil Recovery.” Submitted to *SPE Journal of Economics and Management*.
- <sup>20</sup> Moritis, G. (2010). “EOR/Heavy Oil Survey: CO<sub>2</sub> Miscible, Steam Dominate Enhanced Oil Recovery Processes.” *Oil and Gas Journal*. 108(14):41.
- <sup>21</sup> Dooley, J. J., Dahowski, R. T., and Davidson, C. L. (2010). *CO<sub>2</sub>-Driven Enhanced Oil Recovery as a Stepping Stone to What?* (PNNL-19557). Richland, WA: Pacific Northwest National Laboratory.
- <sup>22</sup> National Energy Technology Laboratory Baseline and Pathway Studies. Links include [http://www.netl.doe.gov/energy-analyses/baseline\\_studies.html](http://www.netl.doe.gov/energy-analyses/baseline_studies.html) and <http://www.netl.doe.gov/energy-analyses/refshelf/PubDetails.aspx?Action=View&PubId=284>
- <sup>23</sup> U.S. Department of Energy. (2011). *Strategic Plan*. p. 18. (DOE/CF-0067). Washington, DC. Accessed at [http://energy.gov/sites/prod/files/2011\\_DOE\\_Strategic\\_Plan\\_.pdf](http://energy.gov/sites/prod/files/2011_DOE_Strategic_Plan_.pdf)
- <sup>24</sup> National Energy Technology Laboratory. (2011). *DOE/NETL Advanced Carbon Dioxide Capture Program: Technology Update*. p. 5 and 86. Morgantown, WV. Accessed at <http://www.netl.doe.gov/technologies/coalpower/ewr/pubs/CO2CaptureTechUpdate051711.pdf>
- Natural Gas Combined Cycle (NGCC) fuel costs in the cited report are based on \$6.55/MMBtu. The projected cost premium for NGCC with carbon capture and storage (CCS) has been adjusted to include \$4/MMBtu gas prices

for consistency with other assessments in the Quadrennial Technology Review. This increases the cost premium for NGCC with CCS to 65% provided here from the 40% in the cited report.

- <sup>25</sup> For information on National Energy Technology Laboratory Baseline Studies, go to [http://www.netl.doe.gov/energy-analyses/baseline\\_studies.html](http://www.netl.doe.gov/energy-analyses/baseline_studies.html)
- <sup>26</sup> Interagency Task Force on Carbon Capture and Storage. (2010). *Report of the Interagency Task Force on Carbon Capture and Storage*. Appendix E. Washington, DC. Accessed at <http://www.fe.doe.gov/programs/sequestration/ccstf/CCSTaskForceReport2010.pdf>
- <sup>27</sup> National Energy Technology Laboratory. (2010). *Cost and Performance Baseline for Fossil Energy Plants Volume 1: Bituminous Coal and Natural Gas to Electricity*. Exhibit ES-2. Morgantown, WV. Accessed at [http://www.netl.doe.gov/energy-analyses/pubs/BitBase\\_FinRep\\_Rev2.pdf](http://www.netl.doe.gov/energy-analyses/pubs/BitBase_FinRep_Rev2.pdf)
- <sup>28</sup> National Academy of Sciences, National Academy of Engineering, National Research Council. (2009). *America's Energy Future: Technology and Transformation*. p. 382–383. Washington, DC: National Academies Press. Accessed at <http://www.nap.edu/catalog/12091.html>
- <sup>29</sup> Carbon Sequestration Leadership Forum. (2010). *Carbon Sequestration Leadership Forum Technology Roadmap*. Washington, DC. Accessed at [http://www.csforum.org/publications/documents/CSLF\\_Technology\\_Roadmap\\_2010.pdf](http://www.csforum.org/publications/documents/CSLF_Technology_Roadmap_2010.pdf)
- <sup>30</sup> International Energy Agency. (2010). *Technology Roadmap: Carbon Capture and Storage*. Paris, France. Accessed at [http://www.iea.org/papers/2009/CCS\\_Roadmap.pdf](http://www.iea.org/papers/2009/CCS_Roadmap.pdf)
- <sup>31</sup> Coal Utilization Research Council and Electric Power Research Institute. (2012). *The CURC-EPRI Coal Technology Roadmap*. Washington, DC. Accessed at <http://www.coal.org/roadmap/>
- <sup>32</sup> National Academy of Sciences, National Academy of Engineering, National Research Council. (2009). *America's Energy Future: Technology and Transformation*, p. 382–383. Washington, DC: National Academies Press. Accessed at <http://www.nap.edu/catalog/12091.html>
- <sup>33</sup> Massachusetts Institute of Technology. (2007). *The Future of Coal*. Cambridge, MA. Accessed at [http://web.mit.edu/coal/The\\_Future\\_of\\_Coal.pdf](http://web.mit.edu/coal/The_Future_of_Coal.pdf)
- <sup>34</sup> Interagency Task Force on Carbon Capture and Storage. (2010). *Report of the Interagency Task Force on Carbon Capture and Storage*. Washington, DC. Accessed at <http://www.fe.doe.gov/programs/sequestration/ccstf/CCSTaskForceReport2010.pdf>
- <sup>35</sup> U.S. Environmental Protection Agency. *Geologic Sequestration Guidance Documents*. Washington, DC. Accessed at <http://water.epa.gov/type/groundwater/uic/class6/gsguidedoc.cfm>
- <sup>36</sup> Interagency Task Force on Carbon Capture and Storage. (2010). *Report of the Interagency Task Force on Carbon Capture and Storage*. p. 12. Washington, DC. Accessed at <http://www.fe.doe.gov/programs/sequestration/ccstf/CCSTaskForceReport2010.pdf>
- <sup>37</sup> Pore spaces are the spaces within a rock body that are unoccupied by solid material. Pore spaces include spaces between grains, fractures, vesicles, and voids formed by dissolution.
- <sup>38</sup> Dipietro, P., Melzer, S., Kuuskraa, V., and Balash, P. (June 2011). "The Role of Underground CO<sub>2</sub> Accumulations in the Emergence of CO<sub>2</sub> Enhanced Oil Recovery." Submitted to *SPE Journal of Economics and Management*.
- <sup>39</sup> National Energy Technology Laboratory. (2010). *Carbon Dioxide Enhanced Oil Recovery*. Morgantown, WV. Accessed at [http://www.netl.doe.gov/technologies/oil-gas/publications/EP/small\\_CO2\\_eor\\_primer.pdf](http://www.netl.doe.gov/technologies/oil-gas/publications/EP/small_CO2_eor_primer.pdf)
- <sup>40</sup> National Energy Technology Laboratory. (2011). *Improving Domestic Energy Security and Lowering CO<sub>2</sub> Emissions with "Next Generation" CO<sub>2</sub>-Enhanced Oil Recovery (CO<sub>2</sub>-EOR)*. (DOE/NETL-2011/1504). p. 9. Morgantown, WV. Accessed at [http://www.netl.doe.gov/energy-analyses/pubs/NextGen\\_CO2\\_EOR\\_06142011.pdf](http://www.netl.doe.gov/energy-analyses/pubs/NextGen_CO2_EOR_06142011.pdf)
- <sup>41</sup> Energy Information Administration. (2012). *Annual Energy Outlook 2012 Early Release Overview*. Washington, DC: Department of Energy. Accessed at [http://www.eia.gov/forecasts/aeo/er/executive\\_summary.cfm](http://www.eia.gov/forecasts/aeo/er/executive_summary.cfm)
- <sup>42</sup> National Energy Technology Laboratory. (2008). *CO<sub>2</sub> Capture Ready Coal Power Plants*. (DOE/NETL-2007/1301). p. 8 and 11. Morgantown, WV. Accessed at [http://www.netl.doe.gov/technologies/carbon\\_seq/refshelf/analysis/pubs/CO2%20CaptureReadyCoalPowerPlants%20Final.pdf](http://www.netl.doe.gov/technologies/carbon_seq/refshelf/analysis/pubs/CO2%20CaptureReadyCoalPowerPlants%20Final.pdf)
- <sup>43</sup> Cost estimates for constructing new carbon dioxide (CO<sub>2</sub>) pipelines and for transporting CO<sub>2</sub> through these pipelines depend on a variety of factors, including the distance between the capture and storage points, the terrain the pipeline has to pass through, the anticipated flow rate of CO<sub>2</sub>, and the population and

infrastructure development density. In certain circumstances, it may be more economical to transport CO<sub>2</sub> a longer distance to a lower-cost, high-quality storage formation than to transport it over a short distance to a more expensive storage operation in a lower-quality storage field. Local costs for labor and materials will also affect overall CO<sub>2</sub> transportation costs. Recent studies have shown that CO<sub>2</sub> pipeline transport costs for a 100-kilometer (62 mile) pipeline transporting 5 million tonnes per year range from approximately \$1–\$3/tonne, depending on the factors discussed above.

- McCollum, D. L., and Ogden, J. M. (2006). "Techno-Economic Models for Carbon Dioxide Compression, Transport, and Storage & Correlations for Estimating Carbon Dioxide Density and Viscosity." Institute of Transportation Studies. University of California, Davis. (Research Report UCD-ITS-RR-06-14). Accessed at [http://pubs.its.ucdavis.edu/publication\\_detail.php?id=1047](http://pubs.its.ucdavis.edu/publication_detail.php?id=1047)
- McCoy, S. T., and Rubin, E. S. (2008). Variability and Uncertainty in the Cost of Saline Formation Storage. *Proceedings of the 9th International Conference on Greenhouse Gas Control Technologies*. Accessed at <http://www.cmu.edu/epp/iecm/rubin/PDF%20files/2009/2009b%20McCoy%20GHGT-9.pdf>
- <sup>44</sup> National Energy Technology Laboratory. "Solid State Energy Conversion Alliance." Accessed at <http://www.netl.doe.gov/technologies/coalpower/fuelcells/seca/>
- <sup>45</sup> U.S. Department of Energy. (2011). *DOE/NETL Advanced Carbon Dioxide Capture R&D Program: Technology Update*. Washington, DC. Accessed at <http://www.netl.doe.gov/technologies/coalpower/ewr/pubs/CO2CaptureTechUpdate051711.pdf>
- <sup>46</sup> Carbon dioxide storage quantities are metered at the injection wells using purchase pumps or volume meters. Carbon dioxide storage locations are monitored and verified using surface and subsurface monitoring, verification, and accounting technologies, as well as various modeling programs.
- <sup>47</sup> National Energy Technology Laboratory. (2010). *Carbon Sequestration Atlas of the United States and Canada*. Morgantown, WV. Accessed at [http://www.netl.doe.gov/technologies/carbon\\_seq/refshelf/atlas/](http://www.netl.doe.gov/technologies/carbon_seq/refshelf/atlas/)
- <sup>48</sup> Concentrating solar power may also be called concentrating solar thermal power or solar thermal electric power.
- <sup>49</sup> Renewable Energy Policy Network for the 21st Century. (2011). *Renewables 2011 Global Status Report*. Paris, France. Accessed at [http://www.ren21.net/Portals/97/documents/GSR/REN21\\_GSR2011.pdf](http://www.ren21.net/Portals/97/documents/GSR/REN21_GSR2011.pdf)
- <sup>50</sup> U.S. Department of Energy. (2012). *SunShot Vision Study*. (DOE/GO-102012-3037). Washington, DC. Accessed at [http://www1.eere.energy.gov/solar/sunshot/vision\\_study.html](http://www1.eere.energy.gov/solar/sunshot/vision_study.html)
- Estimates are based on locations in the Southwest with characteristics ideal for concentrating solar power systems, including direct normal irradiance greater than 6.0 kWh/m<sup>2</sup>/day (2,200 kWh/m<sup>2</sup>/year) and land slope of less than 1°, excluding bodies of water, urban areas, national parks and preserves, wilderness areas, and wildlife refuges. Because the economics of utility-scale solar facilities favor large size, land areas smaller than 1 square kilometer (km<sup>2</sup>) are also excluded.
- <sup>51</sup> Emerging Energy Research. (2010). "Global Concentrated Solar Power Markets and Strategies: 2009-2020." Cambridge, MA.
- <sup>52</sup> Emerging Energy Research. (2010). "Global Concentrated Solar Power Markets and Strategies: 2009-2020." Cambridge, MA.
- <sup>53</sup> Emerging Energy Research. (2010). "Global Concentrated Solar Power Markets and Strategies: 2009-2020." Cambridge, MA.
- <sup>54</sup> Solar Energy Industries Association. (2010). "U.S. Solar Market Insight, 2<sup>nd</sup> Quarter 2010." Washington, DC. Accessed at [http://seia.org/galleries/pdf/SEIA\\_Q2\\_2010\\_EXEC\\_SUMMARY.pdf](http://seia.org/galleries/pdf/SEIA_Q2_2010_EXEC_SUMMARY.pdf)
- <sup>55</sup> These values are representative of those collected from a variety of sources. For example:
- Sargent & Lundy LLC. (2003). "Assessment of Parabolic Trough and Power Tower Solar Technology Cost and Performance Forecasts." (NREL/SR-550-34440). Golden, CO: National Renewable Energy Laboratory.
- Kolb, G. (2011). "An Evaluation of Possible Next-Generation High-Temperature Molten-Salt Power Towers (Draft Report)."
- Turchi, C. (2010). "Parabolic Trough Reference Plant for Cost Modeling with the Solar Advisor Model (SAM)." (NREL/TP-550-47605). Golden, CO: National Renewable Energy Laboratory.
- Turchi, C., Wagner, M., and Kutscher, C. (2010). "Water Use in Parabolic Trough Power Plants: Summary Results from WorleyParsons' Analyses." (NREL/TP-5500-49468). Golden, CO: National Renewable Energy Laboratory.

- Andraka, C. E. (2008). "Cost/Performance Tradeoffs for Reflectors used in Solar Concentrating Dish Systems." Energy Sustainability. (ES2008-54048). Jacksonville, FL.
- <sup>56</sup> Design point efficiency is the solar-to-electric efficiency at solar noon on the summer solstice (best conditions).
- <sup>57</sup> Annual average efficiency is the average solar-to-electric efficiency throughout the year.
- <sup>58</sup> Capacity factor is the total energy delivered over the course of a year divided by the energy that would be delivered by the rated system capacity over the course of a year.
- <sup>59</sup> U.S. Department of Energy. (1997). "Solar Trough Power Plants." Washington, DC. Accessed at <http://www.osti.gov/accomplishments/documents/fullText/ACC0196.pdf>
- National Renewable Energy Laboratory. *Solar Power and Chemical Energy Systems*. Boulder, CO. Accessed at <http://www.nrel.gov/csp/solarpaces/>
- <sup>60</sup> The number increases with thermal energy storage because solar collector area increases, but power block capacity does not.
- <sup>61</sup> Therminol. "Therminol VP-1 Vapor Phase/Liquid Phase Heat Transfer Fluid." Accessed at <http://www.therminol.com/pages/products/vp-1.asp>
- National Renewable Energy Laboratory. *Solar Power and Chemical Energy Systems*. Boulder, CO. Accessed at <http://www.nrel.gov/csp/solarpaces/>
- <sup>62</sup> The design-point values represent an ideal case that is useful for comparing between different components, such as two different receiver designs. This metric is also used for evaluating photovoltaic panels. The annual average efficiency provides a better assessment of actual operation.
- <sup>63</sup> See the AREVA Solar Kimberlina, Kogan Creek, and Sundt projects. AREVA Solar. (2012). "AREVA Solar: Projects." Accessed May 2012 at <http://www.aveva.com/EN/solar-209/aveva-solar-projects.html>
- <sup>64</sup> National Renewable Energy Laboratory. *Solar Power and Chemical Energy Systems*. Boulder, CO. Accessed at <http://www.nrel.gov/csp/solarpaces/>
- <sup>65</sup> Andraka, C. E., and Powell, M. P. (2008). "Dish Stirling Development for Utility-Scale Commercialization." *14th Biennial CSP SolarPACES Symposium*. Las Vegas, NV.
- <sup>66</sup> European Solar Thermal Electricity Association. (2012). "Andasol-1 and Andasol-2: Dispatchable Thermosolar Power Plants." Accessed May 2012 at <http://www.estelasolar.eu/index.php?id=32>
- <sup>67</sup> National Renewable Energy Laboratory. *Solar Power and Chemical Energy Systems*. Boulder, CO. Accessed at <http://www.nrel.gov/csp/solarpaces/>
- <sup>68</sup> U.S. Department of Energy. (2012). "Concentrating Solar Power: Technologies, Cost, and Performance." *SunShot Vision Study*. Washington, DC. Accessed at [http://www1.eere.energy.gov/solar/pdfs/47927\\_chapter5.pdf](http://www1.eere.energy.gov/solar/pdfs/47927_chapter5.pdf)
- <sup>69</sup> U.S. Department of Energy. (2012). "Concentrating Solar Power: Technologies, Cost, and Performance." *SunShot Vision Study*. Washington, DC. Accessed at [http://www1.eere.energy.gov/solar/pdfs/47927\\_chapter5.pdf](http://www1.eere.energy.gov/solar/pdfs/47927_chapter5.pdf)
- <sup>70</sup> The 30% investment tax credit can reduce the levelized cost of electricity to the €0.12–€0.18/kWh range.
- <sup>71</sup> Cohen, G. E. (2008). "Solar Steam at Nevada Solar One." *SolarPaces 2008*. Las Vegas, NV. Accessed at <http://solarpaces2008.sandia.gov/SolarPACES%20PLENARIES/2%20WEDNESDAY%20INDUSTRY%20DAY%20SESSIONS/1%20PLEN%20CSP%20PLANTS%20TODAY/01%20Acciona%20Cohen%20SOLARPACES%202008.pdf>
- <sup>72</sup> Sargent & Lundy. (2003). *Assessment of Parabolic Trough and Power Tower Solar Technology Cost and Performance Forecasts*. (NREL/SR-550-34440). National Renewable Energy Laboratory. Chicago, IL. Accessed at <http://www.nrel.gov/docs/fy04osti/34440.pdf>
- <sup>73</sup> U.S. Department of Energy. (2012). "Concentrating Solar Power: Technologies, Cost, and Performance." *SunShot Vision Study*. Washington, DC. Accessed at [http://www1.eere.energy.gov/solar/pdfs/47927\\_chapter5.pdf](http://www1.eere.energy.gov/solar/pdfs/47927_chapter5.pdf)
- <sup>74</sup> U.S. Department of Energy. (2012). "Concentrating Solar Power: Technologies, Cost, and Performance." *SunShot Vision Study*. Washington, DC. Accessed at [http://www1.eere.energy.gov/solar/pdfs/47927\\_chapter5.pdf](http://www1.eere.energy.gov/solar/pdfs/47927_chapter5.pdf)
- <sup>75</sup> U.S. Department of Energy. (2012). "Concentrating Solar Power: Technologies, Cost, and Performance." *SunShot Vision Study*. Washington, DC. Accessed at [http://www1.eere.energy.gov/solar/pdfs/47927\\_chapter5.pdf](http://www1.eere.energy.gov/solar/pdfs/47927_chapter5.pdf)
- <sup>76</sup> Turchi, C. S. (2011). "Power Tower Reference Plant for Cost Modeling with the System Advisor Model." (NREL/TP-5500-47461). Golden, CO: National Renewable Energy Laboratory.
- <sup>77</sup> Kolb, G. J., et al. (2011). *Power Tower Technology Roadmap and Cost Reduction Plan*. (SAND2011-2419). Albuquerque, NM: Sandia National Laboratories. Accessed at <http://prod.sandia.gov/techlib/access-control.cgi/2011/112419.pdf>



- 
- National Renewable Energy Laboratory. (2003). *Assessment of Parabolic Trough and Power Tower Solar Technology Cost and Performance Forecasts*. (NREL/SR-550-34440). Boulder, CO. Accessed at <http://www.nrel.gov/csp/pdfs/34440.pdf>
- National Renewable Energy Laboratory. *Parabolic Trough FAQs*. Boulder, CO. Accessed at <http://www.nrel.gov/csp/troughnet/faqs.html>
- <sup>78</sup> Solar Energy Industries Association. (2011). *Utility-Scale Solar Projects in the United States Operating, Under Construction, or Under Development*. Washington, DC. Accessed at <http://www.seia.org/galleries/pdf/Major%20Solar%20Projects.pdf>
- National Renewable Energy Laboratory. *Solar Power and Chemical Energy Systems*. Boulder, CO. Accessed at <http://www.nrel.gov/csp/solarpaces/>
- Kolb, G. J., et al. (2011). *Power Tower Technology Roadmap and Cost Reduction Plan*. (SAND2011-2419). Albuquerque, NM: Sandia National Laboratories. Accessed at <http://prod.sandia.gov/techlib/access-control.cgi/2011/112419.pdf>
- Kutscher, C., et al. (2010). *Line-Focus Solar Plant Cost Reduction Plan*. Golden, CO: National Renewable Energy Laboratory. Accessed at <http://www.nrel.gov/docs/fy11osti/48175.pdf>
- <sup>79</sup> National Renewable Energy Laboratory. (2011). *Parabolic Trough FAQs*. Golden, CO. Accessed at <http://www.nrel.gov/csp/troughnet/faqs.html>
- <sup>80</sup> National Renewable Energy Laboratory. (2010). *Western Wind and Solar Integration Study*. Boulder, CO. Accessed at <http://www.nrel.gov/wind/systemsintegration/wwsis.html>
- <sup>81</sup> Based on currently deployed technologies for fuel cells, boilers, and central power stations. The assumed fuel cell efficiency is based on current molten carbonate fuel cell offerings from the FuelCell Energy website (<http://www.fuelcellenergy.com/dfc300ma.php>), and the assumed efficiencies of boilers and central power stations are from the Energy Information Administration's estimate of the current national average efficiencies.
- <sup>82</sup> Solid oxide fuel cells can achieve this efficiency. Molten carbonate fuel cells can achieve this efficiency only in hybrid cycles that capture waste heat to produce steam to drive a turbine to produce electricity.
- <sup>83</sup> Blanchard, J. (2007). *Site Reliability: Fuel Cells Add Reliability to TeleCom Sites*. IEEE 2007 Interlec Proceedings. Rome, Italy. Accessed at [www.relion-inc.com/pdf/ReliOn\\_Intelec07\\_final.pdf](http://www.relion-inc.com/pdf/ReliOn_Intelec07_final.pdf)
- <sup>84</sup> Pike Research. (2011). *Stationary Fuel Cells: Fuel Cells for UPS, Residential, and Large Stationary Applications: Market Analysis and Forecasts*. Boulder, CO. Accessed at <http://www.giiresearch.com/report/pike195796-stationary-fuel-cells-fuel-cells-ups-residential.html>
- <sup>85</sup> Farooque, M. (2009). *DFC Opportunities*. Presentation at the MCFC and PAFC R&D Workshop. Palm Springs, CA. Accessed at [http://www1.eere.energy.gov/hydrogenandfuelcells/pdfs/mcfc\\_pafc\\_workshop\\_farooque.pdf](http://www1.eere.energy.gov/hydrogenandfuelcells/pdfs/mcfc_pafc_workshop_farooque.pdf)
- <sup>86</sup> Spendelow, J., et al. (2011). *Medium-Scale CHP Fuel Cell System Targets*. (Program Record #11014). Washington, DC: Department of Energy. Accessed at [http://www.hydrogen.energy.gov/pdfs/11014\\_medium\\_scale\\_chp\\_target.pdf](http://www.hydrogen.energy.gov/pdfs/11014_medium_scale_chp_target.pdf)
- Remick, R. J., Wheeler, D., and Singh, P. (2010). *MCFC and PAFC R&D Workshop Report*. Washington, DC: Department of Energy. Accessed at [http://www1.eere.energy.gov/hydrogenandfuelcells/pdfs/mcfc\\_pafc\\_workshop\\_summary.pdf](http://www1.eere.energy.gov/hydrogenandfuelcells/pdfs/mcfc_pafc_workshop_summary.pdf)
- <sup>87</sup> Klara, J. National Renewable Energy Laboratory. 32nd International Technical Conference on Coal Utilization & Fuel Systems. June 13, 2007. Clearwater, FL. <http://www.netl.doe.gov/KMD/cds/disk50/Clearwater%20Conference%20Final%20v2.pdf>
- <sup>88</sup> U.S. Environmental Protection Agency. (2008). *Catalog of CHP Technologies*. Washington, DC. Accessed at [http://www.epa.gov/chp/documents/catalog\\_chptech\\_full.pdf](http://www.epa.gov/chp/documents/catalog_chptech_full.pdf)
- <sup>89</sup> U.S. Department of Energy. (2010). "Case Study: Fuel Cells Provide Combined Heat and Power at Verizon's Garden City Central Office." Washington, DC. Accessed at [http://www1.eere.energy.gov/hydrogenandfuelcells/pdfs/fccs\\_verizon10.pdf](http://www1.eere.energy.gov/hydrogenandfuelcells/pdfs/fccs_verizon10.pdf)
- <sup>90</sup> Spendelow, J., et al. (2011). *Medium-Scale CHP Fuel Cell System Targets*. (Program Record #11014). Washington, DC: Department of Energy. Accessed at [http://www.hydrogen.energy.gov/pdfs/11014\\_medium\\_scale\\_chp\\_target.pdf](http://www.hydrogen.energy.gov/pdfs/11014_medium_scale_chp_target.pdf)

- Remick, R. J., Wheeler, D., and Singh, P. (2010). *MCFC and PAFC R&D Workshop Report*. Washington, DC: Department of Energy. Accessed at [http://www1.eere.energy.gov/hydrogenandfuelcells/pdfs/mcfc\\_pafc\\_workshop\\_summary.pdf](http://www1.eere.energy.gov/hydrogenandfuelcells/pdfs/mcfc_pafc_workshop_summary.pdf)
- <sup>91</sup> U.S. Department of Energy. (2007). *Fuel Cell Technologies Program Multi-Year Research, Development and Demonstration Plan*. p. 3.4–14. Accessed at <http://www1.eere.energy.gov/hydrogenandfuelcells/mypp/index.html>
- <sup>92</sup> National Renewable Energy Laboratory. (2010). *1–10 kW Stationary Combined Heat and Power Systems Status and Technical Potential*. (NREL/BK-6A10-48265). p. 7. Golden, CO. Accessed at <http://www1.eere.energy.gov/hydrogenandfuelcells/pdfs/48265.pdf>
- <sup>93</sup> SBI Energy. (2010). *Fuel Cell Technologies Worldwide*. Rockville, MD.
- <sup>94</sup> Information provided by Pike Research in early 2011.
- <sup>95</sup> U.S. Department of Energy. (2011). *2010 Fuel Cell Technologies Market Report*. Washington, DC. Accessed at [http://www1.eere.energy.gov/hydrogenandfuelcells/pdfs/2010\\_market\\_report.pdf](http://www1.eere.energy.gov/hydrogenandfuelcells/pdfs/2010_market_report.pdf)
- <sup>96</sup> Farooque, M. (2009). *DFC Opportunities*. Presentation at the MCFC and PAFC R&D Workshop. Palm Springs, CA. Accessed at [http://www1.eere.energy.gov/hydrogenandfuelcells/pdfs/mcfc\\_pafc\\_workshop\\_farooque.pdf](http://www1.eere.energy.gov/hydrogenandfuelcells/pdfs/mcfc_pafc_workshop_farooque.pdf)
- <sup>97</sup> Technology Transition Corporation. (2010). *Hydrogen and Fuel Cells: The U.S. Market Report, 2010*. p. xiii. Washington, DC. Accessed at [http://www.fchea.org/core/import/PDFs/Technical%20Resources/H2\\_and\\_FCs-The\\_US\\_Market\\_Report\\_by\\_the\\_NHA\\_2010.pdf](http://www.fchea.org/core/import/PDFs/Technical%20Resources/H2_and_FCs-The_US_Market_Report_by_the_NHA_2010.pdf)
- <sup>98</sup> Remick, R., and Wheeler, D. (2010). *Molten Carbonate and Phosphoric Acid Stationary Fuel Cells: Overview and Gap Analysis*. (NREL/TP-560-49072). Golden, CO: National Renewable Energy Laboratory and DJW Technology, LLC. Accessed at <http://www.nrel.gov/docs/fy10osti/49072.pdf>.
- <sup>99</sup> Spendelow, J., et al. (2011). *Medium-Scale CHP Fuel Cell System Targets*. (Program Record #11014). Washington, DC: Department of Energy. Accessed at [http://www.hydrogen.energy.gov/pdfs/11014\\_medium\\_scale\\_chp\\_target.pdf](http://www.hydrogen.energy.gov/pdfs/11014_medium_scale_chp_target.pdf)
- <sup>100</sup> Jenkins, J. (2010). “Doing the Math on Bloom Energy.” *Forbes*. February 25, 2010. Accessed at <http://www.forbes.com/2010/02/25/fuel-cell-costs-technology-ecotech-bloom-energy.html>
- <sup>101</sup> Maru, H., Singhal, S., Stone, C., and Wheeler, D. (2010). *1-10 kW Stationary Combined Heat and Power Systems Status and Technical Potential*. (NREL/BK-6A10-48265). Golden, CO: National Renewable Energy Laboratory. Accessed at <http://www1.eere.energy.gov/hydrogenandfuelcells/pdfs/48265.pdf>
- <sup>102</sup> Current platinum loading is more than 4 g per kW for phosphoric acid fuel cells, compared with approximately 1 g per kW for stationary polymer electrolyte membrane fuel cells. Platinum supply is unlikely to become a bottleneck.
- <sup>103</sup> Brookhaven Lab’s Fuel Cell Catalyst Increases Durability: <http://ae-plus.com/technology/brookhaven-labs-fuel-cell-catalyst-increases-durability>
- U.S. Department of Energy. (2007). *Multi-Year Program Plan, Hydrogen, Fuel Cells and Infrastructure Technologies*. Washington, DC. Accessed at [http://www1.eere.energy.gov/hydrogenandfuelcells/mypp/pdfs/fuel\\_cells.pdf](http://www1.eere.energy.gov/hydrogenandfuelcells/mypp/pdfs/fuel_cells.pdf)
- Greene, D. L., Duleep, K. G., and Upreti, G. (2011). *Status and Outlook for the U.S. Non-Automotive Fuel Cell Industry: Impacts of Government Policies and Assessment of Future Opportunities*. (ORNL/TM-2011/101). Oak Ridge, TN: Oak Ridge National Laboratory. Accessed at [http://cta.ornl.gov/cta/Publications/Reports/ORNL\\_TM2011\\_101\\_FINAL.pdf](http://cta.ornl.gov/cta/Publications/Reports/ORNL_TM2011_101_FINAL.pdf)
- <sup>104</sup> Farooque, M. (2009). *DFC Opportunities*. Presentation at the MCFC PAFC Workshop. Palm Springs, California. Accessed at [http://www1.eere.energy.gov/hydrogenandfuelcells/pdfs/mcfc\\_pafc\\_workshop\\_farooque.pdf](http://www1.eere.energy.gov/hydrogenandfuelcells/pdfs/mcfc_pafc_workshop_farooque.pdf)
- Greene, D. L., Duleep, K. G., and Upreti, G. (2011). *Status and Outlook for the U.S. Non-Automotive Fuel Cell Industry: Impacts of Government Policies and Assessment of Future Opportunities*. (ORNL/TM-2011/101). Oak Ridge, TN: Oak Ridge National Laboratory. Accessed at [http://cta.ornl.gov/cta/Publications/Reports/ORNL\\_TM2011\\_101\\_FINAL.pdf](http://cta.ornl.gov/cta/Publications/Reports/ORNL_TM2011_101_FINAL.pdf)
- In addition, DOE uses models to analyze the sensitivity of costs to durability and other parameter; for example, the fuel cell combined heat and power cost model at DOE Office of Energy Efficiency and Renewable Energy headquarters. The model is based on a levelized cost-of-generation model developed for the California Energy Commission: [http://www.energy.ca.gov/reti/documents/2011-04-18\\_Documentation\\_for\\_COG\\_Model.pdf](http://www.energy.ca.gov/reti/documents/2011-04-18_Documentation_for_COG_Model.pdf)

Prices of natural gas and electricity used in the modeling activity are from the Energy Information Administration's *Annual Energy Outlook 2011*.

The assumed discount rate used in the modeling activity is based on:

Short, W., Packey, D. J., and Holt, T. (1995). *A Manual for the Economic Evaluation of Energy Efficiency and Renewable Energy Technologies*. Golden, CO: National Renewable Energy Laboratory. Accessed at <http://www.nrel.gov/docs/legosti/old/5173.pdf>

<sup>105</sup> Remick, R., and Wheeler, D. (2010). *Molten Carbonate and Phosphoric Acid Stationary Fuel Cells: Overview and Gap Analysis*. (NREL/TP-560-49072). Golden, CO: National Renewable Energy Laboratory and DJW Technology, LLC. Accessed at <http://www.nrel.gov/docs/fy10osti/49072.pdf>.

Greene, D. L., Duleep, K. G., and Upreti, G. (2011). *Status and Outlook for the U.S. Non-Automotive Fuel Cell Industry: Impacts of Government Policies and Assessment of Future Opportunities*. (ORNL/TM-2011/101). Oak Ridge, TN: Oak Ridge National Laboratory. Accessed at [http://cta.ornl.gov/cta/Publications/Reports/ORNL\\_TM2011\\_101\\_FINAL.pdf](http://cta.ornl.gov/cta/Publications/Reports/ORNL_TM2011_101_FINAL.pdf)

<sup>106</sup> Aldefer, R. B., Elridge, M., and Starrs, T. (2000). *Making Connections. Case Studies of Interconnection Barriers and Their Impact on Distributed Generation Projects*. (NREL/SR-200-28053). Golden, CO: National Renewable Energy Laboratory. Accessed at <http://www.nrel.gov/docs/fy00osti/28053.pdf>

Shirley, W. (2006). "Overview of Distributed Generation Interconnection Issues." Washington, DC: Environmental Protection Agency. Accessed at [http://www.epa.gov/statelocalclimate/documents/pdf/2\\_9\\_06\\_Overview\\_DG\\_Interconnection\\_Shirley.pdf](http://www.epa.gov/statelocalclimate/documents/pdf/2_9_06_Overview_DG_Interconnection_Shirley.pdf)

Brooks, S., Elswick, B., and Elliott, R. N. (2006). *Combined Heat and Power: Connecting the Gaps Between Markets and Utility Interconnection and Tariff Practices (Part 1)*. Report No. 1E062. Washington, DC: American Council for an Energy-Efficient Economy. Accessed at <http://www.aceee.org/sites/default/files/publications/researchreports/ie062.pdf>

<sup>107</sup> Morgan, J. (2010). "Reduction in Fabrication Costs of Gas Diffusion Layers." Presentation at the Hydrogen and Fuel Cells Program Annual Merit Review and Peer Evaluation. Arlington, VA. Accessed at [http://www.hydrogen.energy.gov/pdfs/review11/mn002\\_morgan\\_2011\\_o.pdf](http://www.hydrogen.energy.gov/pdfs/review11/mn002_morgan_2011_o.pdf)

<sup>108</sup> Busby, C. F. (2011). "Manufacturing of Low-Cost, Durable Membrane Electrode Assemblies Engineered for Rapid Conditioning." Presentation at the Hydrogen and Fuel Cells Program Annual Merit Review and Peer Evaluation. Arlington, VA. Accessed at [http://www.hydrogen.energy.gov/pdfs/review11/mn004\\_busby\\_2011\\_o.pdf](http://www.hydrogen.energy.gov/pdfs/review11/mn004_busby_2011_o.pdf)

<sup>109</sup> Bessette, N. (2011). "Development of a Low Cost 3-10 kW Tubular SOFC Power System." Presentation at the Hydrogen and Fuel Cells Program Annual Merit Review and Peer Evaluation. Arlington, VA. Accessed at [http://www.hydrogen.energy.gov/pdfs/review11/fc032\\_bessette\\_2011\\_o.pdf](http://www.hydrogen.energy.gov/pdfs/review11/fc032_bessette_2011_o.pdf)

<sup>110</sup> Gross, T. J., Poche, A. J., Jr., and Ennis, K. C. (2011). "Beyond Demonstration: The Role of Fuel Cells in DoD's Energy Strategy." Washington, DC: LMI. Accessed at [http://www.ballard.com/files/PDF/Media/DoD-Fuel-Cell\\_10-19-11.pdf](http://www.ballard.com/files/PDF/Media/DoD-Fuel-Cell_10-19-11.pdf)

U.S. Department of Energy and U.S. Department of Defense. (2010). "Concerning Cooperation in a Strategic Partnership to Enhance Energy Security." Memorandum of Understanding. Washington, DC. Accessed at <http://energy.gov/sites/prod/files/edg/media/Enhance-Energy-Security-MOU.pdf>

U.S. Postal Service. (2011). *U.S. Postal Service Fleet Alternative Vehicle Program Report for Fiscal Year 2010*. Washington, DC. Accessed at <http://about.usps.com/what-we-are-doing/green/news/afv-program-2010-report.htm>

U.S. Department of Energy. (2011). *Market Transformation*. Washington, DC. Accessed at [http://www1.eere.energy.gov/hydrogenandfuelcells/pdfs/market\\_transformation.pdf](http://www1.eere.energy.gov/hydrogenandfuelcells/pdfs/market_transformation.pdf)

<sup>111</sup> Simon, M., Tyler, R., and Dillich, S. (2011). "Recovery Act Projects to Enable Fuel Cell Market Transformation." Presentation at the Fuel Cell Seminar. Orlando, FL.

<sup>112</sup> Energy Information Administration. (2008). *Existing Electric Generating Units by Energy Source*. Washington, DC. Accessed at <http://www.eia.gov/cneaf/electricity/page/capacity/existingunitsbs2008.xls>

<sup>113</sup> Energy Information Administration. (2010). "Table 8.2a – Electricity Net Generation: Total (All Sectors), 1949-2009." *Annual Energy Review 2009*. Accessed at <http://205.254.135.24/emeu/aer/txt/stb0802a.xls>

<sup>114</sup> The National Academies. (2009) *America's Energy Future – Electricity From Renewable Resources*. Washington, DC: The National Academies Press.



- <sup>115</sup> Williams, C. F., Reed, M. J., Mariner, R. H., DeAngelo, J., and Galanis, S. P. J. (2008). *Assessment of Moderate- and High-Temperature Geothermal Resources of the United States*. U.S. Geological Survey Fact Sheet (2008-3082). Washington, DC: Department of Interior. Accessed at <http://pubs.usgs.gov/fs/2008/3082>
- This assessment considered 11 states in the western United States and depths between 3 km and 6 km.
- <sup>116</sup> Augustine, C., et al. (2010). *Updated U.S. Geothermal Supply Curve*. (NREL/CP-6A2-47458). Golden, CO: National Renewable Energy Laboratory. Accessed at <http://www.nrel.gov/docs/fy10osti/47458.pdf>
- Most of the roughly 16,000-GWe deep enhanced geothermal system resource reported here is attributed to heat stored at depths greater than 6 km.
- <sup>117</sup> L'Ecuyer, C., et al. (1993). *Space Conditioning: The Next Frontier*. (EPA 430-R-93-004). Washington, DC: Environmental Protection Agency.
- <sup>118</sup> Lund, J. W., et al. (2010). *Direct Utilization of Geothermal Energy 2010 Worldwide Review*. [Proceedings World Geothermal Congress 2010]. Bali, Indonesia.
- <sup>119</sup> Doris, E., Kreycik, C., and Young, K. (2009). *Policy Overview and Options for Maximizing the Role of Policy in Geothermal Electricity Development*. (TP-6A2-46653). Golden, CO: National Renewable Energy Laboratory. Accessed at [http://www1.eere.energy.gov/geothermal/pdfs/policy\\_overview.pdf](http://www1.eere.energy.gov/geothermal/pdfs/policy_overview.pdf)
- <sup>120</sup> U.S. Department of Energy. (2011). *Innovative Exploration Technologies Technology Needs Assessment*. Washington, DC: Energetics, Inc. Accessed at [http://www1.eere.energy.gov/geothermal/pdfs/iet\\_needs\\_assessment\\_06-2011.pdf](http://www1.eere.energy.gov/geothermal/pdfs/iet_needs_assessment_06-2011.pdf)
- <sup>121</sup> Young, K. R., Augustine, C., and Anderson, A. (2010). *Report on the U.S. DOE Geothermal Technologies Program's 2009 Risk Assessment*. (NREL/CP-6A2-47388). Golden, CO: National Renewable Energy Laboratory. Accessed at <http://www.nrel.gov/docs/fy10osti/47388.pdf>
- <sup>122</sup> Jennejohn, D. (2011). *Annual Geothermal Power Production and Development Report*. Washington, DC: Geothermal Energy Association.
- <sup>123</sup> Lund, J., Gawell, K., Boyd, T., and Jennejohn, D. (2010). *The United States of America Country Update 2010*. Proceedings of the Thirty-Fifth Workshop on Geothermal Reservoir Engineering. Accessed at <http://ere.stanford.edu/pdf/IGAstandard/SGW/2010/lund.pdf>
- <sup>124</sup> Energy Information Administration (2009). *Geothermal Heat Pump Manufacturing Activities*. Washington, DC. Accessed at <http://www.eia.gov/cneaf/solar/renewables/page/ghpsurvey/ghpssurvey.html>
- <sup>125</sup> Massachusetts Institute of Technology. (2006). *The Future of Geothermal Energy*. Cambridge, MA. Accessed at [http://geothermal.inel.gov/publications/future\\_of\\_geothermal\\_energy.pdf](http://geothermal.inel.gov/publications/future_of_geothermal_energy.pdf)
- <sup>126</sup> For more information on innovative exploration technologies, see:  
U.S. Department of Energy. (2011). *Innovative Exploration Technologies Technology Needs Assessment*. Washington, DC: Energetics, Inc. Accessed at [http://www1.eere.energy.gov/geothermal/pdfs/iet\\_needs\\_assessment\\_06-2011.pdf](http://www1.eere.energy.gov/geothermal/pdfs/iet_needs_assessment_06-2011.pdf)
- Young, K., Reber, T., and Witherbee, K. "Hydrothermal Exploration Best Practices and Geothermal Knowledge Exchange on OPENEI." Proceedings of the Thirty-Seventh Workshop on Geothermal Reservoir Engineering. Stanford University. Stanford, CA. January 30, 2012–February 1, 2012. Accessed at <http://pangea.stanford.edu/ERE/pdf/IGAstandard/SGW/2012/Young.pdf>
- U.S. Department of Energy. (2012). "Geothermal Technologies Program Projects Database." Washington, DC. Accessed February 2012 at <http://www4.eere.energy.gov/geothermal/projects>
- <sup>127</sup> Majer, E. L. (2010). *Final Report and Recommendations, Workshop on Induced Seismicity Due to Fluid Injection/production from Energy Related Applications*. Berkeley, CA: Lawrence Berkeley National Laboratory. Accessed at <http://www.escholarship.org/uc/item/6rk229pv>
- <sup>128</sup> Massachusetts Institute of Technology. (2006). *The Future of Geothermal Energy*. Cambridge, MA. Accessed at [http://geothermal.inel.gov/publications/future\\_of\\_geothermal\\_energy.pdf](http://geothermal.inel.gov/publications/future_of_geothermal_energy.pdf)
- <sup>129</sup> U.S. Department of Energy. (2010). *Exploration 1976-2006: A History of Geothermal Energy Research and Development in the United States*. Washington, DC. Accessed at [http://www1.eere.energy.gov/geothermal/pdfs/geothermal\\_history\\_1\\_exploration.pdf](http://www1.eere.energy.gov/geothermal/pdfs/geothermal_history_1_exploration.pdf)
- <sup>130</sup> U.S. Department of Energy. (2011). *Geothermal Technology Program Blue Ribbon Panel Report*. Washington, DC. Accessed at <http://www1.eere.energy.gov/geothermal/brp.html>

- <sup>131</sup> Energy Information Administration. (2011). *International Energy Statistics*. Washington, DC. Accessed June 2011 at <http://www.eia.gov/countries/data.cfm>
- <sup>132</sup> Energy Information Administration. (2011). "Total Electricity Installed Capacity." *International Energy Statistics*. Washington, DC. Accessed November 2011 at <http://www.eia.gov/cfapps/ipdbproject/IEDIndex3.cfm?tid=2&pid=2&aid=7>
- <sup>133</sup> International Atomic Energy Agency. (2011). *Power Reactor Information System*. Vienna, Austria. Accessed at <http://www.iaea.org/programmes/a2/>
- <sup>134</sup> Energy Information Administration. (2011). U.S. Nuclear Statistics. Washington, DC: Energy Information Administration. Accessed at <http://www.eia.gov/cneaf/nuclear/page/operation/statoperation.html>.
- <sup>135</sup> Nuclear Regulatory Commission. (2011). *Expected New Nuclear Power Plant Applications*. Washington, DC. Accessed at <http://www.nrc.gov/reactors/new-reactors/new-licensing-files/expected-new-rx-applications.pdf>
- <sup>136</sup> International Atomic Energy Agency. (2011). *Power Reactor Information System*. Vienna, Austria. Accessed at <http://www.iaea.org/programmes/a2/>
- <sup>137</sup> Energy Information Administration. (2009). *Annual Energy Review 2009*. (DOE/EIA-0384(2009)). Washington, DC. Accessed at <http://www.eia.gov/totalenergy/data/annual/index.cfm>
- <sup>138</sup> Energy Information Administration. (2009). *Annual Energy Review 2009*, Table 9.2. (DOE/EIA-0384(2009)). Washington, DC. Accessed at <http://www.eia.gov/totalenergy/data/annual/index.cfm>
- <sup>139</sup> Nuclear Waste Policy Act of 1982 42 U.S.C. 10101 (1987). Accessed at <http://epw.senate.gov/nwpa82.pdf>
- <sup>140</sup> US Code - Section 10172: Selection of Yucca Mountain site. 42 U.S.C. § 10172 (1987).
- <sup>141</sup> Office of Management and Budget. (2009). *A New Era of Responsibility: Renewing America's Promise FY 2010 Budget Request*. Washington, DC. Accessed at [http://www.whitehouse.gov/sites/default/files/omb/assets/fy2010\\_new\\_era/A\\_New\\_Era\\_of\\_Responsibility2.pdf](http://www.whitehouse.gov/sites/default/files/omb/assets/fy2010_new_era/A_New_Era_of_Responsibility2.pdf).
- <sup>142</sup> Nuclear Regulatory Commission. (2011). *Status of License Renewal Applications and Industry Activities*. Washington, DC. Accessed at <http://www.nrc.gov/reactors/operating/licensing/renewal/applications.html>,
- <sup>143</sup> Nuclear Regulatory Commission. (2011). *Approved Applications for Power Uprates*. Washington, DC. Accessed at <http://www.nrc.gov/reactors/operating/licensing/power-uprates/status-power-apps/approved-applications.html>
- <sup>144</sup> Nuclear Regulatory Commission. (2011). *Pending Applications for Power Uprates*. Washington, DC. Accessed at <http://www.nrc.gov/reactors/operating/licensing/power-uprates/status-power-apps/pending-applications.html>
- Nuclear Regulatory Commission. (2011). *Expected Applications for Power Uprates*. Washington, DC. Accessed June 2011 at <http://www.nrc.gov/reactors/operating/licensing/power-uprates/status-power-apps/expected-applications.html>
- <sup>145</sup> Oak Ridge National Laboratory. (2010). *Consortium for Advanced Simulation of LWRs, A Project Summary*. Oak Ridge, TN. Accessed at [http://www.casl.gov/wp-content/uploads/2011/01/CASL\\_Project\\_Summary11-24-10.pdf](http://www.casl.gov/wp-content/uploads/2011/01/CASL_Project_Summary11-24-10.pdf).
- By way of comparison, the Consortium for Advanced Simulation of Light-Water Reactors Hub has considered potential uprates as high as 20 GWe, while the reference case of the Energy Information Administration's *Annual Energy Outlook* includes an additional 7.3 GWe in uprates (Table A9, fn. 5).
- <sup>146</sup> International Atomic Energy Agency. (2002). *Cost drivers for the assessment of nuclear power plant life extension*. (IAEA-TECDOC-1309). Vienna, Austria. Accessed at [http://www-pub.iaea.org/MTCD/publications/PDF/te\\_1309\\_web.pdf](http://www-pub.iaea.org/MTCD/publications/PDF/te_1309_web.pdf)
- <sup>147</sup> Derived from: Georgia Power. (2011). "Plant Vogtle Units 3 & 4: Fourth Semi-Annual Construction Monitoring Report." Submitted to the Georgia Public Service Commission, Docket No. 29849, Document 134428.
- <sup>148</sup> U.S. Department of Energy, Office of Nuclear Energy. (2009). *Light Water Reactor Sustainability Research and Development Program Plan, FY 2009 – 2013*. (INL/MIS-08-14918). Accessed at [http://www.ne.doe.gov/pdfFiles/LWR\\_sustainability\\_program\\_plan.pdf](http://www.ne.doe.gov/pdfFiles/LWR_sustainability_program_plan.pdf)
- <sup>149</sup> U.S. Department of Energy, Office of Nuclear Energy. (2009). *Light Water Reactor Sustainability Research and Development Program Plan, FY 2009 – 2013*. (INL/MIS-08-14918). Accessed at [http://www.ne.doe.gov/pdfFiles/LWR\\_sustainability\\_program\\_plan.pdf](http://www.ne.doe.gov/pdfFiles/LWR_sustainability_program_plan.pdf)

- <sup>150</sup> U.S. Department of Energy, Office of Nuclear Energy. (2009). *Light Water Reactor Sustainability Research and Development Program Plan, FY 2009 – 2013*. (INL/MIS-08-14918). Accessed at [http://www.ne.doe.gov/pdfFiles/LWR\\_sustainability\\_program\\_plan.pdf](http://www.ne.doe.gov/pdfFiles/LWR_sustainability_program_plan.pdf)
- <sup>151</sup> International Atomic Energy Agency. (2004). *Status of Advanced Light Water Reactor Designs, 2004*. (IAEA-TECDOC-1391). Vienna, Austria.
- <sup>152</sup> Nuclear Energy Research Advisory Committee. (2001). *Subcommittee on Generation IV Technology Planning, A Roadmap to Deploy New Nuclear Power Plants in the United States by 2010*. Washington, DC.
- <sup>153</sup> International Atomic Energy Agency. (2011). *Power Reactor Information System Database*. Vienna, Austria.
- <sup>154</sup> U.S. Nuclear Regulatory Commission. (2012). "NRC Concludes Hearing on Vogtle New Reactors, First-Ever Combined Licenses to be Issued." Washington, DC. Accessed at <http://pbadupws.nrc.gov/docs/ML1204/ML120410133.pdf>
- <sup>155</sup> Overnight costs reflect how much it would cost to build a plant without consideration of time effects or financing costs. The key distinction is that overnight costs capture the *cost of the technology*, whereas the total investment cost also reflects the financial *characteristics of the company* planning to build the plant and the schedule they choose.
- <sup>156</sup> The National Academies. (2009). *America's Energy Future*. Washington, DC: The National Academy Press.
- <sup>157</sup> Du, Y., and Parsons, J. (2009). *Update on the Cost of Nuclear Power*. Cambridge, MA: Center for Energy and Environmental Policy Research, Massachusetts Institute of Technology. Accessed at <http://web.mit.edu/mitei/docs/spotlights/nuclear-fuel-cycle-du.pdf>
- Nuclear Energy Institute. (2011). *The Cost of New Generating Capacity in Perspective*. Washington, DC.
- Electric Power Research Institute. (2011). *Program on Technology Innovation: Integrated Generation Technology Options*. Palo Alto, CA.
- <sup>158</sup> Du, Y., and Parsons, J. (2009). *Update on the Cost of Nuclear Power*. Cambridge, MA: Center for Energy and Environmental Policy Research, Massachusetts Institute of Technology. Accessed at <http://web.mit.edu/mitei/docs/spotlights/nuclear-fuel-cycle-du.pdf>
- Nuclear Energy Institute. (2011). *The Cost of New Generating Capacity in Perspective*. Washington, DC.
- Electric Power Research Institute. (2011). *Program on Technology Innovation: Integrated Generation Technology Options*. Palo Alto, CA.
- <sup>159</sup> Energy Information Administration. (2010). "Statement of Income." *Electric Power Operations*. Washington, DC. Accessed at <http://www.eia.gov/pub/energy/overview/frs/s5810.xls>
- <sup>160</sup> Economic Co-Operation and Development Nuclear Energy Agency. (2011). *Current Status, Technical Feasibility and Economics of Small Nuclear Reactors*. Issy-les-Moulineaux, France: Nuclear Energy Agency.
- <sup>161</sup> Economic Co-Operation and Development Nuclear Energy Agency. (2011). *Current Status, Technical Feasibility and Economics of Small Nuclear Reactors*. Issy-les-Moulineaux, France: Nuclear Energy Agency.
- <sup>162</sup> Rosner, R., and Goldberg, S. (2011). "Small Modular Reactors – Key to Future Nuclear Power Generation in the U.S." Chicago, IL: Energy Policy Institute at Chicago, University of Chicago. Accessed at <http://harrisschool.uchicago.edu/centers/hepi/SMR%20Final%20White%20Paper%207-11.pdf>
- <sup>163</sup> American Nuclear Society. (2010). *Interim Report of the American Nuclear Society President's Special Committee on Small and Medium Sized Reactor (SMR) Generic Licensing Issues*.
- Nuclear Regulatory Commission. (2010). *Potential Policy, Licensing, and Key Technical Issues for Small Modular Nuclear Reactor Designs*. (SECY-10-0034). Washington, DC. Accessed at <http://pbadupws.nrc.gov/docs/ML0932/ML093290268.pdf>
- <sup>164</sup> Generation IV International Forum. (2010) *Overview of GIF*. Issy-les-Moulineaux, France: Nuclear Energy Agency. Accessed at [http://www.gen-4.org/PDFs/GIF\\_Overview.pdf](http://www.gen-4.org/PDFs/GIF_Overview.pdf)
- <sup>165</sup> U.S. Department of Energy. (2010). *Nuclear Energy Research and Development Roadmap Report to Congress*. Washington, DC. Accessed at [http://www.nuclear.gov/pdfFiles/NuclearEnergy\\_Roadmap\\_Final.pdf](http://www.nuclear.gov/pdfFiles/NuclearEnergy_Roadmap_Final.pdf)
- <sup>166</sup> National Research Council of the National Academies. (2008). *Review of DOE's Nuclear Energy Research and Development Program*. Washington, DC: National Academies Press.
- <sup>167</sup> Idaho National Laboratory. (2011). *High Temperature Gas-Cooled Reactor Projected Marketes and Preliminary Economics*. (INL/EXT-10-19037). Idaho Falls, ID.

- <sup>168</sup> Energy Information Administration. (2011). "Natural Gas Prices." *Monthly Energy Review*, Table 9.11. Washington, DC. Accessed July 2011 at [http://www.eia.gov/totalenergy/data/monthly/pdf/sec9\\_17.pdf](http://www.eia.gov/totalenergy/data/monthly/pdf/sec9_17.pdf)
- <sup>169</sup> Generation IV International Forum. (2009). *GIF R&D Outlook for Generation IV Nuclear Energy Systems*. Issy-les-Moulineaux, France: Nuclear Energy Agency. Accessed at [http://www.gen-4.org/PDFs/GIF\\_RD\\_Outlook\\_for\\_Generation\\_IV\\_Nuclear\\_Energy\\_Systems.pdf](http://www.gen-4.org/PDFs/GIF_RD_Outlook_for_Generation_IV_Nuclear_Energy_Systems.pdf)
- <sup>170</sup> World Nuclear Association. (2011). *Fast Neutron Reactors*. London, England.
- <sup>171</sup> Nuclear Energy Institute. (2010). *Safely Managing Used Nuclear Fuel*. Washington, DC.
- <sup>172</sup> Blue Ribbon Commission on America's Nuclear Future. (2011). *Blue Ribbon Commission on America's Nuclear Future Report to the Secretary of Energy*. Washington, DC. Accessed at [http://brc.gov/sites/default/files/documents/brc\\_finalreport\\_jan2012.pdf](http://brc.gov/sites/default/files/documents/brc_finalreport_jan2012.pdf)
- <sup>173</sup> U.S. Department of Energy. (2010). *Nuclear Energy Research and Development Roadmap Report to Congress*. Washington, DC. Accessed at [http://www.nuclear.gov/pdfFiles/NuclearEnergy\\_Roadmap\\_Final.pdf](http://www.nuclear.gov/pdfFiles/NuclearEnergy_Roadmap_Final.pdf)
- <sup>174</sup> Oak Ridge National Laboratory. (2010). *Consortium for Advanced Simulation of LWRs, A Project Summary*. Oak Ridge, TN. Accessed at [http://www.casl.gov/wp-content/uploads/2011/01/CASL\\_Project\\_Summary11-24-10.pdf](http://www.casl.gov/wp-content/uploads/2011/01/CASL_Project_Summary11-24-10.pdf).
- <sup>175</sup> U.S. Department of Energy. (2011). *Small Modular Reactors Fact Sheet*. Washington, DC. Accessed at [http://www.ne.doe.gov/pdfFiles/factSheets/2012\\_SMR\\_Factsheet\\_final.pdf](http://www.ne.doe.gov/pdfFiles/factSheets/2012_SMR_Factsheet_final.pdf)
- <sup>176</sup> Assuming a 1% increase in global electricity supply from 2008 to 2010 and a 16% average capacity factor for photovoltaic. In 2008, global electricity generation totaled 20,260,838 GWh.
- International Energy Agency. (2008). *Electricity/Heat Energy Statistics 2008*. Paris, France. Accessed at [http://www.iea.org/stats/electricitydata.asp?COUNTRY\\_CODE=29](http://www.iea.org/stats/electricitydata.asp?COUNTRY_CODE=29)
- <sup>177</sup> Solar Energy Industry Association. (2011). *US Solar Market Insight – 2010 Year in Review*. Washington, DC: GTM Research.
- <sup>178</sup> Energy Information Administration. (2011). "Electricity Net Generation: Total (All Sectors)." *Annual Energy Review*. Washington, DC. Accessed November 2011 at <http://www.eia.gov/totalenergy/data/annual/showtext.cfm?t=ptb0802a>
- <sup>179</sup> The \$6 billion figure includes revenue associated with the sale of photovoltaic in the United States.
- Solar Energy Industry Association. (2010). *US Solar Market Insight – 2010 Year in Review*. Washington, DC: GTM Research.
- <sup>180</sup> Solar Energy Industry Association. (2010). *US Solar Market Insight – 2010 Year in Review*. Washington, DC: GTM Research.
- <sup>181</sup> Sherwood, L. (2011). *U.S. Solar Market Trends 2010*. Latham, NY: Interstate Renewable Energy Council. Accessed at <http://irecusa.org/wp-content/uploads/2011/07/IREC-Solar-Market-Trends-Report-revised070811.pdf>
- <sup>182</sup> Prices in current U.S. dollars.
- <sup>183</sup> Mints, P. (2011). *Photovoltaic Manufacturer Shipments, Capacity, & Competitive Analysis 2010/2011*. (Report # NPS-Supply6). Palo Alto, CA: Navigant Consulting Photovoltaic Service Program.
- <sup>184</sup> Bloomberg New Energy Finance. (2012). "February Solar Spot Price Index." New York, NY.
- <sup>185</sup> UBS. (2012). *Global Solar Industry Update*. Volume 6. April 19, 2012.
- <sup>186</sup> Mints, P. (2011). *Photovoltaic Manufacturer Shipments, Capacity, & Competitive Analysis 2010/2011*. (Report # NPS-Supply6). Palo Alto, CA: Navigant Consulting Photovoltaic Service Program.
- <sup>187</sup> Goodrich, A., et al. (2011). *Residential, Commercial, and Utility-Scale Photovoltaic System Prices in the United States: Current Drivers and Cost Reduction Opportunities*. (NREL/TP-6A20-53347). Boulder, CO: National Renewable Energy Laboratory.
- <sup>188</sup> Implied non-module costs were calculated by the difference between the installed cost and the module cost.
- <sup>189</sup> Lawrence Berkley National Laboratory. (2010). *Tracking the Sun III. The Installed Cost of Photovoltaics in the US from 1998–2009*. (LBNL-4121E). Berkeley, CA.
- <sup>190</sup> The average installed cost of 3–5 kW residential photovoltaic installations in 2009 (excluding sales/value-added tax) was significantly lower in both Germany (\$4.7/W) and Japan (\$5.9/W) than in the United States (\$7.7/W). Average installed costs vary widely across states; among ≤10 kW systems completed in 2009, average costs range from a low of \$7.1/W in Texas to a high of \$9.6/W in Minnesota.



- Lawrence Berkley National Laboratory. (2010). *Tracking the Sun III. The Installed Cost of Photovoltaics in the US from 1998–2009*. (LBNL-4121E). Berkeley, CA. Accessed at <http://eetd.lbl.gov/ea/ems/reports/lbnl-4121e.pdf>
- <sup>191</sup> U.S. Department of Energy. (2012). *SunShot Vision Study*. (DOE/GO-102012-3037). Washington, DC. Accessed at <http://www1.eere.energy.gov/solar/pdfs/47927.pdf>
- <sup>192</sup> PV Tech. “Balancing act: Study finds solid US solar exports, value accrual; developer sees falling module cost.” August 31, 2011.
- <sup>193</sup> Mints, P. (2010). *Photovoltaic Manufacturer Shipments, Capacity, & Competitive Analysis 2009/2010*. (Report # NPS-Supply5). Palo Alto, CA: Navigant Consulting Photovoltaic Service Program.
- <sup>194</sup> Residential scale system. Note, utility scale inverters have a longer average lifetime than residential scale system inverters.
- <sup>195</sup> Shaheen, S. E., Ginley, D. S., and Jabbour, G. E. (2005). “Organic-Based Photovoltaics: Toward Low-Cost Power Generation.” *MRS Bulletin*. 30( 1):10-15.
- <sup>196</sup> Denholm, P., Margolis, R., Ong, S., and Roberts, B. (2009). *Break-Even Cost for Residential Photovoltaics in the United States: Key Drivers and Sensitivities*. (NREL/TP-6A2-46909). Golden, CO: National Renewable Energy Laboratory.
- <sup>197</sup> U.S. Department of Energy. (2010). *Critical Materials Strategy*. Washington, DC. Accessed at <http://energy.gov/sites/prod/files/edg/news/documents/criticalmaterialsstrategy.pdf>
- <sup>198</sup> Mints, P. (2011). *Photovoltaic Manufacturer Shipments, Capacity, & Competitive Analysis 2010/2011*. (Report # NPS-Supply6). Palo Alto, CA: Navigant Consulting Photovoltaic Service Program.
- <sup>199</sup> Mints, P. (2011). *Photovoltaic Manufacturer Shipments, Capacity, & Competitive Analysis 2010/2011*. (Report # NPS-Supply6). Palo Alto, CA: Navigant Consulting Photovoltaic Service Program.
- <sup>200</sup> See [www.dsireusa.org](http://www.dsireusa.org) for the most up-to-date information on state, utility, and local policies regarding renewable energy and energy efficiency.
- <sup>201</sup> Solar Energy Industry Association. (2010). *US Solar Market Insight – 2010 Year in Review*. Washington, DC: GTM Research.
- <sup>202</sup> RTI International. (2010). *Retrospective Benefit-Cost Evaluation of DOE Investment in Photovoltaic Energy Systems*. Research Triangle Park, NC.
- <sup>203</sup> Ruegg, R., and Thomas, P. (2011). *Linkages from DOE’s Solar Photovoltaic R&D to Commercial Renewable Power from Solar Energy*. (DOE/EE-0403). Washington, DC: Department of Energy.
- <sup>204</sup> U.S. Department of Energy. (2012). *SunShot Vision Study*. (DOE/GO-102012-3037). Washington, DC. Accessed at <http://www1.eere.energy.gov/solar/pdfs/47927.pdf>
- <sup>205</sup> Energy Information Administration. (2011). *Electric Power Annual 2009*. Washington, DC. Accessed at [http://www.eia.gov/cneaf/electricity/epa/epa\\_sum.html](http://www.eia.gov/cneaf/electricity/epa/epa_sum.html)
- <sup>206</sup> Energy Information Administration. (2010). *Updated Capital Cost Estimates for Electricity Generation Plants*. Washington, DC. Accessed at [http://www.eia.gov/oiaf/beck\\_plantcosts/pdf/updatedplantcosts.pdf](http://www.eia.gov/oiaf/beck_plantcosts/pdf/updatedplantcosts.pdf)
- <sup>207</sup> Energy Information Administration. (2011). *Annual Energy Outlook 2011, Levelized Cost of New Generation Resources*. Washington, DC. Accessed at [http://www.eia.gov/oiaf/aeo/electricity\\_generation.html](http://www.eia.gov/oiaf/aeo/electricity_generation.html)
- <sup>208</sup> Energy Information Administration. (2011). *FERC Form 1*. Washington, DC.
- <sup>209</sup> International Energy Agency. (2010). *Renewable Energy Essentials: Hydropower*. Paris, France. Accessed at [http://www.iea.org/papers/2010/Hydropower\\_Essentials.pdf](http://www.iea.org/papers/2010/Hydropower_Essentials.pdf)
- <sup>210</sup> International Energy Agency. (2010). *Energy Systems Technology Analysis Program Technology Brief: Hydropower*. Paris, France. Accessed at <http://www.etsap.org/E-techDS/PDF/E07-hydropower-GS-gct.pdf>
- <sup>211</sup> Energy Information Administration. (2011). “Hydroelectric Net Generation” and “Total Electricity Net Generation.” *International Energy Statistics*. Washington, DC: Department of Energy.
- <sup>212</sup> International Energy Agency. (2010). *Key World Energy Statistics 2010*. Paris, France. Accessed at [http://www.iea.org/textbase/nppdf/free/2010/key\\_stats\\_2010.pdf](http://www.iea.org/textbase/nppdf/free/2010/key_stats_2010.pdf)
- <sup>213</sup> Bureau of Reclamation. (2009). “The History of Hydropower Development in the United States.” Washington, DC. Accessed at <http://www.usbr.gov/power/edu/history.html>
- <sup>214</sup> Bureau of Reclamation. (2009). “The History of Hydropower Development in the United States.” Washington, DC. Accessed at <http://www.usbr.gov/power/edu/history.html>

- <sup>215</sup> Idaho National Laboratory. (2012). "Hydropower's Historical Progression." Idaho Falls, ID. Accessed at [http://hydropower.inel.gov/hydrofacts/historical\\_progression.shtml](http://hydropower.inel.gov/hydrofacts/historical_progression.shtml)
- <sup>216</sup> Gordon, J. L. (2001). Hydraulic Turbine Efficiency. *Canadian Journal of Civil Engineering*. 28(2):238–253.
- <sup>217</sup> For example, the Electric Power Research Institute's efforts in quantifying the full value of hydropower on the electric grid (more information at [http://my.epri.com/portal/server.pt?open=512&objID=396&&PageID=241272&mode=2&in\\_hi\\_userid=2&cached=true](http://my.epri.com/portal/server.pt?open=512&objID=396&&PageID=241272&mode=2&in_hi_userid=2&cached=true)); the International Energy Agency's Implementing Agreement for Hydropower Technologies and Programmes, Annex IV: Hydropower Services (more information at [http://www.ieahydro.org/Hydropower\\_Services3.html](http://www.ieahydro.org/Hydropower_Services3.html)); and the International Energy Agency's Task 24 on Integrating Wind and Hydropower Systems (more information at [http://www.ieawind.org/summary\\_page\\_24.html](http://www.ieawind.org/summary_page_24.html)).
- <sup>218</sup> National Hydropower Asset Assessment Project. "Existing Hydropower Assets." Washington, DC: Department of Energy. Accessed at <http://nhaap.ornl.gov/content/existing-hydropower-assets>
- <sup>219</sup> National Hydropower Asset Assessment Project. "Existing Hydropower Assets." Washington, DC: Department of Energy. Accessed at <http://nhaap.ornl.gov/content/existing-hydropower-assets>
- <sup>220</sup> Electric Power Research Institute. (2007). *Assessment of Waterpower Potential and Development Needs*. Palo Alto, CA. Accessed at [http://www.aas.org/spp/cstc/docs/07\\_06\\_1ERPI\\_report.pdf](http://www.aas.org/spp/cstc/docs/07_06_1ERPI_report.pdf)
- <sup>221</sup> March, P. A., and Wolff, P. J. (2003). *Optimization-Based Hydro Performance Indicator*. Proceedings of WaterPower XIII.
- U.S. Department of the Interior, U.S. Department of the Army, U.S. Department of Energy. (2007). *Potential Hydroelectric Development at Existing Federal Facilities*. Washington, DC: Government Printing Office.
- <sup>222</sup> U.S. Department of Energy. (2011). *An Assessment of Energy Potential at Non-Powered Dams in the United States*. Oak Ridge, TN. Accessed at <http://nhaap.ornl.gov/content/non-powered-dam-potential>
- <sup>223</sup> U.S. Department of Energy. (2004). *Water Energy Resources of the United States with Emphasis on Low Head/Low Power Resources*. (DOE/ID-11111). Washington, DC. Accessed at <http://hydropower.inel.gov/resourceassessment/pdfs/03-11111.pdf>
- <sup>224</sup> Energy Information Administration. (2010). *Updated Capital Cost Estimates for Electricity Generation Plants*. Washington, DC. Accessed at [http://www.eia.gov/oiaf/beck\\_plantcosts/](http://www.eia.gov/oiaf/beck_plantcosts/)
- <sup>225</sup> Cost estimates for American Municipal Power's low-head Ohio River lock and dam projects lie at the higher end of this range. See <http://amppartners.org/generation-assets/hydroelectric/> for more information.
- <sup>226</sup> Despite being a small project at 5 MW, the redevelopment of the Boulder Canyon Hydroelectric Facility has cost only \$1,000/kW, reflecting high power density and favorable site characteristics. See [http://www.bouldercolorado.gov/index.php?option=com\\_content&view=article&id=12679&Itemid=4608](http://www.bouldercolorado.gov/index.php?option=com_content&view=article&id=12679&Itemid=4608) for more information.
- <sup>227</sup> Oak Ridge National Laboratory. (2010). *Summary Report of the 2010 Summit Meeting on Environmental Mitigation Technology for Hydropower*. Oak Ridge, TN. Accessed at <http://www.esd.ornl.gov/WindWaterPower/EMTSSummit.pdf>
- <sup>228</sup> U.S. Department of Energy and U.S. Department of Homeland Security. (2011). *Dams and Energy Sectors Interdependency Study*. Washington, DC. Accessed at <http://energy.gov/sites/prod/files/Dams-Energy%20Interdependency%20Study.pdf>
- <sup>229</sup> Division of Hydropower Administration Compliance. (2004). *Compliance Handbook*. Washington, DC: Federal Energy Regulatory Commission. Accessed at [http://www.ferc.gov/industries/hydropower/gen-info/handbooks/compliance\\_handbook.pdf](http://www.ferc.gov/industries/hydropower/gen-info/handbooks/compliance_handbook.pdf)
- <sup>230</sup> Bedard, R. (2009). *Testimony on Marine and Hydrokinetic Technologies: Finding the Pathway to Commercialization*. [House Committee on Science and Technology, Subcommittee on Energy and Environment]. Washington, DC: Government Printing Office. Accessed at <http://gop.science.house.gov/Media/hearings/energy09/dec3/Bedard.pdf>
- <sup>231</sup> Ocean Energy Systems. (2011). *Annual Report 2011: Implementing Agreement on Ocean Energy Systems*. p. 122. Lisbon, Portugal. Accessed at [http://www.ocean-energy-systems.org/documents/17069\\_oes\\_annual\\_report\\_web\\_21marv2.pdf/](http://www.ocean-energy-systems.org/documents/17069_oes_annual_report_web_21marv2.pdf/)

- <sup>232</sup> International Energy Agency. (2011). *Implementing Agreement on Ocean Energy Systems (OES-IA), Annual Report 2010, Implementing Agreement on Ocean Energy Systems*. Paris, France. Accessed at [http://www.iea-oceans.org/fich/6/2010\\_Annual\\_Report.pdf](http://www.iea-oceans.org/fich/6/2010_Annual_Report.pdf)
- <sup>233</sup> U.S. Department of Energy. (2011). *Marine and Hydrokinetic Technology Database*. Washington, DC. Accessed at <http://www1.eere.energy.gov/water/hydrokinetic/default.aspx>
- <sup>234</sup> Data retrieved from CleanTech PatentEdge™ online patent and intellectual property research service.
- <sup>235</sup> U.S. Department of Energy. (2006). *DOE Hydropower Program Biennial Report 2005-2006*. Oak Ridge, TN. Accessed at [http://hydropower.inel.gov/techtransfer/pdfs/binennial\\_report\\_fy\\_2005\\_2006.pdf](http://hydropower.inel.gov/techtransfer/pdfs/binennial_report_fy_2005_2006.pdf)
- <sup>236</sup> U.S. Department of Energy. (2006). *DOE Hydropower Program Biennial Report 2005-2006*. Oak Ridge, TN. Accessed at [http://hydropower.inel.gov/techtransfer/pdfs/binennial\\_report\\_fy\\_2005\\_2006.pdf](http://hydropower.inel.gov/techtransfer/pdfs/binennial_report_fy_2005_2006.pdf)
- <sup>237</sup> Efficiency is defined as the power generated by the turbine (as measured by torque force and RPM) divided by the power available in the water at the inlet of the turbine (a function of head, flow, and water density).
- <sup>238</sup> Electric Power Research Institute. (2011). *"Fish Friendly" Hydropower Turbine Development and Deployment: Alden Turbine Preliminary Engineering and Model Testing*. Palo Alto, CA.
- <sup>239</sup> Thresher, R. (2010). *First Draft Roadmap: The United States Marine Hydrokinetic Renewable Energy Technology Roadmap*. Golden, CO: National Renewable Energy Laboratory. Accessed at <http://www.oceanrenewable.com/wp-content/uploads/2010/05/1st-draft-roadmap-rwt-8april10.pdf>
- <sup>240</sup> U.K. Department of Energy and Climate Change. (2009). *Marine Energy Action Plan 2010, Executive Summary & Recommendations*. London, England. Accessed at [http://www.decc.gov.uk/en/content/cms/meeting\\_energy/wave\\_tidal/funding/marine\\_action/marine\\_action.aspx](http://www.decc.gov.uk/en/content/cms/meeting_energy/wave_tidal/funding/marine_action/marine_action.aspx)
- <sup>241</sup> Columbia Power Technologies is a renewable energy company developing wave energy convertors. Accessed at <http://www.businesswire.com/news/home/20110308006644/en/Columbia-Power-Technologies-Secures-Governmental-Private-Funding>
- <sup>242</sup> Free Flow Power is a hydropower developer focusing on conventional hydropower, pumped storage hydropower, and marine and hydrokinetic energy. Accessed at [http://www.free-flow-power.com/news\\_and\\_events#mp1](http://www.free-flow-power.com/news_and_events#mp1)
- <sup>243</sup> Global Wind Energy Council. (2010) *Global Wind Report: Annual Market Update 2010*. Brussels, Belgium. Accessed at [http://www.gwec.net/fileadmin/images/Publications/GWEC\\_annual\\_market\\_update\\_2010\\_-\\_2nd\\_edition\\_April\\_2011.pdf](http://www.gwec.net/fileadmin/images/Publications/GWEC_annual_market_update_2010_-_2nd_edition_April_2011.pdf)
- <sup>244</sup> Generation data for 2010 from the U.S. Department of Energy's Energy Information Administration (does not account for a full year's production from 2010 installations because new wind farms were being added throughout the year).
- <sup>245</sup> U.S. Department of Energy. (2008). *20% Wind Energy by 2030*. (DOE/GO-102008-2567). Washington, DC. Accessed at <http://www.nrel.gov/docs/fy08osti/41869.pdf>
- <sup>246</sup> Black & Veatch. (2007). *20 Percent Wind Energy Penetration in the United States: A Technical Analysis of the Energy Resource*. Walnut Creek, CA. Accessed at [http://www.20percentwind.org/Black\\_Veatch\\_20\\_Percent\\_Report.pdf](http://www.20percentwind.org/Black_Veatch_20_Percent_Report.pdf)
- <sup>247</sup> National Renewable Energy Laboratory. (2012). *U.S. 80m Wind Resource Maps*. Golden, CO. Accessed at <http://www.nrel.gov/gis/wind.html>
- <sup>248</sup> Electricity costs include neither transmission costs nor firming costs. Land-based wind power prices are prices charged to utilities from real projects. They are suppressed by the receipt of available state and federal incentives and do not represent the costs to produce the electricity. Offshore price reflects the 2010 cost of a shallow water monopile platform and does not include subsidies. Because there are no domestic offshore wind power projects, these two prices cannot be directly compared.
- <sup>249</sup> Wisner, R., and Bolinger, M. (2010). *2009 Wind Technologies Market Report*. Washington, DC: Department of Energy. (DOE/GO-102010-3107). Accessed at <http://eetd.lbl.gov/ea/emp/reports/lbnl-3716e.pdf>
- <sup>250</sup> Wisner, R., and Bolinger, M. (2010). *2009 Wind Technologies Market Report*. Washington, DC: Department of Energy. (DOE/GO-102010-3107). Accessed at <http://eetd.lbl.gov/ea/emp/reports/lbnl-3716e.pdf>

- <sup>251</sup> Musial, W., and Ram, B. (2010). *Large-Scale Offshore Wind Power in the United States: Assessment of Opportunities and Barriers*. (TP-500-40745). Golden, CO: National Renewable Energy Laboratory. Accessed at <http://www.nrel.gov/wind/pdfs/40745.pdf>
- <sup>252</sup> U.S. Department of Energy. (2011). *A National Offshore Wind Strategy: Creating an Offshore Wind Industry in the United States*. Washington, DC: U.S. Department of Energy and U.S. Department of the Interior. Accessed at [http://www1.eere.energy.gov/wind/pdfs/national\\_offshore\\_wind\\_strategy.pdf](http://www1.eere.energy.gov/wind/pdfs/national_offshore_wind_strategy.pdf)
- <sup>253</sup> Energy Information Administration. (2010). *Levelized Cost of New Generation Resources in the Annual Energy Outlook 2011*. Washington, DC. Accessed at [http://www.eia.gov/oiaf/aeo/pdf/2016levelized\\_costs\\_aeo2011.pdf](http://www.eia.gov/oiaf/aeo/pdf/2016levelized_costs_aeo2011.pdf)
- <sup>254</sup> American Wind Energy Association. (2010). *Small Wind Turbine Global Market Study*. Washington, DC. Accessed at [http://www.awea.org/learnabout/smallwind/upload/2011\\_turbine\\_market\\_report.pdf](http://www.awea.org/learnabout/smallwind/upload/2011_turbine_market_report.pdf)
- <sup>255</sup> American Wind Energy Association. (2010). *Small Wind Turbine Global Market Study*. Washington, DC. Accessed at [http://www.awea.org/learnabout/smallwind/upload/2011\\_turbine\\_market\\_report.pdf](http://www.awea.org/learnabout/smallwind/upload/2011_turbine_market_report.pdf)
- <sup>256</sup> Intergovernmental Panel on Climate Change. (2011). *IPCC Special Report on Renewable Energy Sources and Climate Change Mitigation, Summary for Policymakers*. Cambridge, United Kingdom, and New York, NY, USA: Cambridge University Press. Accessed at <http://srren.ipcc-wg3.de/report>
- <sup>257</sup> Intergovernmental Panel on Climate Change. (2011). *IPCC Special Report on Renewable Energy Sources and Climate Change Mitigation, Wind Energy*. Cambridge, United Kingdom, and New York, NY, USA: Cambridge University Press. Accessed at [http://www.ipcc.ch/news\\_and\\_events/docs/ipcc33/SRREN\\_FD\\_SPM\\_final.pdf](http://www.ipcc.ch/news_and_events/docs/ipcc33/SRREN_FD_SPM_final.pdf)
- <sup>258</sup> Global Wind Energy Council. (2011). *Global Wind Report: Annual Market Update 2010*. Brussels, Belgium. Accessed at [http://www.gwec.net/fileadmin/documents/Publications/Global\\_Wind\\_2007\\_report/GWEC%20Global%20Wind%20Report%202010%20low%20res.pdf](http://www.gwec.net/fileadmin/documents/Publications/Global_Wind_2007_report/GWEC%20Global%20Wind%20Report%202010%20low%20res.pdf)
- <sup>259</sup> U.S. Department of Energy, Office of Energy Efficiency and Renewable Energy. (2011). *2010 Wind Technologies Market Report*. Washington, DC. (DOE/GO-102011-3322). Accessed at <http://www1.eere.energy.gov/wind/pdfs/51783.pdf>
- <sup>260</sup> National Renewable Energy Laboratory estimate based on data from the American Wind Energy Association. American Wind Energy Association. (2011). *Year End 2010 Market Report*. Washington DC. Accessed at: [http://www.awea.org/documents/reports/4Q10\\_market\\_outlook\\_public.pdf](http://www.awea.org/documents/reports/4Q10_market_outlook_public.pdf)
- Wiser, R., and M. Bolinger. (2010). *2009 Wind Technologies Market Report*. Washington, DC: Department of Energy. (DOE/GO-102010-3107). Accessed at <http://eetd.lbl.gov/ea/emp/reports/lbnl-3716e.pdf>
- <sup>261</sup> American Wind Energy Association. (2011). *Year End 2010 Market Report*. Washington DC. Accessed at [http://www.awea.org/documents/reports/4Q10\\_market\\_outlook\\_public.pdf](http://www.awea.org/documents/reports/4Q10_market_outlook_public.pdf)
- Wiser, R., and Bolinger, M. (2010). *2009 Wind Technologies Market Report*. Washington, DC: Department of Energy. (DOE/GO-102010-3107). Accessed at <http://eetd.lbl.gov/ea/emp/reports/lbnl-3716e.pdf>
- <sup>262</sup> American Wind Energy Association. (2011). *Year End 2010 Market Report*. Washington DC. Accessed at [http://www.awea.org/documents/reports/4Q10\\_market\\_outlook\\_public.pdf](http://www.awea.org/documents/reports/4Q10_market_outlook_public.pdf)
- <sup>263</sup> Wiser, R., and Bolinger, M. (2010). *2009 Wind Technologies Market Report*. Washington, DC: Department of Energy. (DOE/GO-102010-3107). Accessed at <http://eetd.lbl.gov/ea/emp/reports/lbnl-3716e.pdf>
- <sup>264</sup> Installed cost data are reported as overnight capital costs and are adjusted from total capital cost. Wiser, R., and Bolinger, M. (2010). *2009 Wind Technologies Market Report*. Washington, DC: Department of Energy. (DOE/GO-102010-3107). Accessed at <http://eetd.lbl.gov/ea/emp/reports/lbnl-3716e.pdf>
- <sup>265</sup> Musial, W., and Ram, B. (2010). *Large-Scale Offshore Wind Power in the United States: Assessment of Opportunities and Barriers*. (TP-500-40745). Golden, CO: National Renewable Energy Laboratory. Accessed at <http://www.nrel.gov/wind/pdfs/40745.pdf>
- <sup>266</sup> Greater uncertainty in actual installation and operations and maintenance costs requires that project owners, as well as construction and maintenance firms maintain additional financial reserves (which translates into higher costs) to address potential cost overruns or other unforeseen costs.
- <sup>267</sup> Wiser, R., and Bolinger, M. (2010). *2009 Wind Technologies Market Report*. Washington, DC: Department of Energy. (DOE/GO-102010-3107). Accessed at <http://eetd.lbl.gov/ea/emp/reports/lbnl-3716e.pdf>



- <sup>268</sup>Power prices noted in the text and in Figure 4 include Renewable Energy Credits (REC), but do not reflect the value of the federal tax credits, state and local incentives, or environmental attributes not captured in REC payments and therefore do not represent wind energy generation costs. The prices would be at least \$20/MWh higher without the production tax credit, investment tax credit, or treasury grant.
- Wiser, R., and Bolinger, M. (2010). *2009 Wind Technologies Market Report*. Washington, DC: Department of Energy. (DOE/GO-102010-3107). Accessed at <http://eetd.lbl.gov/ea/emp/reports/lbnl-3716e.pdf>
- <sup>269</sup>U.S. Department of Energy. (2008). *20% Wind Energy by 2030*. Washington, DC. (DOE/GO-102008-2567). Accessed at <http://www.nrel.gov/docs/fy08osti/41869.pdf>
- <sup>270</sup>U.S. Department of Energy. (2010). *Critical Materials Strategy*. Washington, DC. Accessed at <http://energy.gov/sites/prod/files/edg/news/documents/criticalmaterialsstrategy.pdf>
- <sup>271</sup>U.S. Department of Energy. (2008). *20% Wind Energy by 2030*. Washington, DC. (DOE/GO-102008-2567). Accessed at <http://www.nrel.gov/docs/fy08osti/41869.pdf>
- European Renewable Energy Council and Greenpeace International. (2008). *Energy [R]evolution: A Sustainable World Energy Outlook*. Brussels, Belgium. Accessed at [http://www.energyblueprint.info/fileadmin/media/documents/energy\\_revolution.pdf](http://www.energyblueprint.info/fileadmin/media/documents/energy_revolution.pdf)
- Lemming, J. K., Morthorst, P. E., Clausen, N. E., and Hjuler Jensen, P. (2009). *Contribution to the Chapter on Wind Power in Energy Technology Perspectives 2008*. (Risø-R-1674(EN)). Roskilde, Denmark: Risø National Laboratory for Sustainable Energy. Accessed at <http://130.226.56.153/rispubl/reports/ris-r-1674.pdf>
- Tidball, R., Bluestein, J., Rodriguez, N., and Knoke, S. (2010). *Cost and Performance Assumptions for Modeling Electricity Generation Technologies*. (NREL/SR-6A20-48595). Fairfax, VA: ICF International. Accessed at <http://www.nrel.gov/docs/fy11osti/48595.pdf>
- <sup>272</sup>U.S. Department of Energy. (2008). *20% Wind Energy by 2030*. (DOE/GO-102008-2567). Washington, DC. Accessed at <http://www.nrel.gov/docs/fy08osti/41869.pdf>
- European Renewable Energy Council and Greenpeace International. (2008). *Energy [R]evolution: A Sustainable World Energy Outlook*. Brussels, Belgium. Accessed at [http://www.energyblueprint.info/fileadmin/media/documents/energy\\_revolution.pdf](http://www.energyblueprint.info/fileadmin/media/documents/energy_revolution.pdf)
- Lemming, J. K., Morthorst, P. E., Clausen, N. E., and Hjuler Jensen, P. (2009). *Contribution to the Chapter on Wind Power in Energy Technology Perspectives 2008*. (Risø-R-1674(EN)). Roskilde, Denmark: Risø National Laboratory for Sustainable Energy. Accessed at <http://130.226.56.153/rispubl/reports/ris-r-1674.pdf>
- U.S. Department of Energy. (2011). *2010 Wind Technologies Market Report*. (DOE/GO-102011-3322). Washington, DC. Accessed at <http://www1.eere.energy.gov/wind/pdfs/51783.pdf>
- <sup>273</sup>The trends would be similar for Class III resources because the technology advances associated with larger rotors, taller towers, and improved component reliability that lead to these projections are not dependent upon the wind resource class.
- <sup>274</sup>Levelized cost of electricity (LCOE) and capital cost are presented as a percentage change of the 2010 baseline and reflect the values indicated in the DOE projected goals table. LCOE is obtained by dividing the capital cost by the annual energy production. Here the capital cost is decreasing (red) while the capacity factor (red line) and corresponding annual energy production increases. The combined effect of lower capital cost and increased annual energy production lowers the associated LCOE below the capital cost as shown.
- <sup>275</sup>Offshore turbines are expected to be larger than their onshore counterparts to minimize foundation, interconnection, and electrical infrastructure, as well as the number of trips to and from port. In addition, offshore-specific turbines will be designed to maximize the ease and efficiency of maintenance trips to individual turbines.
- <sup>276</sup>Musial, W., and Ram, B. (2010). *Large-Scale Offshore Wind Power in the United States: Assessment of Opportunities and Barriers*. Golden, CO: National Renewable Energy Laboratory. (TP-500-40745).
- <sup>277</sup>International Energy Agency. (2009). *Technology Roadmap, Wind Energy*. Paris, France. Accessed at [http://www.ieawind.org/wnd\\_info/IEA\\_Paris/Wind\\_Roadmap.pdf](http://www.ieawind.org/wnd_info/IEA_Paris/Wind_Roadmap.pdf)
- <sup>278</sup>U.S. Department of Energy. (2008). *20% Wind Energy by 2030*. Washington, DC. (DOE/GO-102008-2567). Accessed at <http://www.nrel.gov/docs/fy08osti/41869.pdf>
- <sup>279</sup>Mills, A., Wiser, R., and Porter, K. (2009). *The Cost of Transmission for Wind Energy: A Review of Transmission Planning Studies*. (LBNL-1471E). Berkeley, CA: Lawrence Berkeley National Laboratory.

- <sup>280</sup> Mills, A., Wiser, R., and Porter, K. (2009). *The Cost of Transmission for Wind Energy: A Review of Transmission Planning Studies*. (LBNL-1471E). Berkeley, CA: Lawrence Berkeley National Laboratory.
- <sup>281</sup> U.S. Department of Energy. (2008). *U.S. Department of Energy Wind and Hydropower Technologies: Top Ten Program Accomplishments*. (DOE/GO-102008-2622). Washington, DC.
- <sup>282</sup> U.S. Department of Energy. (2008). *20% Wind Energy by 2030*. Washington, DC. (DOE/GO-102008-2567). Accessed at <http://www.nrel.gov/docs/fy08osti/41869.pdf>
- <sup>283</sup> U.S. Department of Energy. (2012). "Environmental Impacts and Siting of Wind Projects." Washington, DC. Accessed May 2012 at [http://www1.eere.energy.gov/wind/impacts\\_siting.html](http://www1.eere.energy.gov/wind/impacts_siting.html)