

EOS



# TRUE SAUNA EXPERIENCE

WITH QUALITY PRODUCTS MADE IN GERMANY

EOS is characterized by a perfect interaction of extensive know-how and a passion for design, performance and safety.

The development process of each product is our top priority. All the EOS prototypes go through extensive tests and measurements. All products are manufactured by competent and highly motivated specialists using the highest quality materials.

The EOS product portfolio contains trendsetting high-quality electric sauna heaters and corresponding sauna controls for private and commercial sauna facilities, as well as infrared systems, steam room equipment and a wide range of accessories. The sauna heaters are characterized by their modern design and their large power range from 3.0 to 72.0 kW.

# CONTENTS

<b>Sauna heaters</b> .....	<b>04</b>
Finnish (dry) sauna heaters .....	04
Bi-O sauna heaters with vaporizer .....	50
EOS Selection sauna heaters .....	74
Event sauna heaters .....	80
<b>Sauna control units</b> .....	<b>88</b>
Sauna control units EOS Econ .....	90
Sauna control units EOS Compact .....	96
Sauna control units EOS EmoTec .....	102
Sauna control units EOS EmoStyle .....	104
Sauna control units EOS EmoTouch .....	106
Extension modules .....	110
Power extension units (LSG) .....	116
<b>Hygiene systems</b> .....	<b>118</b>
<b>Safety systems</b> .....	<b>120</b>
<b>Coloured light systems</b> .....	<b>122</b>
<b>Steam room equipment</b> .....	<b>124</b>
Steam generator .....	126
Control units and accessories for steam rooms .....	128
<b>Infrared systems</b> .....	<b>132</b>
Infrared heaters .....	134
Control units for infrared cabins .....	138
Infrared heating foils and accessories .....	142
Infrared and tanning systems .....	144
<b>Essence dosing systems and flake-ice machines</b> .....	<b>146</b>
Dosing and water splash systems .....	148
Salt nebulizer systems .....	150
Flake-ice machines .....	152
<b>Sauna accessories</b> .....	<b>154</b>
<b>Important notes</b> .....	<b>172</b>

# FINNISH SAUNA HEATERS

## WHY AN EOS SAUNA HEATER

- Know-how and decades of experience of Europe's leading luxury class manufacturer.
- Comprehensive model range from 3 to 72 kW.
- Large design variety in many price categories.
- Well-thought construction in every detail.
- Long-lasting products, robust and reliable.
- Extensive product support and service.
- Continuous quality control and product testing for safety and norm compliance, extra long warranty.
- „Made in Germany“ quality.

FOR TRADITIONAL FINNISH SAUNA



Model 1  
feet optional      Model 2

## EOS Picco W | wall-mounting

- Very compact size sauna heater for saunas up to 4,5 m<sup>3</sup>.
- Single-phase power supply 230 V 1N.
- Available in two versions with three exterior designs: polished chrome steel, matt black or anthracite pearl effect finish.
- Optional feet allow floor-standing installation.
- Rock store fits up to 10 kg stones.



## EOS M3 W | wall-mounting

- Built-in control unit for quick and easy settings.
- Temperature control range 40 - 110 °C.
- Recommended for saunas up to 4 m<sup>3</sup>.
- Very slim design – only 20 cm depth.
- Available in polished chrome steel or anthracite finish.
- Single-phase power supply 230V 1N.
- Rock store fits up to 8 kg stones.

# FINNISH SAUNA HEATERS

An icy cold winter's day or a mild summer's night – a bath in the sauna is always relaxing. With an EOS heater it's easy to feel comfortable in a rustic sauna made of solid wood or in an element sauna of a stylish design.

EOS offers a large variety of Finnish or vaporizer heaters available as floor-standing or wall-mounting heaters in various designs.

EOS sauna heaters stand out through their well-thought construction, choice of top quality materials and meticulous attention to every detail.

The excellent convection of the EOS heaters provides optimum air circulation in the cabin and thus creates a pleasant sauna climate.

Model	Item no.	Size (H×W×D)	Power		
EOS Picco W black	94 7619	Model 1 500×300×215 mm	3,0 kW		
	94 7622		3,5 kW		
EOS Picco W Anthracite	94 7620		3,0 kW		
	94 7623		3,5 kW		
EOS Picco W Stainless steel	94 7621		3,0 kW		
	94 7624		3,5 kW		
EOS Picco W black	94 7625		Model 2 500×300×230 mm	3,0 kW	
	94 7628			3,5 kW	
EOS Picco W Anthracite	94 7626			3,0 kW	
	94 7629			3,5 kW	
EOS Picco W Stainless steel	94 7627			3,0 kW	
	94 7630			3,5 kW	
EOS M3 W Stainless steel	94 1921			600×300×200 mm	3,0 kW
EOS M3 W Anthracite	94 7348				

# FINNISH SAUNA HEATERS

## QUALITY IS ATTENTION TO EVERY DETAIL

For our sauna heaters we use a special high quality powder coating with anthracite pearl effect finish. This powder coating is applied on the sauna heater shell in a complex process and then literally baked on it under very high temperatures. The result is a smooth, slightly shimmering surface with anthracite-grey colour.

Powder coated surfaces are considerably more scratch resistant in comparison to the wet paint and provide sauna heaters an attractive, contemporary design.

Model	Item no.	Size (H×W×D)	Power
EOS Filius W	94 5031	570×400×240 mm	4,5 kW
	94 5032		6,0 kW
	94 5033		7,5 kW
EOS Filius Control W	94 6038	575×470×240 mm	4,5 kW
	94 6039		6,0 kW
	94 6040		7,5 kW



4,5

6,0

7,5

## EOS Filius W | wall-mounting

- Finnish sauna heater for domestic saunas from 4 to 10 m<sup>3</sup>
- Very slim – only 24 cm depth, direct mounting to the sauna wall
- Modern, timeless design. Brushed stainless steel top, outer shell in anthracite pearl effect finish.
- Rock store fits up to 8 kg stones.



4,5

6,0

7,5

## EOS Filius Control W | wall-mounting

- Compact wall-mounting heater with built-in control unit (temperature and heating time control).
- Control unit at the top side for quick and simple operation.
- Very slim - only 24 cm depth, direct mounting to the wall.
- Rock store fits up to 8 kg stones.



- 6,0
- 7,5
- 9,0

## EOS ThermoTec W | wall-mounting

- Wall-mounting heater for private saunas from 6 to 14 m<sup>3</sup>.
- With an elegant, curved die-cast aluminium top cover with integrated holders for optional essence cup holder or aroma tray.
- Stainless steel inner shell, reinforced construction.
- Rock store fits up to 18 kg stones.



- 6,0
- 7,5
- 9,0

## EOS ThermoTec S | floor-standing

- Floor-standing version based on the EOS ThermoTec W model.
- With an elegant, curved die-cast aluminium top cover with integrated holders for optional essence cup holder or aroma tray.
- Stainless steel inner shell, reinforced construction.
- Rock store fits up to 18 kg stones.

## FINNISH SAUNA HEATERS

Model	Item no.	Size (H×W×D)	Power
EOS ThermoTec W	94 5688	600×375×380 mm	6,0 kW
	94 5689		7,5 kW
	94 5690		9,0 kW
EOS ThermoTec S	94 5684	780×375×380 mm	6,0 kW
	94 5685		7,5 kW
	94 5686		9,0 kW



# FINNISH SAUNA HEATERS



Model	Item no.	Size (H×W×D)	Power
EOS Gracil	94 7904	760×505×250 mm	4,5 kW
	94 6755		6,0 kW
	94 6756		7,5 kW
	94 6757		9,0 kW
EOS Gracil black	94 7906	760×505×250 mm	4,5 kW
	94 7243		7,5 kW
	94 7244		9,0 kW
EOS Gracil W	94 7157	740×505×275 mm	6,0 kW
	94 7158		7,5 kW
	94 7159		9,0 kW
EOS Gracil W black	94 7245	740×505×275 mm	7,5 kW
	94 7246		9,0 kW



## EOS Gracil | floor-standing

- Very space-saving – only 25 cm depth.
- Flat rear side with recessed terminal box.
- Outer shell: anthracite pearl effect or matt black finish.
- Optional rear wall cover panel in black or anthracite finish – great for installation in front of glass walls.
- Full size 20 kg rock store despite very shallow construction.



## EOS Gracil W | wall-mounting

- Very space-saving – only 27.5 cm depth.
- Wall mounting with only 3 cm gap to the wall.
- Outer shell: anthracite pearl effect or matt black finish.
- Optional wooden guard rail with direct mounting on the heater.
- Dust & debris collecting tray at the bottom to keep sauna tidy.
- Full size 20 kg rock store despite very shallow construction.



6,0

7,5

9,0

## EOS Moment W | wall-mounting

- Wall-mounting heater for domestic saunas from 6 to 14 m<sup>3</sup>.
- Optimized construction with the well balanced air convection performance - provides quick heat-up times and ensures powerful water splash effect.
- Contemporary, timeless design with a slightly curved outer shell and an elegant black finish.
- Rock store fits up to 15 kg stones.



7,5

9,0

## EOS Moment Control W | wall-mounting

- Very simple and easy to use thanks to the integrated control. Temperature control range 40- 100 °C, heating time limitation up to 4 h.
- Integrated sensor – no separate installation, only power supply connection needed.
- Contemporary, timeless design with the elegant black finish housing and brushed steel top.
- Rock store fits up to 15 kg stones.



Model	Item no.	Size (H×W×D)	Power
EOS Moment W	94 6858	640 × 440 × 330 mm	6,0 kW
	94 6859		7,5 kW
	94 6860		9,0 kW
EOS Moment Control W	94 7581	640 × 440 × 330 mm	7,5 kW
	94 7582		9,0 kW



# FINNISH SAUNA HEATERS

Model	Item no.	Size (H×W×D)	Power
EOS Organic W	94 7549	650×430×385 mm	6,0 kW
	94 7550		7,5 kW
	94 7551		9,0 kW
	94 7890		10,0 kW
	94 7552		10,5 kW
EOS Euro	90 7686	610×460×350 mm	7,5 kW
	90 7687		9,0 kW
	94 7886		10,0 kW
	94 5185		10,5 kW
	90 8076		12,0 kW
Feet	90 7110	Height with feet 760 mm	

**EOS**



6,0

7,5

9,0

10,0

10,5

Guard rail optional

## EOS Organic W | wall-mounting

- Perfectly suitable for small to medium-sized sauna cabins.
- Distinctive, unusual look – the Organic impresses with its unique futuristic design.
- The asymmetrical cut-outs in the top cover ensure optimal air circulation.
- The combination of brushed stainless steel and anthracite pearl effect finish on the outer shell and its curved edges underline the modern character.
- Rock store fits up to 20 kg stones.



7,5

9,0

10,0

10,5

12,0

## EOS Euro | wall-mounting / floor-standing

- Upper class sauna heater for sauna rooms from 7 to 18 m<sup>3</sup>.
- With the optional feet may be used as a floor-standing model.
- Space-saving design – only 35 cm depth.
- Durable triple-shell construction, all made of stainless steel.
- Massive die-cast iron top, polished chrome steel outer shell.
- Rock store fits up to 15 kg stones.



## EOS Cubo/Cubo+ | floor-standing

- Modern design heater for sauna rooms from 7 to 18 m<sup>3</sup>.
- Suitable for domestic and commercial use.
- Compact foot print 40x39 cm thanks to the recessed terminal box.
- Rock store above the heating elements - for improved air convection, longer lifetime of heating elements, simplified servicing.
- Outer shell in anthracite pearl effect finish.
- Brushed stainless steel top.
- Optional guard rail mounting brackets.
- EOS Cubo - rock store fits approx. 25 kg stones.
- EOS Cubo Plus - extra-large rock store fits approx. 45 kg stones. Outer shell: anthracite pearl effect or matt black finish.

### Rear wall cover for EOS Cubo/Cubo+

Optionally available for EOS Cubo/Cubo+ heaters, rear wall cover in anthracite or black finish – ideal e.g. for installation in front of glass.



Model	Item no.	Size (H×W×D)	Power
EOS Cubo	94 5073	720×400×385 mm	7,5 kW
	94 5074		9,0 kW
	94 7880		10,0 kW
	94 6592		10,5 kW
	94 5075		12,0 kW
EOS Cubo+	94 5974	950×400×385 mm	7,5 kW
	94 5975		9,0 kW
	94 7881		10,0 kW
	94 5976		10,5 kW
	94 5977		12,0 kW
EOS Cubo+ black	94 7865	950×400×385 mm	7,5 kW
	94 7866		9,0 kW
	94 7882		10,0 kW
	94 7867		10,5 kW
	94 7868		12,0 kW

# FINNISH SAUNA HEATERS



Model	Item no.	Size (HxWxD)	Power
EOS Cubo Avantgarde black	94 7109	720x400x385 mm	9,0 kW
	94 7885		10,0 kW
	94 7369		10,5 kW
	94 7110		12,0 kW



- 9,0
- 10,0
- 10,5
- 12,0

## EOS EOS Cubo Avantgarde floor-standing

- Exclusive, distinctive design.
- Robust, durable and service-friendly construction.
- Luxurious matt black finish on all sides.
- Uniform appearance on all sides – perfect for installation in front of glass panel or in the centre of the sauna.
- Optimized air convection and rock store size ensure effective heat-up times and powerful water splashing.
- Compact size – only 38,5 cm depth.
- Service-friendly construction – heating elements above rock store with no contact to sauna stones
- With rock store extension frame, 10 kg rounded white quartz stones included in the delivery.



Guard rail optional

Reicht die Einrichter OHG

- 7,5
- 9,0
- 10,0
- 12,0



EOS Cubo 2 - Styling 1

EOS Cubo 2+ black - Styling 2

## EOS Cubo 2 / Cubo 2+ floor-standing

- Very elegant, contemporary design with fully redesigned body and top cover in two stylings.
- Available with classic anthracite or with matt black finish.
- Same appearance on all sides thanks to the integrated rear side cover panel in matching finish.
- Proven, highly durable and long-lasting construction.
- Optimal relation between stone volume and air convection system for fast heat-up times and powerful water splashes.
- Easy to service – heating elements without contact to stones. Rock store above the heating block.
- Compact, place-saving size – only 38.5 cm depth.
- EOS Cubo 2 – rock store fits approx. 25 kg stones.
- EOS Cubo 2+ – extra-large rock store fits approx. 45 kg stones.



Styling 1 – round holes



Styling 2 – structure

# FINNISH SAUNA HEATERS



Model	Item no.*	Size (H×W×D)	Power
EOS Cubo 2 Anthrazit Styling 1	948890	720×400×385 mm	7,5 kW
	948891		9,0 kW
	948892		10,0 kW
	948893		12,0 kW
EOS Cubo 2 Anthrazit Styling 2	948898		7,5 kW
	948899		9,0 kW
	948900		10,0 kW
	948901		12,0 kW
EOS Cubo 2 black Styling 1	948894		7,5 kW
	948895		9,0 kW
	948896		10,0 kW
EOS Cubo 2 black Styling 2	948897		12,0 kW
	948902	7,5 kW	
	948903	9,0 kW	
	948904	10,0 kW	
	948905	12,0 kW	

\* EOS Cubo 2+ – upon request.

## Best EOS technology in a new design



EOS Scent Trophy S  
essence bowl – upon request.  
Guard rail optional.



**360° Look**  
incl. rear wall cover panel in the  
colour of the outer shell.



# FINNISH SAUNA HEATERS



Model	Item no.	Size (H×W×D)	Power
EOS P1 W	94 8906	720×630×380 mm	12,0 kW
	94 8907		15,0 kW
EOS P1 W anthracite	94 8913		12,0 kW
	94 8914		15,0 kW
EOS P1+	94 7889	720×630×380 mm	10,0 kW
	94 6383		10,5 kW
	94 6382		12,0 kW
	94 6381		15,0 kW



- 12,0
- 15,0

## EOS P1 W | wall-mounting

- Sauna heater for commercial saunas 14 to 25 m<sup>3</sup>.
- Slim design – only 380 mm depth.
- Outer shell made of stainless steel or anthracite finish.
- Optimal relation between stone volume and air convection capacity for fast heat-up times and powerful infusions.
- Single circuit wiring. Terminal box at the rear side. Bottom serves as a dust and water collecting tray.
- 30 kg rock store volume.



- 10,0
- 10,5
- 12,0
- 15,0

## EOS P1+ | floor-standing

- Sauna heater for commercial saunas 11 to 25 m<sup>3</sup>.
- Robust, durable construction of stainless steel.
- Optimized air convection for faster heat-up times.
- Slim design – only 380 mm depth.
- 40 kg rock store volume.

KiLife



6,0

7,5

9,0



**Edge / Edge Control:**  
Optional side cover panels  
with anthracite or black finish.

## EOS Edge | floor-standing

- Stylish sauna heater in „tower“ design with the rock store open on all sides.
- Very compact size – only 35 x 35 cm footprint.
- Durable stainless steel housing, adjustable feet.
- Optional side cover panels with anthracite or black finish can be added on 1- 4 sides.
- Up to approx. 100 kg stone volume.



7,5

9,0



**Edge / Edge Control:**  
Guard rail optional

## EOS Edge Control | floor-standing

- Stylish sauna heater in „tower“ design with the rock store open on all sides and built-in control unit.
- Temperature control range 40 - 100 °C. Heating time up to 4 h.



### Mounting brackets for guard rail

Allows to mount a custom-design wooden guard rail directly to the heater. Ideal for installation e.g. in front of glass.

Model	Item no.	Size (H×W×D)	Power
EOS Edge	94 6976	1000×350×350 mm	6,0 kW
	94 6977		7,5 kW
	94 6978		9,0 kW
EOS Edge Control	94 7367		7,5 kW
	94 7368		9,0 kW
Side cover panel, anthracite	94 7115	for EOS Edge / Edge Control	
Side cover panel, black matt	94 7116		

Model	Item no.	Size (H×W×D)	Power
EOS FinnRock	94 3931	760×413×385 mm	7,5 kW
	94 3932		9,0 kW
	94 3933		12,0 kW
EOS FinnRock black	94 7861	760×413×385 mm	7,5 kW
	94 7862		9,0 kW
	94 7863		12,0 kW
EOS Saunadome II	94 5603	1000×410×410 mm	9,0 kW
	94 5604		12,0 kW
	94 5605		15,0 kW
	94 5606		18,0 kW



Alpha Wellness Sensations

- 7,5
- 9,0
- 12,0



## EOS FinnRock | floor-standing

- Designer sauna heater for domestic and commercial saunas from 7 to approx. 18 m<sup>3</sup>.
- Unique design thanks to the partially open rock store with a special design front side grill. Compact footprint – 40×39,5 cm.
- Very robust construction, completely made of stainless steel.
- Outer shell: anthracite pearl effect or matt black finish
- Rock store above the heating elements – for improved air convection, longer lifetime of heating elements and simplified servicing.
- Extra large rock store with 40 kg volume.



Guard rail optional

## EOS Saunadome II | floor-standing

- Upmarket category sauna heater in unique „Tower“ design for domestic and commercial sauna rooms from 9 to approx. 30 m<sup>3</sup>.
- 100 kg rock store – ideal for frequent, powerful water splashes and high temperature stability.
- Rock store open on all sides – allows water splashes from any side.
- Optimal for central placement or installation in front of glass walls.
- High safety – thanks to specially angled side frame the stones and water remain inside the rock store and may not fall out of the heater.
- Very high heat storage capacity.



- 9,0
- 12,0
- 15,0
- 18,0



Mounting brackets for guard rail

## EOS Zeus S / SL | floor-standing

- Luxury class sauna heater with the distinctive round-design. Suitable for domestic and commercial use.
- Ideal for compact or mid-sized saunas.
- Choice of two designs – EOS Zeus S and Zeus SL.
- The highlight of EOS Zeus S is the unique laser-cut solid steel housing with approx. 25 kg rock store. The optionally available matching design round shape protective rail in 360° or 270° sets the crowning touch to the spectacular design of this model.
- Finish – red-brown powder coating in "Rust Marbel"  
Optionally available in anthracite and matt black.
- Safety guard rail – optionally available (rail and mounting brackets to be ordered separately).



- 9,0
- 12,0
- 15,0



## EOS EuroMax | floor-standing

- Sauna heater for domestic and commercial sauna rooms from 9 to approx. 25 m<sup>3</sup>.
- Extra-large rock store with enlarged side air channels ensures top-performance at all times.
- Reinforced, extra durable construction, made of stainless steel.
- Elegant, curved die-cast aluminium top with holders for optional herbs bowl or essence tray.
- Rock store (60kg stone volume) above the heating elements, which may be replaced without removing the stones.

## FINNISH SAUNA HEATERS

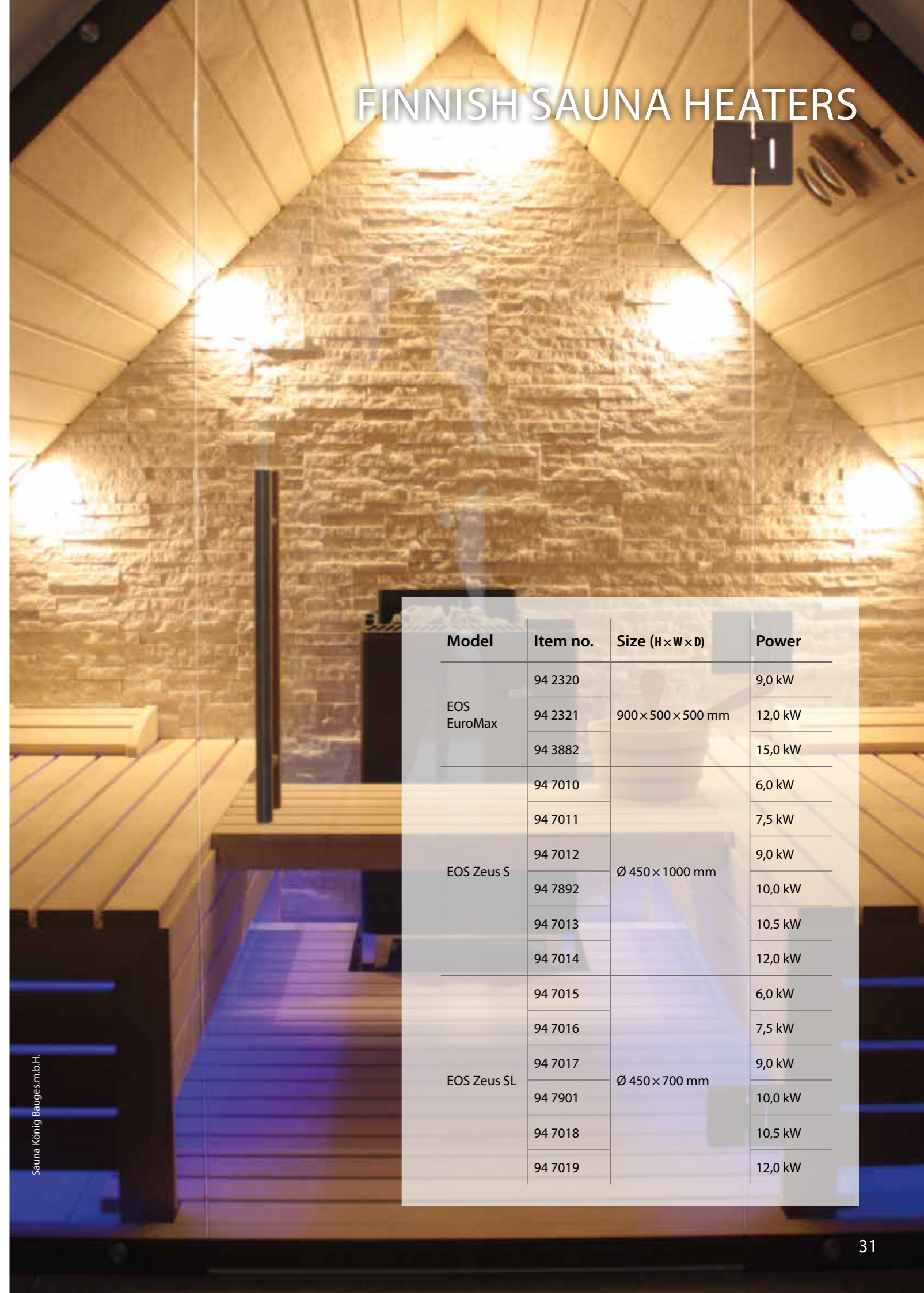

Model	Item no.	Size (H×W×D)	Power
EOS EuroMax	94 2320	900×500×500 mm	9,0 kW
	94 2321		12,0 kW
	94 3882		15,0 kW
EOS Zeus S	94 7010	Ø 450×1000 mm	6,0 kW
	94 7011		7,5 kW
	94 7012		9,0 kW
	94 7892		10,0 kW
	94 7013		10,5 kW
	94 7014		12,0 kW
EOS Zeus SL	94 7015	Ø 450×700 mm	6,0 kW
	94 7016		7,5 kW
	94 7017		9,0 kW
	94 7901		10,0 kW
	94 7018		10,5 kW
	94 7019		12,0 kW



# FINNISH SAUNA HEATERS



## EOS Herkules / Stone S25

floor-standing

- Exclusive luxury class sauna heater for private and commercial saunas.
- Thanks to the flat rear side panel with the recessed terminal block, these heaters may be installed in front of glass panels or in the center of the sauna.
- Side panels in anthracite pearl effect finish and brushed stainless steel provide a distinctive, high contrast, straight-lined design.
- Also available with high-quality matt black finish.
- Optional rear wall cover panel and wooden heater guard rail with brackets available.
- Rock store fits approx. 25 kg stones.
- **EOS Stone S25:** As Herkules S25, but with the front side fitted with massive soapstone panels. Also available with high-quality matt black finish..

7,5  
9,0



EOS Herkules S25

EOS Herkules S25 black



EOS Stone S25

EOS Stone S25 black

## EOS Herkules / Stone S60

floor-standing

- High-performance sauna heater large private and commercial saunas.
- Thanks to the extra large rock store and the included 60 kg sauna stones, EOS Herkules S60 models offer an exceptional heat storage and powerful steam shocks.
- Side panels in anthracite pearl effect finish and brushed stainless steel provide a distinctive, high contrast, straight-lined design.
- Also available with high-quality matt black finish.
- Optional rear wall cover panel and wooden heater guard rail with brackets available.
- Rock store fits approx. 60 kg stones.
- **EOS Stone S60:** As Herkules S60, but with the front side fitted with massive soapstone panels.

9,0  
12,0  
15,0



EOS Herkules S60 black

EOS Herkules S60



EOS Stone S60

Model	Item no.	Size (H×W×D)	Power	
EOS Herkules S25	94 4326	750×400×385 mm	7,5 kW	
	94 4327		9,0 kW	
EOS Herkules S25 black	94 7250		7,5 kW	
	94 7237		9,0 kW	
EOS Stone S25	94 4326		7,5 kW	
	94 4327		9,0 kW	
EOS Stone S25 black	94 7250		7,5 kW	
	94 7237		9,0 kW	
EOS Herkules 60	94 4493		850×510×530 mm	9,0 kW
	94 4272			12,0 kW
	94 4273	15,0 kW		
EOS Herkules 60 black	94 7689	9,0 kW		
	94 7690	12,0 kW		
	94 7691	15,0 kW		
EOS Stone 60	94 4616	9,0 kW		
	94 4586	12,0 kW		
	94 4587	15,0 kW		



7,5

9,0



EOS Mythos S35 CRS  
Anthracite finish with  
brushed stainless  
steel front

EOS Mythos S35  
anthracite  
Guard rail and EOS Cubius  
sauna stones optional

## EOS Mythos S35 | floor-standing

- Exclusive sauna heater for design-oriented sauna cabin.
- The cubistic design is completed by the unique Cubius stones, which offer individual design options. Cubius stones are optionally available.
- Mythos black & white include Cubius stones in matching finish.
- Very space-saving – only 37 cm depth.
- Can be equipped with an optional vaporizer to enable flexible climate forms.
- Incl. pre-mounted 8 m connection cable.
- Optional safety guard rail and EOSafe L safety system available.
- Rock store fits approx. 35 kg stones.



EOS Mythos S35 / S45:  
For optional vaporizer with an-  
thracite, white or black finish,  
please refer to page 73.

## FINNISH SAUNA HEATERS

Model	Item no.	Size (H×W×D)	Power
EOS Mythos S35 CRS	94 4330	840×420×370 mm	7,5 kW
	94 4331		9,0 kW
EOS Mythos S35 anthracite	94 4330		7,5 kW
	94 4331		9,0 kW
EOS Mythos S35 white	94 4330		7,5 kW
	94 4331		9,0 kW
EOS Mythos S35 black	94 7692		7,5 kW
	94 7693		9,0 kW



# FINNISH SAUNA HEATERS

Model	Item no.	Size (H×W×D)	Power
EOS Mythos S45 CRS	94 5583	840×500×370 mm	12,0 kW
	94 5584		15,0 kW
EOS Mythos S45 anthracite	94 5490		12,0 kW
	94 5491		15,0 kW
EOS Mythos S45 white	94 5991		12,0 kW
	94 5992		15,0 kW
EOS Mythos S45 black	94 6068		12,0 kW
	94 6069		15,0 kW
EOS Credo	94 8809	810×500×400 mm	12,0 kW
	94 8808		15,0 kW

36

## Accessories for EOS Mythos S35 / S45 series



Pollmeier Holzbauelemente GmbH

**EOS Mythos Glass:** black glass panel for EOS Mythos S35/S45 heaters optional.



Further Cubius variants, colors and heights are optionally available, which offer individual design options.



# EOS



12,0  
15,0

## EOS Mythos S45 | floor-standing

- Exclusive sauna heater for design-oriented sauna cabin.
- As EOS Mythos S35 model, but with 45 kg rock store volume.
- Can be equipped with an optional vaporizer to enable flexible climate forms.
- Optional safety guard rail and EOSafe L safety system available.



12,0  
15,0

## EOS Credo | floor-standing

- Unique design with black ceramic tiles.
- Cubius stones and diabase sauna stones are inc. in the delivery.
- The cubistic design is perfectly complemented by the elegant base.
- Just 2 cm safety gap thanks to excellent thermal insulation.
- Rock store fits approx. 40 kg stones.
- Optional EOSafe L safety system ensures safety in your sauna.

Alpha Wellness Sensations

## EOS Herkules XL S50

floor-standing

- Unique design featuring innovative construction with two separate rock stores.
- Two 25 kg large rock stores provide a perfect balance between strong air convection and optimal heat storage capacity. This ensures an optimized air convection and allows to make water splashes alternately on the left or on the right side for more steam and more sauna enjoyment.
- Thanks to the stretched design and the flat rear wall with recessed terminal boxes, EOS Herkules XL S50 may be placed in front of glass panels.
- Side panels in anthracite pearl effect finish and brushed stainless steel provide a distinctive, high contrast, straight-lined design.
- Also available with high-quality matt black finish.
- Optional safety guard rail with brackets available.
- Rock store fits approx. 50 kg stones.



EOS Herkules XL S50

EOS Herkules XL S50  
black

12,0

15,0

## EOS BlackRock | floor-standing

- Sauna heater for intensive commercial use.
- Durable construction made of stainless steel.
- High-contrast design with side panels with anthracite finish and corners made of polished stainless steel. Top cover of polished stainless steel or alternatively with all sides and top with stylish matt black finish.
- Looks the same on all sides, no typical rear side – ideal for installation in front of glass panels or for central position. Cable connection on the bottom.
- Thanks to an optional vaporizer 3.0 kW, BlackRock can also be used as Bi-O version for humid sauna operation. Retrofitting possible on site.
- Rock store fits approx. 40 kg stones.

12,0

15,0

18,0



Guard rail optional



For optional vaporizer,  
please refer to page 73



Available as Water mill sauna,  
please refer to page 87

# FINNISH SAUNA HEATERS



Model	Item no.	Size (H×W×D)	Power	
EOS Herkules XL S50	94 4330	750×750×385 mm	12,0 kW	
	94 4331		15,0 kW	
EOS Herkules XL S50 black	94 7692		12,0 kW	
	94 7693		15,0 kW	
EOS BlackRock	94 7140		830×555×555 mm	12,0 kW
	94 7141			15,0 kW
	94 7142	18,0 kW		
EOS BlackRock black	94 7312	12,0 kW		
	94 7313	15,0 kW		
	94 7314	18,0 kW		
Vaporizer	94 7230 / 94 7324	3.0 kW, anthracite / black		

# FINNISH SAUNA HEATERS



Model	Item no.	Size (H×W×D)	Power
EOS 34.G HD (Type 1)	94 8097	950×750×530 mm	15,0 kW
	94 8098		18,0 kW
	94 8099		21,0 kW
EOS 34.G HD (Type 2)	94 7360	950×1000×530 mm	24,0 kW
	94 7361		27,0 kW
	94 7362		30,0 kW
	94 7363		36,0 kW
EOS Goliath HD	94 7827	825×960×470 mm	18,0 kW
	94 7827		24,0 kW
	94 7828		30,0 kW
	94 7829		36,0 kW

## EOS Goliath HD | floor-standing

- Modern, design-oriented sauna heater for large saunas up to 75 m<sup>3</sup>.
- “Heavy-duty” version with copper rails as standard inner wiring and therefore perfectly suitable for saunas with particularly intensive use.
- Very robust and durable, completely made of stainless steel. Reinforced frame construction.
- Optional brackets for heater guard rail mounted directly on the heater.
- External shell in anthracite pearl effect finish. Brushed stainless steel top. Terminal box with ceramic terminals.
- No contact between sauna stones and heating elements for improved heating performance and longer service life of heating elements.
- Rock store fits approx. 75 kg stones.



**Guard rail mounting brackets**  
Optional mounting brackets allow to mount a wooden guard rail in own design directly on the Goliath heater.

- 15,0
- 18,0
- 21,0
- 24,0
- 27,0
- 30,0
- 36,0



Size 1: 15,0 - 21,0 kW (30 kg stone volume)  
Size 2: 24,0 - 36,0 kW (45 kg stone volume)



Frame rack for heater guard rail optional:  
Application and installation example without and with wooden parts

## EOS 34.G HD | floor-standing

- Commercial sauna heater for large saunas up to 75 m<sup>3</sup>.
- “Heavy-duty” version with copper rails as standard inner wiring and therefore perfectly suitable for saunas with particularly intensive use.
- Exceptionally robust and durable construction in two sizes, completely made of stainless steel.
- Terminal box with ceramic terminals at the rear side.
- No contact between sauna stones and heating elements for improved heating performance and longer service life of heating elements. Innovative V-shape supports under the stone compartment prevent water flowing through after a water splash.
- Rock store may be enlarged with optional stack frame (30 - 45 kg).

### Accessories for EOS 34.G HD



Stack frame for additional 30 - 45 kg stones, for EOS 34.G heaters



Stack frame for additional 30 - 45 kg stones and cover protection rail with direct heater mounting.



©PONANT - Gilles Trillard

12,0

15,0

18,0

21,0

24,0



Guard rail optional

## EOS Orbit | floor-standing

- Optionally available round-shaped guard rail greatly enhances the visual appearance. Guard rail available in different wood sorts.
- Floor-standing sauna heater for dry Finnish sauna.
- Ideal for intensive commercial operation. For commercial saunas up to 40 m<sup>3</sup>.
- Timeless round-design, anthracite pearl effect finish. Upon request also available with red-brown powder coating in "Rust Marbel".
- Reinforced stainless steel construction with improved air convection performance. Very robust and durable.
- Ideal for central placement. Concealed cable connection.
- Service-friendly – Stone compartment separated from the heating elements.
- Safety guard rail in 360° or 270° optionally available. Includes mounting brackets for the optional guard rail.
- The optional EOSafe L safety system can be easily and discreetly attached to the heater and ensures safety in your sauna.
- Rock store with up to 40 kg volume.



Gästehaus Oben am Berg

Model	Item no.	Size (H×W×D)	Power
EOS Orbit	94 6421	Ø 655 × 920 mm	18,0 kW
	94 6422		21,0 kW
	94 6423		24,0 kW

### Safety guard rail for EOS Orbit heaters

Safety guard rail 360° Walnut	94 6900
Safety guard rail 270° Walnut	94 6894
Safety guard rail 360° Abachi	94 6896
Safety guard rail 270° Abachi	94 6890

# FINNISH SAUNA HEATERS

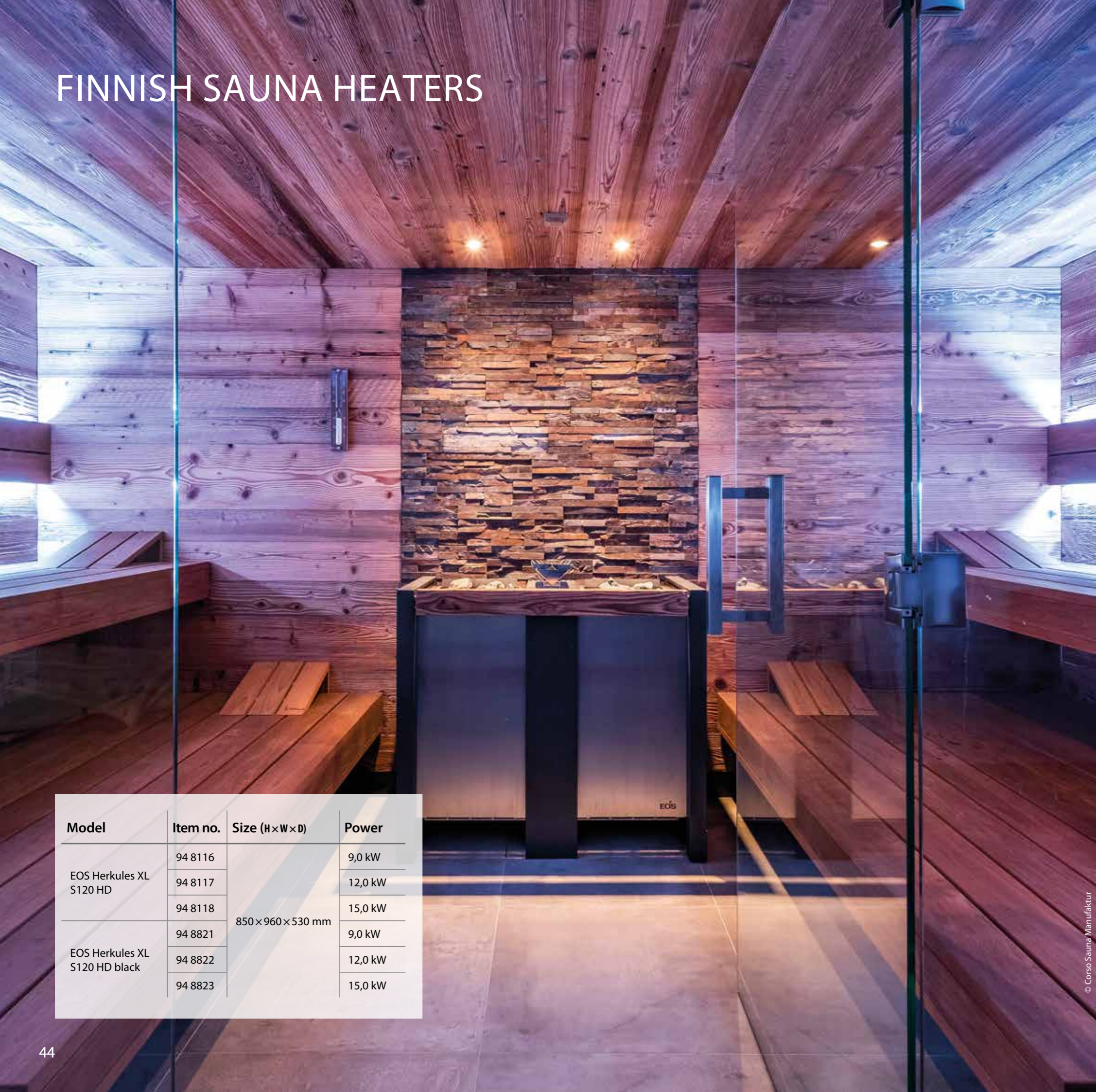

- 18,0
- 24,0
- 30,0



EOS Herkules XL S120 black

EOS Herkules XL S120

## EOS Herkules XL S120 HD

floor-standing

- The flagship of the EOS Herkules series for intensive use in large commercial saunas.
- “Heavy-duty” version with copper rails as standard inner wiring and therefore perfectly suitable for saunas with particularly intensive use.
- The EOS Herkules XL S120 set standards for superior performance, durability and sophisticated design.
- Two separate rock stores with up to 120 kg stones ensure an excellent temperature stability and heat storage capacity.
- The unique construction with rock stores above the heating elements provides continuously high performance and reliability, strong air convection, long service life and easy maintenance.
- Side panels in anthracite pearl effect finish and brushed stainless steel provide a distinctive, high contrast, straight-lined design.
- Also available with high-quality matt black finish.
- Optional rear wall cover panel and wooden heater guard rail with brackets available.
- Optional Herkules Fragrance, vaporizer dish arrangement with an integrated water supply available (see page 70).
- Rock store fits approx. 120 kg stones.

Model	Item no.	Size (H×W×D)	Power
EOS Herkules XL S120 HD	94 8116	850×960×530 mm	9,0 kW
	94 8117		12,0 kW
	94 8118		15,0 kW
EOS Herkules XL S120 HD black	94 8821		9,0 kW
	94 8822		12,0 kW
	94 8823		15,0 kW

© Corso Sauna Manufaktur



EOS Zeus HD  
guard rail optional



EOS Zeus L HD

20,0

24,0

30,0

36,0

EOS Zeus / Zeus L HD with 30.0 kW and 36.0 kW output, incl. stack frame.

## EOS Zeus / Zeus L HD

floor-standing

- Designer luxury class sauna heater for saunas up to 75 m<sup>3</sup>.
- "Heavy-duty" version with copper rails as standard inner wiring and therefore perfectly suitable for saunas with particularly intensive use.
- Suitable for very intensive commercial operation.
- Spectacular round design with red-brown powder coating in "Rust Marbel". High precision laser cut housing.
- Alternatively available in matt black and anthracite pearl effect finish.
- Choice of two designs – EOS Zeus HD and Zeus L HD.
- Optional round shape safety guard rail in matching design. The guard rail is available in different wood sorts and in 270° or 360° design (Ø 940 mm diameter).
- Durable construction with the massive 8 mm steel wall.
- Extra large rock store with up to 60 kg volume.
- Great for installation in front of glass or for central position.
- Includes pre-mounted double-line connection cable with special heavy-duty connectors.



Bergdorf Priesteregg GmbH

Model	Item no.	Size (H×W×D)	Power
EOS Zeus HD	94 7837	Ø 700 × 1250 mm	20,0 kW
	94 7838		24,0 kW
	94 7839		30,0 kW
	94 7840		36,0 kW
EOS Zeus L HD	94 7849	Ø 700 × 790 mm	20,0 kW
	94 7850		24,0 kW
	94 7851		30,0 kW
	94 7852		36,0 kW

Safety guard rail for EOS Zeus heaters	
Safety guard rail 360° Walnut	94 6598
Safety guard rail 270° Walnut	94 6597
Safety guard rail 360° Abachi	94 6606
Safety guard rail 270° Abachi	94 6605



# FINNISH SAUNA HEATERS



Currently the world's most powerful electric sauna heater!



- 42,0
- 48,0
- 54,0
- 60,0
- 72,0

EOS Mega HD

- 36,0
- 42,0
- 48,0

EOS Mega S HD

## EOS Mega S HD / Mega HD | floor-standing

- High-performance sauna heater, specially designed for themed and event commercial saunas.
- “Heavy-duty” version with copper rails as standard inner wiring and therefore perfectly suitable for saunas with particularly intensive use.
- Expertly engineered, reinforced construction made of top-quality stainless steel.
- Optimal relation between stone volume and air convection ability for fast heat-up times and powerful water splashes.
- Rock store separated from heating elements for stable air flow. With unique EOS-designed V-shape profiles to ensure effective and complete evaporation by intensive water splashes.
- Contemporary, timeless design with uniform appearance on all sides. No typical “rear side”. Connections at the bottom.
- Rock store with approx. 95 kg (Mega S HD) / 120 kg (Mega HD) volume.

Model	Item no.	Size (H×W×D)	Power
EOS Mega S HD	94 8094	1000×900×800 mm	36,0 kW
	94 8045		42,0 kW
	94 8044		48,0 kW
EOS Mega HD	94 7735	1000×1200×800 mm	42,0 kW
	94 7736		48,0 kW
	94 7737		54,0 kW
	94 7738		60,0 kW
	94 7739		72,0 kW

Cyprianerhof/Standl Günter



9,0

12,0

## EOS Invisio XL | underbench heater

- Underbench heater for domestic and commercial saunas.
- High safety and place-saving effect thanks to the concealed underbench installation. Only 10cm gap to the partition wall needed.
- Extra-large rock store with up to 75 kg stone volume and water splash gutter across the full width. Includes water funnel, safety grill and pre-mounted cable.



6,0

9,0

12,0

## EOS Invisio Midi | underbench heater

- Underbench heater for domestic and commercial saunas.
- Slim version – only 38 cm depth.
- Rock store fits approx. 20 kg stones.



3,0

4,5

6,0

## EOS Invisio Mini | underbench heater

- Compact version for saunas up to 8 m<sup>3</sup> size.
- Only 66 cm width, rock store fits approx. 15 kg stones.

# FINNISH SAUNA HEATERS

EOS Invisio is a special range of the unique concealed „underbench“ sauna heaters.

EOS Invisio sauna heaters are installed under the sauna benches with a partition wall with only a 10 cm gap to the main sauna wall. Thanks to their construction and unique installation Invisio heaters offer high safety standards and save a lot of valuable space in the cabin. There is no more no risk of accidentally touching the heater and your sauna will look more spacious inside.

In spite of the hidden installation traditional water splashes are of course still possible. All Invisio heaters include a stainless steel water funnel with silicone tube. The special gutter inside the heater spreads the water over the entire heater width to ensure quick evaporation. All Invisio heaters also include pre-mounted cable and safety cover protection grill.

Model	Item no.	Size (H×W×D)	Power
EOS Invisio XL	94 5522	800×1160×580 m	9,0 kW
	94 6390		12,0 kW
EOS Invisio XL Anthracite	94 5816		9,0 kW
	94 6391		12,0 kW
EOS Invisio Midi	94 5786	650×1160×380 mm	6,0 kW
	94 5787		9,0 kW
	94 5788		12,0 kW
EOS Invisio Midi Anthracite	94 5813		6,0 kW
	94 5814		9,0 kW
	94 5815		12,0 kW
EOS Invisio Mini	94 5708	650×660×380 mm	3,0 kW
	94 5709		4,5 kW
	94 5710		6,0 kW
EOS Invisio Mini Anthracite	94 5810		3,0 kW
	94 5811		4,5 kW
	94 5812		6,0 kW

# FINNISH SAUNA HEATERS

## CONCEALED INSTALLATION - SPACE-SAVING AND SAFE

EOS 46.U sauna heaters provide two important advantages - they are installed behind a partition wall with only 22 cm gap to the sauna wall, which saves a lot of valuable space in a sauna room. This will allow more space for sauna benches and will make your sauna look more spacious. With only 20 cm depth EOS 46.U heaters belong to the slimmest models on the market today.

The concealed installation ensures at the same time increased safety in use - the heater cannot be accidentally touched while it is hot. A special safety grill mounted along the top edge of the partition wall effectively prevents objects from being dropped down on the heater. EOS 46.U heaters have been tested and approved for safety and compliance with the latest European norms.

The traditional water splashes are of course possible. Every heater includes a water funnel with the connection hose. Thanks to the special gutter inside the heater the water is spread across its full width for a quick and effective evaporation. And despite their slim depth EOS 46.U heaters still feature an approx. 8 kg rock store.

Model	Item no.	Size (H×W×D)	Power
EOS 46.U	94 4887	870×1120×200 mm	6,0 kW
	94 4888		7,5 kW
	94 4889		9,0 kW
	90 8608		12,0 kW
EOS 46.U XL	94 7219	870×1440×200 mm	15,0 kW
	94 7222		18,0 kW
EOS 46.U Compact	94 6707	870×920×200 mm	6,0 kW
	94 4250		7,5 kW

### Installation example for EOS 46.U sauna heaters

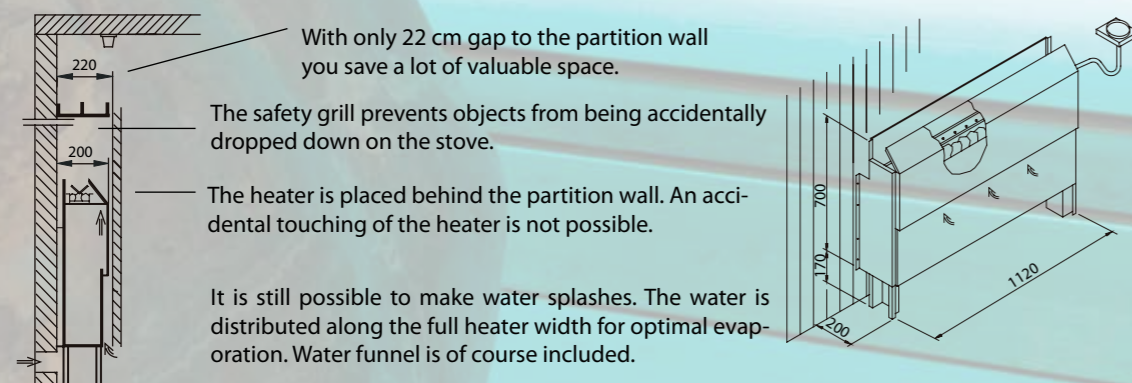

## EOS 46.U / 46.U XL

- For concealed installation behind a partition wall.
- Optimal for intensive commercial use.
- Only 20 cm depth – slim design saves valuable space.
- Very robust and reliable, completely made of stainless steel.
- Integrated gutter for water distribution, stones above the heating elements.
- High safety in use, no risk of touching the heater.
- Includes accessories: cover protection safety grill (46.U – 1200 mm, 46.U XL – 1600 mm), water funnel with silicone hose.
- Rock store with approx. 15 kg (46.U) / 20 kg (46.U XL) stone volume.



## EOS 46.U Compact

- Compact-size version of the 46.U model.
- Only 920 mm width.
- Includes accessories: safety grill, water funnel with silicone hose.
- Rock store with approx. 15 kg stone volume.

# BI-O SAUNA HEATERS



RUHA-Steinmüller Saunamanufaktur

## SAUNA HEATERS WITH VAPORIZER

# EOS



Model 1

Model 2  
feet optional

3,0  
3,5

## EOS Bi-O Picco W | wall-mounting

- Sauna heater for small domestic saunas, 230V 1N power supply.
- Very compact, space-saving design.
- Built-in vaporizer allows to set a large variety of climate forms – from traditional hot & dry to mild and humid.
- Vaporizer output 750 W. Integrated cup holder for essences.
- Available in two versions with three exterior designs: polished chrome steel, matt black or anthracite pearl effect finish.
- Optional feet allow floor-standing installation.
- Rock store fits approx. 10 kg stones.



4,5  
6,0  
7,5

## EOS Bi-O Filius W | wall-mounting

- Versatile heater for domestic saunas in extra-slim design.
- Only 24 cm depth, mounts directly to the sauna wall.
- Modern straight-lined design with anthracite finish outer shell.
- Vaporizer 750 W, can be mounted on the left and on the right. With cup holder for essences. Manual water filling.
- Rock store fits approx. 8 kg stones.



SAVNE ČAPUTA PTUJ PROIZVODNJA IN TRGOVINA, d.o.o.

# BI-O SAUNA HEATERS

## BI-O SAUNA HEATERS – SET THE CLIMATE AS YOU LIKE IT

Today a traditional hot Finnish sauna, tomorrow a mellow warm air both, and the next day an invigorating herbal steamy sauna bath: EOS Bi-O type sauna heaters with an integrated vaporizer allow to set the climate in your sauna just as you like it.

The vaporizer mounted right next to the heater section leaks the steam out next to the stones so that it is spread quickly in the entire cabin. An integrated bowl allows to place oils and sauna essences to make your sauna an aromatically exhilarating experience for the senses.

EOS Bi-O systems ensure optimal safety - sound alarm and automatic switch-off by water shortage are standard and the control units automatically adjust temperature and humidity.

Model	Item no.	Size (H×W×D)	Power	
EOS Bi-O Picco W black	94 7607	Model 1 500×300×215 mm	3,0 kW	
	94 7610		3,5 kW	
EOS Bi-O Picco W anthracite	94 7608		3,0 kW	
	94 7611		3,5 kW	
EOS Bi-O Picco W stainless steel	94 7609		3,0 kW	
	94 7612		3,5 kW	
EOS Bi-O Picco W black	94 7613		Model 2 500×300×230 mm	3,0 kW
	94 7616			3,5 kW
EOS Bi-O Picco W anthracite	94 7614			3,0 kW
	94 7617			3,5 kW
EOS Bi-O Picco W stainless steel	94 7615	3,0 kW		
	94 7618	3,5 kW		
EOS Bi-O Filius W	94 5144A	575×470×240 mm		4,5 kW
	94 5145A			6,0 kW
	94 5146			7,5 kW

## EOS Bi-O Tec W | wall-mounting

- High quality sauna heater with integrated vaporizer for domestic sauna cabins.
- Elegantly curved die-cast aluminium top cover.
- Stainless steel inner shell. Outer shell alternatively in anthracite finish or in polished chrome steel.
- Essences cup holder at the steam output.
- Vaporizer 1,5-2 kW with 5 l water tank, manual water filling.
- Rock store fits approx.15 kg stones.



- 6,0
- 7,5
- 9,0

## EOS Bi-O Organic W | wall-mounting

- Wall-mounting sauna heater with integrated vaporizer for flexible climate forms.
- Unique futuristic design. With the asymmetrical cut-outs in the top cover for air circulation and the curved edges, it is an absolute highlight in every sauna cabin.
- Essences cup holder at the steam output.
- Vaporizer 2 kW with 5 l water tank, manual water filling.
- Rock store fits approx.20 kg stones.



- 6,0
- 7,5
- 9,0
- 10,0
- 10,5



Guard rail optional



With asymmetrical cut-outs in the top cover

Model	Item no.	Size (H x W x D)	Power
EOS Bi-O Tec W anthracite	94 2605A	600 x 450 x 380 mm	6,0 kW
	94 2606A		7,5 kW
	94 2607A		9,0 kW
EOS Bi-O Tec W chrome steel	94 2608A		6,0 kW
	94 2609A		7,5 kW
	94 2610A		9,0 kW
EOS Bi-O Organic W	94 7672	650 x 500 x 385 mm	6,0 kW
	94 7673		7,5 kW
	94 7674		9,0 kW
	94 7891		10,0 kW
	94 7675		10,5 kW

Sauna König Bauges.m.b.H.

- 4,5
- 6,0
- 7,5
- 9,0



## EOS Bi-O Gracil

floor-standing

- Versatile sauna heater with integrated vaporizer for flexible climate settings - from hot and dry to mild and humid.
- Vaporizer 750W on the right, with herbs bowl.
- Extra-slim design – only 25.5 cm depth.
- Thanks to the recessed terminal box EOS Bi-O Gracil has a flat rear side and perfectly suits installations in front of glass panels.
- Elegant, straight-lined design.
- Durable brushed stainless steel top cover.
- Outer shell: anthracite pearl effect or matt black finish
- Optional rear wall cover panel in black or anthracite pearl effect finish.
- Optional wooden guard rail with direct mounting on the heater available.
- Dry-run protection with acoustic alarm. Manual filling. Water tank volume approx. 2l.
- Full size 20kg rock store despite very shallow construction.

## EOS Bi-O Gracil W

wall-mounting

- Versatile sauna heater with integrated vaporizer for flexible climate settings – from hot and dry to mild and humid.
- Vaporizer 750W on the right, with herbs bowl.
- Extra-slim design – only 27.5 cm depth.
- Wall mounting with only 3 cm gap to the wall.
- Wall-hanging model made of stainless steel, with integrated drip pan.
- Elegant, straightlined design.
- Durable brushed stainless steel top cover.
- Outer shell: anthracite pearl effect or matt black finish
- Optional wooden guard rail with direct mounting on the heater available.
- Dry-run protection with acoustic alarm. Manual filling. Water tank volume approx. 2l.
- Full size 20kg rock store despite very shallow construction.



- 6,0
- 7,5
- 9,0

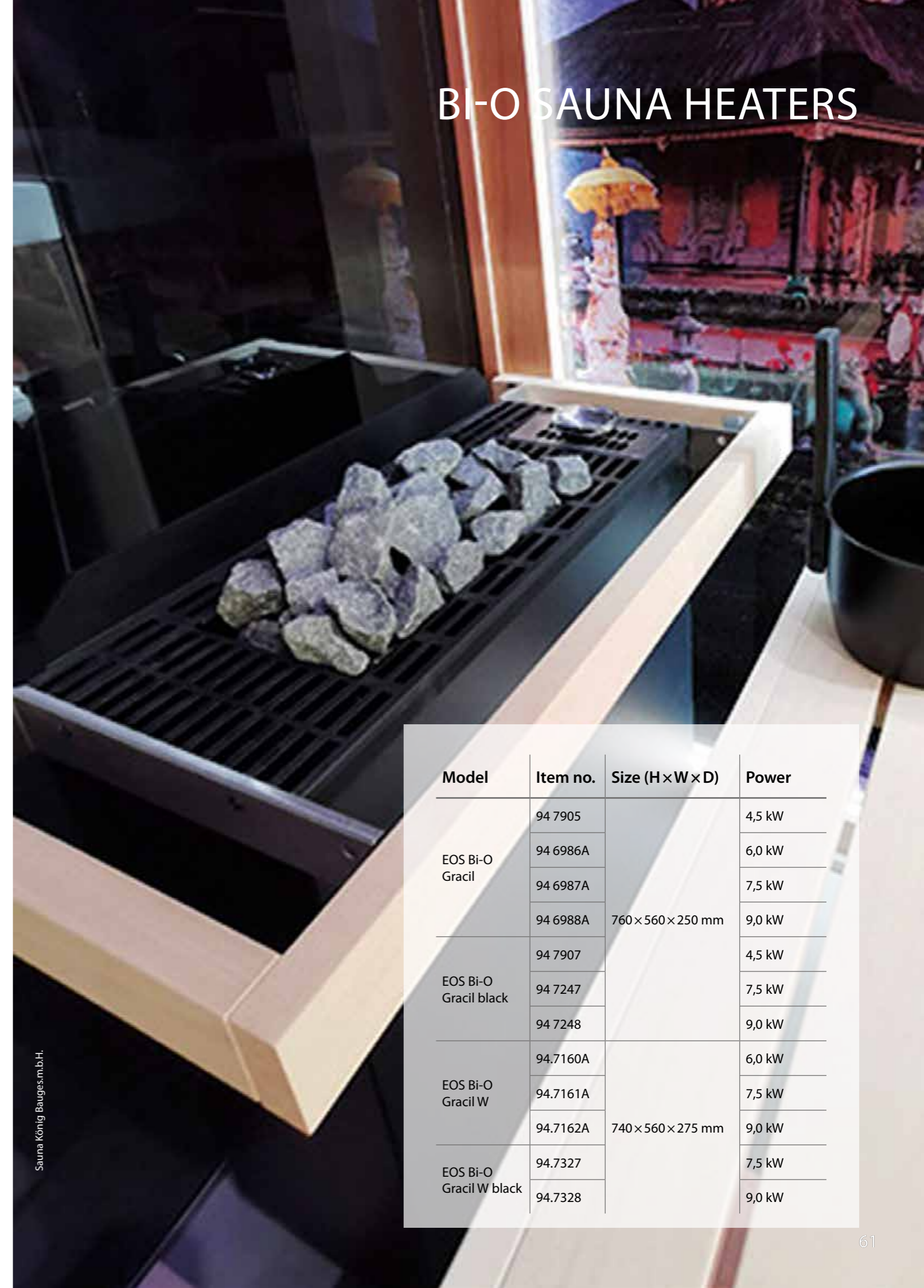

Model	Item no.	Size (H×W×D)	Power
EOS Bi-O Gracil	94 7905	760×560×250 mm	4,5 kW
	94 6986A		6,0 kW
	94 6987A		7,5 kW
	94 6988A		9,0 kW
EOS Bi-O Gracil black	94 7907	740×560×275 mm	4,5 kW
	94 7247		7,5 kW
	94 7248		9,0 kW
EOS Bi-O Gracil W	94.7160A	740×560×275 mm	6,0 kW
	94.7161A		7,5 kW
	94.7162A		9,0 kW
EOS Bi-O Gracil W black	94.7327	740×560×275 mm	7,5 kW
	94.7328		9,0 kW

Sauna König Bauges.m.b.H.

# BI-O SAUNA HEATERS



Model	Item no.	Size (H×W×D)	Power
EOS Bi-O Cubo	94 5922	950×400×395 mm	7,5 kW
	94 5923		9,0 kW
	94 7883		10,0 kW
	94 5924		10,5 kW
	94 5925		12,0 kW
EOS Bi-O Cubo black	94 7471	900×500×500 mm	7,5 kW
	94 7276		9,0 kW
	94 7884		10,0 kW
	94 7472		10,5 kW
	94 7277		12,0 kW
EOS Bi-O Max	94 2317	900×500×500 mm	9,0 kW
	94 2318		12,0 kW
	94 3922		15,0 kW

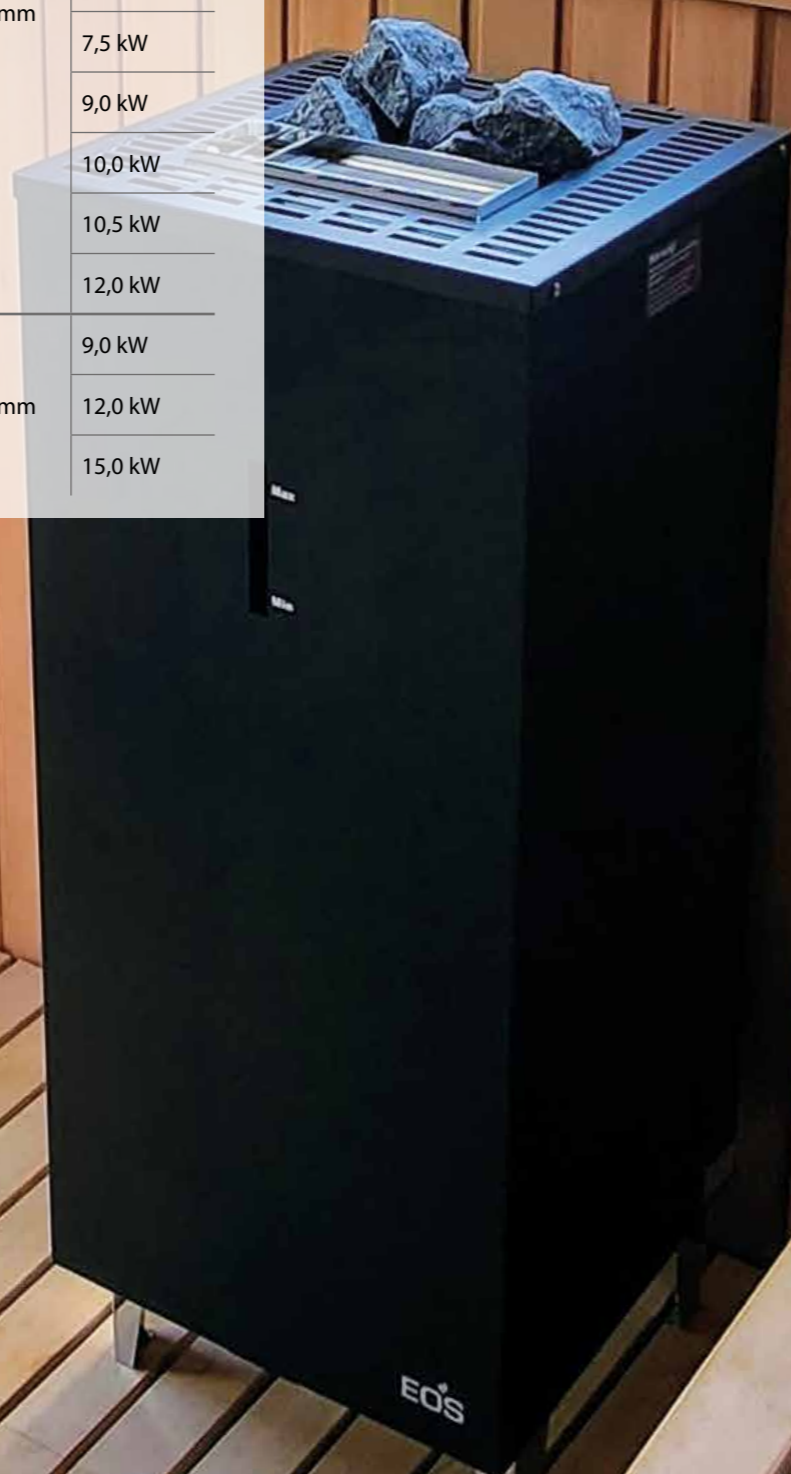

Saunas of the World

- 7,5
- 9,0
- 10,0
- 10,5
- 12,0



## EOS Bi-O Cubo | floor-standing

- Modern design floor-standing sauna heater for domestic and commercial sauna cabins.
- Contemporary straight-lined design with brushed stainless steel top.
- Recessed terminal box make EOS Bi-O Cubo ideal for installation in front of glass panels.
- Innovative construction – vaporizer placed under the heater, which ensures a very space-saving footprint 40x39,5 cm.
- Outer shell: anthracite pearl effect or matt black finish
- 2 kW / 3 kW vaporizer with 9l stainless steel water tank.
- Extra-large essence holder mounted in the rock store.
- Rock store fits approx. 25 kg stones.

## EOS Bi-O Max | floor-standing

- Floor-standing sauna heater for domestic and commercial saunas.
- Optimal for an intensive commercial use.
- Timeless design, die-cast aluminium top and front cover, anthracite pearl effect finish outer shell.
- Proven construction – durable and highly reliable, completely made of high grade stainless steel.
- Extra-large 60 kg rock store for powerful water splashes and temperature stability.
- Service-friendly design - rock store above heating elements.
- Improved air convection thanks to the large side channels – very fast heat-up time and continuously high performance.
- 2 kW vaporizer with stainless steel water tank. Manual filling (automatic filling optionally possible).

- 9,0
- 12,0
- 15,0





- 7,5
- 9,0
- 10,0
- 12,0



Styling 2

Black - Styling 1

## EOS Bi-O Cubo 2 | floor-standing

- Very elegant, contemporary design with fully redesigned body and top cover in two stylings.
- Available with classic anthracite or with matt black finish.
- Same appearance on all sides thanks to the integrated rear side cover panel in matching finish.
- Proven, highly durable and long-lasting construction.
- Optimal relation between stone volume and air convection system for fast heat-up times and powerful water splashes.
- Easy to service – heating elements without contact to stones. Rock store above the heating block.
- 2 kW / 3 kW vaporizer with 9l stainless steel water tank.
- Extra-large essence holder mounted in the rock store.
- Rock store fits approx. 25 kg stones.



Styling 1 – round holes



Styling 2 – structure



# BI-O SAUNA HEATERS

Model	Item no.	Size (H×W×D)	Power
EOS Bi-O Cubo 2 Anthrazit Styling 1	948919	900×400×385 mm	7,5 kW
	948920		9,0 kW
	948921		10,0 kW
	948922		12,0 kW
EOS Bi-O Cubo 2 Anthrazit Styling 2	948927		7,5 kW
	948928		9,0 kW
	948929		10,0 kW
	948930		12,0 kW
EOS Bi-O Cubo 2 black Styling 1	948923		7,5 kW
	948924		9,0 kW
	948925		10,0 kW
	948926		12,0 kW
EOS Bi-O Cubo 2 black Styling 2	948931		7,5 kW
	948932		9,0 kW
	948933		10,0 kW
	948934		12,0 kW

## Best EOS technology in a new design



EOS Scent Trophy S  
essence bowl – upon request.  
Guard rail optional. Image similar.



360° Look

incl. rear wall cover panel in the colour of the outer shell.



7,5

9,0

EOS Herkules S25 Vapor



EOS Herkules S25 Vapor black

EOS Stone S25 Vapor



EOS Stone S25 Vapor black

## EOS Herkules / Stone S25 Vapor | floor-standing

- Exclusive luxury class heater for private and commercial saunas.
- With built-in 2 kW vaporizer (manual refilling) which allows to create various climate forms, from hot and dry to mild and humid.
- An elegant stainless steel holder for essences allows to turn your sauna to a herbal bath or fill it with pleasant fragrances.
- Thanks to the flat rear side panel with the recessed terminal block, these heaters may be installed in front of glass panels or in the center of the sauna.
- Side panels in anthracite pearl effect finish and brushed stainless steel provide a distinctive, high contrast, straight-lined design.
- Also available with high-quality matt black finish.
- Optional rear wall cover panel and wooden heater guard rail with brackets available.
- Rock store fits approx. 25 kg stones.
- **EOS Stone S25 Vapor:** As Herkules S25 Vapor, but with the front side fitted with massive soapstone panels.

## EOS Herkules / Stone S60 Vapor | floor-standing

- High-performance sauna heater for large private and commercial saunas.
- With built-in 2 kW vaporizer (manual refilling) which allows to create various climate forms, from hot and dry to mild and humid.
- A designer stainless steel essence holder is included.
- Thanks to the extra large rock store and the included 60 kg sauna stones, EOS Herkules S60 models offer an exceptional heat storage and powerful steam shocks.
- Side panels in anthracite pearl effect finish and brushed stainless steel provide a distinctive, high contrast, straight-lined design.
- Also available with high-quality matt black finish.
- Optional rear wall cover panel and wooden heater guard rail with brackets available.
- Rock store fits approx. 60 kg stones.
- **EOS Stone S60 Vapor:** As Herkules S60 Vapor, but with the front side fitted with massive soapstone panels.

9,0

12,0

15,0



EOS Herkules S60 Vapor black

EOS Herkules S60 Vapor



EOS Stone S60 Vapor

## BI-O SAUNA HEATERS

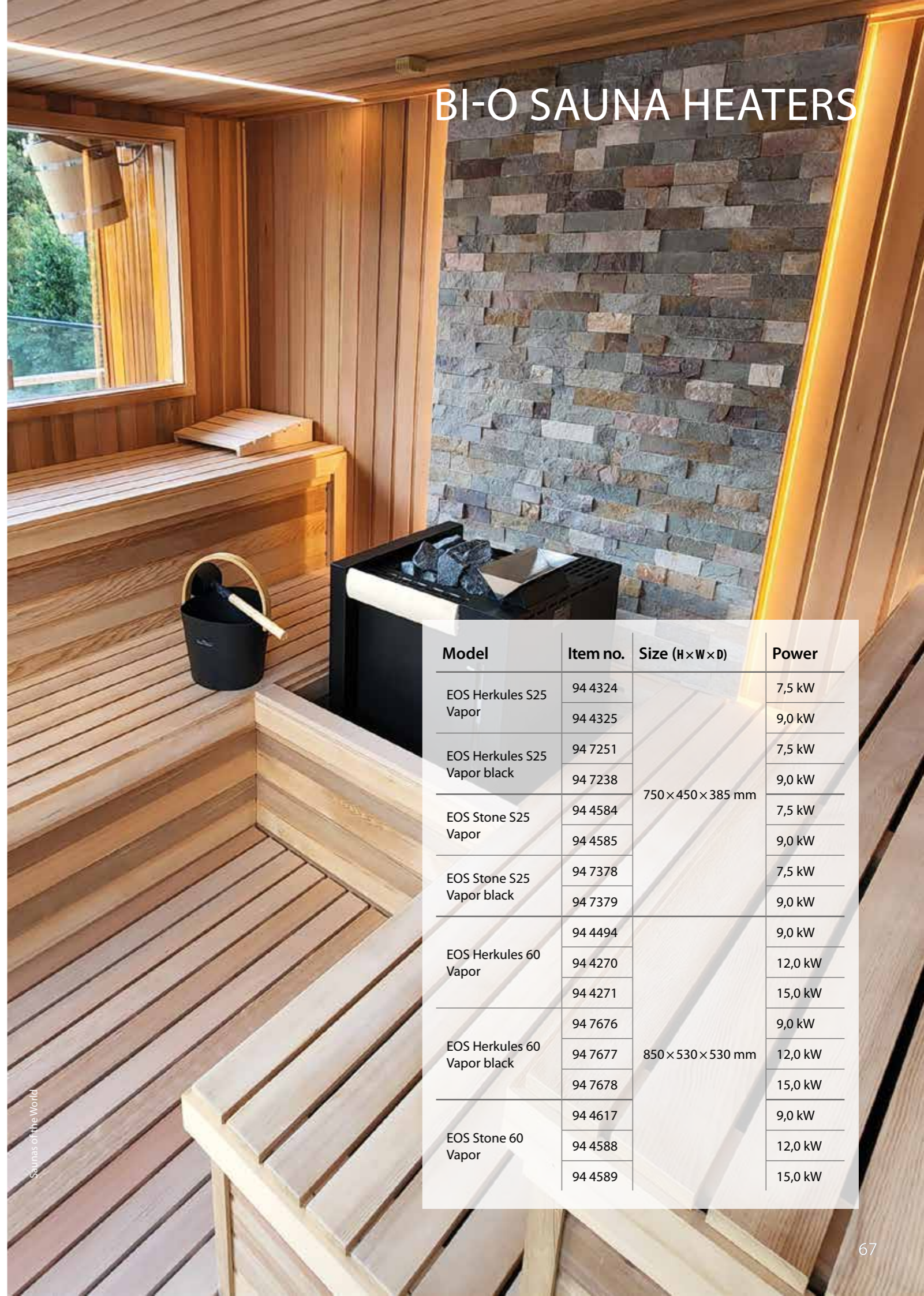

Model	Item no.	Size (H×W×D)	Power	
EOS Herkules S25 Vapor	94 4324	750×450×385 mm	7,5 kW	
	94 4325		9,0 kW	
EOS Herkules S25 Vapor black	94 7251		7,5 kW	
	94 7238		9,0 kW	
EOS Stone S25 Vapor	94 4584		7,5 kW	
	94 4585		9,0 kW	
EOS Stone S25 Vapor black	94 7378		7,5 kW	
	94 7379		9,0 kW	
EOS Herkules 60 Vapor	94 4494		850×530×530 mm	9,0 kW
	94 4270			12,0 kW
	94 4271			15,0 kW
EOS Herkules 60 Vapor black	94 7676			9,0 kW
	94 7677	12,0 kW		
	94 7678	15,0 kW		
EOS Stone 60 Vapor	94 4617	9,0 kW		
	94 4588	12,0 kW		
	94 4589	15,0 kW		

# BI-O SAUNA HEATERS



## EOS Herkules XL S50 Vapor

floor-standing

- Unique design featuring innovative construction with two separate rock stores.
- With built-in vaporizer located right between the rock stores which provides this heater its unique appearance.
- An elegant cup holder for essences or herbs perfectly complements the design and enhances the possibilities.
- Two 25 kg large rock stores provide a perfect balance between strong air convection and optimal heat storage capacity. This ensures an optimized air convection and allows to make water splashes alternately on the left or on the right side for more steam and more sauna enjoyment.
- Side panels in anthracite pearl effect finish and brushed stainless steel provide a distinctive, high contrast, straight-lined design.
- Also available with high-quality matt black finish.
- Optional wooden heater guard rail with brackets available.
- Rock store fits approx. 50 kg stones.



EOS Herkules XL S50 Vapor black

EOS Herkules XL S50 Vapor

## EOS Herkules XL S120 HD Vapor | floor-standing

- The flagship of the EOS Herkules series for intensive use in large commercial saunas set standards for superior performance, durability and sophisticated design.
- With built-in 3-4 kW vaporizer placed in the middle between both rock stores. The vaporizer is equipped with an automatic refilling (integrated top-up device) for convenience in use.
- Two separate rock stores with up to 120 kg stones ensure an excellent temperature stability and heat storage capacity.
- The unique construction with rock stores above the heating elements provides continuously high performance and reliability, strong air convection, long service life and easy maintenance.
- Side panels in anthracite pearl effect finish and brushed stainless steel provide a distinctive, high contrast, straight-lined design.
- Also available with high-quality matt black finish.
- Optional rear wall cover panel and wooden heater guard rail with brackets available.
- Optional Herkules Fragrance, vaporizer dish arrangement with an integrated water supply available (see page 70).
- Rock store fits approx. 120 kg stones.



EOS Herkules XL S120 HD Vapor black

EOS Herkules XL S120 HD Vapor

Model	Item no.	Size (H×W×D)	Power	
EOS Herkules XL S50 Vapor	94 4332	750×750×385 mm	7,5 kW	
	94 4333		9,0 kW	
EOS Herkules XL S50 Vapor black	94 7679		7,5 kW	
	94 7680		9,0 kW	
EOS Herkules XL S120 HD Vapor	94 8119		850×960×530 mm	9,0 kW
	94 8120			12,0 kW
	94 8121	15,0 kW		
EOS Herkules XL S120 HD Vapor black	94 8124	9,0 kW		
	94 8125	12,0 kW		
	94 8126	15,0 kW		

7,5

9,0

12,0



## EOS Bi-O Mat U | behind-the-bench

- Combi-heater with integrated vaporizer 1,5 kW (12 kW version – 2 kW) for concealed behind-the-bench installation.
- Extra slim design - only 22 cm installation depth.
- Robust, durable construction, all made of high grade stainless steel.
- With 5l water tank, manual filling (automatic refilling optionally possible). Dry run protection and acoustic water shortage alarm.
- Includes accessories: dust collecting bottom tray, integrated full-width infusion gutter, cover protection safety grill, water funnel with 1 m silicone hose, pre-mounted 6 m silicone connection cable 5 × 1.5 mm<sup>2</sup>.
- Rock store fits approx. 15 kg stones.

## EOS Bi-O Invisio | External Vaporizer

- For all EOS Invisio sauna heaters – available with 2,0 kW and 3,0 kW power output.
- Can be mounted on the left / right side. Can be also retrofitted at a later time.
- Includes stainless steel steam pipe with the steam outlet with integrated herbs holder and flexible joint.
- Water tank (approx. 12l) made of high-grade stainless steel.
- Manual water filling. Automatic water filling possible with the optional FWA01 top-up device.
- Dry run protection. Made of stainless steel.
- Double drain nozzle facilitates simultaneous connection of the top-up device and water drain tap.
- The sauna heater is not included!



2,0

3,0

Installation example on EOS Invisio XL heater.

Model	Item no.	Size (H × W × D)	Power
EOS Bi-O Mat U	94 4891	1000 × 1120 × 200 mm	7,5 kW
	94 4892		9,0 kW
	94 1127		12,0 kW
EOS Bi-O Invisio Vaporizer	94 6293	530 × 200 × 360 mm (without steam pipe)	2,0 kW
	94 6294		3,0 kW

# BI-O SAUNA HEATERS



EOS Mythos Vapor	Item no.	Size (H×W×D)	Colour
Left, 3,0 kW	945572	840×800×370 mm	anthracite
Right, 3,0 kW	94 5493		
Left + right, 3,0 kW each	94 6250		
Left, 2,0 kW	94 5571		
Right, 2,0 kW	94 5492		
Left + right, 2,0 kW each	94 6253		
Left, 3,0 kW	94 5900	840×800×370 mm	white
Right, 3,0 kW	94 5904		
Left + right, 3,0 kW each	94 6256		
Left, 2,0 kW	94 5899		
Right, 2,0 kW	94 5903		
Left + right, 2,0 kW each	94 6259		
Left, 3,0 kW	94 5902	840×800×370 mm	black
Right, 3,0 kW	94 5906		
Left + right, 3,0 kW each	94 6262		
Left, 2,0 kW	94 5901		
Right, 2,0 kW	94 5905		
Left + right, 2,0 kW each	94 6265		

Model	Item no.	Size (H×W×D)	Colour
EOS BlackRock vaporizer 3,0 kW	94 7230	760×395×105 mm	anthracite
	94 7324		black

## EOS Mythos Vapor | External Vaporizer

- The EOS Mythos Vapor – the optional vaporizer for the Mythos sauna heater series S35 and S45. Retrofitting possible on site.
- The vaporizer can be simply docked on both the left and right side, which gives you a maximum amount of design options.
- With an output of 2,0 kW or 3,0 kW, you will have a powerful steam source that you can adapt to the size of the sauna in order to create a large variety of climate forms – from hot and dry to mild and humid.
- Tank volume up to 10l
- Notice: If there are two or more Mythos vaporizers in one sauna cabin, they should be ordered in a special alternative version.
- In the standard version only one Mythos vaporizer is allowed per sauna heater or sauna room.
- The sauna heater is not included!



Image shows EOS Mythos S35 anthracite Vapor (vaporizer left anthracite)



Image shows EOS Mythos S45 black Vapor (vaporizer left + right black) and optional guard rail

3,0



Image shows BlackRock black version with vaporizer and optional guard rail

## EOS BlackRock Vaporizer

### External Vaporizer

- For EOS BlackRock heaters. Retrofitting possible on site.
- Durable stainless steel water tank with manual drain, 10l tank volume, 3,0 kW power.
- The vaporizer is only intended for use for humidifying sauna cabins, in connection with the EOS BlackRock sauna heater and a corresponding control unit.
- Very slim design – only 10,5 cm depth. The vaporizer can be mounted on any side of the heater.
- The sauna heater is not included!

## EOS Herkules Fragrance



- Quartz-glass bowl, up to ~ 0.75 l volume.
- No assembly necessary.
- Incl. original Himalaya salt rocks, approx. 20 - 24 mm.
- Great for sauna essences, essential oils or salt inhalation bath. One filling typically lasts for several hours.

Glass bowl



Attachment  
(Design varies depending on model)



Sauna heater

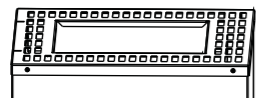

EOS Scent Trophy S2 – with EOS Cubo 2 – Styling 1.

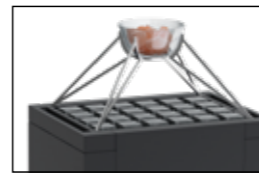

EOS Scent Trophy S7 – with EOS Mythos S45.



## EOS Scent Trophy

- Quartz-glass bowl, up to ~0.75l volume.
- A subtle elegance in your sauna – the Scent Trophy fills your sauna with wonderful scents, helping to turn each bath into a special experience.
- Durable stainless steel arm with swivel mechanism, black finish.
- Incl. original Himalaya salt rocks, approx. 20-24 mm.
- Very easy and fast wall mounting.
- Great for sauna essences, essential oils or salt inhalation bath. One filling typically lasts for several hours.
- Swivel mechanism allows exact position over the heater for a stronger or more gentle evaporation effect.
- EOS Scent Trophy – proudly made for you in Germany!

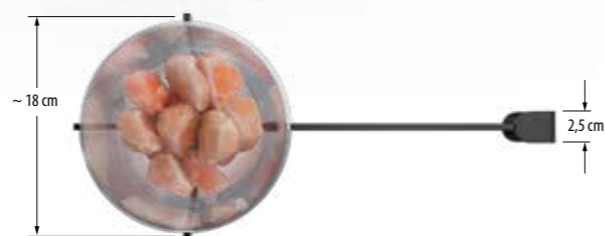

## ACCESSORIES AND UPGRADES

Model	Suitable sauna heaters	Item no.
EOS Scent Trophy W		94 8132
EOS Scent Trophy S1	BlackRock, KUSATEK Independent	94 8991
EOS Scent Trophy S2	Cubo (+, 2, 2+) / Bi-0 Cubo (2), Selection (Bi-0)	94 8992
EOS Scent Trophy S3	FinnRock	94 8993
EOS Scent Trophy S4	Gracil (Bi-0) / Gracil W (Bi-0)	94 8994
EOS Scent Trophy S5	Herkules / Stone S25	94 8995
EOS Scent Trophy S6	Herkules / Stone S60	94 8996
EOS Scent Trophy S7	Mythos S45, Credo	94 8997
EOS Scent Trophy S8	Organic W (Bi-0)	94 8998
EOS Scent Trophy S9	Saunadome II	94 8999
EOS Scent Trophy S10	Zeus S	94 9000
EOS Scent Trophy S11	Mythos S35	94 9034



## Designer essence bowl for saunas.



Made of special heat-resistant quartz glass with precisely-cut swivel arm, EOS Scent Trophy will be a fine design enhancement for your sauna. And it is very practical as well – the glass bowl can be easily removed for cleaning and the swivel arm allows to position the bowl over the heater just as you need it to create a stronger or a more gentle evaporation effect.

Explore more opportunities – try the included original Himalayan salt rocks to enrich the air with salt for an invigorating „sea climate“ effect.

# ACCESSORIES AND UPGRADES

Model	Item no.
EOS Herkules Fragrance	94 6826
EOS Aroma Tray for EOS 34.G HD (Size 1)	94 8839
EOS Aroma Tray for EOS 34.G HD (Size 2)	94 8838
EOS Aroma Tray for EOS Goliath HD	94 8886

## Aroma Tray for EOS 34.G HD and Goliath HD heaters



Innovative accessories for more variety and stimulating bathing sessions in your sauna.

Herb aroma tray made of high grade stainless steel. Very quick and simple installation. The herb tray is attached to the two side parts of the rock store above the sauna heater.

Add enough water to the tub. Herb or fruit slices (e.g. lemon or orange) can then be placed on top.

For a completely relaxed sauna experience!

## EOS Herkules Fragrance



- Essence oil tray with an integrated water supply.
- The vaporizer dish arrangement is designed for retrofitting onto the EOS sauna heater Herkules XL S120 / XL S120 Vapor.
- It is designed to be filled with water and, if necessary, any doses of sauna infusion preparations or essential oils. No flammable substances/materials may be placed in the dishes.
- Herkules Fragrance is designed for operation with an upstream automatic vaporizer dosing unit that controls the water filling quantity, the dosing cycle and the quantity of aromas.

## EOS Aroma Tray

- Innovative accessories for EOS 34.G HD and Goliath HD sauna heaters
- Fill the tub with enough water when it is cold.
- Clean the tub at regular intervals. Residues of flavoring substances can dry out and possibly become resinous.
- You can remove the inner bowl with the strainer for cleaning.
- Use suitable cleaning supplies!
- Make sure that herbs or other flavoring substances are not left dry in the tub. These can possibly become inflamed. Risk of fire!
- Do not use alcohol or undiluted infusions or aroma concentrates!



## Drain pan

- Made of robust plastic, with integrated handle.
- For EOS Bi-O type heaters with vaporizer.
- To collect drain water from the vaporizer.
- Particularly helpful by heaters with the small gap between water drain tap and floor surface.



## FWA Fixed water connection

top up device

- For automatic refilling of EOS Bi-O heater vaporizers from a permanently connected water supply.
- Particularly recommended by commercial use.
- Mounts either on the sauna heater or on the adjacent sauna wall.
- Includes metal braided flex hose with 1/2" connection.
- Mechanical action, no power supply needed.
- Stainless steel water tank.
- FWA 02 – for Herkules/Stone S60 sauna heaters.
- FWA 03 – for Bi-O Cubo sauna heaters.

## Auxiliary vaporizer

- Slim, space-saving design. Essence holder at the steam exit. Wall-mounting.
- Powerful steam source – 2 kW power, 5 l water tank.
- May be retrofitted into existing sauna cabins. Stainless steel housing.
- Manual water filling through the steam opening.
- Dry run protection with sound alarm at water shortage.
- Single phase power supply 230 V 1N ~.



## ACCESSORIES AND UPGRADES

Model	Item no.
Drain pan	94 5425
FWA 01	94 4845
FWA 02	94 4846
FWA 03	94 6071
Auxiliary vaporizer	94 4742





# EOS SELECTION SAUNA HEATERS



SPEC YOUR OWN SAUNA HEATER – TAILORED TO YOUR PREFERENCE

# EOS SELECTION SAUNA HEATERS

## AS INDIVIDUAL AS YOUR NEEDS

EOS Selection offers you a brand-new innovative concept – spec your sauna heater by yourselves to suit your preferences and your individual sauna design.

Unfold your creativity, choose from at least 16 designs, each with two sauna types (Finnish or Bi-O) and four power outputs from 7.5 kW to 12.0 kW.

Built to impress – stylish polished stainless steel body, alternatively available with anthracite, matt black or matt white finish can be refined with an elegant guard rail crafted of solid Abachi or walnut wood and other options.

Make your customers actively participate in design creation process!

All EOS Selection heaters are crafted from the finest quality materials and built to individual order.

Model	Size (H×W×D)	Item no.
EOS Selection / Bi-O Selection	750×420×420 mm	7,5 kW
		9,0 kW
		10,0 kW
		12,0 kW



[www.eos-sauna.com/en/selection](http://www.eos-sauna.com/en/selection)

TAO sauna&spa s.r.o.



- 7,5
- 9,0
- 10,0
- 12,0

Example shows the Selection:  
 - Exterior: anthracite  
 - Top cover: stainless steel  
 - Diabase sauna stones



## EOS Selection / Bi-O Selection | floor-standing

- Outer shell and top cover available in polished stainless steel or with anthracite, matt black or matt white finish.
- Stylish guard rail crafted of solid abachi or walnut can be added as an option to complement the heater design.
- Power output: 7,5 kW / 9,0 kW / 10,0 kW / 12,0 kW.
- Vaporizer (Bi-O Version): 2,0kW (7l water tank).
- Uniform appearance on all sides. No disturbing rear side – great for installation in front of glass or central position.
- Rock store fits approx. 35 - 40 kg / 20 - 22 kg (Bi-O) stones.



Example shows the Bi-O Selection:  
 - Exterior: white  
 - Top cover: stainless steel  
 - Vulcanite sauna stones  
 - Guard rail, Walnut wood (3-sided)



Spec your sauna heater in a few simple steps:

## Sauna heater type



Finnish



Bi-O

## Power output

7,5 kW

for sauna cabin size  
7 - 10m<sup>3\*</sup>

9,0 kW

for sauna cabin size  
9 - 14m<sup>3\*</sup>

10,0 kW

for sauna cabin size  
11 - 15m<sup>3\*</sup>

12,0 kW

for sauna cabin size  
14 - 18m<sup>3\*</sup>

\*Heater power refers to the standard wooden sauna and presents only a rough, non-binding suggestion.

## Outer shell design



Polished stainless steel



Anthracite pear effect



Matt black



Matt white

## Top cover design



Polished stainless steel



Anthracite pear effect



Matt black



Matt white

## Sauna stones – optional



without sauna stones



Diabase sauna stones  
(Grain size: 50 - 100 mm)



Vulcanite sauna stones  
(Grain size: 50 - 100 mm)



Quartz sauna stones  
(Grain size: 50 - 80 mm)

## Heater guard rail – optional



without heater guard rail



Guard rail brackets (without wooden rail)



Abachi – 3-sided  
with mounting brackets



Walnut – 3-sided  
with mounting brackets



Abachi – 4-sided  
with mounting brackets



Walnut – 4-sided  
with mounting brackets

# EVENT SAUNA HEATERS

## EOS WATERMILL SAUNA

The EOS Watermill sauna brings "action" and a unique water splash experience in every sauna room. The Watermill wheel rotates slowly counter-clockwise which already makes it an attraction in the sauna room.

After an automatic signal it starts to rotate in the other direction, so that the scoops take some water from the basin under the wheel and pour it directly into the cascade mounted over the heater, causing powerful and spectacular steam shock effects.

A very large stone volume of the sauna heater ensures at the same time high energy reserves and water evaporation capability.

Design hint: in combination with our coloured light or sound effects the water splashes may be turned into a spectacular ceremony and a unique experience for all sauna guests.

## EVENT HEATER FOR THEMED SAUNAS

# EVENT SAUNA HEATERS

Model	Item no.	Size (H×W×D)	Power
EOS Watermill sauna set with 34.GM HD heater	94 3076	1700×1200×980 mm	18,0 kW
	94 3092		27,0 kW
	94 5149		30,0 kW
	94 3093		36,0 kW
EOS Watermill sauna set with Stone S60 heater	94 5294	1500×800×910 mm	9,0 kW
	94 5295		12,0 kW
	94 5296		15,0 kW
EOS Watermill sauna set with BlackRock heater	94 8862	830×555×555 mm	12,0 kW
	94 8863		15,0 kW
	94 8864		18,0 kW
EOS Watermill sauna set with BlackRock black heater	94 8865	830×555×555 mm	12,0 kW
	94 8866		15,0 kW
	94 8867		18,0 kW
EOS Watermill sauna set with Goliath HD heater	94 6223	1700×1200×980 mm	18,0 kW
	94 6224		24,0 kW
	94 6225		30,0 kW
	94 6226		36,0 kW
Watermill wheel	94 3077		



EOS Watermill sauna set with a Stone S60 heater



EOS Watermill sauna set with a BlackRock heater



EOS Watermill sauna set with a Goliath HD heater



## EOS Watermill sauna with 34.GM HD, Goliath HD, Stone S60 or BlackRock

- High end sauna heater set for luxury class themed saunas
- With a continuously rotating mill wheel and spectacular water splashes at pre-set intervals.
- Mill wheel includes pre-mounted drive and control box.
- Adjustable intervals, e.g. every 30 minutes.
- Automatic water refilling thanks to the built-in top-up device (requires permanent water supply).
- 34.GM HD heater with front panel of massive granite stone. All made of stainless steel, 30 - 45 kg stones, or
- Stone S60 heater, anthracite finish with soapstone front panel, 60 kg stones.
- BlackRock heater, stainless steel / anthracite finish or completely in matt black finish, 40 kg stones.
- Goliath HD heater, anthracite finish, 75 kg stones.



## EOSphere

- Spectacular steam-shock effect with accompanying colour and light effects thanks to the innovative plunging function: The separate rock store heats the stones and then plunges down into the underlying water tank, accompanied by the specially coordinated light effects with colour changes from red to blue.
- High-quality construction, carefully crafted down to the last detail, with a high-contrast design of polished stainless steel and powder-coated components with anthracite pearl effect.
- Fully automatic function with adjustable time intervals and dwell time of the rock store in the water tank. Manual or automatic start.
- Luxury and exclusivity - no mass production, each system is individually handcrafted. Made in Germany quality from EOS.
- 45 kg stones included in delivery.

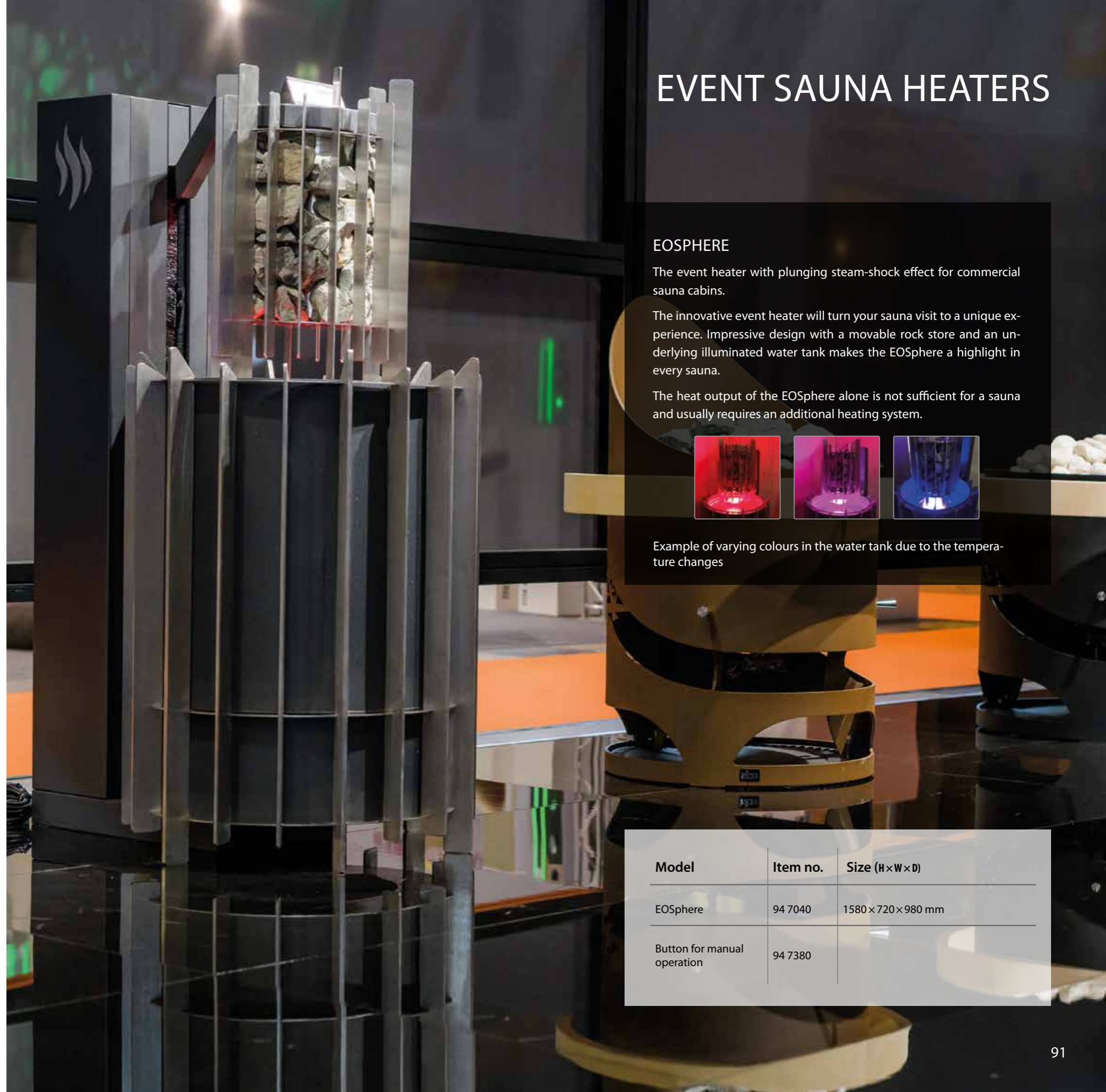

## EOSPHERE

The event heater with plunging steam-shock effect for commercial sauna cabins.

The innovative event heater will turn your sauna visit to a unique experience. Impressive design with a movable rock store and an underlying illuminated water tank makes the EOSphere a highlight in every sauna.

The heat output of the EOSphere alone is not sufficient for a sauna and usually requires an additional heating system.



Example of varying colours in the water tank due to the temperature changes

Model	Item no.	Size (H x W x D)
EOSphere	94 7040	1580 x 720 x 980 mm
Button for manual operation	94 7380	

# EVENT SAUNA HEATERS



## SAUNA INFUSION EVENT

For the sauna infusion event, the rock stores must be lifted using the crank handle and then rotated using the selector handle until they swap position. The rock store that was heated by the heater is then lowered into the water tank using the crank handle.

Please note that the sauna stones must be reheated after each sauna infusion to generate an intense burst of steam. After each sauna infusion event, wait approx. 30 minutes before starting the next one.



Example of the manual rotation device



9,0



Notice: The external housing is not included in the delivery.

## EOS Skiff

An eye-catcher and attraction in your sauna at the same time – the EOS Skiff. With its special design, the unique event sauna heater brings action into your sauna.

The Skiff features two separate rock stores which can be manually rotated around and dipped into a water tank with a special lever without any electrical power – for a spectacular showlike steam-shock effect.

Your guests will be fascinated when the rock stores slowly sink and the sauna infusion is released. Create a sauna according to ancient Banya tradition.

Due to the exclusively manual operation, the EOS Skiff with a heater output of 9.0 kW is low-maintenance.

Approx. 60 kg stone volume – divided into two rock stores with 30 kg stone volume each.

# SAUNA CONTROL UNITS



INNOVATIVE. FUNCTIONAL. RELIABLE.



# SAUNA CONTROL UNIT



EOS Econ D2 and EOS Econ H2 belong to the most popular models of the entire EOS Econ range thanks to the optimal scope of functions, easy operation and particularly good price to value ratio.

All functions and parameters are shown at once on a large illuminated multi-line LCD. While adjusting one parameter all others always remain in sight. Menu navigation in 12 languages make the operation particularly comfortable and easy. In the case of a power loss all settings will remain saved for at least 24 hours.

The keypad lock function allows EOS Econ D2/H2 models to be reliably protected against an unauthorized access. The desired temperature and heating time can be set or adjusted within a few seconds.



Model	Item no.	Size (H×W×D)
EOS Econ D2	94 6138	220×250×60 mm
EOS Econ H2	94 6139	



## EOS Econ D2

- Control unit for dry (Finnish) sauna
- Suitable for commercial operation.
- Extra-large multi-line LCD display, shows all parameters at a glance. Menu navigation in 12 languages.
- 24 h pre-set timer in real time, clock, screen-saver function.
- Switch for cabin light, „Life Guard“ function.
- Heating time limitation 6 h, extendable to 12 h.
- Switching capacity 9 kW, may be extended with an LSG device.



## EOS Econ H2

- As EOS Econ D2 but for dry and humid sauna operation.
- Digital temperature control:  
30 °C - 115 °C (in dry Finnish sauna mode)  
30 °C - 70 °C (in humid sauna operation).
- Humidity control - proportional to time, adjustable in 10 steps.
- Suitable for commercial use.
- 24 h pre-set timer in real time, clock, screen-saver function.
- Heating time limitation 6 h, extendable to 12 h.
- Switching capacity 9 kW, may be extended with an LSG device.



### EOS Econ D3

- Control unit for dry (Finnish) sauna.
- Optimal for commercial operation.
- Extra-large multi-line LCD display, shows all parameters at a glance. Menu navigation in 12 languages.
- 24 h pre-set timer in real time, clock, screen-saver function.
- Heating time limitation 6 h, 12 h or unlimited.
- Supports an optional 2nd temperature sensor (bench sensor).
- Switching capacity 9 kW, may be extended with an LSG device.



### EOS Econ H3

- As the EOS Econ D3 but for dry and humid sauna operation. Optimal for commercial operation.
- Digital temperature control:  
30 °C - 115 °C (in dry Finnish sauna mode)  
30 °C - 70 °C (in humid sauna operation).
- Humidity control - proportional to time (10 steps) or as per relative air humidity in % with an optional humidity sensor.
- Sauna-dry mode (after-heating and extractor fan operation to dry sauna after humid mode).
- Switching capacity 9 kW, may be extended with an LSG device.

SAVNE CAFUTA PTUJ PROIZVODNJA IN TRGOVINA, d.o.o.

EOS Econ is a versatile series of modern sauna control units featuring a large scope of functions and a contemporary, slim-shape design.

The control units EOS Econ are available in a variety of different versions, from very affordable entry-class models to advanced versions with a large scope of special functions such as remote switching or limited access mode. All Econ control units feature a modern high-contrast LCD matrix display with a comfortable menu navigation in 12 languages which makes their operation easy and convenient. They can be mounted directly on the wall surface or installed partially recessed in order to make them look even slimmer.

Thanks to the modern electronic relays EOS Econ models have very low noise operation. Every unit includes temperature sensor with cable.

EOS Econ models have proven to be exceptionally reliable both in domestic and commercial operation. They are compliant with the latest safety norms in Europe and have been independently tested and approved for quality and safety.

Model	Item no.	Size (H×W×D)
EOS Econ D3	94 6140	220×250×60 mm
EOS Econ H3	94 6141	

# SAUNA CONTROL UNITS

## EOS ECON D4 / H4 - FOR DEMANDING USERS:

EOS Econ D4 and H4 models are ideal for domestic and commercial users who need a sauna control unit combining advanced features and modern design with a particularly good price to value ratio.

These models feature for instance a dimmable cabin light output with an automatic detection of inductive and capacitive loads. With an optional remote start module the sauna can be switched on or off from a remote location at a large distance. And the innovative „holiday home mode“ allows to restrict the access to the essential functions only which is particularly helpful by e.g. rented saunas or in a commercial environment.

### OPTIONS:

- Remote Start Module: with this module you can start your sauna from a remote location up to 100 m. An integrated LED lamp indicates the current operation status.
- Bench Sensor: improves temperature control, recommended especially for large saunas or complex layouts. Compatible with EOS Econ D3/H3 and D4/H4 models.
- F2 Humidity sensor: for humidity control as per relative air humidity in a sauna. Compatible with EOS Econ H3 and H4.

Model	Item no.	Size (H×W×D)
EOS Econ D4	94 5842	220×250×60 mm
EOS Econ H4	94 5843	



## EOS Econ D4

All functions like EOS Econ D3, but additionally with:

- Remote switching possible (optional remote start button).
- Dimmable cabin light output, 10-step adjustment.
- Automatic detection of inductive and capacitive loads on light output (manual setting possible).
- Output for fan, adjustable speed (3 steps).
- Innovative „Holiday home mode“ - restricts the access to basic functions only (on/off, temperature, light).
- Switching capacity 9 kW, may be extended with an LSG device.



## EOS Econ H4

As the EOS Econ H3 model, but additionally with:

- Remote switching possible (optional remote start button).
- Dimmable cabin light (10-step, automatic detection of inductive and capacitive loads).
- Output for fan, 3 step speed adjustment.
- „Holiday home mode“ (restricted access mode).
- Switching capacity 9 kW, may be extended with an LSG device.



## EOS Compact DP

- Control unit for the dry (Finnish) sauna.
- Modern, slim-design housing, only 65 mm depth.
- Large 3.5" TFT colour display.
- Temperature control range 30 °C - 115 °C.
- Heating time limitation: 6 h / 12 h / 18 h / unlimited.
- Output for cabin light, fan and EOSafe safety system.
- Switching capacity 10 kW, may be extended with an LSG device.



## EOS Compact HP

- As the EOS Compact DP, but for dry and humid operation.
- Temperature control range:
  - in dry (Finnish) sauna mode: 30 °C - 115 °C
  - in humid sauna mode: 30 °C - 70 °C.
- Humidity control - proportional to time, adjustable in 10 steps.
- With water shortage alarm, sauna dry function (after-heating and extractor fan operation to dry sauna room after humid mode).
- Vaporizer output: up to 3 kW.
- Switching capacity 10 kW, may be extended with an LSG device.

# SAUNA CONTROL UNITS

EOS Compact is a brand-new series of modern sauna control units featuring a large scope of functions and a contemporary, slim-shape design.

The control units EOS Compact are available in a variety of different versions, from very affordable entry-class models to advanced versions with a large scope of special functions such as remote switching or limited access mode. All Compact control units feature a large 3.5" TFT colour display which makes their operation easy and convenient. They can be mounted directly on the wall surface or installed partially recessed in order to make them look even slimmer.

Every unit includes temperature sensor with safety temperature limiter and a 2 m connection cable. They are compliant with the latest safety norms in Europe and have been independently tested and approved for quality and safety.



Modell	Item no.	Size (H×W×D)
EOS Compact DP anthracite	94 7431	220 × 255 × 65 mm
EOS Compact DP white	94 7427	
EOS Compact HP anthracite	94 7432	
EOS Compact HP white	94 7428	

# SAUNA CONTROL UNITS

## EOS COMPACT DC / HC - FOR DEMANDING USERS:

EOS Compact DC and HC models are ideal for domestic and commercial users who need a sauna control unit combining advanced features and modern design.

These models feature for instance a dimmable cabin light output, two-stage fan output and connection for several external modules.

### OPTIONS:

- Eco / Hot function with short-time power boost (via external SBM-Eco / SBM-Hot module).
- Remote start (via external remote start module).
- Remote control via building management system (via external KNX/Modbus module).
- Bench Sensor: improves temperature control, recommended especially for large saunas or complex layouts. Compatible with EOS Compact DC / HC models.
- Combi sensor: Combi sensor includes housing and 4 m silicone cable. Compatible with EOS Compact HC.



## EOS Compact DC

All functions like EOS Compact DP, but additionally with:

- Connection for external modules e.g. remote start, remotecontrol (KNX/Modbus), Eco and Hot.
- Dimmable cabin light output.
- Two-stage fan output.
- Connection for optional bench sensor.
- Switching capacity 10 kW, may be extended with an LSG device.



## EOS Compact HC

As the EOS Compact HP model, but additionally with:

- Connection for external modules e.g. remote start, remotecontrol (KNX/Modbus), Eco and Hot.
- Dimmable cabin light output.
- Two-stage fan output.
- Connection for optional bench and combination sensor.
- Vaporizer output: up to 3 kW
- Switching capacity 10 kW, may be extended with an LSG device.

Model	Item no.	Size (H×W×D)
EOS Compact DC anthracite	94 7433	220×255×65 mm
EOS Compact DC white	94 7429	
EOS Compact HC anthracite	94 7434	
EOS Compact HC white	94 7430	



## EOS Compact DP

- Control unit for the dry (Finnish) sauna.
- All functions like EOS Compact DC, but additionally with a power output of 18 kW (extendable with LSG devices)



## EOS Compact HP

- As the EOS Compact D18, but for dry and humid operation.
- Temperature control range:
  - in dry (Finnish) sauna mode: 30 °C - 115 °C
  - in humid sauna mode: 30 °C - 70 °C.
- Humidity control - proportional to time, adjustable in 10 steps.
- With water shortage alarm, sauna dry function (after-heating and extractor fan operation to dry sauna room after humid mode).
- Vaporizer output: up to 3 kW.
- Switching capacity 18 kW, may be extended with an LSG device.

# SAUNA CONTROL UNITS

Modell	Item no.	Size (HxWxD)
EOS Compact D18 anthracite	94 7447	220x255x90 mm
EOS Compact D18 white	94 7445	
EOS Compact H18 anthracite	94 7448	
EOS Compact H18 white	94 7446	



# SAUNA CONTROL UNITS

## OPTIONAL MODULES:

- App module: allows remote sauna control from a smart phone / tablet via internet using a free EOS Sauna Control app.
- Coloured light module: control of almost any LED system directly from the sauna control unit.
- Sound module: music in your sauna. With stereo amplifier and operation directly from the sauna control unit. Music files can be streamed via Bluetooth, USB, SD card or an analogue input.

For more details please refer to page 114 - 121.



Model	Item no.	Size (H×W×D)
EOS EmoTec D anthracite/silver	94 5559	Display panel: 127×130×25 mm Relay box: 270×300×100 mm
EOS EmoTec D white/silver	94 6053	
EOS EmoTec D anthracite/black	94 7256	
EOS EmoTec H anthracite/silver	94 5560	
EOS EmoTec H white/silver	94 6054	
EOS EmoTec H anthracite/black	94 7257	



## EOS EmoTec D

- Digital control unit for very demanding domestic and commercial saunas. For dry Finnish sauna operation.
- With a separate slim-size display panel (can be installed up to 100 m from the sauna). Surface or recessed mounting possible.
- TFT colour display with menu navigation in 19 languages.
- Innovative operation with jog-dial switch – simple, easy, intuitive.
- Very large scope of functions, e.g. week timer with climate management, light dimming, holiday home mode, service level, guided setup and much more.
- Additional options with external modules (e.g. remote control, colour light, etc.)



## EOS EmoTec H

- Like EOS EmoTec D, but with humidity control – for all EOS Bi-O type sauna heaters.
- Humidity control - proportional to time (10 steps) or as per relative air humidity in % with an optional humidity sensor.
- Numerous comfort functions such as sauna-dry mode, adjustable after-heating temperature, fan runtime, after-heating time, smart-heat function in humid mode and much more.
- Guided setup, pin-code protected service level, additional innovative smart features (software updates, custom firmware, etc.).

# SAUNA CONTROL UNITS



white / black walnut



black / white maple

## EOS EmoStyle D

- Digital sauna control unit for demanding design-oriented domestic and commercial use.
- Exclusive display panel with glass front design. Recessed or surface mounting, up to 100m remote installation.
- Display panel available in white or black design.
- TFT colour display with multi-language navigation, 19 languages.
- Quick and simple operation thanks to capacitive buttons.
- Very large scope of functions, incl. guided setup, pin code protected service level, week timer and many other special functions.
- Additional functions can be added via optional extension modules (remote control, coloured light, sound).

## EOS EmoStyle H

- Like EOS EmoStyle D, but additionally with humid sauna operation control – suitable for all EOS Bi-O type sauna heaters.
- Humidity control – proportional to time (for constant steam production) or as per relative air humidity with an optional humidity sensor (exact rel. air humidity control in %).
- Large scope of additional functions - sauna-dry mode with adjustable temperature and fan operation, smart-heat in humid mode and much more.
- Guided setup menu, pin code protected service level for extended settings and fine tuning, special innovative functions.
- Supports additional bench sensor and humidity sensor.

## EOS EmoStyle Hi

- Luxury class digital sauna control unit.
- As the EOS EmoStyle H model but with display panel suitable for installation inside sauna rooms.
- For all EOS Bi-O type sauna heaters.
- Features a special design display panel with glass front, colour TFT colour display and a stylish wooden inlay cut of maple or walnut with capacitive buttons.
- For display panel installation inside sauna rooms.
- All functions as the EOS EmoStyle D and H models.
- Display panel available in four designs:
  - White glass with maple inlay
  - White glass with walnut inlay
  - Black glass with maple inlay
  - Black glass with walnut inlay

For installation inside sauna cabins!

Model	Item no.	Dimensions (H×W×D)
EOS EmoStyle D white	94 6316	Display panel: 127×130×25 mm
EOS EmoStyle D black	94 6314	
EOS EmoStyle H white	94 6315	Relay box: 270×300×100 mm
EOS EmoStyle H black	94 6319	

Model	Item no.	Dimensions (H×W×D)
EOS EmoStyle Hi white maple	94 6317	Display panel: 200×140 mm
EOS EmoStyle Hi black maple	94 6241	
EOS EmoStyle Hi white walnut	94 6415	Relay box: 270×300×100 mm
EOS EmoStyle Hi black walnut	94 6414	



## EOS EmoTouch 3

New generation touchscreen control system for the highest demands - with fully redesigned graphic user interface and numerous new functions. EOS EmoTouch 3 - complex things have never been so simple to use!

- Digital control system for sauna, steam room and hammam. Ideal for both domestic and commercial use.
- Completely new design - exclusive rimless glass front display with a 7" capacitive colour touch screen display panel.
- Fully redesigned graphic user interface - now with the choice of various cabin designs (themes).
- Can control up to 8 separate cabins from one display panel (saunas, steam rooms and hammams).
- Pin code protected service level for extended settings and fine tuning - allows to adjust the control to suit individual needs.
- Innovative guided setup and numerous smart control functions to make control simple, quick and easy as never before.
- System backup & restore and system image function – helps to save valuable time to set up the system e.g. after a reset.
- Mass storage connection - allows firmware updates.
- Remote control with mobile devices via EOS Spa Control App.
- Additional functions can be added with various optional extension modules (coloured light, sound, remote control, etc.)
- Available in white and black design or with an **individual glass frame** (EOS EmoTouch 3 Individual)
- Digital temperature sensor with 5 m cable included. Supports additional sensors (e.g. sauna bench sensor, humidity sensor, floor sensor, wall sensor and others).



### One control unit for:

- Dry (Finnish) sauna
- Humid (Bi-O) sauna
- Steam room
- Hammam
- Infrared cabin

Control for up to 8 cabins with only one display panel!

## Control for steam rooms and hammams

EOS EmoTouch 3 in combination with the SteamRock II Premium steam generator delivers a high performance package with many unique features.

- Graphic user interface designed for steam rooms and hammams.
- Numerous control functions and settings optimized for steam rooms.
- Innovative tools for performance and operation optimization and tuning with regards to the individual cabin situation.
- Specially designed for operation with the SteamRock steam generator.
- Integrated control for all features - essence dosing control (two fragrances), volt-free output, chemical cleaning system, optional sensors and outputs for floor, bench and wall temperature control.



# SAUNA CONTROL UNITS

## DIGITAL BRAIN FOR YOUR WELLNESS FACILITY

The control unit EOS EmoTouch 3 allows to control up to 8 separate cabins - saunas, steam rooms and hammams from one display panel.

With only one display panel you are in command - in a second you can select every connected cabin and control it individually or choose the overview of all cabins to check their status and control them all at once.

With only one touch you can start and stop all your cabins or choose a separate cabin for individual setting. For every cabin you can make all settings individually as if you had 8 separate control systems.

The new **'EOS EmoTouch 3 Individual'** offers infinite design possibilities – create your favorite design!

EOS EmoTouch 3 - probably the most advanced control system in the world. Designed for you to make complex things easy to use.



Model	Item no.	Size (H×W×D)
EOS EmoTouch 3 white (Sauna)	94 6505	Display panel: 142×210×42 mm
EOS EmoTouch 3 black (Sauna)	94 6504	
EOS EmoTouch 3 Individual (Sauna)	94 8880	
EOS EmoTouch 3 white (Hammam)	94 6992	Relay block: 270×300×100 mm
EOS EmoTouch 3 black (Hammam)	94 6991	
EOS EmoTouch 3 Individual (Hammam)	94 8881	

# EXTENSION MODULES



## EOS EMOTOUCH

Luxury class control system for highest demands. EOS EmoTouch 3 stands out thanks to the unique operation principle via an innovative visual graphic interface and a large capacitive touch screen display. Sauna control has never been so easy and the scope of functions and features leaves hardly any wish unfulfilled.

### LSG Sauna for EOS EmoTouch 3

- Extension module for EOS EmoTouch 3. Allows to connect an additional sauna cabin and control it from the existing EmoTouch 3 display panel.
- Up to eight separate saunas (and/or steam rooms) may be connected to one display panel.
- Includes digital temperature sensor with 5 m cable.
- Includes 10 m sauna bus connection cable.
- Supports dry and humid sauna operation. 9 kW switching capacity. Up to 3 kW vaporizer output.



### LSG Hammam for EOS EmoTouch 3

- Extension module for EOS EmoTouch 3. Allows to control a hammam as an additional cabin from the existing EOS EmoTouch 3 display panel
- Up to eight separate cabins (sauna, steam room, hammam) may be connected to one EmoTouch 3 display panel.
- Includes three digital temperature sensor with 5 m cable for floor, bench and wall temperature control. Temperature control range
- Three separate 3 kW outputs for floor, bench and wall heating. Includes 10 m sauna bus connection cable.

### LSG Infrared for EOS EmoTouch 3

- Extension module for EOS EmoTouch 3. Allows to control a separate infrared cabin with the existing EOS EmoTouch 3 display panel.
- Three outputs (2×dimnable, 1×switchable) - can be controlled individually or bundled in groups. Temperature control as per air temperature or by feeling through zone dimming. Up to 3000W switching capacity.
- Delivery includes 10 m sauna bus connection cable, digital temperature sensor with 5 m cable, 230 V power adaptor (requires two power supplies).
- Hint: Also available as a complete control unit with EOS EmoTec-/ Emo-Style-series display panels.



### LSG Steam for EOS EmoTouch 3

- LSG Steam extension module for EOS EmoTouch 3 allows to operate the steam generators of many other brands. Compatibility must be checked in advance.
- Suitable for EOS SteamRock II Basic and EOS SteamAttrac models.
- Attention: not suitable für SteamRock II Premium.
- Output – switching signal only.
- Includes 10 m sauna bus connection cable and a digital temperature sensor with 5 m cable.

Model	Item no.	Size (H×W×D)
LSG Sauna for EOS EmoTouch 3	94 6640	270×300×100 mm
LSG Hammam for EOS EmoTouch 3	94 6672	
LSG-Infrarot for EOS EmoTouch 3	94 6965	
LSG Steam for EOS EmoTouch 3	94 6967	



## SBM-FL75/150 Coloured light module

- Allows to connect and control almost any RGB or white light LED light (e.g. LED-spots, LED-strips, etc.). No driver needed, direct connection to the module.
- Compatible with voltage-controlled (0-24V) and with current-controlled (0-3000 mA) LED lamps.
- Suitable for LED strips with common „-“ only.
- Output: RGB (3 separately adjustable channels) and white light (may be synchronized with the main light). In EmoTec design housing.
- Available with two power outputs: 67,5W and 135W.
- Compatible control units: EOS EmoTec-/EmoStyle-/ EmoTouch 3-series.

## SBM-S BT Sound module

- The sound module allows to playback music in your sauna and to control it directly at the sauna control unit display.
- The module features an integrated stereo amplifier 2x15W and an integrated MP3 player. Music files can be retrieved from an SD-card, USB connection or via Bluetooth. A NF 3,5 mm analogue music jack is also available for music streaming.
- Compatible control units: EOS EmoTec-/EmoStyle-/ EmoTouch 3-series.

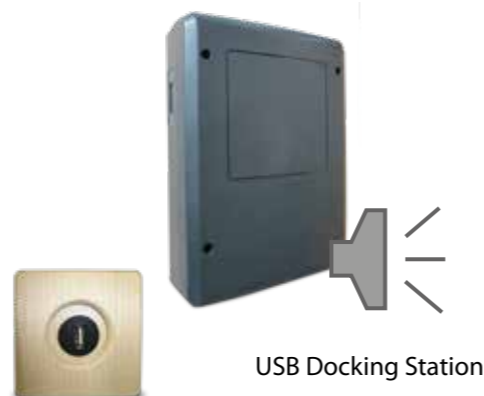

## IR Receiver with remote controller

- Infrared receiver with a wireless remote control for SBM-FL coloured light modules and SBM-S sound modules.
- Allows to quickly and conveniently control coloured light and/ or music from inside a sauna room (infrared cabin). Control of the coloured light and sound over the control panel remains as before possible.
- Set includes: wireless remote control (with battery), 5 m connection cable to the control unit, infrared receiver (black housing) for installation inside sauna (infrared cabin).



# EXTENSION MODULES

## SMART CONTROL

Perfect relaxation is no coincidence, but the result of optimal interaction of all necessary components. EOS combines smart features and the cutting-edge technology with simplicity and comfort in use, setting the quality benchmark both in the private and in the commercial sector. Every connected cabin can be easily enhanced with additional control features – for example you can also control music or LED coloured lighting.

Model	Item no.	Site (H×W×D)
SBM-FL75 coloured light module, 67,5 W	94 5996	270×195×100 mm
SBM-FL150 coloured light module, 135 W	94 6007	270×300×100 mm
SBM-S BT sound module with Bluetooth	94 5921	270×195×100 mm
IR Receiver with remote controller	94 6800	

# EXTENSION MODULES



Model	Item no.
SBM-App module	94 5987
App module cabin address 2	94 7814
App module cabin address 3	94 7815
App module cabin address 4	94 7816
App module cabin address 5	94 7817
App module cabin address 6	94 7818
App module cabin address 7	94 7819
App module cabin address 8	94 7820



Model	Item no.
SBM-Remote start module	94 5782
SBM-GLT-KNX module	94 7078
SBM-GLT-Mod module	94 7077

## SBM-App module



- SBM-App module allows to control a sauna remotely from a smart phone / tablet-PC from any place worldwide (internet access required). Requires the "EOS Spa Control" app on a mobile device.
- With the App, various other cabin types in addition to a sauna cabin, such as steam rooms, hammams and infrared cabins can be conveniently controlled in connection with one SBM-App module each while on the move.
- A quick check of the current sauna condition like its temperature or remaining heating time is easily possible.
- Management of several cabins is also possible.
- Further features are the different preset profiles for the sauna, which can be customized with just a few clicks.
- The temperature of the bench sensor can be accessed and the status of the drying program for sauna, steam room or hammam can be queried.
- Moreover, the potential-free contact can be controlled via app and can e. g. regulate an additional light source.
- Suitable for EOS EmoTec-/EmoStyle-/ EmoTouch 3-series.
- Requires the installation of the EOS Spa Control App (available for Android and iOS). The app will automatically detect the paired sauna control unit and adjust its interface for a simple and intuitive operation.
- Delivery does not include a smartphone or a tablet pc!

## SBM-Remote start module

- Allows to start / stop sauna remotely from up to 100 m distance.
- Integrated LED shows the current operation status (stand-by, heating, error).
- Recessed installation. Connection with a 6P6C RJ12 cable (sauna bus).
- Elegant wooden cover panel of massive walnut wood.
- Suitable for EOS Econ D4/H4, Compact DC/HC, EmoTec-/EmoStyle-/ EmoTouch 3-series.



## SBM-GLT KNX- / Modbus module



- The KNX- / Modbus module allows to integrate your sauna cabin into the central BMS system using the KNX or Modbus communication protocols.
- Suitable for EOS Compact DC/HC, EmoTec-/EmoStyle-/ EmoTouch 3-series.
- Allows remote control for: sauna heater (also with vaporizer), temperature and humidity, light with dimming, volt-free output switching, monitoring of temperature and humidity, sauna status etc.
- Very simple to install. Connection to sauna control unit via sauna bus connector.

## SBM-IR module



- SBM-IR Module allows to control infrared heaters and heating foils in your sauna. Three operation modes are possible: only sauna, only infrared or sauna & infrared at once.
- Temperature control range 30-70°C. Heating control as per air temperature or as per heating intensity.
- Compatible with all type of IR emitters like regular and quartz glass IR heaters, IR heating foils and panels.
- Up to three IR modules can be connected to one sauna control unit - up to 10.5 kW total power possible.
- Can be used as an extension to IR control unit EOS EmoTec IR and InfraStyle-series .

## SBM-IR relay module

- The SBM-IR relay module is used as an add-on module for connecting additional IR emitters in an existing sauna or IR cabin.
- The module is the preferred means of operation for infrared foils in infrared and/or sauna cabins. Emitters may also be connected.
- The (dimnable) IR module or IR relay box is recommended for emitters.
- Wall-mounting installation outside of the cabin.
- Five separate circuits with a total output of 3.5 kW, can be freely defined – all non-dimmable.
- Heating period limitation: 6h / 12h / 18h / 24h.
- Outputs can be assigned to individual zones.
- Up to three extension modules can be connected to one sauna control unit – the total output may not exceed 10.5 kW.



## SBM- Hot / Eco

- Push button and module for Hot / Eco function for sauna:
  - **Hot** is a power boost function (up to 30 minutes)
  - **Eco** is a power-saving mode with manual or automatic operation
- Durable metal housing, flush-mounting installation. With illumination ring in red / green.
- Set includes: push button with external electronic unit and pre-mounted connection cables.
- Suitable for sauna control units: EOS EmoTec-/EmoStyle-/ EmoTouch 3-series.



Model	Item no.
SBM-IR module	94 6966
SBM-IR relay module	94 7131
SBM-HOT	94 6800
SBM-ECO	94 6980

# POWER EXTENSIONS

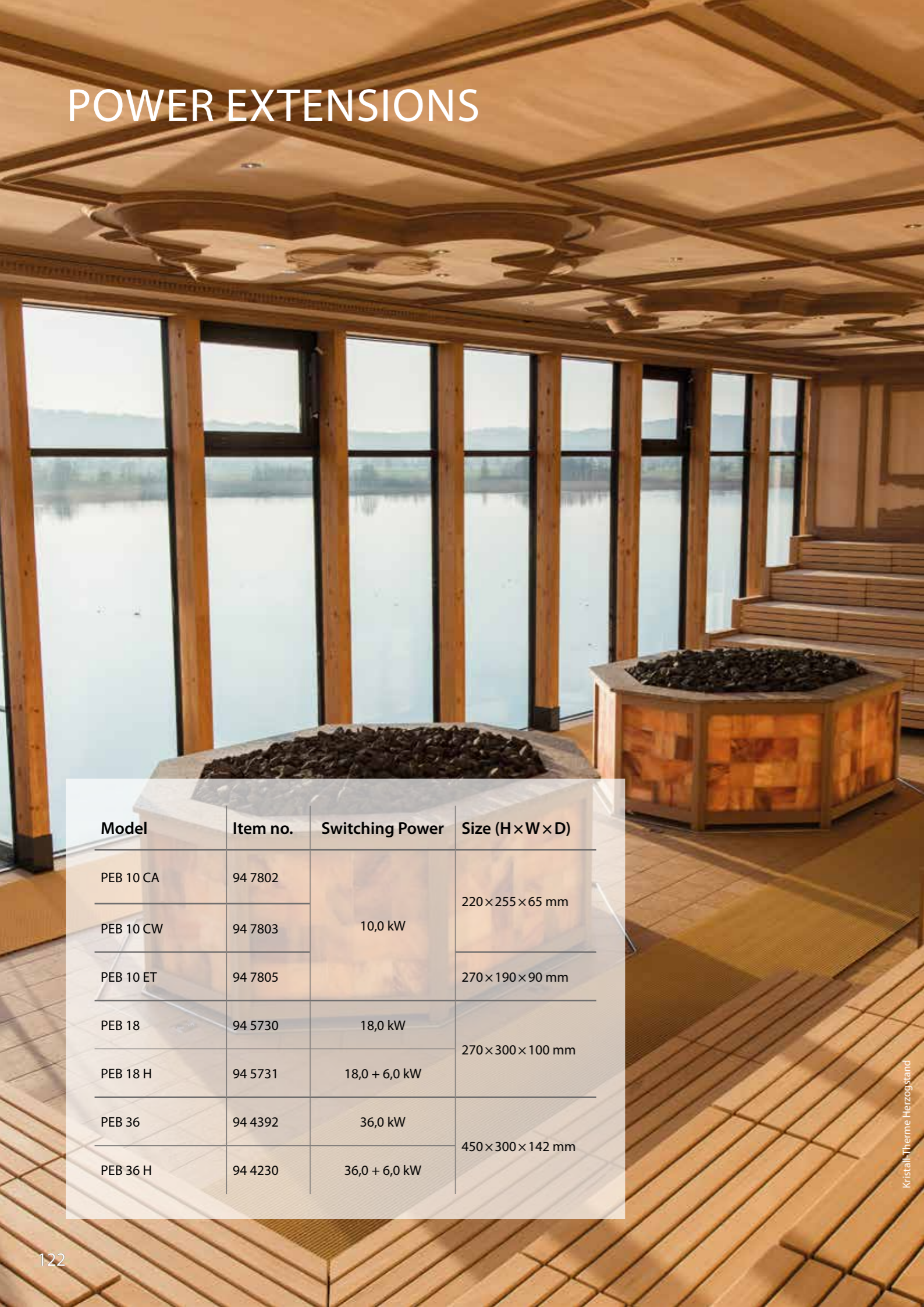

Model	Item no.	Switching Power	Size (H×W×D)
PEB 10 CA	94 7802	10,0 kW	220×255×65 mm
PEB 10 CW	94 7803		
PEB 10 ET	94 7805		270×190×90 mm
PEB 18	94 5730	18,0 kW	270×300×100 mm
PEB 18 H	94 5731	18,0 + 6,0 kW	
PEB 36	94 4392	36,0 kW	450×300×142 mm
PEB 36 H	94 4230	36,0 + 6,0 kW	

Kristall-Therme Herzogstand



## PEB 10 | relay box

- Relay box for power extension for sauna control units. Provides the additional 10 kW switching capacity.
- In combination with a 9 kW (10 kW) sauna control unit suitable for twin-circuit sauna heaters up to 19 kW (20 kW) power (with EOS Compact D18/H18 – up to 28 kW).
- Available with wall-mounting "EOS Compact"-housing in anthracite (LSG 10 CA) or white (LSG 10 CW), or with "EOS Emo-Tec"-housing (LSG 10 ET).



## PEB 18 / 18 H | contactor box

- Contactor box for power extension.
- New improved construction – very quiet in operation.
- In combination with a 9 kW (10 kW) sauna control unit suitable for twin-circuit sauna heaters up to 27 kW (28 kW) power (with EOS Compact D18/H18 – up to 36 kW).
- PEB 18 model: 18 kW power output.
- PEB 18 H: power output 18 kW + additionally 6 kW, optimal for Bi-O type sauna heaters.
- Cable connections from the rear or bottom side possible.



## PEB 36 / 36 H | contactor box

- Professional grade contactor box for power extension.
- New improved construction – very quiet in operation.
- In combination with a 9 kW (10 kW) sauna control units suitable for twin-circuit sauna heaters up to 45 kW (46 kW) power (with EOS Compact D18/H18 – up to 54 kW).
- PEB 36: power output 2× 18 kW.
- PEB 36 H: power output 2× 18 kW + additionally 6 kW, optimal for Bi-O type sauna heaters.

**NOTICE for PEB 18 / 36 devices: Fuse inserts are included and should be specified on site as per selected heater power.**



## EOS UV-Clean

- Air disinfection unit for installation in the air supply area e.g. of a sauna or infrared cabin.
- Cleans the air supply of the sauna from various infectious strains (e.g. viruses, germs and bacteria, as well as other aerosols).
- The outside air is drawn in by integrated fans and purified by means of the highly effective UV-C light.
- Air speeds per switch (depending on the size of the cabin)
- The device can be operated with a connection cable directly via switchable socket or direct connection to the sauna control unit, which prevents the inflow of fresh air when the sauna heater is switched off and ensures the necessary sauna climate.
- Only suitable for indoor use e.g. in sauna cabins. The cabin must be planned and set up according to the specifications before the EOS UV-Clean can be installed. The corresponding air supply section of the sauna cabin is covered by the air supply duct.
- Power supply voltage: 220 - 240V.

EOS UV-Clean cleans the air supply of the sauna from various infectious strains (e.g. viruses, germs and bacteria, as well as other aerosols). The outside air is drawn in by integrated fans and purified by means of the highly effective UV-C light before the air flows into the cabin. The air speeds can be set with a switch depending on the size of the sauna cabin. The radiation is prevented from escaping due to the special internal construction and at the same time the air is guided in a targeted manner.

It is designed for vertical installation on the outer wall of the cabin. The connection cable supplied allows it to be operated directly via a power socket. However, this socket should be coupled with the sauna control unit control unit so that the fans do not continue to run when the heater stops working.

EOS UV-Clean is only suitable for indoor use e.g. in sauna cabins. The cabin must be planned and set up according to the specifications before the EOS UV-Clean can be installed. The corresponding air supply section of the sauna cabin is covered by the air supply duct.

Model	Item no.	Size (H×W×D)
EOS UV-Clean	94 7734	without duct: 600×500×150 mm with duct: 910×500×150 mm

Installation example EOS UV-Clean

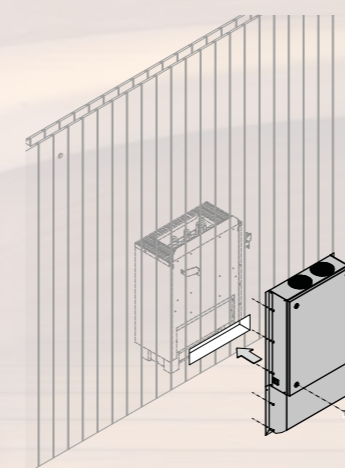

Operating principle

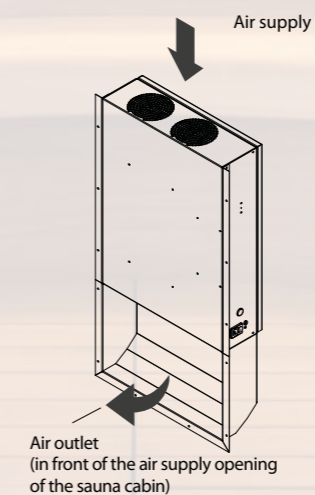

Design and function

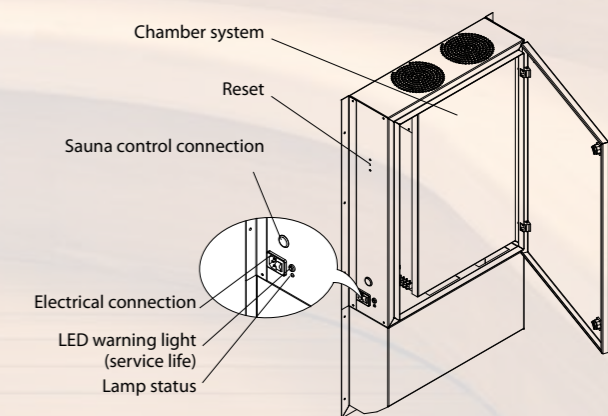

The cover protection rail has been developed by EOS and offers a highly reliable, safe and at the same time simple to use safety solution for sauna cabins with an automatic or remote switching. The rail is mounted directly over the heater to the sauna wall. At free standing sauna heaters it is possible to mount the rail directly on the heater (at many models).

The cover protection rail will react even at a very small pressure. If a towel or a similar object is placed on the heater the rail will bend down and will immediately interrupt the active heating or such heating may not start. After the object is removed, the rail returns to the normal position and the usual operation continues. This prevents the sauna heater from being switched on in an unsafe condition and effectively minimizes the risk of sauna fire.

In conjunction with an EOS sauna heater and control unit the cover protection rail represents a norm-compliant and approved safety solution.



**Type 1** #94 4421  
HWD 140×333×322 mm

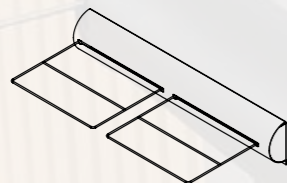

**Type 3** #94 4425  
HWD 140×710×322 mm

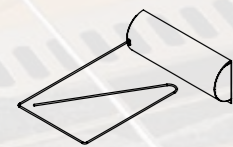

**Type 4** #94 4724  
HWD 140×333×482 mm

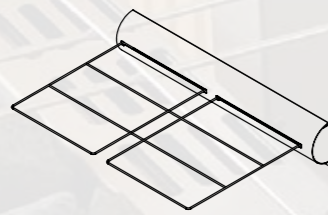

**Type 5** #94 4725  
HWD 140×710×482 mm

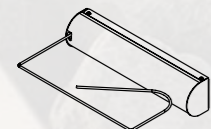

**Type 6** #94 5624  
HWD 140×333×222 mm

Model	Item no.
Emergency button with cover plate	94 5777
Emergency button without cover plate	94 5779
EOSafe L with 27 mm reflector	94 7151
EOSafe L with 52 mm reflector	94 7150
EOSafe L with 52 mm reflector (round sauna heaters)	94 7492
EOSafe D with 5 m cable	94 7149
EOSafe D with 20 m cable	94 7821
EOSafe L & D, with 27 mm reflector	94 7153
EOSafe L & D, with 52 mm reflector	94 7152

Model	Item no.	Size (H×W×D)
Cover protection rail type 1 black / white model	94 4421 94 7320 / 94 7499	140×333×322 mm
Cover protection rail type 3	94 4425	140×710×322 mm
Cover protection rail type 4 black model	94 4724 94 8043	140×333×482 mm
Cover protection rail type 5 black model	94 4725 94 8020	140×710×482 mm
Cover protection rail type 6	94 5624	140×333×222 mm



## Cover protection rail

- Cover protection safety rail for sauna heaters.
- Simple installation, may be retrofitted into an existing sauna.
- High reliability and safety.
- Available in five sizes for EOS sauna heaters.
- Approved safety solution – complies with the current European safety norm (EN 60335-2-53).

## Emergency button

- Special double action emergency button for saunas.
- Two separate circuits (1 x normally closed, 1 x normally open).
- Extra-long housing for easy installation in sauna cabin walls.
- Two circuits allow to launch two separate actions once the button is pressed: e.g. switch off the heater and trigger an alarm.
- Visible front side - protection class IP65.
- Also available in set with a wooden plate (beech wood).



## EOSafe

- EOSafe is an innovative safety solution for sauna cabins.
- **EOSafe L** – for supervision of the sauna heater through a light ray solution with an emitter/receiver on the ceiling and a 27 or 52 mm reflector mounted on the heater. Set includes control unit, emitter/receiver unit, reflector and cables.
- **EOSafe D** – safety solution based on door supervision. The system is able to detect an unauthorized opening of the door and through this ensure due safety. Set includes control unit, RFID device (for glass doors) with 5 m or 20 m cable, and authorization tag.
- The EOSafe is also available as a combination of the „L“ and „D“ solutions with one central controller.
- Power supply: 230V 1N.
- Compatible sauna controls: EOS Econ D4/H4, EOS EmoTec-/EmoStyle-/EmoTouch 3-series. Connection through S-Bus.



## EOS LED Strip



- New generation LED strips – up to 110°C heat resistant and therefore in many cases suitable for installation in the sauna ceiling area.
- Integrated electronic overheating protection for every LED.
- Improved performance - up to 110 lumen light per watt of power consumption.
- Slim size plug on both ends allows quick connection of strips in longer chains.
- Durable construction with mounting holes for quick installation on any flat surface.
- Available as RGB type and as warm white light type.
- Every strip may be shortened to 2/3 or 1/3 length.
- Dimmable (24V =, voltage controlled LEDs).
- Control e.g. with the coloured light module SBM-FL75/150, stand-alone controller or transformer.

## EOS LED Spots

- Universal – suitable for saunas, infrared cabins, steam rooms and hammams.
- Dimmable (constant voltage type). Powerful, brilliant colours, homogeneous light surface.
- Elegant round-shape slim size metal housing.
- Also available with elegant matt black finish.
- Ø84 mm, case depth only 25 mm.
- 4 W / 24V =, protection class IP65. Heat-resistant up to 110°C.
- With pre-mounted 2 m connection cable – allows fast and easy installation
- Available individually, in sets of 5 or 10, as RGB or warm white version.



## EOS LED Control

- Stand-alone control system for LED strips and LED spots.
- Includes compact size wireless remote control with wall holder.
- Up to 20m control range, no direct line of sight needed.
- Includes 230V power adaptor, main electronic unit and 5 m connection cable.
- Easy to install, easy to use. Not dependent on a specific sauna control unit model.
- Direct colour selection, colour sequences, special effects and many other functions.



## Accessories

Connection and extension cables for LED strips. Available in various lengths.



Transformer for LED strips and LED spots. Dimmable. 30 W / 60 W

# COLOURED LIGHT

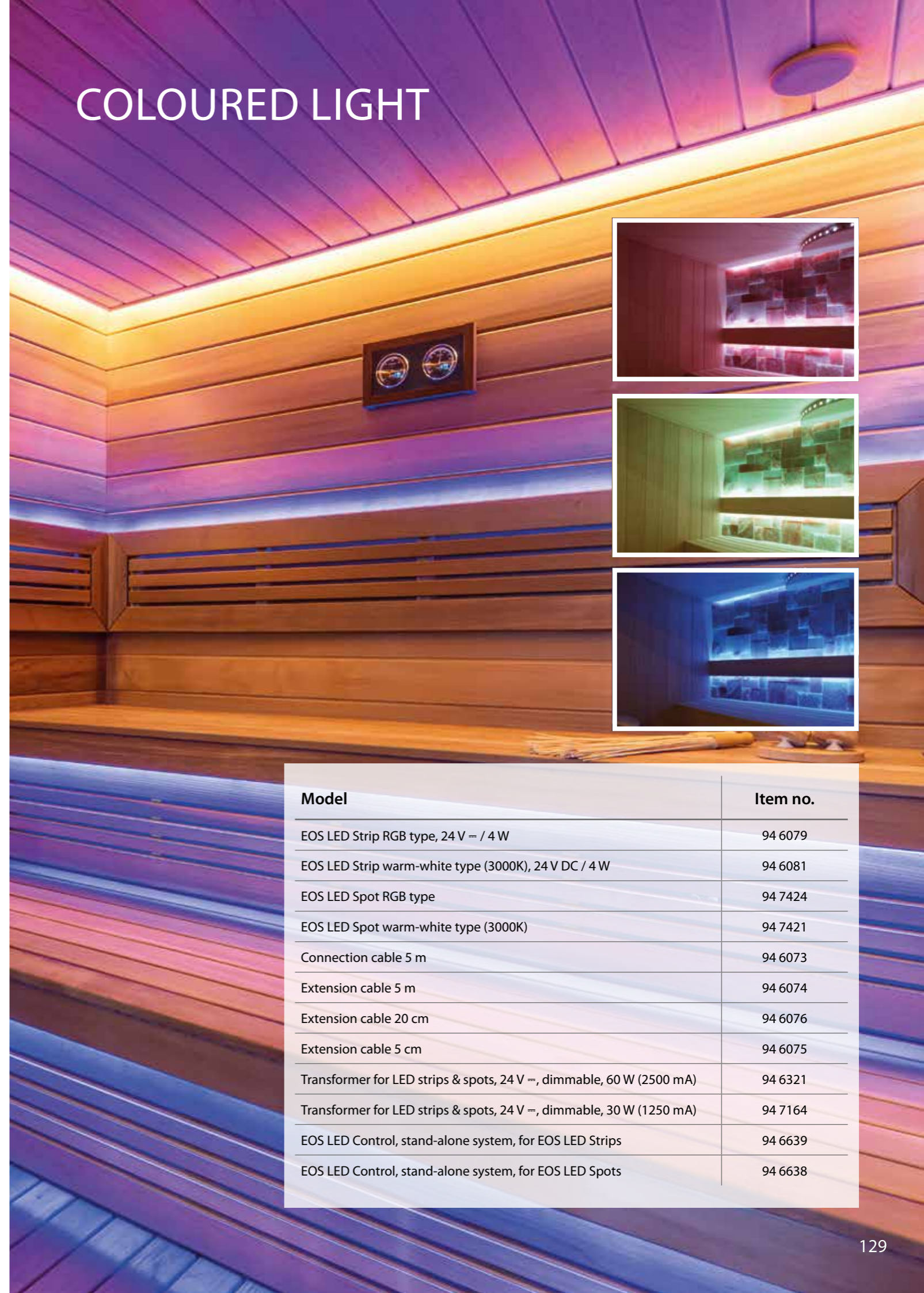

Model	Item no.
EOS LED Strip RGB type, 24 V = / 4 W	94 6079
EOS LED Strip warm-white type (3000K), 24 V DC / 4 W	94 6081
EOS LED Spot RGB type	94 7424
EOS LED Spot warm-white type (3000K)	94 7421
Connection cable 5 m	94 6073
Extension cable 5 m	94 6074
Extension cable 20 cm	94 6076
Extension cable 5 cm	94 6075
Transformer for LED strips & spots, 24 V =, dimmable, 60 W (2500 mA)	94 6321
Transformer for LED strips & spots, 24 V =, dimmable, 30 W (1250 mA)	94 7164
EOS LED Control, stand-alone system, for EOS LED Strips	94 6639
EOS LED Control, stand-alone system, for EOS LED Spots	94 6638

# STEAM ROOM EQUIPMENT



FOR MODERN STEAM ROOMS AND HAMMAMS

# STEAM GENERATORS



## INNOVATIVE STEAM ROOM EQUIPMENT

The idea behind the steam room equipment from EOS is superior performance paired with exceptional reliability and easy handling.

For our products, we rely exclusively on carefully selected materials and perfect workmanship down to the smallest detail – durable technology for long-lasting steam room pleasure. High-quality raw materials and high-quality components are individually manufactured and only delivered to our customers after several functional tests. The built-in descaling system dissolves limescale and rinses the water tank, thus ensuring consistently high performance.

The steam generators are complemented by quality accessories such as light, sound, fragrances, etc., which appeal to all senses and create an unforgettable steam bath experience.

Trust in decades of experience made in Germany.

Model	Power	Item no.	Steam output
EOS SteamAttrac	3 kW	94 6838	4 kg/h
	4 kW	94 6839	5 kg/h
	6 kW	94 6840	8 kg/h
EOS SteamRock II Basic	3/6/9 kW	94 7649	4/8/12 kg/h
	3/6/9/12/15/18 kW	94 7650	4/8/12/16/20/24 kg/h
EOS SteamRock II Premium	3/6/9 kW	94 7643	4/8/12 kg/h
	9/12/15/18 kW	94 7644	12/16/20/24 kg/h



Incl. actuator for drain valve.  
Automatic drain after use.

## EOS SteamAttrac

- Compact steam generator for steam rooms or saunas with humid operation. Suitable for private and commercial use.
- Durable stainless steel outer housing and water tank with high-performance heating elements.
- Stable steam production.
- Dry run protection with automatic switch-off at water shortage.
- Automatic drain after use.
- Reminder indicator for cleaning / descaling.

## EOS SteamRock II Basic

- Steam generator with quality heating elements for steam rooms. Ideal for private and commercial use.
- Variable power output, may be adjusted on site in 3 kW steps.
- Robust, durable construction with quality heating elements. Water tank made entirely of stainless steel, separately replaceable heating elements.
- Very fast steam production, high efficiency.
- Flexible installation thanks to variable steam outlet.
- Fully automatic operation with overheating protection. Integrated automatic descaling system (cleaning and descaling).
- Delivery includes a 5 l container with level probe for descaler liquid.
- Suitable control unit - e.g. LSG Steam for EmoTouch 3, Econ S2.

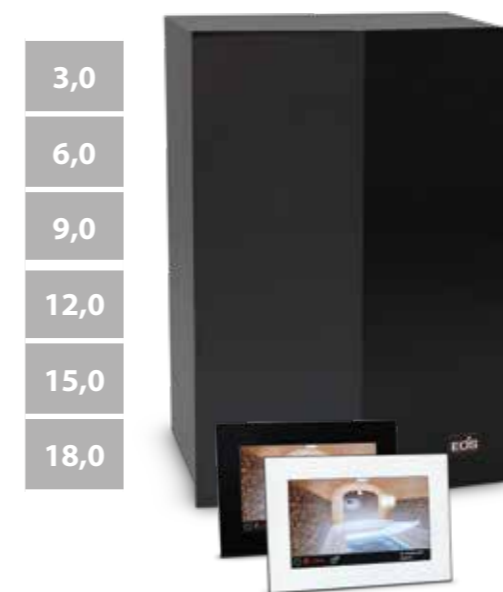

## EOS SteamRock II Premium

- Luxury class steam generator with high-performance quality heating elements for steam rooms. Ideal for particularly demanding use.
- Variable power output, may be adjusted on site in 3 kW steps.
- Includes luxury EOS EmoTouch 3 control system – the 7" colour touch screen display can be installed up to 50m away from the steam generator. Very large scope of functions and features, e. g. coloured light, sound, remote start, etc.
- Built-in descaling and automatic cleaning system.
- Built-in essence dosing system for two fragrances.
- Flexible installation thanks to variable, extra-large 1 1/4" steam outlet for efficient operation.
- Volt-free outputs for bench and floor heating. Outputs for two fans and light (dimmable).
- Temperature sensor with 5 m cable included in delivery.



## Water softening devices

- For steam generators and other vaporizers.
- Compact floor-standing model with electronic control and containers for salt tablets.
- Reliable water softening system with control valve BNT 1650F for 1-6 persons (AKE 40) / 8-20 persons (AKE 120).
- Automatic bypass directs the water past the system during regeneration.
- Integrated mixing valve for setting the water hardness.
- Pressure-resistant container with high quality ion exchange resin.
- Cabinet container also serves as brine preparation tank – practical and space-saving.
- Regeneration period: 25 Min.

## EOS Econ S2

- Control unit for EOS SteamRock II Basic and EOS SteamAttrac steam generator. Suitable for domestic and commercial operation.
- LCD display with multi-language menu navigation. Guided setup.
- Temperature control 30 to 50 °C, variable heating time limitation.
- Output for light and ventilation fan (230V), Timer function.
- Control for essence dosing (for 230V essence dosing pumps), and further special functions.
- Temperature sensor with 5 m cable included in delivery.
- Longer sensor cables (20 m or 50 m) optionally available.



## LSG Steam für EOS EmoTouch 3

- LSG Steam extension module allows to operate the steam generators like EOS SteamRock II Basic and EOS SteamAttrac, as well as many other brands.
- Compatibility by 3rd party brands should be checked in advance.
- Output - switch signal 230V, no load switching.
- Includes 10 m sauna bus connection cable and a digital temperature sensor with 5 m cable.
- Note: not needed for EOS SteamRock II Premium NC, these models are operated directly from EOS EmoTouch 3.



Model	Item no.
Water softening system AKE 40	94 6773
Water softening system AKE 120	94 6818
EOS Econ S2	94 6296
LSG Steam for EOS EmoTouch 3	94 6967

# STEAM ROOM EQUIPMENT



Model	Item no.
Dosing pump 230 V / 8 W	94 6297
Dampfdüse SteamRock	2001 5575
Blower fan (with non-return valve)	2001 4401
Extractor fan	2001 4402
Disc valve for extractor fan	2001 4404
Stainless steel disc valve	2001 5210
Descaling liquid 5 l	2001 6065

Model	Item no.
EOS LED Strip SR warm white 24 V 3 W 355 mm	94 6646
EOS LED Strip SR RGB 24 V 3 W 355 mm	94 6654
EOS LED Strip SR flex warm-white light type (3000 K)	94 7318
EOS LED Strip SR flex RGB type	94 7317



## Blower / Extractor fan

- Blower fan DN 100 (80W T50), with an external 5-step speed controller.
- With a non-return valve.



## Essence dosing pump

- Essence dosing pump for steam rooms. Great for EOS Econ S2.
- High quality peristaltic pump in robust metal housing with anthracite powder coating finish.
- Includes pre-mounted connection cable.
- Includes brass essence injector.
- Dosing performance up to 5l/h. Protection class IP20.

## Steam outlet

- Heat-resistant plastic. With 1 1/4" ext. thread.
- New design for improved steam flow distribution, integrated holder for essences.

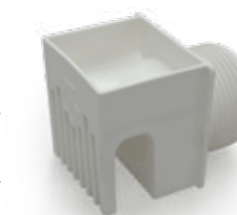

## Blower / Extractor fan

- Extractor fan DN 100 (12,5-15W) 230V 50Hz, for steam rooms.
- Disc valve for extractor fan (non-return valve, optional).



## Descaling liquid

- Descaling liquid for steam generators. Phosphoric acid solution, designed for SteamRock steam generators.
- 5 l canister.



## EOS LED Strip SR for steam rooms

- Ideal for steam rooms. Exceptionally high light output - up to 160 lumen per watt.
- Humidity protection IP65, high mechanical protection thanks to the robust aluminium profile.
- Very compact, slim size - only 20x9 mm. With pre-mounted 5 m connection cable.
- Very simple and quick installation thanks to mounting holes and slim connectors.
- Available as RGB coloured light type and as white light type (3000 K).
- Available in the lengths 355 mm, 520 mm, 1015 mm, 2005 mm, 2170 mm, 2335 mm and 2500 mm.



## EOS LED Strip SR flex for steam rooms

- Special flexible LED strip designed for steam rooms and similar high humidity installations.
- 24V ~, 72 W. IP68 protection class. Dimmable (constant voltage).
- Approx. 5 m length, with 5 m connection cable on both ends. Adhesive layer on the rear side, mounting brackets for mechanical fixation included in delievery.
- Available as RGB coloured light type (60W) and as white light type (warm white, 60W, 3000 K).
- Dividable, can be shortened in 10 cm steps.



# INFRARED SYSTEMS



EQUIPMENT FOR SPA & WELLNESS

# INFRARED HEATERS



## COMFORTING WARMTH FOR BODY AND SOUL

With infrared technology from EOS you create the perfect basis for relaxation.

IR heat can represent an alternative to the classic sauna and at the same time it can be a perfect supplement. Thanks to the short heat-up times, the IR heaters are immediately ready for use, as it does not heat the surroundings, but the body itself. IR heat has been proven to have a positive effect on health – the gentle heat relieves tension and can alleviate chronic pain.

IR heaters from EOS let you experience a pleasant feeling of well-being and ensure lasting relaxation. With the perfectly matched control units from EOS, the infrared experience becomes an even greater pleasure.

Model	Item no.	Size (H×W×D)
EOS IRS 30 Ceramic	94 1878	560×185×65 mm
EOS IRS 35 RHK	94 4305	900×185×65 mm
EOS IRS 50 RHK	94 4306	
EOS IRS 40 RHK	94 4012	560×185×65 mm
EOS Vitae 350 W	94 2865	900×185×65 mm
EOS Vitae 500 W	94 2576	
EOS Vitae 750 W	94 2577	
EOS Vitae Compact 350 W	94 7302	745×185×65 mm
EOS Vitae Compact 500 W	94 7303	
EOS Vitae Compact 750 W	94 7304	
EOS Vitae+ 350 W	94 7000	990×185×65 mm
EOS Vitae+ 500 W	94 7001	
EOS Vitae+ 750 W	94 6862	
EOS Vitae+ Compact 350 W	94 7299	815×185×60 mm
EOS Vitae+ Compact 500 W	94 7300	
EOS Vitae+ Compact 750 W	94 7301	

Alex Company

## EOS IRS 30 Ceramic

- IR-heater for IR warming cabins.
- With 300 W ceramic emitter, IR-C range.
- Reflector shield of polished aluminium.
- With reflector, metal housing, safety grill and cable.

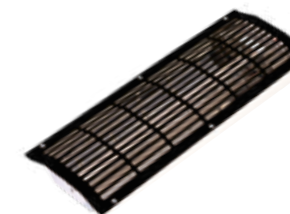

## EOS IRS 35/IRS 50 RHK

- IR-heater for IR warming cabins. IR-C range.
- 350 W or 500 W emitter (tube type with magnesia oxide filling).
- With protective flocked safety grill (black).
- With reflector, metal housing, safety grill and cable.

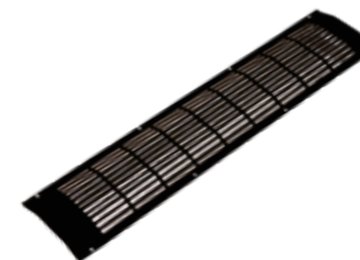

## EOS IRS 40 RHK

- IR-heater for IR warming cabins. IR-C range.
- 400 W emitter (tube type with magnesia oxide filling).
- With protective flocked safety grill (black).
- With reflector, metal housing, safety grill and cable.

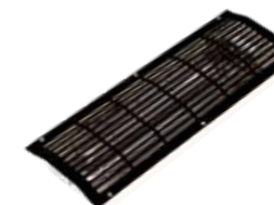

## EOS Vitae / Vitae Compact

- High performance IR-heater for IR warming cabins.
- Full spectre - IR-A, IR-B and IR-C range.
- Full power output in less than 1 sec, very high intensity.
- VITAE type quartz glass emitter with 350, 500 or 750 W.
- With reflector, metal housing, safety grill and cable.
- **EOS Vitae Compact:** extra-short version - 745 mm length.



## EOS Vitae+ / Vitae+ Compact

- Full spectre IR heater with high-performance quartz glass emitter and built-in dimmer.
- With high-performance VITAE quartz-glass emitter 350, 500 or 750 W.
- With pre-assembled housing with reflector shield and protective flocked safety grill (black).
- **EOS Vitae+ Compact:** extra-short version - 815 mm length.



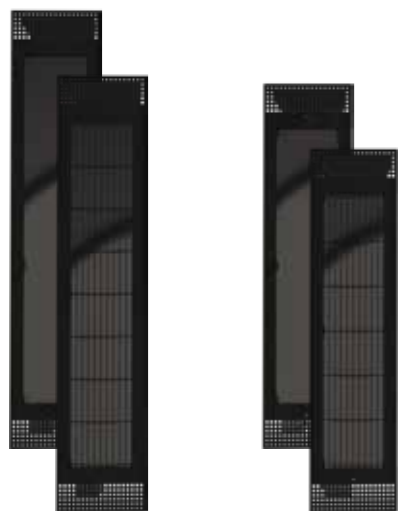

EOS Vitae Protect      EOS Vitae Protect Compact

## EOS Vitae Protect / Protect Compact

- With special glass ceramic screen shield in front of the heat emitter - for a wider heat distribution and additional protection against water drops or humidity during cabin use.
- New design protective safety grill. Alternatively available without the safety grill.
- VITAE type quartz glass emitter with 350, 500 or 750 W.
- With reflector, metal housing, safety grill and cable.
- **EOS Vitae Protect Compact:** extra-short version - 795 mm length.



EOS Vitae Protect+      EOS Vitae Protect+ Compact

## EOS Vitae Protect+ / Vitae Protect+ Compact

- IR heater With built-in dimmer for quick heat adjustment.
- With special ceramic glass filter for additional dispersion of the infrared heat and humidity protection.
- Full-spectre range – IR-A, IR-B and IR-C, full power output in less than 1 sec. Dimmable.
- Available with or without protective flocked safety grill (black).
- **EOS Vitae Protect+ Compact:** extra-short version – 885 mm length.

## EOS Vitae Protect Top



- Ceiling-mounted infrared warming system.
- With housing and reflector. Protective flocked safety grille (black). Completely pre-assembled with two 3 m silicone connection cables 3x1.5 mm<sup>2</sup>.
- The recommended distance from the heater to the body is approx. 80 cm.
- Use only in connection with a suitable control unit. The maximum total load must not exceed 3500W.
- Full spectre infrared radiation – IR-A, IR-B and IR-C.

## Aroma bowl for IR heaters

- With the aroma bowl, you have the opportunity to bring even more nature and wellness into your cabin.
- Particularly recommended with Himalaya salt rocks.
- Suitable for the EOS Vitae and Vitae Protect IR heaters with protective grill.



Model	Item no.	Size (HxWxD)
EOS Vitae Protect 350 W with / without safety grill	94 6502 / 94 6572	950x200x60 mm
EOS Vitae Protect 500 W with / without safety grill	94 5450 / 94 6573	
EOS Vitae Protect 750 W with / without safety grill	94 5451 / 94 6574	
EOS Vitae Protect Compact 350 W with / without safety grill	94 7293 / 94 7287	795x200x60 mm
EOS Vitae Protect Compact 500 W with / without safety grill	94 7295 / 94 7288	
EOS Vitae Protect Compact 750 W with / without safety grill	94 7296 / 94 7289	
EOS Vitae Protect + 350 W with / without safety grill	94 9697 / 94 6995	1040x200x60 mm
EOS Vitae Protect+ 500 W with / without safety grill	94 6998 / 94 6996	
EOS Vitae Protect + 750 W with / without safety grill	94 6999 / 94 6863	
EOS Vitae Protect + Compact 350 W with / without safety grill	94 7296 / 94 7290	885x200x60 mm
EOS Vitae Protect + Compact 500 W with / without safety grill	94 7297 / 94 7291	
EOS Vitae Protect + Compact 750 W with / without safety grill	94 7298 / 94 7292	
EOS Vitae Protect Top 1000 W	94 7703	1440x200x45 mm
EOS Vitae Protect Top 1500 W	94 7704	
Aroma bowl for IR heaters	94 7579	



# CONTROL UNITS FOR INFRARED

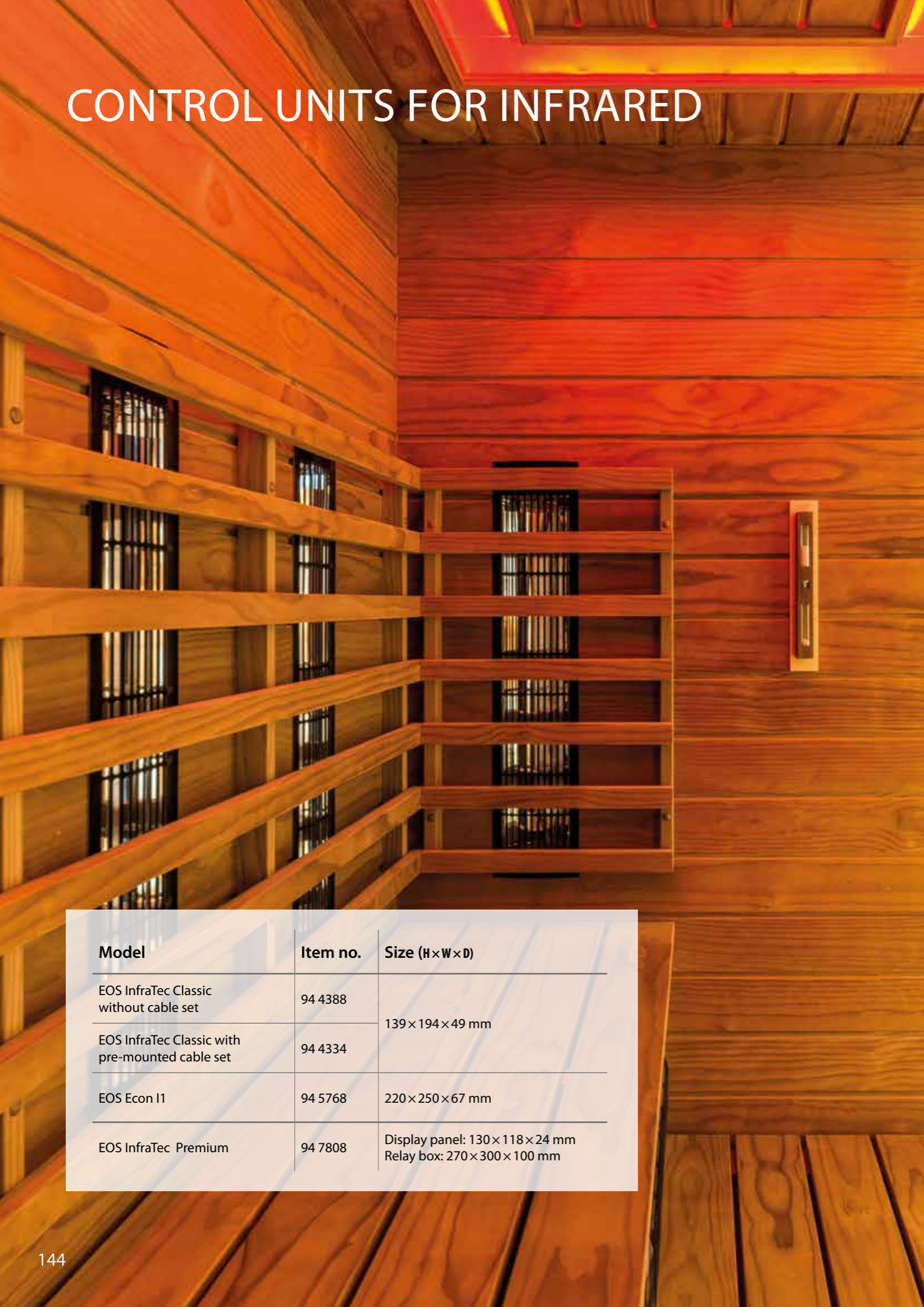

Model	Item no.	Size (H×W×D)
EOS InfraTec Classic without cable set	94 4388	139×194×49 mm
EOS InfraTec Classic with pre-mounted cable set	94 4334	
EOS Econ I1	94 5768	220×250×67 mm
EOS InfraTec Premium	94 7808	Display panel: 130×118×24 mm Relay box: 270×300×100 mm

## EOS InfraTec Classic



- Control unit for infrared warming cabins. Temp. control range 30-70°C.
- LCD display (time, functions, error messages).
- Heating time 1-99 min. Switch for cabin lighting (230V).
- Recessed installation. Available with a pre-mounted cable set or without a cable set. Temperature sensor included.
- 3.500W power output, 230V 1N ~ power supply.

## EOS Econ I1

- Control unit for IR warming cabins. Ideal for large commercial cabins - 9 kW switching power (400V 3N ~ power supply).
- LCD display (time, functions, temperature, heating time). Menu navigation in twelve languages.
- Temperature control range 30-70°C.
- Keypad lock, light switch, heating time up to 6 h, quick timer mode „Life Guard“



## EOS InfraTec Premium



- Control unit for IR warming cabins.
- Compact size recessed control panel, separate relay box.
- Illuminated alphanumeric LCD display (time, functions, temperature, remaining time). Multi-language menu navigation.
- Temperature control range 30-70°C.
- 3.500W power output, 230V 1N ~ power supply.
- Optional sensor for heating foils.
- Three separate heating zones (rear and front – dimmable, feet - switchable). Light switch.

## EOS EmoTec IR

- Digital control panel for infrared cabins. For residential and commercial use.
- Heating control as per air temperature or heat intensity.
- Three separate outputs: 2x 1500W dimmable, 500W switchable.
- Up to five channels - allows to create individual zones or heating groups (e.g. back, front, side, etc.).
- Supports all types of IR emitters and heating foils.
- Total power output can be increased to 10.5kW with extension modules SBM-IR.



## EOS InfraStyle

- Digital luxury-class control panel for infrared cabins. For residential and commercial use.
- Based on the proven construction of the control unit EOS EmoStyle.
- Luxurious display panel with glass front and capacitive buttons.
- Available in black or white design.
- Functions and features as EOS EmoTec IR model.



## EOS InfraStyle i

- Digital luxury-class control panel for infrared cabins with the display panel for installation inside infrared cabin. Flush-mounted installation.
- Luxurious display panel with glass front and natural wood inlay of maple or walnut, capacitive buttons.
- TFT colour display with menu navigation in 19 languages.
- Available in four designs: black or white glass panel, wooden inlay made of natural maple or walnut wood.

# CONTROL UNITS FOR INFRARED

Model	Item no.	Size (H x W x D)
EOS EmoTec IR anthracite / silver	94 7044	Display panel: 127 x 130 x 25 mm Relay box: 270 x 300 x 100 mm
EOS EmoTec IR white / silver	94 7045	
EOS InfraStyle black	94 7046	Display panel: 127 x 130 x 25 mm Relay box: 270 x 300 x 100 mm
EOS InfraStyle white	94 7047	
EOS InfraStyle i white maple	94 7049	Display panel: 200 x 140 mm Relay box: 270 x 300 x 100 mm
EOS InfraStyle i black maple	94 7048	
EOS InfraStyle i white walnut	94 7071	
EOS InfraStyle i black walnut	94 7070	

Model	Item no.	Size (H×W×D)/Description
EOS IR heating foils 650 W	94 3742	Foil size: 1700×800 mm Heating surface: 1620×720 mm
EOS IR heating foils 550 W	94 3743	Foil size: 1450×800 mm Heating surface: 1370×720 mm
EOS IR heating foils 450 W	94 3744	Foil size: 1600×600 mm Heating surface: 1520×520 mm
EOS IR heating foils 350 W	94 3745	Foil size: 1250×600 mm Heating surface: 1170×520 mm
EOS IR heating foils 275 W	94 3835	Foil size: 1600×400 mm Heating surface: 1520×320 mm
EOS IR heating foils 70 W	94 3891	Foil size: 600×300 mm Heating surface: 520×220 mm
Corner cover	94 4566	
Dimmer	94 7467	80×80×55 mm
IR plug adaptor for 5 heaters	94 7811	Connects up to 5 heaters in one line
EOS InfraSteam	94 4140A	520×225×120 mm

## EOS IR heating foils

- IR-heating foils for infrared cabins.
- Available in power outputs: 70/275/350/450/550/650W.
- Different sizes from 600x300 mm to 1700x800 mm.
- Concealed installation under the wooden surface.
- Working temperature approx. 90-100 °C.
- Automatic temperature limitation at 100 °C.
- With connection cable and on-surface high limiter.
- For technical reasons, the effective output can deviate from the nominal value by up to +5%/-10%.



## Corner cover

- Corner cover for IR heaters, with black protective flocking.
- Very practical for IR heater installation in corners.
- Universally fits all EOS IR heaters.

## Dimmer for IR heaters

- Dimmer for manual adjustment of heat intensity.
- Particularly recommended for Vitae quartz heaters.
- Simple and easy adjustment of power without having to leave the cabin. Recessed installation in cabin wall.
- Max. power up to 1000W.



## EOS InfraSteam auxiliary vaporizer

- Compact vaporizer for domestic infrared cabins.
- Essence cup at the steam exit. Very easy to use, manual water filling.
- Built-in control unit. Very slim, place-saving design.
- 750W power output, optimal for 1-2 person cabins.
- 230V, with 3 m mains cord with plug.



## InfraSky 3000 IR system

- Designer ceiling-mounted infrared heating system for relaxation.
- For domestic and commercial operation.
- Perfect for relaxation zones, e.g. mounting over lounge chairs.
- Thanks to the ceiling-mounting provides full freedom of movement, does not block floor space.
- Provides comforting, cozy warmth - ideal for relaxation and rest.
- 6 x high performance 500W Vitae emitters.
- Stylish, sleek housing, available in various finishes.
- Requires an external control unit (e.g. SunTec).

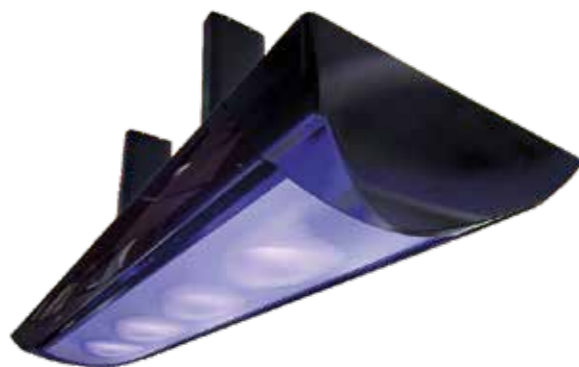

## SunSky 400 tanning system

- Luxury class designer soft-tanning system for ceiling mounting.
- Suitable for domestic and intensive commercial use.
- Thanks to the ceiling-mounting provides full freedom of movement, does not block floor space.
- Special UV-filters provide soft-tanning and allow long, relaxing tanning times - perfect for relaxation and rest.
- 4 x 400W high-pressure tanners.
- Requires an external control unit (e.g. SunTec).



## SunTec / SkyTec Control unit

- **SunTec:** Wall-mounting time controller for SunSky, 30 or 60 minutes countdown timer.
- **SkyTec:** Wall-mounting time controller for InfraSky, 30 or 60 minutes countdown timer.
- EmoTec Design housing, cream white, wall-mounting installation. LED display, illuminated.

## Ceiling suspension SunSky / InfraSky

- Elegant telescopic suspension system specially designed for SunSky and InfraSky systems.
- Available in three sizes for ceiling gaps from 210 to 690 cm.
- Every size is available in three colours: silver grey, black and white.



# INFRARED & TANNING SYSTEMS

Model	Item no.
InfraSky 3000 IR RAL 9022 silver grey	94 4307
InfraSky 3000 IR RAL 9011 black	94 4315
SunSky 400 RAL 9022 silver grey	95 7199
SunSky 400 RAL 9011 black	95 7200
SunSky 400 RAL 9016 white	95 7201
SkyTec (control for InfraSky)	95 4340
SunTec (control for SunSky)	95 3892

Ceiling suspension for SunSky/ InfraSky	Item no.
Typ 200 ceiling gap 210 - 290 mm silver grey RAL 9022	95 3923
Typ 400 ceiling gap ca. 410 - 490 mm silver grey RAL 9022	95 3924
Typ 600 ceiling gap ca. 610 - 690 mm silver grey RAL 9022	95 3925
Typ 200 ceiling gap ca. 210 - 290 mm black RAL 9011	95 4161
Typ 400 ceiling gap ca. 410 - 490 mm black RAL 9011	95 4162
Typ 600 ceiling gap ca. 610 - 690 mm black RAL 9011	95 4163
Typ 200 ceiling gap ca. 210 - 290 mm white RAL 9016	95 5588
Typ 400 ceiling gap ca. 410 - 490 mm white RAL 9016	95 5600
Typ 600 ceiling gap ca. 610 - 690 mm white RAL 9016	95 5601

# ESSENCE DOSING SYSTEMS AND FLAKE-ICE MACHINES



Promet

EQUIPMENT FOR SPA & WELLNESS

## AromaTec II

- Essence dosing and automatic infusion system for saunas.
- Available with dosing for one, two or three fragrances.
- Completely pre-mounted on a robust metal panel.
- With electronic control unit, dosing pump(s) and 1 l container(s) for fragrances.
- 3,2" colour touch screen display for easy and convenient operation.
- Operation via the built-in control unit or an external push-button. Cycles, quantity and intensity adjustable. Week timer, password protection, log file.
- Automatic delay during sauna heat-up time. 230V 1N power supply.



## AromaTec II Basic

- Essence dosing and automatic infusion system for saunas.
- Integrated controller with LCD display. Very simple and easy to use.
- Two operation modes: automatic cycle or manual switching via a remote push button.
- Settings: start time delay, water quantity, dosing intensity, cycle time or time interval by manual dosing.
- Built-in peristaltic pump for 1 fragrance.
- Completely pre-mounted on a robust metal panel. 230V 1N power supply.

## DuftTec Solo

- Essence dosing system for steam rooms.
- Integrated controller. Very simple and easy to use.
- Peristaltic pump with dosing intensity adjustment via interval setting.
- Dosing time adjustable (inside housing)
- Operation only by active steam production. 230V 1N power supply.



## AquaDisp

- Automatic infusion system for saunas. Water splash can effect automatically at pre-set intervals or manually with an optional push-button.
- Recommended for instance for hidden heaters.
- With dosing valve in stainless steel housing, electronic control unit, dosing hose for connection to a sauna heater.
- Push button with cover plate optionally available.
- For control units EOS Econ D1 - D3 and H1 - H3 an additional power adaptor 94 7166 is required.

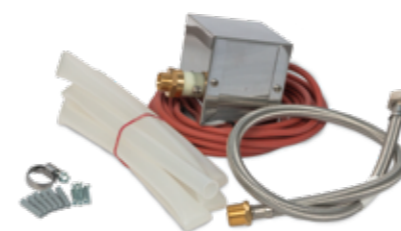

## DuftTec Quattro W

- Dosing system for steam rooms.
- For four fragrances (four separate dosing lines, four pumps).
- Four peristaltic pumps SA-type with dosing tubes 3,2x1,6V with tube holder 4x1 mm and suction tube (PE0,8m), with UNPL control unit.
- Adjustable intervals and dosing intensity. Pre-mounted on PE board for quick installation and connection. 230V 1N power supply.



## DuftTec Quattro T

- Dosing system for steam rooms.
- For four fragrances (four separate dosing lines, four pumps).
- Advanced microprocessor-based control unit, six time programs (8-20 minutes), six dosing quantities per fragrance (0-4 ml per injection), five status LED lamps.
- Four peristaltic pumps SA type with dosing tubes 3,2x1,6V and tube holder 4x1 mm and suction tube (PE0,8m).
- 230V 1N power supply.



Model	Item no.	Size (HxWxD)
AromaTec II 1 essence	94 6242	440x410x170 mm
AromaTec II 2 essences	94 6243	650x500x170 mm
AromaTec II 3 essences	94 6244	750x560x170 mm
AromaTec II Basic	94 6798	710x570x240 mm
DuftTec Solo	94 5261	120x80x90 mm
DuftTec Quattro W	94 5262	500x600x170 mm
DuftTec Quattro T	94 5263	500x600x170 mm
AquaDisp	94 6904	

# SALT NEBULIZER SYSTEMS



Model	Item no.
DuftTec dosing set DD Dosing valve VA 3/8" - 4 x 1, 3 m dosing tube PTFE 4 x 1	94 5267
DuftTec dosing valve Dosing valve VA 3/8" - 4 x 1	94 5268
Console for essence containers up to 10 l Material: PE black; size HWD: 600 x 235 x 240 mm	94 5269
Steam outlet LD kit V4A stainless steel pipe with connector for steam and fresh air	94 5270
Push button panel 4-fold (no illumination) 4-fold push button panel for DuftTec Quattro T, incl. 5 m cable	94 5271
Push button panel 1-fold (with illumination) 1-fold push button panel for SolTec and AromaTec Systems, incl. 5 m cable	94 5143
Bottom housing for flush-mounting installation of 4-fold push button panel, black	94 5272
Bottom housing for flush-mounting installation of 1-fold push button panel, black	94 5137
Wall-through connector for AromaTec units, stainless steel, thread connection	94 5192
Sprinkle head for AromaTec units, stainless steel, thread connection	94 5191
SolTec II SL	94 6245
SolTec V3	94 6246
Salt solution for SolTec 6 x 1 l (boxed) with 6 bags (ca. 5% brine) à 1 l, incl. disinfecting tabs	94 5273
Salt solution for SolTec 6 x 5 l (boxed) with 6 bags (ca. 5% brine) à 5 l, incl. disinfecting tabs	94 5274

## DuftTec / AromaTec accessories

- DuftTec dosing set DD: dosing valve VA 3/8" - 4 x 1, 3 m dosing tube PTFE 4 x 1.
- DuftTec dosing valve: VA steel 3/8" - 4 x 1.
- Console for canisters up to 10l. For various dosing systems.
- Steam outlet LD, V4A stainless steel mixing pipe, connection for steam and air.
- Button plate 4 fold (no illumination) for DuftTec Quattro T dosing system.
- Button plate 1-fold (with illumination) for SolTec and AromaTec systems.
- Bottom housing for flush-mounting installation of 4-/1-fold push button panel
- Wall-through connector for AromaTec units.
- Sprinkle head for AromaTec units.



## SolTec II SL | salt nebulizer

- Salt nebulizer for inhalation in dry rooms like saunas and salt grottos.
- New generation system with 3,2" colour touch-screen display control unit, numerous comfort features (week timer, password protection ...)
- Peristaltic pump with speed control for adjustable dosing quantity, diaphragm compressor, disinfecting set.
- Console VA for 5 l salt solution bag, high grade stainless steel 2-way injector with bezel and wall-through connector.
- Completely pre-mounted on robust metal plate for wall-mounting.
- Optional: salt solution in 1 l or 5 l plastic bags.

## SolTec V3 | salt nebulizer

- Salt nebulizer for inhalation in steam rooms.
- Dosing capacity up to 100 ml/min in continuous operation.
- With top quality diaphragm pump, separate for low-noise operation.
- New generation 3,2" touch-screen control panel with numerous functions.
- Stainless steel injector with bezel and wall-through connector, 5 m dosing tube PTFE 4x1.
- Disinfecting set, console VA for 5 l salt solution bags.
- Optional: salt solution in 1 l or 5 l plastic bags.





## E-Cool Wall | flake ice machine

- Automatic flake ice machine for concealed installation.
- With bottom ice chute or with side ice chute - allows flexible installation options.
- Fully automatic, very low noise operation.
- With a built-in or with an external ice level sensor (incl. mounting bracket and cable).
- Stainless steel chute (tube type) included in delivery.
- Built-in status LEDs allow to quickly check the current operation status.
- Up to 120 kg ice per day production capacity.
- Metal housing with anthracite finish, connection on the rear side (water inlet for ice production, water drain (melting water), water inlet and drain for cooling, mains).
- 230V 1N ~ power supply.



RUHA-Steinmüller Saunamanufaktur

Model	Item no.	Size (H×W×D)
E-Cool Wall B with bottom ice chute, internal ice level sensor	94 6096	560×530×525 mm
E-Cool Wall BE with bottom ice chute and external ice level sensor	94 6220	
E-Cool Wall S with side ice chute, internal ice level sensor	94 6087	
E-Cool Wall SE with side ice chute and external ice level sensor	94 6221	



# SAUNA ACCESSORIES



Kristall-Therme Schwangau

ENHANCE YOUR SAUNA EXPERIENCE

# SAUNA ACCESSORIES



## EOS Sauna bag

- High-quality polyester sauna bag with two front pockets and two side pockets with 2-way zips.
- Spacious main compartment. Floor feet.
- Detachable, length-adjustable shoulder strap with comfortable shoulder pad.
- Dimensions HWD: approx. 32 x 66/56 x 25 cm



## EOS Sauna scarf

- High-quality made of pure cotton. With high/low weaving and EOS logo embroidery. Colour: Black.
- Dimensions: 30 x 140 cm; Quality: 480 gsm

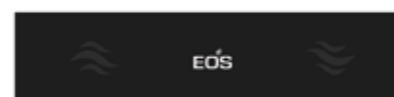

## EOS Sauna bath robe

- Sauna bath robe with pocket and belt.
- Heavy top quality 100% cotton.
- With embroidery. Colour: grey. Washable at 60 °C.



## EOS Sauna bath towel

- High-quality made of pure cotton. With high/low weaving and EOS logo embroidery. Colour: Black.
- Dimensions: 200 x 80 cm; Quality: 480 gsm



Model	Item no.
EOS Sauna bag	94 7801
EOS Sauna scarf	94 7874
EOS Sauna bath towel	94 7873
EOS Sauna bath robe, size S	94 4360
EOS Sauna bath robe, size M	94 4361
EOS Sauna bath robe, size L	94 4362
EOS Sauna bath robe, size XL	94 4363
EOS Sauna bath robe, size XXL	94 4364



## EOS Sauna bucket set

- Designer bucket for traditional water splashes.
- Wooden ladle serves as a handle.
- Made of high quality steel with scratch resistant powder coating.
- Ladle handle of thermo aspen, approx. 42 cm.
- Colour: black finish.

## EOS sauna essence holder

- Sauna essence holder for herbs, aetherial oils and sauna essences in various sizes. Perfect match to EOS Infusion Bucket.
- Quick and simple installation by simply hanging the holder on the infusion bucket.
- Colour: matt black finish.



## EOS cell phone rack

- High-quality holder for mobile phones. Wall-mounting.
- Colour: black finish.
- Dimensions HWD: 85 x 90 x 96 mm.

## EOS glasses rack

- High-quality support for glasses, including anti-slip mat.
- Wall-mounting.
- Colour: black finish.
- Dimensions HWD: 85 x 160 x 120 mm.



## EOS coat rack

- High-quality coat rack for up to two bath robes.
- Colour: black finish.
- Dimensions HWD: 30 x 250 x 100 mm.

# SAUNA ACCESSORIES



Model	Item no.
EOS Sauna bucket	94 7599
EOS sauna essence holder for 2 essence bottles	94 7602
EOS sauna essence holder for 3 essence bottles	94 7603
EOS cell phone rack	94 7766
EOS glasses rack	94 7765
EOS coat rack	94 7767



## EOS Excellent climate station

- Exclusive combination of thermometer and hygrometer.
- Round instruments in a metal plate with anthracite pearl-effect finish and an exclusive frame cut of massive walnut, maple or walnut/maple combinations.
- Ø 100 mm thermometer and hygrometer, range 0-120°C/0-100% rel. air humidity. Size 180x245 mm.
- Available in four design versions with walnut, maple or walnut / maple frame:
  - Typ 100D - walnut frame
  - Typ 100L - maple frame
  - Typ 100 DL - walnut vertical, maple horizontal
  - Typ 100 LD - maple vertical, walnut horizontal

Model	Item no.
EOS Excellent climate station, type 100D	94 6023
EOS Excellent climate station, type 100L	94 6024
EOS Excellent climate station, type 100DL	94 6025
EOS Excellent climate station, type 100LD	94 6026
EOS Excellent sand timer type 15D	94.6019
EOS Excellent sand timer type 15L	94 6020
EOS Excellent sand timer type 15DL	94 6021
EOS Excellent sand timer type 15LD	94 6022

## EOS Excellent sand timer

- Exclusive sand timer for Sauna in stylish, cubistic design. With a high contrast sand filling.
- Hand-cut from a massive walnut or maple wood.
- With an innovative automatic fixation in vertical position thanks to the hidden magnet.
- Available in four design versions with walnut, maple or walnut / maple frame:
  - Typ 15D - walnut
  - Typ 15L - maple
  - Typ 15 DL - walnut front, maple base
  - Typ 15 LD - maple front, walnut base





## Sauna lamp

- Sauna lamp with curved wooden shade 205x270 mm, dazzle-free, with splash-protected and heat resistant (T150°C) oval lamp.
- With oval shape lamp, IP54 class, die-cast aluminium base with matt glass globe and ceramic socket E27, without illuminant.
- Alternatively available also without a wooden shade.
- Special bulb, mini-size, E27, 40W, 300°C proof, optionally available.



## Thermometer/ Hygrometer

- Sauna thermometer, round, wall-mounting, Ø100 mm.
- Measuring range 0 - 120 °C. Upon request also available with Fahrenheit scale.
- Sauna hygrometer, round, wall-mounting, Ø100 mm.
- Measuring range 0 - 100% relative air humidity.
- „Made in Germany“ quality.

## Sauna climate station

- Combi thermo-/hygrometer Ø100 mm or Ø160 mm.
- For temperature and air humidity measurement.
- With highlighted „optimal zones“ for sauna climate.
- „Made in Germany“ quality.



## Sauna climate station in glass & wood design

- Sauna thermometer and hygrometer mounted in a stylish glass frame with wooden enclosure.
- Range 0 - 120 °C / 0 - 100% rel. air humidity.
- Size 180 x 245 mm. Instrument diameter Ø100 mm.
- „Made in Germany“ quality.



## Sand timer

- Classic sauna sand time, wood
- Contrast sand filling for easy reading
- 15 min. runtime

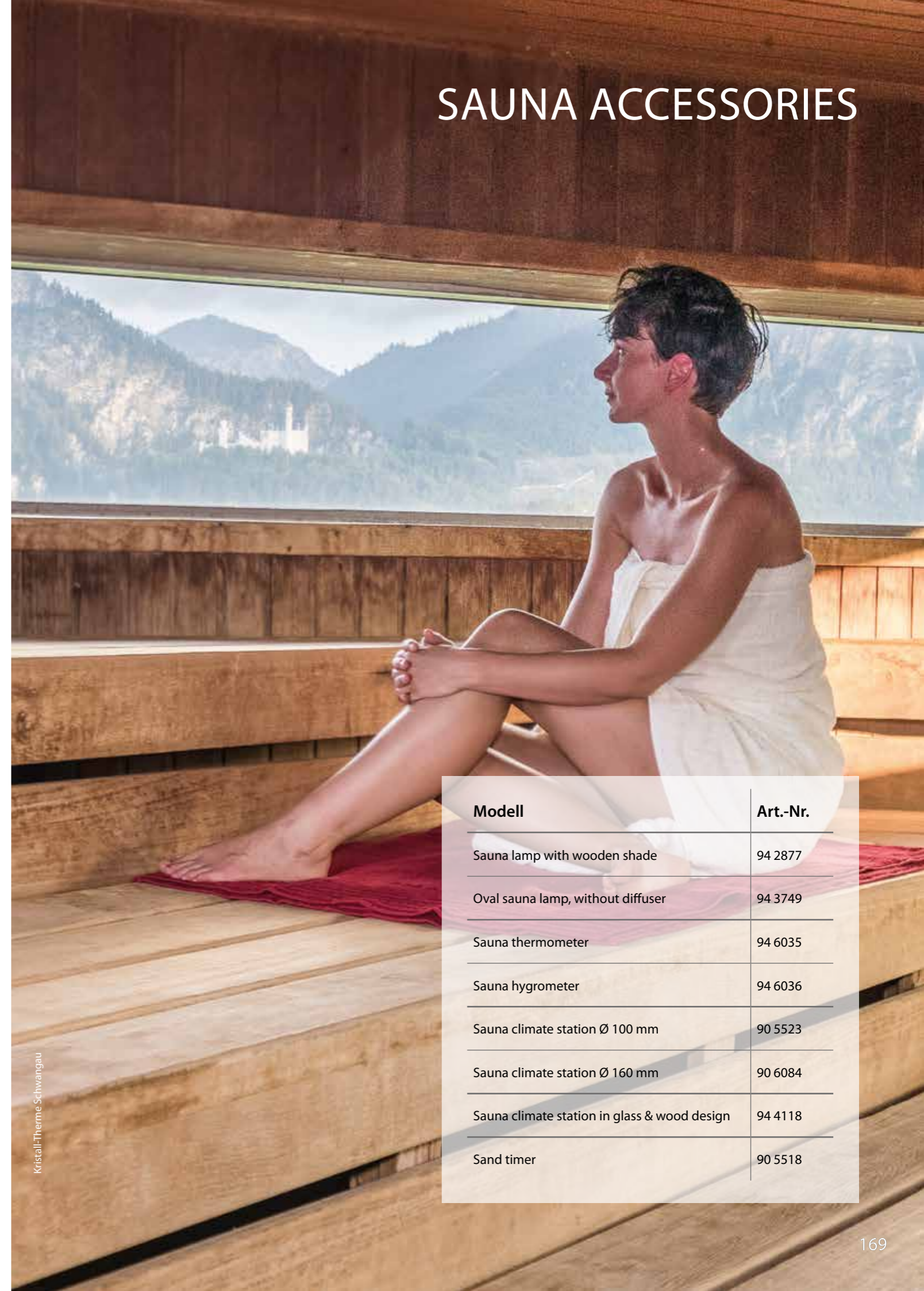

Modell	Art.-Nr.
Sauna lamp with wooden shade	94 2877
Oval sauna lamp, without diffuser	94 3749
Sauna thermometer	94 6035
Sauna hygrometer	94 6036
Sauna climate station Ø 100 mm	90 5523
Sauna climate station Ø 160 mm	90 6084
Sauna climate station in glass & wood design	94 4118
Sand timer	90 5518

Kristall-Therme Schwangau

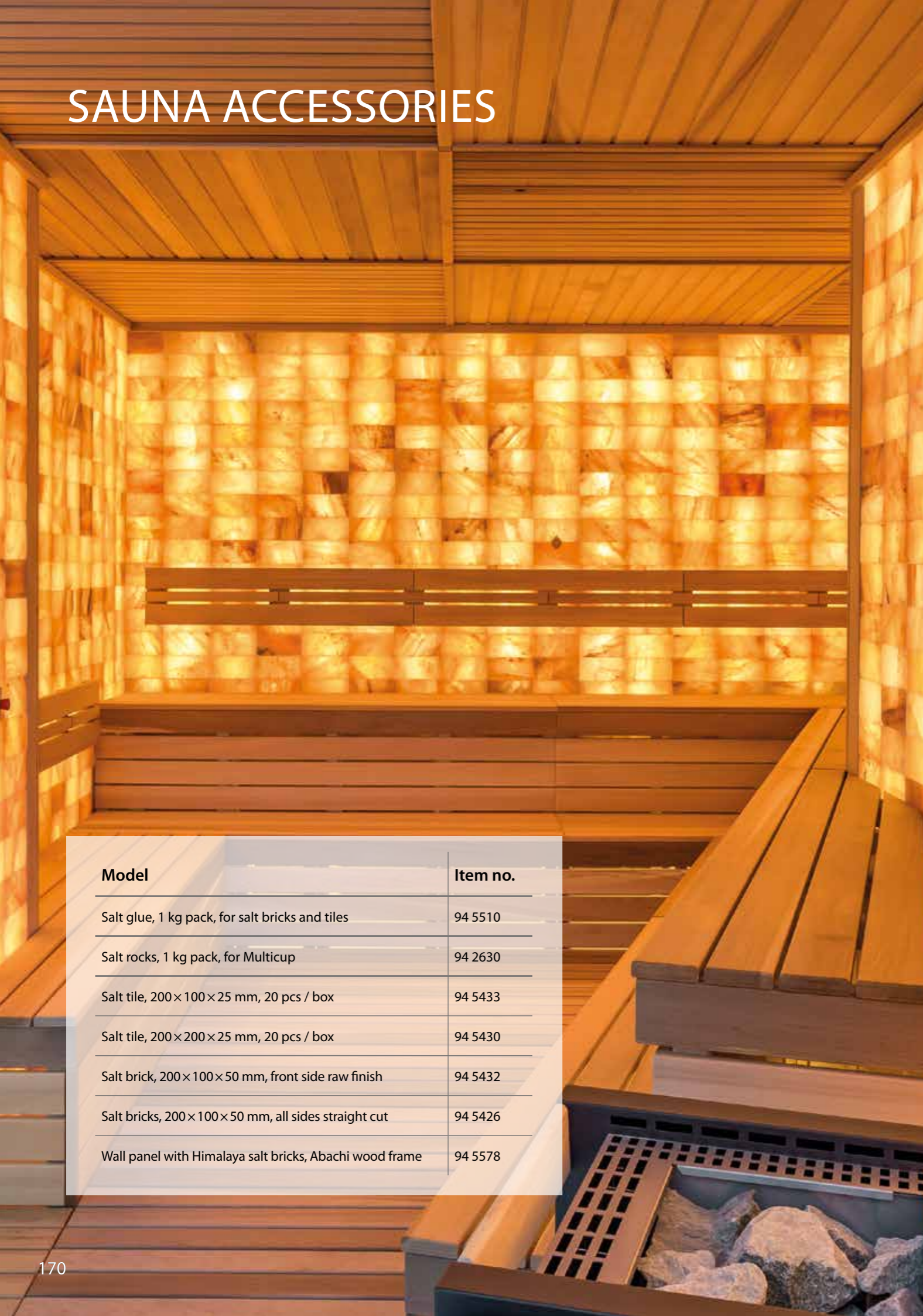

Model	Item no.
Salt glue, 1 kg pack, for salt bricks and tiles	94 5510
Salt rocks, 1 kg pack, for Multicup	94 2630
Salt tile, 200×100×25 mm, 20 pcs / box	94 5433
Salt tile, 200×200×25 mm, 20 pcs / box	94 5430
Salt brick, 200×100×50 mm, front side raw finish	94 5432
Salt bricks, 200×100×50 mm, all sides straight cut	94 5426
Wall panel with Himalaya salt bricks, Abachi wood frame	94 5578



## Himalaya salt

- Himalaya salt for a wide variety of wellness applications.
- Originates from ancient dried seas of the Permian period.
- 1 kg packing, optimal for instance for Multicup.

## Himalaya salt bricks and tiles

- Bricks cut from natural Himalaya rock salt, available in two versions - straight cut on all sides and with raw front side. 20 x 10 x 5 cm.
- Alternatively available as tiles – 20 x 20 x 2,5 cm or 20 x 10 x 2,5 cm.
- For installation we recommend special salt glue (in 1 kg packs).



## Himalaya salt wall panel

- Wall panel with Himalaya salt bricks 1080 x 285 x 40 mm.
- Filled with straight cut bricks 200 x 100 x 50 mm.
- For wall mounting installation on suitable surfaces.



## Sauna set **N I**

- Set N I, 6 parts: sauna bucket 5 l, PVC liner, ladle, sand timer, combi thermo/hygrometer Ø 100 mm, sauna rules board (German). Gift box.

## Sauna set **Stainless Steel**

- Sauna bucket 4,5l, stainless steel with wooden handle
- Stainless steel ladle with wooden handle.



## Drench bucket

- Drench bucket made of Red Cedar wood, with metal rings.
- Special level with pull chain makes water splash easy and effortless.
- Wall mounting frame and other mounting parts made of stainless steel.
- Integrated valve with automatic refilling, 1/2" tube nozzle connection.
- Water volume adjustable 4,5 to 7l. Requires permanent water connection.



## Ergonomic sauna backrest

- Ergonomically shaped backrest, poplar.
- With leather anti-skid strips.
- Size HWD 520 x 400 x 70 mm



## Silicone cable

- High-quality cable with heat-resistant silicone coating.
- Ideal for sauna & steam equipment connection.
- Available in various types for connection of heaters, control units, sensors, lighting and other equipment.
- In standard 2 or 5 m cuts, custom length available on request.



# SAUNA ACCESSORIES

Model	Item no.
Sauna Set N I, 6 items	94 2863
Sauna Set "Stainless Steel" (bucket + ladle)	94 4122
Ergonomically shaped backrest	94 4121
Drench bucket	94 6412

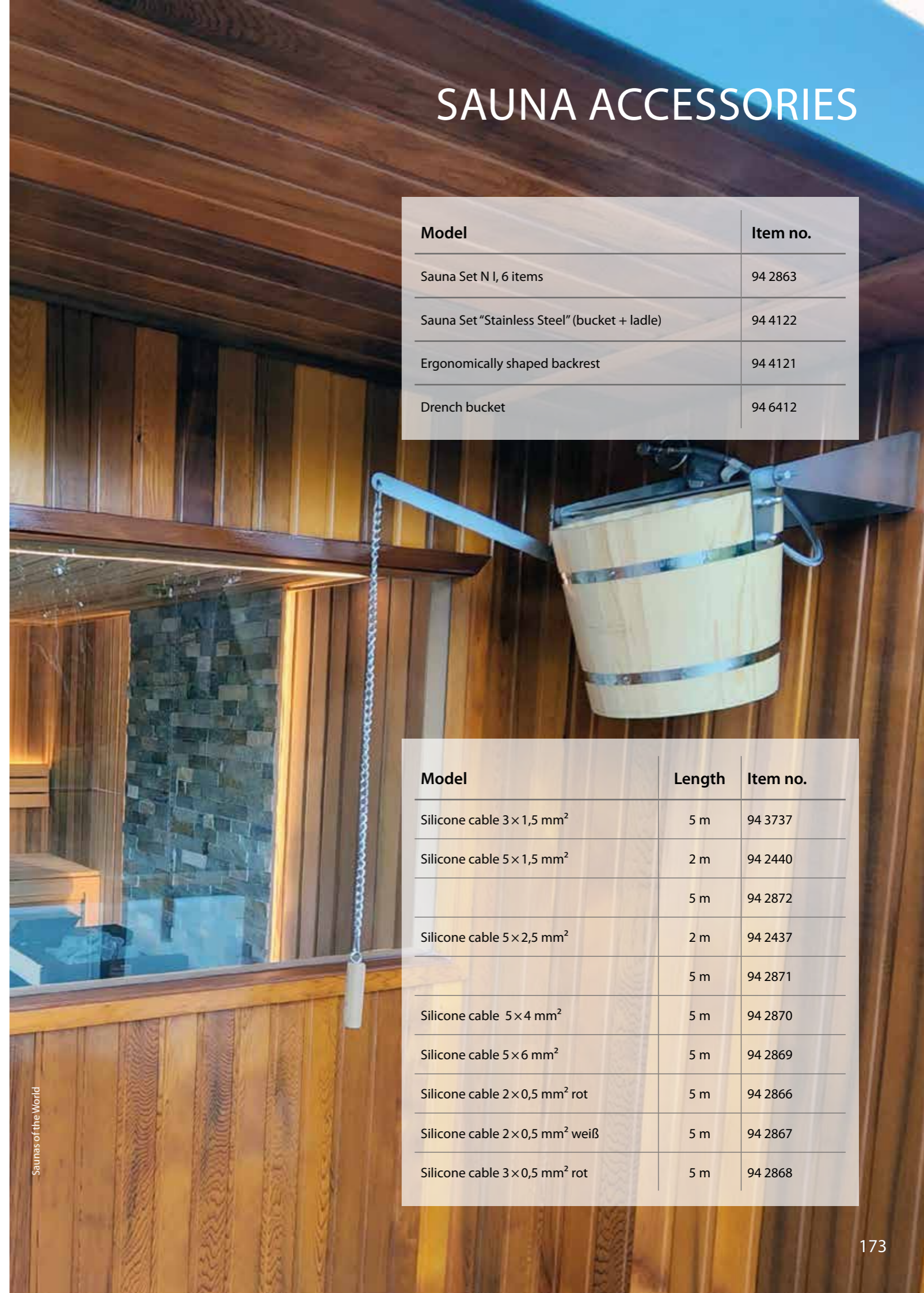

Model	Length	Item no.
Silicone cable 3 x 1,5 mm <sup>2</sup>	5 m	94 3737
Silicone cable 5 x 1,5 mm <sup>2</sup>	2 m	94 2440
	5 m	94 2872
Silicone cable 5 x 2,5 mm <sup>2</sup>	2 m	94 2437
	5 m	94 2871
Silicone cable 5 x 4 mm <sup>2</sup>	5 m	94 2870
Silicone cable 5 x 6 mm <sup>2</sup>	5 m	94 2869
Silicone cable 2 x 0,5 mm <sup>2</sup> rot	5 m	94 2866
Silicone cable 2 x 0,5 mm <sup>2</sup> weiß	5 m	94 2867
Silicone cable 3 x 0,5 mm <sup>2</sup> rot	5 m	94 2868



Model	Item no.
Sauna door 590 mm width	94 9031
Sauna door 680 mm width	94 9032
Door hinge for 6 - 8 mm all-glass doors	94 4345
Double hinge for 6 - 8 mm all-glass doors	94 5937 / 94 7468 (black)
Door handle Premium	94 5320
Door magnet lock 95N, Ø15×8 mm	94 4124
Door magnet lock 150N, Ø15×8 mm	94 4125
U-shape metal clip for 6 mm glass	94 4120
U-shape metal clip for 8 mm glass	94 4126

## Sauna door

- All-glass door, with 2 door hinges, sealing, door knob, magnet lock.
- Wooden frame made of spruce.
- Clear glass sheet
- Glass sheet size WH: 590 or 680×1915 mm
- Frame size WHD: 650 or 740×1960×40 mm



## Door hinge for glass doors

- Door hinge for 6-8 mm glass doors.
- Aluminium zinc alloy.
- Max load: 28 kg/hinge.

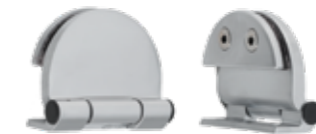

## Double hinge for glass doors

- Door hinge for 6-8 mm glass doors. Opening angle 180°
- Aluminium zinc alloy. Max load: 28 kg/piece.
- Alternatively available with elegant matt black finish.
- Designed for connection of the glass door sheet with another glass sheet.

## Door handle Premium

- Door handle set for glass doors.
- Stylish, timeless design.
- Beech wood inside, metal outside. With mounting parts.
- Drilling distance 200 mm, Ø 7 mm hole, M6 thread.
- Overall height 260 mm, handle diameter Ø 30 mm
- Distance between handle and glass 40 mm



## Door magnet lock

- Magnet lock 95N or 150N, with threaded pin.
- For glass doors. Ø 15x8 mm size.
- U-shape metal clip for fitting on glass sheet. For 6 mm and 8 mm glass sheets.



## Diabase sauna stones

- For all EOS sauna heaters.
- Very fine-grained, resistant structure.
- Very durable – ideal for frequent sauna infusions.
- Colour: medium grey to grey-green.
- Grain size approx. 30 - 150 mm.
- Available as 8 kg, 15 kg, 20 kg or 25 kg packages.



Image shows EOS Selection with diabase sauna stones.

## Dark vulcanite sauna stones

- Vulcanite sauna stones with dark design.
- During sauna infusions, the stone looks almost black and shines with many light reflections.
- Colour: Dark grey with prominent crystalline inclusions.
- Grain size approx. 50 - 100 mm.
- Available as 20 kg or 25 kg package.



Image shows EOS Selection with dark vulcanite sauna stones.

## White quartz sauna stones

- Design sauna stones of quartz.
- Particularly suitable as decorative elements on the sauna heater. Snow-white stones may only be used as the top layer.
- Special rounded shape – offers excellent infusion characteristics thanks to the fine-pored surface
- Colour: white
- Grain size approx. 50-80 mm.
- Available as 10 kg package.



Image shows EOS Selection with white quartz sauna stones.

## SAUNA ACCESSORIES

Model	Item no.
Diabase sauna stones ~8 kg (grain size ~30-60 mm)	94 7338
Diabase sauna stones ~15 kg (grain size ~50 - 100 mm)	94 8054
Diabase sauna stones ~20 kg (grain size ~100-150 mm)	94 7340
Diabase sauna stones ~20 kg (grain size ~50 - 100 mm)	94 7336
Diabase sauna stones ~25 kg (grain size ~50 - 100 mm)	94 7337
Dark vulcanite sauna stones ~20 kg (grain size ~50 - 100 mm)	94 7911
Dark vulcanite sauna stones ~25 kg (grain size ~50 - 100 mm)	94 8114
White quartz sauna stones ~10 kg (grain size ~50 - 800 mm)	94 7698

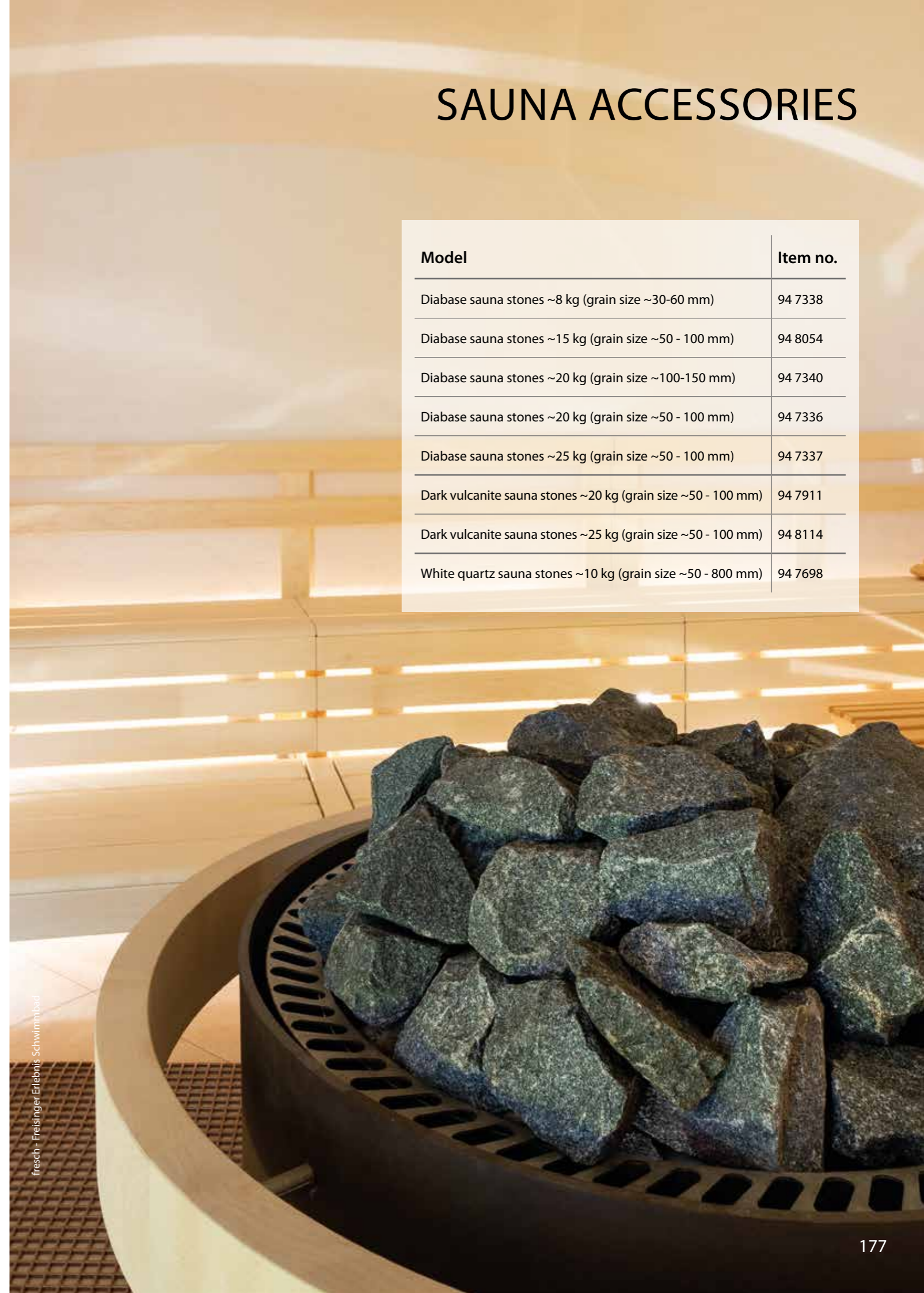

fresch - Freisinger Erlebnis-Schwimmbad

# IMPORTANT NOTES



## SAUNA CONTROL UNITS – FUNCTIONS AND FEATURES

	Dimensions HWD, mm	Touch screen	TFT Farbdisplay	LCD multi-functional display (backlighting)	electronic temperature control	Pre-set timer 0-24 h	Heating time limitation, hours	Cabin light control, output 230V	Cabin light output dimmable	Display of time / pre-set timer 24 h	Temperature control range, dry sauna, °C	Temperature control range, humid sauna, °C	Fan control, output 230 V	Optional 2nd temperature sensor	Optional humidity sensor	Sauna dry program (afterheating)	Data retention after power loss (24 h)	Power extension with LSG box	Optional colour light control	For dry & humid sauna operation	Max switching capacity, kW	
EmoTec / EmoStyle D	Control panel: 127 x 130 x 25 mm Relay box: 270 x 300 x 100 mm	■		■	■	6/12/∞	■	■	■	30-115		■	■			■	■	■				10
EmoTec / EmoStyle H		■		■	■	6/12/∞	■	■	■	30-115	30-70	■	■	■	■	■	■	■	■	■	■	10
EmoStyle Hi	Control panel: 202 x 142 x 42 mm	■		■	■	6/12/∞	■	■	■	30-115	30-70	■	■	■	■	■	■	■	■	■	■	10
EmoTouch 3	Control panel: 141 x 201 mm	■		■	■	6/12/∞	■	■	■	30-115	30-70	■	■	■	■	■	■	■	■	■	■	10
Compact DP	Control panel: 220 x 255 x 65 mm	■		■	■	6/12/18/∞	■	■	■	30-115		■	■			■	■					10
Compact HP		■		■	■	6/12/18/∞	■	■	■	30-115	30-70	■	■			■	■					10
Compact DC		■		■	■	6/12/18/∞	■	■	■	30-115		■	■			■	■					10
Compact HC		■		■	■	6/12/18/∞	■	■	■	30-115	30-70	■	■			■	■					10
Compact D18		■		■	■	6/12/18/∞	■	■	■	30-115		■	■			■	■					18
Compact H18	Control panel: 220 x 255 x 90 mm	■		■	■	6/12/18/∞	■	■	■	30-115	30-70	■	■			■	■					18
Econ D2	Control panel: 220 x 250 x 60 mm			■	■	6/12	■	■	■	30-115						■	■					9
Econ H2				■	■	6/12	■	■	■	30-115	30-70					■	■					9
Econ D3				■	■	6/12/∞	■	■	■	30-115				■		■	■					9
Econ H3				■	■	6/12/∞	■	■	■	30-115	30-70			■	■	■	■					9
Econ D4				■	■	6/12/∞	■	■	■	30-115			■	■		■	■					9
Econ H4				■	■	6/12/∞	■	■	■	30-115	30-70		■	■	■	■	■					9
LSG 10 CA/CW	220 x 255 x 65 mm	Contactor box with switching capacity 10 kW																			10	
LSG 10 ET	270 x 190 x 90 mm																				10	
LSG 18	270 x 300 x 100 mm	Contactor box with switching capacity 18 kW																			18	
LSG 18 H		Contactor box as LSG 18, but with an extra 4 kW output for vaporizer																			18	
LSG 36	450 x 300 x 142 mm	Contactor box with switching capacity 36 kW																			36	
LSG 36 H		Contactor box as LSG 36, but with an extra 4 kW output for vaporizer																			36	

## HEATER POWER SELECTION AND CONNECTIONS

Notice: heater power selection refers to the standard wooden sauna and presents only a rough, non-binding suggestion.\*

Heating power kW	Sauna cabin size in m³																			Min. cable cross section in mm²				
	3-4	3-4,5	4-6	6-8	7-10	9-14	11-15	14-18	18-25	24-30	24-34	35-40	40-50	50-65	60-75	65-80	70-90	80-100	100-130	130-160	Connection 400 V 3N ~	Connection 230 V ~	Fuse protection, A	
3,0	■																						3 x 1,5²	1 x 16
3,5		■																						
4,5			■																					
6,0				■																				
7,5					■																			
9,0						■																		
10,0 / 10,5							■																	
12,0								■																
15,0									■															
18,0										■														
21,0											■													
24,0												■												
27,0													■											
30,0														■										
36,0															■									
42,0																■								
48,0																	■							
54,0																		■						
60,0																			■					
72,0																				■				

\* depending on the used building materials  
Errors and omissions excepted. Technical changes reserved. All information is without guarantee.  
For further information and specifications, please do not hesitate to contact us.

# EOS

805009\_V1.0\_09/2023

**EOS Saunatechnik GmbH**  
Schneiderstriesch 1  
35759 Driedorf, Germany  
[info@eos-sauna.de](mailto:info@eos-sauna.de)  
[www.eos-sauna.com](http://www.eos-sauna.com)



©PONANT/François Lefebvre