

# Down to Earth

Everyday Uses for  
European Space Technology



# Down to Earth

Everyday Uses for  
European Space Technology

*P. Brisson & J. Rootes*



# Foreword



*Lord Sainsbury  
Minister for Science and Technology  
in the UK Government*

The concept of 'spin-off' from space has been around for several years now. But while many people will have heard of the origins of the 'non-stick frying pan', whose space connection is in fact disputed, few will be able to bring many other examples to mind.

Also the idea of technology transfer on a significant scale has been one we have largely associated with NASA and the USA, and the spectacular successes of the Apollo and Shuttle programmes. It is particularly pleasing to me, therefore, that Europe, with its extensive programme of scientific research, Earth observation and communications space missions has a proud record of producing its own beneficial spin-offs. European space industry has found many innovative ways to apply its technology and the European Space Agency (ESA) has been running a successful programme of technology transfer to industry for ten years now.

I find the most interesting aspect of the book is the way in which it demonstrates how often technology developed for one application can have a previously unforeseen but highly innovative use in another. The fact that the imaging systems that we design to probe the far reaches of the universe can also be used to help uncover the innermost secrets of the human cell is indicative of the breadth of applications that can be achieved.

For me the message of the book is doubly valuable, as it shows us that the return on the investment we in Europe make in space research is being significantly increased by the beneficial improvements in everyday life it brings to us here on Earth.

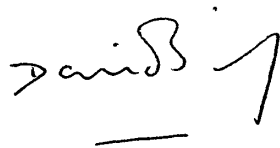
A handwritten signature in black ink, appearing to read 'Dariusz', with a horizontal line underneath and a large flourish to the right.

# Contents



*Introduction*

## A matter of spin

6



*Section One*

## Our living world

8

*Keeping bugs at bay*

*Keeping an eye on the planet*

*Water, pure water!*

*Coping with cruel nature*

*A safer mobile phone*

*Vegetation activity assessed from space*

*Space works to water works*

*Big brother is watching over you*



*Section Two*

## Energy for all

26

*The virtual gas platform*

*From Alpha Centauri to Adelaide*

*A clear view down-hole*

*Cleaner fuels for greener cars*

*A more reliable cat*



*Section Three*

## Healthy living

38

*From supernovas to melanomas*

*Sensing the heart of the problem*

*Materials that remember*

*From outer space to inner space*

*Microwave magic*

*New chip brings better baby pictures*

*Satellite imaging helps prevent strokes*

*A lobster's X-ray eye view*

*Glow worms light the way*

*A blood test on a chip*

*Space pumps help pandas avoid extinction*

*The sweet smell of success*



*Section Four*

## Keeping safe

64

- Screening out vandals*
- Finger prints are the key*
- Monitoring cosmic rays in Concorde*
- Space fashions are cool*
- Carbon brakes and inflating airbags*
- Radar system breaks new ground*
- Rocket textile takes the heat off industry*



*Section Five*

## Building the future

80

- Space gives a smoother ride*
- Software solutions from space*
- Smart cameras for finding fault*
- Distilling the benefits of space training*
- Computer graphics explore new worlds*
- A concrete solution to unwanted vibration*
- Space technology starts a better motor*
- A little light cleaning*
- Well positioned for space*
- Look, no wires !*
- Space robots go where others fear to tread*
- Sensing the heart of unwanted vibrations*
- Gearing up to better motors*
- An eye for colour*
- A material solution to surviving the heat*
- Plastics lead the way*



*Section Six*

## Lifestyles

114

- Getting closer to that hole-in-one*
- Keeping fit with a yoyo*
- Machines with sensitive feelings*
- Landing a potato crisp*



*Conclusion*

## Spin-off: what next?

124

# A matter of spin

Space 'spin-off' is now a widely used term. However, it is worth reminding ourselves that the earliest space systems were based on established proven 'terrestrial' technologies. What space programmes have done over the past 40 years is to invest in raising these technologies to new levels of performance and capability - and this is the benefit that is 'spun off' to us here on Earth.

Space technology 'spin-off' has been such a universally accepted ideal - thanks to NASA's pioneering efforts in seeking to achieve a return on its enormous investment in space research in the 1960s and 1970s - that it is easy to forget that most of the technology used has its roots very much here on Earth.

The reason, as is made only too clear by the occasional, costly, failure on the launch pad, is that space exploration is a complex, risky business. It is also very difficult (impossible before the advent of the Shuttle) to get into space to fix equipment when it breaks down.

From the outset then, reliability has been the primary requirement for each and every spacecraft system and, as all engineers know, reliability can be demonstrated only over a period of time. Wherever possible, early designers sought out tried and trusted materials and components with which to make their spacecraft and most of these were themselves 'spin-offs' from the European and US defence and weapons industries immediately after the Second World War.

The result has been that, today, much of the technology that lies at the heart of spacecraft and their systems has its origins on the ground. What space

research has done, however, has been to develop and perfect these technologies to unprecedented levels so that new and often highly beneficial 'spin-off' applications have been identified back down on Earth.

## Anticipating modern needs

It is also not difficult to see why space technology is so appropriate for our modern needs. The guiding mantra of spacecraft designers has from the start been 'faster, cheaper, lighter' - particularly lighter. Every extra kilogram of weight in a satellite requires several extra kilograms of rocket fuel to launch it, and space engineers have led the way in looking at ways to make things smaller.

Computers provide an excellent example - Charles Babbage certainly didn't have space exploration in mind when he invented his cumbersome mechanical calculating machine. Early users of electronic computers were also content for their devices to fill several rooms. The need to produce small, powerful, self-contained computers was in part stimulated by the space industry and this certainly led to the development of the PCs that we all have on our desks earlier than would otherwise have been the case. In fact, the need to handle vast amounts of data quickly has been a continuing challenge

to space researchers and it is amazing to think that most 12 year-olds now have far more computing power in their bedrooms than Neil Armstrong had in his Apollo lunar landing module.

Space spin-off is therefore an evolutionary process. What is fascinating, however, is the sheer range of uses to which space research - much of it undertaken in Europe - has been put. Common technologies now assist the astronomer using the Hubble Space Telescope to study the cosmos and the biologist seeking to understand the workings of the human cell. Materials developed to protect space instrumentation from the heat of the launcher engines can now be found reducing the fire risk in seat upholstery in theatres.

The list is as diverse as it is long and this book identifies just a sample of what has been achieved in Europe and Canada over the past few years.





# Our living world



*As we move into the 21st century we are becoming ever more aware of the need to preserve the Earth's sensitive ecosystem, to minimise the harmful effects of our own activities on the environment, and to husband and conserve natural resources. Increasingly space technology is helping to supply the tools that enable us to do this*



*Satellite observations have provided us with effective methods to monitor climate change and the impact of land use and development. Some of the underpinning space technologies have been adapted to improve the ways in which we exploit and manage the Earth's natural resources*

# Keeping bugs at bay

## Advanced software developed for space engineering is keeping harmful bacteria out of our water supplies

We take it for granted that the water flowing into our homes is clean and safe to drink. However, to maintain its quality, water-engineers are continually looking for better ways to remove harmful impurities.

One serious biological contaminant is a common parasite, found in water drawn from farmland where sheep and cattle graze, called *Cryptosporidium*. This bacterium causes a serious illness in humans called cryptosporidiosis; in 1993 and 1994, it resulted in more than 100 deaths in two incidents in the USA. Unfortunately *Cryptosporidium* cannot be safely eradicated by chemical means, so water companies have to rely on a multi-layer filtering system known as rapid gravity filtration (RGF) - usually the final physical removal

process in water treatment. The filter beds through which the water passes are designed to catch all solid matter and are regularly purged of contaminants, a process known as 'backwashing'. This must be carried out with an optimum regularity to ensure that the treatment works effectively. The efficient management of the filter beds and backwashing is therefore of paramount importance to the water industry.

### A new simulation program

One major water utility in the UK, Yorkshire Water, decided to model the filtration process on a computer in order to optimize the operation of their water treatment plants and so reduce



the risk of *Cryptosporidium* contamination. Yorkshire Water asked advanced control-software company Cogsys to develop a suitable simulation program that would explore the ideal working conditions in different environmental scenarios.

To develop the program, the company used an in-house computer tool ESL, which is well suited to modelling highly complex systems. ESL, the European Simulation Language, is a robust simulation software package developed for ESA that has proved itself in many engineering applications over 20 years or more. Now, the same advanced software system is being used to help ensure that our drinking water is kept free from unwanted bugs!

*The Cryptosporidium parasite (right) can cause serious illness and even death*

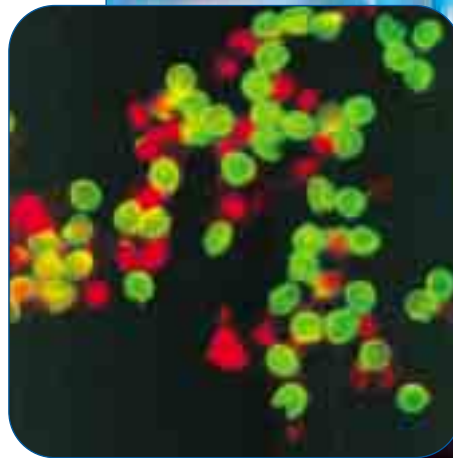

photo courtesy of Cogsys



With the latest image analysis techniques, satellite observations can give us vital data on how we use the land

# Keeping an eye on the planet



Of the many satellites now orbiting high above the Earth, a large proportion are there to remotely observe human activities below. Governments increasingly employ Earth-observation technology to assess how land is used - an activity which when traditionally done on the ground is both time-consuming and expensive. Satellites have the advantage of being able to cover large areas quickly, and being able to fly over a particular location many times (this is important when following changes in land use over time).

One application of satellite observation, increasingly used by government agencies, is to detect crops. This is particularly important in regions where

there are statutory restrictions on how farmers use their land, or where farmers can apply for subsidies for certain crops. In Europe, for example, satellite images can provide intelligence on whether farmers are 'setting aside' the correct proportion of

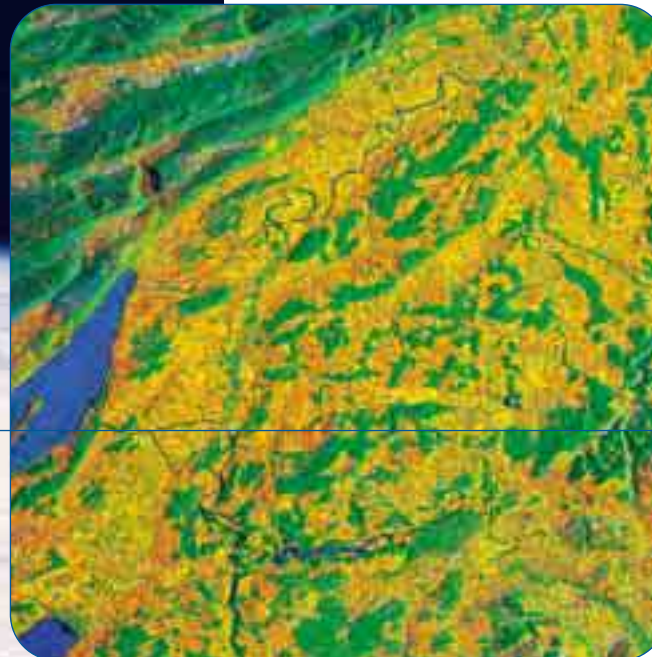

*Satellite image showing different land usages close to Bern in Switzerland*

their land; or in southern Europe they may help ensure that farmers receive the correct subsidies for their olive crops.

Farmers themselves also benefit. Remotely monitoring how fast their crops are growing and whether they have any diseases enables them to decide when to harvest, or apply fertiliser or pesticides. Aid agencies are increasingly exploiting this kind of information to educate and inform farmers in developing countries, so that any local shortfalls in agricultural production and food supply can be predicted.

## Monitoring climate change

The expansion of deserts, or desertification, is another major problem in some parts of the world, and related to this is the impact on our use of water resources. Again, remote sensing is an important tool in monitoring

such changes, as well as global climate change and the impact of human activities on the planet's biodiversity.

Many organisations are involved in interpreting photographs from Earth-observation satellites. One Italian company, ACS SpA, is leading the way in the development of software to aid their analysis. ACS's software has an innovative image-overlay function, which enables pictures from different satellites (or those taken from aircraft) to be combined. This software is already being applied in monitoring land use - for example, in a recent investigation into the populations of olive trees in several Mediterranean countries.

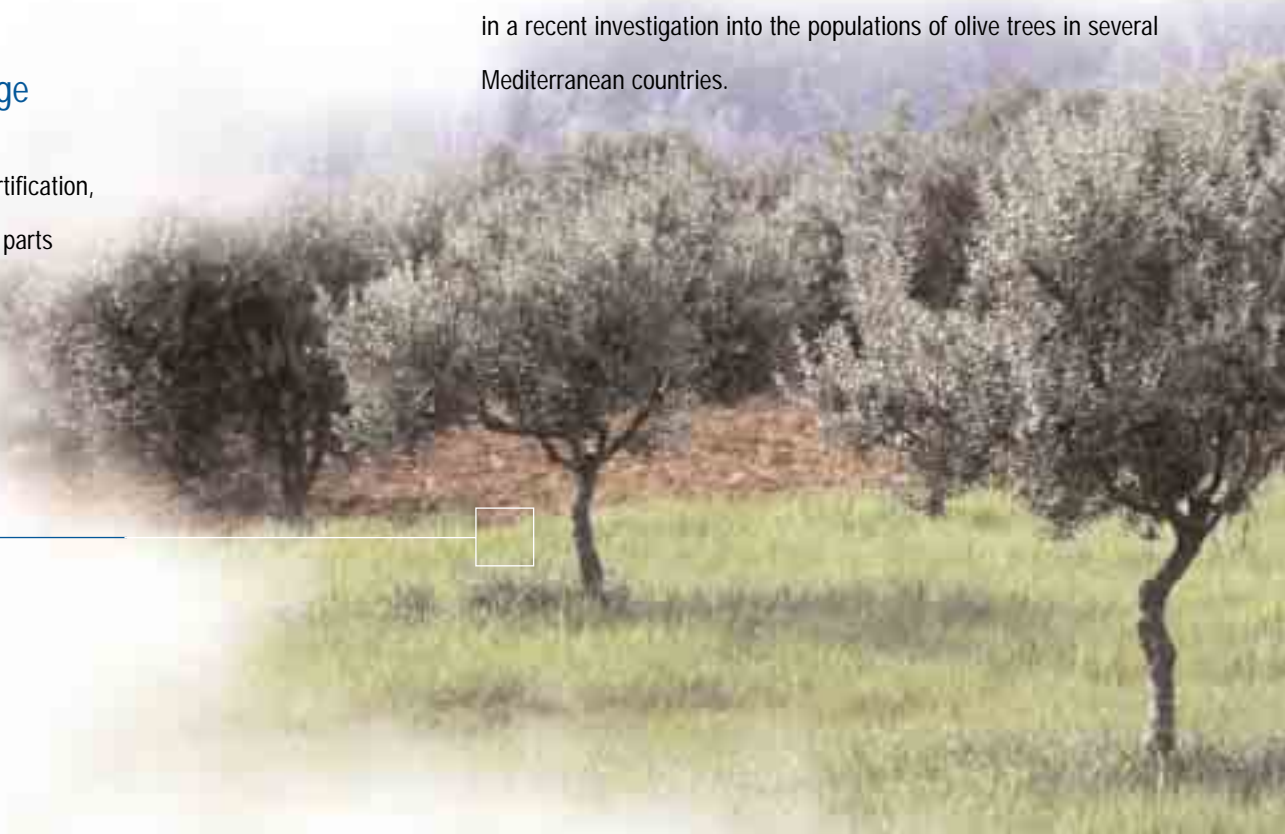

# Water, pure water!

A recycling system developed to supply astronauts with drinking water has helped a leading bottler of spring water to clarify a cloudy problem



Water is one of the largest consumable items by weight on manned spacecraft. On missions of long duration, the crew will consume many litres of water. To help reduce the amount of water that needs to be launched from the ground, technologists at ESA's Space Research and Technology Centre (ESTEC) in Holland have developed an innovative automated filtration system to recycle waste or 'grey' water into drinking water. This waste water may include the condensation that forms on the inside surfaces of the spacecraft, effluent from washing clothes and dishes, and also water discharged from experiments and the life-support equipment.

One of the challenges of recycling waste water from a variety of sources is that it is difficult to anticipate what impurities will be present. It may contain, for instance, volatile organic compounds (VOCs) and pathogenic microbes, both of which are notoriously difficult to remove. The system developed by ESA has proven to be highly effective at removing all types of contamination. The system uses a series of membranes which filter out the various impurities from the waste water as it is pumped through them. Although





limited to the astronauts' needs, the same concept can treat several hundred litres of waste water per hour.

### Spring water in the clear

Such has been the success of this system that it attracted the interest of a major European bottler of spring water. The company concerned was looking for a filtration technology to help it overcome problems at several of the wells it was using as a water source. Water extracted from some natural springs can be discoloured as a result of high concentrations of minerals. This is a particular problem for water obtained from springs fed by hydrothermal wells. Trials carried out with the technology showed that the ESA filtration system was highly efficient at removing these minerals and other impurities.

The same filtration technology is now being considered for recycling waste water on ocean cruise liners.







# Coping with cruel nature

## One of the key features of technology developed for space is that it is often well suited to cope with the most inhospitable conditions on Earth

Space is a cold and uninviting place. Just getting there is a major struggle. Engineers and scientists have to spend a great deal of time making sure that each item of technology or equipment can cope with both the rigours of the journey and the demands of the final environment. In addition, when things go wrong, the final destination is clearly beyond the reach of even the most dedicated repair technician's call-out service!

What is unmistakable is that technologies developed for the space programme and its missions are often ideal for operation in some of the most

challenging working environments on Earth. Typically these are found in the industries that deal with locating and exploiting our Earth's natural resources, such as mining, quarrying, oil exploration and forestry. In order to help ensure that such industries could benefit as much as possible from space research, in 1997 ESA launched the Harsh Environments Initiative (HEI) to identify, transfer and adapt space technologies to operations in harsh terrestrial and marine environments.

## The Harsh Environments Initiative

The prime contractor for the Initiative is a specialist R&D company called C-CORE based in Canada. Now in its third phase, the HEI consists of four main programmes: oil and gas, pipelines, mining and forestry/pulp and paper. The last one represents a recent expansion of the Initiative's scope of activities. Each programme addresses specific challenges faced by that industry and applies leading-edge technologies to address technical problems.

Now more than ever, companies are driven to reduce costs and improve efficiency, whilst simultaneously increasing safety and reducing adverse effects on the environment. During its three-year life, the HEI has helped many technologies originally developed for space to meet the needs of such companies. For example, Earth-observation satellites have been adapted to



help survey and monitor tens of thousands of kilometres of oil pipelines, where the early detection of threats to pipelines integrity can save vast sums of money. In another example, a novel touch-sensitive material called KINOTEX developed to avoid collisions between robots working in space is being adapted to improve the operation and safety of automobiles. KINOTEX is featured in greater detail elsewhere in the book. In a mining application, the radar instruments designed to guide roving planetary vehicles and undertake subsurface exploration are being modified to provide enhanced, high-resolution virtual views of operations where visibility is extremely poor.

### Safer mining

Mining operations and robotics are extremely fertile fields for space technologies and the HEI. One of the most promising projects involves a Belgian company called Space Applications Services (SAS). In a contract for ESA, SAS developed expertise in the field of Man Machine Interfaces (MMI) and created a suite of software programs (called FAMOUS) designed to control the preparation, planning and execution of robotics operations. The HEI and ESA's technology-transfer programmes have been key factors in transferring this technology to improve the productivity and safety of mining operations.

Although, today, mining machines can be controlled remotely by operators on the surface, current methods have a number of drawbacks. For example, incorrect information and delays in receiving information can lead to collisions. The primary objective of this project is to convert from the concept of direct control by the operator to one of operator supervision of multiple machines performing different tasks in the mine. In a move towards this next generation of automated mining, R&D activities are underway to automate different machine sub-tasks, such as loading and dumping, and navigation. In a series of projects based on Sensori-Motor Augmented Reality for Tele-robotics or SMART, space-based technologies such as MMI, ground penetrating radar, loss-less data and image compression and space robotics, to name but a few, will be integrated to control individual machines, while a supervisory system which can simulate particular events will be developed by C-CORE. This will lead to more efficient deployment of machines by optimising the use of shared resources such as tunnel intersections and rock-dumping sites.



# A safer mobile phone

Software designed to test the electromagnetic compatibility of satellite systems has been developed to optimise cellular phone networks



Mobile phones are just the latest contributors to the sea of electromagnetic radiation in which we are all immersed. The nature of the cellular system means that many base stations are needed to give coverage of the areas served, and their effectiveness is strongly affected by local conditions. The need to offer users a good service must be offset against the need to limit stray radiation and protect the public against possible effects from prolonged exposure. From a practical point of view, effective management of this electromagnetic pollution requires tools to optimise the radio-frequency levels generated by base-station transmitters.

Since 1989 an Italian company, Space Engineering SpA., has been developing techniques to analyse and model electromagnetic fields from spacecraft antennae and their effects on nearby equipment. These checks on antenna performance and electromagnetic compatibility, which are vital to avoid malfunctions in sensitive on-board electronic systems, have formed part of several space programmes including Artemis, Meteosat Second Generation and Italsat.



On Earth, propagation of the very-short-wavelength signals used for telecommunications can be badly affected by the presence of buildings, trees and even rainfall. In 1993, the company successfully turned its satellite expertise to modelling the complicated and difficult conditions experienced by mobile receivers in urban locations. The models were validated at the ESTEC Compact Antenna Test Range on a simulated urban site and, in 1998, Space Engineering spun off TeS, (Teleinformatica e Sistemi srl.). The aim of the new company was to exploit the know-how derived from the space work in the rapidly expanding commercial communications market.

## Reducing electromagnetic pollution

The resulting system, Quickplan, has been developed to fulfil the needs of both radio system developers and environmental agencies. The system can calculate and display radio-frequency field levels across a highly complex urban environment, indicating both the optimum location of transmitters and the resulting electromagnetic pollution. Additions and changes to the transmitter network or the cityscape itself can then easily be dealt with - as can the allocation of transmitter frequencies to avoid interference between channels.

Since network planning and radio engineering are all about geography, Quickplan draws upon multiple maps and a powerful graphic interface to create a 3D image of the territory. Each model can be tuned using actual measurements to validate the calculations. With its powerful editing and zoom capabilities, the result is a recognisable and easily understood 3D map of the location, with colour coding that clearly identifies regions where radio-frequency power levels are above or below the desired thresholds.

This successful transfer of space-based expertise has provided a powerful aid for planners of radio systems to reduce their environmental impact and improve the servicing of our seemingly insatiable demand for new services.



# Vegetation activity assessed from space

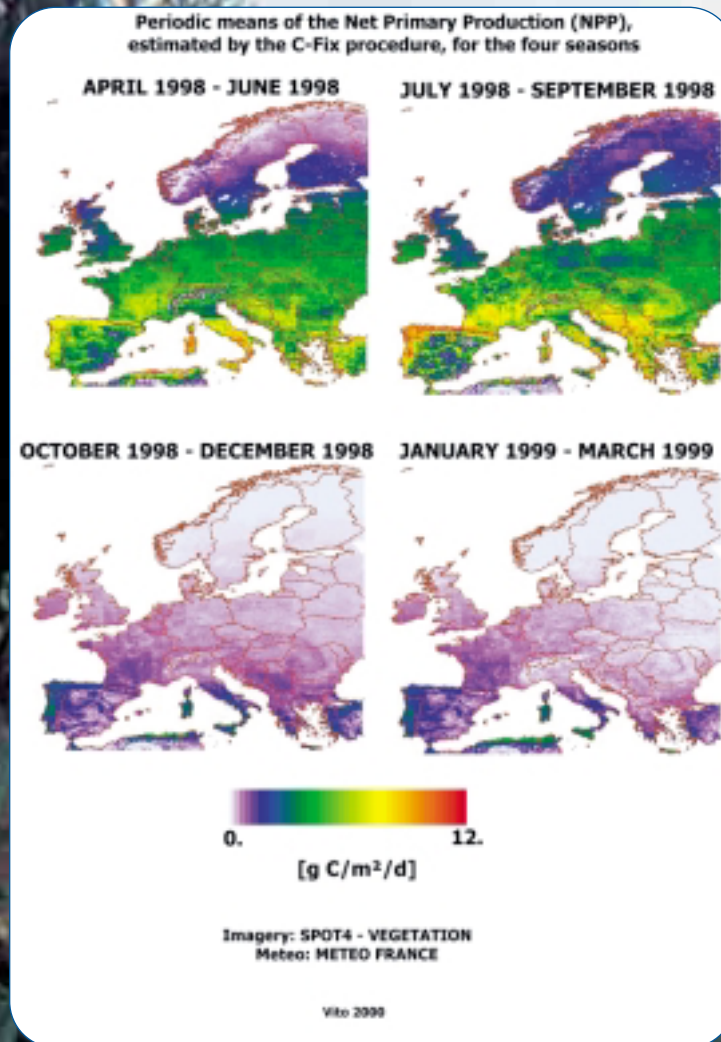

A Belgian project is applying satellite data to estimate the role of plants in the carbon cycle

Although global warming is frequently headline news, the part played by vegetation in absorbing or emitting carbon dioxide, a well-known 'greenhouse' gas, is notoriously difficult to estimate. The take-up of atmospheric carbon dioxide by plants is driven by photosynthesis. However, some of this is re-emitted via respiration so - depending on the equilibrium state of the vegetation - it may act as either a carbon sink or source.

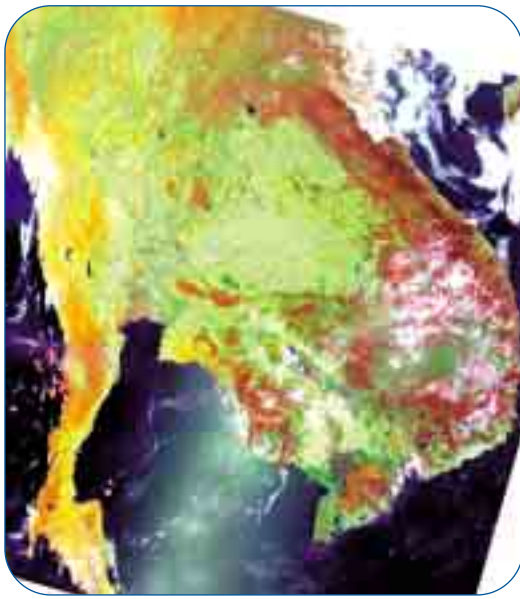

Although the effect is well known, until recently detailed measurements were available only at selected test sites. To obtain information on a continental scale,

researchers have developed simulation models. However, since the real world is a complicated place, with many kinds of plants, terrain, climatic variations and seasons, these models rapidly become highly complex. They end up requiring many inputs in the attempt to mirror reality. Inevitably, as the area represented by each model was enlarged, the availability of the data needed to support it became more problematic and hence validation of the model as well.

The gap between local measurements and regional modelling can partly be bridged by using imagery from Earth-observation satellites. Through a series of research projects, Vito (the Flemish Institute for Technological Research) in Belgium has worked to unravel this complexity and develop a reliable method of estimating carbon-exchange in vegetation using satellite data.

## Combining models and satellite data

The system, C-Fix, attempts to quantify carbon flows on a regional basis by combining a simplified carbon-exchange model with satellite observations. Its aim is to obtain an accurate and repeatable estimate of the behaviour of terrestrial vegetation across the globe. Each day, for a set of locations, the model estimates three kinds of carbon mass fluxes. The first represents the uptake of carbon by photosynthesis, the second concerns respiratory losses which are partly due to plant growth, and the third, losses caused by decomposition of soil litter. Data taken from satellite images provide information on the amount of sunlight available to drive photosynthesis. This is combined with meteorological input from weather stations across the study area.

Using NOAA-AVHRR imagery taken between 1990 and 1997, the researchers applied C-Fix over Belgium with reasonable success. With EU funding, the C-Fix model has now been adapted to cover continental Europe, and the next step will be a demonstration using data from the SPOT 4 satellite to generate images relating to carbon synthesis across Europe and Africa over a full year.

# Space works to water works



Water companies are tapping into satellite-tracking technology to operate their facilities remotely

When we turn on the kitchen tap we don't think about how the clean water reaches our homes. Extracting, treating and distributing water across the nation is a complex business. In the UK, a single water utilities company may have responsibility for literally dozens of reservoirs, pumping stations and treatment plants, all of which are required to operate as an integrated network in order to meet the public's demands for constant fresh water.

With the privatisation and amalgamation of water utilities across Europe, individual companies have been forced to cut costs and devise new and ever-more labour-efficient ways of both monitoring and controlling their networks of water distribution. One of the problems they have had to address has been the wide geographical spread of the individual facilities - often sited on river banks or next to wells located deep in the countryside.



Unbeknown to the water companies, their needs corresponded quite closely - although on a vastly different scale - to those of satellite operators who have, since the start of space exploration, needed to devise systems to enable them to monitor and control remotely spacecraft many miles from Earth.

### Automated control

Science Systems is a UK company which first developed satellite-tracking systems in the early 1980s. An early product was a system called Kernel Telemetry Tracking and Command (TT&C) which formed the basis for a range of control equipment developed for satellites. Via telemetry links, using TT&C, data may be downloaded, systems status monitored and routine commands enacted, allowing the day-to-day operation of the satellite to proceed, largely free from the need for human intervention.

It was Science System's desire to diversify into new markets, coupled with the privatisation of the water industry in the UK - and the consequent release of investment funds - in the mid-1980s that led to the development of

complementary computer-based systems which could be used by water companies. Supervisory Control and Data Acquisition (SCADA) systems, as they came to be known, have now been successfully adopted by several water companies including Welsh Water, Thames Water and Lyonnaise des Eaux. Like the spacecraft orbiting the Earth, many water company sites now operate highly effectively unmanned. Their status and serviceability is constantly monitored, and their routine operations controlled remotely, from a central operations centre serving several sites.





# Big brother is watching over you



The Envisat satellite

## A software package designed to create interferometric data from radar satellites is being used to detect changes to the Earth's surface

Today, the Earth's surface can be mapped using satellite radar imaging. Even small changes on the Earth's surface can be monitored over a long period of time. This is done via a technique called 'interferometry', whereby two radar

signals acquired from approximately the same geographic position but at different times are combined and thus compared. If the signals are identical, the wave-form of the combined signal will remain the same. If there has been any change at ground level then the waveforms will be slightly different and will 'interfere' when combined (in the same way that some ocean waves are partially cancelled and some are re-enforced when they interact). By analysing this interference pattern on a computer, it is possible to identify any changes in topography and to map small displacements.

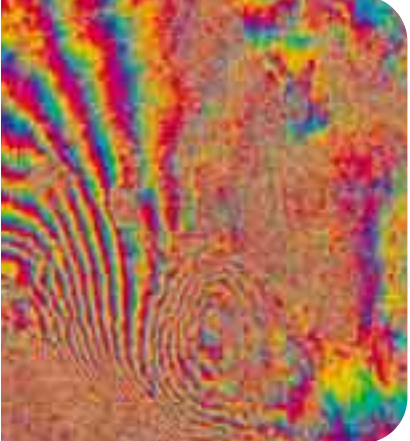

courtesy of CNES

*Ripples in the Earth's surface caused by earthquakes, far left*

*Mount Etna, left*

Interferometric measurements have traditionally been carried out using simultaneous measurements from two or more instruments situated in different locations. However, a single satellite can 'interfere with itself' if its measurements are taken and properly recorded at consecutive passes over the same place. This technique was developed in the 1980s when software became available that could compute the radar data digitally and in a reproducible fashion.

Using its expertise in this area, the French national space agency, Centre National d'Etudes Spatiales (CNES), developed a software package, Diapason, for radar satellites which image the Earth to monitor environmental changes like ESA's ERS-1 and ERS-2 satellites. Not only does the software provide efficient and almost automatic computing capabilities, but it is also simple to use. Diapason can detect changes in sections of the Earth's surface one kilometre across to within a few millimetres in some cases. In particular, very small surface displacements can be noted, which is useful in identifying changes that precede volcano eruptions or, possibly, earthquakes.

## Terrestrial applications of Earth imaging

Recognising that Diapason is user-friendly - it does not require a specialised knowledge of radar - CNES began to think about selling the package outside the space industry. In particular, the organisation targeted large laboratories and geophysicists as potential customers. These users typically buy radar data from governments with radar satellites, and then must find a way to generate useful results.

CNES developed a training programme which encouraged scientists to learn how to use Diapason, focusing on the fact that the software automatically does the work of translating the radar data into information the scientist can easily understand and use. These efforts resulted in the adoption of the software in laboratories across Europe and in the USA, primarily for non-commercial application in the early detection of earthquakes and other tectonic movements. CNES has also been approached by two French companies who wish to license Diapason for commercial use.

# Energy for all



*Generating and managing the on-board power in spacecraft needed for long and complex missions is a continuing challenge. Many of the lessons learnt in space are now being applied in both managing our dwindling supplies of fossil fuels and in identifying alternative sources of power*



*Space has pioneered methods for generating and exploiting electrical power more efficiently. Increasingly, the same technology is being introduced on Earth. The complex process of locating and extracting oil and gas is also benefiting from innovative space technologies*



# The virtual gas platform

Software for simulating space operations is now being applied to extracting and processing natural gas from the North Sea

Early in the development of any complex system, a designer needs to be reassured that the final product will perform as required and be safe. Experimenting on a real prototype system in the early stages of design can, however, be risky, expensive and lengthy. Increasingly, therefore, system designers use computer simulations to analyse, test and perfect their designs.

ESA, of course, sponsors the development of significant numbers of satellites, launchers and ground-support systems, and computer simulation is thus a frequently used tool during the design process.





courtesy of ESL

It was because simulation is used so much - and the need to avoid duplication of effort - that, early in the 1980s, ESA sponsored the design of an all-purpose simulation tool. This resultant package, the ESA Simulation Language (ESL), was developed by ISIM (International Simulation Ltd) and the University of Salford in the UK. The modular package reduced the simulation process to a series of standard subroutines that can be linked together to simulate the requirements of any specific complex system comprising electrical, mechanical or software elements. Designers can therefore choose from a common tool set rather than have to design the simulation from first principles each time.

ESL, now marketed by Cogsys Limited, has subsequently been widely used within the European Space Community for nearly twenty years.

As it is both modular and multi-functional, Cogsys has promoted it for use in other industries.

## Offshore use for ESL

One of the first non-space users of ESL was BG International (formerly British Gas) who, with offshore partners, was exploiting the Armada group of gas fields under the northern part of the North Sea. ESL was used to design production facilities that received and processed gas from three separate adjacent fields. Very simply, ESL allowed strategies to be developed for controlling the gas flow and capacity - off-line and in safe, controlled conditions.

A further use for ESL has been in producing a training simulator for the company's gas-production platforms in the North Morecambe Bay. The Morecambe platform is not normally manned and is largely controlled from the mainland. The training simulator is used to train operators and engineers in operating platform facilities such as processing, fire and gas and utilities systems, and in emergency procedures.

# From Alpha Centauri to Adelaide

Solar cells from the Hubble Space Telescope are being used to help power one of the world's most advanced racing cars



Many of us love the excitement of motor racing. Even people who are not fans recognise that the sport contributes an enormous amount to the development of new, efficient technologies. Unfortunately, one aspect that the race teams don't seem to worry about is the availability and cost of the fuel that powers their engines. However, there is one motor race in the world that does contribute to the development of an environmentally friendly energy source - solar power.

The World Solar Challenge is the biggest race in the world for vehicles powered solely by the energy of the Sun. The race, held every two years, crosses the Australian continent north to south (Darwin to Adelaide) over 3010 kilometres, and the race teams have to cope with some of the most arduous conditions on Earth.

The first World Solar Challenge was held in 1987 in order to show the world the potential of solar power. The best solar cars perform extremely impressively, being capable of travelling 1000 kilometres for a cost of just over 2 Euros! This is about 50 times more efficient than an average family car. No slouches either, some of the cars aim to achieve in excess of 160 kilometres an hour.

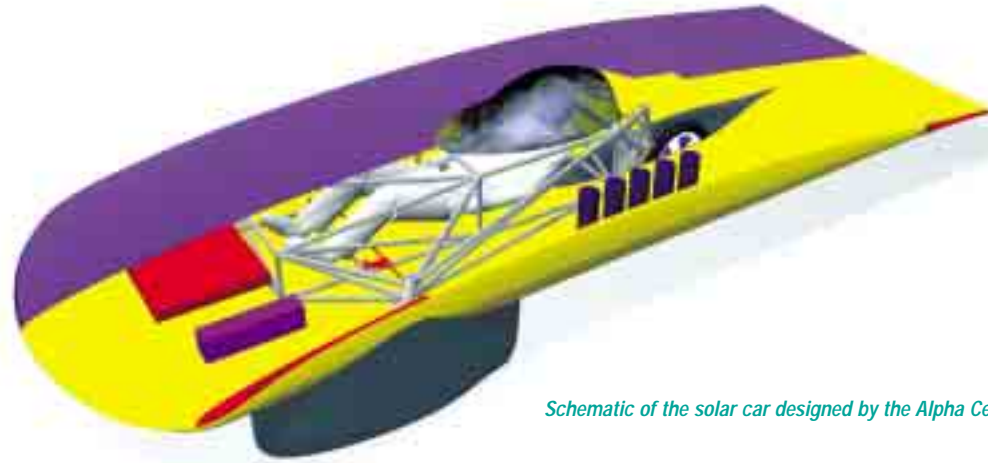

*Schematic of the solar car designed by the Alpha Centauri team*

## ESA in pole position

The competition participants vary from multinationals to high schools and universities. This year, the regular contestants will be joined by a team from the Netherlands, consisting of students from the Delft University of Technology and the University of Amsterdam. One of the unique features of the Dutch entry is that their vehicle will partially be powered by solar cells provided by ESA, which were once employed on the Hubble Space Telescope. On Hubble, the cells are arranged in two huge rectangular wings, which rotate to face the Sun. The Dutch team will also use new cells designed by the original people who produced the cells for Hubble. They will be among some of the best performing and most efficient solar arrays ever designed. The Dutch team has called itself Alpha Centauri after our nearest star. Hubble has studied that star system as it might have planets like our own.

As well as providing part of the solar cells, ESA is supporting the venture by providing technical expertise, and one of its senior scientists leads the advisory team. Thus equipment and technology used in space is being transferred directly to a worthwhile venture aimed at improving the quality of life on Earth.





The imaging technology for  
Proneta's camera came from the  
ERS-2 (left) and Envisat  
(right) satellites



Oil companies now have a cheaper way of diagnosing problems with rigs and pipelines thanks to a camera that can see through oil

## A clear view down-hole

Oil is one of the world's most important resources for providing energy and chemicals, and oil companies are always looking for ways to cut costs and improve efficiency. One potentially valuable aid is being developed by a UK-based company Proneta. This is a camera that can see through oil, so can be used to carry out remote inspections in oil wells and pipelines without cleaning out the oil first.



courtesy of Proneta

A coin viewed through oil using  
Proneta's technology

Conventional video cameras are regularly employed to diagnose problems in drilling and other installations. However, they cannot see through the oil, and so can be used only after all of the oil has been flushed out first with a continuous supply of brine. The cost of the flushing is huge, and the delays caused by transporting the pump and filter equipment to the rig may mean that it is just too expensive to bring in a 'down-hole' camera.

## A space-technology solution

Proneta's answer was to use its experience in the space industry - particularly in designing electro-optic instruments - to develop a camera with sensors that could penetrate oil. The company already had experience of suitable sensors used on meteorological satellites such as ESA's Envisat and ERS missions. These satellites monitor the environment, climate, and changes in sea level. Through the exploratory tests, researchers at Proneta identified the relevant properties of oil that enabled them to design a camera that could achieve useful images. They also established that the equipment could be engineered to withstand the severe environment and the tight constraints on size and bandwidth.

Proneta then had to demonstrate that the camera really would work beyond paper calculations or computer modelling. So, with part-sponsorship from ESA, the company built a test-rig in their laboratory to produce pictures to show to oil companies and other prospective sponsors.



*Offshore oil wells will use the new 'down hole' camera to diagnose problems during production*

Proneta's key patent for the new technology has now been fully granted. Four major oil companies - Shell, BP, Amerada Hess and Chevron - are supporting the development of a full-scale demonstrator, in which the camera will be shown working with real targets. In the meantime, Proneta has gone from strength to strength and has expanded its premises to accommodate its growing team and test and development facilities.

# Cleaner fuels for greener cars



Fuel cells developed by European space engineers will power the cars of tomorrow

Space applications have long been a major driver in the development of fuel cells. These electrochemical devices, which provide electricity from simple chemical reactions (see box) such as the combination of hydrogen (the fuel) and oxygen (from the air in terrestrial applications) to produce water, are ideal for powering spacecraft. There are no moving parts, hydrogen is light, and the only waste production is water.

Based upon its efficiency, high power output and ability to operate for as long as the fuel is available, the fuel cell is also seen by many as the power source of the future for cars and other vehicles. It is roughly twice as efficient as a conventional petrol engine, with virtually no harmful emissions, and can be operated with fuels made from renewable sources. A car electrically powered by a fuel cell is quiet and easy to use.

The German aerospace company, then called Dornier, had made considerable progress in producing a compact, safe and reliable hydrogen fuel-cell for use in spacecraft. When Dornier became part of DaimlerChrysler, its fuel cell



*courtesy of DaimlerChrysler*

technology became available for automotive applications and from then on progress was rapid. In late 2000, two new fuel-cell vehicles were announced, the Mercedes-Benz A-class NECAR 5 and the Jeep Commander 2. Both vehicles are quiet and environmentally friendly, with fuel-cell systems that occupy no more space than a conventional engine.

### User-friendly methanol

The two Mercedes cars actually use methanol (a type of alcohol) as a fuel. This is because hydrogen would have to be carried on board a vehicle as a liquid under high pressure, so there is the danger of explosion. An alternative is to use various hydrocarbon or hydrocarbon-derived fuels that can be first broken down into hydrogen (and carbon dioxide) using a reforming catalyst. Methanol, which can be handled and sold like petrol or diesel, is an excellent choice to feed reforming fuel cells designed for domestic cars. It is produced on a large scale from natural gas and oil and, ultimately, will be available from renewable biomass. Fuel cells are also being developed that use methanol directly as the fuel.

Such is the promise of fuel cells that DaimlerChrysler aims to invest over 1 billion Euros to develop the new drive system for mass production.

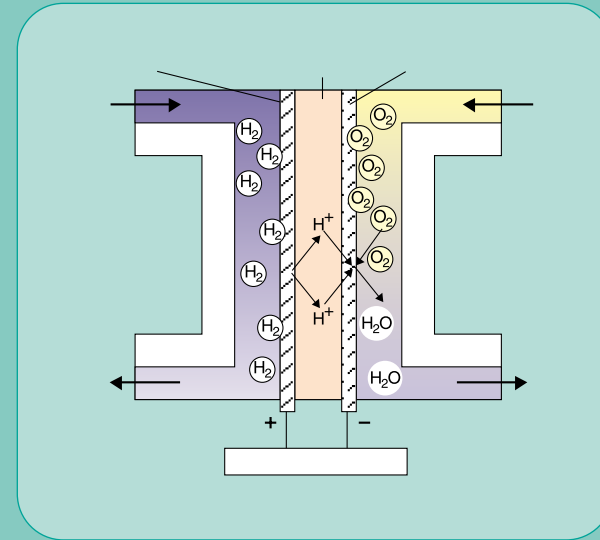

### Fuel cells

*A fuel cell works like a battery but relies on a continuous supply of chemicals to produce the power. As in a battery, the chemicals react at electrodes in a cell to produce electrical energy. Unlike a battery, however, a fuel cell doesn't run down or need recharging. The simplest fuel cell uses hydrogen and oxygen which combine to make water, but other fuels such as methanol and natural gas can be used and these combine with oxygen to give water and carbon dioxide. They also show great promise.*

*The first fuel cell was built in 1839 by Sir William Grove, but found no practical application. Its advantages over nuclear power finally attracted the interest of space researchers in the 1960s. Fuel cells powered Gemini and Apollo spacecraft and today provide electricity and water for the Space Shuttle.*



# A more reliable cat

Lab experiments on the International Space Station (ISS) and crawlers used in pipelines have both benefited from ESA research



As the duration of a Space Shuttle flight is typically less than two weeks, facilities designed for conducting experiments on board the Shuttle's Spacelab are generally used only for short periods. By contrast, on board the International Space Station, the experiments are likely to last many years and so their design has to be fundamentally different. ESA has therefore led the development of new design concepts to improve safety and reduce the time required for the astronauts to carry out maintenance and calibration of equipment.

One of the companies helping ESA was Norwegian-based Prototech. By identifying potential failure points in the Spacelab design, the company was able to improve significantly the reliability, accessibility and performance of experiment modules for the ISS. For example, the pressure tubing used in the Spacelab experiments was replaced by a novel compact manifold system.

Other operations such as the exchange of filters, calibration procedures and leak testing were also improved.



*Prototech's design techniques facilitate the re-design of multi-component systems*



*courtesy of Prototech*

## A boon to oil companies

Prototech's activities were not confined to space applications, however. The company also designs and manufactures equipment for the inspection of offshore pipelines. The results of failures may be as critical in these operations as in space, so Prototech exploited the technology developed in collaboration with ESA to improve the reliability of tools for pipe inspection. One example is the redesign of a crawler (called a 'Pipecat') used to pull ultrasonic inspection tools through oil pipelines. The crawler uses two sets of pads - one is pressed to the tube wall while the other set moves forward. Using the same design techniques as for the space systems, the number of failure points was significantly reduced, and the redesigned system was made more compact and reliable. This is resulting in significant savings for the oil companies in equipment maintenance and retrieval costs. After all, a cat that has stopped crawling is an expensive beast indeed!



*Cutaway view of the Columbus module in which many space experiments are to be carried out (below)*

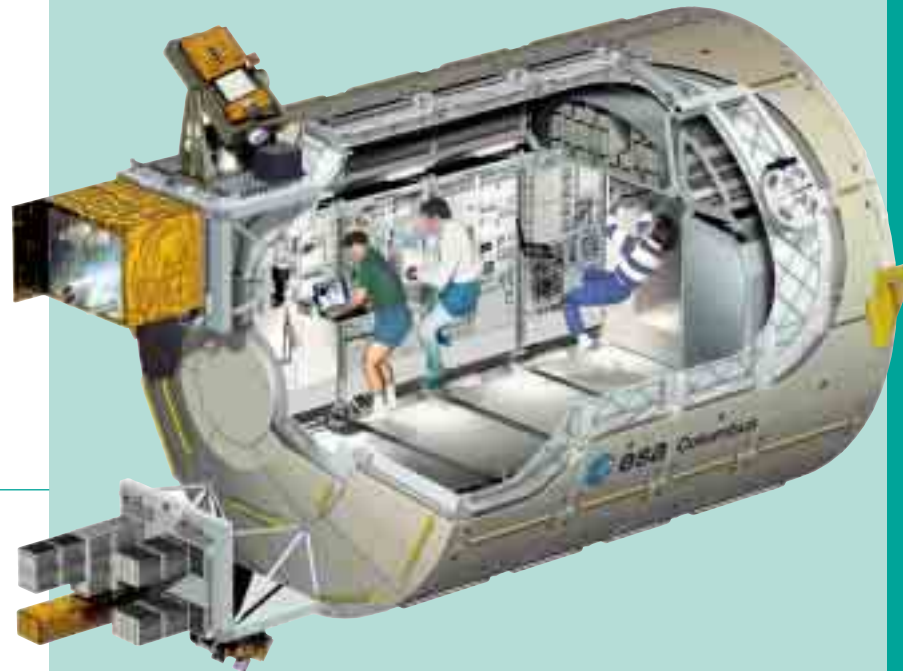



# Healthy living



*It is no coincidence that the complex sensors and instrumentation developed to probe the distant reaches of the Universe can be adapted to assist doctors and biomedical researchers in analysing the human body. Both fields of research place great demands on the development of advanced detection, imaging and data processing techniques*



*Scientists using bio-imaging for diagnosing disease and research have benefited greatly from sharing much common sensing and imaging technology with space researchers and vice versa. Advanced data-processing methods have also been adapted to help analyse the increasing amounts of information that biological researchers have to handle*



# From supernovas to melanomas

Skin cancer is a growing problem as more of us take holidays in the Sun. Now, doctors can spot the early signs thanks to a computer method used to analyse X-rays from space

One of the challenges facing astronomers studying stars and galaxies is to extract meaningful information from the jumble of signals that reach us from the far reaches of the Universe. This was a particular problem for scientists at the Max-Planck Institute for Extraterrestrial Physics in Germany who were using the satellite ROSAT to observe distant X-ray signals from exotic objects like exploding stars - supernovas - and black holes. They therefore developed an algorithm for picking out the weak signals from the background of random 'noise'. This algorithm, known as the Scaling Index Method (SIM), helped the astronomers pinpoint thousands of faint X-ray sources and analyse their structures in a quantitative way.

The researchers quickly realised that the technique would have applications in other situations where vital data might be buried in the background noise. Working with scientists and doctors from Munich, and with the support of the German Space Agency, they developed a system for the early recognition of skin cancer.

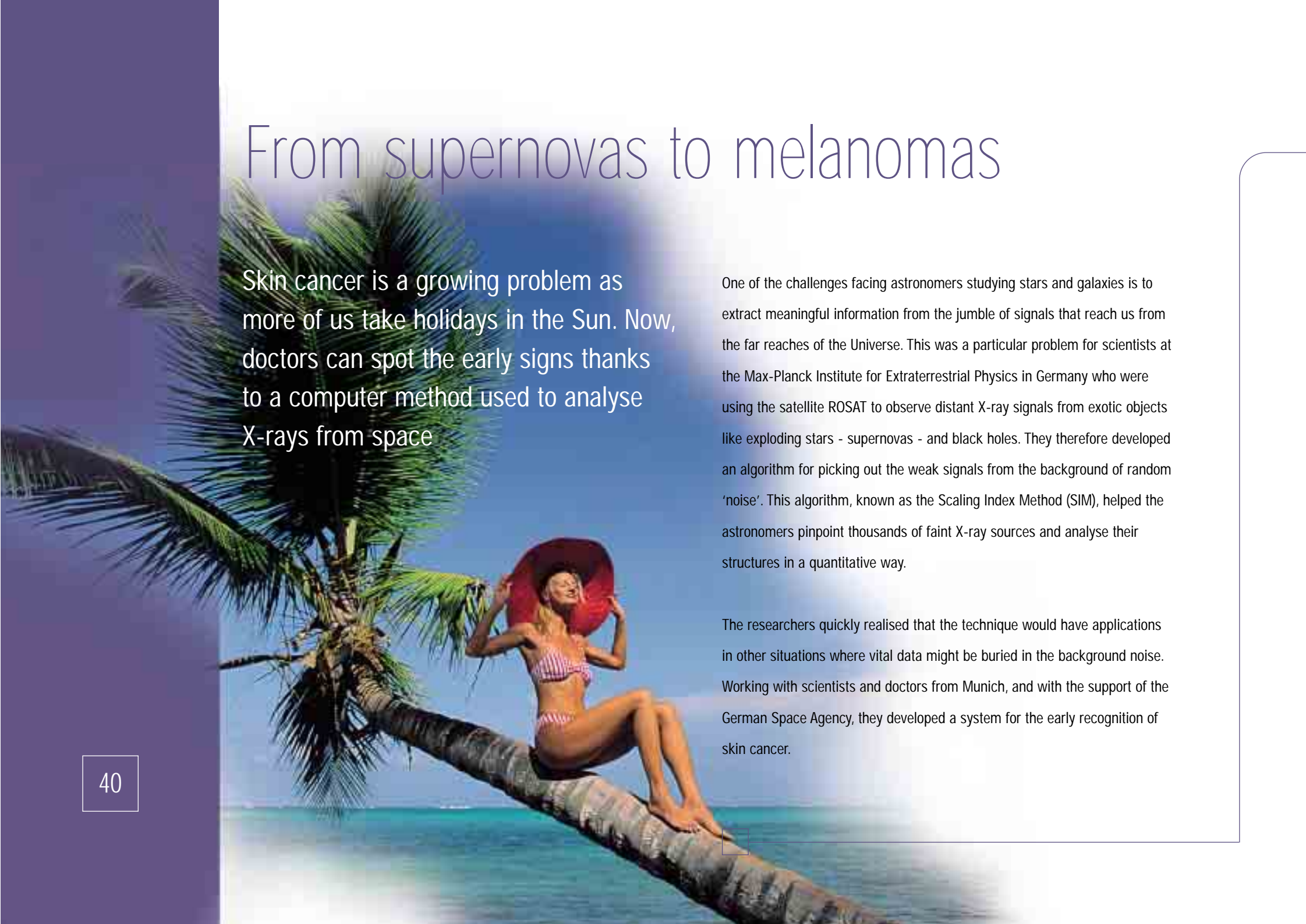

The system, known as MELDOQ (Melanoma Recognition, Documentation and Quality Assurance System) and which incorporates the SIM package, uses a computer to analyse very precisely images of a highly magnified section of the skin surface. It can spot fine differences in colour which can then lead to the detection and measurement of the irregular cell growth associated with malignant melanoma - a particularly virulent form of skin cancer.

Now the MELDOQ system has been built into a range of hand-held tools under the DermoGenius trademark. Use of the tools is so straightforward that even doctors who are not experts in dermatology can diagnose skin cancer much earlier and more accurately. The system can also be used to train medical students in diagnosis.



*The DermoGenius toolset*



*The ROSAT satellite*

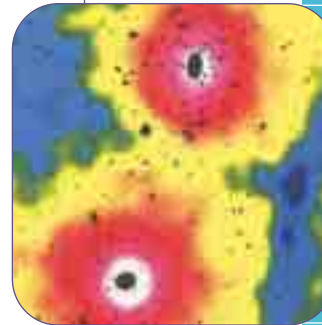

*The cluster of galaxies A3528  
An X-ray image from ROSAT of the large  
confined objects in the Universe. The two  
colourful subclusters, which will merge in  
about 100 million years, contain information  
that tells scientists about the early Universe*



*The scaling index method (SIM) was used  
to analyse data from the X-ray camera  
(left) on the ROSAT satellite*



*The MELDOQ system helps doctors to  
diagnose skin-melanomas*

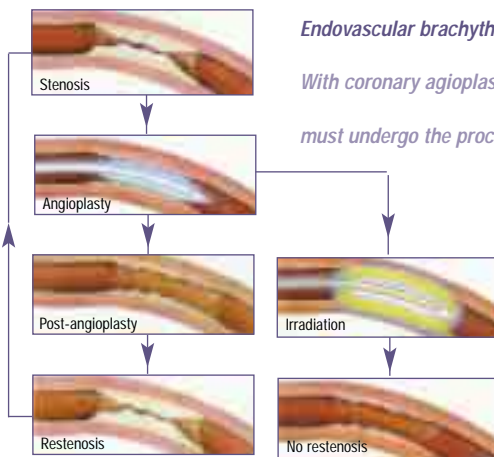

**Endovascular brachytherapy**

*With coronary angioplasty, the common treatment of blocked arteries, many patients must undergo the procedure repeatedly because the closures often re-occur during the healing process. Endovascular brachytherapy treatment irradiates the blood vessel, preventing the re-occurrence of blockages, and ending the treatment cycle*

**Chips to check space radiation can help to treat heart and cancer patients**

# Sensing the heart of the problem

Most people don't realise that space isn't actually empty, but is criss-crossed by dangerous radiation which can damage the electronic equipment on spacecraft. Consequently, space vehicles carry instruments to measure and record the radiation around them and the damage it does to electronics.

One such device is a silicon chip called a RADFET (radiation-sensitive field-effect transistor) developed in the late 1970s by a small UK company - REM (Oxford) Ltd. This device monitors the cumulative dose of radiation and has been incorporated in spacecraft such as Metosat-3 and the Hubble Space Telescope.

The radiation-sensitive chip not only records the amount of radiation received, but can also convert it to a radio signal. The radiation dose can

thus be communicated to mission controllers. This key advantage - remote reading - offers the potential for applications on Earth where remote sensing is necessary in such areas as nuclear safety and medicine.

With the aim of exploiting this development potential, REM and a number of other groups are working to identify commercial applications for the device. The sensing element is also cheap to make and can easily be mass-produced. Furthermore, because the sensor is small, it was quickly realised that it could be used as a dosimeter for monitoring radiotherapy used in treating cancer and heart disease. Previously radiation monitors were expensive, unable to record in real-time and too large to be used inside the body. At the University of New Mexico, an oncologist placed the small chip in a cancer-therapy catheter within a breast cancer.





ESA's Meteosat weather satellite

*A prototype of the miniature dosimeter to be used in laboratory trials for endovascular brachytherapy treatment*

At Harvard Medical School, RADFET sensors were inserted inside tumours in mice, prior to radiation treatment, to record the dose received. The results encouraged REM to pursue further medical applications and, working with the highly regarded Italian institute for cancer research, the Istituto Scientifico Tumori (IST), the company explored a new use for radiation dosimeters in treating blocked arteries.

Sometimes, an artery can be unblocked by inserting a 'balloon catheter' and inflating it so as to expand the blood vessels. Unfortunately, the blockage can re-occur (called restenosis), but recent research has shown that this can be prevented by irradiation, ideally with beta-rays. The process, called 'endovascular brachytherapy', involves inserting a radioactive source into the blood vessel via a catheter.

One problem, however, is that the radiation dose must be monitored carefully to prevent damaging the surrounding tissue. The RADFET offers an effective solution, and is cheap enough to be thrown away after use. Hence this small space-derived device could develop into an important tool in ensuring the efficacy of this treatment for thousands of potential patients around the world.





# Materials that remember

## Tough space materials that return to their original shape can re-position teeth, mend bones and even break rocks!

Shape memory alloys (SMAs) are extraordinary materials. Like an elastic band, they can be stretched and deformed and will return to their original shape.

Even more remarkably, they can 'remember' a shape that has been locked into them - such that if bent into a new shape, they will return to their original form when warmed up, often exerting considerable force in the process.

The European space programme developed SMAs for use as lightweight, temperature-controlled actuators. The unique features of SMAs were, however, showing great promise in a number of other fields, and especially as medical devices. In the 1990s in the UK, Brunel University's Institute of Bioengineering was experimenting with SMAs and one of its researchers, Tony Anson, realised they could be used in the repair of broken bones.

Staples, bent from SMA wire, are placed across the fracture in pre-drilled holes. Body heat then causes the legs of the staple to draw together, both closing and supporting the fracture during healing.

In 1994 Tony set up Anson Medical and two years later the company began working with OrTech, a small dental engineering consultancy in Denmark, and the Danish Technological Institute, to create an orthodontic spring to control the movement of teeth. About a quarter of all children need orthodontic treatment, and many more adults seek help to improve the cosmetic appearance of their teeth. SMAs - which can be stretched much more than conventional springs - allow constant gentle forces to be applied to teeth in a precise way. As well as being more comfortable for the patient, the teeth move two and a half times faster to their pre-destined positions than in previous treatments. Anson Medical subsequently developed a range of other applications and in 2001 was acquired by a major UK company, ensuring the continued exploitation of SMAs in the medical field.

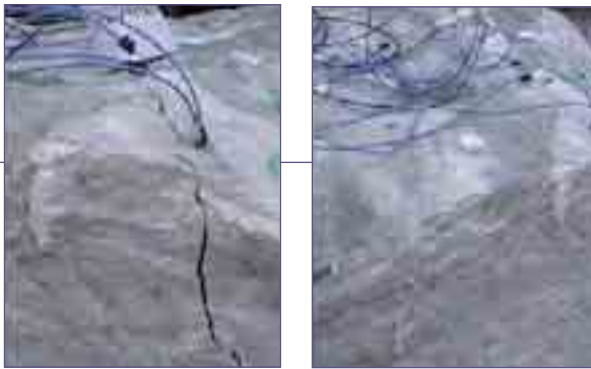

*SMA's can apply enough force to fracture marble*

## Strong as a rock

By complete contrast, forces sufficient to fracture rock are exerted as shape memory alloys revert to their 'remembered' state. This phenomenon can be successfully harnessed to quarry marble. In use, a row of holes is drilled along the line to be cut and cylindrical SMA actuators are inserted. The

actuators are then heated electrically to restore their 'remembered' shape and the rock is simply forced apart. SMA forces can be focused far more accurately than those of traditional explosives and the resulting marble blocks require much less effort in finishing.

D'Appolonia, the Italian member of the Spacelink group with considerable experience in geo-technical engineering, realised that developing the quarrying application would be an ideal project for a European consortium. The company Ripamonti, which had been manufacturing mining equipment since 1970, became a lead partner in an EU-funded CRAFT R&D project. In addition to Ripamonti and D'Appolonia, eight companies from Italy, Spain, Portugal and the UK became involved. The team, with expert advice from Brunel University and Duomo - an organisation dedicated to the maintenance of Milan's magnificent marble cathedral - successfully demonstrated that quarrying applications of shape memory alloys could be competitive. Meanwhile, field trials with full-scale blocks of stone validated the system design in harsh real working conditions.

Today, development is continuing to produce a simple commercial system and to extend the technology into related applications such as mining and demolition. A product should be launched for the stone quarrying market in 2002 to 2003.

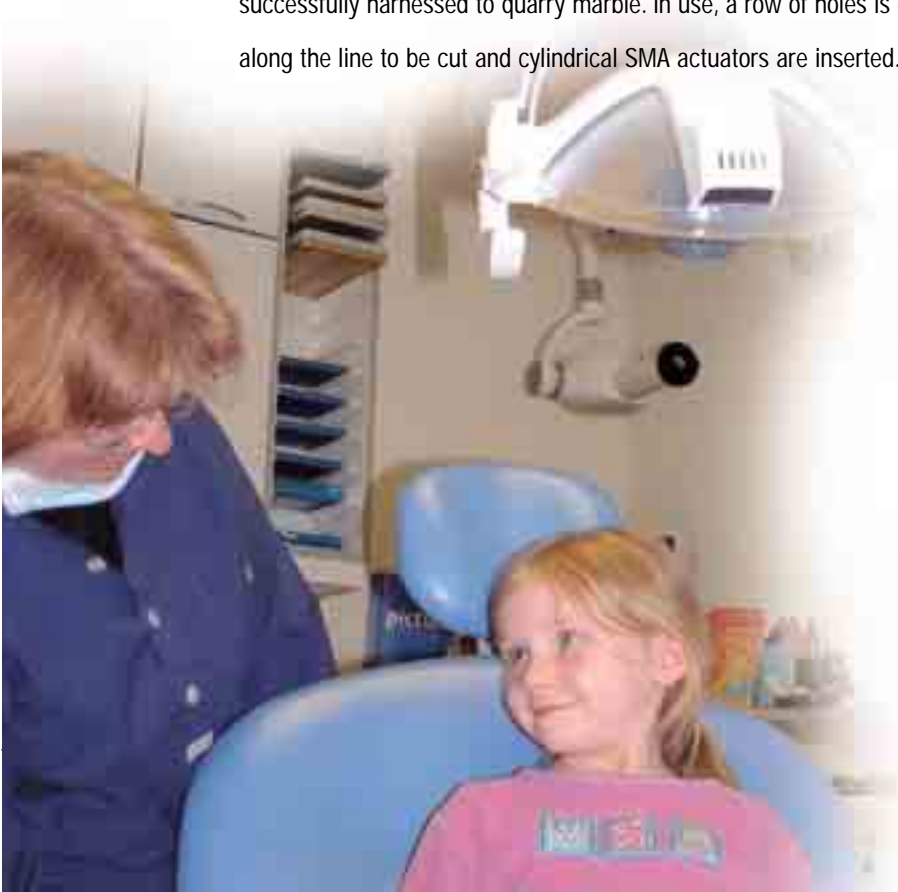





## From outer space to inner space

Everyone is fascinated by those movies made by a tiny camera sitting on the end of a fibre-optic tube moving down the inside of the digestive tract. The device - an endoscope - is, of course, a vital tool to help doctors see internal organs, and to detect and diagnose diseases such as tumours and ulcers without actually having to cut a patient open.

Increasingly, through the development of miniaturised instruments, endoscopy is also being used to carry out minor procedures such as removing small pieces of tissue for tests, and increasingly 'keyhole' surgery. This requires much more accurate imaging and so endoscope manufacturers have been looking for ways to improve their instruments.

*An endoscope from the company Richard Wolf GmbH,  
with a close-up of the optical system*

## Doctors can now see your insides more clearly with instruments improved through technology developed to reduce light scattering in space cameras

Fortunately, it so happened that in the early 1990s European space scientists were developing techniques to address similar deficiencies in equipment deployed in laser communications. An efficient way of transmitting data between spacecraft is to send it as a stream of laser pulses, which is then detected by a camera. One problem, however, is that of light scattering in the detection system. In 1993 a German company, PTS, developed a coating process which produces layered, optically-perfect black surfaces without the use of varnish (which increases light-scattering effects). The coating, called 'Plasmocer', was used in cameras on ESA and Russian satellites, and is planned for use in the SILEX mission, which will test the transmission of data by laser between satellites in geostationary and low-Earth orbits.



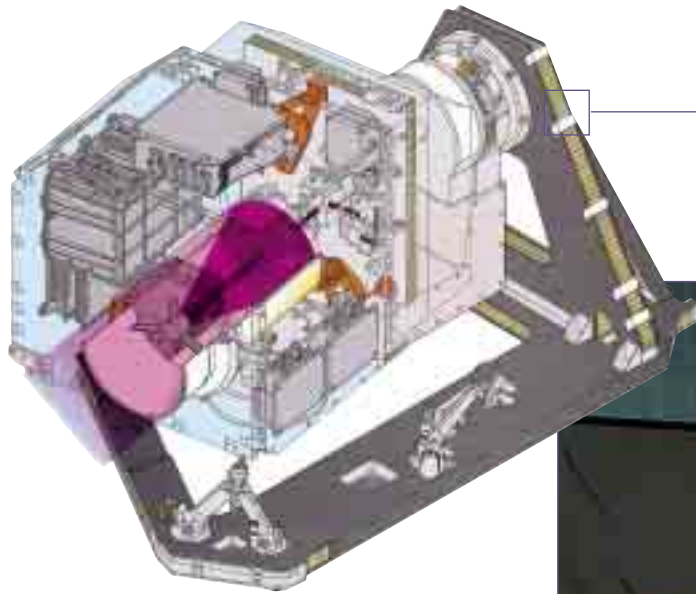

*The SILEX camera*

*The Plasmocer-coated space camera flown on the SILEX mission tested the transmission of data using light from a laser in space.*

SILEX will employ these Plasmocer-coated cameras, and by overcoming the effects of light-scattering, satellite controllers will be able to steer the beam of light more precisely, allowing higher rates of data transmission with low power consumption.

Through the ESA Technology Transfer Programme, Richard Wolf, GmbH, a German company manufacturing medical and industrial endoscopes, learnt about the new coating and decided to try it out. Tests showed that it enhanced the optical quality of the company's product by reducing light scattering by about 20 percent! The coating is now included in the production process to the benefit of doctors and patients throughout Europe.



# Microwave magic

## A technique for mapping the ozone layer may diagnose disease *Star Trek* style!

We are surrounded by microwaves - not only the high-power, well-protected variety that heat our microwave ovens, but also the low-power waves emitted by the millions of mobile phones now in circulation.

Microwaves also have other, more scientific uses. Like other forms of electromagnetic radiation, they are absorbed and emitted by various materials in a uniquely characteristic way. The resulting microwave spectrum allows scientists and engineers to detect and analyse these materials, often remotely.

One of the first applications of microwave spectroscopy was in space. Satellite-based microwave radiometers have been used for some time to measure the distribution of water vapour and other gases in the atmosphere.

Much of the information gleaned has been used not only for short-term weather forecasting, but also, more importantly, in the research leading to the current predictions on global warming and climate change. Indeed, a microwave device developed by British Aerospace (now Astrium) and the Rutherford Appleton Laboratory (RAL) in the UK was the first to map the changes in the size and thickness of the ozone layers above the North and South Poles.

### Diagnosing disease

The Astrium and RAL scientists have not been content to confine their researches to atmospheric effects. For years it has been speculated that individual living cells have their own 'fingerprint' microwave emission characteristics. The Astrium and RAL team, supported by researchers from the University of Wales College of Medicine, believe that, by measuring changes in characteristic







emissions, they may be able to detect abnormalities, perhaps providing an early indication of the onset of disease - a possibility foreseen by the *Star Trek* doctor 'Bones', whose hand-held microwave wand gave an instant diagnosis of anyone it was passed over! The team does not envisage such a straightforward solution, but the equipment developed for Earth observation will provide an excellent starting point.

With help from ESA and venture capitalists, the RAL team are setting up a spin-off company to seek commercial applications. These are not only connected with disease diagnosis; as the team gains a greater understanding of the interaction of microwaves with living cells, it may be possible to use microwaves to influence other biological processes such as those used in making food and drink products.

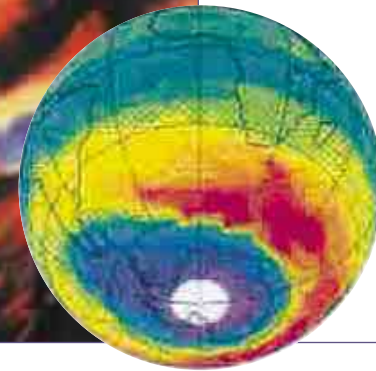
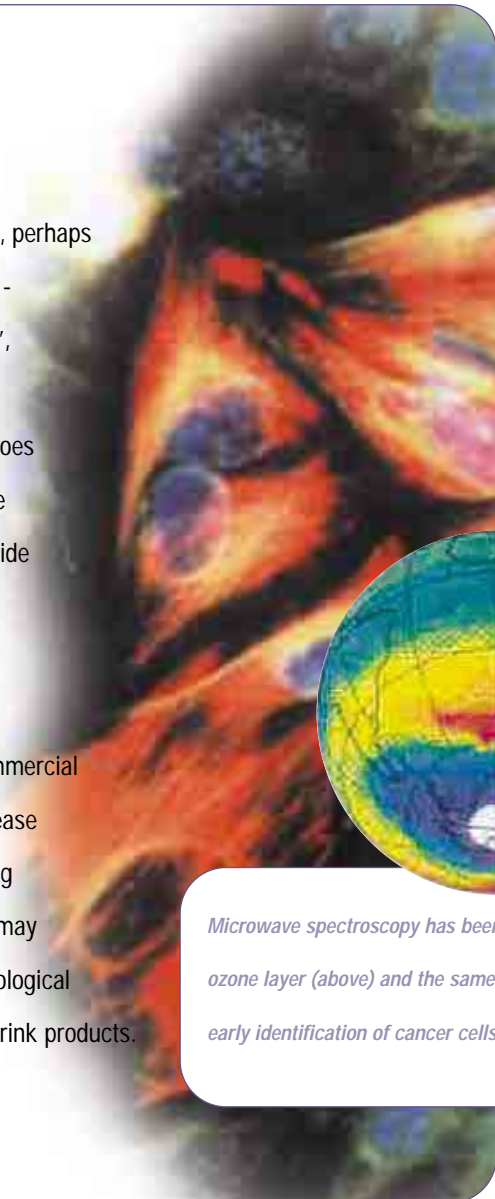

*Microwave spectroscopy has been used to map the hole in the ozone layer (above) and the same technology may assist with the early identification of cancer cells (under)*



# New chip brings better baby pictures

---

## A chip for mathematical processing designed for a satellite will help doctors check your health faster and more accurately

When you go to the hospital for an ultrasound or some other scan, you probably don't realise just how much computer processing goes into creating the image of the expected baby or internal organ seen on the computer screen. Medical imaging requires a huge amount of digital information to be analysed quickly, accurately and cheaply.

Fortunately, mathematics comes to the rescue. The kinds of complex data generated during the scan can be broken down into their component parts using a mathematical method called 'Fourier analysis' (invented by the 18th-century French mathematician Jean-Baptiste Fourier) and then quickly

processed. As well being a standard tool for physicists, it is exploited in many kinds of chemical and biological analysis via a computer algorithm known as the Fast Fourier Transform (FFT). It is also used in electronic engineering to process data, for example, in telephone networks and radio communications.

Spacecraft also have hefty data-processing requirements, and recently a Dutch-based company DoubleBW Systems BV - a spin-off of TNO Physics and Electronics Laboratory which works closely with ESA - has developed a computer chip using FFT for satellite operations. The chip is one of the fastest known and manages to combine exceptional performance with flexibility. It turned out that the chip could be employed in many non-space applications, including seismic data processing, pattern recognition, communications and spectrum analysis. One of the most exciting applications is for the medical world and the company is now modifying the chip so that it can be incorporated in 2D and 3D medical imaging instruments.





Images like this one (left) can be produced more efficiently using the new processing chips

$$X(f) = \int_{-\infty}^{\infty} x(t) e^{-j2\pi ft} dt$$



# Satellite imaging helps prevent strokes

Doctors can now keep track of patients' blood circulation using high-speed imaging software designed for Earth observation

The past 20 years has seen a vast increase in the numbers of orbiting satellites dedicated to producing close-up images the Earth's surface. Once mainly associated with the Superpowers' practice of taking grainy black and white photos of each other's missile silos and troop movements, the quality of satellite images, and the uses to which they are put, have come a long way.

Satellite imagery is now routinely used for such diverse activities as iceberg tracking, checking on supertankers illegally discharging oil, and mapping deforestation. There are now available over the Internet large libraries of images down to a definition of one metre showing individual buildings and roads. These can be of immense value to the town and country planners, the gas, electricity and water utility companies, and also to road planners collecting data on traffic flows.

*Satellite imagery is used  
for iceberg tracking*



Some of these applications require great accuracy from the on-board satellite imaging systems. The European ERS satellites, for instance, gave us precise image 'maps' that can be used to observe and record the change in use of agricultural land - often of considerable economic significance for farmers.

Some of the sophisticated software used was developed by ACS of Italy. It provides real-time imaging and a geometrical correction capability necessary to give the high degree of positional referencing required. That company has since applied the same techniques to meet more down-to-earth imaging needs.



## Monitoring blood flow

For some time, doctors have seen the potential for using scanning techniques to measure the speed of blood flow through the major veins and arteries. The problem has been to convert the mass of scanner data received into useful diagnostic information. Taking advantage the software's ability to process imaging data very rapidly, doctors will now be able to produce images of the blood flow in real-time, greatly simplifying the task of detecting restrictions in blood vessels and providing patients with an early warning system for strokes and other circulatory diseases.







## A lobster's X-ray eye view

The eye of the lobster has been the inspiration for a new type of space telescope. Now a variation of the same technology is helping medical researchers to fight disease

Astronomers are not content with looking at the night sky in just visible light. They also detect and study X-rays from space. This high-energy radiation is associated with violent phenomena in the Universe such as black holes and supernova explosions. X-ray telescopes are rather different from ordinary telescopes, however, because X-rays tend to pass through objects so they can't be focused in the same way as visible light. They have to be steered by bouncing them off metal-coated surfaces at very shallow angles.

This has created a problem in the past in that X-ray telescopes could look at only small areas of the sky at a time. Now, however, it seems that the lobster has the answer. Unlike the human eye, which relies on refractive lenses, lobster eyes have thousands of square tubes bound together - arrayed spherically end-on - which reflect light down the inner walls of each tube to focus it on the retina.

Space scientists at the Space Research Centre at Leicester University have replicated the lobster's eye lenses, using thousands of microscopic, hollow glass tubes bundled together around the surface of a sphere, to focus X-rays from much larger portions of the sky. The Leicester telescope will be mounted aboard the International Space Station.

The lobster-eye X-ray lens is based on microchannel plate technology. A microchannel plate is an array of tiny parallel channels which focus the X-rays, point by point, onto a detector. The Leicester team have been investigating how to exploit this type of innovative X-ray optics in areas other than astronomy.

One possible application is in X-ray lithography - the process used to etch the tiny features on electronic chips. Using microchannel plate lenses allows better focusing of the X-rays leading to increased accuracy in the lithographic technique. This could enable ever-smaller devices - below 0.2 of a micrometre - to be fabricated.

## Imaging beta particles

The Leicester researchers have also been working with a different form of microchannel plate technology to detect and image another kind of energetic radiation - beta particles - which are emitted by certain radioactive elements such as the hydrogen isotope tritium. In medicine, such beta emitters are used to 'label' biological materials so that they can be analysed by monitoring the radiation given off.

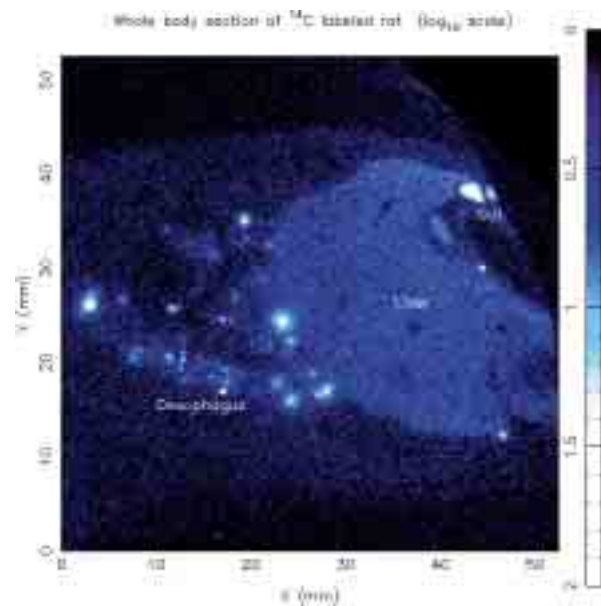

One exciting use is in the new field of proteomics. Now that the human genome - our genetic code - has been analysed, the next stage is to identify and study all the proteins that the genes code for. Proteins are the workhorses of living cells, and understanding how they control the body's biochemical processes is vital in the fight against disease and in the search for new drugs.

Daresbury Laboratory

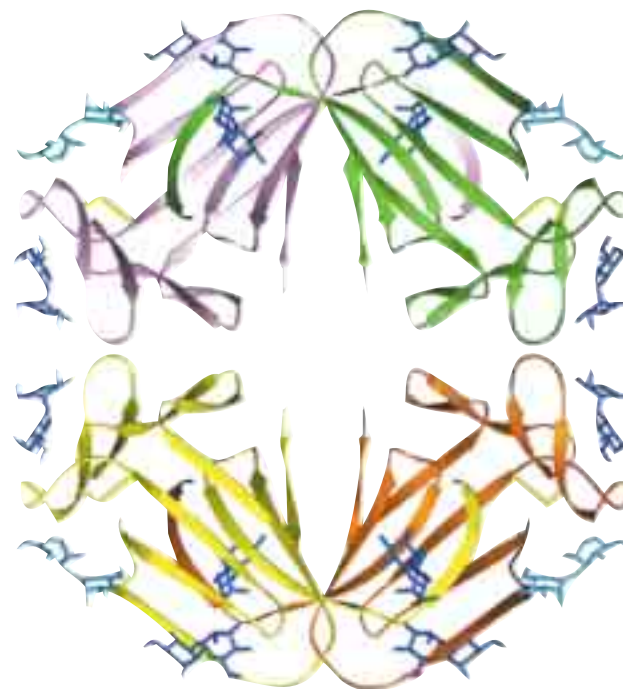

*Surface of a lobster's eye in close-up, above left.*

*X-ray imaging is used to determine protein structures, above right.*

*Radiograph of rat tissue, showing beta isotope uptake, left*

Labelling a protein thought to be associated with a disease with a beta-emitting isotope is one way of probing interactions with potential drug molecules.

In the true spirit of spin-off, the Leicester Space Centre has established a Bio-Imaging Unit and produced prototype beta-radiological equipment. Some recent research exploiting the technique includes measuring the effects of organophosphates - such as fly killer and sheep dip - on brain proteins. The pharmaceutical company Bayer, working with the UK Medical Research Council, is funding further research in this area. Other uses for the equipment include evaluating the use of therapeutic radioisotopes to treat bladder cancer.

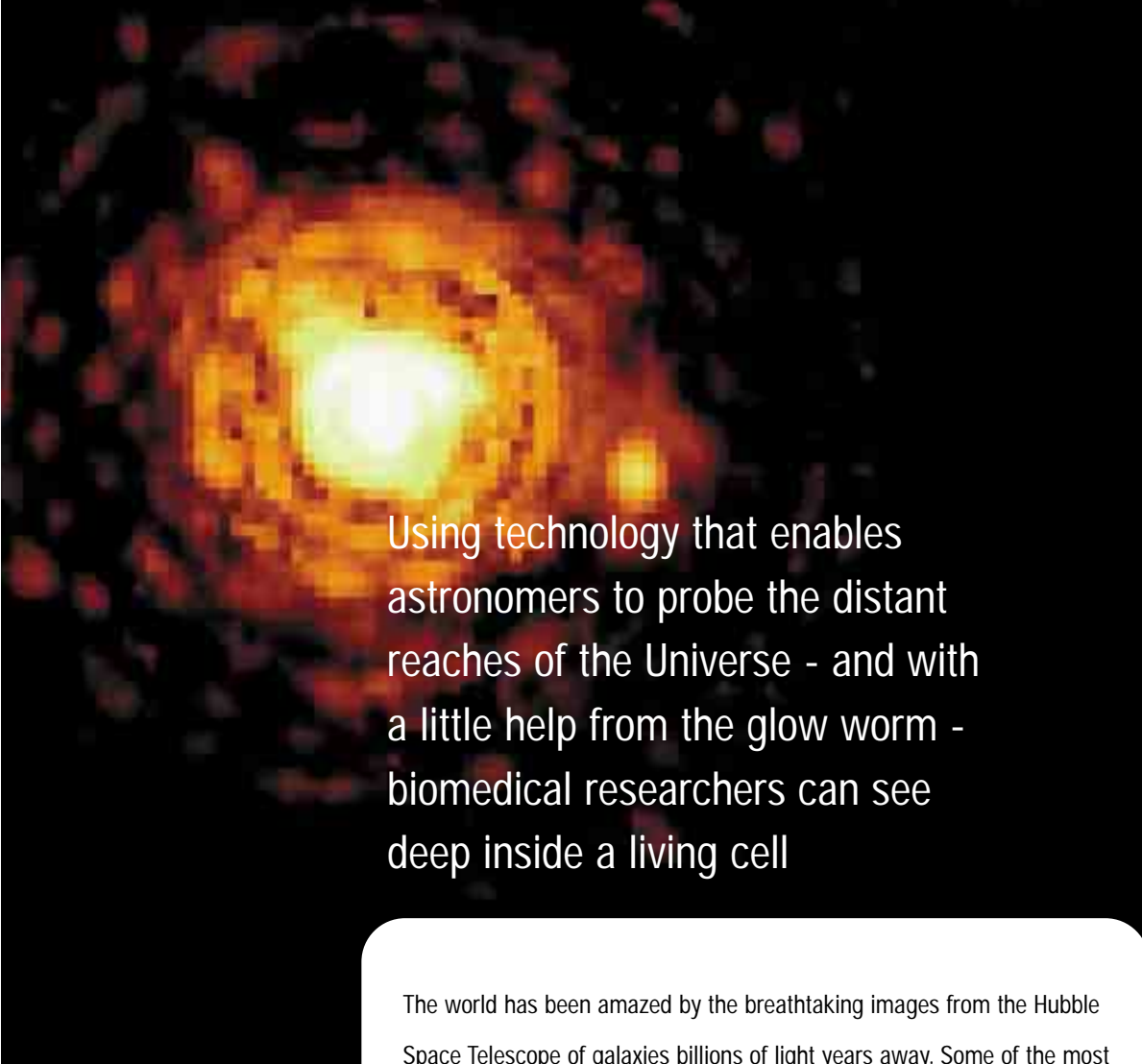

Using technology that enables astronomers to probe the distant reaches of the Universe - and with a little help from the glow worm - biomedical researchers can see deep inside a living cell

The world has been amazed by the breathtaking images from the Hubble Space Telescope of galaxies billions of light years away. Some of the most exciting pictures were taken using an instrument called the Faint Object Camera which was developed by ESA. It is Hubble's 'telephoto lens' providing the sharpest views ever of distant objects in space.

## Glow worms light the way

Like all modern optical instruments used by astronomers, the Faint Object Camera exploits detectors called 'charge-coupled devices', or CCDs. These are silicon chips consisting of arrays of light-sensitive 'pixels', which convert impinging light into an electric charge that can then be used to generate an image. Today, CCDs are found everywhere - in your digital or video camera, for example, or the office photocopier - but those employed in the Faint Object Camera are rather special - in that they can detect single particles of light (photons).

These CCDs are controlled by special software, which ESA went on to license to a UK company specialising in making CCD cameras for biomedical applications. The company was supporting the work of medical researchers in the UK who have for some time been using some novel techniques for 'observing' the workings of living cells.



*Bioluminescent protein extracted from glow worms (far left) can be used to observe chemical signalling in plants and animals - including humans*

## Throwing light on cells

Tony Campbell, a professor at the University of Wales College of Medicine, is one such researcher. He inserts a bioluminescent protein extracted from glow worms into a living cell so that it illuminates the cell's activity. Very simply, the luminescent molecules attach themselves to calcium ions (thought to be the cell's 'messengers') which can then be followed visually as they move around the cell. Using the detector, you can see cells responding in real time and, in an early experiment, Professor Campbell could actually watch the response of a seedling being touched by an ice cube! This ability to observe the innermost workings of a cell is important in understanding and controlling disease, and this has been the main object of Campbell's work.

The story does not stop, however, with CCDs. The technology is moving on. A new type of light detector called a superconducting tunnel junction (STJ) diode is being developed, which can also register the colour of the photons -

information of great interest to astronomers and biomedical researchers alike. Indeed, Campbell is now developing a range of genetically engineered 'rainbow' proteins, programmed to change colour when they bind with a particular chemical in a living cell.

This research has exciting implications for our future health. For example, a potentially cancerous cell will change from red to green, or from red to blue, and the next generation of cameras will be able to record this, providing scientists with more valuable information in the fight against that deadly disease.

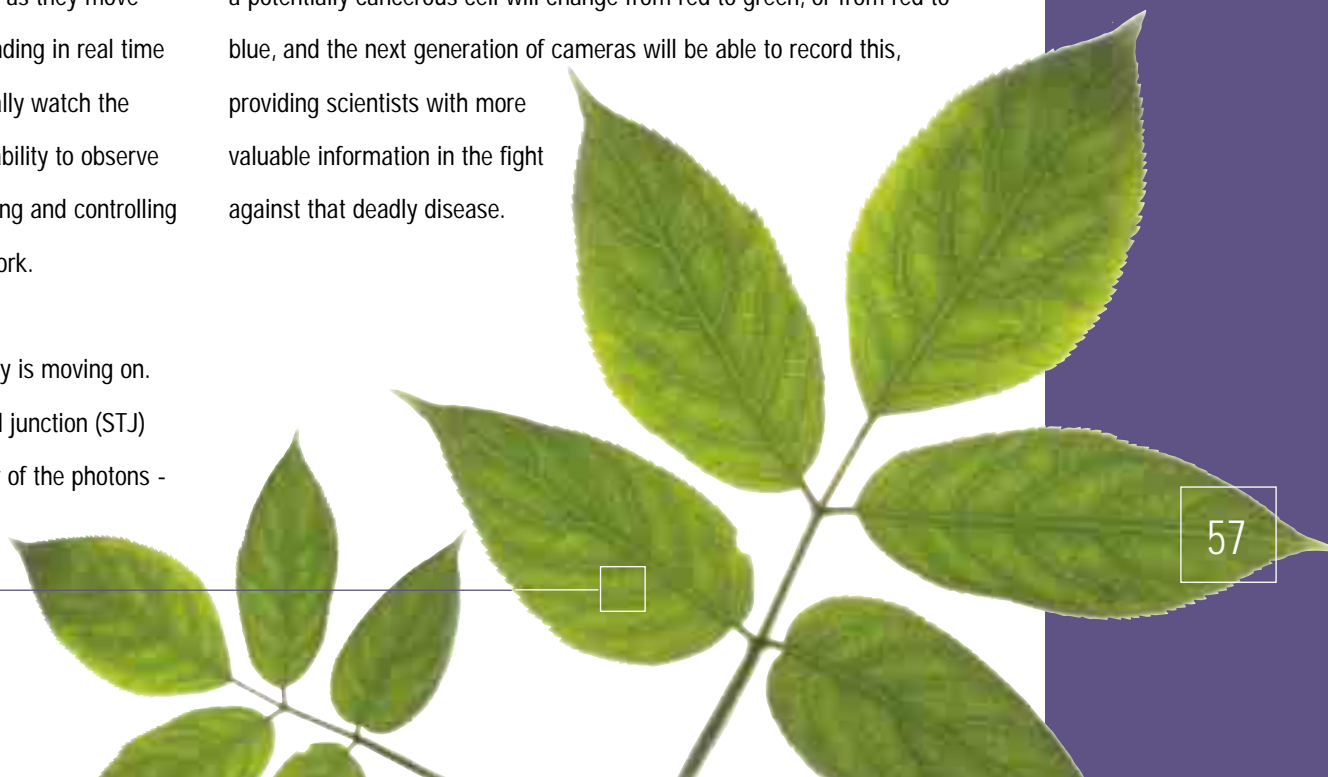



# A blood test on a chip

## An analytical technique perfected to monitor astronauts' health is now finding its way into the hospital laboratory

Many of us will have had a blood test at one time or another, but we probably don't think about the complex analysis that goes on in the hospital lab to give us our results. One powerful analytical method used is high-performance capillary electrophoresis (HPCE), which can separate out complex chemicals like proteins from a biological sample so that they can be identified. The separation is based on the simple physical principle that different substances move at different rates under the influence of an electric field. HPCE has the advantage of requiring only small samples and, with minimum preparation, of being able to detect a wide range of complex substances. As well as being used in the clinic, for example to analyse blood samples for metabolic disorders and monitor concentrations of anti-cancer drugs and anaesthetics

in the body, it is also employed extensively by drug companies and the chemical industry.

In the Netherlands, research on capillary electrophoresis had been centred at Eindhoven University, which several years ago started to investigate the possible applications of HPCE in space. One important use of Shuttle and Space-Station missions is to exploit microgravity conditions to prepare and analyse materials of biological significance. It is, for instance, extremely difficult to grow protein crystals on Earth that are large enough and perfect enough to analyse, partly because of the effects of gravity. Such materials are often limited in stability and so it is necessary to analyse the structure quickly - in other words, in space.

It was with this aim that Eindhoven University, and an industrial consortium including the companies Comprimo BV and Lauerlabs BV, began to develop a range of small, modular, fully-automatic HPCE systems, some adapted for manual operation, to monitor physiological changes in the body fluids of astronauts. These would initially be used on Spacelab missions and possibly in future on the Columbus module of the International Space Station.



## Portable systems for the health industry

In 1994 Spacelink promoted the non-space use of these modular systems, at that time being produced by Lauerlabs BV, through the ESA Technology Catalogue. Helena BioSciences, a UK company making analytical instruments for the health and pharmaceutical industries, immediately spotted the synergy with its own range of products. The company also saw the possibility of improving its analytical support to clients by introducing portable automated machines.

Helena quickly determined that the most effective way of achieving the necessary technology transfer would be to acquire Lauerlabs, and this duly happened in January 1995, bringing the benefits of a valuable programme of space-focused research to the wider European pharmaceutical and clinical community. At the conclusion of the acquisition, Lauerlabs changed its name to Prince Technologies.

In recent years the technology has been further developed to become even more flexible. It has been extended so that it can be used with a wider range of chemicals, and even more excitingly is now being miniaturised so that the separation can be carried out on a chip - which promises even smaller sample sizes and faster separation times.



courtesy of Prince Technologies

One of Prince Technology's HPCE machines



courtesy of Prince Technologies

Modular HPCE units like this one are planned for use on the International Space Station

### Electrophoresis

Electrophoresis gets its name from a the process that causes ions to move under the influence of an electric field. Since opposites attract, the electrically charged ions of substances within the test sample will migrate towards an electrode having the opposite charge. What makes capillary electrophoresis such a powerful tool in separation science is the fact that the ions of different substances move at different rates. These are determined both by the electrical charges involved and the effective size of the ion, which slows its passage through the fluid under test. By exploiting these various speeds of migration, complex mixtures of very similar molecules can be separated for analysis. The technique, which can be automated, is finding wide application in chemical and biological analysis, pharmaceuticals and the study of toxins.

# Space pumps help pandas avoid extinction

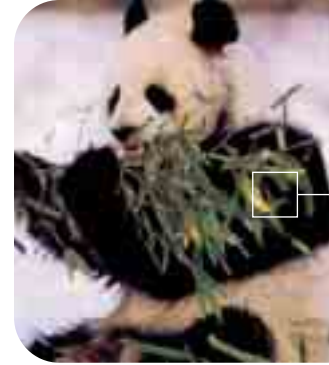

A miniature pump developed for space has been used by vets to help to improve the love life of a female giant panda – (unfortunately with inconclusive results)

Perhaps one of the strangest examples of the unforeseen uses of space technology concerns a miniature pump developed by Brunel University's Institute of Bioengineering in the UK.

Several years ago, a planned ESA micro-biological space mission threw up a requirement for a simple, miniature low-power pump to transfer liquid nutrients around a small orbiting microbiological laboratory, designed to study plant growth in space.

Brunel provided a prototype for such a pump which, in its time, was probably the smallest of its type in the world. Coincidentally, through that extensive network that academics have, they heard of a problem confronting scientists in the USA seeking to stem the decline in the world's population of giant pandas. It had been identified that one of the contributing factors was that the female panda comes into season only once in 12 months – severely

limiting the number of mating opportunities. The scientists had determined therefore that, if they could introduce hormones more frequently into the panda's body, mating should be possible on demand.



*The Brunel Institute's miniature pump*

What was needed was a pump, timer and reservoir small enough to be implanted in the panda's back, providing unobtrusive, regular supplies of hormones which could be made to coincide with the introduction of a male partner.

The Brunel space pump fitted the bill exactly and was eventually implanted in a female panda in Washington Zoo. The pump worked perfectly but the longed-for happy event never materialised proving that, although space spin-off knows no bounds, in matters of the heart technology cannot always provide the answer.





# The sweet smell of success

## Technology that emulates our sense of smell is now being used to detect infections

The human nose is extremely sophisticated. It can detect and distinguish a huge range of odours. As well as informing and enhancing the experience of eating, our noses also act as early-warning devices by helping to sense danger or decay. If you smell gas at home, it is usually easy enough to locate the source. This is not quite so easy to do in space, however, and this is why ESA supported the development of sensors to act as gas detectors on space stations such as MIR.

Scientists studying how smell works in humans have employed electronics to mimic the processes involved. Arrays of sensors can emulate the different type of olfactory receptors found in our noses. Processing electronics then

convert the signals from the sensors into patterns and store them for future recognition. These 'electronic noses' employ many different types of sensors and sampling devices.

The Department of Instrumentation and Analytical Science at University of Manchester Institute of Science and Technology (UMIST) in the UK was under contract to ESA to produce a gas-sensing device for monitoring vital safety functions on MIR - the air quality, in particular any contamination resulting from leaking, and also signs of any fire break-outs.

In 1994 the technology was transferred from UMIST to a company called Aromascan (now called Osmetech plc). Osmetech employs sensors made of conducting polymers arranged in arrays of up to 48 individual detectors. The way the polymers are arranged is unique to Osmetech and enables each element on the array to have a different conductive property. The multiple sensors can detect a range of distinctive smells and odours.

*The Osmetech core sensor array*



## A nose for diagnosis

Osmetech knew that there were many potential applications for the electronic-nose technology. For example, when micro-organisms metabolise, they emit volatile components often possessing a characteristic smell, which the Osmetech sensor array technology can detect. The company realised that the sensor arrays could therefore detect the presence of pathogenic bacteria, fungi and moulds such as those causing urinary tract infection (UTI), infections that result in women going into early labour, bacterial throat infections and pneumonia. These sensors can be incorporated into automated multi-sample instruments for use in a hospital lab or at the doctor's surgery.

Osmetech has gone from strength to strength. In April 2001 it became the first electronic-nose company to make a submission to the American Food and Drug Administration for the use of its UTI detection device. This will enable the technology to be commercialised within the USA and subsequently throughout the rest of the world.



*The MIR Space Station*

# Keeping safe



*The need to protect both complex instrumentation and astronauts from the hostile environment of space is a constant preoccupation of engineers. Increasingly advanced materials and techniques developed for space are being adapted to help to address safety and security issues here on Earth*



*The demands of space travel have thrown up the need for strong lightweight materials that are also heat and impact-resistant. These have quickly found terrestrial applications, as have other space technologies aimed at improving overall safety and security*



# Screening out vandals



Belgian Spacelink partners introduced a French textile manufacturer to a consortium who needed to tackle road and rail transport theft across Europe

Theft from lorries and haulage containers is a growing problem throughout Europe and those with sides made of fabric are particularly vulnerable to attack. Cargo containers spend a lot of time unattended in loading or storage depots and their tarpaulin covers, while light and convenient to use, offer little protection against the knives of vandals and thieves.

By 1996, so serious had this problem become that three companies, a French manufacturer of haulage containers, a Belgian plastics and composites company and a large Belgian rail/road haulier, joined forces with CRIF - a Belgian collective industrial research centre as the main focus of research, to develop a new protection system for containers.

The work was supported under the EC's CRAFT scheme and initial studies pointed towards the development of a better material for fabric screens, which would retain the advantages of lightness, flexibility and ease of cleaning, while offering great strength and resistance to attack. But where to find such a material?

## The French connection

As part of its ESA-sponsored work, the Spacelink network surveys non-space companies to see what kind of technology they might need. It was through this mechanism that the Belgian Spacelink partner Creaction circulated the requirement for a vandal-resistant textile. By good fortune, a French company Société Ariégeoise de Bonneterie, following the success of its flame proof textiles used on the Ariane rockets, had modified its knitting technique to create from steel wire a flexible fabric that was extremely difficult to cut and well-suited to the application.

By December 2000, research was completed and large-scale testing had begun. Parcouri, a consortium of eight European companies that includes a Dutch multinational producer of vehicle covers and a French SME specialising in coach building and kit fixing systems, is now developing a vandal-resistant alternative to the standard tarpaulins currently in use. Within an existing global market of 120 000 units a year, current predictions for the new material show a healthy potential market opening of 7000 units annually.

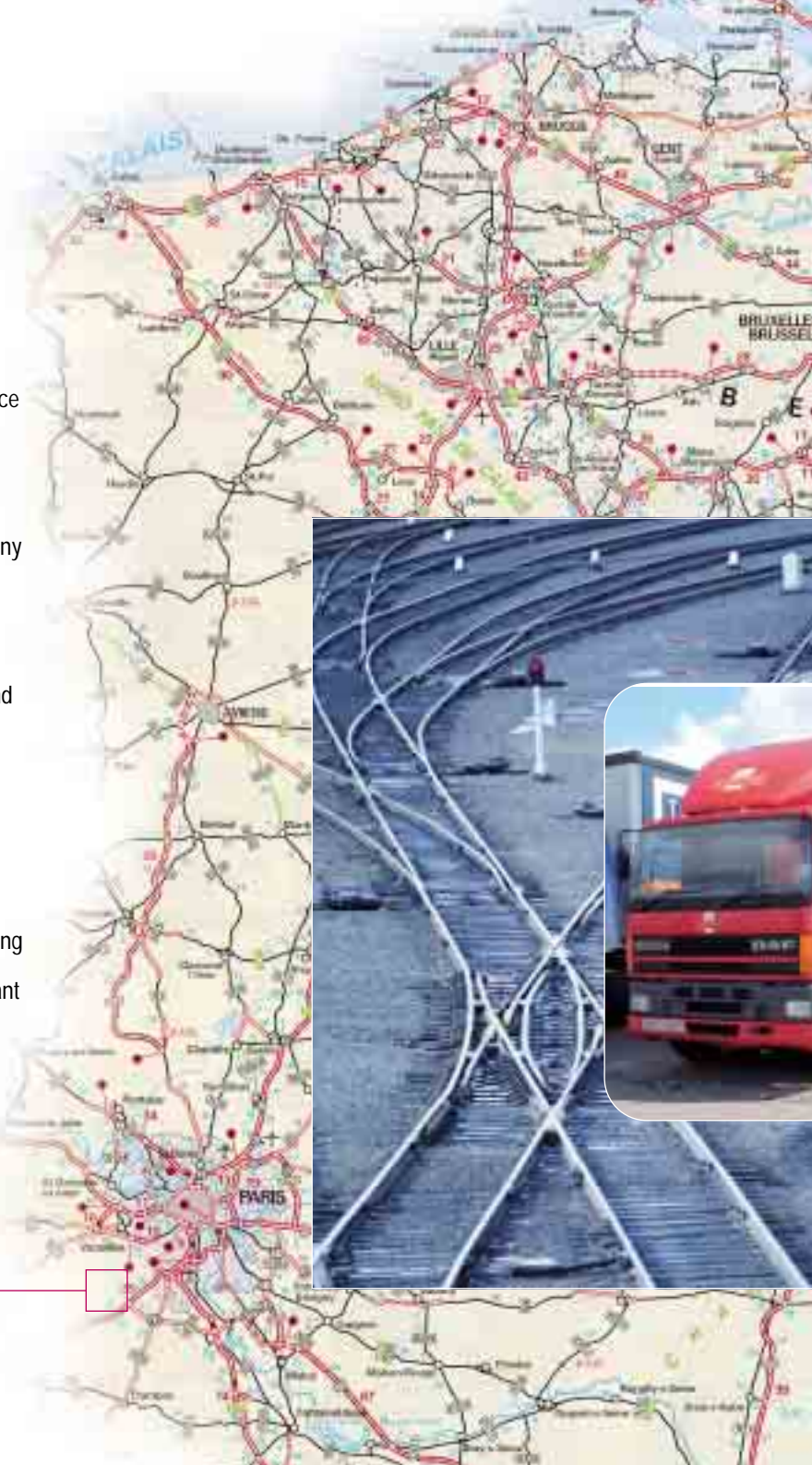

# Finger prints are the key

A tactile sensor developed for Space Station robots is being used to read fingerprints



*The KC-901 fingerprint sensor, above, is being followed by a range of other devices*

Who hasn't lost a key or forgotten a security password? Yet why should we rely on these artificial aids when our fingerprints carry our personal identity code? Now, a device that can recognise the unique pattern of ridges and whorls on our finger tips is about to become reality.

Many attempts have been made to create a reliable fingerprint sensor, but all have suffered from problems. Some were simply too fragile to cope with the harsh everyday operating environment found outside the laboratory. Others wore out quickly or were too sensitive to moisture and heat. Even the variation between a wet or dry finger tip was enough to prevent reliable recognition. But now, a spin-off from space robotics offers a new and promising approach.

The Mobile Servicing System forms part of Canada's contribution to the International Space Station and uses robot technology to assemble, transport and maintain payloads in orbit. A key component is a two-armed robot that can handle the kind of risky servicing and repair tasks usually performed by astronauts on space walks.





During the planning of the project, the Canadian Space Agency quickly realised that sensors that would show the exact location of the workpiece in very close proximity to the fingertips of the robot, would be essential if its 'grippers' were to work properly. Unfortunately, no such sensors existed.

A Canadian company, Kinetic Sciences Inc, was given a contract to develop a proximity sensor that could accurately see features very close to its surface. What was needed was a device that could provide detailed information on the position and distance of objects from actual contact to 10 millimetres away from the fingertip of the robot.



*Fingerprint reader  
Sensor technology developed  
for the Mobile Servicing System  
is now being used to identify  
fingerprints for security  
applications, particularly to  
replace computer passwords*

### Keyless locks

Such was the success of the sensor, that KSI foresaw a much wider commercial application. As the heart of a fingerprint reader, there was an immediate market for the sensor in law enforcement and computer security applications. In the longer term, its potential to create 'keyless' locks would be considerable. As a result, in 1997, the KSI Fingerprint Biometrics Division was formed and its first product, the KC-901 fingerprint sensor, was announced in early 1999. A range of follow-on applications aimed at computer security, e-commerce and keyless locks is currently being developed.



# Monitoring cosmic rays in Concorde

Radiation is not something air travellers normally worry about. Novel sensor technology monitoring radiation in spacecraft is ensuring that frequent high flyers don't get an unexpected dose of cosmic rays

You may not realise that spacecraft are exposed to significant amounts of radiation - some of it from the solar wind, the stream of energetic particles from the Sun, and some of it very-high-energy cosmic rays from deep space.

*Cosmic radiation – such as that from solar flares (left) – can be damaging to equipment as well as people*

This radiation can damage onboard electronic systems if unprotected. In extreme circumstances this can cause the on-board computers to crash, putting the spacecraft and its crew in danger. The radiation also poses health risks for astronauts, particularly those on long-term missions. Spacecraft engineers and designers are therefore keen to find out more about the effects of radiation on spacecraft and astronauts.

In the early 1990s two ambitious experiments were launched on board the NASA Space Shuttle and the UK's UoSAT scientific satellite to measure the amount of radiation the two spacecraft were exposed to during their time in space. The two experiments, called CREAM (Cosmic Radiation Effects and Activation Monitor) and CREDO (Cosmic Radiation Effects and DOSimetry), were designed at the UK's Defence Evaluation and Research Agency (DERA) and AEA Technology along with several other research organisations.

## Risks to high flying aircraft?

Following the experiments' success, people soon realised that the technologies developed could be used for measuring cosmic rays nearer to the ground. Whilst the Earth's atmosphere shields people on the ground from cosmic radiation, high-flying aircraft such as Concorde are, like spacecraft, also exposed. Although the degree of exposure is very small at any one moment, it does build up over time, and there were concerns about the effects on the health of both crew and frequent flyers. To help scientists measure exactly how much radiation the aircraft and people on board were exposed to, a replica of the CREAM experiment was installed on a British Airways' Concorde aircraft.

It was found that the actual radiation levels at high latitudes in the northern hemisphere (where most of these aircraft fly) were less than scientists had predicted. The Earth's magnetic field appears to have a much greater impact in controlling the amount of cosmic rays penetrating the atmosphere at these latitudes.

The CREAM experiment on Concorde also confirmed the findings from the earlier space experiments in that the amount of cosmic radiation increases markedly during periodic increases in solar activity (for example, solar flares and sun spots). Partly in response to this experiment, several organisations are now investigating the possibility of establishing an early warning system for airlines to advise them of an impending surge in solar activity. The intention is that airlines would use this information to re-route their aircraft to higher latitudes, and to advise passengers who are more susceptible to such radiation (such as pregnant women) not to travel.

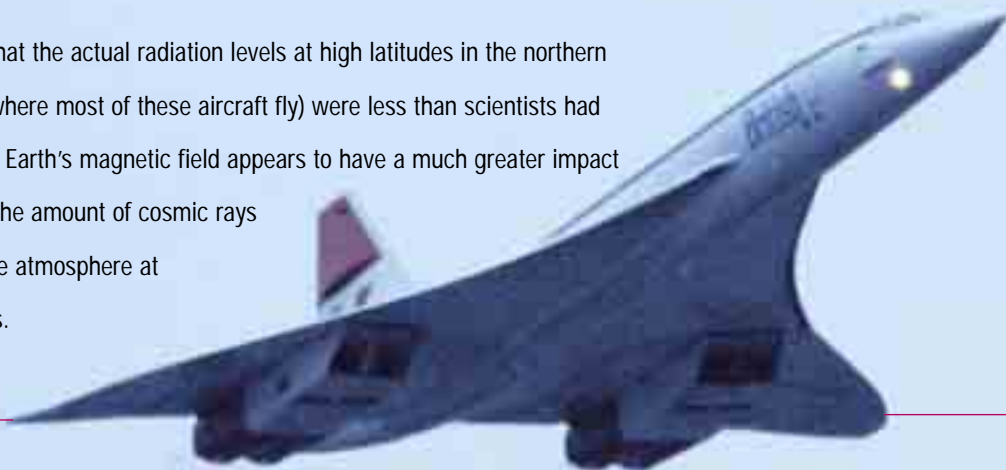

# Space fashions are cool



The Spanish company that co-designed the European space suit has developed air-conditioned clothing for use on Earth

Their system, which is worn as an undergarment, is light in weight and blows cooled air over the wearer's skin - taking advantage of the body's natural perspiration mechanism. Cooling, based upon the Peltier effect which requires few moving parts, is powered by rechargeable batteries to ensure full mobility. The undergarment may be worn on its own or with full protective gear and is currently being assessed by the London Police for use under bullet-proof vests.

For more extreme environments, a full suit can be provided in which air cooling may be supplemented by liquid refrigerant pumped through a network of tubes within the suit.

Drawing upon its space-suit technology, Zodiac can also incorporate breathing systems which support the highest levels of protection, while the use of battery packs ensures independence and freedom of movement for the wearer.

*Work done on the European space suit enabled Zodiac to design a protective suit for use on Earth. The 'air - conditioned' undergarment can be worn under bullet-proof vests to keep police cool*

Clothing that will keep its wearer cool in the hottest environment will be a great relief to many workers. From firemen and motorcyclists in their heavy protective clothing, to bakers and foundry men in their hot workplaces, all suffer from excess heat.

Zodiac, the Spanish company that co-designed the European space suit, has joined forces with a Belgian university and two other partners to develop clothing that will cool its wearer.





*The advanced European space suit concept (EVA suit 2000)*

## The Peltier Effect

*In 1834, the French Physicist Jean Peltier discovered that when an electrical current is passed through a junction of dissimilar conducting materials, heat will be absorbed at one junction and given up at the other. If the current is reversed, heat will be moved in the opposite direction. This discovery remained largely a scientific curiosity until semi conductor materials became available, allowing the manufacture of small, efficient modules with no moving parts, which will pump heat from one location to another at will, allowing their use for heating or cooling*



# Carbon brakes and inflating airbags

Spin-offs from space technology are making travel safer

Most of us have to travel, whether on business or pleasure or just in our everyday activities, and travelling as safely as possible is an important criterion for transport manufacturers. They are continually looking for ways to improve reliability and safety. Technology originally designed for space applications is contributing to such developments, and two French examples show how this is working in practice.

## Composite brakes

Composite materials composed of a carbon matrix reinforced by long carbon fibres can withstand high temperatures, and are very resistant to wear. These materials were originally developed for use in the extreme conditions found in the nozzles of rocket motors. The developers realised that brakes made from such composites were more reliable, reduced vibration, and caused less pollution than traditional braking systems fitted on planes and road vehicles. Messier-Bugatti, based in France, produced a novel carbon braking system for use on aircraft such as the Airbus and now supplies one-third of the world market for carbon composite brakes for commercial planes with more than 100 seats (over 231 planes were equipped in 2000 alone). Similar systems have also been employed on racing cars, road vehicles and passenger trains.



*Overall view of an airbag gas generator, left*

*An airbag gas generator, right*

*The energetic pyrotechnic charge produced by SNPE Propulsion, below*



*courtesy of SNPE Propulsion*



*Messier Bugatti's manufacturing plant for aircraft carbon brakes*

## A better airbag

Another important safety feature - the airbag - has contributed a great deal to safe car travel in recent years, saving many lives and helping to prevent serious injury in collisions. Today, the device is considered to be one of the most important safety devices since the seat belt was first introduced in the 1960s. When an airbag inflates, it is filled up generally by gas coming from the controlled combustion of an energetic material. The typical standard device for the driver is housed in the centre of the steering wheel along with the inflator. An igniter activates compressed-gas capsules and these fill the bag with an inert gas when an impact above a certain force is sensed. The whole inflation process occurs within a split second and the bag is completely deployed in less than a second - quickly enough to restrain the occupant.

As most new cars employ such safety devices, the market for the pyrotechnic charges is large. The French company SNPE Propulsion is using its knowledge in the field of solid propulsion for ballistic missiles and space launches to design and develop the pyrotechnic charges used in airbag gas generators and seat-belt tighteners. SNPE Propulsion estimates that its products are used in one out of every four safety devices fitted to new cars each year.

# Radar system breaks new ground

Ground-penetrating radar developed for space exploration offers new hope in preventing mining accidents and detecting landmines

Radars play an increasing part in everyday life. Most of us are aware of their original purpose of detecting planes or ships, and some of us have suffered the consequences of their role in catching speeding motorists, but not many of us would associate radar with detecting objects underground.

As computer processing power increases and becomes cheaper, ever more complex signal processing can be applied to radar signals and, by careful choice of frequencies, it is now possible to use portable radars to penetrate the ground and produce images of hidden structures and objects.

Ginger, an ESA technology effort, set out to develop a ground-penetrating radar in support of a proposed programme to explore the Moon. Now, the same technology is showing great promise in two new life-saving roles.

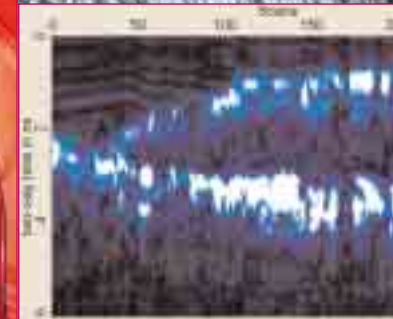

*The CRIS device helps to detect cracks in mine walls*



## Miners 'see' inside rock

Deep underground, liners and supports are often used to maintain the integrity of tunnels. Unfortunately, in some areas where the rock is hard, fine cracks can lead to collapse and a phenomenon known as 'rockburst'. Until now, all miners could rely on was experience and intuition to tell them what is hidden beneath a rock surface, so a means of assessing the rock conditions and the integrity of underground supports would be of great benefit.

Based on the work of Ginger, RST Radar Systemtechnik of Switzerland and MIRARCo of Canada developed CRIS, a dedicated ground-penetrating radar prototype, to detect cracks in the walls and roof of mine drifts. The radar can look through metal mesh and spray-on linings. It can identify cracks from a few millimetres to a depth of more than one metre. A hand-held CRIS prototype has been field-tested and has successfully met all design targets. Future work will concentrate on perfecting the device for use in the harsh underground environment.

## Revealing hidden dangers

Ground-penetrating radars hold out great hope in another area. A lot of ingenuity has been applied to making anti-personnel landmines virtually undetectable and, each year, their removal carries a high cost in injuries and lives.

Now, four industrial partners, - Vallon, RST, Spacebel and Bats - and four research organisations - DLR, RMA, ONERA and ISL - have joined with the Universities of Karlsruhe, Bochum and Milan to create 'HOPE', a hand-held multi-sensor landmine detector. It consists of a metal detector, a radiometer and a ground-penetration radar. The aim is to reduce the number of false alarms when detecting mines, speeding up the process and improving safety for operators. The 5 million Euro development is being partially funded by the Schweizer Nationalfond, the ESA TTP, and the EU, with a further 50 percent from industry.

So far, the results are very promising. The device detects foreign bodies, including plastic mines, by collecting radar data from the ground in horizontal slices; advanced off-line techniques can then be employed to generate a 3D image of the body. A prototype system has successfully detected small landmines to a depth of 40 centimetres.

The HOPE detector



Anti-personnel mine





# Rocket textile takes the heat off industry

A flameproof textile first developed for Ariane rockets has been welcomed by industry for fire prevention and heat protection

A woven fabric that will withstand flames and protect against extreme heat seems an unlikely outcome from space technology, but these are precisely the properties needed by designers of rocket motors to defend sensitive equipment from the rocket flame.

In 1990, Aérospatiale and SEP (Société Européenne de Propulsion) approached a family-owned textile company in Montferrier, France for help in developing flame-proof materials for use in rockets. SAB (Société Ariégeoise de Bonneterie) drew upon its 40-plus years of experience in textile knitting and coating to produce Flamebreak, a unique textile that both stops the advance of fire and insulates against the transmission of heat.

Using a special knitting technique, Kevlar and Preox fibres are combined to create an optical filter capable of blocking 90 percent of infrared radiation over a wide temperature range. By layering the material, almost all heat transfer can be eliminated. In a further development for the Ariane-5 rocket,





courtesy of Tourism Toronto

Flamebreak may be impregnated with an Aerospatiale silicon coating to produce a laminated material with excellent flame-resistance.

### Cool customers

The remarkable properties of Flamebreak are perhaps best illustrated by its application at CEA, (Commissariat à l'Énergie Atomiques) in France. During high-temperature studies of the cooling system of a nuclear reactor core, Flamebreak protected employees from heat (2100 to 2500 °C) and dripping molten metal, while transparent screens, also made from Flamebreak, permitted researchers to observe their tests at close hand.

In a field with few competitors, commercial applications for Flamebreak are widespread. Companies in the metal and glass-working industries, such as Pechiney SA and St Gobain SA, have used the remarkable insulating properties of Flamebreak to good effect in shielding their production workers,

while the excellent performance of Flamebreak as a fire-retardant has been incorporated into upholstered seats for vehicles and public buildings, most notably in the Toronto Skydome.



courtesy of Tourism Toronto

*Flameproof textiles from Ariane  
in Toronto's Skydome*



*Ariane-5*

Rocket textile takes the heat off industry **Keeping safe**

# Building the future



*It seems that the complex demands of space exploration stimulate the need for innovation in an almost inexhaustible range of technologies. It is not surprising that the resultant spin-offs penetrate all sectors of industry - bringing wide-ranging benefits to business and our everyday lives*





*Software processes and techniques, smart sensors and actuators are just a few of the technologies that are being adapted to increase the efficiency and competitiveness of European industry in the wider global market*





# Space gives a smoother ride

Anti-vibration technology developed from space platforms is finding wide application in building construction and instrumentation markets

Vibration is a problem that is always with us. From wind and traffic vibrations that can damage large bridges to the nano-perturbations that affect our most sensitive instruments, its consequences can range from mere inconvenience to total system failure. In space, problems with very small vibrations are particularly acute. Weight must be kept to a minimum, and increases in the strength of high performance materials are often not matched in terms of their stiffness. Engineering has evolved lighter but more flexible and vibration

prone structures. Unfortunately, satellite instruments usually focus their attention on small objects at very great distances so that any local disturbances become greatly accentuated. Yet these same instruments must often rely on motors and moving parts that excite the very vibrations that impede performance.

Micromega Dynamics is a spin-off company of the Université Libre de Bruxelles (ULB) and specialises in the area of active vibration control. The Department of Mechanical Engineering and Robotics at ULB was established in October 1987 and, from the beginning, tackled the control of vibration using active systems. Their approach was based on Mechatronics, a science that combines mechanics, electronics and software. Sensors are used to detect unwanted vibrations and, through a control loop, electromechanical actuators are used to cancel them out.

The active damping of a truss structure using piezoelectric actuators was successfully demonstrated as early as 1989 and attracted interest from the European Space Agency. This early success led to several collaborations with European aerospace companies and research laboratories and an in-orbit

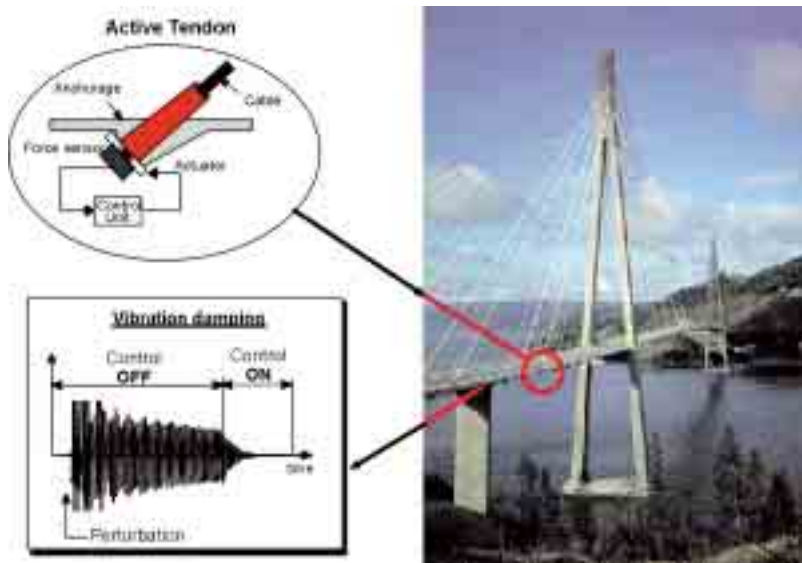

courtesy of Micromega Dynamics

*Active damping technology is helping reduce unwanted vibrations in large structures such as cable-stayed bridges*

active-damping experiment was flown in 1995 (CFIE). From this beginning, Micromega Dynamics was formed in 1999. It has been supported by the Wallonia Space Logistics (WSL) incubator initiative.

WSL is the first incubator in Europe to concentrate on encouraging high-tech start-ups seeking to exploit space technologies. It was set up with an initial investment capital of 7.5MEuro and aims primarily to capitalise on the technological breakthroughs brought about by Wallonia Universities as well as space-sector companies. Science parks and incubators have been making an effective contribution to technology transfer for some time, but WSL signals an important and exciting development for the space industry.

Micromega Dynamics offers services in the design and realization of active solutions for vibration control and micro-positioning. Today's instrumentation and production processes routinely call for amazing precision, often down to optical wavelengths, and it is here that active-damping techniques find wide application. Currently, the company is involved in an ESA-GTSP project that calls for in-orbit testing of a long-stroke, high-resolution optical positioning device. When it is realized that the 'long' stroke referred to is just one millimetre and the 'high' resolution a staggering one millionth of a millimetre, the technical challenge is clear.

At the opposite end of the scale, Micromega is also investigating active-damping technology to control long cable supports such as are used in space station construction and suspension bridges. Cable-stayed bridges already span 750 metres and in future may exceed 1000 metres. These structures are very flexible and, as a result, they are sensitive to wind and traffic-induced vibration. To improve their structural damping, Micromega place an actuator at the end of each cable and this, obeying signals from an associated sensor system, exerts a force which counteracts and cancels incoming vibrations.

Cable structures are increasingly seen in large construction projects, including guyed towers and the roofs of large buildings, and their integrity is widely taken for granted. Active-vibration damping, based on space technology, offers a safe route to sustaining even larger and lighter structures with the same degree of confidence.



# Software solutions from space

*ERS Earth-observation satellite*

Every modern spacecraft carries a number of complex electronic systems to provide the intricate functions of power, guidance, control and communication. At the heart of each of these are dozens of computer chips necessary to carry out the myriad calculations needed each second to enable the craft to do its job.

These on-board systems are matched on the ground by an even larger array of computer-based systems dedicated to keeping each mission safe and on track. All of these systems, in space and on the ground, have one thing in common - they need software to enable them to function, and to communicate with each other.

The need for spacecraft computers to be 'bug free' led to ESA pioneering highly effective techniques for producing and testing software. Now the rest of the world is benefiting

In the early days, this gave space-programme managers a problem. ESA is a multinational organisation and, particularly for larger projects such as the Ariane launcher and the ERS Earth-observation satellites, multinational teams from practically all of the contributing nations were involved in producing individual parts of the spacecraft and ground systems. This meant that packages of software were being produced by varying methodologies and to differing standards, all over Europe, only to be required to seamlessly communicate one with another when the final craft was assembled.

Needless to say, this was very difficult to achieve and, early on, ESA was one of the first organisations to see the need for comprehensive, unified software standards to ensure that systems could be produced to a common model such that, when fitted together, individual software packages would talk together, using common languages and protocols.

Prentice-Hall has sold  
more than 9000 copies of  
the new guides to industry



## Standards for all

ESA's first set of software standards were published in 1984. These identified common development methodologies, languages and test methods and quickly became the 'bible' for space projects throughout Europe. However, it was not until many space companies started to use the standards for their non-space related programmes that the seeds of technology transfer were sown. Space companies had become so convinced of the advantages that many adopted the ESA standards throughout their organisations.

It was through this use of the standards in non-space projects that wider industry got wind of the benefits to be had and, in response to widespread demand, in 1994 ESA commissioned publishers Prentice-Hall to produce generalised versions of its *Software Engineering Standards* and *Software Engineering Guides* to meet the world-wide demand.

Since that time, Prentice-Hall has sold more than 9000 copies of the guides to companies all over Europe as well as in other parts of the world, including the USA and Australia.

## Software requirements management

*If ESA has had a significant influence on software development standards worldwide, it can also claim to have a more profound - if not so direct - influence in the area of 'requirements management'. Even in the early days, space systems were so complex that, when it came to testing the completed article, engineers had difficulty in confirming that it could in fact meet the specifications laid down for it. In*

*the 1980s a team of ESA research engineers started working on a standardised software-based method for linking all of the design, development, manufacture and test phases of a project, providing a through-life audit trail to give ESA managers confidence that project requirements were being met.*

*One of these engineers was Richard Stevens and, when he left ESA in 1992, he started a company called Quality Systems and Software (QSS), since acquired by Telelogic AB of Sweden, which promotes the 'requirements management' concept through a software product called DOORS. The company and its product have been spectacularly successful. Literally hundreds of companies and government organisations worldwide have standardised on the DOORS product. One of the largest multinationals, Motorola, jointly developed a DOORS-based system with QSS to help control and monitor their worldwide technology and R&D operations. As a result, Motorola claims to have made significant cost savings and vastly improved its strategic decision-making process.*

*In the highly important areas of software standardisation and management, ESA has given a significant and influential lead, with untold benefits to high-technology industry throughout Europe and the rest of the world.*





# Smart cameras for finding fault

## High-speed smart vision sensors used on satellites are taking over the tedious task of checking for defects on the factory production line

Quality control is an extremely important part of manufacturing. Yet, it is not usually as easy as to automate as the rest of a production process, and often requires visual judgement, which is slow, expensive and unreliable. Now, however, the need for human intervention in industrial inspection could be reduced as the result of a 'smart' camera developed for accurate satellite positioning.

Communications satellites have to be positioned exactly in relation to the Earth to achieve perfect signal transmission, and this requires onboard equipment that can make very precise measurements (as well as being

compact, light and needing little power). Celsius Tech Electronics of Sweden, together with ESA, found that a 'smart' optical sensing system from Integrated Vision Products (IVP) of Sweden was ideal.

This system keeps the satellite and its antennas accurately positioned by comparing the view of Earth from space with the same pre-programmed image, using prominent landmarks such as the Cape of Good Hope. What is more, the whole electronic system with its sensors, processors and memory is on a single chip no larger than a fingernail!

The exceptional speed and processing power of the IVP system, which can capture more than 4000 images per second, and its flexibility to carry out a range of image-processing directly on the chip, means that it has found many industrial applications.

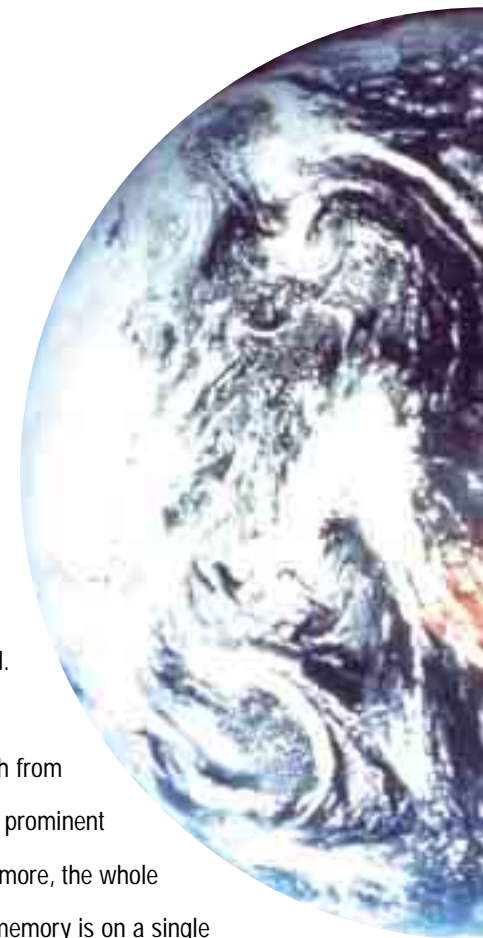



## Seeing in 3D

An important use is in smart cameras, particularly for 3D 'profiling' (which combines smart vision sensors with laser illumination to create a three-dimensional image of an object). This requires a large amount of image processing - particularly for fast, real-time applications - and so the IVP vision chip is ideal.

Currently, a real-time 3D system is being developed for inspecting railway tracks. IVP's system can also be used to make models of the human body for designing orthopaedic appliances or making made-to-measure shoes.

One of the most significant applications is in factory inspection. This may involve highly repetitive tasks that nevertheless require great concentration. Automated inspection systems combining 3D with colour-imaging can detect superficial flaws in products such as compact-disc labels, ceramic tiles and textiles.

*IVP imaging chips (below) enable satellites to position themselves accurately with respect to the Earth. The smart camera system (bottom) can detect defects in food products*

Taking advantage of the speed and unblinking precision of the new IVP system, the Italian technology-transfer company D'Appolonia also proposed using smart cameras on-line to watch the production process itself. A recently completed research and development project has now demonstrated a prototype application automating the inspection of fabrics while still on the loom.

Incorporating smart cameras actually in the production machinery could allow faults to be detected and repaired as they occur - a prospect that promises to improve efficiency in many manufacturing industries.

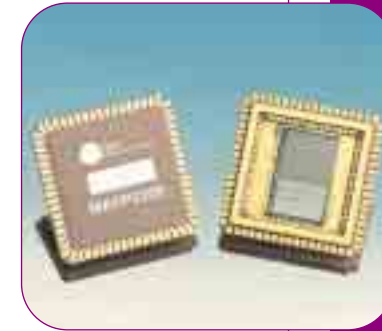

*courtesy of IVP*



A software system to rehearse controlling a spacecraft is now helping the pharmaceutical industry to train its process workers

## Distilling the benefits of space training

For many years, computer simulations have been used in the space industry to prepare operations personnel for the task of controlling spacecraft in orbit. The computer program simulates all the possible manoeuvres and situations in a space mission. In the months before launch, the ground-control staff train with the simulation to react correctly to all normal and emergency situations. During this process, the control procedures and control systems are also tested.

Software simulations allow 'learning by doing' without risk to expensive operational equipment. Training can be repeated as often as necessary. Specific scenarios - even dangerous ones - can be rehearsed by setting the simulator into pre-defined conditions. The result is a highly flexible training tool which is the key to reducing risks during the mission itself.



Until recently, the software, which had to be bought in at great cost, also needed expensive workstations to run on. Now, through a contract with VEGA of Darmstadt in Germany, ESA has developed a new system which runs on a standard desktop PC. Known as SIMSAT-NT, it will make pre-mission simulation exercises cheaper and quicker to develop based on standard PC technologies.



## Benefits to industry

This year, VEGA has started to work with one of Europe's leading pharmaceutical companies, Merck KGaA of Darmstadt, on a pilot project to see whether this sort of simulation training could be used in teaching apprentices to operate distillation equipment. Distillation is a major process in the chemical industry, and the pilot system has the potential to be used more widely, for training process operators in the heavy chemicals sector as well as in speciality chemicals like pharmaceuticals. The training is highly interactive. Live schematics and 3D graphic representations of the chemical process help students to understand its operation, and to practise procedures for monitoring and controlling the various process steps.

The project is scheduled to finish in September, but Merck is already seeing benefits in that the simulations are encouraging instructors to consider new ideas for training.







ESA engineering offers 3D computer simulation techniques to industry

# Computer graphics explore new worlds

Over the past 20 years, computer graphic animation has become an important scientific tool, representing the streams of data in a visual manner and providing insights not available in any other way. Computer-drawn models, often in three dimensions, can be used to simulate the changes in a complex system such as the development of a tropical storm or a rocket being launched.

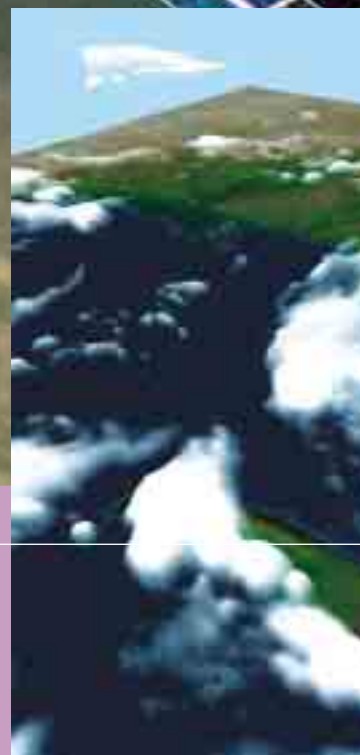

courtesy of Silicon Worlds

*3D visualisation and simulation programs such as those produced by Silicon Worlds can help enormously in planning and training*



For 10 years, Frank Bagiana worked in ESA's ESTEC establishment in the Netherlands, researching the software for such 3D visualisation and simulation. His aim was to develop computer tools that could support astronaut training, provide video links to remote locations and simulate future satellite missions. For example, ESA engineers employed the software to visualise, in real time, the deployment of the antennas and solar panels of the ERS-2 satellite after launch.

The same software was also used to animate the motion of Hurricane Andrew over a period of four days in 1994, using infrared and water-vapour data received from ESA's Meteosat meteorological satellites. The animated

sequence provided meteorologists with a unique view of how hurricanes form and behave.

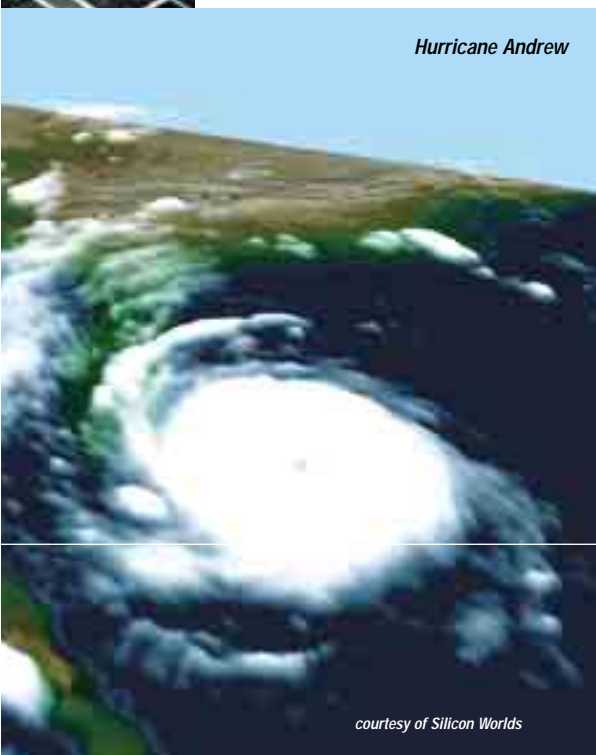

*Hurricane Andrew*

*courtesy of Silicon Worlds*

## Going commercial

In 1996, with the backing of ESA, Bagiana decided to offer his expertise to European industry and established a

spin-off company in Paris called 'Silicon Worlds'. The aim was to apply expertise in virtual reality and other visualisation techniques across a whole spectrum of markets from automobiles to the media.

Four years on, the business has expanded and diversified. Silicon Worlds has built up extensive experience in working with ESA and EADS (the European aerospace manufacturer, formerly Aerospatiale). As well as modelling the complete International Space Station, Silicon Worlds has developed a system capable of representing flights of the ESA launcher, Ariane-5, in 3D and in real time. Visual images are linked to the ArianeSpace dynamic simulator, which allows engineers to follow complete flights from lift-off to payload separation. The simulation, which includes the trajectory around the Earth and a close-up view of the vehicle itself, was used to create a visual representation of the ill-fated maiden flight of Ariane-501.

Recently, Silicon Worlds joined with French and German partners in an EU ESPRIT project to create a commercial PC-based tool for the broader industrial market. The company's role was to develop and commercialise the 3D visualisation element of the simulator. Silicon Worlds is now developing 3D internet technologies aimed at e-commerce and e-learning applications.



# A concrete solution to unwanted vibration

A technology developed to protect satellites and space structures from vibrations during launch is making life a little bit quieter on building sites

Have you ever stopped to wonder why concrete mixers are so noisy? They might make life easier for bricklayers, but the sound they make is unpleasant and potentially damaging. In fact, mechanical shocks occurring in the mixers due to the rough contact between the gears and the driving crown cause the tank to vibrate and act like a bell. Edil Lame, an Italian manufacturer of



concrete mixers, has for some time been investigating possible technical solutions to decrease the noise. Unfortunately, these approaches have not proven to be reliable, mainly because of the poor conditions in which the systems have to operate (dust, water, weight of the mixed materials, and so on).

## A damping device

D'Appolonia, the Italian representative of the Spacelink Group, found the answer in space technology. The French company Artec Aerospace had developed the SPADD (Smart PASSive Damping Device) to protect satellites and space structures from vibrations during launch. Artec had already seen the potential for adapting the technology for damping systems needed in a range of other applications, including electronic circuit boards and tennis racquets.



*Artec's SPADD devices decrease the noise generated by concrete mixers*



D'Appolonia made the introduction and, based on the successful results of a feasibility study supported by the ESA Technology Transfer Programme, a contract has now been signed between Artec and Edil Lame for the manufacture and marketing of the first batch of 1000 SPADD devices. Edil Lame expects to introduce the SPADD device into between 3000 and 5000 mixers a year.



courtesy of Artec Aerospace





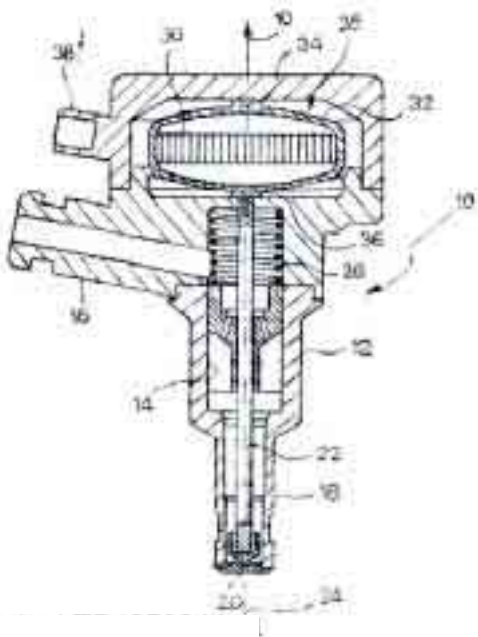

# Space technology starts a better motor

The device is an actuator (for implementing fine movements) developed by Cedrat Recherche, a spin-off company from the Polytechnic Institute of Grenoble, and is based on the piezoelectric effect. This is a well-established phenomenon whereby a small voltage passing across a crystal such as quartz causes it to change shape (or vice versa - pressure on the crystal induces a voltage). The distances moved are small but the forces produced are large. The effect is exploited in many electromechanical devices such as quartz clocks and microphones, and is ideal for controlling movements fast and accurately and with little power.

Cedrat had already developed piezo actuators for the French Space Agency CNES, for the micro-positioning and vibration damping of satellite optical

An original drawing above, a CAD image and an actual photograph of the novel actuator device from Cedrat, right and far right

## A novel device used to control spacecraft will help build the next generation of greener, more efficient cars

When the Rosetta space probe, one of ESA's main 'Cornerstone' missions, is launched in 2003 to study comet Wirtanen, it will use a clever piece of technology soon to benefit engineering nearer home.

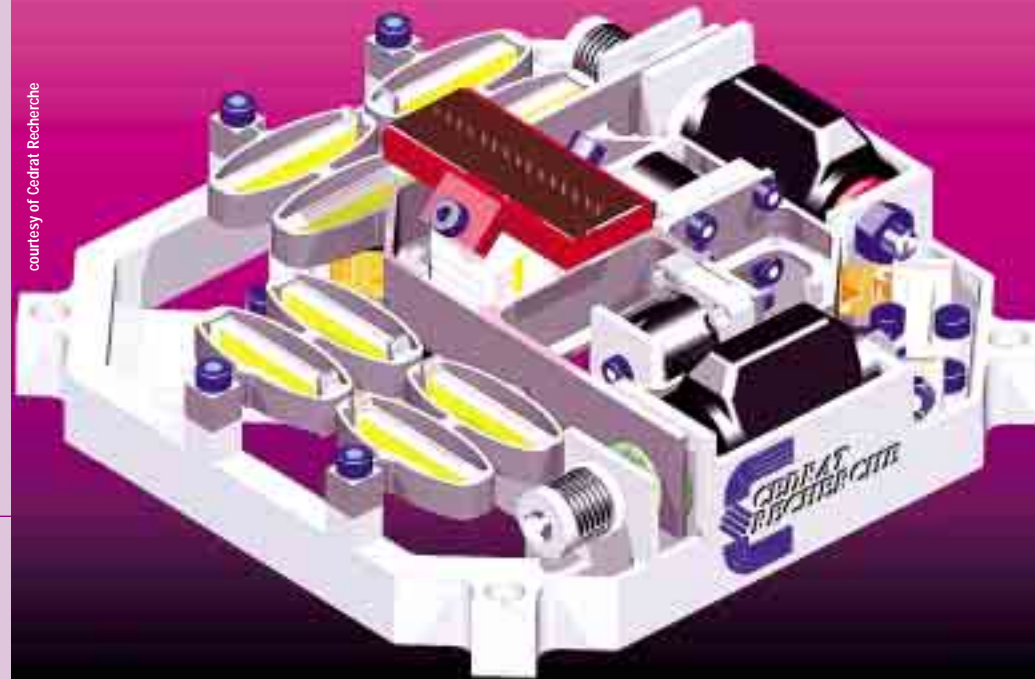

systems. Further applications followed, including optical shutters, piezoelectrically-controlled valves and non-magnetic rotating motors for sensitive instrumentation. The devices developed for the Rosetta probe were delivered to ESA in 2000.

Cedrat's actuators employ a clever combination of synthetic piezoelectric materials and mechanical engineering to give a much greater range of movement than previous piezo devices. So it is not surprising that these amplified piezo actuators have found many non-space uses, for example in instrumentation such as microscopes, camera shutters and hospital MRI scanners (where extraneous magnetic fields must be avoided).



courtesy of Cedrat Recherche

## From comets to cars

The technology is increasingly penetrating more established fields of engineering. The coming generation of car engines already face enormous demands in terms of efficiency, power output and low emissions. They will need to respond rapidly to changes in driving conditions, constantly optimising engine performance. Microchips are already able to supply the real-time electronic commands needed for adaptive engine management, and new actuators are needed to translate these into the mechanical language of the engine. Much attention has been given to the improvement of fuel-injection systems, where the electrical control of individual injectors can significantly affect engine performance. Amplified piezo actuators with their combination of very fast response times, low-voltage operation, high operating forces and precise control offer one very promising approach to the automotive injector of the future. With this in mind, an automotive injector designed by Cedrat Recherche and Fiat, and based on the amplified piezo actuator, has recently been patented.

# A little light cleaning

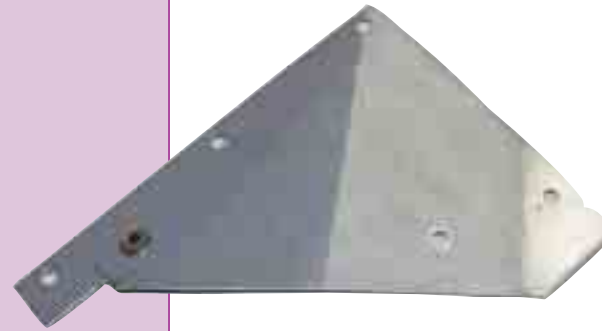

courtesy of Lasea



## Laser cleaning developed to keep space instruments pristine is doing the same for industrial equipment

Space engineers face many unusual problems, and cleaning optical surfaces in satellite instrumentation, far away from human access, is a typical example. The fragility of the optics and the problems of using volatile solvents that are apt to boil off into the vacuum of space make conventional cleaning methods on board a satellite impractical.

To tackle this problem, studies at the Centre Spatial de Liège (CSL) followed quite a different path and explored the use of laser light for surface cleaning. Scientists found that there were three ways by which light from a pulsed

*These images show the effects of using the laser cleaning process on a component from an F16 aircraft (left) and on tyre production moulds (right)*

laser could remove pollutants from surfaces. The first uses an intense pulse of laser energy to heat unwanted dirt particles very rapidly, causing explosive evaporation which drives them clear of the surface; a second process involves pulses of laser energy exciting shock waves in the surface, which literally shake the dirt clear; and a third method uses laser energy to break the pollutant's chemical bonds, enhancing its volatility so that it evaporates.

Careful control of the laser ensures that little energy is absorbed by the underlying surface so no damage occurs. Properly applied, laser cleaning has the advantages of needing no chemicals or abrasive action and working well in the vacuum of space.

As a result of their studies, in 1996 the CSL team were able to design software capable of modelling the laser and its interaction with various substrate materials, opening the way for a wide range of new applications, including the development of robot laser cleaners designed to maintain satellite optics in flight.

### From cleaning moulds to paint stripping

The potential of laser surface cleaning for industrial applications soon became evident and in 1999 a small company, LASEA (Laser Engineering Applications SA), was formed specialising in the laser removal of coatings from a wide range of materials. Early applications have included the rapid cleaning of complex production moulds for glass and tyres, avoiding damage and saving as much as eight hours in equipment down times. In collaboration with the Belgian Air Force, LASEA developed a process to enable the local stripping of different paint coatings on F-16 and C-130 aircraft to give inspection access for preventive maintenance.

LASEA now markets a range of laser cleaning equipment and is developing laser robot cleaners. Recent applications include using lasers in aeroplane manufacture for the surface treatment of materials before welding. LASEA recently began specialising in the field of ablation of coatings by laser on different substrates such as glass, metal and plastic.

The ability to direct the laser, combined with the fact that it does not damage the substrate and the absence of chemical products, allows the creation of high-precision designs for decoration and for more technical applications. In this field, LASEA has developed and patented two automated machines for the glass sector and the medical sector.



courtesy of Lockheed Martin



# Well positioned for space

Testing and calibration tools developed for space robots have set a world-wide standard for industry

Robots, just like people, live in an imperfect world. The idea that a robot, working alone in space, might be programmed with perfect knowledge of its environment within which it will then carry out tasks with perfect accuracy is an impossible ideal. Errors and variations will always exist in the robot and its world, which will affect both its precision and performance.

The traditional solution of human intervention through tele-manipulation is not always an option. As a result, ESA contracted the Belgian company, Krypton Electronic Engineering, to study ways of making robot control more precise.



The aim was to support an in-orbit demonstration of ESA's Autonomous Interactivity Concept - a way of improving the competence of pre-programmed robots - and this required an accurate picture of the performances and responses of robotic manipulators under real-world operating conditions.

It was rapidly discovered that few commercial tools were available for robot calibration. Existing performance data, where available at all, was inadequate.

*Production lines that employ robots, such as those used in automobile manufacture, are a promising target market for the Rodym system*

As a result, measurement systems and procedures all had to be developed which would identify the differences between perfect robots in a computer-generated world and real robots working on the shop floor. Once these errors were known and compensated, it would be possible to be confident that robotic tasks planned on Earth would be faithfully performed in space. The system that evolved, Rodym, ensures that a robot consistently reaches its correct position during each of its programmed actions. To achieve this, a mathematical model is used to generate adjustments, compensating for the inevitable errors between the robot's actual and programmed positions. The position data needed for these calculations must be very precise indeed and, once again, no commercial measurement solutions were available.

Rodym employs a multiple camera system that is capable of measuring accurately the position and orientation of up to 256 infrared emitting diodes, which are attached to and move with, the robot. Once these are exactly located in relation to the operating environment, error corrections can readily be made. Using a similar camera / LED system, it is also possible to evaluate and correct the positioning of any tool that the robot is using.



courtesy of Krypton Electronic Engineering

## On the Shop Floor

Today, Krypton has become market leader in the field of industrial robot calibration and testing. The methods and tools first developed for space applications have become mature and most constructors of industrial robots now own at least one Krypton measurement system. Robots that have been calibrated with Rodym positioning and compensation are capable of more accurate performances, leading to better quality, higher outputs and less down time - an advantage not lost on BMW who have decided to make Rodym a standard feature of their production systems.



courtesy of Krypton Electronic Engineering

# Look, no wires!

The need for wireless equipment in manned spacecraft is helping to drive the development of truly mobile technology on Earth

courtesy of Parthus Technologies

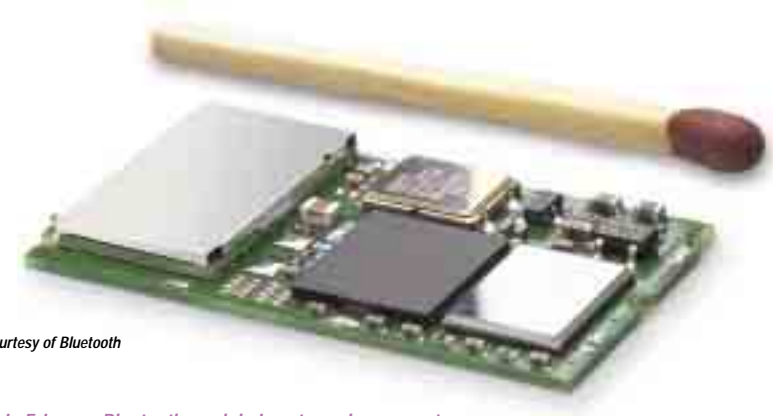

courtesy of Bluetooth

*This Ericsson Bluetooth module is extremely compact*

The mobile phone has revolutionised personal communications. Wireless, handheld devices can combine many different features including a connection to the Internet and text messaging (as anyone who has children knows!). Now the frontiers of wireless technology are expanding even further with a new wireless communications standard called Bluetooth™, named after Harald Bluetooth, a medieval Scandinavian king. Bluetooth has been developed by a consortium of leading electronics companies - the Bluetooth Special Interest Group (SIG) - which includes 3Com, Ericsson, IBM, Intel, Lucent, Microsoft, Motorola, Nokia and Toshiba.

In practice, Bluetooth is a tiny microchip which incorporates a radio transceiver that is built into a variety of digital devices such as mobile phones, personal digital assistants, printers, fax machines, PC's, laptops, digital cameras, stereos and headsets, allowing them to be connected together without wires or cables.



Today, Bluetooth is being designed into mobile phones and MP3 players, and headsets, allowing the user to listen to phone calls or music through a headset with no visible connection between the two devices. In the next few years Bluetooth will be built into hundreds of millions of electronic devices worldwide.

ESA quickly recognised the unique value of Bluetooth for space exploration - where wireless connections between spacecraft equipment and astronauts are the ideal solution. ESA sponsored Parthus Technologies, an Irish company, to develop a wireless technology based on Bluetooth that could easily be embedded into a variety of spacecraft equipment. Parthus is a world leader in the design and development of the integrated circuits and software that underpin mobile devices.



courtesy of Bluetooth

*The Ericsson Bluetooth Development Kit*



## The BlueStream chip design

The result was BlueStream, a chip design that can be used as a basis for a wide range of wireless applications not just for spacecraft operations but also for computing and global positioning systems. Parthus' approach of integrating BlueStream with other complementary technologies also helps to overcome one of the main challenges of wireless technology, power consumption.

Today, Parthus' BlueStream chip design is the most widely licensed Bluetooth technology in the wireless industry, with four of the top 10 wireless semiconductor companies integrating it into their products. Some of the announced licensees include 3Com, Agilent and Hitachi, the world's largest supplier of mobile phone chip sets. Parthus now employs over 400 people worldwide and BlueStream accounts for 35 percent of its revenues.



# Space robots go where others fear to tread

Technology developed to cope with the demands of space applications is making light work of dangerous and difficult jobs on Earth

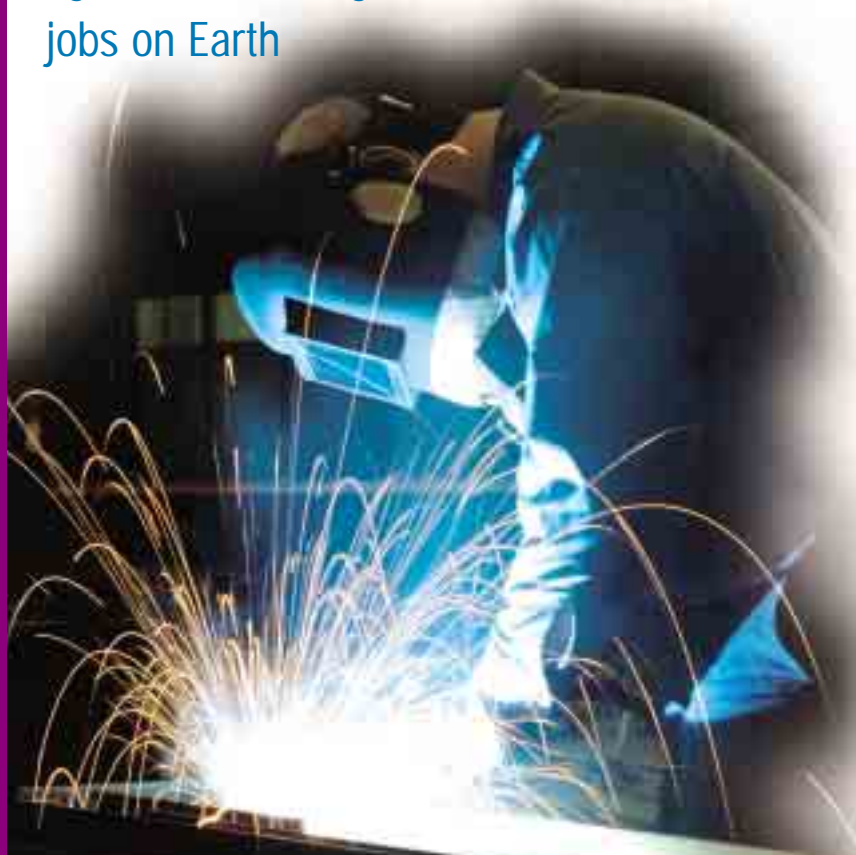

Robots may only be inhuman mechanical devices, but they might also be considered our friends as they cope with the jobs we either can't - or simply prefer not - to do. Some of the best performing robots have been developed for jobs in space such as the construction and maintenance of structures like the International Space Station. As well as having to be reliable, autonomous and flexible, space robots also tend to be lighter and stronger than their Earthly counterparts, mainly because getting equipment into space is itself an incredibly costly exercise. They have been designed to cope with risky operations often carried out in harsh and dangerous environments.

But space is not the only place where harsh conditions exist. Many manufacturing operations, particularly in traditional 'heavy' industries, are very hazardous and uncomfortable for human operators, and this is where robot technology can excel. Recognising this, Meganic ApS, a company based in Denmark, has developed a range of long-reach manipulators for use with robotic systems in applications such as welding, painting and sand-blasting.



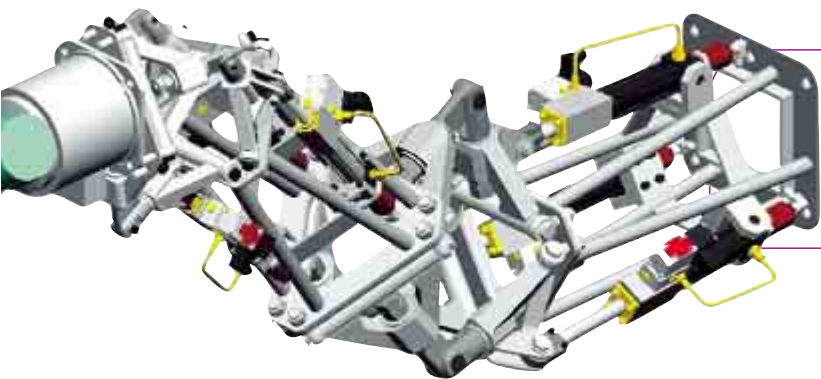

*One of Meganic's robotic manipulator arms*

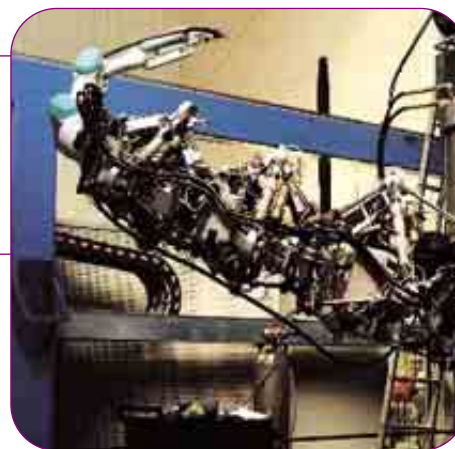

courtesy of Meganics

The manipulators have some unique features, such as a hollow structure which allows space for internal piping. Some of the first systems are being employed by the Odense Steel Shipyard, enabling operations to be performed in remote areas of the ship where the confined conditions would be intolerable for humans. Because they are based on space technology, Meganic's robots are particularly well placed to be able to perform a variety of complex operations in extremely harsh conditions.

The partners behind Meganic have a long history in developing robot technology. In the mid 1990s Odense Steel Shipyard, Amrose A/S and Odense University undertook a project to develop methods for flexible robotic welding of confined steel structures. They then saw the need for developing a long-reach redundant manipulator able to horizontally access confined steel structures and perform welding. Their first approach was inspired by research in North America being performed by NASA, Virginia Tech. and Dynacon (Canada). These parties had developed the Variable Geometry Truss (VGT)

technology for long-reach and high payload operations, but the technology needed further development.

The problems of the early prototypes were overcome by changing the basic geometry of the robot to a Double Tripod formation. By arranging the actuators as a truss structure, a high stiffness was maintained and the new manipulator was invented, together with a new company, Meganic ApS, to exploit it. The potential sales for parallel manipulators have been estimated at around 30 000 units a year, and Meganic is well on its way to capturing a fair share of this market.

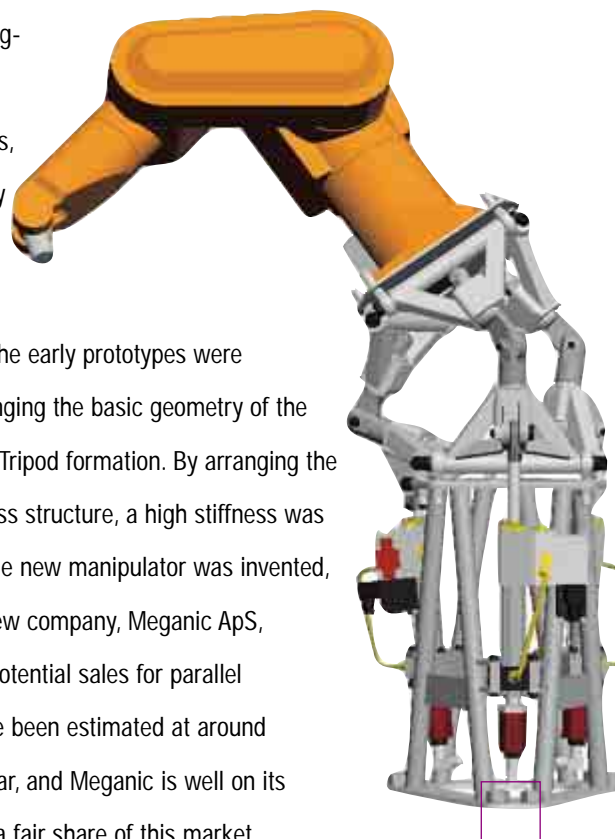

# Sensing the heart of unwanted vibrations

## Tiny sensors from space are helping to warn of potentially catastrophic equipment failure

When car parts or washing machines vibrate, we normally treat them as little more than annoying inconveniences. Vibration in industrial machinery, however, is much more serious. It may indicate expensive and potentially dangerous failures of vital pieces of equipment.

The German company Ops Automation based in Troisdorf recognised the need for a vibration detector that was robust and inexpensive and could be applied to a wide range of industrial machinery. At the Hanover Fair in 1998 the company noticed the tiny sensors exhibited by another Germany company Mirow. These had been developed for the aerospace industry and were based on piezofilm technology. Piezofilms are transparent plastic films which develop an electrical charge when a mechanical stress is applied. The effect depends

on direction, so piezofilm sensors are excellent at detecting pressure fluctuations, vibrations or force changes.

The sensors were extremely sensitive and reacted quickly. They had been employed by Mirow and the Technical University of Berlin to sense, for example, pressure changes which indicate what happens to spacecraft, such as ESA's Hermes, as they pass through the Earth's atmosphere.

Ops Automation realised that piezofilm sensors had potential as industrial vibration detectors, but that further development was needed to produce a marketable product - a cheap, strong device that could be mass-produced. The work was carried out by Ops Automation with support from ESA. The project culminated in 2000 with the patent application on the design.

## What's in a noise?

In parallel with the design of the sensor, the company also developed an intelligent signal-processing unit which could analyse the frequencies of the characteristic vibration that a machine makes. If any defects occur (such as machine bearings breaking up) the noise changes, and this can then be monitored. It is the combination of the vibration detector and the noise-analysis unit that gives operators advance warning of impending machine failure. Called VIBROSYS, the system is now being used in a variety of applications, such as monitoring the huge numbers of pumps employed in the petro-chemical industry, and in many other machines used by various processing companies.

The business has really taken off. After securing 860kEuro of venture capital, Ops Automation transformed itself into a public company. As well as creating at least 20 new jobs, the company is expected to have a turnover of around 20 MEuro by 2005.



*courtesy of Ops Automation*



# Gearing up to better motors

Mathematics describing the spin of a coin has led to a novel type of gearbox

*The nutation gearbox design could replace many of the small electric motors we use everyday*



*courtesy of Stam*

Nutation, from the latin word to nod, usually describes the circular movements of a growing shoot or the wavy path followed by the Earth's axis as it travels around the Sun. It is also the motion of a coin, spinning like a top, as it slows and falls. Careful observation shows that as the coin slows, it describes a circle on the table top. Interestingly, its diameter is smaller than the diameter of the coin itself. This means that, for each nutation of the coin, the circumference of the circle traced on the table top is less than the circumference of the coin and the coin must therefore rotate. Even closer observation reveals that, although the point of contact between the coin and the table moves very quickly, the coin itself rotates quite slowly. The

visible effect is that of an apparent gearing between the two motions. This is not an illusion, but a real and useful effect which can be accurately described mathematically.

Many everyday appliances rely upon small electric motors to operate - video recorders, car window winders and seat adjusters, tape drives and CD players all have them. Often



*A cutaway graphic showing the novel gear arrangement*

the required shaft speed of the motor is quite low but, to provide significant power, small machines work best at high speeds. To reduce the speed of rotation and so gain an increase in output torque, or twisting power, a gearbox is needed - just as in a car.

If the difference between the speed of the motor and its load is great, conventional gears may need several stages of speed reduction. This leads to power loss, noise and expense. Unfortunately, large increases in output torque also cause large forces on the teeth of conventional gears, so larger teeth and better materials are needed.

## Nutating gears

Drawing upon the gearing effects of nutation, an Italian space company Stam srl has created a new form of gearbox that overcomes these disadvantages. The device called SPACEGEAR was developed for use in satellites and uses an arrangement in which one bevel gear 'nutates' with another instead of rotating. The gear ratio is determined by the difference in the number of teeth of the fixed and moving gears and not, as with conventional gears, on the

ratio of their circumferences. By applying the principle of nutation twice, very high reduction ratios of up to 3000 can be achieved. The design, which combines two pairs of gears, makes any ratio possible with the same simple configuration. Because the design ensures that at least two teeth are in contact at any one time, loadings are reduced and materials of lower strength may be used.

The SPACEGEAR is particularly suited to electrically-driven automotive components where high reduction ratios are required but space is at a premium. Using nutator technology, smaller, faster electric motors can provide the same level of mechanical power as their conventional counterparts. At present, such mechanisms and their electric motors typically cost from 200 Euros for a small car to 2000 Euros for a luxury car. The European automotive industry produces about 15 million cars per year, offering a potential market of 4.5 billion Euros. Stam is exploring materials for mass manufacture - both metal or plastic - and is developing a computer program for designing nutating-gear systems.

# An eye for colour



Textile manufacturers can look forward to a more reliable method of checking fabric colours using Earth-observation technology

## A spectrographic system

Ideally textile manufacturers would prefer to rely on an automatic system to control colour. Here technology originally developed for Earth observation came to the rescue. This was a spectrographic system employed to assess remotely how much agrochemical was being used by farmers, with the aim of increasing efficiency of application and preventing ecological damage.

The system was also used to evaluate the spread of weeds in crops.

By combining a spectrograph from the Finnish company Specim with a colour camera, the University of Insubria in Como, Italy - in cooperation with the Italian engineering company D'Appolonia and a group of local companies - created a prototype optical system that could compare fabric colours accurately. It works by viewing a line across the material and measuring the spectrum of each element along it. In this way the entire fabric can be scanned as it moves across the line.

The eye is an amazing device. It can recognise more than 30 000 different colours and can colour-match the subtlest of shades. Skilled colour matchers are traditionally employed in many manufacturing industries to check that coloured fabric or paper, for example, have a consistent hue. However, there are limitations to human assessment - two fabric samples may look the same under artificial light but quite different in daylight, textured surfaces viewed from different angles can also look different, and colour perception can vary from individual to individual.

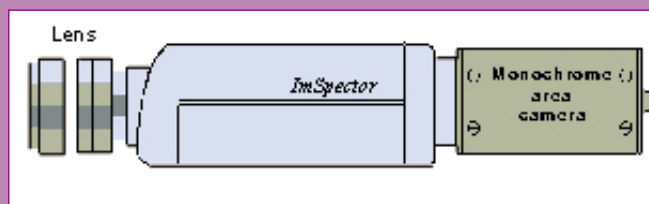

*The core components of the novel optical system*



courtesy of Specim



The system has the potential to provide significantly better colour resolution than a conventional camera and can even match the performance of the human eye. Since it is the fabric that moves, complicated scanning mechanics are not needed and measurement times are reduced.

In December 2000, the prototype system was presented to a group of textile manufacturers in Como for evaluation and further research. The event was organised by the Italian Textile and Silk Associations. If successful, the system will help manufacturers to cut costs and improve their competitiveness in world markets.





# A material solution to surviving the heat

A new lightweight alloy developed to help spacecraft cope with extremes of temperature is exciting the interest of aircraft and car manufacturers



courtesy of Airbus Industrie

Rocket engines generate a tremendous amount of heat during the launch of a spacecraft. When in space, spacecraft have to cope with being baked by the Sun and frozen when in the Earth's shadow. On returning to Earth, they have to withstand the very high temperatures generated during re-entry. This extreme thermal environment requires some advanced materials to ensure not only that the spacecraft survives, but also that its payload - be it astronauts or instruments - is undamaged.

## A versatile alloy

An Austrian company, Plansee AG, has developed a novel alloy called gamma-titanium aluminide for exactly this application. The product, which goes under the brand-name Gamma-Met 100, is intended to replace the heavier, more expensive and difficult-to-manufacture super-alloys and ceramics currently used on spacecraft. The material can withstand temperatures up to an incredible 900°C. Gamma-Met 100 is unique in that it is suitable for use on both the spacecraft airframe and its rocket



*Spacecraft have to withstand incredible temperatures on take-off and re-entry*

system, which previously required different types of materials. In addition, the new alloy can be used in both very small (of the order of millimetres in length) and very large (of the order of metres) components - again something not previously possible using the same material.

Plansee pioneered the manufacturing process for this material and devised several innovations to enable it to be produced in large sheets. This is important because the material can then be fabricated in many different ways for various applications.

Gamma-Met is currently being considered for use on board various European rockets. Test pieces of the material will be flown on NASA's next generation reusable launch vehicle, the successor to the Space Shuttle. The material has generated considerable interest amongst aircraft and aero-engine manufacturers, and is under evaluation for use in the improved powerplants of next-generation aircraft such as Airbus Industrie's new double 'decker Jumbo' airliner, the A380. The material is also being looked at by several European car-makers.





*Composite plastics are used  
to make the ablative heat  
shields on spacecraft*

# Plastics lead the way

Innovative materials have often provided the solution to the problems and challenges encountered in space missions. Now the same technologies are helping meet the challenges we face on Earth

In order to improve products and exploit new markets, all industry sectors are constantly looking for materials which are more resource-efficient, stronger, lighter, more flexible, more easily produced - the list of demands is endless. Because of the challenges inherent in its missions, space has often been the environment from which some of the most innovative materials have emerged. Of all materials, plastics are undoubtedly some of the most important - and the most fascinating.



*Foam insulation and metalised polymer blankets developed for space are now being used in terrestrial applications*

Many of the plastics applications that we take for granted actually originated as a result of space requirements. For example, the special polymer-based textile that was created to protect cables and components from the heat generated by Ariane's rocket motor has been developed for flame-resistant covers for auditorium seating and as vandal-proof protective sheeting used on road-haulage trucks. The polymeric sensors used to detect gases and volatile chemicals on board space vehicles are now being employed as 'artificial noses' able to help with the early identification of disease and decay. Each of these cases, and others, are featured elsewhere in this book.

Such examples are impressive, but our world is currently facing a number of fundamental problems. As the world's population grows, so do the demands placed on the environment. Research commissioned in 1999 by APME (the Association of Plastics Manufacturers in Europe) and ESA concluded that by the year 2050, mankind will be faced with three major challenges to its future development and survival:

- Scarcity of, and demand for, fresh water.
- Demand for energy resources but recognising its effect on our climate.
- The need for sustainable, affordable housing for a growing world population.

Because of their unique combination of qualities, it is natural that scientists and engineers look to plastics to provide solutions to such challenges, and the technologies that have been developed for use in space appear to be some of the most promising. For example, the advanced plastics-based water purification systems used on the International Space Station (ISS) are being developed with the intention of ultimately delivering fresh water to millions of people where there are water shortages around the world. In a similar venture, giant seafaring bubbles and plastics-based pipelines which use technology and techniques developed for space, may provide a solution to the challenge of global water distribution. With regard to energy resources, the photovoltaic cells designed to meet the enormous power requirements of modern spacecraft may help us to find a long-term alternative to fossil fuels. Solar power and fuel-cell technologies that rely heavily on plastics also feature elsewhere in this book.

In perhaps one of the most interesting examples, the multi-layer construction of astronauts' space suits may provide a radical solution to the challenge of designing energy-efficient, low-cost sustainable housing. The complex,

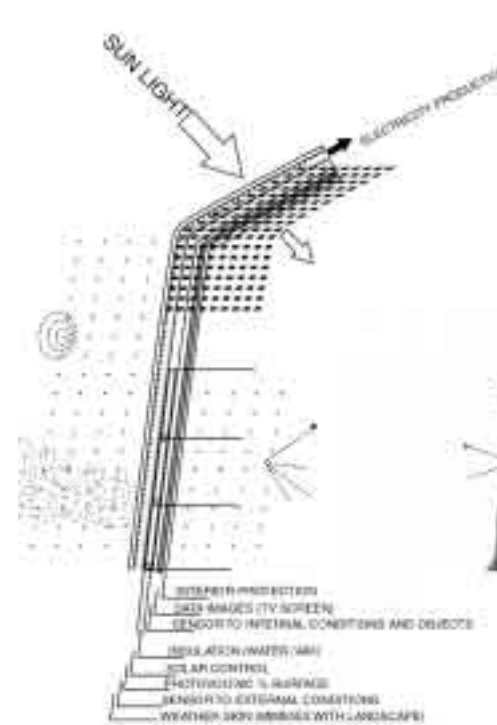

*The energy efficiency of astronauts' space suits is providing the inspiration behind some of the leading innovations in housing design*

plastics-fibre-based suits that astronauts wear in space are actually a microcosm of many of the functions of a house – protecting, reflecting heat while retaining the amount necessary, repelling cold and transferring moisture away from the body. More than ten types of polymers are used in space-suit construction. Architects are now considering how plastics layer design could be applied to conventional housing, but perhaps the most intriguing development will be seen in the “house of the future” which provides energy for use by the house, in the house. Space technology cannot, of course, provide all the answers, but the versatile nature of plastics could allow this concept to become reality.



# Lifestyles

*Our quality of life and leisure time are becoming even more important to us as we face increasing demands at work. Space technology is helping us enjoy our lives just that little bit more*





*Space technology gave us freeze-dried food and 'space ice-cream' - and now can make a better crisp! It is also helping us to improve our performances in sports and other pastimes*

# Getting closer to that hole-in-one

## Technology designed to give a space probe a spin may help golfers sink that putt every time

Golf is a pastime enjoyed by millions, but many players find putting to be the most frustrating and unpredictable aspect of their game. The ball just seems to miss the hole for no reason at all. Certainly, that magical hole-in-one is likely to remain a dream for most of us.

Trying to land a probe from a spacecraft on a planet or some other body in space is also a tricky exercise. The probes are usually unguided, and the mechanisms that eject them from the spacecraft must be able to perform in a precise and predictable way. To ensure stability, the probes are given, in addition to the linear momentum of ejection, a spinning motion. Much the

same principle is employed when a bullet leaves the barrel of a pistol or rifle. So, it might follow that if a golf ball can be endowed with a spin as it leaves the face of the putter, the chances of holing the shot should be increased.

### Spin and eject

This is the approach that the Norwegian-based companies Prototech and Saab Ericsson Space took when they developed a 'Spin-and-Eject Device' (SED) mechanism for ESA. During the development, the R&D team used advanced computer tools for simulating motion to model the ejection phase of releasing space probes, and to investigate the effects of surface irregularities. Extensive testing using high-speed cameras verified the performance of the SED technique.



*ESA's Huygens Probe is attached to the Orbiter propulsion module via the Spin-and-Eject Device below the high Gain Antenna*

In addition to developing and manufacturing equipment for space applications, Prototech prides itself in converting bright ideas into commercial products. The company soon realised that the SED technology could be usefully applied to designing new sports equipment. Furthermore, the simulation techniques developed would be invaluable in investigating the practicality of new designs.

Being keen golfers, the Prototech team turned its attention to this sport first, and used the motion-simulation tools to design a club with an optimised spin and eject phase that caused the ball to start spinning immediately after it was struck. Currently, selected golfers are testing the novel putter design on the greens, and a new company, Clyve AS, has been set up to commercialise the golf club. It remains to be seen whether it will be accepted by the sport's authorities, but in the meantime there are at least a few Norwegian golfers who appear to have developed a unique competitive advantage!





# Keeping fit with a yoyo

## A novel exerciser developed for astronauts is now coming to the aid of athletes and stroke victims

Keeping fit in the weightless environment of space requires special kinds of exercise programmes and equipment. After all, what use are exercise weights if they just float around of their own accord? In space, everyone can manoeuvre objects they would not have a chance of lifting on Earth, but the down side of this is that the body does not get the exercise it needs to keep in top condition. Being in space is an extremely demanding activity, and a huge amount of attention is paid to astronauts' well-being and fitness. As missions get longer and longer this becomes even more important, and engineers and doctors are working together to design equipment and exercise programmes suited to the specific needs of space travel and weightlessness.

YoYo Technology based in Stockholm, Sweden has developed a machine designed to meet these unusual requirements. With support from the Karolinska Institute, the Swedish Space Corporation and the Swedish National Space Board, YoYo has developed equipment that uses the inertia of flywheels to provide resistance. The Fly-Wheel Resistance Exerciser (FWRE) differs from the normal equipment found in gyms because it provides 'two-way' resistance. The user is required to pull the cord from a flywheel. At the full stroke the flywheel begins to wind the cord back in. The user has then to resist this by pulling back on the cord. In effect, this is the same principle as that behind the yoyo - a children's toy which has certainly stood the test of time.



*One of YoYo Technology's flywheel-based exercisers*



YoYo Technology



## A flywheel with impact

The advantage of this system is that the load can be easily varied by changing the flywheel or altering its diameter. Users can also determine the amount of 'impact' in their training. Unusually, astronauts in space are encouraged to do high-impact exercise as it maximises body strength while also minimising bone loss.

Having successfully designed equipment to meet the needs of the space industry, YoYo Technology is now turning its attention to terrestrial applications such as sports training and medical rehabilitation. The equipment is being used by the Swedish Olympic athletics team. It is also being employed in orthopaedics to aid the recovery of stroke patients, and is proving particularly useful in re-establishing nerve connections in damaged muscles. A variant of the equipment is also being developed for use in home gyms, a market that is worth many millions of Euros worldwide.

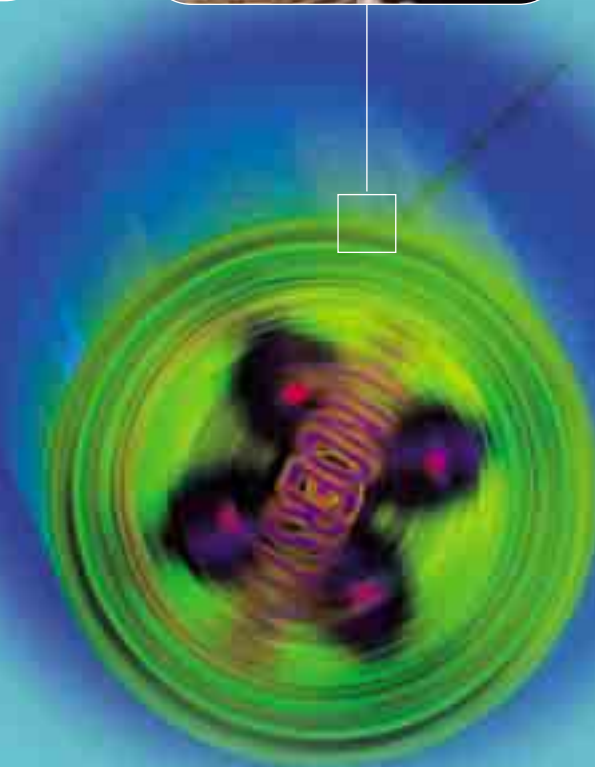

# Machines with sensitive feelings

Musicians are some of the first people to benefit from a novel technology that gives space robots a sense of touch

courtesy of Tactex Controls

Robots are no longer the insensitive mechanical devices we generally take them to be. Now they can see, hear and even feel their surroundings, reacting to their environment, and adapting their behaviours as needed.

To help in the construction and maintenance of the International Space Station, the Canadian Space Agency has been coordinating the development of the 'Special Purpose Dexterous Manipulator' (SPDM). This is a two-handed robot which is essentially an extension of the astronauts' own limbs. Until recently, these augmented limbs lacked one critical feature - a sense of touch. Without a sense of touch, machines can easily accidentally knock other objects. In space, obviously, this can have drastic consequences. Although automated vision systems have been under intensive development for several years, tactile sensing technologies are rare and relatively primitive.



courtesy of Campolar East

*A touch pad for musicians (above) and a prototype sensor for use in cars (left) are two of the first items to exploit the KINOTEX technology*





Recognising this challenge, Canadian company Canpolar East developed KINOTEX. This is a novel sensor that emulates human touch and can be applied like a skin or sleeve to cover entire robotic

limbs. Described as a 'deformable integrating cavity', the sensor consists of a sheet or block of polymer foam with an opto-electronic transducer embedded in it. When the foam is deformed, its optical properties are altered, generating a proportional signal in the transducer. Normally arranged in arrays, these sensors can detect and interpret contacts at many points over the surface of the machine. Because they use light to detect change, KINOTEX sensors can be very small and are immune to interference from sources such as electromagnetic radiation. They are also very responsive, sensing minute amounts of pressure and reacting extremely quickly to change.

### A musical touch pad

Canpolar East is aware that KINOTEX could have many commercial uses and is adapting the technology in partnership with a number of other organisations. One of the first companies to market an application is Tactex Controls. Their KINOTEX touch pad measures the pressure and position of

fingers placed on its surface, so a musician can 'play' it like an instrument. The touch pad can also be used to control mixers and other sound processors, and in 2001 won an award for 'Most Innovative Product' from a leading music-industry publication. Tactex is also developing touch pads for the computer games market.

Many other industries are implementing KINOTEX products. For example, automotive companies have acquired the rights to develop pressure-sensitive car seats that help increase safety. The KINOTEX sensors are also being considered for incorporation into energy absorbing bumpers for determining the severity of crashes and detecting collisions with pedestrians. It looks as though the feelings of machines will be soon just as sensitive as ours!





# Landing a potato crisp

## A small German company has used its aerodynamics expertise to help develop a new food packaging machine

A glance around the shelves of any supermarket shows the enormous variety of packaging to which we have become accustomed. Foodstuffs in particular can be awkwardly shaped, fragile and difficult to handle, yet demands for greater production speeds continue to grow.

In 1998, ROVEMA, a German packaging-machine manufacturer was faced with the problem of designing a machine that could fill packets with lightweight food products such as potato crisps more quickly than its competitors. Surprisingly, the aerodynamics of dropping a potato crisp into a packet without breaking it are conceptually similar to those of landing a

spacecraft. Both must consider the optimum speed of descent and how ambient conditions and airflow will affect the falling object. With this in mind, ROVEMA

approached MST-Aerospace, the German partner of ESA's Technology Transfer network, for help. Familiar with this type of problem, MST introduced ROVEMA to another German company, Hypersonic Technology (HTG) in Katlenburg-Lindau near Göttingen.

Hypersonic Technology is a small company that specialises in aerodynamic modelling and computation for space projects such as ESA's ELITE initiative, which examines the flight characteristics of Europe's launchers. The company has access to wind tunnels and has developed considerable expertise in solving problems relating to aerodynamic flow.

©Rovema





*One of Rovema's food-bagging machines, which has been designed with the help of space expertise*



Working with ROVEMA, HTG was able to design a bagging system that could be incorporated into a new, market-leading, packaging machine that would be capable of handling irregularly shaped light foods at a rate between 30 and 50 percent faster than standard equipment. Despite its greatly increased operating speed, the new machine would maintain an acceptable level of breakages. The two companies then worked together to develop the system in use. Their efforts were successful and, following its first public viewing in May 1999 at INTERPACK, the Dusseldorf international packaging trade fair, the machine is now available on the international market.



*Landing a spacecraft on Earth, or the ESA Huygens probe on Saturn's moon Titan, as seen here (right), is almost like dropping a crisp into a bag*

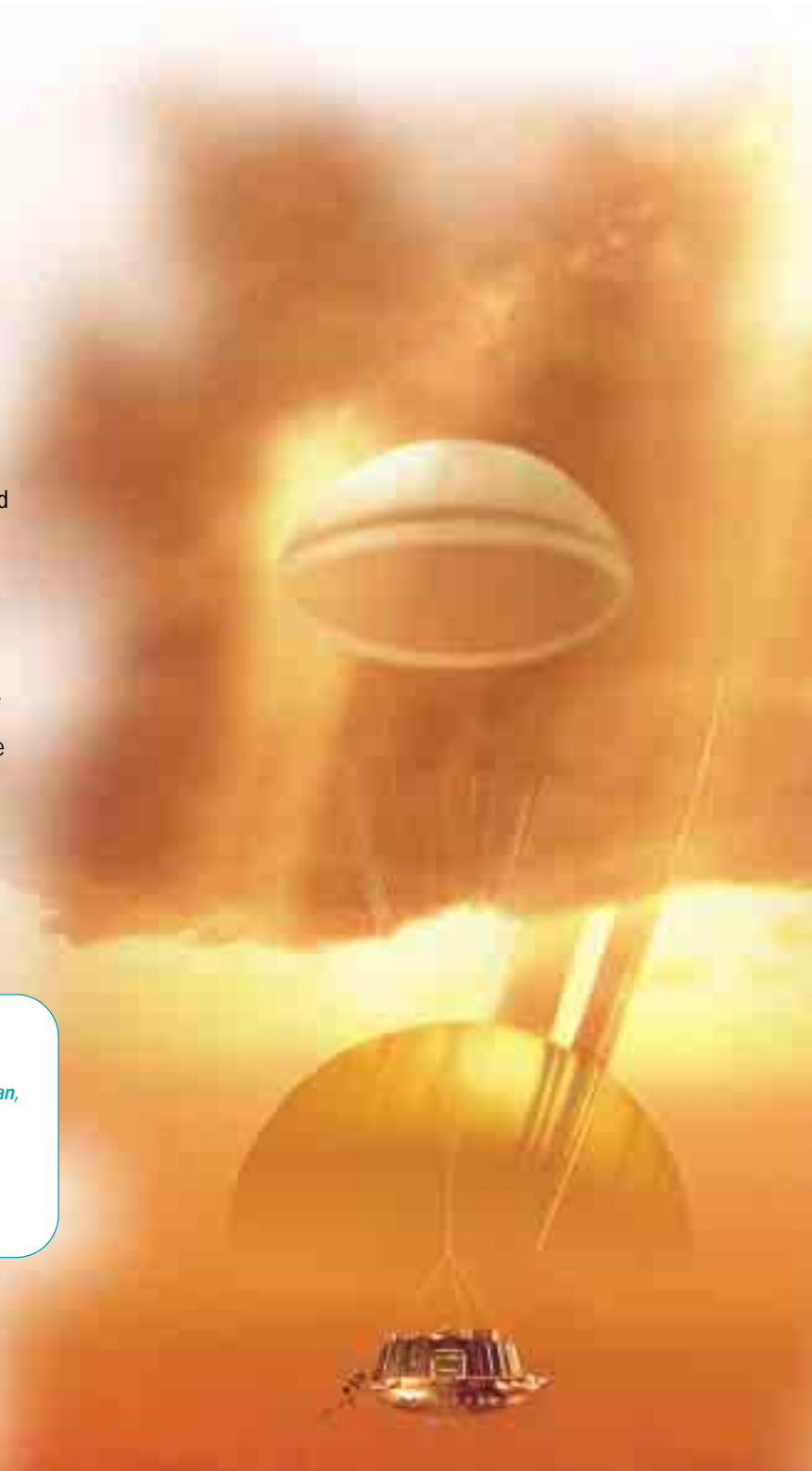

# Spin-off: what next?

The first 40 years of space spin-offs have given us smaller, faster computers, exotic materials and a host of advanced technology to enhance our everyday lives. Spin-offs from the next 40 years are likely to reflect the increase in importance of prolonged, manned space missions and miniaturised satellite systems.

As may be expected, the type of spin-off we get from space tends to reflect the types of space missions being mounted. In the past ESA has concentrated on Earth observation, communications and space science missions, leaving manned flight largely to the United States of America and Russia, and the high level of spin-off of imaging and communication technologies and analytical software from European programmes tends to reflect this. In the future, ESA's involvement in the International Space Station (ISS), the planned Mars missions and the increased emphasis on small satellite clusters should lead to new and ever more exciting spin-off opportunities.

The ISS will allow scientists to conduct experiments in microgravity over long periods of time in comparative comfort. From work with ESA's Spacelab missions on the Shuttle we know that removing the effect of gravity from the biological cell growth cycle can lead to a better understanding of this process. We also know that growing complex crystalline protein structures (such as those which can be associated with genetic disease) in microgravity can make them more regular, more straightforward to analyse and hence easier to find drugs to treat them.

As life-support in space becomes more of an issue for European astronauts, advances in this area are liable to become available to us down on Earth. For some years, ESA has been working on the 'Melissa' project, which will use biological filters and other techniques to convert human waste into drinking water, food and oxygen. Elements of this highly impressive system, already under development, are starting to be assessed for use on Earth in treating biological and other waste in a highly eco-friendly manner, and it is likely that we will get further benefits in the coming years.

Finally, the drive towards the goals of 'smaller, cheaper, more efficient' space systems will see the introduction of very small – some grapefruit-sized – satellites, operating in constellations, to give the necessary coverage of the Earth's surface for weather forecasting and climate monitoring. These satellites will need miniaturised systems – power supplies, sensors, and communications equipment – many of which already in the course of design. We may expect, therefore, that this move to more miniaturisation will be reflected in the size (or rather lack of size) of an increasing amount of the electronic equipment, which we seem to need to support our everyday lives. One potentially exciting technology is Lithium-Ion batteries. It is likely that

these smaller, more efficient batteries will replace lead-acid batteries in our cars. ESA is already undertaking pioneering work in developing control systems for Li-Ion batteries for future spacecraft and is looking for ways of making this expertise available to the European car industry.

This, then, has not been the definitive book of space spin-off - far from it. It is just a fascinating look at a few examples of how space research in Europe and Canada has benefited us all here on Earth in one way or another. The future is looking ever brighter.







## Pierre Brisson

Pierre Brisson is Head of the ESA Technology Transfer Programme. A Master of Science, Engineer and Doctor in Electronics, Pierre was a Principal Investigator for the Microgravity Crystal-Growth Experiments on the European Spacelab missions in the mid-1980s. He has 25 patents and over 50 publications to his name. Pierre has been with the programme since it started in 1989. Pierre is a jiu-jitsu enthusiast and throws himself wholeheartedly into anything he does – the programme's success is in no small part a result of his drive and motivation.



## John Rootes

John Rootes is the Managing Director of JRA Technology Ltd., a Marlow-based, United Kingdom technology-transfer support consultancy. JRA is one of the founder members of the SPACELINK Group of companies that assists ESA in carrying out its Technology Transfer Programme throughout Europe and that has supported over 100 spin-offs. John trained as an aeronautical engineer and his interests range from vintage aeroplanes to next-generation spacecraft. This is the third spin-off publication that he will have helped ESA to produce, and the first destined for wider circulation to the general public.

# Providing the Link

The SPACELINK Group is a consortium of technology transfer companies located throughout Europe, established by ESA to assist European researchers in finding spin-off applications for their space technology.

As the examples given in this book show, technology transfer can take many forms; Patent licensing, the establishment of joint venture or spin-off companies, or simply space and non-space companies coming together to access European or National funding to adapt space technology for terrestrial uses.

All of these transfer mechanisms have their complexities and often technology transfer specialists are required to guide companies through the maze of partner search, negotiation and form filling activities necessary to secure a technology transfer agreement.

To assist European space researchers in these areas, ESA has set up a network of such advisors, capable of providing support on an in-country basis to all of ESA's contributing nations.

The network is called the SPACELINK Group and it has been in operation since 1991. SPACELINK uses a technology catalogue called IMPACT to promote spin-off technologies throughout Europe, and also a web-based technology market place accessed through the main ESA site ([www.esa.int](http://www.esa.int)). Group activities have resulted in almost 100 technology transfers since the start of the programme and many more beneficial contacts between space and non-space industry. The resultant impact on commercial activity already runs into several hundreds of MEuro - and these are just the transfers which SPACELINK has taken an active part in promoting. Many more take place without assistance and, as can be seen by the diversity of applications covered in the preceding pages, the impact on our everyday lives has been considerable.

For more information on ESA's technology transfer activities or any of the technologies contained in this book, contact:

Pierre Brisson  
Head of ESA TTP  
ESTEC, PO Box 299  
2200 AG Noordwijk  
The Netherlands

Tel: +31 71 565 4929  
Fax: +31 71 565 3854  
E-mail: [Pierre.Brisson@esa.int](mailto:Pierre.Brisson@esa.int)

Or visit our website at: <http://www.esa.int/technology>

# Acknowledgements

ESA would like to thank John Rootes and the staff of JRA Technology Ltd., in particular Peter Russell, Adrian Wheldon, David Mercer, Nina Hall and Peter Hodgkinson, for their dedicated efforts in researching, writing and illustrating this book.

The very valuable assistance received from the ESA Technology Transfer Group, CNES, EARTO, the Spacelink Group members, and all contributing space and non-space companies and research organisations is also gratefully acknowledged.

**Compiled by:**

*JRA Technology Ltd.*

**Published by:**

*ESA Publications Division*

*ESTEC, PO Box 299*

*2200 AG Noordwijk*

*The Netherlands*

**Editors:**

*Peter Russell & Bruce Battrick*

**Design & Layout:**

*Leigh Edwards and Carel Haakman*

**Copyright:**

*© 2001 European Space Agency*

*ISBN No. 92-9092-682-1*

*ISSN No. 0250-1589*

**Price:**

*25 Euros / 60 Dutch Guilders*

**Printed in:** *The Netherlands*