

CASTLE SERIES

1954

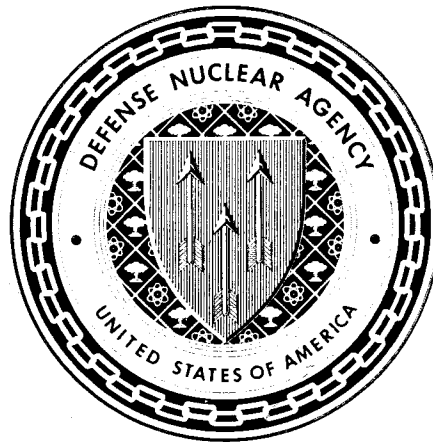

#405

**United States Atmospheric Nuclear Weapons Tests
Nuclear Test Personnel Review**

**Prepared by the Defense Nuclear Agency as Executive Agency
for the Department of Defense**

Destroy this report when it is no longer
needed. Do not return to sender.

PLEASE NOTIFY THE DEFENSE NUCLEAR AGENCY,
ATTN: STTI, WASHINGTON, D.C. 20305, IF
YOUR ADDRESS IS INCORRECT, IF YOU WISH TO
BE DELETED FROM THE DISTRIBUTION LIST, OR
IF THE ADDRESSEE IS NO LONGER EMPLOYED BY
YOUR ORGANIZATION.



UNCLASSIFIED

SECURITY CLASSIFICATION OF THIS PAGE (When Data Entered)

REPORT DOCUMENTATION PAGE		READ INSTRUCTIONS BEFORE COMPLETING FORM
1. REPORT NUMBER DNA 6035F	2. GOVT ACCESSION NO.	3. RECIPIENT'S CATALOG NUMBER
4. TITLE (and Subtitle) CASTLE SERIES, 1954		5. TYPE OF REPORT & PERIOD COVERED Technical Report
		6. PERFORMING ORG. REPORT NUMBER KT-81-0026(R)
7. AUTHOR(s) Edwin J. Martin Richard H. Rowland		8. CONTRACT OR GRANT NUMBER(s) DNA 001-79-C-0472
9. PERFORMING ORGANIZATION NAME AND ADDRESS Kaman Tempo P. O. Drawer QQ (816 State Street) Santa Barbara, California 93102		10. PROGRAM ELEMENT, PROJECT, TASK AREA & WORK UNIT NUMBERS Subtask U99QAXMK506-09
11. CONTROLLING OFFICE NAME AND ADDRESS Director Defense Nuclear Agency Washington, DC 20305		12. REPORT DATE 1 April 1982
		13. NUMBER OF PAGES 530
14. MONITORING AGENCY NAME & ADDRESS (if different from Controlling Office)		15. SECURITY CLASS. (of this report) UNCLASSIFIED
		15a. DECLASSIFICATION/DOWNGRADING SCHEDULE N/A Since UNCLASSIFIED
16. DISTRIBUTION STATEMENT (of this Report) Approved for public release; distribution unlimited.		
17. DISTRIBUTION STATEMENT (of the abstract entered in Block 20, if different from Report)		
18. SUPPLEMENTARY NOTES This work sponsored by the Defense Nuclear Agency under RDT&E RMSS Code B350079464 U99QAXMK50609 H2590D. For sale by the National Technical Information Service, Springfield, Virginia 22161.		
19. KEY WORDS (Continue on reverse side if necessary and identify by block number) Nuclear Testing Nuclear Test Personnel Review (NTPR) CASTLE, BRAVO, ROMEO, KOON, UNION, YANKEE, NECTAR Enewetak, Bikini Pacific Proving Ground		
20. ABSTRACT (Continue on reverse side if necessary and identify by block number) CASTLE was an atmospheric nuclear weapons test series held in the Marshall Islands at Enewetak and Bikini atolls in 1954. This is a report of DOD personnel in CASTLE with an emphasis on operations and radiological safety.		

DD FORM 1473
1 JAN 73

EDITION OF 1 NOV 65 IS OBSOLETE

UNCLASSIFIED

SECURITY CLASSIFICATION OF THIS PAGE (When Data Entered)

UNCLASSIFIED

SECURITY CLASSIFICATION OF THIS PAGE(When Data Entered)

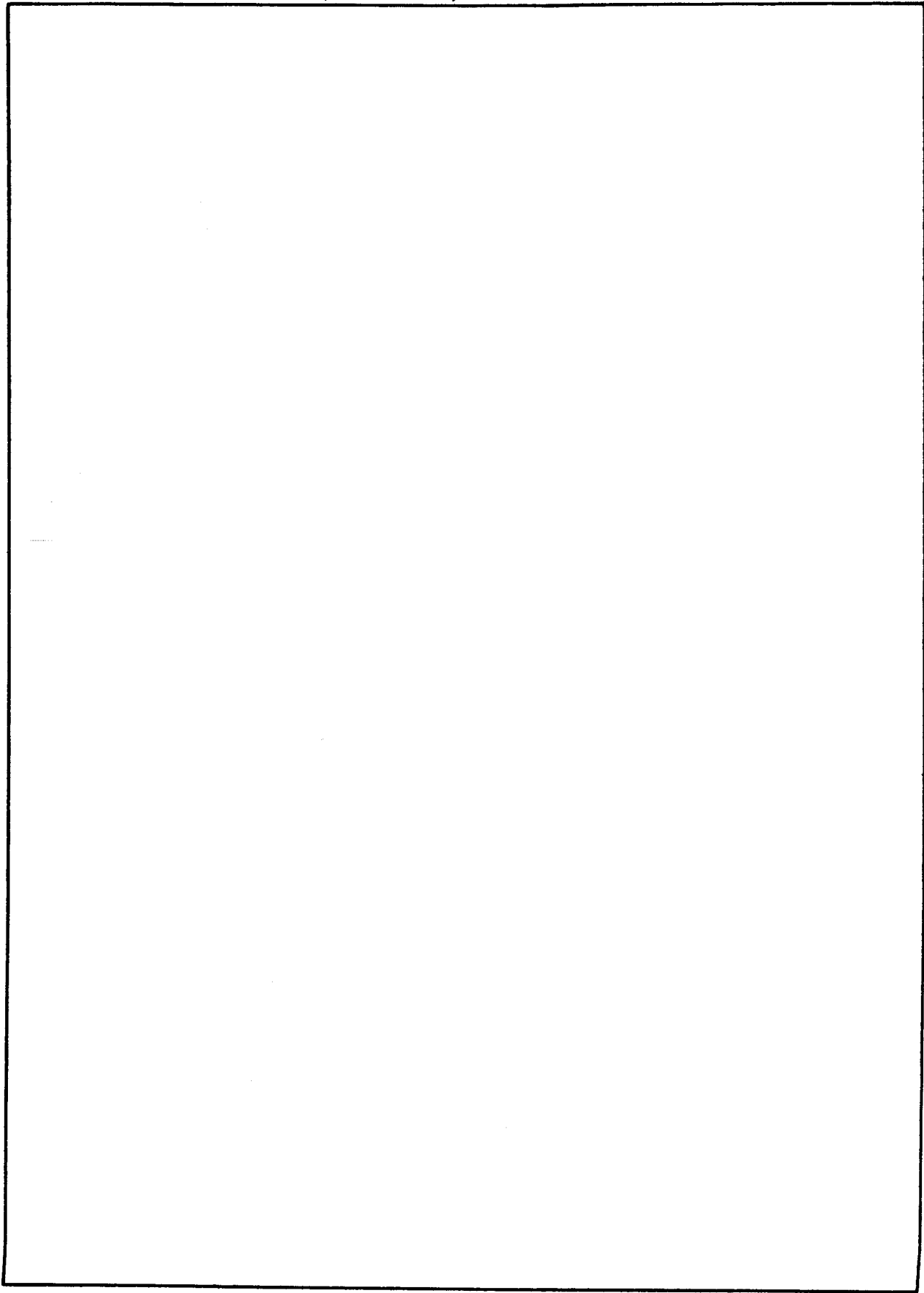

UNCLASSIFIED

SECURITY CLASSIFICATION OF THIS PAGE(When Data Entered)

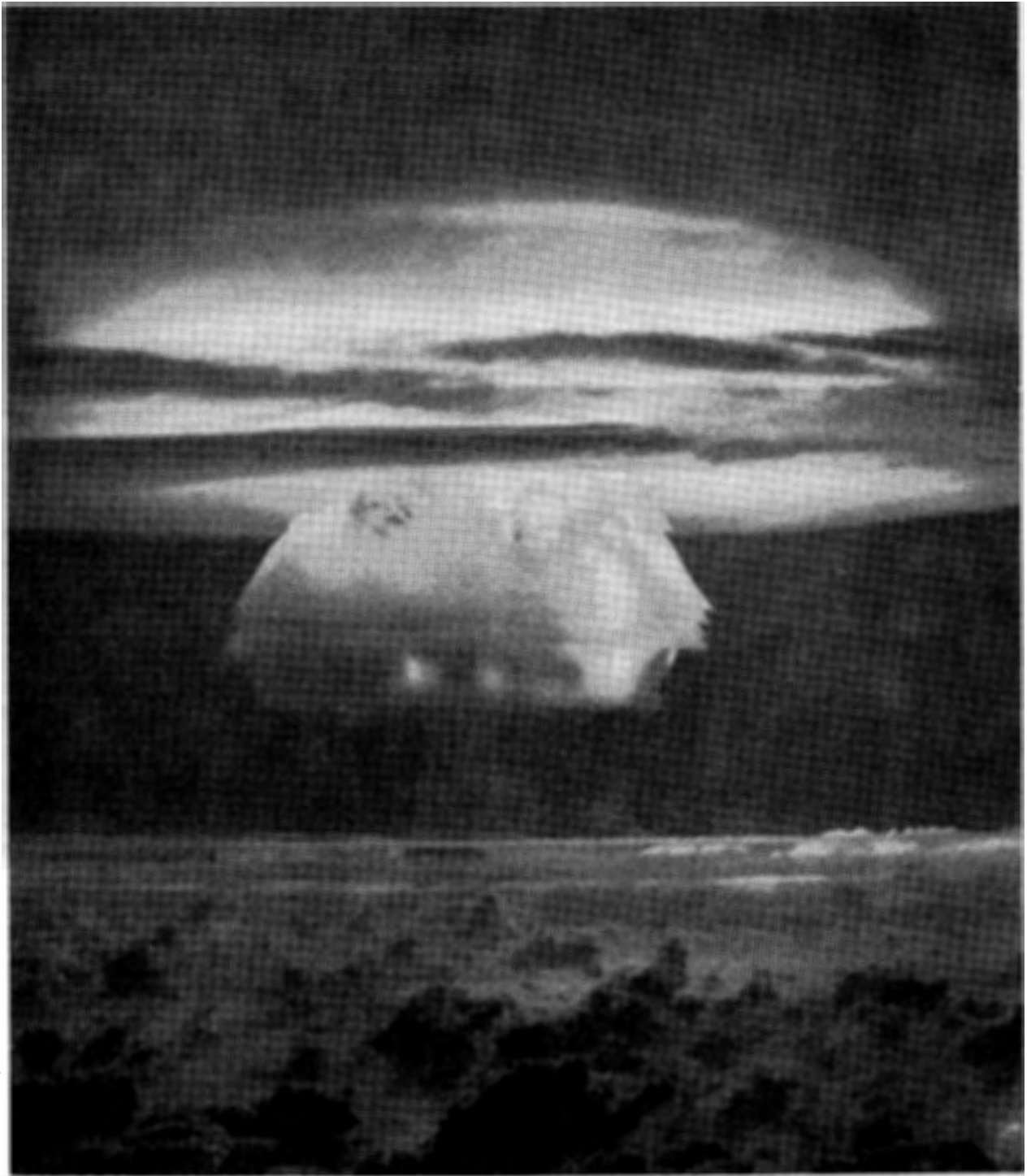

CASTLE, BRAVO thermonuclear detonation, 1 March 1954.

FACT SHEET

CASTLE was a six-detonation nuclear weapon test series (see table) held at the Atomic Energy Commission's (AEC) Pacific Proving Ground (PPG) in Spring 1954. The PPG consisted principally of Enewetak* and Bikini atolls in the northwestern Marshall Islands in the Central Pacific Ocean.

Date	Assigned Name	Location	Magnitude
1 March	BRAVO	Bikini; sandspit off Nam Island	15 MT ^a
27 March	ROMEO	Bikini; barge in BRAVO crater	11 MT
7 April	KOON	Bikini; surface of Eneman Island	110 KT
26 April	UNION	Bikini; barge in lagoon off Iroij Island	6.9 MT
5 May	YANKEE	Bikini; barge in UNION crater	13.5 MT
14 May	NECTAR	Enewetak; barge in MIKE ^b crater	1.69 MT

Notes:

^aOne kiloton equals the approximate energy release of the explosion of one thousand tons of TNT; one megaton equals the approximate energy release of the explosion of one million tons of TNT.

^b 10.4-MT IVY series detonation in 1952.

HISTORICAL BACKGROUND

The CASTLE series was held to test large-yield thermonuclear, or hydrogen, devices. Work on this class of devices had progressed through the GREENHOUSE, GEORGE experimental shot in 1951 and the IVY, MIKE shot of 1952. MIKE was the first device that generated a substantial explosive energy from the fusion, or joining, of hydrogen atoms. These explosive

* The spelling of Marshall Island place names has changed in recent years in order to more accurately render the sounds of the Marshall Island names using English spelling.

devices were developed by the AEC, the civilian agency authorized to perform this activity by the Atomic Energy Act of 1946.

The devices were tested at the PPG by a joint military and civilian organization, designated as Joint Task Force 7 (JTF 7). This was a military organization in form, but was populated by military, civil service, and contractor personnel of the Department of Defense (DOD) and AEC. The commander of this force was the appointed representative of the AEC and reported also to the Joint Chiefs of Staff (JCS) and the Commander in Chief, Pacific (CINCPAC). The peak DOD numerical strength at CASTLE was approximately as follows:

Uniformed military	9,800
DOD civil servants	250
DOD contractors	60
	<hr/>
Total personnel	10,110

Numerous technical experiments were carried out in conjunction with each of the six detonations. These experiments measured the power and efficiency of the devices and attempted to gauge the military effects of the explosions. DOD personnel participated in this test operation as individuals whose duty stations were at the AEC design laboratories, as units performing separate experiments, and as units performing various support roles. The CASTLE operations placed almost all of the Navy support group at Bikini, where its ships provided living space for personnel who were evacuated from the islands for the first test and then could not return to live there because of the potential radiation exposure.

An extensive radiological safety program was instituted whose objectives were:

1. Maintenance of personnel radiation exposure at the lowest possible level consistent with medical knowledge of radiation effects and the importance of the test series.
2. Avoidance of inadvertent contamination of populated islands or transient shipping.

The program established an organization to provide radiological safety (radSAFE) expertise and services to the separate components of the task force who were responsible for personnel safety within their commands. Personnel were trained in radiological safety, and standards governing maximum permissible exposures (MPE) were established. Film badges were provided to a large portion of the participating personnel. Persons likely to be exposed to radiation were badged as well as a representative group of the remainder. An extensive weather forecasting group was established in order to predict wind directions and areas of potential fallout. Personnel were evacuated from danger areas before each detonation and re-entry to contaminated areas was restricted to the personnel required to retrieve important data. The amount of radiation exposure for these personnel was monitored.

TEST OPERATIONS AND EXPOSURES

The first event of this series, designated BRAVO, had a yield of 15 MT and was the largest device ever detonated in atmospheric nuclear testing by the U.S. Government. Significantly exceeding its expected yield, BRAVO, detonated at Bikini Atoll, released large quantities of radioactive materials into the atmosphere, which were caught up in winds that spread the particles over a much larger area than anticipated. This resulted in the contamination and exposure of some individuals either stationed or residing on distant atolls or aboard various vessels. Acute radiation effects were observed among some of these people.

A limited number of JTF 7 personnel received radiation exposures considerably in excess of the initially established CASTLE MPE. This operational limit was established at 3.9 roentgens (R) gamma within any 13-week period of the operation. In particular, three members of the U.S. Navy Bikini Boat Pool had heavily exposed badges with readings from 85 to 95 R, and 28 Army and Air Force personnel had film badge exposures that read as high as 78 R. All these men were medically evaluated at Kwajalein. Subsequently, follow-up on 29 of them was done at Tripler Hospital in Hawaii.

The results of these medical observations were reported as "essentially negative" or "generally negative."

BRAVO fallout on some Navy ships also resulted in additional personnel who had exposures approaching or exceeding the CASTLE MPE of 3.9 R. To allow for operational completion of the remaining CASTLE shots, it became necessary to issue a number of waiver authorizations permitting exposures of as much as 7.8 R. In a limited number of cases, even this level was exceeded.

As a result of BRAVO, 21 individuals on the USS Philip (DDE-498) and 16 on the USS Bairoko (CVE-115) sustained small skin lesions resembling burns that were definitely classified as beta burns. The affected personnel received radiological contamination while on the weather deck or stationed near ventilation blowers. These all healed without complications. The USS Patapsco (AOG-1), a Navy gasoline tanker, which was approximately 180-195 nautical miles (333-360 kilometers) northeast of BRAVO's ground zero at the time of detonation, received fallout as it returned to Pearl Harbor. Exposure estimates as high as 18 R are possible, assuming an individual was on deck 24 hours a day with the ship retaining 100 percent of all fallout radioactivity and using the highest reading from radiation surveys. For an individual who spent only 8 hours a day on deck and 16 hours a day inside, and assuming that the storm conditions washed off 50 percent of the activity en route, the estimated dose is 3.3 R.

The other five CASTLE detonations, though extremely important as weapon tests, did not produce significant, unexpected personnel radiation exposures.

While small numbers of personnel at CASTLE did receive exposures in excess of imposed standards, by far the largest portion did not. In fact, the radiation exposure for JTF 7 personnel at CASTLE averaged about 1.7 R. The recorded CASTLE exposures are summarized in the table on the following page.

CASTLE Exposures

Service	No. of Persons Badged	Dose Unavail	Exposure Range (R)						High Recorded (R)
			Zero ^a Exposure	0.001- 1.000	1.001- 3.000	3.001- 5.000	5.001- 10.00	Over 10.0	
Army	1,503	8 >1% ^b	27 2%	1,276 85%	121 8%	60 4%	8 >1%	3 >1%	78 ^c
Navy	6,255	35 >1%	113 2%	3,544 57%	1,945 31%	453 7%	157 3%	8 >1%	96
Air Force	844	15 2%	12 1%	494 58%	208 25%	59 7%	25 3%	31 4%	52 ^d
Marine Corps	193	2 1%	13 7%	67 35%	78 40%	29 15%	4 2%	0 0%	5.510
Other Govt Contractor	2,175	170 8%	86 4%	1,221 56%	323 15%	292 13%	81 4%	2 >1%	27.825
Totals % of Total	10,970	230 2%	251 2%	6,602 60%	2,675 24%	893 8%	275 3%	44 >1%	96

Notes:

^aZero doses were not recorded in the Consolidated List of CASTLE Radiological Exposures for many units.

^bPercent of total service personnel in each group.

^cThree unbadged Army personnel on Rongerik Island originally were assigned a dose of 98 R, which was taken from a badge mounted on a tent pole.

^dThe high value comes from badges worn by Air Force personnel on Rongerik. The U.S. Air Force has assigned an estimated total dose of 86 R to each member of its Rongerik group.

PREFACE

Between 1945 and 1962, the U.S. Atomic Energy Commission (AEC) conducted 235 atmospheric nuclear weapon tests at sites in the United States and in the Pacific and Atlantic oceans. In all, about 220,000 Department of Defense (DOD) participants, both military and civilian, were present at the tests. Of these, approximately 142,000 participated in the Pacific test series and approximately another 4,000 in the single Atlantic test series.

In 1977, 15 years after the last aboveground nuclear weapon test, the Center for Disease Control (CDC) of the U.S. Department of Health and Human Services noted more leukemia cases than would normally be expected among about 3,200 soldiers who had been present at shot SMOKY, a test of the 1957 PLUMBBOB Series. Since that initial report by the CDC, the Veterans Administration (VA) has received a number of claims for medical benefits from former military personnel who believe their health may have been affected by their participation in the weapon testing program.

In late 1977, the DOD began a study that provided data to both the CDC and the VA on potential exposures to ionizing radiation among the military and civilian personnel who participated in the atmospheric testing 15 to 30 years earlier. In early 1978, the DOD also organized a Nuclear Test Personnel Review (NTPR) to:

- Identify DOD personnel who had taken part in the atmospheric nuclear weapon tests
- Determine the extent of the participants' exposure to ionizing radiation
- Provide public disclosure of information concerning participation by DOD personnel in the atmospheric nuclear weapon tests.

2

This report on Operation CASTLE is one of many volumes that are the product of the NTPR. The DOD Defense Nuclear Agency (DNA), whose Director is the executive agent of the NTPR program, prepared the reports, which are based on the military and technical documents reporting various aspects of each of the tests. The reports of the NTPR provide a public record of the activities and associated radiation exposure risks of DOD personnel for interested former participants and for use in public health research and Federal policy studies.

The information from which this report was compiled was primarily extracted from planning and after-action reports of Joint Task Force 7 (JTF 7) and its subordinate organizations. What was desired were documents that accurately placed personnel at the test sites so that their degree of exposure to the ionizing radiation resulting from the tests could be assessed. The search for this information was undertaken in archives and libraries of the Federal Government, in special collections supported by the Federal Government, and, where reasonable, by discussion or review with participants.

For CASTLE, the most important archival source is the Modern Military Branch of the National Archives in Washington. The Naval Archives at the Washington Navy Yard also was helpful, as was the collection of documents assembled by the Air Force Weapons Laboratory (AFWL) Historian, the collection now being housed in the AFWL Technical Library at Kirtland Air Force Base, Albuquerque, New Mexico. Other archives searched were the Department of Energy archives at Germantown, Maryland, its Nevada Operations Office archives at Las Vegas, and the archives of the Test Division of the Los Alamos Scientific Laboratory (LASL).

JTF 7 exposure records were retrieved from the archives, and an additional file of exposure-related documents that had been microfilmed by the Reynolds Electrical and Engineering Company, Inc. was also useful.

The major gap in information sources is in primary documentation of personnel movement in areas of potential radiation exposure. This has

been compensated for, where possible, with inferences drawn from secondary sources and the exposure records themselves.

The work was performed under RDT&E RMSS B350079464 U99 QAXMK 506-09 H2590D for the Defense Nuclear Agency by personnel from Kaman Tempo (formerly General Electric--TEMPO) and R.F. Cross Associates as subcontractor. Personnel contributing research, editing, and graphics and not listed on the DD-1473 form include:

S. Bruce-Henderson, Kaman Tempo, Santa Barbara

F.R. Gladeck, Kaman Tempo, Alexandria

J.H. Hallowell, Kaman Tempo, Santa Barbara

F.W. McMullan, Kaman Tempo, Albuquerque

R.H. Miller, Kaman Tempo, Albuquerque

R.E. Pozega, Kaman Tempo, Albuquerque

W.E. Rogers, Kaman Tempo, Santa Barbara

C.F. Shelton, Kaman Tempo, Alexandria

P. Sturman, Kaman Tempo, Alexandria

B.L. Treloar, Kaman Tempo, Santa Barbara

L. Berkhouse, R.F. Cross Associates

S. Davis, R.F. Cross Associates

P. Dean, R.F. Cross Associates

M.K. Doyle, R.F. Cross Associates

C.B. Jones, R.F. Cross Associates.

Guidance was provided by the Biomedical Advisor of the Defense Nuclear Agency, Dr. Edwin T. Still, and Mr. Kenneth W. Kaye of his office.

TABLE OF CONTENTS

	<u>Page</u>
FACT SHEET	1
PREFACE	6
ILLUSTRATIONS	17
TABLES	21
<u>Chapter</u>	
1 OVERVIEW	25
Introduction	25
Purpose	25
Historical Background	26
Report Organization	26
Nuclear Tests and Radiation Exposures	27
Experimental Program	31
Weapon Development	31
Yield Measurements	32
Diagnostic Measurements	33
Effects Experiments	35
Environmental Measurements	35
Systems Response Experiments	36
Oceanic Testing Operations	37
Marshall Islands Setting	37
Physical Conditions in 1954	42
Radiological Conditions in 1954	47
Special Problems in Oceanic Testing	51

CONTENTS (continued)

<u>Chapter</u>		<u>Page</u>
1 (continued)		
	Joint Task Force 7	53
	Task Group 7.1 (Scientific)	55
	Task Unit 1 -- LASL Programs	55
	Task Unit 2 -- Production	56
	Task Unit 3 -- Special Materials and Facilities	56
	Task Unit 4 -- LASL Assembly	56
	Task Unit 6 -- Firing Party	56
	Task Unit 7 -- Radiological Safety	56
	Task Unit 8 -- Technical Photography	57
	Task Unit 9 -- Documentary Photography	57
	Task Unit 12 -- UCRL Program	57
	Task Unit 13 -- DOD Programs	57
	Task Unit 14 -- UCRL Assembly	57
	Task Unit 15 -- Timing	57
	Task Group 7.2 (Army)	58
	Task Group 7.3 (Navy)	61
	Task Group 7.4 (Air Force)	69
	Task Group 7.5 (Base Facilities)	71
2	RADIOLOGICAL SAFETY	74
	Radsafe Planning	75
	Organization and Responsibilities	76
	Task Group 7.1	79
	Radiation Control	81
	Decontamination	82
	Laboratory Analysis	82
	Task Group 7.2	83
	Task Group 7.3	84
	Task Group 7.4	85

CONTENTS (continued)

<u>Chapter</u>	<u>Page</u>
2 (continued)	
Training	87
Task Group 7.1	87
Task Group 7.2	92
Task Group 7.3	92
Task Group 7.4	94
Safety Criteria	94
Radsafe Standards	95
Radiation Exposure Waivers	96
Radsafe Monitoring and Instrumentation	100
Radsafe Instrumentation	100
Personnel Film Badges and Records	101
Pre-event Safety Measures	107
Hazard Zones	107
Fallout Prediction	108
Hodographs	109
Particle Trajectory Forecasts	110
Weather	112
Radex Areas	115
Offsite Monitoring	116
Command Briefings	118
Radiation Protection Modifications	120
Evacuation, Disposition, and Reentry	123
Bikini Shots	123
Enewetak Shot	125
Postevent Safety Measures	125
General Procedures	125
Cloud Tracking	132
Cloud Sampling	132
Sample Recovery Techniques	139

CONTENTS (continued)

<u>Chapter</u>		<u>Page</u>
2 (continued)		
	Personnel Decontamination	144
	Naval Vessel Decontamination	149
	Equipment Decontamination	150
	Aircraft Decontamination	152
	Task Group 7.4 Aircraft	154
	Other Aircraft	161
3	DOD EXPERIMENTAL PARTICIPATION	166
	Weapon Development	166
	Effects Experiments	168
	Blast and Shock (Program 1)	168
	Nuclear Radiation (Program 2)	177
	Blast Effects (Program 3)	184
	Response of Humans to Accidental Fallout Radiation (Program 4)	186
	Operations	188
	Radiation Exposure Potential	189
	Staffing	189
	Project Reports	189
	Tests of Service Equipment and Techniques (Program 6)	189
	Burst Detection Studies (Program 7)	197
	Cloud Photography (Program 9)	199
4	BRAVO TEST	201
	Decision to Shoot	201
	Preparations	203
	DOD Activities	203
	The Test	205
	Reentry to Bikini	221
	Evacuations	224

CONTENTS (continued)

<u>Chapter</u>		<u>Page</u>
4 (continued)		
	<u>Patapsco Contamination</u>	230
	Operations Afloat	232
	Offsite Operations	232
	BRAVO Fallout Exposures	235
	Task Group 7.3 Exposures	235
	Enewetak-Based Personnel	235
	Task Groups 7.1 and 7.5 Bikini Personnel	238
	Task Group 7.4 Exposures	238
	Personnel Exposures -- Rongerik	238
	<u>Patapsco Crew</u>	240
	Marshallese Population	241
	Radiation Effects and Medical Observation of Task Force Personnel	241
5	TESTS AFTER BRAVO	246
	Schedule Changes	246
	Operational Implications	248
	ROME0	250
	Preshot Preparation	250
	DOD Activities	254
	The Test	255
	Contamination	255
	Aircraft Decontamination	267
	Personnel Exposures	267
	K00N	267
	Preshot Preparation	271
	DOD Activities	275
	The Test	276
	Contamination	276
	Aircraft Decontamination	283

CONTENTS (continued)

<u>Chapter</u>		<u>Page</u>
5 (continued)		
	UNION	283
	Preshot Preparation	283
	DOD Activities	287
	The Test	290
	Contamination	290
	Aircraft Decontamination	296
	YANKEE	296
	Preshot Preparation	296
	DOD Activities	300
	The Test	304
	Contamination	304
	Aircraft Decontamination	310
	NECTAR	310
	Preshot Preparation	310
	DOD Activities	314
	The Test	315
	Contamination	315
	Aircraft Decontamination	323
6	SUMMARY OF U.S. ARMY PARTICIPATION IN CASTLE	325
	Headquarters Joint Task Force 7	325
	Task Group 7.1 (Scientific)	325
	Task Group 7.2 (Army)	330
7	SUMMARY OF U.S. NAVY PARTICIPATION IN CASTLE	332
	Headquarters Joint Task Force 7	332
	Task Group 7.1 (Scientific)	336
	Task Group 7.2 (Army)	339
	Task Group 7.3 (Navy)	339
	Task Unit 7.3.0 (Special Devices Unit)	339

CONTENTS (continued)

<u>Chapter</u>		<u>Page</u>
7	(continued)	
	Task Unit 7.3.1 (Surface Security Unit)	340
	Task Unit 7.3.2 (Carrier Unit)	349
	Task Unit 7.3.3 (Patrol Plane Unit)	351
	Task Unit 7.3.4 (Flagship Unit)	353
	Task Unit 7.3.5 (Utility Unit)	355
	Task Unit 7.3.6 (Atomic Warfare Ship Countermeasures Unit)	363
	Task Unit 7.3.7 (Bikini Harbor Unit)	366
	Task Element 7.3.7.2 (Mine Project Unit)	368
	Task Unit 7.3.8 (Enewetak Harbor Unit)	372
	Task Unit 7.3.9 (Transport Unit)	372
	Other Naval Units in the PPG or in Nearby Waters during CASTLE	373
8	SUMMARY OF U.S. AIR FORCE PARTICIPATION IN CASTLE	384
	Headquarters Joint Task Force 7	384
	Task Group 7.1 (Scientific)	388
	Task Group 7.4 (Air Force)	390
9	SUMMARY OF U.S. MARINE CORPS PARTICIPATION IN CASTLE	397
	Task Group 7.1 (Scientific)	397
	Task Group 7.3 (Navy)	397
10	SUMMARY OF JOINT DEFENSE AGENCY, OTHER GOVERNMENT, CONTRACTOR, AND FOREIGN PARTICIPATION IN CASTLE	400
	Headquarters Joint Task Force 7	400
	Task Group 7.1 (Scientific)	401
	Task Group 7.2 (Army)	407
	Foreign Participation	408
11	PERSONNEL EXPOSURES	409
	REFERENCES	413

CONTENTS (continued)

<u>Appendix</u>		<u>Page</u>
A	COPIES OF CASTLE DOCUMENTS	431
B	TERMS, ABBREVIATIONS, ACRONYMS, AND UNITS	471
C	ISLAND SYNONYMS	491
D	INDEX OF PARTICIPATING ORGANIZATIONS	497

LIST OF ILLUSTRATIONS

<u>Figure</u>	<u>Page</u>
Frontispiece: CASTLE, BRAVO thermonuclear detonation, 1 March 1954.	
1 The Central Pacific.	38
2 Enewetak Atoll, 1954.	39
3 Bikini Atoll, 1954.	40
4 Aerial view of Parry during CASTLE.	43
5 Typical metal buildings used at Enewetak during CASTLE.	44
6 Tents on Parry during CASTLE.	44
7 Assembly area on southern tip of Parry looking south.	46
8 Enewetak airfield looking west.	46
9 Eneman camp, Bikini, looking south-southwest.	48
10 Enewetak detonation sites.	50
11 Organization chart, Joint Task Force 7.	54
12 Organization and functions of the task force Radsafe Office.	78
13 Radsafe organization for Task Group 7.1.	81
14 Task Group 7.2 radsafe organization.	84
15 Organization and responsibilities for Task Group 7.4.	86
16 Pacific Proving Ground search areas and security zones for Operation CASTLE.	109
17 Joint Task Force 7 weather element organization.	113
18 "Booties" worn for radiation protection during radiation survey on Rongelap after BRAVO.	129
19 Three types of protective suits used during CASTLE.	130
20 Protective clothing being worn during CASTLE instrument recovery on Adrikan Island.	130
21 Wilson 1 sector search mission for cloud tracking.	133
22 Wilson 2 sector and vector search for cloud tracking.	133
23 F-84G sampler aircraft.	135
24 F-84G sampling panel.	138
25 F-84G samplers parked at Enewetak airstrip.	139

ILLUSTRATIONS (continued)

<u>Figure</u>		<u>Page</u>
26	Sample recovery schematic.	140
27	Cutting filter paper retaining wire in left tank.	141
28	Removal of filter paper from left tank.	142
29	Deposition of filter paper in shielded cave.	142
30	Preparing to roll filter paper.	143
31	Filter paper being rolled.	143
32	A "pig," a shielded container for sample transport.	145
33	Lifting pig containing filter paper.	145
34	Removal of gas sample from "snap-bag" through sampling probe.	146
35	Personnel monitoring after removal of contaminated clothing.	148
36	Scrubbing to remove radioactivity before suit removal.	149
37	Shipboard decontamination using high-pressure seawater and scrub brushes.	150
38	Parry contaminated storage area.	151
39	Decontamination equipment on Parry.	153
40	Tent for changing contaminated clothing at Parry.	154
41	B-36 decontamination.	162
42	B-36 decontamination.	163
43	B-36 decontamination.	163
44	F-84G decontamination.	164
45	Placement of anchored fallout collector buoys.	180
46	Preparation of fallout collector tray.	181
47	Recovery of sea mines by the <u>USS Reclaimer</u> (ARS-42) following UNION shot.	187
48	Decontamination hosedown of the <u>Granville S. Hall</u> (YAG-40) by the <u>Molala</u> (ATF-106).	194
49	Deck crew continuing washdown of YAG-40 (<u>Granville S. Hall</u>).	194
50	Further washdown of YAG-40 (<u>Granville S. Hall</u>); YAG-39 (<u>George Eastman</u>) alongside.	195
51	Project 6.4 test aircraft being decontaminated.	195
52	Scrubbing Project 6.4 test aircraft.	196

ILLUSTRATIONS (continued)

<u>Figure</u>		<u>Page</u>
53	BRAVO search vectors and track of <u>Daigo Fukuryu Maru</u> .	204
54	Locations of instrument stations for DOD experiments, BRAVO.	206
55	Ship positions at detonation time, BRAVO.	207
56	BRAVO blast damage to Eneman Island building.	209
57	Fire damage at Eneman Island from BRAVO-induced electrical short circuit.	209
58	Cloud dimensions for BRAVO.	211
59	BRAVO close-in gamma fallout pattern at H+1.	212
60	BRAVO reconstructed fallout at H+3.	214
61	BRAVO reconstructed fallout at H+6.	216
62	BRAVO reconstructed fallout at H+12.	219
63	Layout of Rongerik installations.	222
64	Photo of Rongerik installations.	222
65	Ship positions on 2 March, 24 hours after BRAVO.	223
66	Ship positions on 3 March, 48 hours after BRAVO.	225
67	Post-BRAVO survey personnel at Rongelap.	233
68	<u>USS Nicholas</u> (DDE-449) crewman holding sick rat at Rongerik after BRAVO.	234
69	Estimated total (accumulated) dose contours, BRAVO H+96.	236
70	ROME0 predicted fallout pattern.	254
71	ROME0 instrumentation stations for the DOD scientific projects on Bikini Atoll.	256
72	Ship positions at detonation time, shot ROME0.	257
73	ROME0 cloud dimensions.	259
74	ROME0 fallout pattern.	262
75	ROME0 atoll exposure rates at H+1.	264
76	Ship positions at detonation time, KOON.	274
77	KOON predicted fallout pattern.	275
78	KOON instrumentation stations for the DOD scientific projects on Bikini Atoll.	277
79	KOON close-in gamma fallout pattern.	281

ILLUSTRATIONS (continued)

<u>Figure</u>		<u>Page</u>
80	UNION predicted fallout pattern.	287
81	UNION instrumentation stations for the DOD scientific projects on Bikini Atoll.	288
82	Ship positions at detonation time, UNION.	289
83	UNION cloud dimensions.	291
84	UNION close-in gamma fallout pattern.	294
85	YANKEE predicted fallout pattern based on the method of elliptical approximations.	301
86	YANKEE instrumentation stations for the DOD scientific projects at Bikini Atoll.	302
87.	Ship positions at detonation time, YANKEE.	303
88	YANKEE cloud dimensions.	305
89	Area extent of YANKEE fallout cloud.	307
90	YANKEE heavy fallout area.	309
91	NECTAR predicted fallout pattern based on the method of elliptical approximations.	314
92	NECTAR instrumentation stations for the DOD scientific projects at Enewetak Atoll.	316
93	Ship positions at detonation time, NECTAR.	317
94	NECTAR cloud dimensions.	319
95	NECTAR close-in gamma fallout pattern.	321
96	NECTAR fallout areas.	322
97	Exposure rates versus time at six locations on Bikini Atoll.	412

LIST OF TABLES

<u>Table</u>		<u>Page</u>
1	CASTLE detonations, 1954.	25
2	Task Group 7.1 population at the Pacific Proving Ground, 1954.	58
3	Task Group 7.2 population at the Pacific Proving Ground, 1954.	60
4	Task Group 7.2 military police detachment locations.	60
5	Operation CASTLE, functions and complements of Task Group 7.3.	64
6	Estimated Task Group 7.3 personnel at Enewetak Atoll, 1954.	69
7	Task Group 7.4 personnel strength at the Pacific Proving Ground, 1954.	72
8	CASTLE Maximum Permissible Limits for radiation exposure.	97
9	CASTLE airborne monitoring survey schedule of the AEC New York Operations Office.	117
10	Summary of Bikini radsafe activities.	126
11	Shipboard radsafe activities.	127
12	F-84G sampling systems.	137
13	CASTLE aircraft.	155
14	Cloud-sampler aircraft decontaminated in CASTLE.	159
15	Number of aircraft that obtained usable cloud samples, CASTLE.	160
16	CASTLE Task Group 7.4 aircraft decontamination materials used.	161
17	Radiological contamination of Patrol Squadron 29 aircraft as of 18 May 1954.	165
18	Approximate unit strengths of Task Group 7.1 at the Pacific Proving Ground.	167
19	DOD scientific personnel radiation exposures.	170
20	BRAVO aircraft.	208
21	Average topside intensities of Task Group 7.3 ships following BRAVO.	215
22	Offsite fallout summary.	231
23	Summary of fallout exposures for BRAVO Navy elements.	237
24	Task Group 7.4 BRAVO aircraft decontamination.	239
25	Summary of estimated fallout exposure for BRAVO.	242

TABLES (continued)

<u>Table</u>	<u>Page</u>
26 Contamination readings of Rongerik personnel after BRAVO.	243
27 Planned and final sequence of CASTLE events and locations.	247
28 Summary of the status of transient shipping in the Pacific Proving Ground area on or about 27 March 1954.	252
29 Aircraft participating in ROMEO.	258
30 Aircraft positioning data for ROMEO.	258
31 ROMEO radiation summary.	263
32 Average topside radiation intensities of Task Group 7.3 ships at various times following ROMEO.	266
33 ROMEO airborne monitoring survey results of the AEC New York Operations Office.	268
34 Selected film badge readings.	269
35 Task Group 7.4 ROMEO aircraft decontamination.	270
36 Summary of the status of transient shipping in the Pacific Proving Ground on or about 7 April 1954.	273
37 Aircraft participating in KOON.	278
38 Aircraft positioning data for KOON.	278
39 KOON radiation summary.	280
40 KOON airborne monitoring survey results of the AEC New York Operations Office.	282
41 Task Group 7.4 KOON aircraft decontamination.	284
42 Summary of the status of transient shipping in the Pacific Proving Ground area on or about 26 April 1954.	285
43 Aircraft positioning data for UNION.	290
44 UNION radiation summary.	293
45 UNION atoll survey by Wilson 3 and 4 on shot day.	295
46 Secondary UNION fallout on vessels of Joint Task Force 7 on shot day.	295
47 UNION airborne monitoring survey results of the AEC New York Operations Office.	297
48 Task Group 7.4 UNION aircraft decontamination.	298
49 Summary of the status of transient shipping in the Pacific Proving Ground area on or about 5 May 1954.	299
50 YANKEE radiation summary.	308

TABLES (continued)

<u>Table</u>	<u>Page</u>
51 YANKEE airborne monitoring survey results of the AEC New York Operations Office.	311
52 Task Group 7.4 YANKEE aircraft decontamination.	312
53 Summary of the status of transient shipping in the Pacific Proving Ground area on or about 14 May 1954.	313
54 Shot-time aircraft position data for NECTAR.	318
55 NECTAR radiation summary.	320
56 NECTAR airborne monitoring survey results of the AEC New York Operations Office.	323
57 Task Group 7.4 NECTAR aircraft decontamination.	324
58 CASTLE personnel exposure, U.S. Army organizations.	326
59 CASTLE personnel exposure, U.S. Navy organizations.	333
60 <u>USS Curtiss</u> (AV-4) operational activities during CASTLE test series.	341
61 <u>USS Epperson</u> (DDE-719) operational activities during CASTLE test series.	342
62 <u>USS Nicholas</u> (DDE-449) operational activities during CASTLE test series.	343
63 <u>USS Renshaw</u> (DDE-499) operational activities during CASTLE test series.	344
64 <u>USS Philip</u> (DDE-498) operational activities during CASTLE test series.	345
65 <u>USS Grosse Point</u> (PC-1546) operational activities during CASTLE test series.	346
66 Evacuation and resurvey activities, March-April 1954.	348
67 <u>USS Bairoko</u> (CVE-115) operational activities during CASTLE test series.	350
68 Patrol squadron 29 (VP-29) operations.	352
69 <u>USS Estes</u> (AGC-12) operational activities during CASTLE test series.	354
70 <u>USS Gypsy</u> (ARSD-1) operational activities during CASTLE test series.	356
71 <u>USS Mender</u> (ARSD-2) operational activities during CASTLE test series.	357

TABLES (continued)

<u>Table</u>	<u>Page</u>
72 <u>USS Apache</u> (ATF-67) operational activities during CASTLE test series.	358
73 <u>USS Cocopa</u> (ATF-101) operational activities during CASTLE test series.	359
74 <u>USS Molala</u> (ATF-106) operational activities during CASTLE test series.	360
75 <u>USS Sioux</u> (ATF-75) operational activities during CASTLE test series.	361
76 <u>USS Tawakoni</u> (ATF-114) operational activities during CASTLE test series.	362
77 <u>YAG-39 (USS George Eastman)</u> and <u>YAG-40 (USS Granville S. Hall)</u> operational activities during CASTLE test series.	365
78 <u>USS Belle Grove</u> (LSD-2) operational activities during CASTLE test series.	367
79 <u>USS Reclaimer</u> (ARS-42) operational activities during CASTLE test series.	369
80 <u>USS Shea</u> (DM-30) operational activities during CASTLE test series.	370
81 <u>USS Terrell County</u> (LST-1157) operational activities during CASTLE test series.	371
82 <u>USNS Fred C. Ainsworth</u> (T-AP-181) operational activities during CASTLE test series.	374
83 LST-551 operational activities during CASTLE test series.	375
84 LST-762 operational activities during CASTLE test series.	376
85 LST-1146 operational activities during CASTLE test series.	377
86 CASTLE personnel exposure, U.S. Air Force organizations.	385
87 Task Group 7.4 parent organizations.	392
88 CASTLE personnel exposure, U.S. Marine Corps organizations.	398
89 Helicopter transport squadron (HMR-362) operational statistics.	399
90 CASTLE personnel exposure, joint defense agencies, other government, and contractors.	402
91 <u>Exposure by task group for shots ROMEO, KOON, UNION, YANKEE and NECTAR.</u>	410
92 Exposure by service branch and other organizations for entire CASTLE test series.	410

CHAPTER 1
OVERVIEW

INTRODUCTION

Purpose

CASTLE was a test series in which six nuclear fusion devices were detonated at the Atomic Energy Commission's (AEC) Pacific Proving Ground (PPG) at Enewetak and Bikini atolls in the spring of 1954. Table 1 lists the detonations.

Table 1. CASTLE detonations, 1954.

Date	Assigned Name	Location	Magnitude
1 March	BRAVO	Bikini; sandspit off Nam Island	15 MT ^a
27 March	ROMEO	Bikini; barge in BRAVO crater	11 MT
7 April	KOON	Bikini; surface of Eneman Island	110 KT
26 April	UNION	Bikini; barge in lagoon off Iroij Island	6.9 MT
5 May	YANKEE	Bikini; barge in UNION crater	13.5 MT
14 May	NECTAR	Enewetak; barge in MIKE ^b crater	1.69 MT

Notes:

^aOne kiloton equals the approximate energy release of the explosion of one thousand tons of TNT; one megaton equals the approximate energy release of the explosion of one million tons of TNT.

^b10.4 MT, IVY series detonation in 1952.

This report documents the participation of Department of Defense (DOD) personnel who were active in this test series. Its purpose is to bring together the available information about this atmospheric nuclear test series pertinent to the exposure of DOD personnel, both uniformed and civilian employees. The report attempts to explain the reasons that DOD

personnel were present at these tests, lists the DOD organizations represented, and describes their activities. It discusses the potential radiation exposure involved in these activities and the measures taken for the protection of personnel from these participating DOD organizations. It presents the exposures recorded by the participating DOD units. The information is limited to these points.

Historical Background

CASTLE was the culmination in the development of the super, or hydrogen, bomb that began in 1950. Fusion, or thermonuclear, reactions had been used in 1952 to generate a very powerful detonation of the MIKE device in Operation IVY, but MIKE was not a deliverable nuclear weapon. In BRAVO, the first test of the CASTLE series, a device more powerful than MIKE was exploded that, although not a weapon, was capable of delivery by an aircraft (Reference 1).

The BRAVO detonation also generated a cloud of device debris and coral particles that brought unexpected heavy exposures of ionizing radiation to some of the U.S. servicemen aiding in the conduct of the tests, to foreign fishermen, and to Marshall Islands residents. Radiation injuries resulted to some in the latter groups.

CASTLE also was the first Pacific test in which the University of California Radiation Laboratory (UCRL) at Livermore provided a nuclear device for testing, detonated as the KOON event of the series. All previous nuclear test devices had been designed at the Los Alamos Scientific Laboratory (LASL), New Mexico.

Report Organization

Subsequent sections of this overview chapter discuss the form of experimental nuclear weapon test programs with the emphasis on the potential radiation exposure of participating DOD personnel. The experimental activities are considered first without particular reference to the geographic location of the testing, and are then related to the geographic

limitations on such activities at the Pacific Proving Ground (PPG). The portion of the experimental program of heaviest DOD participation is emphasized.

The chapter concludes with a description of Joint Task Force 7 (JTF 7), the organization that conducted Operation CASTLE, and indicates how the DOD elements within JTF 7 functioned.

Chapter 2 is concerned with the radiological safety (radsafe) aspects of the tests. This chapter documents the procedures, training, and equipment used to protect participants from the radiation exposure inherent in the test operations.

Chapter 3 focuses on the role of the DOD in the experimental program of CASTLE in general, leading to a discussion of the DOD operations for the test events in particular in Chapters 4 and 5. Chapter 4 discusses the BRAVO detonation, and Chapter 5 presents the detonations following BRAVO.

Chapters 6 through 9 report participation by the Army, Navy, Air Force, and Marine Corps, respectively. Chapter 10 summarizes the participation of other government agencies and contractors. A listing of participating units and a statistical characterization of their personnel exposures are included in these chapters. The personnel exposures are discussed in Chapter 11.

Appendixes include: A -- Radsafe-related documents prepared for CASTLE; B -- Glossary of Terms, Abbreviations, Acronyms, and Units; C -- Island Synonyms; and D -- Index of Participating Organizations.

NUCLEAR TESTS AND RADIATION EXPOSURES

Nuclear testing before 1963 usually consisted of the unconfined detonation of nuclear devices (usually not weapons) in the atmosphere. The devices might be placed on a platform or a barge on the surface, placed atop a tower, supported by a balloon, dropped from an airplane, or flown

on a rocket. On occasion, devices were detonated underwater or buried in the earth.

In theory, personnel could be exposed either by the radiation emitted at the time of explosion and for about 1 minute thereafter -- usually referred to as initial radiation -- or the radiation emitted later (residual radiation). In practice, however, there was no involuntary direct exposure of personnel to initial radiation during testing. This is part of the violent nuclear explosion process itself; close enough proximity for initial radiation exposure would place an observer within the area swept by lethal blast and heat waves.

The neutron component of initial radiation did indirectly contribute to the possibility of personnel exposure. Neutrons are emitted in large amounts by nuclear weapon explosions. They have the property of altering certain nonradioactive materials so that they become radioactive. This process, called activation, works on some forms of sodium, silicon, calcium, manganese, and iron, as well as other common materials. The activation products thus formed were added to the inventory of the radioactive products formed in the explosion process. The radiation emitted by this inventory is referred to as residual radiation.

The potential for personnel exposure to residual radiation was much more of a real problem. In the nuclear explosion process, fissioning atoms of the heavy elements, uranium and plutonium, split into lighter elements, releasing energy. These lighter atoms are themselves radioactive and decay, forming another generation of descendants from the original fissions. This process is rapid immediately after the explosion but slows later and continues for years at very low levels of radioactivity.

The overall radioactivity of all the fission products formed decays at a rate that is closely approximated by a rule that states that for each sevenfold increase in time the intensity of the radiation will decrease by a factor of ten. Thus, a radiation rate of 1 roentgen per hour (R/hr) at

1 hour after the burst would be expected to be 0.1 R/hr after 7 hours and 0.01 R/hr after 49 hours. This rule seems to be valid for about 6 months following an explosion, after which the observed decay is somewhat faster than that predicted by this relationship. The activation products, in general, decay at a faster rate than the fission products.

Fission products and the activation products, along with unfissioned uranium or plutonium from the device, are the components of the radioactive material in the fallout cloud, and this cloud is the primary source of potential exposure to residual radiation.

In a nuclear airburst in which the central core of intensely hot material, or fireball, does not touch the surface, the bomb residues (including the fission products, the activation products resulting from neutron interaction with device materials, and unfissioned uranium and/or plutonium) are vaporized. These vapors condense as the fireball rises and cools, and the particles formed by the condensation are small and smoke-like. They are carried up with the cloud to the altitude at which its rise stops, usually called the cloud stabilization altitude. The spread of this material then depends on the winds and weather. If the burst size is small, the cloud stabilization altitude will be in the lower atmosphere and the material will act like dust and return to the Earth's surface in a matter of weeks. Essentially all debris from bursts with yields equivalent to kilotons of TNT will be down within 2 months (Reference 2). The areas in which this fallout material will be deposited will appear on maps as bands following the wind's direction. Larger bursts (yields equivalent to megatons of TNT) will have cloud stabilization altitudes in the stratosphere (above about 10 miles [16 km] in the tropics); the radioactive material from such altitudes will not return to Earth for many months and its distribution will be much wider. Thus, airbursts contribute little potential for radiation exposure to personnel at the testing area, although there may be some residual and short-lived radiation coming from activated surface materials under the burst if the burst altitude is sufficiently low for neutrons to reach the surface.

Surface and near-surface bursts pose larger potential radiation exposure problems. These bursts create more radioactive debris because more material is available for activation within range of the neutrons generated by the explosion. In such explosions, the extreme heat vaporizes device materials and activated Earth materials as well. These materials cool in the presence of additional material gouged out of the burst crater. This extra material causes the particles formed as the fireball cools to be larger in size, with radioactivity embedded in them or coating their surfaces. The rising cloud will lift these particles to altitudes that will depend on the particle size and shape and the power of the rising air currents in the cloud, which in turn depend on the energy of the burst. The largest particles will fall back into the crater or very near the burst area with the next largest falling nearby. It has been estimated that as much as 80 percent of the radioactive debris from a land-surface burst falls out within the first day following the burst (Reference 2).

Bursts on the surface of seawater generate particles consisting mainly of salt and water drops that are smaller and lighter than the fallout particles from a land burst. As a consequence, water-surface bursts produce less early fallout than similar weapons detonated on land. The large-yield surface bursts in the PPG over relatively shallow lagoon waters or on very little truly dry land probably formed a complex combination of land-surface- and water-surface-burst particle-size characteristics.

Several surface detonations at the PPG were of such a large size that they formed underwater craters. These craters retained a fraction of the weapon's radioactive debris and activated materials. The water that overlies these craters acted as a shield to protect surface operations from the radiation from this material, but it also provided a means for the material to move from the craters into the general circulation system of the lagoon waters. The craters were subject to washing and silt plumes were observed to come from them for long periods after the shots; it is reported that plumes from the MIKE crater were visible a year after the detonation (Reference 3, p. 207).

5

Detonations on towers may be considered as low airbursts or ground bursts, depending upon the relative height of the detonation and its yield. A larger burst will create more fallout than a smaller burst on an equal height tower not only because of the additional fission products and weapon debris, but also because it will pull up more Earth materials, or even form a crater. In addition, the materials of the tower itself provide a source of easily activated materials. The particles of the tower material may also act as centers for the debris vapors to condense on to form the larger particles that lead to heavier early fallout. Devices that fission uranium or plutonium inefficiently will cause more of these radioactive components of the device residue to be dispersed.

EXPERIMENTAL PROGRAM

Central to the test series was the experimental program. This program and its requirements dictated the form of the test organization and the detail of personnel participation. Like most of the preceding nuclear test series, CASTLE's experimental program incorporated two aspects, the most important of which was the development of the weapons themselves; the secondary experiments involved the measurement of the explosive and radiation effects.

These two aspects can serve as a rough measure of differentiation of interest between the major participants: the AEC interest in weapon development, and the DOD interest in the military application of the effects of the explosions. The several parts of the weapon development and the effects studies each had particular features that led to the possibility of radiation exposure.

Weapon Development

In testing devices, weapon designers are interested in two classes of measurements: the total energy release, or equivalent explosive yield, of the device, and the rate of release. The total energy release measurements are called yield measurements, and the rate of release measurements are called diagnostic measurements.

YIELD MEASUREMENTS. Device yield is usually determined by several methods, two of which involve photo-optical techniques. Growth of the intensely hot and radiating mass of device debris and air that constitute the nuclear fireball varies with its yield. Cameras were therefore used to record this growth, and film records subsequently analyzed to infer yield. The duration and the intensity of the energy pulse in the optical-thermal spectral region also vary with yield; thus, light detectors coupled to recorders were also used to derive yield.

In addition, yield may be determined by collecting and analyzing a representative sample of the device debris. Inferences are then drawn regarding the yield, based on knowledge of the materials in the unexploded device.

The construction, instrumentation placement, and data recovery for the photo-optical yield determinations did not usually require personnel to be in areas with a high potential for exposure to radiation. Cameras and light detectors need only a clear field of view of the burst point and enough breadth of view to encompass the fireball. Camera placement did not involve personnel at times and places of heavy contamination. Film recovery generally did not involve high exposure potential, as the photo stations were usually at ranges and in directions not heavily contaminated by fallout.

The sampling of device debris, however, necessitated much closer contact with higher levels of radioactivity. The technique used in CASTLE and most atmospheric tests was to fly aircraft with collectors directly through portions of the radioactive cloud. About 90 percent of the fission debris was usually considered to be in the upper portion of the radioactive cloud (Reference 2). Several aircraft were used to obtain a representative sample. The aircrews were exposed to the radiation emitted by the radioactive particles in the cloud as they flew through. The aircraft flying these sampling missions picked up significant amounts of radioactive material on their surfaces, posing additional and continuing

radiation exposures to the aircrews as they returned to base, as well as to decontamination ground crews. The samples collected were radiologically "hot" and required special handling as they were taken from the aircraft and prepared for shipment to the laboratory for analysis.

DIAGNOSTIC MEASUREMENTS. The explosion of a nuclear device is a progressive release of increasing amounts of nuclear radiation, some of which directly escapes the device. The rest of the radiant energy interacts with the associated material of the device itself and is converted into differing forms of radiation and into the kinetic energy of the remaining materials in a small fraction of a second. The intensely hot core then reradiates, heating the surrounding air and creating a shock wave that propagates outward from the burst point.

The weapon diagnosticians used sophisticated techniques to follow the processes that occur during the device explosion. Detectors and collectors were run up to, and sometimes inside, the device case so that the radiation being sampled could be directly channeled some distance away and there be recorded by instrumentation designed to survive the ensuing blast. To enhance its transport, radiation was conducted through pipes (often evacuated or filled with special gases) from the device to stations where recording instrumentation was located or where the information could be retransmitted to a survivable recording station.

Radiation measurements are based upon the effects that result from the interaction of the radiation with matter. Fluorescence is one such effect. Materials that fluoresce with radiation exposure were placed in view of cameras or light detectors to provide a record of the variation of fluorescent intensity with time, thereby providing an indirect measurement of the radiation environment.

Other methods of detecting radiation involve the shielding (attenuation) properties of earth materials, water, and other substances. These materials are also used to baffle or collimate radiation to ensure that radiation is directed toward the detecting instrument.

Radiofrequency energy produced by the explosion can be detected by radio receivers and, with the addition of filtering and processing circuitry, can also provide information about the energy flow from the explosion. Such measurements permit remote placement of receiving and recording instruments.

Preshot preparation included the hazards normally associated with heavy construction, and some exposures of workers to radiation occurred in areas contaminated by earlier tests.

The potential for radiation exposure of personnel associated with weapon diagnostic experiments depended upon the proximity of the measurement or data recovery point to ground zero and the time lapse between the detonation and the data collection.

The primary radiation exposure potential is from fission* products and materials made radioactive by neutron activation of device and Earth materials in the vicinity of ground zero. Thus, the distance from ground zero is a principal factor in assessing exposure to persons engaged in the experimental program.

Since radioactive material decays with time, the time lapse between the explosion and exposure is a critical factor in dose assessment. Primary recording media for these experiments were photographic films from oscilloscope, streak, or framing cameras located in survivable bunkers near the detonation point. Because radiation fogs film in time, these films and other time-sensitive data were removed from the bunkers by helicopter-borne personnel within hours of the detonation to minimize damage by fogging. This recovery constituted the main potential for exposure of weapon diagnostics participants.

* Although the CASTLE devices were thermonuclear, or fusion, devices, a significant portion of their energy release resulted from fission processes.

Effects Experiments

All the CASTLE shots tested new weapon developments. Priorities of time and space and go or no-go considerations favored the weapon development experiments over the effects experiments. Although the effects experiments were clearly secondary, they directly involved a relatively large number of DOD organizations and individuals and are therefore of prime importance for this report. In fact, the total support requirements for the effects experiments were 60 percent of the total support requirement (Reference 4, p. 57).

The effects experiments were intended to acquire urgently needed military data that could not be obtained from the smaller yield tests at the Nevada Proving Ground (NPG), now called the Nevada Test Site (NTS). These experiments may be classed into two general kinds. The first class of measurements was made to document the hostile environment created by the nuclear detonation. The second class of effects experiments documented the response of systems to the hostile environment; these measurements are termed systems response experiments.

ENVIRONMENTAL MEASUREMENTS. The purpose of environmental measurements was to gain a comprehensive view of the hostile environment created by a nuclear detonation to allow military planners to design survivable military hardware and systems and train personnel to survive. Examples of environmental measurements include static (crushing) and dynamic (blast wind) air pressures in the blast wave, heat generated by the detonation, and fallout radiation. The measurement techniques employed for CASTLE varied with the effect being measured, but usually measuring devices or gauges were placed at a variety of ranges from ground zero and their measurement recorded in some way. A wide variety of gauges and data recording techniques was used. In some cases, measurements were similar to those being made by the weapon designers, but at greater distances or longer after the detonation, which simplified the recording of the data, although the recovery problems were by no means trivial.

Rugged, self-recording gauges had been developed for blast and thermal radiation measurements by 1954 so that complete loss of data from a project would not occur if instrument recovery were delayed, for example, by heavy fallout. For nuclear radiation measurements, however, prompt data recovery was still desirable because the gauges used might be thin foils of material that would be made radioactive by the burst-time neutrons; hence, early observation was necessary, before the information contained in the induced radiation pattern decayed away.

The potential for radiation exposure of personnel responsible for environmental measurements in general depended on their proximity to the device and the time that elapsed between detonation and instrument recovery, as was the case for weapon development experimentation: the nearer in space or time to the detonation, the greater the potential for exposure.

SYSTEMS RESPONSE EXPERIMENTS. To document the response of systems to the hostile environment, military hardware (such as aircraft or naval mines) was exposed to the effects of nuclear detonations.

The techniques used for the systems response experiments were conceptually simple: exposure of the system of interest and observation of its response. Actual conduct of the experiments was far more complex. The level of the threat to which the system was exposed almost always required documentation so that the response could be properly understood, necessitating an environmental experiment along with the systems response experiment. It was often not enough to know whether the system survived, but rather, the response of the component parts and their interactions was required, entailing the placement of sophisticated instrumentation and recording devices.

While the potential radiological exposure for these systems response experiments was governed primarily by the closeness in space or time, an additional problem arose. Often, when the subject of the exposure itself was recovered for closer examination, it could be contaminated by device

debris or even be radioactive because of the activating effects of the device's neutron output.

OCEANIC TESTING OPERATIONS

The implications of oceanic testing have only incidentally been remarked upon. These are now discussed, especially as they relate to DOD operations during CASTLE.

Marshall Islands Setting

The Marshall Islands are in the easternmost part of the area known as Micronesia ("tiny islands"). The Marshalls cover about 770 thousand mi^2 (2 million km^2) of the Earth's surface but the total land area is only about 70 mi^2 (180 km^2). Two parallel chains form the islands: Ratak (or Sunrise) to the east, and Ralik (or Sunset) to the west; both Enewetak and Bikini are in the Ralik chain at its northern extreme. Figure 1 shows these islands in the Central Pacific, Figure 2 is a map of Enewetak Atoll, and Figure 3 is a map of Bikini Atoll.

Typical atolls, Enewetak and Bikini are coral caps set on truncated, submerged volcanic peaks that rise to considerable heights from the ocean floor. Coral and sand have gradually built up narrow islands into a ring-like formation with open ocean on the outside and a relatively sheltered lagoon on the inside. Both atolls have two passages, a wide passage and a deep one, that permit access to their lagoons from the sea. Enewetak also has a third. All the islands are low-lying, with elevations seldom over 20 feet (6 meters) above high tide.

During nuclear testing, the more populated, support-oriented sections were the south and southeast areas of the atoll where the larger islands exist. Devices were detonated on the northern islands and over the northern reefs. The western sections of the atoll were not involved in test activities except for limited use as instrumentation sites.

Elliptically shaped, Enewetak is approximately 550 nmi (1,020 km) southwest of Wake Island and 2,380 nmi (4,410 km) southwest of Honolulu.

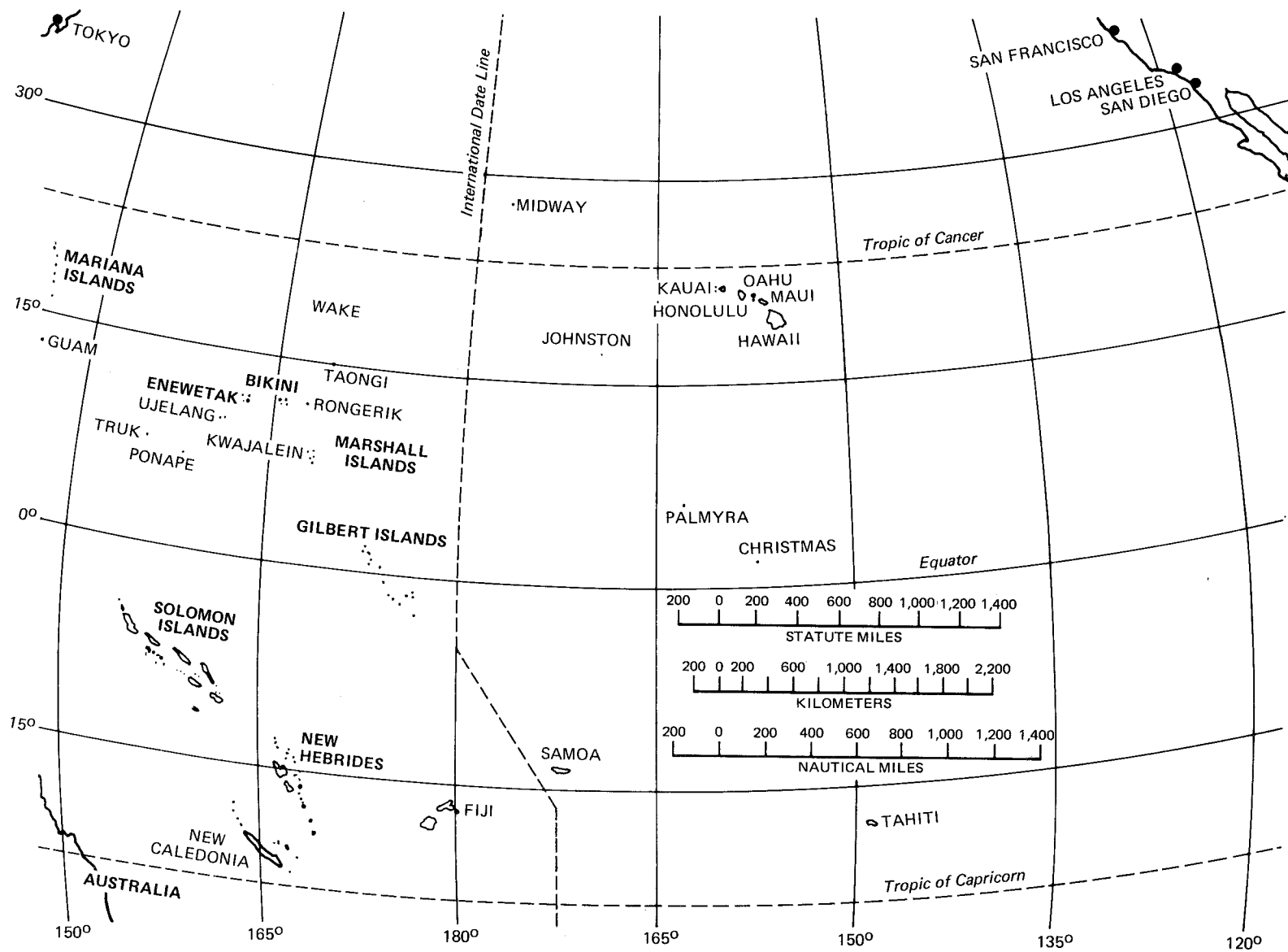

Figure 1. The Central Pacific.

ENEWETAK

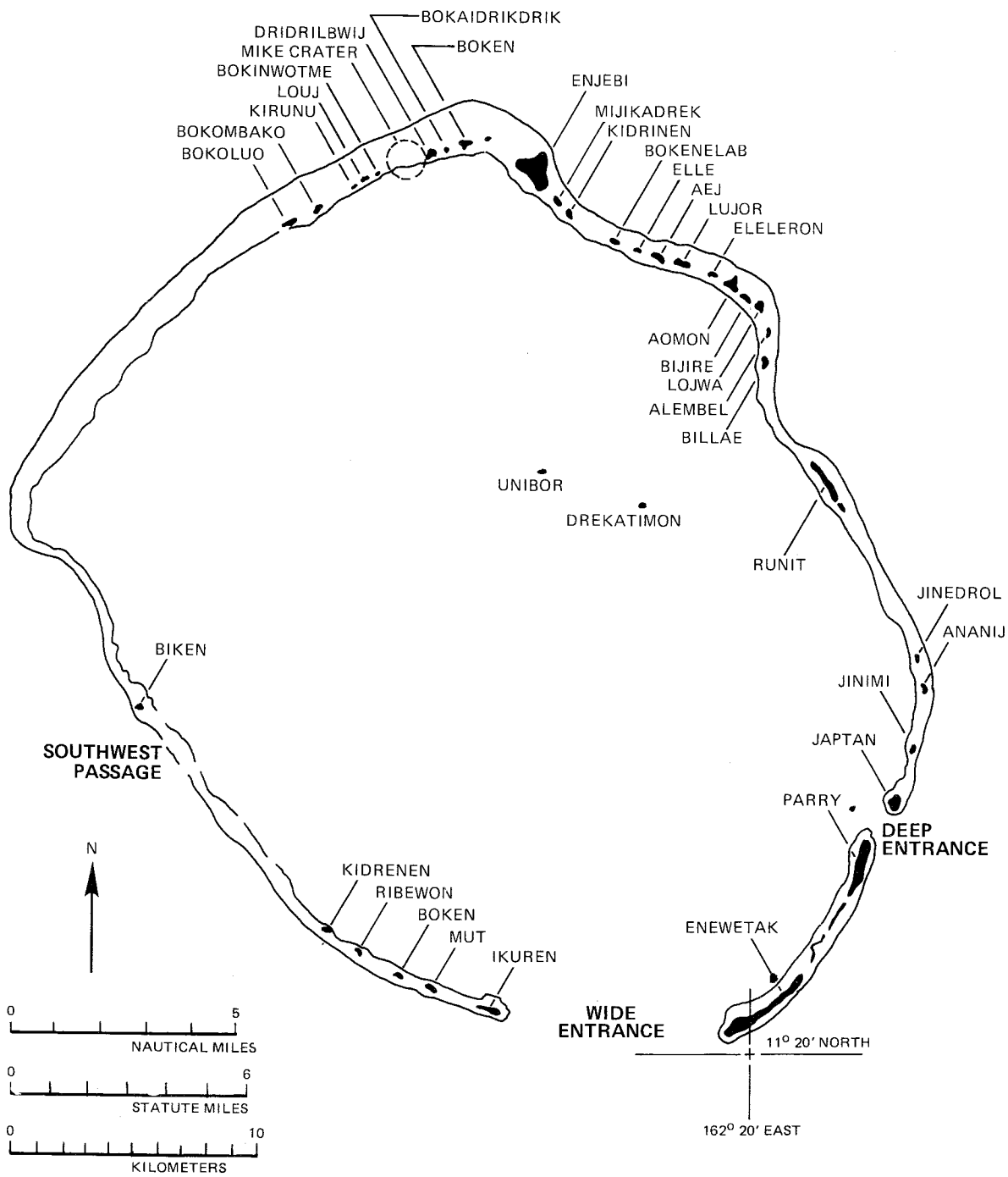

Figure 2. Enewetak Atoll, 1954.

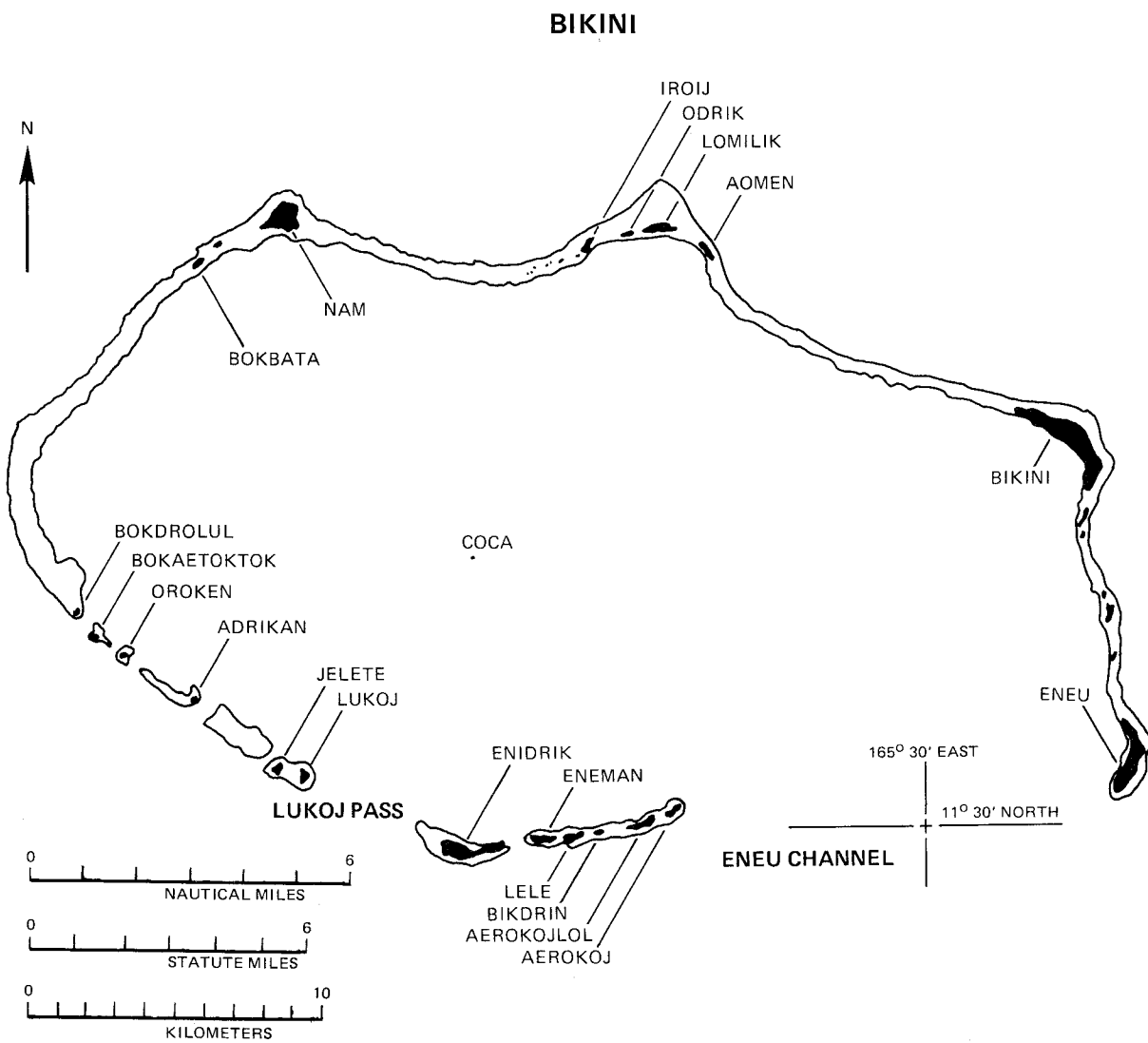

Figure 3. Bikini Atoll, 1954.

It encloses a lagoon 23 miles (37 km) in diameter and has a total land area of 2.75 mi² (7.12 km²), with elevations averaging 10 feet (3 meters) above mean sea level. The support section of Enewetak (Enewetak, Parry, and Japtan islands) constitutes about 34 percent of the atoll's land surface. The string of islands from Runit to Bokoluo, the detonation area, constitutes about 32 percent. The various names used for the islands of the atoll are listed in Appendix C, "Island Synonyms."

Bikini is 189 nmi (350 km) east of Enewetak. Its islands consist of about 2.7 mi² (7 km²) of surface area and encircle a lagoon that is 25 miles (40.2 km) long and 15 miles (24.1 km) wide, with a maximum depth of about 200 feet (61 meters). The land area is concentrated in the eastern islands, from Bikini to Eneu islands, which form about 53 percent of the land total, with 24 percent taken up by the southern section of Enidrik to Aerokoj. The detonation area in the north occupies about 19 percent of the land area.

The climate of Enewetak and Bikini is tropical marine, generally warm and humid. Temperature changes are slight, ranging from 70° to 90°F (21° to 32°C). Rainfall is moderate, and prolonged droughts may occur. North of both atolls is open ocean for a thousand miles, with the only inhabited island being Wake. Storms are infrequent, although typhoons occur; nevertheless, both wind and sea are continuous erosional agents. Although possible at any time, most tropical storms occur from September to December. Much cumulus cloud cover exists in the area.

The Enewetak-Bikini region incorporates three basic wind systems. The northeast trade winds extend from the surface to 25,000 to 30,000 feet (7.6 to 9.1 km), the upper westerlies from the top of the trades to the base of the tropopause at 55,000 to 60,000 feet (16.8 to 18.3 km), and the Krakatoa easterlies from the tropopause up into the stratosphere. These systems are all basically east-to-west or west-to-east currents. Day-to-day changes reflect the relatively small north-south components, which are markedly variable. Greatest variation occurs in the upper westerlies, particularly during late summer and fall.

The steady northeast trade winds in the lower levels cause the water at the surface of the lagoons to flow from northeast to southwest, where it sinks to the bottom and returns along the lower levels of the lagoons, rising to the surface along the eastern arc of the reefs and islands, where it is moved by the winds to the southwest again. The lagoon waters

moving in this closed loop also mix with those of the open ocean, resulting in a flushing action.

At Bikini, ocean water flows in over the northern and eastern reefs and flows out of the western portion of the Eneu Channel. The water exchanges over the western reefs with the tides, the ocean water flowing in and mixing with the flood and lagoon water flowing out with the lows. The net rate of flushing of Bikini waters is such that half of the lagoon waters are replaced by ocean water in 22 days and the original volume will account for only 10 percent of the lagoon volume after 2½ months.

At Enewetak, the flushing is more rapid and has two major routes. The first is directly through the eastern reefs to the western reefs; the second is through the Deep Passage between Japtan and Parry and out the Wide Passage west of Enewetak. These two routes also function to keep the waters of the northern part of the lagoon separate from the southern waters.

The land areas of Enewetak and Bikini atolls, their lagoons, and the waters within 3 miles (4.8 km) of their seaward sides constituted the PPG.* These islands are part of the Trust Territory, a strategic area trusteeship of the United Nations, administered by the United States. The U.S. agency in charge of the PPG itself was the AEC.

The Test Division of the AEC Division of Military Applications, Santa Fe Operations Office, administered the test site through its Enewetak Branch Office, which supervised engineering, construction, maintenance, operation, and management activities performed by its contractor, Holmes & Narver, Inc. (H&N), of Los Angeles.

Physical Conditions in 1954

Enewetak had been the site of nuclear testing since 1948: the islands in the southeast quadrant served as the base for the task forces, and the

* After 1956, the PPG was designated the Enewetak Proving Ground, or EPG.

islands from north through east-northeast were used for the tests themselves. The principal base islands were Enewetak, which bordered the Wide Passage, and Parry, northeast of Enewetak, which bordered the Deep Passage. These two islands account for about 30 percent of the atoll's land area.

Parry and Enewetak had been densely populated during IVY, serving as the home and working facilities for Joint Task Force 132 (JTF 132) (the predecessor of JTF 7) except for the Air Force task group (TG 132.4) and those living aboard ships. Included in the working facilities was an airfield occupying the southern end of Enewetak. Shops, warehouses, laboratories, and living space occupied most of the rest of the island's area. An aerial view of Parry is shown in Figure 4, and typical Enewetak living shelters are shown in Figures 5 and 6. In preparation for CASTLE, several important additions and improvements were made at Enewetak.

The first was the construction of a device assembly area on the southern end of Parry Island. The assembly area provided a specially secured,

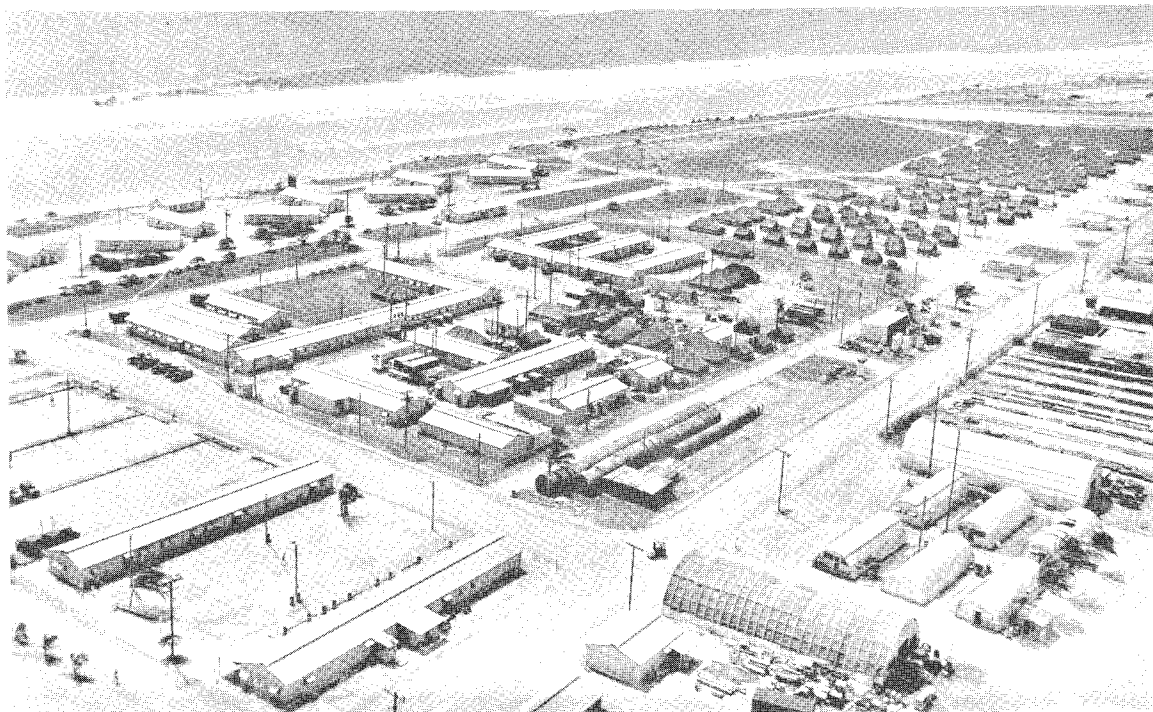

Figure 4. Aerial view of Parry during CASTLE.



Figure 5. Typical metal buildings used at Enewetak during CASTLE.



Figure 6. Tents on Parry, CASTLE.

single location for working on the nuclear devices. It included support and shelter of the assembly teams, machine tool facilities, and high-explosive magazines at hand. This was completed in March 1954 (Reference 5, p. 2-199).

The devices were largely assembled in this area and then transported by water to the test location. A ramp was available within the area so that an LST could take devices aboard by truck. The barge-detonated devices were assembled in a shelter (called a cab) on the barge, which was moored in a specially constructed slip equipped with a large overhead crane to handle heavy loads (Figure 7). After completion of work, the device barges were towed to their final destinations.

The Air Force component of the joint task force, based on Kwajalein in previous operations, was moved to Enewetak for CASTLE. This move required considerable improvement in the airfield that occupied the southern half of Enewetak Island. Figure 8 shows the extreme western end of the island looking west. The light area near the right wing of one of the parked B-36s is a decontamination area that was constructed for CASTLE.

In the northeastern arc of the islands, a causeway constructed for GREENHOUSE (1951) to link Eleleron, Aomon, Bigire, and Lojwa islands was widened. A major construction camp was built on the Lojwa end of this complex. This required some work that is more properly described in the following subsection (p. 47) on the radiological condition of Enewetak.

Generally, the northern and eastern islands involved in the shot or shot-support activities had been graded extensively. Japtan, lying just across the Deep Passage from Parry, still contained a considerable stand of coconut palms, pandanus, scaevola, and other tropical vegetation.

In October 1952, H&N, acting as the resident contractor for the AEC, began construction of a camp on Eneman Island on the southern perimeter of Bikini. An airstrip to serve Bikini-Enewetak traffic was also begun on the neighboring islands of Aerokojlol and Aerokoj and on the causeway that was



Figure 7. Assembly area on southern tip of Parry looking south, CASTLE.



Figure 8. Enewetak airfield looking west, CASTLE.

built to link them. This causeway was constructed from onsite materials and shored on either side by bulkheads. Before the CASTLE series got underway, Eneman, Lele, and Bikdrin islands had also been linked with the airstrip islands to form a complex 3 miles (4.8 km) long, traversable by wheeled vehicles. Additional causeways were constructed in 1953 that joined Iroij, Odrik, Lomilik, and Aomen islands in the northeastern arc of the Bikini islands. A causeway westward over the reefs from Nam in the northwest portion of Bikini was also built during 1953, terminating at an artificial island that became the detonation point for BRAVO, the first test of the CASTLE series.

Camps were also built on Nam, Lomilik, and Eneu to house construction workers building the test-related structures on or near these islands and island complexes. According to the directives of the AEC, all construction was to be of an expendable nature. A petroleum, oil, and lubricants (POL) storage area was also built on Lele to serve the main camp on Bikini at Eneman. Figure 9 shows the Eneman base camp viewed from the lagoon looking south-southwest. The large building in the center is the cab for the KOON device. The island to the right is Enidrik and has a blast line shaved down its center for the KOON test.

Radiological Conditions in 1954

The CASTLE planning literature refers to a detailed and comprehensive survey of the radiological condition of the islands at Enewetak in 1954 just before CASTLE. No record, however, has been found of this. Therefore, in order to assess the possibility of task force personnel exposure to ionizing radiation while preparing for CASTLE, it is possible only to discuss the test activities that had taken place at Enewetak and introduce any anecdotal or partial information that is available.

Enewetak had been used for nuclear tests in 1948, 1951, and 1952. The SANDSTONE (1948) detonations on Enjebi, Aomon, and Runit left portions of these islands contaminated. In February 1949, a survey party from the Hanford, Oak Ridge, and Los Alamos laboratories of the AEC found "a very



Figure 9. Eneman Camp, Bikini, looking south-southwest, CASTLE.

low activity of alpha" on the shot islands and only small "pools" of activity within 1,000 feet (305 meters) of the craters formed by the explosions. These areas were covered with soil during that year; a radiological survey in March 1950 showed less than 0.001 R/hr on Enjebi and Aomon and an average of 0.002 R/hr on Elereron. On Runit the general radioactivity was 0.0015 R/hr, but some of the old shot tower footings showed 0.012 R/hr. After a third survey in April and May of that year, it was concluded that no possibility of overexposure to gamma radiation existed on any island of the atoll and the wearing of film badges was discontinued (Reference 6).

The GREENHOUSE (1951) detonations were on Enjebi, Eleleron, and Runit and apparently left these islands and other areas contaminated. The DOG and ITEM tower residues were left in place on Enjebi after GREENHOUSE. Shot GEORGE of GREENHOUSE left a large radioactive crater on Eleleron.

MIKE, the first thermonuclear device, detonated on Eluklab in 1952 during Operation IVY, destroyed the island and left an underwater crater.

Eluklab had been located just west of Boken, at the northernmost extension of the atoll. A large air-dropped device was exploded over the reef just off Runit as the second event of the IVY series. The locations of all these pre-CASTLE detonations are shown in Figure 10.

A qualitative measure of the radiological conditions at Enewetak before CASTLE is available in the form of a joint task force TG 7.1 planning discussion held at LASL in March 1953. A LASL spokesman said that Enjebi "was still quite hot" at that time and that this should be taken into consideration in planning instrument placement for CASTLE (Reference 7).

A slightly more quantitative description of the contamination from prior tests and the subsequent work necessary to make it possible to work in the area is recorded in the final report for CASTLE of the base support contractor (Reference 5). An advance camp was to be set up on Lojwa in the Eleleron-to-Lojwa complex, and it was necessary to fill the crater on Eleleron resulting from the GEORGE detonation of GREENHOUSE. The "average radiation level in this area [presumably near the crater] was 50 to 95 mr per hour in December [1952]. . . . Some experimental work was done toward decontaminating the areas and it was found that the most satisfactory results were obtained by removal of vegetation and up to 12 inches of top soil." The disposal of this contaminated layer of soil is not discussed in Reference 5. The crater itself is a likely prospect. The crater was being filled in the spring of 1953 and by May 1953 the radiation level was low enough that "construction forces could live ashore in camps indefinitely, within allowable dosage" (Reference 5, p. 2-51). Before this, the construction personnel had been flown from Parry to Lojwa daily, or had lived in the lagoon on an LCU equipped as a houseboat. The actual campsite at Lojwa had to be scraped to a depth of about 3 inches (8 cm) and backfilled with uncontaminated coral to ensure its long-term habitability.

The MIKE detonation was many times larger than any prior Enewetak tests, and the crater formed was probably still radioactive. The crater, however, was thickly blanketed by seawater that provided a high degree of

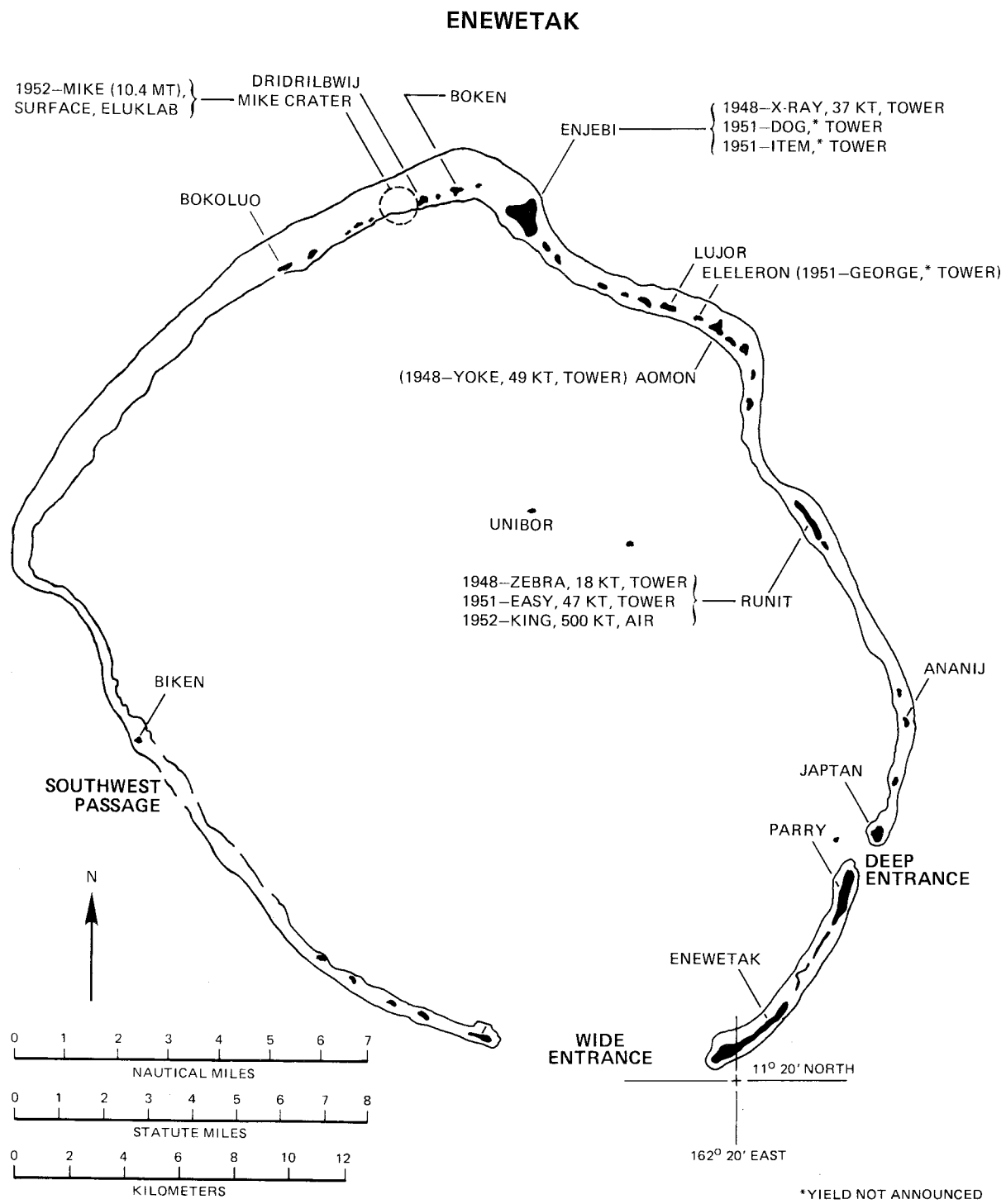

Figure 10. Enewetak detonation sites.

shielding from the crater's nuclear radiation to the surface operations. Scientific stations were built on Dridrilbwiij for CASTLE, the island next to the Eluklab crater, and no mention of special difficulties due to radiation is made in the construction report, although personnel film badges were still required.

Bikini was the location of the first postwar nuclear detonation. In July 1946, the CROSSROADS tests were conducted in the lagoon. Two 23-KT devices were detonated: one airburst over a target fleet, and the second burst underwater in the lagoon about 2 nmi (3.7 km) west of Bikini Island. There was no continuing radiological exposure of personnel on the surface at Bikini from these tests, although there was very-low-level contamination in the lagoon bottom.

Special Problems in Oceanic Testing

Testing in the Marshalls offered a large uninhabited area for test activities and for the favorable disposition of the test debris if the winds were in the right direction. However, the area was almost all water, offering little dry space to place shot towers, instrumentation shelters, test structures, or places to live. At Enewetak Atoll the total land area is only about 1,800 acres (730 hectares), and the prime acreage in the southeastern quadrant (about one-third of the total) housed that part of the task force not based on ships. The land area of Enewetak Island, the largest of the atoll, is only about 320 acres (130 hectares), and about half of this was occupied by an airstrip and associated activities. Furthermore, the land suitable for testing was not necessarily distributed in the appropriate directions and sizes for instrument placement. Lack of land area was one of the factors necessitating use of both Bikini and Enewetak atolls, starting in 1954 with CASTLE. The addition of Bikini also precluded damage to the Enewetak facilities by very-large-yield devices.

The lack of land was compensated for in part by civil engineering projects. Causeways were constructed that linked strings of islands to support the long pipe runs of some experiments over thousands of feet. These also

permitted land transportation from construction camps to proposed zero points, thus allowing more time during the workday to be expended on the job rather than in commuting by water from base islands. Some artificial islands were created as shot points and instrument locations.

Floating data-collection stations compensated for the lack of land area. These were used extensively in the nuclear radiation program. Anchored rafts and buoys, serving as fallout-collection stations, were placed in the lagoon and in the open sea. Ships also acted as fallout collectors. These offered the advantage of moving to the most desirable collection areas, that is, areas of heaviest fallout, and following the fallout within the limits of their speed. Two ships were modified for remote operation and control from other locations or below decks, where heavily shielded quarters protected skeleton crews and scientific parties.

Barge-mounted test devices, a technique first used in CASTLE, also compensated for the lack of land at the PPG. This allowed the available land area to be used for the placement of measurement instrumentation and reuse of the same burst point without the long delays required for radiological cooling by natural decay and expensive and long decontamination procedures, as described for the GEORGE crater of Operation GREENHOUSE. Reuse of zero points also allowed use of instrument locations and recording shelters for multiple tests, saving construction costs and time and increasing test-scheduling flexibility.

The use of shot barges, however, precluded the acquisition of some weapon development data that required a precise line of sight between the test device and the recording instrumentation. Barge movement by lagoon currents was minimized by special mooring techniques, but not to the degree necessary for some measurements. The barges also precluded use of the pipe runs required for some other diagnostic measurements.

Shot barges fitted well into the two-atoll testing scheme that was developed for CASTLE. Enewetak was the base of operations and Bikini was

like another shot island, except that its remoteness allowed very-large-yield tests without endangering the permanent facilities at Enewetak or requiring its evacuation. Bikini was without permanent facilities and depended on Enewetak for its overhead support. Part of this support was the combination of personnel, equipment, and materials required to assemble the test devices themselves. The new assembly area at Enewetak and the barge-zero stations allowed most of the support functions to remain at Enewetak.

JOINT TASK FORCE 7

JTF 7 was established as a permanent organization in 1953 to conduct nuclear weapon testing in the Pacific. It existed through 1958 when it conducted HARDTACK, the last test series before the 1958 through 1961 nuclear test moratorium. JTF 7 was the successor to JTF 132, which had conducted the IVY test series in 1952.

The joint task force incorporated into its organization elements of the four services, other governmental agencies including the AEC, and civilian organizations under contract. The AEC, charged with responsibility for nuclear energy development by the Atomic Energy Acts of 1946 and 1954, designated Commander JTF 7 (CJTF 7) as its representative. JTF 7 was also a subordinate command of the Commander-in-Chief of the Pacific (CINCPAC), who provided overall security and logistic support. The Chief of the Armed Forces Special Weapons Project (AFSWP) exercised technical direction of the weapon effects tests of primary concern to the Armed Forces. The complexity of these relationships is illustrated in Figure 11.

The resulting organization, though complex, worked well enough, as it conformed with the realities of the situation. The realities were that the tests were being conducted to develop nuclear weapons, an activity limited by law to a civilian agency, the AEC. The tests were being conducted in an area that came under the jurisdiction of the AEC (in the sense that the AEC was the U.S. government agency primarily responsible

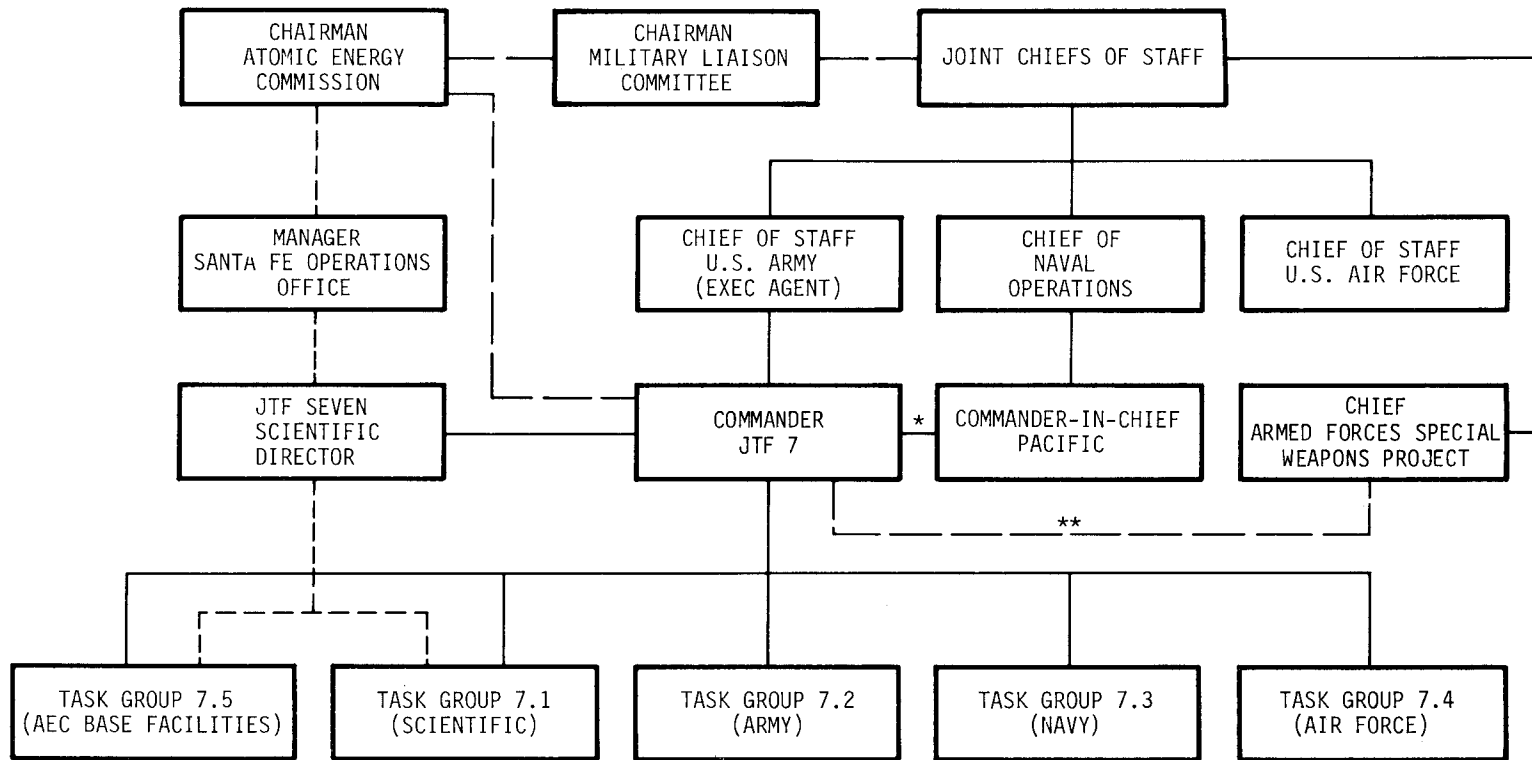

————— OPERATIONAL CONTROL
 - - - - - LIAISON
 AEC POLICY

* By decision of the JCS on 13 April 1951, CJTF reported to the appropriate commander under the JCS (CINCPAC) for movement control, logistic support and general security with respect to the task force and Enewetak Atoll (later broadened to include Bikini Atoll). In the absence of the task force commander from the Enewetak area, the senior task force officer present, as ATCOM, reported to CINCPAC for these purposes.

** By decision of the JCS on 23 April 1953, the Chief AFSWP exercised, within any task force organization, technical direction of the weapon effects tests of primary concern to the Armed Forces at atomic tests conducted outside the continental United States. Prior to the onsite phase of an overseas test operation, the task force consulted the Chief AFSWP on modifications or deletions to the DOD weapon effects test programs.

Figure 11. Organization chart, Joint Task Force 7.

for the islands that were included in the PPG). The United States, however, did not actually own the territory being used, but rather it was held in trust. Furthermore, the territory was remote from the United States and required special supply and security arrangements appropriate to military operations. Finally, the organization for which the weapons were being developed was the U.S. military establishment.

The DOD requirements for nuclear weapons were apparently forwarded to the AEC weapons laboratories through the Military Liaison Committee (see Figure 11). The AEC laboratories then designed the devices that were tested at the appropriate proving ground, either the NPG or the PPG. The special location of the PPG required a military operation to conduct the tests. The JTF 7 Scientific Director actually directed the tests and CJTF 7 enforced his decisions. The joint task force was divided into functional and service-branch oriented units, each of which reported to CJTF 7 through separate task group commanders.

Task Group 7.1 (Scientific)

TG 7.1 was the centerpiece of the operation. It contained representatives of the organizations providing the devices and the representatives of the DOD laboratory organizations interested in the effects of the devices. All the other groups at the PPG were there to assist TG 7.1.

TG 7.1 was primarily led by LASL. The newer laboratory, UCRL, did provide one test device in CASTLE and a large contingent of personnel, but most of the key positions in TG 7.1 were held by LASL personnel. There was a "Deputy for UCRL," a position that recognized both the new laboratory and its junior position. The task group was organized into task units with special functions. There were 12 task units, but they were designated 1 through 15, with no task units corresponding to 5, 10, and 11.

TASK UNIT 1 -- LASL PROGRAMS. The function of this unit was to make diagnostic measurements of the LASL-designed nuclear devices. DOD personnel did participate to a certain extent in this task unit, as further discussed in Chapter 3. TU 1 personnel totaled about 145.

TASK UNIT 2 -- PRODUCTION. This unit produced special materials for use in the nuclear devices of both TU 1 and TU 12 (UCRL Program). TU 2 worked at Parry. Its personnel were from an AEC contract organization, Herrick L. Johnston, Inc., of Columbus, Ohio. This group left the PPG in April. TU 2 personnel totaled about 45.

TASK UNIT 3 -- SPECIAL MATERIALS AND FACILITIES. The mission of this unit was the handling and delivery of the special materials produced by TU 2 to the users in TU 4 (LASL Assembly) and TU 14 (UCRL Assembly). Like TU 2, this unit was composed of employees of an AEC contractor, the Cambridge Corporation of Denver, Colorado. This group also left the PPG in April. TU 3 personnel totaled about 60.

TASK UNIT 4 -- LASL ASSEMBLY. This unit was composed of LASL personnel and personnel from its contractor, American Car and Foundry, Inc. (ACF). The LASL-designed devices were actually assembled by ACF except for the NECTAR device, which was fabricated at LASL. This unit worked primarily at Parry. TU 4 personnel totaled about 75.

TASK UNIT 6 -- FIRING PARTY. TU 6 armed and fired the devices. Its work involved checking the various electromechanical links that prevented premature device detonation and removing them just before activating the firing mechanism. All the Bikini devices were detonated by signals sent over a wire system from the bunker at Station 70 on Eneu, which was manned by TU 6 for BRAVO, but the remaining Bikini tests were initiated by a radio signal from the USS Estes to the evacuated bunker. The test at Enewetak, NECTAR, was wire-detonated from Parry. The single person identified with TU 6 was from LASL.

TASK UNIT 7 -- RADIOLOGICAL SAFETY. This unit was made up of Army personnel from the 1st Radiological Safety Support Unit (RSSU) from Ft. McClellan, Alabama, commanded by a military officer from LASL, and was supplemented by personnel from DOD and AEC agencies. The activities of TU 7 are described in Chapter 2. TU 7 personnel numbered about 54.

TASK UNIT 8 -- TECHNICAL PHOTOGRAPHY. This task unit provided still and motion picture services for the scientific and technical operations. It was composed of LASL personnel with DOD supplements and numbered about 20.

TASK UNIT 9 -- DOCUMENTARY PHOTOGRAPHY. This task unit, made up of personnel from the Air Force 1352nd Motion Picture Squadron based at Look-out Mountain Laboratory, took motion pictures and still photographs of the operations, including crater survey and cloud photography. Besides five camera crews and up to four aircraft stations, TU 9 also had six remote camera installations. TU 9 personnel numbered 51.

TASK UNIT 12 -- UCRL PROGRAM. This task unit was the UCRL unit comparable to TU 1 (LASL Programs). TU 12 and TU 14 (UCRL Assembly) combined numbered about 272.

TASK UNIT 13 -- DOD PROGRAMS. This task unit is described in Chapter 3.

TASK UNIT 14 -- UCRL ASSEMBLY. This task unit, composed entirely of UCRL employees, did assembly work on the KOON device in the shot cab on Eneman and on the device that was to be used for the ECHO test on Eleleron. Most of the work on the KOON device was finished before BRAVO. The device for the ECHO event was nearly completely assembled when the event was cancelled on 13 April.

TASK UNIT 15 -- TIMING. This unit provided timing signals transmitted by wire and radio that were primarily intended to coordinate the device firing systems; however, the unit also serviced all experiments requiring preshot instrument starting and reference timing signals. Personnel from Edgerton, Germeshausen, and Grier (EG&G), an AEC contractor, manned this task unit and numbered about 70 persons.

The geographic distribution of TG 7.1 personnel as CASTLE progressed is shown in Table 2.

Table 2. Task Group 7.1 population at the Pacific Proving Ground, 1954.

Date	Enewetak	Bikini	Other Locations	Total
1 Jan	59	32	0	91
1 Feb	404	327	5	736
15 Feb	513	342	16	871
1 Mar	520	485	17	1,022
29 Mar	595	294	2	891
5 Apr	617	211	0	828
26 Apr	441	178	0	619
5 May	344	152	0	496
15 May	393	0	0	393

Source: Reference 8, April and May Installments.

Task Group 7.2 (Army)

This group, the successor to TG 132.2, was the permanent garrison force in the PPG and had been present during Operation IVY. Its lineage dated back to the inception of nuclear weapon testing at Enewetak in 1948 (Operation SANDSTONE). The bulk of TG 7.2 was the 7126th Army Unit (AU), which had been formed from several Army units (listed in Chapter 6) that had made up TG 132.2.

TG 7.2 missions included control of all task force military personnel remaining in the forward area after the close of IVY, reestablishment of the normal garrison force functions, provision of base facilities for tenant units, serving as the representative of the CINCPAC at Enewetak, and providing internal military security and ground defense for the atoll. The tasks as finalized by CJTF 7 Operation Plan 3-53 (Reference 9) were as follows:

1. Provide for the ground security of Enewetak and Bikini atolls
2. Prevent unauthorized entry into exclusion areas, coordinating this activity with CTG 7.5
3. With transportation support furnished by TG 7.3 and TG 7.4, guard Enewetak and Bikini atolls to prevent unauthorized removal of significant samples from shot islands and unauthorized photography and trespassing
4. Deny entry of uncleared personnel to Enewetak and Bikini atolls
5. Coordinate security and stevedoring support requirements with CTG 7.5
6. Provide and operate the overall system for all forward area task force interatoll and long-haul communications except air operations, air weather, internal naval communications, and the TG 7.1 interatoll radio circuit
7. Continue to operate all base facilities at Enewetak Island, except those specifically allocated to CTG 7.4 and CTG 7.5
8. Conduct port and stevedoring operations at Enewetak Atoll with the assistance of CTG 7.5
9. Operate and maintain a TG 7.2 Boat Pool at Enewetak
10. Provide support services for Hq JTF 7 as required
11. Provide monitoring and decontamination services
12. Conduct emergency postshot evacuation of all Enewetak Atoll personnel if ordered by CJTF 7
13. With assistance from TG 7.4, provide logistic support for those elements of JTF 7 based on Enewetak Island
14. Ship all surplus equipment and materiel in accordance with instructions from CJTF 7
15. Support TG 7.1 as directed by CJTF 7.

The population of TG 7.2 is shown in Table 3. Most TG 7.2 activity was at Enewetak Island; however, some military police detachments were located elsewhere (see Table 4).

Table 3. Task Group 7.2 population at the Pacific Proving Ground, 1954.

Date	Army	Navy (Enewetak Boat Pool)	Total
1 Jan	1,190	48	1,238
1 Feb	1,235	37	1,272
1 Mar	1,259	28	1,287
1 Apr	1,214	62	1,276
1 May	1,123	52	1,175
19 May	1,012	42	1,054

Source: Reference 10.

Table 4. Task Group 7.2 military police detachment locations, CASTLE.

Pre-BRAVO		Post-BRAVO	
Location	Number of Personnel	Location	Number of Personnel
Enewetak	66	Enewetak	70
Parry	75	Parry	67
Bijire	28	Bijire	36
Eneman	52	Other	29
Nam	13	TOTAL	202
Lomilik	3		
Eneu	4		
TOTAL	241		

Source: Reference 10.

Task Group 7.3 (Navy)

This group provided the living support at Bikini as well as several specialized sea transport and scientific experiment support activities.

The TG 7.3 tasks as they were finalized in JTF 7 Operation Plan 3-53 (Reference 9) were as follows:

1. Provide for the security of Enewetak-Bikini danger area.
2. Operate a boat pool at Bikini.
3. Provide a forward area interatoll surface transportation system.
4. Control harbor operations at Enewetak and Bikini.
5. Detail two PBM amphibians and required personnel to the operational control of CTG 7.4 to provide amphibious airlift services between Enewetak and Bikini when required.
6. Provide shipboard assembly facilities for the experimental devices and laboratory, shop, and office space for TG 7.1.
7. Transport the experimental devices and associated personnel between and within Enewetak and Bikini atolls. Provide suitable escort in transit and conduct rehearsals of this activity as required.
8. Operate a ship-to-shore and intra-atoll helicopter lift system at Bikini to support preshot operations and postshot flights for damage survey and recovery of scientific data. Assist CTG 7.4 in this activity at Enewetak upon conclusion of Bikini operations.
9. Provide space on the USS Bairoko for a mobile radiochemical laboratory and a photodosimetry trailer and the associated operations of the radsafe unit (TU 7) of TG 7.1.
10. Conduct all aircraft decontamination operations aboard the Bairoko without outside assistance; conduct aircraft decontamination operations ashore at Bikini with assistance from CTG 7.1.
11. Provide decontamination crews for TG 7.3 aircraft at Enewetak Atoll; assist with TG 7.4 aircraft decontamination when required.
12. Provide shipboard command, control, and communications facilities for CJTF 7; staff, communications,

and electronic facilities for TG 7.4 aircraft control; and command and administration space for Hq TG 7.1 and Hq TG 7.5.

13. Provide shipboard housing for all task force elements at Bikini.
14. Provide emergency postshot evacuation of personnel (for less than 48 hours) if necessary.
15. Provide for radiological safety of all embarked task force personnel.
16. Provide alternate emergency communication channels for the task force if needed.
17. Provide facilities and aerological personnel aboard the Estes for the Task Force Weather Central and facilities for communications security monitoring personnel.
18. Assist CTG 7.5 in positioning and mooring device barges and provide standby support for moored barges during bad weather.
19. Position, service, and recover tethered and free-floating buoyage systems and instrumentation for TG 7.1 projects.
20. Assist in carrying out crater surveys as required.
21. Direct the movement of drone vessels during shot periods, in coordination with CTG 7.1, and assist in large-scale decontamination of these vessels and effects aircraft loaded thereon.
22. Assist CTG 7.4 in search and rescue (SAR) operations as required.
23. Station one DDE between Enewetak and Bikini atolls during the Bikini shot phases to assist in aircraft control.
24. Coordinate with CTG 7.4 to integrate TG 7.3 aircraft into shot-time aircraft positioning plans.
25. Control TG 7.3 aircraft in shot areas in accordance with shot-time positioning plans and orders from the JTF Air Operations Center (AOC) on the Estes. Assume control of shot area as necessary for air defense and alert CTG 7.4 to remove test aircraft from the area if necessary.
26. Augment CTG 7.2 personnel as necessary to support TG 7.3 elements on Enewetak Island.
27. Provide additional support for TG 7.1 as directed by CJTF 7.

In order to carry out this long list of functions, TG 7.3 was organized into task elements. The task elements with their functions, the naval units involved, and numbers of persons are presented in Table 5.

Throughout Operation CASTLE, the vast majority of the 6,351 personnel of TG 7.3 remained on board the ships to which they were assigned. Prior to BRAVO, detonated on 1 March at Bikini Atoll, only a few men were stationed on Eneman Island at Bikini. These included the personnel and aircraft of the Bikini Fighter Element, TE 7.3.2.2, the Bikini Boat Pool dispatcher (who worked on board the boat pool houseboat YFN-934), and approximately half of the personnel of HMR-362 with six HRS-2 helicopters. Following shot BRAVO, Eneman was abandoned, TE 7.3.2.2 was transferred to Enewetak Island, and the HMR-362 personnel moved their equipment from the island back on board the Bairoko and continued to operate from the carrier. The boat pool dispatcher continued to work on board YFN-934 in the interim periods between Bikini shots.

Since Navy activities were concentrated at Bikini, particularly after shot BRAVO, the majority of the task group ships remained there almost constantly. Originally, the flagship, Estes, was to be based at Enewetak between Bikini shots. However, when all Bikini operations moved afloat after 1 March, the Estes remained at Bikini for most of the operation.

Relatively few TG 7.3 personnel were stationed on shore at Enewetak Atoll during the shot phase of Operation CASTLE. A rough estimate of the number of people and their location is shown in Table 6.

The Surface Security Unit, 7.3.1, always had two destroyer escorts stationed at Enewetak. Similarly, the Utility Unit, 7.3.5, had at least two tugs (ATFs) there. Ships assigned to the atoll rotated at regular intervals. The LSTs of the Transport Unit, 7.3.9, were based at Enewetak. YAG-39 (USS George Eastman) and YAG-40 (USS Granville S. Hall) were also based at Enewetak because the personnel of Project 6.4 were located on Parry Island. On several occasions other task group ships came over from

Table 5. Operation CASTLE, functions and complements of Task Group 7.3.

Task Element/Unit		Ship Name, Hull Number	Complement ^a			Personnel in Consolidated List ^b			Comments
Number	Name		Off	EM	Civ	Off	EM	Civ	
7.3.0	SPECIAL DEVICES UNIT								
7.3.0.0	Special Devices Element	<u>Curtiss</u> (AV-4)	40	668	0	51	594	0	Provided surface transportation for shot devices from the United States to the PPG; in the PPG provided laboratory and machine shop facilities to TG 7.1, assisted in positioning aircraft at shot time using a Raydist system; served as a radsafe check-point and decontamination station.
7.3.0.1	Escort Element	Destroyers as assigned (See 7.3.1)							Escort Division Twelve provided a screen for <u>Curtiss</u> (AV-4) from Hawaii to the PPG.
7.3.1	SURFACE SECURITY UNIT	Commander Escort Division 12	NA	NA	NA	3	5	0	On board <u>Epperson</u> (DDE-719); unit provided surface security for both atolls, a plane guard for <u>Bairoko</u> (CVE-115), a control ship for TG 7.4 aircraft during shots, scientific project support, and escorts for 7.3.0 and 7.3.9 as required.
		<u>Nicholas</u> (DDE-449)	16	257	0	17	255	0	
		<u>Philip</u> (DDE-498)	17	246	0	18	256	0	
		<u>Renshaw</u> (DDE-499)	17	242	0	19	250	0	Assisted Project 2.5a in recovering fallout buoys.
		<u>Epperson</u> (DDE-719)	20	287	0	25	283	0	Assisted Project 2.5a in recovering fallout buoys.
		PC-1546	5	55	0	5	57	0	Supported JTF 7 Rongerik weather station and Project 6.6 personnel at Rongerik Atoll for shots YANKEE and NECTAR.

NA -- Not Available.

Sources:

^aFrom TG 7.3 Final (Reference 11) or Operation Plan 1-53 (Reference 12).

^bFrom Consolidated List of Exposures (Reference 13).

(continued)

Table 5. Operation CASTLE, functions and complements of Task Group 7.3 (continued).

Task Element/Unit		Ship Name, Hull Number	Complement ^a			Personnel in Consolidated List ^b			Comments
Number	Name		Off	EM	Civ	Off	EM	Civ	
7.3.1.0	Enewetak Surface Security Unit	Ship(s) as assigned (See 7.3.1)							
7.3.2	CARRIER UNIT								
7.3.2.0	Carrier Element	<u>Bairoko</u> (CVE-115)	69	823	0	69	817	0	Operated the intra-atoll system at Bikini; provided space for the task force Radsafe Center at Bikini.
		15 HMR-362 helicopters	21	97	0	21	57	0	Provided intra-atoll helicopter lift system at Bikini from <u>Bairoko</u> (CVE-115).
7.3.2.1	Bikini Fighter Element	VC-3, 3 F4U-5Ns	4	15	0	NA	NA	NA	Based at Eneman airstrip originally; provided air security at Bikini Atoll until shot BRAVO; moved to Enewetak following shot BRAVO.
7.3.2.2	Enewetak Fighter Element	VC-3, 3 F4U-5Ns	4	15	0	NA	NA	NA	Based at Enewetak; provided air security at Enewetak Atoll; combined with TE 7.3.2.1 following shot BRAVO.
7.3.3	PATROL PLANE UNIT	VP-29 (augmented) 12 P2V-6s	53	365	0	52	176	0	Based at Naval Air Station, Kwajalein; provided air searches and security for the PPG danger area; assisted Project 2.5a in recovering fallout buoys.
		P2V-5	3	5	0	Included in VP-29			Based at Enewetak; supported Project 6.4.
		P4Y-2	3	5	0	Included in VP-29			Based at Enewetak; supported Project 1.4.
		2 PBM-5As	6	10	0	Included in VP-29			Based at Enewetak; provided inter-atoll air transportation.

NA -- Not Available.

Sources:

^aFrom TG 7.3 Final (Reference 11) or Operation Plan 1-53 (Reference 12).

^bFrom Consolidated List of Exposures (Reference 13).

(continued)

Table 5. Operation CASTLE, functions and complements of Task Group 7.3 (continued).

Task Element/Unit		Ship Name, Hull Number	Complement ^a			Personnel in Consolidated List ^b			Comments
Number	Name		Off	EM	Civ	Off	EM	Civ	
7.3.4	JOINT TASK FORCE FLAGSHIP UNIT	<u>Estes</u> (AGC-12)	46	601	2	45	513	0	Provided headquarters facilities for JTF 7, TG 7.1 through 7.4, the Rad-safe Office, and air control at Bikini Atoll.
7.3.5	UTILITY UNIT								Provided towing and related services to the joint task force
		<u>Mender</u> (ARSD-2)	5	59	0	5	67	0	Supported Project 1.4.
		<u>Gypsy</u> (ARSD-1)	6	56	0	6	55	0	Supported Project 1.4.
		<u>Apache</u> (ATF-67)	5	77	0	5	78	0	Supported Projects 1.4 and 2.5.
		<u>Sioux</u> (ATF-75)	5	81	0	5	81	0	Supported Projects 1.4, 2.5, and 2.7.
		<u>Cocopa</u> (ATF-101)	5	76	0	7	75	0	Supported Project 1.4.
		<u>Molala</u> (ATF-106)	6	80	0	6	82	0	Supported Project 6.4 as TE 7.3.6.1.
		<u>Tawakoni</u> (ATF-114)	6	75	0	6	74	0	Supported Projects 1.4 and 6.4 as TE 7.3.6.1.
7.3.6	AW SHIP COUNTERMEASURES TEST UNIT								Provided support for Projects 6.4 and 6.5.
7.3.6.0	Drone Ship Element	<u>George Eastman</u> (YAG-39)	4	47	0	4	55	0	
		<u>Granville S. Hall</u> (YAG-40)	4	48	0	3	51	0	
7.3.6.1	Towing and Decontamination Element	ATFs as assigned (See 7.3.5)							
7.3.7	BIKINI HARBOR UNIT								Provided harbor services, including fuel replenishment facilities at Bikini Atoll.

Sources:

^aFrom TG 7.3 Final (Reference 11) or Operation Plan 1-53 (Reference 12).

^bFrom Consolidated List of Exposures (Reference 13).

(continued)

Table 5. Operation CASTLE, functions and complements of Task Group 7.3 (continued).

Task Element/Unit		Ship Name, Hull Number	Complement ^a			Personnel in Consolidated List ^b			Comments
Number	Name		Off	EM	Civ	Off	EM	Civ	
7.3.7.0	Landing Ship Dock Element	<u>Belle Grove</u> (LSD-2)	20	318	0	19	321	0	Boat Pool mother ship; also transported shot devices from Enewetak to Bikini as TE 7.3.9.0.
7.3.7.1	Boat Pool Element	15 LCMs, 5 LCUs, 2 LCPRs, 1 LCPL, 1 28-ft MWB, 1 AVR, YCV-9, YFN-934	4	233	0	4	215	0	Provided intra-atoll surface lift at Bikini Atoll, in conjunction with H&N. YFN-934 served as the houseboat for the boat pool during interim periods; YCV-9 served as a helicopter landing platform to assist in preparation of the shot sites.
7.3.7.2	Mine Project Element	<u>Shea</u> (DM-30)	16	256	0	16	263	0	All Mine Project Elements supported Project 3.4.
7.3.7.3	Mine Laying and Recovery Element	Explosive Ordnance Disposal Unit One	2	8	0	2	8	1	Probably on LST-1157 roster. Includes Explosive Ordnance Disposal Unit One, Mine Project Six, and probably Naval Beach Group One personnel.
		Naval Beach Group One	0	9	0	NA	NA	NA	
		LST-1157	7	127	0	11	173	2	
		<u>Reclaimer</u> (ARS-42)	6	88	0	6	88	0	
7.3.7.4	Mine Readying and Analysis Element	LST-1157 (see 7.3.7.3)							
		Mine Project Six	2	30	2	2	30	2	On LST-1157 roster.
7.3.8	ENEWETAK HARBOR UNIT	YOG-61	0	10	0	NA	NA	NA	Provided harbor and fuel services at Enewetak Atoll.
		YO-120	0	11	0	NA	NA	NA	
		YOGN-82	0	6	0	NA	NA	NA	
		1 AVR	NA	NA	NA	NA	NA	NA	

NA -- Not Available.

Sources:

^aFrom TG 7.3 Final (Reference 11) or Operation Plan 1-53 (Reference 12).

^bFrom Consolidated List of Exposures (Reference 13).

(continued)

Table 5. Operation CASTLE, functions and complements of Task Group 7.3 (continued).

Task Element/Unit		Ship Name, Hull Number	Complement ^a			Personnel in Consolidated List ^b			Comments
Number	Name		Off	EM	Civ	Off	EM	Civ	
7.3.8.0	Underwater Detection Unit	1 LCM	1	22	0	1	12	0	Operated a hydrophone system at Enewetak Atoll.
7.3.9	TRANSPORT UNIT								
7.3.9.0	Special Devices Transport Element	Belle Grove (LSD-2) (See 7.3.7.0)							
7.3.9.1	Special Devices Transport Element	LST-762	6	122	0	6	118	0	Transported shot devices from Enewetak to Bikini; provided inter- atoll surface transportation.
7.3.9.2	Escort Element	Ship(s) as assigned See 7.3.1							
7.3.9.3	Escort Element	Ship(s) as assigned See 7.3.1							
7.3.9.4	Material Transport Element	LST-551	6	99	0	6	99	0	Provided interatoll surface transportation.
		LST-825 (Replaced LST-551)	6	102	0	NA	NA	NA	
7.3.9.5	Material Transport Element	LST-1146	NA	NA	NA	6	89	0	
7.3.9.6	Personnel Transport Element	Fred C. Ainsworth (T-AP-181)	7	23	167	8	21	169	Provided afloat housing for TG 7.5 at Bikini Atoll; served as a radsafe checkpoint and decontamination station.

NA -- Not Available.

Sources:

^aFrom TG 7.3 Final (Reference 11) or Operation Plan 1-53 (Reference 12).

^bFrom Consolidated List of Exposures (Reference 13).

Table 6. Estimated Task Group 7.3 personnel at Enewetak Atoll, 1954.

	Enlisted Men	Officers
Enewetak Island (236 total)		
TG 7.2 Boat Pool Detachment	112	
Underwater Detection Unit, 7.3.8.0	22	1
Enewetak Harbor Unit, 7.3.8	27	1
Serving in Army Post Office 187	3	
Enewetak and Bikini Fighter Elements, 7.3.2.1, 7.3.2.2	30	8
Project 1.4 P4Y-2 aircraft (1)	5	3
Project 6.4 P2V-5 aircraft (1)	5	3
PBM-5A aircraft (2)	10	6
Parry Island (5 total)		
Task Group Hq Communications (boat pool personnel)	5	

Sources: Reference 9, p. D-3; Reference 11, p. 7c-1; Reference 14, April Installment, p. 59, May Installment, pp. 212-213, 238.

Bikini to assist in sorties for shot NECTAR, which was cancelled a number of times before it was finally detonated on 14 May.

Task Group 7.4 (Air Force)

The Air Force task group had not been based at Enewetak during IVY, the previous test series at the PPG, but at Kwajalein. The mission of this task group was generally to provide air transport, aircraft and crews for cloud sampling, air operations control, and general air support. The specifics of the JTF 7 Operation Plan 3-53 (Reference 9) were:

1. Provide, maintain, and operate aircraft in support of the following scientific missions
 - a. Cloud sampling and cloud tracking
 - b. Measurements of blast, gust, and thermal effects on aircraft

- c. Technical and report photography
 - d. Airborne direction of sampling aircraft.
2. Conduct weather reconnaissance flights to provide Task Force Weather Central with required data.
 3. Operate task force weather stations at Enewetak, Ponape, Rongerik, Majuro, and Kusaie, and support TG 7.1 requirements at weather stations.
 4. Administer and logistically support the Task Force Weather Central.
 5. Resupply weather islands utilizing PBM aircraft made available by Kwajalein Naval Air Station.
 6. Operate an interatoll air transport system between Enewetak and Bikini and dispatch C-47 flights to Kwajalein and other atolls as required.
 7. Operate an intra-atoll airlift system at Enewetak, utilizing liaison aircraft and helicopters.
 8. As required, detail helicopters and associated personnel to CTG 7.3 to augment the TG 7.3 intra-atoll airlift system at Bikini.
 9. Conduct task force administrative flights and flights to maintain the proficiency of rated task force personnel.
 10. Provide SAR coverage in the forward area with the assistance of CTG 7.3.
 11. Control and position flights for official observers as required by CJTF 7.
 12. Operate and maintain an AOC on Enewetak Island.
 13. Provide supervisory personnel for the task force AOC aboard the Estes during shot phases.
 14. Provide the senior naval aviator of TG 7.3 -- Air Defense Element at Enewetak -- with data and communications facilities to maintain air security of the Enewetak portion of the Enewetak-Bikini area.
 15. Operate airdrome facilities at Enewetak and Bikini atolls, except for POL storage facilities at both locations.
 16. Provide and operate complete Military Air Transport Service (MATS) terminal facilities at Enewetak and coordinate MATS traffic management with CTG 7.2.
 17. Provide Airways and Air Communications Service (AACS) as required in support of task force operations.

18. Prepare shot-time aircraft positioning plans and coordinate the integration of TG 7.3 aircraft with CTG 7.3.
19. During shot periods, assume overall positioning control of task force aircraft, other than security forces, operating in shot areas. Relay instructions to TG 7.3 test aircraft through CTG 7.3 on the Bai-roko. In the event of interception of unidentified aircraft in the shot area, relinquish control in the area to CTG 7.3 for the duration of the defensive effort.
20. Augment CTG 7.2 personnel as necessary to support TG 7.4 at Enewetak Island.
21. Provide decontamination crews and facilities for TG 7.4 aircraft at Enewetak Atoll and assist TG 7.3 in aircraft decontamination as required.
22. Assist TG 7.2 in emergency evacuation of personnel based on Enewetak Island.
23. Support TG 7.1 as directed by CJTF 7.

To implement these functions, the task group was organized into three units, the Test Aircraft Unit (TAU), the Test Services Unit (TSU), and the Test Support Unit (TSuU).

The function of the TAU was to operate and maintain the aircraft used in support of the TG 7.1 scientific program. The TSU's function was to operate and maintain the aircraft used in support of the test operations, e.g., weather reconnaissance, documentary photography, and search and rescue. The TSU also supplied airways communications services and operated the major air facility of the PPG at Enewetak and the airstrip at Bikini. The TSuU's function was to operate and maintain the aircraft used in the Enewetak-Bikini airlift, weather island resupply, and the intra-atoll airlift on Enewetak. Personnel strength for TG 7.4 is shown in Table 7. Figure 15 (see Chapter 2, p. 86) illustrates the relationship among the several units.

Task Group 7.5 (Base Facilities)

TG 7.5 built the scientific stations required by TG 7.1 and the camps and other support facilities required by the task force, except for some

Table 7. Task Group 7.4 personnel strength at Pacific Proving Ground, 1954.

	Jan	Feb	Mar	Apr	May
Organization					
Headquarters	99	103	101	99	94
Test Aircraft Unit (TAU)	306	343	299	341	310
Test Services Unit (TSU)	737	738	747	700	392
Test Support Unit (TSuU)	581	601	610	601	568
Total	1,723	1,785	1,757	1,741	1,364
Location					
Enewetak	1,514	1,571	1,599	1,627	1,206
Bikini	62	63	0	7	6
Weather I	87	88	63	59	60
Kwajalein	34	31	56	20	11
Hawaii-CONUS	26	32	39	28	81

Source: Reference 15, January-May 1954 Installment.

construction activities by TG 7.2 on Enewetak Island. Since the PPG was administered by the AEC, TG 7.5 was an AEC organization. TG 7.5 provided and maintained the base facilities, a function that had been part of TG 132.1 in IVY. Consistent with the AEC policy of using contractors as much as possible, TG 7.5 was made up primarily of H&N employees. The functions assigned to TG 7.5 were listed in the JTF 7 Operation Plan 3-53 (Reference 9) as follows:

1. Support CTG 7.1 in the accomplishment of TG 7.1 missions.
2. Operate, manage, and direct camp facilities at Bikini and on all occupied islands of Enewetak Atoll, except Enewetak Island.
3. Conduct necessary liaison with CTG 7.2 to enable him to prevent unauthorized entry into exclusion areas.
4. Operate and maintain local communications systems at Bikini and at Enewetak atolls, except Enewetak Island.

5. Assist CTG 7.2 in port and stevedoring operations at Enewetak.
6. Conduct port and stevedoring operations at Bikini.
7. Operate and maintain a TG 7.5 boat pool at Enewetak and Bikini atolls.
8. Be responsible for removal of TG 7.5 personnel (and supporting military personnel) and equipment from the shot-site danger area.
9. Evacuate TG 7.5 personnel (and supporting military personnel) from Bikini Atoll when directed by CJTF 7.
10. Be prepared, upon directive from CJTF 7, to conduct emergency postshot evacuation of TG 7.5 personnel from islands of Enewetak Atoll other than Enewetak Island. Assume responsibility for the emergency evacuation of TG 7.2 military police from Eleleron Island.
11. Assist CTG 7.1 in decontamination of AEC facilities and equipment as necessary.
12. Augment the shipboard housekeeping personnel of CTG 7.3 as necessary to support TG 7.1 and 7.5 elements afloat.
13. Provide support services for Hq JTF 7, as required.
14. Redeploy contractor personnel as necessary to expedite construction.

The number of H&N personnel at PPG peaked in December 1953 at slightly over 2,300. There were about 1,230 on Enewetak, with the remainder at the Bikini camps. During the active phase of testing, the Enewetak contingent declined slightly, but the Bikini numbers dropped sharply. By 1 March the Bikini contingent was down to about 560, by April it was down to 300, and by May down to 100 (Reference 5, pp. 4-6, 4-7).

CHAPTER 2 RADIOLOGICAL SAFETY

Radiological safety for the tests was based on adapting then-current safety principles and procedures to the environment of a large field operation. The protective measures were derived from:

1. Recommendations of national and international advisory bodies on radiation exposure limits
2. Regulations issued by Commander, Joint Task Force 7 (CJTF 7) based on these recommendations
3. Administrative rules and controls that implemented these regulations.

Methods to limit human exposure to radiation were based on the use of both physical safeguards, e.g., barriers to restrict access to radiation exclusion (radex) areas, and procedural controls, e.g., training to acquaint personnel with the problems of radiation. This chapter explains the regulations, administrative rules, and procedures used by JTF 7 to limit exposure and measure the effectiveness of the controls.

The concept of radiological safety (radsafe) for Operation CASTLE required each task unit to provide for its own safety under directives issued by CJTF 7. Each task unit was delegated support functions for the benefit of the task force as a whole, but task units were basically self-sufficient in manpower, maintenance, and training (Reference 9, Appendix B).

The CJTF 7 radsafe directives had three underlying objectives (Reference 16, p. 5):

1. Maintenance of personnel radiation exposures at the lowest possible level consistent with medical knowledge of radiation effects and the importance of the test series

2. Avoidance of inadvertent contamination of populated islands or transient shipping
3. A rapid evaluation of the relationship between forecast and actual cloud travel utilizing aerial tracking of the fallout radiation cloud.

Initial radsafe planning was based on the limited Pacific Proving Ground (PPG) experience. Only 11 nuclear tests had occurred in the Pacific and of these only 2, during Operation IVY, were large-yield devices. The IVY experience did not indicate the widespread radiological contamination that could be caused by a large-yield weapon. BRAVO, the first detonation in Operation CASTLE, contaminated the shot islands to the extent that one observer concluded "Operation CASTLE must be reported as the nightmare of radiological safety test operations" (Reference 17, p. 6).^{*} Nevertheless, the organization and planning proved flexible enough to accommodate even this unanticipated major radiological contamination and the additional precautionary measures and monitoring efforts that necessarily ensued. No personnel were allowed to live on any part of Bikini Atoll throughout the remainder of the test series, but were housed at Enewetak and aboard the task force ships. Access to the Bikini Atoll was restricted to those with official duties, and lengths of visits were controlled.

The radsafe planning and safety criteria used by CJTF 7 and the task units, as they evolved to meet the objectives of CJTF 7 during the operation, are the subject of this chapter.

RADSAFE PLANNING

Radiological safety was a major joint task force concern during the planning and operational phases of the CASTLE tests. Original planning

^{*} The author of this comment, after an additional 25 years experience in the field of radiation protection, no longer holds this view, but rather states that the radiological safety problems of CASTLE presented a challenge in protecting the 17,000 task force personnel that was admirably met (Reference 18).

was for four very-high-yield detonations. As plans progressed, the schedule was enlarged to seven shots (reduced during the operation to six). Since each extra event was potentially dose-additive to many of the participants, the permissible exposure per event decreased as the number of shots increased. Radsafe planning was designed, in part, to minimize the number of people who might be exposed above the general criteria level (Reference 16, p. 17). This required either exposure of a greater number of people, or provisions for exposure waivers for some personnel.

The Joint Task Force Radiological Safety Plan was cognizant of these points. Published as Annex N to Reference 9, Task Force Operation Plan 3-53 (see Appendix A), the plan established radiation safety as a command responsibility, as did Annex I to Reference 19, Operation Order 1-53 (see Appendix A). The plan also specified safety criteria for the entire task force and defined specific task group responsibilities and missions for applying these criteria. Information developed during preceding test series, particularly Operation IVY, formed the basis for the plan.

The radsafe plan for each task group was derived from the Joint Task Force Plan. It laid out in detail the application of safety criteria in the context of operations for each service and outlined procedures for implementing them, including training, installation of equipment aboard task group ships, monitoring, and decontamination of personnel and equipment.

Organization and Responsibilities

Overall organizational planning and authority for radiological safety rested with the CJTF 7. The Commander's staff coordinated radsafe information collected before and during shot operations and also maintained liaison with the Commander-in-Chief of the Pacific (CINCPAC) regarding radiological exposures outside the PPG. Elements of control existed at all command levels, and operational control was applied through normal command channels.

A decentralized system of operational control, utilizing elements of the CJTF 7 staff and units within each task group, was established for

Operation CASTLE. A Radsafe Office was located in Hq JTF 7 with ultimate responsibility for the CASTLE radsafe program. This office was designed to be the primary task force shot-time authority for all radsafe matters requiring headquarters staff action and for all radsafe information affecting various operational decisions that were expected to arise. The functions of the office included preparation and presentation of the radsafe portion of the command briefings before a shot and continual reconnaissance of the area to determine the relatively close-in and long-range fallout aspects after a shot. Additional responsibilities involved the necessary liaison with representatives of the Hq USAF; with the Atomic Energy Commission (AEC) Health and Safety Laboratory, New York Operations Office (HASL, NYKOPO); with the task force Biomedical Advisor and Staff Surgeon; and with other special advisors to CJTF 7. Figure 12 shows the organization and functions of the task force Radsafe Office.

Each task group established a self-sufficient radsafe unit. In addition to routine task group radsafe matters, each task group radsafe unit provided some general support to the joint task force. These support functions were as follows:

- Task Group 7.1. Execution of the major functions concerning onsite recovery operations, operation of field radiochemistry laboratories, and operation of a complete photodosimetry service for the entire task force.
- Task Group 7.2. Provision of monitors for security sweeps and maintenance of a pool of trained monitors and decontamination operators to back up TG 7.1.
- Task Group 7.3. Provision of facilities afloat for ship-based recovery operations, together with the necessary helicopter services and execution of the lagoon water-sampling plan.
- Task Group 7.4. Execution of the radsafe portion of the aircraft cloud-sampling program and provision of aircraft and personnel to conduct the task force cloud-tracking program.
- Task Group 7.5. Assumption of radsafe responsibilities for the entire PPG (except Enewetak Island) during interim operational periods.

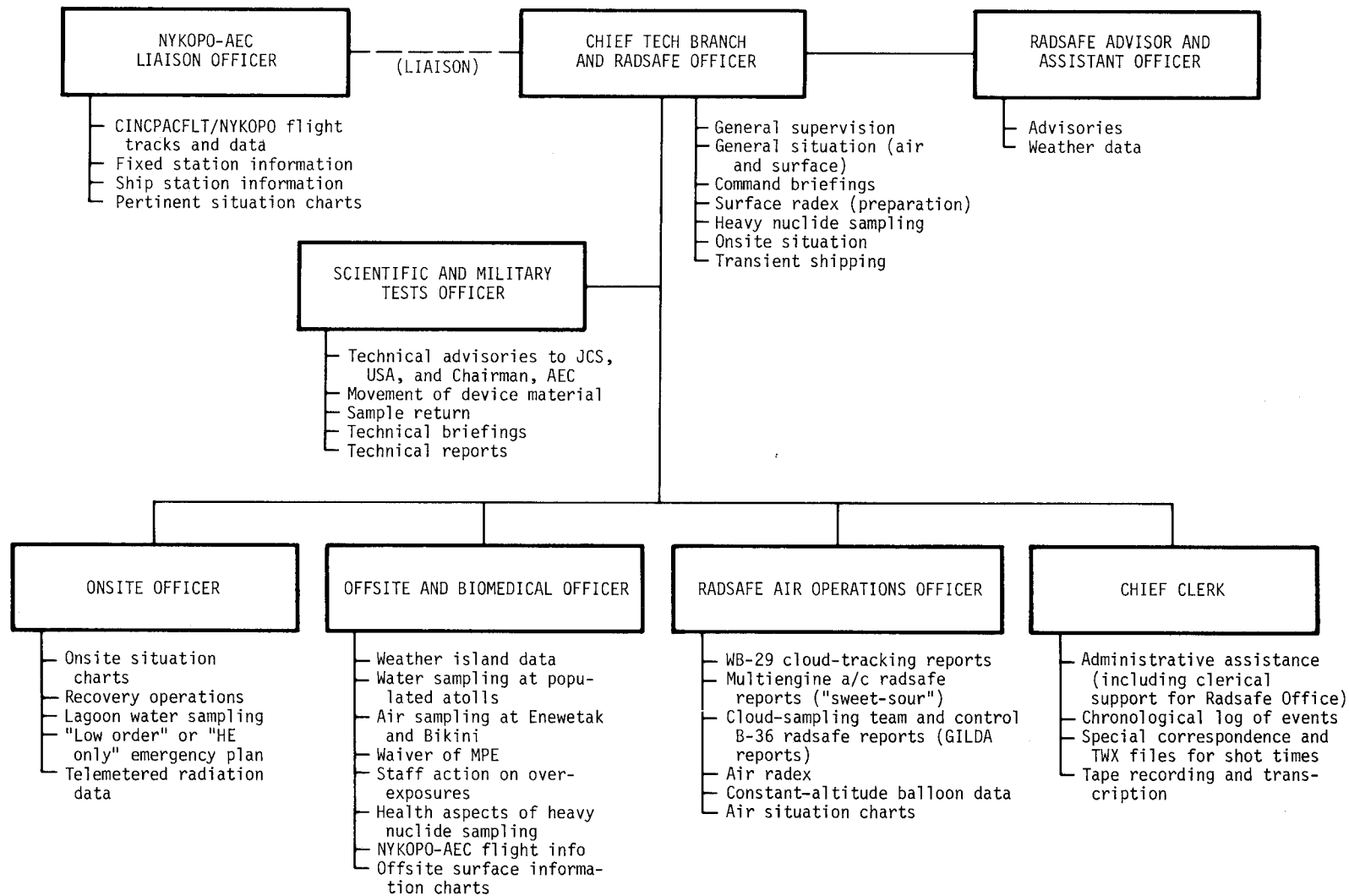

Figure 12. Organization and functions of the task force Radsafe Office, CASTLE.

With the exception of TG 7.1, radsafe assignment for most personnel was "additional duty;" positions existed for only a few "primary duty" staff and supervisory personnel. Each task group was assigned at least one fully trained radiological defense engineer who supervised the activities of the task group. Thus, the Army task group trained radsafe personnel from each activity in its group, the Navy task group placed radiological safety under Damage Control in accordance with routine Navy organizational practices, and the Air Force task group utilized flight crewmembers as monitors and ground personnel for aircraft decontamination. The one exception, TG 7.1, had been designated the major radsafe unit for onsite operations and was given the responsibility for specific centralized and highly technical radsafe services. Considerable staffing problems had to be solved before assembling the necessary TG 7.1 "primary duty" technicians, most of whom were military personnel on temporary duty assignments. Even for this unit, however, the "additional duty" philosophy was utilized where possible for personnel economy (Reference 9, Appendix B).

TASK GROUP 7.1. A radsafe unit, TU 7, was continued from Operation IVY. The unit became a technical service group for TG 7.1 and assisted the unit and supervisory personnel of each scientific project by providing technical advice and training for project personnel designated as monitors (Reference 17, p. 13). In addition, TU 7 was the radsafe organization for TG 7.5 as well as the technical radsafe unit for JTF 7.

By direction of Reference 9, Operation Plan 3-53, CTG 7.1 was to provide for:

- Radiological protection of TG 7.1 and TG 7.5 personnel
- Maintenance of operational efficiency for TG 7.1 and TG 7.5 in the presence of radiological contamination
- Technical assistance to other JTF 7 elements on non-medical matters pertaining to radiological safety.

To accomplish the above mission, the Commander, TU 7, performed the following tasks (Reference 19):

1. Organized and commanded a radsafe unit
2. Supervised all ground-monitoring services associated with scientific missions; this included monitoring of water supplies at inhabited distant atolls (if necessary) and establishing suitable tables of allowable residual radiation levels for equipment, personnel, vehicles, boats, etc.
3. Furnished laboratory services and technical assistance to all task groups, including:
 - a. Procurement, storage, and issuance of film badges and specified items of radsafe personnel equipment
 - b. Development and interpretation of exposed film badges
 - c. Maintenance of film badge exposure records
 - d. Provision of facilities at the Parry Radsafe Center and aboard the USS Bairoko for calibration, repair, and maintenance of monitoring instruments and for storage and issuance of spare radiac equipment parts
4. Procured radsafe clothing for JTF 7 personnel
5. Procured and issued special high-density goggles to specified personnel of JTF 7
6. Provided decontamination facilities for personnel and equipment
7. Conducted laboratory studies to determine the nature of radiological hazards.

TU 7 also issued a safety bulletin to be read by all personnel, including visitors, at PPG. The bulletin stressed the need for cooperation by all groups to minimize radiation exposures by following AEC guidelines regarding radiation protection, decontamination, and contaminated waste disposal. The bulletin also stressed individual responsibility for keeping personal radiation exposures to a minimum. Restricted entry to contaminated areas, proper use of monitoring equipment and protective clothing, and sanitary eating and drinking habits were all listed as elements of individual responsibility.

The organization of TU 7 is shown in Figure 13. Major functions of the unit were radiation control, decontamination, and laboratory analysis.

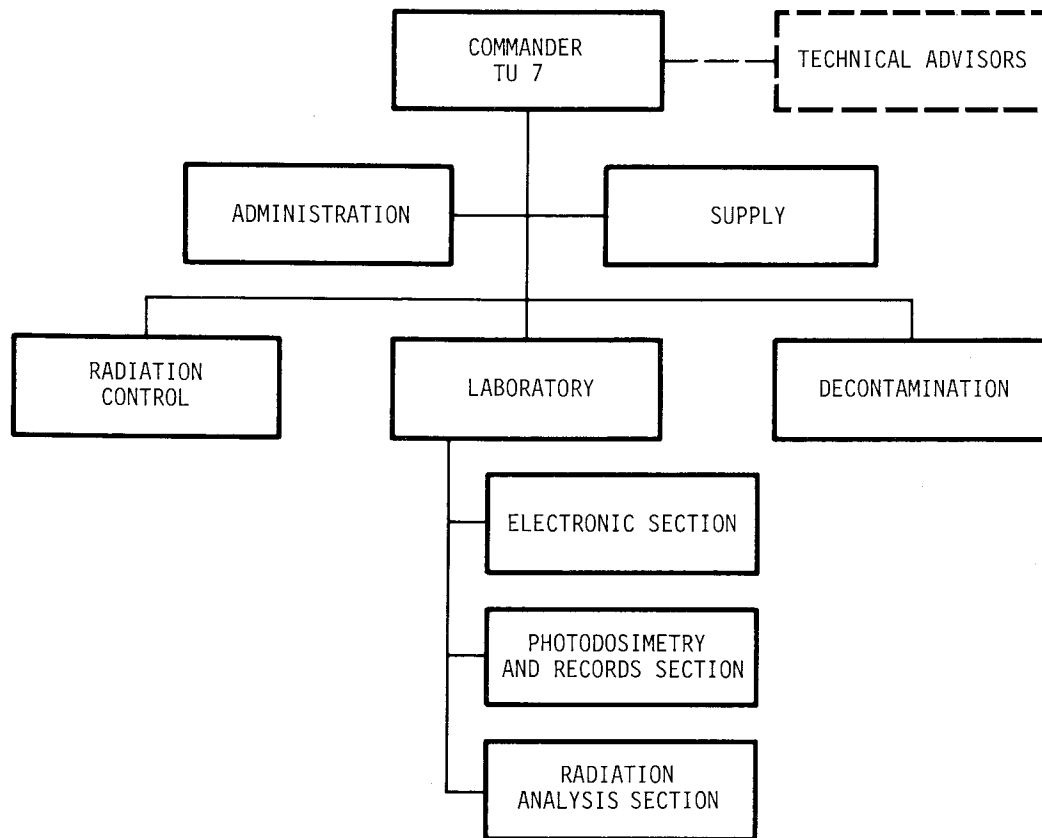

Figure 13. Radsafe organization for Task Group 7.1, CASTLE.

Radiation Control. The Radiation Control Group was organized to provide for the radiological safety of personnel entering contaminated areas. The group established operations stations for all radsafe activities at several centers. At these stations, radiological situation data were gathered and information required by monitors was maintained in memoranda and situation maps. The situation maps delineated areas cleared by radsafe personnel, as well as those areas requiring monitor escort.

Two radsafe centers were established for Operation CASTLE, one at Parry and one aboard the Bairoko in Bikini Lagoon. Each was equipped to

accomplish the unit mission independently. TU 7 personnel moved between the two centers as the radiological situation warranted.

Subcenters of the Bikini Radsafe Center were established aboard a barge adjacent to the USNS Fred C. Ainsworth, aboard the USS Curtiss, and aboard the USS Estes. These substations were primarily control and personnel decontamination points for TG 7.1 and TG 7.5.

Since the concept of subcenters had not been considered in initial staffing procurement plans, full staffing was not available. TU 7 personnel were thinly scattered throughout, reducing their effectiveness in some areas, but this did permit decentralized and controlled recovery operations.

Dual communications between the Bairoko Radsafe Center and the subcenters were maintained by the task group administrative net and a dedicated frequency radsafe net. These nets permitted direct communication between control points and the dosimetry record unit aboard the Bairoko.

Decontamination. The Decontamination Group of TU 7 was to provide for the protection of personnel against radiological contamination and to establish effective contamination control. The following arrangements were made for this:

- Personnel decontamination stations were set up at the Parry Radsafe Center, aboard the Bairoko and the Curtiss, and aboard a barge alongside the Ainsworth
- Equipment decontamination areas were demarcated at Parry
- Entry and exit checkpoints were established at Parry, aboard the Bairoko and the Curtiss, and aboard a barge alongside the Ainsworth.

Laboratory Analysis. The Laboratory Group provided technical assistance to the Radiation Control and Decontamination Groups and laboratory services to all JTF 7 radsafe organizations. The group maintained all radsafe instrumentation for JTF 7 and processed and interpreted all film

badges. In addition, one section collected, interpreted, and disseminated data on the radioactivity of contaminants.

TASK GROUP 7.2. TG 7.2 performed all radsafe monitoring and decontamination services for Enewetak Island, provided couriers to accompany the aerial movement of radioactive cargo, and operated contaminated laundry facilities for TG 7.4. The organization of TG 7.2 Radsafe (see Figure 14) consisted of 39 personnel, exclusive of personnel assigned to the monitor pool. Unit radsafe officers and NCOs, together with 50 AEC security-cleared ("Q"-cleared) men, 10 decontamination personnel, and a radiological safety engineer (placed on temporary duty with TG 7.2 by CJTF 7 to act as TG 7.2 Radsafe Officer during CASTLE), were trained to support radsafe missions for TG 7.1. Because of the unexpectedly large requirement for emergency backup monitors, unforeseen restrictions on the original monitors, and rotation of personnel during CASTLE, it became necessary to train more unit radsafe officers, unit radsafe NCOs, and backup monitors locally. Within TG 7.2, the motor pool personnel were trained as backup monitors.

After BRAVO, because of the change in operational method necessitated by the contamination of Bikini Atoll, TG 7.2 was instructed to furnish many backup monitors. By BRAVO D+10, 34 backup monitors had been sent to TG 7.1. Through March and April, 39 more were trained. Since the loss of key personnel (i.e., Q-cleared) hampered some units, CTG 7.2 requested that the requirement for radsafe backup monitors be minimized as much as possible consistent with the emergency. CTG 7.1 agreed, but stated that the problem would continue indefinitely. CJTF 7 then ordered that communication personnel not be used for radsafe monitoring, which further reduced the number of trained, cleared monitors. The overall requirement declined steadily after KOON, and by NECTAR only 17 monitors were on temporary duty assignment to TG 7.1.

While assigned to TG 7.1, the TG 7.2 monitors' duties included work in the dosimetry section, decontamination work, supply work, and recovery

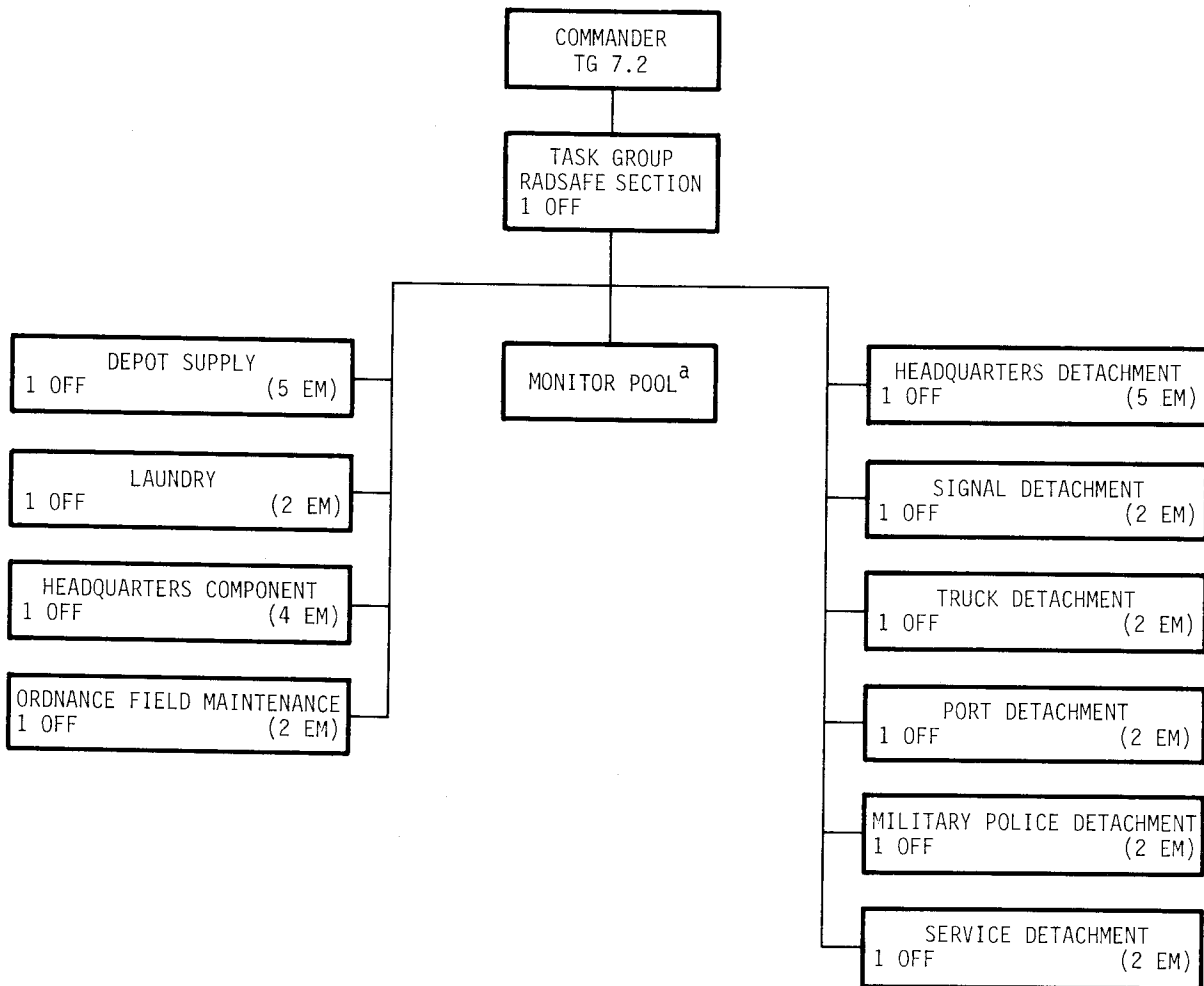

^aUpon completion of training, personnel from the monitor pool were given emergency assignments by name in numbers indicated in radsafe organization structure. Remaining trained personnel constituted an emergency reserve to be committed at the direction of Commander TG 7.2.

Figure 14. Task Group 7.2 radsafe organization, CASTLE.

work from the islands. The Third Installment of Unit History TG 7.2 indicates that designated decontamination personnel without Q-clearances were unacceptable; therefore, backup monitors were used as decontamination personnel (Reference 10, April Installment).

TASK GROUP 7.3. Responsibility for overall coordination of TG 7.3 radsafe activities lay with the task group commander. Two officers in his Plans and Operations Division (N-3) were specifically assigned as atomic defense officers, with advisory assistance from the staff medical officer.

Their duties were to oversee and evaluate compliance of individual units with task group radsafe requirements.

In addition to providing their own radsafe monitors (including one airborne monitor for each TG 7.3 multiengine aircraft) and radiac equipment (with responsibility for its repair and calibration) TG 7.3 provided:

- Monitors and decontamination crews aboard each ship within the task group
- Facilities for personnel decontamination on the Bairoko
- Facilities for the radsafe unit (Radsafe Center) of TG 7.1 when the task force was embarked
- Decontamination crews and facilities for all aircraft at Bikini Atoll
- Decontamination crews and facilities for TG 7.3 aircraft aboard the Bairoko at Enewetak Atoll; limited assistance ashore was furnished by CTG 7.4 as required
- Helicopter air service for radiological surveys and postshot recovery operations (monitors furnished by TG 7.1)
- Collection of lagoon water samples for radioactivity analyses
- Water-spray equipment aboard all vessels likely to be in the fallout area
- Air-to-ground reporting of approximate air radiation intensities encountered by all aircraft operating between Enewetak and Bikini from H-hour to H+24 during the Bikini phase.

TASK GROUP 7.4. Within TG 7.4, each of the three subordinate units shown in Figure 15 had specific operational responsibilities. The Test Support Unit (TSuU) responsibilities were:

- Provision of helicopter and liaison air service for radiological surveys and postshot recovery operations with monitors furnished by TG 7.1; monitors also gave full mission instructions
- Provision of radiac equipment, decontamination equipment, and protective clothing throughout TG 7.4
- Maintenance of TG 7.4 radiac equipment (repair, spare parts, calibration)

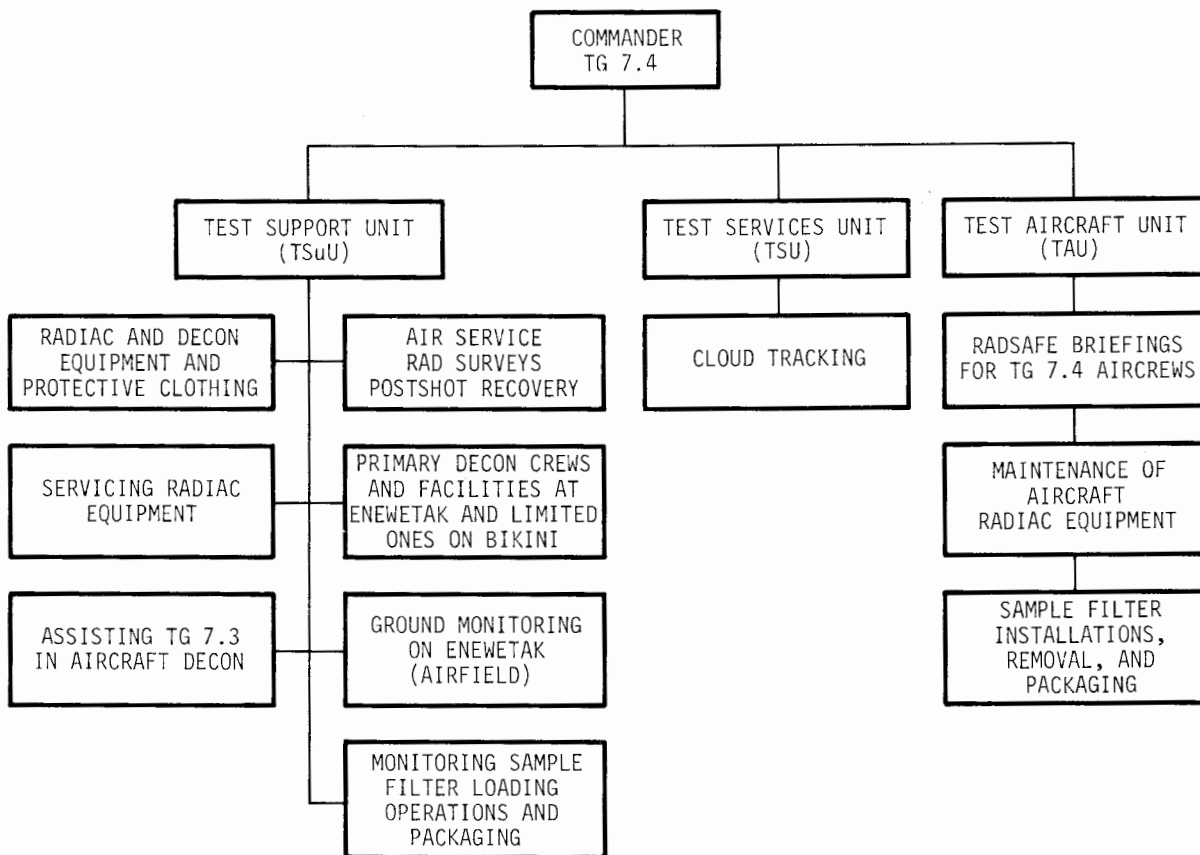

Figure 15. Organization and responsibilities for Task Group 7.4, CASTLE.

- Provision of primary decontamination crews and facilities for aircraft at Enewetak Island and limited crews and facilities at the Bikini airstrip
- Assistance to TG 7.3 in aircraft decontamination with TG 7.4 equipment when needed
- Promulgation of the air radex area for each shot
- Performance of ground monitoring on Enewetak Island, except in those areas or activities assigned to other task groups
- Monitoring of sample filter loading operations and their subsequent removal and packaging.

The Test Services Unit (TSU) conducted cloud-tracking aircraft flights to collect postshot radiological data; these flights were in the air from about H+6 up to H+54.

The Test Aircraft Unit (TAU) gave radsafe briefings for all TG 7.4 aircrews and maintained the specialized radiac equipment installed in its aircraft. The TAU also performed the aerial sample filter installation, removal, and packaging.

Training

Annex N to JTF 7 Operation Order 3-53 (see Appendix A) specified and directed that two levels of training -- basic indoctrination and technical -- be required, but allowed each task group to vary the scope of instruction according to the group's operational requirements. Basic indoctrination included nontechnical instruction in radiological measures and techniques. Such instruction was to be given to all task force personnel to encourage efficient performance of duties within the allowable exposure levels for radioactive contaminants. Technical training was required of all personnel who staffed the task force radsafe organizations and performed the monitoring and other technical operations, such as decontamination and instrument repair. The technical instruction was to be obtained through existing service courses and at training sessions established at the task group level.

Little information has been found on the level of instruction or the content of the basic indoctrination given by the various task groups; the course instituted by the Army (described on p. 92) is probably representative, however.

TASK GROUP 7.1. The technical radsafe group depended on obtaining from the AEC and the services both trained personnel and the specialized training the task group required. The sources for technically qualified health physics personnel were the Health Division of Los Alamos Scientific Laboratory (LASL) and special organizations within the Department of Defense (DOD). In the interim between IVY and CASTLE, the Department of the Army authorized the Chief Chemical Officer to establish the 1st Radsafe Support Unit (RSSU) with the mission of supporting test operations at both the Nevada and Pacific Proving Grounds. This organization was established

at the Chemical Corps Training Command, Ft. McClellan, Alabama, in early 1953 and provided the bulk of Army personnel for TU 7.

The technically trained Navy personnel were provided to TG 7.1 from the National Naval Medical Center; Special Weapons Unit, Pacific Fleet; Armed Forces Special Weapons Project (AFSWP), Sandia Base; and the Naval Radiological Defense Laboratory. One Marine Corps noncommissioned officer was obtained from the 2nd Marine Division, Fleet Marine Force (Reference 17).

Initial TG 7.1 personnel requirements were for 14 officers and 86 enlisted men. In late March, after a conference with the TG 7.1 Scientific Deputy and the task group commander, this requirement was reduced to 12 officers and 36 enlisted men. This reduction in personnel was directed by a policy through which:

1. Training programs would be initiated by the task group radsafe officer to qualify program and project personnel in radsafe principles and techniques of monitoring
2. The radsafe organizations of TG 7.1 and TG 7.5 would be consolidated
3. An increase of the military support mission of CTG 7.1 would be made so that the following services could be provided to TG 7.1 and TG 7.5:
 - a. Support of the overall radsafe program by training and providing radsafe monitors as needed
 - b. Support of the overall radsafe program by training and providing decontamination personnel as needed.

In mid-August the 1st RSSU received its initial notice of TU 7 personnel requirements. This created a strain on the organization since the RSSU had only nine men available for duty. Additional difficulties were encountered by the release of experienced men from military service. In spite of these problems, 2 officers and 28 enlisted men were designated by 1 September for clearance and assignment to TU 7. The Navy (Op-36) received notice and initiated action in the latter part of August. The Air

Force declined to participate in the radsafe support operation (Reference 16, p. 17).

The Chemical Corps Training Command issued orders for 1st RSSU personnel in October 1953. The Army Chemical Center issued orders for three radiological safety engineers in November 1953. The Chief of Naval Personnel issued orders for naval personnel in October 1953. CTU 7, through invitation, secured the services of three LASL health physicists as technical advisors.

Owing to staff delays in procuring military personnel, TU 7 performed its mission with a shortage of three control officers, one laboratory officer, and one photodosimetry technician. The lack of the three control officers materially hampered the unit's effectiveness in conducting decentralized controlled recovery operations. The void was partly filled by using supply and laboratory officers in secondary control functions (Reference 16).

Between November 1953 and April 1954, three classes were established to qualify Project 7.1 and Holmes & Narver (H&N) supervisory personnel as radsafe monitors: one at the Nevada Proving Ground (November 1953); one on Eneman Island, Bikini Atoll (February 1954); and one at Parry, Enewetak Atoll (April 1954). About 200 individuals were qualified as radsafe monitors by these schools. Comparable training sessions were conducted by the health physics organizations of Edgerton, Germeshausen & Grier, Inc. (EG&G); UCRL, Livermore site; and the U.S. Naval Radiological Defense Laboratory (Reference 17).

Instructions for the conduct of the initial course were provided by the LASL Health Division, UCRL, EG&G, 1st RSSU, and JTF 7. Training included an examination of the fundamentals of radiological safety, classroom instruction, and a series of practical field exercises. These fundamentals included:

1. Radioactivity
 - a. Concept of radioactivity resulting from atomic detonations
 - b. Definition of the following terms: radiation, alpha particle, beta particle, gamma radiation, decay, fission, curie, roentgen, milliroentgen per hour, radiation intensity, and attenuation
 - c. Range and energy relations of fission-product radiations
2. Biological effects
 - a. Concept of ionization
 - b. External and internal radiation effects
 - c. Radiation doses
 - 1) Lethal (acute and chronic)
 - 2) Probable early effects of acute radiation dose over the whole body
 - 3) Local effects, beta-ray burns
 - 4) Symptoms of radiation sickness
3. Recognition of radiation effects
 - a. Methods of detecting of nuclear radiation by film, crystal, ionization, and heat
 - b. Survey meters
 - c. Pocket dosimeters
 - d. Photographic film badges
4. Protection of personnel from radiation effects
 - a. Shielding characteristics of materials
 - b. Control of radiation dose
 - c. Clothing and equipment
 - d. Decontamination facilities
 - e. Safety indoctrination.

Exercises and problems were of 2 or 4 hours' duration with 12 people in each instructional group. The eight sessions were as follows:

1. Dosimetry: Familiarization with film badges and pocket dosimeters as radiation-dose-measuring devices and practice in charging, reading, and determining the correction factor on dosimeters

2. Ion-chamber-type survey meter: Operation, use, and calibration
3. Geiger-Mueller-type survey meter: Operation, use, and calibration
4. Shielding properties of common materials: Effect of various absorbers of gamma radiation and determination of their absorption coefficient and half-thickness
5. Maintenance of instruments: Basic concepts of maintenance and some of the details of maintenance applicable to the Geiger-Mueller counter and ion-chamber-type instruments
6. Decontamination: Familiarization with some of the methods used in the decontamination of radiologically contaminated materials, use of a few of these methods, and comparisons of the results
7. Field monitoring: Practice in monitoring of large contaminated areas and plotting of isointensity lines by comparing the results of rapid and detailed surveys
8. Problems: Introduction to the calculations necessary for the solution of exposure and time-of-stay problems through the use of radiation-calculator slide rules and tables.

The second and third schools at Bikini and Enewetak were attended by much smaller groups that received a 1-day condensed version of the exercises. These secondary courses were considered emergency supplementary instruction. Instructors were TU 7 personnel.

The lack of continuity in operations and the loss of experienced personnel between operations necessitated the establishment of a training program for unit laboratory technicians, photodosimetry technicians, and radiological-instrument repairmen. Schooling for instrument repairmen was arranged through JTF 7 and AFSWP at the Naval Schools Command, Treasure Island, San Francisco, and consisted of 1 month of instruction in the maintenance and repair of military radiac instruments. All TG 7.1 repairmen were graduates of this school.

Arrangements were made with the Nucleonics Branch of the Signal Corps Engineering Laboratories to conduct familiarization courses with mobile field laboratories for the laboratory and photodosimetry technicians.

Photodosimetry technicians attended a 1-week course, and laboratory technicians attended a 2-week course at Evans Signal Laboratory early in October 1953 (Reference 17).

TASK GROUP 7.2. A radiological safety indoctrination program was instituted for all TG 7.2 personnel. The program included instruction in the following subject areas:

- Basic physics; theory of nuclear explosions
- Explosion phenomena, including blast, heat, nuclear radiation, and fallout
- Details of an airburst
- Comparison of air, surface, and subsurface bursts
- Danger of radiation to personnel
- Accumulated dose and tolerance exposure levels
- Decontamination procedures.

The unit radsafe officers attended the atomic defense course at the Fleet Training Center at Pearl Harbor or were trained locally.

A memorandum entitled "Radiological Safety Monitors Procedures" was published by CTG 7.2 on 23 February 1954. It served as a monitor's handbook and was distributed to each radsafe officer, radsafe noncommissioned officer, monitor, and backup monitor of TG 7.2.

It became the practice to hold several briefings before each shot to apprise personnel of their responsibilities and action to be taken in the event of radioactive fallout. On the day preceding each shot, staff officers, detachment commanders, and radsafe officers were briefed on general radsafe rules, dosimetry, and instrumentation for the officer couriers of radiological samples. A special bulletin from CTG 7.2 issued to each member of TG 7.2 on the day preceding each shot included individual safety and security precautions.

TASK GROUP 7.3. In August 1953, 4 months before the Navy Radiological Safety Plan was distributed, Hq TG 7.3 promulgated instructions describing

the atomic defense preparations that would be required (Reference 14, May Installment, p. 128). To implement these requirements, the "Navy Task Group placed radsafe under Damage Control in accordance with routine organizational practices" (Reference 9, p. 83). It was the responsibility of the commanding officer of each ship or unit to ensure that his personnel obtained adequate training in atomic defense measures and radiological effects, that washdown systems were properly installed and functioning, and that the ship's Atomic Defense Bill (including allotments of radiac instruments and protective clothing) was properly filled.

Schools for radiological defense were located at the Fleet Training Centers at San Diego and Pearl Harbor, but specific information on training activities before deployment of individual units is sparse. The Underwater Detection Unit, 7.3.8.0, sent 1 man to San Diego for a 1-week course at the Radiological Safety School, and the Boat Pool Unit, 7.3.7.1, sent 40 men to the same facility for 2 weeks of training. Furthermore, all boat pool petty officers were given 2 weeks of training at the radsafe school. Otherwise, the final report of TG 7.3 simply states that ship commanders were responsible for the training of their men and reporting them ready "to carry out their radsafe missions" (Reference 11, pp. 3b-2 through 3b-5).

No information has been found on the literature or curriculum that instructors used in the Navy courses. According to the Radiological Safety Plan the basic guidance for conducting radsafe operations was in the Navy Bureau of Medicine and Surgery publication, Radiological Safety Regulations (NavMed P-1325; Reference 20). This was to be applied to test operations with some reservations, however, since (Reference 21, Annex G-I-4):

. . . its provisions do not apply for special operations such as field tests and . . . for such operations naval personnel will operate under regulations set forth by the Task Force commander as approved by the Chief of Naval Operations.

In addition, task group personnel were to be guided by Navy Instructions USF 82 and 85, which dealt with standard decontamination procedures and contaminated waste disposal (Reference 12, Annex G).

TASK GROUP 7.4. Each unit of TG 7.4 was required to train radsafe monitors, including one airborne monitor for each multiengine aircraft. Although all assigned personnel were supposed to receive basic radsafe training, there is no indication that this actually occurred.

SAFETY CRITERIA

Radsafe criteria based on AEC industrial safeguards were approved by the Surgeons General of the Army and Air Force, the Chief of the Navy Bureau of Medicine and Surgery, and the Director, AEC Division of Biology and Medicine. CJTF 7 disseminated operational rules for radiological situations as an Annex to the JTF 7 Operation Order (Reference 19). Each task group implemented the annex with its own orders or plans.

The radsafe criteria measuring units were the roentgen (R) and the rem. The roentgen, a measure of radiation in air, denotes an exposure intensity. The rem is a unit of radiation dose, i.e., a measure of radiation energy deposited within the body that takes into account its capability of causing an effect. It is measurable in fractions of a rem, such as a millirem (mrem), which is 1/1,000th of a rem. For most forms of ionizing radiation, such as beta and gamma, the rem dose is less than the roentgen exposure, for not all of the energy measurable in air penetrates body tissues. Another unit often used in discussing radiation doses is the rad. The rad is a measure of radiation energy deposited in any material; for biological tissue, a rad of low-quality radiation such as from gamma- or X-rays essentially equals a rem.

At the time of the CASTLE series the distinction was usually not made between exposure (properly expressed in units of roentgens) and absorbed dose (properly expressed in units of rem, although at the time often expressed in roentgens); presumably external whole-body exposure and absorbed dose were assumed equivalent. This history expresses the measured data in

exposure units (roentgens). Although the original references often referred to dose, there is no evidence that whole-body energy deposition was determined, nor that dose was indeed measured.

In this report all measurements of exposure intensity (roentgen) are given in whole units and decimal fractions. This is not the common way these are reported in the source literature. The lower exposure intensities were usually reported in milliroentgens (mR) and the higher exposure intensities in roentgens (R). Often the same measuring device could measure both the lower and higher intensities but with different dial settings and thus differing accuracies.

Personnel records show the same sort of differentiation. The lower individual exposures are usually recorded in millirem but the larger maximums allowed or permitted are stated in whole rem. This use of different measuring units for different levels of radiation could cause some confusion to readers who are unfamiliar with the field; therefore, the whole-unit convention is used.

Radsafe Standards

In accordance with the safety criteria prescribed by the JTF 7 Operation Plan, two kinds of radsafe standards were established; Maximum Permissible Exposures and Maximum Permissible Limits. Maximum Permissible Exposure, usually abbreviated MPE and sometimes referred to as the "rule dose," set 3.9 rem (gamma) over a 13-week period as the maximum allowable accumulation of whole-body gamma radiation per individual during Operation CASTLE. This total would increase automatically by 0.3 rem (gamma) per week for each week the operation extended beyond 13 weeks (Reference 9, Annex G). For recordkeeping purposes, the operation was assumed to begin 15 days before the first detonation. The MPE for CASTLE was identical to the federal standard approved by the National Committee on Radiation Protection (NCRP) for those in radiologically hazardous occupations. This standard permitted accumulation of radiation exposure at the rate of 0.3 rem per week to a total of no more than 15 rem in one 12-month period.

A higher dose, based on prompt health effects, was incorporated into planning for tactical or emergency situations. The tactical dose concept gave broad guidelines to assist command decisions, i.e., an exposure of 100 R would result in no acute effects, an exposure of 450 R would be lethal to half those exposed, etc. (The tactical dose rationale assumes the dose would be received as a single lifetime exception to the potential occupational dose.)

Planning documents warned the task groups that previous exposure records should be checked to assure that individuals with prior exposure did not exceed the MPE. This warning was probably directed to the scientific projects of TG 7.1, whose personnel might have been exposed in the laboratory, since the previous field test (UPSHOT-KNOTHOLE) at the Nevada Proving Ground (later named Nevada Test Site) had been completed about 9 months before CASTLE.

The crewmembers of TG 7.4 sampling aircraft were authorized an MPE of 20 R for the entire period of Operation CASTLE. Anyone exposed to the 20 R maximum was to be removed from further work with radioactive materials until sufficient time elapsed to bring his average exposure down to 0.3 R per week. It was planned to expose the sampling crews to a maximum of only 10 R in order to reserve the remainder as a contingency against accident (Reference 16, p. 26).

In addition to the overall exposure limit, specific Maximum Permissible Limits (MPLs) related to radioactive contamination on parts of the body, clothing and personal effects, food, water, air, vehicles and equipment, and materials. These MPLs specified either the level of decontamination required or the upper limit for restriction of activity. Table 8 lists the CASTLE MPLs.

Radiation Exposure Waivers

Absolute adherence to the radiological standards prescribed for routine laboratory or industrial use was recognized as unrealistic for the special conditions of a field test (Reference 9). Provision was made for

Table 8. CASTLE Maximum Permissible Limits for radiation exposure^a.

<u>Personnel</u>	
Skin	0.001 R/hr (about 1,000 CPM)
Hands	30 rep (β) for the operational period
<u>Clothing</u>	
Outer clothing	0.007 R/hr
Under clothing	0.002 R/hr
<u>Vehicles and equipment</u>	
Vehicles, interior surfaces	0.007 R/hr (β and γ)
Vehicles, exterior surfaces	0.007 R/hr (γ only measured at 5 to 6 inches; 13 to 15 cm)
Ships and boats, fixed alpha	2,500 DPM/150 cm ² for enclosed areas
	5,000 DPM/150 cm ² for open surfaces
Ships and boats, final clearance	0.015 R/day (= 0.0006 R/hr) (no α)
Aircraft, cloud tracking	3.0 R/hr
Aircraft, occupied section	0.007 R/hr
Respirators, interior surfaces	0.002 R/hr
<u>Air</u>	
Particles smaller than 5 microns	10 ⁻⁶ μ Ci/cc (β and γ 24-hr average)
Particles larger than 5 microns	10 ⁻⁴ μ Ci/cc (β and γ 24-hr average)
Total	5 x 10 ⁻¹² μ Ci/cc (α only)
<u>Water (potable)</u>	
	5 x 10 ⁻³ μ Ci/cc (β and γ calculated at 3 days after burst)
	10 ⁻⁷ μ Ci/cc (α only)

Note:

^aThe acronyms CPM, rep, and DPM are defined in the glossary (Appendix B).

Source: Reference 19, Annex I.

exceeding the MPE when the commander determined that requirements for the successful completion of the operation required a departure from normally acceptable safety standards. Such a decision was thus a command responsibility, and authorization for a departure from the accepted standard did not constitute a reassessment of procedures normally considered safe (Reference 17, p. 40).

The intent of the CASTLE waiver plan was to achieve a reasonable compromise between individual doses expected during necessary operational activities and the MPE, where these activities carried potential for a higher exposure than permitted by the MPE. CJTF 7 was expected to consider conservation of personnel exposures, the knowledge of initial radiation effects, the international import of the tests, and the cost aspects of delays due to conservative radiological precautions, both in appropriated funds and lost test data. The plan established criteria for MPE waiver in certain cases, taking into full consideration individual safety and the need for completion of the CASTLE mission. The MPE waiver provision was cleared with and approved by the Surgeons General of the Army and the Air Force, Navy BuMed, and the AEC (Reference 22).

After the heavy Bikini contamination, a number of waiver authorizations were granted for higher exposure levels for the operation. The waivers were primarily for TG 7.1 scientific personnel, the TG 7.5 support personnel, and TG 7.3 personnel already exposed, and were initially granted only after deliberation at high task force levels. For example, after shot BRAVO fallout produced some high exposures among TG 7.3 personnel, the task group commander initiated a request to the CJTF 7 to waive the 13-week 3.9-R MPE established for CASTLE. A conference on board the Estes on 12 March reviewed the situation, and subsequently CTG 7.3 formally "recommended that the Maximum Permissible Exposure (MPE) of personnel of certain critical groups of TG 7.3 be increased to 7.8 R (a 26-week integration)." Groups included in the waiver were (Reference 23):

- Helicopter and fixed-wing aircraft pilots
- Boat pool crews

- Flight deck crew of the Bairoko
- Entire crew of the USS Philip
- "Certain individuals," 40 in all, whose names were to be forwarded to joint task force headquarters at a later date.

Nine days later, on 21 March, CJTF 7 sent a message from Enewetak to the Chief, AEC Division of Military Applications, CINCPAC, and the Army Chief of Staff, who was the Joint Chiefs of Staff's Executive Agent for CASTLE, stating that he was acting on the advice "from my staff surgeon, radiological safety advisors, and scientific director" and was accepting the request for a waiver of MPE for the groups CTG 7.3 listed. He also concurred that these individuals should be assigned "to activities requiring minimum or no exposure."

As the operation progressed, more waivers were requested. The Commander, TG 7.4 wrote (Reference 24, p. 72):

The present maximum exposure of 3.9 r per 13-week test period is not a realistic MPE in consideration of heavy work loads in extensively contaminated areas. The use of waivers to cover exposures in excess of this MPE becomes a needless routine without much significance when operations are conducted in large contamination areas without much interval between detonations. A large number of individuals did exceed 3.9 r, but very few exceeded 6.0.

TG 7.1 noted in the final radsafe report that the requirements of the military projects to work in contaminated areas and with contaminated equipment soon led to block requests for an authorized exposure of 7.8 R for the test series. The waiver of the MPE early in the series created a loss of confidence in the established limit of 3.9 R, which was soon reflected in the actions of the nonmilitary task groups. When it became apparent that an MPE waiver could be obtained upon application, the practices of conservation of exposure and wide utilization of recovery and contractor personnel became minimal. In many cases, waivers were requested after overexposure, and in others approved waivers were never utilized. Although 10.8 percent of TG 7.1 exceeded the MPE, only 33 percent of the overexposures were covered by waivers, and 22 percent of the

waivers granted were not utilized. For TG 7.5, 14.2 percent exceeded the MPE, with less than 3 percent covered by waivers (Reference 17, p. 40).

The Commander, TG 7.1, soon realized the deteriorating situation and decided to relieve any TG 7.1 or TG 7.5 individuals exceeding 6.0 R of duty and return them to the United States. This policy greatly assisted the Control Group in minimizing personnel exposures.

Radsafe Monitoring and Instrumentation

The overall radiation protection plan was based on the premise that Enewetak Atoll was the primary base of operation and Bikini was the forward shot area (Reference 22, Appendix B). All personnel working at Bikini were evacuated from the atoll before each shot (except for the BRAVO detonation firing party).^{*} The ships, with evacuees, were stationed outside of the anticipated fallout area. All islands near the shot point were considered too contaminated for reentry until cleared by a radsafe survey.

RADSAFE INSTRUMENTATION. The standard radsafe survey meter used by TU 7 was the AN/PDR-39 ion chamber.[†] Other instruments in use included the AN/PDR T1B and the AN/PDR-18A or -18B ion chamber, for survey in highly contaminated areas, and lower range Geiger-Mueller type instruments consisting of various models of the AN/PDR-27, the Beckman MX-5, and the Nuclear Corporation 2610 (Reference 17, p. 42).

* For the NECTAR shot on Enewetak, no evacuation was necessary. The device was not detonated until it was determined that fallout radiation would not contaminate the inhabited islands of the atoll.

† The Navy's Bureau of Ships was responsible for procuring and distributing sufficient radiac equipment for all elements of TG 7.3 to have a full complement. A complete accounting of the types and numbers of radiac instruments employed by TG 7.3 has not been found. Evidently, neither the AN/PDR-39 instrument nor the similar AN/PDR-T1B was issued (Reference 11, p. 11B-1). The primary instrument for TG 7.3 was the AN/PDR-27F, with the AN/PDR-18A available for use in higher radiation fields (Reference 11, p. 115).

At Enewetak, TG 7.2 used an "electronic" radiation monitor (presumably an ion chamber) coupled to an Esterline-Angus recorder. In addition, a cascade impactor driven by a Gast pump and an Electrolum sampler were in operation under the supervision of the TG 7.2 Radsafe Officer.

Specialized instrumentation (described on page 138) was installed in the TG 7.4 sampler aircraft to alert pilots to both dose rate and cumulative dose.

Three types of pocket dosimeter, the Victoreen (0 to 5 R), the Cambridge (0 to 1 R), and the Keleket (0 to 0.2 R), were used by monitors but were found to be unreliable. The dosimeters reportedly gave readings that were consistently high by a factor of two; of those used, 63 percent either became inoperative or were lost (Reference 17, pp. 43-44). CTG 7.3 commented that about 15 percent of its pocket dosimeters would not hold a charge and generally proved to be "awkward and slow" in operation (Reference 11, p. 11b-1).

No information has been found regarding the methods used to calibrate the survey meters except for a paragraph in Reference 25 that indicates:

1. Some meters may not have been calibrated before use
2. The calibration may have been against ^{60}Co or ^{226}Ra
3. The low range on the AN/PDR-39 and the AN/PDR-T1B was not calibrated.

PERSONNEL FILM BADGES AND RECORDS. Personnel film badge dosimetry employed badges that combined two types of film to achieve an extended range of exposure readings. DuPont 502 provided low dose coverage, reasonably accurate between 0.1 R and 3.0 R and usable to about 10 R. DuPont 606, with a range of approximately 10 R to 300 R, ensured high dose coverage; however, this particular combination of films had decreased accuracy in the region of 10 R to 15 R. Both films were probably used in evaluating this range (Reference 17, p. 43).

The initial plan was to badge "all personnel expected to receive significant amounts of radiation . . . [and] . . . a representative 10% of

other personnel" (Reference 11, p. 11a-11). Shot BRAVO "contaminated some of the ships to the point that it would have been most desirable to issue film badges to all personnel on them . . . [because] . . . many people with no film badges received significant radiation" (Reference 11, pp. 11a-11 and 11a-12). Sufficient badges were not available, however, and furthermore TU 7 lacked the personnel to process a larger number of badges. Even so, the TU 7 technicians attempted to estimate the doses of those without badges "based on film badges of similarly exposed personnel, but it was impossible to do this accurately in many cases." After BRAVO, more badges became available, with assignment priorities given to "people expected to receive significant radiation and people who had already received a relatively large amount of radiation" (Reference 11, p. 11a-12).

Additionally, after BRAVO, a notice from CINCPAC directed all ships entering a circular area within 450 nmi (833 km) of a point near Bikini to have 5 percent of their crews wear film badges or dosimeters until out of the area. Processing was to be performed when specifically directed by CINCPAC (Reference 16, Tab C). There is no indication that it was necessary to process the badges.

Two methods of film badging were used in normally noncontaminated areas, i.e., areas not under control of the TG 7.1 Radiation Control Group. The first was area badging. This system involved "spotting" an island or vessel with film badges in key places to provide coverage of living and working areas. Efforts were coordinated with the Radsafe Officer to ensure coverage of areas assigned to each task group.

The second method was personnel badging. Film badges to be worn throughout presumed fallout periods were issued to certain individuals, for example, detachment radsafe commissioned and noncommissioned officers. The readings of the personnel and area badges for each detachment were averaged to make a blanket assessment of total radiation dose to each member of the detachment.

Some types of activities required badging an entire group. For example, film badges were issued on D-1 of each shot to all crewmembers of TG 7.4 sampling aircraft and to crewmembers of any other aircraft expected to fly within 100 nmi (185 km) of the shot site at H-hour.

Badges were issued at the radSAFE centers to parties entering radiological exclusion (radex) areas. The records do not specify whether a badge was issued to each member of a party or a single badge was used to represent doses for the entire party.

All film badge processing and maintenance of dose record cards for all personnel was performed by TU 7 of TG 7.1 in compliance with JTF 7 regulations. Personnel Exposure Sheets were used by a large percentage of units and groups during CASTLE to keep track of personal identification data, issue and return date for individual film badges, and recorded radiation exposure. In some cases these sheets were also modified to include date of pocket dosimeter issue and the exposure reading upon return that same day. Although established procedures called for transfer of individual badge information to 5- x 8-inch record cards, only about 50 percent of CASTLE dosimetry data were entered on these record cards. In general, most TG 7.3 dose data were cumulated on lists of shipboard personnel rather than the 5x8 cards.

The 5x8 record cards, "Individual Accumulative Radiation Exposure Record," were developed in two different formats. One version of the form included badge number, date of development of the badge, the film badge reading in milliroentgens, and an accumulated dose [sic] column (also in milliroentgens). Another format provided issue dates of both film badges and pocket dosimeters, the exposure in milliroentgens for both (if recorded), and an accumulated exposure column in milliroentgens used to total film badge readings. Although attempts were made to provide all data on the cards or Personnel Exposure Sheets, not all fields were always completed.

The 5x8 record cards and the Personnel Exposure Sheets were updated with exposure information (when possible) as soon as it was available after developing and/or reading. The 5x8 record cards were used as a current tabulation of personnel exposure. This system was designed to inform the monitors of the total dose received by any task group member. Even so, overexposures sometimes occurred because of the time required for processing, posting the results, and notifying affected personnel.

At the conclusion of CASTLE, the record cards and Personnel Exposure Sheets were transferred to CTG 7.1, who was responsible for keeping total dose records on the entire task force. For most units where 5x8 record cards were not used, rosters of shipboard personnel were used to list and total all badge readings for each individual. These unit master lists and the 5x8 record cards were used to develop the Consolidated List of CASTLE Radiological Exposures (Reference 13), which was used as the basis for the dose tabulations in Chapters 6 through 10. Although the Consolidated List does not distinguish between exposures determined from film badges and those calculated or assessed, these data are often obtainable from the 5x8 record cards or the Personnel Exposure Sheets.

In the process of accumulating the names for the Consolidated List, some badges with zero readings were ignored. Therefore, a badged individual who had only zero readings may not appear on the Consolidated List. This practice was not uniform, but a cursory examination of the microfilm record (Reference 87) that contains the Personnel Exposure Sheets, the 5x8 cards, and the rosters of shipboard personnel reveals that men with badges issued at the Enewetak airfield with zero readings do not appear on the Consolidated List unless, of course, they were issued another badge at another time that did indicate exposure. The extent of this is difficult to judge without examining all the microfilmed records. Personnel of TG 7.4 (Air Force) were primarily affected, and the Consolidated List erroneously indicates that less than half were badged; the Naval Air Station at Kwajalein also ignored zero readings in cumulating badged personnel. This has no significance for assessing the total radiological exposure;

however, it does mean that any average exposure extracted from the Consolidated List data will be high because some zero readings were not included.

After shot BRAVO the maintenance of exposure records became a function of each task group, with TU 7 serving as the task force interim repository. Each task group " . . . was required to send an alphabetical roster of personnel in triplicate to Task Unit 7." The exposure records "included not only exposures of persons with film badges, but also estimated exposures of other persons based on film badge readings of people similarly exposed" (Reference 11, p. 11a-12).

TG 7.3 employed two different systems for categorizing these exposures. Under the first regime, used within TG 7.3 only, units filed weekly reports with task group headquarters, which separated the accumulated exposures into nine categories: 0-1 through 6-7 in 1-R increments, 7-7.8 R, and over 7.8 R. At a later date (not determined), the joint task force command instituted a different reporting system, requiring that reports of individual accumulated exposures from all task groups "four days after each shot" be organized into the following categories: 0-2.5, 2.5-3.9, 3.9-7.8, and over 7.8 R. Both systems, however, continued in use, and all Navy units filed two separate reports of personnel exposures (Reference 11, pp. 11a-13 and 11a-14).

Roughly 40 percent of TU 7 activities involved the maintenance of these exposure records for more than 10,000 individuals. Their accuracy reflected the accuracy of the individual task group personnel sections, individual cooperation in designating proper home stations, and cooperation in returning film badges for processing.

Duplicate sets of exposure records for TG 7.1 and TG 7.5 were maintained at the Bikini and Enewetak Radsafe Centers. Usually, these duplicate records were available about 36 hours after exposure. TG 7.2 and TG 7.4 maintained operational control files within their respective headquarters. TG 7.3 maintained operational control records aboard each ship. Upon completion of Operation CASTLE, the records were disposed of as follows:

- A consolidated list of personnel exposures, together with exposed film badges and control film badges, was forwarded to the Chief, AFSWP
- A consolidated list of personnel exposures was forwarded to the Director, Division of Biology and Medicine, AEC
- Individual records of Navy and Air Force personnel were forwarded to their unit of permanent assignment for inclusion in the health record of the individual
- Individual records of Army military and civilian personnel were forwarded in accordance with SR-40-1025-66, dated 21 April 1953, for inclusion in the individual's field military 201 file or the civilian 201 file
- Individual records of AEC-administered and -controlled personnel were forwarded to each laboratory or agency having administrative jurisdiction over such personnel.

The completion of records was delayed 6 weeks because TG 7.3 film badges from several ships were not received until 1 month after the end of the operation. The development and recording of these badges required special arrangements with the Health Division of LASL since TU 7 had been deactivated.

Difficulties were encountered in notifying Air Force units of exposures because some of these units were disbanded shortly after completion of the operation.

The following indicates some of the problems confronting radsafe personnel and film badging (Reference 17):

Daily knowledge of activities throughout the Atoll when personnel were traveling by small boat and helicopter from a number of housing areas and the maintenance of daily current exposure records at five control stations on two atolls with limited transportation and communication facilities proved to be the most difficult control problems.

In many instances records were from 24 to 48 hours behind the activities of the individual. When the records were made current, the individual was listed as an overexposure, and the Control Officer was criticized for not informing the individual of his current exposure at

time of entry. This time delay was caused by the practice of issuing film badges at Eniwetok and developing the film at Bikini and by a lack of night transportation in the lagoon.

The practice of entry control by film-badge exposures left much to be desired, but it was the only method available in the absence of reliable self-reading dosimetric devices. The practice of issuance and development of film badges may have penalized many individuals because of inherent inaccuracies of the film badge in the presence of low-energy radiation and low dosages.

PRE-EVENT SAFETY MEASURES

Hazard Zones

A security zone, 150 x 300 nmi (278 x 556 km), was established around Enewetak and Bikini prior to CASTLE (Reference 26),* and this also served as a radSAFE precaution area. The area was patrolled by P2V aircraft and destroyers to assure that no unauthorized vessels were present. The Navy also diverted shipping from within a sector 500 nmi (926 km) from ground zero in an arc extending from the southwest, clockwise to the east. Involving primarily U.S. shipping, this was done on all shots from H-hour to H+24.

After BRAVO, maximum cooperation with other nations was sought to control shipping in the hazard zone. The area was officially designated a danger zone and redefined as the sector centered on 12°N, 164°E, from 240° clockwise to 95°, with a radial distance 450 nmi (833 km). A subsector (designated Area Green) was defined as the region bounded by 10°15'N, 16°40'N, 160°10'E, and 170°20'E, which was subject to more intensive air and sea search prior to a shot than the rest of the danger zone. Additionally, all U.S. shipping that passed within 600 nmi (1,111 km) of Bikini came under the operational control of CTG 7.3 (for radSAFE diversion if necessary).

* The area was bounded by 160°35' to 166°16'E and 10°15' to 12°45'N.

P2V aircraft swept the forecast fallout sector, using visual sightings and search radar out to 800 nmi (1,482 km) on D-2, out to 600 nmi (1,111 km) on D-1, and, if necessary, in front of the cloud on D-day. Since the reliable range of the P2V search radar was taken as 30 to 50 nmi (56 to 93 km), the effective round-trip sweep width of a single P2V was 120 to 200 nmi (222 to 370 km). The P2V aircraft crews were instructed to report shipping sighted in the D-2 sweeps and to attempt to divert ships sighted on D-1 and D-day.

The area involved was huge, and a single (or even two or more) aircraft could search only a small portion of it. The search plan was modified after BRAVO to search Area Green intensively with three P2V aircraft on D-1, and to make a parallel search with two P2V aircraft out to 600 nmi (1,111 km) with a 240-nmi (444-km) sweep width centered on the forecast direction of significant fallout. This procedure was expected to concentrate the search effort in the areas where the maximum fallout would occur. The capability was also maintained, and used on some shots, to search on D-day in advance of the cloud. Another danger area (Evelyn) was defined for the one shot at Enewetak, NECTAR, to avoid excessive drain on aircraft availability owing to numerous shot cancellations. Area Evelyn was centered on Enewetak Lagoon, 270° clockwise through north to 90°, with a radius of 300 nmi (556 km), plus a rectangular strip 60 nmi (111 km) wide and 600 nmi (1,111 km) long, immediately adjacent to the south. Since the upper airborne particle trajectories normally moved toward the east, this smaller area could be searched faster (and therefore at a later starting time before H-hour) and with fewer aircraft, taking advantage of the relatively clear easternmost portion of the 450-nmi (833-km) danger zone without necessitating detailed searching. Figure 16 shows the locations of these various areas.

Fallout Prediction

The Radsafe Office prepared the fallout predictions, delineated the danger zone and radex areas, and presented the predictions at command briefings before each shot.

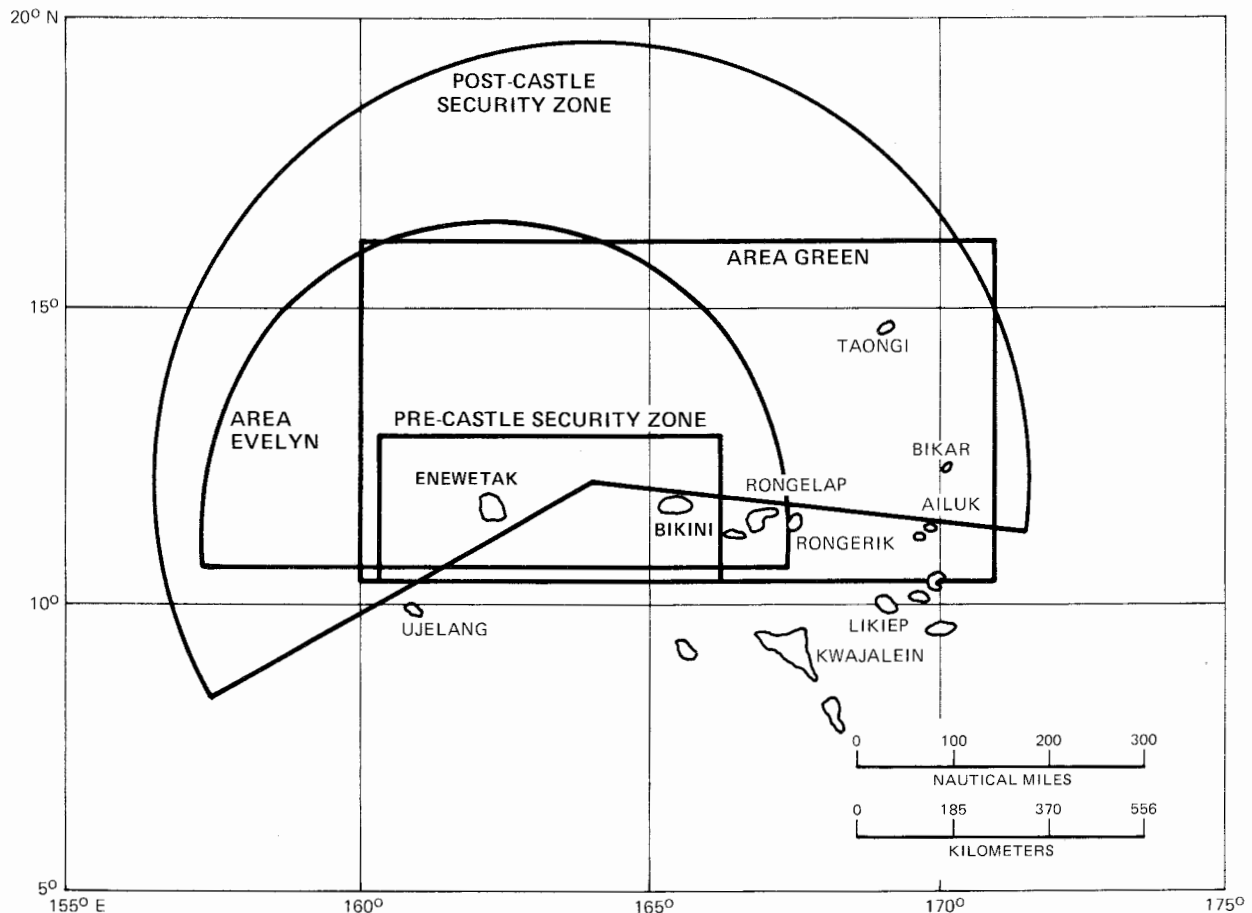

Figure 16. Pacific Proving Ground search areas and security zones for Operation CASTLE.

Fallout predictions were based on weather observations and on the results of previous operations, primarily those in Nevada, for which the most data were available. Two types of analyses of weather-wind data were used in preparing the fallout predictions: hodographs and trajectory forecasts of the paths that would be assumed by particles falling from a given height through the various wind layers.

HODOGRAPHS. A hodograph is a plot of wind speeds and directions. It presents a vector diagram representing the horizontal projection of the path of a wind-sounding balloon rising in the atmosphere at a constant rate. The hodograph may also be considered to represent the horizontal

projection of the path of a particle falling from some level in the stabilized cloud at a constant fall rate. The associated points on the surface represent the locations where the particles would land if they originated over ground zero at the given altitude. For the CASTLE Series, vectors were drawn for 5,000-foot (1,524-meter) increments of altitude, showing wind direction, and with lengths proportional to the time that 100-micron particles would travel while falling through the layer. These wind-vector diagrams graphically illustrated the favorable or unfavorable wind patterns at the two shot atolls. Using a hodograph, direct time and distance measurements could be calculated (or "normalized") in terms of 100-micron particles, and the behavior of any smaller sized particles could be estimated by taking multiples of the distances. Before BRAVO it was thought that particle sizes down to 70 microns were significant (which amounted to doubling the distances taken directly from the normalized hodograph). After BRAVO, however, particle sizes down to 50 microns were considered significant, and appropriate adjustments were made in the predicted fallout pattern.

PARTICLE TRAJECTORY FORECASTS. Maps of the path that a particle at a constant altitude would take due to the winds were known as particle trajectory forecasts. These forecasts of trajectories from the shot site covered the period from H-hour to H+72 in 10,000-foot (3.05-km) increments ranging from 10,000 to 60,000 feet (3.05 to 18.30 km). The initial forecast was for H-hour and revised trajectories for the same 72-hour period were issued at H+6 and H+15. Radsafe personnel used the forecasts to assist in analysis of the long-range fallout aspects and to alert sampling units of probable locations and altitudes of areas with airborne radioactive particles.

Data from past exercises used in fallout prediction consisted of particle-size measurements (which gave the rate of fall from various altitudes) and observations of downwind and crosswind variation of radiation intensity with distance from ground zero. Additional considerations included initial size of the radiation source (that is, the areal extent of

the cloud before transport by winds) and the diffusion rate of the cloud as it was moved by the winds.*

The primary fallout plot technique initially used on CASTLE was a joint analysis of the hodograph and the 72-hour airborne particle trajectory forecast to define the fallout area for the first 12-hour period and assess the orientation and areal extent of the cloud after the first 12 hours. For BRAVO, the method of elliptical approximations was first attempted; its use was extremely limited, however, because of uncertainties in its application to high-yield events. The BRAVO data were used to refine this method for subsequent events.

The method of elliptical approximations drew ellipses over the hodograph between wind levels. The minor axes of the ellipses were determined by the amount of change in wind direction between wind layers. The radiation intensity associated with the ellipses was based on scaling and past experience. The method was based largely on empirical data from the Nevada Proving Ground (NPG), and it had been used successfully to predict the fallout fields from low-yield PPG detonations.

As the tests began, it became apparent that a more accurate method was needed to clearly define the fallout from high yields. The large differences between NPG and PPG shot yields and cloud heights made the accuracy of using elliptical approximations for CASTLE shots suspect. There was no assurance that the high-yield fallout mechanisms were described at all. For example, the trapping characteristics of the atmospheric boundary with the stratosphere (the tropopause) could only be conjectured, and even if

* Because little was known about the fallout mechanism of high-yield events and because of errors in other parameters of the fallout forecast, some additional safety factor was assumed necessary, even though the value of the factor could not be precisely stated. For CASTLE, the estimate of the diffusion-caused widening of the fallout-contaminated area with distance was increased by the addition of a 15° sector on each side of the calculated fallout area. In previous operations the factor used was 10° (Reference 16, p. 61).

the tropopause were discounted as a barrier, no reliable indications of the significance of the height of the above-tropopause cloud existed. Furthermore, even if these factors had been known, the only available long-range fallout data on land-surface bursts were limited to a single low-yield shot (SUGAR of the 1951 JANGLE series), which meant that the assignment of reasonable values to isodose lines derived from the prediction system was both difficult and possibly inaccurate. Consequently, although the elliptical approximations system of fallout forecasting was used on BRAVO to augment other data, it was limited to discussions of the relative merits of the assumptions and scaling upon which it was based. Since there was no real basis for assuming the system was valid, it did not override the many other factors involved in shot decisions. Nevertheless, as the tests progressed and observed fallout effects answered some of the many questions involved, the system was relied upon to a much greater extent (Reference 16, pp. 57 and 58).

The elliptical approximations method, or any other extension of the surface radex area beyond about 6 to 12 hours, was also limited by being based on the ground-zero winds. A new method was needed to accommodate the changes in wind systems as particles drifted farther from ground zero. Thus, during CASTLE a new technique was developed that utilized airborne particle trajectory analyses and progressive forecasts of wind patterns in accordance with time and displacement aspects of the cloud. Practical methods were devised to apply such a system to the last three CASTLE shots for a valid forecast period of H-hour to H+24 (Reference 16, Tab D).

Weather

Because fallout forecasts depend primarily on forecasts of wind fields, the accuracy of the CASTLE fallout predictions was related to the accuracy of weather predictions. CJTF 7 in Operation Plan 3-53 (Reference 9) assigned responsibility to CTG 7.4 to administer and logistically support weather elements to provide meteorological data and to perform radsafe missions required to conduct CASTLE operations. TG 7.4 was responsible for a four-island ground weather reporting element, an aircraft weather

reconnaissance element, and manning support for a Task Force Weather Central. The organization of the JTF 7 weather element is shown in Figure 17.

The Task Force Weather Central, located on Parry, was under operational control of CJTF 7. When CJTF 7 transferred his command post to the Estes for each of the five shots fired at Bikini, the Task Force Weather Central was moved aboard the Estes to provide him with the direct support required to make the "go" or "no go" firing decision (Reference 16, Tab E).

The weather observational network for CASTLE consisted of stations at Parry, Bikini, Rongerik, Majuro, Kusaie, Ponape, and Kwajalein, with additional data coming from Midway, Wake, Marcus, Guam, Iwo Jima, and Johnston

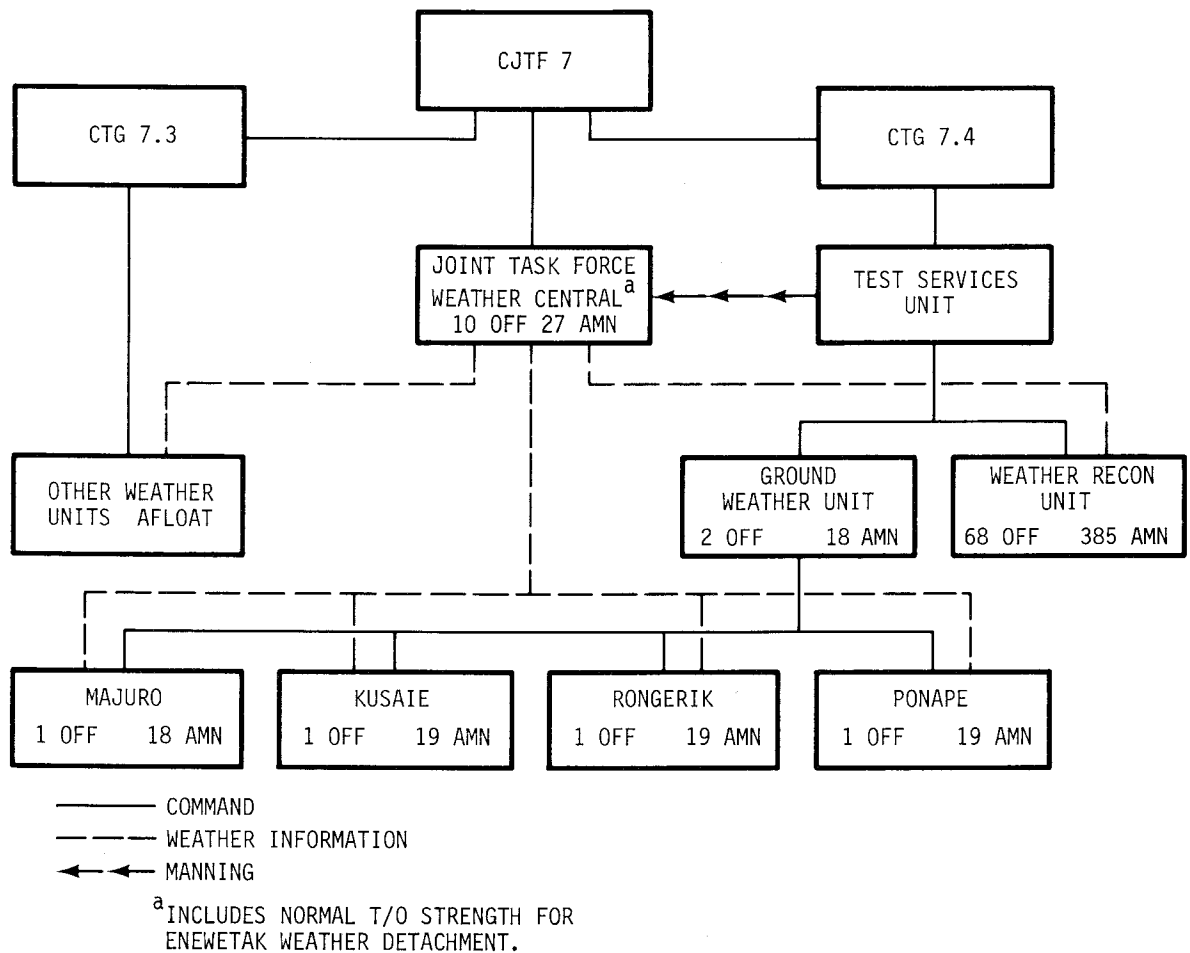

Figure 17. Joint Task Force 7 weather element organization, CASTLE.

islands, and some elements of TG 7.3. Weather balloons were routinely released twice daily to check winds aloft, with the releases increasing to eight per day prior to a shot. The maximum height attained by the balloons was 120,000 feet (36.60 km), and they averaged about 85,000 feet (25.91 km).

Additional TG 7.3 meteorological support was supplied by weather reconnaissance observations made every half-hour by P2V-6 aircraft while on their security patrols. The Curtiss and the Bairoko reported surface observations hourly and radar wind soundings (rawinsondes) twice daily (Reference 22, pp. M-1 through M-3).

All units using balloons to obtain upper wind readings encountered equipment problems. The Curtiss relied on radiosondes as well as rawinsondes to gather meteorological information. Rawinsonde tests determined the winds aloft patterns by radar observation of a balloon. Radiosonde, in contrast, used a balloon-mounted radio transmitter to automatically send meteorological information to a weather station. CTG 7.3 planned for the Curtiss to take hourly surface and twice daily radiosonde readings before each shot and report at 2200 to CJTF 7. Problems were encountered, however, with balloons freezing and bursting before reaching the tropopause. Also, because of the number of shot cancellations resulting from inauspicious weather, by the fifth shot (YANKEE) the Curtiss had depleted its supply of weather balloons. The consequence of balloons icing and bursting was that critical wind observations were sometimes terminated before reaching the maximum altitudes where wind patterns were significant (Reference 16, p. 90).

Preshot planning forecasts issued at H-48 and H-36 hours consisted of wind forecasts for the shot site at 10,000-foot (3.05-km) increments from the surface to 90,000 feet (27.40 km). Following the selection of a specific shot time, forecasts were issued at 24, 12, 8, and 4 hours before H-hour. These forecasts were more detailed: winds were forecast to the nearest 10° and to the knot for each 2,000-foot (0.61-km) increment from

the surface to 20,000 feet (6.10 km), for each 5,000-foot (1.52-km) increment from 20,000 to 70,000 feet (6.10 to 21.30 km), and for the 80,000- and 90,000-foot (24.40- and 27.40-km) levels.

Radex Areas

Radiological exclusion (radex) areas were determined by the Radsafe Office. These were usually defined as locations where significant fallout could occur within 6 hours after detonation. The plots were delineated by 50-R (10-R for some shots) contours based upon the predicted infinite dose.* The radex areas were used to define dangerous areas and to deny entry to task force units into certain areas except by specific authorization.

The surface radex area was constructed using the basic forecast hodograph limiting bearings of resultant winds to all significant levels. An additional 15° sector was added to each side of these limiting bearings to allow for diffusion, changes in the forecast wind pattern, and deviation from a point-source origin of fallout. Usually, the radex area consisted of two sectors. One defined the low-level trade wind portion of the cloud, and the other defined the midlevels. For all surface radex areas, the radial distance of the sectors was taken as that average distance representing 6 hours of particle fall at 5,000 ft/hr (1.52 km/hr). This established outer limits of surface contamination that considered the fall of particles of all sizes during the 6-hour period. The surface radex was valid from H-hour to H+6 and revised as necessary when forecast winds changed.

The forecast air radex areas were constructed in two regions describing the volumes of contaminated air above 10,000 feet (3.05 km) and above 40,000 feet (12.20 km). The first volume was needed for test and service aircraft operating in the shot area to assist them in avoiding contaminated regions. The second volume was primarily for use in cloud-sampling

* The infinite dose is the dose from external sources that a person would receive by remaining within fallout contamination until it naturally decayed (that is, infinitely long).

operations to assist aircraft in finding the best sampling areas. Preparation of the air radex area consisted of selecting an altitude at the bottom of the volume under consideration, considering this altitude as a surface plane, and constructing a hodograph using appropriate winds above the surface. Areas of possible contamination were then predicted by the use of diffusion factors applied to the resultant winds obtained, and modified to account for deviation from a point-source origin of fallout (Reference 16, pp. 66 and 67).

Offsite Monitoring

Much of the CJTF 7 planning correspondence (Reference 16, Tab C) clearly shows concern for the safety of the native population on the various atolls in the PPG. An 11 December 1953 communication to CINCPAC stated, "The decision to shoot should be reached with the understanding that no health hazard to . . . populated islands . . . will ensue." However, CJTF 7 did not believe it necessary to monitor the islands for radioactivity, or to sample the drinking water of distant atolls -- a procedure followed during Operation IVY in 1952. CINCPAC did not completely concur. A 31 October 1953 letter directed CJTF 7 to sample drinking water in the event "that radiological conditions require." A later letter (11 February 1954) directed CJTF 7 to assist the AEC New York Operations Office, Health and Safety Laboratory (NYKOPO, HASL) in aerial monitoring of inhabited atolls in the Marshall, Mariana, and Western Caroline islands. The surveys were to be made only of those atolls where the possibility of contamination existed, rather than of all atolls as was done during Operation IVY.

The aerial monitoring was conducted by aircraft operating from Kwajalein and Guam (VP-29) and from Oahu (VW-1). The radiation detection equipment was provided by the AEC, but AEC staff members did not participate in the monitoring flights. Table 9 lists the potential flights and the islands each flight was expected to monitor.

Ground monitoring stations were established by HASL at Truk, Yap, Ponape, Kusaie, Majuro, Rongerik, Ujelang, Wake, and Midway. Automatic recorders continuously monitored gamma radiation; however, the upper limit

Table 9. CASTLE airborne monitoring survey schedule of the AEC New York Operations Office.

Kwajalein Flights (D+1)			Guam Flights (D+1 to D+4)		
Able	Baker	Charlie	Dog	Easy	Fox
Kwajalein	Kwajalein	Kwajalein	Guam	Guam	Guam
Lae	Nam	Mokil	Ruta	Namonuito	Gaferut
Ujae	Ailinglapalap	Ponape	Agiguan	Truk	Faraulap
Wotho	Namorik	Ujelang	Tinian	Losap	West Fayu
Bikini	Ebon		Saipan	Namoluk	Ifalik
Ailinginae	Jaluit		Farallon de Medinilla	Lukunor	Woleai
Rongelap	Mili		Anatahan	Satawan	Eauripik
Rongerik	Arno		Sairguan	Kuop	Palau
Taongi	Majuro		Goguan	Pulap	Ngulu
Bikar	Aur		Alamagan		Yap
Utirik	Maleolap		Pagan		Ulithi
Taku	Erikub		Agrihan		
Ailuk	Wotje		Asuncion		
Likiep			Maug		
			Farallon de Pagaros		
Hawaiian Flights (D+2 to D+6)					
George		How		Item	
Pearl		Midway		Pearl	
Midway		Pearl		Lanai	
(Over south beaches enroute, passing all islands in Hawaiian chain)		(Over north beaches enroute, passing all islands in Hawaiian chain)		Kahaoulawe	
				Hawaii	
				Maui	
				Molokai	
				(Over south beaches enroute, north beaches on return)	
Source: Reference 16.					

of this equipment was 0.1 R/hr. Additionally, the Air Force established monitoring stations at Oahu, Guam, Luzon, Tokyo, Okinawa, Shemya, and Anchorage where gamma intensity readings were planned at 12-hour intervals using a 2610A portable survey meter.

HASL also established a worldwide network of 122 stations that used gummed film to trap fallout particles for subsequent analyses. The U.S. Weather Bureau operated 39 of the stations in the continental United States and 14 at overseas locations; the Air Weather Service operated 23 overseas stations; the State Department operated 31; 3 were operated by the Navy and Coast Guard; and 2 were operated by the Atomic Bomb Casualty Commission. The Canadian Meteorological Service cooperated by operating 9 stations, and the Canadian Atomic Energy Commission operated 1 station. All stations were scheduled to make two simultaneous 24-hour gummed-film collections starting at 1230 (GMT) each day.

In addition, single gummed-film stands were installed on most ships of the Military Sea Transportation Service (MSTS) scheduled to be on routes in the Pacific Ocean. The ship collections were made daily (Reference 27).

Command Briefings

The decision to detonate a particular test device was made at a series of command briefings beginning at H-36 hours. Fallout exposure evaluation was critical to the shot, no-shot decisions. The evaluations were presented by a senior representative of the Radsafe Office. The radsafe briefing included:

- Forecast winds for H-hour, hodographs, and resultant wind diagrams. For each briefing, hodographs were constructed with the latest wind information in order to show the development of the wind pattern.
- Surface radex areas, limiting bearings, radial distances, hot area, cool area, and long-range fallout plot. The surface radex area was drawn using the hodograph for forecast H-hour winds. A 15° sector was added to each limiting bearing. A representative radial distance was indicated for a 6-hour fallout period. A hot and a cool area were indicated. The

hot area was the sector from surface to 60,000 feet (18.30 km) and the cool area was that area enclosed by bearing lines from winds at 60,000 to 90,000 feet (18.30 to 27.40 km). The long-range (24-hour) fallout plot was drawn to show its location relative to native atolls and populations and was presented in conjunction with the surface radex area.

- Seventy-two-hour airborne particle trajectory forecast. The airborne particle trajectory forecast (constructed by Weather Central) was used to evaluate contamination on air routes and to extend the surface radex area beyond H+6.
- Air radex area. The air radex area normally did not affect the shot decision, and it was not directly used at briefings unless requested. (This radex area was plotted and kept displayed at the Radsafe Office.)
- Radiation hazard outlooks. The following specific potential hazards were evaluated at each briefing:
 - Bikini and Enewetak. The outlook was determined from the forecast hodograph for the shot atoll.
 - Ujelang. Both the long-range fallout plot and shot atoll hodographs were used to evaluate the outlook for Ujelang.
 - Native atolls in the southeast quadrant. Both the fallout plot and shot atoll hodographs were used to evaluate the outlook for native atolls in the southeast quadrant.
 - Aircraft control destroyer. The shot atoll hodograph was used to recommend safe positioning of the control destroyer for at least 6 hours and retirement in the most favorable direction in the event fallout was experienced.
 - Fleet tugs (ATFs) and YAGs. This was presented to indicate the major activity (drone liberty ships, Project 6.4) taking place within or near the surface radex area, and within close range of the armed device prior to H-hour.
 - Air routes through Wake and Kwajalein. The impact on the air routes was determined by the 72-hour airborne particle trajectory forecast. The trajectories at 10,000, 20,000, and 30,000 feet (about 3, 6, and 9 km) were considered to have the major impact on these routes between H-hour and H+24.

- Surface routes inside 500 nmi (926 km), about 1 day of cloud travel. A display of all known transient shipping was presented in conjunction with both the surface radex area and the long-range fallout plot.
- CINCPAC advisories (72-hour trajectory, native population outlook, air and surface routes). The general features of the proposed advisories to CINCPAC were presented for coordination and concurrence of CJTF 7.
- Position of task force ships. Recommended positioning of the task force ships was based on the surface radex area. (Operational problems relative to the surface radex area and fleet positioning were resolved by the commander and staff based on the radSAFE briefing information.)
- Cloud-tracking plan. The plan was reviewed as necessary to adjust to changes in forecast wind patterns.

A general overall statement of favorability or unfavorability of the radSAFE shot conditions was given as summary and conclusion to the radSAFE briefing.

Radiation Protection Modifications

Special radiation protection measures were available to TG 7.4 cloud-tracking and -sampling aircrew members. In Operation IVY, pilots of the F-84G sampling aircraft wore a lead-cloth suit and a lead-covered helmet for radiation protection. Because the lead-cloth suits were bulky and restricted movement, protective clothing for pilots was redesigned for Operation CASTLE. The 4926th Test Squadron at Kirtland AFB, New Mexico, developed a nylon sleeveless vest with a chest-size section of fiberglass and lead. Later, the vest was modified by adding more lead material to the sides for torso protection. The final vest weight was about 6 pounds (2.72 kg). The vest proved satisfactory for escape in water when tested in the Kirtland AFB swimming pool. Also, a lead vest weighing about 14 pounds (6.35 kg) was developed for WB-29 crewmembers.

In addition to the lead vests for pilots, the seat backs and bottoms of F-84G sampler aircraft were sheathed with lead. (The thickness is not

known.) Sampler aircraft were also pressurized and fitted with a special filter to prevent the entry of radioactive particles. All TG 7.4 crewmembers were required to breathe 100 percent oxygen during and after sampling missions to reduce the possibility of inhaling radioactive particles.

Certain temporary modifications to the task group ships were required to comply with the regulations set forth in the Radiological Safety Plan. In 1954, Navy ships were not normally equipped with a washdown system. Instead, ships ordered to support nuclear testing relied upon a temporary arrangement "of hoses and special nozzles, connected to the fire main system." For the CASTLE operation, the equipment necessary to rig this apparatus was supplied by the Navy Bureau of Ships (BuShips) and arrived in the PPG on board the Bairoko for installation aboard the ships (Reference 11, p. 11a-1). A BuShips representative assigned to the staff of TG 7.3 supervised the work on all ships except the fleet tug, USS Tawakoni, which reported "with a washdown system already installed by the ship's force from standard firefighting equipment" (Reference 11, p. 11a-1).

In addition to its own washdown system, the Bairoko also carried a helicopter decontamination "bathtub" to be used by helicopters of HMR-362. The bathtub was a 60- by 20-foot (18.3- by 6.1-meter) canvas rectangle constructed of 20-ounce canvas, and was described by the TG 7.3 final report (Reference 11, p. 11a-3) as follows:

The tarpaulin was treated with canvas preservative for waterproofing. When the tarpaulin was in place aft of the elevator the sides were raised by use of stanchions and wire cable to form a so-called "bathtub." Fresh water under pressure was provided on the flight deck by using a P-500 pump connected to fresh water mains below decks.

The bathtub was equipped with two drains. The function of the bathtub was to collect the wash water and duct it directly over the side rather than spilling it on the flight deck.

After installation of ship washdown systems, the crews were given a lecture on radiological safety, followed by an "atomic defense inspection."

The inspection began with an atomic defense exercise that simulated an encounter with radiological contamination under conditions likely to occur during the CASTLE tests rather than in battle. Staff and ship's officers, according to the TG 7.3 final report (Reference 11, p. 11a-3), observed and evaluated the

. . . ship's closure of gas tight envelope, decontamination stations, washdown systems in operation, Radiological Defense Bill, radiac equipment, decontamination equipment, and pre-contamination preparation of the ship.

During the inspection, observers did uncover "numerous small deficiencies which were corrected." The judgment expressed in TG 7.3's final report (Reference 11, p. 11a-4) was that:

The inspections instilled in ship's personnel confidence in their ability to protect themselves from radiation and thus improved morale in many cases. All inspections were considered satisfactory, and subsequent events proved their worth.

Operation of ship washdown systems during fallout was a constant source of exposure to radiation for some personnel, according to the TG 7.3 final report (Reference 11, p. 11a-3):

During operation of the washdown systems it was found necessary to have a few personnel topside and exposed to radiation in order to clear the fire main strainers, replace ruptured hoses, and to take the kinks out of the hoses when the washdown system was first turned on.

Furthermore, when a ship encountered fallout, the crew was required to close off all ventilation to spaces below decks. Crews found this raised temperatures beyond tolerable levels in the engineering spaces. Consequently, according to a report filed from the Philip after CASTLE, "from time to time it was necessary to relax the material condition in order to resume ventilation of these spaces." The result was unavoidable exposure of personnel in those areas to airborne radiation. As one ship later reported (Reference 28):

. . . personnel directly in front of the blowers later developed minor radiation burns on the neck and around the beltline. These burns were not immediately discernible but showed up a few days after exposure. Successfully treated as ordinary skin irritations, these burns were no more serious than to cause some discomfort in the hot climate.

Evacuation, Disposition, and Reentry

BIKINI SHOTS. Bikini personnel evacuations before shots followed a standard procedure. Once a shot device was armed, no major ships were permitted within its vicinity. Eneu Island served as a staging area for the personnel who were ashore preparing for a shot. Ships scheduled to take on passengers anchored off the island at about 1300 on D-1. All passengers were on board before nightfall and in time to conduct a thorough muster. The following ships received the majority of evacuees:

- Fred C. Ainsworth: H&N construction personnel
- Curtiss: scientific and technical personnel
- Bairoko: personnel scheduled for early reentry via helicopter, such as radsafe monitors, the teams responsible for restoring basic services in the shore camps, and firing party boat crews
- Estes: staff personnel from the task force and task group headquarters and their commanders, firing party personnel, and, when required, firing party boat crews
- USS Belle Grove: H&N small craft dispatcher and boat pool personnel from both TG 7.3 and TG 7.5.

Most ships left the lagoon for their assigned operating areas before the shot device was armed. The only exceptions were the Belle Grove, the tug assigned to tow the shot-site support barge (YCV) to sea, and the Estes, which evacuated the firing party (Reference 11, p. 11a). No ship other than the Estes was permitted within 20 nmi (37 km) of ground zero once the firing circuit for the shot device was ready to activate (Reference 11, p. 6-5).

After the task group ships cleared the lagoon, they proceeded to assigned operating areas in a sector generally southeast of the lagoon.

Their activities once outside the lagoon are found in the TG 7.3 final report (Reference 11, p. 6-7):

During the night ships operated independently in their assigned areas which were roughly 5 miles square, except for certain project ships which were carrying out their special functions in other areas.

Shots were usually detonated about one-half hour before sunrise. As shot time approached, ships were maneuvered to new areas, if the predicted radiological situation required, which would put them into safe areas at or shortly before the detonation (Reference 11, p. 6-7). These "shot time positions" were at least 30 nmi (56 km) distant from the shot site (Reference 11, p. 6-6). According to the TG 7.3 installment history (Reference 14, p. 127):

Operational considerations required that the ships be positioned at a distance no greater than was required for safety, and demanded that some ships be stationed until after shot time on bearings involving a slight risk of being in the fallout area. To maintain voice communications and thereby tactical control, all operating areas had to be adjacent to one another.

The prevailing winds and predicted blast and thermal effects were the major considerations in positioning of task group ships outside the anticipated fallout area at a safe distance from ground zero.

Reentry hour was established after several postshot surveys were conducted. About 2½ hours after the detonation, a helicopter from HMR-362 left the Bairoko for the Estes to pick up the CTG 7.1. This flight then performed the preliminary radiological survey and returned to the Bairoko. Other helicopter radiological surveys followed shortly. TG 7.4 cloud and fallout tracking missions provided additional information on the early radiological environment for the Radsafe Office on the Bairoko (Reference 11, p. 6-7).

When the task force commander authorized reentry, the Estes moved first into the lagoon, followed by the Belle Grove and the Bairoko. This order

enabled helicopter and LCM recovery missions to begin as soon as possible. Crews began decontaminating the small craft left behind in the lagoon during the shot. Likewise, personnel on board the Bairoko decontaminated HMR-362 helicopters as they returned aboard the carrier from survey or recovery missions. A returning helicopter would land in the canvas bathtub, where it was scrubbed and hosed down with fresh water (Reference 11, p. 6-7).

After initial survey and recovery efforts were underway, the Curtiss and the Ainsworth returned to the lagoon, followed by the rest of the task group ships. These vessels entered last since many of their postshot activities were dependent upon radiological surveys of the water in the vicinity of the shot site (Reference 11, p. 6-7).

Table 10 summarizes radSAFE-related activities at Bikini near each shot time.

ENEWETAK SHOT. Shot NECTAR, fired on 14 May at 0620, did not require a full-scale evacuation of Enewetak Atoll. Instead, personnel moved to Enewetak, Parry, and other islands in the southern portion of the atoll. Nevertheless, "all ships were evacuated to nearby operating areas at sea as a precautionary measure." Reentry began immediately after the detonation and within an hour all ships had returned to their berths in the lagoon in readiness to evacuate the atoll should fallout pose a danger to personnel (Reference 11, p. 6-8).

POSTEVENT SAFETY MEASURES

General Procedures

All personnel on Bikini were evacuated before each detonation. Early reconnaissance by helicopter established the radiological levels in the lagoon and on the islands of the atoll. All islands were considered contaminated until cleared by TG 7.1 RadSAFE Control personnel.

Preoperation planning called for Enewetak postshot control and decontamination activities to be centered at Enewetak and Parry islands. On

Table 10. Summary of Bikini radsafe activities, CASTLE.

Time	Activity
D-5	Sweep of Bikini Atoll by LCM. Begin personnel reduction at work sites.
D-3	Weather central transfers operations from Parry to the <u>Estes</u> (AGC-12). Air and ground sweep of Bikini Atoll.
D-2	Air and group sweep of Bikini Atoll. TG 7.3 begins 24-hour P2V patrol.
(0900)	Shot-day weather outlook given to CJTF 7.
(1100)	Radsafe Center operational on the <u>Bairoko</u> (CVE-115).
(H-36)	First command briefing. ^a Shot-day hodographs and transit ship plots presented.
D-1	P2V search of possible fallout areas to 600 nmi (111 km).
(1100)	Second command briefing. ^a Weather, existing and forecast hodography, 72-hour air particle trajectory plot, transit ship plots.
(1130)	Forecast air and surface radex areas for H-hour to H+6.
(1200)	Bikini evacuation complete.
(H-18)	Advisory to CINCPAC re fallout.
(1300)	All task groups account for personnel to CJTF 7.
(1800)	Final accounting of task force personnel to evacuation officer.
(1900)	Ships leave Bikini Lagoon.
D-day	
(0000)	Final command briefing. ^a
(H-5)	Modify forecast radex areas if necessary.
(H-3)	Informal weather briefing to CJTF 7.
(H-hour)	Detonation.
(H-hour to H+4)	Radiation data telemetered from Eneman and other critical locations. Results reported periodically to CJTF 7.
(H+3)	Modify air and surface radex areas.
(H+4)	Wilson 2 cloud tracker directed to begin task. Radsafe and physical damage survey. Recovery timetable established. Recovery in areas of low contamination begins. TG 7.3 helicopter obtains lagoon water samples.
(H+5)	Radsafe Center aboard the <u>Bairoko</u> (CVE-115) reports results of initial atoll survey to CJTF 7.
(H+9)	Sample return flights No. 1 and No. 2 depart from Enewetak.

Note:

^aAt early command briefings, the execute order was confirmed.

Bikini, the Eneman base camp was to be the center of operations. Parties recovering scientific data soon after the shot would operate from Navy vessels in the lagoon, until early radiological surveys determined that the atoll environment was safe enough to move data-recovery operations ashore.

When shot BRAVO, the first CASTLE shot at Bikini, was detonated on 1 March, it contaminated the base facilities on Eneman Island and the pre-operation plan was abandoned. To provide for personnel safety during recovery operations, four Navy ships served as platforms for TU 7 radsafe activities (Reference 9, Annex N). These functions are indicated in Table 11.

Table 11. Shipboard radsafe activities, CASTLE.

Location	Radsafe Center	Radsafe Checkpoint	Decontamination Station
<u>Bairoko</u> (CVE-115)	X	X	X
<u>Curtiss</u> (AV-4)		X	X
<u>Fred C. Ainsworth</u> (T-AP-181)		X	X
<u>Estes</u> (AGC-12)	X		

A barge moored alongside the Ainsworth provided the radsafe checkpoint and decontamination station.

The task force conducted radsafe operations from these vessels for the remaining four shots at Bikini. To alleviate the crowded working space conditions, the Curtiss and the Ainsworth's radsafe barge were designated as radsafe subcenters, primarily for the use by, and control of, personnel from TG 7.1 and TG 7.5 (Reference 17, p. 14).

Because the entire atoll had been contaminated to some extent, all task force personnel stationed at Bikini lived aboard ship for the remainder of the Bikini shots. No personnel left shipboard without permission. Entry and exit at contaminated areas were strictly controlled through radsafe

checkpoints under the supervision of the TG 7.1 Control Officer. In several cases, the Control Officer is reported to have posted additional monitors on lightly contaminated islands to advise working parties of conditions and to ensure that all workers wore the proper protective clothing. All personnel entering moderately or heavily contaminated areas were reported to be accompanied by a trained monitor and the personnel were badged. Records do not indicate the exposure levels that defined "light," "moderate," or "heavy" contamination. Cumulative personnel dose records were maintained at the checkpoints. Each center maintained current radiological situation maps of the atoll, so that the accompanying monitor could advise the party leader of the allowable stay time in any area. In lightly contaminated areas only foot protection was required (Figure 18), but in more heavily contaminated areas fuller covering was provided. This radsafe protective clothing was of cloth or plastic material with tight closures around the wrists and ankles, and also the neck if it did not fully cover the head. Although these clothes did not protect the wearer from gamma or neutron radiation, the layer of cloth did protect from beta radiation. Their function was to trap emitting particles, which would lodge in the cloth instead of on the wearer's skin. This made decontamination much easier and also prevented the inadvertent transport of the contaminated particles back to the base areas. Respirators were sometimes worn with these protective garments to prevent the wearer from inhaling radioactive particles. Figure 19 shows three different types of protective suits. Figure 20 shows the suits being worn during instrument recovery operations on a contaminated island.

Checkpoints were also established aboard the Bairoko and at the airstrip on Parry Island. Aircraft departing on missions into highly contaminated areas had their interiors lined with paper. Upon return, the paper liners were removed and the interiors decontaminated using brushes and industrial-type vacuum cleaners.

One report (Reference 17, p. 58) noted that "everyone and everything in the northern Marshall Islands had become radiologically contaminated to

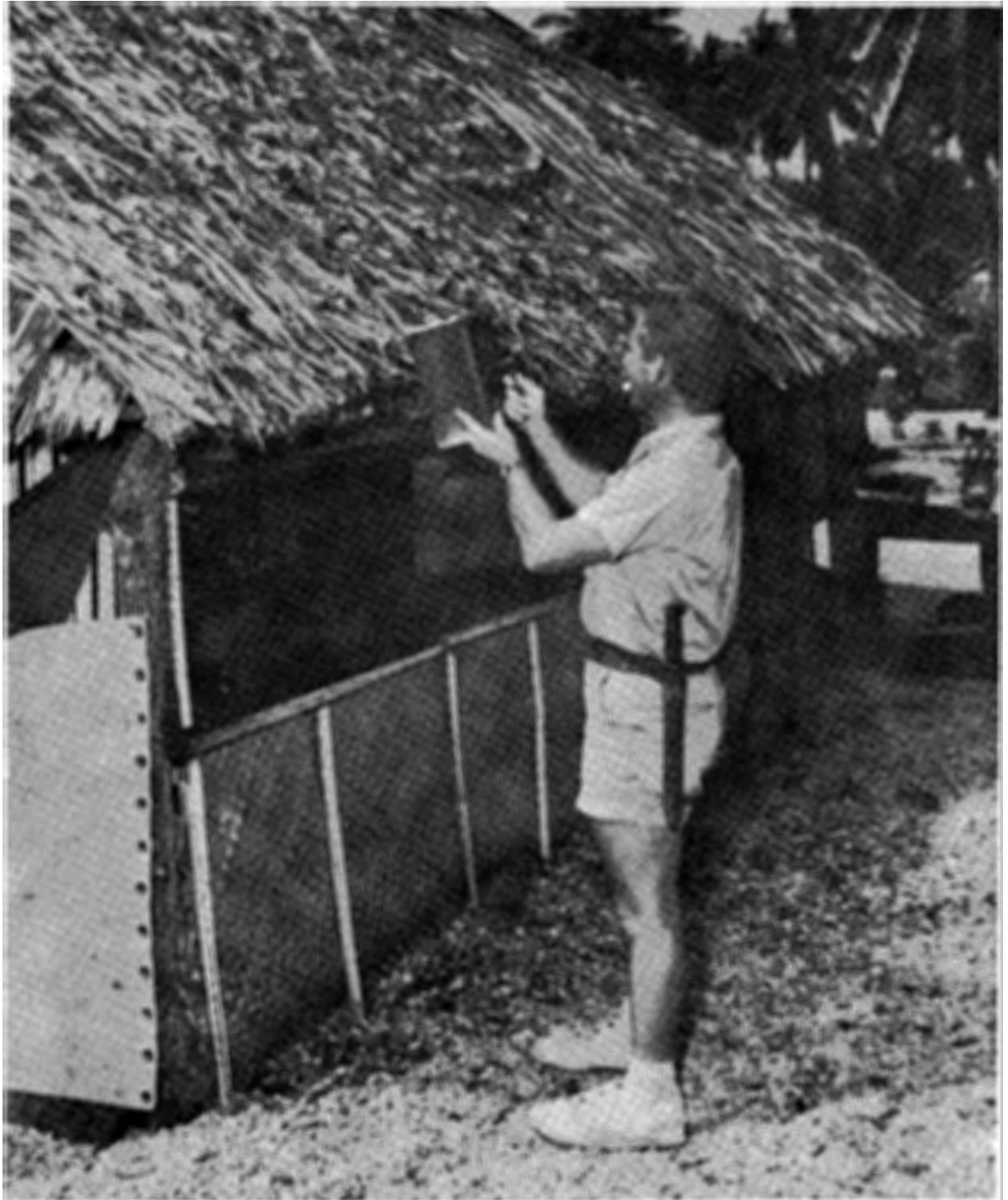

Figure 18. "Booties" worn for radiation protection during radiation survey on Rongelap after CASTLE, BRAVO.



Figure 19. Three types of protective suits used during CASTLE.



Figure 20. Protective clothing being worn during CASTLE instrument recovery on Adrikan Island.

some extent." All packages, persons, and letters returning from the area were probably contaminated in excess of background radiation. For this reason, the sale to the general public of shipping containers from the PPG was restricted.

Interstate Commerce Commission regulations required that all shipments of radioactive isotopes in commercial carriers be packaged so that no significant alpha or beta radiation would be emitted from the exterior of the package, and the gamma radiation emission at any surface of the package was required to be less than the equivalent of 0.010 R of radium gamma radiation (filtered through 0.5 inch [1.27 cm] of lead) for 24 hours. This meant, in many cases, a holding period in excess of 4 months from the release from contaminated storage to the acceptable shipment of items by common carrier in the United States. Because agencies often could not wait out this decay period, courier service was utilized. Courier service was not subject to ICC regulations unless a common carrier was used. These shipments had to comply to CJTF regulations on transport of radioactive materials.

Charts and maps were displayed at the Radsafe Office on the Estes and on Parry Island to keep CJTF 7 staff apprised of the radiological situation. This display included (Reference 17, Tab C):

- Hodographs and surface radex
- Airborne particle trajectory forecast
- Long-range fallout forecast chart
- Danger area and search area chart
- Transient shipping chart
- Native population chart (i.e., number of people on each populated atoll)
- Air radex chart
- Cloud-tracking chart (records of inflight reports)
- Onsite radsafe situation charts
- Offsite radsafe situation chart
- Radiation intensities of task force ships
- Status of recovery of scientific experiments.

Cloud Tracking

Tracking the debris with aircraft was the primary method planned to verify radioactive cloud travel in the predicted direction. Three types of survey were used to determine the cloud location: (1) "Wilson" flights of WB-29s scheduled specifically for tracking purposes, (2) inflight data from all aircraft flying between Bikini and Enewetak for the first 24 hours after detonation, and (3) radio intercept of reports from and between cloud-sampler aircraft.

The major areas of concern were (in order of importance):

1. Downwind,* especially Enewetak and Ujelang
2. Upwind
3. Upwind of the native-populated atolls to the southeast
4. Air and surface transportation routes through Wake and the Marshall Islands.

Figures 21 and 22 show the planned flight paths of the Wilson cloud-tracking aircraft. Clouds more than 24 hours old were considered sufficiently dissipated to be harmless. The 24-hour time period translated into a distance of approximately 500 nmi (926 km).

Cloud Sampling

Cloud-sampling operations were undertaken to obtain scientifically valuable data for the evaluation of nuclear explosions. These data were collected as gaseous fractions and samples of particulate material from the nuclear clouds. Operation IVY was a significant milestone in the use of manned aircraft for cloud-sampling operations. LASL scientists placed a heavy support requirement on the Air Force to sample the cloud produced by the world's first thermonuclear device, IVY-MIKE, and this requirement was carried over into the CASTLE series.

Planning between the LASL and the Air Force Special Weapons Center (AFSWC) was undertaken in 1951. Several different types of aircraft, including the B-36, B-47, B-45, F-89, and F-84 models were considered for

* Refers to the low-altitude trade winds, rather than winds aloft.

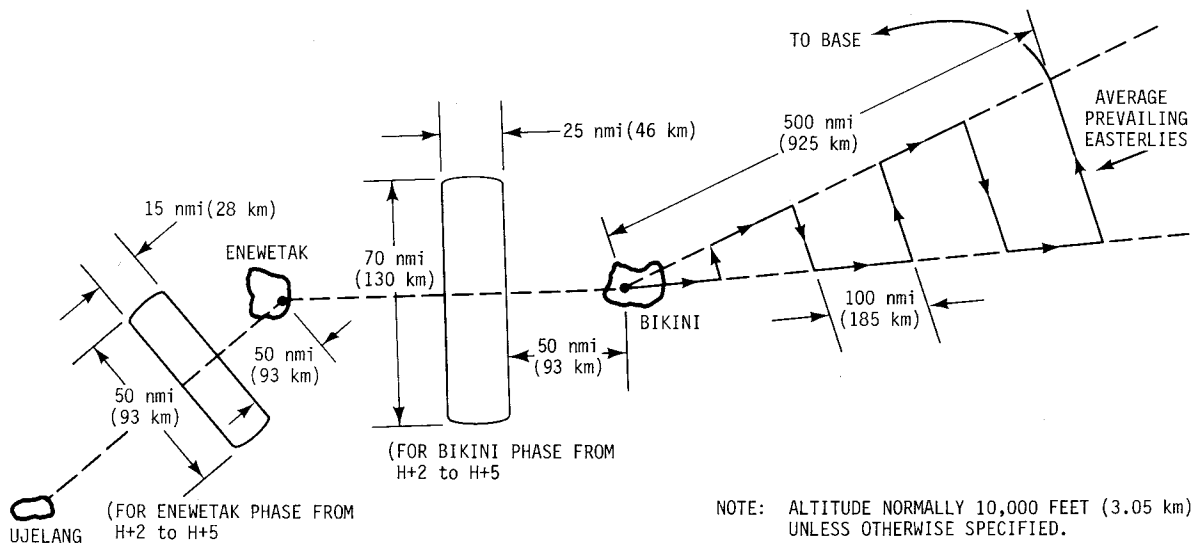

Figure 21. Wilson 1 sector search mission for cloud tracking, CASTLE.

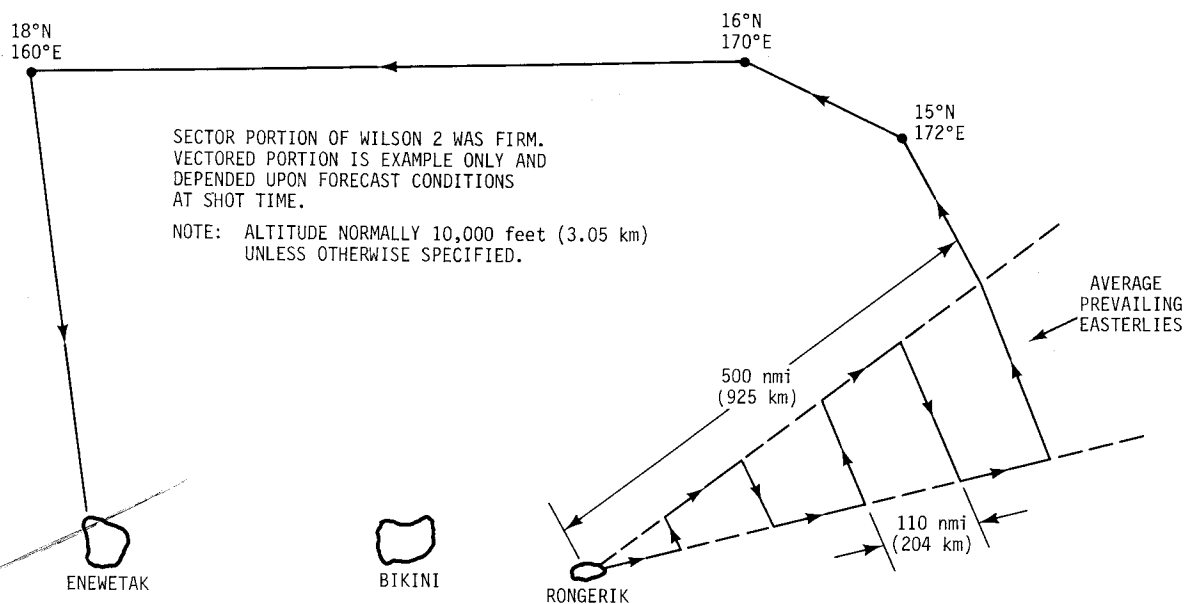

Figure 22. Wilson 2 sector and vector search mission for cloud tracking, CASTLE.

suitability. In early 1952 a decision was made to employ the F-84G single-place fighter-bomber. This aircraft had an ejection seat, anti-G suit provisions, windshield defroster system, automatic fuel transfer system, and an inflight refueling system. First accepted by the Air Force in June 1951, it was considered a first-line combat aircraft (Reference 29). Sixteen of these aircraft were specially modified for IVY sampling operations under the supervision of the Air Materiel Command (Reference 29, p. 66). These aircraft received four new avionics systems, radiac instruments, and dual cloud-sampling systems. A filter was also installed in the cabin pressurization system to prevent nuclear cloud particulates from entering the cockpit.

One of the two sampling systems was called a "snap-bag." This consisted of a plastic bag mounted in the gun deck of the aircraft nose. The system was actuated by a trigger switch on the control stick enabling collection of gaseous samples for 10 to 20 seconds (Reference 29, Chapter 8 et seq). A second sampling system involved modifications to the wingtip fuel tanks for the purpose of collecting particulate matter in the nuclear clouds. A diagram of this wingtip system is shown in the inset of Figure 23. The operation was fairly simple; the pilot could open the valve behind the air scoop to admit ram air through the scoop. This air passed through filter paper, where particulate matter was collected, and then was vented. An ion chamber was mounted in the tiptank as a sensor to measure radioactivity of the filter paper and indicated the amount of sample collected at any given time.

Figure 23 also shows the major modifications made to these F-84G aircraft to include the four avionics systems: the ARA-8 homing device, ARC-3 VHF radio transceiver, the APX-6 IFF transponder, and the F-5 autopilot. Note also the sampling probe on the nose, which fed to the snap-bag.

In January 1953, shortly after Operation IVY was concluded, AFSWC representatives met with LASL representatives to discuss CASTLE sampling requirements (Reference 29, p. 94). The sampling project manager outlined

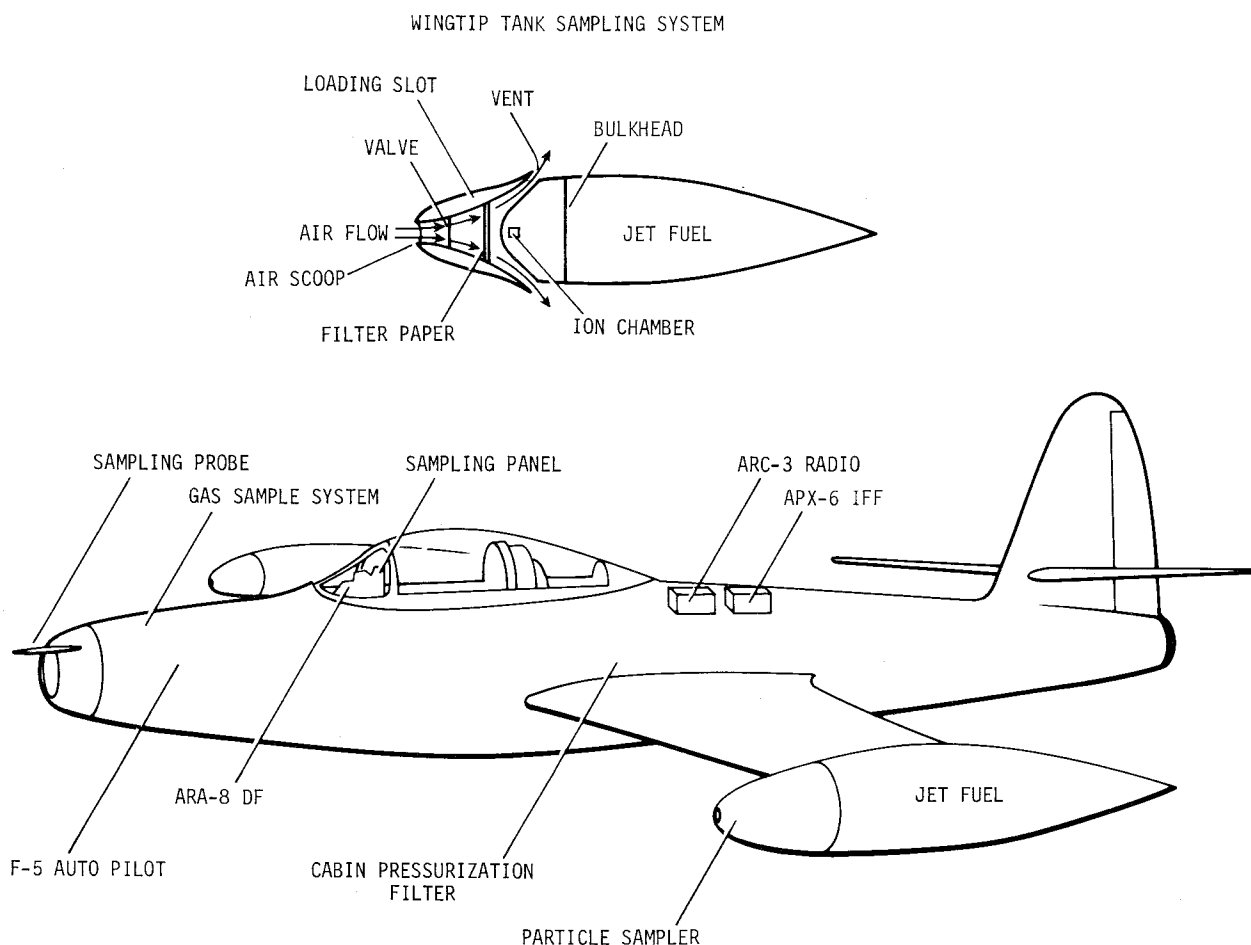

Figure 23. F-84G sampler aircraft, CASTLE.

general requirements that were later formalized by the IVY/CASTLE Scientific Director and approved by the laboratory. A new emphasis on high-altitude sampling was specified by the sampling project manager; such missions required an aircraft capable of operating at or about 55,000 feet (16.76 km) for at least one-half hour (Reference 29, p. 95). A decision was made in August 1953 to use the same 15 (one was lost during IVY) F-84G aircraft that were used in IVY and two featherweight B-36 aircraft.

All the F-84G aircraft were rewired, fitted with new electronics, including a new type gamma intensity rate meter, and ten were equipped with a new gas-sampling device called a "double-squeegee." The remaining five

retained the snap-bag gas-sampling devices used in IVY. The B-36s were fitted with a filter installed in the cabin pressure system and each received both a double-squeegee gas-sampling system and a particulate-sampling device. One of these B-36s was equipped with an array of electronics to serve as backup to the primary B-36 controller, which, like the F-84Gs, was also used in IVY (Reference 29, pp. 97-98). The WB-29 aircraft were equipped to perform "heavy nuclide" sampling. The WB-29s carried a "shoe box" in each wing; each box had two filter panels but the aircraft had no special instrumentation, controls, or sampling indicators. The only proof of sample collection while airborne was the aircraft background as measured by a T1-B radiac meter (Reference 29, Chapter 8, et seq).

The double-squeegee was designed for operation at altitudes of 36,000 to 50,000 feet (10.97 to 15.24 km). Two air-cooled, four-stage radial compressors, operated electrically, exhausted a portion of the jet engine intake air into a 500-in³ (8,193-cm³) collection vessel at 3,000 lb/in² (211 kg/cm²). Each compressor was rated at 1,728 in³/min (28,317 cm³/min). Both compressors operated in parallel, pumping into a single collection vessel. There were two versions of the double-squeegee that differed only with respect to filtering the compressor input air. A "special" double-squeegee was used on three F-84Gs, which contained a special filter integral to the sampling system. The other seven F-84G systems used the filter in the cabin pressurization system (Reference 29, Chapter 8 et seq). (Air passing through the filter was not used for breathing during cloud sampling operations; TG 7.4 policy required sampler aircraft personnel to breathe 100-percent oxygen from the time of cloud entry to mission completion at Enewetak.) Table 12 summarizes the sampling systems installed on the F-84Gs.

The RB-36 that served as the airborne sampler controller was No. 1386 (radio call sign Cassidy). The radio compartment contained two ART-13 HF transceivers; one operated in the range of 3.3 to 18.1 MHz, the other from 200 to 600 kHz. The TG 7.4 Technical Advisor rode in this compartment and had selection switches enabling monitoring or communication with sampler

Table 12. F-84G sampling systems, CASTLE.

Aircraft Number	Tiptanks	Snap-Bag	Double-Squeegee	Special Double-Squeegee
51-1028	X		X	
51-1030	X		X	
51-1032	X			X
51-1033	X			X
51-1037	X		X	
51-1038	X		X	
51-1042	X		X	
51-1043	X		X	
51-1045	X		X	
51-1046	X			X
51-1049	X	X		
51-1051	X	X		
51-1053	X	X		
51-1054	X	X		
51-1055	X	X		

aircraft in the HF, VHF, and UHF bands. The sampling project manager rode on the flight deck, which had a more comprehensive communication capability. Other communication and navigation equipment in the RB-36 included two ARC-3 VHF transceivers, one APN-9 Loran receiver, one ARN-6 radio compass, one ARN-14 VHF omnireceiver, one ARN-18 UHF direction-finding receiver, one ARC-27 UHF transceiver, and one APX-6 IFF transponder. The ARN-6, ARN-14, ARN-18, and APN-9 units were principally for navigation purposes. The ART-13 was capable of transmitting a CW homing signal to a range of 125 to 150 nmi (232 to 278 km); this signal was received by samplers in order to home on Cassidy (Reference 29, Chapter 8 et seq).

The two B-36H samplers were Nos. 1083 and 1086. Of these the backup sampler controller, No. 1083, did not have the ARN-14, ARN-18, and ARC-27.

Based on the decontamination data given in Chapters 4 and 5, it appears that different WB-29s served as the heavy nuclide sampler on various shots and the shoe boxes were easily moved from one aircraft to another. The B-36H double-squeegee systems had six compressors pumping into six 900-in³ (14,743-cm³) containers at 3,000 lb/in² (211 kg/cm²) (Reference 9, Annex D).

The F-84Gs were equipped with a sampling panel mounted atop the main instrument panel. The sampling panel is shown in Figure 24. This panel contained radiac instruments and indicator lights for each sampling system. The rate meter for the tiptank ion chamber (see Figure 24) had a three-stage scale: 0-1 R/hr, 0-10 R/hr, or 0-100 R/hr. The reading from this meter was transmitted by the pilot to the sampler control aircraft where the sampling project manager maintained control of each mission.

The top center of the sampling panel had an integrating dosimeter (Integron). The Integron meter recorded the total cockpit dose in the range of 0-7.5 R with an error of ±20 percent during sampling missions (Reference 29, Chapter 8 et seq). The IM-71/PD (Jasper) rate meter measured

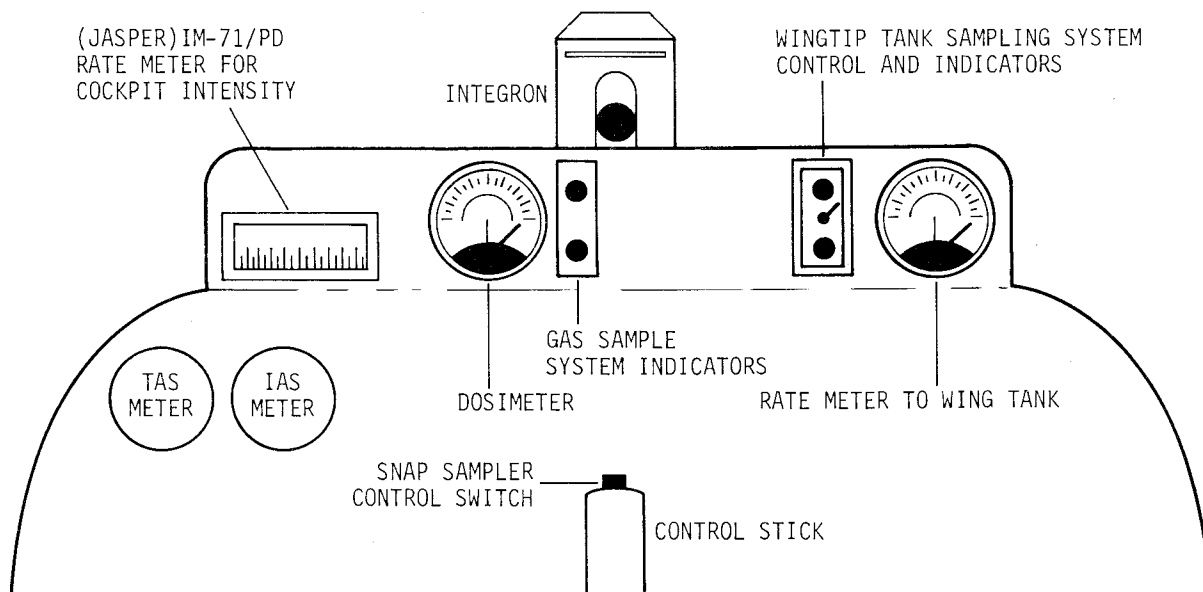

Figure 24. F-84G sampling panel, CASTLE.

cockpit intensity. This instrument was manufactured by the Evans Signal Laboratory for the AEC and had a range of 0.005-800 R/hr.

The radiac instruments for the F-84Gs were in storage at LASL during part of 1953 and were shipped separately to the PPG, where they were installed by personnel in the Nuclear Applications Section of the TAU. The last Integron installation was not completed until 1 March 1954, slightly more than 4 hours before BRAVO (Reference 29, Chapter 8, pp. 15-17 et seq).

Sample Recovery Techniques

Upon completion of sampling operations, the samplers returned to the airfield at Enewetak, where the samples were immediately recovered from the aircraft. Figure 25 shows typical F-84G parking for sample recovery. Detailed techniques for recovering filter papers from the wingtip tanks



Figure 25. F-84G samplers parked at Enewetak airstrip during CASTLE.

were published by LASL and forwarded to the AFSWC just before REDWING (Reference 29, pp. 220-225). Figure 26 is a schematic illustration of the setup for sample recovery.

A Filter Recovery Subsection in the Nuclear Applications Section of the TAU was manned by one officer and three airmen. These personnel were responsible for removing all gaseous and filter paper samples (Reference 29, Chapter 8).

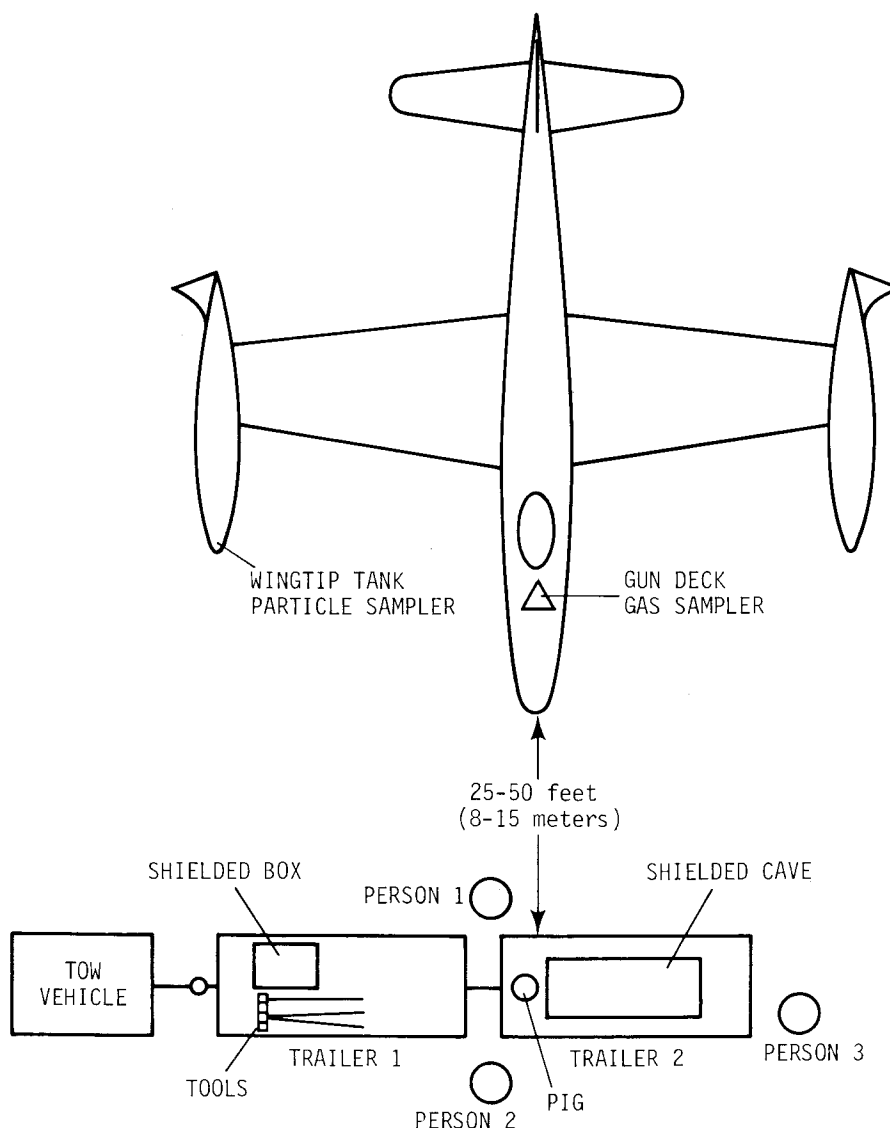

Figure 26. Sample recovery schematic illustration, CASTLE.

Three people were directly engaged in particle sample removals. A fourth person served as an overall supervisor to ensure compliance with sample removal procedures. A minimum distance of 25 feet (8 meters) was used as a criterion for separation of sample removal equipment from the hot sample pod, as well as for personnel while not removing samples. Person No. 1 advanced to the pod, cut the filter-retaining wire (Figure 27), then returned to his initial position, still holding long-handled tongs. Person No. 2 advanced with a 9-foot (3-meter) removal pole, secured the sample (Figure 28), and deposited it in the shielded "cave," or enclosure (Figure 29). Person No. 1 stood by to help No. 2 by using the long-handled tongs if the sample should fall to the ground. After the sample was deposited in the cave, he returned the tongs to the tool trailer and secured a hook tool. He then joined No. 2 and opened the sample holder for No. 3 to insert a rolling tool over the filter paper (Figure 30). As No. 3 rolled the filter paper (Figure 31), No. 1 and No. 2 stood "well clear of the cave, aircraft, and other radiation sources." Person No. 3 put the



Figure 27. Cutting filter paper retaining wire in left tank, CASTLE.



Figure 28. Removal of filter paper from left tank, CASTLE.

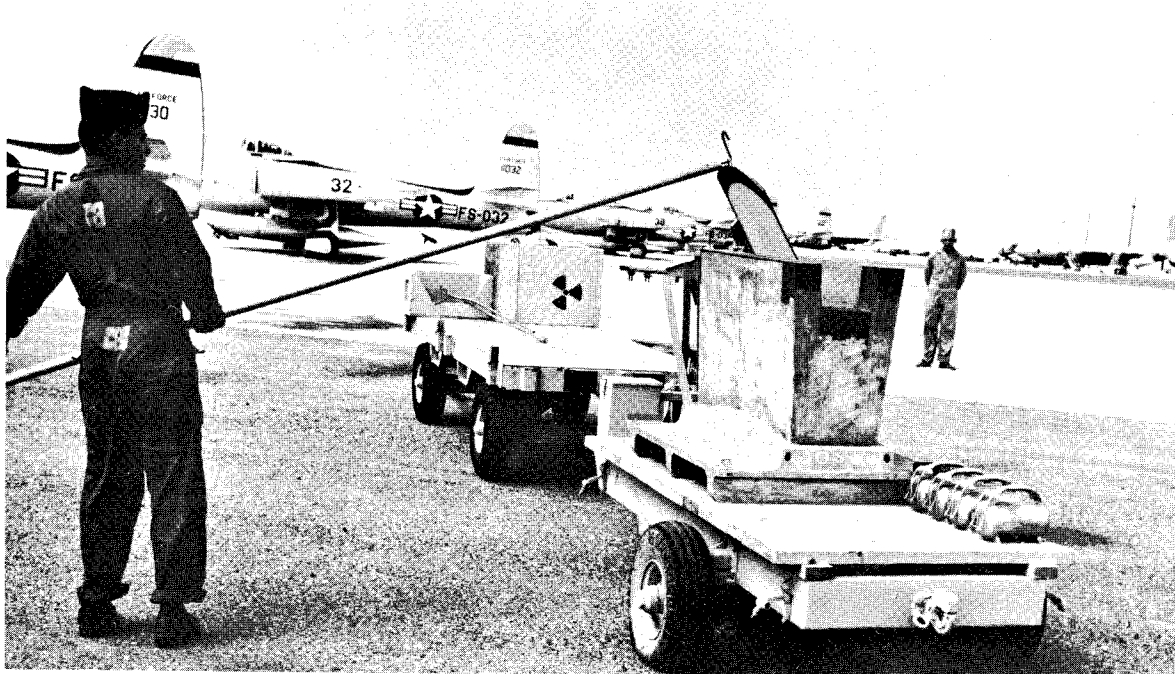

Figure 29. Deposition of filter paper in shielded cave, CASTLE.



Figure 30. Preparing to roll filter paper, CASTLE.

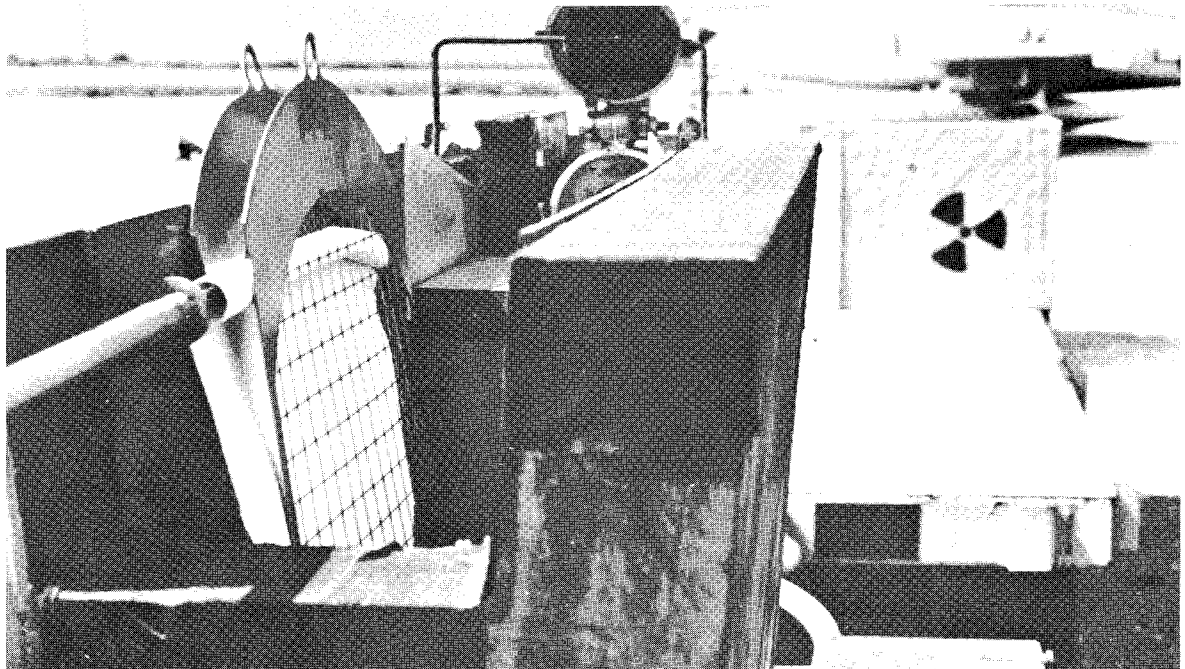

Figure 31. Filter paper being rolled, CASTLE.

rolled paper in a "pig," a shielded container for sample transport (Figure 32), and returned his tool. Person No. 1 measured the radiation through the pig using a long-handled tool and this information was recorded. Person No. 1 returned the tool, then both No. 1 and No. 2 lifted the pig, whose lid closed automatically, from the cave with a carrying pole (Figure 33), carried it to a third trailer 25 feet (8 meters) away, and deposited it in a shielded box. This operation was repeated on the second sample pod, then the next aircraft, until all filters were removed.

Since double-squeegee samples were already bottled and the system used quick-disconnect couplings, recovery time was generally less than 2 minutes after opening the gun-deck hatch (Reference 29, Chapter 8). Snap-bag samples were recovered by pumping the sample bag contents through the sampling probe as illustrated in Figure 34.

Some of the filter paper samples were loaded aboard R-6D aircraft for departure to the continental United States at about H+6 (Flyaway 1). Other filter paper samples and gas samples were ferried by TG 7.4 light aircraft to the TG 7.1 laboratory on Parry Island for immediate analysis and/or processing. Additional filter paper samples left the PPG at about H+10 aboard Flyaway 2. Flyaway 3 departure was between H+24 and H+36 and normally carried only gas samples. Flyaway 4 departed between D+4 and D+5. U.S. Air Force involvement with samples in the continental United States was through the 1009th Special Weapons Squadron team at McClellan AFB, California, and contractor laboratories in Chicago and Boston (Reference 22, Annex D).

Personnel Decontamination

TU 7 of TG 7.1 (7.1.7) organized decontamination operations to protect personnel against the effects of radiological contamination by reducing the amounts of radioactive material carried into nonradioactive areas. Checkpoints through which all entries and exits were controlled enabled personnel, protective gear, and equipment to be directed to one of the decontamination centers if required.

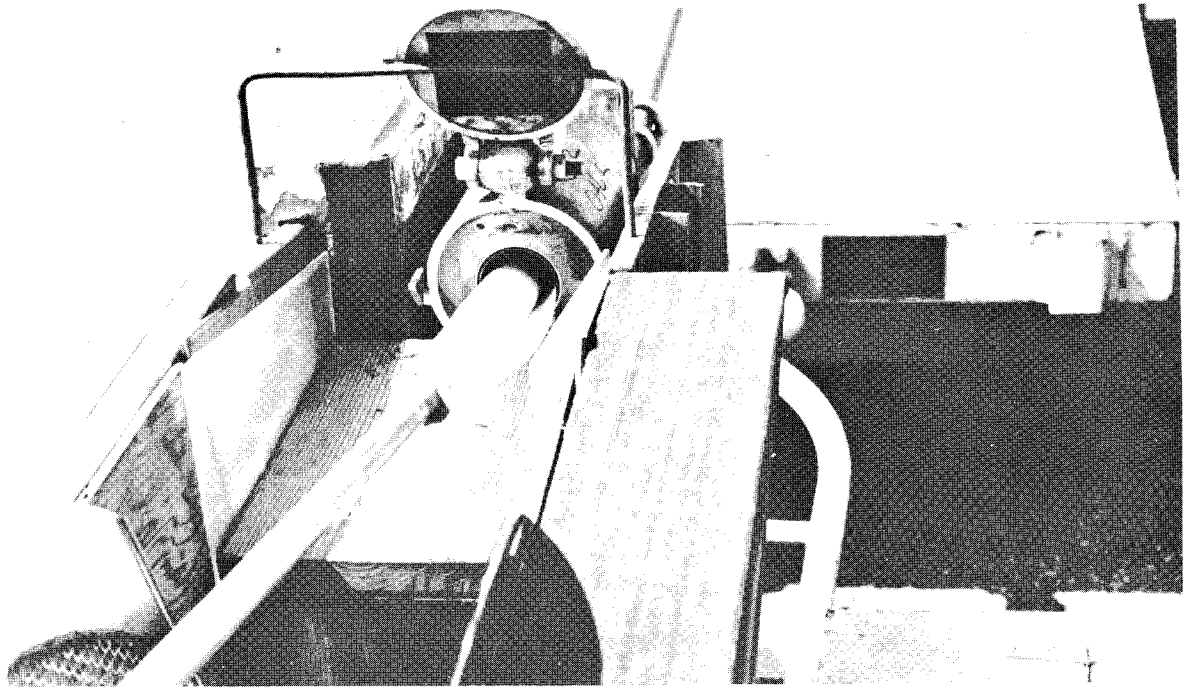

Figure 32. Filter being placed in a "pig," a shielded container for sample transport, CASTLE.

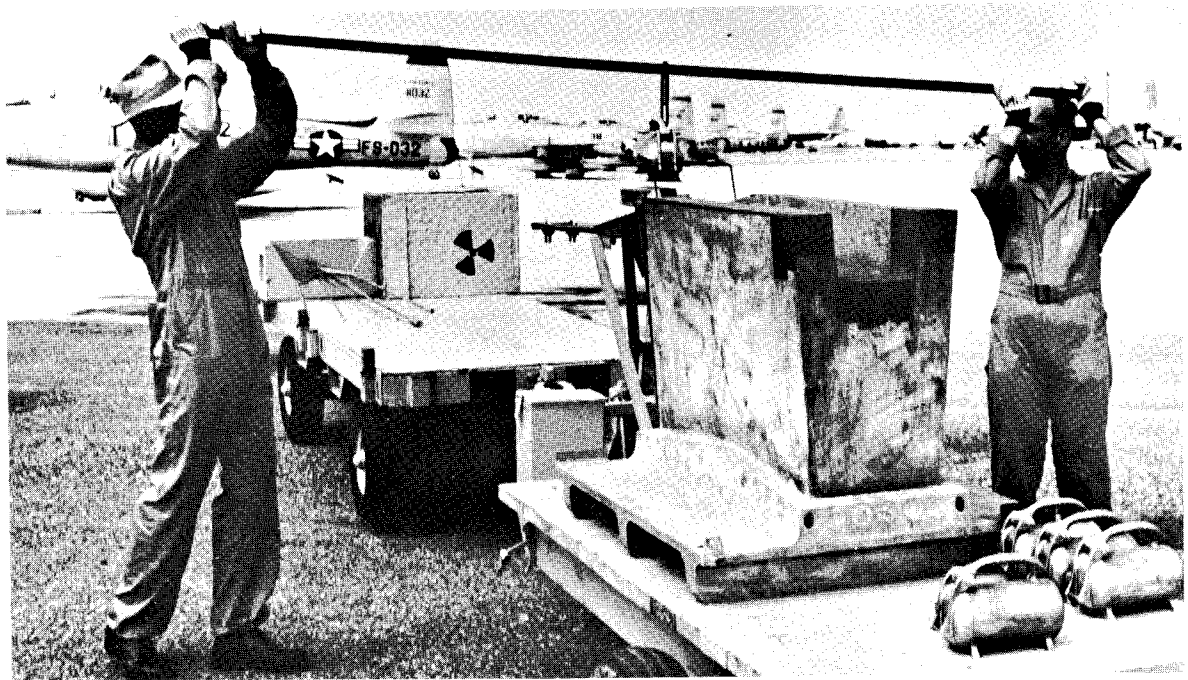

Figure 33. Lifting pig containing filter paper, CASTLE.



Figure 34. Removal of gas sample from "snap-bag" through sampling probe, CASTLE.

Personnel decontamination stations were established at the Parry Radsafe Center, aboard the Bairoko and the Curtiss, and aboard the barge alongside the Ainsworth. Equipment decontamination areas were made available at Parry and at the Kwajalein airstrip (the Kwajalein decontamination was provided by the Naval Air Station).

These stations included a clean-clothing change room, a contaminated-clothing change area, a shower area, and a monitoring point. At the Parry Radsafe Center the clean-clothing change room, showers, and monitoring checkpoint were all located within the same building, whereas a contaminated clothing change area was located in a squad tent adjacent to the shower area. All persons who were found to be contaminated in excess of the background radiation readings were required to shower with soap until residual contamination had been removed. Figure 35 shows the monitoring procedure aboard the Curtiss, and Figure 36 shows initial decontamination of personnel at Parry. The Bairoko decontamination station consisted of salt-water showers and contaminated-clothing storage containers on the catwalk adjacent to the flight deck, with the change room consisting of a cabin just off the catwalk. The Curtiss decontamination station used the aft shower facilities for a change and shower area. The radsafe barge alongside the Ainsworth, which handled the greatest number of personnel, was equipped with a control tent, clean-clothing change tent, clothing issue area, and outside salt-water showers. All persons returning to the Ainsworth were monitored before being permitted to board the ship. This ensured that all contamination was removed aboard the barge.

Personnel decontamination progressed satisfactorily, although there were reportedly objections to slightly contaminated lagoon water being used for salt-water showers (Reference 17, p. 58). Other than aboard the Ainsworth, the arrangement of change room and shower facilities aboard ship did not completely prevent the spread of contamination. Contaminated individuals, in many cases, had to walk through the ships to reach the contaminated-clothing change room or showers. The barge facilities adjacent to the



Figure 35. Personnel monitoring after removal of contaminated clothing (also note removable covering on deck and ladder in background), CASTLE.



Figure 36. Scrubbing to remove radioactivity before suit removal, CASTLE.

Ainsworth provided the most effective solution for controlling shipboard contamination.

Naval Vessel Decontamination

BRAVO created a mass naval decontamination operation, since this event contaminated ships before the washdown systems were turned on. All vessels anchored in the lagoon required decontamination, and a vigorous washdown of top surfaces by means of firehoses was initiated shortly after fallout ceased (Figure 37). This action removed about 80 percent of the contamination, except for the wooden flight deck of the Bairoko. Despite the cleanup efforts, contamination from BRAVO caused background levels aboard ship and on the islands of Bikini to exceed established permissible contamination levels; therefore, emergency personnel levels and equipment release levels were increased to 0.015 R/hr (Reference 16, p. 57).

Small boats (LCMs and LCTs) that were left in the Eneu anchorage became heavily contaminated, requiring strong hosing with water and a mixture of boiler compound and lye. These caustics were normally used to



Figure 37. Shipboard decontamination using high-pressure seawater and scrub brushes, CASTLE.

remove paint and iron rust and were an effective supplement to strong hosing. Fresh-water flushing and repainting, however, were required following decontamination. In dry dock, steam was utilized to remove grease and oil from bearing surfaces. As expected, the most difficult items to decontaminate were canvas covers, tarpaulins, ropes, and fabric bumpers. In most cases, these items were simply moved to a storage area on Parry and the radioactivity allowed to decay (Figure 38). Versene scrubbing was attempted on the large canvas bathtub on the flight deck of the Bairoko, but was abandoned when it was found that the treatment dissolved the radioactive particles and caused a spread of contamination and an increase in contaminated areas.

Equipment Decontamination

Other than for marine equipment, little decontamination was attempted at Bikini. Construction and technical equipment was washed and isolated



Figure 38. Parry contaminated storage area, CASTLE.

at the time of shipment to Enewetak. The equipment and its transport vessel were decontaminated at Enewetak after the equipment was unloaded. The main base for equipment decontamination was established at the Parry Island contaminated storage area (see Figure 38). All Bikini equipment with excessive readings was washed with a high-powered spray from a firetruck or Navy tug and transferred to Enewetak for final decontamination. At a boat landing checkpoint on Parry, vehicular or other mobile equipment being discharged was monitored. If below the permissible contamination limit, the equipment was moved to its destination; if not, the equipment was moved to the decontamination area for storage or decontamination.

At Enewetak, the decontamination area was soon filled with an assortment of items that varied from personal luggage to heavy cranes. At one time more than 1,200 items were awaiting decontamination. A standard practice of flushing, scrubbing, steaming, and storing was followed for most of the metal items. Wooden, plastic, rubber, and fabric materials were stored until decay reached the acceptable release level of 0.010 R/hr.

Daily rain showers, typical of the Marshalls in the spring, provided additional decontamination for articles stored outdoors.

The release of vehicles and equipment contaminated at 0.010 R/hr or less still presented a problem when these items were removed from storage for use at Enewetak or shipped to the United States. Even these low emission levels jeopardized low-level decay measurements in sensitive areas; therefore, low-level contaminated equipment was excluded from them. Further decontamination of these items would have been difficult and impractical.

Scientific experiments were usually decontaminated by brushing or a water spray before transport to Parry. In some cases, however, the entire decontamination procedure (e.g., TG 7.4 aircraft) was conducted at Parry (Figure 39).

Figure 40 shows a tent for changing contaminated clothing at Parry. Contaminated clothing was removed at this and similar checkpoints to avoid the spread of contamination into uncontaminated areas. TG 7.2 used three mobile laundry units to decontaminate clothing for TG 7.4. The laundry plant on Enewetak Island employed 41 men on the day shift and 17 men on the evening shift. The contaminated wastewater drained directly into the lagoon.

Radiation of personnel and material was measured with side-window-type Geiger counters. The instruments, which contained counter tubes with wall thicknesses of about 30 mg/cm^2 , were used with the beta shield open. When possible, the surface of the probe was held from 1 to 6 inches (2.5 to 15 cm) from the surface under observation.

Aircraft Decontamination

Table 13 lists all aircraft involved in CASTLE. In addition to the TG 7.4 cloud tracking and sampler aircraft, P2V-6 aircraft required decontamination, as did the amphibious aircraft used to evacuate weather station personnel from Rongerik and natives from Rongelap. The RAF Canberra sampler



Figure 39. Decontamination equipment on Parry, CASTLE.



Figure 40. Tent for changing contaminated clothing at Parry, CASTLE.

aircraft and four unmanned F4U aircraft used in Project 6.4 (Proof Testing of Atomic Weapons Ship Countermeasures) also required decontamination.

TASK GROUP 7.4 AIRCRAFT. Decontamination of sampler aircraft used in CASTLE was required after each test shot. Other aircraft occasionally required decontamination. Within TG 7.4, aircraft decontamination was a mission for the Aircraft Decontamination Section of the TAU which, during the buildup phase, had one officer and three airmen, two of whom had considerable experience from three previous operations (Reference 30).

Procedures for decontamination operations underwent constant revision from event to event as experience increased. TG 7.4 issued a new Annex N, dated 16 March 1954, which superseded the 26 February 1954 annex. The new annex required all units of TG 7.4 to furnish personnel for decontamination operations using revised procedures (Reference 31, Operation Order 2-54):

From the experience gained following shot BRAVO in decontamination of assigned aircraft, it was apparent that the techniques and utilization of personnel must be revised.

Table 13. CASTLE aircraft.

Aircraft Type/ Serial No. (No. of Aircraft)	Task Force Affiliation	Call Sign	CASTLE Base	Function	Home Organization
(W)B-29/335 (W)B-29/1819 (W)B-29/2195 (W)B-29/2202 (W)B-29/7264 (W)B-29/7271 (W)B-29/7335 (W)B-29/7343 (W)B-29/7740	7.4 TSU	Wilson	Enewetak	Weather recon, cloud track, sampler	77th Strategic Recon Sq, Ellsworth AFB 57th Strategic Recon Sq, March AFB 57th Strategic Weather Recon Sq, Hickam AFB
(R)B-36/1386 (F)B-36/1083	7.4 TAU	Cassidy	Enewetak	(2) RB-36 sampler controller (and photo plane for Projects 3.2 and 9.1)	7th Bomb Wing, 9th and 36th Bomb Sq, Carswell AFB
(F)B-36/1086		Floyd		(1) Featherweight B-36 cloud sampler	
B-36D/49-2653	7.4 TAU	Elaine-1	Enewetak	Project 6.2a effects experiment	WADC and 11th Bomb Wing, Carswell AFB
B-47/50-037	7.4 TAU	Elaine-2	Enewetak	Project 6.2b effects experiment	WADC
B-50(3)	7.4 TAU	Hardtime	Guam	Project 6.1 IBDA experiment	97th Bomb Wing, Biggs AFB
C-47(4)	7.4 TSuU	Reflector	Enewetak	Enewetak-Bikini airlift	4931st Test Support Sq, Enewetak
C-54(3)	7.4 TSU	Pewter	Enewetak	Project 9.1 and documentary photo	4931st Test Support Sq, Enewetak
C-54(1)	JTF 7	Lord Calvert	Enewetak	Use of CJTF 7	4931st Test Support Sq, Enewetak
F-84G/028 F-84G/030 F-84G/032 F-84G/033 F-84G/037 F-84G/038 F-84G/042 F-84G/043 F-84G/045 F-84G/046 F-84G/049 F-84G/051 F-84G/053 F-84G/054 F-84G/055	7.4 TAU	Tiger	Enewetak	Cloud sampler	4926th Test Sq, Kirtland AFB

(continued)

Table 13. CASTLE aircraft (continued).

Aircraft Type/ Serial No. (No. of Aircraft)	Task Force Affiliation	Call Sign	CASTLE Base	Function	Home Organization
F4U5N(3)	7.3.2.1		Bikini	Fighter element (on Enewetak post-BRAVO)	VC-3
F4U5N(3)	7.3.2.2		Enewetak	Fighter element	VC-3
F4U(4)	7.3	None	Enewetak	Project 6.4 washdown experiments	NAS, Alameda
H-13(3) H-19(7)	7.4 TSuU	Peanut	Enewetak	Intra-atoll airlift - Enewetak	4931st Test Support Sq, Enewetak
HRS-2(12)	7.3.2	Dago	<u>Bairoko</u>	Intra-atoll airlift - Bikini	HMR-362
L-13(10)	7.4 TSuU	Mosquito	Enewetak	Intra-atoll airlift	4931st Test Support Sq, Enewetak
P2V-5	7.3.3		NAS Kwajalein	Controller for YAG exp (Proj 6.4)	
P2V-6/12622	7.3.3		NAS Kwajalein	Transient Ship Search, NYKOPO flights	VP-29, Whidby Island NAS
P2V-6/12632					
P2V-6/12634					
P2V-6/12635					
P2V-6/12637					
P2V-6/12638					
P2V-6/12639					
P2V-6/12640					
P2V-6/12641					
P2V-6/12642					
P2V-6/12643					
P2V-6/12644					
P4Y2/59763	7.3.3		Enewetak	Project 1.4 telemetry receiver	NAS, Patuxent River
PBM5A ^a (2)	7.4 TSuU	Lena	Enewetak	Inter-atoll airlift	
SA-16 ^a (3)	7.4 TSU	Stable	Enewetak	Search and rescue (SAR)	78th ARS Sq
SA-16 ^a (2)	7.4 TSuU		Enewetak	Enewetak-Bikini airlift post-BRAVO	
UF-1 ^a (1)			NAS Kwajalein	Weather island resupply	NAS, Kwajalein
----- (1)		Viking		VIP aircraft	
UK Canberra(2)	RAF	Eager Beaver	NAS Kwajalein	Cloud sampler	United Kingdom

Note:

^aAmphibious aircraft.

Entirely too much time was used to decontaminate aircraft and excessive exposures were being accumulated by aircraft maintenance personnel who participated in decontamination.

Maintenance crews in the 4930th Test Support Group (Test Support Unit) did not assist with aircraft decontamination after the BRAVO shot. For subsequent shots, although personnel from the TSuU were still involved, nonmaintenance personnel were used. These men were assigned to decontamination teams of 15 men each that operated on 6-hour shifts. TG 7.4, which was primarily responsible for aircraft operations, was most involved in this.

Holmes & Narver constructed the Enewetak decontamination pad used for the CASTLE aircraft. This pad drained toward a 24-inch (61-cm) central catch basin that drained into the lagoon through an 8-inch (20-cm) pipe. The general procedure for decontamination operations was:

1. On D-day sampler F-84G, WB-29, and FB-36 aircraft were parked in the designated hot decay area.
2. All other aircraft were checked on landing for evidence of radiological contamination. If an aircraft was contaminated above 0.025 R/hr, it was isolated and posted.
3. Sampler FB-36 aircraft were parked on the decontamination pad and checked for radiation intensities.
4. Unless urgency was a factor, no decontamination was undertaken until D+1. Sampler aircraft were given decontamination priority over those accidentally contaminated.
5. Decontaminated aircraft were released to maintenance personnel before release to flying crews.
6. Before aircraft were cleared for flying again, the radiation intensity at crew positions had to be less than 0.010 R/hr.

Following sequential operations for decontaminating various aircraft, radiation intensity measurements sometimes increased rather than decreased. Three primary causes were proposed (Reference 30):

1. Wash water (containing a concentrated amount of contaminants) collected in engine cowlings

2. Instruments were faulty
3. The recorded measurement was the highest reading obtained on measuring several different points on the aircraft.

Table 14 summarizes the individual TG 7.4 aircraft and identity by tail number for which detailed decontamination data are available in the TAU source document (Reference 30).

Table 15 lists sampler aircraft totals from a different source (Reference 29). There are some discrepancies between References 29 and 30, and others exist as well. For example, History of Task Group 7.4 (Reference 15) indicates that 14 F-84G sampler aircraft participated in BRAVO, yet the 4926th document (Reference 30) details decontamination data on only 10 for this shot. The fact that no decontamination data are available for a specific aircraft, however, does not necessarily imply that the aircraft was not airborne or not contaminated.

An important factor that must be borne in mind concerning the radiation intensity readings or data is that the recorded data for the survey of any one aircraft at any one time represent the highest reading obtained from measuring several points on the aircraft. Not known are the number of points surveyed, the location of these points, the average decay rate, and the effect of activation products on the gross fission product. Despite these factors and the lack of an accurately known decay rate law, a $t^{-1.2}$ decay rate is used in Chapters 4 and 5 to make some estimates of aircraft initial contamination levels.

Tables 24, 35, 41, 48, 52, and 57 contain detailed aircraft decontamination data for each shot. Each table lists the aircraft type and its identification number with radiological survey and decontamination information. Date and time for each survey were not always recorded. Question marks appear in the tables where this occurred. Following the last survey, the aircraft were released to maintenance operations. The decontamination procedures used were (Reference 30):

Table 14. Cloud-sampler aircraft decontaminated during CASTLE.

Type A/C	Tail No.	1 Mar BRAVO	27 Mar ROMEO	7 Apr KOON	26 Apr UNION	5 May YANKEE	14 May NECTAR
B-36	1083	X	X	X			X
B-36	1086	X	X	X	X	X	X
B-36	1386				X	X	X
B-29	7335	X					
B-29	2195		X				
B-29	7740		X			X	
B-29	1819		X			X	X
B-29	7269			X	X	X	X
B-29	7271				X		
B-29	7343					X	
B-29	2202					X	
B-29	335						X
F-84	028				X		
F-84	030	X	X	X	X		X
F-84	032	X	X		X	X	
F-84	033	X	X	X	X		
F-84	037	X	X	X	X	X	
F-84	038	X	X	X	X		X
F-84	042	X	X			X	
F-84	043	X	X			X	X
F-84	045	X	X				X
F-84	046	X	X	X		X	X
F-84	049			X		X	
F-84	051			X		X	
F-84	053	X	X	X			
F-84	054		X		X		X
F-84	055		X				X
Totals		13	17	11	11	14	13

Source: Reference 30.

Table 15. Number of aircraft that obtained usable cloud samples, CASTLE.

Aircraft Type	BRAVO	ROMEO	KOON	UNION	YANKEE	NECTAR
B-36	2	2	2	1	1	2
B-29	1	1	1	1	1	1
F-84	<u>12</u>	<u>12</u>	<u>14</u>	<u>7</u>	<u>7</u>	<u>7</u>
TOTAL	15	15	17	9	9	10

Source: Reference 29.

1. Aircraft were parked in an isolated area and allowed a cooling off (decay) period of 20 hours.
2. Stands were positioned and cowling removed. A 1:5 mixture of gunk-kerosene was applied over the aircraft exterior surface and engines. This was washed off using a warm water and detergent mixture followed by a plain warm water wash. After 30 minutes for the surfaces to drain, radiation measurements were made.
3. Radiation measurements were made using AN/PDR-39 instruments.
4. The procedure in (1) to (3) above was repeated.

Reportedly, after two such washings the contamination level could not be noticeably reduced further. Nevertheless, many aircraft were subjected to more than two washings.

For the first two shots, BRAVO and ROMEO, the F-84G samplers were first washed with a citric acid solution. This type of decontamination was suggested by a LASL scientist as a means of collecting potentially valuable radioanalysis data on certain heavy radionuclides, but the procedure was scrapped after ROMEO. Decontamination of the F-84Gs required up to 30 gallons (114 liters) of gunk, 150 gallons (568 liters) of kerosene, 100 gallons (379 liters) of soapy water, and 300 gallons (1,140 liters) of rinse water for each aircraft, depending upon the degree of contamination. Larger aircraft required commensurately more materials. Table 16 summarizes the decontamination materials used.

Table 16. CASTLE TG 7.4 aircraft decontamination materials used.

	BRAVO	ROMEO	KOON	UNION	YANKEE	NECTAR	Total
Aircraft decontaminated	19	17	15	11	14	12	88
Kerosene (gallons) ^a	2,320	2,375	7,250	3,490	3,214	3,000	21,649
Gunk (gallons) ^a	594	475	1,450	820	623	585	4,547
Detergent (pounds) ^b	14	14.5	14.5	14	14	14	85
Rubber Gloves (pair)	12	8	5	10	10	8	53
Aprons (each)	3	4	3	3	5	4	22
Respirator Filters (each)	280	120	70	70	70	70	680
Water (gallons) ^a	11,900	15,852	8,100	8,840	16,500	15,000	76,192

Notes:

^aOne gallon equals 3.79 liters.

^bOne pound equals 0.46 kg.

Source: Reference 30.

Figures 41 through 43 show decontamination operations for a B-36. Note the overhead cable and safety harnesses for personnel working on the wings. Also, the need for supporting personnel, equipment, and vehicles is evident. Figure 44 shows a scrubbing operation on the wing of an F-84G aircraft.

OTHER AIRCRAFT. Contaminated aircraft were also a problem on the Bairoko and at the Kwajalein Naval Air Station. On the Bairoko the problem was the landing gear of HMR-362 helicopters returning from deliveries of work parties to contaminated sites. Helicopters returning from such missions were landed in a canvas bathtub to hose off their landing gear (Reference 32).

VP-29 aircraft and the two RAF Canberra cloud samplers based at Kwajalein Naval Air Station during CASTLE received decontamination. The NAS



Figure 41. B-36 decontamination, CASTLE.



Figure 42. B-36 decontamination, CASTLE.

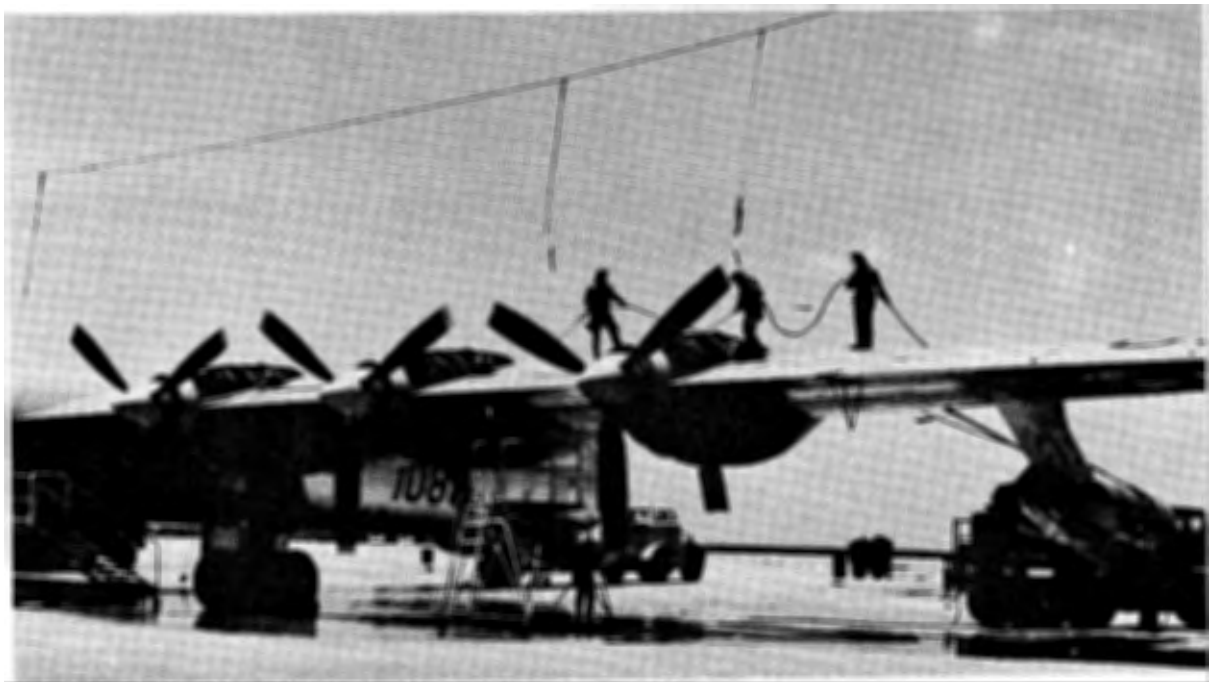

Figure 43. B-36 decontamination, CASTLE.



Figure 44. F-84G decontamination, CASTLE.

report of operations during CASTLE states that station aircraft used during the evacuation of Rongerik and Rongelap also required this treatment. Levels of contamination are not given, although a summary of the radiological condition of VP-29 aircraft at the end of the series was published and is shown in Table 17. The VP-29 P2V-6 searching for transient shipping during BRAVO was so heavily contaminated that it was forced to return to its base, but the levels are not in the accounts (Reference 33).

The RAF Canberras based at Kwajalein sampled all CASTLE events except UNION. Selected contamination readings are available for these aircraft and show for BRAVO D+3 a high reading of 0.180 R/hr around the engines, which dropped to 0.120 R/hr after one washing with gunk and soap and water. After ROMEO, a high reading of 0.900 R/hr, again around the engines, was recorded after sample removal (Reference 34).

Decontamination at Kwajalein was done at the pad used by TG 132.4 in Operation IVY. VP-29 and NAS personnel decontaminated their own aircraft and supervised the UK personnel working on the RAF aircraft.

Table 17. Radiological contamination of Patrol Squadron 29 (VP-29) aircraft as of 18 May 1954, CASTLE.

Aircraft Number	Highest Gamma (R/hr)	Highest Gamma plus Beta (R/hr)	Average Gamma (R/hr)	Average Beta plus Gamma (R/hr)
126544	0.0014	0.0042	0.0008	0.0015
126534	0.0015	0.003	0.0007	0.0014
126537	0.0004	0.0015	0.0002	0.0006
126539	0	0.001	0	0.0006
126541	0.0015	0.0019	0.0002	0.0007
126543	0.0006	0.0013	0.0004	0.0006
126532	0.0047	0.0049	0.0025	0.0013
126535	0.0003	0.001	0.0016	0.0004
126538	0.0009	0.002	0.0004	0.0007
126540	0.0002	0.0012	0.00015	0.0005
126542	0.0002	0.0015	0.00015	0.0004
126522	0.00035	0.003	0.00015	0.0015

Source: Reference 33.

Apparently, in the decontamination process fallout products were spread around the airfield and recontaminated other aircraft to low levels. The B-36 used in the effects experiments did not come into contact with shot debris clouds during its flights, but when it returned to the United States, its undercarriage was found to be contaminated with fallout products in oil and paint, which required special cleaning to remove. The level of this contamination was "10 mr [per hr]" (Reference 35, p. 133).

CHAPTER 3 DOD EXPERIMENTAL PARTICIPATION

The CASTLE experimental program primarily focused on development of usable thermonuclear weapons, with secondary interest on their effects. The DOD participated both in weapon development and effects experiments but concentrated on the latter. Within JTF 7, execution of the experimental program was the function of the scientific task group (TG 1).

WEAPON DEVELOPMENT

TG 1 was subdivided into 12 task units that conducted the program. Both of the AEC weapon design laboratories had task units (TU 1 and TU 12) that conducted their experiments; an additional task unit (TU 13) conducted DOD weapon effects experiments. Support for these experiments was provided by nine additional task units.

The 12 task units are described in Chapter 1. The names of the task units and the number of persons who participated in each are shown in Table 18.

The DOD had several administrative and special reporting units for military personnel on active duty who participated in weapon design experiments at Los Alamos and Livermore. Some of these units were the:

- 8451st Area Administrative Unit, Washington, D.C.
- 8452nd Area Administrative Unit, Sandia Base, New Mexico
- Naval Administrative Unit, Sandia Base, New Mexico
- 1090th USAF Special Reporting Group, Sandia Base, New Mexico
- 1146th USAF Special Activities Squadron, Fort Myer, Virginia.

The Naval Research Laboratory (NRL) provided personnel and conducted experiments for Los Alamos in the Los Alamos Scientific Laboratory (LASL) weapon development program (References 36 through 39). The Air Force supported the weapon development program through cloud-sampling operations to

Table 18. Approximate unit strengths of Task Group 7.1 at the Pacific Proving Ground, CASTLE.^a

Element	Uniformed DOD	Civilian ^b	Total
Commander	2	1	3
Scientific Deputy		1	1
Advisory Group		14	14
Classification		3	3
Deputy Administration	1	1	2
Deputy for UCRL (in TU 12)			
J-1	30	3	33
J-3	19	1	20
J-4	26	5	31
J-6	3	8	11
Task Units			
1 LASL Programs	26	119	145
2 Production		45	45
3 Special Materials & Facilities		60	60
4 LASL Assembly		75	75
6 Firing Party		1	1
7 Radiological Safety	44	10	54
8 Technical Photography	4	16	20
9 Documentary Photography	28	23	51
12 UCRL Programs	8	264	272
13 DOD Programs	130	258	388
14 UCRL Assembly (in TU 12)			
15 Timing and Firing	4	66	70
Totals	325	974	1,299
Total with exposure records ^c	311	933	1,244

Sources and Notes:

^aReference 8, April Installment, p. 15.

^bIncludes both DOD and AEC civil servants and contractor personnel. The data do not permit disaggregation, although some inferences can be drawn from the duties of the task units. (See Chapter 1, Overview, "Task Group 7.1 [Scientific]".)

^cConsolidated List of CASTLE Radiological Exposures TG 7.1, TU 7, Reference 13.

provide essential data to weapon designers. This task entailed a large commitment of Air Force equipment and personnel in an important and inherently high-radiation-exposure activity (Reference 29). There was, finally, the contribution of all the services to the weapon design experiments of the joint task force as a whole through providing the support services necessary to conduct these experiments.

EFFECTS EXPERIMENTS

DOD effects experiments were conducted by the Armed Forces Special Weapons Project (AFSWP), a Joint Defense agency. AFSWP solicited service requirements for weapon effects information, assisted DOD laboratories in the design of experiments, and coordinated planning and execution with the AEC during the planning of the weapon design experiments (Reference 7). During test preparations, special construction requirements for the effects experiments were coordinated with the AEC base-support contractor (TG 7.5). The following guidelines were established as preselection criteria for proposed experiments (Reference 40, p. 15):

1. Each project must be justified on the basis of a military requirement
2. Each project must be such that its objectives could not be attained except by a full-scale test, and not at NTS; furthermore, its objectives must be attainable at the PPG without unreasonable support requirements
3. Each project had to conform to the shot schedule (yields, locations, burst heights) established for the developmental program of the AEC.

The DOD effects program was organized as TU 13 and subdivided into programs for the execution of experiments with functionally similar objectives.

Blast and Shock (Program 1)

The blast and shock program was designed to investigate blast wave propagation through the air, ground, and water. A description of the

experiments and projects within this program follows, limited to but inclusive of those aspects pertinent to radiological exposure. Where data are available, the actual exposures of TU 13 participants have been provided; however, reports found seldom identify exposures in this detail. Table 19 summarizes what can be derived from TU 13 reports on the exposure of DOD experiment participants. The exposures reported in this table are suggestive of those of the particular projects rather than an exact reporting.

Projects 1.1a, 1.1b, and 1.1d -- Blast Pressures and Shock Phenomena
Measurements by Photography

Agencies: Naval Ordnance Laboratory (NOL)
Sandia Corporation (SC)

Operations: Documentation of peak shock overpressures, visible shock-wave effects, and motion of shock wave on water by smoke-rocket and direct-shock photography.

Shots: All.

Radiation Exposure Potential: This project should have posed a minimum potential exposure for the project personnel, as film data from Edgerton, Germeshausen, & Grier, Inc. (EG&G) and the Air Force Lookout Mountain Laboratory (LML) were used. The only identifiable radiation potential was from the placement of the rocket launchers for the smoke rockets on Iroij and Enidrik for KOON and UNION, since this could have exposed project personnel to residual radiation from BRAVO.

Staffing: Eight people were associated with this project, seven from NOL (five civilians and two military), and one civilian from SC.

Project Report: Reference 41.

Project 1.1c -- Base Surge Measurements by Photography

Agency: Naval Ordnance Laboratory (NOL)

Table 19. DOD scientific personnel radiation exposures, CASTLE.

Element	No. of Persons Badged	No Reading	Exposure Ranges (R)													Collective Exposure (man-R)	Mean Exposure (R)	
			0	0.001-0.5	0.5-1	1-1.5	1.5-2	2-2.5	2.5-3	3-4	4-5	5-10	10-15	Over 15	Over 3.9 ^a			High
Project 1.1a, b, d	8	1		1	1	2		1	2								3.6	
1.1c	2	0		1					1								3.2	
1.2a	2	0				2											1.3	
1.2b	19	0				4	5	3	1	2	4					4	4.3	
1.3	Same Personnel as Project 1.2a																	
1.4	28	2		5	4	1	4	3		5	3	1				4	5.1	
1.5	Offsite																	
1.6	3	1		1				1									2.5	
1.7	1	1																
1.8	7	0			2	3			1	1							3.4	
Program 1 Total	70	5		8	7	12	9	7	3	11	7	1				8	5.1	
Percent		7.1		11.4	10.0	17.1	12.9	10.0	4.3	15.7	10.0	1.4				11.4		
Collective Exp (man-R)				2	5	15	16	16	8	39	32	8					137	1.95
Project 2.1	3	0						1		1							3.7	
2.2	2	0									1	1				2	6.3	
2.3	6	0		1	1		1		3								2.7	
2.5a	25	0		1	5	4	5	2	2	4	1		1			2	11.1	
2.5b	13	0			1	1				4	5					7	6.2	
2.6a	13	1			3		1	1	2	2	1	2				3	9.2	
2.6b	6	0			1	2	1			2							3.8	
2.7	7	0		1		1	1	2	1		1					1	4.9	
2.7a	3	0				1	1	1									2.5	
Program 2 Total	78	1		3	11	9	11	6	9	13	9	5	1			15	11.9	
Percent		1.3		3.9	14.1	11.5	14.1	7.7	11.5	16.7	11.4	6.4	1.3			19.2		
Collective Exp (man-R)				0.8	8.3	11.3	19.3	13.5	24.8	45.5	40.5	37.5	12.5				214	2.74
Project 3.1	1	0						1									1.6	
3.2	10	0		2	2	3				2		1				1	5.7	
3.3	2	0							1	1							3.0	

Note:

^aMaximum Permissible Exposure

(continued)

Table 19. DOD scientific personnel radiation exposures, CASTLE (continued).

Element	No. of Persons Badged	No Reading	Exposure Ranges (R)													Collective Exposure (man-R)	Mean Exposure (R)		
			0	0.001-0.5	0.5-1	1-1.5	1.5-2	2-2.5	2.5-3	3-4	4-5	5-10	10-15	Over 15	Over 3.9 ^a			High	
Project 3.4	0	0																	
3.5	1	0			1														1.0
Program 3 Total	14	0		2	3	3	1		1	3		1				1		5.7	
Percent				10.3	21.4	28.4	7.1		7.1	21.4		7.1				7.1			
Collective Exp (man-R)				0.5	2.3	3.8	1.8		2.8	10.5		7.5						29	2.07
Program 4 Total	0																		
Project 6.1	0	0																	
6.2a	6	0	3	3															0.1
6.2b	3	2	1																0
6.4	90	3		10	5	6	9	6	4	11	11	24	1			36			10.8
6.5	5	0			1			1	2	1									3.6
6.6	5	0			2										3	3			78
Program 6 Total	109	5	4	13	8	6	9	7	6	12	11	24	1	3	39	78			
Percent		4.6	3.7	11.9	7.3	5.5	8.3	6.4	5.5	11.0	10.1	22.0	0.9	2.8	35.8				
Collective Exp (man-R)				3.3	6	7.5	15.8	15.8	16.5	42.0	49.5	180	125	234				583	5.4
Project 7.1	1	0			1														0.9
7.2	Offsite																		
7.4	5	1	1	2	1														0.7
Program 7 Total	6	1	1	12	2														0.9
Percent		16.7	16.7	33.3	33.3														
Collective Exp (man-R)				0.5	1.5													2	0.33
Project 9.1	1	0		1															
Other DOD	8	0			1	2		2				3			3				7.1
TOTAL All Programs	286	12	5	29	32	32	30	22	19	39	27	34	2	3	62	78			
Percent		4.2	1.8	10.1	11.2	11.2	10.5	7.7	6.6	13.6	9.4	11.9	0.7	1.1	21.7				
Collective Exp (man-R)				7.3	24	40	52.5	44.5	52.3	136.5	121.5	255	25	234				998	3.49
Percent				0.7	2.4	4.0	5.3	4.5	5.2	13.7	12.2	25.6	2.5	23.5					

Note:

^aMaximum Permissible Exposure

Operations: Evaluation of photographic data to predict base-surge effects from surface detonations. Photography from other projects was used.

Shots: All.

Radiation Exposure Potential: Slight (data for the project were from other units).

Staffing: Two civilians from NOL, attached to this project, received total exposures of 0.120 R and 3.165 R. The individual receiving 3.165 R also participated in Projects 1.1a, 1.1b, and 1.1d, and probably did not receive significant exposure as part of this project.

Project Report: Reference 42.

Project 1.2a -- Ground Level Pressures from Surface Bursts

Agency: Sandia Corporation (SC)

Operations: Instrumentation was installed on various islands of both atolls for this project and Projects 1.3 and 1.7. Measurements for this project were obtained on blast pressure versus time at ground levels with Wiancko gauges.

Shots: All.

Radiation Exposure Potential: Placement of instruments in areas contaminated by prior shots and recovery of data would have posed a potential moderate exposure.

Staffing: Two civilians from SC were associated with this project; they had total readings of 1.315 R and 1.195 R, but also participated in Project 1.3.

Project Report: Reference 43.

Project 1.2b -- Ground Surface Air Pressure versus Distance from High-Yield Detonations

Agencies: Ballistic Research Laboratories (BRL)
9301st Test Support Unit, Aberdeen Proving Ground

1090th USAF Special Reporting Group
1083rd USAF Special Reporting Squadron

Operations: A total of 71 self-recording instrument stations were installed at islands and reefs of both atolls.

Shots: All.

Radiation Exposure Potential: Moderate (gauge installation and pickup).

Staffing: Nineteen men were associated with this project, five from BRL; two from the 1090th, one from the 1083rd, and eleven from the 9301st (six Air Force and five Army). Those from BRL were civilians, the rest, military. The group's exposures are presented in Table 19.

Project Report: Reference 44.

Project 1.3 -- Dynamic Pressure Measurements

Agency: Sandia Corporation (SC)

Operations: Instrumentation was installed at various stations to measure the theoretical relationship between dynamic pressure and overpressure to evaluate gauges.

Shots: All.

Radiation Exposure Potential: Moderate (data recovery and gauge placement in contaminated areas).

Staffing: Two civilians from SC received totals of 1.315 R and 1.195 R; however, this should not be uniquely associated with this project as the same two men are also cited in the project report for Project 1.2a.

Project Report: Reference 43.

Project 1.4 -- Underwater Pressure Measurements

Agencies: Office of Naval Research (ONR)
Naval Research Laboratory (NRL)
David Taylor Model Basin (DTMB)
Naval Ordnance Laboratory (NOL)

Sandia Corporation (SC)
1090th Air Force Reporting Group
8451st Area Administrative Unit
Task group units as noted

Operations: Measurements of water pressures were taken from floating, moored buoys. The installation of the mooring system and the servicing of the clocks and batteries in the instrumented buoys required the participation of the USS Gypsy, the USS Mender, the USS Cocopa, and the USS Tawakoni, as well as the support of a barge, several miscellaneous small boats, and swimmers. The gauges were self-recording except for some information telemetered to a PB4Y-2 aircraft (No. 59763) that was due south of the instrument array at a nominal distance of 40 statute miles (64.4 km) and an altitude of 10,000 feet (3.05 km).

Shots: BRAVO, ROMEO, UNION, YANKEE (Bikini); NECTAR (Enewetak).

Radiation Exposure Potential: High. Recovery of the buoys throughout the series and, after BRAVO, the laying of the moors for the Bikini shots required ship operations in contaminated waters. As the shots were postponed by weather, the buoys had to be hoisted and their clocks and batteries serviced. The average time to lay the moor was 1½ hours and the recovery required 1 hour.

The buoys themselves were radiologically contaminated. In an extreme case of recovery (a buoy from the UNION event that contained a film-type recorder and thus required early retrieval), the buoy's exterior was reading 1.200 R/hr and the interior was reading 0.500 R/hr, as was the seawater.

The project report states that between UNION and YANKEE the "ambient radioactive level aboard [Cocopa] became higher than the permissible limit" and the work had to be completed by the Tawakoni. This was a result of "radioactive silt," perhaps churned up in the formation of the UNION crater, lodging in the seawater pipes. The same document reports that protective clothing was worn in handling the contaminated buoys and that the support ships were rotated to equalize the exposure.

For NECTAR at Enewetak, Holmes & Narver (H&N) handled the mooring and buoy recovery. After recovery, the buoys were placed on a barge and taken to a decontamination area.

Staffing: Twenty-eight TG 7.1 personnel were definitely associated with this project, although an exposure record was not located for one of them. Of the remaining 27, the distribution is as follows: 1 civilian from ONR, 2 civilians from NRL, 4 civilians from DTMB, 5 military from 1090th, 1 military from 8451st, 1 civilian from SC, and 13 from NOL (1 military and 12 civilians).

Project Report: Reference 45.

Project 1.5 -- Acoustic Pressure Signals in Water

Agencies: Office of Naval Research (ONR)
Bureau of Ships (BuShips)

Operations: Observations were made at several Underwater Sound Transmission Experimental Facilities (USTEF) stations in the Pacific and Atlantic oceans to detect long-distance transmission of underwater sound. Sites were remote from the test area and there is no indication that project personnel visited the PPG.

Shots: ROMEO, UNION, YANKEE (Bikini); NECTAR (Enewetak).

Radiation Exposure Potential: None.

Project Report: Reference 46.

Project 1.6 -- Water Wave Measurements

Agencies: Scripps Institution of Oceanography (SIO)
USS Sioux

Operations: Underwater gauges were used to record hydrostatic pressure vibrations in Bikini Lagoon. Divers placed some instrumentation, and recovery was made by LCM, buoy boat, and helicopter. Inundation indicators were established at Ailinginae Atoll to measure the inundation of the land.

Shots: All Bikini shots.

Radiation Exposure Potential: High because of instrument placement and recovery in contaminated waters.

Staffing: Three civilians were associated with the project, all from SIO or University of California. No exposure is listed for one person; the others received 1.530 R and 0.035 R. Exposures are given in Table 19. Exposures for the Sioux appear in Table 59.

Project Report: Reference 47.

Project 1.7 -- Ground-Motion Studies on Operations IVY and CASTLE

Agency: Sandia Corporation (SC)

Operations: Accelerometer stations were established at about 15-foot (4.5-meter) depths on Eneman and Lele to record ground motion from KOON.

Shots: KOON (Bikini).

Radiation Exposure Potential: Moderate.

Staffing: One person definitely associated with this project was a civilian from SC, but no exposure record is available for him.

Project Report: Reference 48.

Project 1.8 -- Dynamic Pressure Investigation

Agencies: Ballistic Research Laboratories (BRL)
9301st Test Support Unit (Ordnance)
Naval Administrative Unit (NAU)

Operations: Jeeps and self-recording gauges were installed on Aero-kojlol, Enidrik, and Boken (for KOON), and Runit (for NECTAR) to determine dynamic pressure as a damage parameter.

Shots: KOON (Bikini); NECTAR (Enewetak).

Radiation Exposure Potential: Moderate; resulting from data recovery and the inspection of the jeeps for damage and evidence of their movement. Six of the jeeps used in KOON were too contaminated to transport to Enewetak for use at NECTAR.

Staffing: Seven were associated with this project, three from BRL (two military, one civilian), three from the 9301st TSU (two military, one civilian), and one military from NAU.

Project Report: Reference 49.

Nuclear Radiation (Program 2)

This program had two major objectives: (1) documentation of the initial neutron and gamma radiation from large-yield nuclear detonations, and (2) documentation of fallout from large-yield surface detonations. Fallout information from large-yield detonations was available only from the MIKE detonation of Operation IVY (1952), and this was limited to data upwind and crosswind from the burst point. An ambitious program was instituted for CASTLE to study the downwind deposition of weapon debris. This planned effort and unplanned incidents following BRAVO resulted in much information about fallout from the CASTLE shots.

Project 2.1 -- Gamma Radiation Dosimetry

Agency: Signal Corps Engineering Laboratories (SCEL)

Operations: Films and chemical-dosimetry vials were installed in shelters from 1 to 15 nmi (1.9 to 27.8 km) from ground zero on islands and reefs of both atolls (18 islands and throughout the perimeter of Bikini and 10 along the northern section of Enewetak). Stations were activated as late as possible and information was recovered as soon as radsafe conditions permitted. Helicopters were used to the extent possible.

Shots: BRAVO, ROMEO, KOON, UNION (Bikini); NECTAR (Enewetak).

Radiation Exposure Potential: Exposure potential existed for those activating the stations subsequent to BRAVO and for all personnel involved in recovery.

Staffing: Three people were associated with this project, all from SCEL. One was a civilian, and the others were military.

Project Report: Reference 50.

Project 2.2 -- Gamma Rate versus Time

Agency: Signal Corps Engineering Laboratories (SCEL)

Operations: Scintillation detectors were used to measure initial and residual gamma rates as a function of time and distance. The instrument stations were self-contained and required only timing signals to turn them on at predetermined times. Instrumentation was installed on 14 islands along the northern, southern, and southwestern perimeters of Bikini Atoll and on Bokoluo at Enewetak.

Shots: BRAVO, ROMEO, KOON, UNION (Bikini); NECTAR (Enewetak).

Radiation Exposure Potential: High during instrument recovery.

Staffing: Two civilians associated with this project, both from SCEL, received 4.040 and 6.280 R.

Project Report: Reference 51.

Project 2.3 -- Neutron Flux Measurements

Agencies: Naval Research Laboratory (NRL)
Oak Ridge National Laboratory (ORNL)
Headquarters, Military District of Washington

Operations: Neutron flux was measured by installing fission detectors at sites on islands in northern Bikini Atoll, although only the stations on Bokbata and the reef were used. Recovery was delayed on both shots, occurring on D+5 for BRAVO and D+3 for ROMEO. Some samples were counted in the field in two trailers set up on Parry; others were flown to NRL.

Shots: BRAVO, ROMEO (Bikini).

Radiation Exposure Potential: Some exposure potential to those in recovery operations. The project report states that no serious difficulties were encountered despite the rather high residual radiation. In addition, there may have been some potential for personnel in the trailers on Parry.

Staffing: Six were associated with the project, including three civilians from NRL, two civilians from ORNL, and one military from Hq, Military District of Washington.

Project Report: Reference 52.

Project 2.5a -- Distribution and Intensity of Fallout

Agencies: Naval Radiological Defense Laboratory (NRDL)
Naval Receiving Station, Treasure Island (NRS TI)
USS Sioux, USS Apache, USS Tawakoni, USS Epperson,
USS Renshaw, and VP-29

Operations: Fallout was collected from arrays of buoys anchored pre-shot in the lagoon (Figure 45) and floating free in the open ocean, and from "below grade" collecting stations located on nine islands throughout Bikini Atoll, except for the northwest section, and four islands (Bokoluo, Enjebi, Elle, and Biken) at Enewetak Atoll. Recovery occurred as soon as possible after shots; sample analysis and data reduction were performed at PPG.

Shots: BRAVO, ROMEO, KOON, and UNION (Bikini); NECTAR (Enewetak).

Radiation Exposure Potential: Potential exposure existed for all personnel involved in recovery operations and setting of arrays after the first shot. The pertinent project report notes that instructions stated that although "every effort should be made to recover the important stations as early as possible . . . if recovered buoys produce dangerously high radiation fields aboard ship, it may be necessary to break off and return to Enewetak to off-load."

Staffing: Twenty-four were definitely associated with this project, twenty-one civilians and one military from NRDL and three military from NRS TI. Their exposures are given in Table 19. Exposures for the personnel of ships and aircraft assisting in this project are given in Table 59.

Project Report: Reference 53.



Figure 45. Placement of anchored fallout collector buoys, CASTLE.

Project 2.5b -- Fallout Studies

Agency: Army Chemical Center (ACC)

Operations: Fallout was collected on trays located at sites throughout the atolls, including about 17 islands at Bikini and 9 at Enewetak (Figure 46). Recovery commenced between D+1 and D+9, depending upon fallout conditions for each shot. Two 2-man teams recovered samples from land stations by helicopter and from raft stations by LCM. Samples were packaged in windy and usually contaminated areas.

Shots: BRAVO, ROMEO, KOON, UNION (Bikini); NECTAR (Enewetak).

Radiation Exposure Potential: High, particularly for those involved in recovery operations and packaging of samples.

Staffing: Thirteen people participated in the project, six civilians and seven military, all from ACC.

Project Report: Reference 54.



Figure 46. Preparation of fallout collector tray, CASTLE.

Project 2.6a -- Chemical, Physical, and Radiochemical Characteristics
of the Contaminant

Agency: Naval Radiological Defense Laboratory (NRDL)

Operations: Analysis of samples provided by Projects 2.5a and 6.4,
with laboratory operations at NRDL and probably Parry.

Shots: All.

Radiation Exposure Potential: Likely for any personnel involved in
field work and perhaps some potential for those performing analysis
later.

Staffing: Fifteen were associated with this project, but exposures
are not given for one civilian and one military. Exposures for the
others (13 civilians from NRDL) are given in Table 19.

Project Report: Reference 55.

Project 2.6b -- Radiochemical Analysis of Fallout

Agency: Army Chemical Center (ACC)

Operations: Samplers on eight islands at Bikini Atoll, two islands at
Enewetak Atoll, Unibor in the Enewetak Lagoon, and on a barge collected
data for analysis in the laboratory trailer at Parry. Much of this
was done by Project 2.5b personnel who normally employed helicopters.

Shots: BRAVO, ROMEO, KOON, UNION (Bikini); NECTAR (Enewetak).

Radiation Exposure Potential: High during recovery operations; moder-
ate during analysis.

Staffing: Six were associated with this project, three civilians and
three military, all from ACC.

Project Report: Reference 56.

Project 2.7 -- Distribution of Radioactive Fallout by Survey and
Analysis of Contaminated Sea Water

Agencies: Scripps Institution of Oceanography (SIO)
Naval Radiological Defense Laboratory (NRDL)

Atomic Energy Commission (AEC), New York Operations Office
USS Sioux and other vessels from TG 7.3

Operations: Water-sampling and submerged radiation-meter techniques were used to obtain fallout data in free ocean areas. Following YANKEE and NECTAR, vessels traversed fallout fields, collecting data used in conjunction with aircraft surveys conducted by the AEC. (Times involved were H+6 to D+4 for YANKEE, with completion of operations for NECTAR by 0530 on D+2.)

Shots: YANKEE (Bikini); NECTAR (Enewetak).

Radiation Exposure Potential: High for all personnel collecting samples, less severe for those performing the aerial survey or for those shipping samples to NRDL for analysis.

Staffing: Seven civilians were associated with this project; four from SIO and three from NRDL. Exposures for crews of the naval vessels appear in Table 59.

Project Report: Reference 57.

Project 2.7a -- Radioactivity of Open-Sea Plankton Samples

Agencies: Scripps Institution of Oceanography (SIO)
Naval Radiological Defense Laboratory (NRDL)
USS Sioux

Operations: Two samples (on 7 and 9 May) were taken from the Sioux while traversing the fallout pattern subsequent to YANKEE. Samples were collected from widely dispersed locations; but most analysis occurred in the continental United States.

Shots: YANKEE (Bikini).

Radiation Exposure Potential: High for all personnel involved in sample collecting, both naval crews and scientific personnel.

Staffing: Three civilians from SIO were associated with this project.

Project Report: Reference 58.

Blast Effects (Program 3)

This program consisted of five projects.

Project 3.1 -- Air Pressure Measurements

Agency: Stanford Research Institute (SRI)

Operations: A concrete structure instrumented to measure blast loading was built on Enidrik. Equipment records were recovered on D+2 and D+8, with gauge recovery later by Project 3.2 personnel.

Shots: KOON (Bikini).

Radiation Exposure Potential: A potential existed for personnel making initial recoveries.

Staffing: One SRI employee was associated with this project; he received 1.615 R.

Project Report: Reference 59.

Project 3.2 -- Crater Survey

Agencies: Stanford Research Institute (SRI)
Army Map Service (AMS)
Lookout Mountain Laboratory (LML)
Raydist Navigation Corporation
Holmes & Narver, Inc. (H&N)
LCU-1348

Operations: Fathometer traverses, lead-line soundings, and photo interpretation were used to measure apparent craters. The fathometer was mounted on an LCU that traversed the craters. Raydist provided some of the location aids, LML provided photography, usually taken on burst day from an RB-36 of TG 7.4 TAU, and H&N provided lead-line soundings. BRAVO crater was surveyed on D+6; surveys for KOON and UNION were modified and the data supplemented by information obtained from other agencies.

Shots: BRAVO, KOON, UNION (Bikini).

Radiation Exposure Potential: Exposure was possible for survey party personnel. For example, during the post-BRAVO survey, the radiation

level 10 feet (3 meters) above the water surface was 0.025 to 0.075 R/hr.

Staffing: One military and nine civilians, six from SRI, one from AMS, one from Raydist, and one from H&N, were associated with this project. Their exposures appear in Table 19. Exposures for personnel from other task groups appear in Tables 58, 86, and 90.

Project Report: Reference 60.

Project 3.3 -- Blast Effects on Tree Stand

Agencies: U.S. Forest Service (USFS)
Ballistic Research Laboratories (BRL)

Operations: To determine blast effects on tree stands, natural stands on Jelete, Lukoj, and Enidrik were used as indicators of effects. Because of expected contamination from BRAVO and ROMEO, all project work was completed before BRAVO except arming of gauges. BRL (Project 1.2b) installed self-recording, static, overpressure, and dynamic pressure gauges. Participation was planned for KOON only, but the unexpectedly large radius of effects from BRAVO provided additional data.

Shots: BRAVO, KOON (Bikini).

Radiation Exposure Potential: Possible exposure for those making post-shot inspection photographs of tree stands.

Staffing: Two civilians, both from USFS, were associated with this project and received 3.040 and 2.825 R.

Project Report: Reference 61.

Project 3.4 -- Sea Minefield Neutralization by Means of a Surface-Detonated Nuclear Explosion

Agencies: Bureau of Ordnance
USS Shea, USS Reclaimer, USS Terrell County

Operations: One hundred twenty-one inert sea mines were planted in seven rows between 3,000 feet (914 meters) and 13,800 feet (4,206 meters) from ground zero. Mines were laid on 10 to 13 April and on

25 April. Recovery was begun on 27 April with mines closest to ground zero, but then switched to outer strings because of high radiation levels (10 R/hr). The inner string was left for several days. Mines were recovered by the Reclaimer, washed down as necessary to reduce radioactivity, and then transferred to the Terrell County. Figure 47 shows such a recovery.

Shots: UNION (Bikini).

Radiation Exposure Potential: High for personnel involved in recovery operations.

Staffing: No personnel from TG 7.1 were specifically associated with this project. Exposures for personnel from other naval task group units are presented in Table 59.

Project Report: Reference 62.

Project 3.5 -- Blast Effects on Miscellaneous Structures

Agency: Armed Forces Special Weapons Project (AFSWP)

Operations: Survey of accidental damage to base camp structures on Eneman and Aerokoj, airfield facilities on Aerokojlolo, and concrete instrument shelters on Bokbata and Nam following BRAVO.

Shots: BRAVO (Bikini).

Radiation Exposure Potential: Potential exposure present for any personnel involved in damage surveys.

Staffing: One military person from AFSWP was associated with this project. He received 1.000 R, although this was probably not accrued solely in the Project 3.5 effort.

Project Report: Reference 63.

Response of Humans to Accidental Fallout Radiation (Program 4)

Immediately after the accidental exposure of the Marshall Islanders on Rongelap, Ailinginae, and Utirik, and the 28 task force personnel on Rongerik following BRAVO (see Chapter 4), Project 4.1 was organized. The

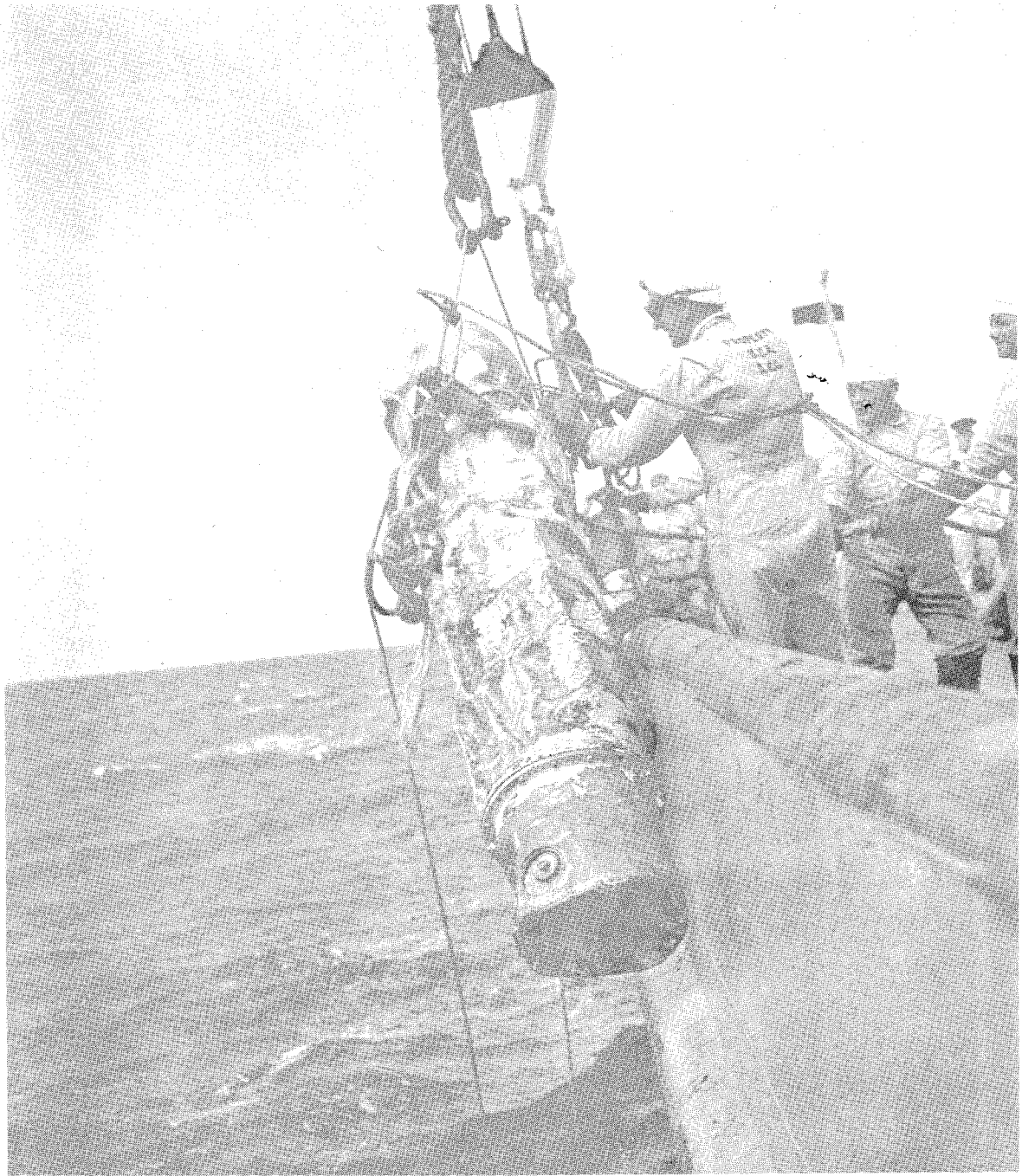

Figure 47. Recovery of sea mines by the USS Reclaimer (ARS-42) following the UNION shot, CASTLE.

purposes of this project were to (1) evaluate the severity of radiation injury to the human beings exposed, (2) provide for all necessary medical care, and (3) conduct a scientific study of radiation injuries to human beings.

The organizations and ships involved were:

Naval Medical Research Institute

Naval Radiological Defense Laboratory (NRDL)

Patrol Squadron 29 (VP-29)

Naval Air Station, Kwajalein

Los Alamos Scientific Laboratory (LASL)

USS Nicholas

USS Renshaw

USS Philip

Applied Fisheries Laboratory, University of Washington

Hanford Atomic Power Operations

OPERATIONS. The primary operation was the evacuation and decontamination of the people involved from 28.5 to 78 hours after BRAVO was detonated. This process and the operational units involved are described in Chapter 4. The evacuees were taken to Kwajalein where immediate medical needs were attended to and initial scientific studies made. Residual radiation at the contaminated atolls was surveyed during March to establish the exposure levels of the natives. These missions are summarized in Table 66. The people of Rongelap were later taken to Majuro in the Marshalls where they remained until 1957, when they returned to Rongelap. Utirik, which was less heavily contaminated, was reoccupied by its evacuated inhabitants in June of 1954. Medical followup studies on the Marshall Islanders have continued from 1956 to the present, under the supervision of the Brookhaven National Laboratory (Reference 64). The U.S. service personnel were taken to Tripler General Hospital in Honolulu for bioassay and observation, but they have not been included in the medical reviews by Brookhaven.

RADIATION EXPOSURE POTENTIAL. The radiation exposures of project personnel (as opposed to the people inadvertently exposed) were limited to exposure at the contaminated atolls at the time of evacuation, exposure at the time of surveys made somewhat later, and exposures during decontamination of evacuation equipment (primarily aircraft) at Kwajalein.

STAFFING. Individuals involved in all aspects cannot be ascertained from project documentation, nor can the exposures recorded in the Consolidated List (Reference 13) for identifiable Project 4.1 personnel be isolated to exposure from their participation in Project 4.1 activities. The exposures presented in Chapters 8 and 9 should be consulted for the organizations involved.

PROJECT REPORTS. References 25, 65, 66, 67, and 68.

Tests of Service Equipment and Techniques (Program 6)

This program covered a miscellaneous group of six projects.

Project 6.1 -- Test of Interim Indirect Bomb Damage Assessment Procedures

Agencies: 97th Bombardment Wing, Strategic Air Command,
Biggs AFB, Texas

Operations: Three B-50s and crews of the 97th Bombardment Wing positioned on Guam flew to Enewetak 2 to 3 days before each test to pick up radiofrequency crystals, film badges, and dosimeters. At detonation they were normally 15, 23, and 30 nmi (27, 42, and 56 km) from the burst, recording the burst on radarscope photographs. Only two aircraft were in position for UNION and YANKEE. One of the B-50s was also required to do crater photography (Reference 69, Number 2-54 Change 5).

Shots: All.

Radiation Exposure Potential: The aircraft were at a long slant range from these burst points and the potential for initial radiation exposure appears small. The aircraft returned to Enewetak to pick up

support crews and drop off instrumentation after each shot before they returned to Guam, but as no major fallout incidents occurred at Enewetak the potential for exposure to residual radiation was small.

Staffing: No personnel from TG 7.1 were associated with this project. The exposures for the 97th Bombardment Wing are listed with TG 7.4, but are obviously not for the crews of the Project 6.1 aircraft, as these aircraft were Guam-based.

Project Report: Reference 70.

Project 6.2a -- Blast and Thermal Effects on B-36 Aircraft In Flight

Agencies: Allied Research Associates (ARA)
Wright Air Development Center (WADC)
Strategic Air Command Test Detachment (SAC)
University of Dayton
11th Bombardment Wing

Operations: A specially instrumented and maintained B-36D aircraft (No. 49-2653) was flown in most of the shots to confirm predicted responses. The same aircraft was used in similar experiments in IVY and UPSHOT-KNOTHOLE.

Shots: BRAVO, ROMEO, UNION, YANKEE (Bikini); NECTAR (Enewetak).

Radiation Exposure Potential: The range of the aircraft from bursts limited the possibility of initial radiation exposure for the flight crew. Aircraft altitudes and slant ranges at burst time for the various shots were:

BRAVO -- 33,000 feet (10.06 km), slant range 60,580 feet
(18.46 km)

ROMEO -- 37,000 feet (11.28 km), slant range 63,580 feet
(19.38 km)

KOON -- 40,000 feet (12.19 km), slant range 56,570 feet
(17.24 km)

UNION -- 37,100 feet (11.31 km), slant range 62,700 feet
(19.11 km)

YANKEE -- 40,000 feet (12.19 km), slant range 56,990 feet
(17.37 km)

NECTAR -- 33,000 feet (10.06 km), slant range 126,380 feet
(38.52 km).

On YANKEE, 0.020 R/hr was recorded in the aircraft for a period of 20 seconds. After the tests, the aircraft was returned to the manufacturer for work and was found to be radiating about 0.010 R/hr at hot spots on the landing gear, perhaps due to operating from the same runway used by sampler aircraft, as the Project 6.2a B-36D did not fly near the cloud.

Staffing: Six civilians were associated with this project; four from the University of Dayton and two from WADC. Their exposures are given in Table 19. Included in this is the aircraft commander who received 0.100 R, but the rest of the aircrew cannot be identified from the project report.

Project Report: Reference 35.

Project 6.2b -- Thermal Effects on B-47B Aircraft In Flight

Agencies: Allied Research Associates (ARA)
Wright Air Development Center (WADC)
Cook Research Laboratories (CRL)
Naval Radiological Defense Laboratory (NRDL)

Operations: A B-47B aircraft (No. 50-037), used in similar experiments during IVY, was flown in five shots to determine thermal effects. Instrumentation and aircraft positioning were determined by WADC, NRDL provided measurements, and CRL installed and maintained the instrumentation.

Shots: BRAVO, ROMEO, KOON, UNION (Bikini); NECTAR (Enewetak).

Radiation Exposure Potential: The range of the aircraft from bursts limited the possibility of initial radiation exposure of the flight crew. Aircraft positions at burst time for the various shots were:

BRAVO -- 35,000 feet (10.67 km), slant range 61,800 feet
(18.84 km)

ROMEO -- 35,000 feet (10.67 km), slant range 83,500 feet
(25.45 km)

KOON -- 35,000 feet (10.67 km), slant range not reported

UNION -- 35,000 feet (10.67 km), slant range 64,500 feet
(19.66 km)

YANKEE -- did not participate

NECTAR -- 35,000 feet (10.67 km), slant range 45,800 feet
(13.96 km).

The aircraft flew away from the cloud and was not exposed to significant residual radiation exposure potential.

Staffing: Three civilians were associated with this project, two from CRL and one from WADC. Their exposures are given in Table 19. Exposures for the aircrew are included in Table 87.

Project Report: Reference 71.

Project 6.4 -- Proof Testing of Atomic Weapons Ship Countermeasures

Agencies: Bureau of Ships (BuShips)
Naval Radiological Defense Laboratory (NRDL)
Army Chemical Center (ACC)
Mare Island Naval Ship Yard (MINSY)
Naval Unit, Chemical Corps School (NUCCS)
Naval Schools Command, Treasure Island (NSC TI)
YAG-39 (USS George Eastman)
YAG-40 (USS Granville S. Hall)
USS Molala, USS Tawakoni, USS Bairoko, USS Estes
P2V5 aircraft
8542nd AAU

Operations: Equipped for remote control, YAG-39 and YAG-40 maneuvered in the fallout patterns of four Bikini shots. YAG-39 carried a wash-down system, but YAG-40 did not. Each was instrumented for radiation measurements and each carried an unmanned F4U aircraft secured to the weather deck, also instrumented for radiation measurements. The ships were unmanned during the first two shots, with control provided by P2V5 aircraft, as well as the Molala and possibly the Bairoko. During the last two shots, a crew aboard the YAG-39 in a heavily shielded control room controlled both the YAG-39 and the unmanned YAG-40, with some assistance from the P2V5 and the Bairoko. Both ships were taken to Enewetak for decontamination, with the Instrument Group boarding as soon as possible to retrieve radiation records. Various operational

and experimental decontamination procedures were followed. Approximately 300 men from various ships of TG 7.3 assisted in survey, sample recovery, and ship and aircraft decontamination work. Coordination of this effort was done on the Estes.

Figures 48, 49, and 50 show the sequence of decontamination for YAG-40. Figure 48 shows the tug, Molala, hosing the ship down as she returned to Enewetak. Figures 49 and 50 show crews dressed in protective clothing on the YAG-40 using hoses from the YAG-39 to continue the sequence. Figures 51 and 52 show one of the aircraft carried on the YAG decks being decontaminated at Parry (these were aircraft from Alameda NAS that had been scheduled for salvage; four were used in the tests).

Shots: BRAVO, ROMEO, UNION, YANKEE (Bikini).

Radiation Exposure Potential: High for personnel aboard the vessels, as well as for those engaged in recovery and decontamination operations. For example, the average exposures received by NRDL and YAG personnel were 0.170 R for BRAVO, 1.030 R for ROMEO, 1.100 R for UNION, and 0.026 R for YANKEE.

Staffing: One hundred and five people are specifically associated with this project, including seven civilians for whom exposure records are apparently unavailable. Of the remaining 98, 39 were military associated with TG 7.3. Of the TG 7.1 group, 43 were civilians (35 NRDL, 5 BuShips, 1 MINSY, 1 AFSWP, and 1 ACC) and 16 were military (6 NRDL, 4 NSC TI, 3 BuShips, 1 NUCCS, 1 AFSWP and 1 8542nd AAU). Overall exposures are presented in Table 19. Exposures for other members of TG 7.3 participating in Project 6.4 appear in Table 59.

Project Report: Reference 72.

Project 6.5 -- Decontamination and Protection

Agencies: Army Chemical Corps (ACC)
Corps of Engineers, Washington, D.C.
Armed Forces Special Weapons Project (AFSWP)
YAG-39, YAG-40
Barge (type YC-500)

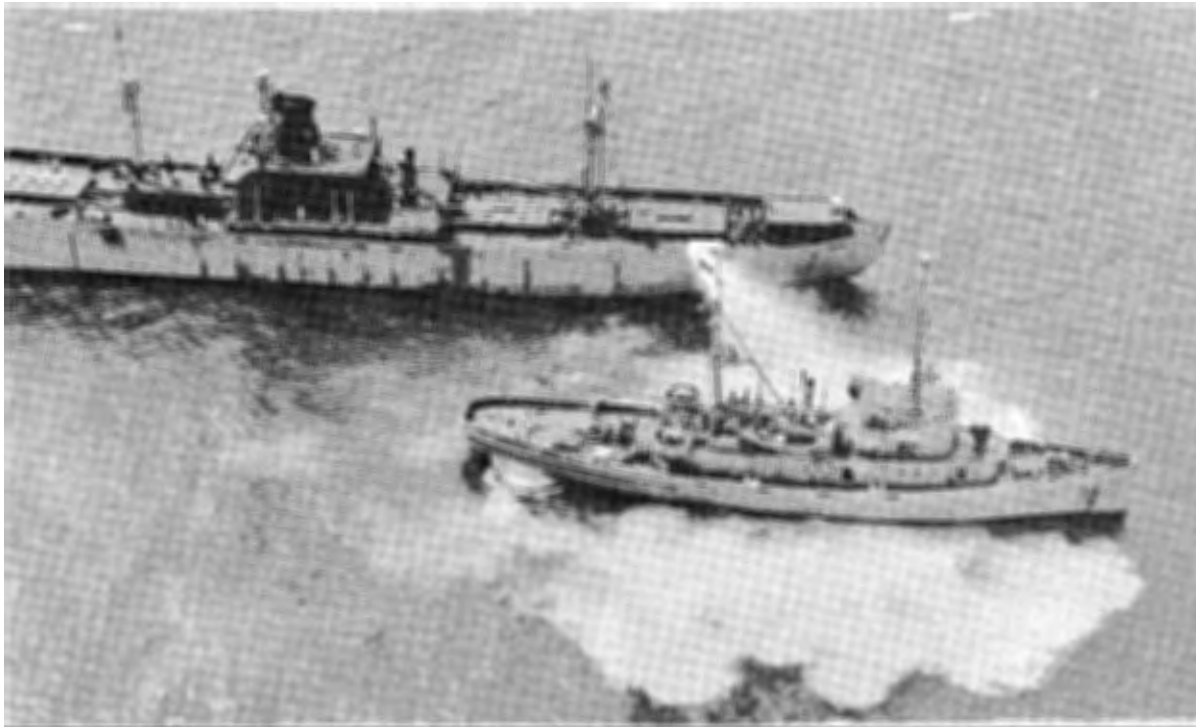

Figure 48. Decontamination hosedown of YAG-40 (USS Granville S. Hall) by the USS Molaala (ATF-106), CASTLE.



Figure 49. Deck crew continuing washdown of YAG-40 (USS Granville S. Hall), CASTLE.

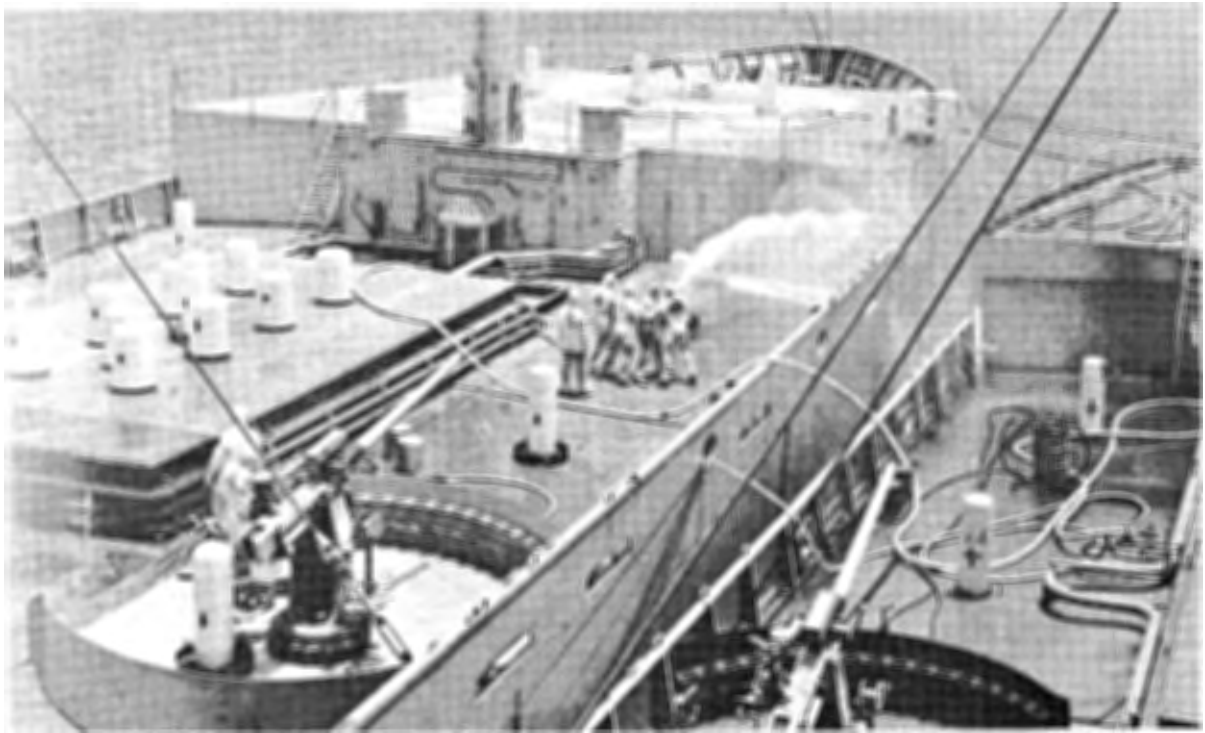

Figure 50. Further washdown of YAG-40 (USS Granville S. Hall), YAG-39 (USS George Eastman) alongside; CASTLE.



Figure 51. Project 6.4 test aircraft being decontaminated, CASTLE.



Figure 52. Scrubbing Project 6.4 test aircraft, CASTLE.

Operations: Sets of panels of outdoor construction surfaces were mounted on YAG-39 and YAG-40, which maneuvered through fallout patterns from Bikini shots, and on a stationary barge in the Enewetak Lagoon to sample fallout from NECTAR. All surfaces were contaminated significantly. Decontamination was performed at Parry, using such procedures as high- and low-pressure hosing, scrubbing, and application of washing compounds.

Shots: BRAVO, ROMEO, UNION (Bikini); NECTAR (Enewetak).

Radiation Exposure Potential: High for those on the YAGs and for the personnel participating in decontamination procedures and experiments at Parry.

Staffing: Five were associated with this project, three civilians (two from ACC, one from Corps of Engineers) and two military (one from AFSWP and one from ACC). Their exposures are given in Table 19. Exposures for those involved from TG 7.3 are given in Table 59.

Project Report: Reference 73.

Project 6.6 -- Effects of Nuclear Detonation on the Ionosphere

Agencies: Signal Corps Engineering Laboratories (SCEL)
9471st TSU

Operations: Ionospheric recorders were set up at Enewetak (Parry Island) and Rongerik atolls in the Marshalls and at distant locations. Following the fallout from BRAVO, operations at Rongerik were curtailed; recorders were started before each shot and left to operate unattended.

Shots: All.

Radiation Exposure Potential: Although the potential for exposure appeared quite low, owing to the remoteness of the stations, the actual exposure turned out to be high at Rongerik because of BRAVO.

Staffing: Five people were definitely associated with this project, one civilian and four military. Three of the military were the enlisted personnel of the 9471st TSU who were on Rongerik and were exposed to the BRAVO fallout. They were assigned an exposure of 98 R in Reference 13 based upon a badge on a tent pole in their work area, but based on later research the exposures were reduced to 78 R (Reference 68).

Project Report: Reference 74.

Burst Detection Studies Program (Program 7)

This program conducted a variety of experiments in nuclear explosion electromagnetic pulse generation, airborne low-frequency sound, and collection of nuclear weapon debris.

Project 7.1 -- Electromagnetic Radiation Calibration

Agencies: National Bureau of Standards (NBS)
Naval Electronics Laboratory (NEL)
Signal Corps Engineering Laboratories (SCEL)
1009th USAF Special Weapons Squadron

Operations: Seventeen stations operated to obtain information on the radiofrequency signal generated by each shot. All stations were distant from the PPG except for one operated remotely by NBS on Eneu. Following contamination by BRAVO, this station was removed and re-located on Runit.

Shots: All.

Radiation Exposure Potential: For the remotely located stations, the potential was slight. A greater potential existed, however, for personnel moving the contaminated NBS trailer from the initial location on Eneu to Runit after BRAVO.

Staffing: One uniformed person was associated with this project, receiving 0.915 R.

Project Report: Reference 75.

Project 7.2 -- Detection of Airborne Low-Frequency Sound from Nuclear Explosions

Agencies: National Bureau of Standards (NBS)
Naval Electronics Laboratory (NEL)
Signal Corps Engineering Laboratories (SCEL)
Office of Naval Research (ONR)

Operations: Fifteen acoustic stations were operated to measure low-frequency sound. All stations were remote from the PPG.

Shots: All.

Radiation Exposure Potential: None, offsite operations.

Staffing: Not applicable, since all stations were remote from the PPG.

Project Report: Reference 76.

Project 7.4 -- Calibration Analysis of Close-In Atomic Device Debris

Agencies: Hq USAF
1009th USAF Special Weapons Squadron
Los Alamos Scientific Laboratory (LASL)
University of California Radiation Laboratory (UCRL)
F-84, WB-29, and B-36 aircraft from TG 7.4 TAU

Operations: Sampling devices on F-84, WB-29, and B-36 aircraft were used to obtain nuclear debris samples close in to the detonations. Long-range calibration samples were also collected by WB-29 aircraft. Aircraft generally did not enter the cloud until 2 hours after burst; the clouds were followed for 5 to 7 hours while samples were being obtained. Collection of close-in particulate samples was under the technical direction of LASL, gas sample collection was supervised by Hq USAF, and gas separation and some analysis was performed by UCRL.

Shots: All.

Radiation Exposure Potential: Exposure potential existed for aircraft crews, as well as for those processing samples upon the aircraft's return and those decontaminating the aircraft.

Staffing: Five people were definitely associated with this project, three from the 1009th (two civilians, one military), one civilian from LASL, and one civilian from UCRL. Their exposures are presented in Table 19. Exposures for personnel from other task groups, notably TG 7.4, are given in Table 87.

Project Report: Reference 77.

Cloud Photography (Program 9)

A single project, Project 9.1, made up this program in order to determine the rise rate of the cloud and the height at which the cloud ceased to rise.

Project 9.1 -- Cloud Photography

Agencies: Edgerton, Germeshausen & Grier, Inc. (EG&G)
Lookout Mountain Laboratory (LML)
1090th USAF Special Reporting Group

Operations: Technical aerial photography was conducted by LML, with backup ground photography by EG&G in conjunction with its photography work for LASL. One RB-36 and three C-54 aircraft, each equipped with two cameras, flew one mission per aircraft for all six shots. The flights were 40 to 100 nmi (74 to 185 km) from ground zero.

Shots: All.

Radiation Exposure Potential: A slight potential existed for all aircrews and for the personnel decontaminating aircraft after flights. The exposures accrued by the RB-36 crew, however, while acting as photo aircraft for this project for 10 minutes after burst, were far outweighed by those accrued over the next several hours while acting as the sampler controller aircraft. Burst-time altitude for the RB-36 was about 40,000 feet (12.19 km). The three C-54 aircraft were used by the Documentary Photography element after H+1. They were at 10,000 to 14,000 feet (3.05 to 4.27 km) altitude and 40 to 60 nmi (74 to 111 km) from ground zero, except on YANKEE when they were 90 to 100 nmi (167 to 185 km) distant.

Staffing: One person (military) was definitely associated with this project, receiving 0.250 R. Exposures of other participants are given in Tables 86 and 90.

Project Report: Reference 78.

CHAPTER 4

BRAVO TEST

The first event of the CASTLE series, BRAVO, was scheduled for detonation on a small artificial island connected to Nam by a causeway. The island was built over the reef some 3,000 feet (914 meters) southwest of Nam. The device, provided by Los Alamos Scientific Laboratory (LASL), was to be detonated on 1 March 1954 if meteorological conditions were favorable.

DECISION TO SHOOT

The preshot 5-day advisory message to the Atomic Energy Commission (AEC), the Joint Chiefs of Staff (JCS), and the Commander-in-Chief of the Pacific (CINCPAC) indicated that the BRAVO fallout would form a fan-shaped pattern from northwest to northeast if the predicted winds held. Based on this favorable wind pattern, a search for transient shipping was conducted northwest of ground zero on BRAVO D-2. The flight pattern was centered on a bearing of 300° from ground zero and consisted of radar coverage by the patrol aircraft of a rectangular corridor 200 nmi (370 km) wide by 800 nmi (1,480 km) long. On BRAVO D-1 a search sector was set up on a heading of 330° . With radar coverage, this search encompassed a trapezoid 600 nmi (1,110 km) long with end lengths of 100 nmi (185 km) at ground zero and 200 nmi (370 km) at the outer end. Results of these searches were negative (Reference 79).

On BRAVO D-1 at 1100 hours, the task force predicted (in the H-18 advisory to the CINCPAC) "no significant fallout . . . for the populated Marshalls." Moreover, the task force predicted that no safety problems would exist except on air or surface routes in the sector 275° to 80° clockwise to a range of 450 nmi (833 km) (Reference 16, p. K-2).

At the 1800 weather briefing, the predicted winds were less favorable; nevertheless, the decision to shoot was reaffirmed, but with another review of the winds scheduled for 2400. The USS Renshaw, acting as the air controller between Enewetak and Bikini, was ordered repositioned from its planned 270° bearing, 90-nmi (167-km) range from Bikini to a more southerly 230° bearing 90-nmi (167-km) range from Bikini. The cloud track flight, designated "Wilson 2," was set up at 2200. It would hold west of Bikini at H+2 at 10,000 feet (3.05 km) in a position to intercept and warn of debris coming west toward Enewetak and Ujelang and then fly east after 2 hours, searching a sector between 55° and 85° through ground zero to find the cloud if it had not already appeared to the west (Reference 8).

The midnight briefing indicated less favorable winds at 10,000- to 25,000-foot (3.05- to 7.52-km) levels. Winds at 20,000 feet (6.10 km) were headed for Rongelap to the east. The predicted speed of these winds was low enough to be of no concern, although it was recognized that both Bikini and Eneman islands would probably be contaminated (Reference 16, p. K-3). The decision to shoot was reaffirmed, at least until the 0430 briefing. A burst-day flight to search for transient shipping was added at this time, to be centered on a 65° vector to a distance of 600 nmi (1,110 km).

At 0430 "no significant changes" in the winds had occurred, except at Bikini where the lower level winds were showing more "northerly and westerly components." The JTF Radsafe Office recommended that the fleet sortie area southeast of Bikini be moved outward from 30 to 50 nmi (56 to 93 km). This was ordered for smaller and slower units, but the larger vessels remained in their original areas to maintain good UHF communications with the firing bunker on Eneu and to be in good position for prompt re-entry. The USS Estes also had to be within range for its role as the master Raydist navigation system station in controlling experimental aircraft flights near the burst point.

The change with time of the direction of interest is illustrated by the vectors shown in Figure 53, which shows the patterns flown by VP-29 P2V aircraft based at the Kwajalein Naval Air Station in searching for transient shipping on D-2 and D-1, and the special added flight on D-Day itself.

PREPARATIONS

The general plan for Bikini operations (including BRAVO) was to withdraw work and scientific parties to the fleet units in the lagoon so the ships could clear the lagoon and assume their night steaming stations southeast of the atoll before dark on the evening before the predawn shot.

In preparing for BRAVO, the firing party, a small group from the AEC weapon design laboratories, proceeded to the location of the emplaced device and started the arming process. This consisted of mechanically altering the device to create a circuit capable of carrying the firing signal to the device. This circuit was still not complete, however, as a similar gap existed in the firing bunker at Station 70 on Eneu. After work at the device was completed, the firing party and the military police detailed to guard the device withdrew to Eneu. The fleet cleared the lagoon before the arming process was completed, thus ensuring that task force personnel (except for the firing party) were never in the atoll while the device could be detonated.

The firing party was left on Eneu in the firing bunker and the small boat or helicopter crew and military police that had provided transportation and protection rejoined the fleet. Final links in the firing circuit were then closed, and the device was ready for detonation.

DOD ACTIVITIES

The DOD-sponsored experiments for BRAVO included 29 projects in TU 13 of TG 7.1. TU 13 projects were:

- Program 1, Blast and Shock; Projects 1.1a-1.1d, 1.2a-b, 1.3, 1.4, 1.6

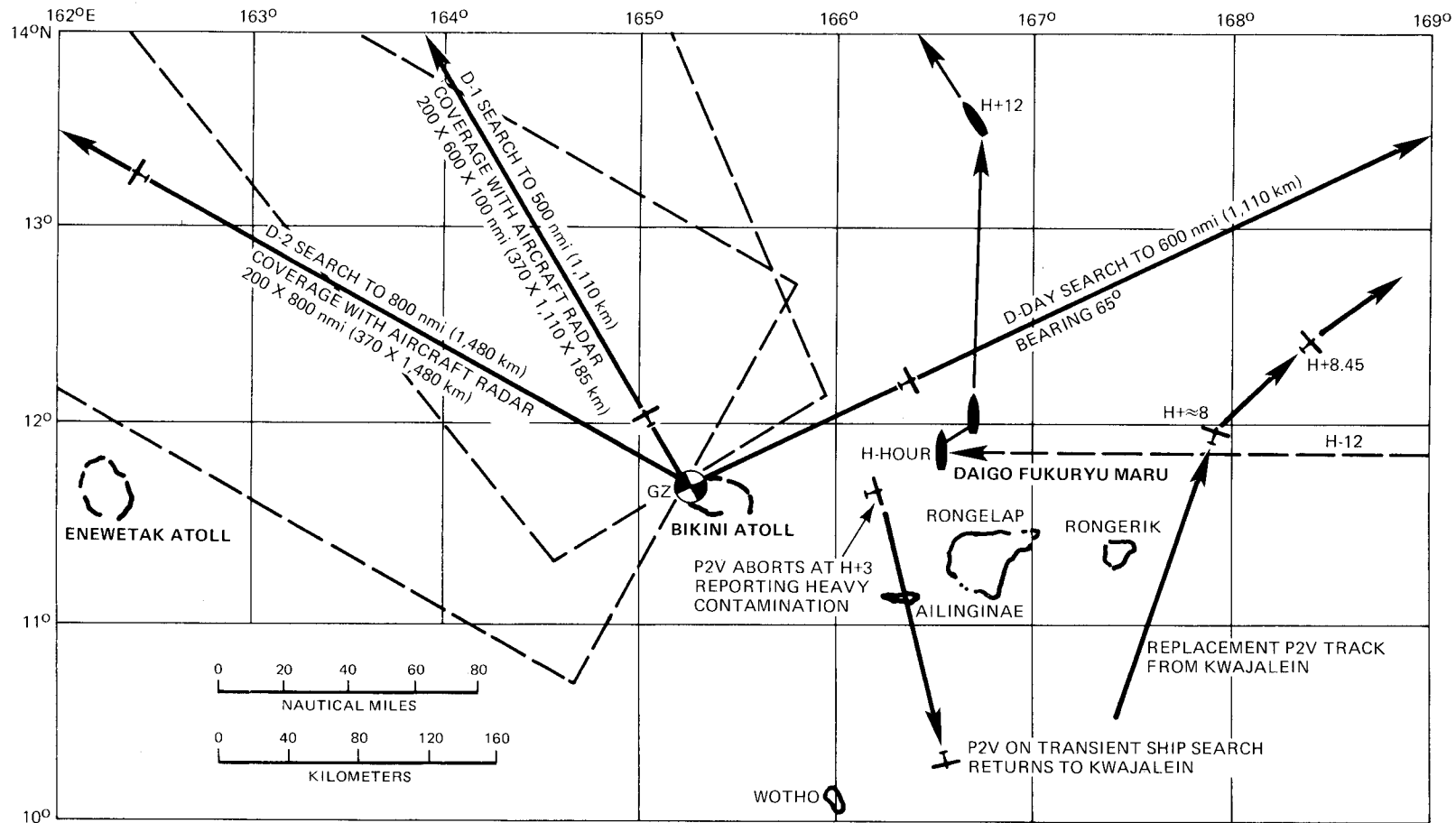

Figure 53. BRAVO search vectors and track of the Daigo Fukuryu Maru, CASTLE, BRAVO (sources: Reference 16 and Japanese Aide Memoire of 27 March 1956).

- Program 2, Nuclear Radiation and Fallout; Projects 2.1, 2.2, 2.3, 2.5a-b, 2.6a-b
- Program 3, Blast Effects; Projects 3.2, 3.3, 3.5
- Program 6, Systems Effects; Projects 6.2, 6.2a-b, 6.4, 6.5, 6.6
- Program 7, Electromagnetics; Projects 7.1, 7.2, 7.4
- Program 9, Cloud Photography.

Chapter 3 contains a detailed description of these projects as well as a description of the participation of the DOD in other portions of the CASTLE experimental programs. The locations of instrument stations for these projects are indicated in Figure 54.

The locations of the ships of the fleet at burst time are shown in Figure 55. Aircraft missions and positions are given in Table 20.

THE TEST

At 0645 the firing signal was sent and the device exploded, releasing the energy equivalent of 15 million tons (MT) of TNT. This yield was much greater than expected. In a few seconds, a fireball nearly 3 miles (4.8 km) in diameter had formed, and a crater about 1 mile (1.6 km) across and 200 feet (60 meters) deep was gouged from the reef off Nam. The illumination from the fireball was visible for nearly a minute on Rongerik, 135 nmi (250 km) east of the burst. It was also observed on a Japanese fishing boat 85 nmi (157 km) east-northeast of Bikini. Within 1 minute the fireball had risen to 45,000 feet (13.7 km) and the pulverized coral from the crater was pulled up into a cloud that was already 3 miles (4.8 km) across with a stem 2,000 feet (600 meters) wide.

Within this first minute, the blast wave from the explosion had moved outward from the burst point, stripping the nearby islands of vegetation. The blast wave was received with diminished force 14 nmi (22.5 km) across the lagoon at the evacuated camp on Eneman, where it damaged considerably the lightweight temporary buildings (Figure 56). An electrical short circuit caused a fire, destroying much scientific equipment (Figure 57). The

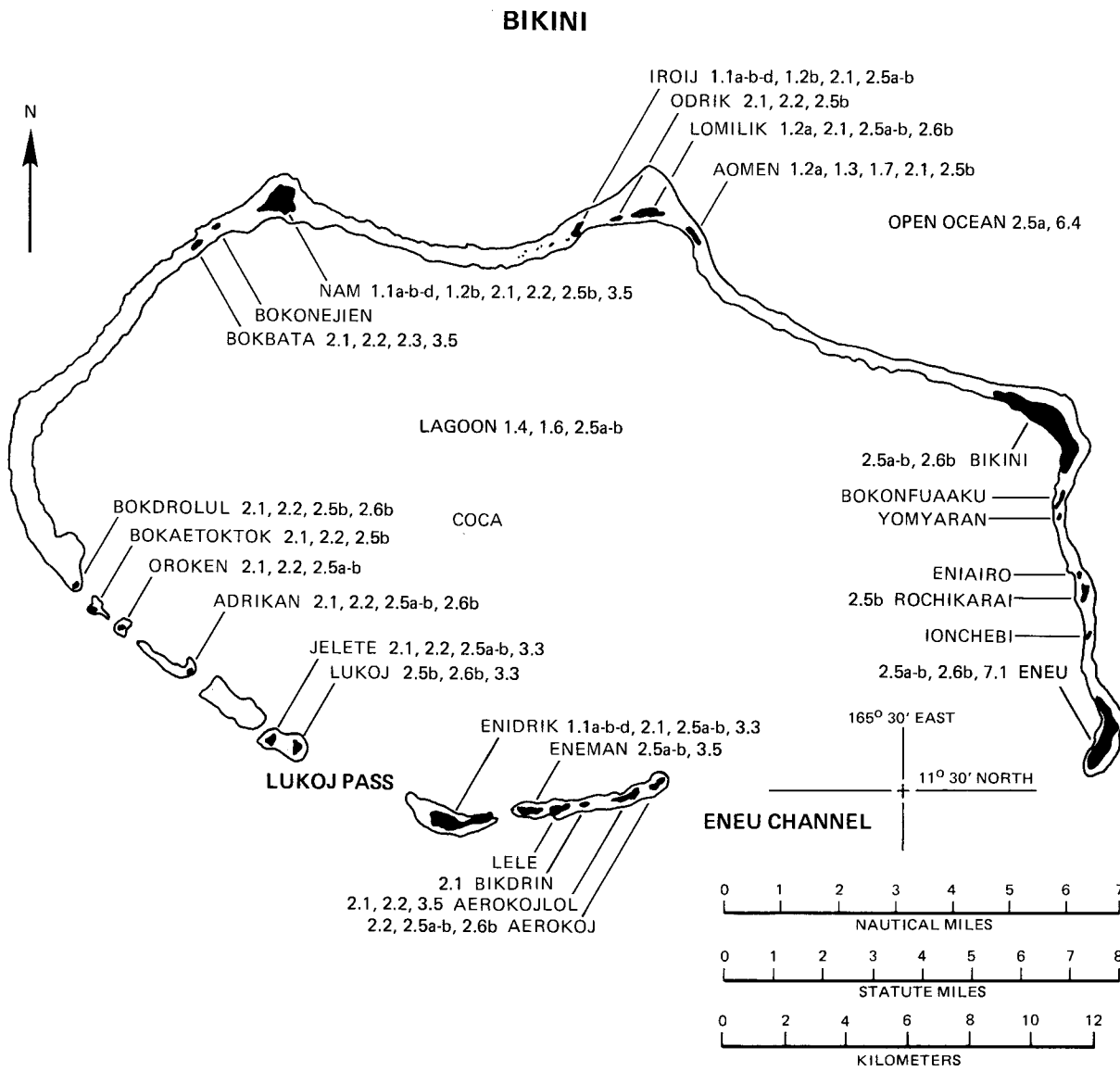

Figure 54. Locations of instrument stations for DOD experiments, CASTLE, BRAVO.

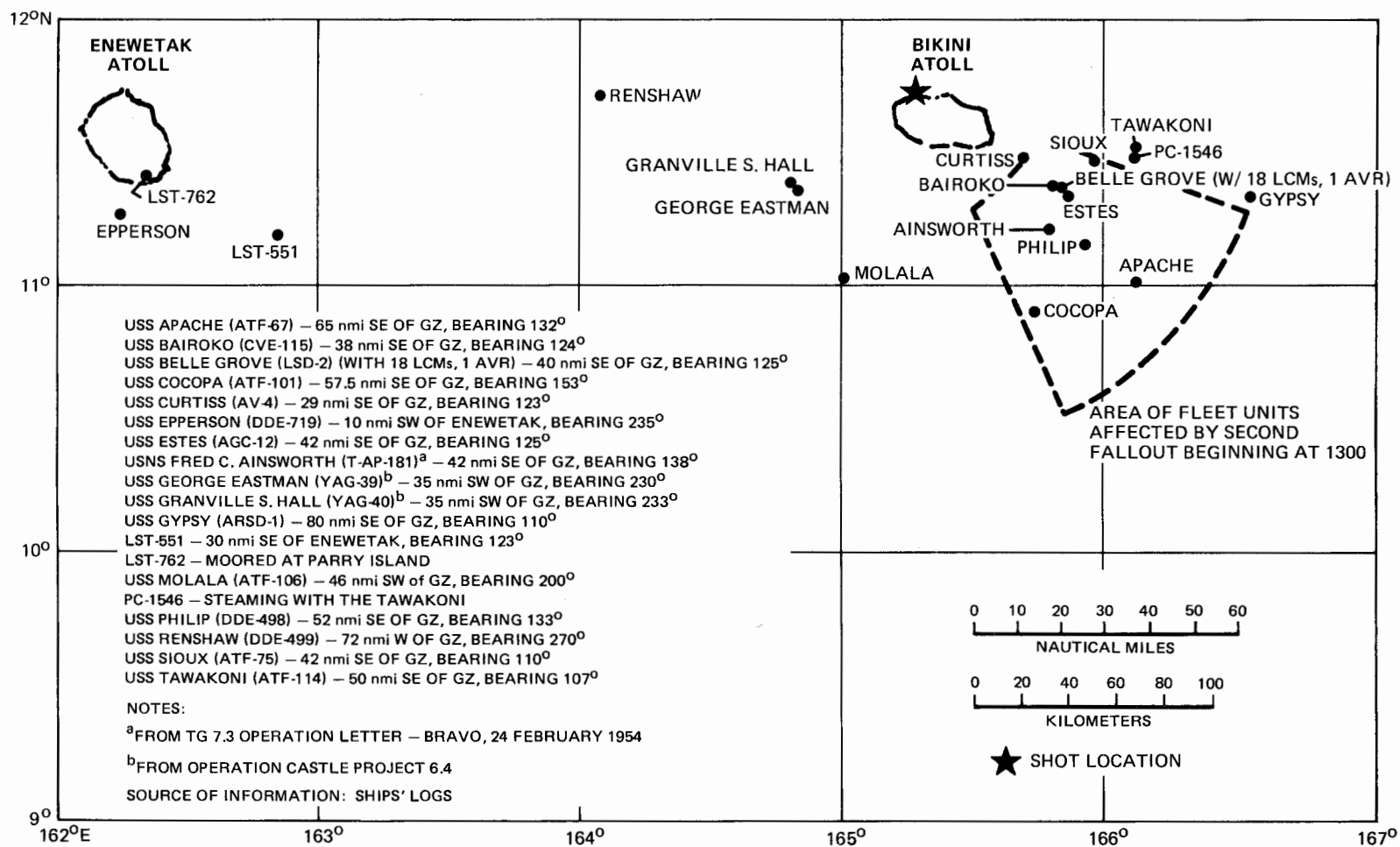

Figure 55. Ship positions at detonation, CASTLE, BRAVO.

Table 20. CASTLE, BRAVO aircraft.

Aircraft		Mission	Project	Burst-time Location ^a / Remarks
No.	Type			
2	P2V-6	Shipping search		One contaminated 120 km east at 350 meters altitude at H+3
1	P2V-5	YAG controller	6.4	West of Bikini
1	P4Y-2	Telemetry receiver	1.4	Altitude 3 km, slant range 46 km south
1	B-36D	Effects	6.2a	Altitude 10 km, slant range 18.5 km south
1	B-47	Effects	6.2b	Altitude 10.7 km, slant range 18.8 km east
1	B-50	Indirect Bomb Damage Assessment	7.1	Altitude 10.4 km, slant range 27.8 km
1	B-50	Indirect Bomb Damage Assessment	7.1	Altitude 9.5 km, slant range 42.6 km
1	B-50	Indirect Bomb Damage Assessment	7.1	Altitude 9.1 km, slant range 55.6 km
1	RB-36	Sampler control	9.1	Altitude 12.2 km, slant range 92 km northeast
3	C-54	Photo	9.1	Altitude 3 to 4.4 km, slant range 92 km south, west, and north
1	WB-29	Sampler		Wilson 1
12-14 ^b	F-84G	Samplers		Sampled south and east edge from H+2 to H+7
2	B-36	Samplers		Sampled H+2 to H+7
2	WB-29	Cloud track		H+2 to H+20; no significant contact
1	Canberra	Sampler		UK aircraft, Kwajalein based

Notes:

^aOne meter = 3.28 feet; 1 kilometer = 3,281 feet.^bSources vary as to number; decontamination data available for ten only.

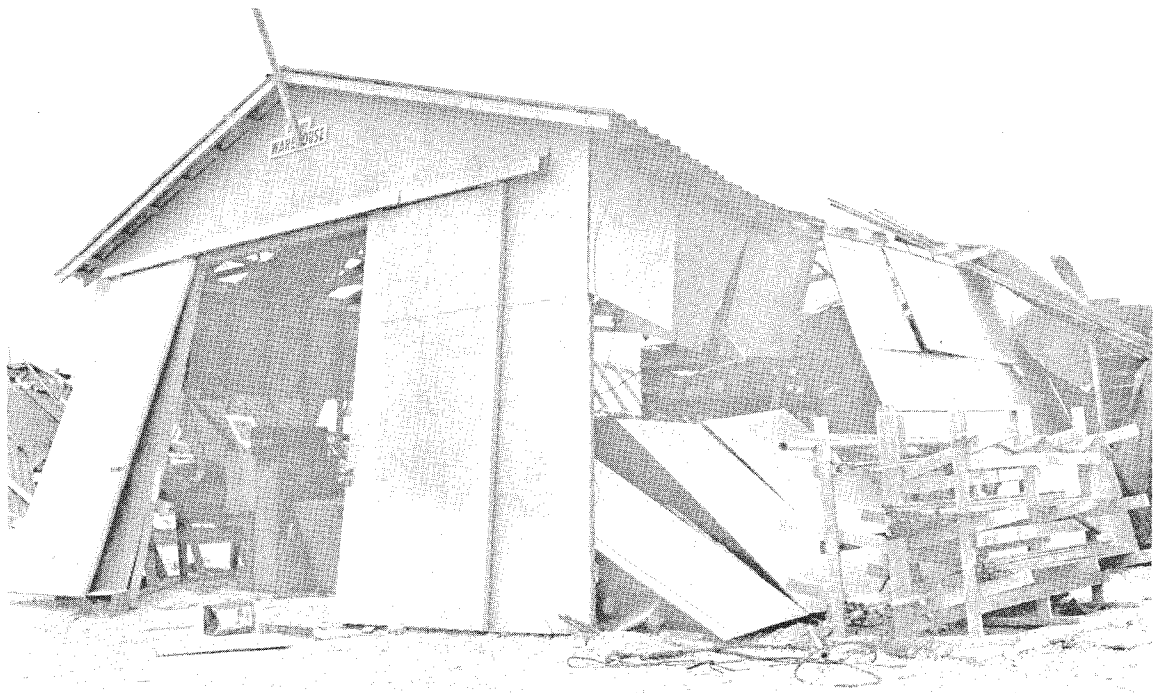

Figure 56. CASTLE, BRAVO blast damage to Eneman Island building.



Figure 57. Fire damage at Eneman Island from CASTLE, BRAVO-induced electrical short circuit.

shock wave was perceived at the Japanese fishing boat as two loud reports like rifle shots, arriving 7 or 8 minutes after the flash was seen. At Rongerik the shock wave shook the windows in the buildings 11 minutes after the first blast was observed (Reference 68).

The cloud formed was like a funnel with the narrowing at about 25,000 feet (19 km) altitude. The growth of the cloud is shown in Figure 58. As early as 10 minutes after burst, the cloud was already more than 65 miles (106 km) across. At about H+30 minutes, aircraft from the cloud photography project visually observed material falling from the cloud from the point at which the funnel flared out (Reference 26).

At Station 70 on Eneu, radiation readings began to rise within one-half hour of the burst and at 1 hour reached 250 R/hr (see Figure 59). The personnel within the bunker were well sheltered; during the fallout peak the reading within the structure was 0.035 R/hr (Reference 16, p. K-3). The fallout picture at Bikini at this time is summarized in Figure 59.

At 0800, the fleet began to receive fallout, which resembled pinhead-sized white and gritty snow. The USS Bairoko and the USS Philip were preparing for the reentry sequence to Bikini. A helicopter had been launched from the Bairoko for radiological reconnaissance, but was recalled when the CTG 7.1 informed the Bairoko that the Eneman complex was radiologically too hot for reoccupation. The source of information for CTG 7.1 may have been the Station 70 bunker on Eneu. Plans for the launch of four other helicopters, including one to aid the USS Molala in controlling the YAGs lying west of Bikini, were also cancelled (Reference 80).

The radiation levels aboard the ships built up quickly, from 0.0002 to 1 R/hr on the Bairoko in 5 minutes. At this time the Bairoko was 31 nmi (57 km) at 133⁰ from the Bikini ground zero. Washdown systems were started on all affected ships, and CTG 7.3 ordered the vessels south to 50 nmi (93 km) from Bikini at "best speed" (Reference 80).

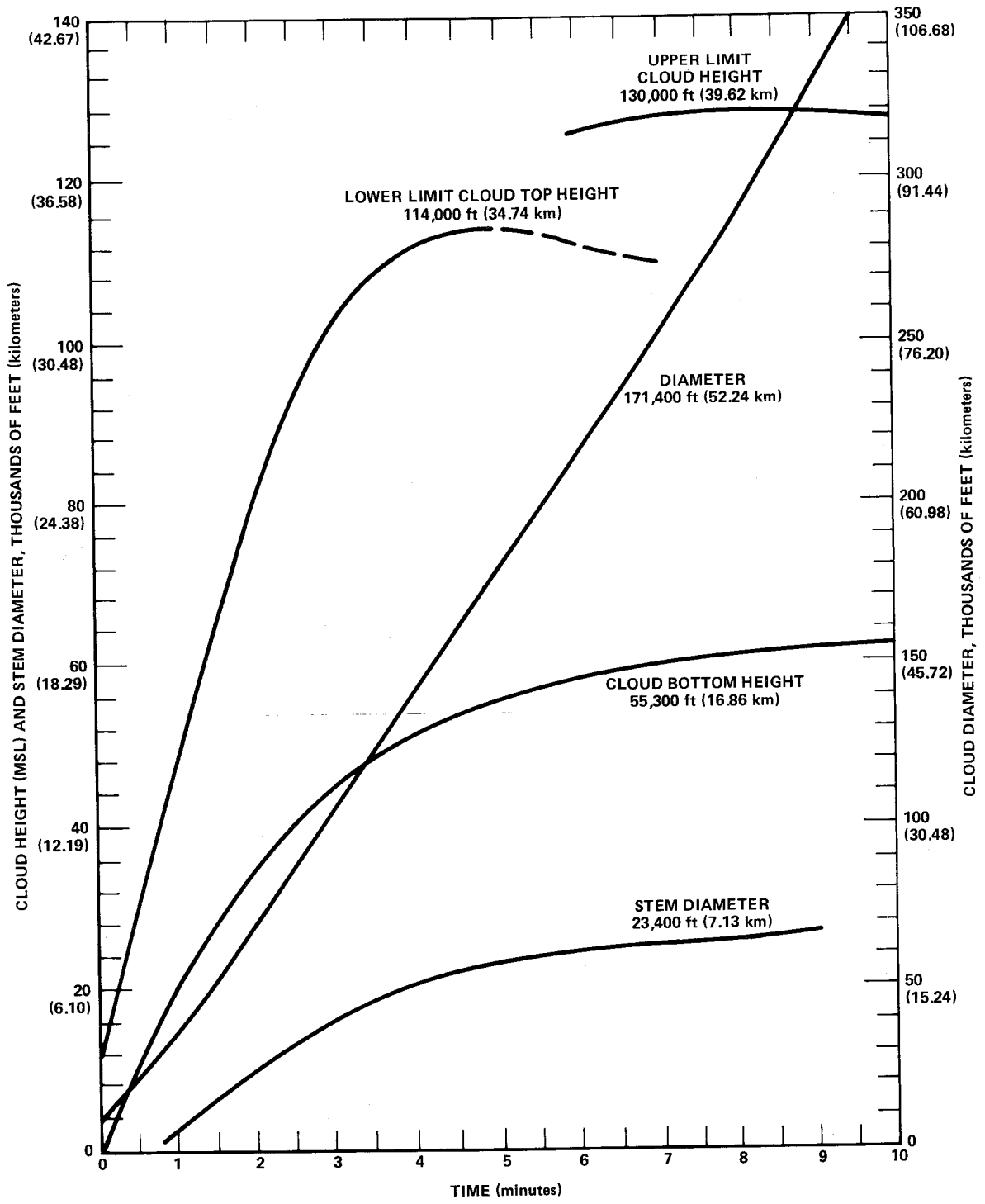

Figure 58. Cloud dimensions for CASTLE, BRAVO (source: Reference 81).

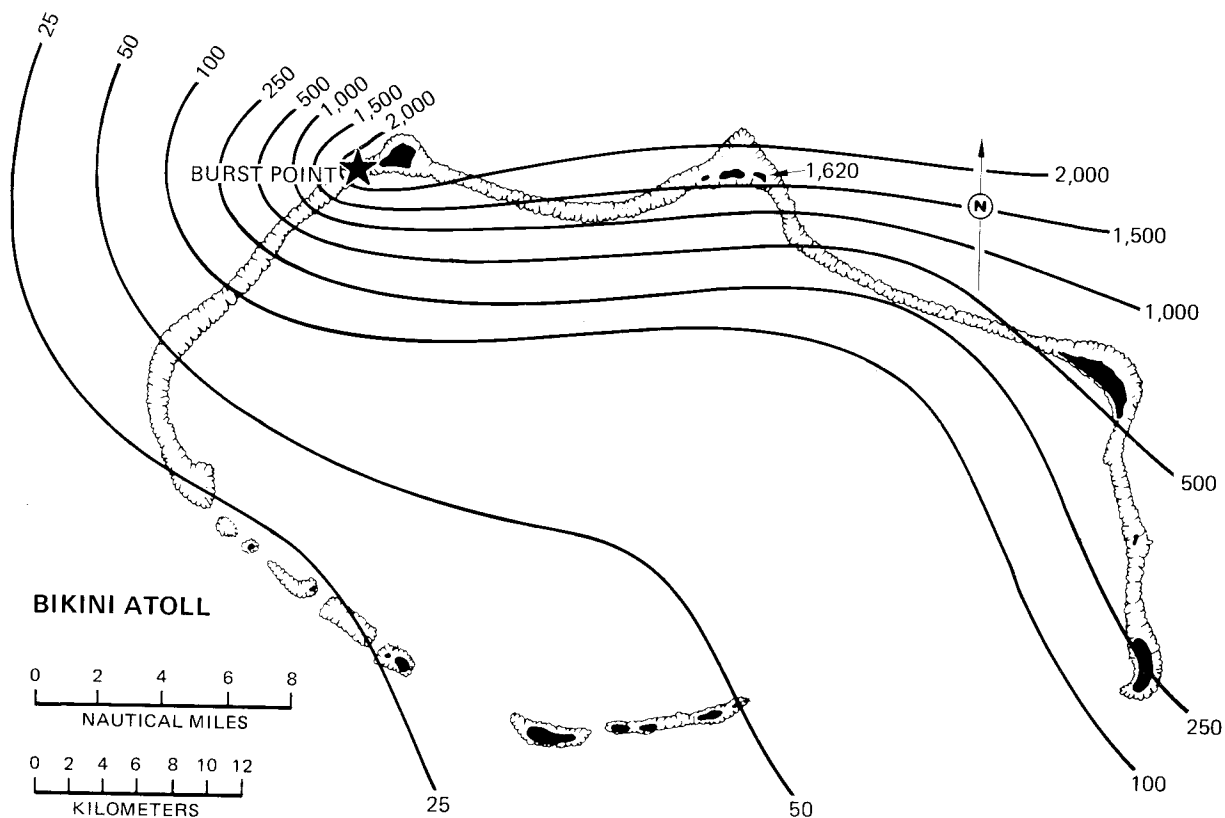

Figure 59. CASTLE, BRAVO close-in gamma fallout pattern at H+1; 0745 local time (R/hr).

The same gritty, snow-like material began to fall on the Japanese fishing boat at about 0815. The crew, most of which was topside, had begun to retrieve its long fishing lines from the water soon after the shock wave passed. The crew secured the lines and remained on deck to process the catch during the fallout (Reference 82). The ship proceeded north toward its separate destiny, unobserved by the task force. The name of this ship was the Daigo Fukuryu Maru (Fortunate Dragon No. 5). The aide memoire produced by the Japanese government detailing the ship's movements is reproduced in Appendix A of this report.

At 0949, a P2V aircraft from VP-29 on Kwajalein, sweeping the sector centered on a bearing of 65° from the shot point for transient shipping, became heavily contaminated and aborted its mission. The aircraft sent a

message stating that heavy contamination (0.5 to 1.0 R/hr) should be expected on an 86° bearing, 238 nmi (441 km) from Enewetak. The message did not reach the JTF 7 Radsafe Center until 5 days later, although no explanation of this delay is given by the source documents (Reference 16, p. K-4).

The question of how far east the P2V was when it left its track and returned to Kwajalein is of considerable interest. The account in the radsafe compendium (Reference 16) says that "From the logs, it appears that [it] . . . reached a position approximately 65 nmi due east of GZ [the burst point] by 0950M only to abort" (p. K-4). The CTG 7.3 memo (Reference 79) states that "a relief aircraft was ordered . . . [to] a position 180 miles bearing 065° true from ground zero". (The approximate position where the previous search had terminated.) If the first account is correct, then the search broke off just before the Daigo Fukuryu Maru would have come into view, whereas the second has the P2V flying right by the fishing boat. Figure 53 shows the track of the Daigo Fukuryu Maru and the P2V abort point from the first account. Figure 60 shows a plot of the reconstructed fallout pattern at the approximate time the P2V aborted.

Cloud sampling began 2 hours after the detonation and continued for 5 hours, with aircraft working from 30,000 to 45,000 feet (9.1 to 13.7 km) on the south and southeast edge of the cloud (Reference 16, p. K-47). This sampling was performed close to the burst point and, although the sampler aircraft were in contact with radsafe personnel on the Estes, little concerning the picture of the cloud's overall movement was learned. Twelve or fourteen F-84s and two B-36s were used in this sampling, with one B-36 acting as controller.

Fallout reached some elements of the fleet later, depending on their positions. The USS Gypsy did not receive fallout until 1400 and some units were less contaminated.

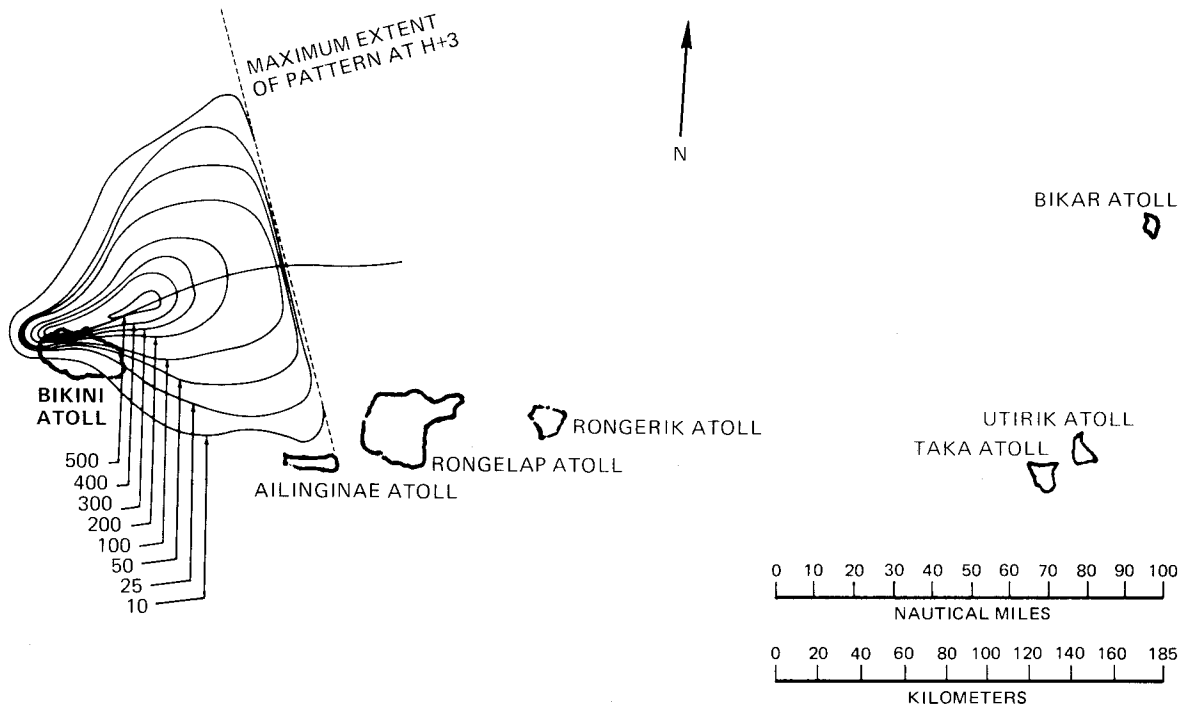

Figure 60. CASTLE, BRAVO reconstructed fallout at H+3; 0945 local time (R/hr). Reconstruction is by NRDL and shows gamma field levels that would have existed had the fallout been on land areas (source: Reference 53).

Washdown on the ships was effective, but some problems did arise. On the Bairoko, one of the two ships most seriously exposed, the regular wash-down equipment was secured after 2 hours and firehoses were then used on exposed areas throughout the day. At that time readings of 5 R/hr were made in gutters on the flight deck. A reading of 25 R/hr was recorded in a flight deck drain. The ventilation system was closed at the onset of the fallout, preventing much contaminated material from being carried below decks. The captain reported that the engineering spaces never exceeded readings of 0.008 R/hr (Reference 80). The Bairoko was able to launch helicopters at 1015 to retrieve the firing party still in the firing bunker on Eneu. The retrieval was completed at 1230.

The average readings for certain ships are presented in Table 21 for several hours on D-day and at selected later times.

Table 21. Average topside intensities (R/hr) of Task Group 7.3 ships following CASTLE, BRAVO.^a

Date	Local Time	Curtiss (AV-4)	Estes (AGC-12)	Ainsworth (T-AP-181)	Belle Grove (LSD-2)	Cocopa (ATF-101)	Apache (ATF-67)	Sioux (ATF-75)	PC-1546	Bairoko (CVE-115)	Philip (DDE-498)	Gypsy (ARSD-1)
1 March	0900	0.008	0.400 ^b	---	---	---	---	---	---	0.500	0.750	---
	1000	0.005	0.200 ^b	---	---	---	---	---	---	0.500	0.265	---
	1100	0.003	0.150 ^b	---	---	---	---	---	---	0.500	0.196	---
	1200	0.002	0.100	---	0.004	---	---	---	0.001	0.350	0.145	---
	1300	0.005	0.100	0.001	0.005	0.005	0.003	0.004	0.003	0.300	0.147	---
	1400	0.018	0.110	0.002	0.012	0.010	0.007	0.008	0.006	0.240	0.138	0.007
	1500	0.025	0.120	0.010	0.020	0.014	0.002	0.009	0.015	0.200	0.134	0.030
	1600	0.045	0.140	0.016	0.035	0.018	0.012	0.010	0.021	0.170	0.180	0.200
	1700	0.055	0.120	0.022	0.075	0.020	0.050	0.022	0.025	0.140	0.225	0.230
	1800	0.050	0.120	0.019	0.150	0.075	0.017	0.050	0.080	0.200	0.262	0.250
	1900	0.040	0.120	0.020	0.190	0.075	0.020	0.034	0.090	0.180	0.194	0.200
	2000	0.037	0.120	0.020	0.300	0.110	0.030	0.015	0.086	0.180	0.199	0.150
2 March	0000	0.030	0.120	0.020	0.080	0.075	0.030	0.040	0.080	0.160	0.018	0.130
	0400	0.025	0.120	0.020	0.060	0.070	0.030	0.030	0.050	0.145	0.156	0.110
	0800	0.020	0.080	0.020	0.060	0.030	0.025	0.012	0.040	0.134	0.111	0.080
	1200	0.015	0.050	0.020	0.050	0.020	0.010	0.010	0.030	0.108	0.078	0.045
	1600	0.010	0.030	0.012	0.050	0.020	0.010	0.009	0.020	0.036	0.060	0.040
2000	0.010	0.020	0.010	0.020	0.018	0.010	0.007	0.015	0.030	0.047	0.035	
3 March	0000	0.009	0.020	0.008	0.020	0.015	0.008	0.006	0.014	0.027	0.039	0.035
	0400	0.008	0.018	0.007	0.015	0.012	0.003	0.006	0.013	0.025	0.041	0.035
	0800	0.007	0.016	0.006	0.012	0.007	0.003	0.005	0.012	0.022	0.034	0.025
4 March	0800	0.0032	0.007	0.005	0.008	0.005	0.002	0.004	0.006	0.014	0.017	0.020
5 March	0800	0.0012	0.004	0.004	0.007	0.003	0.002	0.004	0.003	0.009	0.008	0.014
6 March	0800	0.001	0.004	0.003	0.005	0.002	0.002	0.004	0.002	0.006	0.007	0.012
7 March	0800	0.001	0.0027	0.002	0.003	0.002	0.001	0.004	0.001	0.004	0.005	0.010
8 March	0800	0.001	0.0021	0.0015	0.002	0.0015	0.001	0.004	0.001	0.003	0.004	0.008

Notes:

^aAll ships not listed here received negligible contamination.^bEstimated.

Source: Reference 80.

After several hours, the snow-like material stopped falling on the fleet. This cessation of fallout indicated that the cloud dispensing these particles, probably extending about 100 miles (160 km) across, had moved eastward. The time of its passage over the inhabited atoll of Rongelap, 105 nmi (194 km) east of Bikini, is not accurately known and can only be inferred from its arrival at about 1430 at Rongerik farther east. The fallout reconstruction shown in Figure 61 shows the front of the fallout passing the easternmost portion of Rongelap at 1245 local time.

At Rongerik, 135 nmi (250 km) east of Bikini, 25 men of the 6th Weather Squadron operated a weather observatory for the Weather Reporting Element (WREP), Test Support Unit, TG 7.4, and 3 men from the 9710th TSU operated an ionospheric sounder for Project 6.6, TU 13, TG 1.

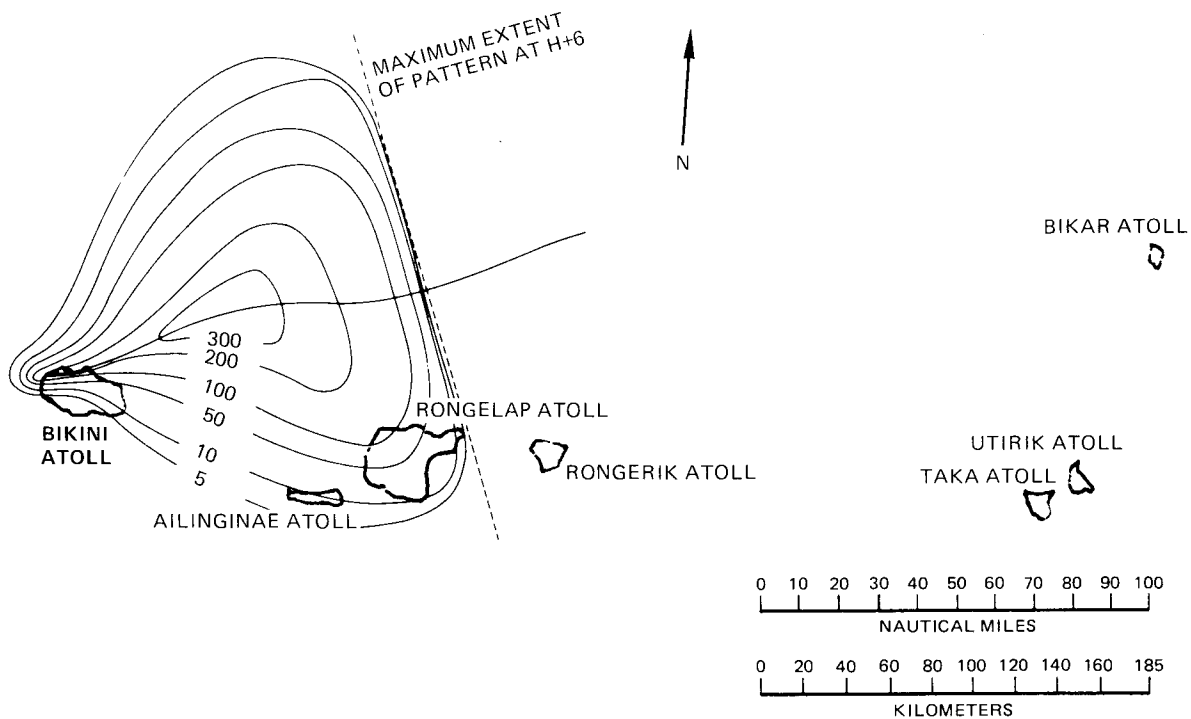

Figure 61. CASTLE, BRAVO reconstructed fallout at H+6; 1245 local time (R/hr). Reconstruction is by NRDL and shows gamma field levels that would have existed had the fallout been on land areas (source: Reference 53).

A fallout-recording device had been left by a representative of the Health and Safety Laboratory (HASL) of the AEC, New York Operations Office, who was concerned with recording offsite fallout. The device was calibrated to record the low levels of radiation expected at offsite locations. Its maximum reading was 0.100 R/hr and the HASL representative had warned the Rongerik personnel to contact him if the meter reading went "off-scale" (i.e., if the radiation exceeded the measuring capacity of the device). Such a message was sent at 1515, was received at the Airways and Air Communications Service (AACS) Center at Enewetak at 1543, and delivered to the Army Communications Center at Enewetak at 1547 for retransmittal to Hq JTF 7. Records do not show if this message was retransmitted or not but, at any rate, the command levels were unaware of the extent of the fallout at Rongerik (Reference 83).

The personnel at Rongerik continued normal activities during the remainder of the day. Most changed from the usual tropical short sleeves and shorts to long sleeves and long pants. The fallout material gathered to a depth of 1/4 to 1/2 inch (0.6 to 1.2 cm) deep in places and left a visible layer on tables in the mess hall and barracks (Reference 68).

Those at Rongerik made some simple scientific observations of this fallout. They observed it under a microscope, and they also noted that it made a cathode ray tube glow (Reference 68).

Meanwhile, at those fleet units arrayed in a sector bounded by 110° and 155° bearings from ground zero at ranges from 20 to 70 nmi (37 to 130 km), a second fallout began about 1300 and continued into the evening. It reached maximum at 1800 and had ceased by 2400. This fallout appeared to be composed of much smaller particles that had taken considerably longer to fall from the great heights to which they had been carried than the large particles from the morning fallout. Again washdown systems were turned on. A TG 7.1 radsafe representative on the Bairoko advised that all nonessential personnel remain below decks to minimize the possibility of inhaling the small particles (Reference 79).

After this second fallout episode, the task force decided to abandon the attempt to reenter Bikini Lagoon that day. The major units and those vessels with TG 7.1 and TG 7.5 personnel aboard were sent west to Enewetak to offload these people and to prepare for a return to Bikini and the beginning of operations afloat there. The USS Belle Grove remained south of Bikini to reenter the following day if possible.

The cloud-tracking aircraft Wilson 2 had begun its flight 2 hours after detonation and had been scheduled to fly for 3 hours in a racetrack course 50 nmi (93 km) west of Bikini to warn if the fallout was headed westward. It was then to fly eastward searching for the cloud in a sector bounded by the bearings 55° to 85° through the burst point. Owing to some confusion at the Air Operations Control (AOC) Center, Wilson 2 was held to the west of Bikini for 6 hours. A portion of its flight path is shown in Figure 62 along with the reconstructed fallout at approximately this time. In its entire flight, Wilson 2 recorded only one radiation reading of any significance, and this was at 1550, 150 nmi (278 km) at a 60° bearing from ground zero. The aircraft flew at 10,000 feet (3.05 km) throughout its flight.

At 1553, the P2V aircraft dispatched to replace the transient shipping search P2V aircraft that had been forced to return because of contamination picked up the desired heading to continue the sweep centered on the 65° bearing. In attempting to pick up the heading slightly earlier, the P2V had encountered radiation at 160 nmi (296 km) bearing 85° from the burst point. This had forced the P2V to swing east to pick up the search vector farther out from ground zero. This plane, based at Kwajalein, was coming from the south toward the 65° bearing when it encountered the radiation. These flights were flown at a much lower altitude (1,000 feet; 305 meters) than the Wilson flights.

The remainder of the flight was apparently uneventful until the plane sighted the USS Patapsco on a course of 30° (Reference 16). The P2V contacted the Patapsco advising an "easterly" course so as to avoid the 65° bearing. The Patapsco accepted this advice, leaving a course that would

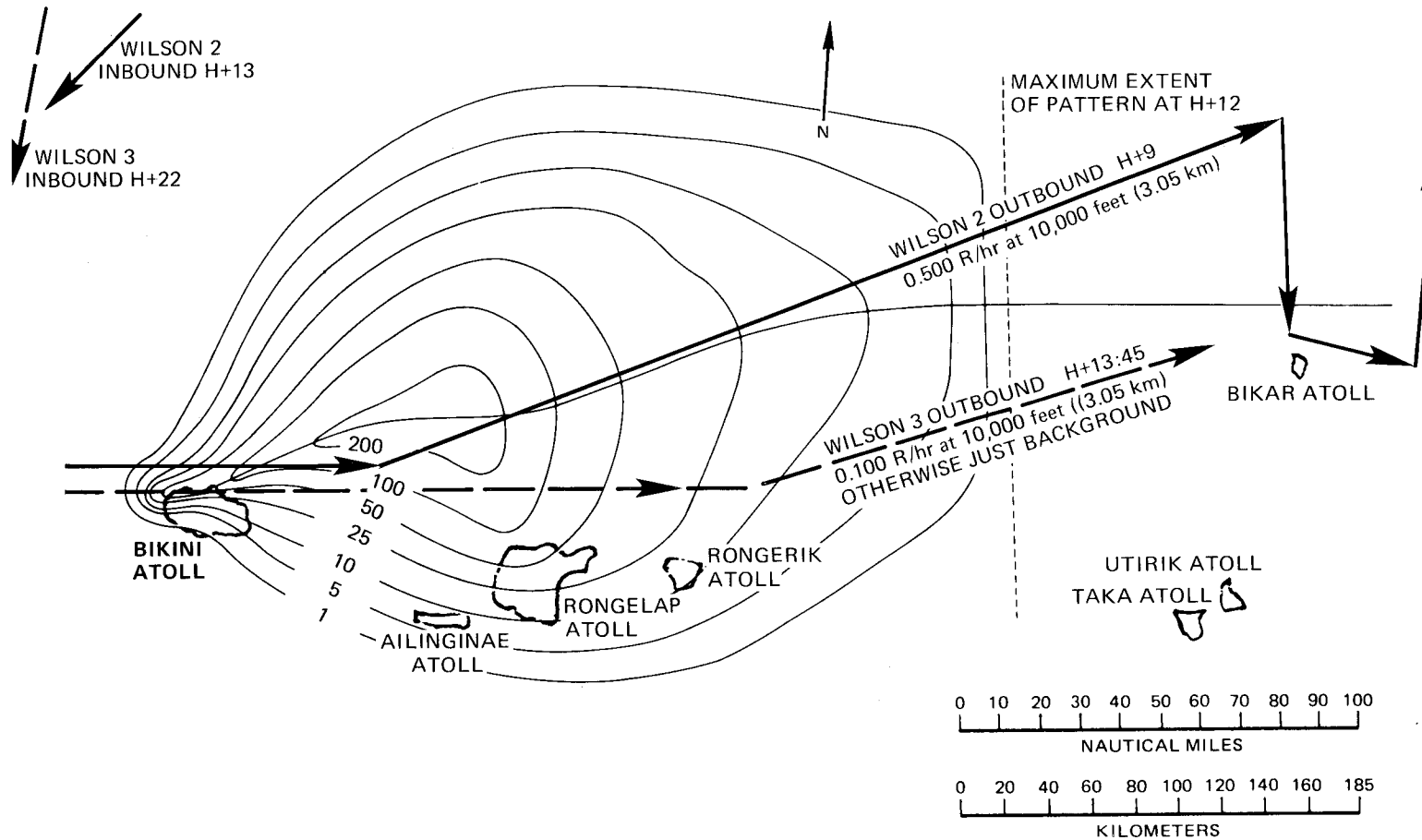

Figure 62. CASTLE, BRAVO reconstructed fallout at H+12; 1845 local time (R/hr). Reconstruction is by NRD and shows gamma field levels that would have existed had the fallout been on land areas (source: Reference 53).

have tended to minimize exposure to take a course that was probably nearly along the "hot line" of the BRAVO cloud.

At 1900 a second cloud-track aircraft, Wilson 3, was sent east from Enewetak. The flight path was nearly straight east until beyond Rongerik, and then the aircraft headed generally northeast while making several zig-zag swings across this northeast vector in search of the cloud. At the southern tip of one of these swings, after 2200, Wilson 3 got two readings that may have been the northern edge of the cloud, but these readings were not much above the background readings taken throughout the flight. Low readings were taken at 10,000 feet (3.05 km) over the Rongelap and Rongerik atolls shortly after 2000 hours.

It is clear that at this time Hq JTF 7 did not know where the cloud was, nor where it had been. There was apparently no great concern about this, however, as the Wilson 4 cloud-track flight was cancelled at 1930 (Reference 26). The MIKE experience indicated that although less than 6 percent of the detonation's radioactive debris had been accounted for, no problems had occurred. The controlling assumption was that the cloud had gone out on the 65° bearing and that the tracking aircraft were simply behind it. The morning's contamination of the fleet lying southeast of Bikini and the unquantified report of contamination by the VP-29 P2V that aborted were not consistent, but this contamination was believed the result of a wind change at the 20,000-foot (6.1-km) level. This wind change was presumed to have resulted in a widespread east-west distribution of fine particles (Reference 16, p. K-5) and was apparently assumed to be a minor irritation, not a major problem.

During the briefing of the task force commander on the Estes at 2000 a second message arrived from the Rongerik detachment. This message reiterated that the pen had been off the chart since 1450 and requested an acknowledgment (Reference 83). At about the same time, messages were received from Wilson 3 indicating low readings above this area (Reference 16). At 2200 a reply was prepared explaining to the Rongerik detachment

that their reported fallout should pose no significant hazard. This reassuring message was not actually sent from the ship until 0500 the following day.

A copy of the Rongerik message to JTF 7 was delivered to the CTG 7.4 WREP on Enewetak slightly later in the evening. He conferred with his superior, the Commander, Test Services Unit, after which a message was sent to Rongerik ordering the cessation of all operations and the placement of all personnel in metal buildings. A layout of the island installations and a photograph of the stations at Rongerik, showing one of the metal buildings there, are shown in Figures 63 and 64. This message was sent just after 2400 on 2 March (Reference 84).

The TG 7.4 officers wanted more information on the situation on Rongerik. They decided that the most expedient way to obtain it was to send a radsafe advisor to Rongerik aboard a regularly scheduled resupply flight from Kwajalein the following morning. The advisor was sent from Enewetak to Kwajalein on an 0300 Military Air Transport Service (MATS) flight to catch the resupply flight.

During the night, Enewetak Atoll experienced fallout that reached a maximum of 0.010 to 0.015 R/hr. It had commenced as early as 1745 in rain at Parry and Enewetak islands with 0.003 to 0.004 R/hr.

REENTRY TO BIKINI

The position of the fleet 24 hours after the shot is shown in Figure 65. The Belle Grove reentered Bikini Lagoon on 2 March. The three barges, ten LCUs, and ten LCMs that had been left in the lagoon off Eneu were heavily contaminated by fallout of the previous day. Intensities at H+12 were "several roentgens per hour" (Reference 80).

Decontamination of these small craft consisted of a primary washdown with high-pressure firehoses, followed by additional hosing and scrubbing by decontamination personnel who were able to safely board the craft after the primary hosing. The Gypsy was quite effective in working close to the

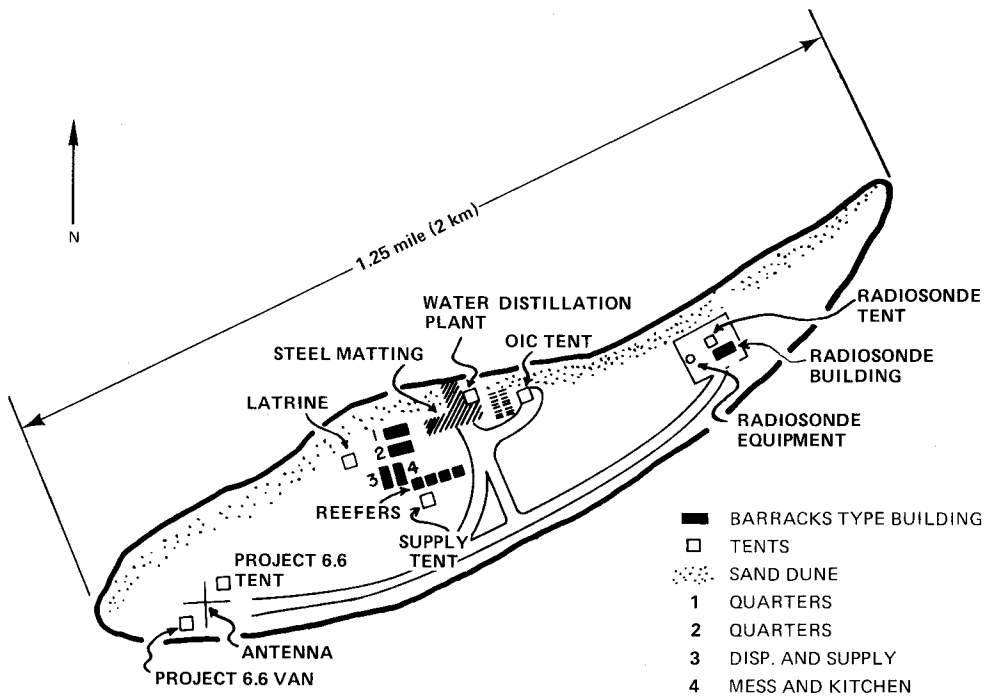

Figure 63. Layout of Rongerik installations, CASTLE.



Figure 64. Photo of Rongerik installation, CASTLE.

223

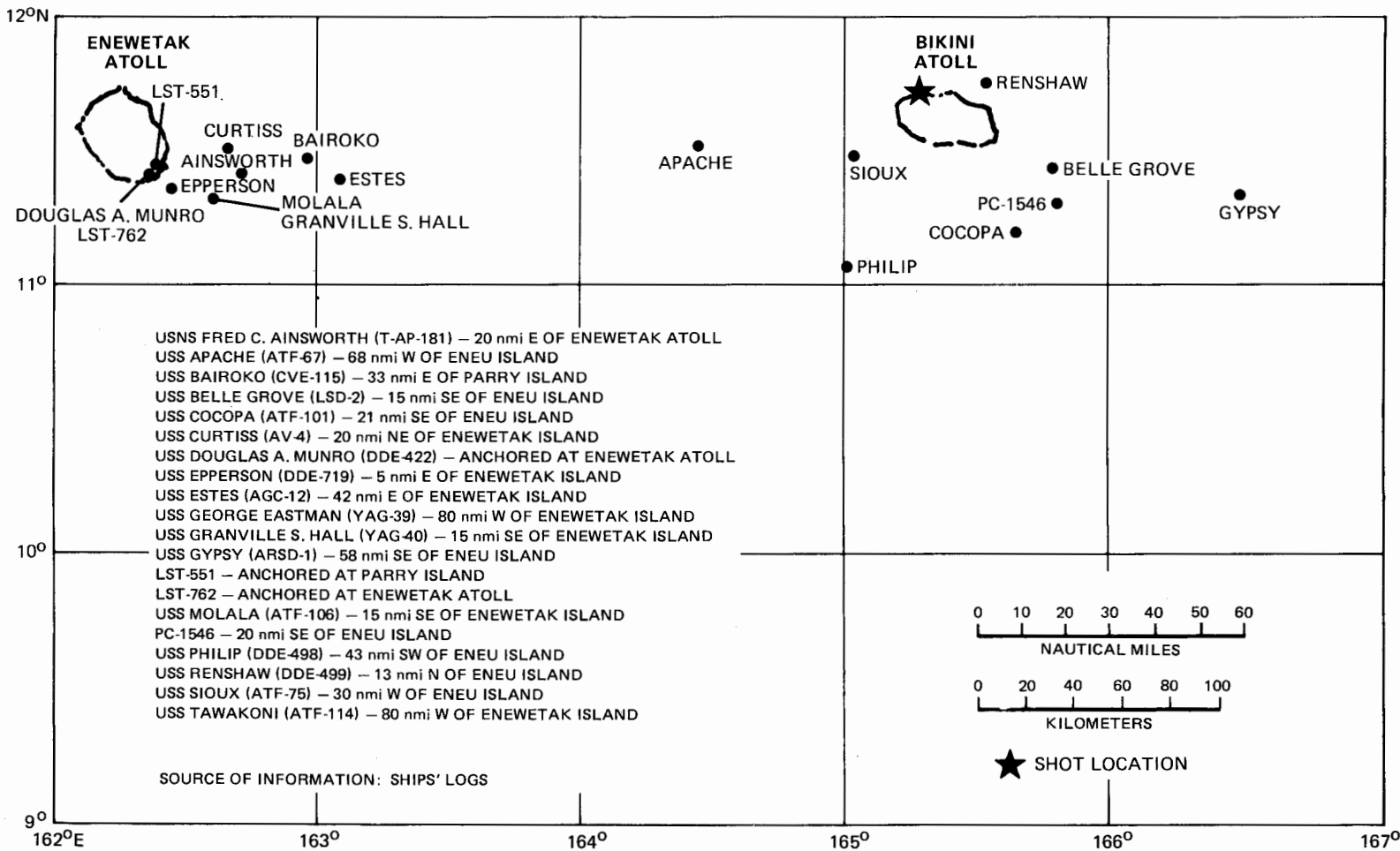

Figure 65. Ship positions on 2 March, 24 hours after CASTLE, BRAVO.

boats for additional hosing after the first hosings. Average intensity was down to 0.002 R/hr by 22 March (Reference 80).

The location of the fleet 48 hours after BRAVO is shown in Figure 66. At 0830 on 3 March, the Bairoko reentered Bikini Lagoon and anchored off Eneu. Helicopters operated throughout the day from the flight deck on postponed data-recovery and other missions. The helicopters landed in a canvas "bathtub" on the carrier's deck if they had been to an island station where they could have collected radioactivity on their wheels. This bathtub prevented washwater containing the contaminants from flowing onto the flight deck (Reference 32).

Some flight deck drains were still clogged and "hot" from the BRAVO washdown. Readings were about 0.100 R/hr, with one as high as 0.500 R/hr. Crews unclogged drains throughout the day. Other spots, such as parts of the antiaircraft guns, were decontaminated by hand scrubbing and rinsing. Cocomat fenders and canvas were flushed to wash away contaminants, then located away from personnel to allow natural decay of residual radioactivity. Decontamination for the Bairoko was considered complete by the end of 4 March (Reference 32).

Contamination of Bikini lagoon water by radioactivity was considered a threat to fleet operations there after each shot. By 3 days after BRAVO, contaminants on the order of 1 microcurie per liter ($\mu\text{Ci}/\text{l}$) began to appear; following a buildup, however, the level of contamination began to fall after 10 days. Drinking water distilled from lagoon waters showed no significant radioactivity. Some radioactivity built up outside ship salt-water pumps, drains, and other installations. The highest noted reading of this kind was 0.030 R/hr on the outside of a condenser on the USS Curtiss (Reference 80).

EVACUATIONS

The TG 7.4 radsafe officer sent by the Commander, Test Services Unit WREP, along with two other WREP personnel, to determine the radiological

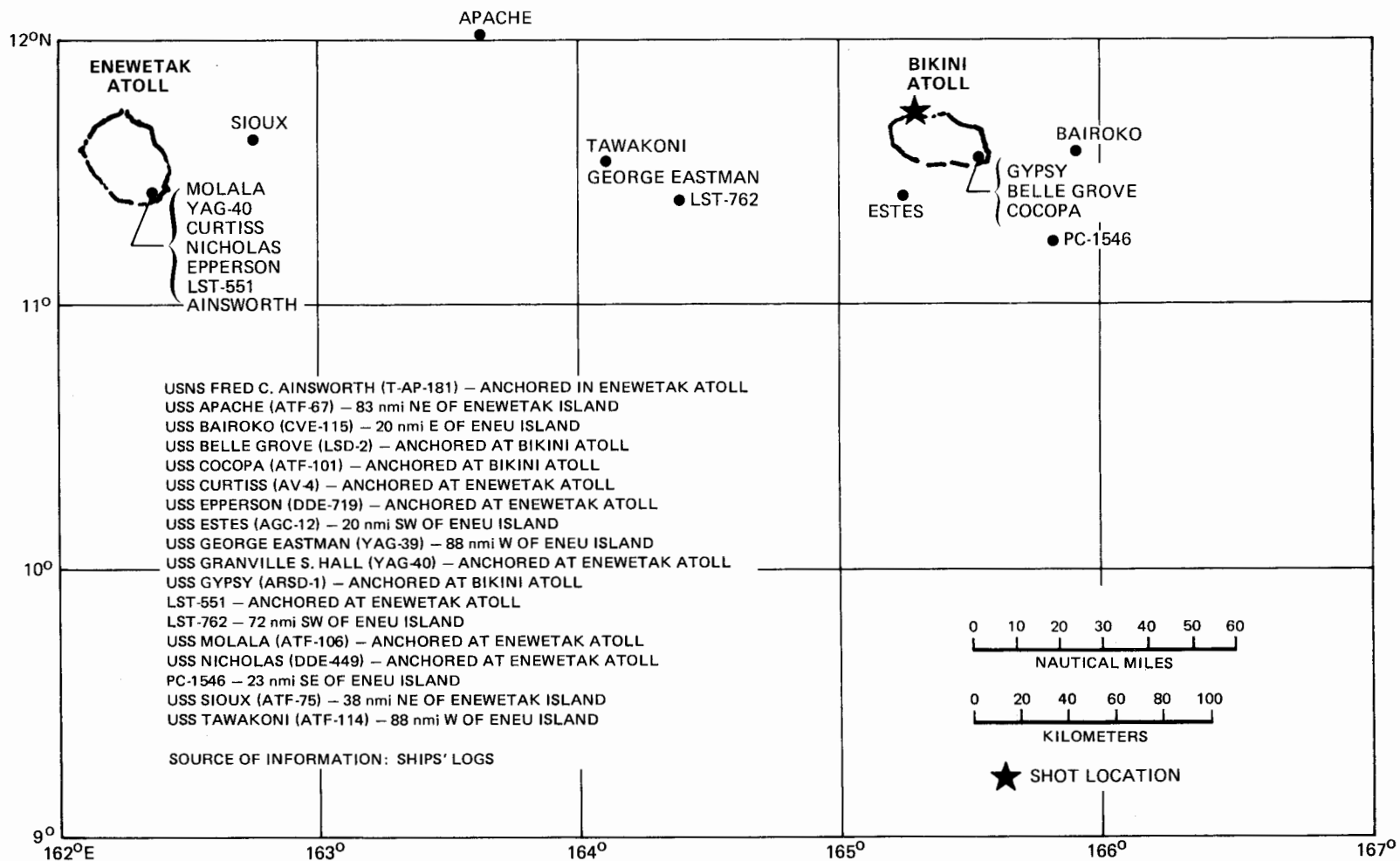

Figure 66. Ship positions on 3 March, 48 hours after CASTLE, BRAVO.

condition at Rongerik, left on the Navy UF-1 amphibian from Kwajalein at 0800 on 2 March. The aircraft was over Rongerik at 0945 and took flyover measurements of the occupied island of the atoll and then the entire atoll at altitudes of 500 feet (153 meters) and below. The readings were 0.200 R/hr at 500 feet (153 meters) and 0.350 R/hr at 25 feet (7.6 meters) (Reference 16, p. K-7).

The UF-1 then climbed to 5,000 feet (1.52 km) in an attempt to communicate directly with the Estes, then at Enewetak; the TG 7.4 radsafe officer wanted an additional amphibious airplane from Enewetak to aid in evacuation. Some garbled and ineffective transmissions ensued, followed by a message denying permission for evacuation and then one permitting it. The radsafe officer had decided to evacuate the island on the basis of his own evaluation of the local situation; it is not clear whether any or all of the Enewetak messages were received by the UF-1, which was descending to land in the lagoon at 1130.

On Rongerik, the radsafe officer quickly briefed the detachment personnel on what he knew, asked the warrant officer in charge to select eight men for evacuation, and made a hasty radiological survey with the following results (Reference 84):

1. Inside the building where the men spent most of their time (the reading, however, was regarded as low because the building had been hosed down thoroughly early in the morning): 0.6 R/hr
2. Outside the same building at waist height as taken in front of the building on the pierced steel planking platform: 1.8 R/hr
3. Beside the same building at the sand surface: 2.4 R/hr
4. Surface of a bed in a living tent: 1.2 R/hr.

At about 1230 the amphibian left the lagoon and arrived at Kwajalein at approximately 1400 with the eight evacuees and the three WREP representatives aboard. The men were taken in the alphabetic order of their last names.

Because no other amphibious aircraft were available, the same UF-1 and crew returned after a brief lunch at Kwajalein, where the cargo originally meant for Rongerik was offloaded. The UF-1 returned to Kwajalein at about 1830 with the remaining 20 men from Rongerik (Reference 84).

A conference was held at 1330 at which the task force radSAFE officer, the task force and task group commanders, and the Scientific Director reviewed what was known of the fallout situation. A decision had been made, albeit at the local level, to evacuate the U.S. personnel on Rongerik, and now the other atolls in the vicinity had to be considered.

As part of the offsite fallout monitoring program of the AEC Health and Safety Laboratory, postshot flights were conducted over all the Marshalls. Several patterns, designated Able, Baker and Charlie, were flown by VP-29. Able, a flight over the northern Marshalls, was underway on 2 March.

Before the conference was over, an inflight report from flight Able indicated 1.350 R/hr at 1340, 2 March, extrapolated to ground level at Rongelap Island, 0.400 R/hr at 1328 at Ailinginae, and 0.001 R/hr at 1300 at Wotho. It was decided that evacuation of Rongelap was necessary and that other islands likely to be involved would be determined from the readings of the remaining portion of the flight Able pattern (Reference 26).

Accordingly, the destroyer Philip left for Rongelap immediately. Instructions were issued to dispatch an Air Force SA-16 amphibian flight with two radSAFE monitors to check surface conditions at Rongelap before dark. The destroyer was directed to be off Rongelap ready to start evacuation at dawn the following day. A Trust Territory representative and an interpreter were requested to move by PBM seaplane from Kwajalein to arrive at Rongelap at the same time. The SA-16 flight was set up and the two monitors were especially briefed to make readings at waist height, to use several meters of the same type for comparison, and to use different types for cross-checking.

An average reading of 1.400 R/hr at approximately 1700 taken in the living area of Rongelap Island by these monitors supported the decision that same night to order the Philip to commence evacuation operations at dawn. Evacuation began about 0730, 3 March, and was completed by 1030. It developed that all the people on the atoll but away from the living area had returned home after BRAVO in order to discuss the unusual phenomena of the visible light and audible shock. This factor simplified evacuation by concentrating all natives on the home island of Rongelap.

Interrogation of the Rongelap people disclosed that all were present except for 18, who were fishing at Ailinginae. Following the Rongelap operation, the destroyer proceeded to Ailinginae, removed the remaining 18 and proceeded to Kwajalein. A total of 17 male and 20 female adults and 15 male and 14 female children were removed by destroyer and debarked at Kwajalein. An additional 16 old and sick were removed from Rongelap by PBM at about 0930 and flown to Kwajalein. All evacuees underwent decontamination procedures during the trip to Kwajalein, and again on Kwajalein (Reference 65).

The full report from flight Able, received at approximately 1900, 2 March, indicated Utirik ground contamination of 0.240 R/hr at 1651, 2 March, and contamination of 0.076 R/hr at about 1716, 2 March, at Ailuk, the nearest populated island to the south. Bikar, the nearest island to the north, was contaminated to about 0.600 R/hr at about 1628, 2 March, but was determined to be unpopulated. Taongi, the next nearest island to the north, showed 0.014 R/hr at 1525; it was also unpopulated. Based on these readings, another destroyer (the Renshaw) was sent to Utirik to anticipate an order for evacuation at dawn on 4 March. Meanwhile, a PBM flew monitors to Utirik on 3 March to conduct a ground survey while the destroyer was on the way. This ground survey, conducted similarly to that for Rongelap, indicated 0.160 R/hr at 1830, 3 March. The exposure of the Utirik people was computed at 58 R if they remained on the atoll.

The destroyer was subsequently ordered to start evacuation the following morning, 4 March. Between 1100 and 1300, 157 people were removed, underwent decontamination procedures on the destroyer en route to Kwajalein, and debarked on 5 March. Questioning of Utirik inhabitants disclosed that all had been evacuated. The destroyers evacuating Rongelap and Utirik were also directed to obtain drinking water samples from these atolls. A check of these samples indicated the drinking water contained from 2 to 28 times the task force standard allowance of radioactive contaminants (for full-time usage) (Reference 65).

The status of Ailuk Atoll, with a reported population of 401, came under consideration at approximately 2000 on 2 March. The expected dose without evacuation was determined to be less than 20 R, i.e., less than the standard used by the task force for its sampling aircraft crews. This was the major factor in the decision not to evacuate Ailuk. All other populated atolls on the flight Able pattern received less contamination than Ailuk (Reference 26).

During the afternoon of 2 March, a directive was issued to execute the offsite monitoring flights Baker and Charlie on 3 March. These flights covered all Marshall Islands south of Kwajalein and were conducted to determine whether winds at the 20,000-foot (6.1-km) level could have carried debris to the south and west and contaminated some of the southern Marshalls. The flights were executed on 3 March, but no significant ground contamination was found. An additional flight (designated King) covered the Gilbert Islands on 6 March for the same reasons. At the request of the task force, CINCPAC obtained advance clearance from the British for the Gilberts flight. A maximum of 0.00008 R/hr on 6 March was reported through CINCPAC to the U.S. Naval Attache in London (Reference 16, p. K-10).

Throughout the actions involving evacuation of island inhabitants, the standard reference used to determine whether an atoll was populated was OpNav 122-100-M, June 1951, Trust Territory of the Pacific Islands.

Because of the 18 people on Ailinginae (reported to be unpopulated), confirmation of the status of other atolls involved in significant fallout was obtained from the Trust Territory representative at Kwajalein. Of particular interest were Bikar and Taka for BRAVO fallout and Taongi for future shots. These atolls proved to be unpopulated as reported; the people on Ailinginae were not permanent residents, but only temporarily at Ailinginae to fish.

The offsite fallout findings, summarized by a member of the CTG 7.1 Advisory Group, are presented in Table 22.

PATAPSCO CONTAMINATION

The Patapsco, a gasoline tanker, was moored at Enewetak to unload aviation gasoline 2 days prior to the BRAVO detonation. The ship was ordered to leave and proceed at full speed from Enewetak to Pearl Harbor because it lacked adequate radiation equipment and protection gear. The ship's speed was reduced to one-third full speed on 28 February, however, because of a cracked cylinder liner. The ship was about 180 to 195 nmi (333 to 361 km) east of Bikini when BRAVO was detonated.

The ship had been vectored approximately along the BRAVO cloud hot line by the transient shipping search aircraft on D-day afternoon. In the early to mid-afternoon of the following day (H+31 to H+32.5), at a range of about 565 to 586 nmi (1,051 to 1,084 km) from ground zero, it began to receive fallout. The intensity of the fallout radiation is not accurately known. Flight Able reported that a little later in the afternoon Bikar (290 nmi 537 km east of Bikini) was reading about 0.600 R/hr. Estimates made by analysts working with the rates measured when the ship arrived at Pearl Harbor range from as high as 0.620 R/hr (Reference 85) to 0.183 R/hr (Reference 86).

No steps to decontaminate the ship were taken en route to Pearl Harbor because it appeared to those on board that the level of radiation was too low to cause concern. The ship arrived at Pearl Harbor on 7 March and was

Table 22. Offsite fallout summary, CASTLE, BRAVO.

Location	True Bearing	Distance (nmi) ^b	Fallout Time of Arrival	Intensity (R/hr)	Infinity Dose (R)	Intensity (R/hr)	Time	Intensity (R/hr)	Time	Average Resultant Wind Speed to Tropopause (knots) ^c
Lae	160	174	H+39			0.00008				3.2
Ujae	170	168	H+37			0.0001				3.2
Wotho	154	100	H+13.2	0.0023	0.17	0.0010				3.8
Ailinginae	115	79	H+3.6	12.000	220	0.445	H+58	0.400	H+29.7	8.1
Rongelap Atoll										
Enewetak Is.	105	98.5	H+5.4	46.800	4,200	3.000 ^a	H+53.2			8.9
Rongelap Is.	109	100	H+5.6	9.800	350	1.400 ^a	H+36	1.350	H+30.9	8.9
Rongerik	098	133	H+8	9.000	350	2.000	H+28.5			10.4
Taongi	052	280				0.0014	H+32.6	Fringe effect only		
Bikar	084	285	H+16.3	1.400	120	0.600	H+33			14.4
Utirik	096	270	H+21.6	0.450	48	0.160	H+55			10.2
Taka	097	261	H+20.3	0.290		0.160	H+34			10.4
Mejit	104	340	H+30.2							9.6
Ailuk	107	291	H+27.1	0.110	13	0.076	H+34.8			8.9
Jemo	110	268	H+24.8			0.018	H+34.7			8.8
Likiep	115	262	H+26.2			0.006	H+34.9			8.1
Nam	142	265				0.000016	H+48.5			4.2
Ailinglapalap	142	338				0.00008	H+38.9			4.8
Arno	127	641				0.0006	H+51.6			5.3
Majuro	128	441				0.0020	H+51.4			5.5
Aur	122	400				0.00036	H+50.9			5.9
Maleolap	117	387	H+42.3			0.0036	H+50.6			7.1
Erikub	119	321	H+40.0			0.0040	H+50.2			6.8
Wotje	114	321	H+39.0			0.0200	H+50.0			6.0
Kusaie	200	225				0.0005	H+54.4			
Ponape	235	503								
Ujelang	245	286				0.0020	H+49.5			
Pingelap	229	426								

Note:

^aReading on ground.^bOne nautical mile equals 1.85 km.^cOne knot equals 1.85 km/hr.

Source: Reference 26.

placed under restricted availability on 9 March. On 22 March, the Patapsco crewmen and Pearl Harbor Naval Shipyard personnel started to decontaminate the ship.

OPERATIONS AFLOAT

By 4 March, most of the fleet units were again in Bikini Lagoon. The major units had withdrawn to Enewetak to offload excess TG 7.1 and 7.5 personnel on 1 March and prepare for the BRAVO follow-on operations.

The land areas of Bikini, as well as the lagoon surface, had received a heavy fallout of the contaminated coral particles from the BRAVO shot. Readings in tenths of roentgens per hour on Eneu in the southeast of the atoll, and in tens of roentgens per hour on Lomilik in the north, were made 10 days after BRAVO. This meant that personnel could go ashore only for short periods of time, but even then their cumulative doses built up.

The situation aboard ships in the lagoon was such that long-term tenancy was possible. The fallout particles sank to the bottom and the overlying water shielded the ships from the particles' radioactivity.

The land area in the southern string of islands had radiologically decayed sufficiently by this time that work crews could go ashore and stay long enough to clear the airstrip joining Aerokoj and Aerokojlol. This restored better air transportation between Bikini and Enewetak, which had been reduced to flying boat service in the interim.

Task force personnel lived aboard the major ships at Bikini and commuted via small boat or helicopter if work was required ashore. Careful control of exposure was required to avoid buildup over the Maximum Permissible Exposure.

OFFSITE OPERATIONS

BRAVO affected offsite operations. Much effort was spent in resurveying the atolls that were evacuated immediately following the test. The object was to better establish the doses the inhabitants received and to do some preliminary research on absorption of radioactive materials by flora

and fauna. This was performed by personnel, including DOD, who were planning similar work on the Enewetak shot (NECTAR) in CASTLE (Reference 3).

The survey teams were carried aboard ships of the Surface Security Unit (TE 7.3.1). The vessels used, the dates of the surveys, and the islands surveyed were (Reference 16):

5 Mar - 8 Mar	<u>Renshaw</u>	Likiep, Jemo, Ailuk, Mejit
8 Mar - 12 Mar	<u>Nicholas</u>	Utirik, Bikar, Rongerik, Ailinginae, Rongelap
25 Mar - 6 Apr	<u>Nicholas</u>	Rongelap
21 Mar - 3 Apr	<u>Philip</u>	Rongelap, Ailinginae.

The 8 to 12 March survey disclosed that personnel protection was still required in some areas. Figure 67 shows personnel leaving the Nicholas whaleboat 9 March on Rongelap with feet wrapped in "booties" worn to avoid picking up contaminated material on shoes. Figure 68 shows a Nicholas crewman on Rongerik the following day holding a sick rat. He is wearing heavy gloves, but appears to be wearing ordinary sneakers without booties.



Figure 67. Post-CASTLE, BRAVO survey personnel at Rongelap.

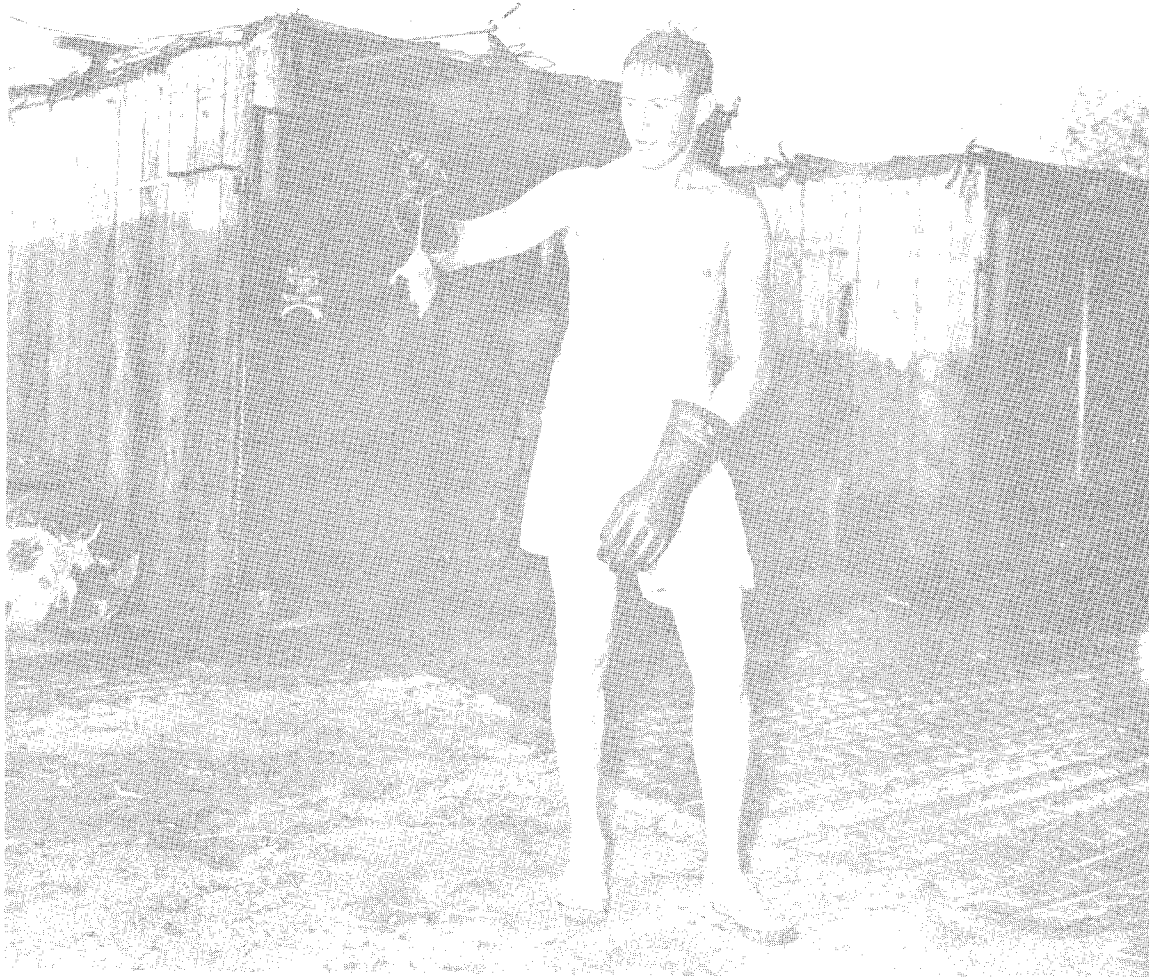

Figure 68. USS Nicholas (DDE-449) crewman holding sick rat at Rongerik after CASTLE, BRAVO.

Rongerik was manned only intermittently during the shot periods following these surveys. TG 7.4 personnel were flown to the island on 12, 19, and 26 March to make daylight weather soundings and were removed the same day. On 12 April a Navy patrol boat (PC-1546) carrying weather personnel anchored in the lagoon. All personnel were housed on the boat; weather personnel went ashore to make weather observations and operate Project 6.6 instrumentation, but only for short periods. On 7 May the boat, its crew, and its passengers departed. On 14 May a rollup team visited the island.

BRAVO FALLOUT EXPOSURES

BRAVO was without question the worst single incident of fallout exposures in all the U.S atmospheric testing program. The accumulated dose contours after 96 hours are shown in Figure 69. Not only were U.S. military personnel involved, but also foreign nationals and Marshall Islanders.

The cumulative nature of the Consolidated List of CASTLE Radiological Exposures (Reference 13) makes it impossible to assign portions of the personnel exposure to BRAVO, as opposed to the CASTLE series as a whole. The microfilm file of cards (Reference 87) on which it is presumably based shows, in some cases, event-by-event exposures, and estimates were made for portions of the task force at the time. Other estimates have been or can be made for other personnel involved.

Task Group 7.3 Exposures

In summing up BRAVO operations, the Navy prepared a tabulation of the exposures of the appropriate fleet units (Table 23), and the contribution to the BRAVO collective exposure by TG 7.3 forces can be derived from this. This tabulation was through 22 March and contains exposures received in the potentially hazardous decontamination activities and the survey visits by the crews of the Renshaw and the Philip to the contaminated islands of Rongelap Atoll.

ENEWETAK-BASED PERSONNEL. Badges were exposed on Enewetak at fixed locations and some of these, at least, are included in the microfilm file of 5x8 cards (Reference 87) from which Reference 13 is derived. Two of these badges, marked 103 and 106, were placed in the 8600th AAU area and the "Laundry Area;" they read 0.075 R and 0.110 R, respectively (Index 1020 control film 4904-10). The cumulative exposure record of units whose presence became unnecessary after BRAVO, (that is, TU 2 and 3 of TG 7.1; (see Chapter 3) and probably left the PPG before the completion of the series, is consistent with the two badges above. A credible exposure for personnel on Enewetak for the BRAVO period is 0.1 R.

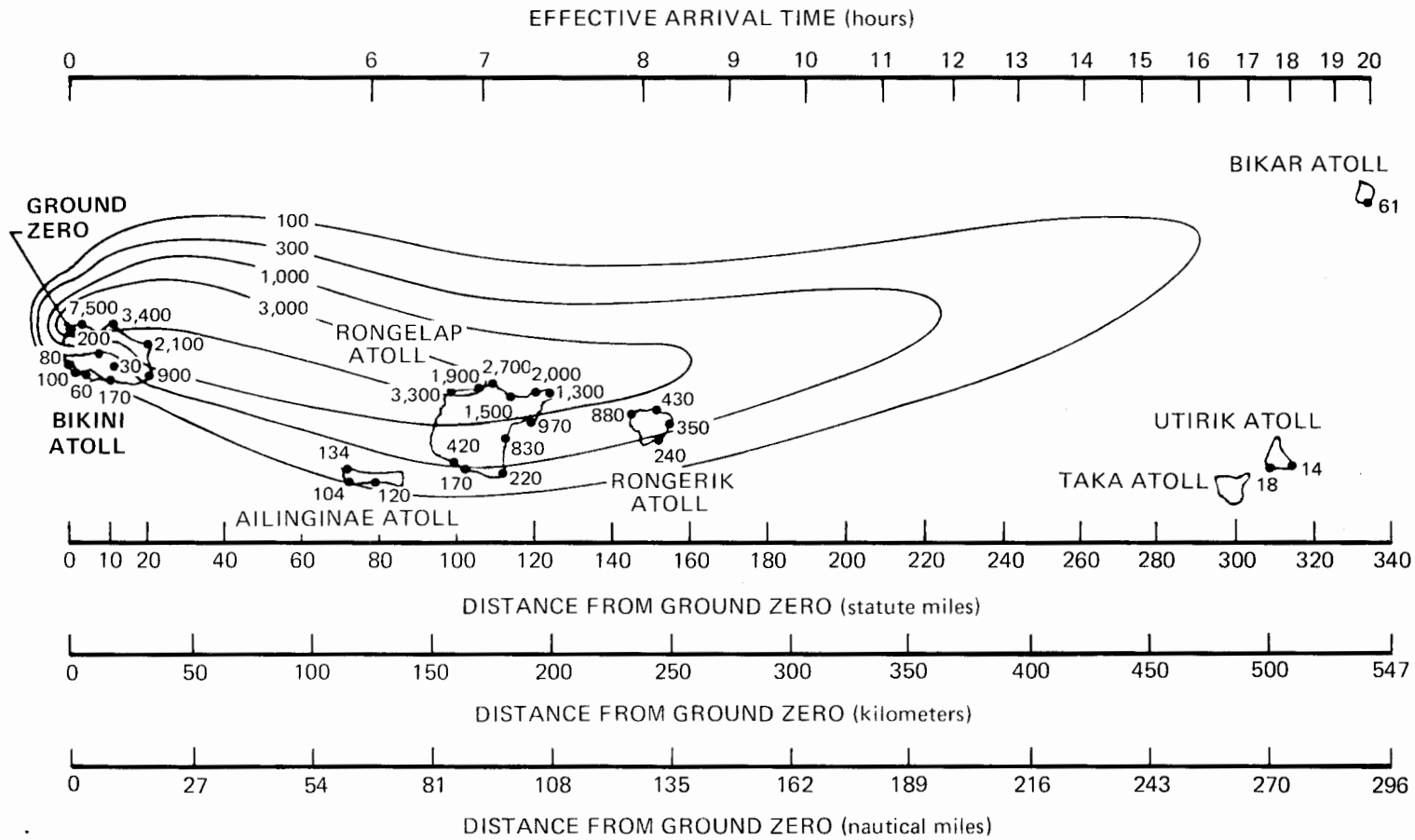

Figure 69. Estimated total (accumulated) dose contours (rad), CASTLE, BRAVO H+96 (source: Reference 88, p. 437).

Table 23. Summary of accumulated radiation exposure for CASTLE, BRAVO Navy elements.^a

Unit	Exposure (R)								
	0.0- 0.999	1.0- 1.999	2.0- 2.999	3.0- 3.999	4.0- 4.999	5.0- 5.999	6.0- 6.999	7.0- 7.8	Over 7.8
TG 7.3 Staff	10	47							
USS Bairoko (CVE-115)	448	227	40	54	64	9	1		
HMR-362		96	15	4	1				
USS Curtiss (AV-4)	709								
VP-29	432								
USS Estes (AGC-12)	145	376	115	3	5	7			
USS Belle Grove (LSD-2)	166	148	22						
TG 7.3 Boat Pool	104	96	17	8	4	1	1	3	3
LST-762	128								
LST-551	104								
USS Epperson (DDE-719)	298								
USS Nicholas (DDE-449)	292								
USS Renshaw (DDE-499)	259								
USS Philip (DDE-498)	30	71	64	74	9	10	5		
PC-1546	53	6							
USS Gypsy (ARSD-1)	1	32	29	1					
USS Motala (ATF-106)	86								
USS Apache (ATF-67)	83								
USS Sioux (ATF-75)	80								
USS Tawakoni (ATF-114)	76	1							
USS Cocopa (ATF-101)	79								
USNS Ainsworth (T-AP-181)	197								
YAG-39 (USS George Eastman)	47								
YAG-40 (USS Granville S. Hall)	51								
TG 7.3 Underwater Detection Unit	22								
Project 1.4 Aircraft	8								
Project 6.4 Aircraft	8								
VC-3	20		23						
Total Exposures	3,936	1,100	325	144	83	27	7	3	3
Percent of Total	69.93	19.55	5.77	2.56	1.47	0.48	0.12	0.05	0.05

Note:

^aAs of 22 March 1954.

Source: Reference 80.

TASK GROUPS 7.1 AND 7.5 BIKINI PERSONNEL. For the elements of TG 7.1 and TG 7.5 at Bikini, the mean value of the crew of the ship to which they were evacuated has been used to calculate collective exposure. This may result in both overestimates and underestimates, depending on assumptions.

Task Group 7.4 Exposures

The contributions to the JTF 7 collective exposure from the sampler aircraft flight crews and ground personnel have not been considered in this summary, as they cannot be readily extracted from Reference 13 or simply estimated. Detailed records, however, are available on cloud tracker and sampler aircraft contamination (Table 24).

For BRAVO, the initial radioactive decay period was 20 hours or more before decontamination was undertaken. The reading of 12.000 R/hr on 4 March for WB-29 No. 7335 is probably a typographical error in the source document (Reference 30). Other records (Reference 29) indicate that 4.755 R/hr was the highest contamination read on an aircraft from BRAVO, and that was on 1 March. Since the figure of 4.755 R/hr is not shown in Table 24, it was probably recorded on an aircraft for which there are no data in the 4926th document (Reference 30). The reason a reading of 12.000 R/hr on 4 March is of some concern is that it means the radiation intensity on 1 March

could have been 2,000 R/hr ($t^{-1.2}$ decay rate), a most unlikely level. If 0.120 mR/hr was the actual 4 March reading, then on 1 March the intensity could have been 20.300 R/hr, which is within bounds for similar aircraft on other events. Because of a reported immediate wash with a subsequent reading of 0.065 R/hr, more validity can be associated with a reading of 0.120 R/hr for the first survey. Another late first survey was on F-84G No. 038. Applying similar assumptions, the 1 March intensity could have been around 1.520 R/hr. By the same token, B-36 No. 1086 on 1 March might have had a reading of some 50.000 R/hr.

Personnel Exposures -- Rongerik

Twelve film badges were issued by TG 7.1 radsafe for the personnel on this remote weather station. These badges were numbered 00309 through

Table 24. Task Group 7.4 CASTLE, BRAVO aircraft decontamination.^a

Aircraft Type/ Tail No.	First Survey			Second Survey			Total Decon Hours	Total Decon Pers
	Reading (R/hr)	Date (Time)	Type of Decon	Reading (R/hr)	Date (Time)	Type of Decon		
B-36/1083	1.400	1 Mar (1200)	Decay	0.500	4 Mar (0245)	Wash		
B-36/1086	1.100	2 Mar (0900)	Decay	0.800	4 Mar (???)	Wash		
WB-29/7335	12.000	4 Mar (0830)	Wash	0.065	4 Mar (1510)			
F-84/030	2.800	1 Mar (1400)	Decay	0.105	4 Mar (0945)	Acid		
F-84/032	2.800	1 Mar (1400)	Decay	0.045	2 Mar (0950)	Acid		
F-84/033	3.800	1 Mar (1400)	Decay	0.130	4 Mar (0955)	Acid		
F-84/037	3.400	1 Mar (1400)	Decay	0.120	4 Mar (0940)	Acid		
F-84/038	0.009	4 Mar (1415)	Acid	0.028	4 Mar (1515)	Gunk		
F-84/042	0.090	4 Mar (1415)	Acid	0.028	4 Mar (1515)			
F-84/043	0.190	4 Mar (1425)	Acid	0.070	5 Mar (1400)	Gunk		
F-84/045	0.190	4 Mar (1725)	Acid	0.049	5 Mar (1530)	Gunk		
F-84/046	0.400	1 Mar (1400)	Decay	0.180	4 Mar (1605)	Acid		
F-84/053		4 Mar (1430)	Acid		5 Mar	Gunk		
Aircraft Type/ Tail No.	Third Survey			Fourth Survey			Total Decon Hours	Total Decon Pers
	Reading (R/hr)	Date (Time)	Type of Decon	Reading (R/hr)	Date (Time)	Type of Decon		
B-36/1083	0.280	4 Mar (1130)	Wash	0.080	5 Mar (???)		19	17
B-36/1086	0.400	2 Mar	Wash	0.400	3 Mar (???)		18	17
F-84/030	0.105	4 Mar (1400)	Wash	0.060	5 Mar (0830)		1	16
F-84/032	0.018	4 Mar (1127)					0.5	16
F-84/033	0.018	4 Mar (1127)					0.5	16
F-84/037	0.030	4 Mar (1205)					0.5	16
F-84/038	0.020	5 Mar (1500)					1	16
F-84/042	Released						0.5	16
F-84/043	0.060			Released			1	16
F-84/045	0.030	5 Mar (1630)	Gunk	Released			1	16
F-84/046	0.042	5 Mar (1750)		Released			0.5	16
F-84/053	Released						1	16

Note:

^aAircraft maintenance crews decontaminated the aircraft after BRAVO. This practice was changed for the rest of the CASTLE shots.

00320 and were sent to Rongerik on 25 February by the TG 7.4 Technical Advisor (Reference 30). Four of these badges apparently were actually worn by four of the twenty-five men from the 6th Weather Squadron there. Two others were placed on exposed positions on the island. One (badge 00315) was placed "between barracks," presumably between the blocks marked "1" and "2" on the sketch map (Figure 63), and recorded 82 R. The second badge in an exposed location was 00314, which was placed on a tent pole 7 feet (2.1 meters) above the floor of the "Project 6.6 tent" and recorded 98 R. The six remaining badges were stored in a refrigerator (presumably the "reefers," on the map of Figure 63), and all recorded 37.5 to 39.5 R (Reference 65).

An assignment of exposure to personnel was made by the TG 7.4 Technical Advisor and was recorded by the NCO in charge of dosimetry and decontamination in the TG 7.4 Nuclear Applications Section. This assignment has been filed along with the 5x8 cards on which Reference 13 is based and can be found in the microfilm file (Reference 87).

Unfortunately, in this assignment of exposure, two errors were made that in turn have been picked up in Reference 13. The first error was that 15 of the 25 Air Force personnel established as being on Rongerik were not assigned an exposure. The second error was the assignment of an exposure to a surname not otherwise established as belonging to any man known to have been on Rongerik at the time. The person with this surname, not accompanied by given name, rank, or serial number, or other identification, was recorded in Reference 13 as having received 40 R. The assessment of the other men's exposures is straightforward. The three Army men of the 9710th TSU were assigned the exposures from the "6.6 tent" pole badge (98 R), and the ten Air Force men were assigned exposures between 40 R and 52 R, based perhaps on a knowledge of their activities.

PATAPSCO CREW. The contribution of the crew of the Patapsco to the collective exposure is based on a recent estimate that considered the natural washdown provided by documented rain and the weather-deck versus below-deck exposure (Reference 86).

MARSHALL ISLANDS POPULATION. Estimates for exposures to both U.S. personnel and Marshall Islanders were made in the Project 4.1 after-action report (Reference 65) and have been used here. The unevacuated population at Ailuk was not included in the Project 4.1 information, but it may be simply estimated by comparing the intensity of the readings made at Ailuk and nearby Utirik at nearly the same time on 2 March.

All of these have been summed up in Table 25, which presents the total collective exposure as a result of BRAVO and how it was distributed among groups. Comment on this table appears in Chapter 11.

RADIATION EFFECTS AND MEDICAL OBSERVATION OF TASK FORCE PERSONNEL

The Rongerik detachment of 28 that was evacuated to Kwajalein by air came in two groups, the first eight arriving at approximately 1400 hours and the second group at about 1830 hours.

Upon arrival the men were checked for the presence of radioactive materials on their bodies. There they showered to remove the material. The first group had from 7 to 11 showers and the second group had 5 each. The contamination present and the decontamination results of the showers are shown in Table 26.

After about a week at Kwajalein, the Air Force and Army personnel evacuated from Rongerik were returned to Enewetak Atoll (Reference 15):

It was decided by higher headquarters to bring the 28 personnel to Enewetak for further physical examination and to relieve the Kwajalein Hospital, whose facilities were limited in the field of radiological medicine, of the responsibility of those men. The first group arrived 8 March and the remainder followed the next day, and all were quartered in the Enewetak Post Infirmary where daily blood counts and physical checks were instituted.

On 17 March the group was moved back to Kwajalein to be "examined by specialists in radiological medicine in a location more remote from the possibility of future contamination" (Reference 15). However, on 13 March

Table 25. Summary of estimated fallout exposure for CASTLE, BRAVO.

Group	Persons	Mean Gamma Exposure (R)	Collective Exposure	
			(man-R)	(%)
JTF 7				
Headquarters	86 ^a	0.1 ^b	9	<1
Task Group 7.1				
Enewetak	520 ^c	0.1 ^b	52	<1
Bikini	485 ^c	0.5 - 2.4 ^d	447	1.4
Task Group 7.2	1,287 ^e	0.1 ^b	129	<1
Task Group 7.3	5,628 ^f	1 ^f	5,628	17.4
Task Group 7.4	1,725 ^g	0.1 ^{b,o}	173	<1
Task Group 7.5				
Enewetak	1,220 ^h	0.1 ^b	122	<1
Bikini	590 ^h	0.5 ^d	295	<1
Rongerik Detachment	28	78 ⁱ	2,184	6.7
Total JTF 7			9,039	27.9
Patapsco (AOG-1)	110 ^j	3.3 ^k	363	1.1
Total U.S.			9,948	30.7
Rongelap Marshall Islanders	64 ⁱ	175 ⁱ	11,200	34.6
Rongelap Islanders on Ailinginae	18 ⁱ	69 ⁱ	1,242	3.8
Utirik Marshall Islanders	157 ⁱ	14 ⁱ	2,198	6.8
Ailuk Marshall Islanders	401 ^l	4 ^m	1,604	5
Daigo Fukuryu Maru	23 ⁿ	290 ⁿ	6,670	20.6
Grand Total			32,316	100

Sources and Notes:

^aConsolidated List of CASTLE Radiological Exposures (Reference 13).

^bMicrofilm 5x8 cards (Reference 87, Index 1020 control film 4904-10).

^cTG 7.1 Installment History, May Installment, p. 20 (Reference 8).

^dMean of ships used in evacuation weighted by number of personnel (*Ibid*)

^eTG 7.2 History (Reference 10, April-May Installment).

^fTable 23 (Source: Reference 80).

^gCTG 7.4 Final Report (Reference 24).

^hCompletion Report (Reference 5, pp. 4-6, 4-7).

ⁱReference 64, p. 7.

^jMuster roll.

^kNOSC memo 25 Jan 1979 (Reference 86).

^lRadSafe Vol 2 (Reference 16).

^mEstimated as ratio of Utirik.

ⁿVoyage of Lucky Dragon (Reference 82, p. 158).

^oDoes not consider sampler aircraft crew.

Table 26. Contamination readings of Rongerik personnel after CASTLE, BRAVO (R/hr).^a

	0	.001- .005	.006- .010	.011- .015	.016- .025	.026- .050	.051- .099	Over .100	High
2 Mar Preshower	---	6	2	4	6	2	1	7	0.250
After 1st Shower	---	11	9	6	2	---	---	---	0.025
After Last Shower	---	12	10	5	1	---	---	---	0.025
3 Mar	---	22	6	---	---	---	---	---	0.010
3 Apr	27	1	---	---	---	---	---	---	0.0005

Note:

^aBy AN/PDR 27C survey instrument.

Source: Reference 68.

two of the Air Force men had already returned to Kwajalein to assist in repairing some U.S. Navy electronic equipment.

During this second period at Kwajalein the group was observed by the medical personnel of the newly established Program 4. This program had been hurriedly set up after the BRAVO fallout incident to aid and observe the Marshall Islanders who were exposed on Rongelap, Ailinginae, and Utirik. These Marshall Islanders also were at Kwajalein during this period. This medical surveillance of the servicemen lasted until at least early April as information on their blood components is given in the Program 4 report until H+42 days (April 11, 1954) (Reference 65, p. 72), for skin lesions for H+47 days (Reference 65, p. 40), and for beta activity in urine for "44 days post detonation" (Reference 66, p. 17).

Three men assigned to a Navy Bikini Boat Pool LCM that was working off the Belle Grove presented film badges with BRAVO readings of 85 to 95 R. These apparent high exposures were not discovered until the badges were developed 10 days after BRAVO. Thorough investigation at that time failed to reveal how these three men could have received so much radiation. Some

discrepancy in badging or wearing of badges is likely, as careful examination of the badges by densitometer revealed nothing unusual in the radiation to which they were subjected (Reference 16, pp. J-38 and K-67). These men, however, were sent to Kwajalein on 16 March to be observed by the medical team. They were transferred on 29 April to Tripler Army Hospital, Oahu, Hawaii, as part of a contingent of 29 men, where they were discharged to duty after complete, essentially negative, clinical and laboratory studies were made.

The other personnel transferred on 29 April to Tripler for medical observation included 26 of the 28 Army and Air Force personnel exposed on Rongerik. (The History of TG 7.4 [Reference 15] identifies the former group of 28 as "Rongerik personnel, now TDY that station.")

Of the two Air Force personnel who were not among those sent to Tripler, one was a Warrant Officer and the other a Staff Sergeant. The Warrant Officer, involved in electronic repair activity at Kwajalein, was also sent to Majuro on 17 March to assist there in electronic repair work. He was apparently at Majuro during the week of 22 to 29 April. This probably accounts for his not making the trip to Hawaii with the remaining personnel. The Staff Sergeant returned to the United States early and was at Tinker AFB, Oklahoma, on 27 March 1954. His departure from the PPG was an emergency leave and not connected with his participation in the series. He definitely did not go to Tripler Hospital.

/ At Tripler the medical observations consisted of the following:

- Radioanalysis of urine, feces and blood
- Treatment of skin irritations
- Psychological consultation
- Ophthalmologic examination
- Surgical consultation
- General physical examination
- Complete dental examination
- Routine hematology and urinalysis.

These details are inferred from a medical record of one of the Air Force personnel involved, since detailed hospital records are not available for the whole group.

The results of these observations were "essentially negative" (Reference 16, p. J-38) for the sailors and they were discharged to duty. Results for the servicemen in general were described as "generally negative" in the 15-year review of the medical findings of the Marshall Islanders who had been heavily exposed (Reference 89); but in the 20-year survey, the same source simply relates that the "American servicemen were taken to Tripler Army Hospital for further examination and later returned to duty" (Reference 64, p. 1). This latter source is an excellent summary of the handling and treatment of the Marshall Islanders and contains also a long-term medical review of the crewmen of the Daigo Fukuryu Maru contributed by Japanese medical authorities.

About 20 days after BRAVO, 16 personnel of the Bairoko and 21 personnel of the Philip were reported to have small skin lesions resembling burns (Reference 16, Annex J, p. J-38). The lesions were most apparent at the neck and waist, and reportedly developed sometime between 3 March and 15 March. When the affected personnel were examined (between 20 March and 3 April) all lesions were in the process of healing (Reference 16, Annex K, p. K-66). The lesions were definitely classified as beta burns. Most exposures evidently occurred while personnel were on the weather deck -- in one case for as short a time as 7 minutes. Some below-deck personnel stationed near ventilation blowers may have been contaminated, however, when these units were intermittently operated to reduce the below-deck heat.

CHAPTER 5 TESTS AFTER BRAVO

Test operations following BRAVO were seriously affected by the physical damage and radiological contamination from that burst and by the many postponements and schedule changes due to unfavorable weather. The Commander, TU 13 of TG 7.1 cited a number of BRAVO's effects on subsequent operations (Reference 40, p. 16). Among the more important were the:

- (1) gradual loss of personnel as their total cumulative radiation exposure exceeded the maximum limit because of radiological contamination of Bikini Atoll land areas to which entry was mandatory for project purposes;
- (2) loss of equipment by Projects 2.2 and 2.5 from a secondary fire caused by BRAVO on the Eneman Island support facility;
- (3) conversion from land-based to ship-based operations at Bikini, with attendant difficulties of personnel transport, communications, and equipment handling;
- (4) severe boating conditions at Bikini during delay periods because of unfavorable weather, which restricted maintenance of the experimental test stations;
- (5) deterioration of test stations caused by salt spray, humidity, rain, and intense sun during the repeated shot-day postponements because of unfavorable weather; and
- (6) changes of shot sequence, sites, and predicted yields.

SCHEDULE CHANGES

The pre-CASTLE schedule called for seven shots as listed in Table 27. This schedule reflected a concept designed to preserve the use of the Aerokojlol-Aerokoj airstrip and facilities on Eneman, and on those islands connected to it by causeways, until the last shot. The airstrip was only about 2.5 miles (4 km) from the burst point of this last shot, and an oil storage facility was even closer on Lele. Since these would probably become useless following the Eneman shot, it was placed last.

Table 27. Planned and final sequence of CASTLE events and locations.

Shot Name	Sponsor	Pre-CASTLE Target Date and Sequence	Revised Date and Sequence (as of 6 Mar 54)	Revised Date and Sequence (as of 13 Apr 54)	Actual Date and Sequence	Yield	Originally Planned Location	Actual Location
BRAVO	LASL	1 Mar (1)	---- (1)	---- (1)	1 Mar (1)	15 MT	Reef off Nam, Bikini	Reef off Nam, Bikini
UNION	LASL	11 Mar (2)	29 Mar (4)	16 Apr (4)	26 Apr (4)	6.9 MT	Barge off Iroij, Bikini	Barge off Iroij, Bikini
YANKEE	LASL	22 Mar (3)	17 Apr (6)	27 Apr (6)	5 May (5)	13 MT	Barge off Iroij, Bikini	Barge in UNION crater, Bikini
ECHO	UCRL	29 Mar (4)	24 Apr (7)	Cancelled	Cancelled	---	Eleleron, Enewetak	Cancelled
NECTAR	LASL	5 Apr (5)	8 Apr (5)	20 Apr (5)	14 May (6)	1.69 MT	Barge off Iroij, Bikini	Barge in MIKE (IVY series) crater, Enewetak
ROMEO	LASL	15 Apr (6)	13 Mar (2)	---- (2)	27 Mar (2)	11 MT	Barge off Iroij, Bikini	Barge in BRAVO crater
KOON	UCRL	22 Apr (7)	22 Mar (3)	---- (3)	7 Apr (3)	110 KT	Eneman, Bikini	Eneman, Bikini

Source: Reference 4, pp. 32 and 33.

The radius of the blast effects of BRAVO, however, was greater than expected, and there was concern that the Eneman site, where the KOON device was already nearly completely assembled in place, could not effectively survive blasts at the closer location contemplated for shots UNION, YANKEE, NECTAR, and ROMEO. CTG 7.1 therefore decided to schedule the second shot (which was switched from UNION to ROMEO) on a barge in the water-filled crater formed by BRAVO and move the Eneman surface shot (KOON), the last shot on the schedule, forward to the third position. The schedule as of 6 March is given in Table 27.

The dropping of ECHO, scheduled for detonation on the surface at Eleleron, to the end of the schedule was related to the fact that the device, like that for KOON (the Eneman surface device), was to be provided by the University of California Radiation Laboratory (UCRL); and as the date for KOON was moved forward, the extra labor required to prepare for its earlier detonation depleted the ECHO device assembly labor pool.

These shot schedules were based on considerations of the time required for test preparations and assumed favorable weather. The favorable weather did not appear. The second test, ROMEO, was not fired until 2 weeks after its second scheduled date; KOON was fired 11 days later on 7 April.

A new schedule was promulgated 1 week after the KOON firing, which reflected changing test priorities of the Atomic Energy Commission (AEC) weapon designers as a result of the first three tests. The Eleleron shot (to have been called ECHO) was cancelled, and one of the Bikini shots (NECTAR) was moved to the MIKE crater at Enewetak. The revised schedule as of 13 April for the remaining shots was UNION (16 April), NECTAR (20 April), YANKEE (27 April). This final schedule was modified to reverse the NECTAR and YANKEE shot sequence due to weather.

OPERATIONAL IMPLICATIONS

The schedule changes affected DOD operations in several ways. The DOD had a considerable investment in preparing for experiments to be conducted

in conjunction with the cancelled ECHO test, but the "loss" of this effort probably decreased the radiological exposure of DOD personnel.

More disruptive to the DOD operations were the preparations to fire and subsequent postponements due to weather. ROMEO was scheduled on the 13th, the 15th, and the 21st of March; on each occasion instrumentation had to be prepared, timing devices reset, etc. The fact that much of Bikini was a radiological exclusion (radex) area, which required a trained radsafe monitor to accompany each working party, taxed the capabilities of the radsafe unit. Individual projects were exposed to radiation in unanticipated ways. For example, Project 1.4 reports the elaborate procedures required to service instrumentation if the shots were delayed longer than 4 to 7 days (Reference 45). Such work was complicated by the fact that it had to be done in the radioactive environment caused by BRAVO.

Support instrumentation, such as Raydist slave stations used in the positioning of experimental effects aircraft, had to be serviced and repositioned due to the effects of BRAVO and to the changing concepts of the operation. This required the personnel from the Armed Forces Special Weapons Project (AFSWP) to enter radiologically contaminated areas to retrieve equipment (Reference 90).

Following BRAVO, the ships and small craft at Bikini assumed a significant increase in responsibility. The original planning called for post-shot reentry to the camps on Eneman and Eneu, but this was impossible. The change to an afloat operation at Bikini placed additional requirements on TG 7.3. While anticipated as a possibility, this was never considered probable before BRAVO (Reference 9, p. 114). The single most significant operational effect was related to the employment of ships after the detonation. All major vessels were required to remain permanently at Bikini for use as housing. Originally the USS Estes was to be stationed at Enewetak between detonations. The USS Bairoko had to prepare to conduct all Bikini helicopter operations from its flight deck. The Air Force helicopters and one L-13 were returned to Enewetak, and the responsibility of

providing local air transportation at Bikini became solely that of TG 7.3 (Reference 9, p. 134). The Bikini boat pool had a sharply increased workload in order to provide transportation between the shipboard living quarters and work sites.

All ships would evacuate the Bikini Lagoon before all scheduled shots. The movement of fleet units out of Bikini Lagoon during evacuation maneuvers for postponed attempts did have some advantage because it helped flush out the contaminated lagoon waters from the ships' seawater systems with open ocean water (Reference 16, p. L-3), preventing a large buildup of radioactive contaminants within the systems.

ROMEO

ROMEO, the second CASTLE test, was the first barge-mounted, water-surface detonation. Because of concern that the experiments being prepared at Eneman for shot KOON might suffer blast damage from ROMEO, its scheduled site was changed from south of Iroi to the BRAVO crater, which was a greater distance from Eneman.

Preshot Preparation

ROMEO was ready to fire on 13 March, and the sequence of sea and air searches, weather analyses, fallout predictions, briefings, and advisory messages to the Commander-in-Chief of the Pacific Fleet (CINCPAC) began. Unacceptable weather delayed the detonation for 2 weeks. During this period, the task force maintained an 18-hour standby capability to conduct the test.

The weather-caused delays had two consequences for subsequent tests. First, the method of conducting air searches for the protection of transient shipping was changed when it was determined the search plan was not flexible enough to cope with the large geographic shifts in the long-range fallout forecast that could occur between successive tentative shot days. The new procedures included specification of an expanded hazard zone (Area Green, see Figure 16) to control shipping, and the use of three or more

radar-equipped search aircraft. Second, since initial BRAVO data were available, the method used to determine the air radex volume, or area, was changed for high-yield bursts. The new method considered the initial radiation source as an area rather than a point.

On the morning of 26 March, a favorable forecast of H-hour winds for the following day set in motion once again the entire preshot schedule of events. This forecast gave east-northeast winds to approximately 8,000 feet (2.4 km), southerlies to about 12,000 feet (3.7 km), southeasterlies to 20,000 feet (6.1 km), southerlies to southwesterlies to about 55,000 feet (16.8 km), and east-southeasterlies to easterlies above 55,000 feet (16.8 km). All units and external agencies were notified accordingly that the ROMEO schedule was firm for 27 March at 0630.

Following the noon command briefings, CINCPAC was advised of the forecast 72-hour air particle trajectories for 10,000, 30,000, 40,000, and 50,000 feet (3.05, 9.15, 12.19, and 15.25 km). The advisory stated that no significant fallout was forecast for populated Marshall atolls and recommended no closure of air routes. It also stated that no fallout problems were forecast outside Area Green and that an intensive search was being conducted in this area, plus a 240-nmi (445-km) wide sector out to 600 nmi (1,110 km), centered on a true bearing of 340° . (The sector search was scheduled and run again postshot centered on 305° true from 200 nmi [370 km] to 600 nmi [1,110 km] from ground zero. Starting at H-2, four search aircraft were used on parallel flight tracks, with 60 nmi [111 km] coverage per aircraft, in advance of the cloud.) In addition, CINCPAC was requested to divert all shipping from the sector covering 260° clockwise to 90° true out to 450 nmi (833 km) from ground zero. The request included a statement that no known shipping was in this area. Table 28 shows the known transient shipping near the Pacific Proving Ground (PPG) on shot day.

At approximately 1500 the surface and air radex areas were announced as follows:

Table 28. Summary of the status of transient shipping in the Pacific Proving Ground area on or about 27 March 1954.

Vessel	Location/Course
PC-1172	Kwajalein at 0600, 27 March
LST-1157	10°40'N, 170°14'E, course 270, 9.5 knots (17.6 km/hr)
LSIL-9035, LSIL-9309 (French vessels)	19°31'N, 168°42'E, course 270, 10 knots (18.6 km/hr)
Fishing vessel	Last reported 7°30'N, 168°E, course 330 (no further contacts in Area Green and sector searches)
<u>Kaiko Maru</u>	Departed Wake 1545, 22 March; estimated position at 2000 26 March, 10°N, 174°E; destination 10°N, 175°E
<u>Malika</u> (British vessel)	Requested by ComNavFor Marianas at 1900 22 March to stay clear of enlarged danger area.
<u>Dai Maru</u>	Departed Wake for Japan 0130 22 March via route point 20°N, 165°E
<u>USS Genessee</u> (AOG-8)	14°10'N, 179°39'W at 1200 on 27 March; ETA Pearl 2200 on 30 March, course 082
Japanese fishing boat, No. KN2482	Visual/radar search aircraft contact: 15°02'N, 167°53'E, course 116, 10 knots (18.5 km/hr) at approximately 1300 on 22 March; patrol plane diverted vessel to course 90; no further contact made with this boat
Fishing boat	Visual/radar search aircraft contact at 1130 on 21 March: 19°45'N, 161°18'E, course 120, 10 knots (18.5 km/hr), nationality unknown; upon direction search aircraft turned vessel to the northeast at 1230; no further contacts made with this boat
<u>M/V Gunners Knot</u>	0600 on 27 March, position 7°10'N, 168°E, course 270, 10 knots (18.5 km/hr)
<u>M/V Roque</u>	0600 on 27 March, Kwajalein

Source: Reference 16.

Surface Radex. True bearings from ground zero 240° clockwise to 50°; radial distance of 90 nmi (167 km) for H-hour to H+6, plus a circular radex around ground zero of 25 nmi (46 km) radius. It was recommended that the air control DDE (the USS Renshaw) move to a true bearing of 250° 90 nmi (167 km) from ground zero.

Air Radex. For H+1, 10,000 feet (3.05 km) to about 40,000 feet (12.19 km), 280° clockwise to 75° bearings from ground zero, maximum distance 20 nmi (6.1 km); 40,000 feet (12.19 km) and up: 270° clockwise to 90° bearings from ground zero, maximum distance 35 nmi (65 km). For H+6, multiply distances by six (210 nmi [389 km]).

On Enewetak, TG 7.2 radsafe officers were briefed, film badges issued, and couriers instructed on monitoring duties. Plans were made to muster all TG 7.2 personnel on the ocean side of Enewetak Island. The muster enabled the personnel to witness the detonation at Bikini Atoll and served as a rehearsal for the type of muster to be performed if an evacuation were required.

The P2V patrol squadron assigned to TG 7.3 and stationed at Kwajalein was directed to assume CASTLE radsafe monitor responsibilities for Kwajalein from H-hour to H+24 and to report radiation intensities in excess of 0.01 R/hr to the task force headquarters by Operational Immediate precedence. At Wake Island, TG 7.4 was directed to set up a special monitor station for the period H-hour to H+36.

At the 1800 command briefing the observed and forecast wind patterns were completely favorable and the decision to shoot the following morning was confirmed. At approximately 2300, a directive was passed to CTG 7.4 on the cloud-tracking flights for the first 12-hour period on shot day. Two WB-29 cloud trackers were to operate in a racetrack holding pattern 50 nmi (93 km) west of ground zero, one at 10,000 feet (3.05 km), the other at approximately 5,000 feet (1.52 km). The directive specified a flight by Wilson 2 from H+2 to H+14 from base to a 3-hour holding pattern at 10,000 feet (3.05 km), and thence to a 500-nmi (926-km) radius sector with true bearings from ground zero of 60° and 90° at 10,000 feet (3.05 km).

Wilson 3 was directed to search in the holding pattern from H+2 until released, at an altitude selected by the pilot to clear natural clouds, but not in excess of 5,000 feet (1.52 km) (Reference 16, Tab L).

A complete command briefing was held at midnight and all previous factors, advisories, and decisions were confirmed. It was decided, however, to recheck the winds at 0430 and just before shot time. The forecast fallout plot given at this briefing is shown in Figure 70.

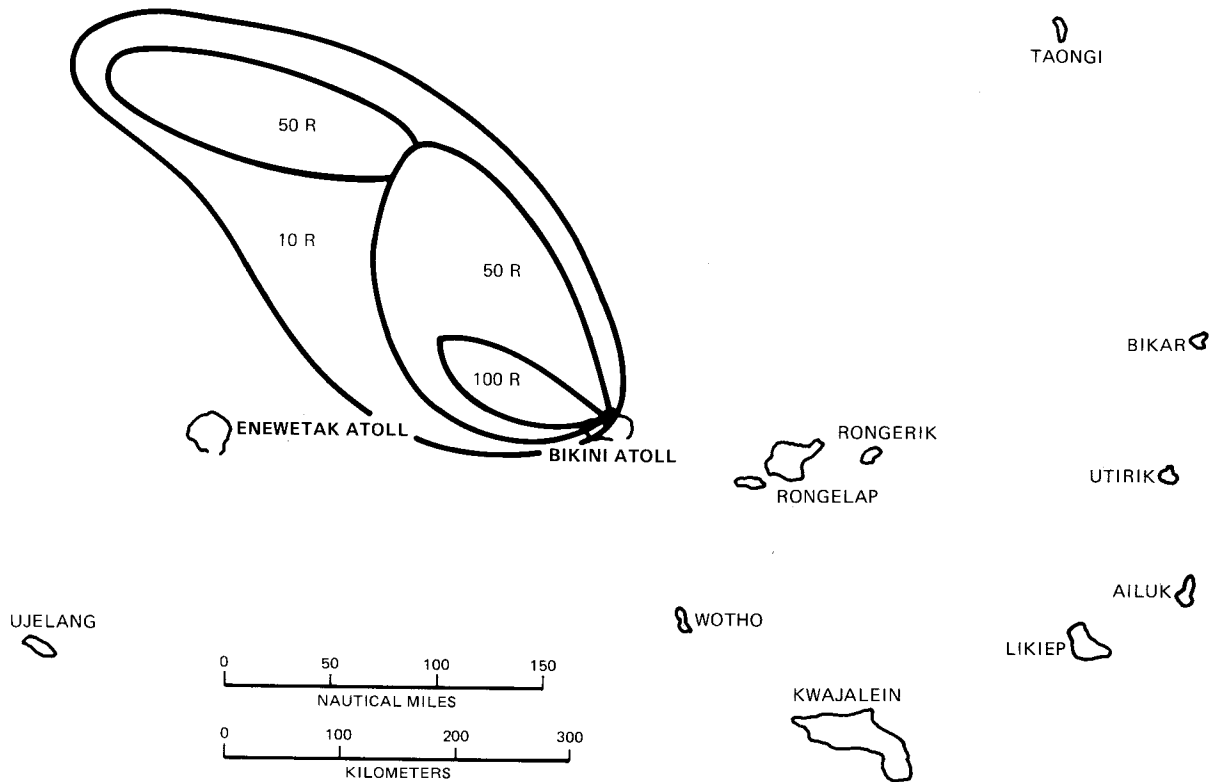

Figure 70. CASTLE, ROMEO predicted fallout pattern; contours enclose the 100-, 50-, and 10-R infinite dose areas (source: Reference 16).

DOD Activities

The DOD-sponsored experiments for ROMEO included 27 projects in TU 13 of TG 7.1. TU 13 projects were:

- Program 1, Blast and Shock; Projects 1.1a, 1.1b, 1.1c, 1.1d, 1.2a, 1.2b, 1.3, 1.4, 1.5, 1.6
- Program 2, Nuclear Radiation and Fallout; Projects 2.1, 2.2, 2.3, 2.5a, 2.5b, 2.6a, 2.6b
- Program 6, System Effects; Projects 6.1, 6.2a, 6.2b, 6.4, 6.5, 6.6
- Program 7, Electromagnetics; Projects 7.1, 7.2, 7.4
- Program 9, Cloud Photography; Project 9.1.

The instrument station locations on the islands of the atoll are shown in Figure 71. Details of the experimental projects can be found in Chapter 3. The locations of the TG 7.3 ships at burst time are shown in Figure 72. Aircraft participation is given in Table 29; the positions of some of these aircraft at burst time are presented in Table 30.

The Test

The late checks of the weather/radsafe conditions indicated a more favorable shot-time wind pattern than forecast (i.e., deeper southerlies in the levels between the trades and 55,000 feet [16.8 km]). ROMEO was detonated at 0630 with a yield of 11 MT. The embarked task force personnel and ships had no adverse incidents. Postshot advisories were issued before H+30 minutes on 27 March 1954 to the Chairman, AEC; Army Chief of Staff; and CINCPAC indicating time of detonation and confirming personnel safety. The detonation produced a cloud whose upper limit reached an altitude of about 123,000 feet (37.5 km) (Figure 73). The lowest levels (surface to 6,000 feet [1.8 km]) of the stem moved to the southwest at a speed of approximately 11.5 mi/hr (18.5 km/hr). The next higher level (to 20,000 feet [6.1 km]) moved to the west-northwest at about 13.7 mi/hr (22 km/hr). The upper levels and the stem moved out to the north. Outside the PPG, all levels probably moved out to the east except the lowest levels, which continued in a westerly direction.

CONTAMINATION. The first contact with cloud radiation was reported at 0903 (H+2:33) by Wilson 3, flying at 5,000 feet (1.52 km) at the south end of the racetrack pattern. The next report at 0933 at the north end of the

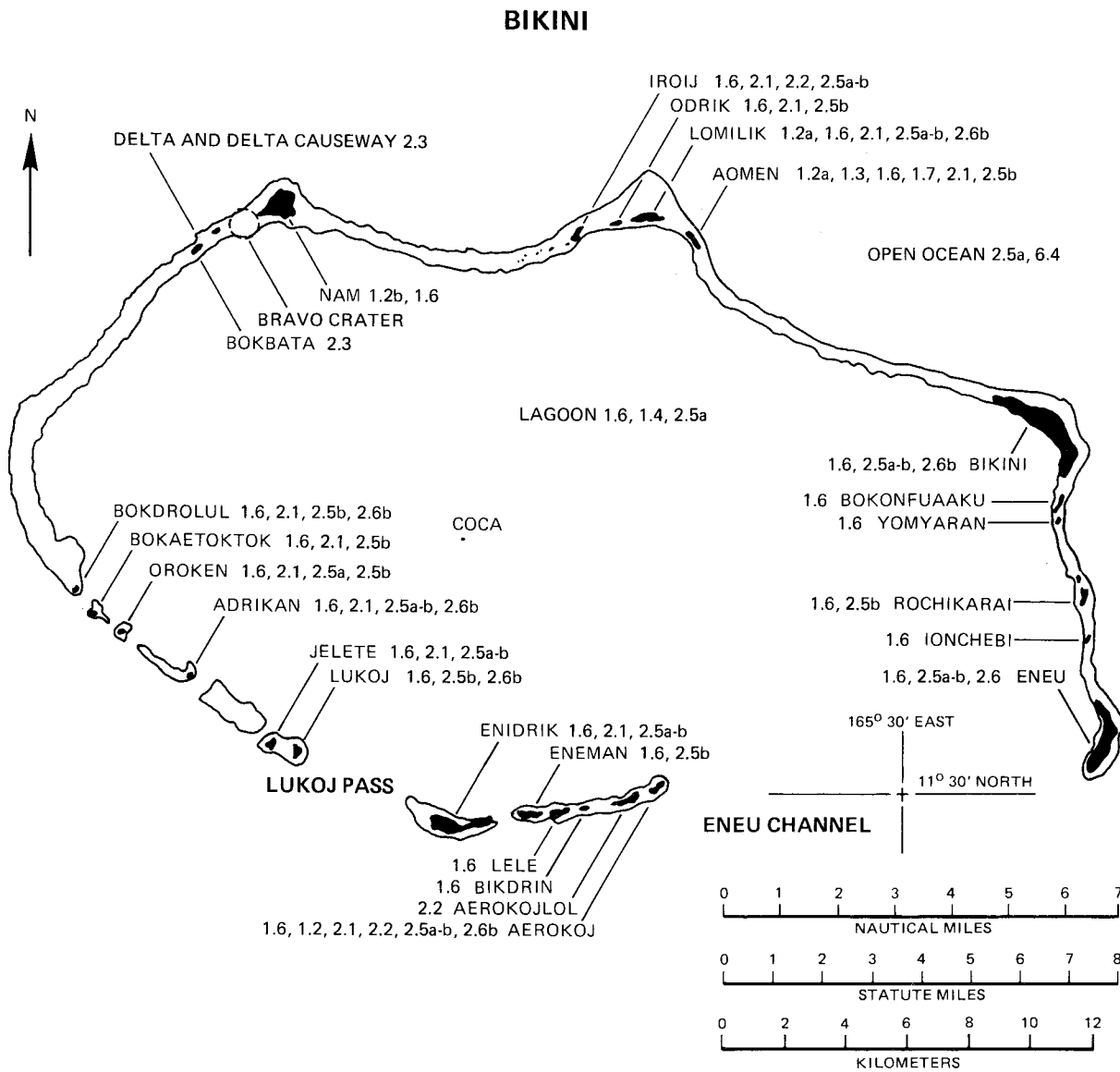

Figure 71. CASTLE, ROMEO instrumentation stations for the DOD scientific projects on Bikini Atoll.

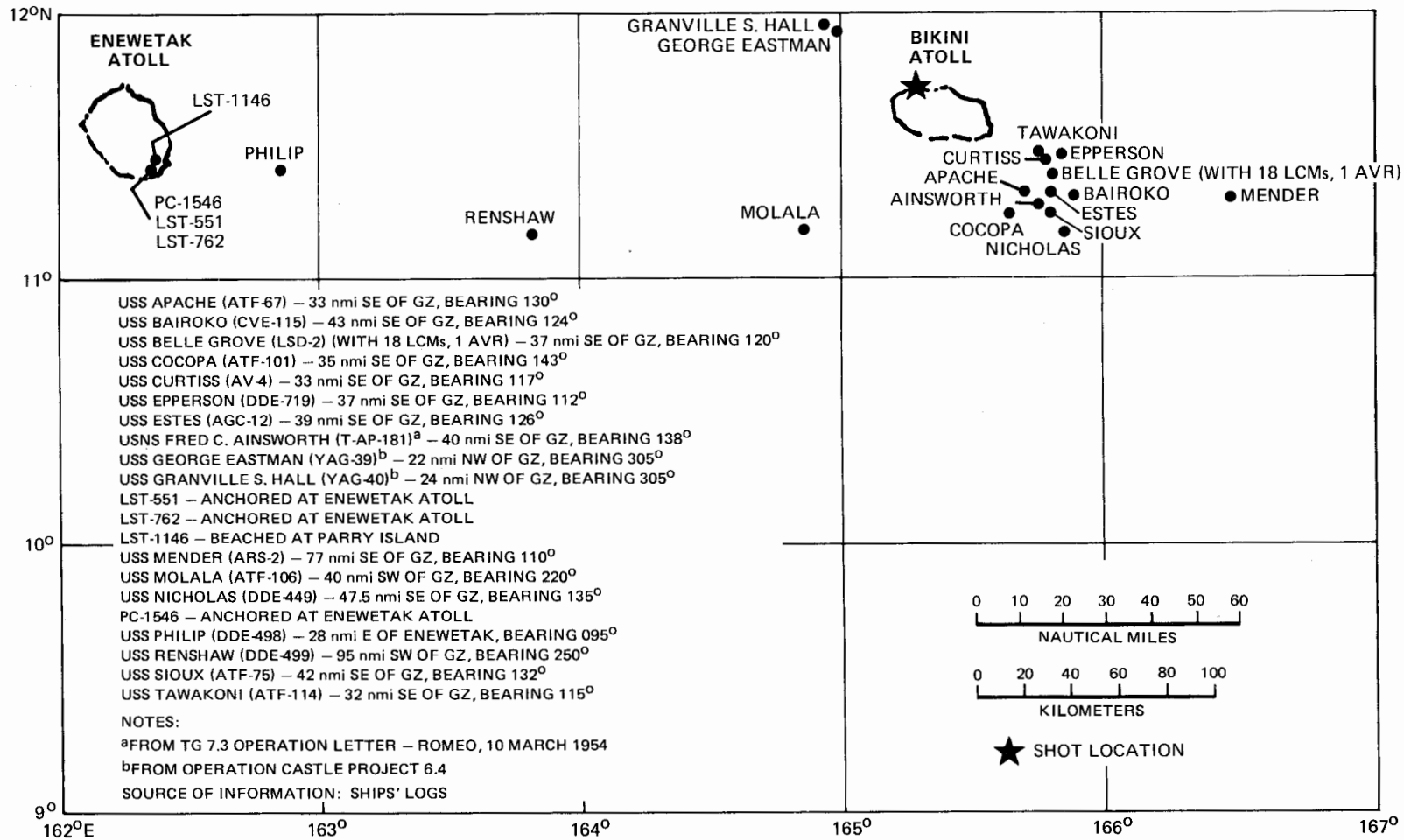

Figure 72. Ship positions at detonation time, CASTLE, ROMEO.

Table 29. Aircraft participating in CASTLE, ROMEO.

Aircraft	Number	Use
F-84	14	Samplers
B-36	1	Sampler
	1	Sampler Controller
	1	Effects
B-47	1	Effects
C-54	3	Technical Photography
B-50	3	Indirect Bomb Damage Assessment (IBDA)
WB-29	3	Sampling and Cloud Radiation Monitoring

Table 30. Aircraft positioning data for CASTLE, ROMEO.

Aircraft	Altitude (km) ^b	Slant Range ^a (km) ^b	Heading (deg)	Direction ^a (deg)
B-36 Effects	11.3	19.4	180	090
B-47 Effects	10.6	25.5	090	085
B-50 IBDA ^c	9.8	27.8	---	---
B-50 IBDA ^c	9.5	42.6	---	---
B-50 IBDA ^c	9.1	55.6	---	---
C-54-1	4.3	138.9	---	330
C-54-2	3.2	92.6	---	090
C-54-3	3.8	138.9	---	210

Notes:

^aFrom ground zero.

^bOne kilometer equals 3,281 feet.

^cIndirect Bomb Damage Assessment.

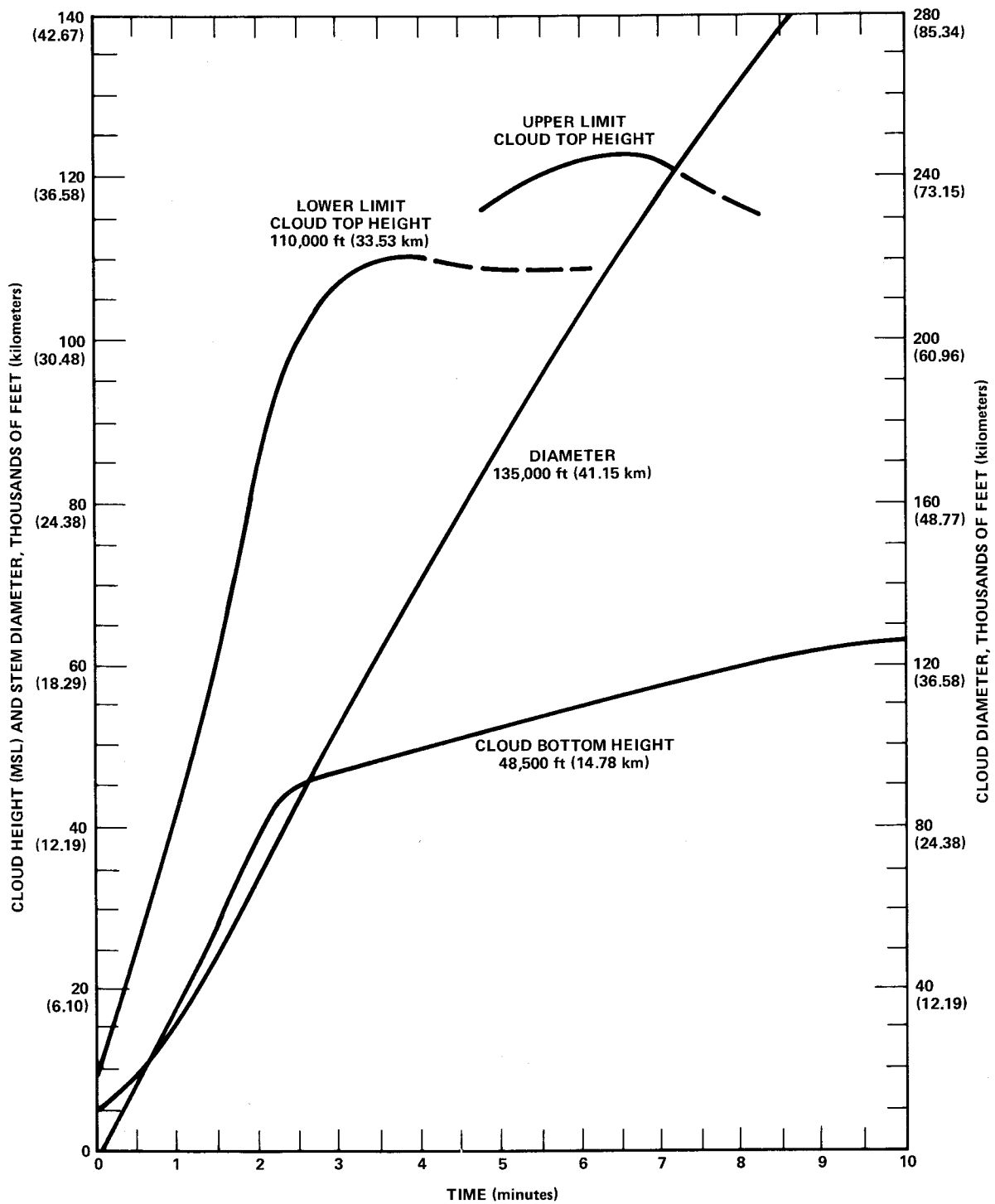

Figure 73. CASTLE, ROMEO cloud dimensions (source: Reference 81).

pattern was negative. Subsequent reports at the south end of the pattern at 0941, 1033, 1038 and 1057 indicated contamination of 0.05 to 0.10 R/hr. This was undoubtedly the lowest portion of the stem since it was encountered within minutes of the time forecast by the preshot air radex area and hodograph. At 1219, radiation levels of approximately 2 R/hr were reported by Wilson 3 at the north end of the pattern; it is believed that this was some of the same fallout encountered by Wilson 2 (discussed below). One significant difference was noted, however, in that Wilson 3 reported the simultaneous collection of a "white frost or snow" on the front of the aircraft. At this time, the aircraft was ordered to the south end of the pattern to "cool off." The frost-like material was washed off when the aircraft passed through a rain shower while responding to the order, and the aircraft's radiation background dropped markedly. Subsequent readings in the pattern were background, and at approximately 1430 Wilson 3 was ordered to attempt to locate the southern edge of that portion of the cloud believed to be moving west-northwest. It was suggested that Wilson 3 proceed from the holding pattern to 12.5°N, 163°E and thence to Enewetak. No contamination was reported on this phase of the flight, which indicated that cloud movement was more northerly than had been presumed.

Wilson 2 was directed to fly in the holding pattern from H+2 to H+5, then search a sector east of ground zero (limiting bearings 60° and 90° true). The first contact with the cloud was reported by Wilson 2 at 1118 at the north end of the racetrack pattern, with the radiation level reported at 0.850 R/hr. This was probably fallout from the southwesternmost edge of cloud segments that were moving north. Wilson 2 did not encounter contamination at the southern end of the pattern. Wilson 3, however, 5,000 feet (1.52 km) lower, reported radiation from approximately 0900 to 1100 (establishing an upper limit of about 8,000 feet [2.45 km] for cloud segments moving in a southwesterly direction and confirming both the air radex area and the hodograph). Immediately after the initial cloud contact, Wilson 2 proceeded east toward the previously designated search sector. At that time, however, the Radsafe Office desired additional information concerning any possible cloud movement toward Enewetak; accordingly,

Wilson 2 was ordered at 1200 to return to the holding pattern. At 1215, Wilson 2 reported encountering cloud segments of approximately 2 R/hr at the northwest corner of the holding pattern. In order to evaluate the possibility of fallout at Enewetak and also to determine aircraft background, this aircraft was also ordered to proceed to a position in the south end of the pattern. Subsequent reports showed no cloud moving toward Enewetak, and the aircraft's background was 0.240 R/hr. At 1430, the aircraft was directed to proceed to the originally specified search area east of Bikini. No radiation above background was encountered on a subsequent search out to 13.5°N, 171.5°E (100 nmi [185 km] west of Bikar) and thence to base. The crew exposure on Wilson 2 and Wilson 3 during these flights was of the order of 1.4 R (Reference 16, Tab L, p. 39).

Wilson 4 was directed at H+12 to proceed from Enewetak at a 10,000-foot (3.05-km) altitude to a sector bearing 60° to 90° from ground zero and search out to 500 nmi (926 km). From this sector the return to base was via a point 16°N, 162°E. The flight was performed as ordered, and no radiation was encountered.

Wilson 1 collected heavy-element samples; it "encountered heavy radiation necessitating immediate return to base." The specific radiation levels encountered are not known; however, the highest reading on any WB-29 returning to base following ROMEO was 20 R/hr (Aircraft No. 2195; see Table 35).

Subsequent Wilson flights were cancelled when no appreciable air contamination appeared to exist at that time in the vicinity of the test site.

No D-day fallout was deposited on task group ships in the sortie area. At approximately 1800, the USS Epperson, on security patrol 50 nmi (93 km) northwest of Bikini, reported fallout with average readings of 0.025 R/hr and maximums of 0.100 R/hr. The Epperson left the area at 1900 to avoid unnecessary personnel exposure.

At 0900 two helicopters departed from the Bairoko for the initial rad-safe survey and two other helicopters were sent to Eneman Island with work parties to clear debris from the airstrip. At 1000, radiation of low intensity, except at the crater, was reported. The lagoon was reported clear by the USS Belle Grove, and at 1315 ships began to reenter the lagoon.

Bikini was not heavily contaminated after ROMEO, since the winds carried most of the radioactivity to the northwest. Data from the free-floating buoys of Project 2.5 were not sufficient to produce reliable contours. Figure 74 presents estimates of the fallout pattern and intensity derived from these data. The maximum intensity was observed at 35 nmi (65 km) from ground zero; this corresponded to a land reading of 435 R/hr at H+1 (Reference 40).

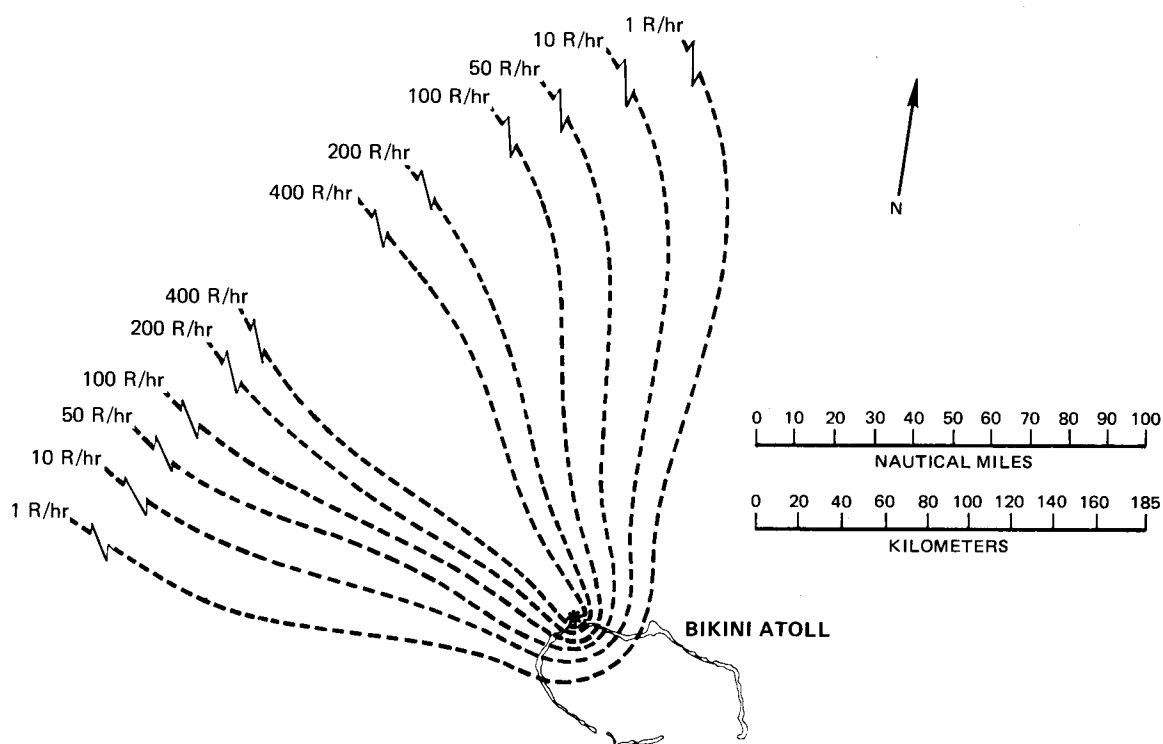

Figure 74. CASTLE, ROMEO close-in gamma fallout pattern at H+1 (source: Reference 53).

A partial radsafe survey was conducted on D-day. Results of this survey indicated no extensive recontamination of the atoll except within the Bokbata-Nam chain. Table 31 shows the results of early radiation surveys. Island exposure rates at H+1 are shown in Figure 75.

Table 31. CASTLE, ROMEO radiation summary (R/hr).

Island	Extrapolated H+4	D+1	D+2	BRAVO Background at ROMEO
Eneu	0.03	0.03	0.06	0.03
Bikini ^a	0.20	0.12	0.14	0.12
Aomen	0.80	0.80	0.60	0.22
Lomilik ^a	1.6	1.7	0.75	1.1
Odrick ^a	0.8 - 1.4	1.4	0.85	1.2
Iroij ^a	0.8 - 1.0	1.3	1.0	1.3
Nam ^a	2,000		100	0.6
Bokbata ^a	1,000	50.0 ^b	55	1.2
Oroken	0.04	0.10 ^c	0.16 ^c	0.04
Adrikan	0.02	0.40 ^c	0.32 ^c	0.02
Enidrik	0.005	0.005	0.05	0.01
Aerokoj	0.005	0.005	0.04	0.01
Eneman	0.012	0.012	0.06	
Crater		1,100 ^d		
Ships			0.02 - 0.04	

Notes:

^aContamination by ROMEO shot.

^b200-foot (60-meter) altitude.

^cRadiation shine from water in Southwest Passage.

^dAt 300 feet (90 meters).

Source: Reference 91.

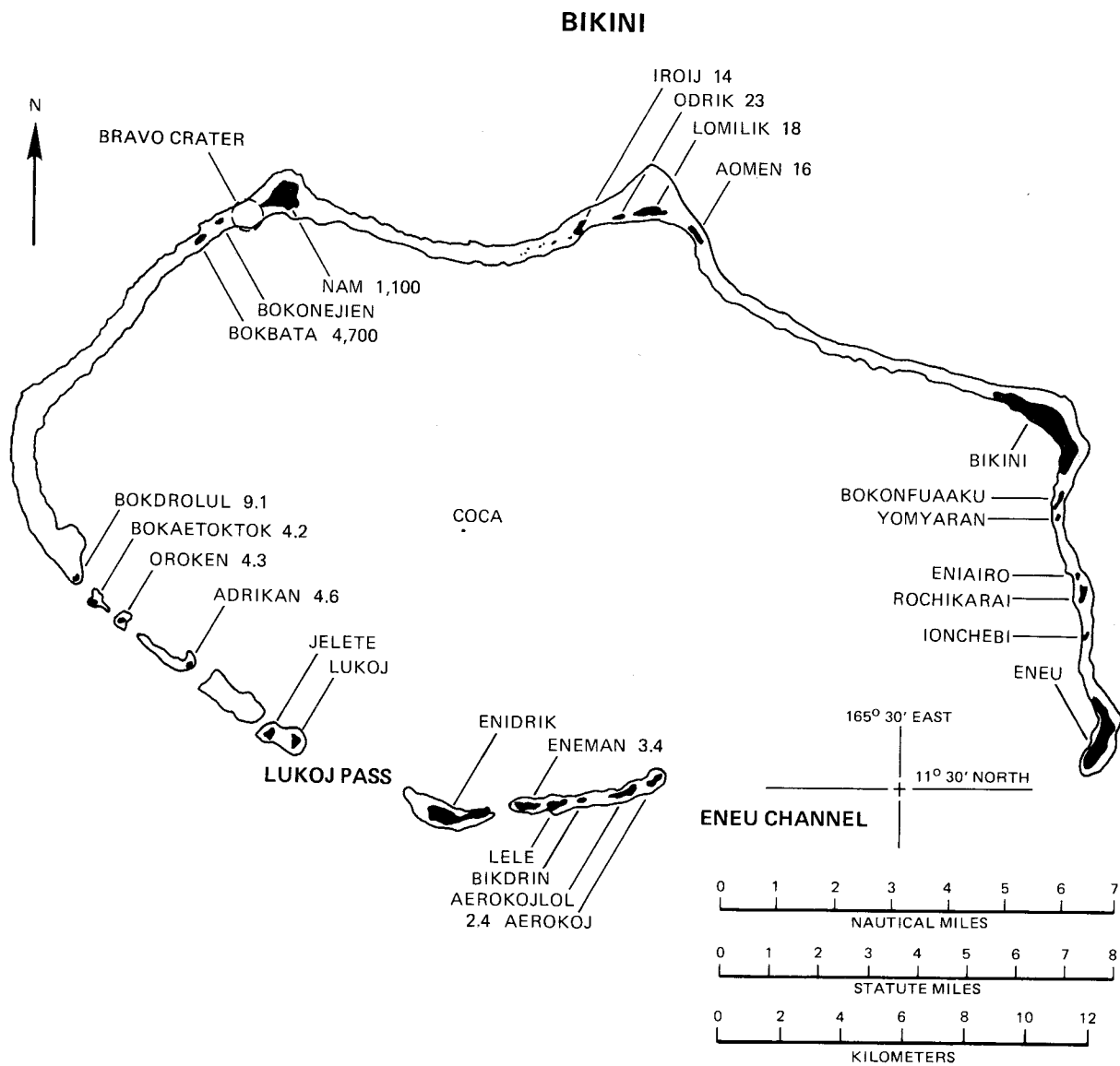

Figure 75. CASTLE, ROMEO atoll exposure rates at H+1 (R/hr). Individual cloud reading taken from aerial surveys at about H+3 and normalized to H+1 using $t^{-1.2}$ decay rate. The BRAVO contamination was subtracted (source: Reference 81).

Unforeseen fallout of small radioactive particles (less than 5 microns) occurred on the night of D+1 and covered the atoll, raising radiation levels by approximately 0.100 R/hr. The small radioactive fallout particles were more difficult to remove than the fallout from the larger BRAVO particles. The secondary fallout stopped between 0700 and 0800 on D+2. Residual topside levels for ships that received fallout are given in Table 32.

Fallout contaminated the western quarter of the lagoon with radiation levels comparable to those of BRAVO. Lagoon flushing through the southwest passage substantially increased background radiation levels in the vicinity of Oroken, Bokaetoktok, and Bokdrolul.

On shot day the low-intensity contamination moving to the southwest was reported by Wilson 3, and accordingly an alert message was dispatched to the Enewetak garrison indicating the presence of a westerly movement of roentgen-range contamination approximately 60 nmi (111 km) west-northwest of ground zero. Although calculations indicated the contamination would pass to the north of Enewetak, all personnel at that atoll were directed to remain on alert status until H+24. No significant fallout was subsequently experienced, a fact verified by a report at 1900 from the Enewetak monitoring system indicating 0.001 R/hr maximum on Enewetak and Parry and zero background on Lojwa. The low-intensity contacts southwest of ground zero were not considered significant for Ujelang.

Fallout began on Enewetak Island on D+2 at 1500, with peak readings of 0.010 to 0.015 R/hr. There were also local "hot spots" with readings as high as 0.040 R/hr. These areas were posted with danger signs, and personnel were not allowed to enter them. On D+5, the maximum intensity was 0.010 R/hr at Enewetak Island.

On 31 March, the TG 7.3 unit on Kwajalein reported 0.009 R/hr maximums on the windward side of tree trunks, averages of 0.001 to 0.003 R/hr on beaches, and 0.001 to 0.004 R/hr on windward sides of buildings. The average Kwajalein background before 31 March was 0.00005 R/hr. Aircraft on

Table 32. Average topside radiation intensities (R/hr) of Task Group 7.3 ships at various times following CASTLE, ROMEO.

Date	Time	Estes (AGC-12)	Bairoko (CVE-115)	Belle Grove (LSD-2)	Epperson (DDE-719)	Renshaw (DDE-499)	Philip (DDE-498)	Cocopa (ATF-101)	Mender (ARSD-2)	Apache (ATF-67)	Sioux (ATF-75)	Molala (ATF-106)	LST-551	Ainsworth (T-AP-181)
27 Mar	1400						0.0004							
	1500						0.0016			0.0002			0.0001	
	1600				0.0005		0.0026			0.0020			0.0021	
	1700				0.0010		0.0025			0.0012			0.0025	
	1800				0.0015		0.0025			0.0018			0.0029	
	1900				0.0250		0.0024			0.0009			0.0028	
	2000				0.0100		0.0019			0.0006			0.0028	
28 Mar	0000				0.0035		0.0018			0.0006	0.0010	0.0020	0.0011	
	0400				0.0040		0.0007			0.00035	0.0020	0.0100	0.0011	
	0800				0.0150		0.0013			0.0003	0.0800	0.0130	0.0003	
	1200				0.0070		0.0005			0.0280	0.0160	0.0090	0.0007	
	1600	0.0003		0.0003	0.0050		0.0007		0.0003	0.0420	0.0160	0.0070	0.0008	0.0003
	2000	0.0020	0.0010	0.0040	0.0045	0.0002	0.0008		0.0015	0.0200	0.0300	0.0054	0.0027	0.0015
29 Mar	0000	0.0120	0.0250	0.0200	0.0030	0.0200	0.0120	0.0250	0.0270	0.0250	0.0180	0.0050	0.0150	0.0240
	0400	0.0100	0.0250	0.0100	0.0035	0.0100	0.0210	0.0200	0.0200	0.0200	0.0180	0.0035	0.0250	0.0100
	0800	0.0080	0.0250	0.0110	0.0080	0.0090	0.0190	0.0100	0.0180	0.0200	0.0300	0.0020	0.0220	0.0220
30 Mar	0800	0.0087	0.0110	0.0140	0.0050	0.0070	0.0110	0.0050	0.0080	0.0100	0.0080	0.0020	0.0100	0.0070
31 Mar	0800	0.0063	0.0070	0.0080	0.0030	0.0030	0.0083	0.0050	0.0070	0.0080	0.0040	0.0020	0.0075	0.0050
1 Apr	0800	0.0032	0.0060	0.0050	0.0010	0.0025	0.0058	0.0030	0.0050	0.0060	0.0040	0.0010	0.0050	0.0040
2 Apr	0800	0.0025	0.0050	0.0040	0.0005	0.0015	0.0046	0.0030	0.0040	0.0040	0.0030	0.0010	0.0028	0.0025
3 Apr	0800	0.0025	0.0030	0.0030	0.0002	0.0010	0.0033		0.0030	0.0030	0.0020	0.0010	0.0020	0.0015

Note: Manned ships other than those listed did not receive significant contamination.

Source: Final Report, Operation CASTLE, CTG 7.3 (Reference 11).

training flights in the local area were reportedly concentrating contamination to levels of 0.02 R/hr on engines.

Table 33 presents the preliminary results from the AEC New York Operations Office (NYKOPO) flights. Table 34 gives selected film-badge readings from Enewetak and Wake islands.*

AIRCRAFT DECONTAMINATION. The ROMEO shot saw a major change in personnel use for aircraft decontamination. Maintenance personnel removed engine cowlings but did not participate in washing. Wash crews were divided into four groups, each working a 6-hour shift with no breaks. Night lighting was improved and a trapeze-type safety harness was erected for workers on the top of B-36 wings. Small holes were drilled in cowlings to minimize accumulation of contaminated wash water. The cooling off, or decay, period was increased from 20 to 44 hours, which significantly reduced personnel exposures (reportedly 25 to 44 percent). A B-29 (No. 2195) reading of 1 R/hr on 30 March had a level of 20 R/hr 52 hours earlier. The data of Table 35 indicate that two other aircraft (F-84Gs) were contaminated in excess of 10 R/hr after ROMEO.

Personnel Exposures

The records usually do not disaggregate the exposures to specific units by shot, and no large groups were identified as having participated solely in ROMEO. Data for some individuals are available, however. For example, the Chairman of the AEC officially observed the detonation. His recorded exposure of 0.03 R might be representative of individuals who viewed the shot from the flagship or a VIP aircraft.

KOON

The third CASTLE event, KOON, was detonated at 0620, 7 April 1954, on Eneman Island, located on the southern rim of Bikini Atoll. Although one author has described this detonation as almost a "fizzle" (Reference 92),

* Since shot KOON was scheduled to occur soon after ROMEO, some film badges were left out for both shots.

Table 33. CASTLE, ROMEO airborne monitoring survey results of the AEC New York Operations Office.

Location ^a	Flight Able					
	Local Time (19 March)	Maximum Ground Reading (R/hr)	Local Time (28 March)	Maximum Ground Reading (R/hr)	Local Time (31 March)	Maximum Ground Reading (R/hr)
Kwajalein	1200	0.00010	0704	0	1435	0.00020
Lae	1602	0.000012	0747	0	0832	0.00008
Ujae	1615	0.00006	0754	0	0840	0.00024
Wotho	1643	0.00005	0829	0	0910	0.00170
Ailinginae (Sifo Island)	1710	0.02000	1123	0.00600	1005	0.02600
Rongelap Island	1720	0.01500	1134	0.02800	1022	0.07800
Rongerik Island	1739	0.08000	1153	0.03600	1036	0.04800
Taongi	--	--	1315	0.00100	1158	0.00040
Bikar	1848	0.01200	1415	0.00008	1257	0.01500
Utirik Island	1910	0.01200	1438	0	1320	0.00680
Taka	--	--	1448	0.00080	1330	0.00680
Ailuk	1938	0.00100	1503	0.00160	1345	0.00240
Jemo	1951	0.00002	1518	0.00080	1400	0.00240
Likiep	--	--	1525	0.00040	1407	0.00100

Location ^a	Flight Baker		Other NYKOPO Flights		
	Local Time (3 April)	Maximum Ground Reading (R/hr)	Flight	Date	Maximum Ground Reading (R/hr)
Namu	0834	0.00040	Dog ^b	1 April	0
Ailinglapalap	0857	0.00055	Fox ^b	3 April	0
Namorik	0933	0.00070			
Ebon	959	0.00110			
Kili	1004	0.00090			
Jaluit	1035	0.00140			
Mili	1125	0.00070			
Arno	1146	0.00090			
Majuro	1153	0.00090			
Aur	1209	0.00090			
Maloelap	1230	0.00050			
Erikub	1253	0.00009			
Wotje	1304	0.00140			
Kwajalein	1354	0.00140			

Notes:

^aAtoll is specified unless otherwise indicated.

^bSee Table 9 for description of Dog and Fox flights.

Source Reference 16.

Table 34. Selected film badge readings (R), 1954.

Enewetak Island Location	24 Mar - 9 Apr ^{a,b}	Wake Island Location	24 Mar - 30 Mar
8600th AAU Area	---	PAA ^C Living Area	0.290
Laundry	0.495	School/Housing Area	0.290
Provost Marshall's office	1.570	Bachelor Housing	0.245
Bldg 502 (Hq orderly rm)	0.480	Base Ops (indoors)	0.160
Loran station	0.375	Fire Station (indoors)	0.160 0.160
Skeet range	1.010		
Motor pool	0.520		
"G" row tent #6	0.380		
Chapel	1.235		
NCO mess	0.265		
Main cargo pier	0.330		

Notes:

^aTime span approximate.

^bNote that shot KOON was detonated on 7 April.

^cPan American Airways.

Source: Reference 87, Reel 9, various indexes.

Table 35. Task Group 7.4 CASTLE, ROMEO aircraft decontamination.

Aircraft Type/ Tail No.	First Survey			Second Survey			Type of Decon
	Reading (R/hr)	Date (Time)	Type of Decon	Reading (R/hr)	Date (Time)	Type of Decon	
B-36/1083	0.250	27 Mar (1600)	Decay	0.060	29 Mar (1200)	Wash	
B-36/1086	3.200	27 Mar (1200)	Decay	0.220	29 Mar (0540)	Wash	
B-29/2195	20.000	27 Mar (1005)	Decay	1.000	30 Mar (0050)	Wash	
B-29/7440	0.600	27 Mar (1600)	Decay	0.050	30 Mar (0000)	Wash	
B-29/1819	1.000	27 Mar (2145)	Decay	0.170	29 Mar (0000)	Wash	
F-84/030	5.500	27 Mar (1200)	Decay	0.220	29 Mar (1840)	Acid	
F-84/032	1.200	27 Mar (1433)	Decay	0.065	29 Mar (1520)	Acid	
F-84/033	10.000	27 Mar (1030)	Decay	0.345	29 Mar (1840)	Acid	
F-84/037	22.000	27 Mar (0955)	Decay	0.600	29 Mar (1525)	Acid	
F-84/038	1.700	27 Mar (1025)	Decay	0.440	29 Mar (1845)	Acid	
F-84/042	2.200	27 Mar (1335)	Decay	0.840	29 Mar (1720)	Acid	
F-84/043	2.000	27 Mar (1330)	Decay	0.080	29 Mar (1515)	Acid	
F-84/045	0.600	27 Mar (1340)	Decay	0.030	29 Mar (1530)	Acid	
F-84/046	4.000	27 Mar (1205)	Decay	0.190	29 Mar (1855)	Acid	
F-84/053	5.500	27 Mar (1215)	Decay	0.180	29 Mar (1705)	Acid	
F-84/054	6.000	27 Mar (1210)	Decay	0.300	29 Mar (1710)	Acid	
F-84/055	3.900	27 Mar (1052)	Decay	0.150	29 Mar (1954)	Acid	

Aircraft Type/ Tail No.	Third Survey			Fourth Survey			Total Decon Hours	Total Decon Pers
	Reading (R/hr)	Date (Time)	Type of Decon	Reading (R/hr)	Date (Time)	Type of Decon		
B-36/1083	0.034	29 Mar (1453)	???	0.030	???	(???)	2.33	26
B-36/1086	0.120	29 Mar (1145)	Wash	0.060	29 Mar (???)		5.5	26
B-29/2195	0.175	30 Mar (0545)					5	26
B-29/7740	0.018	30 Mar (0220)					1.5	26
B-29/1819	0.044	30 Mar (0150)					2	26
F-84/030	0.170	29 Mar (2130)	Wash	0.110	30 Mar (0050)		0.75	25
F-84/032	0.048	29 Mar (1700)	Wash	0.060	30 Mar (0045)		0.75	25
F-84/033	0.165	29 Mar (2045)	Wash	0.130	30 Mar (0045)		0.75	25
F-84/037	0.400	29 Mar (1915)	Wash	0.400	30 Mar (0035)		0.75	25
F-84/038	0.300	29 Mar (2130)	Wash	0.220	30 Mar (0045)		0.75	25
F-84/042	0.080	29 Mar (1845)	Wash	0.050	30 Mar (0045)		0.75	25
F-84/043	0.090	29 Mar (1700)	Wash	0.075	30 Mar (0040)		0.75	25
F-84/045	0.022	29 Mar (1720)	Wash	0.020	30 Mar (0030)		0.75	25
F-84/046	0.115	29 Mar (2030)	Wash	0.120	30 Mar (0030)		0.75	25
F-84/053	0.100	29 Mar (1900)	Wash	0.090	30 Mar (0035)		0.75	25
F-84/054	0.300	29 Mar (1905)	Wash	0.240	30 Mar (0040)		0.75	25
F-84/055	0.060	30 Mar (0040)					0.75	25

Source: Reference 30.

its 110-KT yield completed the destruction of the camp facilities at Eneman and resulted in the temporary closure of the Bikini Island anchorage.

Preshot Preparation

Aerial searches of Area Green and a sector 240 nmi (444 km) wide out to 600 nmi (1,111 km), centered on a 30° bearing from Eneman, began on 5 April. The series of preshot briefings continued until midnight, when the decision was made to postpone the shot 24 hours to await more favorable weather. By the morning of 6 April, the synoptic weather forecast indicated favorable conditions for the following day, and the sequence of the preshot precautions began again.

At approximately 1400 on 6 April, the forecast surface and air radex areas were announced as follows (Reference 16, Tab M):

Surface Radex. True bearings from ground zero, 240° clockwise to 70°; radial distance 90 nmi (167 km) for H-hour to H+6, plus a circular radex area around ground zero of 15 nmi (27.8 km) radius. It was recommended that the air control DDE move to 240° and 90 nmi (167 km) from ground zero, and the task force ships move to a position southeast from ground zero as soon as possible after the shot.

Air Radex. For H+1, 10,000 feet (3.05 km) to 40,000 feet (12.19 km), 240° clockwise to 20° from ground zero for a maximum distance 20 nmi (37 km) and 20° clockwise to 85° from ground zero for a maximum distance of 30 nmi (56 km).

For 40,000 feet (12.19 km) and up, 240° clockwise to 10° from ground zero for a maximum distance of 35 nmi (65 km), and 10° clockwise to 95° from ground zero for a maximum distance of 45 nmi (83 km).

For H+6, multiply distances by 6. Due to initial cloud growth, supplement the 10,000-foot (3.05-km) radex for H+1 with a sector bearing 85° true, clockwise to 240° true for a maximum distance of 5 nmi (9.3 km). Supplement the 40,000-foot (12.20-km) radex for H+1 with a sector bearing 95° true, clockwise to 240° true for a maximum distance of 15 nmi (27.8 km).

The routine H-18 advisory was dispatched to CINCPAC announcing the KOON schedule. The advisory indicated that no known transient ships were

in the danger area and stated that a search centered on a 45° sector would be conducted. The search sector was later cancelled because the search at 30° on the previous day had reported no vessels. The CJTF 7 decided that the sector search would be conducted in advance of the fall-out cloud "if necessary" (Reference 16, Tab M). No indications are given of the conditions that might require this search. Table 36 shows the known shipping activity near the PPG around shot time.

The officer-in-charge, Wake Island Weather Bureau Station, assumed radsafe monitor responsibility for Wake and was requested to make special reports to the task force headquarters if intensities reached 0.010, 0.050, 0.100, and 0.500 R/hr. Radiac instruments were supplied to the Wake station by TG 7.4. In accordance with operational requirements, the task force fleet was positioned in a sector from 90° to approximately 120° from ground zero at a minimum distance of 26 nmi (48 km). Figure 76 shows the location of the fleet for KOON.

At the midnight command briefing, the forecast shot-time winds were favorable, having considerable southerly flow in the mid-levels. However, light to moderate scattered showers were forecast for H-hour and later. The decision to shoot was affirmed, pending the weather/radsafe situation at 0430 on shot day. The forecast fallout plot by the method of elliptical approximations is shown in Figure 77.

Based on the recommendations contained in the surface radex area directive, CTG 7.3 informed all task groups of the following flagship (the Estes) movements near shot time:

- The H-hour position would be on a bearing from ground zero of 88° true at 25 nmi (46 km)
- At H+5 minutes (i.e., after completion of firing requirements), the ship would commence moving south at 15 knots (28 km/hr)
- The H+2 position would be 134° true, 33 nmi (61 km) from ground zero, with a possibility of moving from that position at approximately H+3 if required.

Table 36. Summary of the status of transient shipping in the Pacific Proving Ground on or about 7 April 1954.

Vessel	Location/Course
<u>USS Reclaimer</u> (ARS-42)	10°45'N, 168°E, course 270, 10 knots (18.5 km) at 1200 on 6 April; diverted to Kwajalein, ETA 0700, 7 April
LST-1146	9°35'N, 196°E, course 94, 9 knots (16.7 km/hr) at 1200 on 6 April; at 1400 on 6 April altered course to 53; at 0110 on 7 April altered course to 90
<u>USS Unadilla</u> (ATA-182)	7°20'N, 169°30'E, course 117, 10 knots (18.5 km) at 1200 on 6 April; at 1530 on 6 April altered course to 94
<u>USS Hanna</u> (DE-449)	At Matalanim Island at 1200 on 6 April, thence to Ponape
<u>USNS Gen Morton</u> (T-AP-138)	20°37'N, 176°12'E, course 267, 15.8 knots (29.2 km/hr) at 1200 on 6 April
<u>USS Karin</u> (AF-33)	At Enewetak at 1200 on 6 April
<u>USNS Barrett</u> (T-AP-196)	20°18'N, 169°40'E, course 87, 15.8 knots (29.2 km/hr) at 1200 on 6 April
Japanese fishing boat	Visual/radar contact by search aircraft, 19°28'N, 171°56'E, course 125, 8 knots (14.8 km/hr) at approximately 1730 on 5 April; subsequent visual/radar contact by search aircraft at approximately 1800 on 6 April, 18°15'N, 172°11'E, course 100, 6 knots (11.1 km/hr), evaluated as same vessel
Japanese fishing boat	Visual/radar contact by search aircraft, 19°N, 171°32'E, course 315, 10 knots (18.5 km/hr) at approximately 1730, 5 April
Japanese fishing boat	Visual/radar contact by search aircraft, 15°1'N, 169°31'E, course 335, 6 knots (11.1 km/hr) at approximately 1600, 6 April; subsequent visual/radar contact by search aircraft at approximately 1900, 6 April, 15°25'N, 169°21'E, course 340, 7 knots (13 km/hr), evaluated as same vessel
<u>M/V Gunners Knot</u>	Truk at 1200, 6 April
<u>M/V Roque</u>	Nukuoro at 1320, 6 April, scheduled to Kapingamarangi and return to Ponape by 10 April

Source: Reference 16.

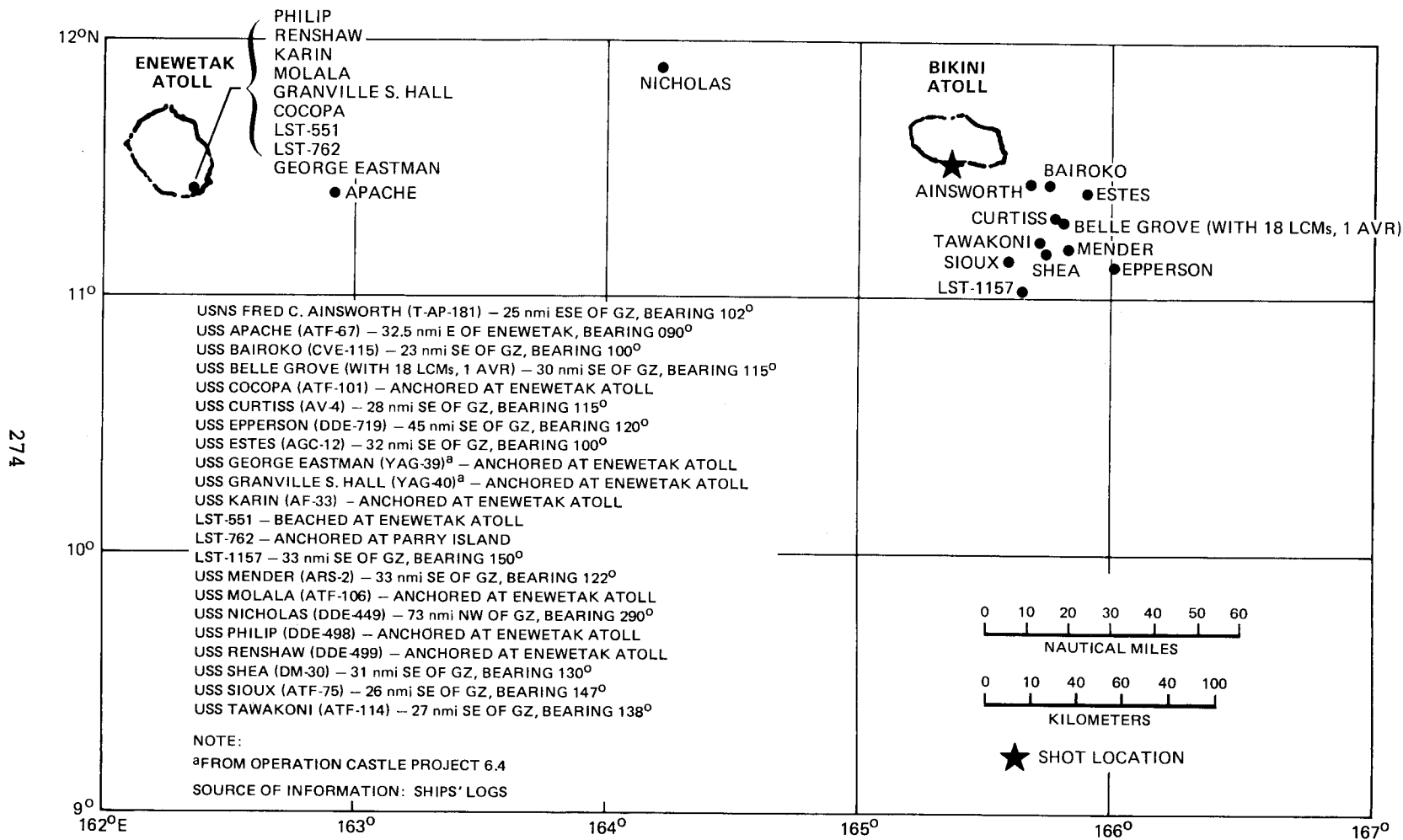

Figure 76. Ship positions at detonation time, CASTLE, KOON.

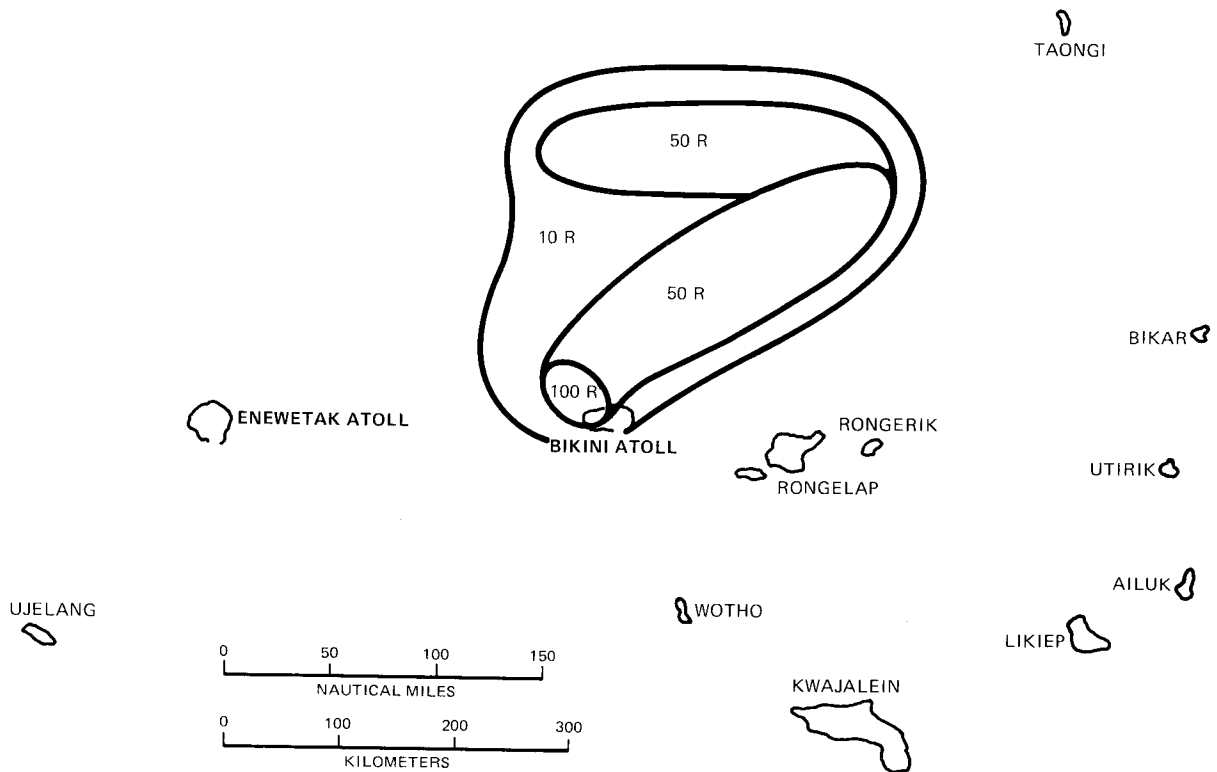

Figure 77. CASTLE, Koon predicted fallout pattern; contours enclose the 100-, 50-, and 10-R infinite dose forecasts (source: Reference 16).

The aircraft positioning ship (the USS Curtiss) was initially on a bearing of 120° , 25 nmi (46 km) from ground zero, then moved south approximately 15 nmi (28 km) after H+10 minutes (i.e., after completion of the Raydist navigation system requirements). All other ships except the destroyers moved south with the Curtiss postshot. The aircraft controller DDE (the USS Nicholas) was at 240° true at 90 nmi (167 km) from ground zero.

DOD Activities

The DOD-sponsored experiments for Koon included 27 projects in TU 13 of TG 7.1. TU 13 projects were:

- Program 1, Blast and Shock; Projects 1.1a, 1.1b, 1.1c, 1.1d, 1.2a, 1.2b, 1.3, 1.4, 1.5, 1.6

- Program 2, Nuclear Radiation and Fallout; Projects 2.1, 2.2, 2.3, 2.5a, 2.5b, 2.6a, 2.6b
- Program 6, Systems Effects; Projects 6.1, 6.2a, 6.2b, 6.4, 6.5, 6.6
- Program 7, Electromagnetics; Projects 7.1, 7.2, 7.4
- Program 9, Cloud Photography; Project 9.1.

The locations of the instrument stations for these projects are shown in Figure 78. Details of each project are given in Chapter 3. TG 7.4 aircraft participation is given in Table 37. Table 38 indicates the positions of some of these aircraft at burst time.

The Test

At shot time (0620), a rain shower between the fleet and ground zero possibly extended to ground zero. The debris cloud reached an altitude of about 55,000 feet (16.8 km). The lowest portion of the stem (estimated at below 5,000 feet [1.5 km]) moved to the west at an average velocity of about 17.3 mi/hr (27.8 km/hr). (Contact was made with this portion of the cloud at H+5 by Wilson 2, about 59 nmi 109 km to the west of ground zero. The intensity was 0.015 R/hr.) The middle segments of the cloud (1.5 to 7.6 km) initially moved north, then east-northeast at about 17.4 mi/hr (28 km/hr). The top section of the cloud moved to the east-northeast at approximately 34 mi/hr (55 km/hr) (Reference 16, Tab M).

CONTAMINATION. The Wilson 1 aircraft encountered radiation intensities of 5 R/hr while collecting cloud samples.

Wilson 2, flying at 10,000 feet (3.05 km), made no contact with the cloud while in the racetrack pattern between Bikini and Enewetak/Ujelang. Wilson 2 began a sector search at H+4 and located the cloud east of ground zero. This area was the forecast H+6 position of the 20,000- and 30,000-foot (6.1- and 9.1-km) particle trajectories. A maximum reading of 0.250 R/hr was reported at H+5.5 about 100 nmi (185 km) east-northeast of Bikini. This layer of the cloud was probably responsible for the contamination subsequently noted at Rongerik and Rongelap atolls.

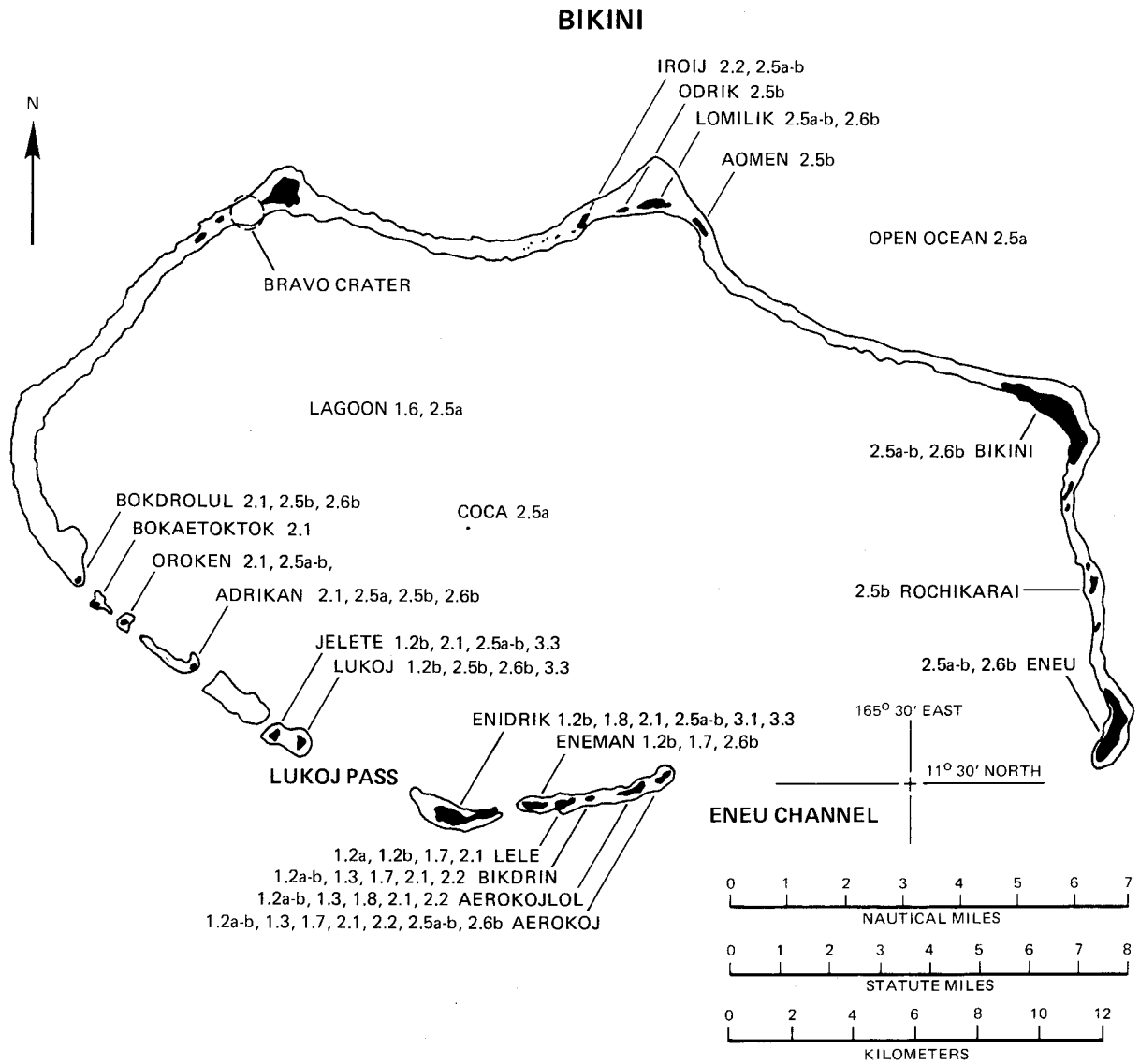

Figure 78. CASTLE, KOON instrumentation stations for the DOD scientific projects on Bikini Atoll.

Table 37. Aircraft participating in CASTLE, KOON.

Aircraft	Number	Use
F-84	15	Samplers
B-36	1	Effects
	2	Samplers
	1	Sampler control
B-47	1	Effects
B-50	3	Indirect Bomb Damage Assessment (IBDA)
WB-29	2	Sampling and cloud tracking
C-54	3	Technical photography
Viking	3	VIP aircraft
SA-16	2	Search and rescue
C-47	1	Airlift

Table 38. Aircraft positioning data for CASTLE, KOON.

Aircraft	Altitude (km) ^b	Slant Range ^a (km)	Heading (deg)	Direction ^a (deg)
B-36 Effects	12.2	17.2	090	090
B-47 Effects	10.7	14.9	070	
B-50 IBDA ^c	9.8	22.2	---	229
B-50 IBDA ^c	9.5	37.1	---	224
B-50 IBDA ^c	9.1	50.0	---	225
C-54-1	4.3	139.0	---	330
C-54-2	3.7	92.7	---	090
C-54-3	3.2	139.0	---	210

Notes:

^aFrom ground zero.

^bOne kilometer equals 3,281 feet.

^cIndirect Bomb Damage Assessment.

The Wilson 3 aircraft, flying at 5,000 feet (1.5 km), contacted the cloud while in the racetrack holding pattern at H+5.25. The intensity was 0.015 R/hr in a later sector search at an altitude of 8,900 feet (2.7 km); intensities of 0.050 R/hr were encountered at H+7 about 100 nmi (185 km) northeast of Bikini.

No aircraft flying between Bikini and Enewetak encountered airborne radiation. Subsequent Wilson flights were cancelled.

Based on a helicopter preliminary damage and radsafe survey at approximately H+2, all units of the task force were issued an advisory directive as follows (Reference 16, Tab M):

- Lele through Aerokoj and Eneu not appreciably contaminated
- Reentry hour expected to be 1100 on 7 April
- CTG 7.3 have task force vessels stand off the lagoon entrance at 1000 pending the outcome of the lagoon water survey of the Eneman and Eneu anchorages
- Upon confirmation of reentry hour, all units reenter Eneu anchorages in accordance with previous instructions.

The results of the preliminary survey indicated that Bokbata, Nam, Enidrik, and Bikini islands and the Iroi-j-Aomen chain were contaminated. Lagoon contamination was restricted to a V-shaped pattern with the apex at Eneman and tips covering the Bokbata-Aomen area. A reading of 0.100 R/hr was obtained over the Eneman anchorage at H+4. Eneu anchorage was clear of contamination, whereas Bikini anchorage showed traces of contamination at H+4. Reentry and recovery occurred largely on shot day. Table 39 shows the radiation levels on various islands of the atoll.

A gamma-rate record was obtained at Iroi-j. The fallout arrived at about H+20 minutes, and a maximum exposure rate of 23 R/hr was observed at H+40 minutes. The integrated exposure was 51 R until H+15 (Reference 40, p. 48).

Table 39. CASTLE, KOON radiation summary (R/hr).

Island	Extrapolated H+4	D+1	D+2	BRAVO and ROMEO Background at KOON
Eneu	0.03	0.03	0.03	0.03
Bikini ^a	5.0	0.67	0.07	0.10
Aomen ^a	20.0	2.5	1.6	0.35
Lomilik ^a	10.0	1.6	0.80	0.50
Odrik ^a	5.0	1.0	0.60	1.47
Iroij ^a	5.2	1.0	0.60	1.45
Nam ^a	250.0	30.0	16.0	1.5
Bokbata ^a	600.0		16.0	9.0
Oroken ^a	0.60	0.08	0.02	0.012
Adrikan ^a	0.50	0.07	0.01	0.008
Enidrik ^a	210.0	2.4 ^b	1.8	0.008
Eneman			0.02	0.010
Aerokoj	0.02	0.02	0.02	0.018
Crater	5000.0 ^d	50.0 ^c	60.0 ^d	

Notes:

^aContaminated by KOON shot.

^bReading at 100 feet (30 meters).

^cReading at 200 feet (60 meters).

^dAltitude not given.

Source: Reference 91.

The close-in fallout pattern is given in Figure 79. The exposure rates were extrapolated to H+1 by using observed field decay rates.

The results of the NYKOPO airborne monitoring survey flights are given in Table 40.

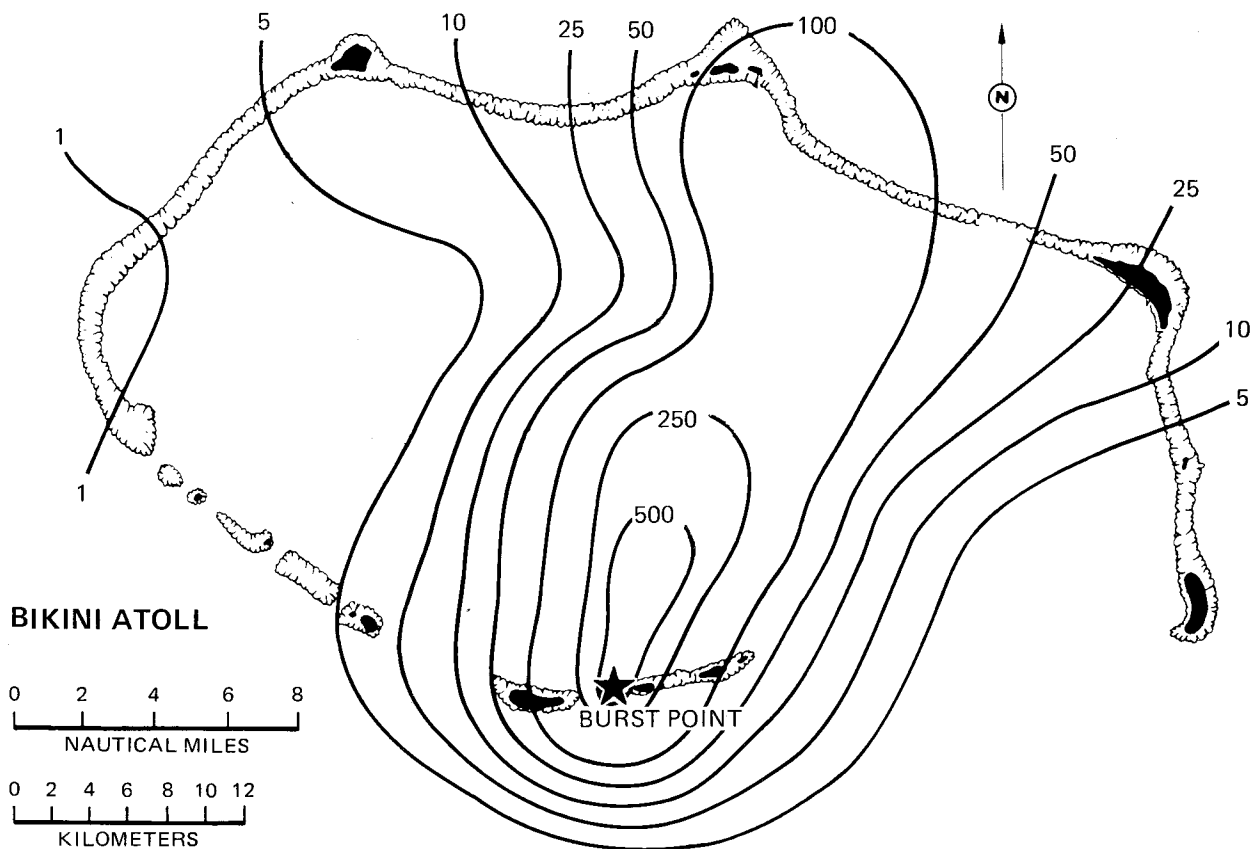

Figure 79. CASTLE, KOON close-in gamma fallout pattern (R/hr) at H+1 (source: Reference 53, p. 78).

Table 40. CASTLE, KOON airborne monitoring survey results of the AEC New York Operations Office.

Location ^a	Flight Able				Flight Baker		
	Local Time (8 April)	Maximum Ground Readings (R/hr)	Local Time (12 April)	Maximum Ground Readings (R/hr)	Location ^a	Local Time (12 April)	Maximum Ground Readings (R/hr)
Lae	0915	0.00017	0920	0.00004	Namu	0916	0.0004
Ujae	0930	0.00025	0930	0.00002	Ailinglapalap	0937	0.0004
Wotho	0956	0.0011	0959	0.00025	Namorik	1013	0.0003
Ailinginae	1022	0.057	1059	0.0077	Ebon	1037	0.0002
Rongelap Island	1033	0.094	1109	0.0178	Kili	1104	0.0003
Rongerik	1047	0.082	1124	0.0186	Jaluit	1116	0.0003
Taongi	1210	0	1247	0.00004	Mili	1201	0.0008
Bikar	1312	0.020	1345	0.0080	Arno	1225	0.0012
Utirik	1332	0.012	1415	0.0038	Majuro	1245	0.0002
Taka	1338	0.016	1422	0.0019	Ani	1245	0.0002
Ailuk	1356	0.0017	1441	0.0008	Maloelap	1328	0.0002
Jemo	1407	0.0020	1452	0.0004	Erikub	1352	0.0002
Likiep	1414	0.0012	1457	0.00004	Wotje	1404	0.0008
Kwajalein	1454	0.00053	1200	0.0015 ^b	Kwajalein	1452	0.0004

Notes:

^aAtoll unless otherwise indicated.

^bGround observation (probably erroneously high reading).

Source: Reference 16.

Air Force flights collected radioactive samples to the south of Hawaii between 8 and 10 April. The debris was widely dispersed throughout the area, but the maximum radiation levels were low (hundredths of a milliroentgen per hour). One flight reported a peak 170 nmi (315 km) southwest of Hawaii at H+56 at 14,000 feet (4.27 km). This air sample collection point was directly along the path of the 40,000-foot (12.19-km) airborne particle trajectory. A second radioactive sample was collected 100 nmi (185 km) southeast of Hawaii 26 hours later at 19,000 feet (5.79 km). Another less active sample was obtained off the coast of Southern California on 12 April. Aircraft operating from Guam made no collections of KOON debris.

AIRCRAFT DECONTAMINATION. The decay period after the KOON shot was reduced from that of the ROMEO shot (to 20 hours) because of a possible early turnaround requirement. In addition, Table 41 indicates that the aircraft were generally only lightly contaminated compared to the two previous shots. Citric acid washings were discontinued starting with KOON. The first survey of 0.007 R/hr on F-84G No. 049, some 48 hours after the first surveys on the other F-84s, indicates an intensity of about 0.730 R/hr on 7 March, which is reasonable by comparison with other aircraft.

UNION

The UNION device, with a yield of 6.9 MT, was detonated at 0610 on 26 April from a barge anchored in 120 feet (37 meters) of water in the Bikini Lagoon off Iroij Island.

Preshot Preparation

The UNION detonation was initially scheduled for 16 April. The appropriate JTF 7 staff moved from Enewetak to the Bikini area on 15 April; at the midnight briefing, however, the weather was unfavorable and a 24-hour delay was ordered. By 1500 on 16 April, it became obvious that the weather would not improve within the foreseeable future and the shot was postponed indefinitely, subject to the condition that the joint task force maintain an 18-hour capability to conduct the test.

Table 41. Task Group 7.4 CASTLE, K00N aircraft decontamination.

Aircraft Type/ Tail No.	First Survey			Second Survey		
	Reading (R/hr)	Date (Time)	Type of Decon	Reading (R/hr)	Date (Time)	Type of Decon
B-36/1083	0.220	7 Apr (1340)	Decay	0.100	8 Apr (1110)	Wash
B-36/1086	0.800	7 Apr (1425)	Decay	0.260	8 Apr (0620)	Wash
B-29/7269	0.240	7 Apr (1130)	Decay	0.021	8 Apr (1420)	Wash
F-84/030	0.800	7 Apr (1050)	Decay	0.044	8 Apr (1515)	Soap
F-84/033	0.460	7 Apr (1000)	Decay	0.035	8 Apr (1454)	Soap
F-84/037	0.800	7 Apr (1045)	Decay	0.105	8 Apr (1555)	Soap
F-84/038	0.305	7 Apr (1140)	Decay	0.039	8 Apr (1535)	Soap
F-84/046	0.180	7 Apr (1120)	Decay	0.042	8 Apr (1538)	Soap
F-84/049	0.007	9 Apr (1210)	Decay	0.005	9 Apr (1330)	
F-84/051	0.225	7 Apr (1048)	Decay	0.012	8 Apr (1600)	Soap
F-84/053	0.200	7 Apr (1125)	Decay	0.024	8 Apr (1452)	Soap

Aircraft Type/ Tail No.	Third Survey		Total Decon Hours	Total Decon Pers
	Reading (R/hr)	Date (Time)		
B-36/1083	0.066	8 Apr (1343)	2.33	26
B-36/1086	0.230	8 Apr (0940)	4	26
B-29/7269	0.011	8 Apr (1515)	0.5	26
F-84/030	0.038	8 Apr (1635)	1	6
F-84/033	0.023	8 Apr (1530)	1	6
F-84/037	0.100	8 Apr (1630)	1	6
F-84/038	0.035	8 Apr (1604)	1	6
F-84/046	0.040	8 Apr (1600)	1	6
F-84/049			1	6
F-84/051	0.008	8 Apr (1640)	1	6
F-84/053	0.020	8 Apr (1532)	1	6

Source: Reference 30.

The weather remained unfavorable through 25 April, when acceptable conditions were predicted for the next day. Accordingly, the sequence of preshot activities began. The sector search for transient vessels centered on a bearing of 40° from ground zero. Two vessels were sighted within the sector (but not in Area Green), but were judged not to be in danger. The usual weather and command briefings were held and CINCPAC was

advised of the decision to detonate. The advisory indicated that no significant fallout was expected on populated atolls and that no closure of air routes would be necessary. Known shipping in the area is listed in Table 42.

Table 42. Summary of the status of transient shipping in the Pacific Proving Ground area on or about 26 April 1954.

Vessel	Location/Course
<u>USNS Faribaut</u> (T-AK-179)	Kwajalein on 22 April
<u>USS Wandank</u> (ATA-204)	11°07'N, 175°19'E, course 76, 6.7 knots (12.4 km/hr) at 1200, 25 April
<u>USNS Leo</u> (T-AKA-60)	At Enewetak at 1200 on 25 April through 1200 on 27 April
PC-1546	Departed Rongerik 1330 on 26 April to 10°27'N, 167°27'E, 18 knots (33.3 km/hr), thence to Bikini via route points 10°22'N, 166°56'E and 10°32'N, 166°04'E, 12 knots (30.6 km/hr), ETA Bikini 0500 on 27 April
<u>USNS Pvt J.F. Merrell</u> (T-AKV-4)	21°26'N, 168°40'E, course 260, 16.5 knots (30.6 km/hr) at 1200 on 27 April
<u>USNS Gen M.M. Patrick</u> (T-AP-150)	7°39'N, 156°20'E, course 269, 14.9 knots (27.6 km/hr)
LST-762	ETD Enewetak 1300 on 27 April, to 10°45'N, 163°0E, 5 knots (9.3 km/hr)
Freighter	Visual contact by search aircraft at 17°12'N, 167°40'E, course 270, 10 knots (18.5 km/hr) at 2300 on 25 April
Fishing boat	Radar contact by search aircraft, at 19°33'N, 171°0E, 10 knots (18.5 km/hr), nationality unknown
<u>M/V Roque</u>	Departed Ponape 25 April; 1200 on 26 April position 8°18'N, 155°27'E

Source: Reference 16.

In order to obtain more frequent UNION weather data from Rongerik, a patrol boat (PC-1546) housed the weather detachment at the atoll rather than the group flying in and out for weather runs during daylight hours as had been done since BRAVO. The boat was directed to take weather personnel

aboard after the midnight weather sounding and to be prepared to move south at "best speed" in the event of fallout.

Based on the midnight weather forecast, the surface and air radex areas from H-hour to H+6 were:

Surface Radex. True bearings from ground zero: 240° clockwise to 70°, radial distance of 75 nmi (139 km); 270° clockwise to 80°, radial distance of 100 nmi (185 km). Circular radex area around ground zero of 30 nmi (56 km)

Air Radex. For H+1, 10,000 feet (3.05 km) to 40,000 feet (12.19 km) (true bearings from ground zero): 95° clockwise to 35°, maximum distance 10 nmi (18.5 km); 35° clockwise to 95°, maximum distance 35 nmi (65 km).

For H+1, 40,000 feet (3.05 km) and up (true bearings from ground zero): 85° clockwise to 50°, maximum distance 25 nmi (46.3 km); 50° clockwise to 85°, maximum distance 60 nmi (111 km).

For H+6, 10,000 feet to 40,000 feet (12.19 km) (true bearings from ground zero): 90° clockwise to 45°, maximum distance 30 nmi (55.6 km); 45° clockwise to 90°, maximum distance 180 nmi (333 km).

For H+6, 40,000 feet (12.19) and up (true bearings from ground zero): 85° clockwise to 50°, maximum distance 80 nmi (148 km); 50° clockwise to 85°, maximum distance 290 nmi (537 km).

The radsafe situation was recommended as favorable at the 0100 (26 April) command briefing. Since light surface winds were predicted to move south, it was recommended that the task force ships (except those required to be closer for operational reasons) move 50 nmi (93 km) southeast of ground zero. It was also decided to make a final weather and rad-safe check at 0400. The forecast fallout was based on midnight weather, using the method of elliptical approximations as shown in Figure 80. A new fallout prediction technique, based on time and space changes in the wind pattern, was also used for UNION, and the results presented at the command briefing. The pattern was similar to that shown in Figure 80 except that the mid-line was reported to be a little farther south (Reference 16, Tab N).

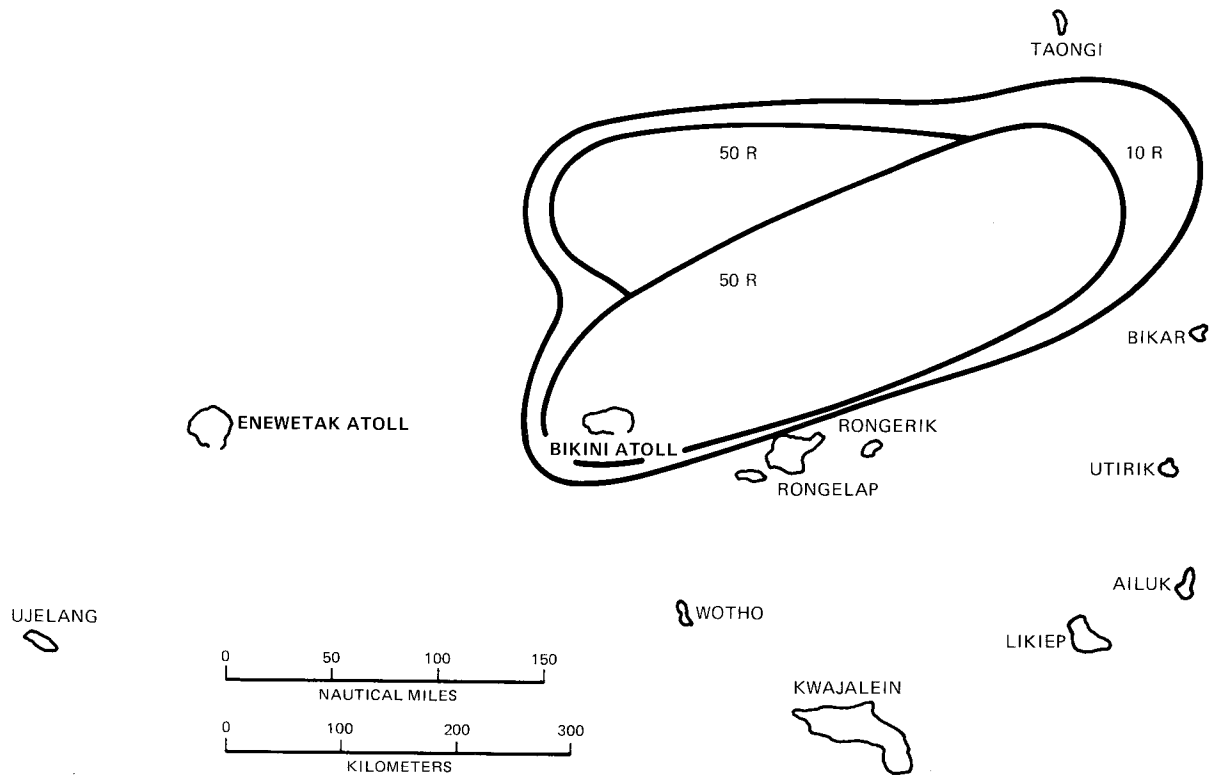

Figure 80. CASTLE, UNION predicted fallout pattern; contours enclose the 50- and 10-R infinite dose areas (source: Reference 16).

DOD Activities

The DOD-sponsored experiments for UNION included 28 projects in TU 13 of TG 7.1. TU 13 projects were:

- Program 1, Blast and Shock; Projects 1.1a, 1.1b, 1.1c, 1.1d, 1.2a, 1.2b, 1.3, 1.4, 1.5, 1.6
- Program 2, Nuclear Radiation and Fallout; Projects 2.1, 2.2, 2.5a, 2.5b, 2.6a, 2.6b
- Program 3, Blast Effects; Projects 3.2, 3.4
- Program 6, System Effects; Projects 6.1, 6.2a, 6.2b, 6.4, 6.5, 6.6
- Program 7, Electromagnetics; Projects 7.1, 7.2, 7.4
- Program 9, Cloud Photography; Project 9.1.

The instrument station locations on the islands of the atoll are shown in Figure 81. Details of each project are given in Chapter 3. The locations of the task force ships at burst time are given in Figure 82. The positions of the nonsampling aircraft at burst time are presented in Table 43.

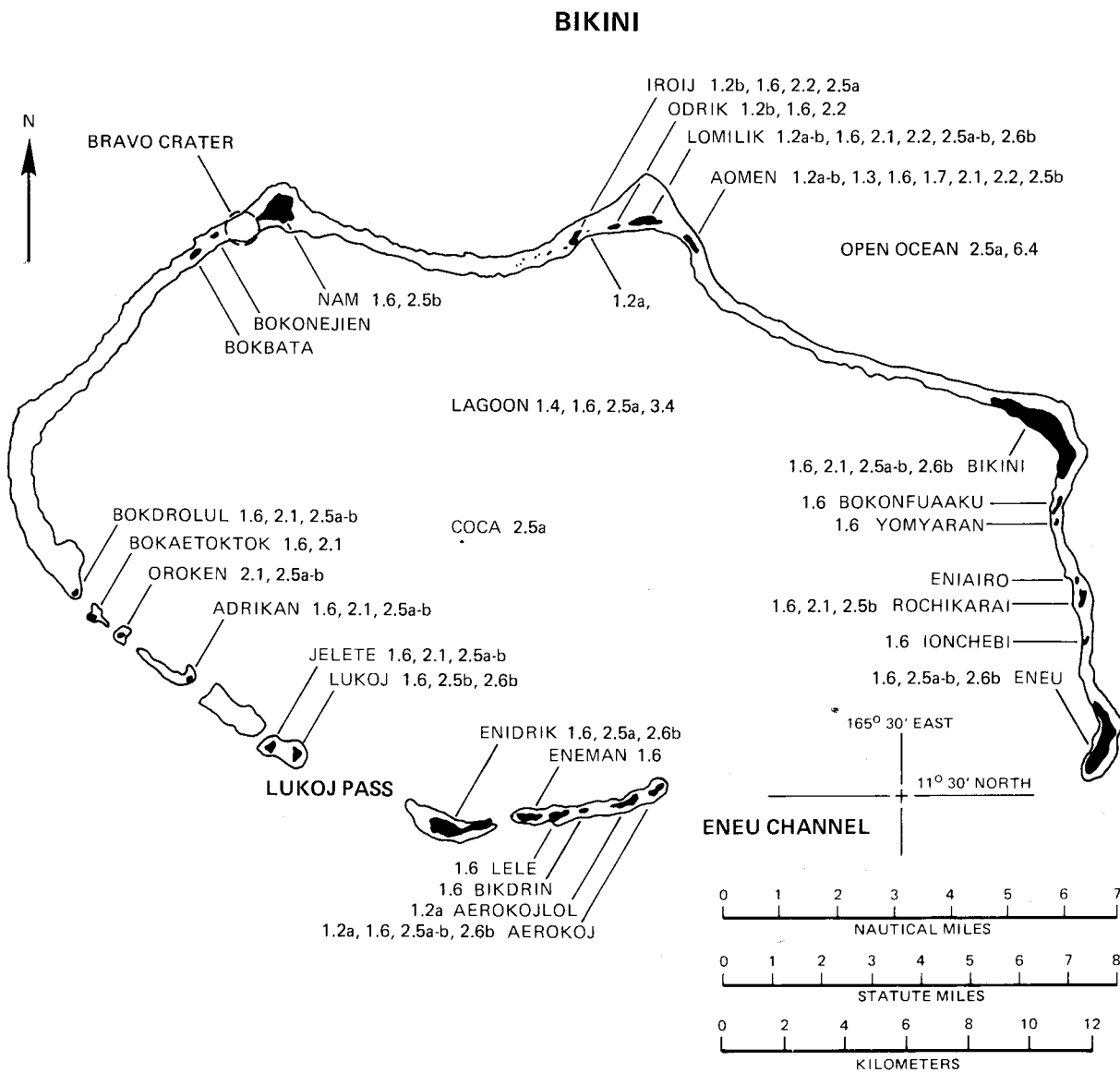

Figure 81. CASTLE, UNION instrumentation stations for the DOD scientific project instrument locations.

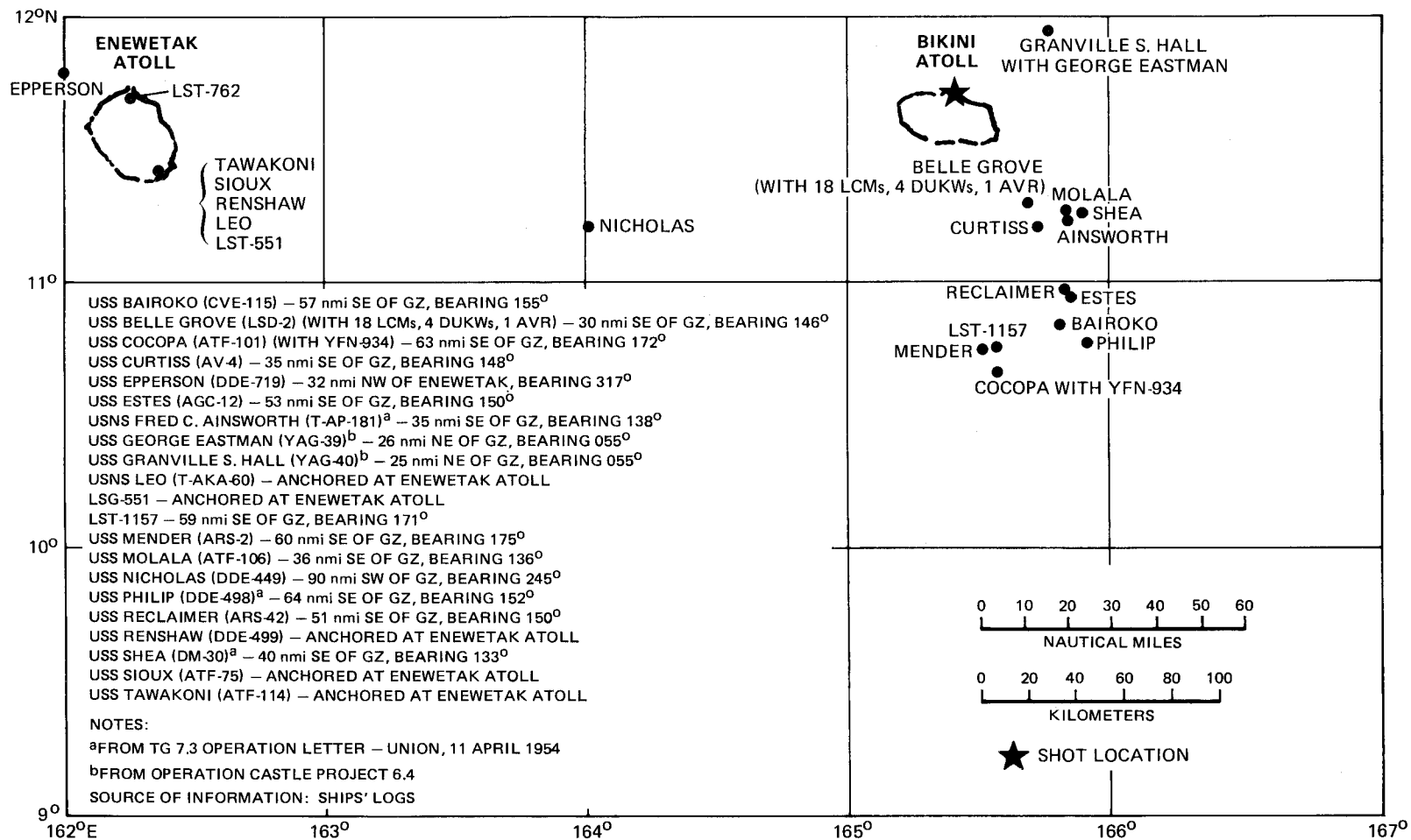

Figure 82. Ship positions at detonation time, CASTLE, UNION.

Table 43. Aircraft positioning data for CASTLE, UNION.

Aircraft	Altitude (km) ^b	Slant Range ^a (km) ^b	Heading (deg)	Direction ^a (deg)
B-36 Effects	12.2	19.1	188	---
B-47 Effects	10.7	20.0	180	174
B-50 IBDA ^C	abort	---	---	---
B-50 IBDA ^C	9.4	42.6	---	---
B-50 IBDA ^C	9.1	55.6	---	---
C-54-1	4.3	138.9	315	---
C-54-2	3.2	92.6	270	---
C-54-3	3.8	138.9	225	---

Notes:

^aFrom ground zero.

^bOne kilometer equals 3,281 feet.

^cIndirect Bomb Damage Assessment.

The Test

The UNION cloud reached an altitude of about 94,000 feet (28.65 km) (Figure 83). Cloud travel was influenced by three winds. The low-altitude portion moved toward the west, the middle portion moved east-northeast, and the mushroom cap is believed to have moved to the north and west. None of the cloud-tracking aircraft made contact with fallout from the cloud mushroom cap (Reference 16, Tab N, p. 33).

CONTAMINATION. The Wilson 2 and Wilson 3 flights, in the air until about H+13, detected no contamination moving toward Enewetak or Ujelang, and at H+15 Wilson 2 proceeded to monitor the upwind sector of the pattern. Wilson 2 noted low-level contamination in the vicinity of Rongelap; accordingly, PC-1546 was ordered to move south out of the area and return to Bikini. An early report (H+3) from a sampling aircraft indicated an aerial reading in the roentgen-per-hour range 10 nmi (18.5 km) south of the shot

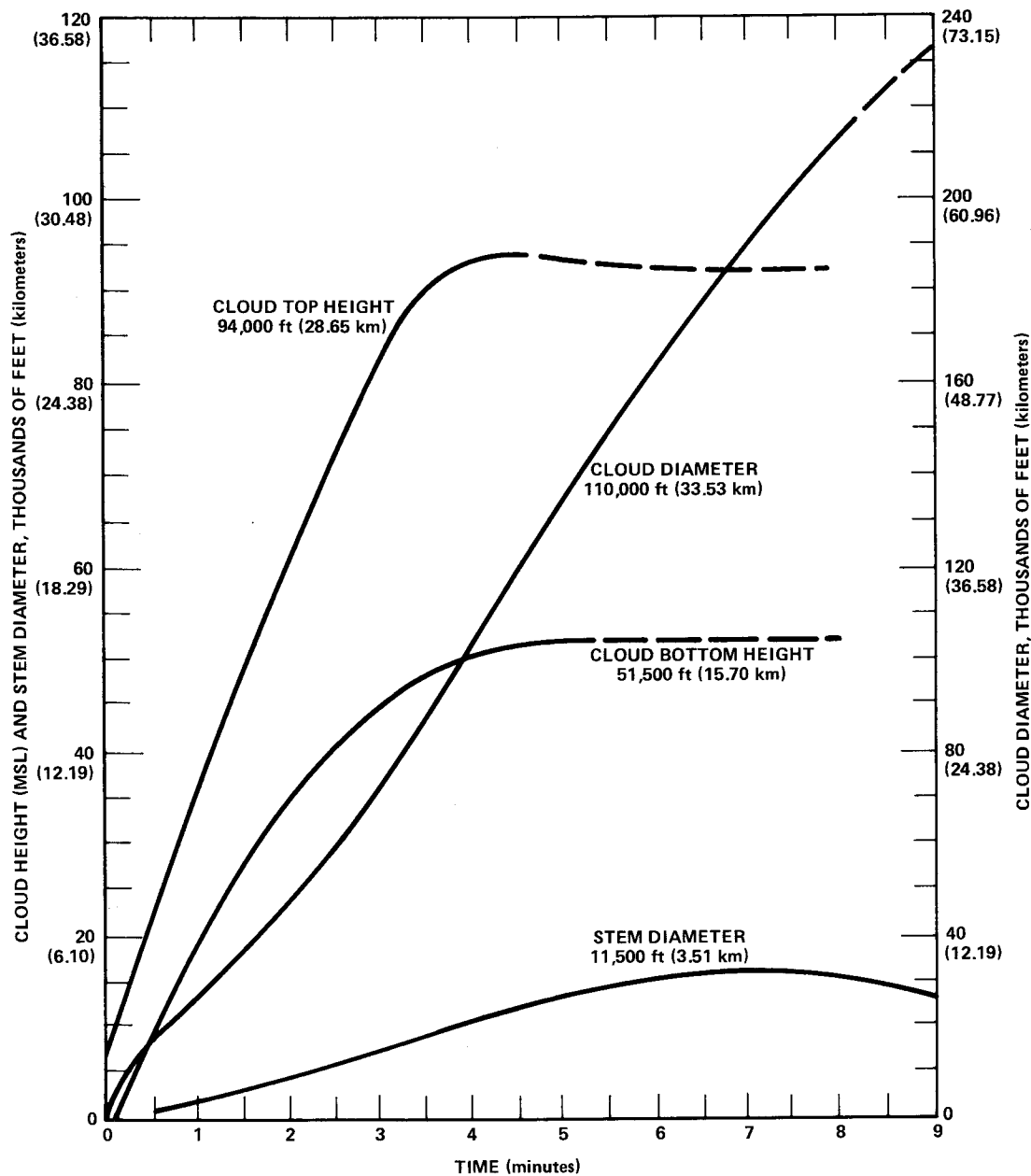

Figure 83. CASTLE, UNION cloud dimensions (source: Reference 81).

island. Wilson 3 was directed to monitor the area, then return to the holding pattern. Based on the Wilson 3 report of insignificant contamination of the southern islands, the fleet approached to a point 10 nmi (18.5 km) south of Eneu to prepare for the preliminary damage and radiation survey. The radsafe report (Reference 17) notes:

In view of the small amount of experience with water surface shots, cautious actions were imperative. Subsequent movements and events on shot day were delayed for approximately one to two hours, a factor of considerably less importance than taking an unnecessary risk with the embarked task force.

At H+4, the radiological survey helicopters were launched from the Bairoko. Based on this survey, reentry to the lagoon was set at 1500. The survey covered the eastern and northern islands of the atoll and was conclusive enough to limit scientific recovery to Eneu, Bikini, and Aero-koj on the first day. The survey on D+1 indicated that recontamination was limited to the Iroi-j-Aomen and the Bikini-Eneu sequence of islands. No significant secondary fallout was encountered at Bikini as a result of this detonation.

Lagoon water was substantially contaminated with radioactive sediment. D-day readings of 4.2 R/hr were obtained at an altitude of 500 feet (about 150 meters) over ground zero. This contamination moved to the west and southwest, allowing small-boat operations in the area of ground zero. Lagoon water movement toward the Southwest Passage increased radiation levels in the vicinity of Oroken, Bokaetoktok, and Bokdrolul. Table 44 shows radiation intensity on the various islands. Figure 84 gives the radiation contours at H+1.

At 1400, Wilson 3 (and later Wilson 4, flying from H+12 to H+26) was directed to make a low-altitude (300 to 600 feet; 92 to 183 meters) survey at various atolls southeast of ground zero. Table 45 lists the results of this survey.

During the shot day and throughout the night, secondary fallout was encountered by some of the ships as indicated in Table 46 (Reference 17, Tab N).

Enewetak Atoll reported a maximum reading of 0.004 R/hr. Weather reconnaissance flights on D+1 to the west, south, and northeast encountered

Table 44. CASTLE, UNION radiation summary (R/hr).

Island	Extrapolated H+4	D+1	D+4	Background
Eneu ^a	0.75	0.10	0.03	0.01
Bikini ^a	70.00	8.50	0.80	0.03
Aomen ^a	140.00	15.00	2.00	0.40
Lomilik ^a	140.00	15.00	2.40	0.40
Odr ik ^a	85.00	10.00	1.00	0.36
Nam			1.00	2.50
Iroij ^a	85.00	10.00	1.00	0.40
Bokbata		1.20	2.20	4.00
Oroken		0.01	0.50 ^b	0.01
Adrikan		0.01	0.60 ^b	0.01
Enidrik		0.06	0.10 ^b	0.90
Eneman Crater		6.50	4.00	100.00
Aerokoj		0.01	0.01	0.01
Crater ^a	4.20 ^c		0.01	0

Notes:

^aContaminated by UNION.

^bRadiation from contaminated water.

^cReading at 500 feet (150 meters).

Source: Reference 91.

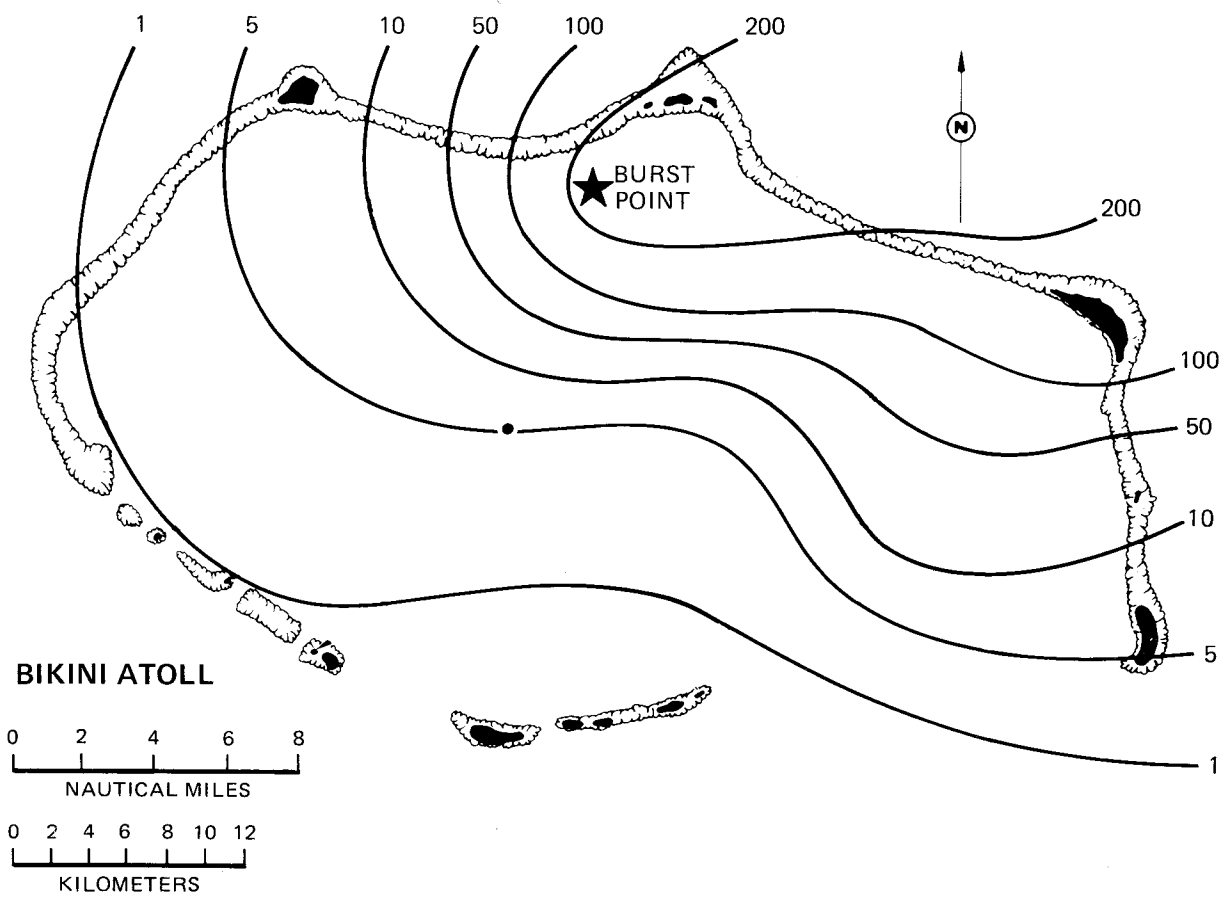

Figure 84. CASTLE, UNION close-in gamma fallout pattern at H+1 (R/hr)
(source: Reference 53).

Table 45. CASTLE, UNION atoll survey by Wilson 3 and Wilson 4 on shot day.

Atoll	Time	Reading (R/hr)	Altitude (feet/meters)
Ailinginae	1500	0.005	300/92
Rongelap	1507	0.007	450/137
Rongerik	1525	0.007	450/137
Bikar	1632	0.005	600/183
Utirik	1655	0.004	600/183
Taka	1702	0.006	600/183
Ailuk	1725	0.004	600/183
Jemo	1732	0.003	600/183
Wotje	1803	0.003	400/122
Mejit	1848	0.003	---
Likiep	1901	<0.001	---
Wotho	2341	0.001	200/61

Table 46. Secondary CASTLE, UNION fallout noted on vessels of JTF 7 on shot day.

Vessel	Time	Average (R/hr)	Maximum (R/hr)
<u>USS Cocopa</u> (ATF-101)	2200	0.002	0.004
<u>USS Mender</u> (ARSD-2)	2100	0.002	0.004
<u>USS Shea</u> (DM-30)	0730	0.003	0.005
LST- 1157	1930	0.002	0.003
<u>USS Nicholas</u> (DDE-449) ^a	1320	0.002	0.004
	1416	0.037	0.110

Note:

^aNicholas reported all clear at 1443; departed for Bikini (ETA 1745, 26 April)

no contamination except for a single contact of 0.001 R/hr, 800 nmi (1,480 km) northeast of ground zero at H+33. Air Force sample collections made from D+4 to D+7 near Hawaii and off the California coast detected very low levels of radiation.

The results of the NYKOPO monitoring survey flight over the inhabited atolls are shown in Table 47.

AIRCRAFT DECONTAMINATION. Because of a possible early turnaround after the UNION shot, the cowlings of a B-36 control aircraft (No. 1386) were removed 10 minutes after landing and decontamination was started immediately without a decay period. Its initial survey of 0.090 R/hr was comparatively low (see Table 48), justifying the procedural change. All other aircraft were "cooled" for 26 to 44 hours before decontamination was started. The 26-hour period was used for those aircraft scheduled for YANKEE. As a consequence, some aircraft were released to maintenance with radiation readings as high as 0.400 R/hr. Even after a 44-hour decay period, some of the other aircraft were released with high readings. WB-29 aircraft No. 7271 presented considerable difficulty with contamination on its nose area where soft putty had been used as a sealer and apparently entrapped some radioactive particulate material. It was released with a reading of 1.700 R/hr, which was quite high but considerably down from its initial intensity of 40.000 R/hr.

YANKEE

YANKEE, the final CASTLE detonation at Bikini, was fired at 0610 on 5 May 1954. The 13.5-MT device was detonated on a barge anchored south of Iroij at the same location as the UNION shot. CJTF 7 intended to detonate NECTAR at Enewetak prior to YANKEE; however, unfavorable Enewetak winds concurrent with favorable Bikini weather led to a 4 May cancellation of NECTAR and the scheduling of YANKEE.

Preshot Preparation

An initial informal command briefing was held at 1100 on 4 May on Parry. No significant fallout was predicted outside the danger area, and

Table 47. CASTLE, UNION airborne monitoring survey results of the AEC New York Operations Office.

Location ^a	Flight Able						Other NYKOPO Flights		
	Local Time (21 April)	Maximum Ground Reading (R/hr)	Local Time (27 April)	Maximum Ground Reading (R/hr)	Local Time (1 May)	Maximum Ground Reading (R/hr)	Flight	Date	Maximum Ground Reading (R/hr)
Lae	0824	0.00030	0853	0	0655	0.00004	Baker	21 April	0.00040
Ujae	0834	0	0903	0.00020	0707	0.00008	Baker	2 May	0.00012
Wotho	0901	0	0930	0	0737	0.00030	Charlie	2 May	0.00007
Ailinginae	0952	0.00240	1029	0.00160	0830	0.00004			
Rongelap Island	1006	0.01200	1041	0.00800	0845	0.02000			
Rongerik	1020	0.00800	1055	0.01100	0858	0.00800			
Taongi	1145	0.00004	1223	0.00020	1014	0.00004			
Bikar	1241	0.00040	1318	0	1111	0.00370			
Utirik	1259	0.00080	1335	0.00200	1135	0.00170			
Taka	1304	0.00040	1342	0.00240	1138	0.00070			
Ailuk	1323	0.00010	1402	0.00040	1159	0.00060			
Jemo	1332	0.00008	1410	0	1209	0.00012			
Likiep	1343	0.00004	1422	0.00060	1216	0.00008			
Kwajalein	1435	0	1510	0	1200	0.00010 ^b			

Notes:

^aAtoll unless otherwise indicated

^bGround observation.

Source: Reference 16.

Table 48. Task Group 7.4 CASTLE, UNION aircraft decontamination.

Aircraft Type/ Tail No.	First Survey			Second Survey			Type of Decon
	Reading (R/hr)	Date (Time)	Type of Decon	Reading (R/hr)	Date (Time)	Type of Decon	
B-36/1086	1.000	26 Apr (1215)	Decay	0.210	27 Apr (1555)	Wash	
B-36/1386	0.090	26 Apr (1300)	Wash	0.085	27 Apr (1650)		
WB-29/7269	0.200	26 Apr (2120)	Decay	0.140	27 Apr (1000)	Wash	
WB-29/7271	40.000	26 Apr (0945)	Decay	2.200	28 Apr (1015)	Wash	
F-84/028	36.000	26 Apr (1010)	Decay	2.100	28 Apr (0810)	Wash	
F-84/030	4.000	26 Apr (1151)	Decay	0.440	27 Apr (0840)	Wash	
F-84/032	8.000	26 Apr (1015)	Decay	0.360	28 Apr (0820)	Wash	
F-84/033	6.000	26 Apr (1103)	Decay	0.600	27 Apr (0930)	Wash	
F-84/037	1.800	26 Apr (1225)	Decay	0.300	27 Apr (0925)	Wash	
F-84/038	4.200	26 Apr (1149)	Decay	0.340	28 Apr (0815)	Wash	
F-84/054	2.600	26 Apr (1223)	Decay	0.445	27 Apr (0930)	Wash	

Aircraft Type/ Tail No.	Third Survey		Total Decon Hours	Total Decon Pers
	Reading (R/hr)	Date (Time)		
B-36/1086	0.210	27 Apr (1930)	3.5	26
B-36/1386			3	12
WB-29/7269	0.080	27 Apr (1445)	2	13
WB-29/7271	1.700	28 Apr (1320)	2.5	13
F-84/028	0.600	28 Apr (1130)	1	6
F-84/030	0.240	27 Apr (1400)	1.5	6
F-84/032	0.110	28 Apr (1130)	1	6
F-84/033	0.240	27 Apr (1515)	0.75	6
F-84/037	0.070	27 Apr (1400)	1.5	6
F-84/038	0.110	28 Apr (1130)	1	6
F-84/054	0.160	27 Apr (1400)	1	6

Source: Reference 30.

no transient ships were known to be in the danger area (Table 49). Therefore, the decision to detonate was communicated to CINCPAC. An air search of Area Green was initiated and orders were given for a 0615 postshot sector search centered on 50°. The headquarters and task group command staffs then flew to Bikini.

Table 49. Summary of the status of transient shipping in the Pacific Proving Ground area on or about 5 May 1954.

Vessel	Location/Course
LSTs 762 and 975	Approximately 650 nmi (1,200 km) east-northeast of ground zero at H-hour, en route to Pearl Harbor
<u>USS Navasota</u> (AOG-106)	Arrived Kwajalein 0735 on 5 May, ETD for Midway 5 May
<u>USS Shea</u> (DM-30)	Arrived Kwajalein 1900 on 4 May, ETD for Pearl Harbor 5 May
<u>USNS Leo</u> (T-AKA-60) and <u>USS Arequipa</u> (AF-31)	At Enewetak 1200 on 4 May
<u>USS Reclaimer</u> (ARS-42)	Departed Bikini to Guam 1200 on 4 May via 10°40'N, 165°10'E, 10°40'N, 155°E, 11 knots (20 km/hr); ETA Guam 1800 on 9 May
Destroyer ^a	Radar contact from search aircraft at 2000 on 4 May, 10°45'N, 162°54'E, course 190 true
Destroyer ^a	Visual contact from search aircraft at 2030 on 4 May, 10°31'N, 165°51'E, course 150 true, 10 knots (18.5 km/hr)
<u>M/V Roque</u>	Departed area 27 April; 5 May position, Rota

Note:

^aType of ship unclear from reference, given as "1 DD."

Source: Reference 16.

At 1700 on 4 May, the following radex areas were announced:

Surface Radex. True bearings from ground zero 240° clockwise to 90°, radial distance of 60 nmi (110 km) for H-hour to H+6, plus a circular radex area around ground zero of 15 nmi (27.8 km) radius. This was later modified to 320° clockwise to 70° for a maximum distance of 60 nmi (110 km), 70° clockwise to 200° for a maximum distance of 30 nmi (56 km), and 200° clockwise to 260° for a maximum distance of 70 nmi (130 km), plus a circular radex around ground zero of 15 nmi (27.8 km) radius.

It was recommended that the air control destroyer (the Nicholas) move to a true bearing from ground zero of 270° and 90 nmi (167 km).

Air Radex. For H+1, 10,000 feet (3.05 km) to 40,000 feet (12.19 km), 225° clockwise to 290° from ground zero for a maximum distance of 25 nmi (46 km), 290° clockwise to 30° for a maximum distance of 20 nmi (37 km), 30° clockwise to 100° for a maximum distance 30 nmi (56 km), and 100° clockwise to 225° for a maximum distance of 5 nmi (9.3 km).

For H+1, 40,000 feet (12.19 km) and up, 230° clockwise to 320° from ground zero for a maximum distance of 30 nmi (56 km), 320° clockwise to 50° for a maximum distance of 15 nmi (27.8 km), 50° clockwise to 115° for a maximum distance of 55 nmi (102 km), and 115° clockwise to 230° for a maximum distance of 15 nmi (27.8 km).

For H+6, 10,000 feet (3.05 km) to 40,000 feet (12.19 km), 245° clockwise to 290° from ground zero for a maximum distance of 110 nmi (204 km), 290° clockwise to 30° for a maximum distance of 75 nmi (139 km), and 30° clockwise to 85° for a maximum distance of 130 nmi (241 km).

For H+6, 40,000 feet (12.19 km) and up, 230° clockwise to 320° from ground zero for a maximum distance of 110 nmi (204 km) and 50° clockwise to 115° for a maximum distance of 250 nmi (463 km).

Command briefings at 1830 and at midnight confirmed the favorable weather predictions for shot time. The forecast fallout pattern, based on the midnight briefing, is shown in Figure 85. The task force fleet was located east-southeast of ground zero at 25 to 35 nmi (46 to 65 km); rad-safe recommended that the slower ships move to 50 nmi (93 km) on a bearing of 120° and that the other ships move south after the H-hour firing requirements were completed.

DOD Activities

The DOD-sponsored experiments for YANKEE included 20 projects in TU 13 of TG 7.1. TU 13 projects were:

- Program 1, Blast and Shock; Projects 1.1a, 1.1b, 1.1c, 1.1d, 1.2a, 1.2b, 1.3, 1.4, 1.5, 1.6
- Program 2, Nuclear Radiation and Fallout; Projects 2.6a, 2.7, 2.7a
- Program 6, System Effects; Projects 6.1, 6.2a, 6.4
- Program 7, Electromagnetics; Projects 7.1, 7.2, 7.4
- Program 9, Cloud Photography; Project 9.1.

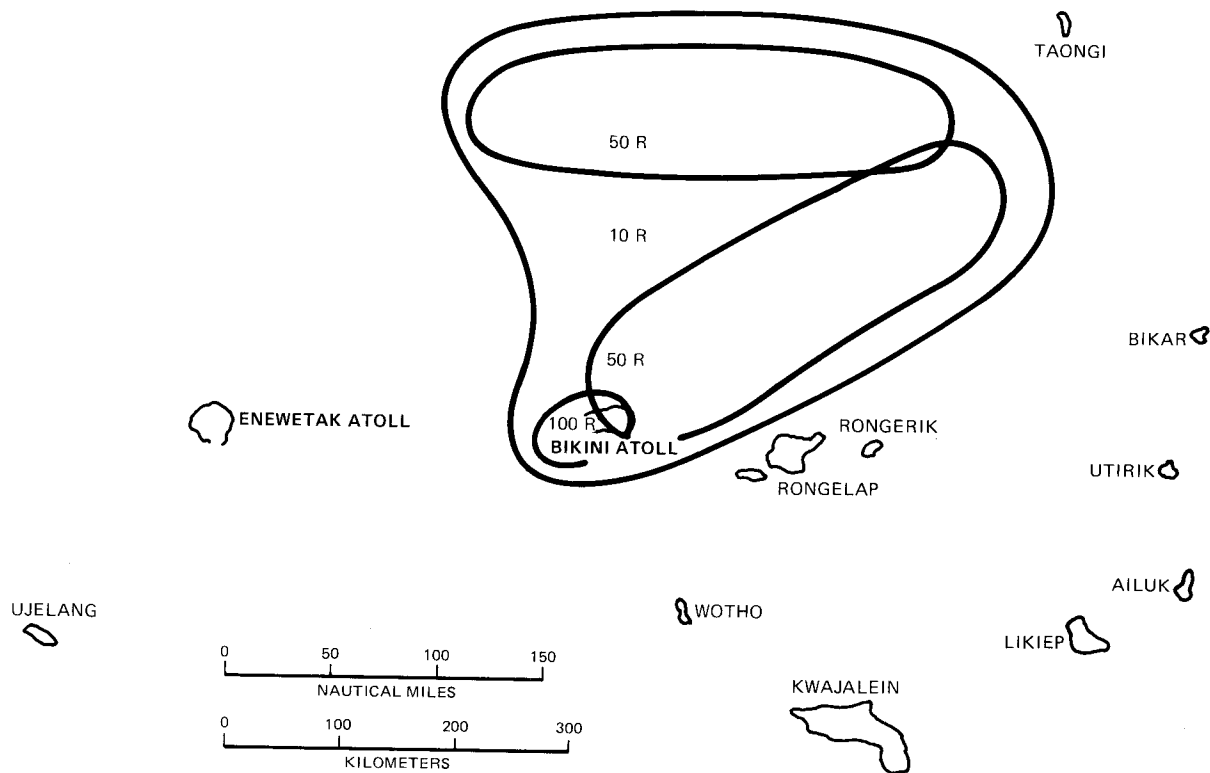

Figure 85. CASTLE, YANKEE predicted fallout pattern, based on the method of elliptical approximations; contours enclose the 100-, 50-, and 10-R infinite dose areas (source: Reference 16).

The instrument station locations on the islands of the atoll are shown in Figure 86. The details of each project are given in Chapter 3. The locations of the task force fleet are given in Figure 87.

The aerial sampling effort for YANKEE was reduced to about one-half the normal activity. This was done to enable TG 7.4 to participate in the Enewetak detonation within 24 hours, if required. Nine F-84s, one FB-36, and one WB-29 sampler were used in YANKEE.

The B-36 effects aircraft at detonation time was flying a 180° heading at a 40,000-foot (12.2-km) altitude and a slant range of 58,000 feet (17.7 km) from ground zero. The B-47 effects aircraft aborted with a fuel leak. At burst time, one of the B-50 indirect bomb damage assessment (IBDA)

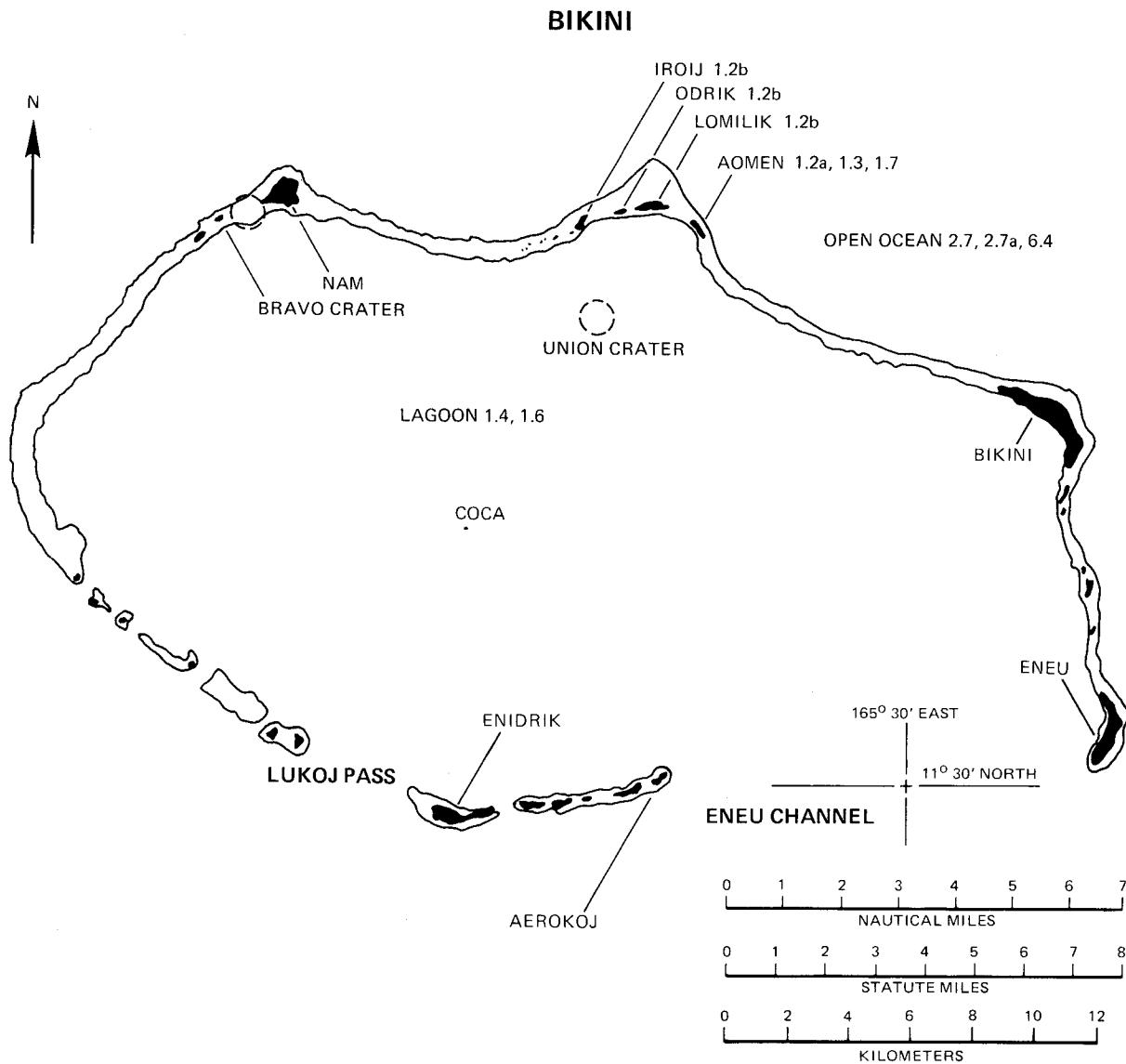

Figure 86. CASTLE, YANKEE instrumentation stations for the DOD scientific projects at Bikini Atoll.

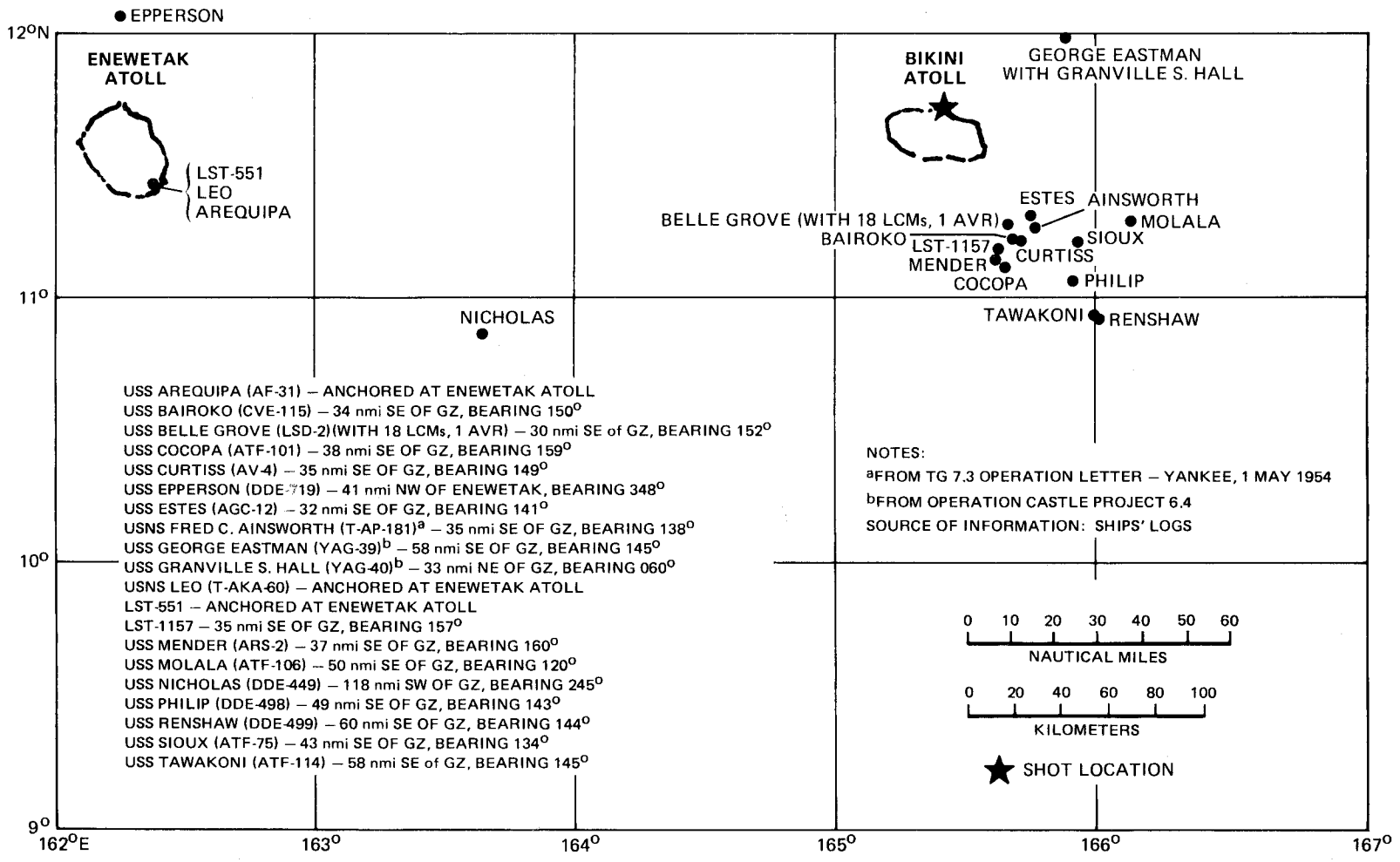

Figure 87. Ship positions at detonation time, CASTLE, YANKEE.

aircraft was at a 32,000-foot (9.8-km) altitude and a slant range of 91,000 feet (27.8 km). A second B-50 IBDA aircraft was at a 30,000-foot (9.1-km) altitude and a slant range of 182,000 feet (55.5 km). The third IBDA B-50 aborted. A maximum radioactivity reading of 0.020 R/hr was recorded for 10 to 15 seconds onboard the B-36 effects aircraft; this was the only radiation noted by the effects aircraft during the CASTLE series.

The Test

The early cloud dimensions following the 0610 detonation are shown in Figure 88. The lowest level of the stem (surface to 15,000 feet [4.6 km]) was influenced by 17.3-mi/hr (27.8-km/hr) winds from the east. This movement was confirmed by a cloud-tracking aircraft reporting a maximum intensity of 0.063 R/hr at H+4, 60 nmi (111 km) west-southwest of ground zero at 10,000 feet (3.05 km).

CONTAMINATION. Based on the position of cloud tracker contact and the forecast air trajectories, this contamination is believed to have passed to the south of Enewetak Atoll. The peak activity reported at Enewetak was 0.002 R/hr. Remnants of this portion of the cloud probably account for the 0.005 R/hr radiation level reported 460 nmi (852 km) southwest of ground zero during a weather reconnaissance mission on D+1. The middle level of the cloud (16,000 to 60,000 feet [5 to 18 km]) moved to the east-northeast at 17.3 mi/hr (27.8 km/hr). Several contacts were subsequently made with fallout from this segment. Between H+5 and H+7, the trailing edge of the cloud was clearly defined by one of the cloud-tracking aircraft; maximum intensities of 2 R/hr were reported 300 nmi (556 km) east-northeast of Bikini. The cloud top moved initially to the north and west. In the fallout process, however, this debris was carried back toward the east and intercepted several times. The first was at H+15, when a tracker aircraft was able to completely delineate a fallout area that was centered 340 nmi (630 km) to the east-northeast of ground zero (92 nmi [170 km] north of Bikar Atoll); the maximum reading inside this area was about 0.5 R/hr. At the same time, another cloud-tracking aircraft located radioactivity of 6 R/hr in this same general area, but at an altitude of 1,500

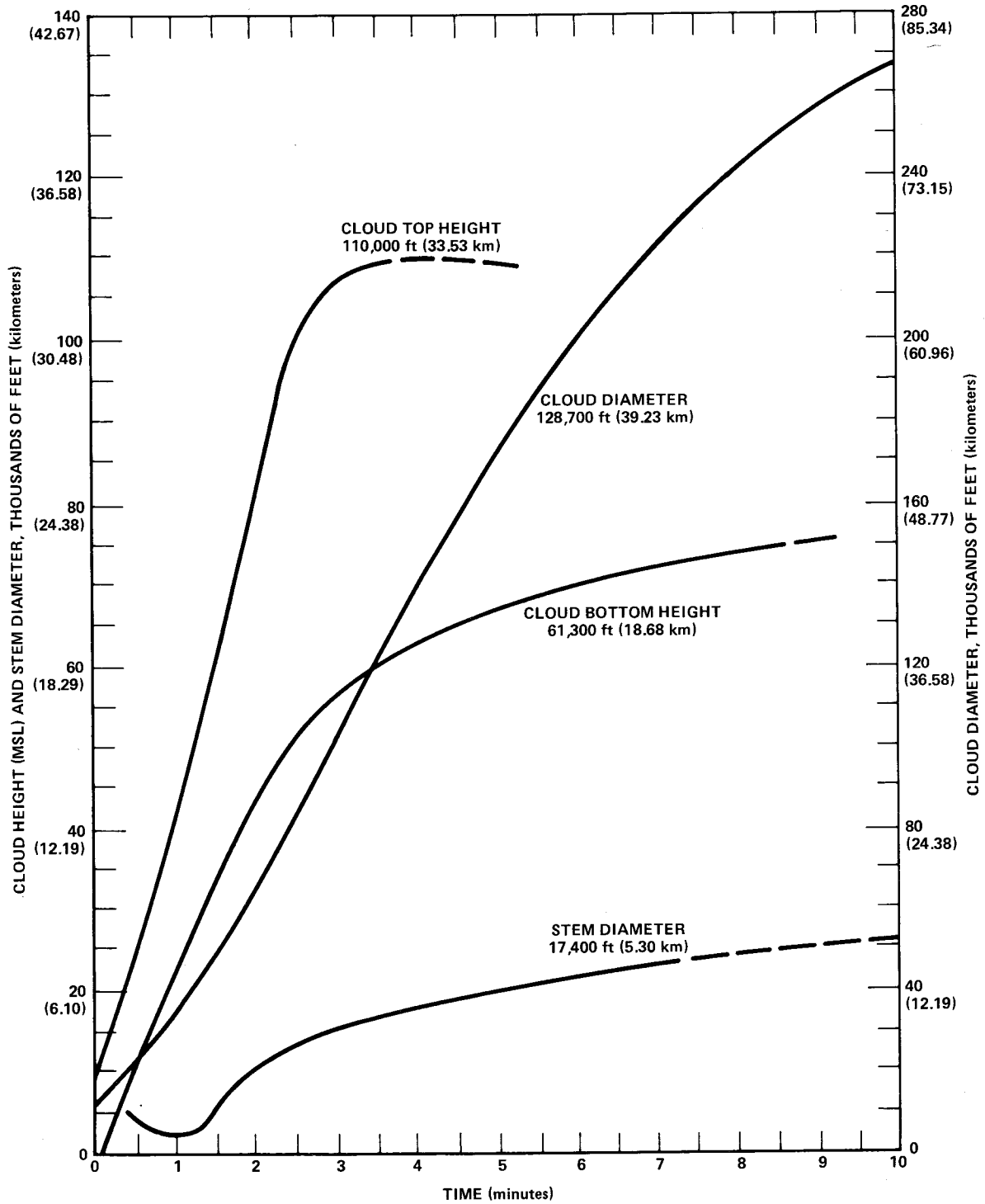

Figure 88. CASTLE, YANKEE cloud dimensions (source: Reference 81).

feet (457 meters) (Reference 16, Tab O). Figure 89 shows the dimensions of the cloud based on the aerial tracking observations.

At 0900 the Bairoko, 10 nmi (19 km) off Eneu, launched radsafe survey helicopters. This survey covered the islands of the atoll and was conclusive enough to limit data-recovery operations to Eneu and Aerokoj on the first day. This survey indicated that recontamination was extensive throughout the atoll and lagoon both to the east and west. The radiation intensities on islands of the atoll are shown in Table 50. No significant secondary fallout was encountered at Bikini as a result of this detonation.

Lagoon water was heavily contaminated with radioactive sediment. Readings of 1 R/hr were obtained at a 100-foot (30.5-meter) altitude in the vicinity of ground zero on D+1. Floating objects revealed readings of 1 to 3 R/hr on shot day. Small boats and barges in Bikini-Eneu anchorage were contaminated to a moderate degree (1 to 6 R/hr). The initial radsafe reports indicated that the lagoon was too contaminated for reentry by the fleet. Following a conference, the decision was made for the Estes to return to Enewetak while other ships remained at sea in the Bikini area. A short sortie from 1600 to 2040 into the lagoon was made by the Estes, Curtiss, and Belle Grove in order to use the Belle Grove's boats to exchange passengers. Reentry to the lagoon was made at 0815 on 6 May. The Curtiss departed that evening for Enewetak, landing CTG 7.3 at Parry Island the following morning (Reference 14, pp. 174-175). Lagoon water movement toward the Southwest Passage substantially increased radiation levels in the Enidrik-Bokdrolul area.

The YANKEE fallout pattern is shown in Figure 90.

Two LSTs, 762 and 975, en route in company from Enewetak to Hawaii, encountered the fallout cloud about 700 nmi (1,300 km) east-northeast of ground zero at H+35 to H+41. LST-762 was equipped with standard task force washdown equipment, but LST-975 had only standard firefighting equipment. At 12⁰56'N, 176⁰51'E at 1300 on 6 May, radiation intensities of 0.015

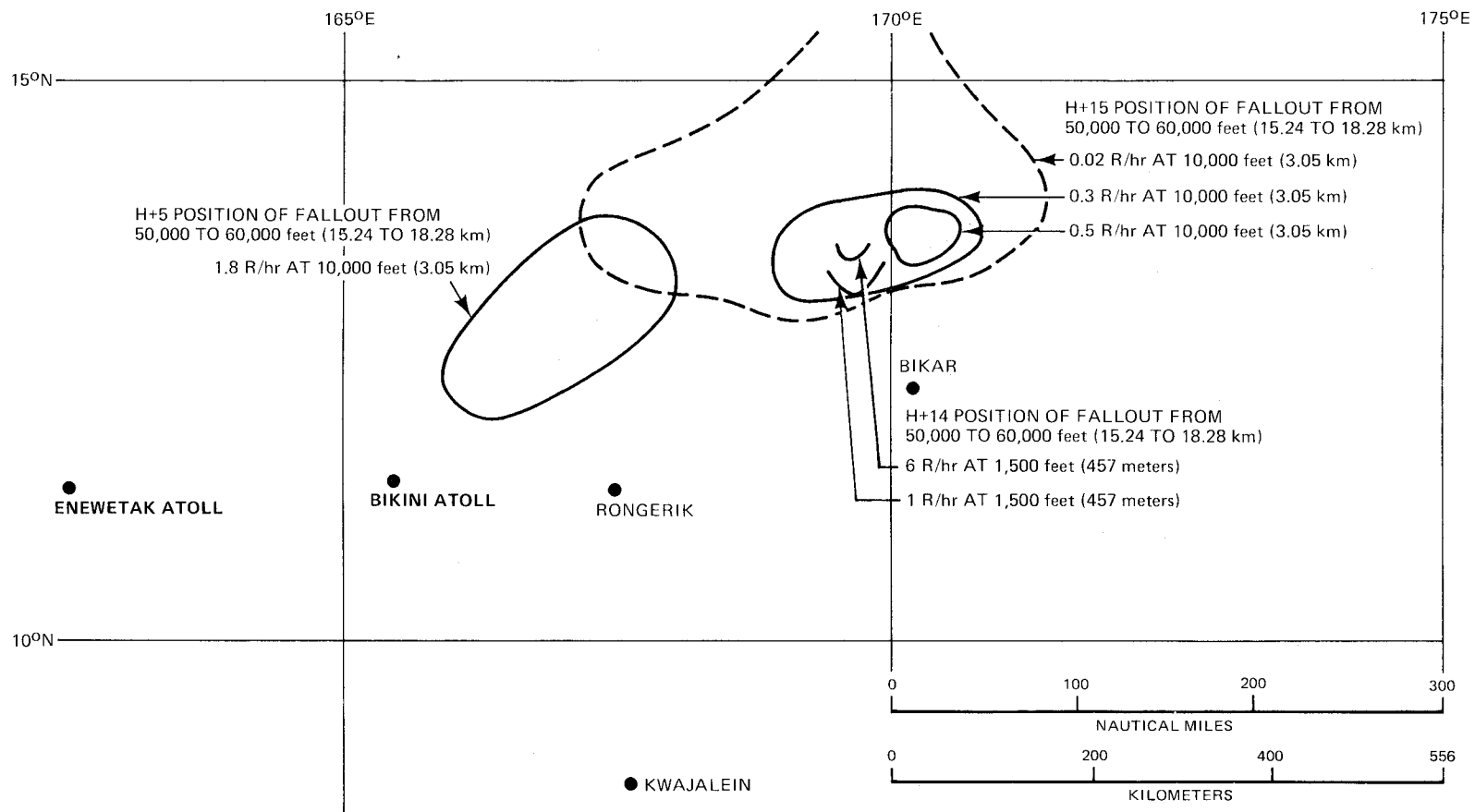

Figure 89. Areal extent of CASTLE, YANKEE fallout cloud (source: Reference 16, Tab D).

Table 50. CASTLE, YANKEE radiation summary (R/hr).

Island	Extrapolated H+4	D+1	D+5 ^a	Background
Eneu ^b	18.00	2.00	0.44	0.02
Bikini ^b	225.00	25.00	2.00	0.32
Aomen ^b	50.00	6.00	0.80	1.00
Lomilik ^b	65.00	7.50	1.20	1.00
Odrirk ^b	95.00	12.00	2.00	0.25
Iroij ^b	95.00	12.00	4.00	1.00
Nam ^b	10.00		1.00	0.80
Bokbata			0.95	3.00
Oroken ^b	3.50(?)	0.50 ^c	0.12 ^c	0.01
Adrikan ^b	1.30	0.60 ^c	0.01 ^c	0.08
Enidrik ^b	0.18	0.01	0.1 - 1.0	0.03
Aerokoj ^b	0.505	0.01	0.01	0.01
Crater		1.00 ^d		
Lagoon			80.00 (west)	

Notes:

^aFinal aerial survey.

^bContaminated by YANKEE.

^cRadiation shine from water in Southwest Passage.

^dReading at 100 feet (30.5 meters).

Source: Reference 91.

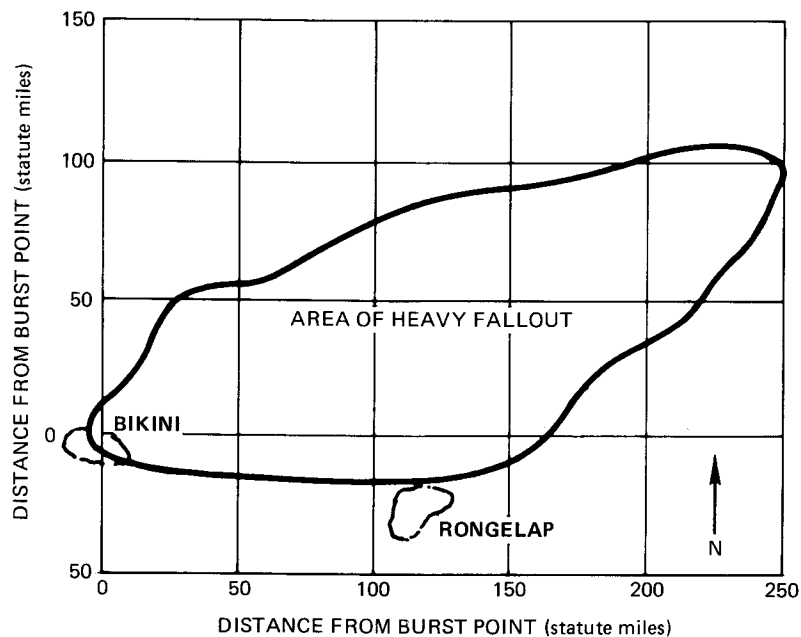

Figure 90. CASTLE, YANKEE heavy fallout area. The area within the contour would have been a full radex area 24 hours after the shot had the fallout been over dry land (after Reference 81).

R/hr (and increasing) were noted. The LSTs carried out decontamination procedures. At 1700, readings averaged 0.020 R/hr (0.040 R/hr maximum), with the highest readings on wind-exposed surfaces. The ships' position at 2000 was $13^{\circ}16'N$, $177^{\circ}97'E$. A steady decrease in radiation intensity was noted after 2330, and decontamination continued throughout the night. LST-762 reported a maximum of 0.040 R/hr; LST-975, 0.096 R/hr. By 0800 on 7 May (position $14^{\circ}30'N$, $178^{\circ}40'E$), intensities had dropped to an average of 0.005 R/hr and a maximum of 0.015 R/hr. At 0700 on 8 May at position $15^{\circ}5'N$, $178^{\circ}44'E$, LST-762 indicated an average of 0.003 R/hr and a maximum of 0.008 R/hr; LST-975 reported 0.007 and 0.010 R/hr, respectively.

No individual exposures are available for this incident. It is not clear whether the cumulative exposures reported for the crew of LST-762 and reported in Reference 13 included this radiation, or whether the ship's film badges had been given to TU 7 for processing before the ship departed Enewetak.

The preliminary results of the off-atoll surveys by NYKOPO are shown in Table 51.

AIRCRAFT DECONTAMINATION. After YANKEE, the B-36 (No. 1386) control aircraft, with an initial radiation reading of 0.100 R/hr, was again decontaminated without a cooling period but all other aircraft cooled for about 24 hours before decontamination was started. The other B-36 (No. 1086) had the highest recorded contamination for the test series, measuring 42 R/hr shortly after landing (see Table 52). Some aircraft again were released with relatively high contamination levels (0.230 to 0.800 R/hr). Priorities were also changed to decontaminate five F-84Gs first.

NECTAR

NECTAR (1.69 MT), the final shot of Operation CASTLE, was fired at 0620 on 14 May from a barge anchored in the MIKE crater (formerly Eluklab Island) at Enewetak Atoll. NECTAR was ready for detonation on 22 April, ahead of YANKEE, and detailed preshot preparations were made on 4, 5, and 11 May. At each date, the shot was postponed because of unacceptable wind patterns.

Preshot Preparation

At noon on 13 May the weather forecast indicated acceptable conditions for firing the following day; consequently, the appropriate messages were transmitted to the task force and external agencies indicating a decision to fire. Air search was initiated in Area Evelyn.* No known transient shipping was within the danger area (Table 53). No postshot sector search was scheduled.

* Area Evelyn had been designated 1 May when it became apparent that daily searches of the entire Area Green were difficult with the aircraft available. Evelyn was defined as a semicircular sector of 300 nmi (555 km) radius to the north of an east-west line through the center of Enewetak, plus an additional 60-nmi (111-km) wide strip south of the semicircle.

Table 51. CASTLE, YANKEE airborne monitoring survey results of the AEC New York Operations Office.

Location ^a	Flight Able						Other NYKOPO Flights		
	Local Time (6 May)	Maximum Ground Reading (R/hr)	Local Time (7 May)	Maximum Ground Reading (R/hr)	Local Time (9 May)	Maximum Ground Reading (R/hr)	Flight	Date	Maximum Ground Reading (R/hr)
Lae	0830	0	0822	0.00120	0726	0.00010	Baker	9 May	0.00040 ^c
Ujae	0845	0	0832	0.00080	0737	0.00016	Charlie	9 May	0.00020
Wotho	0912	0.00008	0857	0.00160	0810	0.00020	Easy	12 May	0.00060
Ailinginae	1024	0.00080	1005	0.01000	0916	0.00120			
Rongelap Island	1038	0.00800	1019	0.03000	0928	0.00650			
Rongerik	1052	0.00300	1033	0.02160	0943	0.00400			
Taongi	1215	0.00020	1151	0.00020	1111	0			
Bikar	1315	0.01500	1247	0.03400	1203	0.00400			
Utirik	1335	0.00080	1318	0.00600	1223	0.00120			
Taka	1340	0.00080	1312	0.00560	1226	0.00150			
Ailuk	1400	0.00020	1330	0.00070	1245	0.00070			
Jemo	1410	0.00020	1339	0.00320	1245	0.00030			
Likiep	1415	0.00020	1346	0.00320	1302	0.00050			
Kwajalein	1455	0.00040	1800	0.00450 ^b	1335	0.00020			

Notes:

^aAtoll unless otherwise indicated.

^bGround observation.

^cAt Wotje; next highest 0.00030 R/hr at Ani.

Source: Reference 16.

Table 52. Task Group 7.4 YANKEE aircraft decontamination.

Aircraft Type/ Tail No.	First Survey			Second Survey			Type of Decon
	Reading (R/hr)	Date (Time)	Type of Decon	Reading (R/hr)	Date (Time)	Type of Decon	
B-36/1086	42.000	5 May (1158)	Decay	None			Wash
B-36/1386	0.100	5 May (1250)	Wash	0.050	5 May (1700)		
WB-29/7740	1.000	5 May (1100)	Decay	0.220	6 May (0900)		Wash
WB-29/7343	20.000	5 May (1050)	Decay	3.200	6 May (0905)		Wash
WB-29/7269	0.600	5 May (2245)	Decay	0.300	6 May (0850)		Wash
WB-29/1819	0.310	6 May (0503)	Decay	0.140	6 May (0852)		Wash
WB-29/2202	0.280	5 May (2105)	Decay	0.100	6 May (0845)		Wash
F-84/032	8.000	5 May (1045)	Decay	0.210	6 May (0800)		Wash
F-84/037	38.000	5 May (0915)	Decay	1.700	6 May (0825)		Wash
F-84/042	10.000	5 May (1138)	Decay	0.900	6 May (0817)		Wash
F-84/043	8.000	5 May (1139)	Decay	0.700	6 May (1520)		Wash
F-84/046	1.100	5 May (1025)	Decay	0.090	6 May (1520)		Wash
F-84/049	11.000	5 May (1100)	Decay	1.200	6 May (0821)		Wash
F-84/051	18.000	5 May (1050)	Decay	1.600	6 May (0832)		Wash

Aircraft Type/ Tail No.	Third Survey			Fourth Survey			Total Decon Hours	Total Decon Pers
	Reading (R/hr)	Date (Time)	Type of Decon	Reading (R/hr)	Date (Time)	Type of Decon		
B-36/1086	0.340	6 May (1450)					2	26
B-36/1386							4	26
WB-29/7740	0.160	6 May (1610)					1	13
WB-29/7343	1.000	7 May (0815)	Decay	0.320	9 May (1600)		1	13
WB-29/7269	0.140	6 May (1635)					1	13
WB-29/1819	0.080	6 May (1145)					1.5	13
WB-29/2202	0.060	6 May (1145)					0.75	13
F-84/032	???						1	6
F-84/037	0.800	6 May (1655)	Decay	0.220	10 May (0900)		1	6
F-84/042	???	6 May (1039)					1	6
F-84/043	0.230	6 May (1030)					1	6
F-84/046	0.050	???					1	6
F-84/049	0.460	???					0.5	6
F-84/051	0.600	???					0.5	6

Source: Reference 30.

Table 53. Summary of the status of transient shipping in the Pacific Proving Ground area on or about 14 May 1954.

Vessel	Location/Course
<u>USS Namakagon</u> (AOG-53)	ETD Enewetak 1200 on 13 May for Kwajalein
<u>USS Epping Forest</u> (LSD-4)	9°40'N, 172°10'E, 13 knots (24 km/hr), ETA Kwajalein 1200 on 14 May
<u>USS Apache</u> (ATF-67)	Departed Bikini 2200 on 13 May with YC-1081 in tow via route points 10°55'N, 166°10'N, 175°E; thence great circle to Pearl Harbor, ETA 0800 on 25 May
<u>USNS Merrell</u> (T-AKV-4)	ETA Guam 15 May.

Source: Reference 16.

The forecast surface and air radex areas were issued as follows:

Surface Radex. True bearing from ground zero 250° clockwise to 80°, radial distance 60 nmi (111 km) for H-hour to H+6, plus a circular radex area around ground zero of 10 nmi (18.5 km) radius.

Air Radex. For H+1, 10,000 feet (3.05 km) to 40,000 feet (12.19 km), 275° clockwise to 30° for a maximum distance of 15 nmi (27.8 km) from ground zero, 30° clockwise to 100° for a maximum distance of 35 nmi (64.9 km), and 100° clockwise to 275° for a maximum distance of 5 nmi (9.3 km).

For H+1, 40,000 feet (12.19 km) and up, 240° clockwise to 330° for a maximum distance of 25 nmi (46.3 km) from ground zero, 330° clockwise to 40° for a maximum distance of 15 nmi (27.8 km), 40° clockwise to 110° for a maximum distance of 60 nmi (111 km), and 110° clockwise to 240° for a maximum distance of 15 nmi (27.8 km).

For H+6, 10,000 feet (3.05 km) to 40,000 feet (12.19 km), 275° clockwise to 30° for a maximum distance of 70 nmi (129.6 km) from ground zero, and 30° clockwise to 100° for a maximum distance of 180 nmi (333.4 km).

For H+6, 40,000 feet (12.19 km) and up, 260° clockwise to 300° for a maximum distance of 70 nmi (129.6 km) from ground zero, and 40° clockwise to 100° for a maximum distance of 300 nmi (555.6 km).

A destroyer (the Epperson) was stationed near Ujelang Atoll to evacuate the population there if necessary. The cloud-tracking aircraft were deployed to detect any movement of contamination toward Ujelang.

The command briefing held at 0030 on 14 May confirmed the decision to shoot. Figure 91 shows the forecast fallout pattern presented at the briefing.

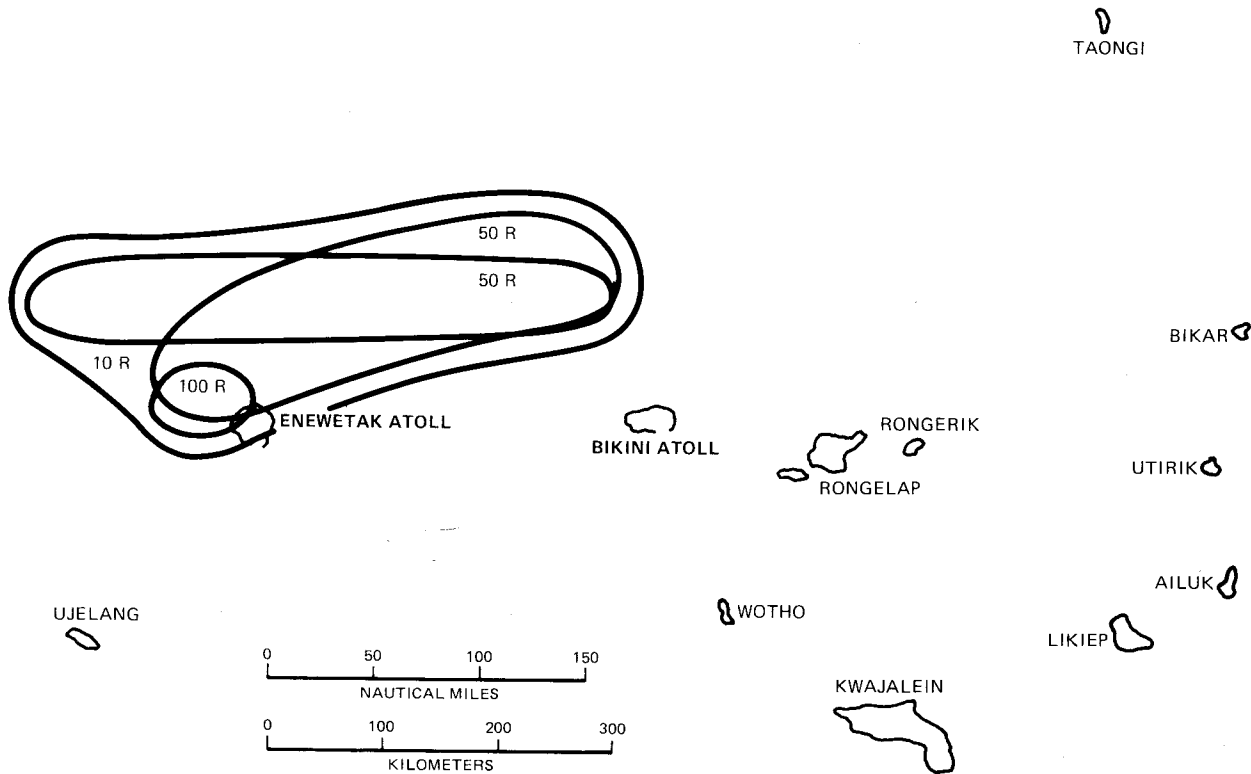

Figure 91. CASTLE, NECTAR predicted fallout pattern based on the method of elliptical approximations; the contours enclose the 100-, 50-, and 10-R infinite dose areas (source: Reference 16).

DOD Activities

The DOD-sponsored experiments for NECTAR included 25 projects in TU 13 of TG 7.1. TU 13 projects were:

- Program 1, Blast and Shock; Projects 1.1a, 1.1b, 1.1c, 1.1d, 1.2a, 1.2b, 1.3, 1.4, 1.5, 1.8
- Program 2, Nuclear Radiation and Fallout; Projects 2.1, 2.2, 2.5a, 2.5b, 2.6a, 2.6b, 2.7
- Program 6, System Effects; Projects 6.1, 6.2a, 6.2b, 6.6

- Program 7, Electromagnetics; Projects 7.1, 7.2, 7.4
- Program 9, Cloud Photography; Project 9.1.

The instrument station locations on Enewetak Atoll are shown in Figure 92. The project details are described in Chapter 3.

There was no preshot evacuation of Parry and Enewetak, although task force ships remained in the vicinity to provide an evacuation capability if required. TG 7.2 was mustered on the beach at Parry to view the shot. The shot countdown was broadcast in the area and the task group personnel were instructed to turn away from the burst and cover their eyes prior to zero time. The locations of the ships of the fleet at burst time are shown in Figure 93. The positions of TG 7.4 effects aircraft are shown in Table 54.

The Test

Heavy rain showers in the Enewetak area when NECTAR was detonated may have affected the close-in deposition of the fallout. The cloud reached an altitude of about 71,000 feet (21.6 km). The lower portion (below 20,000 feet [6 km]) of the cloud moved to the west-northwest, and the upper cloud moved north. Figure 94 gives the cloud dimensions. Few contacts were made with the cloud by either the TG 7.4 sampler aircraft or the Wilson cloud-tracking aircraft. No postshot weather reconnaissance flights were made.

An F-84 sampler aircraft veered off the runway while landing after a sampler mission and nosed into a sand dune. The crash crew arrived before TG 7.4 could remove the radioactive samples. When the latter arrived at the aircraft, they had to move the crash crew well away before removing the samples. Two U.S. Army personnel were reported to be sitting on the wing of the "hot" airplane (Reference 29); however, they could not be identified.

CONTAMINATION. Following the shot, the fleet returned to the atoll and by 0745 was anchored in the lagoon. A damage and radiation survey of

ENEWETAK

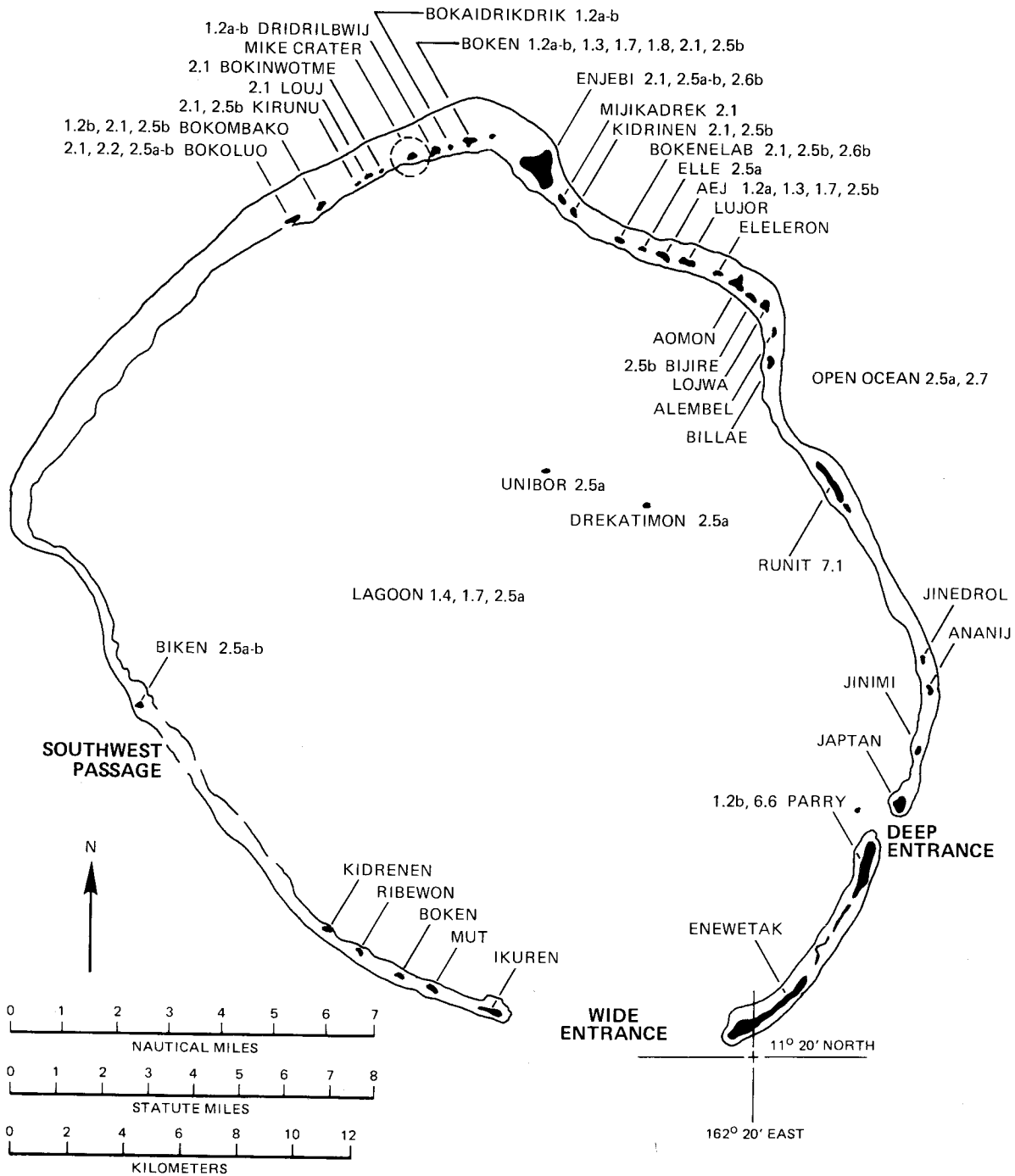

Figure 92. CASTLE, NECTAR instrumentation stations for the DOD scientific projects at Enewetak Atoll.

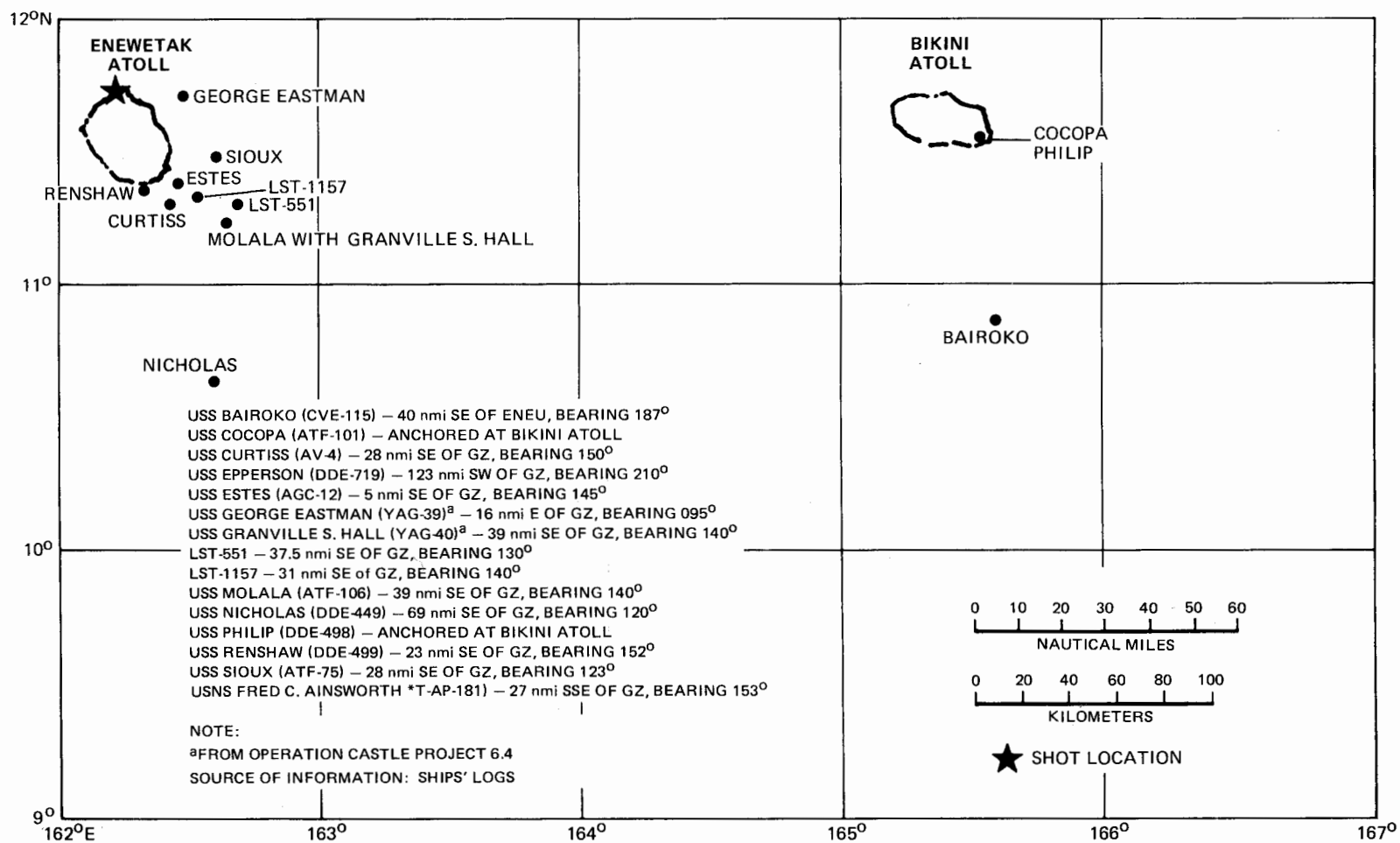

Figure 93. Ship positions at detonation time, CASTLE, NECTAR.

Table 54. Shot-time aircraft position data for CASTLE, NECTAR.

Aircraft	Altitude (km) ^b	Slant Range ^a (km) ^b	Heading (deg)	Direction ^a (deg)
B-36 Effects	10.2	38.5	360	---
B-47 Effects	10.7	14.0	120	121
B-50 IBDA ^c	9.8	22.2	---	---
B-50 IBDA ^c	9.5	37.0	---	---
B-50 IBDAC	9.1	50.0	---	---

Notes:

^aFrom ground zero.

^bOne kilometer equals 3,281 feet.

^cIndirect Bomb Damage Assessment.

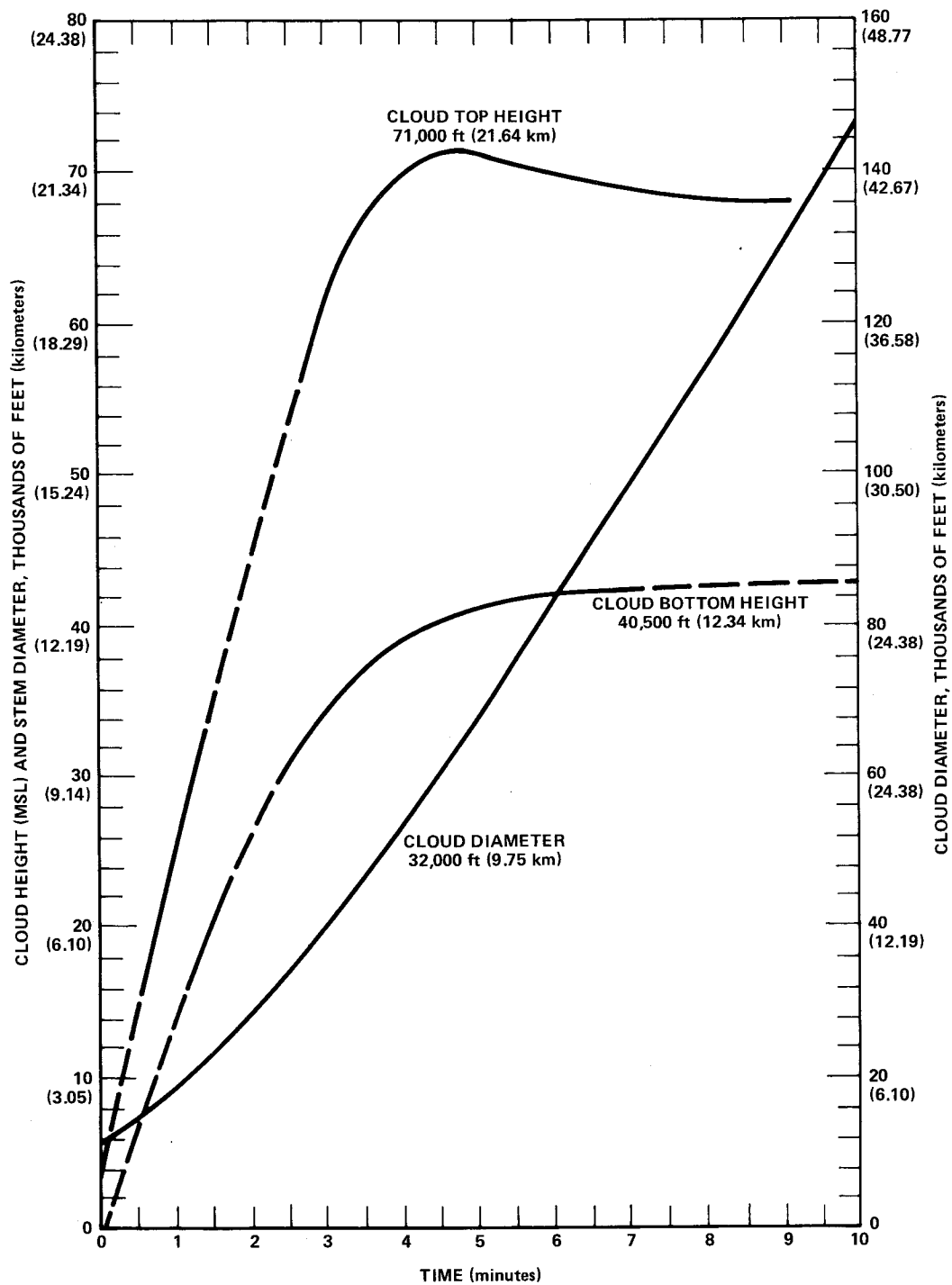

Figure 94. CASTLE, NECTAR cloud dimensions (source: Reference 81).

the atoll islands was conducted at approximately H+4. This survey was conclusive enough to limit scientific recovery to the southern and eastern islands. The survey, whose readings are shown in Table 55, indicated that radioactive contamination extended north of a line from Bokoluo to Billae. Secondary fallout, amounting to 0.002 R/hr, was experienced at Parry on the evening of the detonation. Lagoon water was moderately contaminated in the vicinity of the Bokoluo-Dridrilbwij chain but cleared within 2 days.

Table 55. CASTLE, NECTAR radiation summary (R/hr).

Island	H+4 ^a	D+1 ^b	D+2	Island	H+4 ^a	D+1 ^b	D+2
Enewetak	0	0	0	Kidrinen	0.35	0.04	0.04
Parry	0	0	0	Mijikadrek	0.42	0.04	0.06
Japtan	0	0	0	Enjebi	0.70	0.08	0.08
Jinimi	0	0	0	Boken	0.98	0.12	0.14
Ananij	0	0	0	Bokaidrikdrik		0.22	0.60
Jinedrol	0	0	0	Dridrilbwij	60.0	6.8	7.00
Runit	0	0	0	Louj	70.0	8.0	12.00
Billae	0.05	0.006	0.006	Bokinwotme	75.0	8.4	1.00
Alembel	0.08	0.01	0.01	Kiruna	8.0	0.80	0.36
Lojwa	0.10	0.01	0.01	Bokombako	3.9	0.44	0.36
Bijire	0.12	0.014	0.01	Bokoluo	2.2	0.26	0.28
Aomon	0.17	0.02	0.02	Biken	0	0	
Eleleron	0.17	0.02	0.02	Kidrenen	0	0	
Lujor	0.10	0.012	0.02	Ribewon	0	0	
Aej	0.14	0.016	0.02	Boken	0	0	
Elle	0.17	0.02	0.02	Mut	0	0	
Bokenelab	0.17	0.02	0.02	Ikuren	0	0	

Notes:

^aExtrapolated.

^bPeriod preceded by heavy rainfall.

Source: Reference 91.

The fallout pattern on the northern end of Enewetak Atoll (Figure 95), was documented by fallout samples from land and raft stations, and by rad-safe surveys on land. The aerial survey operated north of the atoll to determine NECTAR fallout areas and contours, which are shown in Figure 96.

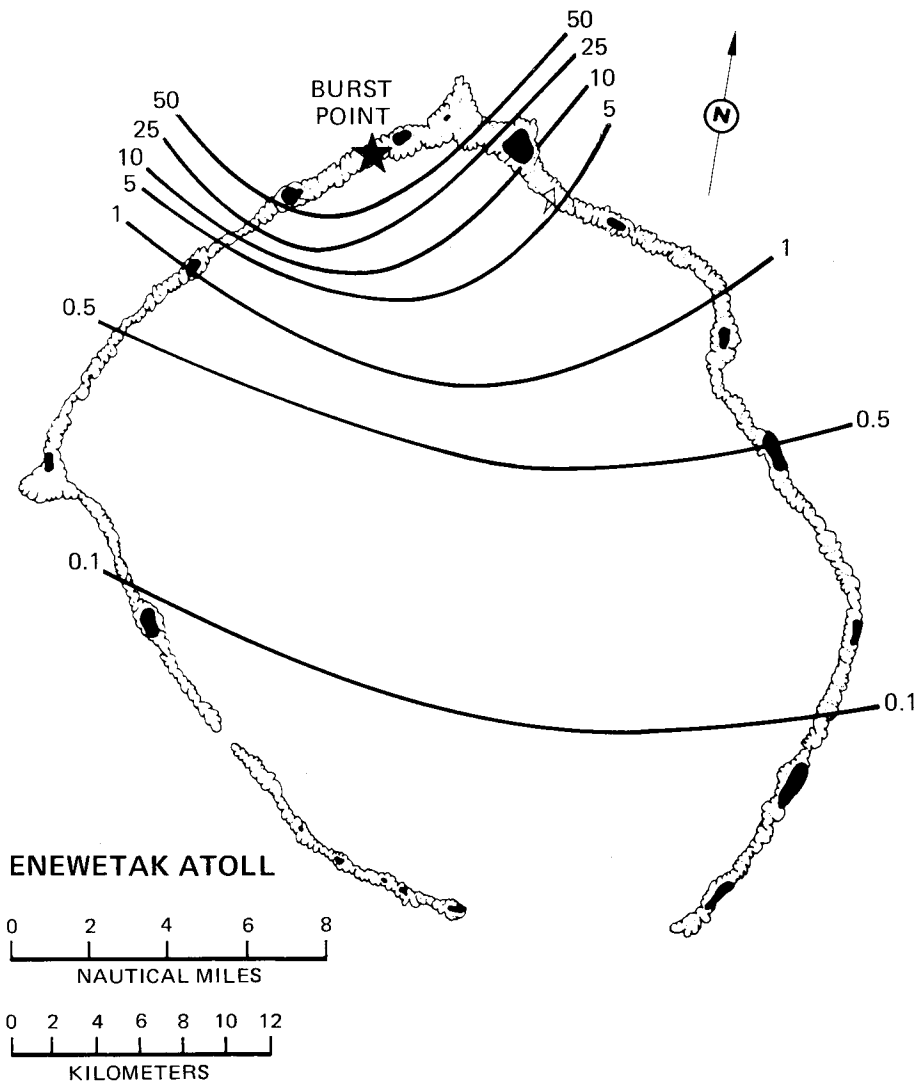

Figure 95. CASTLE, NECTAR close-in gamma fallout pattern (R/hr) at H+1 (source: Reference 53).

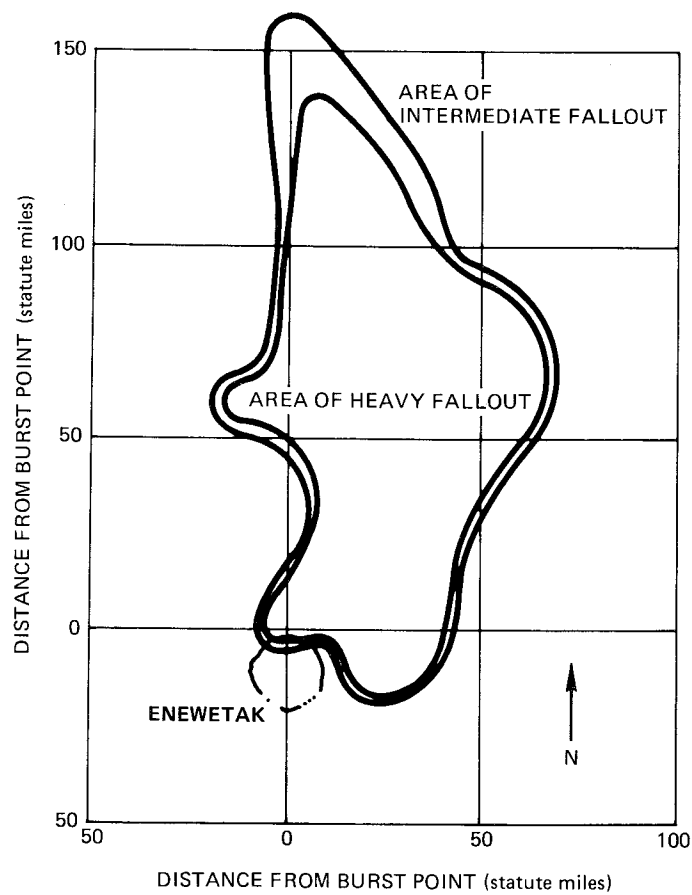

Figure 96. CASTLE, NECTAR fallout areas. Inner contour is the area that would have been a full radex area 24 hours after the shot had the fallout been over dry land. The outer contour would have enclosed an area of limited radex area 24 hours postshot (after Reference 81).

The results of the NYKOPO flights are given in Table 56. The Air Force detected low-level activity at numerous locations in the mid-Pacific from H+50 to H+113, but the samples may not have been from the NECTAR detonation (Reference 16, Tab P, p. 33).

Table 56. CASTLE, NECTAR airborne monitoring survey results of the AEC New York Operations Office.

Location ^a	Flight Able				Other NYKOPO Flights		
	Local Time (15 May)	Maximum Ground Reading (R/hr)	Local Time (16 May)	Maximum Ground Reading (R/hr)	Flight	Date	Maximum Ground Reading (R/hr)
Lae	0722	0.00020	0647	0.00008	Baker	16 May	0.00015
Ujae	0733	0.00008	0657	0.00006	Charlie	16 May	0.00010
Wotho	0800	0.00008	0722	0.00008			
Ailinginae	0854	0.00140	0823	0.00080			
Rongelap Island	0907	0.00580	0836	0.00420			
Rongerik	0925	0.00580	0854	0.00300			
Taongi	1046	0	1006	0			
Bikar	1142	0.00300	1103	0.00170			
Utirik	1204	0.00100	1124	0.00080			
Taka	1208	0.00100	1125	0.00060			
Ailuk	1228	0.00040	1134	0.00010			
Jemo	1248	0.00040	1157	0.00020			
Likiep	1335	0.00010	1202	0.00010			
Kwajalein	1335	0.00010	1236	0.00008			

Note:

^aAtoll unless otherwise indicated.

Source: Reference 16.

AIRCRAFT DECONTAMINATION. Following NECTAR, the aircraft sat for 24 hours while the contamination decayed to lower levels. The aircraft were contaminated less by NECTAR than any other CASTLE series event (see Table 57). Releases were made with intensity levels on all aircraft below 0.400 R/hr as the series concluded.

Table 57. Task Group 7.4 NECTAR aircraft decontamination.^a

Aircraft Type/ Tail No.	First Survey			Second Survey		
	Reading (R/hr)	Date (Time)	Type of Decon	Reading (R/hr)	Date (Time)	Type of Decon
B-36/1083	3.000	14 May (1200)	Decay	0.420	15 May (1030)	Wash
B-36/1086	0.170	14 May (1405)	Decay	0.120	15 May (0945)	Wash
B-36/1386	0.032	14 May (1435)	Decay	0.016	15 May (0700)	Wash
WB-29/1819	4.500	14 May (1425)	Decay	0.800	15 May (1115)	Wash
WB-29/7269	0.042	14 May (2035)	Decay	0.026	15 May (1045)	Wash
WB-29/335	0.046	14 May (2040)	Decay	0.020	15 May (1040)	Wash
F-84/030	0.105	14 May (1600)	Decay	0.033	15 May (0730)	Wash
F-84/038	0.120	14 May (0950)	Decay	0.050	15 May (0800)	Wash
F-84/043	0.180	14 May (1605)	Decay	0.070	15 May (0735)	Wash
F-84/045	0.160	14 May (1610)	Decay	0.060	15 May (0730)	Wash
F-84/046	0.180	14 May (1620)	Decay	0.070	15 May (0730)	Wash
F-84/054	0.195	14 May (1615)	Decay	0.050	15 May (0730)	Wash
F-84/055	0.250	14 May (1615)	Decay	0.090	15 May (0730)	Wash

Aircraft Type/ Tail No.	Third Survey		Total Decon Hours	Total Decon Pers
	Reading (R/hr)	Date (Time)		
B-36/1083	0.260	15 May (1555)	3.5	26
B-36/1086	0.060	15 May (1400)	2.5	26
B-36/1386	0.007	15 May (0800)	1.33	26
WB-29/1819	0.399	15 May (1740)	1.33	26
WB-29/7269	0.020	15 May (1750)	1.33	26
WB-29/335	0.014	15 May (1740)	1	26
F-84/030	0.025	15 May (1010)	0.5	26
F-84/038	0.018	15 May (1000)	0.5	26
F-84/043	0.020	15 May (1055)	0.5	26
F-84/045	0.020	15 May (1100)	0.5	26
F-84/046	0.020	15 May (1059)	0.5	26
F-84/054	0.030	15 May (1012)	0.5	26
F-84/055	0.012	15 May (1010)	0.5	26

Source: Reference 30.

CHAPTER 6
SUMMARY OF U.S. ARMY PARTICIPATION IN CASTLE

HEADQUARTERS JOINT TASK FORCE 7

The following Army organizations had personnel who received badges as part of Hq JTF 7. Their exposures are presented in Table 58.

CIC, Washington, D.C. One civilian.

Department of the Army, G-3. Two officers are listed who were probably observers.

Office of Chief Signal Officer. One civilian is listed -- probably an observer.

Walter Reed Hospital, Washington, D.C. One officer whose function has not been identified was badged with Hq JTF 7.

TASK GROUP 7.1 (SCIENTIFIC)

Personnel from the following Army organizations were badged with TG 7.1. Their functions are listed in terms of scientific project activity, and where established, with a reference to the project number. These projects are further described in Chapter 3. Personnel exposures for the Army participants appearing in the Consolidated List of CASTLE Radiological Exposures (Reference 13) are presented in Table 58.

Army Map Service, Washington, D.C. One civilian from this organization participated in Project 3.2. His exposure was low.

Army Chemical Center, Radiological Division, Chemical and Radiological Laboratories, Edgewood Arsenal, Maryland. Twelve civilians and thirteen military participated in Projects 2.5b, 2.6b, 6.4, and 6.5. These projects involved the collection of fallout contamination and

Table 58. CASTLE personnel exposure, U.S. Army organizations.

Element	No. of Persons Listed	No Reading	Exposure Ranges (R)													Collective Exposure (man-R)	Mean Exposure (R)
			0	0.001-0.5	0.5-1	1-1.5	1.5-2	2-2.5	2.5-3	3-4	4-5	5-10	10-15	Over 15	Over 3.9 ^a		
Hq JTF 7																	
CIC (Civ)	1	0		1											0		
Dept Army G3	2	0	1	1											0		
OCSig 0 (Civ)	1	0		1											0		
Walter Reed Hospital	1	0		1											0		
Total Hq JTF/7 Army	5	0	1	4											0	1 0.20	
TG 7.1																	
Army Map Svc (Civ)	1	0			1										0		
ACC (Civ)	12	0			1	1			1	7	1	1			3	6.2	
ACC (Mil)	13	0		1	1	2	1	1		3	3	1			4	5.5	
AA&GM	3	0		2						1					0		
BRL (Civ)	7	0				3	2				2				2	4.3	
BRL (Mil)	8	0				3	1	1	1	1	1				1	4.1	
Corps of Eng (Civ)	1	0						1							0		
MDW-Hq	1	0								1					0		
SCEL (Civ)	8	0		2	1		1			2		1	1		2	6.3	
SCEL (Mil)	8	1				1		1	1	2	1	1			2	6.8	
1st GMB Ft. Bliss	1	0		1											0		
1st RSSU	28	0			5	2	1	4	4	6	5	1			7	5.1	
4th Army Hq	1	0			1										0		
531st AAA	1	0						1							0		
4050th ASU	1	0		1											0		

Note:

^aMaximum Permissible Exposure.

Source: Consolidated List of CASTLE Radiological Exposures, Reference 13.

(continued)

Table 58. CASTLE personnel exposure, U.S. Army organizations (continued).

Element	No. of Persons Listed	No Reading	Exposure Ranges (R)													Collective Exposure (man-R)	Mean Exposure (R)			
			0	0.001-0.5	0.5-1	1-1.5	1.5-2	2-2.5	2.5-3	3-4	4-5	5-10	10-15	Over 15	Over 3.9 ^a			High		
TG 7.1 (continued)																				
4052nd ASU	4	0		1	2		1									0				
4054th Ft. Bliss	2	0		1						1						0				
7125th AAU	1	0						1								0				
8451st AAU	1	0		1												0				
8452nd AAU	37	1		9	10	5	4	4	1	3						0				
9423rd TSU	1	0													1	4.1				
9465th TSU	1	0		1												0				
9471st TSU	8	0		2		1				1	1				3	4	78			
9577th TSU	1	0			1											0				
Total TG 7.1 Army	150	2		22	23	18	12	14	12	24	16	5			3	26	558	3.72		
TG 7.2																				
7126th Hq Det	239	3	5	35	192	2	2									0				
7126th MP Det	218	0	3	114	51	10	18	4	5	5	7	1				10	5.95			
7126th Port Det	145	0	2	3	124	4	1	3	1	4	1	2				4	5.6			
7126th Service Det	309	0	14	46	248	1										0				
7126th Signal Det	248	0	1	56	181	4	1	1	2	2						0				
7126th Truck Det	135	0	1	13	116	2	1	1			1					1	4.91			
7126th Total	1,294	3	26	267	912	23	23	9	8	12	8	3				15				
8600th AAU	35	3		5	25		2									0				
CIC Det	5	0			5											0				
CID Det	3	0			3											0				
Misc.	11	0		9	1		1									0				
Total TG 7.2 Army	1,348	6	26	281	946	23	26	9	8	12	8	3				15	5.95	997	0.74	
Army Total	1,503	7	27	307	969	41	38	22	20	36	24	8				3	41	78	1,556	1.03

Note:

^aMaximum Permissible Exposure.

Source: Consolidated List of CASTLE Radiological Exposures, Reference 13.

evaluation of decontamination techniques; the exposures were high, as reflected in the Table 58.

Anti-Aircraft Artillery and Guided Missile (AA&GM) Center, Ft. Bliss, Texas. Three men from this unit were badged with TG 7.1. They were probably personnel on temporary duty for radsafe (TU 7). During 1953 TG 7.1 recruited from Ft. Bliss (Reference 8, September 1953 Installation). No other activity has been associated with these men.

Ballistic Research Laboratories, Aberdeen, Maryland. BRL, supported by the 9301st Test Support Unit (Ordnance) at Aberdeen Proving Ground, staffed Projects 1.2b and 1.8. A total of 18 BRL and 9301st TSU personnel are shown in the Consolidated List of CASTLE Radiological Exposures (Reference 13) but only 10 are identified with the projects by name. Exposures for two exceeded 3.9 R. Four of the military were Air Force enlisted men, not soldiers, and their exposures are listed in Table 86 under non-Air-Force organizations in TG 7.1. The exposures for the Army personnel and the civilians from BRL and the 9301st are shown combined under BRL in Table 58.

Corps of Engineers, Washington, D.C. One civilian participant in Project 6.5, Decontamination and Protection, was exposed to 2.275 R.

Military District of Washington, Hq. One officer participated with NRL in Project 2.3 making neutron measurements. His exposure was 2.7 R.

Signal Corps Engineering Laboratories (and Evans Signal Laboratory), Ft. Monmouth, New Jersey. Eight civilians and eight military participated in Projects 2.1 and 2.2 in gamma dosimetry and in Projects 6.6, 7.1, and 7.2 in electromagnetic effects. The latter two projects involved offsite participation; the exposures of the civilian associated with Project 6.6 was 0.200 R. The gamma dosimetry projects involved instrument recovery in contaminated areas; four persons were exposed to over 3.9 R.

1st Guided Missile Brigade, 2nd Guided Missile Group, Ft. Bliss, Texas.

One military, for whom no activity has been discovered, is listed. His exposure was low. He may have been on temporary duty with the radsafe (TU 7) activity.

1st Radiological Safety Support Unit, Ft. McClellan, Alabama. This unit provided the core of TU 7 for TG 7.1. Twenty-eight military participated; the details of their activities are found in Chapter 2. Exposures for seven of these men exceeded 3.9 R for the series.

4th Army Hq, Ft. Sam Houston, Texas. One military with no identified participation. A joint task force representative visited 4th Army Hq to solicit radsafe personnel for temporary duty at CASTLE (Reference 8, September 1953 Installment), and perhaps this man's service was a result.

531st AAA Battalion, Ellsworth AFB, South Dakota. One military with no identified participation.

4050th ASU Hq Battery, Ft. Sill, Oklahoma. One military with low exposure and no identified participation.

4052nd ASU Hq and Hq Battery, 9th Training Battalion, Ft. Bliss, Texas. Four military badged with TG 7.1, but no specific activity was documented for the group. Probably on temporary duty with TU 7. See note above under AA&GM.

4054th Staff and Faculty, Department of Tactics and Combined Arms, Ft. Bliss, Texas. The two military listed are probably TU 7 temporary duty personnel (see note under AA&GM above). Recorded exposure for one was high.

7125th AAU JTF 7, Washington, D.C. Two men identified with TG 7.1, but only one man was badged.

8451st AAU, AFSWP, Washington, D.C. One man with a low exposure. See 8452nd AAU below.

8452nd AAU, Sandia Base, New Mexico. Thirty-seven military listed. This organization and the one above (8451st AAU) were apparently administrative support units serving U.S. Army personnel in the Armed Forces Special Weapons Project (AFSWP) and the men were probably stationed at Los Alamos Scientific Laboratory (LASL). Personnel of the 8452nd are credited with participation in Project 6.4.

9301st Test Support Unit, Aberdeen Proving Ground, Maryland. See BRL above.

9423rd Test Support Unit, Ft. Myer, Virginia. One military with a high exposure was badged with TG 7.1, but no particular activity has been associated with this individual.

9465th TSU (home station unidentified). One military with a low exposure and no identified project activity was badged with TG 7.1.

9471st TSU, Ft. Monmouth, New Jersey. Eight men from this unit executed Project 6.6, which involved offsite ionosondes. Three men were on Rongerik during the BRAVO fallout incident and were assigned an exposure of 98 R based upon a badge exposed in their tent. A later reconstruction assigns them 78 R (Reference 68), and this has been listed in Table 58.

9577th TSU (home station unidentified). One military from this unit was badged with TG 7.1, but his function has not been identified.

TASK GROUP 7.2 (ARMY)

Most of the Army personnel in the task force were in this group. Only a portion of the men in this group were badged, but the list of personnel in Reference 13 closely approximates the total number of persons in TG 7.2, which leads to the conclusion that most of the readings are the "calculated estimates" referred to in the introduction to that document (Reference 13, p. 2) rather than badge readings. The values given for the men and used in Table 58 are usually rounded to even tenths of roentgens, giving evidence of ratio taking and rounding off. This was probably done on the

basis of badges worn by a few individuals, supplemented by readings from badges at fixed locations on Enewetak. A supplementary list of exposures entitled "TG 7.2 (Miscellaneous)" is appended to the TG 7.2 portion of Reference 13. Fourteen of these names can be identified with the Army units listed below, but eleven cannot. These eleven have been entered in Table 58 under TG 7.2 Misc.

7126th AU, Enewetak Atoll. This organization was the successor to several Army units in Operation IVY. These were absorbed into the several detachments of the 7126th. The detachments, with the units they absorbed, were:

Hq and Hq Detachment

Service Detachment

Signal Detachment (absorbed 7131st AU Signal Detachment)

Military Police Detachment (absorbed 516th MP Service Company)

Port Detachment (absorbed 511th Transport Port Company)

Truck Detachment (absorbed 4th Transport Truck Company).

Exposures for the whole 7126th were low, reflecting their primary operating location at Enewetak.

8600th AAU Communications Security Detachment. This unit arrived in December 1953 and was in the Pacific Proving Ground (PPG) throughout the CASTLE Series with operating locations at Enewetak and Bikini. This group had 35 military; its exposures appear to be low and extremely uniform, indicating that most were estimates.

CIC Provisional Detachment, Ft. Holabird, Maryland. Five personnel were assigned to TG 7.2. The exposures appear to be calculated rather than actual readings.

18th MP Criminal Investigation Detachment (CID). Three warrant officers were assigned to the Hq 7126th from this organization. Their exposures appear to be identical to those of a large group of 7126th Hq personnel.

CHAPTER 7
SUMMARY OF U.S. NAVY PARTICIPATION ORGANIZATIONS IN CASTLE

Naval organizations and individuals participated in CASTLE in Headquarters, JTF 7; in TG 7.1 (Scientific); in TG 7.2 (Army); in TG 7.3 (Navy); and as units that had missions that took them to or near the Pacific Proving Ground (PPG) during CASTLE. Most naval participation occurred in the TG 7.3 activities. These activities supported the scientific programs directly by providing instrumentation platforms and data recovery operations and indirectly by providing evacuation and sealift capability.

This chapter lists the naval organizations given as the affiliation for personnel appearing in the Consolidated List of CASTLE Radiological Exposures (Reference 13). It also gives the number of uniformed or civilian persons shown as being with that organization, and the function of the organization in the CASTLE operation. Table 59 statistically summarizes all Navy Consolidated List personnel exposures for each organization.

The order of presentation of these participating organizations is by task force group, followed by non-task-force naval units that appeared at the PPG during CASTLE. Appendix D (Index of Participating Organizations), an alphabetical arrangement of all organizations covered in this report, can be used by readers unfamiliar with the task force structure to locate naval units.

HEADQUARTERS JOINT TASK FORCE 7

Bureau of Ships, Code 588, Washington, D.C. One civilian. No function identified; may have been an observer or connected with BuShips activities in TG 7.1.

Table 59. CASTLE personnel exposure, U.S. Navy organizations.

Element	No. of Persons Listed	No Reading	Exposure Ranges (R)													Collective Exposure (man-R)	Mean Exposure (R)	
			0	0.001-0.5	0.5-1	1-1.5	1.5-2	2-2.5	2.5-3	3-4	4-5	5-10	10-15	Over 15	Over 3.9 ^a			High
Hq JTF 7																		
BuShips 88	1	0		1												0		
CNO Op 36	2	0	1	1												0		
-----	2	0		2												0		
Total Hq JTF 7 Navy	5	0	1	4											0	0.370	1	0.166
TG 7.1																		
BuShips (Civ)	5	0		1		1	1	1					1		1	9.6		
BuShips (Mil)	3	0		1							1	1			2	9.3		
DTMB (Civ)	4	0					1			2	1				1	4.3		
HO (Civ)	1	0		1											0			
MINSY (Civ)	2	0			1								1		1	10.8		
NAU (Mil)	29	2	8	5	2	3	4	2		3					3	4.9		
NM&DSO	1	0								1					0			
Nav Med Sch	2	0								1					0			
NOL (Civ)	16	1		2	5	3	1	1		2	1				1	4.5		
NOL (Mil)	1	0								1					0			
NRDL (Civ)	76	5	2	6	10	7	5	5	8	11	6	11			18	9.2		
NRDL (Mil)	8	0		3	1	2	1	1		1					0			
NRL (Civ)	33	1		5	4	4	2	3	4		5	5			10	7.8		
NRL (Mil)	6	0		1	2	1				1	1				1			
NRS TI	3	0			1		1						1		1	4.3		
Nav Sta N.O.	1	0					1								0			
Nav Supply Activity	1	0		1											0			
Nav Schl Cmd	5	0		1	1		1		1	1					0			
NUCCS	1	0					1								0			
ONR (Civ)	1	0						1							0			
SWU-NAS San Diego	1	0								1					0			
TG 7.1 Total Navy	200	9	2	30	30	20	17	16	16	22	18	18	2		39	11.1	486.6	2.433
TG 7.2			(see Enewetak Boat Pool, 7.3.8, below)															

Note:

^aMaximum Permissible Exposure.

Source: Consolidated List of CASTLE Radiological Exposures (Reference 13).

(continued)

Table 59. CASTLE personnel exposure, U.S. Navy organizations (continued).

Element	No. of Persons Listed	No Reading	Exposure Ranges (R)													Collective Exposure (man-R)	Mean Exposure (R)
			0	0.001-0.5	0.5-1	1-1.5	1.5-2	2-2.5	2.5-3	3-4	4-5	5-10	10-15	Over 15	Over 3.9 ^a		
TG 7.3																	
7.3.0 Special Devices Unit																	
Curtiss (AV-4) ^b	645	1	12	489	80	27	32	3	1						0		0.436
7.3.1 Surface Security Unit																	
Epperson (DDE-719)	308	0	25	187	79	3	12	2						0			0.369
Nicholas (DDE-449)	272	0		11	217	36	8							0			0.866
Renshaw (DDE-499)	269	1		84	147	8	8	15	4	1				0			0.759
Philip (DDE-498)	274	13		2	14	15	7	23	51	71	37	40		83	10.5		3.65
Grosse Point (PC-1546)	62	0		2	44	13	2		1					0			0.946
7.3.2 Carrier Task Unit																	
Bairoko (CVE-115)	886	0	18	136	212	146	101	105	75	44	38	12		59	7.52		1.57
HMR-362	77	0	6	3		12	9	13	3	17	10	4		17	5.5		2.54
VC-3	5	0			4	1								0			0.966
7.3.3 Patrol Plane Unit																	
VP-29	228	0		222	4	1								0			0.112
NAS-Kwajalein	13	0		12					1					0			0.40
VR-7	19	0			19									0			0.069
7.3.4 Flagship Unit																	
Estes (AGC-12) ^b	558	0		13	178	179	64	75	16	24	5	4		13	6.95		1.46
7.3.5 Utility Unit																	
Apache (ATF-67)	83	0		9	38	9	6	5	2	6	2	6		8	8.58		1.60
Cocopa (ATF-101)	82	0			12	16	22	9	8	11	3	1		5	5.12		2.01
Gypsy (ARSD-1)	61	0			26	8		24	1	2				0			1.58
Mender (ARSD-2)	72	0		2	42	4	7	2		8	2	5		9	7.03		1.70
Molala (ATF-106)	88	0			2	18	17	18	17	9	3	4		9	7.57		2.40
Sioux (ATF-75)	86	0	1	1	22	22	39	1						0			1.29
Tawakoni (ATF-114)	80	0		5	28	27	10	4	5	1				0			1.26

Notes:

^aMaximum Permissible Exposure.

^bIncludes U.S. Marine Corps personnel in ship's company.

Source: Consolidated List of CASTLE Radiological Exposures (Reference 13).

(continued)

Table 59. CASTLE personnel exposure, U.S. Navy organizations (continued).

Element	No. of Persons Listed	No Reading	Exposure Ranges (R)													Collective Exposure (man-R)	Mean Exposure (R)	
			0	0.001-0.5	0.5-1	1-1.5	1.5-2	2-2.5	2.5-3	3-4	4-5	5-10	10-15	Over 15	Over 3.9 ^a			High
TG 7.3 (continued)																		
7.3.6 Atomic Warfare Countermeasures																		
YAG-39	59	0		1	6	6	2	2	2	10	3	25	1	1	30	24.39	5.70	
YAG-40	54	0		5	1	2	3	3	1	6	11	22			33	8.58	6.65	
7.3.7.1 Bikini Harbor Element																		
Belle Grove (LSD-2)	340	0	2	4	27	114	122	30	22	18	1				2	4.57	1.71	
Boat Pool	220	0		12	21	26	34	20	19	41	23	16		3	49	96	3.91	
7.3.7.2 Mine Project Element																		
Shea (DM-30)	279	8	7	264											0		0.171	
Reclaimer (ARS-42)	94	0	14	68	7	2	2	1							0		0.272	
7.3.7.3 Mine Laying and Recovery Element																		
Terrell County (LST-1157)	186	0	6	86	55	21	14	2	1					1	1	16.05	0.727	
Mine Proj 6 Beach Grp 1																		
7.3.7.4 Mine Readying and Analysis Element																		
EODU	11	2		4	1	2	1	1							0		1.00	
7.3.8 Enewetak Harbor Unit																		
TG 7.2 Boat Pool	112	1	1	61	49										0		0.397	
UW Detection	13	0	7	6											0		0.060	
7.3.9 Transport Unit																		
Ainsworth (T-AP-181)	198	0		194	4										0		0.230	
LST-551	105	0		67	30	5		1	1		1				1	4.12	0.523	
LST-762	124	0		75	2	12	12	10	6	4	1				1	4.09	0.90	
LST-1146	95	0	11	84											0	0.290	0.86	
TG 7.3 Total	6,058	26	110	1,937	1,358	735	534	369	237	273	140	139	1	5	320	96	10,182	1.681
Total Navy	6,263	35	113	1,971	1,388	755	550	384	255	295	158	156	4	5	389	96	10,670	1.704

Note:

^aMaximum Permissible Exposure.

Source: Consolidated List of CASTLE Radiological Exposures (Reference 13).

335

Office Chief of Naval Operations, Op 36, Washington, D.C. Two officers; may have been observers. They were from the CNO office, which was primarily concerned with nuclear weapons.

U.S. Navy, Washington, D.C. Two additional naval officers who were assigned to JTF 7 appear in the Consolidated List (Reference 13) with no organizational affiliation listed. Exposures for naval personnel in Hq JTF 7 are shown in Table 59.

TASK GROUP 7.1 (SCIENTIFIC)

The following organizations appear in the Consolidated List under TG 7.1 (Scientific). The description of each organization's activity here may be limited to a reference to a TU 13 project. These projects are described as a group in Chapter 3, "DOD Experimental Participation." Exposures for naval personnel in TG 7.1 are given in Table 59.

Bureau of Ships, Washington, D.C. Five civilians and three military from this organization participated in Project 6.4, which evaluated wash-down systems on the ships YAG-39 and YAG-40.

David Taylor Model Basin, Carderock, Maryland. Four civilians from DTMB participated in Project 1.4, which involved underwater pressure measurements.

Hydrographic Office, Washington, D.C. One civilian is named whose function has not been identified.

Mare Island Naval Ship Yard, California. Two civilians are listed; one is credited with participation in Project 6.4.

Naval Administrative Unit, Sandia Base, New Mexico. This organization appears to be a unit that administered the naval personnel who were on duty assignments at Los Alamos Scientific Laboratory (LASL) and the Armed Forces Special Weapons Project (AFSWP) Field Command. This inference is based on the fact that at least one officer, designated NAU

on the Consolidated List, is credited with being from AFSWP in the Project 1.8 after-action report (Reference 49). Furthermore, in the Consolidated List of REDWING Radiological Exposures (1956), in which the NAU designation is not used, four of the twelve naval officers on the CASTLE listing reappear in REDWING as naval officers whose organization is simply "LASL," and a fifth is listed as a civilian at LASL. Twenty-nine officers and men from NAU appear in the TG 7.1 portion of the CASTLE listing; their activities are assumed to have been in TU 1 and TU 13 (LASL and DOD).

Naval Medical and Dental Supply Office, Brooklyn Navy Yard, New York. One representative from this group was badged with TG 7.1; his function has not been identified.

Naval Medical School, Bethesda, Maryland. Two representatives of this organization were included in the Consolidated List for TG 7.1. Their function has not been identified.

Naval Electronics Laboratory, San Diego, California. Participated in Project 4.1 at remote offsite locations; NEL personnel were not exposed to radiation during CASTLE operations.

Naval Ordnance Laboratory, White Oak, Silver Spring, Maryland. This organization was one of the three major naval laboratory organizations represented at CASTLE. Sixteen civilians and four military participated. Seven of these were associated with Project 1.1 and thirteen with Project 1.4, both of which were in the Blast and Shock Program. Two civilians worked with Project 3.4 with Mine Project 6. Two of the military in the NOL contingent on Project 1.1 were Air Force enlisted personnel, as was one on Project 1.4. Their exposures are not included in the NOL exposures in Table 59, but are included in the Air Force exposures given in Table 86 under TG 7.1 non-Air-Force organizations.

Naval Radiological Defense Laboratory, San Francisco, California. This naval laboratory was the largest naval group in TG 7.1, with 76 civilians and 8 military involved in nuclear radiation projects (Projects 2.5a, 2.6a, 2.7, and 6.4). These experiments had an inherently greater potential for exposure to nuclear radiation both in data-recovery operations and the associated laboratory operations than others, as illustrated by the higher than average exposures for these personnel (Table 59).

Naval Research Laboratory, Washington, D.C. NRL was the third major naval laboratory organization participating in CASTLE. Thirty-three civilians and six military manned two projects in TU 13, Projects 1.4 and 2.3, and four interrelated experiments for LASL in TU 1.

Naval Receiving Station, Treasure Island, California. This organization furnished three enlisted personnel to NRDL for Project 2.5a. These, judging from their ratings, were seamen and were likely used in buoy-recovery operations. One received 11 R, well over the Maximum Permissible Exposure (MPE) of 3.9 R.

Naval Station, New Orleans, Louisiana. One individual from this station appears on the Consolidated List for TG 7.1, but his test activity cannot be identified.

Naval Supply Activity, Brooklyn, New York. One individual from this organization was badged with TG 7.1, but his test activity cannot be identified.

Naval Schools Command, Treasure Island, California. Four men from this organization were used by NRDL in Project 6.4, all in the "Personnel Protection" (radsafe) activity. Exposures for this group are somewhat lower than for others who participated in this same activity for Project 6.4. Exposures for Naval Schools Command men are given in Table 59, which includes a fifth man whose activity cannot be definitely associated with any test project or other discrete activity.

Naval Unit, Chemical Corps School, Ft. McClellan, Alabama. This unit provided one officer who worked in the ship contamination studies activity of Project 6.4. His exposure recorded on the Consolidated List was 1.950 R (see Table 59).

Office of Naval Research, Washington, D.C. One civilian participated in Project 1.4. His exposure is given in Table 59.

Special Weapons Unit, Naval Air Station, San Diego, California. One officer from this unit appears on the Consolidated List; he served in the radsafe task unit (TU 7).

TASK GROUP 7.2 (ARMY)

Boat Pool Detachment. This group, remaining at Enewetak from Operation IVY, provided small boat support for the garrison force at Enewetak. Administrative control of the unit appears to have remained with TG 7.2 even after the arrival of CTG 7.3 at the PPG. The unit provided intra-atoll sealift service for Enewetak in cooperation with the small boat service provided by the Holmes & Narver (H&N) boat pool. This unit has 111 men and 1 officer on the Consolidated List. The exposures recorded are all less than 1 R and were assessed on the basis of the number of tests in which individuals had been involved. The assessments ranged from 0 R for one individual who participated only in shot NECTAR to 0.800 R for members of the detachment who were considered participants in the entire CASTLE series. The exposure entries are included with TG 7.3 (TU 7.3.8) in Table 59.

TASK GROUP 7.3 (NAVY)

The personnel exposures from the Consolidated List are presented in Table 59 for naval units of TG 7.3.

Task Unit 7.3.0 (Special Devices Unit)

The USS Curtiss arrived at Enewetak on 24 January carrying the special devices. The Curtiss, under escort by the USS Estes, departed for California at 1530 on 14 May. During its stay at Enewetak, the Curtiss was

responsible for receiving, transporting, and safeguarding special devices; providing shipboard facilities for assembly of these devices and space for TG 7.1 administration and laboratories; acting as the flagship for CTG 7.3 en route to the forward area (after 6 March); providing transportation to the forward area for approximately 100 officers and 50 enlisted personnel of JTF 7; and assisting JTF Weather Central by taking surface readings hourly, and radiosonde balloon and radar wind readings twice daily. Personnel decontamination facilities were located near the ship's stern, which proved to be an awkward location because personnel requiring decontamination had to walk through the ship. Due to overcrowding on the USS Bairoko, CTG 7.3 shifted his flag to the Curtiss on 6 March.

The operational activities of the Curtiss for each CASTLE shot are described in Table 60. The Curtiss' assigned duties should not have exposed it to radioactive material, as the ship's crew did not assist in decontamination of other units. The Curtiss was contaminated by shot BRAVO, however; from 0800 to 1800 on 1 March, it was exposed to fallout and was required to use its washdown system. No crewmen received exposures in excess of 3.9 R.

Task Unit 7.3.1 (Surface Security Unit)

This unit consisted of four escort destroyers of Escort Division 12, the USS Epperson, the USS Nicholas, the USS Renshaw, and the USS Philip, and one patrol craft, the USS Grosse Point. Escort Division 12 provided a screen for the Curtiss from Hawaii to Enewetak, acting as Task Element 7.3.0.1. The general function of the unit was to assure the atolls' security. The operational activities of each vessel during the CASTLE shots are described in Tables 61 through 65.

At Bikini, the destroyers were assigned to search and rescue (SAR) missions to investigate submarine contacts in conjunction with the Patrol Plane Unit 7.3.3, to warn and divert unauthorized shipping from the danger area, and to function as Task Element 7.3.9.2 of Transport Unit 7.3.9, escorting ships transporting shot devices from Enewetak to Bikini (see Tables 61 through 65).

Table 60. USS Curtiss (AV-4) operational activities during the CASTLE test series.

Shot	Shot Date	Time of Det.	Ship Location/Activities		
			Preshot	At Shot Time	Postshot
BRAVO (B)	1 Mar	0645	28 February at 1750 left berth N-2, Bikini, for assigned operating area	Steamed in assigned operating area	At 1323 set condition Able throughout ship; at 1757 departed assigned area for Enewetak Atoll; 2 March <u>Fred C. Ainsworth</u> (T-AP-181) on station 1,000 yards (900 meters) astern; at 0848 anchored berth C-2, Enewetak
ROMEO (B)	27 Mar	0630	26 March at 1956 left berth N-6, Bikini, for operating area BF 24-29-L; launched weather balloon at 2235; 27 March at 0245 <u>Nicholas</u> (DDE-449) assumed position 1,000 yards (900 meters) astern <u>Curtiss</u> (AV-4)	Steamed in operating area	At 1535 anchored berth N-6, Bikini; at 1600 embarked 78 passengers for transportation to Enewetak; at 1957 departed Bikini; at 2031 rendezvoused with <u>Nicholas</u> ; 28 March at 0750 anchored off Parry Island, Enewetak, and discharged 78 passengers
KOON (B)	7 Apr	0620	5 April at 1238 left Eneman, Bikini, for operating area BG 28-34-L; 6 April at 1436 rendezvoused with <u>Epperson</u> (DDE-719)	Steamed independently in operating area BG 28-36-L	At 1138 anchored berth N-6, Bikini; at 1948 left berth en route to Enewetak; at 2305 an unidentified luminous object passed over ship from bow to stern, yellowish-orange in color, traveling at a high rate of speed and a low altitude
UNION (B)	26 Apr	0605	25 April at 1931 left Eneu, Bikini, for operating area BG 30-35-R; 26 April at 0408 on station in operating area BH 35-40-L	Steamed on station in assigned operating area	At 0728 on station in operating area BH 50-55-R; at 1653 anchored in berth N-6, Bikini
YANKEE (B)	5 May	0610	4 May at 1616 left Iroij, Bikini, for operating area AG 30-35-R; at 2222 <u>Philip</u> (DDE-498) on station 1,000 yards (900 meters) astern	In assigned operating area with <u>Philip</u>	At 1318 conducted transfer of personnel with <u>Estes</u> (AGC-12); at 1653 anchored N-5, Bikini; at 1920 left anchorage for operating area BH 35-40-L
NECTAR (E)	14 May	0620	13 May at 1841 left anchorage B-2, Enewetak, for operating area EH 16-21	Steamed independently in operating area	At 0745 anchored berth L-3, Enewetak; at 1528 underway for San Francisco

Source: USS Curtiss (AV-4) Deck Log.

Table 61. USS Epperson (DDE-719) operational activities during the CASTLE test series.

Shot	Shot Date	Time of Det.	Ship Location/Activities		
			Preshot	At Shot Time	Postshot
BRAVO (B)	1 Mar	0645	28 February steamed on ASW patrol off Enewetak Atoll; at 0730 made bathythermograph (B/T) drop; at 0735 recovered B/T; 1 March continued on ASW patrol; at 0120 CIC obtained unidentified radar contact, left patrol area to investigate; at 0230 identified contact as LST-551, returned to DB-1 and DB-2	Continued on patrol	At 0743 proceeded to investigate unidentified radar contact; at 0821 identified contact as LST-551; 2 March steamed as a unit of TU 7.3.1; at 0214 relieved by <u>Renshaw</u> (DDE-499), proceeded to patrol area DB-2; at 0823 secured to mooring N-3, Enewetak; from 1310-1416 received fuel from the <u>Karin</u> (AF-33); at 1506 secured to mooring N-3, Enewetak; 3 March at 0700 underway to Bikini Atoll
ROMEO (B)	27 Mar	0630	26 March at 0829 underway to patrol area off Nam Island; at 2305 rendezvoused with <u>Bairoko</u> (CVE-115), proceeded astern at 1,500 yards (1.4 km)	Steamed as before; at 0617 exercised crew at general quarters; at 0656 secured from general quarters	At 1317 released by <u>Bairoko</u> ; at 1420 secured mooring N-13, Bikini; LCM came alongside; at 1557 underway from harbor; from 1933-1950 washdown system activated; 28 March steamed north of Bikini; at 0740 made B/T drop; at 0800 B/T drop satisfactory; from 0810 to 1527 searched for buoys by visual and DF means; at 1416 sighted buoy; at 2008 anchored in Bikini Lagoon.
KOON (B)	7 Apr	0620	Steamed in company of <u>Bairoko</u> at Station Baker off Bikini	Steamed as before	At 0830 followed <u>Bairoko</u> during helicopter operations; at 1045 proceeded to eastern end of Eneman Island for search and rescue (SAR) duty; 8 April at 0555 made radar contact with <u>Karin</u> ; at 0842 received provisions from <u>Karin</u> in Eneu Channel; at 1234 underway for ASW patrol south of Bikini
UNION (B)	26 Apr	0605	Steamed independently on ASW patrol north of Enewetak; at 0420 commenced westward sweep of patrol area	Steamed as before	At 0630 resumed westward sweep of patrol area; at 0808 began eastward sweep of northern patrol area; at 0954 left northern area for sweep to south of Enewetak; at 1255 returned to patrol area north of Enewetak; continued sweeps throughout the day
YANKEE (B)	5 May	0610	4 May at 1630 underway to patrol area north of Enewetak Atoll; at 2001 ship returned to find LVCP with crew of 3 men; at 2202 notified 3 men found; steamed to patrol area north of Enewetak	Steamed as before	At 1800 secured to mooring N-3, Enewetak Lagoon
NECTAR (E)	14 May	0620	13 May at 1844 underway to station, 10 miles (18 km) north of Ujelang Atoll	Steamed as before	At 1252 proceeded to Enewetak Atoll; at 1600 B/T drop; at 1605 B/T aboard; at 1907 secured at mooring B-3, Enewetak; at 2203 underway for Pearl Harbor

Source: USS Epperson (DDE-719) Deck Log.

Table 62. USS Nicholas (DDE-449) operational activities during the CASTLE test series.

Shot	Shot Date	Time of Det.	Ship Location/Activities		
			Preshot	At Shot Time	Postshot
BRAVO (B)	1 Mar	0645	Steamed as part of TU 32.6.4 with <u>Mispillion</u> (AO-105), <u>Edmonds</u> (DE-406), PC-1145, <u>HMNZS Hawea</u> (DE-70) on search and rescue (SAR) south of Kwajalein for downed RAF Canberra bomber	Steamed with <u>Mispillion</u> as guide	At 0800 position 06°36'N, 161°44'E; steaming through day; at 1950, PC-1141 joined formation outboard <u>HMNZS Hawea</u> ; continued on SAR until returning to Enewetak on 3 March
ROMEO (B)	27 Mar	0630	26 March at 0821 anchored Rongelap Atoll; left Bikini at 1910; steered various courses to retrieve whaleboats at 2052; 27 March, steaming en route from Rongelap Atoll to join TG 7.3; 0200 rendezvoused with <u>Curtiss</u>	On station 1,000 yards (900 meters) astern <u>Curtiss</u> (AV-4) in operating area	At 1307 independently on patrol southeast of Bikini; anchored berth N-13, Bikini, at 1747; underway at 1956 ahead of <u>Curtiss</u>
KOON (B)	7 Apr	0620	Steamed independently between Bikini and Enewetak as DDE air control	Steamed independently between Bikini and Enewetak	At 1915 anchored berth N-8, Bikini
UNION (B)	26 Apr	0605	At 1541 25 April left berth N-7, Bikini, for DDE air control station	Steamed independently on DDE station bearing 250° 90 miles (165 km) from Bikini Atoll	At 1318 turned on washdown system; at 1429 system secured; at 1825 anchored berth N-8, Bikini
YANKEE (B)	5 May	0610	4 May at 1448 underway from berth Q-5, Enewetak Atoll, to assigned patrol area as air control DDE	Steamed independently on assigned station	Steamed for remainder of the day
NECTAR (E)	14 May	0620	13 May at 0829 left berth N-4, Enewetak, underway for assigned operating area as air control DDE	Steamed independently as air control DDE off Enewetak	At 0935 conducted ASW drills; at 1623 anchored berth N-3, Enewetak; fueled from YO-120 at 1655; underway from Enewetak at 2130 with <u>Epperson</u> (DDE-719), <u>Renshaw</u> (DDE-499)

Source: USS Nicholas (DDE-449) Deck Log.

Table 63. USS Renshaw (DDE-499) operational activities during the CASTLE test series.

Shot	Shot Date	Time of Det.	Ship Location/Activities		
			Preshot	At Shot Time	Postshot
BRAVO (B)	1 Mar	0645	28 February at 1100, underway from berth N-5, Enewetak, to air control station, 10°41'N, 164°06'E; 1 March proceeded to new control station, 11°42'N, 164°06'E at 0531	Steamed to control station	Arrived at control station at 0832; at 2054 control duties completed, proceeding to Enewetak; on 2 March at 0945 received small boat along starboard to disembark a passenger; 3 March remained at sea on patrol off Enewetak; 4 March underway in the early morning to Utirik Atoll; arrived off Utirik about 0800; executive officer and landing party went ashore in gig at 0810 and returned at 1055 with first evacuees; motor whaleboat also employed in evacuation; evacuated and decontaminated 154 natives of Utirik Atoll between 1055-1256; at 1314 underway for Kwajalein Atoll
ROMEO (B)	27 Mar	0630	26 March at 1601 underway from Bikini for DDE air control station at 11°10'N, 163°50'E; 27 March steaming on station at 0032; proceeding to new control station 10°42'N, 164°07'E at 0500	Steamed on control station	At 1344 released from control station, proceeded to patrol area south of Enidrik Island; at 1845 on patrol station
KOON (B)	7 Apr	0620	Anchored at berth K-2, Enewetak	Anchored at berth K-2, Enewetak	Remained anchored
UNION (B)	26 Apr	0605	Moored at berth N-3, Enewetak with <u>Leo</u> (T-AKA-60) and other small craft of the Pacific fleet	Moored at berth N-3, Enewetak	Remained anchored
YANKEE (B)	5 May	0610	4 May steaming on a random patrol north of Bikini; at 1914 ceased patrolling; rendezvoused with <u>Bairoko</u> (CVE-115) at 2117	Steamed on patrol southeast of Bikini with <u>Bairoko</u> in assigned sector	At 1030 proceeded to lifeguard station astern <u>Curtiss</u> (AV-4); at 1055 returned to plane guard station with <u>Bairoko</u> ; at 1318 proceeded to lifeguard station with <u>Estes</u> (AGC-12); at 1442 returned to station 100 yards (90 meters) astern <u>Bairoko</u> ; at 1602 proceeded to remain 5,000 yards (4.6 km) off Eneu Channel, Bikini; at 1857 proceeded to assigned sector southeast of Bikini
NECTAR (E)	14 May	0620	13 May left anchorage K-2, Enewetak, for area southeast of Enewetak at 1900; arrived on station at 2145 in assigned sector	Steamed on assigned station	Entered Enewetak Lagoon at 0633; anchored at berth B-2, Enewetak at 0820; moved to berth C-2, Enewetak, at 0840; moved to berth B-2, Enewetak, at 1727; underway for Pearl Harbor at 2157

Source: USS Renshaw (DDE-499) Deck Log.

Table 64. USS Philip (DDE-498) operational activities during the CASTLE test series.

Shot	Shot Date	Time of Det.	Ship Location/Activities		
			Preshot	At Shot Time	Postshot
BRAVO (B)	1 Mar	0645	28 February steaming independently on patrol 3-4 miles (5.6-7.5 km) northwest of Bikini Atoll; at 1430 changed course for area BG-25; 1 March at 0235 rendezvoused with <u>Bairoko</u> (CVE-115) at 1,000 yards (900 meters)	Steamed in assigned area 1,000 yards (900 meters) off <u>Bairoko</u>	Continued steaming with <u>Bairoko</u> off Bikini; 2 March steamed off Bikini in formation with <u>Belle Grove</u> (LSD-2), <u>Gypsy</u> (ARSD-2), <u>Cocopa</u> (ATF-101), and <u>Grosse Point</u> (PC-1546); at 0706, <u>Belle Grove</u> left the formation; at 1153 <u>Cocopa</u> and <u>Gypsy</u> detached; at 1536 <u>Grosse Point</u> was detached; continued on patrol until entering <u>Bikini Lagoon</u> at 1858; at 1910 anchored in berth N-10; at 2145 underway to Eneu Channel en route to Rongelap Atoll
ROMEO (B)	27 Mar	0630	Conducted patrol 2-6 miles (3.7-11 km) off Deep Entrance to Enewetak Atoll	Conducted patrol eastward of Deep Entrance to Enewetak Lagoon	At 1035 began steering various courses to form bent line screen 2,500 yards (2.3 km) in front of LST-551 en route to Bikini Atoll; 28 March at 0751 LST-551 entered lagoon while <u>Philip</u> (DDE-498) moved to patrol station off Ene-man Island; at 1305 came into lagoon via Lukoj Pass; at 1405 lying to 800 yards (730 meters) off <u>Estes</u> (AGC-12); at 1414 underway Lukoj Pass to conduct patrol off Bikini
KOON (B)	7 Apr	0620	Anchored in Enewetak Lagoon	Anchored in Enewetak Lagoon	At 1116 left anchorage for patrol 2-6 miles (3.7-11 km) off Enewetak
UNION (B)	26 Apr	0605	Steamed in formation with <u>Bairoko</u> and other TG 7.3 ships southeast of Bikini	Steamed in operating area astern of <u>Bairoko</u>	Patrolled off Bikini Atoll at 2044 in visual contact with <u>Estes</u> en route to Enewetak; at 2338 made contact with <u>Mo'ala</u> (ATF-106) and YAG-40
YANKEE (B)	5 May	0610	4 May at 1256 left anchorage N-1, Bikini, to patrol south of Bikini; at 2208 took station 1,000 yards (900 meters) astern <u>Curtiss</u> (AV-4) on 5 May at 0315 left <u>Curtiss</u> and proceeded to sector of area approximately 140°T, 50 miles (92 km) from Station Baker	Steamed in assigned area; at 0638 on station with the <u>Curtiss</u> 1,500 yards (1.4 km) astern	At 0818 relieved of escort duty with <u>Curtiss</u> , maneuvered to stay within area BG 45-50-R; at 1200 steamed in area BG 30-35-R; at 1555 and 1926 made bathythermograph (B/T) drops; 6 May at 1801 anchored at berth N-7, Bikini
NECTAR (E)	14 May	0620	Anchored at berth N-1, Bikini	Anchored at berth N-1, Bikini	At 0745 left anchorage for sea to receive fuel from <u>Bairoko</u> ; at 0837 took B/T readings; at 0923 took on fuel from <u>Bairoko</u> ; at 1230 anchored in berth N-1, Bikini

Source: USS Philip (DDE-498) Deck Log.

Table 65. USS Grosse Point (PC-1546) operational activities during the CASTLE test series.

Shot	Shot Date	Time of Det.	Ship Location/Activities		
			Preshot	At Shot Time	Postshot
BRAVO (B)	1 Mar	0645	28 February underway to conduct ASW patrol off Bikini; 1 March in designated operating area with <u>Tawakoni</u> (ATF-114)	Steamed in designated operating area	At 2120 commenced screening <u>Belle Grove</u> (LSD-2), TU 7.3.7; 2 March 2 March joined formation with <u>Philip</u> (DDE-498) and other ships; left formation at 1541 to proceed to Bikini Lagoon; at 1634 moored to starboard side of <u>Cocopa</u> (ATF-101), berth N-1, Bikini Lagoon
ROMEO (B)	27 Mar	0630	Anchored at Enewetak	Anchored at Enewetak	Remained anchored
KOON (B)	7 Apr	0620	6 April at 1600 underway from Ailinginae Atoll for assigned area southwest of atoll	Steamed in assigned operating area; at 0633 began firing illuminating shells; at 0635 completed firing	At 0928 departed Ailinginae Atoll en route Bikini; at 1203 arrived assigned area; at 1928 anchored in berth N-7, Bikini
UNION (B)	26 Apr	0605	Anchored in lagoon at Rongerik Atoll	Anchored in lagoon at Rongerik Atoll	Underway from Rongerik Atoll to Bikini at 1326; 27 April arrived Bikini Atoll at 0401; anchored in berth N-8, Bikini
YANKEE (B)	5 May	0610	Anchored in lagoon at Rongerik Atoll	Anchored in lagoon at Rongerik Atoll	Underway to assigned station at 1255
NECTAR (E)	14 May	0620	13 May anchored at berth Able-3, Pearl Harbor	No log available, presumably moored in Pearl Harbor	No log available, presumably moored in Pearl Harbor

Source: Grosse Point (PC-1546) Deck Log.

During the Bikini shots, one ship always provided the carrier, Bairoko, with a plane guard; another escorted the Curtiss; and two ships were always assigned to Enewetak to provide security for the atoll. One of these ships sortied from Enewetak on shot day at Bikini to a station halfway between the atolls, where it served as an aircraft control station. The ship carried an Air Force officer from TG 7.4, who acted as an air controller. The Renshaw served in this capacity for the first two shots and the Nicholas for the last four.

The Surface Security Unit, in conjunction with the Patrol Plane Unit, also provided postshot support to the sea-phase portion of Project 2.5a, which consisted of assisting in locating fallout collector buoys equipped with radio transmitters.

In addition to these planned activities, elements of the Surface Security Unit searched on two occasions for downed RAF Canberra bombers that were incoming to Kwajalein from the Admiralty Islands (the first was lost at sea; the second was forced to land on the beach at Ailinglapalap Atoll), provided interatoll transportation following the temporary closure of the Bikini airstrip after BRAVO, supported weather station activities on Rongerik for UNION and YANKEE, and were scheduled to act as a fallout detection unit and evacuation ship at Ujelang during shot NECTAR if such activities had been required.

After shot BRAVO, the Philip was heavily contaminated by fallout while serving as plane guard for the Bairoko. Eighty-three of the ship's crew received exposures of more than 3.9 R, with a maximum exposure of 10.5 R recorded. Consequently, the CTG 7.3 recommended that the Philip's entire crew receive a waiver of the MPE, and that the ship be assigned duties unlikely to expose the crew to further contamination. Nevertheless, the ship received additional slight contamination after ROMEO while en route from Enewetak to Bikini on 28 March.

The heavy contamination of the atolls to the east of Bikini after BRAVO required evacuation of the Marshall Islander populations, which was done by

units of the Surface Security Unit. These atolls were also surveyed and resurveyed in order to establish the degree of contamination, and to establish how the fallout may have been taken up in the food chain by plants and animals. This required several returns to the atolls, which were still radiologically hot enough to require that shore parties be badged. These activities are summarized in Table 66.

Table 66. CASTLE evacuation and resurvey activities, March-April 1954.

Dates	Ship	Activity	Location(s)
3 Mar	Philip (DDE-498)	Evacuation	Rongelap and Ailinginae atolls
4 Mar	Renshaw (DDE-499)	Evacuation	Utirik Atoll
5-8 Mar	Renshaw (DDE-499)	Resurvey	6 March: Likiep, Jemo Island, and Ailuk Atoll; 7 March: Mejit Island
8-12 Mar	Nicholas (DDE-449)	Resurvey	9 March: Utirik and Aon Islands at Utirik Atoll, and Bikar Island at Bikar Atoll; 10 March: Enewetak Island at Rongerik Atoll, and Ailinginae Atoll; 11 March: northern Rongelap Atoll
25-26 Mar	Nicholas (DDE-449)	Resurvey	Rongelap Atoll
21-23 Apr	Philip (DDE-498)	Resurvey	21-23 April: Rongelap Atoll; 23 April: Ailinginae Atoll

Source: Reference 16, Appendix H.

Rongerik remained too radioactive for continuous occupancy after BRAVO and required evacuation because of the contamination of the weather station and the Project 6.6 station there. However, because JTF 7 still required weather information from this station, it was operated intermittently to make daylight soundings before shots ROMEO and KOON by personnel flown in and out by seaplane. For shots UNION and YANKEE, personnel were

conveyed to the site by the Grosse Point, which was used to house them while off duty.

Task Unit 7.3.2 (Carrier Unit)

During CASTLE, the Carrier Unit was composed of the escort carrier Bairoko, Marine Helicopter Transport Squadron HMR-362 with 12 Sikorsy HRS-2 helicopters, and Fleet Composite Squadron VC-3 with six F4U-5N Corsair fighter aircraft. The latter was divided into the Bikini Fighter Element, 7.3.2.1, and the Enewetak Fighter Element, 7.3.2.2, each with three aircraft. The Bairoko and HMR-362 participated in all five shots at Bikini and remained there when shot NECTAR was fired at Enewetak. Operational activities of the Bairoko are summarized in Table 67.

The most important mission of the Bairoko and HMR-362 was to operate the ship-to-shore and interisland airlift at Bikini, which provided transportation to working parties before shots, and to damage-survey and data-recovery parties following shots. The Bairoko also transported all the washdown equipment to the PPG for installation on task group ships. In addition, it furnished space, facilities, and assistance in shipboard decontamination of HMR-362 aircraft in a canvas "bathtub" erected on the flight deck. It provided administrative and working facilities to the radsafe task unit of TG 7.1, which included a photodosimetry trailer and a trailer housing a radiochemical analysis laboratory.

During shot-phase activities, the Bairoko evacuated TG 7.1 personnel who required quick reentry into the area via helicopter, including radsafe monitors and the Task Force Radiological Safety Center personnel required to operate the photodosimetry and radiochemical analysis laboratories. The carrier also took aboard the men and equipment of the Bikini Fighter Element, the personnel and equipment of HMR-362, and CTG 7.3. After shot BRAVO on 1 March, the Bairoko removed the Bikini Fighter Element to Enewetak, where it operated for the remainder of CASTLE. On 6 March, CTG 7.3 shifted his flag to the Curtiss because of overcrowding on the Bairoko. Due to the contamination on Eneman Island, HMR-362 continued to berth and

Table 67. USS Bairoko (CVE-115) operational activities during the CASTLE test series.

Shot	Shot Date	Time of Det.	Ship Location/Activities		
			Preshot	At Shot Time	Postshot
BRAVO (B)	1 Mar	0645	28 February at 2307 underway from Bikini to operating area; 1 March at 0243 rendezvoused with <u>Philip</u> (DDE-498)	At 0645, 38 nmi (70 km) bearing 132° from shot; at 0803 material condition Able set when heavy fallout detected; washdown system operated from 0810-0931; firehoses used after securing washdown system; at 1800 a second fallout began; firehoses continued in use until 1845; steamed from from Bikini to Enewetak	2 March decontamination efforts started again after 0800 radiological monitoring; use of high-pressure hoses and scrubbing carried on all day; 3 March arrived Bikini, launched helicopter radsafe surveys
ROMEO (B)	27 Mar	0630	26 April at 2024 underway from Bikini Lagoon to operational area off Bikini	At 0630, 43 nmi (80 km) bearing 124° from shot; from 0700-0710, washdown gear operating, but no new fallout received	At approximately 0900 launched two helicopters for initial radiological survey; at 1405 anchored in berth N-5, Bikini; 28 March at 0859 after shifting moored to buoy T-2, Bikini; 29 March washdown system operated 0130-0215; reactivated at 0320
KOON (B)	7 Apr	0620	Steamed in the company of the <u>Epperson</u> (DDE-719) in the operational area off Bikini	At 0620, 23 nmi (43 km) bearing 100° from shot	At 1104 anchored in berth N-5, Bikini
UNION (B)	26 Apr	0605	25 April at 1853 underway for Bikini operating area with <u>Philip</u>	At 0605, 57 nmi (105 km) bearing 155° from shot	At 1611 anchored in berth N-5, Bikini
YANKEE (B)	5 May	0610	4 May at 1555 underway with <u>Renshaw</u> (DDE-499) from Bikini to assigned operating area	At 0610, 34 nmi (63 km) bearing 150° from shot; at 0625 set modified condition Able; between 0652-0702 washdown gear on	At 1643 anchored in berth N-6, Bikini
NECTAR (E)	14 May	0620	13 May at 1746 underway from Kwajalein Atoll to Bikini Atoll	At 0620, steaming from Kwajalein to Bikini, 40 nmi (74 km) SE of Eneu	From 0912-1045 <u>Philip</u> alongside to fuel; at 1206 anchored in berth N-3, Bikini; at 1701 underway for Enewetak

Source: USS Bairoko (CVE-115) Deck Log.

5

mess on board the Bairoko and to operate the helicopter lift system from the carrier. Seventeen personnel from HMR-362 received exposures of more than 3.9 R (with a maximum of 5.5 R) because of the heavy fallout the Bairoko encountered after shot BRAVO. Consequently, CTG 7.3 recommended that these individuals be given an MPE waiver to avoid impairing continued operations.

The Consolidated List for VC-3 includes only five of the nine pilots; enlisted maintenance personnel are not shown. It is assumed that these personnel, if badged, were included in some other list, perhaps the Bairoko's list. However, their duty stations would have been with the six F4U aircraft at Enewetak after shot BRAVO. Table 23, which provides accumulated radiological exposure of TG 7.3 personnel by ships and units as of 22 March 1954, shows VC-3 with 20 personnel. All personnel are in the lowest category, 0.0 to 0.999 R. VC-3 ground personnel could be expected to have radiological exposures similar to or lower than the Air Force ground personnel, who also operated out of the Enewetak air facility. There is no record of VC-3 flight missions into areas of potential radiological exposure.

Task Unit 7.3.3 (Patrol Plane Unit)

This unit consisted of Patrol Squadron VP-29 with twelve P2V-6 Neptune aircraft, a P2V-5 Neptune assigned to Project 6.4, a P4Y-2 Privateer aircraft assigned to Project 1.4, and two specially configured PBM-5A Mariner aircraft. The patrol squadron was based at the Naval Air Station (NAS), Kwajalein, for the duration of CASTLE. The other four aircraft operated from the Enewetak Island airstrip at Enewetak Atoll.

VP-29 flew security sweeps of the PPG danger area to warn away transient shipping and aircraft prior to shots. The squadron also flew radiological reconnaissance missions in the northern Marshall Islands in support of the AEC's World Wide Fallout Monitoring Program (see Table 68). VP-29 assisted in locating Project 2.5a fallout-collector buoys. The two PBMs, operating under the control of TG 7.4 (Air Force), were specially

Table 68. Patrol Squadron 29 (VP-29) operations, CASTLE.

Type Flight	Number of Flights	Hours Flown	Night Hours	Day Hours
Cargo and admin	22	50.6	4.2	46.4
Antisubmarine warfare	53	579.3	326.4	252.9
Survey	27	197.5	1.9	195.6
Escort	28	266.1	154.9	111.2
Recon	72	712.5	274.0	438.5
Buoy recovery	4	36.6	1.7	34.9
Buoy evaluation	2	12.7	0.0	12.7
HASL (AEC) special project	8	86.3	3.8	82.5
TOTAL	216	1,941.6	766.9	1,174.7

Source: Reference 14.

configured to increase their passenger capacity to provide interatoll air-passenger service. The P2V-5 was airborne at shot time on shots BRAVO, ROMEO, UNION, and YANKEE, providing airborne remote control capability for operation of the test ships YAG-39 and YAG-40. The P4Y-2 was airborne at shot time on all shots except KOON, serving as an airborne telemetry station for data from instrumentation placed in the lagoon for Project 1.4. Its nominal position was 50 nmi (93 km) south of the burst at shock arrival time at 10,000 feet (3.05 km) altitude. There are no instances of significant contamination among personnel of the Patrol Plane Unit, although a VP-29 aircraft was sufficiently contaminated by the BRAVO cloud that its mission was aborted.

Kwajalein NAS, besides providing basing support for VP-29, provided the aircraft and crew following shot BRAVO for the evacuation of the Rongerik Weather Station and the Project 6.6 personnel. Aircraft from this station also provided the airlift for the evacuation of the Rongelap and Utirik natives. The exposed natives were decontaminated, fed, housed, and

clothed by Kwajalein NAS. The aircraft used in these evacuations also required considerable decontamination.

The RAF Canberras that were permitted to sample the CASTLE detonation clouds were based and supported at Kwajalein NAS. Kwajalein NAS support also included supervision of the decontamination of the sampling aircraft. Thirteen personnel from Kwajalein NAS, including one civilian, have exposures reported in the Consolidated List. The exposures were not very large (less than 0.500 R), with the exception of the civilian, who received almost 3 R. These exposures probably were accrued from decontamination and evacuation operations. VP-29 operational activities are summarized in Table 68.

Task Unit 7.3.4 (Joint Task Force Flagship Unit)

The Estes, an amphibious force flagship with additional communications equipment installed, served as the Flagship Element during CASTLE. It provided command, control, and communications facilities for JTF 7 headquarters, as well as for TG 7.1 and 7.4 during CASTLE. During Bikini operations, the JTF Weather Central and Radiological Safety Office were also located on board the Estes.

Originally, the Estes was to have been based at Enewetak between shots at Bikini. When the entire Bikini operation had to move afloat after shot BRAVO on 1 March, the Estes remained at Bikini for most of the CASTLE series. The ship was present for all Bikini shots, and returned to Enewetak for shot NECTAR on 14 May. Table 69 summarizes the ship's operational activities for CASTLE shots.

The Estes was contaminated by radioactive fallout after BRAVO and ROMEO. The peak intensity topside occurred about 2 hours after BRAVO, when it was estimated at 0.400 R/hr (see Table 21). Fifteen of the crew were given an MPE waiver; however, none of these individuals actually exceeded 3.9 R. Thirteen other crewmen did have excessive exposures (maximum of 6.95 R) without a waiver of MPE. These individuals were among a group

Table 69. USS Estes (AGC-12) operational activities during the CASTLE test series.

Shot	Shot Date	Time of Det.	Ship Location/Activities		
			Preshot	At Shot Time	Postshot
BRAVO (B)	1 Mar	0645	28 February at 1842 underway from Bikini to operating area; at 2022 arrived at assigned operating area; steamed independently off Bikini	Steamed as before	At 0830 set condition Purple II; at 1125 set condition Purple III; at 1535 set condition Purple II; 2 March steamed en route from Bikini to Enewetak; at 0845 moored to buoy B-1, Enewetak; at 1831 underway from Enewetak to Bikini; 3 March anchored at anchorage N-4, Bikini, at 0843
ROMEO (B)	27 Mar	0630	26 March at 2039 underway from Bikini to assigned operating area; at 2259 arrived at assigned position	Steamed as before	27 March at 1325 anchored at berth N-4, Bikini; 28 March at 0737 underway; at 0934 anchored in berth A-6, Bikini
KOON (B)	7 Apr	0620	5 April at 1207 underway for operating area; 7 April steamed to remain on station	Steamed on station	At 1101 anchored at berth N-3, Bikini; 8 April at 1845 received provisions from <u>Karin</u> (AF-33)
UNION (B)	26 Apr	0605	25 April at 2228 underway; at 2348 arrived in operating area; 26 April steamed to remain on station; at 0545 mustered crew	Steamed as before	At 1552 anchored at berth N-4, Bikini; at 1952 underway from Bikini to Enewetak; from 2220-2230 lost power to running lights
YANKEE (B)	5 May	0610	4 May at 2049 underway for operating area; at 2218 arrived in operating area	Steamed as before	At 1355 <u>Curtiss</u> (AV-4) approached starboard for highline transfer; at 1428 CTG 7.3 arrived by highline; at 1708 anchored at berth N-4, Bikini; at 1934 underway to Enewetak; 6 May at 0823 moored at buoy B-1, Enewetak; at 2015 received provisions from the <u>Arequipa</u> (AF-31)
NECTAR (E)	14 May	0620	13 May at 1857 underway from Enewetak to assigned operating area; at 2001 arrived in operating area	Steamed in assigned assigned operating area	At 0741 anchored in anchorage C-1, Enewetak; at 1526 underway en route to San Diego

Source: USS Estes (AGC-12) Deck Log.

of twenty assigned to temporary duty on board LST-762 at Enewetak between 27 March and 15 April. They were probably on temporary duty for YAG decontamination.

Task Unit 7.3.5 (Utility Unit)

The Utility Unit consisted of two salvage lifting vessels, the USS Gypsy and the USS Mender, and five fleet tugs, USS Apache, USS Cocopa, USS Molala, USS Sioux, and USS Tawakoni. The Mender replaced the Gypsy on 25 March 1954, when the Gypsy left for Pearl Harbor. Tables 70 through 76 summarize each ship's activity on a shot-by-shot basis.

The basic assignment of the Utility Unit was to provide harbor and towing services to the joint task force. The unit also gave extensive support to a number of scientific projects. The Sioux and the Apache planted fallout collection buoys prior to all shots except KOON for Project 2.5a and retrieved the buoys after the shots. The Gypsy, Mender, and all the tugs except the Molala assisted Project 1.4 in a variety of ways, but the primary support tug was the Cocopa. During all shots except KOON and NECTAR, the Molala and the Tawakoni assisted Projects 6.4 and 6.5 by prepositioning the YAGs in the predicted fallout area and retrieving them after the shot.

All these activities required the Utility Unit ships to operate in waters that had been contaminated by one or more shots. The Cocopa was withdrawn from support of Project 1.4 after UNION and before YANKEE because of a buildup of background radiation in the tug from radioactive silt retained in her seawater piping; she was replaced in that activity by the Tawakoni (Reference 45). The sources of the radioactive silt were the new craters formed at Bikini by BRAVO and UNION.

A number of ships also were contaminated by fallout from BRAVO: the Gypsy, Cocopa, Apache, and Sioux (Table 21). The Gypsy in particular was most difficult to decontaminate because of corrosion on the decks, which tended to retain fallout. Furthermore, all ships of the Utility Unit

Table 70. USS Gypsy (ARSD-1) operational activities during the CASTLE test series.

Shot	Shot Date	Time of Det.	Ship Location/Activities		
			Preshot	At Shot Time	Postshot
BRAVO (B)	1 Mar	0645	28 February at 1731 underway for operating area assigned for BRAVO	Steamed in assigned operating area	At 1840 maneuvered to take station by <u>Bairoko</u> (CVE-115) and <u>Philip</u> (DDE-498), maneuvered to stay in assigned sector; 2 March at 1201 proceeded to enter Bikini; at 1308 anchored off Eneu Island; at 1345 underway to continue work schedule; at 1540 moored portside to YC-108 off Eneu Island; at 1806 underway in Bikini Lagoon to anchor off Eneu Island; 3 March at 1238 underway to wash down LCUs near Eneu Island; at 1625 completed LCU washdown, anchored at Eneu
ROMEO (B)	27 Mar	0630	26 March at 1256 underway from Bikini Atoll to Kwajalein Atoll; 27 March at 1100 moored portside to YOGN-53, Kwajalein Atoll	Moored at Kwajalein	29 March at 1922 underway to Ailinglapalap Atoll; 30 March at 0738 moored off Bigatgelang Island, Ailinglapalap Atoll
KOON (B)	7 Apr	0620	Did not sortie	Moored starboard side to berth "Fox," Kwajalein, awaiting escort to Pearl Harbor	Remained moored
UNION (B)	26 Apr	0605	Did not sortie	Moored to berth B-7, Pearl Harbor	Remained moored
YANKEE (B)	5 May	0610	Did not sortie	Moored to berth B-4, Pearl Harbor	Remained moored
NECTAR (E)	14 May	0620	Did not sortie	Drydocked in Drydock 1, Pearl Harbor	Remained drydocked

Source: USS Gypsy (ARSD-1) Deck Log.

Table 71. USS Mender (ARSD-2) operational activities during the CASTLE test series.

Shot	Shot Date	Time of Det.	Ship Location/Activities		
			Preshot	At Shot Time	Postshot
BRAVO (B)	1 Mar	0645	In Sasebo, Japan	In Sasebo, Japan	1 March at 1555 underway to Guam
ROMEO (B)	27 Mar	0630	26 March at 1703 underway from Bikini to operating area BF-L	Steamed in operating area	27 March at 1409 anchored in berth N-2, Bikini; 30 March steamed in and out of Bikini Lagoon several times until 2010
KOON (B)	7 Apr	0620	Underway for operating area BG 34-38	Steamed to remain in operating area	At 1555 anchored in Bikini Lagoon
UNION (B)	26 Apr	0605	25 April at 1656 underway from Bikini to operating area BH 30-35-L	Steamed to remain on station BI 50-55-L	26 April at 1847 moored starboard side to LCU-1224 in Bikini Lagoon
YANKEE (B)	5 May	0610	4 May underway from Bikini to assigned operating area BH 30-35-L	Steamed to remain in operating area	6 May at 1847 anchored in Eneu area, Bikini Lagoon
NECTAR (E)	14 May	0620	12 May at 1839 left Enewetak for Pearl Harbor	Steamed en route to Pearl Harbor	Continued steaming

Source: USS Mender (ARSD-2) Deck Log.

Table 72. USS Apache (ATF-67) operational activities during the CASTLE test series.

Shot	Shot Date	Time of Det.	Ship Location/Activities		
			Preshot	At Shot Time	Postshot
BRAVO (B)	1 Mar	0645	Underway from Bikini to rendezvous point with TG 7.3; at 0340 at rendezvous point	Maintained station in rendezvous area	At 1440 commenced maneuvering at various courses and speeds to wash down ship; at 1505 left rendezvous point to carry out operations; at 1734 commenced steering various courses and speeds for washdown
ROMEO (B)	27 Mar	0630	Underway from Bikini to rendezvous with TG 7.3; at 0135 arrived in rendezvous area	Maintained station in rendezvous area	At 0835 maneuvered in vicinity of Ainsworth (T-AP-181); between 0920 and 0955 had motor launch in water; from 1602-1715 commenced steering various courses and speeds to effect washdown
KOON (B)	7 Apr	0620	Underway from Bikini to Enewetak	Continued steaming from Bikini to Enewetak	At 0940 anchored in vicinity of berth K-2, Enewetak
UNION (B)	26 Apr	0605	Underway from Enewetak to Kwajalein	Continued steaming from Enewetak to Kwajalein	27 April at 0802 moored to berth Easy, Kwajalein
YANKEE (B)	5 May	0610	Did not sortie	Moved to berth Easy, Kwajalein	Remained moored
NECTAR (E)	14 May	0620	Underway independently from Bikini to Pearl Harbor; at 0420 made radar contact with Mogiri Island	Continued steaming from Bikini to Pearl Harbor	Steamed as before

Source: USS Apache (ATF-67) Deck Log.

Table 73. USS Cocopa (ATF-101) operational activities during the CASTLE test series.

Shot	Shot Date	Time of Det.	Ship Location/Activities		
			Preshot	At Shot Time	Postshot
BRAVO (B)	1 Mar	0645	Underway from Bikini with four YCVs on main tow and YFN-934 on starboard wing drum	Steamed in Bikini operating area	At 1845 took station by Philip (DDE-498) in company with Belle Grove (LSD-2), Gypsy (ARSD-1), and Grosse Point (PG-1546); 2 March at 1405 released YFN-934; approached YC-1081 at 1437; at 1527 anchored in Bikini; from 1636-1807 fueled from Grosse Point; released YCN at 1710
ROMEO (B)	27 Mar	0630	26 March at 2012 underway for operating area with YFN in tow	Underway for assigned duties	At 1358 anchored at Eneu, Bikini; at 1424 sent diver over to investigate propeller
KOON (B)	7 Apr	0620	Did not sortie	Anchored berth Able, K-2,	At 0725 underway to shift berths to Able berth B-1, Enewetak; at 0743 Enewetak anchored; at 1737 underway from Enewetak to Bikini
UNION (B)	26 Apr	0605	25 April at 1725 underway with YFN-934 in tow in assigned area off Bikini	Steamed in assigned area	At 1843 anchored at Bikini, transferred YFN-934 to LCM-42
YANKEE (B)	5 May	0610	4 May at 1430 underway in assigned operating area from Bikini	Steamed in assigned operating area	Remained steaming in assigned operating area until 6 May; at 0751 anchored northeast of berth N-12, Bikini
NECTAR (E)	14 May	0620	Did not sortie	Anchored west of Eneu Island, Bikini	Remained anchored

Source: USS Cocopa (ATF-101) Deck Log.

Table 74. USS Molala (ATF-106) operational activities during the CASTLE test series.

Shot	Shot Date	Time of Det.	Ship Location/Activities		
			Preshot	At Shot Time	Postshot
BRAVO (B)	1 Mar	0645	28 February at 1202 underway in column formation with YAG-39 and YAG-40; 1 March at 0414 boat offloaded 8 personnel from YAG-39 and YAG-40; completed transfer at 0442	Steamed from Bikini to Enewetak	At 1041 rendezvoused with Tawakoni (ATF-114); (ATF-114); at 1211 transferred YAG-39 personnel to Tawakoni; at 1600 took YAG-40 in tow; 2 March at 1708 cast off tow; anchored in berth F-7, Enewetak at 1723
ROMEO (B)	27 Mar	0630	26 March at 1850 underway to operating area from Bikini with YAG-39 and YAG-40; 27 March 0308-0400 27 March debarked passengers from YAG-39 and YAG-40	Steamed in operating area	At 0855 rendezvoused with Tawakoni; at 1006 transferred YAG-39 personnel to Tawakoni; 28 March at 1252 took YAG-40 in tow; on 29 March at 1554 moored YAG-40; at 1618 anchored in berth C-1, Enewetak
KOON (B)	7 Apr	0620	Did not sortie	Anchored in berth C-1, Enewetak	Remained anchored
UNION (B)	26 Apr	0605	25 April at 1915 underway from Bikini in column formation with YAG-39 and YAG-40; 26 April from 0300-0357 took passengers aboard from YAG-39 and YAG-40	Steamed from Bikini to Enewetak	From 1727-1812 transferred personnel to YAG-39; at 2015 put YAG-40 in tow; 29 April continued steaming; at 1051 ceased towing; at 1205 anchored in berth B-1, Enewetak
YANKEE (B)	5 May	0610	4 May at 1502 underway from Bikini to operating area 3,000 yards (2.7 km) from YAG-40; 5 May from 0207-0326 debarked personnel from YAG-39 and YAG-40	Steamed in operating area, then left for Enewetak	From 1534-1630 transferred personnel to YAG-39 and YAG-40; at 1700 took YAG-40 in tow; 7 May continued steaming from Bikini to Enewetak with YAG-40 in tow; at 1140 anchored YAG-40 at mooring C-1, Enewetak; at 1214 anchored in vicinity of berth D-4, Enewetak
NECTAR (E)	14 May	0620	13 May at 1842 underway with YAG-40 in tow from Enewetak to operating area; 14 May at 0115 steering casualty	Steamed in operating area	14 May at 1303 anchored YAG-40 in berth C-3, Enewetak; at 1315 anchored in berth C-4, Enewetak

Source: USS Molala (ATF-106) Deck Log.

Table 75. USS Sioux (ATF-75) operational activities during the CASTLE test series.

Shot	Shot Date	Time of Det.	Ship Location/Activities		
			Preshot	At Shot Time	Postshot
BRAVO (B)	1 Mar	0645	Underway for operating area BF 35-40-L in connection with Project 2.5a	Steamed in assigned operating area	At 1413 turned on washdown system for 30 minutes; continued using it intermittently; 2 March cut in spray system from 2345 (1 March) - 0000 and 0115-0145; at 0025 in search of buoys throughout day; 3 March at 0831 anchored in berth C-3, Enewetak
ROMEO (B)	27 Mar	0630	26 March at 1013 underway from mooring A-7, Bikini, in connection with Project 2.5a; at 1613, 1748, 1855, 2146, 2202, 2258 dropped buoys; 27 March continued dropping buoys	Steamed independently, dropping buoys as part of Project 2.5a	At 0847 commenced maneuvers to close with Apache (ATF-67) to transfer personnel from Ainsworth (T-AP-181); at 0937 one man from Project 2.5a came aboard; at 1408 began picking up buoys; 28 March continued collecting and tracking buoys; 29 March at 1710 anchored berth C-1, Enewetak; at 0832 30 March unloaded buoys
KOON (B)	7 Apr	0620	5 April at 1007 underway for operating area with YFN-934 in tow	Steamed in assigned operating area	At 1338 anchored in berth N-12, Bikini; at 1412 cast off YFN-934; 8 April at 1220 picked up DTMB instrument buoy
UNION (B)	26 Apr	0605	Did not sortie	Anchored in berth B-1, Enewetak	At 0910 underway for northern end of atoll; at 1044 anchored in berth 874, Enewetak; 27 April at 0704 civilian personnel with Project 2.5a came aboard while laying to; at 0509 underway to lay buoys; from 1345-2113 laid buoys; 28 April at 0924 anchored in berth C-2, Enewetak; at 1211 underway to retrieve buoys; 29 April from 2000-0120 maneuvering and laying buoys; 30 April at 0050 anchored in berth C-4, Enewetak
YANKEE (B)	5 May	0610	4 May at 1015 underway from Enewetak to operating area BG 40-45-L; 5 May at 0402 arrived in operating area	Steamed in assigned operating area	At 0958 stopped all engines, laying to for test of equipment for Project 2.5a; at 1141 maneuvered at various courses for operating area BG 30-45-L; intermittently conducted tests of sounding equipment; 6 May at 0615 began taking water samples; at 1820 took soundings; 7 May at 0457, 1232, 1831, 2150 took water samples; 8 May at 1425 took water sample
NECTAR (E)	14 May	0620	13 May at 1855 underway to operating area EF 18-23	Steamed in assigned operating area; at 1602 saw bright light off starboard quarter	At 0851 anchored in berth B-1, Enewetak; at 1822 underway for operating area

Source: USS Sioux (ATF-75) Deck Log.

Table 76. USS Tawakoni (ATF-114) operational activities during the CASTLE test series.

Shot	Shot Date	Time of Det.	Ship Location/Activities		
			Preshot	At Shot Time	Postshot
BRAVO (B)	1 Mar	0645	28 February at 1640 transferred YCV-9 to <u>Cocopa</u> (ATF-101); at 2000 left Bikini Lagoon for assigned operating area	Steamed in assigned operating area	At 1045 maneuvered and rendezvoused with <u>Molala</u> (ATF-106), 600 yards (550 meters) astern; at 1710 made inspection of YAG-39; 2 March towing YAG-39 en route to Enewetak; at 1306 maneuvered to put whale boat in water to board YAG-39; at 1900 moored to buoy in anchorage C-3, Enewetak; between 2000-2205 moored YAG-39 with 2 M-boats and a YTL assisting, cracked starboard and port quarters while mooring YAG; at 2225 left Enewetak Atoll for Bikini; 3 March at 1955 anchored in vicinity of YCV-9, Eneu
ROMEO (B)	27 Mar	0630	26 March at 1318 underway with YFN-935 in tow; at 1501 anchored vicinity of Eneu Island; at 1820 underway again; at 2110 maintained position 1,000 yards (900 meters) on starboard beam of <u>Cocopa</u>	Steamed in assigned operating area	At 1812 proceeded to intercept YAG-39; 28 March at 1219 maneuvering by YAG-39; steamed with YAG-39 until 29 March around 0800; at 1140 anchored in berth K-2, Enewetak
KOON (B)	7 Apr	0620	6 April at 0634 underway from Enewetak for assigned evacuation area BG 30-34-R	Steamed in assigned evacuation area	7 April at 1550 picked up passengers at Eneu Channel and proceeded out of channel to vicinity of Eneman Island; at 1902 entered lagoon by Eneu Channel; at 1928 anchored off Eneu Island, Bikini Atoll
UNION (B)	26 Apr	0605	Did not sortie	Anchored in berth C-5, Enewetak	26 April at 2000 underway to assigned operating area; 28 April at 0948 anchored mooring D-4, Enewetak
YANKEE (B)	5 May	0610	4 May at 1600 underway with YFN-934 in tow	Steamed in operating area	Until 6 May, at 0400, remained in operating area; at 0823 anchored in Bikini off Eneu Island; at 1330 LCM-41 and LCM-42 took YFN-934; at 1730 underway for decontamination project; at 1803 moored alongside LCU-636; at 1926 underway to N-11 anchorage; at 1935 anchored in N-11, Bikini
NECTAR (E)	14 May	0620	8 May at 1608 underway from Bikini to Pearl Harbor with YCV-9 in tow	Steamed from Bikini to Pearl Harbor with YCV-9 in tow	Continued steaming; 18 May at 0613 cast off YCV-9; at 0640 moored alongside DE-3 at Pearl Harbor

Source: USS Tawakoni (ATF-114) Deck Log.

assisted in decontaminating the harbor craft and small boats left behind in Bikini Lagoon during shots detonated there. A total of 31 personnel of the Utility Unit received exposures greater than 3.9 R during CASTLE.

Task Unit 7.3.6 (Atomic Warfare Ship Countermeasures Test Unit)

This unit contained two task elements. The Drone Ship Element, 7.3.6.0, was made up of the specially modified Liberty ships, YAG-39 (USS George Eastman) and YAG-40 (USS Granville S. Hall). The Towing and Decontamination Element, 7.3.6.1, included the Molala, whose primary responsibility was servicing the YAGs, and the Tawakoni, both of them fleet tugs of the Utility Unit. The principal purpose of the unit was to use the YAGs as data-collection platforms for Projects 6.4 and 6.5, which required both ships to be positioned in the area of heaviest fallout. Both YAGs were instrumented with fallout-collection devices, as well as with various test materials, in order to determine their susceptibility to fallout contamination and the ease with which they could be decontaminated. Each ship had a shielded control compartment and, in addition, could be operated by remote control. While YAG-39 mounted a washdown system topside, YAG-40 did not, thereby providing a control situation for the experiments being conducted on board both ships.

The YAGs were employed on shots BRAVO, ROMEO, UNION, and YANKEE. Neither ship had a crew on board for the first two shots, but on the latter two YAG-39 carried a skeleton crew that controlled the ship from the shielded control compartment. The usual pattern of operation was for crews to sail both YAGs to Bikini Lagoon prior to the tests. Before the ships left the lagoon, most YAG crewmen were transferred to other TG 7.3 ships for evacuation sorties. Skeleton crews then sailed the YAGs to a debarkation point in the anticipated fallout area accompanied by the Molala. The tug removed the skeleton crews and took over the YAGs by remote control. (There is evidence that the Bairoko might also have had remote-control capabilities.) An Enewetak-based P2V-5 aircraft equipped with remote controls assumed control of the YAGs for the duration of shot-time activities. The skeleton crew on board YAG-39 could also control

YAG-40. After fallout ceased, the Molala and the Tawakoni returned the crews to YAG-39, if radiological conditions warranted. If YAG-39 were reboarded, she returned under her own power; otherwise, both ships were towed back to the Enewetak Lagoon off Parry Island, where the ships underwent a radiological survey and, if necessary, decontamination. Neither ship was positioned in the fallout area during BRAVO because of a miscalculation in predicting the fallout location and thus did not require major decontamination; nor did shot UNION contaminate either ship. YAG-40 had to be decontaminated following shot ROMEO, and both ships were decontaminated after shot YANKEE. Shot activities are summarized in Table 77.

Thirty men on board YAG-39 and thirty-three men on board YAG-40 accumulated exposures in excess of 3.9 R. The highest exposure assessed was 24.39 R. This was made up of 4.39 R from film badge readings for the tests prior to YANKEE plus an estimate of 20.0 R for YANKEE according to medical records. Individuals from other units of TG 7.3 assisted in decontaminating these two ships, possibly encountering radiological exposure. After the tests, the ships remained at Enewetak until 26 May for additional decontamination before sailing to San Francisco via Pearl Harbor. By 25 May the average topside reading for YAG-39 was 0.007 R/hr, with average interior and below-deck readings of 0.002 R/hr. These levels were expected to be down to 0.004 R/hr and 0.001 R/hr, respectively, at the time of arrival at Pearl Harbor, and 0.003 R/hr and 0.0005 R/hr at San Francisco. Crewmembers were expected to receive 0.5 to 1 R on the trip to San Francisco. Readings for YAG-40 were higher: 0.040 R/hr topside and 0.008 R/hr inside on 25 May, with 0.025 R/hr and 0.004 R/hr expected at Pearl Harbor, and 0.014 R/hr and 0.002 R/hr at San Francisco. The additional exposure for the crew was expected to be 3 to 5 R. Subsequent investigations of the medical records of 41 of the 54 crewmen for the period that YAG-40 was in transit to San Francisco disclosed that their mean exposure was 1.676 R, with an exposure range of 0.705 R to 4.56 R, somewhat less than the initially expected exposure. These additional exposures are not reflected in the Consolidated List. For two of the YAG crew, the

Table 77. YAG-39 (USS George Eastman) and YAG-40 (USS Granville S. Hall) operational activities during CASTLE test series.

	YAG-39	YAG-40
BRAVO		
Operations:	Operated from 220 ⁰ to 240 ⁰ at ranges from 10 to 40 nmi (18 to 74 km) from shot point to H+6. Not in fallout.	
Crew:	None (remote control)	None (remote control)
Recovery:	<u>Tawakoni</u> tow	<u>Molala</u> tow
Decontamination:	None required	None required
ROME0		
Operations:	Operated from 220 ⁰ to 300 ⁰ at ranges of 25 to 50 nmi (46 to 92 km) from shot point to H+10. In fallout.	
Crew:	None (remote control)	None (remote control)
Recovery:	Skeleton crew	<u>Molala</u> tow
Decontamination:	None required	Required
KOON		
Operations:	Neither ship participated; both were at Enewetak.	
UNION		
Operations:	Operated from 40 ⁰ to 80 ⁰ at ranges of 20 to 50 nmi (37 to 92 km) from shot point to H+8.	
Crew:	Skeleton crew	None (remote control)
Recovery:	Full crew rejoined at H+11	H+14 <u>Molala</u> tow
Decontamination:	None required	None required
YANKEE		
Operations:	Operated at 60 ⁰ to 80 ⁰ at ranges of 30 to 55 nmi (56 to 102 km) from shot point to H+12. In fallout.	
Crew:	Skeleton crew	None (remote control)
Recovery:	Full crew rejoined at H+9	H+11 <u>Molala</u> tow
Decontamination:	Required	Required
NECTAR		
Operations:	Did not participate	
Source: Reference 72.		

projected additional exposure would have raised their total to over 15 R; these men did not return aboard the YAG.

Task Unit 7.3.7 (Bikini Harbor Unit)

The USS Belle Grove, as Task Element 7.3.7.0, and the Bikini Boat Pool, as Task Element 7.3.7.1, made up the Bikini Harbor Unit. The Bikini Boat Pool operated 15 LCMs, 5 LCUs with permanent crews (LCU-637, -638, -1224, -1225, and -1348), 2 LCPRs, an LCPL, a 28-foot motor whale boat (MWB), an Air Force crash boat (AVR), and a covered barge, YFN-934. The latter served as a dispatching facility and spare parts store for boat pool operations between shots. Together with the H&N Boat Pool, the Navy Boat Pool provided interisland and ship-to-shore transportation to the joint task force at Bikini. The Belle Grove also transported shot devices from Ene-wetak to Bikini as the Special Devices Transport Element, 7.3.9.0, of TU 7.3.9, the Transport Unit.

During evacuations for Bikini shots, the Belle Grove took the 15 Navy LCMs and the AVR into its well deck. Remaining craft, including the five LCUs, were moored in the lagoon in the lee of Eneu Island. A Utility Unit tug towed YFN-934 to sea. Both Navy and H&N personnel, along with a TG 7.1 radsafe advisor, went aboard the Belle Grove, which was one of the last ships to leave the lagoon and one of the first to reenter during shot operations, allowing critical construction and recovery operations to proceed with the least possible interruption. The Belle Grove's activity for each shot is described in Table 78.

After reentry following a shot, the Belle Grove put both boat pools into operation as soon as the lagoon was declared safe for boating. At the same time, Navy boat pool personnel, with assistance from ships' crews, began decontaminating the craft left behind. These assignments created a far greater possibility of radiological exposure than for most other units. This is reflected in the waiver of MPE for boat pool crews following shot BRAVO. Altogether 49 members of the boat pool and 2 crewmen from the Belle Grove received exposures over 3.9 R.

Table 78. USS Belle Grove (LSD-2) operational activities during the CASTLE test series.

Shot	Shot Date	Time of Det.	Ship Location/Activities		
			Preshot	At Shot Time	Postshot
BRAVO (B)	1 Mar	0645	28 February underway from anchorage N-3, Bikini, to assigned operating area BF 30-35-R with 18 LCMs and 1 AVR in well deck	Steamed in assigned operating area	At 1245 set the gas-tight envelope, repair parties manned and crew at shelter stations; between 1252-1537 washdown system on; at 1651 closed in on <u>Bairoko</u> (CVE-115); at 1717 helicopter left radiac cargo on ship; at 1720 helicopter left 1 USAF officer on ship; at 2012 set gas-tight envelope; from 2025-2115 washdown system on; 2 March steamed in company with <u>Philip</u> (DDE-498), <u>Gypsy</u> (ARSD-1), <u>Cocopa</u> (ATF-101), <u>Grosse Point</u> (PC-1546); at 0706 detached from unit, proceeded to Bikini; at 0804 anchored N-3; at 1220 debarked 13 LCMs
ROMEO (B)	27 Mar	0630	26 March at 2130 underway for operating area BF 29-34-R, with 14 boat pool LCMs, 4 civilian LCMs, 1 AVR below deck	Steamed in assigned operating area	At 1328 anchored berth N-2, Bikini
KOON (B)	7 Apr	0620	5 April departed Bikini for operating area BG 32 36-L with 14 boat pool LCMs, 4 civilian LCMs, 1 AVR	Steamed in assigned operating area	At 1136 anchored berth N-2, Bikini
UNION (B)	26 Apr	0605	25 April at 1937 underway from berth N-2, Bikini, to assigned operating area BG 25-30-R with 1 AVR, 18 LCMs, 4 DUKWs; at 0324 took station 10 miles (18 km) from <u>Curtiss</u> (AV-4); at 0353 proceeded to operating area BH 45-50-R	Steamed in assigned operating area	At 1656 anchored berth N-2, Bikini
YANKEE (B)	5 May	0610	4 May at 1645 underway from berth N-2, Bikini, to assigned operating area BG 25-30-R with 1 AVR and 18 LCMs; at 0310 changed course for area BG 35-40-R	Steamed in assigned operating area	At 1743 anchored berth N-2, Bikini; at 2013 underway from berth N-2 to operating area BG 35-40-R with LCMs and AVR still embarked; 6 May at 0743 anchored berth N-2, Bikini
NECTAR (E)	14 May	0620	By 13 May steaming from Enewetak to Rongerik with LCU-292 (civilian), LCU-637, LCU-1348	Steamed to Rongerik	14 May at 0640 disembarked LCU-292; at 0640 disembarked LCU-637; at 0824 disembarked LCU-1348; from 1848 to 1903 embarked LCUs; at 1955 departed from Rongerik en route to Enewetak; 16 May at 0650 anchored berth B-2, Enewetak

Source: USS Belle Grove (LSD-2) Deck Log.

The film badges of three men indicated exposures of 85, 95, and 96 R. These individuals are believed to have worked aboard an LCM alongside the Belle Grove. During the washdown of the Belle Grove, considerable water reportedly accumulated in the LCM alongside. Subsequently, these individuals were believed to have worked on decontaminating the LCM. Their exposures were reportedly a result of concentrated fallout in the LCM. Thorough investigation, however, failed to reveal how they could have received this much radiation. It was later concluded that some discrepancy in badging or wearing of film badges must have occurred. Careful examination of the badges by densitometer revealed nothing unusual in the radiation to which they were subjected. Clinical and laboratory studies conducted on all three individuals at Tripler Army Hospital, Oahu, Territory of Hawaii, were essentially negative, and they were discharged to duty (Reference 16).

Task Element 7.3.7.2 (Mine Project Element)

The destroyer minelayer USS Shea, the salvage vessel USS Reclaimer, Explosive Ordnance Disposal Unit 1, Naval Beach Group 1, and Mine Project 6 made up the Mine Project Element of TG 7.3., which was in the PPG only for the conduct of Project 3.4, Sea Minefield Neutralization by Means of a Surface Detonated Nuclear Explosion. The project entailed laying seven strings of mines, containing 121 in all, at specified distances from ground zero. The mines were inert-loaded, but otherwise functional, with a detonator installed to assess the shot's effects on the mine's components. After the shot, the Mine Laying and Recovery Element, 7.3.7.3, recovered 100 mines and turned them over to the Mine Readying and Analysis Element, 7.3.7.4, which recorded the effects of blast and pressure on each mine. Forty-eight of the test mines were returned to the United States for further study. The project was confined to one shot, UNION, detonated on 26 April. Tables 79, 80, and 81 describe activities of the Reclaimer, the Shea, and the USS Terrell County during the CASTLE test series.

Project personnel were exposed to radiation during the mine recovery process. On the day following shot UNION, 27 April, some mines indicated

Table 79. USS Reclaimer (ARS-42) operational activities during the CASTLE test series.

Shot	Shot Date	Time of Det.	Ship Location/Activities		
			Preshot	At Shot Time	Postshot
BRAVO (B)	1 Mar	0645	28 February moored starboard side to berth Baker 18 in Pearl Harbor	Moored starboard side to berth Baker 18 in Pearl Harbor	Moored starboard side to berth Baker 18 in Pearl Harbor through 8 March
ROMEO (B)	27 Mar	0630	26 March moored starboard side to berth DE-4 in Pearl Harbor	Moored starboard side to berth DE-4 in Pearl Harbor	27 March at 1253 underway from Pearl Harbor to Bikini
KOON (B)	7 Apr	0620	6 April enroute from Pearl Harbor to Bikini; at 1245 changed course to Kwajalein	Approached Kwajalein; at 0646 entered Gea Pass	At 0754 anchored in berth 14, Kwajalein; at 1211 underway for Bikini
UNION (B)	26 Apr	0605	25 April at 1121 left Bikini anchored to go alongside <u>Terrell County</u> (LST-1157) to receive mines to support Scientific Project 3.4; at 1420 completed taking on mines; from 1435-1450 laid mines; from 1620-1639 laid mines; at 1745 underway for assigned operating area BH 25-30-L	At 0620 cleared topside of all nonessential personnel; closed all doors, hatches, and ports from topside to interior of ship; tested washdown equipment	At 1006 changed station to BI 35-40-L; at 1505 began approaching Eneu Channel; at 1811 anchored in N-1, Bikini; 28 April at 1113 underway to recover mines; at 1325 began recovery operation, ceased activity by 2204; 29 April remained anchored until 0730 when underway to Aomen area for continued mine recovery; at 0820 anchored in Aomen area for mine recovery; continued recovery at least through 30 April
YANKEE (B)	5 May	0610	4 May at 1445 underway for Guam	Continued steaming to Guam	Continued steaming to Guam
NECTAR (E)	14 May	0620	8 May modified destination; steamed to Sasebo, Japan; 13 May at 1441 moored in Sasebo, Japan	Moored in Sasebo, Japan; tested sprinkling system	Moored in Sasebo, Japan

Source: USS Reclaimer (ARS-42) Deck Log.

Table 80. USS Shea (DM-30) operational activities during the CASTLE test series.

Shot	Shot Date	Time of Det.	Ship Location/Activities		
			Preshot	At Shot Time	Postshot
BRAVO (B)	1 Mar	0645	Moored portside to berth 3 in Long Beach, California	Moored portside to berth 3 in Long Beach, California	Moored portside to berth 3 in Long Beach through 8 March
ROMEO (B)	27 Mar	0630	Steamed from Pearl Harbor to Bikini; at 0415 crossed international dateline	Steamed as before	27 March at 1203 made bathythermograph (B/T) drop; steamed as before; 29 March at 1155 made B/T drop; 29 March at 1407 anchored in anchorage B-9, Bikini
KOON (B)	7 Apr	0620	Steamed in assigned operating area BG 34-38-R with <u>Terrell County</u> (LST-1157) and <u>Mender</u> (ARSD-2)	Steamed in assigned operating area	At 0830 entered assigned operating area BG 24-29-R; at 1217 anchored in berth N-14, Bikini
UNION (B)	26 Apr	0605	25 April at 1715 underway from Bikini Lagoon to assigned sector	Steamed in assigned operating area	At 1726 anchored in Bikini Lagoon
YANKEE (B)	5 May	0610	4 May at 1556 underway from berth N-6, Bikini Lagoon, en route to Kwajalein	En route to Kwajalein	At 0853 moored starboard side of YOGN-182, Kwajalein; 0940 took on fuel; at 1448 underway for Pearl Harbor
NECTAR (E)	14 May	0620	13 May at 1612 underway from Pearl Harbor to Long Beach, California	En route to Long Beach, California	En route to Long Beach, California

Source: USS Shea (DM-30) Deck Log.

Table 81. USS Terrell County (LST-1157) operational activities during CASTLE test series.

Shot	Shot Date	Time of Det.	Ship Location/Activities		
			Preshot	At Shot Time	Postshot
BRAVO (B)	1 Mar	0645	Moored beside LST-1134 at berth B-23, Pearl Harbor	Moored beside LST-1134 at berth B-23, Pearl Harbor	Remained moored
ROMEO (B)	27 Mar	0630	Underway from Pearl Harbor to Bikini	Steamed as before	Steamed as before; 29 March at 1343 anchored at B-10, Bikini
KOON (B)	7 Apr	0620	Underway from Enewetak to assigned Bikini operating area with <u>Curtiss (AV-4)</u> , <u>Mender (ARSD-2)</u> and <u>Shea (DM-30)</u>	Steamed as before	At 1350 moored starboard side <u>Belle Grove (LSD-2)</u> at N-2, Bikini; at 1514 cast off; at 1546 anchored at N-14, Bikini
UNION (B)	26 Apr	0605	25 April at 1420 completed transfer of mines for Scientific Project 3.4 to <u>Reclaimer (ARS-42)</u> ; at 1753 underway from Bikini to assigned operating area BH 30-35-L; 26 April at 0355 commenced steering various courses and speeds to remain in area BI 50-55-L	Steamed in area BI 50-55-L; at 0622 set condition Able and mustered crew to quarters and atomic defense	At 0646 secured from general quarters and set regular watch; remained steaming in area BI 50-55-L until 1028; commenced steering various courses and speeds to remain in area BI 40-45-L; at 1331 changed course to approach assigned area BI 30-35-L; at 1431 approached assigned area BI 20-25-L; at 1800 anchored in berth N-14, Bikini; 27 April 1800-1855 pumped fuel to <u>Grosse Point (PC-1546)</u>
YANKEE (B)	5 May	0610	4 May at 1408 underway from Bikini to operating area BH 30-35-L	Steamed as before	Steered at various courses and speeds to remain in assigned area BH 30-35-L; at 1200 steamed on various courses and speeds in assigned area BH 15-20-L; 6 May steamed off Bikini to remain in assigned area BH 45-50-R; at 0230 departed area BH 45-50-R for Bikini; at 0833 anchored at berth N-1, Bikini
NECTAR (E)	14 May	0620	13 May at 1854 underway from Enewetak to operating area EG 20-25	Steamed as before	At 0640 underway to berth K-2, Enewetak; at 0930 anchored at K-2, Enewetak; at 1606 got underway; at 1643 anchored at C-1, Enewetak; 17 May at 1827 left for Kwajalein

Source: Terrell County (LST-1157) Deck Log.

radiation intensities as high as 10 R/hr. These were returned to the lagoon immediately and left there for several days until radiation levels dropped. Only one individual involved in the project received an exposure in excess of the MPE. He was aboard the Terrell County and was exposed to 16.055 R; how has not been determined.

Task Unit 7.3.8 (Enewetak Harbor Unit)

In general, the Enewetak Harbor Unit's responsibilities included supervision of port and harbor operations, fuel replenishment facilities, SAR operations, and atoll security. The unit included an Air Force crash boat (AVR), an LCM, and the fuel barges YOG-61, YOGN-82 and YO-120. In addition, an Underwater Detection Unit with one LCM was assigned as Task Element 7.3.8.0 to operate and maintain hydrophone arrays across both entrances to the lagoon.

Initially, the commanding officer of the Estes was to exercise administrative and operational control over these forces. This assignment also required administering and coordinating the activities of the Navy detachment that operated the Army's boat pool at Enewetak (described in this chapter under TG 7.2). However, when the Estes was forced to remain at Bikini for long periods after shot BRAVO contaminated the atoll, the responsibility for this assignment was assumed by the highest ranking Navy officer among the ships present at Enewetak.

None of the members of the Enewetak Harbor Unit, Underwater Detection Unit, or the personnel assigned to the Navy detachment of TG 7.2 exceeded an exposure of 3.9 R. From the the readings given in the Consolidated List, the exposures appear to have been assigned rather than individual badge readings, as the exposures are in even tenths of a roentgen and are restricted to a few values. Perhaps some badges were worn and the remaining exposures were based on representative badge readings.

Task Unit 7.3.9 (Transport Unit)

This unit consisted of permanently assigned ships and ships assigned from other task units on temporary duty. The latter included the Belle

Grove, which transported some shot devices between Enewetak and Bikini as the Special Devices Transport Element, 7.3.9.0, and escort destroyers, which served to screen this activity as Task Element 7.3.9.2. LST-762 and LST-551, both permanently assigned to the unit, also transported shot devices under escort from Enewetak to Bikini. Otherwise, these two LSTs, along with LST-1146 and the Terrell County (assigned to Task Element 7.3.7.3), carried passengers and freight between the two atolls. The USNS Fred C. Ainsworth, a ship of the Military Sea Transportation Service (MSTS) with a civilian crew, was the other permanent member of the unit. This ship provided housing and mess facilities for H&N personnel, TG 7.5, at Bikini. It also served as a radsafe center and decontamination facility, utilizing a barge moored alongside for these activities. Tables 82 through 85 describe activities of each TU 7.3.9 ship during the shots for CASTLE.

Typically, the LSTs remained at Enewetak for Bikini shots, and at Bikini, the Ainsworth evacuated personnel from TG 7.5 and sortied for its Bikini operating area. The ship returned to the lagoon only after initial recovery operations had begun.

The Ainsworth was slightly contaminated by BRAVO fallout on 1 March (Table 21). LST-762 was also contaminated by YANKEE fallout while under tow by LST-975 en route to Pearl Harbor.

Two individuals in the unit recorded exposures slightly in excess of the MPE. One of them was a crewman on board LST-762, the other a crewman on board LST-551. The LST-762 crewman was logged out from 25 February to at least 8 March on emergency leave to Treasure Island, California, and no reference is made to his returning. Neither crewmember had received an MPE waiver. No details have been found of any special mission assignment undertaken by either crewmember to account for the high readings.

OTHER NAVAL UNITS IN THE PPG OR IN NEARBY WATERS DURING CASTLE

Except for VR-7, no units in the following listing are represented in the personnel exposures of the Consolidated List. These units were not

Table 82. USNS Fred C. Ainsworth (T-AP-181) operational activities during CASTLE test series.

Shot	Shot Date	Time of Det.	Ship Location/Activities		
			Preshot	At Shot Time	Postshot
BRAVO (B)	1 Mar	0645	28 February left Eneman Island for Eneu and anchored in berth N-4, Bikini, for final loading of passengers at 1100; underway to evacuation area BG 30-35-R at 1838	Steamed in assigned area	By 1300 began receiving BRAVO fallout; at 1800 en route to Enewetak with Curtiss (AV-4) and Estes (AGC-12) to allow task force to reorganize and resume Bikini operations afloat; on 2 March anchored at Enewetak Atoll at 0943; on 4 March at 1847 departed for Bikini, arriving 5 March at 0900
ROMEO (B)	27 Mar	0630	26 March departed Eneman for Eneu anchorage and anchored in berth N-3, Bikini, at 1616; underway to evacuation area BG 29-34-L at 2011	Steamed in assigned area	On 27 March at 1336 anchored in Bikini Atoll
KOON (B)	7 Apr	0620	On 5 April at 1310 departed Bikini anchorage for assigned area	Steamed in assigned area	On 7 April at 1019 departed evacuation station and anchored at N-4 in Bikini Atoll at 1150
UNION (B)	26 Apr	0605	On 25 April TG 7.5 LCMs removed decontamination barge from alongside and moored to buoy off Eneu at 1638; sailed for assigned operating area BG 30-35-L at 1835 with 200 passengers onboard	Steamed in assigned area	On 26 April at 1100 departed assigned area for anchorage number 3 in Bikini Atoll; anchored at 1710
YANKEE (B)	5 May	0610	On 4 May TG 7.5 LCMs removed decontamination barge from alongside and moored to buoy off Eneu at 1300; underway to area BG 30-35-L at 1616	Steamed in assigned area	On 5 May at 1210 departed evacuation station and anchored in Bikini Atoll at 1838; at 1955 departed Bikini for sea; on 6 May at 0725 reanchored in Bikini Atoll; 11 May at 1819 underway for Enewetak; 12 May at 1052 anchored in Enewetak Atoll
NECTAR (E)	14 May	0620	On 13 May at 1901 underway for assigned evacuation station; on station at 2030	Steamed in assigned area	On 14 May at 0730 departed assigned station for Enewetak Atoll; anchored in Enewetak at 0801; took on 75 passengers and at 1715 departed for Pearl Harbor; arrived Pearl Harbor on 21 May

Sources: Installment History of Operation CASTLE (Reference 14); Operation Letters for BRAVO, ROMEO, UNION, YANKEE, NECTAR; Ainsworth (T-AP-181) Deck Log.

Table 83. LST-551 operational activities during CASTLE test series.

Shot	Shot Date	Time of Det.	Ship Location/Activities		
			Preshot	At Shot Time	Postshot
BRAVO (B)	1 Mar	0645	28 February underway for area 30 nmi (56 km) west of Enewetak	Steamed as before	At 1047 anchored at anchorage area C-1, off Parry Island, Enewetak; at 1537 beached at Parry Island
ROMEO (B)	27 Mar	0630	26 March at 2058 anchored off Parry Island at berth B-2, Enewetak	Remained anchored	At 0723 beached at Parry Island; at 0906 temporarily anchored at anchorage B-2, Enewetak; at 1017 underway for Bikini
KOON (B)	7 Apr	0620	6 April at 1744 beached at Parry Island	Remained beached	At 0713 underway for anchorage off Enewetak; at 0803 anchored
UNION (B)	26 Apr	0605	25 April at 1913 anchored at berth N-4, Enewetak	Remained anchored	At 1340 underway to shift anchorages; at 1440 anchored at B-2, Enewetak; at 1603 underway to Bikini; 27 April at 1425 anchored at berth N-14, Bikini
YANKEE (B)	5 May	0610	4 May at 0817 anchored at berth N-4, Enewetak	Remained anchored	Remained anchored
NECTAR (E)	14 May	0620	13 May at 1853 underway from Enewetak to assigned operating area	Steamed as before	At 0812 anchored at berth C-1, Enewetak

Source: LST-551 Deck Log.

Table 84. LST-762 operational activities during CASTLE test series.

Shot	Shot Date	Time of Det.	Ship Location/Activities		
			Preshot	At Shot Time	Postshot
BRAVO (B)	1 Mar	0645	28 February at 1437 beached Parry Island, Enewetak	Moored portside to pier, Parry Island, Enewetak	1 March at 1445 underway for anchorage area A off Parry Island, Enewetak; anchored in anchorage area A with D-4 at 1509; 2 March at 1713 underway for Bikini
ROMEO (B)	27 Mar	0630	Anchored off Enewetak Island	Remained anchored	Remained anchored
KOON (B)	7 Apr	0620	Anchored in anchorage A off Parry Island, Enewetak	Remained anchored	At 1233 underway for Bikini
UNION (B)	26 Apr	0605	Anchored off Bokaidrikdik Island, Enewetak	Remained anchored	26 April at 1142 underway for anchorage area A berth N-4, off Enewetak; 27 April at 1411 underway for Pearl Harbor
YANKEE (B)	5 May	0610	4 May steamed en route for Pearl Harbor; at 0835 sighted LST-975	Steamed as before in company with LST-975	In fallout from H+35 to H+41, 700 nmi (1,296 km) east-northeast of Bikini; highest reading 0.096 R/hr; washdown system activated and decontamination procedures used
NECTAR (E)	14 May	0620	13 May under tow by LST-975 for Pearl Harbor	Entered Pearl Harbor channel	Moored starboard side to pier, berth B-3, Pearl Harbor at 0755

Source: LST-762 Deck Log.

Table 85. LST-1146 operational activities during CASTLE test series.

Shot	Shot Date	Time of Det.	Ship Location/Activities		
			Preshot	At Shot Time	Postshot
BRAVO (B)	1 Mar	0645	26 February left Japan for Pearl Harbor	Destination changed to Guam	6 March arrived in Guam
ROMEO (B)	27 Mar	0630	Beached and moored portside at Parry Island	Beached at Parry Island	Anchored off Enewetak Island at 0737
KOON (B)	6 Apr	0620	Underway en route from Enewetak to Pearl Harbor	En route to Pearl Harbor	Passed Kapenor Island at 0834; passed Lukonor Island and Likiep Atoll at 0935; passed Mejit Island at 2054
UNION (B)	26 Apr	0605	Steamed from Pearl Harbor to San Diego, California	Steamed as before	Steamed as before
YANKEE (B)	5 May	0610	Drydocked in San Diego, California	Remained drydocked	Remained drydocked
NECTAR (E)	14 May	0620	Drydocked in San Diego, California	Remained drydocked	Remained drydocked

Source: LST-1146 Deck Log.

assigned to JTF 7 and were primarily supply ships and tankers that entered the PPG between shots.

USS Arequipa (AF-31). Commander, Service Forces, Pacific Fleet refrigerated cargo ship. Operated out of Pearl Harbor to resupply Kwajalein, Enewetak, and Bikini. No potential for radiation exposure was encountered by this ship during its stay in the PPG from 1 May to 8 May.

Log Summary: On 1 May at 0914 underway 120 nmi (222 km) west of Bikini. On 2 May en route to Enewetak. On 3 May anchored in Enewetak Lagoon; at 1842 underway for rendezvous point with the USS Navasota and the USNS Leo 3 nmi (5.6 km) from Eneu Channel. On 4 May at 0540 ordered to proceed to Enewetak, anchored there at 0750. Shot YANKEE conducted on 5 May at Bikini. Remained at Enewetak until 6 May when underway at 1838 to Bikini. Arrived Bikini 8 May at 0800; at 1642 underway for Wake Island.

USS Deliver (ARS-23). Commander, Service Forces, Pacific Fleet cargo ship. Operated out of Pearl Harbor to resupply Kwajalein. No radiation exposure was encountered during its stays in late April and early May.

Log Summary: Remained at Kwajalein for shots UNION (26 April) and YANKEE (5 May); at the time of shot NECTAR on 14 May the ship was east-southeast of Enewetak, approximately 10°30'N, 176°20'E.

USS Douglas A. Munro (DDE-442). Temporarily assigned by Commander-in-Chief, Pacific (CINCPAC), to Kwajalein. Assisted in an SAR mission for an RAF Canberra bomber between 2 and 3 March as part of TU 32.6.4. No radiation exposure was encountered.

Log Summary: Shot BRAVO conducted 1 March; ship well south of radioactive cloud, under operational control of Commander, NAS, Kwajalein, as part of TU 32.6.4. During 1 to 3 March searched area southwest of Kwajalein for RAF Canberra bomber lost on 23 February. On 4 March was ordered to assist in evacuation of Utirik Atoll; however, the Renshaw had already completed this task; the ship returned to Kwajalein.

USS Edmonds (DE-406). Ship stationed at Guam. As part of TU 32.6.4, it assisted in an SAR mission between 24 February and 2 March for an RAF Canberra bomber inbound for Kwajalein from the Admiralty Islands. The ship was well south of the radioactive cloud during shot BRAVO on 1 March.

USS Genesee (AOG-18). Gasoline tanker in area from 17 to 22 March, a period during which no test shots were carried out.

Log Summary: On 17 March at 1722 underway for Bikini. On 18 March at 1144 moored to the side of the Bairoko at Bikini Lagoon; at 1559 underway to Enewetak. On 19 March at 0820 moored at anchorage F-1; remained at Enewetak until departure for Pearl Harbor on 22 March.

USS Karin (AF-38). Commander, Service Forces, Pacific Fleet refrigerated cargo ship. Operated out of Pearl Harbor to resupply Kwajalein, Enewetak, and Bikini. No radiation exposure was encountered during its resupply mission to the PPG from 2 to 9 April.

Log Summary: On 2 April underway for Enewetak; arrived 5 April; remained anchored during shot KOON; at 1119 left buoy N-3, Enewetak, for Bikini; on 8 April at 0754 anchored berth N-1, Bikini; on 9 April at 1807 underway for Wake Island.

USNS Leo (T-AKA-60). Commander, Service Forces, Pacific Fleet cargo ship. Operated out of Pearl Harbor to resupply Kwajalein, Enewetak, and Bikini. No radiation exposure was encountered.

Log Summary: After arrival remained anchored until 22 April when underway for Enewetak, arriving 23 April. Remained at Enewetak during shot UNION on 26 April. Departed on day of shot YANKEE, 5 May, at 1414 for San Francisco.

LST-975. On 28 April steaming from Yokosuka, Japan, to Pearl Harbor; at 0255 was ordered to rendezvous with LST-762 at 11°N, 175°36'E to take it in tow to Pearl Harbor. On 4 May rendezvoused at 0840, and commenced

towing at 1156. On 6 May at 1505 the crew was ordered to general quarters and at 1540 began washing down the ship to decrease radioactivity from shot YANKEE fallout; at 1556 secured from general quarters. On 14 May arrived at Pearl Harbor.

In a message from CJTF 7 to the Chairman, AEC, dated 070918Z May 1954, the shot YANKEE H+60 advisory stated that both ships had reported light fallout on 6 and 7 May. The highest intensity on LST-762 was reported as 0.040 R/hr. At 062000Z May 1954, the average intensity on board was 0.015 R/hr, and the position of both vessels was 14°3'N, 178°40'E, approximately 810 nmi (1,500 km) from ground zero.

USS Manatee (AO-58). Task force oiler; in area from 13 to 19 March and from 11 to 15 April. No test events occurred during either of these periods.

Log Summary: On 14 March departed Kwajalein to fueling area near PPG to refuel ships of TG 7.3. On 15 March at 0734 anchored at Enewetak until 2212 when underway to Kwajalein, arriving 18 March; departed for Midway Island. No shots were conducted during this period. On 11 April refueled YAG-39 and YAG-40 at Enewetak. On 12 April underway at 1918 to fueling area near PPG to refuel ships of TG 7.3. On 13 April at 1839 secured at N-1, Bikini. On 14 April at 1205 underway to Guam. No shots were conducted during this period.

USS Merapi (AF-38). Commander, Service Forces, Pacific Fleet refrigerated cargo ship. Operated out of Pearl Harbor to resupply Kwajalein, Enewetak, and Bikini. No shots were conducted during this period.

Log Summary: On 6 March underway for Enewetak; on 7 March changed destination to Bikini. On 8 March at 0741 anchored off Eneman Island, Bikini. On 9 March at 1813 underway to Enewetak; on 10 March at 1108 anchored off Parry Island.

USS Mispillion (AO-105). Task force oiler; in area from 21 February to 4 March. During the BRAVO test, the ship was well south of the fallout area.

Log Summary: Between arrival and 24 February, refueled ships of TG 7.3 at Bikini and Enewetak. On 24 February directed to Kwajalein to lead SAR mission as Commander, TU 32.6.4, in area southwest of Kwajalein for downed RAF Canberra bomber. On 26 February arrived Kwajalein and shortly thereafter departed for SAR mission, which was completed at 1110 on 3 March with negative results, after which the ship left for Guam. During SAR mission, led TU 32.6.4, composed of the Nicholas, the Edmonds, the USS Silverstein, PC-1145, PC-1141, and HMNZS Hawea.

USS Namakagon (AOG-53). Gasoline tanker in area from 10 to 13 May. Refueled POL buoys and barges at Enewetak; on 13 May departed at 1404 for Kwajalein, arriving on 14 May at 1727, the day of shot NECTAR. No radiation exposure was involved.

USS Navasota (AO-106). Task force oiler; in area from 30 April until sometime after 5 May.

Log Summary: Between arrival and 3 May refueled ships of TG 7.3 at Bikini and Enewetak. On 3 May at 1744 underway to Kwajalein, arriving 5 May at 0840, the day of shot YANKEE. No radiation exposure occurred.

USS Patapsco (AOG-1). Gasoline tanker; departed Enewetak 27 February at 1705. Subjected to shot BRAVO fallout en route to Pearl Harbor.

The Patapsco was not part of TG 7.3. It was at Enewetak to deliver a load of aviation gasoline and was ordered to leave Enewetak 2 days before shot BRAVO because it lacked adequate radiation equipment and protective gear.

The ship proceeded from Enewetak toward Pearl Harbor. On 28 February, however, the ship's speed was reduced to one-third full speed because of a cracked cylinder liner. The ship was about 180 to 195 nmi (333 to 361 km) east of Bikini when BRAVO was detonated; it began receiving fallout about 1500 on 2 March, at a distance of about 565 to 586 nmi (1,051 to 1,084 km) east of Bikini.

No attempts to decontaminate the ship occurred en route to Pearl Harbor; the level of radiation appeared to those on board to be too low to cause concern. The ship arrived at Pearl Harbor on 7 March and was placed under restricted availability on 9 March. On 22 March the Patapsco crewmen and Pearl Harbor Naval Shipyard personnel began to decontaminate the ship.

The crew was not badged; however, exposure limits have been estimated (References 85 and 86), based upon the 0.010-R/hr (average) readings of the radiation aboard ship upon its arrival at Pearl Harbor. The highest estimate was 18 R and the lowest was 3.3 R.

PC-1141. Stationed at Kwajalein. As part of TU 32.6.4, it assisted in an SAR mission between 1 and 3 March for an RAF Canberra bomber. Shot BRAVO was conducted during this period; the ship was well south of any fallout.

PC-1145. Stationed at Kwajalein. As part of TU 32.6.4, it assisted in an SAR mission between 27 February and 3 March for the RAF Canberra bomber. The ship was well south of any fallout when shot BRAVO was fired 1 March.

USS Silverstein (DE-534). Temporarily assigned by CINCPAC to Kwajalein. As part of TU 32.6.4, it assisted in an SAR mission between 2 and 3 March for the RAF Canberra bomber in area southwest of Kwajalein. The ship was well south of the fallout area when shot BRAVO was detonated on 1 March.

USS Unadilla (ATA-182). Commander, Service Forces, Pacific Fleet cargo ship. The Unadilla operated out of Pearl Harbor to resupply Kwajalein. It visited Kwajalein on 8 and 9 April and encountered no radiation. It left in company with the Gypsy for Pearl Harbor on 9 April.

VR-7. Nineteen officers and men of this transport squadron appear on the Consolidated List, although their mission has not been ascertained. They may have flown logistic support missions into Enewetak or flown

cloud samples back to the United States and were therefore badged.
The exposures presented in Table 59 are low.

CHAPTER 8
SUMMARY OF U.S. AIR FORCE PARTICIPATION IN CASTLE

Air Force participation in CASTLE was primarily in TG 7.4, with some participation in Hq JTF 7 and TG 7.1 (Scientific). The organizations listed below have been extracted from various documents generated during the period, primarily the Consolidated List of CASTLE Radiological Exposures (Reference 13), and do not necessarily reflect Air Force organizational structure in the order or in the form that they are listed. Not all Air Force personnel were badged, and since the list of such badges was the primary source of this list, it is possible that Air Force organizations participated that are not listed below.

HEADQUARTERS JOINT TASK FORCE 7

The following Air Force organizations had personnel who received badges as part of the Hq JTF 7. Exposures for those appearing in the Consolidated List (Reference 13) are presented in Table 86.

Hq USAF Deputy Chief of Staff for Operations. One military officer who was probably an observer.

Hq Strategic Air Command. One civilian who may have been an observer or who may have had some liaison function involving the SAC indirect bomb damage assessment (IBDA) or other SAC experiments.

1110th Air Support Detachment, 1110th Group, Hq, USAF. A single officer, described in a Lookout Mountain Laboratory photo caption as its commanding officer (Negative 22-2230), was badged with Hq JTF 7. Plans (Reference 93) called for nine from the group to form the detachment and be assigned to TG 7.4, but no personnel with this home station are on the Consolidated List. The function of this detachment was to launch a series of balloons that would float at constant altitude to aid in fallout prediction. Launch point and consequent location of

Table 86. CASTLE personnel exposure, U.S. Air Force organizations.

Element	No. of Persons Listed	No Reading	Exposure Ranges (R)													Collective Exposure (man-R)	Mean Exposure (R)
			0	0.001-0.5	0.5-1	1-1.5	1.5-2	2-2.5	2.5-3	3-4	4-5	5-10	10-15	Over 15	Over 3.9 ^a		
Hq JTF 7																	
Hq USAF DCS	1	0			1											0	
Hq SAC	1	0		1												0	
1110th Air Support Det	1	0		1												0	
1254th Air Trans Grp	8	0		7	1											0	
Total Hq JTF 7 Air Force	11	0		9	2											0	4 0.363
TG 7.1																	
AFSWC	3	0		2	1											0	
LML (Civ)	19	3	1	5	6	1		1		2						0	
LML (Mil)	29	4		7	3	11		3	1							0	
SMAMA	4	0			3	1										0	
Team 101	1	0			1											0	
WADC	11	3	4	3	1											0	
5th Air Base Group	1	0			1											0	
1009th Special Wpns Sq	9	1	1	2	4	1										0	
1083rd Special Reprtng Sq	1	0								1						0	
1090th Special Reprtng Grp	42	3	1	8	9	4	7	3	2	3	2					3	
1146th Special Actvities Sq	6	1			1	1		1		1			1			1	
6501st Support Sq	1	0			1											0	
Non-AF orgs																	
ACF	1	0	1													0	
BRL	6	0			1	1	1	1	1	1						0	
EG&G	2	0	1								1					1	4.3
HAPO	1	0				1										0	
NOL	3	0			1		1		1							0	
Total TG 7.1 Air Force	140	15	9	27	33	21	9	9	5	8	3	1			5	156	1.12

Note:

^aMaximum Permissible Exposure

Source: Consolidated List of CASTLE Radiological Exposures (Reference 13).

(continued)

Table 86. CASTLE personnel exposure, U.S. Air Force organizations (continued).

Element	No. of Persons Listed	No Reading	Exposure Ranges (R)											Over 15	Over 3.9 ^a	Collective Exposure (man-R)	Mean Exposure (R)
			0	0.001-0.5	0.5-1	1-1.5	1.5-2	2-2.5	2.5-3	3-4	4-5	5-10	10-15				
TG 7.4																	
Bergstrom AFB	1	0											1			1	
Biggs AFB																	
97th Bombardment Wing	4	0		4												0	
341st Bomb. Sq	1	0		1												0	
Carswell AFB																	
7th Bomb. Wing 9th Sq	10	0			1			1		1	4	2	1			7	
7th Bomb. Wing 436th Sq	18	0						3	1	2	1	7	4			12	
11th Bomb. Wing	1	0		1												0	
-----	18	0		2				1	2	7	4	2				6	
Ellsworth AFB																	
77th Strategic Recon Sq	15	0			4	11										0	
-----	10	0		7	2			1								0	
Enewetak																	
4930th Test Support Grp	29	0	1	23	2	1	2									0	
4931st Test Support Sq	41	0	1	21	8	2	1	1	1	4	2					2	
4932nd Test Support Sq	99	0		92	5	1	1									0	
50th Air Trans Sq	1	0		1												0	
1500th Air Trans Sq	11	0		11												0	
1500-3 Air Base Wing	4	0		2	2											0	
CIC TG 7.4	1	0		1												0	
-----	30	0		21	2	4		2	1							0	
Ent AFB	5	0						2	1	2						0	
Hamilton AFB																	
1901st AACCS Det	2	0			1							1				1	
Hickam AFB																	
47th Air Trans Sq	7	0		4	3											0	
49th Air Trans Sq	8	0		8												0	
51st Air Trans Sq	3	0		2	1											0	
57th Strategic Weather Recon Sq	22	0		5	2	2	4	2		4	1	2				3	
Documntary Photo Element	12	0		12												0	
Hq TSUP	5	0		5												0	
-----	134	0		35	36	26	17	10	1	2	2	5				7	

Note:

^aMaximum Permissible Exposure.

Source: Consolidated List of CASTLE Radiological Exposures (Reference 13).

(continued)

Table 86. CASTLE personnel exposure, U.S. Air Force organizations (continued).

Element	No. of Persons Listed	No Reading	Exposure Ranges (R)												Over 15	Over 3.9 ^a	Collective Exposure (man-R)	Mean Exposure (R)
			0	0.001-0.5	0.5-1	1-1.5	1.5-2	2-2.5	2.5-3	3-4	4-5	5-10	10-15					
TG 7.4 (continued)																		
Kirtland AFB																		
Special Wpns Ctr	2	0		1		1												0
4926th Test Sq	115	0		26	26	27	16	3	3	7	5	2						7
4932nd Test Support Sq	1	0		1														0
-----	13	0		8	2	2			1									0
Lookout Mtn AFS	2	0		2														0
March AFB																		
57th Strategic Recon Sq	3	0		2								1						1
Maxwell AFB																		
Air University	2	0		1				1										0
McClellan AFB																		
Team 101	6	0		2	3	1												0
55th Weather Recon Sq	1	0														1		1
-----	1	0				1												0
Scott AFB	1	0			1													0
Tinker AFB																		
6th Weather Sq	31	0		3	1	1		1								25		25
-----	12	0	1	7	2			1	1									0
Travis AFB																		
1960th AACS Det	4	0		2								1			1			1
Walker AFB	2	0		1				1										0
Washington Nat'l Airport																		
1298th Air Trans Sq	1	0		1														0
WPAFB	2	0		2														0
Other	3	0		2		1												0
Total TG 7.4 Air Force	694	0	3	319	104	81	41	30	12	29	19	24	5	27	27	2,882		4.15
Total Air Force	845	15	12	355	139	102	50	39	17	37	22	25	5	27	32	3,042		3.74

Note:

^aMaximum Permissible Exposure.

Source: Consolidated List of CASTLE Radiological Exposures (Reference 13).

personnel was to be island or shipboard. The photo mentioned above was taken aboard the USS Curtiss on 30 April.

1254th Air Transport Group, Washington, D.C. Eight men from this organization were badged with Hq JTF 7. They were a mixture of commissioned and noncommissioned officers, which, considering their organization and its location, suggests that they were aircrew for one or two VIP transport aircraft.

TASK GROUP 7.1 (SCIENTIFIC)

Personnel from the following Air Force organizations were badged with TG 7.1. Their functions in terms of scientific project activities are indicated where possible with a reference to a project number. The projects are further described in Chapter 3. Exposures for these Air Force participants are presented in Table 86.

Air Force Special Weapons Center, Kirtland AFB, New Mexico. AFSWC was the parent organization of a number of the elements in TG 7.4. AFSWC activities were pervasive, and while it is not completely clear why three AFSWC personnel were badged with TG 7.1, one of them is identified in the CTG 7.1 final report (Reference 4) as working with the LASL group interested in sampling.

Lookout Mountain Laboratory, Hollywood, California. Nineteen civilians and twenty-nine uniformed personnel from LML provided documentary photo service for the task force and also participated in Project 9.1, Cloud Photography.

Sacramento Air Materiel Area, McClellan AFB, California. Four military were badged with TG 7.1, although no function for this group is established in TG 7.1 reports. McClellan AFB is the home of a laboratory where radiochemical analyses were performed, and this group may have been concerned with preparations for sending samples there.

Team 101, McClellan AFB, California. One military from this unit was badged with TG 7.1, and four others were badged with TG 7.4. This team was associated with the 1009th Special Reporting Squadron in Projects 7.1 and 7.4. The exposure for this individual has been grouped with the other four Team 101 personnel in the TG 7.4 section of Table 86.

Wright Aeronautical Development Center, Wright-Patterson AFB, Ohio. Three civilians and eight military were badged. WADC participated in Projects 6.2a and 6.2b, which involved the exposure of B-36 and B-47 in-flight aircraft to weapon effects. Personnel exposures appear to be modest, with one man 0.5 to 1 R and three men receiving 0.001 to 0.5 R. Exposure was probably due to elevated background radiation at Enewetak.

5th Air Base Group, Travis AFB, California. One military was badged with TG 7.1, but his function in the group is not evident.

1009th Special Weapons Squadron, Hq USAF, Washington, D.C. Nine military are on the TG 7.1 list from this group, of which one can be associated with Project 7.1 and three with Project 7.4.

1083rd Special Reporting Squadron, Sandia Base, New Mexico. One military officer from this organization served as an assistant project officer on Project 1.2b. The squadron was apparently for administrative support (e.g., pay, recordkeeping, and leaves) of Air Force personnel serving in non-Air-Force organizations. The officer on Project 1.2b was serving at the Army's Ballistic Research Laboratories.

1090th Special Reporting Group, Sandia Base, New Mexico. This group, like the organization above, was set up to enable Air Force personnel to serve in non-Air-Force organizations. Several of the officers among the 42 officers and men of the group can be identified with LASL and as program leaders for AFSWP. Three of the group were exposed to over 3.9 R.

1146th Special Activities Squadron, Fort Meyer, Virginia. Six men from this group were badged with TG 7.1. This squadron was another administrative organization set up to provide support for Air Force personnel on detached duty. Two men with this unit can be associated with Naval Research Laboratory experiments for Los Alamos Scientific Laboratory (LASL), and another has been associated with LASL activities.

6501st Support Squadron, Wright-Patterson AFB, Ohio. One military is included with the TG 7.1 list, but no function is identified. The home location of his unit indicates that he may have been involved with WADC activities in the aircraft effects program.

Non-Air-Force Organizations. Air Force personnel served with other than Air Force organizations in TG 7.1. These included the following Atomic Energy Commission (AEC) contractors and organizations: Edgerton, Germeshausen and Grier, Inc. (EG&G), American Car and Foundry (ACF), and the Hanford Atomic Power Operation. Air Force personnel also served with the Army's Ballistic Research Laboratories and its support unit, the 9301st TSU, and with the Naval Ordnance Laboratory. Their exposures are given in Table 86. Air Force personnel were also in AFSWP, but their exposures are included in Chapter 10 (Table 90), not by service affiliation.

TASK GROUP 7.4 (AIR FORCE)

The Consolidated List for CASTLE lists 53 home stations for Air Force personnel. The 699 individuals named represented about 41 percent of the TG 7.4 maximum operational strength. Apparently TG 7.4 did not provide estimates of exposure for unbadged personnel as did TG 7.2 and TG 7.3.

An inspection of the 53 home stations on the list shows that about a dozen are probably duplications of other units on the list, so the number is probably less. In addition, ten units are incompletely identified, and if these were completely identified they might also be duplications.

The parent organizations and home stations of the TG 7.4 units are listed in Table 87. These have been derived from the TG 7.4 planning and after-action documentation.

The home stations and organizations derived from the Consolidated List are listed alphanumerically and described below. Personnel exposures are presented in Table 86.

Bergstrom Air Force Base, Austin, Texas. One person is listed, but no function is identified.

Biggs AFB, Texas.

97th Bombardment Wing. Four men.

341st Bombardment Squadron. One man.

The 97th Bombardment Wing provided the three B-50 aircraft and crews for Project 6.1, Test of Indirect Bomb Damage Assessment (IBDA) Procedures. These aircraft were based on Guam, flying to Enewetak for 2 or 3 days before each test and returning to Guam afterward. Ground crew personnel were brought in with the aircraft. The few badges issued may have been for the flight crews, who may have been involved in crater photography.

Carswell AFB, Texas.

7th Bombardment Wing, 9th Bombardment Squadron. Ten men.

7th Bombardment Wing, 436th Bombardment Squadron. Eighteen men.

11th Bombardment Wing. One man.

Unidentified Unit. Eighteen men.

Personnel from this Strategic Air Command (SAC) Base operated as a portion of the SAC Detachment of the Test Aircraft Unit (TAU) of TG 7.4. The 7th Bombardment Wing personnel operated B-36 cloud-sampler and sampler-control aircraft, and their records reflect these high exposure activities. The 11th Bombardment Wing officer was associated with Project 6.2a as the aircraft commander of the B-36 that was exposed to blast and thermal loading in flight during all the CASTLE shots. His exposure was low. This unidentified group may be an element of the 11th Bombardment Wing.

Table 87. Task Group 7.4 parent organizations, CASTLE.

Task Group 7.4 Unit	Parent Organization/Station
Headquarters, TG 7.4	Air Force Special Weapons Center Kirtland AFB, New Mexico
Test Support Unit (TSuU)	Air Force Special Weapons Center Kirtland AFB, New Mexico
4930th Test Support Group	Air Force Special Weapons Center Kirtland AFB, New Mexico
4931st Test Support Squadron	Air Force Special Weapons Center Kirtland AFB, New Mexico
4932nd Test Support Squadron	Air Force Special Weapons Center Kirtland AFB, New Mexico
Test Aircraft Unit (TAU)	Air Force Special Weapons Center Kirtland AFB, New Mexico
4926th Test Squadron (Sampling)	4925th Test Group (Atomic) Air Force Special Weapons Center Kirtland AFB, New Mexico
SAC Test Detachment	Wright Air Development Center Wright-Patterson AFB, Ohio 8th Air Force Carswell AFB, Texas
Test Services Unit (TSU)	Hq Military Air Transport Service Andrews AFB, Washington, D.C.
Weather Reconnaissance Element	57th Weather Reconnaissance Squadron, APO 953, San Francisco, California
Weather Central Element	6th Weather Squadron Tinker AFB, Oklahoma
Weather Reporting Element	6th Weather Squadron Tinker AFB, Oklahoma
Communications Element	1960th AACS Squadron APO 953, San Francisco, California
SAR Element	78th Air Rescue Squadron APO 953, San Francisco, California
Documentary Photo Element	Documentary Photo Unit Andrews AFB, Washington, D.C. Lookout Mountain Laboratory Hollywood, California

Ellsworth AFB, South Dakota.

77th Strategic Reconnaissance Squadron. Fifteen men.

Unidentified Unit. Ten men.

The 77th Strategic Reconnaissance Squadron (SRS) was subordinate to the 28th Strategic Reconnaissance Wing (SRW) at Ellsworth AFB. Personnel orders (SO#1) issued by the 28th SRW on 4 January 1954 at Ellsworth AFB named 18 men from the 77th SRS, 5 men from the 28th Armament and Electrical Maintenance Squadron, 5 men from the 28th Field Maintenance Squadron, and 2 men from the 28th Periodic Maintenance Squadron for duty as CASTLE participants. The 77th SRW flew an RB-36 aircraft for sampler control and documentary photography missions, while the other squadrons maintained the aircraft. These units were part of the TAU.

Enewetak (APO 187).

4930th Test Support Group. Twenty-nine men.

4931st Test Support Squadron. Forty-one men.

4932nd Test Support Squadron. Ninety-eight men.

50th Air Transport Squadron. One man.

1500th Air Transport Squadron. Eleven men.

1500-3 Air Base Wing. Four men.

Unidentified Unit. Thirty men.

APO 187, Enewetak, was the home station given by the units listed above. The first three are identical to the elements of TG 7.4 Test Support Unit (TSuU) that operated the Enewetak airfield, providing Enewetak and Enewetak-Bikini airlift for the task force. The 4930th Group was the headquarters element of the 4931st Squadron, which operated the aircraft, and the 4932nd Squadron, which operated the airfield service. The 4931st Squadron shows more exposures in the higher ranges, undoubtedly due to flight operations in contaminated areas.

The 50th and 1500th Air Transport Squadrons were involved with the logistic flights into the PPG and the personnel exposures are not remarkable. The 1500-3 Air Base Wing was also involved in air transport,

being a Military Air Transport Service (MATS) unit. One man whose unit is not identified received the maximum exposure of the Enewetak group.

Ent AFB, Colorado. Five officers from this base, headquarters of the Air Defense Command, were badged with TG 7.4, but their functions have not been identified. Their recorded exposures are higher than would be expected for simple liaison functions or observers. Officers from this base had served in IVY as radsafe personnel.

Hamilton AFB, California. Two men from the 1901st Airways and Air Communications Service (AACS) Detachment served in the Communications Element of the TSU. One received an exposure of 5 to 10 R.

Hickam AFB, Territory of Hawaii.

47th Air Transport Squadron. Seven men.

49th Air Transport Squadron. Eight men.

51st Air Transport Squadron. Three men.

57th Strategic Weather Reconnaissance Squadron. Twenty-three men.

Documentary Photo Element. Twelve men.

Hq, TSUP.* Five men.

Unidentified Unit. One hundred thirty-four men.

The largest contingent of personnel from this base is not listed as being affiliated with any unit, so it is not possible to discuss its function and consequent exposure. Five exposures of 5 to 10 R are recorded; two other exposures exceeded 9.0 R. Identifiable areas of participation include air transport, weather reconnaissance, and documentary photo activity for the TSU (Provisional) of TG 7.4.

Kirtland AFB, New Mexico.

Hq Special Weapons Center. Two men.

4926th Test Squadron. One hundred fifteen men.

4932nd Test Support Squadron. One man.

Unidentified Unit. Thirteen men.

* The initials "TSUP" presumably are for Test Services Unit (Provisional), although they also could be for Test Support Unit (Provisional).

Kirtland is the home base of the Air Force Special Weapons Center, which was the parent organization of several elements of TG 7.4. The 4926th Squadron operated the F-84 sampler aircraft. The single 4932nd Squadron representative may be a stray from the Enewetak list or may actually have been based at Kirtland AFB.

Lookout Mountain AFS, California. Two LML men listed in TG 7.4, along with the larger group badged with TG 7.1, provided documentary photo services.

March AFB, California. The 57th Strategic Reconnaissance Squadron has three men listed but their function has not been identified. How the 57th SRS related to the 57th Strategic Weather Reconnaissance Squadron (SWRS), (Hickam AFB), if at all, is not clear.

Maxwell AFB, Alabama. Two men from the Air University are listed but their function has not been established.

McClellan AFB, California.

Team 101. Six men.

55th Weather Reconnaissance Squadron. One man.

Unidentified Unit. One man.

Team 101 men were all associated with radioactive sample analyses conducted at McClellan AFB.

Scott AFB, Illinois. One man from this base was badged with TG 7.4, but his function has not been identified.

Tinker AFB, Oklahoma. The 6th Weather Squadron provided weather personnel for the Weather Reporting Element of the TSU of TG 7.4, including the 25 Air Force men exposed to BRAVO fallout on Rongerik. Eleven men are listed on the Consolidated List for this Rongerik contingent, but it has been established in Chapter 4 that this list is incomplete and contains one name improperly listed. In the exposures given in Table 86, this has been corrected.

Travis AFB, California. The 1960th AACCS Detachment consisted of three men who participated in the Communications Element of the TSU.

Walker AFB. Two men are listed; no function has been identified.

Washington National Airport. The 1298th Air Transport Squadron supplied one man, whose function has not been identified.

Wright-Patterson AFB, Ohio. WPAFB supplied two men, probably associated with WADC projects involving measurement of blast and thermal effects on B-36 and B-47 aircraft. The majority of WADC personnel were apparently badged with TG 7.1.

Non-Air-Force Locations Listed. Majuro Atoll was listed as the home station of two men who were probably Weather Reporting Element personnel. A single individual was listed with CINCPAC as a home station and was presumably at PPG on liaison duty.

CHAPTER 9
SUMMARY OF U.S. MARINE CORPS PARTICIPATION IN CASTLE

TASK GROUP 7.1 (SCIENTIFIC)

One Marine noncommissioned officer from the Second Battalion, 6th Marines, Camp LeJeune, North Carolina, was badged with TG 7.1 but his activity has not been identified. He was probably with TU 7 (Radsafe), as he had worked in this area during the 1952 IVY series. Exposures are shown in Table 88.

TASK GROUP 7.3 (NAVY)

Most Marine Corps participation was in TG 7.3.

HMR-362. This helicopter transport squadron, initially equipped with twelve HRS-2 helicopters, provided ship-to-shore and other airlift services at Bikini. This squadron was based on the USS Bairoko after BRAVO, having been shore-based at Eneu before shot operations began. Operational statistics are summarized in Table 89.

USS Curtiss. A 63-man Marine contingent was part of the ship's company. Exposures are presented in Table 88. The Curtiss served as the weapon element of the task group, and providing guards was undoubtedly an important Marine Corps function.

Table 88. CASTLE personnel exposure, U.S. Marine Corps organizations.

Element	No. of Persons Listed	Exposure Ranges (R)													Collective Exposure (man-R)	Mean Exposure (R)		
		0	0.001-0.5	0.5-1	1-1.5	1.5-2	2-2.5	2.5-3	3-4	4-5	5-10	10-15	Over 15	Over 3.9 ^a			High	
Task Group 7.1																		
2nd Battalion, 6th Marines	1					1									0			1.6
Task Group 7.3																		
HMR-362	77	6	3		12	9	13	3	17	10	4			17	5.5			2.54
USS Curtiss	63		63											0				0.25
Total USMC	141	6	66		12	10	13	3	17	10	4			17	5.5	213		1.51

Note:

^aMaximum Permissible Exposure.

Source: Consolidated List of CASTLE Radiological Exposures (Reference 13).

Table 89. Helicopter transport squadron (HMR-362) operational statistics, CASTLE.

	Jan/Feb	March	Apr/May	Total	Avg
Aircraft assigned	12	11	11		11.3
Average number of aircraft in commission	11.7	10.3	9.4		10.5
Aircraft availability (%)	97.5	93.6	85.5		92.2
Number of sorties	1,123	730	825	2,678	
Number of hours	915	733.6	800.6	2,449.2	
Number of passengers	6,062	4,769	6,862	17,693	
Cargo (pounds)	74,555	24,395	48,555	147,505	
Accidents	1	0	0	1	
Casualties	1	0	0	1	

Source: Reference 11, Appendix 7b-1.

CHAPTER 10
SUMMARY OF JOINT DEFENSE AGENCY, OTHER GOVERNMENT,
CONTRACTOR, AND FOREIGN PARTICIPATION IN CASTLE

HEADQUARTERS JOINT TASK FORCE 7

The following organizations had representatives badged as part of the JTF 7 headquarters. Unless otherwise noted, they are presumed to have been at CASTLE as observers or as liaison personnel.

Armed Forces Special Weapons Project (AFSWP), Washington, D.C. Three officers, including the Chief, AFSWP.

Joint Task Force 7. The Hq List of JTF 7 has 34 persons whose organization is listed simply as "Wash DC;" these were probably personnel permanently assigned to the test organization. Fourteen were civilians and twenty-two were military.

LDO, Kwajalein. One participant with an incompletely identified organization. May be a typographical error for LNO, meaning Liaison Officer.

NSC, Washington, D.C. One officer participant.

Office of the Secretary of Defense, Military Liaison Committee. Four officers.

Office of the Secretary of Defense, Department of the Army. One civilian participant.

Office of the Secretary of Defense, Research & Development. One civilian participant.

Personnel from the following Atomic Energy Commission (AEC) organizations were badged with Hq JTF 7.

AEC, Washington

AEC, Division of Military Applications (two military officers)

AEC, Los Alamos Scientific Laboratory

AEC, New York Operations Office

AEC, Oak Ridge National Laboratory

AEC, University of California Radiation Laboratory.

Personnel from the following Federal Government agencies (other than the AEC) were badged with Hq JTF 7.

Federal Civil Defense Agency (one civilian participant)

Department of Justice (one civilian participant).

Exposures for the personnel of all these organizations are presented in Table 90.

TASK GROUP 7.1 (SCIENTIFIC)

Personnel exposures for those appearing in the Consolidated List of CASTLE Radiological Exposures (Reference 13) are presented in Table 90. Joint defense agency personnel badged as part of TG 7.1 were the Armed Forces Special Weapons Project (AFSWP) personnel, as were those of the task force.

Armed Forces Special Weapons Project. Eight military were included in TG 7.1. Most of them were Program Directors for DOD effects experiments in TU 13, directing and coordinating activities of several related projects. An exception to this was Project 3.4, which was initiated after BRAVO to survey the unexpected blast damage on several test islands, including Nam and the Bikini base island of Eneman. This project was handled directly by AFSWP without a project agency.

Joint Task Force 7. Three military identified simply as "JTF 7" were badged with TG 7.1.

Table 90. CASTLE personnel exposure, joint defense agencies, other government, and contractors.

Element	No. of Persons Listed	No Reading	Exposure Ranges (R)												Collective Exposure (man-R)	Mean Exposure (R)
			0	0.001-0.5	0.5-1	1-1.5	1.5-2	2-2.5	2.5-3	3-4	4-5	5-10	10-15	Over 15		
Hq JTF 7 Joint Defense																
AFSWP	3	0		2	1											
JTF 7	34	0	3	23	7	1										
LDO Kwajalein	1	0		1												
NSC Washington	1	0		1												
OSD MLC	4	0	2	2												
OSD DA (Civ)	1	0		1												
OSD R&D (Civ)	2	0		1		1										
Total Joint Defense	46	0	5	31	8	2										15
Hq JTF 7 Atomic Energy Commission																
Washington	3	0	1	2												
DMA	3	0	1	2												
LASL	3	0		3												
NYO	3	0		2	1											
ORNL	1	0		1												
UCRL	3	0		3												
Total AEC	16	0	2	13	1											4
Hq JTF 7 Other Federal Government																
FCDA	1	0		1												
Dept. of Justice	1	0		1												
Total Other Fed. Govt	2	0		2												0.5
TG 7.1 Joint Defense																
AFSWP	8	2			2	1		1	2							
JTF 7	3	0	1	1				1								
Total TG 7.1 Joint Defense	11	2	1	1	2	1		1	1	2						12.5
TG 7.1 Atomic Energy Commission																
Div Biol Med	1	0								1						
HAPO (Mil)	1	0				1										
LASL (Civ)	174	29	3	49	30	17	11	12	5	6	7	5		12		
LASL (Mil)	1	0		1												
ORNL	2	0			1		1									
Sandia Corp	37	3		5		6	2	3	2	5	5	6		11		
UCRL	252	38	30	73	45	29	13	10	8	5	1			1		
Total TG 7.1 AEC	468	70	33	128	76	53	27	25	16	16	13	11		24		502

Note:

^aMaximum Permissible Exposure.

Source: Consolidated List of CASTLE Radiological Exposures (Reference 13).

(continued)

Table 90. CASTLE personnel exposure, joint defense agencies, other government, and contractors (continued).

Element	No. of Persons Listed	No Reading	Exposure Ranges (R)												Over 15	Over 3.9 ^a High	Collective Exposure (man-R)	Mean Exposure (R)	
			0	0.001-0.5	0.5-1	1-1.5	1.5-2	2-2.5	2.5-3	3-4	4-5	5-10	10-15						
TG 7.1 Other Government Agencies																			
USFS USDA	2	0							1		1								
NBS	7	2			2	2		1											
PHS	1	0		1															
Total TG 7.1 Other Govt Agencies	10	2		1	2	2		1	1	1							13	1.300	
TG 7.1 AEC Contractors																			
ACF	43	17	7	17	2														
AFL U of Wash	5	1		1		2		1											
Camco	56	47	8	1															
EG&G	67	7	1	12	3	6	6	7	5	6	11	3					14		
HLJ	41	12	16	13															
Total TG 7.1 AEC Contractors	212	84	32	44	5	8	7	7	5	6	11	3					14	160	0.755
TG 7.1 DOD Contractors																			
ARA	7	3		4															
Cook Res.	9	5	3	1															
Duke University	1	0		1															
Raydist	3	0						1	1	1									
Scripps	9	0	1	2				1	1	1	1						1		
SRI	10	0		1	3	5		1											
Texas Instruments	1	1																	
UC Berkeley	2	1	1																
UCLA	2	0	1	1															
U of Dayton	14	1	6	7															
U of L	1	0		1															
Washington Univ	1	1																	
Total TG 7.1 DOD Contractors	60	12	12	18	3	5	4	2	1	2	1						1	40	0.666
TG 7.1 (no affil listed)	10	0	1	7	1		1											4	0.400
TG 7.2 Other Government Agencies																			
USCG	9	0		2	7													5.7	0.633
TG 7.5 AEC Organizations																			
Holmes & Narver	1,331	0		747	122	45	37	33	36	110	132	67		2	201			2,097	1.575

Note:

^aMaximum Permissible Exposure.

Source: Consolidated List of CASTLE Radiological Exposures (Reference 13).

1st Naval District. One military participated whose unit identification was incomplete and whose function was unknown.

AEC organizations were represented in TG 7.1 by large groups from the weapon design laboratories.

Division of Biology and Medicine, AEC.

Hanford Atomic Power Operation. One Air Force veterinary officer from Hanford participated. He assisted the University of Washington Applied Fisheries Laboratory personnel in their Enewetak surveys and assisted in the resurveys of Rongelap and Rongerik after BRAVO. His exposure is in Table 86 as well as Table 90.

Los Alamos Scientific Laboratory (LASL), New Mexico. One military who was with LASL was primarily active in TU 1.

Oak Ridge National Laboratory (ORNL), Tennessee. Two civilians participated in Project 2.3.

Sandia Corporation, Albuquerque, New Mexico. This AEC captive organization participated as project agency in several DOD projects (1.1a, 1.1b, 1.1d, 1.2a, 1.3, 1.4, and 1.7) besides participating in its role as the weaponizing agent for AEC.

University of California Radiation Laboratory (UCRL), Livermore, California.

Other Federal Government agencies that participated in TG 7.1 are as follows:

U.S. Forest Service, Berkeley, California. Two civil servants executed Project 3.3 on tree blowdown. They received exposures in the 2.5 to 3 and 3 to 4-R range.

National Bureau of Standards, Washington, D.C. and Boulder, Colorado.

Seven civilians participated in TG 7.1, and NBS participated in Projects 7.1 and 7.2. No NBS personnel cited in the project reports are on the TG 7.1 Consolidated List. This is understandable for Project 7.2 as it was offsite, but is not clear for Project 7.1, for which NBS had stations on Eneu and Runit.

Public Health Service, Washington, D.C. One civilian with a low (0.001- to 0.5-R range) exposure.

Military personnel with AEC contractors participated in TG 7.1 as listed below.

American Car and Foundry Co., Albuquerque, New Mexico. One military who worked on fabrication of weapon components was listed from this contractor organization. He was an Air Force officer and his dosimetry is in Table 86 as well as combined in Table 90.

Applied Fisheries Laboratory, University of Washington. Five civilians worked on a long-term survey of radiological contamination on atoll flora and fauna. They took part in the Rongelap and Rongerik re-surveys in March following BRAVO.

Cambridge Corporation, Denver, Colorado. This organization participated in TU 13, providing specialized services. After the cancellation of the ECHO event these services were not required, and its personnel left the PPG in April.

Edgerton, Germeshausen & Grier, Boston, Massachusetts. EG&G was given as the affiliation for two Air Force personnel. EG&G provided timing and firing electronics and technical film coverage. Exposures are given in both Table 90 and Table 86.

Herrick L. Johnson, Inc., Columbus, Ohio. This contractor produced special materials as TU 2. Its personnel left the PPG after the cancellation of the ECHO event as these services were no longer required.

Contractors to Department of Defense (DOD) organizations were represented in TG 7.1 and are listed below. Exposures are presented for these in Table 90.

Allied Research Associates, Boston, Massachusetts. Seven civilians from this group provided thermal measurement instrumentation for the aircraft effects experiments, Projects 6.2a and 6.2b, were listed in the TG 7.1 Consolidated List. Four received exposures; all were less than 0.5 R.

Cook Research Laboratories, Chicago, Illinois. A 9-man civilian contingent installed and maintained thermal instrumentation on the B-47 aircraft of Project 6.2b.

Duke University, Durham, North Carolina. One individual from Duke was badged with TG 7.1, but his function has not been determined. He received an exposure of less than 0.5 R.

Raydist Navigation Corporation, Norfolk, Virginia. Three civilians provided navigational aid service for test aircraft in the Bikini area as part of Project 6.1. Raydist personnel also assisted informally in Project 3.2.

Scripps Institution of Oceanography, La Jolla, California. Nine civilians took part in Projects 1.6, 2.7, and 2.7a. Both sets of projects had high potential risks at times of data recovery and sample collection. The highest exposure recorded was in the 4- to 5-R range for one participant.

Stanford Research Institute, Menlo Park, California. Ten civilians concerned with airblast and crater measurement participated in Projects 3.1 and 3.2.

Texas Instruments, Dallas, Texas. One civilian was apparently badged with TG 7.1, but no reading was recorded. No function has been identified for this person.

University of California, Berkeley, California. Two civilians participated; their functions are not established by the test literature. Two other UC organizations, LASL and UCRL, had major roles, and Scripps Institution had a smaller role. Perhaps these individuals were related to the laboratory or Scripps activities or were liaison people. No exposure was recorded for either.

University of California, Los Angeles, California. Two civilians, one of whom was a Regent of the University. UCLA did some pretest analytical work for Project 6.2b, and perhaps this was the reason for attendance. One received an exposure of less than 0.5 R and the other was recorded zero.

University of Dayton, Ohio. Fourteen civilians assisted with the B-36 aircraft effects experiments, Project 6.2a. Exposures recorded are all under 0.5 R.

University of L. One civilian with a low exposure was listed with this affiliation in the Consolidated List. The complete identification of the university listed is not given in the source.

Washington University, St. Louis, Missouri. One civilian with no identified participation was badged with TG 7.1; no exposure was recorded.

In addition, nine civilians and one military were listed in the Consolidated List for TG 7.1 without any organizational affiliation.

TASK GROUP 7.2 (ARMY)

No joint defense agency contractors were badged with TG 7.2, but one non-DOD Federal agency, the U.S. Coast Guard, was represented by one officer and eight enlisted men who manned the Loran station on Enewetak Island. These men did not participate in the test series, but were present throughout. Their exposures appear to have been estimates rather than actual readings from the badges each man wore.

FOREIGN PARTICIPATION

The United Kingdom was allowed to sample the debris clouds generated by the CASTLE detonations. This was done using RAF Canberra aircraft based on Kwajalein. The NAS, Kwajalein, provided airbase support, and VP-29 personnel supervised aircraft decontamination activities. The task force provided personnel film badges to the RAF crews, but after developing the film badges the information was apparently turned over to UK authorities as these readings were not published in the Consolidated List.

CHAPTER 11 PERSONNEL EXPOSURES

Estimated exposures for task force personnel for BRAVO are summarized in Table 25. The estimates were made in several ways but the estimate for the largest group exposed, that is, TG 7.3, is extracted from a Navy tabulation (Table 23) through 22 March. Because the authorities making this had information not now available, this estimate has been, and is here, accepted as accurate. The Navy estimate for TG 7.3 was based primarily on film badge readings. Recorded radiation exposure data are available for 85 to 90 percent of all TG 7.3 personnel, depending upon the data sources used for TG 7.3 personnel strength. Where film badge data for individuals were lacking, exposure estimates were based on film badges of other exposed personnel. It is because this estimate for this large group was available that the construction of Table 25, with its many assumptions concerning the smaller groups, was considered worthwhile.

Given that Table 25 is a fair estimate of the BRAVO contribution to the collective exposure from the CASTLE series, then this can be subtracted from the whole-series data from the Consolidated List (Reference 13) to yield an estimate of the contribution of the five shots that followed (see Table 91). Table 92, which summarizes Tables 58, 59, 86, 88 and 90, displays the information from the Consolidated List for the entire CASTLE series. Table 25 shows that the JTF 7 total exposure for BRAVO was about 9,000 man-R, and Tables 58, 59, 86, 88, and 90 show that the total JTF 7 exposure for the CASTLE series was about 17,300 man-R. Thus, BRAVO appears to have contributed a little over half of the exposure. Taking the most accurate portion of Table 25, the TG 7.3 estimate, and comparing it with the TG 7.3 total from Table 59 shows about the same relationship. Fortunately, there were no non-task-force exposures for the later events that were comparable to those represented by the non-JTF 7 exposure statistics in the rest of Table 25.

Table 91. Exposures by task group for CASTLE shots ROMEO, KOON, UNION, YANKEE, and NECTAR.

Element	Number of Recorded Exposures	Mean Exposure (R)
Hq JTF 7	85	0.3
TG 7.1	1,218	1.5
TG 7.2	1,349	0.3
TG 7.3	5,413	1.8
TG 7.4	662	4.4
TG 7.5	1,331	1.6
All JTF 7	10,058	1.7

Table 92. Exposures by service branch and other organizations for the entire CASTLE series.

Element	Number of Recorded Exposures	Mean Exposure (R)
Joint DOD	57	0.5
Army	1,464	0.6
Navy-Marine	5,619	1.8
Air Force	801	3.8
AEC Organizations	484	1.0
Other Government	21	0.9
AEC Contractors	1,543	1.5
DOD Contractors	60	0.7
All JTF 7	10,049	1.35

The number of recorded exposures, or more properly listings in the Consolidated List, does not always correspond to other information in this report on personnel strength. One of the major factors in this is the fact that not all personnel received a badge or an explicit estimate of CASTLE exposure. It may be possible to estimate exposures of personnel not badged using the following assumptions:

1. Personnel received the exposure while working on the islands of Bikini Atoll
2. Records may be found that indicate the dates and times the individuals were on the islands.

Accordingly, Figure 97 was prepared to show how exposure varied with time during the series at various locations on Bikini Atoll.

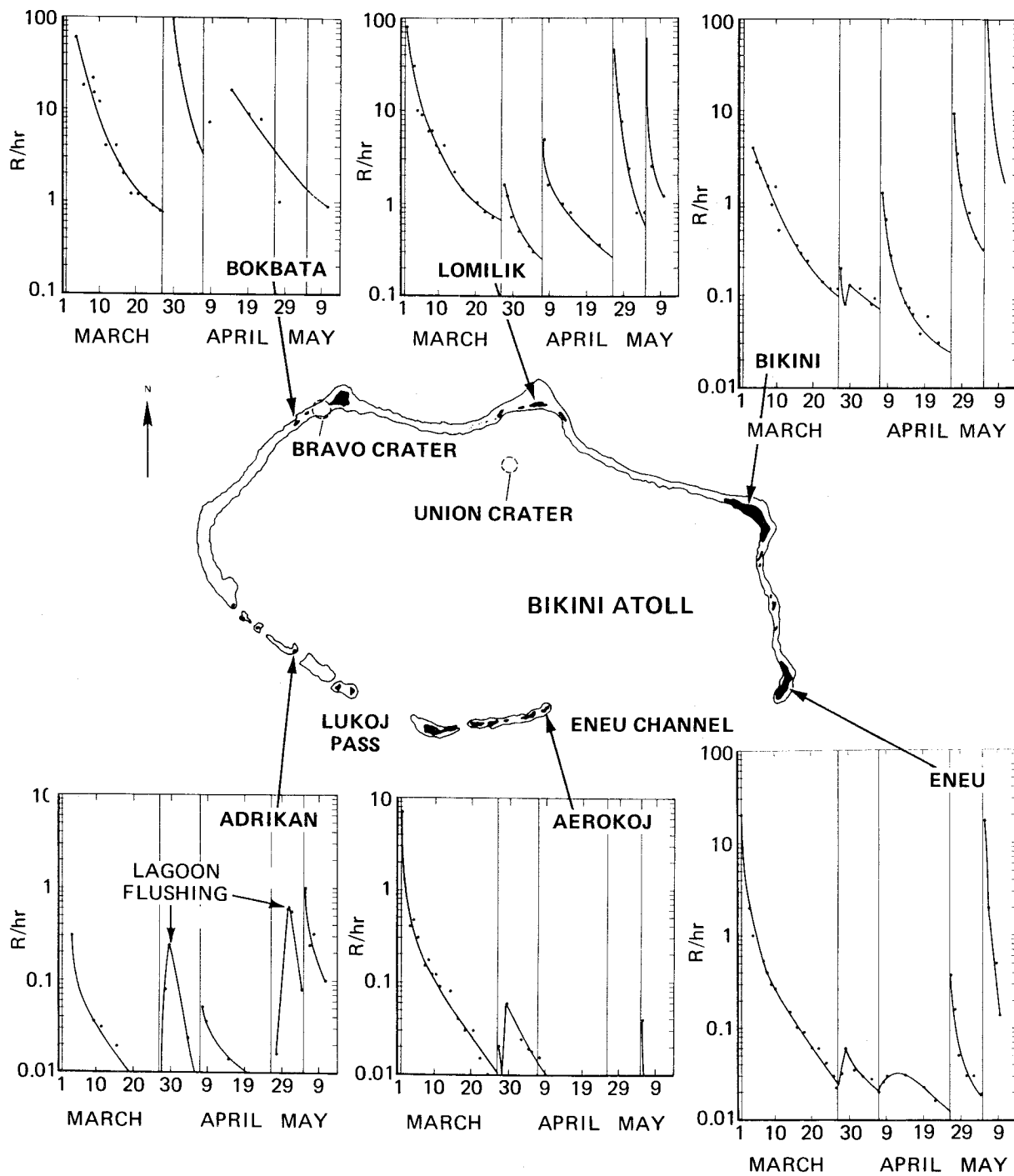

Figure 97. Exposure rates versus time at six locations on Bikini Atoll. Note changes in scale among the graphs.

REFERENCES

AVAILABILITY INFORMATION

An availability code appears at the end of many reference citations for those who wish to read or obtain copies. Availability status was correct at the time the reference list was prepared. Many documents indicated as unavailable will become available during the declassification review process. The Department of Energy Coordination and Information Center (DOE CIC) and the National Technical Information Service (NTIS) will be provided future DNA-WT documents bearing an "EX" after the report number.

Source documents with an availability code of DOE CIC may be reviewed at the following address:

Department of Energy
Coordination and Information Center
(Operated by Reynolds Electrical & Engineering Co., Inc)
ATTN: Mr. Richard V. Nutley
2753 S. Highland
P.O. Box 14100
Las Vegas, Nevada 89114
Telephone: (702) 734-3194; FTS: 598-3194.

Source documents bearing an NTIS availability code may be purchased at the following address:

National Technical Information Service
(Sales Office)
5285 Port Royal Road
Springfield, Virginia 22161
Telephone: (703) 787-4650.

When ordering by mail or phone, please include both the price code and the NTIS number. The price code appears in parentheses before the NTIS order number; e.g., (A07) AD 000 000.

Additional ordering information or assistance may be obtained by writing to the NTIS, Attention: Customer Service, or by calling (703) 487-4660.

Reference citations with no availability codes may be available at the location cited or in a library.

BASIC REFERENCES

1. "The Debate Over the Hydrogen Bomb," Scientific American, Vol. 233, No. 4
H.F. York
October 1975
2. Environmental Radioactivity, Second Edition
M. Eisenbud
Academic Press, New York
1973
3. Bikini-Enewetak Studies, 1964. Part 1 -- Ecological Observations
A.D. Welander et al.
Laboratory of Radiation Biology
University of Washington
15 September 1966
UWFL 93
4. Report of the Commander, Task Group 7.1, March-May 1954, Operation CASTLE
Task Group 7.1
June 1954
Ref. Copy: NTIS as AD 995 017*
WT-940 EX
5. Completion Report (U)
Holmes and Narver, Inc.
1954
(A19) AD A995 081*
6. History of Operation Greenhouse 1948-1951
E.R. Quesada
Joint Task Force 3
December 1951
(A02) AD 740 867*
WT-47

*Available from NTIS; order number appears before the asterisk.

**Available at DOE CIC.

***Not available.

7. Summary of Notes of a Meeting of DOD Representatives at LASL J Division (U)
March 1953***
8. Installment History of Operation CASTLE (U)***
Task Group 7.1

30 Sep 1953	Installment R-2300
31 Dec 1953	Installment CRD-316-54E
10 Apr 1954	Installment
30 May 1954	Installment
9. Operation Plan 3-53 (U)
Hq JTF 7
10 Nov 1953***
10. Unit History Task Group 7.2 (U)***
Task Group 7.2

Oct 53-Jan 54	Installment
Feb 54-7 Apr 54	Installment
8 Apr 54-19 May 54	Installment
11. Final Report, Operation CASTLE (U)
Commander, Task Group 7.3
1954***
12. Operation Plan 1-53 (U)
Task Group 7.3
18 April 1954***
13. Consolidated List of CASTLE Radiological Exposures
J.D. Servis, Commander TU-7
Task Group 7.1
14 July 1954***
14. Installment History of Operation CASTLE (U)***
Task Group 7.3

24 Jan 1954	Installment
7 Apr 1954	Installment
15 May 1954	Installment

*Available from NTIS; order number appears before the asterisk.

**Available at DOE CIC.

***Not available.

15. History of Task Group 7.4 (U)***
 Task Group 7.4
 July-Aug 1953 Installment
 Sept 1953 Installment
 Oct 1953 Installment
 Nov 1953 Installment
 Dec 1953 Installment
 Jan 1954 Installment
 Feb 1954 Installment
 Mar 1954 Installment
 Apr 1954 Installment
 May 1954 Installment
 Jan 1953-26 Jun 1954 Installment
16. Final Report Radiological Safety, Operation CASTLE, Spring 1954 (U),
 2 volumes
 R.A. House
 JTF 7, Tech Branch J-3***
17. Radiological Safety
 J.D. Servis
 Los Alamos Scientific Laboratory
 August 1954
 (A04) AD A995 086* WT-942 EX
18. Letter, Col John Servis (Ret) to R. Miller
 Nov 1980
19. Operation Order 1-53 (U)
 Hq JTF 7
 20 June 1953***
20. Radiological Safety Regulation
 NavMed P-1325
 1951**
21. Operations Orders***
 Task Group 7.3
- | | | |
|--------------|-------------|-------------|
| Number 2-54 | 9 Jun 1954 | S-28-54-E |
| Number 4-54 | 15 Feb 1954 | SRD-117-54E |
| Number 5-54 | 17 Feb 1954 | SRD-128-54E |
| Number 6-54 | 21 Feb 1954 | S-163-54E |
| Number 7-54 | 6 Mar 1954 | SRD-188-54E |
| Number 9-54 | 3 Apr 1954 | SRD-251-54 |
| Number 10-54 | 18 Apr 1954 | SRD-281-54E |

*Available from NTIS; order number appears before the asterisk.

**Available at DOE CIC.

***Not available.

22. History of Operation CASTLE (U)
H.G. Bechanan, Lt USNR, and C.O. Jones, 2LT USA
Hq JTF 7
1954***
23. Maximum Permissible Exposures (Letter)
Commander TG 7.3 to Commander JTF 7
18 Mar 1954
24. Final Report of Commander, Air Task Group (U)
Task Group 7.4
1954***
25. Physical Factors and Dosimetry in the Marshall Island Radiation Exposures, Operation CASTLE, Report on Addendum Report for Project 4.1
C.A. Sondhaus, V.P. Bond
Naval Radiological Defense Laboratory
December 1955
(A03) AD 338 337* WT-939
26. BRAVO Shot, Operation CASTLE, Memo for Record with Attachments (U)
A.C. Graves, R.W. Clarkson
Hq JTF 7
12 April 1954***
27. World-Wide Fallout from Operation CASTLE (U)
R.J. List
U.S. Weather Bureau
May 1955*** NYO-4645
28. Radiological Defense from USS Philip (DDE 498) taken from OPNAV Notice 03500
Office of the Chief of Naval Operations**
29. History of Air Force Atomic Cloud Sampling (U)
W.A. Minge
AF Systems Command Publication Series 61-142-1
January 1963***
30. Aircraft Decontamination
4926th Sq, TG 7.4
1954

*Available from NTIS; order number appears before the asterisk.

**Available at DOE CIC.

***Not available.

31. Operation Order
 Task Group 7.4
- | | |
|-------------|---------------|
| Number 1-53 | 15 Aug 1953** |
| Number 2-53 | 6 Oct 1953** |
| Number 1-54 | 9 Feb 1954** |
| Number 2-54 | 26 Feb 1954** |
| Number 3-54 | 1954 |
| Number 4-54 | 29 Mar 1954** |
| Number 5-54 | 7 Apr 1954** |
| Number 6-54 | 9 Apr 1954** |
| Number 7-54 | 19 Apr 1954** |
| Number 8-54 | 1 May 1954** |
- Dates as noted
 Ref. Copy: AFWL Library
32. USS Bairoko (CVE-115); Radiological Contamination
 Commanding Officer to CTG 7.3
 7 March 1954
 Ref. Copy: National Archives
33. Participation of US NAS Kwajalein in Operation CASTLE
 Commander NAS, Kwajalein, to CJTF 7
 27 August 1954 JTF log S-428-54W
 Ref. Copy: National Archives 374
34. British Participation . . . Memo for the Record
 W.V. Hughs, Capt. USAF, JTF 7 Liaison Officer
 5 April 1954 59A-2946 Box 3
 Ref. Copy: National Archives
35. Blast and Thermal Effects on B-36 Aircraft in Flight, Operation CASTLE, Project 6.2A
 G.C. Miller, E.J. Schlei, C.R. Andrews
 Air Force Flight Dynamics Laboratory
 June 1956 WT-925
 (A08) AD 338 333L*
36. Photoelectric Measurements of Time Interval . . . (U)
 W.L. Smith, LT USNR; J. Yandle, T/SGT, USAF; B. Caldwell, T/SGT, USAF; R. Richardson
 Naval Research Laboratory
 1954*** NRL 4417

*Available from NTIS; order number appears before the asterisk.

**Available at DOE CIC.

***Not available.

37. High Resolution Spectroscopy (U)
 J.H. Beck; J.H. Campbell
 Naval Research Laboratory
 Mar 1955*** NRL 4519
38. The Chord Experiment
 W.B. Fussell
 Naval Research Laboratory
 June 1955*** NRL 4590
39. Color Temperature at Operation CASTLE (U)
 W.B. Fussell
 Naval Research Laboratory
 1955 NRL 4616
 (A02) AD A995 118*
40. Summary Report of the Commander, Task Unit 13 -- Military Programs
 1-9 (U)
 AFSWP
 January 1959 WT-934 EX
 (A06) AD A995 123*
41. Blast Pressures and Shock Phenomena Measurements by Photography
 Naval Ordnance Laboratory
 December 1955 WT-902 EX
 (A05) AD A995 102*
42. Base Surge Measurements by Photography
 Naval Ordnance Laboratory
 September 1966 WT-903
 (A03) AD 361 766*
43. Dynamic Pressure Measurements
 C.D. Broyles and M.L. Merrett
 Sandia Corporation
 27 Jan 1957 WT-906
 (A03) AD 361 771*
44. Ground Surface Air Pressure Versus Distance from High Yield Detona-
 tions, Operation CASTLE, Pacific Proving Grounds, March-May 1954,
 Project 1.2B
 J.J. Meszaros, C.N. Kingery
 Army Ballistic Research Laboratories
 May 1957 WT-905
 (A05) AD 341 053*

*Available from NTIS; order number appears before the asterisk.

**Available at DOE CIC.

***Not available.

45. Underwater Pressure Measurements, Operation CASTLE, Project 1.4
W.J. Thaler
Naval Research Laboratory, David Taylor Model Basin, Naval Ordnance
Laboratory, Office of Naval Research
June 1958 WT-908 EX
(A12) AD A995 105*
46. Ground Level Pressures from Surface Bursts (U)
C.D. Broyles and M.L. Merrett
Sandia Corporation
30 Oct 1957 WT-904 EX
(A03) AD A995 108*
47. Water Wave Measurements (U)
J.D. Isaacs and L.W. Kidd
Scripps Institution of Oceanography
29 Oct 1959 WT-910
(A03) AD 341 056*
48. Ground Motion Studies on Operations IVY and CASTLE (U)
W.R. Perret
Sandia Corporation
1954*** WT-9002
49. Dynamic Pressure Investigation, Operation CASTLE, Project 1.8
E.J. Bryant
Ballistic Research Laboratories
March 1957 WT-911
(A03) AD 361 767*
50. Gamma Radiation Exposure, Report to the Scientific Director, Operation CASTLE, Project 2.1
R.H. Dempsey, R.G. Larrick, G.A. Baraff, O.E. Johnson
Army Signal Engineering Laboratories
March 1949 WT-912
(A03) AD 341 055*
51. Gamma Rate Versus Time, Report to the Scientific Director, Operation CASTLE, Project 2.2 (U)
P. Brown, G. Carp
Army Signal Engineering Laboratory
February 1959 WT-913
(A03) AD 338 330*

*Available from NTIS; order number appears before the asterisk.

**Available at DOE CIC.

***Not available.

52. Neutron Flux Measurements, Operation CASTLE, Project 2.3, Report to the Scientific Director (U)
 T.D. Hanscome, D.K. Willett, A. Brodsky
 Navy Research Laboratory
 October 1955
 (A05) AD A995 099* WT-914 EX
53. Distribution and Intensity of Fallout
 Naval Radiological Defense Laboratory
 March 1956
 (A08) AD 361 836* WT-915
54. Fallout Studies, Operation CASTLE, Project 2.5B (U)
 E.F. Wilsey, R.J. French, H.I. West
 Army Chemical Corps
 February 1956
 (A07) AD A995 116* WT-916 EX
55. Chemical, Physical, and Radiochemical Characteristics of the Contaminant, March-May 1954
 Naval Radiological Defense Laboratory
 January 1956
 (A08) AD A995 109* WT-917 EX
56. Radiochemical Analysis of Fallout
 Army Chemical and Radiological Laboratories
 April 1956
 AD 224 417* WT-918
57. Distribution of Radioactive Fallout by Survey and Analysis of Sea Water, Operation CASTLE, Project 2.7 (U)
 T.F. Folsom, L.B. Werner
 Scripps Institution of Oceanography, Naval Radiological Defense Laboratory
 April 1959
 (A05) AD A995 085* WT-935 EX
58. Radioactivity of Open-Sea Plankton Samples
 T.R. Folsom, F.D. Jennings, and M.W. Johnson
 Scripps Institution of Oceanography
 April 1958
 AD 465 307* WT-954

*Available from NTIS; order number appears before the asterisk.

**Available at DOE CIC.

***Not available.

59. Air Pressure Measurements, Operation CASTLE, Project 3.1 (U)
L.M. Swift and E.J. Wells
Stanford Research Institute
May 1955*** WT-919
60. Crater Survey (U)
R.B. Vaile
Stanford Research Institute
Jan 1955*** WT-920
61. Blast Effects on Tree Stand
W.L. Fons and T.G. Storey
U.S. Forest Service
Mar 1955 WT-921
AD 465 294*
62. Sea Minefield Neutralization by Means of a Surface Detonated Nuclear
Explosion, Operation CASTLE, Project 3.4 (U)
G.M. Davidson, M.G. Geiger
Army Special Weapons Project
March 1955 WT-922
(A03) AD 361 835*
63. Blast Effects on Miscellaneous Structures, Operation CASTLE, Project
3.5
W.J. Christensen
AFSWP
July 1955 WT-901
(A04) AD 356 271*
64. Twenty-Year Review of Medical Findings in a Marshallese Population
Accidentally Exposed to a Radioactive Fallout
R.A. Conard
Brookhaven National Laboratory
September 1975 BNL 50424
65. Study of Response of Human Beings Accidentally Exposed to Significant
Fallout Radiation, Operation CASTLE, Project 4.1
E.P. Cronkite, V.P. Bond, L.E. Browning, W.H. Chapman, S.H. Cohn, R.A.
Conard, C.L. Dunham, R.S. Farr, W.S. Hall, R. Sharp, N.R. Shulman
Naval Medical Research Institute, Naval Radiological Defense Labora-
tory, Defense Atomic Support Agency, Oak Ridge National Laboratory
October 1954 WT-923
(E05) AD 465 295*

*Available from NTIS; order number appears before the asterisk.

**Available at DOE CIC.

***Not available.

66. Nature and Extent of Internal Radioactive Contamination of Human Beings, Plants, and Animals Exposed to Fallout, Operation CASTLE, Project 4.1
 S.H. Cohn, R.W. Rinehart, J.K. Gong, J.S. Robertson, W.L. Milne, W.H. Chapman, V.P. Bond
 Naval Radiological Defense Laboratory, Naval Medical Research Institute
 December 1955 WT-936
 (A02) AD 617 134*
67. Medical Examination of Rongelap People Six Months After Exposure to Fallout Operation CASTLE
 V.P. Bond, R.A. Conrad, J.S. Robertson, E.A. Weden
 Naval Medical Research Institute, Naval Radiological Defense Laboratory
 April 1955 WT-937
 (A03) AD 465 292*
68. Exposure of Marshall Islanders and American Military Personnel to Fallout, Operation CASTLE, Project 4.1 Addendum
 R. Sharp, W.H. Chapman
 Naval Medical Research Institute
 March 1957 WT-938 EX
 (A03) AD A995 077*
69. Operation Plan (U)
 Task Group 7.4

Number 1-54	28 Feb 1954
Number 2-54	16 Mar 1954**
Number 3-54	24 Mar 1954**
Number 4-54	15 Jun 1954**

 Dates as noted
 Ref. Copy: AFWL Library
70. Test of Interim IBDA Procedures, Operation CASTLE, Project 6.1 (U)
 R. Triantafellu
 Air Force Strategic Air Command
 January 1956 WT-924
 (A03) AD 361 832*
71. Thermal Effects on B-47B Aircraft, Operation CASTLE, Project 6.2B (U)
 C.W. Luchsinger
 Cook Electric Company, Air Force Flight Dynamics Laboratory
 April 1957 WT-926
 (A04) AD 338 026*

*Available from NTIS; order number appears before the asterisk.

**Available at DOE CIC.

***Not available.

72. Proof Testing of Atomic Weapons Ship Countermeasures, Operation CASTLE (U)
 G.G. Molumphy, M.M. Bigger
 Naval Radiological Defense Laboratory
 October 1957 WT-927
 (A20) AD 362 110*
73. Decontamination and Protection, Operation CASTLE, Project 6.5
 J.C. Maloney, E.H. Dhein, M. Morgenthau
 Army Chemical Center
 September 1955 WT-928
 (A04) AD 465 306*
74. Effects of Nuclear Detonations on the Ionosphere, Operation CASTLE, Project 6.6 (U)
 F.B. Daniels, A.K. Harris
 Army Signal and Research Engineering Laboratories
 May 1956 WT-929
 (A04) AD 361 772*
75. Electromagnetic Radiation Calibration, Operation CASTLE, Pacific Proving Grounds, March-May 1954, Project 7.1 (U)
 M.H. Oleson
 Air Force Office of Atomic Energy
 June 1958***
76. Detection of Airborne Low-Frequency Sound from Nuclear Explosions, Operation CASTLE, Project 7.2 (U)
 G.B. Olmsted
 Atomic Energy Commission
 May 1955 WT-931 EX
 (A04) AD A995 117*
77. Nuclear Calibration Analysis of Atomic Device Debris (U)
 C.K. Reed, W. Singlevich
 Air Force Headquarters
 July 1959 WT-932 EX
 (A03) AD A995 084*
78. Cloud Photography, Operation CASTLE, Project 9.1
 EG&G
 January 1958 WT-933
 (A03) AD 357 960*

*Available from NTIS; order number appears before the asterisk.

**Available at DOE CIC.

***Not available.

79. Radiological Fallout on Japanese Vessel Daigo Fukuryu Maru Following BRAVO, Report and Analysis (U)
CTG 7.3 to CJTF 7
17 March 1954***
80. Radioactive Contamination of Ships and Radiological Exposure of Personnel of Task Group 7.3 due to BRAVO (U)
Commander TG 7.3 to Chief of Naval Operations
22 March 1954***
81. Compilation of Local Fallout Data from Test Detonations 1945-1962 Extracted from DASA 1251; Vol. 2, Oceanic U.S. Tests
H.A. Hawthorne, ed.,
GE-TEMPO
June 1979
(A16) AD A079 310* DNA 1251 EX2
82. The Voyage of the Lucky Dragon
R.E. Lapp
Harper & Bros., NY
1957
83. Rongerik Incident: Report with Attachments
Task Group 7.4
1954**
84. Evacuation of Rongerik: Report with Attachments
Task Group 7.4
April 1954
85. Exposure Estimates of the Crew of the USS Patapsco -- Memorandum
J. McGahan, SAI, to D. Auton, DNA
19 January 1979
86. Gamma Dose Estimates for Patapsco Crew
R.R. Hammond and W.W. Perkins
Naval Ocean Systems Center
25 January 1979
87. Personnel Radiation Exposure Records -- Microfilm (Microfilm of 5x8 cards from which the Consolidated List (CPO 7.1U7#3) was probably derived in large part)
1954***

*Available from NTIS; order number appears before the asterisk.

**Available at DOE CIC.

***Not available.

88. Effects of Nuclear Weapons
S. Glasstone and P.J. Dolan, ed.,
U.S. GPO
1977
89. Medical Survey of the People of Rongelap and Utirik Islands, Thirteen, Fourteen, and Fifteen Years after Exposure to Fallout Radiation (March 1967, 1968, 1969)
R.A. Conard, et al
Brookhaven National Laboratory
June 1970
(A07) BNL-50220*
90. Personal Recollection of Warren Fackenthal at Albuquerque, New Mexico
February 1980
91. Report of Commander, Task Group 7.1, Operation CASTLE (U)
A.C. Graves
Los Alamos Scientific Laboratory
June 1954
(A01) AD A995 017* WT-940 EX
92. Blowing on the Wind, The Nuclear Test Ban Debate, 1954-1960
R.A. Devine
Oxford University Press
1978
93. Operation Plan 3-53
Hq USAF
n.d.
Ref. Copy: National Archives 133-54-3

READING LIST

This short list of books and documents is pertinent to the subject of DOD participation in Operation CASTLE. The list is divided into several categories: Background and General; CASTLE Planning; and CASTLE After-Action Reports. The latter two are primarily reports issued by Joint Task Force 7 or its components. Some are included as basic references.

*Available from NTIS; order number appears before the asterisk.

**Available at DOE CIC.

***Not available.

Background and General

Effects of Nuclear Weapons

S. Glasstone and P.J. Dolan, ed.,
U.S. GPO
1977

Environmental Radioactivity, Second Edition

M. Eisenbud
Academic Press, New York
1973

Compilation of Local Fallout Data from Test Detonations 1945-1962
Extracted from DASA 1251; Vol. 2, Oceanic U.S. Tests

H.A. Hawthorne, ed.,
GE-TEMPO
June 1979 DNA 1251 EX2
(A16) AD A079 310*

Proving Ground: An Account of Radiobiological Studies in the Pacific
1946-1961

N.O. Hines
University of Washington Press, Seattle
1962

"The Debate Over the Hydrogen Bomb," Scientific American, Vol. 233, No. 4
H.F. York
October 1975

CASTLE Planning Documents

The task force prepared a series of documents in preparation for
CASTLE. The basic ones were:

Operation Plan 3-53 (U)

Hq JTF 7
10 Nov 1953***

Operation Order 1-53 (U)

Hq JTF 7
20 June 1953***

*Available from NTIS; order number appears before the asterisk.

**Available at DOE CIC.

***Not available.

Other JTF 7 documents designated Movement Directives and Operational Check Lists detailed the general instructions in the basic planning documents. This sequence of operation plans and orders was reflected in the subordinate groups within the task force, for example:

Operation Order (U)***

Task Group 7.2

Number 1-53	13 Oct 1953	S-485
Number 3-53	22 Dec 1953	S-683

Dates as indicated

Operation Plan 1-53 (U)

Task Group 7.3

18 April 1954***

Operations Orders***

Task Group 7.3

Number 2-54	9 Jun 1954	S-28-54-E
Number 4-54	15 Feb 1954	SRD-117-54E
Number 5-54	17 Feb 1954	SRD-128-54E
Number 6-54	21 Feb 1954	S-163-54E
Number 7-54	6 Mar 1954	SRD-188-54E
Number 9-54	3 Apr 1954	SRD-251-54
Number 10-54	18 Apr 1954	SRD-281-54E

Dates as noted

Operation Plan (U)

Task Group 7.4

Number 1-54	28 Feb 1954
Number 2-54	16 Mar 1954
Number 3-54	24 Mar 1954
Number 4-54	15 Jun 1954

Dates as noted

Ref. Copy: AFWL Library

CASTLE After-Action Reports

The task force prepared a formal history of the operation:

History of Operation CASTLE (U)

H.G. Bechanan, Lt USNR, and C.O. Jones, 2LT USA

Hq JTF 7

1954***

*Available from NTIS; order number appears before the asterisk.

**Available at DOE CIC.

***Not available.

Reports were prepared also by the subordinate commanders:

Report of the Commander, Task Group 7.1, Mar-May 1954, Operation CASTLE (U)
Task Group 7.1
June 1954 WT-940 EX
(A01) AD A995 017*

Final Report of the Commander (U)
Task Group 7.2
19 May 1954*** S-198-54W

Final Report, Operation CASTLE (U)
Commander, Task Group 7.3
1954***

Final Report of Commander, Air Task Group (U)
Task Group 7.4
1954***

Report of the Commander (U)
Task Group 7.5
1954*** S-349-54W

Other units also prepared reports of their participation; examples of these are:

Final Report, Communications Security Detachment (U)
8600th Area Unit
8 May 1954***

Completion Report (U)
Holmes and Narver, Inc.
1954
(A01) AD A995 081*

The many scientific projects involved in the nuclear weapon testing usually reported their activities in a series of reports usually designated the "WT Series." For CASTLE, the WT reports numbered WT-901 through WT-956 were used.

*Available from NTIS; order number appears before the asterisk.

**Available at DOE CIC.

***Not available.

Other after-the-fact reports of direct interest to the subject matter of this report are:

Radiological Safety (U)

J.D. Servis
Los Alamos Scientific Laboratory
August 1954 WT-942 EX
(A04) AD A995 086*

Final Report Radiological Safety, Operation CASTLE, Spring 1954 (U), 2 volumes

R.A. House
JTF 7, Tech Branch J-3***

BRAVO Shot, Operation CASTLE, Memo for Record with Attachments (U)

A.C. Graves, R.W. Clarkson
Hq JTF 7
12 April 1954***

World-Wide Fallout from Operation CASTLE (U)

R.J. List
U.S. Weather Bureau
May 1955*** NYO-4645

The Voyage of the Lucky Dragon

R.E. Lapp
Harper & Bros., NY
1957

Twenty-Year Review of Medical Findings in a Marshallese Population Accidentally Exposed to a Radioactive Fallout

R.A. Conard
Brookhaven National Laboratory
September 1975 (A08) BNL 50424*

*Available from NTIS; order number appears before the asterisk.

**Available at DOE CIC.

***Not available.

25

APPENDIX A
COPIES OF CASTLE DOCUMENTS

UNITED STATES
ATOMIC ENERGY COMMISSION
WASHINGTON 25, D. C.

IN REPLY REFER TO:

MAT:NDG

JAN 21 1954

Major General P. W. Clarkson, USA
Commander, Joint Task Force SEVEN
Temporary "U" Building, Room 2005
12th and Constitution Avenue, N. W.
Washington 25, D. C.

Dear General Clarkson:

Presidential approval has been received for executing CASTLE with March 1, 1954 as the starting date. Permission has also been granted to detonate seven shots and to expend fissionable and fusionable materials in the amounts indicated below.

This letter should be construed as your authority to execute CASTLE as planned.

Sincerely yours,

K. D. Nichols
K. D. Nichols
General Manager

Enclosure:
Cys 1A & 2A Fissionable and Fusionable
Material For CASTLE Devices

-- RETYPED COPY --

HEADQUARTERS, Joint Task Force SEVEN
Washington 25, D.C.
20 June 1953, 1600 R

Annex I to CJTF SEVEN Operation Order No. 1-53

RADIOLOGICAL SAFETY

1. Radiological safety of all task force military and civilian personnel is a command responsibility and radiological safety activities will be performed through normal command channels.
2. The Commander, Joint Task Force SEVEN will:
 - a. Specify the measures necessary to insure the radiological safety of task force personnel and furnish technical advisory assistance to task group radiological safety officers.
 - b. Inform CINCPAC of radiological hazards which may exist in areas outside of task force responsibility.
 - c. Maintain an information center (RadSafe Office) with displays of current air and surface radexes, radiological situation maps of atolls and peripheral aerial and surface areas and such other allied data as may be appropriate.
 - d. Designate monitors and couriers to accompany radioactive and special cargo shipments on sample return aircraft, and monitor loading and unloading of such cargo.
3. Prior to the on-site operational phase, task group commanders will:
 - a. Organize radiological safety units or elements within their task groups.
 - b. Require radiological safety personnel to review radiological safety procedures employed on previous operations and become thoroughly acquainted with existing training measures through attendance at appropriate Service schools.
 - c. Require radiological safety personnel to become qualified in the calibration and testing of standard RADIAC equipment.
 - d. Procure complete allowances of RADIAC equipment and special clothing. The requirements of CTG 7.5 will be included in the allowances for CTG 7.1 for necessary issue to TG 7.5 personnel during the operational phase and for subsequent loan or sale to CTG 7.5 for post-operational use at the proving ground.
4. The Commander, TG 7.1, having major technical radiological safety responsibilities, will prepare to perform the following radiological

safety services at ENIWETOK and BIKINI ATOLLS (using space provided by CTG 7.3 at BIKINI):

a. All ground monitoring services associated with scientific missions except those in conjunction with aircraft and airborne collection of scientific data.

b. Laboratory services and technical assistance to all task groups, to include:

(1) Procurement of film badges and specified supplementary items of personnel radiological safety equipment.

(2) Laboratory services to develop and interpret film badges.

(3) Records of exposures from film badges. (Duplicates will be furnished task group commanders).

(4) Laboratory services for the radio-chemical analysis of water samples.

(5) Provision of primary facilities at PARRY ISLAND radiological safety building for calibration, repair and maintenance of instruments and storage of spare parts of RADIAC equipment. Similar limited facilities will be maintained at BIKINI during the operational phase at that atoll.

(6) Monitoring the removal and packaging of radioactive sources and samples except as indicated in paragraph 4a above.

c. Provision of radiological safety surface situation maps after shot times to the task force commander and the task groups requiring the information.

d. Procurement of radiological safety clothing as necessary for TG 7.1, TG 7.5 and specified recovery personnel.

e. Provision of technical personnel to inspect radiologically contaminated items for all task groups and certify destruction, disposal, or unserviceability of such items as required.

g. Provision of personnel and equipment decontamination facilities for RadSafe survey and recovery operations.

h. Limited fall-out studies within the Pacific Proving Ground for radiological safety documentation only.

i. Assumption of radiological safety responsibilities of TG 7.5 during the overseas phase of operation.

j. The integration with TG 7.1 of key radiological safety personnel made available by CTG 7.5. Such personnel will assist CTG 7.1 during the operational phase and will be assigned duties amenable to training in the fundamental radiological safety services to be assumed by CTG 7.5 upon completion of the overseas phase of the operation.

5. The Commander, TG 7.2 will prepare to perform the following:

- a. All ground monitoring services associated with ENIWETOK ISLAND, except in those areas or activities assigned to other task groups.
 - b. Provision and training of own radiological safety monitors, 50 of which will be "Q" cleared for emergency monitor support of TG 7.1 if required.
 - c. Provision and training of own contamination personnel, 10 of which will be designated for emergency decontamination support of TG 7.1 if required.
 - d. Provision of own RADIAC equipment and protective clothing.
 - e. Provision of own repair, spare parts and calibration facilities for RADIAC equipment.
 - f. Provision of contaminated clothing laundry facilities for TG 7.4.
6. The Commander, TG 7.3 will prepare to:
- a. Provide and train own radiological safety monitors, including one airborne monitor for each multi-engine aircraft crew assigned to TG 7.3.
 - b. Provide own RADIAC equipment and protective clothing.
 - c. Provide monitors and decontamination crews aboard each ship within the task group.
 - d. Provide own repair, spare parts and calibration facilities for RADIAC equipment.
 - e. While task force is embarked, provide space for use of the radiological safety unit of TG 7.1.
 - f. Assume responsibility for decontamination of all aircraft at BIKINI ATOLL, assisted by CTG 7.1 ashore, as required.
 - g. Provide decontamination crews and facilities for own aircraft at ENIWETOK ATOLL. Limited assistance will be furnished by CTG 7.4, if required.
 - h. Provide necessary helicopter air service for radiological surveys and post-shot recovery operations (monitors furnished by TG 7.1).
 - i. Provide water spray equipment aboard all vessels likely to be in the fall-out area.
 - j. Collect lagoon water samples.
7. The Commander, TG 7.4 will prepare to:
- a. Provide and train own radiological safety monitors, including one airborne monitor for each multi-engine aircraft crew assigned TG 7.4.
 - b. Provide own RADIAC equipment and protective clothing.
 - c. Provide own repair, spare parts and calibration facilities for RADIAC equipment.

- d. Provide primary decontamination crews and facilities for aircraft at ENIWETOK ISLAND and limited crews and facilities at the BIKINI airstrip.
 - e. Assist TG 7.3 in aircraft decontamination with TG 7.4 equipment, if required.
 - f. Provide necessary helicopter and liaison air service for radiological surveys and post-shot recovery operations (monitors furnished by TG 7.1).
 - g. Provide monitoring services for the removal and packaging of radioactive samples or data collected by aircraft.
 - h. Provide cloud tracking aircraft for post-shot radiological safety "situation data" up to radius of 500 miles in the significant quadrant for period of 48 hours, starting at approximately H plus 6 hours for each shot. (See para. 2c(3) of Annex J).
 - i. Promulgate the air radex for each shot.
 - j. Establish a simple code to be used in conjunction with the periodic weather reconnaissance reports to report approximate air radiation intensities encountered on regularly established weather reconnaissance or cloud tracking flights.
8. The Commander, TG 7.5 will prepare to:
- a. Develop a schedule of requirements for radiological safety services required from CTG 7.1.
 - b. Provide and train key radiological personnel for integration into and training with the radiological safety organization of TG 7.1 during the overseas phase of the operation. The total number and qualifications of such personnel will be as determined necessary by CTG 7.5 commensurate with the assumption of responsibilities indicated in 8c, below.
 - c. Assume residual task force radiological safety functions at the Pacific Proving Ground upon completion of the overseas phase of the operation. Required equipment and supplies will be made available at that time, to CTG 7.5 on a loan or sale basis from stocks provided by CTG 7.1.
9. Training. The inclusion of radiological safety organizations throughout the task force will require two general levels of training; basic indoctrination and technical training. The scope of instruction within each of these levels will vary in accordance with the requirements of different operational and staff levels. Basic indoctrination will include primary, non-technical instruction in radiological safety measures and techniques. This must be imparted to all personnel of the task force to enable them to perform their assigned duties efficiently within the allowable low exposures, regardless of the presence of radioactive contaminants. Technical training will include the training

of the majority of the personnel who will be required to staff the task force radiological safety organizations and perform the technical operations involved. This will be accomplished through the utilization of existing Service courses and establishment of suitable courses at task group level. This instruction will be designed to train radiological defense monitors, decontamination personnel and radiological instrument repairmen.

Original signed by the Assistant Chief of Staff, J-3
for the Commander Joint Task Force 7

-- RETYPED COPY --

HEADQUARTERS, Joint Task Force SEVEN
Washington 25, D.C.
20 June 1953, 1600 R

Appendix to Annex I

Radiological Safety, CJTF SEVEN Operation Order No. 1-53

RADIOLOGICAL SAFETY REGULATIONS

1. The Maximum Permissible Exposure (MPE) for personnel involved in this operation is 3.9 roentgens, gamma only, unless reduced because of previous or anticipated future exposure. All exposure to external gamma radiation will be regarded as total body irradiation. Special MPE of 20 roentgens, gamma only, is authorized for crew members of air sampling aircraft. The maximum permissible exposures as stated above are applicable to a field experimental test of nuclear devices in peacetime, wherein numbers of personnel engaged in these tests have been previously exposed or will be continuously exposed to potential radiation hazards. It may become necessary from a study of personnel records to reduce the MPE for certain individuals who have participated recently in other atomic tests. Under a military tactical situation or emergency the maximum permissible exposures above do not apply.
2. All atoll land and lagoon areas in or near which a detonation takes place will be considered contaminated until cleared for operations by the task force commander. Entry to and exit from contaminated areas will be via RadSafe checkpoints only.
3. Contaminated land areas of intensities greater than 100 mr/hr will be delineated as such; Personnel entering these areas must be accompanied by a monitor and will be subject to clearances by the RadSafe Officer, TG 7.1. RadSafe clothing and equipment will be issued to the personnel.
4. Contaminated land areas of intensities less than 100 mr/hr and greater than 10 mr/hr will be controlled areas; Personnel entering these areas will be subject to clearance by the RadSafe Officer of TG 7.1. Monitors will not be required for entry into these controlled areas.
5. Contaminated land areas of intensities of less than 10 mr/hr will be considered unrestricted from a RadSafe viewpoint. Areas coming within this limitation will be designated specifically by CJTF SEVEN prior to unrestricted entry.
6. RadSafe monitors assigned to individuals or groups working in contaminated areas or with contaminated equipment during recovery operations will act in an advisory capacity to keep the recovery party leader

informed of radiation intensities at all times. The recovery party leader is expected to accept this advice and act accordingly. It is the responsibility of both the leader and the members of the recovery party to adhere to the limits established in these regulations.

7. Film badges, dosimeters and protective clothing (coveralls, booties, caps, gloves, dust respirators, etc.) as deemed necessary will be issued to personnel entering contaminated areas by appropriate task group RadSafe supply sections.
8. All personnel within viewing distance of an atomic detonation who are not supplied with protective goggles will turn away from the detonation point and close their eyes during the time of burst. At least 10 seconds should be allowed before looking directly at the burst.
9. The arrival and proposed use of radioactive sources at the Pacific Proving Ground will be reported to the Task Force Radiological Safety Officer.
10. All samples of radioactive materials which are couriered in aircraft will be packaged and loaded so as to reduce radiation to a minimum. The RadSafe Officer of TG 7.4 will have a survey made of the package to determine if adequate precautions have been taken. The following criteria will determine space and packaging requirements:
 - a. Prior exposure of aircraft and courier personnel.
 - b. Anticipated future exposures on trip.
 - c. Length of time of exposure on trip.
 - d. In all cases, crew members will be limited to exposure rates of less than 20 mr/hr.
11. All air and surface vehicles or craft used in contaminated areas will be checked through the appropriate task group decontamination section upon return from such areas.
12. The Maximum Permissible Limits (MPLs) of contamination listed herein are to be regarded as advisory limits for control of contamination under average conditions, and are subject to revision by waiver from the task force commander in individually designated cases when extenuating circumstances indicate the need and justification therefor. All readings of surface contamination are to be made with Geiger counters, with tube walls not substantially in excess of 30 mg/cm² with shield open. The surface of the probe should be held one (1) inch to two (2) inches from the surface that is under observation unless otherwise specified. In all cases other than emergency or tactical situations the ultimate criteria will be limited by the authorized MPEs for personnel, with measurements made using standard equipment and techniques for such exposure. Special instances may arise after shot and inside

the surface radex in which rescue operations will be carried out without regard to the radiological hazard. Monitors aboard rescue craft shall be required to determine the extent of the actual radiation hazard experienced in order that appropriate medical tests may be initiated. For emergency operations, the criteria prescribed for tactical situation (para. 13 below) will be used as a guide. For operational purposes the MPLs presented below will not be considered applicable to spotty contamination provided such areas can be effectively isolated from personnel.

a. Personnel and clothing MPLs are as follows:

(1) Skin readings should not be more than 1 mr/hr. Complete decontamination by bathing will be utilized for readings in excess of his level. Beta radiation exposure to the hands should not exceed 30.0 rep/week.

(2) Underclothing and body equipment such as the internal surfaces of respirators should be reduced to 2 mr/hr.

(3) Outer clothing should be reduced to 7 mr/hr.

b. Vehicle MPLs: The interior surfaces of occupied sections of vehicles should be reduced to 7 mr/hr. The outside surfaces of vehicles should be reduced to less than 7 mr/hr, gamma only, at five (5) or six (6) inches from the surface.

c. Ship and Boat MPLs:

(1) Operational clearances, implying that contamination exists and special procedures are required, will normally be granted by commanding officers on the technical advice of radiological defense staff members. In peacetime, a maximum fixed contamination level of 300 mr/week ordinarily will not be exceeded except for "Operational Necessity". For this operation an MPL of 600 mr/week will be used as the upper limit for "operational necessity" unless otherwise specifically raised or lowered. Fixed alpha contamination should not exceed 500 cpm (counts per minute) per 150 cm² of area.

(2) For ships and boats operating in contaminated waters, reasonable allowances will be made to differentiate between the relative contribution to the total flux from fixed contamination and that due to "shine" from contaminated waters. For this operation it will be assumed that not more than ten percent of the radiation flux entering the vessel through the sides is due to contamination which will remain fixed on the vessel upon reentry to uncontaminated waters. Ships and boats encountering levels of contamination greater than determined by the above will request special instructions.

(3) Final clearances, normally granted by commanding officers, will be given upon completion of the operation provided no point of contamination is greater than 15 mr/day (beta and gamma) and no detectable alpha exists.

(4) In general, boats operating in waters near shot islands after shot times may become contaminated. Monitors shall be aboard all boats operating after shot time, either as passengers or members of the boat crew, until such time as radiological restrictions are lifted.

(5) No ships with personnel shall be permitted inside the 1.5 p.s.i. line unless specifically directed otherwise. Bearings of danger from immediate radioactive fall-out for ship operations will be established by CJTF SEVEN on the basis of forecast wind directions at the intended time of detonation. This danger section will be designated as surface radex. All ships of the task force shall be required to remain outside the surface radex - danger bearing, radial limitation and time restriction. However, if ships are directed tactically into the surface radex, movement of ships shall be governed by tactical exposure guides.

(6) Individuals on board ships of the task force shall be protected collectively from hazards of blast, heat and radioactivity by movement of the ships.

(7) It is desired to point out that the employment of the ships and units in TG 7.3, insofar as radiological safety is concerned, is not considered routine usage within the purview of NavMed P-1325, "Radiological Safety Regulations." Current revision of NavMed P-1325 indicates that its provisions will not apply for special operations such as field tests and that for such operations naval personnel will operate under regulations set forth by the task force commander. The regulations set forth herein have been designed as a reasonable and safe compromise considering conservation of personnel exposures, the international import of tests and the cost aspects of shot delays chargeable to excessive radiological precautions.

d. Aircraft MPLs:

(1) The interior surfaces of occupied sections of aircraft should be reduced to 7 mr/hr.

(2) No aircraft in the air at H Hour will be at slant ranges from ground zero less than as determined by the following effects unless specifically directed otherwise. (Based on maximum predicted yield and 20 mile visibility):

Blast (at predicted shock arrival): 0.5 p.s.i.

Thermal (H Hour): Fabric control surfaces: 1.0 cal/cm²

Metal control surfaces: 6.0 cal/cm²

After detonation no aircraft shall operate inside the air radex or closer than 10 nautical miles from the rising or visible cloud unless specifically directed otherwise. If a tactical or emergency situation arises where aircraft must enter the air radex, tactical exposure allowance shall apply.

(3) All multi-engine task force aircraft in the air at H Hour within 100 miles of the detonation point shall carry a person designated as

radiological safety monitor equipped with suitable RADIAC equipment and a radex plot. This monitor shall be capable of calculating allowable exposures under both tactical and operational conditions.

(4) All persons in aircraft at shot time, or at subsequent times when engaged in operations in or near the cloud or radex track, shall wear film badges.

(5) Pilots and copilots of aircraft in the air at shot time shall use modified all-purpose 0.1 density filter goggles. Copilots should, as an extra precaution, cover their eyes with forearm at zero hour.

e. In air and water the following continuous levels of radioactivity are considered safe from the viewpoint of personnel drinking and breathing: (uc - microcurie).

	Beta or Gamma Emitter	Long-lived Alpha Emitters
Water	5×10^{-3} uc/cc (at H+3 days)	10^{-7} uc/cc
Air	10^{-6} uc/cc	6×10^{-12} uc/cc

NOTE: In air for any 24 hour period after a shot, 10^{-4} uc/cc of which particles less than 5 microns shall not exceed 10^{-6} uc/cc).

13. All radiological safety operations for Operation CASTLE will be considered as routine and will comply with permissible radiological exposures for routine work, except "special operations" which must be specifically designated by CJTF SEVEN. In tactical situations the military commander must make the decision regarding allowable exposures. As military personnel are normally subject to only random exposure, health hazards are at a minimum. Current Department of Defense information on exposure to gamma radiation in tactical situations is indicated below:
- a. Uniform acute (immediate) exposure of 50 roentgens to a group of Armed Forces personnel will not appreciably affect their efficiency as a fighting unit.
 - b. Uniform acute exposure of 100 roentgens will produce in occasional individuals nausea and vomiting, but not to an extent that will render Armed Forces personnel ineffective as fighting units. Personnel receiving an acute radiation exposure of 100 or more roentgens should be given a period of rest and individual evaluation as soon as possible.
 - c. Uniform acute exposure of approximately 150 roentgens or greater can be expected to render Armed Forces personnel ineffective as troops within a few hours through a substantial incidence of nausea, vomiting, weakness and prostration. Mortality produced by an acute exposure of 150 roentgens will be very low and eventual recovery of physical fitness may be expected.
 - d. Field commanders should, therefore, assume that if substantial numbers of the men receive acute radiation exposures substantially above

100 roentgens there is a grave risk that their commands will rapidly become ineffective as fighting units.

e. Internal radiation hazards caused by entry of radioactive substances through the mouth, through the lungs or through cuts or wounds do not exist after an air burst. Internal hazards following a contaminating surface explosion may be avoided if ordinary precautions are taken. Only under unusual circumstances will there be internal hazard from residual contamination. This eliminates the necessity for masking and consequent reduction of tactical efficiency.

14. This appendix has been designed for reduced security classification in order to facilitate wide dissemination.

Original signed by the Assistant Chief of Staff, J-3
for the Commander Joint Task Force 7

-- RETYPED COPY --

HEADQUARTERS, Joint Task Force SEVEN
Washington 25, D.C.
10 November 1953, 1600 R

Annex N to CJTF SEVEN Operation Order No. 3-53

RADIOLOGICAL SAFETY

1. Radiological safety of all task force military and civilian personnel is a command responsibility and radiological safety activities will be performed through normal command channels.
2. The Commander, Joint Task Force SEVEN will:
 - a. Specify the measures necessary to insure the radiological safety of task force personnel and furnish technical advisory assistance to task group radiological safety officers.
 - b. Inform CINCPAC of radiological hazards which may exist in areas outside the task force responsibility.
 - c. Maintain an information center (RadSafe Office) with displays of current air and surface radexes, radiological situation maps of atolls and peripheral aerial and surface areas and such other allied data as may be appropriate.
 - d. Arrange for the designation of monitors and couriers to accompany radioactive and special cargo shipments on sample return aircraft and to monitor loading and unloading of such cargo.
3. Task Group Commanders will:
 - a. Provide radiological safety units within their task groups and insure that these units are in the required condition of readiness to carry out the radiological safety missions of their respective task groups.
 - b. Provide complete allowances of radiac equipment and special clothing. The requirements of CTG 7.5 will be included in the allowances of CTG 7.1 for necessary issue to TG 7.5 personnel during the operational phase and for subsequent loan or sale to CTG 7.5 for post-operational use at the Pacific Proving Ground.
 - c. Prior to the first shot minus 10 days, forward to CTG 7.1 (for use of the RadSafe Center in conjunction with film badge radiation dosage control) a listing of task group personnel to whom film badges will be issued during the overseas phase of the operation. Within five days following each shot, provide CTG 7.1 with additions to previous lists. Lists will indicate full name, rank or rate, serial or service number if applicable and home station or laboratory as appropriate.

4. The Commander, TG 7.1, having the major technical radiological safety unit, will:
 - a. Perform all ground monitoring services associated with scientific missions except those in conjunction with aircraft and airborne collection of scientific data.
 - b. Provide laboratory services and technical assistance to all task groups, to include:
 - (1) Provision of standard type film badges and specified supplementary items of personnel radiological safety equipment.
 - (2) Laboratory services to develop and interpret film badges.
 - (3) Records of exposures from film badges. (Duplicates will be furnished task group commanders).
 - (4) Laboratory services for the radiochemical analysis of water samples.
 - (5) Provision of primary facilities at PARRY ISLAND radiological safety building for calibration, repair and maintenance of instruments and storage of spare parts of radiac equipment. Similar limited facilities will be maintained at BIKINI during the operational phase at that atoll.
 - (6) Monitoring the removal and packaging of radioactive sources and samples except, as indicated in paragraph 4a above, removal operations from aircraft will remain the radiological safety responsibility of the task group to which the aircraft are assigned.
 - c. Provide radiological safety surface situation maps after shot times to the task force and task group commanders.
 - d. Provide and issue special high density goggles to specified personnel of the task force.
 - e. Provide and maintain radiac equipment and protective clothing as necessary for TG 7.1, TG 7.5 and specified recovery personnel.
 - f. Provide technical personnel to assist task group commanders in the inspection of radiologically contaminated items and the certification of destruction, disposal or unserviceability of such items as required.
 - g. Maintain a radiological safety center (RadSafe Center) for the control of TG 7.1 radiological safety operations.
 - h. Provide personnel and equipment decontamination facilities for radiological safety survey and recovery operations.
 - i. Perform limited fall-out studies within the Pacific Proving Ground for radiological safety documentation only.
 - j. Assume radiological safety responsibilities of TG 7.5 during the overseas phase of the operation.
 - k. Integrate within TG 7.1 key radiological safety personnel made available by CTG 7.5. Such personnel will assist CTG 7.1 during the

operational phase and will be assigned duties amenable to training in the fundamental radiological safety services to be assumed by CTG 7.5 upon completion of the overseas phase of the operation.

1. Assist CTG 7.3 to the extent of providing equipment, personnel and supervision for the rough operational decontamination of aircraft ashore at BIKINI ATOLL. Decontamination will be limited to washdown of exterior and vacuum cleaning of interiors. No detailed decontamination will be attempted by TG 7.1 personnel. Aircraft crews will assist in the operation.

5. The Commander, TG 7.2 will:

- a. Perform all ground monitoring services associated with ENIWETOK ISLAND except in those areas or activities assigned to other task groups.
- b. Provide own radiological safety monitors, fifty (50) of which will be "Q" cleared for emergency monitor support of TG 7.1 if required.
- c. Provide own decontamination personnel, ten (10) of which will be designated for emergency decontamination support of TG 7.1 if required.
- d. Provide own radiac equipment and protective clothing.
- e. Provide own repair, spare parts and calibration facilities for radiac equipment.
- f. Provide contaminated clothing laundry facilities for TG 7.4.
- g. Provide contaminated equipment storage area with the necessary security.

6. The Commander, TG 7.3 will:

- a. Provide own radiological safety monitors, including one airborne monitor for each multi-engine aircraft crew assigned to TG 7.3.
- b. Provide own radiac equipment and protective clothing.
- c. Provide own repair, spare parts and calibration facilities for radiac equipment.
- d. Provide monitors and decontamination crews aboard each ship within the task group.
- e. Provide facilities for personnel decontamination on the CVE.
- f. While the task force is embarked, provide space for use of the radiological safety unit (RadSafe Center) of TG 7.1.
- g. Provide decontamination crews and facilities for all aircraft at BIKINI ATOLL. Limited assistance ashore will be furnished by CTG 7.1 in accordance with paragraph 4l, as required.
- h. Provide decontamination crews and facilities for own aircraft aboard the CVE at ENIWETOK ATOLL. Limited assistance ashore will be furnished by CTG 7.4, as required.

i. Provide necessary helicopter air service for radiological surveys and post-shot recovery operations (monitors furnished by TG 7.1).

j. Collect lagoon water samples.

k. Provide water spray equipment aboard all vessels likely to be in the fall-out area.

l. During the BIKINI phase provide for air to ground reporting of approximate air radiation intensities encountered by all aircraft operating between ENIWETOK and BIKINI from H Hour to H plus 24 hours. It is not contemplated that aircraft should be scheduled for this specific requirement alone. Reports will be routed to the RadSafe Office at the task force command post by the most expeditious means. Reports will be prepared and coded in accordance with paragraph 7k, below.

7. The Commander, TG 7.4 will:

a. Provide own radiological safety monitors, including one airborne monitor for each multi-engine aircraft crew assigned to TG 7.4.

b. Provide own radiac equipment and protective clothing.

c. Provide own repair, spare parts and calibration facilities for radiac equipment.

d. Provide facilities for personnel decontamination on ENIWETOK ISLAND.

e. Provide decontamination crews and facilities for own aircraft at ENIWETOK ATOLL.

f. At ENIWETOK ATOLL, assist TG 7.3 in aircraft decontamination with TG 7.4 equipment, as required.

g. Provide necessary helicopter and liaison air service for radiological surveys and post-shot recovery operations (monitors furnished by TG 7.1).

h. Provide monitoring services for the removal (by TG 7.1 personnel) of radioactive samples or data collected by aircraft.

i. Provide cloud tracking aircraft for post-shot radiological safety "situation data" up to radius of 500 miles in the significant quadrant for a period of 48 hours, starting at approximately H plus 6 hours. Reports will be prepared and coded in accordance with paragraph 7k below.

j. During the BIKINI phase, provide for air to ground reporting of approximate radiation (air) intensities encountered by all aircraft operating between ENIWETOK and BIKINI from H Hour to H plus 24 hours. It is not contemplated that aircraft should be scheduled for this specific requirement alone. Reports will be routed to the RadSafe Office at the task force command post by the most expeditious means. Reports will be prepared and coded in accordance with paragraph 7k below.

k. Employ simple codes (to be furnished separately by CJTF SEVEN) in conjunction with the periodic weather reconnaissance reports to report approximate air radiation intensities encountered on regularly established weather reconnaissance or cloud tracking flights and for reports required from aircraft operating during the BIKINI phase between ENIWETOK and BIKINI from H Hour to H plus 24 hours. Reports will indicate the approximate position, altitude and order of magnitude of radiation encountered.

l. Develop the air RADEX for each shot.

8. The Commander, TG 7.5 will:

a. Develop a schedule of requirements for radiological safety services required from CTG 7.1 and assist CTG 7.1 in decontamination of AEC facilities and equipment as necessary.

b. Provide key radiological personnel for integration into and training with the radiological safety organization of TG 7.1 during the overseas phase of the operation. The total number and qualifications of such personnel will be as determined necessary by CTG 7.5, commensurate with the assumption of responsibilities indicated in paragraph 8c, below.

c. Assume residual task force radiological safety functions at the Pacific Proving Ground upon completion of the overseas phase of the operation. Required equipment and supplies will be made available at that time to CTG 7.5 on a loan or sale basis from stocks provided by CTG 7.1.

Original signed by the Assistant Chief of Staff, J-3
for the Commander Joint Task Force 7

-- RETYPED COPY --

HEADQUARTERS, Joint Task Force SEVEN
Washington, 25 D.C.
10 November 1953

Appendix I to Annex N
Radiological Safety, CJTF SEVEN Operation Plan No. 3-53

RADIOLOGICAL SAFETY REGULATIONS

1. General

a. Radiological Defense (RadDefense) operations or Radiological Safety (RadSafe) operations, short term RadOps, are general terms. They are used to denote the means by which a unit can control and confine the damage and radiological effects of an atomic explosion or of a radioactive material spread by other means, thereby preventing and avoiding health hazards to personnel. They are interpreted to include measures such as training, organization, distribution of radiological personnel, development of techniques and procedures, use of detecting equipment, protection or removal of exposed personnel and decontamination of personnel, structures and equipment.

b. Following each detonation there will be areas of surface radiological contamination and areas of air radiological contamination. These areas are designated as Radiological Exclusion Areas (RADEX). Prior to shot times, the forecast air and surface RADEX will be disseminated by CJTF SEVEN in the target area. These RADEXES will represent a forecast from H Hour until dissemination of a later surface and air RADEX at about H plus 4 hours. The later RADEXES will be based upon the master radiological "situation map" maintained in the RadSafe Office of CJTF SEVEN. Since the air RADEX after shot times will be based on monitored tracking by aircraft over significant large ocean areas, information promulgated from the forecast air RADEX may have to be extended beyond the originally anticipated 4 hour period.

c. The surface RADEX will be determined by actual survey with Radiation Detection, Indication and Computation (RADIAC) equipment after shot time. The most rapid method of accomplishing surface survey in the early stages will be by helicopter flight in and around the surface of contaminated areas. From the radiation intensities measured at a known altitude, it is possible to obtain an estimate of the radiation dosage rates which would be encountered on the surface of the ground or water. Actual water samples from the lagoon will also be utilized. Ground survey will follow these guides to determine definitely the contaminated regions and objects. Formal ground survey of the shot atoll, as feasible, will be accomplished on H plus 24 hours.

2. The Maximum Permissible Exposures (MPEs) and Maximum Permissible Limits (MPLs) as stated herein are applicable to a field experimental test of

nuclear devices in peacetime wherein numbers of personnel engaged in these tests have been previously exposed or will be continuously exposed to potential radiation hazards. It may become necessary from a study of personnel records to reduce the MPE for certain individuals who have recently been over-exposed to radiation. Further, the MPEs and MPLs are subject to revision by waiver from the task force commander in individually designated cases when circumstances indicate the need and justification therefor.

3. Due to the special nature of field tests it is considered that a policy of strict adherence to the radiological standards prescribed for routine work is not realistic. The regulations set forth herein have been designed as a reasonable and safe compromise considering conservation of personnel exposures, the international import of the test and cost aspects of operational delays chargeable to excessive radiological precautions. In all cases other than emergencies or tactical situations the ultimate criteria will be limited by the MPEs for personnel. Special instances may arise such as in the case of an air-sea rescue within the RADEX or in the case of tactical situations in which operations will be carried out without regard to the MPEs and MPLs prescribed herein. For such emergency or tactical operations the criteria prescribed below for tactical situations will be used as a guide. Wherever possible, however, film badges will be carried and RadSafe monitors will accompany such operations to determine the extent of the actual radiation hazard experienced in order that appropriate medical action may be initiated.
4. Task force radiation dosage control will start on first shot minus fifteen (15) days and terminate upon departure of individuals from the forward area or on the last shot plus fifteen (15) days, whichever occurs first. All personnel will be considered to have arrived at the Pacific Proving Ground by first shot minus fifteen (15) days. Prior and subsequent to this period, radiation dosage control will be as prescribed by CTG 7.5.
5. a. The MPE for personnel involved in this operation, as defined by paragraph 4, above, is 3.9 roentgens (gamma only). This exposure may be acquired at any time during a thirteen (13) week period of the operation. Provided no previous over-exposure remains for compensation, 3.9 roentgens may be acquired without regard to the individual's past radiation history. This MPE will be considered further augmented (without separate action) by 0.3 roentgens per week for each week in excess of thirteen (13) weeks required during the operational period defined by paragraph 4, above.
b. A special MPE of 20 roentgens (gamma only) is authorized for the operational period as defined by paragraph 4, above, for crew members of air sampling aircraft.

- c. All exposure to external gamma radiation will be regarded as total body irradiation.
6. Those individuals exposed to ionizing radiation in excess of the value computed by paragraph 5a, above, will be informed that appropriate remarks will be included in their medical records. Military personnel in this category will be advised that they should not be exposed to further radiation until sufficient time has elapsed in order to bring their average radiation dose down to 0.3 roentgens per week. Civilian personnel in this category will be informed that limitations on further radiation exposure will be as determined by the laboratory or agency having administrative jurisdiction over such personnel.
 7. All atoll land and lagoon areas in or near which a detonation takes place will be considered contaminated until cleared for operations by the task force commander. Entry to and exit from contaminated areas will be via RadSafe check points only.
 8. Contaminated land and water areas will be delineated as such. Personnel entering these areas will be subject to clearances by the RadSafe Office, TG 7.1, and will normally be accompanied by a RadSafe monitor. RadSafe clothing and equipment will be issued to the personnel.
 9. Contaminated land areas of intensities less than 10 mr/hr (gamma only) will be considered unrestricted from a RadSafe standpoint. Areas coming within this limitation will be designated specifically by CJTF SEVEN prior to unrestricted entry.
 10. RadSafe monitors assigned to individuals or groups working in contaminated areas or with contaminated equipment during recovery operations will act in an advisory capacity to keep the recovery party leader informed of radiation intensities at all times. The recovery party leader is expected to accept this advice and act accordingly. It is the responsibility of both the leader and the members of the recovery party to adhere to the limits established in these regulations. The RadSafe monitor will limit his activities to monitoring and will not engage in actual recovery operations.
 11. Film badges, dosimeters and protective clothing (coveralls, booties, caps, gloves, dust respirators, etc.) as deemed necessary will be issued to personnel entering contaminated areas by appropriate task group RadSafe supply sections. All personnel dosage film badges will be procured from and returned to the laboratory of TU 7, TG 7.1, where all processing and recording will be accomplished.
 12. All personnel within viewing distance of an atomic detonation who are not supplied with protective goggles will turn away from the detonation point and close their eyes during the time of burst. At least 10 seconds should be allowed before looking directly at the burst.

13. The arrival and proposed use of radioactive sources at the Pacific Proving Ground will be reported to the RadSafe Officer of TG 7.1.
14. Transportation of radioactive material to and from the forward area shall be in accordance with AEC regulations for escorted shipment of such material. The assignment of couriers and RadSafe monitors will be the subject of separate instructions. No radioactive material shall be removed from the test site except as authorized in experimental projects.
15. All samples of radioactive material which are couriered in aircraft will be packaged and loaded so as to reduce radiation to a minimum. Prior to departure of such aircraft, the RadSafe Officer, TG 7.4, will have a survey made of the aircraft cargo to determine if adequate precautions have been taken. The following criteria will determine space and packaging requirements:
 - a. Prior exposure of aircraft crew, courier and passengers.
 - b. Anticipated future exposures on trip, considering length of trip, compartmental loading requirements and capability to isolate personnel from radioactive material.
16. All air and surface vehicles or craft used in contaminated areas will be checked through the appropriate task group decontamination section upon return from such areas.
17. The MPLs listed herein are to be regarded as advisory limits for control under average conditions. All readings of surface contamination are to be made with Geiger counters, with tube walls not substantially in excess of 30 mg/cm² with shield open unless otherwise specified. The surface of the probe should be held one (1) inch to two (2) inches from the surface that is under observation unless otherwise specified. For operational purposes the contamination MPLs presented below will not be considered applicable to spotty contamination provided such areas can be effectively isolated from personnel.

a. Personnel and Clothing MPLs

(1) Skin readings should not be more than 1.0 mr/hr. Complete decontamination by bathing will be utilized for readings in excess of this level. If the body is generally contaminated and especially if contamination is on the eyes or gonads, special efforts should be made to reduce the contamination level. In general, however, it is not considered profitable to abrade the skin or epilate the scalp in an attempt to reduce stubborn contamination below 1 mr/hr (about 1000 cpm). Beta radiation exposure to the hands should not exceed 30.0 rep for the operational period, as defined in paragraph 4, above.

(2) Underclothing and body equipment such as the internal surfaces of respirators should be reduced to 2 mr/hr.

(3) Outer clothing should be reduced to 7 mr/hr.

b. Vehicle MPLs. The interior surfaces of occupied sections of vehicles should be reduced to 7 mr/hr. The outside surfaces of vehicles should be reduced to less than 7 mr/hr (gamma only) at five (5) or six (6) inches from the surface.

c. Ship and Boat MPLs

(1) It is desired to point out that the employment of the ships and units in TG 7.3, insofar as radiological safety is concerned, is not considered routine usage within the purview of NavMed P-1325, "Radiological Safety Regulations". Current revision of NavMed P-1325 indicates that its provisions do not apply for special operations such as field tests and that for such operations naval personnel will operate under regulations set forth by the task force commander as approved by the Chief of Naval Operations.

(2) In general, ships and boats operating in waters near shot sites after shot times may become contaminated. Monitors shall be aboard all such craft operating after shot time, either as passengers or members of the crew, until such time as radiological restrictions are lifted.

(3) Task Group commanders will take necessary action to ensure that personnel of ships and boats are not over-exposed to radiation and that ships and boats are not contaminated excessively. The criterion in both cases is that no personnel will be over-exposed as defined by paragraph 5a, above, except in emergencies or tactical operations, and that after the operational period no personnel will receive more than 0.3 roentgens per week from contaminated equipment.

(4) For ships and boats operating in contaminated waters, reasonable allowances will be made to differentiate between the relative contribution to the total flux from fixed contamination and that due to "Shine" from contaminated waters. Fixed alpha contamination should not exceed 2500 dpm (disintegrations per minute) per 150 cm² of area for enclosed areas (cabins, etc.) and 5000 dpm per 150 cm² area for open surfaces where ventilation is good.

(5) At the conclusion of the operation, final clearances will be granted by task group commanders or by commanding officers, if so ordered, to those ships and boats showing no point of contamination greater than 15 mr/day (beta and gamma) and no detectable alpha. Other ships and boats will be granted operational clearances by task group commanders or by commanding officers, if so ordered. An operational clearance implies that contamination exists and that special procedures as necessary are instituted aboard ship.

(6) Individuals on board ships of the task force shall be protected collectively from hazards of blast, heat and radioactivity by movement and positioning of the ships.

(7) No ships with personnel shall be permitted inside the 1.5 p.s.i. line unless specifically directed otherwise. Bearings of danger from immediate radioactive fall-out for ship operations will be established by CJTF SEVEN on the basis of forecast wind directions at the intended time of detonation. This danger section will be designated as surface RADEX. All ships of the task force shall be required to remain outside the RADEX - danger bearing, radial limitation and time restriction unless specifically directed otherwise. However, if ships are directed tactically into the surface RADEX, movement of ships shall be governed by tactical exposure guides.

d. Aircraft MPLs

(1) The interior surfaces of occupied sections of aircraft should be reduced to 7 mr/hr.

(2) No aircraft in the air at H hour will be at slant ranges from ground zero less than as determined by the following effects unless specifically directed otherwise. (Based on maximum predicted yield and 20 mile visibility).

Blast (at predicted shock arrival): 0.5 p.s.i.
Thermal (H Hour): Fabric control surfaces: 1.0 cal/cm²
Metal control surfaces: 6.0 cal/cm²

(3) After detonation no aircraft shall operate inside the air RADEX or closer than 10 nautical miles from the rising or visible cloud unless specifically directed otherwise. Non-excepted aircraft involved in routine operations encountering unexpected regions of aerial contamination will, immediately upon detecting such contamination, execute a turnout. Cloud tracking aircraft will execute turnout from contaminated areas at a level of not more than 3.0 r/hr. If a tactical or emergency situation arises where aircraft must enter the air RADEX or visible cloud, tactical exposure allowances shall apply.

(4) All multi-engine task force aircraft in the air at H Hour within 100 miles of the detonation point shall carry a person designated as radiological safety monitor, equipped with suitable radiac equipment and a RADEX plot. This monitor shall be capable of calculating allowable exposures under both tactical and operational conditions.

(5) All persons in aircraft at shot time or at subsequent times when engaged in operations in or near the cloud or RADEX track shall wear film badges.

(6) Crew members of aircraft in the air at zero hour will take special precautions to avoid (for at least 10 seconds) the direct and reflected light resulting from the burst. At the discretion of the airplane commander this could be done with protective high density goggles, by turning away from the burst with eyes closed, by covering the eyes with the forearm, by turning the cockpit lights up to highest intensity or by any combination of the above.

e. In air and water the following continuous levels of radioactivity are considered safe from the viewpoint of personnel drinking and breathing (uc = microcurie):

Beta or Gamma Emitter

Water 5×10^{-3} uc/cc (calculated to H + 3 days)

Air (24 hour average)

 Particles less than 5 micron diameter 10^{-6} uc/cc

 Particles greater than 5 micron diameter 10^{-4} uc/cc

18. In tactical situations the military commander must make the decision regarding allowable exposures. As military personnel are normally subject to only random exposure, health hazards are at a minimum. Current Department of Defense information on exposure to gamma radiation in tactical situations is indicated below:
- a. Uniform acute (immediate) exposure of 50 roentgens to a group of Armed Forces personnel will not appreciably affect their efficiency as a fighting unit.
 - b. Uniform acute exposure of 100 roentgens will produce in occasional individuals nausea and vomiting but not to an extent that will render Armed Forces personnel ineffective as fighting units. Personnel receiving an acute radiation exposure of 100 or more roentgens should be given a period of rest and individual evaluation as soon as possible.
 - c. Uniform acute exposure of approximately 150 roentgens or greater can be expected to render Armed Forces personnel ineffective as troops within a few hours through a substantial incidence of nausea, vomiting, weakness and prostration. Mortality produced by an acute exposure of 150 roentgens will be very low and eventual recovery of physical fitness may be expected.
 - d. Field commanders should, therefore, assume that if substantial numbers of their men receive acute radiation exposures substantially above 100 roentgens there is a grave risk that their commands will rapidly become ineffective as fighting units.
 - e. Internal radiation hazards caused by entry of radioactive substances through the mouth, through the lungs or through cuts or wounds do not exist after an air burst. Internal hazards following a contaminating surface explosion may be avoided if ordinary precautions are taken. Only under unusual circumstances will there be internal hazard from residual contamination. This eliminates the necessity for masking and consequent reduction of tactical efficiency.
19. The RadSafe Officer, TG 7.1, will maintain standard type film badge records of radiation exposures for all task force personnel. Records will indicate full name, rank or rate, serial or service number, if applicable, organization, home station or laboratory, date of exposure, approximation duration of over-exposure in hours and minutes

(for Army personnel only) and remarks such as limitations on assignment because of over-exposure. Upon completion of the operation, disposition of these records will be as follows:

- a. A consolidated list of exposures listing military personnel and civilian personnel under military control by full name, rank or rate, serial or service number (if applicable), organization, home station or laboratory and exposure in milliroentgens, together with exposed film badges and control film badges, will be forwarded to the Chief, AFSWP.
- b. A consolidated list of personnel and exposures as indicated in paragraph 19a, above, including all AEC personnel, will be forwarded to the Director, Division of Biology and Medicine, AEC.
- c. Individual records of Navy and Air Force military personnel and civilian personnel will be forwarded to their unit of permanent assignment for inclusion in the individual's health record (Medical History Sheets, NavMed H-8 and the Individual Health Record for Navy and Air Force personnel, respectively). For those military personnel exposed to ionizing radiation in excess of that defined in paragraph 5a, above, a statement will be included to the effect that the individual is not to be subjected to ionizing radiation before a specific date, the date to be computed by the RadSafe Officer, TG 7.1, to allow sufficient time to elapse in order to bring the average radiation dose down to 0.3 roentgens per week. Limitations on Navy and Air Force civilian personnel with reference to over-exposures will be as determined by the laboratory or agency having administrative jurisdiction over such personnel.
- d. Individual records of Army military and civilian personnel will be forwarded in accordance with SR 40-1025-66 dated 21 April 1953 to their unit of permanent assignment for inclusion in the individual's field military 201 file or the civilian personnel 201 file (whichever is applicable). These records will indicate date of exposure, amount of exposure in milliroentgens, approximate duration of over-exposure in hours and minutes and a space for remarks such as limitations on assignment (as indicated in paragraph 19c, above) because of over-exposures.
- e. Individual records of AEC controlled and administered civilian personnel will be processed in accordance with special instructions prescribed by the laboratory or agency having administrative jurisdiction over such personnel.
- f. Upon completion of provisions of paragraph 19a, b, c, d, and e, above, letter reports will be submitted through channels to the Surgeon General, USA; the Chief, Bureau of Medicine and Surgery, USN; the Surgeon General, USAF and the Director, Division of Biology and Medicine, AEC, indicating, in general, the action taken to dispose of individual dose records, comments on over-exposures if applicable and any pertinent remarks considered of interest to the above offices.

20. Training. The inclusion of radiological safety organizations throughout the task force will require two general levels of training; basic indoctrination and technical training. The scope of instruction within each of these levels will vary in accordance with the requirements of different operational and staff levels. Basic indoctrination will include primary, non-technical instruction in radiological safety measures and techniques. This must be imparted to all personnel of the task force to enable them to perform their assigned duties efficiently within the allowable low exposures, regardless of the presence of radioactive contaminants. Technical training will include the training of the majority of the personnel who will be required to staff the task force radiological safety organizations and perform the technical operations involved. This will be accomplished through the utilization of existing Service courses and establishment of suitable courses at task group level. This instruction will be designed to train radiological defense monitors, decontamination personnel and radiological instrument repairmen.
21. These regulations have the concurrence of the Surgeon General, USA; the Chief of Naval Operation; the Surgeon General, USAF and the Director, Division of Biology and Medicine, AEC.
22. This appendix has been designed for reduced security classification in order to facilitate wide dissemination and may be downgraded to RESTRICTED - SECURITY INFORMATION provided all references to Joint Task Force SEVEN and its subordinate units are deleted.

Original signed by the Assistant Chief of Staff, J-3
for the Commander Joint Task Force 7

-- RETYPED COPY --

HEADQUARTERS, Joint Task Force SEVEN
Washington 25, D.C.
10 November 1953

Appendix II to Annex N

Radiological safety, CJTF SEVEN Operation Plan No. 3-53

RADIOLOGICAL SAFETY OFFICE AND CENTER

1. A JTF SEVEN radiological safety office (RadSafe Office) and a TG 7.1 radiological safety center (RadSafe Center) will be established for each shot. The RadSafe Office, manned by personnel of the Technical Branch of the task force Operations Division (J-3), will operate as the task force agency responsible for the dissemination of task force radiological directives, the presentation of radiological shot briefing material and the maintenance of displays of radiological information having an impact on the overall task force mission. The RadSafe Center will be established by CTG 7.1 and will serve as operations headquarters for the radiological safety activities of TG 7.1. Pertinent data collected at the RadSafe Center will be forwarded to the RadSafe Office at the task force command post.

2. Detailed Duties

a. Radsafe Office

(1) The RadSafe Office, in coordination with CTG 7.4 who will develop the air RADEX plot, will assemble the overall RADEX situation and disseminate the air and surface RADEX prior to shot time (forecast) and will originate messages from time to time after shot time announcing R (Reentry) Hour, radiological clearances of previously closed areas, radiological directives to task groups, advisories to commands external to the task force and revisions of the air and surface RADEX as required.

(2) The RadSafe Office will be responsible for the preparation of RadSafe forecast information for the shot briefings.

(3) The RadSafe Office will maintain displays of radiological information pertinent to the test area and having an impact outside this area to include radiation levels on atoll islands and lagoon, RADEX information, cloud trajectories and their relation to occupied atolls and air and surface routes contiguous to the danger area, ship movements in the danger area, results of water sampling and such other items of special radiological consideration as may be required by the operation or the scientific projects.

(4) Physical Locations of the RadSafe Office

a. For BIKINI ATOLL shots: Command ship

b. For ENIWETOK ATOLL shots: Operations Division (J-3), JTF SEVEN Headquarters building, PARRY ISLAND.

b. RadSafe Center

(1) The RadSafe Center will maintain radiological situation data on lagoon waters and islands of the shot atoll, based on air and ground survey information, supplemented by monitor reports. This information will be the basis of periodic situation reports or maps and briefing information furnished to the task force and task group commanders.

(2) The RadSafe Center will provide information for the planning of TG 7.1 radiological safety operations and for the disposition of all working parties within the contamination area. It will establish radiological safety check points. It will maintain an operations table giving details for all groups who plan to enter contaminated areas each day, including name of monitor, destination, general type of mission (program or project number) and time of departure and return.

(3) The RadSafe Center will provide special clothing to previously designated recovery personnel, have cognizance over working schedules of the radiochemical laboratory, photodosimetry developing facilities, contaminated laundry, personnel decontamination facilities, radiac repair, etc. of TG 7.1. Personnel decontamination facilities afloat will be coordinated with existing ship facilities.

(4) Physical Locations of RadSafe Center

a. For BIKINI ATOLL shots: The RadSafe Center will initially operate from the CVE facilities. At a later time, radiological conditions permitting, the center will provide a detachment at pre-prepared positions ashore to operate all its activities except radiochemistry and photodosimetry.

b. For ENIWETOK ATOLL shots: The RadSafe Center will operate all of its facilities from the radiological safety building on PARRY ISLAND (Building 57).

Original signed by the Assistant Chief of Staff, J-3
for the Commander Joint Task Force 7

-- RETYPED COPY --

HEADQUARTERS, Joint Task Force SEVEN
Washington 25, D.C.
10 November 1953

Appendix III to Annex N

Radiological Safety CJTF SEVEN Operational Plan No. 3-53

HAZARDS RESULTING FROM ATOMIC BOMB EXPLOSIONS

1. Nature of Hazards

- a. When an atomic bomb explosion occurs, tremendous quantities of energy in a variety of forms are released. This energy is propagated outward in all directions.
- b. The immediate reaction is intense emission of ultraviolet, visible and infrared (heat) radiation, gamma rays and neutrons. This is accompanied by the formation of a large ball of fire. A large part of the energy from the explosion is emitted as a shock wave. The ball of fire produces a mushroom shaped mass of hot gas, the top of which rises rapidly. In the trail below the mushroom cap, a thin column is left. The cloud and column are then carried downwind, the direction and speed being determined by the direction and speed of the wind at the various levels of air from the surface to base of mushroom cap. Part of the energy from the explosion results in an ocean surface wave which is considered of minor nature directly to the task force.
- c. All personnel of the task force will be well outside of the range of all hazard at the time of detonation, except for the light from the fire ball. The light of explosion is so intense that permanent injury to the eye may result from viewing the ball of fire at close range with the naked eye or through binoculars. Ordinary dark glasses will not suffice and all personnel who do not have the special protective glasses, which will be issued in limited numbers by TG 7.1, must be facing 180 degrees from the detonation with the eyes closed.
- d. The emission of dangerous nuclear radiation can be separated into two time periods. The primary radiation which occurs at the time of the flash is composed of gamma rays and neutrons. Casualties may result from this primary radiation if the exposure occurs within a certain range of ground zero. Secondary radiation is due to the activation of the soil around ground zero and to fall-out.
- e. Following the detonation, personnel entering shot areas will be exposed to beta particles and gamma rays coming from induced neutron activity in the soil and any fission products which might have been deposited on the ground. There may also be a potential alpha particle hazard from the unfissioned fissionable materials which may be deposited on the ground.

2. Protection

a. Against the primary radiological effects, distance will provide protection.

b. Against the secondary radioactivity hazards from radioactive fission products, induced radioactivity and unfissioned residue, detection and avoidance provide the best protection. Suitable instruments indicate both the presence and intensity of radioactivity at a given place. Area reconnaissance, the maintenance of contamination situation maps, the posting of areas of hazard and minimizing the spread of contaminated material into uncontaminated areas constitute the active measures for reducing the radiological hazard.

c. Personnel within an operational radius of ground zero who are to be facing in the direction of the flash will be required to wear special goggles to protect their eyes against excessive light. Personnel within the above operational radius who are not provided goggles will face, with eyes closed, in the opposite direction from the flash. After ten (10) seconds, such personnel may turn around and observe the phenomena.

3. Anticipated Hazard Areas

a. Immediately under the bomb burst there will be an area of intense radioactivity extending downwind and, to some extent, crosswind and upwind with gradually decreasing intensity.

b. Extending downwind (and to some extent, crosswind and upwind), an airborne radioactive hazard will exist. Its characteristics will depend on the meteorological influences such as wind speed and direction at various altitudes up to the maximum height reached by the cloud.

c. Contaminated water in the lagoon adjacent to the shot site may be of consequence and will be analyzed by the radiological safety unit of TG 7.1 immediately after shot time and at other intervals.

d. Unless care is exercised, individuals or objects entering contaminated areas may transfer radioactivity to clean areas.

e. By means of instruments such as Geiger-Mueller counters and ion chambers it is possible to detect the area of contamination and to measure the intensity of the radioactivity. Radiation intensity will normally be measured and reported in roentgens per hour. Besides those instruments, dosimeters and film badges will be used as indicators of the accumulated exposure to radioactivity. Only personnel involved in work near, or in, radioactive areas will wear film badges to provide a permanent record of exposure, except that film badges will be issued to ten (10) percent of ship crews to aid in estimated crew dosage in the event of heavy fall-out.

f. The intensity of the radioactive hazard tends to decrease with time due to decay of radioactive materials and dispersion and dilution, depending upon climatic conditions. As an approximation, the intensity

of the surface contamination from the fission products decreases by radioactive decay inversely with the time after the detonation. As a further approximation, the intensity of water contamination decreases by radioactive decay and diffusion inversely with the square of the time after the detonation.

4. This appendix has been designed for reduced security classification in order to permit wide dissemination to all personnel of the command and may be downgraded to RESTRICTED - SECURITY INFORMATION provided all references to Joint Task Force SEVEN and its subordinate units are deleted.

Original signed by the Assistant Chief of Staff, J-3
for the Commander Joint Task Force 7

COPY OF AIDE MEMOIRE GIVEN TO THE U.S. AMBASSADOR ALLISON
BY THE VICE-MINISTER OF FOREIGN AFFAIRS, OKUMURA
MARCH 27, 1954

The following data has been obtained as a result of investigations conducted by the Japanese Government with regard to the Fukuryu Maru No. 5.

The course of the Fukuryu Maru No. 5, its movement and circumstances of the accident as described hereunder are conclusions drawn from (1) statements made by the vessel's skipper, fishing master and other members of the crew; (2) entries in the ship's log-book and fishing records and (3) meteorological conditions at the time of the accident as revealed from the investigation by the Central Meteorological Observatory. All dates and hours given here are Japan Standard Time.

I. Stricken Vessel:-

Name:	Fukuryu Maru No. 5
Type:	Fishing boat, 99.9 tons
Registration No.:	SO 2-893
Owner's name and address:	Kakuichi Nishikawa 13-724, Yaizu, Yaizu-shi Shizuoka Prefecture
Skipper's name and address:	Hisakichi Tsutsui 50, Ryoyashiki, Sakushima-Mura Hazu-Gun, Aichi Prefecture
Number of crew:	23 persons
Content and kind of cargo:	Tuna and other fish Total 2,299.3 kan

II. Course and Movement of the Fukuryu Maru No. 5:-

1. The Fukuryu Maru No. 5 left the port of Yaizu, Shizuoka Prefecture, at 1130 hours on January 22 and headed south-eastward. On or about January 27, and from a position in the neighborhood of Lat. $27^{\circ}36'N$. and Long. $148^{\circ}37'E$. it shifted its course eastward. It started fishing on February 3, at Lat. $26^{\circ}17'1/2'N$. and Long. $171^{\circ}30'E$. Fishing operation was made several times until February 12. Later, in order to fish in the neighborhood of the Marshall Islands, the vessel changed its course and, while fishing on the way, it reached on February 23, a position in the proximity of Lat. $11^{\circ}11.3'N$. and Long. $173^{\circ}33'E$.
2. After February 23, the vessel directed its course toward the west and engaged in fishing operations. On March 1, at approximately 0115 hours it arrived at the position of Lat. $12^{\circ}03'1/2'N$. and Long. $166^{\circ}56'1/2'E$. and started to set lines. It completed

setting lines at 0342 hours at Lat. $11^{\circ}52' 1/2''$ N. and Long. $166^{\circ}35'$ E. Afterward it cruised for ten (10) minutes toward the north-east (estimated cruising distance: $1\ 1/4$ nautical miles), and drifted with its engine stopped. About 0412 hours, after it had drifted about twenty (20) minutes (estimated westward tide-way, about one half ($1/2$) nautical mile), a streak of light which seemed to have resulted from an atomic bomb explosion was seen. The vessel's position at that time was approximately Lat. $11^{\circ}53' - 1/4''$ N. and Long. $166^{\circ}35' - 1/4''$ E.

3. About seven or eight minutes after the light had been seen, a detonation apparently resulting from an atomic bomb explosion was heard and the vessel immediately started hauling in its lines. This operation ended at 1030 hours and the vessel headed toward the north to get out of the area.
4. After 0440 hours, March 2 the vessel shifted its course toward the north-west and headed for Yaizu. It entered the port of Yaizu at 0600 hours on March 14.

III. Circumstances of the Accident:-

1. About 0412 hours on March 1, a reddish brilliant light was seen in the direction of west-southwest of the vessel. The color of this light gradually turned to white-yellow and again back to red and faded away.
2. No wind resulting from the explosion was felt within the next seven or eight minutes but two blasts were heard in succession. A cloud having the shape of a mushroom was seen in the direction where the light was first seen and this cloud started to expand covering the sky with dark clouds.
3. As the crew saw the light, some of them realized that probably an atomic test, about which they remembered having read in the newspapers, might have occurred. Anticipating danger, they started hauling in the lines at about 0430 hours, from the position where they had previously finished setting the lines, progressing in the opposite direction toward the northeast. The lines were hauled in by machine using what is called a line-hauler. While hauling in the lines the vessel's engine repeated the process of "go slow ahead" and "stop" and the same again. In the present instance all hands with the exception of a few engineers on watch were working on the upper deck and in the wheel house.
4. In the midst of the operation of hauling lines, about three (3) hours later than the moment the light had been seen, and at the estimated position of Lat. $11^{\circ}56' 3/4''$ N. and Long. $166^{\circ}42' 1/2''$ E. ashes started to fall on the deck, which was turned white. As the hauling operation ended about 1030 hours in the vicinity of the estimated position of Lat. $12^{\circ}03'$ N. and Long. $166^{\circ}53'$ E. the

vessel headed for north in the direction where ashes were not falling and cruised with a speed of seven (7) nautical miles per hr trying to evacuate the area.

5. The crew, after having hauled in the lines, worked on the upper deck engaging in processing the catch. The ashes kept falling until about noon, when the vessel reached the estimated position of Lat. 12°14'N. and Long. 166°53'E.
6. In the following two or three days all the crew suffered from a slight headache and some of them felt nausea.
7. Seven or eight days after the accident, the crew began to feel painful irritations, from what looked like burns on the neck, face, ears and places where they wore "hachimaki" (a cotton towel wrapped around the head) which were exposed to the ashes.

IV. Miscellaneous:-

1. There is no evidence that the Fukuryu Maru No. 5 received warnings, by radio message or any other means, which being in the area before the accident occurred. (sic)

Investigation conducted so far showed no evidence of any receipt of any kind of warning by vessels other than the Fukuryu Maru No. 5.

2. The crew of the vessel did not hear any sound of aircraft at the time of the accident.
3. Matters Relating to Communications:
 - a. The communication log is found to have been duly and properly entered.
 - b. The vessel had one (1) Licensed Radio Operator, Second Class, who has a slight knowledge of English.
 - c. The condition of the radio equipment was good.
 - d. Listening hours of the vessel's radio were unfixed.
 - e. The communication waves were 2091 kc and 3251.5 kc.

V. Degree of the Damage:

The amount of damage suffered by the Fukuryu Maru No. 5 is now under investigation.

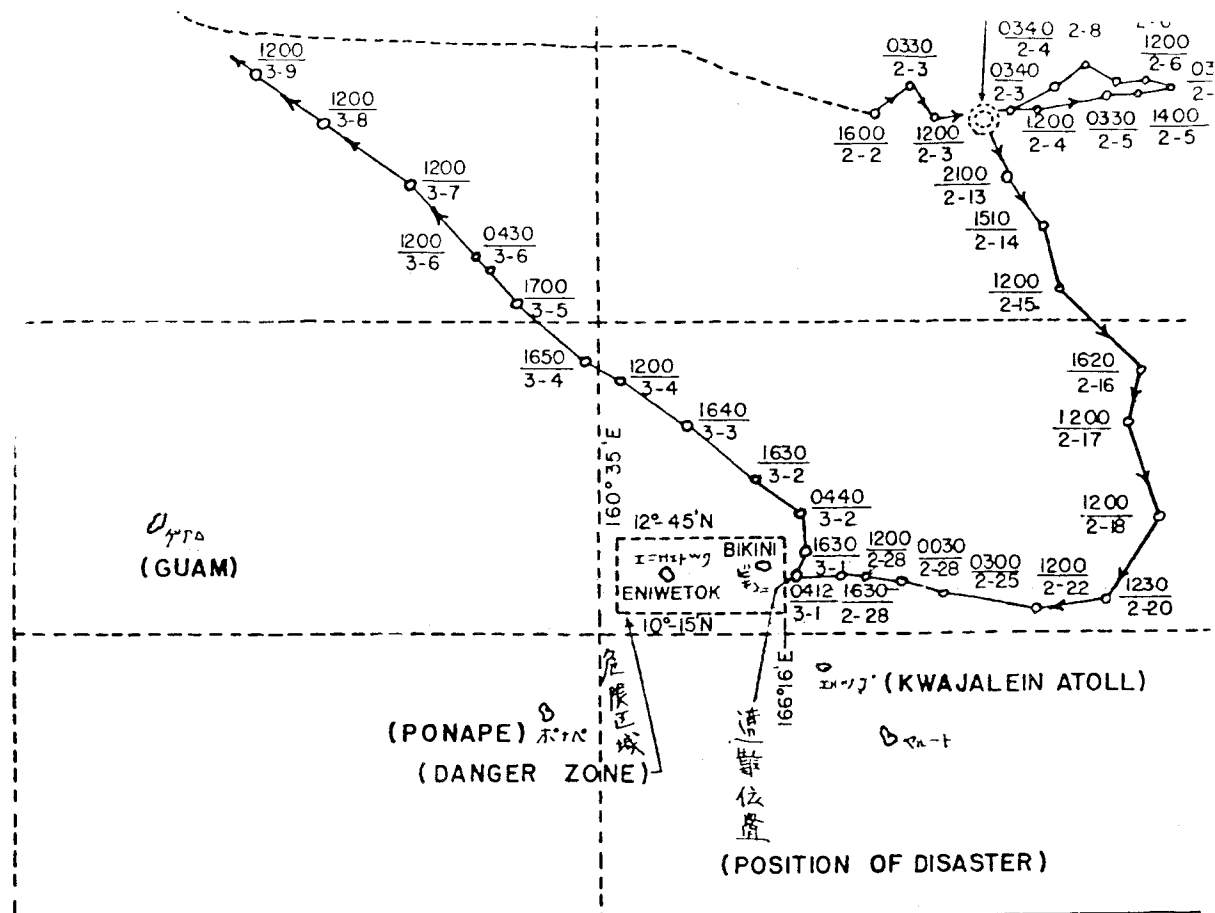

FROM AIDE MEMOIRE OF MARCH 27, (TIMES ARE JAPANESE)
 (ship reported time of flash 0412, 1 March 1954 (local or ship's time))

POSITION OF FUKURYU MARU

Time of Burst	11°53-1/4'N, 166°34-1/4'E
Time Fallout Started	11°56-3/4'N, 166°42-1/2'E
Time Fallout Stopped	12°14'N, 166°53'E

COPY OF AIDE-MEMOIRE PREPARED BY THE EMBASSY OF JAPAN
TO THE UNITED STATES
APRIL 12, 1954

It is reported that on March 31, Mr. Lewis L. Strauss, Chairman of the Atomic Energy Commission, made the following statements, among others, concerning the thermonuclear test which took place at the Bikini Atoll on March 1, 1954.

' . . . A Japanese fishing trawler, the 'Fortunate Dragon', appears to have been missed by the search but, based on a statement attributed to her skipper, to the effect that he saw the flash of the explosion and heard the concussion six minutes later, it must have been well within the danger area. . . .

' . . . The situation with respect to the 23 Japanese fishermen is less certain due to the fact that our people have not yet been permitted by the Japanese authorities to make a proper clinical examination. It is interesting to note, however, that the reports which have recently come through to us indicate that the blood count of these men is comparable to that of our weather station personnel. . . .'

The portion of Mr. Strauss' statement quoted above not being entirely consistent with information officially received here, the Japanese Embassy wishes to place it on record that facts ascertained by the Japanese authorities on these points are as follows:

1. Upon investigation, it has been established that the crew of the Fukuryu Maru No. 5 heard the detonation of the explosion seven or eight minutes after the crew saw its flash. It is estimated that the position of the vessel when they saw the flash and the spot where the ash fell upon them were respectively 19 miles and 26 miles outside the danger-zone which the United States Government had previously established and publicized by the official publication 'Notice to Mariners'. For the details as to the movement of the vessel reference is made to the . . . Aide-Memoire handed in Tokyo to Ambassador Allison by Vice Minister Okumura of Foreign Affairs on March 27, 1954.
2. Dr. John J. Morton, of the Atomic Bomb Casualty Commission examined the Japanese crew members on the 19th of March in Tokyo and on the 20th at Yaizu. Dr. Merrill Eisenbud of the Atomic Energy Commission viewed the affected persons, accompanied by Dr.

Morton, on March 25th in Tokyo and on the 26th at Yaizu. Their visits included an examination of the injured fishermen both by external observation and by obtaining specimens of their blood and excreta.

The more thorough check-up offered by the doctors has not yet been undertaken because of the special psychological situation in which these simple fishermen find themselves. They resent and refuse the type of clinical examination which they feel might place them in the position of experimental objects. This is especially true where the examination is to be conducted by physicians other than Japanese. The Japanese authorities, however, are continuing their efforts to persuade the patients to undergo a more complete examination by American personnel at the earliest opportunity.

3. As to the question of the blood count of the exposed fishermen, information furnished to the American Embassy in Tokyo by the Japanese Government would appear to show that there is little ground to conclude the conditions of these fishermen are not serious, especially when the extraordinary nature of these cases are taken into consideration.

APPENDIX B

TERMS, ABBREVIATIONS, ACRONYMS, AND UNITS

Many of the definitions in this glossary relating to nuclear device and radiation phenomena have been quoted or extracted from The Effects of Nuclear Weapons (3rd edition), S. Glasstone and P.J. Dolan, 1977.

- AAA. Anti-Aircraft Artillery (Army).
- AA&GM. Anti-Aircraft Artillery and Guided Missile Center, Ft. Bliss, Texas (Army).
- AACS. Airways and Air Communication Service (Air Force).
- AAU. Administrative Area Unit (Army).
- ACC. Army Chemical Center, Edgewood Arsenal, Maryland.
- accelerometer. An instrument for determining the acceleration of the system with which it moves.
- ACF. American Car and Foundry, Inc. Later ACF Industries, Inc.
- AEC. Atomic Energy Commission, Washington, D.C. Independent agency of the Federal government with statutory responsibilities for atomic energy matters. No longer exists; its functions have been assumed by the Department of Energy and the Nuclear Regulatory Commission.
- AF. Store ship (Navy); also Air Force.
- AFSWC. Air Force Special Weapons Center, Kirtland AFB, New Mexico.
- AFSWP. Armed Forces Special Weapons Project.
- AGC. Amphibious force flagship; now LCC.
- airburst. The detonation of a nuclear device in the air at a height such that the expanding fireball does not touch the earth's surface when the luminosity (emission of light) is at a maximum.
- air particle trajectory. The direction, velocity, and rate of descent of windblown radioactive particles.
- AKA. Attack cargo ship; now LKA.
- allowable dose. See MPE and MPL.
- ALOO. Albuquerque Operations Office of the AEC (DOE).
- alpha emitter. A radionuclide that undergoes transformation by alpha-particle emission.
- alpha particle. A charged particle emitted spontaneously from the nuclei of some radioactive elements. It is identical with a helium nucleus, having a mass of 4 units and an electric charge of 2 positive units. See also radioactivity.
- alpha rays. A stream of alpha particles. Loosely, a synonym for alpha particles.
- AMN. Airman; enlisted Air Force personnel.
- AMS. Army Map Service, Washington, D.C.
- AN/PDR-39. An ion-chamber-type survey meter; this was the standard radsafe meter. Others in use included the Navy version, the AN/PDR-T1B, the AN/PDR-18A and -18B, and lower range Geiger-Mueller instruments (AN/PDR-27, Beckman MX-5, and Nuclear Corporation 2610).
- AQ. Oiler (Navy).

AOC. Air Operations Control Center.

AOG. Gasoline tanker.

AP. Transport ship.

APG. Aberdeen Proving Ground, Maryland.

ARA. Allied Research Associates, Boston, Massachusetts.

ARS. Salvage ship.

ARSD. Salvage lifting ship.

ASA. Army Security Agency.

ASU. Army Support Unit

ASW. Anti-Submarine Warfare.

ATA. Auxiliary ocean tug.

ATCOM. Atoll commander.

ATF. Fleet ocean tug.

atoll. A ring of coral reefs, usually with small islets, that surrounds a lagoon. Most are isolated reefs rising from the deep sea that have built up on submerged volcanoes. They vary considerably in size; the largest atoll, Kwajalein in the Marshall Islands, has an irregular shape that extends for 84 miles (135 km). See also coral reef.

atomic bomb (or weapon). A term sometimes applied to a nuclear weapon utilizing fission energy only. See also fission, nuclear device.

atomic explosion. See nuclear explosion.

attenuation. The process by which radiation is reduced in intensity when passing through some material. It is due to absorption or scattering or both, but it excludes the decrease of intensity with distance from the source (inverse square law), which see.

AU. Army Unit.

AV. Seaplane tender.

AVR. Aircraft rescue vessel.

AW. Distilling ship.

B-29. A 4-engine, propeller-driven bomber developed by Boeing, used for weather reconnaissance, cloud tracking, aerial sampling and photography, and aerial refueling at the PPG. These versions designated RB-29, WB-29, and KB-29.

B-36. A long-range, strategic bomber powered by six pusher propeller engines, supplemented by four jet engines. Developed by Consolidated Aircraft. Used as the subject of effects experiments and as a sampler controller aircraft. Also designated FB-36, RB-36, and WB-36.

B-47. A 6-jet-engine bomber with sweptback wings and a double-wheel bicycle landing gear, developed by Boeing. Used as the subject of effects experiments.

B-50. A 4-engine bomber developed by Boeing, with some features like those of the B-29, but having a taller tail fin and larger engines and nacelles.

B-57. U.S. version of English Electric Canberra bomber used as cloud sampling aircraft.

background radiation. The radiation of man's natural environment, consisting of that which comes from cosmic rays and from the naturally radioactive elements of the Earth, including that from within man's body. The term may also mean radiation extraneous to an experiment.

barge. A floating platform used as the support for the cab, or shelter, in which nuclear devices were being prepared for testing.

base surge. The particulate dust cloud that rolls out from the bottom of the cloud column produced by the detonation of a nuclear device. For underwater bursts, the base surge is a cloud of water droplets, and the flowing properties are those of a homogeneous liquid.

"bathtub". A washdown system used on an aircraft carrier flight deck for decontaminating helicopter landing gear. The bathtub's purpose was to prevent water used to hose the aircraft wheels from running onto the flight deck. It was a low-walled canvas rectangle treated with waterproofing preservatives.

bathythermograph (B/T). A device for obtaining a record of temperature with depth in the upper 1,000 feet (300 meters) of the ocean, from a ship underway.

becquerel (Bq). See curie (Ci).

beta burns. Beta particles that come into contact with the skin and remain for an appreciable time can cause a form of radiation injury sometimes referred to as "beta burn." In an area of extensive early fallout, the whole surface of the body may be exposed to beta particles.

beta emitter. A radionuclide that disintegrates by beta particle emission. All beta-active elements existing in nature expel negative particles, i.e., electrons or, more exactly, negatrons. Beta-emitting particles are harmful if inhaled or ingested.

beta particle (ray). A charged particle of very small mass emitted spontaneously from the nuclei of certain radioactive elements. Most (if not all) of the direct fission products emit (negative) beta particles. Physically, the beta particle is identical to an electron moving at high velocity.

blast. The detonation of a nuclear device, like the detonation of a high explosive such as TNT, results in the sudden formation of a pressure or shock wave, called a blast wave in the air and a shock wave when the energy is imparted to water or Earth.

blast wave. An air pulse in which the pressure increases sharply at the front accompanied by winds propagated from an explosion.

blast yield. That portion of the total energy of a nuclear explosion that manifests itself as blast and shock waves.

bomb debris. See weapon debris.

BRL. Ballistics Research Laboratories, Aberdeen Proving Ground, Maryland (Army).

BuMed. Bureau of Medicine and Surgery (Navy).

burst. Explosion; or detonation. See also airburst, high-altitude burst, surface burst.

BuShips. Bureau of Ships (Navy).

C-47. A twin-engine transport aircraft manufactured by Douglas Aircraft Company (Air Force version of the DC-3).

C-54. A 4-engine military cargo and personnel transport manufactured by Douglas Aircraft Company (Air Force version of the DC-4).

cab. The shelter that covers a nuclear device being prepared for test. May be located on a tower, on the Earth's surface, or on a barge.

Canberra. An RAF twin-turbojet, all-weather, tactical bomber developed by English Electric. Also built in the United States and used by the Air Force as the B-57.

cathode-ray tube. A vacuum tube in which cathode rays (electrons) are beamed upon a fluorescent screen to produce a luminous image. The character of this image is related to, and controlled by, one or more electrical signals applied to the cathode-ray beam as input information. The tubes are used in measuring instruments such as oscilloscopes and in radar and television displays.

cave. A heavily shielded enclosure in which radioactive materials can be remotely manipulated to avoid radiation exposure of personnel.

Ci; c. Abbreviation for curie, which see. Ci is preferred now but c was the abbreviation used in the 1950s.

CIC. Counter-Intelligence Corps (Army).

CID. Criminal Investigation Detachment (Army).

CINCPAC. Commander-in-Chief of the Pacific.

CJTF 7. Commander, Joint Task Force 7.

cloud column (funnel). The visible column of weapon debris (and possibly dust or water droplets) extending upward from the point of a nuclear burst.

closed area. The land areas of Bikini and Enewetak and the water areas within 3 miles of them that the United States closed to unauthorized persons.

cloud phenomena. See fallout, fireball, radioactive cloud.

collimate. To align nuclear weapon radiant outputs within an assigned solid angle through the use of baffles in order to enhance measurements.

CNO. Chief of Naval Operations.

Co. Chemical symbol for cobalt.

cobalt. Metallic element with radionuclide ^{60}Co used as calibration source for gamma instruments.

Condition "Purple". See Purple conditions.

Consolidated List. Consolidated List of Radiological Exposures. The list that covers all recorded individual radiological exposures for all joint task force participants (see Reference 13).

contamination. The deposit of radioactive material on the surfaces of structures, areas, objects, and personnel following a nuclear detonation. This material generally consists of fallout in which fission products and other device debris have become incorporated with particles of dust, vaporized components of device platforms, etc. Contamination can also arise from the radioactivity induced in certain substances by the action of neutrons from a nuclear explosion. See also decontamination, fallout, weapon debris.

coral reef. A complex ecological association of bottom-living and attached shelled marine animal fossils that form fringing reefs, barrier reefs, and atolls. The lagoons of barrier reefs and atolls are important places for the deposition of fine-grained calcium carbonate mud.

CPM. Counts per minute, a measure of radioactive material disintegration.

crater. The depression formed in the surface of the Earth by a surface or underground explosion. Crater formation can occur by vaporization of the surface material, by the scouring effect of airblast, by throwout of disturbed material, or by subsidence.

CRL. Cook Research Laboratories, Chicago, Illinois.

cryogenic materials. Materials used for producing very low temperatures.

C/S. Chief of Staff.

CTG. Commander, Task Group.

curie (Ci). A unit of radioactivity; it is the activity of a quantity of any radioactive species in which 3.700×10^{10} (37 billion) nuclear disintegrations occur per second (approximately the radioactivity of 1 gram of radium). The gamma curie is sometimes defined correspondingly as the activity of material in which this number of gamma-ray photons is emitted per second. This unit is being replaced by the becquerel (Bq), which is equal to one disintegration per second.

CVE. Escort aircraft carrier.

CW net. Carrier wave network. An organization of stations capable of direct radio communications on a common channel or frequency.

Daigo Fukuryu Maru (Fortunate Dragon No. 5). Japanese fishing trawler in Bikini Atoll area on 1 March 1954.

D-day. The term used to designate the unnamed day on which a test takes place. The equivalent rule applies to H-hour. Time in plans is indicated by a letter which shows the unit of time employed in figures, with a minus or plus sign to indicate the amount of time before or after the reference event, e.g., D+7 means 7 days after D-day, H+2 means 2 hours after H-hour.

DDE. Escort destroyer.

DE. Destroyer escort.

debris (radioactive). See weapon debris.

decay (radioactive). The decrease in activity of any radioactive material with the passage of time due to the spontaneous emission from the atomic nuclei of either alpha or beta particles, sometimes accompanied by gamma radiation, or by gamma photons alone. Every decay process has a definite half-life.

decontamination. The reduction or removal of contaminating radioactive material from a structure, area, object, or person. Decontamination may be accomplished by (1) treating the surface to remove or decrease the contamination; (2) letting the material stand so that the radioactivity is decreased as a result of natural decay; and (3) covering the contamination in order to attenuate the radiation emitted.

device. Nuclear fission and fusion materials, together with their arming, fuzing, firing, chemical-explosive, and effects-measuring components, that have not reached the development status of an operational weapon.

DM. Minelayer destroyer. Converted destroyers designed to conduct high-speed minelaying operations.

DOD. Department of Defense. The Federal executive agency responsible for the defense of the United States. Includes the four services and special joint defense agencies. Reports to the President through the Secretary of Defense.

dose. A general term denoting the quantity of ionizing radiation absorbed. The unit of absorbed dose is the rad (which see). In soft body tissue the absorbed dose in rads is essentially equal to the exposure in roentgens. The biological dose (also called the RBE dose) in rems is a measure of biological effectiveness of the absorbed radiation. Dosage is used in older literature as well as exposure dose and simply exposure, and care should be exercised in their use. See also exposure.

dose rate. As a general rule, the amount of ionizing (or nuclear) radiation that an individual or material would receive per unit of time. It is usually expressed as rads (or rems) per hour or multiples or divisions of these units such as millirads per hour. The dose rate is commonly used to indicate the level of radioactivity in a contaminated area. See survey meter.

dosimeter. An instrument for measuring and registering the total accumulated dose of (or exposure to) ionizing radiation. Instruments worn or carried by individuals are called personnel dosimeters.

dosimetry. The measurement and recording of radiation doses and dose rates. It is concerned with the use of various types of radiation instruments with which measurements are made. See also dosimeter, survey meter.

DPM. Disintegrations per minute, a measure of radioactivity, literally atoms disintegrating per minute. Difficult to directly compare with roentgens per hour for mixtures of radionuclides.

DTMB. David Taylor Model Basin, Carderock, Maryland (Navy).

dynamic pressure. Air pressure that results from the mass air flow (or wind) behind the shock front of a blast wave.

EG&G. Edgerton, Germeshausen & Grier, Boston, Massachusetts (now EG&G, Inc.). An AEC contractor. Provided timing and firing electronics and technical film coverage.

electromagnetic radiation. Electromagnetic radiations range from X-rays and gamma rays of short wave length (high frequency), through the ultraviolet, visible, and infrared regions, to radar and radio waves of relatively long wavelength.

elliptical approximations. Method of predicting fallout areas. Data received that have the same values are plotted from a vertical slice of the atmosphere. The equal or near-equal conditions are generally found to form a closed path that appears roughly elliptical in shape. The elliptical approximation is the ellipse drawn through these data points having nearly the same values. The ellipse is drawn so that the set of data comes closest to the curve.

EODU. Explosive Ordnance Disposal Unit (Navy).

ETA. Estimated time of arrival.

ETD. Estimated time of departure.

exposure. A measure expressed in roentgens of the ionization produced by gamma rays (or X-rays) in air. The exposure rate is the exposure per unit time (e.g., roentgens per hour). See dose, dose rate, roentgen.

exposure rate contours. Lines joining points which have the same radiation intensity that define a fall-out pattern, represented in terms of roentgens per hour.

F4U. A single-engine Navy fighter developed by Vought-Sikorsky and Chance Vought. Six F4U5N models were used in CASTLE as a fighter element. An additional four earlier models scheduled for salvage were used for unmanned fallout experiments in CASTLE Project 6.4.

F-84G. Single-engine jet fighter developed by Republic Aircraft and used from IVY (1952) through REDWING (1956) as cloud sampler aircraft.

FB-36. Featherweight B-36 bomber; i.e., a B-36 bomber stripped of equipment (such as armament) to increase its performance in a noncombat mode.

fallout. The process or phenomenon of the descent to the Earth's surface of particles contaminated with radioactive material from the radioactive cloud. The term is also applied in a collective sense to the contaminated particulate matter itself. The early (or local) fallout is defined, somewhat arbitrarily, as particles reaching the Earth within 24 hours after a nuclear explosion. The delayed (or worldwide) fallout consists of the smaller particles, which ascend into the upper troposphere and stratosphere and are carried by winds to all parts of the Earth. The delayed fallout is brought to Earth, mainly by rain and snow, over extended periods ranging from months to years.

fathometer. A depth-sounding instrument. The depth of water is measured by noting the time the echo of a sound takes to return from the bottom.

film badges. Used for the indirect measurement of ionizing radiation. Generally contain two or three pieces of film of different radiation sensitivities. They are wrapped in paper (or other thin material) that blocks light but is readily penetrated by gamma rays. The films are developed and the degree of fogging (or blackening) observed is a measure of the gamma-ray exposure, from which the absorbed dose is calculated. Film badges can also measure beta and neutron radiation.

fireball. The luminous sphere of hot gases that forms a few millionths of a second after a nuclear explosion as the result of the absorption by the surrounding medium of the thermal X-rays emitted by the extremely hot (several tens of millions of degrees) device residues. The exterior of the fireball in air is initially sharply defined by the luminous shock front and later by the limits of the hot gases themselves.

fission. The process of the nucleus of a particular heavy element splitting into two nuclei of lighter elements, with the release of substantial amounts of energy. The most important fissionable materials are uranium-235 and plutonium-239; fission is caused by the absorption of neutrons.

fission detectors. Radiation pulse detector of the proportional counter type in which a foil or film of fissionable materials is incorporated to make it respond to neutrons.

fission products. A general term for the complex mixture of substances produced as a result of nuclear fission. A distinction should be made between these and the direct fission products or fission fragments that are formed by the actual splitting of the heavy-element nuclei into nuclei of medium atomic weight. Approximately 80 different fission fragments result from roughly 40 different modes of fission of a given nuclear species (e.g., uranium-235 or plutonium-239). The fission fragments, being radioactive, immediately begin to decay, forming additional (daughter) products, with the result that the complex mixture of fission products so formed contains over 300 different radionuclides of 36 elements.

fixed alpha. Alpha radioactivity that cannot be easily removed as evidenced by no measured change in a swipe of a 100-cm² area.

fluorescence. The emission of light (electromagnetic radiation) by a material as a result of the absorption of energy from radiation. The term may refer to the radiation emitted, as well as to the emission process.

FOPU. Fallout Prediction Unit.

forward area. The PPG and adjoining areas (e.g., Kwajalein).

fusion. The combination of two light nuclei to form a heavier nucleus, with the release of the difference of the nuclear binding energy of the fusion products and the sum of the binding energies of the two light nuclei.

gamma rays. Electromagnetic radiations of high photon energy originating in atomic nuclei and accompanying many nuclear reactions (e.g., fission, radioactivity, and neutron capture). Physically, gamma rays are identical with X-rays of high energy; the only essential difference is that X-rays do not originate from atomic nuclei of high energy. Gamma rays can travel great distances through air and can penetrate considerable thickness of material, although they can neither be seen nor felt by human beings except at very high intensities, which cause an itching and tingling sensation of the skin. They can produce harmful effects even at a long distance from their source (The Effects of Nuclear Weapons, 3rd edition).

Geiger-Mueller counter. A gas discharge pulse counter for ionizing radiation. See also AN/PDR-39 and ion-chamber-type survey meter.

GMT. Greenwich Mean Time.

gray (Gy). A recently introduced ICRP term; 1 Gy equals 100 rad.

ground zero (GZ). The point on the surface of land or water at, or vertically below or above, the center of the burst of a nuclear weapon.

gunk. A viscous commercial preparation that is soluble both in water and petroleum derivatives. It acts as a wetting agent in removing grease and particulate matter from metal and other nonporous surfaces.

H-13. U.S. Army helicopter developed for close support with landing-skid-mounted armament. Used in CASTLE for Enewetak airlift.

H-19. Large utility helicopter manufactured by Sikorsky Aircraft Division of United Aircraft Corporation. Used in CASTLE for Enewetak airlift.

H-hour. Time zero, or time of detonation. When used in connection with planning operations it is the specific hour on which the operation event commences. See D-day.

half-life. The time required for a radioactive material to lose half of its radioactivity due to decay. Each radionuclide has a unique half-life.

HASL, NYKOPO. Atomic Energy Commission's Health and Safety Laboratory, New York Operations Office.

HE. High explosive.

high-altitude burst. Defined, somewhat arbitrarily, as a detonation in or above the stratosphere. The distribution of the energy of the explosion between blast and thermal radiation changes appreciably with increasing altitude.

HMNZS. His (Her) Majesty's New Zealand Ship.

HMR. Marine Helicopter Transport Squadron.

hodograph. A common hodograph in meteorology represents the speed and direction of winds at different altitude increments.

hot; hot spot. Commonly used colloquial term meaning a spot or area relatively more radioactive than some adjacent area.

HRS-2. Helicopter manufactured by Sikorsky Aircraft. Used in CASTLE for Bikini airlift.

IBDA. Indirect Bomb Damage Assessment. A revised target analysis based on new data such as actual weapon yield, burst height, and ground zero obtained by means other than direct assessment.

ICRP. International Commission on Radiological Protection.

initial radiation. Also known as prompt radiation. Electromagnetic radiations of high energy emitted from both the fireball and the radioactive cloud within the first minute after a detonation. It includes neutrons and gamma rays given off almost instantaneously, as well as the gamma rays emitted by the fission products and other radioactive species in the rising cloud. Initial radiations from ground or near-ground bursts activate both Earth materials and device debris to create contamination.

inverse square law. The decrease in radiation intensity with distance from a single-point source is inversely proportional to the square of the distance removed.

ion-chamber-type survey meter. A device for measuring the amount of ionizing radiation. Consists of a gas-filled chamber containing two electrodes (one of which may be the chamber wall) between which a potential difference is maintained. The radiation ionizes gas in the chamber and an instrument connected to one electrode measures the ionization current produced.

ionization. The process of adding electrons to, or knocking electrons from, atoms or molecules, thereby creating ions. High temperatures, electrical discharges, and nuclear radiation can cause ionization.

ionizing radiation. Any particulate or electromagnetic radiation capable of producing ions, directly or indirectly, in its passage through matter. Alpha and beta particles produce ion pairs directly, while gamma rays and X-rays liberate electrons as they traverse matter, which in turn produce ionization in their paths.

ionosphere. The region of the atmosphere, extending from roughly 40 to 250 miles (64 to 400 km) above the Earth, in which there is appreciable ionization. The presence of charged particles in this region profoundly affects the propagation of radio and radar waves.

irradiation. Exposure of matter to radiation.

isodose lines. Dose or dose-rate contours. In fallout, contours plotted on a radiation field within which the dose rate or the total accumulated dose is the same.

isotope. Atoms with the same atomic number (same chemical element) but different atomic weight; i.e., the nuclei have the same number of protons but a different number of neutrons.

JCS. Joint Chiefs of Staff.

JTF 7. Joint Task Force 7 and its predecessor, JTF 132, was a combined force of personnel of the Department of Defense (Air Force, Army, Marine Corps, Navy), the AEC, and their contractors. JTF 7 was responsible for all aspects of nuclear weapon tests in the Pacific testing area from 1953 to 1958. The last atmospheric nuclear test in the Pacific was conducted by JTF 8.

KB-29. Aerial refueling version of the B-29.

L-13. Single-engine, 2-place light aircraft used in Enewetak airlift.

kinetic energy. Energy associated with the motion of matter.

LASL. Los Alamos Scientific Laboratory, Los Alamos, New Mexico.

LCM. Landing craft, mechanized.

LCP(L). Landing craft, personnel (large).

LCP(R). Landing craft, personnel (ramp).

LCT. Landing craft, tank.

LCU. Utility landing craft.

LML. Lookout Mountain Laboratory, Hollywood, California (Air Force).

Loran. Long-range navigation system. One Loran station was maintained by the U.S. Coast Guard Station on Enewetak Island.

LSD. Landing ship, dock.

LSIL. Landing ship, infantry (large).

LST. Landing ship, tank.

MATS. Military Air Transport Service; later, Military Airlift Command (joint Air Force).

megaton (energy). Approximately the amount of energy that would be released by the explosion of one million tons of TNT.

microcurie. One-millionth of a curie.

micron. One-millionth of a meter (i.e., 10^{-6} meter or 10^{-4} centimeter); it is roughly four one-hundred-thousandths (4×10^{-5}) of an inch.

milliroentgen. One-thousandth of a roentgen.

MINSY. Mare Island Naval Ship Yard, California.

MPE. Maximum Permissible Exposure (rule dose). That exposure to ionizing radiation that is established by authorities as the maximum over certain periods without resulting in undue risk to human health.

MPL. Maximum Permissible Limit. That amount of radioactive material in air, water, foodstuffs, etc. that is established by authorities as the maximum that would not create undue risk to human health.

mR; mr. Abbreviation for milliroentgen.

MSTS. Military Sea Transportation Service, (Navy).

mushroom cap. Top of the cloud formed from the fireball of a nuclear detonation.

M/V. Motor vessel.

MWB. Motor whale boat.

NAS. Naval Air Station.

NAU. Naval Administrative Unit, Sandia Base, New Mexico.

NavMed. Naval Medical School, Bethesda, Maryland.

NBS. National Bureau of Standards.

NCO. Noncommissioned officer.

NCRP. National Committee on Radiation Protection and Measurements. Before 1956 simply the National Committee on Radiation Protection.

NEL. Naval Electronics Laboratory.

neutron. A neutral elementary particle (i.e., with neutral electrical charge) of approximately unit mass (i.e., the mass of a proton) that is present in all atomic nuclei, except those of ordinary (light) hydrogen. Neutrons are required to initiate the fission process, and large numbers of neutrons are produced by both fission and fusion reactions in nuclear explosions.

neutron flux. The intensity of neutron radiation. It is expressed as the number of neutrons passing through 1 cm² in 1 second.

NM&DSO. Navy Medical and Dental Supply Office, Brooklyn Navy Yard, New York.

NPG. Nevada Proving Ground, now the Nevada Test Site (NTS).

NRDL. Naval Radiological Defense Laboratory.

NRL. Naval Research Laboratory.

NRS TI. Naval Receiving Station, Treasure Island, California.

NSC TI. Naval Schools Command, Treasure Island, California.

NTPR. Nuclear Test Personnel Review.

NTS. Nevada Test Site.

NUCCS. Naval Unit, Chemical Corps School, Ft. McClellan, Alabama.

nuclear cloud. See radioactive cloud.

nuclear device (or weapon or bomb). Any device in which the explosion results from the energy released by reactions involving atomic nuclei, either fission or fusion, or both. Thus, the A- (or atomic) bomb and the H- (or hydrogen) bomb are both nuclear weapons. It would be equally true to call them atomic weapons, since the energy of atomic nuclei is involved in each case. However, it has become more or less customary, although it is not strictly accurate, to refer to weapons in which all the energy results from fission as A-bombs. In order to make a distinction, those weapons in which part of the

energy results from thermonuclear (fusion) reactions of the isotopes of hydrogen have been called H-bombs or hydrogen bombs.

nuclear explosion. Explosive release of energy due to the splitting, or joining, of atoms. The explosion is observable by a violent emission of ultraviolet, visible, and infrared (heat) radiation, gamma rays, neutrons, and other particles. This is accompanied by the formation of a fireball. A large part of the energy from the explosion is emitted as blast and shock waves when detonated at the Earth's surface or in the atmosphere. The fireball produces a mushroom-shaped mass of hot gases and debris, the top of which rises rapidly. See also radiation, gamma rays, fireball, nuclear weapon, fission, fusion, blast.

nuclear fusion. See thermonuclear fusion.

nuclear radiation. Particulate and electromagnetic radiation emitted from atomic nuclei in various nuclear processes. The important nuclear radiations, from the weapons standpoint, are alpha and beta particles, gamma rays, and neutrons. All nuclear radiations are ionizing radiations, but the reverse is not true; X-rays, for example, are included among ionizing radiations, but they are not nuclear radiations since they do not originate from atomic nuclei.

nuclear tests. Tests carried out to supply information required for the design and improvement of nuclear weapons and to study the phenomena and effects associated with nuclear explosions.

nuclide. Any species of atom that exists for a measurable length of time. The term nuclide is used to describe any atomic species distinguished by the composition of its nucleus; i.e., by the number of protons and the number of neutrons. Isotopes of a given element are nuclides having the normal number of protons but different numbers of neutrons in this nuclei. A radionuclide is a radioactive nuclide.

NYKOPO. New York Operations Office (Atomic Energy Commission).

off-scale. Radiation (or other physical phenomena) greater than the capacity of a measuring device to measure.

ONR. Office of Naval Research, Washington, D.C.

OPNAV. Office of the Chief of Naval Operations.

ORNL. Oak Ridge National Laboratory, Tennessee.

oscilloscope. The name generally applied to a cathode-ray device.

overpressure. The transient pressure, usually expressed in pounds per square inch, exceeding the ambient pressure, manifested in the shock (or blast) wave from an explosion.

P2V5 and 6. Twin-engine patrol bomber used for maritime patrol and antisubmarine warfare. Developed by Lockheed for the U.S. Navy. Used in CASTLE as controller and transient ship search.

P4Y2. Four-engine patrol bomber developed by Consolidated from the Air Force B-24 for the U.S. Navy. Used in CASTLE as a telemetry receiver for Project 1.4.

PBM5A. Twin-engine, patrol-bomber flying boat, developed by Martin for the U.S. Navy. Used in CASTLE for airlift.

PC. Patrol craft.

peak overpressure. The maximum value of the overpressure (which see) at a given location.

permissible contamination or dose. That dose of ionizing radiation that is not expected to cause appreciable bodily injury to a person at any time during his lifetime.

phantom. A volume of material closely approximating the density and effective atomic number of tissue. The phantom absorbs ionizing radiation in the same manner as tissue, thus radiation dose measurements made within the phantom provide a means of approximating the radiation dose within a human or animal body under similar exposure conditions. Materials commonly used for phantoms are water, masonite, pressed wood, and beeswax.

piq. A heavily shielded container (usually lead) used to ship or store radioactive materials.

POL. Petroleum, oil, and lubricants. The storage area for these products is referred to as a POL farm.

POMAR. Position operational, meteorological aircraft report.

PPG. Pacific Proving Ground (after 1956 designated the Eniwetok Proving Ground, or EPG).

prompt radiation. See initial radiation.

Purple conditions. A shipboard warning system used in radiological defense. Various numbered conditions were sounded when radioactive fallout was encountered. Responses to the sounded warnings included closing of various hatches and fittings, turning off parts of the ventilation system, and removing personnel from a ship's open decks. The higher the Purple condition number, the more severe the radiological situation.

"Q"-clearance. A security clearance granted by the Atomic Energy Commission, based upon an investigation conducted by the FBI.

R; r. Symbol for roentgen.

Ra. Chemical symbol for radium.

rad. Radiation absorbed dose. A unit of absorbed dose of radiation; it represents the absorption of 100 ergs of ionizing radiation per gram (or 0.01 J/kg) of absorbing material, such as body tissue. This unit is presently being replaced in scientific literature by the Gray (Gy), numerical equal to the absorption of 1 joule of energy per kilogram of matter.

RadDefense. Radiological defense. Defense against the effects of radioactivity from atomic weapons. It includes the detection and measurement of radioactivity, the protection of persons from radioactivity, and decontamination of areas, places, and equipment. See also radsafe.

radex area. Radiological exclusion area. Following each detonation there were areas of surface radiological contamination and areas of air radiological contamination. These areas were designated as radex areas. Radex areas were used to chart actual or predicted fallout and also used for control of entry and exit.

radiation. The emission of any rays, electromagnetic waves, or particles (e.g., gamma rays, alpha particles, beta particles, neutrons) from a source.

radiation decay. See decay (radioactive).

radiation detectors. Any of a wide variety of materials or instruments that provide a signal when stimulated by the passage of ionizing radiation; the sensitive element in radiation detection instruments. The most widely used media for the detection of ionizing radiation are photographic film and ionization of gases in detectors (e.g., Geiger counters), followed by materials in which radiation induces scintillation.

radiation exposure. Exposure to radiation may be described and modified by a number of terms. The type of radiation is important: alpha and beta particles, neutrons, gamma rays and X-rays, and cosmic radiation. Radiation exposure may be from an external radiation source, such as gamma rays, X-rays, or neutrons, or it may be from radionuclides retained within the body emitting alpha, beta, or gamma radiation. The exposure may result from penetrating or nonpenetrating radiation in relation to its ability to enter and pass through matter -- alpha and beta particles being considered as nonpenetrating and other types of radiation as penetrating. Exposure may be related to a part of the body or to the whole body. See also whole body irradiation.

radiation intensity. Degree of radiation. Measured and reported in roentgens (R), rads, rems, and rep, multiples and divisions of these units, and multiples and divisions of these units as a function of exposure rate (per hour, day, etc.).

radioactive (or nuclear) cloud. An all-inclusive term for the cloud of hot gases, smoke, dust, and other particulate matter from the weapon itself and from the environment, which is carried aloft in conjunction with the rising fireball produced by the detonation of a nuclear weapon.

radioactive nuclide. See radionuclide.

radioactive particles. See radioactivity.

radioactive pool. A disk-like pool of radioactive water near the surface formed by a water-surface or sub-surface detonation. The pool gradually expands into an annular form, then reverts to a larger irregular disk shape at later times with a corresponding attenuation of radioactivity. Pools formed by CASTLE shots over water contained radioactive Earth particulates as well as other radioactive materials because of the shallowness of the water.

radioactivity. The spontaneous emission of radiation, generally alpha or beta particles, often accompanied by gamma rays, from the nuclei of an (unstable) nuclide. As a result of this emission the radioactive nuclide is converted (decays) into the isotope of a different (daughter) element, which may (or may not) also be radioactive. Ultimately, as a result of one or more stages of radioactive decay, a stable (nonradioactive) end product is formed.

radiological survey. The directed effort to determine the distribution and dose rate of radiation in an area.

radionuclide. A radioactive nuclide (or radioactive atomic species).

radiosonde. A balloon-borne instrument for the simultaneous measurement and transmission of meteorological data, consisting of transducers for the measurement of pressure, temperature, and humidity; a modulator for the conversion of the output of the transducers to a quantity that controls a property of the radiofrequency signal; a selector switch, which determines the sequence in which the parameters are to be transmitted; and a transmitter, which generates the radiofrequency carrier.

radiosonde balloon. A balloon used to carry a radiosonde aloft. These balloons have daytime bursting altitudes of about 80,000 feet (25 km) above sea level. The balloon measures about 5 feet (1.5 meters) in diameter when first inflated and may expand to 20 feet (6 meters) or more before bursting at high altitude.

radium. A radioactive element with the atomic number 88 and an atomic weight of 226. In nature, radium is found associated with uranium, which decays to radium by a series of alpha and beta emissions. Radium is used as a radiation source for instrument calibration.

radops. Radiological safety operations.

radsafe. Radiological safety. General term used to cover the training, operations, and equipment used to protect personnel from potential overexposures to nuclear radiation during nuclear tests.

RAF. Royal Air Force (Britain).

rainout. Removal of radioactive particles from a nuclear cloud by rain.

rawin. Radar wind sounding tests that determine the winds aloft patterns by radar observation of a balloon.

rawinsonde. Radar wind sounding and radiosonde (combined).

Raydist. A Norfolk, Virginia firm called Raydist Navigation Corporation that provided navigational aid service for test aircraft in the Bikini area during CASTLE. Also the equipment made by this firm.

Raydist slave stations. Support instrumentation used in the positioning of experimental effects aircraft.

RB-29. Reconnaissance version of the B-29.

RB-36. Reconnaissance version of the B-36.

RBE. Relative biological effectiveness. A factor used to compare the biological effectiveness of absorbed radiation doses (i.e., rads) due to different types of ionizing radiation. For radiation protection the term has been superseded by Quality Factor.

reefer. Slang for refrigerator.

rem. A special unit of biological radiation dose equivalent; the name is derived from the initial letters of the term "roentgen equivalent man (or mammal)." The number of rems of radiation is equal to the number of rads absorbed multiplied by the RBE of the given radiation (for a specified effect). The rem is also the unit of dose equivalent, which is equal to the product of the number of rads absorbed multiplied by the "quality factor" and distribution factor for the radiation. The unit is presently being replaced by the sievert (Sv).

rep. An obsolete special unit of absorbed dose.

residual nuclear radiation. Nuclear radiation, chiefly beta particles and gamma rays, that persists for a time following a nuclear explosion. The radiation is emitted mainly by the fission products and other bomb residues in the fallout, and to some extent by Earth and water constituents, and other materials, in which radioactivity has been induced by the capture of neutrons.

R-hour. Reentry hour.

roentgen. (R; r) A special unit of exposure to gamma (or X-) radiation. It is defined precisely as the quantity of gamma (or X-) rays that will produce electrons (in ion pairs) with a total charge of 2.58×10^{-4} coulomb in 1 kilogram of dry air under standard conditions. An exposure of 1 roentgen results in the deposition of about 94 ergs of energy in 1 gram of soft body tissue. Hence, an exposure of 1 roentgen is approximately equivalent to an absorbed dose of 1 rad in soft tissue.

RSSU. Radiological Safety Support Unit (Army).

RTTY. Radio teletype.

SA-16. Air Force general purpose amphibian for air-sea rescue work. Manufactured by Grumman Aircraft Engineering Corporation, New York. Redesignated UY-16. Used in CASTLE for search and rescue.

SAC. Strategic Air Command (Air Force).

sampler aircraft. Aircraft used for collection of gaseous and particulate samples from nuclear clouds to determine the level of radioactivity or the presence of radioactive substances.

SC. Sandia Corporation, Albuquerque, New Mexico.

scattering. The diversion of radiation (thermal, electromagnetic and nuclear) from its original path as a result of interactions (or collisions) with atoms, molecules, or larger particles in the atmosphere or other media between the source of the radiations (e.g., a nuclear explosion) and a point some distance away. As a result of scattering, radiations (especially gamma rays and neutrons) will be received at such a point from many directions instead of only from the direction of the source. See also skyshine.

SCEL. Signal Corps Engineering Laboratories, Ft. Monmouth, New Jersey (Army).

scintillation. A flash of light produced by ionizing radiation in a fluor or a phosphor, which may be crystal, plastic, gas, or liquid.

shear (wind). Refers to differences in direction (directional shear) of wind at different altitudes.

shielding. Any material or obstruction that absorbs (or attenuates) radiation and thus tends to protect personnel or equipment from the effects of a nuclear explosion. A moderately thick layer of any opaque material will provide satisfactory shielding from thermal radiation, but a considerable thickness of material of high density may be needed for gamma radiation shielding. See also attenuation.

shock. Term used to describe a destructive force moving in air, water, or Earth caused by detonation of a nuclear detonation.

shock wave. A continuously propagated pressure pulse (or wave) in the surrounding medium, which may be air, water, or Earth, initiated by the expansion of the hot gases produced in an explosion.

sievert (Sv). A recently introduced ICRP measure of "dose equivalent" that takes into account the "quality factor" of different sources of ionizing radiation. One sievert equals 100 rem.

SIO. Scripps Institution of Oceanography, La Jolla, California.

skyshine. Radiation, particularly gamma rays from a nuclear detonation, reaching a target from many directions as a result of scattering by the oxygen and nitrogen in the intervening atmosphere.

slant range. The straight-line distance of an aircraft at any altitude from ground zero or the distance from an airburst to a location on the ground.

SRI. Stanford Research Institute, Stanford, California.

stratosphere. Upper portion of the atmosphere, approximately 7 to 40 miles (11 to 64 km) above the Earth's surface, in which temperature changes but little with altitude and cloud formations are rare.

surface burst. A nuclear explosion on the land surface, an island surface or reef, or on a barge.

surface zero. See ground zero. Also the location on the ground surface directly above an underground zero point.

survey meters. Portable radiation detection instruments especially adapted for surveying or inspecting an area to establish the existence and amount of radiation present, usually from the standpoint of radiological protection. Survey instruments are customarily powered by self-contained batteries and are designed to respond quickly and to indicate directly the exposure rate conditions at the point of interest. See AN/PDR-36, Geiger-Mueller counter, and ion-chamber-type survey meter.

survey, radiation. Evaluation of the radiation hazards associated with radioactive materials.

"sweet-sour". Aerial survey radsafe reports made during the test series; connotes uncontaminated (sweet) or contaminated (sour) aerological conditions.

SWU-NAS, S.D. Special Weapons Unit, Naval Air Station, San Diego, California.

T-AP. Personnel transport (Military Sea Transportation Service).

TAU. Test Aircraft Unit.

TDY. Temporary duty assignment.

TE. Task Element.

thermal radiation. Electromagnetic radiation emitted in two pulses from a surface or airburst from the fireball as a consequence of its very high temperature; it consists essentially of ultraviolet, visible, and infrared radiation. In the first pulse, when the temperature of the fireball is extremely high, ultraviolet radiation predominates; in the second pulse, the temperatures are lower and most of the thermal radiation lies in the visible and infrared regions of the spectrum.

thermonuclear fusion. Refers to the processes in which very high temperatures are used to bring about the fusion of light nuclei, such as those of the hydrogen isotopes (deuterium and tritium), with the accompanying liberation of energy. The high temperatures required to initiate the fusion reaction are obtained by means of a fission explosion. See also fusion.

TNT equivalent. A measure of the energy released as the result of the detonation of a nuclear device or weapon, expressed in terms of the mass of TNT that would release the same amount of energy when exploded. The TNT equivalent is usually stated in kilotons (1,000 tons) or megatons (1 million tons). The basis of the TNT equivalence is that the explosion of 1 ton of TNT is assumed to release 1 billion calories of energy. See also megaton, yield.

tropopause. The boundary dividing the stratosphere from the lower part of the atmosphere, the troposphere. The tropopause normally occurs at an altitude of about 25,000 to 45,000 feet (7.6 to 13.7 km) in polar and temperate zones, and at 55,000 feet (16.8 km) in the tropics. See also stratosphere, troposphere.

troposphere. The region of the atmosphere, immediately above the Earth's surface and up to the tropopause, in which the temperature falls fairly regularly with increasing altitude, clouds form, convection is active, and mixing is continuous and more or less complete.

Trust Territories. The Marshall Islands were Trust Territories under the jurisdiction of the United Nations. Assigned by the United Nations to the United States in trust for administration, development, and training.

TU. Task Unit.

TSU. Test Services Unit.

TSUP. Test Support Unit Provisional.

TSuU. Test Support Unit.

TWX. Pronounced "twix"; teletypewriter exchange.

type commander. The officer or agency having cognizance over all Navy ships of a given type. This is in addition to the particular ship's assignment in a task force or fleet.

UCLA. University of California, Los Angeles.

UCRL. University of California Radiation Laboratory, Livermore, California.

UF-1. The Navy designation for the SA-16A. Used in CASTLE for weather, island resupply, and VIP aircraft.

UHF. Ultra-high frequency.

UK. United Kingdom.

ultraviolet. Electromagnetic radiation of wavelengths between the shortest visible violet (about 3,850 angstroms) and soft X-rays (about 100 angstroms).

USFS. U.S. Forest Service.

USNS. United States Navy Ship; vessels of this designation are manned by civilian crews.

USTEF. Underwater Sound Transmission Experimental Facilities.

VC. Fleet composite squadron (formerly VU).

Versene. A detergent.

Viking. Radio call sign of VIP aircraft.

VP-29. Kwajalein-based naval patrol squadron that flew security sweeps in P2V-6 aircraft during CASTLE.

VR-7. Naval air transport squadron.

VW-1. Airborne early warning squadron. Used for aerial monitoring of radiation during CASTLE.

WADC. Wright Air Development Center, Wright-Patterson AFB, Ohio (Air Force).

WB-29. Weather reconnaissance version of B-29 used for cloud tracking and sampling.

WB-36. Weather reconnaissance version of B-36.

weapon debris. The radioactive residue of a nuclear device after it has been detonated, consisting of fission products, various products of neutron capture, weapon casing and other components, and uranium or plutonium that has escaped fission.

whole body irradiation. Exposure of the body to ionizing radiation from external radiation sources. Critical organs for the whole body are the lens of the eye, the gonads, and the red-blood-forming marrow. As little as only 1 cm³ of bone marrow constitutes a whole-body exposure. Thus, the entire body need not be exposed to be classed as a whole-body exposure.

Wilson. Radio call sign for WB-29 cloud tracker aircraft.

Wilson cloud. A mist or fog of minute water droplets that temporarily surrounds a fireball following a nuclear detonation in a humid atmosphere. This is caused by a sudden lowering of the pressure (and temperature) after the passing of the shock wave and quickly dissipates as temperatures and pressures return to normal.

worldwide fallout. Consists of the smaller radioactive nuclear detonation particles that ascend into the upper troposphere and the stratosphere and are carried by winds to all parts of the Earth. The delayed (or worldwide) fallout is brought to Earth, mainly by rain and snow, over extended periods ranging from months to years.

WREP. Weather Reporting Element Provisional.

WT. Prefix of Weapon Test (WT) report identification numbers. These reports were prepared to record the results of scientific experiments.

YAG. Miscellaneous auxiliary ship (Navy).

YC. Open lighter (nonself-propelled; Navy).

YFN. Covered lighter (nonself-propelled; Navy).

yield. The total effective energy released in a nuclear detonation. It is usually expressed in terms of the equivalent tonnage of TNT required to produce the same energy release in an explosion. The total energy yield is manifested as nuclear radiation (including residual radiation), thermal radiation, and blast and shock energy, the actual distribution depending upon the medium in which the explosion occurs and also upon the type of weapon. See TNT equivalent.

yield (blast). That portion of the total energy of a nuclear detonation that is identified as the blast or shock wave.

yield (fission). That portion of the total explosive yield attributable to nuclear fission, as opposed to fusion. The interest in fission yield stems from the interest in fission product formation and its relationship to radioactive fallout.

YO. Fuel oil barge; self-propelled.

YOG. Gasoline barge; self-propelled.

YOGN. Gasoline barge; nonself-propelled.

ZI. Zone of Interior (conterminous United States).

INDEX OF UNITS

Conversion Factors -- U.S. to Metric (SI) Units

To Convert from	To	Multiply by
angstrom	meters (m)	1.000 000 x E -10
atmosphere (normal)	kilopascal (kPa)	1.013 25 x E +2
bar	kilopascal (kPa)	1.000 000 x E +2
barn	meter ² (m ²)	1.000 000 x E -28
British thermal unit (thermochemical)	joule (J)	1.054 350 x E +3
cal (thermochemical)/cm ²	megajoule/m ² (MJ/m ²)	4.184 000 x E -2
calorie (thermochemical)	joule (J)	4.184 000
calorie (thermochemical)/g	joule per kilogram (J/kg)*	4.184 000 x E +3
curie	gigabecquerel (GBq) [†]	3.7000 000 x E +1
degree Celsius [§]	degree kelvin (K)	$t_k = t_C^0 + 273.15$
degree (angle)	radian (rad)	1.745 329 x E -2
degree Fahrenheit	degree kelvin (K)	$t = (t_F^0 + 459.67)/1.8$
electron volt	joule (J)	1.602 19 x E -19
erg	joule (J)	1.000 000 x E -7
erg/second	watt (W)	1.000 000 x E -7
foot	meter (m)	3.048 000 x E -1
foot-pound-force	joule (J)	1.355 818
gallon (U.S. liquid)	meter ³ (m ³)	3.785 412 x E -3
inch	meter (m)	2.540 000 x E -2
jerk	joule (J)	1.000 000 x E +9
joule/kilogram (J/kg) (radiation dose absorbed)	gray (Gy)*	1.000 000
kilotons	terajoules (TJ)	4.183

* The gray (Gy) is the accepted SI unit equivalent to the energy imparted by ionizing radiation to a mass of energy corresponding to one joule/kilogram.

† The becquerel (Bq) is the SI unit of radioactivity; 1 Bq = 1 disintegration/s.

§ Temperature may be reported in degrees Celsius as well as degrees kelvin.

Conversion Factors (continued)

To Convert from	To	Multiply by
kip (1000 lbf)	newton (N)	4.448 222 x E +3
ktap	newton-second/m ² (N•s/m ²)	1.000 000 x E +2
micron	meter (m)	1.000 000 x E -6
mil	meter (m)	2.540 000 x E -5
mile (international)	meter (m)	1.609 344 x E +3
ounce	kilogram (kg)	2.834 952 x E -2
pound-force (lbf avoirdupois)	newton (N)	4.448 222
pound-force inch	newton-meter (N•m)	1.129 848 x E -1
pound-force/inch	newton/meter (N/m)	1.751 268 x E +2
pound-force/foot ²	kilopascal (kPa)	4.788 026 x E -2
pound-force/inch ² (psi)	kilopascal (kPa)	6.894 757
pound-mass (lbm avoirdupois)	kilogram (kg)	4.535 924 x E -1
pound-mass-foot ² (moment of inertia)	kilogram-meter ² (kg•m ²)	4.214 011 x E -2
pound-mass/foot ³	kilogram-meter ³ (kg•m ³)	1.601 846 x E +1
rad (radiation dose absorbed)	gray (Gy)	1.000 000 x E -2
rem	sievert (Sv)*	1.000 --- x E -2
roentgen	coulomb/kilogram (C/kg)	2.579 760 x E -4
shake	second (s)	1.000 000 x E -8
slug	kilogram (kg)	1.459 390 x E +1
torr (mm Hg, 0°C)	kilopascal (kPa)	1.333 22 x E -1

* The sievert (Sv) is the SI unit of measure for "dose equivalent" that takes into account the quality factor of different sources of ionizing radiation; 1 Sv = 100 rem

Commonly Used Nuclear Energy Units and Abbreviations

Basic Unit	Measured Property	Prefixes and Numerical Values					
		Pico 10^{-12}	Micro 10^{-6}	Milli 10^{-3}	1	Kilo 10^3	Mega 10^4
barn	cross section		μb	mb	b		
curie	radioactivity	$\mu\mu\text{Ci};$ $\mu\mu\text{c}$	$\mu\text{Ci};$ μc	$\text{mCi};$ mc	$\text{Ci};$ c	$\text{kCi};$ kc	MCi Mc
dose rate	radiation dose			$\text{mR/hr};$ mr/hr	$\text{R/hr};$ $\text{r/hr},$ rem/hr		
electron volt	energy				eV	keV	MeV
gram	mass	μg	μg	mg	g	kg	
meter	length			mm	m	km	
rad (radiation absorbed dose)	radiation		μrad	mrad	rad		
roentgen	radiation dose		$\mu\text{R};$ μr	$\text{mR};$ mr	$\text{R};$ r		
rem (roentgen equivalent man)	radiation dose		μrem	mrem	rem		
rep (roentgen equivalent physical)	radiation dose		μrep	mrep	rep		
second	time		μs	ms	s		
ton (TNT equivalent)	device energy					KT	MT
watt	power	$\mu\mu\text{w}$	μw	mw	w	kw	Mw

APPENDIX C
ISLAND SYNONYMS

CAPITALIZED entries are the code names used by the joint task force for the islands. Underscored entries are the names of the islands as used in this report. All other entries are spellings of the islands that may appear in other literature.

Aaraanbiru	VERA - <u>Alembel</u> - Arambiru (Enewetak Atoll)
ABLE	<u>Bokbata</u> - Bokobyada (Bikini Atoll)
<u>Adrikan</u>	YOKE - Arriikan (Bikini Atoll)
<u>Aej</u>	OLIVE - Aitsu (Enewetak Atoll)
<u>Aerokoj</u>	OBOE - Airukiiji (Bikini Atoll)
<u>Aerokojlol</u>	PETER - Airukiraru (Bikini Atoll)
Airukiiji	OBOE - <u>Aerokoj</u> (Bikini Atoll)
Airukiraru	PETER - <u>Aerokojlol</u> (Bikini Atoll)
Aitsu	OLIVE - <u>Aej</u> (Enewetak Atoll)
<u>Alembel</u>	VERA - Aaraanbiru - Arambiru (Enewetak Atoll)
ALFA	<u>Bokaetoktok</u> - Bokaetokutoku (Bikini Atoll)
ALICE	<u>Bokoluo</u> - Bogallua (Enewetak Atoll)
ALVIN	<u>Jinedrol</u> - Chinieero (Enewetak Atoll)
<u>Ananij</u>	BRUCE - Aniyaanii (Enewetak Atoll)
Anerowij	TOM - <u>Munjor</u> - Munjur (Enewetak Atoll)
Aniyaanii	BRUCE - <u>Ananij</u> (Enewetak Atoll)
<u>Aomen</u>	GEORGE - Aomoen (Bikini Atoll)
Aomoen	GEORGE - <u>Aomen</u> (Bikini Atoll)
<u>Aomon</u>	SALLY (Enewetak Atoll)
Arambiru	VERA - <u>Alembel</u> - Aaraanbiru (Enewetak Atoll)
Arriikan	YOKE - <u>Adrikan</u> (Bikini Atoll)
BAKER	<u>Bokonejien</u> (Bikini Atoll)
BELLE	<u>Bokombako</u> - Bogombogo (Enewetak Atoll)
Bigiren	ROGER - <u>Bikdrin</u> (Bikini Atoll)
Biijiri	TILDA - <u>Bijire</u> - Bijile - Bikile (Enewetak Atoll)
Bijile	TILDA - <u>Bijire</u> - Biijiri - Bikile (Enewetak Atoll)
<u>Bijire</u>	TILDA - <u>Bijile</u> - Biijiri - Bikile (Enewetak Atoll)
<u>Bikdrin</u>	ROGER - Bigiren (Bikini Atoll)
<u>Biken</u>	LEROY - Rigile - Rigili (Enewetak Atoll)
Bikile	TILDA - <u>Bijire</u> - Bijile - Biijiri (Enewetak Atoll)
<u>Bikini</u>	HOW - (Bikini Atoll)
<u>Billae</u>	WILMA - Piirai - Piirai (Enewetak Atoll)
Billee	LUCY - <u>Kidringen</u> - Kirinian (Enewetak Atoll)
Bogairikk	HELEN - <u>Bokaidrikdrik</u> - Bogeirik - Bokaidrik (Enewetak Atoll)
Bogallua	ALICE - <u>Bokoluo</u> (Enewetak Atoll)

Bogan	IRWIN - <u>Boken</u> - Pokon (Enewetak Atoll)
Bogeirik	HELEN - <u>Bokaidrikdrik</u> - Bogairikk - Bokaidrik (Enewetak Atoll)
Bogen	REX - <u>Jedrol</u> - Jieroru (Enewetak Atoll)
Bogombogo	BELLE - <u>Bokombako</u> (Enewetak Atoll)
Bogon	IRENE - <u>Boken</u> (Enewetak Atoll)
<u>Bokaetoktok</u>	ALFA - <u>Bokoaetokutoku</u> (Bikini Atoll)
Bokaidrik	HELEN - <u>Bokaidrikdrik</u> - Bogairikk - Bogeirik (Enewetak Atoll)
<u>Bokaidrikdrik</u>	HELEN - Bogairikk - Bogeirik - Bokaidrik (Enewetak Atoll)
<u>Bokandretok</u>	WALT (Enewetak Atoll)
<u>Bokbata</u>	ABLE - <u>Bokobyaada</u> (Bikini Atoll)
<u>Bokdrolul</u>	BRAVO - <u>Bokororyuru</u> (Bikini Atoll)
<u>Boken</u>	IRENE - Bogon (Enewetak Atoll)
<u>Boken</u>	IRWIN - Pokon - Bogan (Enewetak Atoll)
<u>Bokenelab</u>	MARY - <u>Bokonaarappu</u> - <u>Bokonarppu</u> (Enewetak Atoll)
<u>Bokinwotme</u>	EDNA - <u>Sanildefonso</u> (Enewetak Atoll)
<u>Boko</u>	SAM (Enewetak Atoll)
<u>Bokoaetokutoku</u>	ALFA - <u>Bokaetoktok</u> (Bikini Atoll)
<u>Bokobyaada</u>	ABLE - <u>Bokbata</u> (Bikini Atoll)
<u>Bokoluo</u>	ALICE - <u>Bogallua</u> (Enewetak Atoll)
<u>Bokombako</u>	BELLE - <u>Bogombogo</u> (Enewetak Atoll)
<u>Bokonaarappu</u>	MARY - <u>Bokenelab</u> - <u>Bokonarppu</u> (Enewetak Atoll)
<u>Bokonarppu</u>	MARY - <u>Bokenelab</u> - <u>Bokonaarappu</u> (Enewetak Atoll)
<u>Bokonejien</u>	BAKER (Bikini Atoll)
<u>Bokonfuaaku</u>	ITEM (Bikini Atoll)
<u>Bokororyuru</u>	BRAVO - <u>Bokdrolul</u> (Bikini Atoll)
BRAVO	<u>Bokdrolul</u> - <u>Bokororyuru</u> (Bikini Atoll)
BRUCE	<u>Ananij</u> - <u>Aniyaanii</u> (Enewetak Atoll)
Buganegan	HENRY - <u>Mut</u> - Mui (Enewetak Atoll)
CHARLIE	<u>Nam</u> - <u>Namu</u> (Bikini Atoll)
Chieerete	WILLIAM - <u>Jetele</u> (Bikini Atoll)
Chinieero	ALVIN - <u>Jinedrol</u> (Enewetak Atoll)
Chinimi	CLYDE - <u>Jinimi</u> (Enewetak Atoll)
CLARA	<u>Kirunu</u> - <u>Eybbiyae</u> - Ruchi (Enewetak Atoll)
CLYDE	<u>Jinimi</u> - Chinimi (Enewetak Atoll)
<u>Coca</u>	(Bikini Atoll)
Cochita	DAISY - <u>Louj</u> - Lidilbut (Enewetak Atoll)
DAISY	<u>Louj</u> - Cochita - Lidilbut (Enewetak Atoll)
DAVID	<u>Japtan</u> - Muti (Enewetak Atoll)
DOG	<u>Iroj</u> - Yurochi (Bikini Atoll)
<u>Drekatimon</u>	OSCAR (Enewetak Atoll)
<u>Dridrilbwij</u>	GENE - <u>Teiteiripucchi</u> (Enewetak Atoll)
EASY	Uorikku - <u>Odrik</u> (Bikini Atoll)
Eberiru	RUBY - <u>Eleleron</u> (Enewetak Atoll)
EDNA	<u>Bokinwotme</u> - <u>Sanildefonso</u> (Enewetak Atoll)
<u>Eleleron</u>	RUBY - Eberiru (Enewetak Atoll)
<u>Elle</u>	NANCY - Yeiri (Enewetak Atoll)

<u>ELMER</u>	<u>Parry</u> - Medren (Enewetak Atoll)
<u>Elugelab</u>	<u>FLORA</u> - <u>Eluklab</u> (Enewetak Atoll)
<u>Eluklab</u>	<u>FLORA</u> - <u>Elugelab</u> (Enewetak Atoll)
<u>Eneman</u>	<u>TARE</u> - <u>Eninman</u> (Bikini Atoll)
<u>Eneu</u>	<u>NAN</u> - <u>Enyu</u> (Bikini Atoll)
<u>Enewetak</u>	<u>FRED</u> - <u>Eniwetok</u> (Enewetak Atoll)
<u>Engebi</u>	<u>JANET</u> - <u>Enjebi</u> (Enewetak Atoll)
<u>Eniairo</u>	<u>KING</u> (Bikini Atoll)
<u>Enidrik</u>	<u>UNCLE</u> - <u>Eniirikku</u> - (Bikini Atoll)
<u>Eniirikku</u>	<u>UNCLE</u> - <u>Enidrik</u> (Bikini Atoll)
<u>Eninman</u>	<u>TARE</u> - <u>Eneman</u> (Bikini Atoll)
<u>Eniwetok</u>	<u>FRED</u> - <u>Enewetak</u> (Enewetak Atoll)
<u>Enjebi</u>	<u>JANET</u> - <u>Engebi</u> (Enewetak Atoll)
<u>Enyu</u>	<u>NAN</u> - <u>Eneu</u> (Bikini Atoll)
<u>Eybbiyae</u>	<u>CLARA</u> - <u>Kirunu</u> - Ruchi (Enewetak Atoll)
<u>FLORA</u>	<u>Eluklab</u> - <u>Elugelab</u> (Enewetak Atoll)
<u>FOX</u>	<u>Lomilik</u> - <u>Romurikku</u> (Bikini Atoll)
<u>FRED</u>	<u>Enewetak</u> - <u>Eniwetok</u> (Enewetak Atoll)
<u>GENE</u>	<u>Dridrilbwij</u> - <u>Teiteiripucchi</u> (Enewetak Atoll)
<u>GEORGE</u>	<u>Aomen</u> - <u>Aomoen</u> (Bikini Atoll)
<u>Giriinien</u>	<u>KEITH</u> - <u>Kidrenen</u> - <u>Grinem</u> (Enewetak Atoll)
<u>GLENN</u>	<u>Ikuren</u> - <u>Igurin</u> (Enewetak Atoll)
<u>Grinem</u>	<u>KEITH</u> - <u>Kidrenen</u> - <u>Giriinien</u> (Enewetak Atoll)
<u>HELEN</u>	<u>Bokaidrikdrik</u> - <u>Bogairikk</u> - <u>Bogeirik</u> - <u>Bokaidrik</u> (Enewetak Atoll)
<u>HENRY</u>	<u>Mut</u> - <u>Buganegan</u> - <u>Mui</u> (Enewetak Atoll)
<u>HOW</u>	<u>Bikini</u> (Bikini Atoll)
<u>Igurin</u>	<u>GLENN</u> - <u>Ikuren</u> (Enewetak Atoll)
<u>Ikuren</u>	<u>GLENN</u> - <u>Igurin</u> (Enewetak Atoll)
<u>Inedral</u>	<u>URIAH</u> (Enewetak Atoll)
<u>Ionchebi</u>	<u>MIKE</u> (Bikini Atoll)
<u>IRENE</u>	<u>Boken</u> - <u>Bogon</u> (Enewetak Atoll)
<u>Ircij</u>	<u>DOG</u> - <u>Yurochi</u> (Bikini Atoll)
<u>IRWIN</u>	<u>Boken</u> - <u>Bogan</u> - <u>Pokon</u> (Enewetak Atoll)
<u>ITEM</u>	<u>Bokonfuaaku</u> (Bikini Atoll)
<u>JAMES</u>	<u>Ribewon</u> - <u>Libiron</u> - <u>Ribaion</u> (Enewetak Atoll)
<u>JANET</u>	<u>Enjebi</u> - <u>Engebi</u> (Enewetak Atoll)
<u>Japtan</u>	<u>DAVID</u> - <u>Muti</u> (Enewetak Atoll)
<u>Jedrol</u>	<u>REX</u> - <u>Jieroru</u> - <u>Bogen</u> (Enewetak Atoll)
<u>Jelete</u>	<u>WILLIAM</u> - <u>Chieerete</u> (Bikini Atoll)
<u>Jieroru</u>	<u>REX</u> - <u>Jedrol</u> - <u>Bogen</u> (Enewetak Atoll)
<u>JIG</u>	<u>Yomyaran</u> (Bikini Atoll)
<u>Jinedrol</u>	<u>ALVIN</u> - <u>Chinieero</u> (Enewetak Atoll)
<u>Jinimi</u>	<u>CLYDE</u> - <u>Chinimi</u> (Enewetak Atoll)
<u>KATE</u>	<u>Mijikadrek</u> - <u>Mujinkarikku</u> - <u>Muzinbaarikku</u> (Enewetak Atoll)
<u>KEITH</u>	<u>Kidrenen</u> - <u>Giriinien</u> - <u>Grinem</u> (Enewetak Atoll)

<u>Kidrenen</u>	KEITH - Giriinien - Grinem (Enewetak Atoll)
<u>Kidrinen</u>	LUCY - Billee - Kirinian (Enewetak Atoll)
KING	<u>Eniairo</u> (Bikini Atoll)
Kirinian	LUCY - <u>Kidrinen</u> - Billee (Enewetak Atoll)
<u>Kirunu</u>	CLARA - <u>Eybbiyae</u> - Ruchi (Enewetak Atoll)
<u>Lele</u>	SUGAR - Reere (Bikini Atoll)
<u>LEROY</u>	<u>Biken</u> - Rigile - Rigili (Enewetak Atoll)
Libiron	JAMES - <u>Ribewon</u> - Ribaion (Enewetak Atoll)
Lidilbut	DAISY - <u>Louj</u> - Cochita (Enewetak Atoll)
<u>Lojwa</u>	URSULA - <u>Rojoa</u> (Enewetak Atoll)
<u>Lomilik</u>	FOX - Romurikku (Bikini Atoll)
<u>Louj</u>	DAISY - Cochita - Lidilbut (Enewetak Atoll)
LOVE	<u>Rochikarai</u> (Bikini Atoll)
LUCY	<u>Kidrinen</u> - Billee - Kirinian (Enewetak Atoll)
<u>Lujor</u>	PEARL - <u>Rujiyoru</u> - Rujoru (Enewetak Atoll)
<u>Lukoj</u>	VICTOR - Rukoji (Bikini Atoll)
MACK	<u>Unibor</u> (Enewetak Atoll)
MARY	<u>Bokenelab</u> - Bokonaarappu - Bokonarppu (Enewetak Atoll)
Medren	ELMER - <u>Parry</u> (Enewetak Atoll)
<u>Mijikadrek</u>	KATE - <u>Mujinkarikku</u> - Muzinbaarikku (Enewetak Atoll)
MIKE	<u>Ionchebi</u> (Bikini Atoll)
Mui	HENRY - <u>Mut</u> - Buganegan (Enewetak Atoll)
Mujinkarikku	KATE - <u>Mijikadrek</u> - Muzinbaarikku (Enewetak Atoll)
<u>Munjor</u>	TOM - <u>Anerowij</u> - Munjur (Enewetak Atoll)
Munjur	TOM - <u>Munjor</u> - Anerowij (Enewetak Atoll)
<u>Mut</u>	HENRY - Buganegan - Mui (Enewetak Atoll)
Muti	DAVID - <u>Japtan</u> (Enewetak Atoll)
Muzinbaarikku	KATE - <u>Mijikadrek</u> - Mujinkarikku (Enewetak Atoll)
<u>Nam</u>	CHARLIE - <u>Namu</u> (Bikini Atoll)
Namu	CHARLIE - <u>Nam</u> (Bikini Atoll)
NAN	<u>Eneu</u> - Enyu (Bikini Atoll)
NANCY	<u>Elle</u> - Yeiri (Enewetak Atoll)
OBOE	<u>Aerokoj</u> - Airukiiji (Bikini Atoll)
<u>Odrik</u>	EASY - Uorikku (Bikini Atoll)
OLIVE	<u>Aej</u> - Aitsu (Enewetak Atoll)
<u>Oroken</u>	ZEBRA - <u>Ouruken</u> (Bikini Atoll)
OSCAR	<u>Drekatimon</u> (Enewetak Atoll)
Ouruken	ZEBRA - <u>Oroken</u> (Bikini Atoll)
<u>Parry</u>	ELMER - Medren (Enewetak Atoll)
PEARL	<u>Lujor</u> - <u>Rujiyoru</u> - Rujoru (Enewetak Atoll)
PERCY	<u>Taiwel</u> (Enewetak Atoll)
PETER	<u>Aerokojlol</u> - Airukiraru (Bikini Atoll)
Piiraa	WILMA - <u>Billae</u> - Piirai (Enewetak Atoll)
Piirai	WILMA - <u>Billae</u> - Piiraa (Enewetak Atoll)
Pokon	IRWIN - <u>Boken</u> - Bogan (Enewetak Atoll)

Reere	SUGAR - <u>Lele</u> (Bikini Atoll)
REX	<u>Jedrol</u> - Bogen - Jieroru (Enewetak Atoll)
Ribaion	JAMES - <u>Ribewon</u> - Libiron (Enewetak Atoll)
<u>Ribewon</u>	JAMES - Libiron - Ribaion (Enewetak Atoll)
Rigile	LEROY - <u>Biken</u> - Rigili (Enewetak Atoll)
Rigili	LEROY - <u>Biken</u> - Rigile (Enewetak Atoll)
<u>Rochikarai</u>	LOVE (Bikini Atoll)
ROGER	<u>Bikdrin</u> - Bigiren (Bikini Atoll)
Rojoa	URSULA - <u>Lojwa</u> (Enewetak Atoll)
Romurikku	FOX - <u>Lomilik</u> (Bikini Atoll)
RUBY	<u>Eleleron</u> - Eberiru (Enewetak Atoll)
Ruchi	CLARA - <u>Kirunu</u> - Eybbiyae (Enewetak Atoll)
Rujiyoru	PEARL - <u>Lujor</u> - Rojoru (Enewetak Atoll)
Rujoru	PEARL - <u>Lujor</u> - Rujiyoru (Enewetak Atoll)
Rukoji	VICTOR - <u>Lukoj</u> (Bikini Atoll)
<u>Runit</u>	YVONNE (Enewetak Atoll)
SALLY	<u>Aomon</u> (Enewetak Atoll)
SAM	<u>Boko</u> (Enewetak Atoll)
Sanildefonso	EDNA - <u>Bokinwotme</u> (Enewetak Atoll)
SUGAR	<u>Lele</u> - Reere (Bikini Atoll)
<u>Taiwel</u>	PERCY (Enewetak Atoll)
TARE	<u>Eneman</u> - Eninman (Bikini Atoll)
Teiteiripucchi	GENE - <u>Dridrilbwij</u> - (Enewetak Atoll)
TILDA	<u>Bijire</u> - Bijile - Biijiri - Bikile (Enewetak Atoll)
TOM	<u>Munjor</u> - Anerowij - Munjur (Enewetak Atoll)
UNCLE	<u>Enidrik</u> - Eniirikku (Bikini Atoll)
<u>Unibor</u>	MACK (Enewetak Atoll)
Uorikku	EASY - <u>Odrik</u> (Bikini Atoll)
URIAH	<u>Inedrah</u> (Enewetak Atoll)
URSULA	<u>Lojwa</u> - Rojoa (Enewetak Atoll)
VAN	(Enewetak Atoll)
VERA	<u>Alembel</u> - Aaraanbiru - Arambiru (Enewetak Atoll)
VICTOR	<u>Lukoj</u> - Rukoji (Bikini Atoll)
WALT	<u>Bokandretok</u> (Enewetak Atoll)
WILLIAM	<u>Jelete</u> - Chieerate (Bikini Atoll)
WILMA	<u>Billae</u> - Piirai - Piiraa (Enewetak Atoll)
Yeiri	NANCY - <u>Elle</u> (Enewetak Atoll)
YOKE	<u>Adrikan</u> - Arriikan (Bikini Atoll)
<u>Yomyaran</u>	JIG (Bikini Atoll)
Yurochi	DOG - <u>Iroj</u> (Bikini Atoll)
YVONNE	<u>Runit</u> - (Enewetak Atoll)
ZEBRA	<u>Oroken</u> - Ourukaen (Bikini Atoll)

APPENDIX D
INDEX OF PARTICIPATING ORGANIZATIONS

- AACS. See Airways and Air Communications Service.
- AAG&M. See Anti-Aircraft Artillery and Guided Missile School.
- ACC. See Army Chemical Center.
- ACF. See American Car and Foundry.
- AEC. See Atomic Energy Commission.
- AFL U of Wash. See Applied Fisheries Laboratory, University of Washington.
- AFSWC. See Air Force Special Weapons Center.
- AFSWP. See Armed Forces Special Weapon Project.
- AFWL. See Air Force Weapons Laboratory.
- USNS Fred C. Ainsworth (T-AP-181). Operations: 68 (Table 5), 123, 125, 341 (Table 60), 358 (Table 72), 361 (Table 75), 373, 374 (Table 82); Radsafe Activities: 82, 127 (Table 11), 147, 149; Fallout Involvement: 215 (Table 21), 266 (Table 32); Personnel Exposure: 237 (Table 23), 335 (Table 59); Position Data: 207 (Figure 55), 223 (Figure 65), 225 (Figure 66), 257 (Figure 72), 274 (Figure 76), 289 (Figure 82), 303 (Figure 87), 317 (Figure 93).
- Air Defense Hq. See Ent Air Force Base.
- Air Force. 5, 69-71, 384-396. See also entries for individual Air Force units.
- Air Force Headquarters (Hq USAF). 77.
- Air Force Special Weapons Center. Operations: 132, 133, 134, 140, 388, 392 (Table 87), 394; Personnel Exposure: 385 (Table 86), 387 (Table 86), 390.
- Air Force Weapons Laboratory. 6 (archival source for CASTLE data).
- Air University. 387 (Table 86), 395.
- Airways and Air Communications Service. 70, 217, 394. See also 1901st and 1960th AACS.
- Allied Research Associates. 190, 191, 403 (Table 90), 406.
- American Car and Foundry. 56, 385 (Table 86), 390, 403 (Table 90), 405.
- AMS. See Army Map Service.
- Anti-Aircraft Artillery and Guided Missile School (Army). 326 (Table 58), 328.
- USS Apache (ATF-67). Operations: 66 (Table 5), 179, 355, 358 (Table 22), 361 (Table 25); Position Data: 207, 223, 225 (Figure 66); 274, 313 (Table 53); Fallout Involvement: 215 (Table 21), 266; Personnel Exposure: 237 (Table 23), 334 (Table 59).
- Applied Fisheries Laboratory, University of Washington. 188, 403 (Table 90), 405.
- ARA. See Allied Research Associates.
- USS Arequipa (AF-31). 299 (Table 49), 303 (Figure 87); 354 (Table 69), 378.
- Army. 5, 58-60, 325-331. See also entries for individual Army units.
- Army Chemical Center. Radsafe monitors: 88, 89; Experimental Participation: 181, 182, 192, 196, 325; Personnel Exposure: 326 (Table 58).
- Army Chief of Staff. 54 (Figure 11), 99, 255.
- Army Communications Center. 217.
- Department of the Army G-3. 325, 326 (Table 58).
- Army Map Service. 184, 185, 325, 326 (Table 58).
- Armed Forces Special Weapons Project. And JTF 7: 54 (Figure 11); Radsafe Activi-

- ties. 88, 91, 196; Experimental Activity: 168, 193; Personnel Exposure: 336, 337, 400, 401, 402 (Table 90). See also 8541st and 8452nd AAU.
- Atomic Bomb Casualty Commission. 118.
- Atomic Energy Commission. Role in Weapons Development: 1, 2, 5, 25, 31, 53, 55, 248; In JTF 7: 54 (Figure 11), 72; Radsafe Activities: 98, 351; Contractors: 390, 400; Personnel Exposure: 402 (Table 90). See also divisions of the AEC.
- Atomic Energy Commission, Division of Biology and Medicine. 94, 106, 402 (Table 90), 404.
- Atomic Energy Commission, Division of Military Applications. Test Site Administration: 42, 45, 47; Personnel Exposure: 99, 401, 402 (Table 90).
- Atomic Energy Commission, Military Liaison Committee. 54 (Figure 11), 55.
- USS Bairoko (CVE-115). Activities: 61, 63, 64 (Table 5), 71, 80, 85, 114, 156 (Table 13), 249, 340, 347, 349, 350, 356 (Table 70), 363, 367 (Table 78), 379, 397; Radsafe Activities: 81, 82, 121, 126 (Table 10), 127 (Table 11), 128, 147, 149, 150, 161, 224, 262, 292, 306; Personnel Exposure: 4, 98, 124, 214, 215 (Table 21), 237, 245, 334 (Table 59), 351; Position Data: 123, 207 (Figure 55), 210, 223 (Figure 65), 225 (Figure 66), 274 (Figure 76), 289 (Figure 82), 303 (Figure 87), 317 (Figure 93), 342, 343, 345.
- Ballistic Research Laboratories. Experimental Participation: 122, 173, 176, 177, 185; Personnel Exposures: 326 (Table 58), 328, 330, 385; Air Force Personnel in BRL: 390.
- USNS Barrett (T-AP-196). 273 (Table 36).
- Beach Group One (Navy). 67 (Table 5), 335, (Table 59), 368.
- USS Belle Grove (LSD-2). Activities: 67 (Table 5), 68 (Table 5), 123, 124, 221, 262, 306, 345 (Table 64), 346 (Table 65), 359 (Table 73), 366, 367 (Table 78), 372, 373; Personnel Exposures: 237 (Table 23), 243, 335 (Table 59), 368; Fallout Involvement: 215 (Table 21), 266 (Table 32); Position Data: 218, 221, 223 (Figure 66), 257 (Figure 72), 274 (Figure 76), 289 (Figure 82), 303 (Figure 87), 306.
- Bergstrom Air Force Base. 386 (Table 86), 391.
- Biggs Air Force Base. See 97th Bombardment Wing and 341st Bombardment Squadron.
- Boat Pool Detachment, Bikini. 3, 67 (Table 5), 93, 243, 366.
- Boat Pool Detachment, Enewetak (Navy). 67 (Table 5), 69 (Table 6), 237 (Table 23), 372.
- Boat Pool, Task Group 7.2 Enewetak Harbor Unit. 69 (Table 6), 335 (Table 59), 339.
- BRL. See Ballistic Research Laboratory.
- BuMed. See Navy Bureau of Medicine and Surgery.
- BuShips. See Navy Bureau of Ships.
- Cambridge Corporation. 56, 403 (Table 90), 405.
- Camco. See Cambridge Corporation.
- Canadian Atomic Energy Commission. 118.
- Canadian Meteorological Service. 118.
- Carswell Air Force Base. See 7th Bombardment Wing, 9th Bombardment Squadron; 7th Bombardment Wing, 436th Bombardment Squadron; and 11th Bombardment Wing, 36th Bombardment Squadron.
- Chief of Naval Operations. 54 (Figure 11) 333 (Table 59).
- Chief of Staff, U.S. Air Force. 54 (Figure 11).
- CIC Provisional Detachment. 325, 326-327 (Table 58), 331.
- CIC, Task Group 7.4. 386 (Table 86).
- CIC Washington, D.C. 325.
- CID. See 18th Military Police.
- CINCPAC. See Commander-in-Chief, Pacific.
- U.S. Coast Guard. 118, 403 (Table 90), 407.
- USS Cocopa (ATF-101). Activities: 66 (Table 5), 345 (Table 64), 346 (Table 65), 355, 359 (Table 73), 362 (Table 76), 367 (Table 78); Fallout Involvement: 215 (Table 21), 266 (Table 32), 295 (Table

- 46); Personnel Exposure: 237 (Table 23), 334 (Table 59); Position Data: 223 (Figure 65), 225 (Figure 66), 257 (Figure 72), 274 (Figure 76), 289 (Figure 82), 303 (Figure 87), 317 (Figure 93).
- Commander-in-Chief, Pacific. And JTF 7: 2, 53, 54 (Figure 11), 58 (Table 10); Notifications and Advisories: 102, 120, 126 (Table 10), 201, 229, 250, 251, 255, 271, 284, 289; Radsafe Activities: 76, 99, 116; Personnel Exposure: 396.
- CNO. See Chief of Naval Operations.
- Communications Element. See 1950th AACS Squadron, 1960th AACS.
- Cook Research Laboratories. 191, 192, 403 (Table 90), 406.
- Corps of Engineers (Army). 193, 196, 326 (Table 58), 328.
- CRL. See Cook Research Laboratory.
- USS Curtiss (AV-4). Activities: 65 (Table 5), 114, 123, 125, 275, 339, 341 (Table 10), 343 (Table 62), 344 (Table 63), 345 (Table 64), 347, 349, 354 (Table 69), 366 (Table 78), 371 (Table 81), 374 (Table 82); Radsafe Activities: 82, 127 (Table 11); Fallout Involvement: 215 (Table 21), 224; Personnel Exposure: 257 (Table 23), 334 (Table 59), 398 (Table 88); Position Data: 207 (Table 55), 223 (Figure 65), 222 (Figure 66), 257 (Figure 72), 274 (Figure 76), 275, 289 (Figure 82), 303 (Figure 87), 317 (Figure 93).
- Daigo Fukuryu Maru (Japanese vessel). Position Data: 204 (Figure 53), 465-468; Personnel Exposure: 3, 212, 242 (Table 25), 245, 469-470.
- Dai Maru (Japanese vessel). 252 (Table 28).
- David Taylor Model Basin (Navy). 173, 175, 333 (Table 59), 336.
- DBM. See Atomic Energy Commission, Division of Biology and Medicine.
- USS Deliver (ARS-23). 170 (Table 19), 171, 378.
- Department of Justice. 401, 402 (Table 90).
- Division of Biology and Medicine. See Atomic Energy Commission.
- Division of Military Applications. See Atomic Energy Commission.
- DMA. See Atomic Energy Commission, Division of Military Applications.
- Documentary Photo Element, Hamilton Air Force Base. 386 (Table 86).
- Documentary Photo Element, Hickam Air Force Base. 394.
- Documentary Photo Unit, Andrews Air Force Base. 392 (Table 87).
- DTMB. See David Taylor Model Basin.
- Duke University. 403 (Table 90), 406.
- Egerton, Germeshausen and Grier. Activities: 169, 199, 405; Radsafe Activities: 57, 89; Personnel Exposure: 385 (Table 86), 390, 403 (Table 90).
- USS Edmonds (DC-406). 343 (Table 62), 379, 381.
- EG&G. See Egerton, Germeshausen and Grier.
- Ellsworth Air Force Base. See 77th Strategic Reconnaissance Squadron.
- Enewetak, APO-187. 393.
- Ent Air Force Base. 386 (Table 86), 394.
- USS Epperson (DDE-719). Operations: 64 (Table 5), 179, 261, 313, 341 (Table 60), 342 (Table 61), 343 (Table 62), 350 (Table 67); Fallout Involvement: 266 (Table 32); Personnel Exposure: 237 (Table 23), 333 (Table 59); Position Data: 207, 223 (Figure 65), 225 (Figure 66), 257, 274 (Figure 76), 289 (Figure 82), 303 (Figure 87), 317 (Figure 93).
- USS Epping Forest (LSD-4). 313 (Table 53).
- EODU. See Explosive Ordnance Disposal Unit.
- USS Estes (AGC-12). Operations: 56, 62, 63, 66 (Table 5), 70, 113, 123, 124, 202, 220, 226, 249, 272, 306, 339, 341 (Table 60), 344 (Table 63), 345 (Table 64), 353, 354 (Table 69), 372, 374 (Table 82); Radsafe Activities: 82, 85, 98, 126 (Table 10), 131, 193, 213; Fallout Involvement: 215 (Table 21), 266 (Table 32); Personnel Exposure: 237 (Table 23), 334 (Table 59); Position Data: 207 (Figure 55), 223 (Figure 65), 225 (Figure 66), 257, 274 (Figure 76), 289 (Figure 82), 303 (Figure 87), 317 (Figure 93).

Evans Signal Laboratory (Army). 92, 139, 328.

Explosive Ordnance Disposal Unit (Navy). 67 (Table 5), 335 (Table 59), 368.

USNS Faribaut (T-AK-179). 285 (Table 42).

FCDA. See Federal Civil Defense Agency.

Federal Civil Defense Agency. 92, 93, 401, 402 (Table 90).

Fleet Composite Squadron (Navy). Operations: 65 (Table 5), 156 (Table 13), 349, 351; Personnel Exposure: 237 (Table 23), 334 (Table 59).

Fleet Training Center. 92 (Pearl Harbor), 93 (San Diego).

U.S. Forest Service. 185, 403 (Table 90), 404.

USS Genesee (AOG-18), 252 (Table 28), 379.

USS George Eastman. See YAG-39.

USS Granville S. Hall. See YAG-40.

USS Grosse Point (PC-1546). Operations: 64 (Table 5), 234, 285 (Table 42), 340, 345 (Table 64), 346 (Table 65), 349, 359 (Table 73), 366 (Table 78), 371 (Table 81); Fallout Involvement: 215 (Table 21), 290; Personnel Exposure: 237 (Table 23), 334 (Table 59); Position Data: 207 (Figure 55), 225 (Figure 66); 257 (Figure 72), 285 (Table 42).

MV Gunners Knot. 252 (Table 28), 273 (Table 36).

USS Gypsy (ARSD-1). Operations: 66 (Table 5), 345 (Table 64), 355, 356 (Table 70), 359 (Table 73), 367 (Table 78), 382; Fallout Involvement: 213, 215 (Table 21), 221; Personnel Exposure: 237 (Table 23), 334 (Table 59); Position Data: 207 (Figure 55), 223 (Figure 65), 225 (Figure 66).

H&N. See Holmes & Narver, Inc.

Hamilton Air Force Base. See 1901st AACCS Detachment.

Hanford Atomic Power Operation. 47, 188, 385 (Table 86), 390, 402 (Table 90), 404.

USS Hanna (DE-449). 273 (Table 36).

HAPO. See Hanford Atomic Power Operation.

HASL. See New York Operations Office, Health and Safety Laboratory.

Herrick L. Johnson, Inc. 56, 403 (Table 90), 405.

Hickam Air Force Base. See 74th, 49th, 51st Air Transport Squadrons; 57th Strategic Weather Reconnaissance Squadron; Documentary Photo Element; and Hq, TSUP.

HLJ. See Herrick L. Johnson, Inc.

HO. See Hydrographic Office.

Holmes & Narver, Inc. Operations: 42, 45, 67 (Table 5), 72, 73, 123, 157, 175, 184, 366, 373; Radsafe Activities: 89, 157; Personnel Exposure: 339, 403 (Table 90).

HMNZS Hawea (DE-70) (New Zealand vessel). 343 (Table 62), 381.

HMR-362. See Marine Helicopter Transport Squadron 362.

Hq USAF Deputy Chief of Staff for Operations. 384, 385 (Table 86).

Hq TSUP. 386 (Table 86), 394.

Hydrographic Office (Navy). 333 (Table 59), 336.

Interstate Commerce Commission. 131.

JCS. See Joint Chiefs of Staff.

Joint Chiefs of Staff. 54 (Figure 11), 201, 203, 213.

Joint Task Force 132. 43, 53.

KN2483 (Japanese fishing boat). 252 (Table 28).

Kaiko Maru (Japanese vessel). 252 (Table 28).

USS Karin (AF-33). Operations: 379; Position Data: 273 (Table 36), 274 (Figure 76), 342 (Table 61), 354 (Table 69).

Kirtland Air Force Base. See Air Force Special Weapons Center, 4926th Test Squadron, and 4932nd Test Support Squadron.

LASL. See Los Alamos Scientific Laboratory.

LCM-41. 362 (Table 76).

LCM-42. 359 (Table 73), 362 (Table 76).

LCU-292. 367 (Table 78).

LCU-636. 362 (Table 76).

LCU-637. 366, 367 (Table 78).

LCU-638. 366.

LCU-1224. 366.

LCU-1335. 366.

LCU-1348. 184, 366, 367 (Table 78).

LDO, Kwajalein. 400, 402 (Table 90).

USNS Leo (T-AKA-60). Operations: 344 (Table 63), 378, 379; Position Data: 285 (Table 42), 289 (Figure 82), 299 (Table 49), 303 (Figure 87).

LML. See Lookout Mountain Laboratory.

Lookout Mountain Laboratory. 57, 169, 184, 199, 384, 385 (Table 86), 387 (Table 86), 388, 392 (Table 87), 395.

Los Alamos Scientific Laboratory. Operations: 26, 55, 56, 57, 132, 134, 139-140, 166, 167 (Table 18), 198, 201, 247 (Table 27), 330, 390, 401, 404, 407; Radsafe Activities: 47, 87, 89, 106; Personnel Exposure: 336, 337, 338, 402 (Table 90).

LSIL-9035 (French vessel). 252 (Table 28).

LSIL-9309 (French vessel). 252 (Table 28).

LST-551. Operations: 68 (Table 5), 335 (Table 59), 342 (Table 61), 345 (Table 64), 373, 375 (Table 83); Personnel Exposure: 237 (Table 23), 335 (Table 59); Position Data: 207 (Figure 55), 223 (Figure 65), 225 (Figure 66), 257 (Figure 72), 274 (Figure 76), 289 (Figure 82), 303 (Figure 87), 217 (Figure 93).

LST-762. Operations: 68 (Table 5), 373, 376 (Table 84), 379; Radsafe Activities: 380; Fallout Involvement: 306, 380; Personnel Exposure: 237 (Table 23), 335 (Table 59); Position Data: 207 (Figure 55), 223 (Figure 65), 225 (Figure 66), 257 (Figure 72), 274 (Figure 76), 285 (Table 42), 299 (Table 49).

LST-825. 68 (Table 5).

LST-975. Operations: 373, 379; Fallout Involvement: 306, 379; Position Data: 299 (Table 49).

LST-1134. 371 (Table 81).

LST-1146. See USS Summit County.

LST-1157. See USS Terrell County.

Malika (British vessel). 252 (Table 28).

USS Manatee (AO-58). 380.

Mare Island Naval Shipyard. 192, 193, 333 (Table 59), 336.

Marine Corps. 397-398. See also entries under individual Marine Corps units.

Marine Helicopter Transport Squadron 362 (Marine Corps). Operations: 63, 65, 124, 156 (Table 13), 349, 397, 399 (Table 89); Radsafe Activities: 124, 125, 161; Personnel Exposure: 237 (Table 23), 334 (Table 59), 351, 398 (Table 88).

MATS. See Military Air Transport Service.

Maxwell Air Force Base. See Air University.

McClellan Air Force Base. See Team 101, 55th Weather Reconnaissance Squadron.

MDW-HQ. See Military District of Washington.

USS Mender (ARSD-2). Operations: 66, (Table 5), 355, 357 (Table 71), 370 (Table 80), 371 (Table 81); Fallout Involvement: 266 (Table 32), 295 (Table 46); Personnel Exposure: 344 (Table 59); Position Data: 257 (Figure 72), 274 (Figure 76), 289 (Figure 82), 303 (Figure 87).

USS Merapi (AF-38). 380.

USNS Pvt. J.F. Merrell (T-AKV-4). 285 (Table 42), 313 (Table 53).

Military Air Transport Service. 70, 392 (Table 87).

Military District of Washington. 178, 179, 326 (Table 58), 328.

Military Sea Transportation Service. 118, 373.

Mine Project Element (Task Group 7.3). 368.

Mine Project Six (Navy). 67 (Table 5), 335 (Table 59), 337, 368.

MINSY. See Mare Island Naval Shipyard.

USS Mispillion (AO-105). 343 (Table 62), 380, 381.

USS Molala (ATF-106). Operations: 66 (Table 5), 192, 210, 345 (Table 64), 353, 360 (Table 74), 362 (Table 76), 365 (Table 77); Radsafe Activities: 193, 194 (Figure 48), 363; Fallout Involvement: 266 (Table 32); Personnel Exposure: 237 (Table 23), 334 (Table 59); Position Data: 207 (Figure 55), 223 (Figure 65), 225 (Figure 66), 257 (Figure 72), 274 (Figure 76), 289 (Figure 82), 303 (Figure 87), 317 (Figure 93).

USNS General Morton (T-AP-138). 273 (Table 36).

MSTS. See Military Sea Transportation Service.

USS Douglas A. Munro (DDE-442). 223 (Figure 65), 378.

USS Namakagon (AOG-53). 313 (Table 53), 381.

NAS, Alameda. See Naval Air Station, Alameda.

NAS, Kwajalein. See Naval Air Station, Kwajalein.

National Bureau of Standards. 197, 198, 403 (Table 90), 405.

National Committee on Radiation Protection. 95.

NAU. See Naval Administrative Unit.

Nav Schl Cmd. See Naval Schools Command.

Nav Sta N.O. See Naval Station, New Orleans.

Naval Administrative Unit. Operations: 166, 176; Personnel Exposure: 333 (Table 59), 336, 337.

Naval Air Station, Alameda. 156 (Table 13), 193.

Naval Air Station, Kwajalein. Operations: 65 (Table 5), 156, 351, 352, 378, 408; Radsafe Activities: 147, 161, 164, 353; Personnel Exposure: 104, 334 (Table 59).

Naval Air Station, New Orleans. 333 (Table 59), 338.

Naval Air Station, Patuxent River. 156 (Table 13).

U.S. Naval Attache, London. 229.

Naval Electronics Laboratory. 197, 198, 337.

Naval Medical and Dental Supply Office. 333 (Table 59), 337.

Naval Medical Center. 88.

Naval Medical Research Institute. 188.

Naval Medical School. 333 (Table 59), 337.

Naval Ordnance Laboratory. Operations: 169, 172, 173, 175, 390; Personnel Exposure: 333 (Table 59), 337, 385 (Table 86).

Naval Radiological Defense Laboratory. Operations: 88, 179, 183, 191, 192, 216 (Figure 61), 219 (Figure 62); Radsafe Activities: 84; Personnel Exposure: 188, 333 (Table 59), 338.

Naval Receiving Station, Treasure Island. 179, 333 (Table 59), 338.

Naval Research Laboratory. Operations: 166, 173, 178, 179; Personnel Exposure: 333 (Table 59), 338.

Naval Schools Command, Treasure Island. 91, 193, 333 (Table 59), 338.

Naval Supply Activity, Brooklyn. 333 (Table 59), 338.

Naval Unit Chemical Corps School. 192, 193, 333 (Table 59), 339.

USS Navasota (AOG-106). 299 (Table 49), 378, 381.

Navy. 61-68, 332-383. See also entries for individual Navy units.

Navy Bureau of Medicine and Surgery. 94, 98.

Navy Bureau of Ships. Operations: 175, 192, 193, 332; Radsafe Activities: 100, 121; Personnel Exposure: 333 (Table 59), 336.

NBS. See National Bureau of Standards.

NEL. See Naval Electronics Laboratory.

New York Operations Office, Health and Safety Laboratory (AEC). Operations: 77,

- 116, 118, 183, 217, 267, 268 (Table 33), 280, 282 (Table 40), 296, 297 (Table 47), 310-311 (Table 51), 323 (Table 56), 352 (Table 68); Radsafe Activities; 77; Personnel Exposure: 401, 402 (Table 90).
- USS Nicholas (DDE-449). Operations: 65 (Table 5), 188, 233, 234 (Figure 68), 276 (Figure 77), 340, 341 (Table 60), 343 (Table 62), 347, 348 (Table 66), 381; Fallout Involvement: 295 (Table 46), 299; Personnel Exposure: 237 (Table 23), 333 (Table 59); Position Data: 225 (Figure 66), 257 (Figure 72), 274 (Figure 76), 289 (Figure 82), 299, 303 (Figure 87), 317 (Figure 93).
- NM&DSO. See Naval Medical and Dental Supply Office.
- NOL. See Naval Ordnance Laboratory.
- NRDL. See Naval Radiological Defense Laboratory.
- NRL. See Naval Research Laboratory.
- NRS TI. See Naval Receiving Station, Treasure Island.
- NSC TI. See Naval Schools Command, Treasure Island.
- NSC, Washington, D.C. 400, 402 (Table 90).
- NUCCS. See Naval Unit Chemical Corps School.
- NYKOPO. See New York Operations Office, Health and Safety Laboratory.
- Oak Ridge National Laboratory, AEC. Radsafe Activities: 47; Experimental Participation: 178, 179; Operations: 401, 404; Personnel Exposure: 402 (Table 90).
- Office, Chief of Naval Operations, Op 36. 336.
- Office of Chief Signal Officer (Army). 325, 326.
- Office of Naval Research. Experimental Participation: 173, 175, 198; Personnel Exposure: 333 (Table 59), 339.
- Office of the Secretary of Defense. 400, 402 (Table 90).
- ONR. See Office of Naval Research.
- ORNL. See Oak Ridge National Laboratory.
- OSD. See Office of the Secretary of Defense.
- USS Patapsco (AOG-1). Fallout Involvement: 4; Position Data: 218, 230; Radsafe Activities: 232, 240, 242 (Table 25), 382; Operations: 381.
- USNS Gen. M.M. Patrick (T-AP-150). 285 (Table 42).
- Patrol Plane Unit 7.3.3. 340.
- Patrol Squadron 29 (Navy). Operations: 64 (Table 5), 116, 156 (Table 13), 179, 188, 203, 204 (Figure 53), 351, 352 (Table 68), 353, 408; Radsafe Activities: 161, 220, 227; Fallout Involvement: 164, 165 (Table 17), 212, 352; Personnel Exposure: 164, 188, 237 (Table 23), 334 (Table 59).
- PC-1141. 343 (Table 62), 381, 382.
- PC-1145. 343 (Table 62), 381, 382.
- PC-1152. 252 (Table 28).
- PC-1546. See USS Grosse Pointe.
- USS Philip (DDE-498). Operations: 64 (Table 55), 210, 227, 228, 233, 340, 341 (Table 64), 345 (Table 64), 374, 348 (Table 66), 350 (Table 67), 356 (Table 70), 359 (Table 73), 367 (Table 78); Fallout Involvement: 266 (Table 32); Personnel Exposure: 4, 99, 122, 235, 237 (Table 23), 245, 334 (Table 59); Position Data: 207 (Figure 55), 223, 257 (Figure 72), 274 (Figure 76), 289 (Figure 82), 303 (Figure 87), 317 (Figure 93); Experimental Participation: 188.
- PHS. See U.S. Public Health Service.
- Project 1.4 Aircraft (Navy). 237 (Table 23).
- Project 6.4 Aircraft (Navy). 237 (Table 23).
- U.S. Public Health Service. 403 (Table 90), 405.
- Radiological Safety School, San Diego. 93.
- Raydist Navigation Corporation. 184, 185, 403 (Table 90), 406.
- USS Reclaimer (ARS-42). Operations: 67 (Table 5), 187 (Figure 47), 368, 369 (Table 79), 371 (Table 81); Personnel Exposure:

- 335 (Table 59); Experimental Participation: 185, 186; Position Data: 273 (Table 36), 289 (Figure 82), 299 (Table 49).
- USS Renshaw (DDE-499). Operations: 64 (Table 5), 179, 188, 202, 228, 253, 340, 342 (Table 61), 343 (Table 62), 344 (Table 63), 347, 348 (Table 66), 360 (Table 67), 378; Fallout Involvement: 266 (Table 32); Personnel Exposure: 235, 237 (Table 23), 333 (Table 59); Position Data: 207 (Figure 55), 223 (Figure 65), 253, 257, 274 (Figure 76), 289 (Figure 82), 303 (Figure 87), 317 (Figure 93).
- Rongerik Weather Station. 352.
- M/V Roque. 252 (Table 28), 273 (Table 36), 285 (Table 42), 299 (Table 49).
- RSSU. See 1st Radiological Safety Support Unit.
- SAC. See Strategic Air Command.
- SAC Test Detachment. See Strategic Air Command.
- Sacramento Air Material Area. 385 (Table 86), 388.
- Sandia Corporation. Operations: 404; Experimental Participation: 169, 172, 173, 174, 175, 176; Personnel Exposure: 402 (Table 90).
- SC. See Sandia Corporation.
- SCEL. See Signal Corps Engineering Laboratory.
- Scott Air Force Base. 387 (Table 86), 395.
- Scripps Institution of Oceanography. Experimental Participation: 175, 176, 182, 183; Operations: 406, 407; Personnel Exposure: 403 (Table 90).
- USS Shea (DM-30). Operations: 67 (Table 5), 368, 370, 371 (Table 81); Fallout Involvement: 295 (Table 46); Personnel Exposure: 335 (Table 59); Position Data: 274 (Figure 76), 289 (Figure 82), 299 (Table 49); Experimental Participation: 185.
- Signal Corps Engineering Laboratories (Army). Radsafe Activities: 91; Experimental Participation: 177, 178, 197, 198; Personnel Exposure: 326 (Table 58), 328.
- USS Silverstein (DE-534). 381, 382.
- SI0. See Scripps Institution of Oceanography.
- USS Sioux (ATF-75). Operations: 66 (Table 5), 179, 183, 237 (Table 23), 355, 361 (Table 75); Fallout Involvement: 215 (Table 21); Position Data: 207 (Figure 55), 223 (Figure 65), 225 (Figure 66), 257 (Figure 72), 275 (Figure 76), 289 (Figure 82), 303 (Figure 87), 317 (Figure 93); Personnel Exposure: 334 (Table 59).
- SMAMA. See Sacramento Air Material Area.
- Special Weapons Center. See Air Force Special Weapons Center.
- Special Weapons Unit, Naval Air Station, San Diego. 88, 333 (Table 59).
- SRI. See Stanford Research Institute.
- Stanford Research Institute. Experimental Participation: 184, 185; Personnel Exposure: 403 (Table 90), 406.
- Strategic Air Command. Operations: 384, 392 (Table 87); Fallout Involvement: 190; Personnel Exposure: 385 (Table 86), 391.
- Surgeons General of the Army, Navy, and Air Force. 94, 98.
- USS Summit County (LST-1146). Operations: 68 (Table 5), 373, 377 (Table 85); Position Data: 257 (Figure 72), 273.
- SWU-NAS, San Diego. See Special Weapons Unit, Naval Air Station, San Diego.
- USS Tawakoni (ATF-114). Operations: 66 (Table 5), 192, 346 (Table 65), 355, 360 (Table 74), 362 (Table 76), 363, 365; Radsafe Activities: 121; Personnel Exposure: 237 (Table 23), 334 (Table 59); Position Data: 207 (Figure 55), 223 (Figure 65), 225 (Figure 66), 257 (Figure 72), 274 (Figure 76), 289 (Figure 82), 303 (Figure 87); Experimental Participation: 179.
- Team 101 (Air Force). 385 (Table 86), 387 (Table 86), 389, 395.
- USS Terrell County (LST-1157). Operations: 67 (Table 5), 185, 186, 368, 369 (Table 79), 370 (Table 80), 371 (Table 81); Fallout Involvement: 295, (Table 46); Personnel Exposure: 335 (Table 59), 372;

Position Data: 252 (Table 28), 274 (Figure 76), 289 (Figure 82), 303 (Figure 87), 317 (Figure 93).

Texas Instruments. 403 (Table 90), 406.

Tinker Air Force Base. See 6th Weather Squadron.

Travis Air Force Base. See 1960th AACS.

Tripler General Hospital, Honolulu. 3, 188, 368.

Hq, TSUP, Hickam Air Force Base. 386 (Table 86).

UC Berkeley. See University of California, Berkeley.

UCLA. See University of California, Los Angeles.

UCRL. See University of California Radiation Laboratory.

USS Unadilla (ATA-182). 273 (Table 36), 382.

Underwater Detection Unit (Navy). Operations: 69 (Table 6), 372; Radsafe Activities: 93. Personnel Exposure: 237 (Table 23), 335 (Table 59).

University of California. 176.

University of California, Berkeley. 403 (Table 90), 407.

University of California, Los Angeles. 403 (Table 90), 407.

University of California Radiation Laboratory, Livermore. Role in Weapon Development: 26; Operations: 55, 57, 167, 404, 407; Radsafe Activities: 89; Personnel Exposure: 402 (Table 90).

University of Dayton. 190, 191, 403 (Table 90), 407.

University of L. 403 (Table 90), 407.

USCG. See U.S. Coast Guard.

USFS. See U.S. Forest Service.

U.S. Navy, Washington, D.C. 336.

UW Detection Unit. See Underwater Detection Unit.

VC-3. See Fleet Composite Squadron.

VP-29. See Patrol Squadron 29.

VR-7. 334 (Table 59), 373, 382.

VW-1. 166.

WB-29. Operations: 198, 199, 238; Radsafe Activities: 159; Position Data: 253.

WADC. See Wright Aeronautical Development Center.

Wake Island Weather Bureau Station. 272.

Walker Air Force Base. 387 (Table 86), 396.

Walter Reed Hospital, Washington, D.C. (Army). 325, 326 (Table 58).

USS Wandank (ATA-204). 285 (Table 42).

Washington National Airport. See 1298th Air Transport Squadron.

Washington University. 403 (Table 90), 407.

U.S. Weather Bureau. 118.

Weather Central Element. See 6th Weather Squadron.

Weather Reporting Element, Test Support Unit. Operations: 216, 392 (Table 87), 395, 396; Fallout Involvement: 221, 224.

WREP. See Weather Reporting Element.

Wright Aeronautical Development Center. Operations: 155 (Table 13), 392 (Table 87), 396; Fallout Involvement: 190, 191; Personnel Exposure: 385 (Table 86), 389.

Wright Patterson Air Force Base. 387 (Table 86), 392 (Table 87), 396.

YAG-39 (USS George Eastman). Operations: 63, 66 (Table 5), 192, 352, 360 (Table 74), 362 (Table 76), 363, 365 (Table 77), 380; Radsafe Activities: 193, 194, (Figure 49), 195 (Figure 50), 196; Position Data: 223 (Figure 65), 225 (Figure 66), 257 (Figure 72), 274 (Figure 73), 289 (Figure 82), 303 (Figure 87), 317 (Figure 93); Personnel Exposure: 237 (Table 23), 335 (Table 59); Fallout Involvement: 364.

YAG-40 (USS Granville S. Hall). Operations: 63, 66 (Table 5), 192, 196, 345 (Table 64), 351, 360 (Table 74), 363, 365, 380; Radsafe Activities: 193, 194 (Figure 48), 195 (Figure 50); Personnel Exposure: 237 (Table 23), 335 (Table 59),

364, 366; Position Data: 223 (Figure 65), 225 (Figure 66), 257 (Figure 72), 274 (Figure 76), 289 (Figure 82), 303 (Figure 87), 317 (Figure 93).

YC-108. 356 (Table 70).

YC-500. 193.

YC-1081. 359 (Table 73).

YCV-9. 67 (Table 5), 362 (Table 76).

YFN-934. 63, 67 (Table 5), 359 (Table 73), 361 (Table 75), 362 (Table 76), 366.

YFN-935. 362 (Table 76).

YO-120. 67 (Table 5), 372.

YOG-61. 67 (Table 5), 372.

YOGN-53. 356 (Table 70).

YOGN-82. 67 (Table 5), 372.

YOGN-182. 370 (Table 80).

1st Guided Missile Brigade (Army). 326 (Table 58), 329.

1st Naval District. 404.

1st Radiological Safety Support Unit (Army). Operations: 56, 87, 88, 89, 353, Personnel Exposure: 326 (Table 58), 329.

2nd Marine Division. 88.

4th Army Headquarters. 326 (Table 58), 329.

4th Transport Truck Company (Army). 331.

5th Air Base Group (Air Force). 385 (Table 86), 389.

6th Marines. 397, 398 (Table 88).

6th Weather Squadron (Air Force). Operations: 216, 392 (Table 87), 395; Personnel Exposure: 240, 387 (Table 86).

7th Bombardment Wing, 9th Bombardment Squadron (Air Force). 155 (Table 13), 386 (Table 86), 391.

7th Bombardment Wing, 36th Bombardment Squadron (Air Force). 155 (Table 13).

7th Bombardment Wing, 436th Bombardment Squadron (Air Force). 155 (Table 13), 386 (Table 86), 391.

8th Air Force. 392 (Table 87).

11th Bombardment Wing (Air Force). 155 (Table 13), 190, 386 (Table 86).

18th Military Police, Criminal Investigation Detachment (Army). 327 (Table 58), 331.

28th Field Maintenance Squadron (Air Force). 393.

28th Periodic Maintenance Squadron (Air Force). 393.

28th Strategic Reconnaissance Wing (Air Force). 393.

47th Air Transport Squadron. 386 (Table 86), 394.

49th Air Transport Squadron. 386 (Table 86), 394.

50th Air Transport Squadron. 386 (Table 86), 393.

51st Air Transport Squadron. 386 (Table 86), 394.

55th Weather Reconnaissance Squadron (Air Force). 387 (Table 86), 395.

57th Strategic Reconnaissance Squadron (Air Force). 155 (Table 13), 387 (Table 86), 394, 395.

57th Strategic Weather Reconnaissance Squadron (Air Force). 155 (Table 13), 386 (Table 86), 387 (Table 86), 395.

77th Strategic Reconnaissance Squadron (Air Force). 155 (Table 13), 386 (Table 86), 393.

78th Air Rescue Squadron (Air Force). 156 (Table 13).

97th Bombardment Wing (Air Force). Operations: 155 (Table 13), 189, 391; Personnel Exposure: 190, 386 (Table 86).

341st Bombardment Squadron (Air Force). 386 (Table 86), 391.

511th Transport Port Company (Army). 330.

516th Transport Port Company (Army). 331.

531st Anti-Aircraft Artillery Battalion (Army). 326 (Table 58), 329.

1009th Special Weapons Squadron (Air Force). Operations: 144, 197, 198, 199, 389; Personnel Exposure: 385 (Table 86).

1083rd Special Reporting Squadron (Air Force). 173, 385, 389.

1090th Special Reporting Group (Air Force). Operations: 166, 173, 174, 175, 199; Personnel Exposure: 385 (Table 86), 389.

1110th Air Support Detachment, 1110th Group (Air Force). 384, 385 (Table 86).

1146th Special Activities Squadron (Air Force). 166, 385 (Table 86), 390.

1254th Air Transport Group (Air Force). 385 (Table 86), 388.

1289th Air Transport Squadron (Air Force). 387 (Table 86), 396.

1352nd Motion Picture Squadron (Air Force). 57.

1500th Air Transport Squadron (Air Force). 386 (Table 86), 393.

1500-3 Air Base Wing (Air Force). 386 (Table 86), 393.

1901st Airways and Air Communications Service Detachment (Air Force). 386 (Table 86), 394.

1960th AACS (Air Force). 387 (Table 86), 392 (Table 87), 396.

4050th Army Support Unit. 326 (Table 58), 329.

4052nd Army Support Unit. 327 (Table 58), 329.

4054th Staff and Faculty, Dept. of Tactics and Combined Arms (Army). 327 (Table 58), 329.

4925th Test Group (Atomic) (Air Force). 392 (Table 87).

4926th Test Squadron (Air Force). Operations: 155 (Table 13); Experimental Participation: 120; Radsafe Activities: 158; Personnel Exposure: 387 (Table 86), 394, 395.

4930th Test Support Group (Air Force). 157, 386 (Table 86), 392 (Table 87), 393.

4931st Test Support Squadron, Enewetak (Air Force). 155 (Table 13), 386 (Table 86), 392 (Table 87), 393.

4932nd Test Support Squadron (Air Force). 386-387 (Table 86), 392 (Table 87), 393, 394.

6501st Support Squadron (Air Force). 385 (Table 86), 390.

7125th AAU (Army). 327 (Table 58), 329.

7126th Army Unit. 58, 327 (Table 58), 331.

7131st Army Unit Signal Detachment. 331.

8451st AAU (Army). 166, 175, 327 (Table 58), 329.

8452nd Administrative Area Unit (Army). 166, 192, 193, 327 (Table 58), 330.

8600th Administrative Area Unit (Army). 235, 269 (Table 34), 327 (Table 58), 330.

9301st Test Support Unit (Ordnance) (Army). Operations: 173, 176, 177, 330, 390; Personnel Exposure: 328.

9423rd Test Support Unit (Army). 327 (Table 58), 330.

9465th Test Support Unit (Army). 327 (Table 58), 330.

9471st Test Support Unit (Army). 197, 327 (Table 58), 330.

9577th Test Support Unit (Army). 327 (Table 58), 330.

9710th Test Support Unit (Army). 216, 240.

DISTRIBUTION LIST

DEPARTMENT OF DEFENSE

Armed Forces Staff College
ATTN: Library

Assistant Secretary of Defense, Public Affairs
ATTN: PAO

Defense Nuclear Agency
ATTN: PAO
ATTN: GC
ATTN: BA
5 cy ATTN: NTPR
25 cy ATTN: TITL

Defense Technical Information Center
12 cy ATTN: DD

Field Command
Defense Nuclear Agency
ATTN: FCLS
ATTN: FCLS, Maj D. Norton

Interservice Nuclear Weapons School
ATTN: TTV

National Defense University
ATTN: ICAF Tech Library

DEPARTMENT OF THE ARMY

Army Library
ATTN: Military Doc Sec

Army Nuclear Test Personnel Review
2 cy ATTN: DAAG-AMR-R TAGO

U.S. Army Center of Military History
ATTN: DAMH-HSO

U.S. Army Chemical School
ATTN: ATZN-CM-CS
ATTN: ATZN-CM-AL

U.S. Army Comd & General Staff College
ATTN: Library

U.S. Army Nuclear & Chemical Agency
ATTN: Library

U.S. Army War College
ATTN: Library

DEPARTMENT OF THE NAVY

Aviation History Unit
Department of the Navy
ATTN: Library

Bureau of Medicine and Surgery
Department of the Navy
ATTN: Asst for Med Surgery

Engineering Duty Officer School
Department of the Navy
ATTN: Library

DEPARTMENT OF THE NAVY (Continued)

James Carson Breckinridge Library
Department of the Navy
ATTN: Library Div

Marine Corps Nuclear Test Personnel Review
ATTN: Code MSRB-60

Merchant Marine Academy
ATTN: Director of Libraries

Naval Aviation School Command
ATTN: Library

Naval Hospital Corps School
ATTN: Library

Naval Ocean Systems Center
ATTN: Library

Naval Oceanographic Office
ATTN: Code 025, Historian

Naval Postgraduate School
ATTN: Code 1424, Library

Naval Research Laboratory
ATTN: Library

Naval School
Naval Construction Battalion Center
ATTN: Commanding Officer

Naval School of Health Sciences
ATTN: Library

Naval Sea Systems Command
ATTN: Nuclear Technology Div

Naval Surface Weapons Center
ATTN: Library

Naval War College
ATTN: Professor 8 Libraries

Naval Weapons Center
ATTN: Code 233

Naval Weapons Evaluation Facility
ATTN: Library

Navy Dept Library
ATTN: Librn

Navy Nuclear Power School
ATTN: Library

Navy Nuclear Test Personnel Review
2 cy ATTN: W. Loeffler

U.S. Naval Academy
Nimitz Library
ATTN: Documents & Reports Dept

Marine Corps Base
ATTN: Document Custodian

DEPARTMENT OF THE NAVY (Continued)

Office of the Judge Adv Gen
Department of the Navy
ATTN: Code 73

Marine Corps Historical Center
2 cy ATTN: Code HDH-2

U.S. Merchant Marine Academy
ATTN: Librn

U.S. Naval Air Station Library
Department of the Navy
ATTN: Library

DEPARTMENT OF THE AIR FORCE

Academy Library DFSELD
U.S. Air Force Academy
ATTN: Library

Aerospace Defense Command
ATTN: Historian

Air Force Communications Command
ATTN: Historian

Air Force Institute of Technology
ATTN: Library

Air Force Logistics Command
ATTN: Historian

Air Force Nuclear Test Personnel Review
ATTN: HQ USAF/SGES

Air Force School of Aerospace Medicine
ATTN: Strughold Library

Air Force Systems Command
ATTN: Historian

Air Force Technical Applications Center
ATTN: Historian

Air Force Weapons Laboratory
Air Force Systems Command
ATTN: Tech Library

Air National Guard
ATTN: Historian

Air Training Command
ATTN: Historian

Air University Library
Department of the Air Force
ATTN: AUL-LSE

Military Air Lift Command
ATTN: Historian

Commander-in-Chief
Pacific Air Forces
ATTN: Historian

Tactical Air Command
Department of the Air Force
ATTN: Historian

DEPARTMENT OF THE AIR FORCE (Continued)

Strategic Air Command
Department of the Air Force
ATTN: NRI-STINFO Library
ATTN: Historian

U.S. Air Force Occupational & Env Health Lab
ATTN: NTPR

DEPARTMENT OF ENERGY

Department of Energy
ATTN: OMA

Department of Energy
Nevada Operations Office
ATTN: Health Physics Div
2 cy ATTN: R. Nutley

Department of Energy
Human Health & Assessments Division
ATTN: EV-31

OTHER GOVERNMENT AGENCIES

Centers for Disease Control
U.S. Public Health Service
ATTN: G. Caldwell

Central Intelligence Agency
ATTN: Office of Medical Services

Department of Health & Human Svcs
ATTN: Office of General Counsel

Exec Ofc of The President
Management & Budget Off Lib
ATTN: Librn

Library of Congress
ATTN: Library Service Division
ATTN: Science & Technology Div
ATTN: Serial & Govt Publication

National Atomic Museum
ATTN: Historian

Department of Commerce
National Bureau of Standards
ATTN: Librn

National Technical Information Service
12 cy ATTN: Customer Services

Occupational Safety & Health Admin
ATTN: C. Wright

Office of Health & Disability (ASPER)
ATTN: R. Copeland

Ofc of Workers Compensation Program
Department of Labor
ATTN: R. Larson

U.S. Coast Guard Academy Library
ATTN: Librn

U.S. House of Representatives
ATTN: Committee on Armed Svcs

OTHER GOVERNMENT AGENCIES (Continued)

U.S. House of Representatives
Committee on Interstate & Foreign Commerce
ATTN: Subcommittee on Health & Envir

U.S. Military Academy
ATTN: Director of Libraries

U.S. Senate
Committee on Armed Services
ATTN: Committee on Veterans Affairs

U.S. Senate
ATTN: Committee on Veterans Affairs

Veterans Administration-RO
Providence, RI
ATTN: Director

Veterans Administration-RO
Montgomery, AL
ATTN: Director

Veterans Administration-RO
Anchorage, AK
ATTN: Director

Veterans Administration-RO
Phoenix, AZ
ATTN: Director

Veterans Administration-RO
Little Rock, AR
ATTN: Director

Veterans Administration-RO
Los Angeles, CA
ATTN: Director

Veterans Administration-RO
San Francisco, CA
ATTN: Director

Veterans Administration-RO
Denver, CO
ATTN: Director

Veterans Administration-RO
Hartford, CT
ATTN: Director

Veterans Administration-RO
Wilmington, DE
ATTN: Director

Veterans Administration-RO
Washington, D. C.
ATTN: Dept Veterans Benefit, Central Ofc
ATTN: Director
ATTN: Board of Veteran Appeal

Veterans Administration-RO
St. Petersburg, FL
ATTN: Director

Veterans Administration-RO
Atlanta, GA
ATTN: Director

OTHER GOVERNMENT AGENCIES (Continued)

Veterans Administration-RO
Honolulu, HI
ATTN: Director

Veterans Administration-RO
Chicago, IL
ATTN: Director

Veterans Administration-RO
Seattle, WA
ATTN: Director

Veterans Administration-RO
Indianapolis, IN
ATTN: Director

Veterans Administration-RO
Des Moines, IA
ATTN: Director

Veterans Administration-RO
Wichita, KS
ATTN: Director

Veterans Administration-RO
Louisville, KY
ATTN: Director

Veterans Administration-RO
New Orleans, LA
ATTN: Director

Veterans Administration-RO
Togus, ME
ATTN: Director

Veterans Administration-RO
Baltimore, MD
ATTN: Director

Veterans Administration-RO
Boston, MA
ATTN: Director

Veterans Administration-RO
St. Paul, MN
ATTN: Director

Veterans Administration-RO
Jackson, MS
ATTN: Director

Veterans Administration-RO
Huntington, WV
ATTN: Director

Veterans Administration-RO
St. Louis, MO
ATTN: Director

Veterans Administration-RO
Ft. Harrison, MT
ATTN: Director

National Archives
ATTN: Librn

OTHER GOVERNMENT AGENCIES (Continued)

Veterans Administration-RO
Lincoln, NE
ATTN: Director

Veterans Administration-RO
Reno, NV
ATTN: Director

Veterans Administration-RO
Manchester, NH
ATTN: Director

Veterans Administration-RO
Newark, NJ
ATTN: Director

Veterans Administration-RO
Milwaukee, WI
ATTN: Director

Veterans Administration-RO
Albuquerque, NM
ATTN: Director

Veterans Administration-RO
Buffalo, NY
ATTN: Director

Veterans Administration-RO
New York, NY
ATTN: Director

Veterans Administration-RO
Winston-Salem, NC
ATTN: Director

Veterans Administration-RO
Fargo, ND
ATTN: Director

Veterans Administration-RO
Cleveland, OH
ATTN: Director

Veterans Administration-RO
Muskogee, OK
ATTN: Director

Veterans Administration-RO
Portland, OR
ATTN: Director

Veterans Administration-RO
Pittsburgh, PA
ATTN: Director

Veterans Administration-RO
Philadelphia, PA
ATTN: Director

Veterans Administration-RO
San Francisco, CA
ATTN: Director

Veterans Administration-RO
San Juan, Puerto Rico
ATTN: Director

OTHER GOVERNMENT AGENCIES (Continued)

Veterans Administration-RO
Columbia, SC
ATTN: Director

Veterans Administration-RO
Sioux Falls, SD
ATTN: Director

Veterans Administration-RO
Houston, TX
ATTN: Director

Veterans Administration-RO
Waco, TX
ATTN: Director

Veterans Administration-RO
Salt Lake City, UT
ATTN: Director

Veterans Administration-RO
White River Junction, VT
ATTN: Director

Veterans Administration-RO
Roanoke, VA
ATTN: Director

Veterans Administration-RO
Cheyenne, WY
ATTN: Director

Veterans Administration-RO
San Diego, CA
ATTN: Director

Veterans Administration-RO
Boise, ID
ATTN: Director

Veterans Administration-RO
Detroit, MI
ATTN: Director

Veterans Administration-RO
Nashville, TN
ATTN: Director

The White House
ATTN: Domestic Policy Staff

DEPARTMENT OF ENERGY CONTRACTORS

Lawrence Livermore National Lab
ATTN: Tech Info Dept Library

Los Alamos National Lab
ATTN: Library
ATTN: ADPA MMS 195

Sandia National Lab
ATTN: W. Hereford
ATTN: Central Library

Reynolds Electrical & Engr Co., Inc
ATTN: CIC
ATTN: W. Brady

OTHER

Adams State College
ATTN: Librn

Akron Public Library
ATTN: Librn

Alabama State Dept of Archives & History
ATTN: Military Records Div

University of Alabama
ATTN: Reference Dept, Dralier 3
ATTN: Director of Libraries (Reg)

University of Alaska Library at Anchorage
ATTN: Librn

University of Alaska
ATTN: Dir of Libraries

Albany Public Library
ATTN: Librn

Alexander City State Jr College
ATTN: Librn

Allegheny College
ATTN: Librn

Allen County Public Library
ATTN: Librn

Altoona Area Public Library
ATTN: Librn

American Statistics Index
Congressional Info Service, Inc
ATTN: Cathy Jarvey

Anaheim Public Library
ATTN: Librn

College of Wooster
ATTN: Gov Docs

Angelo State University Library
ATTN: Librn

Angelo Iacoboni Public Library
ATTN: Librn

Anoka County Library
ATTN: Librn

Appalachian State University
ATTN: Library Docs

Arizona State University Library
ATTN: Librn

University of Arizona
ATTN: Gov Doc Dept/C. Bower

Arkansas College Library
ATTN: Library

Brooklyn College
ATTN: Doc Div

OTHER (Continued)

Arkansas Library Comm
ATTN: Library

Arkansas State University
ATTN: Library

University of Arkansas
ATTN: Gov Docs Div

Austin College
ATTN: Librn

Atlanta Public Library
ATTN: Ivan Allen Dept

Atlanta University
ATTN: Librn

Auburn University Library at Montgomery (Reg)
ATTN: Librn

C. W. Post Ctr Long Island University
ATTN: Librn

Bangor Public Library
ATTN: Librn

Bates College Library
ATTN: Librn

Baylor University Library
ATTN: Docs Dept

Beloit College Libraries
ATTN: Serials Docs Dept

Bemidji State College
ATTN: Library

State University College
ATTN: Gov Docs

Akron University
ATTN: Gov Docs

Boston Public Library (Reg)
ATTN: Docs Dept

Bowdoin College
ATTN: Librn

Bowling Green State University
ATTN: Lib Gov Docs Services

Bradley University
ATTN: Librn

Brandeis University Library
ATTN: Docs Section

Brigham Young University
ATTN: Librn

Brigham Young University
ATTN: Docs Collection

Brookhaven National Laboratory
ATTN: Tech Library

OTHER (Continued)

Broward County Library Sys
ATTN: Librn

Brown University
ATTN: Librn

Bucknell University
ATTN: Reference Dept

Buffalo & Erie Co Public Library
ATTN: Librn

State University Library of California at Fresno
ATTN: Library

University Library of California at Los Angeles
ATTN: Pub Affairs Serv U.S. Docs

University of California at San Diego
ATTN: Docs Dept

State College Library of California at Stanislaus
ATTN: Library

California State Polytechnic University Library
ATTN: Librn

California State University at Northridge
ATTN: Gov Doc

California State Library (Reg)
ATTN: Librn

California State University at Long Beach Library
ATTN: Librn

California State University
ATTN: Librn

California State University
ATTN: Librn

California University Library
ATTN: Gov Pub Dept

California University Library
ATTN: Librn

California University Library
ATTN: Gov Docs Dept

California University Library
ATTN: Docs Sec

University of California
ATTN: Gov Docs Dept

Calvin College Library
ATTN: Librn

Kearney State College
ATTN: Gov Docs Dept

Cambria County Library Sys
ATTN: Librn

Carleton College Library
ATTN: Librn

OTHER (Continued)

Carnegie Library of Pittsburgh
ATTN: Librn

Carnegie Mellon University
ATTN: Dir of Libraries

Carson Regional Library
ATTN: Gov Pubs Unit

Case Western Reserve University
ATTN: Librn

Casper College
ATTN: Librn

University of Central Florida
ATTN: Library Docs Dept

Central Michigan University
ATTN: Library Docs Sec

Central Missouri State Univ
ATTN: Gov Docs

Central State University
ATTN: Lib Docs Dept

Central Washington University
ATTN: Lib Docs Sec

Central Wyoming College Library
ATTN: Librn

Charleston County Library
ATTN: Librn

Charlotte & Mecklenburg County Public Library
ATTN: E. Correll

Chattanooga Hamilton County, Bicentennial Library
ATTN: Librn

Chesapeake Public Library System
ATTN: Librn

Chicago Public Library
ATTN: Gov Pubs Dept

State University of Chicago
ATTN: Librn

Chicago University Library
ATTN: Dir of Libraries
ATTN: Docs Processing

Cincinnati University Library
ATTN: Librn

Citadel, Daniel Library
ATTN: Librn

Claremont Colleges Libraries
ATTN: Doc Collection

Clemson University
ATTN: Dir of Libraries

OTHER (Continued)

Cleveland Public Library
ATTN: Docs Collection

Cleveland State University Library
ATTN: Librn

Coe Library
ATTN: Docs Div

Colgate University Library
ATTN: Ref Lib

Colorado State University Libraries
ATTN: Librn

University of Colorado Libraries
ATTN: Dir of Libraries

Columbia University Library
ATTN: Docs Svc Ctr

Columbus & Franklin Cty Public Library
ATTN: Gen Rec Div

Compton Library
ATTN: Librn

Connecticut State Library (Reg)
ATTN: Librn

University of Connecticut
ATTN: Gov't of Connecticut

University of Connecticut
ATTN: Dir of Libraries

Cornell University Library
ATTN: Librn

Corpus Christi State University Library
ATTN: Librn

Culver City Library
ATTN: Librn

Curry College Library
ATTN: Librn

University of North Carolina at Asheville
ATTN: Librn

Dallas County Public Library
ATTN: Librn

Dallas Public Library
ATTN: Librn

Dalton Junior College Library
ATTN: Librn

Dartmouth College
ATTN: Librn

Davenport Public Library
ATTN: Librn

Davidson College
ATTN: Librn

OTHER (Continued)

Dayton & Montgomery City Public Library
ATTN: Librn

University of Dayton
ATTN: Librn

Decatur Public Library
ATTN: Librn

Dekalb Community College So Cpus
ATTN: Librn

Delaware Pauw University
ATTN: Librn

University of Delaware
ATTN: Librn

Delta College Library
ATTN: Librn

Delta State University
ATTN: Librn

Denison University Library
ATTN: Librn

Denver Public Library (Reg)
ATTN: Docs Div

Dept of Library & Archives (Reg)
ATTN: Librn

Detroit Public Library
ATTN: Librn

Dickinson College Library
ATTN: Librn

Dickinson State College
ATTN: Librn

Alabama Agricultural Mechanical University & Coll
ATTN: Librn

Drake University
ATTN: Cowles Library

Drew University
ATTN: Librn

Duke University
ATTN: Pub Docs Dept

Duluth Public Library
ATTN: Docs Sec

East Carolina University
ATTN: Lib Docs Dept

East Central University
ATTN: Librn

East Islip Public Library
ATTN: Librn

OTHER (Continued)

East Orange Public Library
ATTN: U.S. Gov't Depository

East Tennessee State University Sherrod Library
ATTN: Docs Dept

East Texas State University
ATTN: Library

Monmouth County Library Eastern Branch
ATTN: Librn

Eastern Illinois University
ATTN: Librn

Eastern Kentucky University
ATTN: Librn

Eastern Michigan University Library
ATTN: Library

Eastern Montana College Library
ATTN: Docs Dept

Eastern New Mexico University
ATTN: Librn

Eastern Oregon College Library
ATTN: Librn

Eastern Washington University
ATTN: Librn

El Paso Public Library
ATTN: Docs & Geneology Dept

Elko County Library
ATTN: Librn

Elmira College
ATTN: Librn

Elon College Library
ATTN: Librn

Enoch Pratt Free Library
ATTN: Docs Ofc

Emory University
ATTN: Librn

Evansville & Vanderburgh Cty Public Library
ATTN: Librn

Everett Public Library
ATTN: Librn

Fairleigh Dickinson University
ATTN: Depository Dept

Florida A & M University
ATTN: Librn

Florida Atlantic University Library
ATTN: Div of Pub Docs

OTHER (Continued)

Florida Institute of Technology
ATTN: Library

Florida International University Library
ATTN: Docs Sec

Florida State Library
ATTN: Docs Sec

Florida State University
ATTN: Librn

University of Florida
ATTN: Dir of Library (Reg)
ATTN: Docs Dept

Fond Du Lac Public Library
ATTN: Librn

Ft Hays State University
Ft Hays Kansas State College
ATTN: Librn

Ft Worth Public Library
ATTN: Librn

Free Public Library of Elizabeth
ATTN: Librn

Free Public Library
ATTN: Librn

Freeport Public Library
ATTN: Librn

Fresno Cty Free Library
ATTN: Librn

Gadsden Public Library
ATTN: Librn

Garden Public Library
ATTN: Librn

Gardner Webb College
ATTN: Docs Library

Gary Public Library
ATTN: Librn

Geauga Cty Public Library
ATTN: Librn

Georgetown University Library
ATTN: Gov Docs Room

Georgia Institute of Technology
ATTN: Librn

Georgia Southern College
ATTN: Librn

Georgia Southwestern College
ATTN: Dir of Libraries

Georgia State University Library
ATTN: Librn

OTHER (Continued)

University of Georgia
ATTN: Dir of Libraries (Reg)

Glassboro State College
ATTN: Librn

Gleeson Library
ATTN: Librn

Graceland College
ATTN: Librn

Grand Forks Public City-County Library
ATTN: Librn

Grand Rapids Public Library
ATTN: Dir of Lib

Greenville County Library
ATTN: Librn

Grinnell College Library
ATTN: Librn

Guam RFK Memorial University Library
ATTN: Fed Depository Coll

University of Guam
ATTN: Librn

Gustavus Adolphus College
ATTN: Librn

South Dakota University
ATTN: Librn

Hardin-Simmons University Library
ATTN: Librn

Hartford Public Library
ATTN: Librn

Harvard College Library
ATTN: Dir of Lib

Harvard College Library
ATTN: Serials Rec Div

University of Hawaii Library
ATTN: Gov Docs Coll

Hawaii State Library
ATTN: Fed Docs Unit

University of Hawaii at Monoa
ATTN: Dir of Libraries (Reg)

University of Hawaii
Hilo Campus Library
ATTN: Librn

Haydon Burns Library
ATTN: Librn

Hennepin County Library
ATTN: Gov Docs

Henry Ford Community College Library
ATTN: Librn

OTHER (Continued)

Herbert H. Lehman College
ATTN: Lib Docs Div

Hofstra University Library
ATTN: Docs Dept

Hollins College
ATTN: Librn

Hopkinsville Community College
ATTN: Librn

Wagner College
ATTN: Librn

University of Houston Library
ATTN: Docs Div

Houston Public Library
ATTN: Librn

Tulane University
ATTN: Docs Dept

Hoyt Public Library
ATTN: Librn

Humboldt State College Library
ATTN: Docs Dept

Huntington Park Library
ATTN: Librn

Hutchinson Public Library
ATTN: Librn

Idaho Public Library & Information Center
ATTN: Librn

Idaho State Library
ATTN: Librn

Idaho State University Library
ATTN: Docs Dept

University of Idaho
ATTN: Dir of Libraries (Reg)
ATTN: Docs Sec

University of Illinois Library
ATTN: Docs Sec

Illinois State Library (Reg)
ATTN: Gov Docs Br

Illinois University at Urbana-Champaign
ATTN: P. Watson Docs Lib

Illinois Valley Community College
ATTN: Library

Illinois State University
ATTN: Librn

Indiana State Library (Reg)
ATTN: Serial Sec

Indiana State University
ATTN: Docs Library

OTHER (Continued)

Indiana University Library
ATTN: Docs Dept

Indianapolis Marion County Public Library
ATTN: Social Science Div

Iowa State University Library
ATTN: Gov Docs Dept

Iowa University Library
ATTN: Gov Docs Dept

Butler University
ATTN: Librn

Isaac Delchdo College
ATTN: Librn

James Madison University
ATTN: Librn

Jefferson County Public Library
Lakewood Regional Library
ATTN: Librn

Jersey City State College
ATTN: F. A. Irwin Library Periodicals
Doc Sec

Johns Hopkins University
ATTN: Docs Library

La Roche College
ATTN: Librn

Johnson Free Public Library
ATTN: Librn

Kalamazoo Public Library
ATTN: Librn

Kansas City Public Library
ATTN: Docs Div

Kansas State Library
ATTN: Librn

Kansas State University Library
ATTN: Docs Dept

University of Kansas
ATTN: Dir of Library (Reg)

University of Texas
ATTN: Lyndon B. Johnson School of Public
Affairs Library

Maine Maritime Academy
ATTN: Librn

University of Maine
ATTN: Librn

OTHER (Continued)

Kent State University Library
ATTN: Docs Div

Kentucky Dept of Library & Archives
ATTN: Docs Sec

University of Kentucky
ATTN: Gov Pub Dept
ATTN: Dir of Lib (Reg)

Kenyon College Library
ATTN: Librn

Lake Forest College
ATTN: Librn

Lake Sumter Community College Library
ATTN: Librn

Lakeland Public Library
ATTN: Librn

Lancaster Regional Library
ATTN: Librn

Lawrence University
ATTN: Docs Dept

Brigham Young University
ATTN: Docs & Map Sec

Lewis University Library
ATTN: Librn

Library and Statutory Dist & Svc
2 cy ATTN: Librn

Earlham College
ATTN: Librn

Little Rock Public Library
ATTN: Librn

Long Beach Public Library
ATTN: Librn

Los Angeles Public Library
ATTN: Serials Div U.S. Docs

Louisiana State University
ATTN: Gov Doc Dept
ATTN: Dir of Libraries (Reg)

Louisville Free Public Library
ATTN: Librn

Louisville University Library
ATTN: Librn

Hoover Institution
ATTN: J. Bingham

OTHER (Continued)

Manchester City Library
ATTN: Librn

Mankato State College
ATTN: Gov Pubs

University of Maine at Farmington
ATTN: Dir of Libraries

Marathon County Public Library
ATTN: Librn

Principia College
ATTN: Librn

University of Maryland
ATTN: McKeldin Library Docs Div

University of Maryland
ATTN: Librn

University of Massachusetts
ATTN: Gov Docs Coll

Maui Public Library
Kahului Branch
ATTN: Librn

McNeese State University
ATTN: Librn

Memphis & Shelby County Public Library &
Information Center
ATTN: Librn

Memphis State University
ATTN: Librn

Mercer University
ATTN: Librn

Mesa County Public Library
ATTN: Librn

Miami Dade Community College
ATTN: Librn

University of Miami Library
ATTN: Gov Pubs

Miami Public Library
ATTN: Docs Div

Miami University Library
ATTN: Docs Dept

University of Santa Clara
ATTN: Docs Div

Michigan State Library
ATTN: Librn

Michigan State University Library
ATTN: Librn

Murray State University Library
ATTN: Lib

OTHER (Continued)

Michigan Tech University
ATTN: Lib Docs Dept

University of Michigan
ATTN: Acq Sec Docs Unit

Middlebury College Library
ATTN: Librn

Millersville State College
ATTN: Librn

State University of New York
ATTN: Docs Librn

Milwaukee Public Library
ATTN: Librn

Minneapolis Public Library
ATTN: Librn

University of Minnesota
ATTN: Dir of Libraries (Reg)

Minot State College
ATTN: Librn

Mississippi State University
ATTN: Librn

University of Mississippi
ATTN: Dir of Libraries

Missouri University at Kansas City General
ATTN: Librn

University of Missouri Library
ATTN: Gov Docs

M.I.T. Libraries
ATTN: Librn

Mobile Public Library
ATTN: Gov Info Div

Midwestern University
ATTN: Librn

Montana State Library
ATTN: Librn

Montana State University Library
ATTN: Librn

University of Montana
ATTN: Dir of Libraries (Reg)

Montebello Library
ATTN: Librn

Moorhead State College
ATTN: Library

Mt Prospect Public Library
ATTN: Gov't Info Ctr

OTHER (Continued)

Nassau Library System
ATTN: Librn

Natrona County Public Library
ATTN: Librn

Nebraska Library Community
Nebraska Public Clearinghouse
ATTN: Librn

University of Nebraska at Omaha
ATTN: Univ Lib Docs

Nebraska Western College Library
ATTN: Librn

University of Nebraska
ATTN: Dir of Libraries (Reg)

University of Nebraska Library
ATTN: Acquisitions Dept

University of Nevada Library
ATTN: Gov Pubs Dept

University of Nevada at Las Vegas
ATTN: Dir of Libraries

New Hampshire University Library
ATTN: Librn

New Hanover County Public Library
ATTN: Librn

New Mexico State Library
ATTN: Librn

New Mexico State University
ATTN: Lib Docs Div

University of New Mexico
ATTN: Dir of Libraries (Reg)

University of New Orleans Library
ATTN: Gov Docs Div

New Orleans Public Library
ATTN: Librn

New York Public Library
ATTN: Librn

New York State Library
ATTN: Docs Control Cultural Ed Ctr

State University of New York at Stony Brook
ATTN: Main Lib Docs Sec

State University of New York Col Memorial Lib
at Cortland
ATTN: Librn

State University of New York
ATTN: Lib Docs Sec

North Texas State University Library
ATTN: Librn

OTHER (Continued)

State University of New York
ATTN: Librn

New York State University
ATTN: Docs Ctr

State University of New York
ATTN: Docs Dept

New York University Library
ATTN: Docs Dept

Newark Free Library
ATTN: Librn

Newark Public Library
ATTN: Librn

Niagara Falls Public Library
ATTN: Librn

Nicholls State University Library
ATTN: Docs Div

Nieves M. Flores Memorial Library
ATTN: Librn

Norfolk Public Library
ATTN: R. Parker

North Carolina Agricultural & Tech State
University
ATTN: Librn

University of North Carolina at Charlotte
ATTN: Atkins Lib Doc Dept

University Library of North Carolina at Greensboro
ATTN: Librn

University of North Carolina at Wilmington
ATTN: Librn

North Carolina Central University
ATTN: Librn

North Carolina State University
ATTN: Librn

University of North Carolina
ATTN: BA SS Div Docs

North Dakota State University Library
ATTN: Docs Librn

University of North Dakota
ATTN: Librn

North Georgia College
ATTN: Librn

Minnesota Div of Emergency Svcs
ATTN: Librn

OTHER (Continued)

Northeast Missouri State University
ATTN: Librn

Northeastern Oklahoma State University
ATTN: Librn

Northeastern University
ATTN: Dodge Library

Northern Arizona University Library
ATTN: Gov Docs Dept

Northern Illinois University
ATTN: Librn

Northern Michigan University
ATTN: Docs

Northern Montana College Library
ATTN: Librn

Northwestern Michigan College
ATTN: Librn

Northwestern State University
ATTN: Librn

Northwestern State University Library
ATTN: Librn

Northwestern University Library
ATTN: Gov Pubs Dept

Norwalk Public Library
ATTN: Librn

Northeastern Illinois University
ATTN: Library

University of Notre Dame
ATTN: Doc Ctr

Oakland Community College
ATTN: Librn

Oakland Public Library
ATTN: Librn

Oberlin College Library
ATTN: Librn

Ocean County College
ATTN: Librn

Ohio State Library
ATTN: Librn

Ohio State University
ATTN: Lib Docs Div

Ohio University Library
ATTN: Docs Dept

Oklahoma City University Library
ATTN: Librn

Oklahoma City University Library
ATTN: Librn

OTHER (Continued)

Oklahoma Department of Libraries
ATTN: U.S. Gov Docs

University of Oklahoma
ATTN: Docs Div

Old Dominion University
ATTN: Doc Dept Univ Lib

Olivet College Library
ATTN: Librn

Omaha Public Library Clark Branch
ATTN: Librn

Onondaga County Public Library
ATTN: Gov Docs Sec

Oregon State Library
ATTN: Librn

University of Oregon
ATTN: Docs Sec

Ouachita Baptist University
ATTN: Librn

Pan American University Library
ATTN: Librn

Passaic Public Library
ATTN: Librn

Queens College
ATTN: Docs Dept

Pennsylvania State Library
ATTN: Gov Pubs Sec

Pennsylvania State University
ATTN: Lib Doc Sec

University of Pennsylvania
ATTN: Dir of Libraries

University of Denver
ATTN: Penrose Library

Peoria Public Library
ATTN: Business, Science & Tech Dept

Free Library of Philadelphia
ATTN: Gov Pubs Dept

Philipsburg Free Public Library
ATTN: Library

Phoenix Public Library
ATTN: Librn

University of Pittsburgh
ATTN: Docs Office, G8

Plainfield Public Library
ATTN: Librn

OTHER (Continued)

Popular Creek Public Library District
ATTN: Librn

Association of Portland Library
ATTN: Librn

Portland Public Library
ATTN: Librn

Portland State University Library
ATTN: Librn

Pratt Institute Library
ATTN: Librn

Louisiana Tech University
ATTN: Librn

Princeton University Library
ATTN: Docs Div

Providence College
ATTN: Librn

Providence Public Library
ATTN: Librn

Public Library Cincinnati & Hamilton County
ATTN: Librn

Public Library of Nashville and Davidson County
ATTN: Librn

University of Puerto Rico
ATTN: Doc & Maps Room

Purdue University Library
ATTN: Librn

Quinebaug Valley Community College
ATTN: Librn

Auburn University
ATTN: Microforms & Docs Dept

Rapid City Public Library
ATTN: Librn

Reading Public Library
ATTN: Librn

Reed College Library
ATTN: Librn

Augusta College
ATTN: Librn

University of Rhode Island Library
ATTN: Gov Pubs Ofc

University of Rhode Island
ATTN: Dir of Libraries

Rice University
ATTN: Dir of Libraries

Louisiana College
ATTN: Librn

OTHER (Continued)

Richland County Public Library
ATTN: Librn

Riverside Public Library
ATTN: Librn

University of Rochester Library
ATTN: Docs Sec

University of Rutgers Camden Library
ATTN: Librn

State University of Rutgers
ATTN: Librn

Rutgers University
ATTN: Dir of Libraries (Reg)

Rutgers University Law Library
ATTN: Fed Docs Dept

Salem College Library
ATTN: Librn

Samford University
ATTN: Librn

San Antonio Public Library
ATTN: Bus Science & Tech Dept

San Diego County Library
ATTN: C. Jones, Acquisitions

San Diego Public Library
ATTN: Librn

San Diego State University Library
ATTN: Gov Pubs Dept

San Francisco Public Library
ATTN: Gov Docs Dept

San Francisco State College
ATTN: Gov Pubs Coll

San Jose State College Library
ATTN: Docs Dept

San Luis Obispo City-County Library
ATTN: Librn

Savannah Public & Effingham Liberty Regional
Library
ATTN: Librn

Scottsbluff Public Library
ATTN: Librn

Scranton Public Library
ATTN: Librn

Seattle Public Library
ATTN: Ref Docs Asst

OTHER (Continued)

Selby Public Library
ATTN: Librn

Shawnee Library System
ATTN: Librn

Shreve Memorial Library
ATTN: Librn

Silas Bronson Public Library
ATTN: Librn

Sioux City Public Library
ATTN: Librn

Skidmore College
ATTN: Librn

Slippery Rock State College Library
ATTN: Librn

South Carolina State Library
ATTN: Librn

University of South Carolina
ATTN: Librn

University of South Carolina
ATTN: Gov Docs

South Dakota School of Mines & Technical Library
ATTN: Librn

South Dakota State Library
ATTN: Fed Docs Dept

University of South Dakota
ATTN: Docs Librn

South Florida University Library
ATTN: Librn

Southeast Missouri State University
ATTN: Librn

Southeastern Massachusetts University Library
ATTN: Docs Sec

University of Southern Alabama
ATTN: Librn

Southern California University Library
ATTN: Docs Dept

Southern Connecticut State College
ATTN: Library

Southern Illinois University
ATTN: Librn

Southern Illinois University
ATTN: Docs Ctr

Southern Methodist University
ATTN: Librn

University of Southern Mississippi
ATTN: Library

OTHER (Continued)

Southern Oregon College
ATTN: Library

Southern University in New Orleans Library
ATTN: Librn

Southern Utah State College Library
ATTN: Docs Dept

Southwest Missouri State College
ATTN: Library

University of Southwestern Louisiana Libraries
ATTN: Librn

Southwestern University
ATTN: Librn

Spokane Public Library
ATTN: Ref Dept

Springfield City Library
ATTN: Docs Sec

St Bonaventure University
ATTN: Librn

St Johns River Junior College
ATTN: Library

St Joseph Public Library
ATTN: Librn

St Lawrence University
ATTN: Librn

St Louis Public Library
ATTN: Librn

St Paul Public Library
ATTN: Librn

Stanford University Library
ATTN: Gov Docs Dept

State Historical Soc Library
ATTN: Docs Serials Sec

State Library of Massachusetts
ATTN: Librn

State University of New York
ATTN: Librn

Stetson University
ATTN: Librn

University of Steubenville
ATTN: Librn

Stockton & San Joaquin Public Library
ATTN: Librn

Stockton State College Library
ATTN: Librn

Albion College
ATTN: Gov Docs Librn

OTHER (Continued)

Superior Public Library
ATTN: Librn

Swarthmore College Library
ATTN: Ref Dept

Syracuse University Library
ATTN: Docs Div

Tacoma Public Library
ATTN: Librn

Hillsborough County Public Library at Tampa
ATTN: Librn

Temple University
ATTN: Librn

Tennessee Technological University
ATTN: Librn

University of Tennessee
ATTN: Dir of Libraries

College of Idaho
ATTN: Librn

Texas A & M University Library
ATTN: Librn

University of Texas at Arlington
ATTN: Library Docs

University of Texas at San Antonio
ATTN: Library

Texas Christian University
ATTN: Librn

Texas State Library
ATTN: U.S. Docs Sec

Texas Tech University Library
ATTN: Gov Docs Dept

Texas University at Austin
ATTN: Docs Coll

University of Toledo Library
ATTN: Librn

Toledo Public Library
ATTN: Social Science Dept

Torrance Civic Center Library
ATTN: Librn

Traverse City Public Library
ATTN: Librn

Trenton Free Public Library
ATTN: Librn

Trinity College Library
ATTN: Librn

Trinity University Library
ATTN: Docs Coll

OTHER (Continued)

Tufts University Library
ATTN: Docs Dept

University of Tulsa
ATTN: Librn

UCLA Research Library
ATTN: Pub Affairs Svc/U.S. Docs

Uniformed Services University of the Health Sciences
ATTN: LRC Library

University Libraries
ATTN: Dir of Lib

University of Maine at Orono
ATTN: Librn

University of Northern Iowa
ATTN: Library

Upper Iowa College
ATTN: Docs Coll

Utah State University
ATTN: Librn

University of Utah
ATTN: Special Collections

University of Utah
ATTN: Dir of Library

Utica Public Library
ATTN: Librn

Valencia Library
ATTN: Librn

Valparaiso University
ATTN: Librn

Vanderbilt University Library
ATTN: Gov Docs Sec

University of Vermont
ATTN: Dir of Libraries

Virginia Commonwealth University
ATTN: Librn

Virginia Military Institute
ATTN: Librn

Virginia Polytechnic Institute Library
ATTN: Docs Dept

Virginia State Library
ATTN: Serials Sec

University of Virginia
ATTN: Pub Docs

Volusia County Public Library
ATTN: Librn

OTHER (Continued)

Washington State Library
ATTN: Docs Sec

Washington State University
ATTN: Lib Docs Sec

Washington University Libraries
ATTN: Dir of Lib

University of Washington
ATTN: Docs Div

Wayne State University Library
ATTN: Librn

Wayne State University Law Library
ATTN: Docs Dept

Weber State College Library
ATTN: Librn

Wesleyan University
ATTN: Docs Librn

West Chester State College
ATTN: Docs Dept

West Covina Library
ATTN: Librn

University of West Florida
ATTN: Librn

West Georgia College
ATTN: Librn

West Hills Community College
ATTN: Library

West Texas State University
ATTN: Library

West Virginia College of Grad Studies Library
ATTN: Librn

University of West Virginia
ATTN: Dir of Libraries (Reg)

Westerly Public Library
ATTN: Librn

Western Carolina University
ATTN: Librn

Western Illinois University Library
ATTN: Librn

Western Washington University
ATTN: Librn

Western Wyoming Community College Library
ATTN: Librn

Westmoreland City Community College
ATTN: Learning Resource Ctr

OTHER (Continued)

Whitman College
ATTN: Librn

Wichita State University Library
ATTN: Librn

Williams & Mary College
ATTN: Docs Dept

Emporia Kansas State College
ATTN: Gov Docs Div

William College Library
ATTN: Librn

Willimantic Public Library
ATTN: Librn

Winthrop College
ATTN: Docs Dept

University of Wisconsin at Whitewater
ATTN: Gov Docs Lib

University of Wisconsin at Milwaukee
ATTN: Lib Docs

University of Wisconsin at Oshkosh
ATTN: Librn

University of Wisconsin at Platteville
ATTN: Doc Unit Lib

University of Wisconsin at Stevens Point
ATTN: Docs Sec

University of Wisconsin
ATTN: Gov Pubs Dept

University of Wisconsin
ATTN: Acquisitions Dept

Worcester Public Library
ATTN: Librn

Wright State University Library
ATTN: Gov Docs Librn

Wyoming State Library
ATTN: Librn

University of Wyoming
ATTN: Docs Div

Yale University
ATTN: Dir of Libraries

Yeshiva University
ATTN: Librn

Yuma City County Library
ATTN: Librn

Simon Schwob Mem Lib, Columbus Col
ATTN: Librn

DEPARTMENT OF DEFENSE CONTRACTORS

Advanced Research & Applications Corp
ATTN: H. Lee

JAYCOR

ATTN: A. Nelson
10 cy ATTN: Health & Environment Div

Kaman Tempo

ATTN: DASIAC
ATTN: E. Martin

Kaman Tempo

ATTN: R. Mitler

Science Applications, Inc
JRB Associates Div
10 cy ATTN: L. Novotney

DEPARTMENT OF DEFENSE CONTRACTORS (Continued)

Kaman Tempo

ATTN: C. Jones

National Academy of Sciences

ATTN: C. Robinette
ATTN: Med Follow-up Agency
ATTN: Nat Mat Advisory Bd

Pacific-Sierra Research Corp

ATTN: H. Brode, Chairman SAGE

Science Applications, Inc

ATTN: Tech Lib

R & D Associates

ATTN: P. Haas

REFERENCE LIBRARY FILE COPY