



Living high-tech!



# Product Overview 2011

# Content

	Editorial .....	3
	<b>ECoS 2</b> .....	<b>4</b>
	■ ECoS - Just Play .....	5
	■ Functions in detail.....	7
	■ Expandibility .....	11
	<b>ECoSlink Terminal</b> .....	<b>12</b>
<b>NEW</b>	<b>L.net Adapter</b> .....	<b>13</b>
	<b>Navigator</b> .....	<b>15</b>
	■ Equipment and handling.....	15
	■ Expandibility .....	16
	<b>Navigator Accessories</b> .....	<b>17</b>
<b>NEW</b>	■ Connection cable for ECoS .....	17
<b>NEW</b>	■ USB cable for PC.....	17
	<b>ECoSBoost</b> .....	<b>19</b>
	<b>ECoSDetector</b> .....	<b>20</b>
<b>NEW</b>	■ ECoSDetector - Reliable localisation .....	20
<b>NEW</b>	■ ECoSDetector Extension.....	21
<b>NEW</b>	■ ECoSDetector Standard .....	21
	<b>ECoSControl Radio</b> .....	<b>22</b>
	<b>Central Station® - Reloaded</b> .....	<b>24</b>
	<b>SwitchPilot</b> .....	<b>27</b>
	■ SwitchPilot - Do as you please.....	27
	■ SwitchPilot Servo & SwitchPilot Extension .....	28
	■ Servo motor with plastic gearing.....	29
	■ Servo motor with metal gearing.....	29
	■ Servo extension cable .....	29
<b>NEW</b>	<b>RailCom® Plus</b> .....	<b>30</b>
	<b>LokSound</b> .....	<b>33</b>
<b>NEW</b>	■ LokSound V4.0 - The reference.....	34
<b>NEW</b>	■ LokSound micro V4.0 - Small looks, big performance.....	36
	■ LokSound V3.0 M4 - Brings your locos to life.....	38
	■ LokSound XL V3.5 - Big sound for big engines.....	39
<b>NEW</b>	■ LokSound V4.0 - Available sounds ex works.....	40
<b>NEW</b>	■ LokSound micro V4.0 - Available sounds ex works .....	43
	■ LokSound V3.0 M4 - Available sounds ex works.....	44
	■ LokSound XL V3.5 - Available sounds ex works.....	46
	<b>LokPilot</b> .....	<b>49</b>
	■ LokPilot V4.0 - Drive better with the 4th!.....	50
	■ LokPilot V4.0 DCC- Future built-in .....	51
<b>NEW</b>	■ LokPilot micro V4.0 - PowerPack exponent Four.....	52
<b>NEW</b>	■ LokPilot micro V4.0 DCC - Real power packs.....	53
	■ LokPilot digital sets .....	54
	■ LokPilot digital sets 21MTC.....	55
	■ LokPilot Basic - More than just simple .....	56
	■ LokPilot V3.0 M4 - The all-round talent.....	57
	■ LokPilot Fx V3.0 - There's a lot to switch .....	58
	■ LokPilot Fx micro V3.0 - Small and practical.....	59
	■ LokPilot XL V3.0 - Power pack for outdoors .....	60
	■ Technical data - Overview LokPilot decoders.....	61
	<b>Accessories</b> .....	<b>62</b>
<b>NEW</b>	■ PowerPack for LokPilot V4.0 & LokSound V4.0 .....	62
	■ Change over of skis .....	62
	■ 21MTC Adapter board.....	63
	■ 21MTC Adapter board 2.....	63
<b>NEW</b>	■ Adapter board for PluX12,16,22 .....	63
	■ Thin cables & cable harnesses, permanent magnets .....	64
	<b>LED interior lighting sets for passenger cars</b> .....	<b>65</b>
<b>NEW</b>	<b>Loudspeakers</b> .....	<b>66</b>
	<b>LokProgrammer</b> .....	<b>68</b>
	<b>Decoder Tester</b> .....	<b>70</b>
	<b>ESU Decoders - Comparison chart</b> .....	<b>71</b>

# Editorial



Dear ESU Fans,

This year's upcoming UK royal wedding already looms on the medial horizon. While royalist fans from all over the world look forward to the forthcoming marriage of Prince William and Kate, we don't want to

be at the back of the queue and may now inform you about some very important new ESU products.

Of course, we'll come straight to the point and would now like to present you with our highlight for this year. The **LokSound V4.0 Decoder** supersedes our successful LokSound V3.5 decoder. Since its introduction the LokSound V3.5 has been convincing model railroaders with super-realistic sounds, great lighting effects and excellent motor control. Countless locos all over the world equipped with a LokSound V3.5 decoder run their laps effortlessly and reliably.

We took our time with the introduction of the new LokSound decoder to be able to prepare it thoroughly with all the functions you expect from us as the inventor of the LokSound decoder and as the world-wide leading expert for model railway sounds. Therefore the LokSound V4.0 is now able to play super-realistic sounds simultaneously via 8 sound channels.

The new amplifier is up to three times louder than its forerunner. The sound storage is twice as big. The new flexible sound schedule allows prototypical sound sequences when used with the new Function Mapping, without any compromises. Now your three-cylinder locos are even more realistic.

Diesel-Hydraulic and Diesel-Electric locos to benefit from the LokSound V4.0 decoder, the turbocharger can be played separately from the Diesel motor and thus sounds even more realistic. The volume of each sound can be adjusted individually to suit your taste, but that is not all!

Finally, thanks to **RailComPlus®**, the LokSound V4.0 will be automatically detected by your DCC command station. From now on, the inconvenient typing of loco names and loco data belongs in the past. You will find out more about this remarkable function on page 30.

Aside from that the load control of the decoder has been considerably improved.

For the LokSound V4.0, ESU will edit the whole range of sounds to push the decoder's additional limits and impressively convey the ESU LokSound to be the reference for good sound!

The **LokSound micro V4.0** perfectly matches the quality of its big brother, the LokSound V4.0. Our new decoder for N- and TT-Gauge locomotives is not only considerably smaller than its forerunner but also significantly louder allowing a much better sound experience with the very small N-,TT-gauge loudspeakers.

Both decoders will be available in all contemporary plug and interface versions such as 6-pin, 8-pin, 21MTC and PluX12 as well as the brand-new Next18.

Introduced in Q4/2010, the LokPilot V4.0 will also be equipped with RailCom Plus® from February 2011 onwards.

We will also introduce a range of new digital N-Gauge decoders with the **LokPilot micro V4.0**. Compared to their forerunners, the LokPilot micro V4.0 decoders are smaller and thinner, however, they still offer the same fantastic possibilities and functions as their H0 brothers and are also detected by a command station thanks to their RailCom Plus® function.

Our **ECoS ESU command station** is an obvious choice. Thanks to a high-resolution colour graphic it is well-suited for the use with RailComPlus®. Hence, the ECoS is the only existing command station that supports the detection of M4 and RailCom Plus®, making it even more valuable than before.

During the last year the ECoS experienced several updates. Beside the new user-defined loco image upload function the ECoS is now able to display a track occupancy detection signal on the track plan.

In middle of 2010, we published our **Loco Icon Bazaar** for sharing self-made loco images as not every model railroader has the time and resources to photograph all of his/her locos. The Loco Icon Bazaar offers the possibility for model railroaders to upload their loco images and thus make them available for other interested model railway fans. In no matter of time the amount of images boomed far beyond 1000! At this point we would like to thank all ESU Community members for their support!

The new **L.net Adapter** should make the change-over from substantially equipped older systems much easier for their owners.

Last but not least we may warmly recommend you some new accessory articles. Beside the **PowerPack Energy Storage** which allays the fears of all LokSound V4.0 and LokPilot V4.0 decoders from dirty tracks, we would like to bring the **new loudspeakers** to the front .

Also the new **USB adapter for the LokProgrammer**, which now comes with a completely new developed software by the way, as well as a **Plux12 adapter board** are to be mentioned.

We hope our new products will bring you excitement and pleasure. That is what it's all about. After all, model railroading is your hobby.

Have fun reading!

## The ESU-Team



Loco Icon Bazaar

# ECoS Command Station

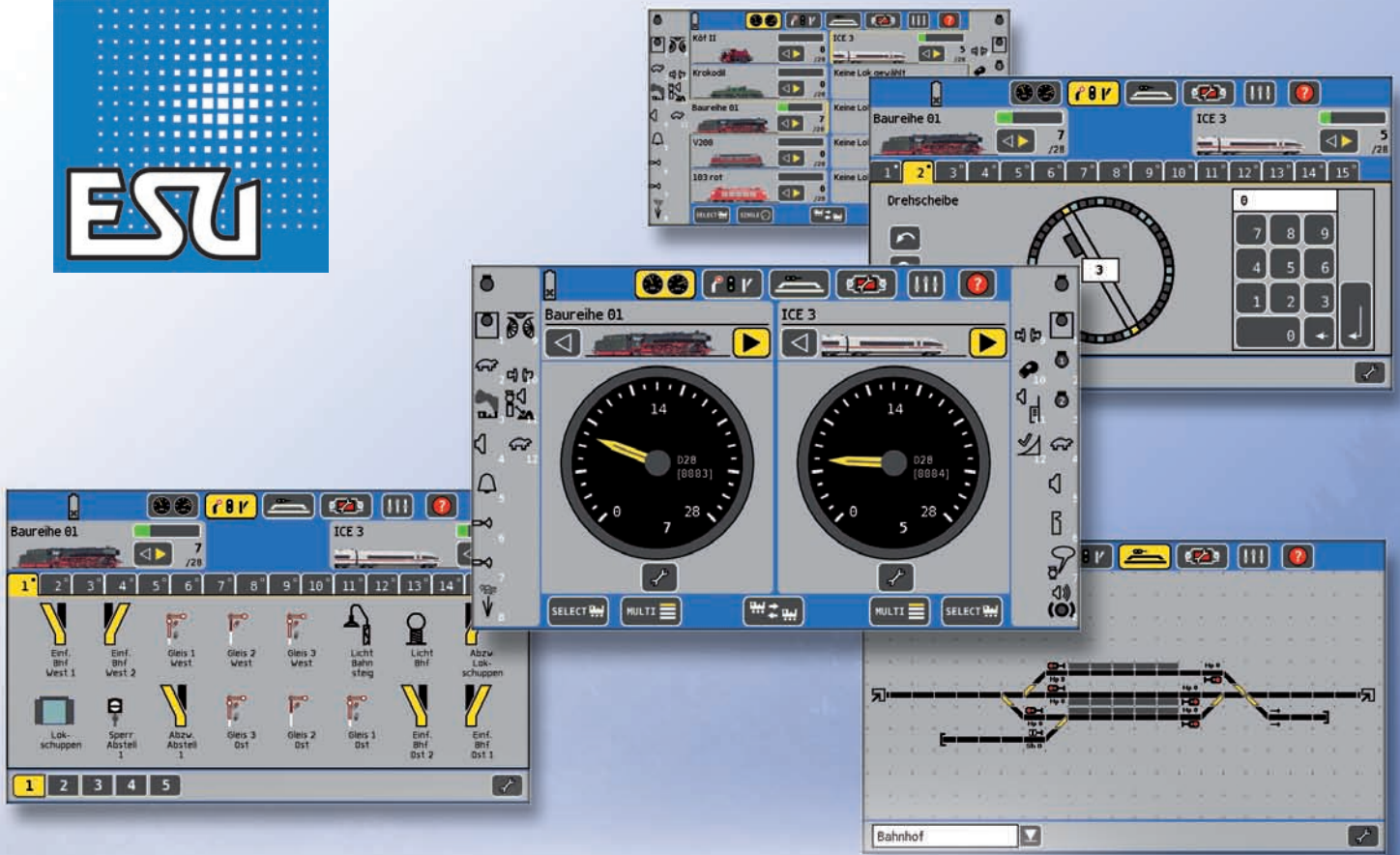

## ECoS – Just Play



- ▶ The ECoS 50200 is already the second generation of our successful ECoS command station. With the latest ECoS command station, ESU continues to offer state-of-the-art digital technology combined with contemporary functional range and easy handling all this for a fair price-performance ratio, since 2006.

The ECoS has - like most of the recent central stations - a large, touch-sensitive coloured display with high resolution. In combination with its ground-breaking and easily operated user interface and excellent contrast values of the coloured screen, ECoS reaches unprecedented ergonomics: unlike all the other central stations, the ECoS can be also operated without a stylus - all symbols and writings are hugely marked and clearly structured.

ECoS has 9 function keys per integrated cab. The light-, and function keys 1 to 8 show the current state of the function via LEDs.

Discover the fascinating possibilities of the ECoS command station on the following pages. But take heed: ECoS performance is so good, that even we had to re-read a few passages to believe it!

### What ECoS can do

With an ECoS command station you acquire an open system. As is expected of ESU, from the beginning we wanted to be open to, and compatible with, present systems and norms. Just like our decoders, the ECoS is a real multi-protocol command station.

As a multi-protocol command station, ECoS supports DCC, Märklin® Motorola®, Selectrix® and the M4 data protocol. M4 drives and controls locomotives equipped with mfx® decoders without any restrictions. M4 is completely compatible. You can even continue to use almost all of your present loco decoders. ECoS is therefore the only digital command station worldwide that unifies 4 data protocols.

With an ECoS you can run locos: via two integrated cabs with large, easy-grasp motor driven (!) throttle knobs and 9 precise click-function keys you control your locos. In combination with the touch screen, you can control up to 22 functions per engine.

ECoS controls turnouts and magnetic accessories: a large, graphical control panel provides you access for up to 1200 turnouts (DCC or Motorola® protocol).

With ECoS you can plan and control routes: simply put turnouts and magnetic accessories graphically in groups and switch them together. Routes will be activated either by feedback contacts or by key. You can even use s88 occupancy detectors or ECoSDecoder feedback modules.

With ECoS you can operate shuttle trains very easily: put a rail contact at both ends of the track and ECoS will do the rest.

The ECoS built-in booster has so much power that, in most cases, you don't need additional ones.

ECoS supports ECoSlink, a high-speed bus system, based on CAN, that transmits data instantaneously to the command station.

With ECoS, never before has it been so simple to program your decoders: the large, colored TFT screen offers good contrast and displays a lot of information in unabbreviated text. A programming track establishes contact with your decoders.

Of course, the ECoS has a pre-installed DCC RailCom® and RailComPlus® function: with its „global detector“ it recognizes RailCom®-compatible decoders (e.g. our LokPilot V3.0 decoder) directly on the main track. You also have the possibility to feedback the turnout position via the SwitchPilot to the ECoS command station.

Furthermore ECoS also supports the simplified start up with RailComPlus®, you do not need to think about your loco's address or its allocation of function keys anymore, the ECoS will do this for you.

ECoS is compatible. Besides Selectrix®, Märklin®-Motorola®, and M4, ECoS speaks all variants of the DCC-Norm. With the integrated analog controllers (joysticks) you can even control the whistle of LokSound decoders, never before more precisely.

ECoS is expandable. Each ECoS command station sports a network port for connection with a computer. Thus you can update software or use a computer for operation.

### Who needs ECoS?

ECoS is basically the command station for all. Beginners, who are looking for a simple-to-operate cab, will be at home right away: the large, graphic touch screen display shows all information in plain text; in case of doubt use the integrated help function. Never was it easier to switch to digital control. And ECoS runs DC or AC driven trains.

Even model railroaders, who already own a digital command station, should step up to ECoS: next to the extreme simple inputs, and the possibilities for route-and shuttle train programming, you will learn to appreciate the manifold programming features for decoders. You can connect your present equipment to the input of ECoSniffer, and continue to use it: you don't need to discard anything that you want to keep using!

The new L.Net Adapter, which will be available this year allows the bi-directional integration of any device already existing, into the ECoS system.

Due to its enormous output-performance, the ECoS command station is recommended especially for operators of Gauge 1 or G layouts: at last you can run multiple trains without an external booster. Total interplay with our LokSound XL decoders is matter of fact.

### ECoS 50000

We have also good news for all owners of the first monochrome-display ECoS generation: it is understood that ESU is still committed to the device. Both ECoS devices will be developed in parallel and their functional range will be identical. Of course, there will be further updates for both devices.

With this opportunity, ESU assures all ECoS owners a full investment protection: All accessories can be used with both generations of the ECoS.

# ECoS Command Station

## ► Features

ECoS leaves the factory with extensive features: Two cabs with motorized throttle knobs and 9 function keys each, plus a two-axis, center-click joystick each. With it, you can blow the whistle of the LokSound V3.5 and the new LokSound V4.0 decoder, analogically, almost as you would with the prototype. A real and optimally placed loco selection key helps you to select the loco desired.

The large, coloured TFT display shows all information in plain words. There is a touch-sensitive screen that you can work either with your finger, or the provided peg.

Each ECoS command station integrates a 4A-steady-output booster. Conventional model railroad transformers don't have enough power, which is why we supply you with a stabilized 90 VA (!) power supply. The output voltage is adjustable from 15V to 21V. The Power aplenty for your layout!

Decoder programming takes place via a dedicated programming track. This is independent of the mainline and normal operation on the layout is not affected during programming. ESU takes this for granted.

The new ECoSlink high speed bus serves as communicator between systems. The bus can be connected to throttles (e.g. Märklin® mobile station® 60651, 60652), ECoSDetector track occupancy feedback module, Navigator stations, ECoSlink Terminals and other system components. ECoSlink is robust (up to 100 metres cable length is no problem) and extremely fast: Forget all others!

Via the internal extension slot you are able to connect the ECoSControl Radio handheld that has been especially developed for the ECoS command station.

Each ECoS Command Station incorporates a galvanically isolated jack for s88 feedback modules. Track-occupancy information can be used for route- and shuttle train operation.

An ECoSniffer jack is provided for connecting „old“, existing digital command stations. A galvanically isolated jack for connecting DCC-conform boosters tops off the list of ECoS features.

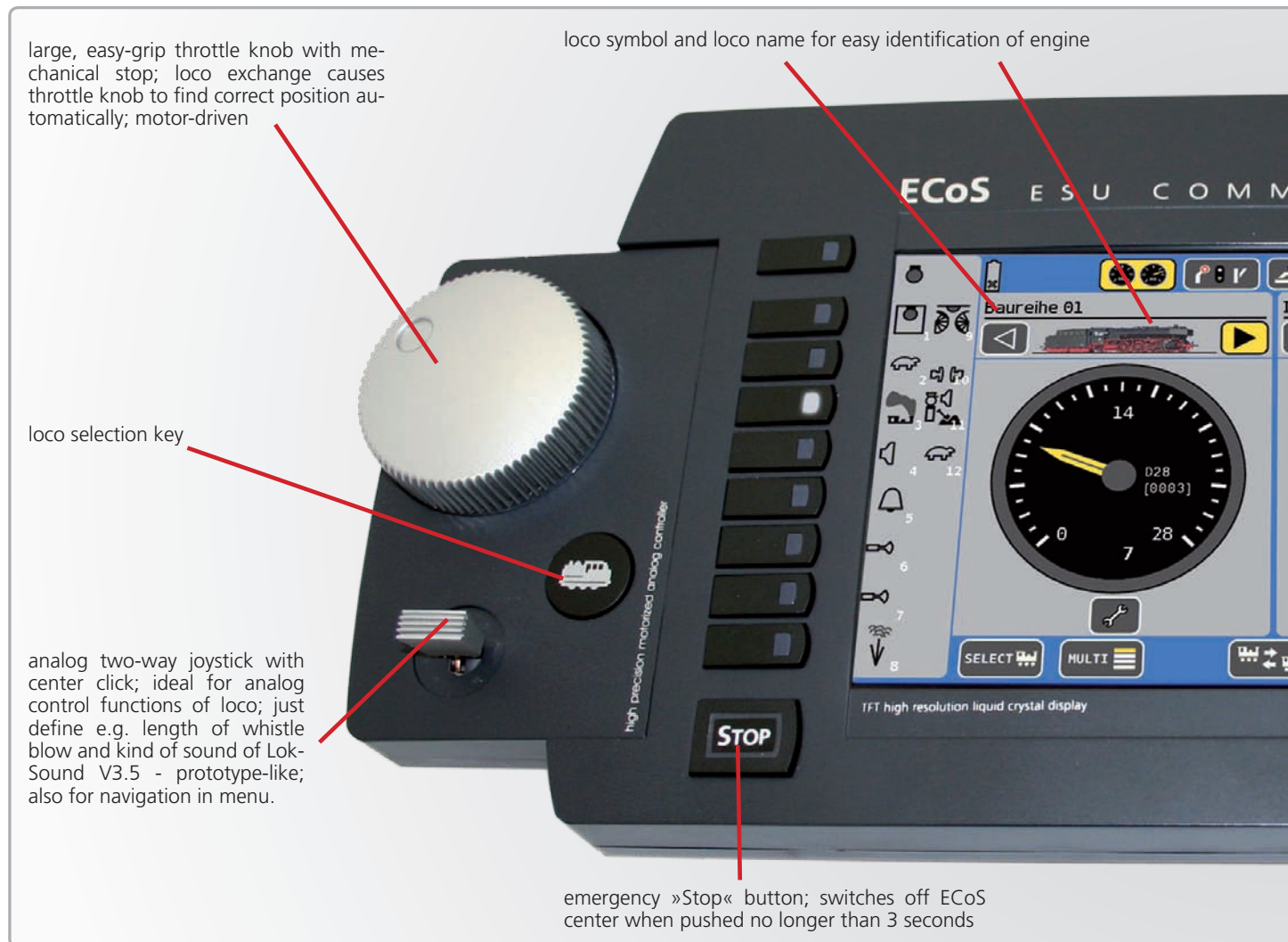

## Functions in detail

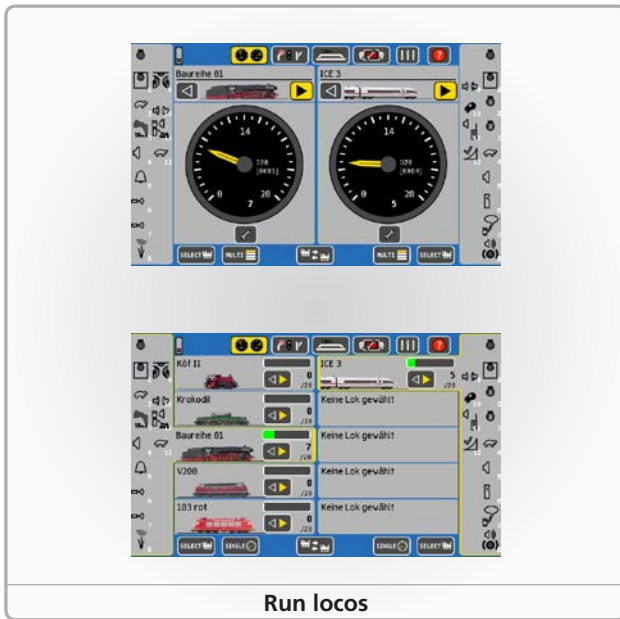

Run locos

### Run locos

The ECoS command station has two control panels on which the locos can be independently controlled of each other. Apart from the large, informative speedometer you may keep up to 10 locos in direct access.

The ECoS command station can manage up to 16384 locos. Each loco's characteristics are memorized, so in the future you can call each engine by name. Also you can assign a loco symbol and these symbols keep you abreast of the function of each loco, regardless of whether it's latching or non-latching. The operation of locos with RailComPlus® and the mfx®-compatible M4 protocol is much easier. Within these operational modes the information between ECoS and loco will be exchanged automatically. Via the ECoS web interface you are able to upload self-made loco icons on your ECoS. A navigation menu with substantial sorting and filtering options make fast finding and immediate control of your locos possible.

Of course, ECoS supports all DCC addresses (upt to 9999) and 128 speed steps, during Motorola® operation up to 255 addresses and 27 speed steps are possible, depending on the decoder's features. Locomotives equipped with an mfx® decoder will be recognized automatically by the ECoS and can be driven without any restrictions.

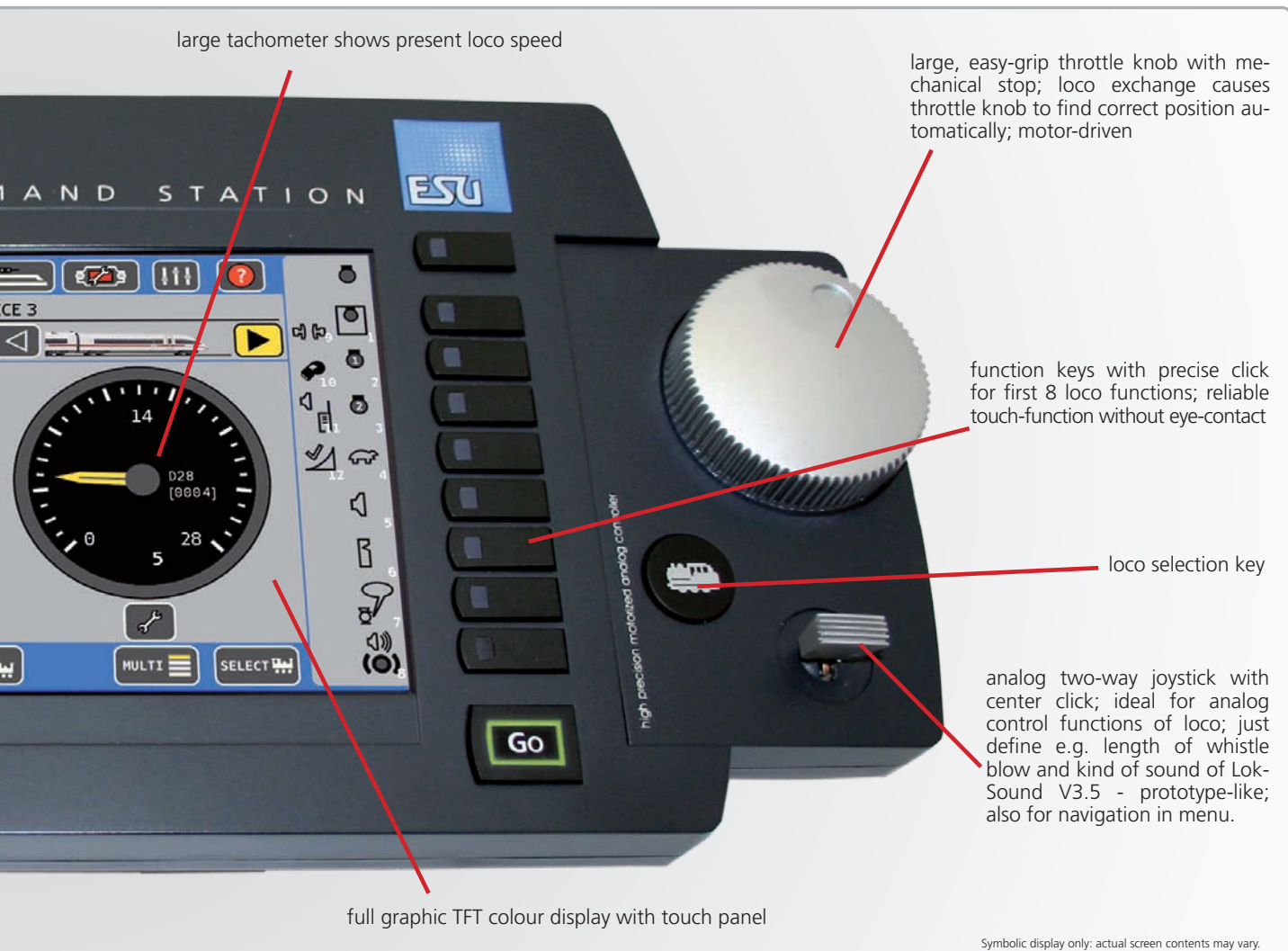

large tachometer shows present loco speed

large, easy-grip throttle knob with mechanical stop; loco exchange causes throttle knob to find correct position automatically; motor-driven

function keys with precise click for first 8 loco functions; reliable touch-function without eye-contact

loco selection key

analog two-way joystick with center click; ideal for analog control functions of loco; just define e.g. length of whistle blow and kind of sound of Lok-Sound V3.5 - prototype-like; also for navigation in menu.

full graphic TFT colour display with touch panel

Symbolic display only; actual screen contents may vary.

# ECoS Command Station

## Functions in detail



### Operate turnouts and magnetic accessories

Just like with locos, you can name turnouts and magnetic accessories. The large signal box on the screen of your ECoS shows you all turnouts and their switch-position.

You can put turnouts in the depot area and to each magnetic accessory you can assign its exact function, so you can tell simple-, double or 3-way turnouts apart from de-coupler tracks or even streetlights, etc.

If you use a RailCom®-compatible turnout decoder like e.g. the SwitchPilot, it is possible to synchronize the actual turnout settings with those displayed on the ECoS. If the turnout isn't set correctly, it will be shown on the control panel.



### Turntable control

It is possible to control the well-known Märklin® turntables graphically with the ECoS command station; ECoS is able to control the specific Märklin® decoder directly. If you do not wish to use this decoder, you can simply convert your turntable via a LokPilot V4.0 decoder. We offer a substantial manual that describes how to do it on our website.

When it comes to turntable control the ECoS is not limited to one turntable alone, theoretically you may create up to 75 turntables.

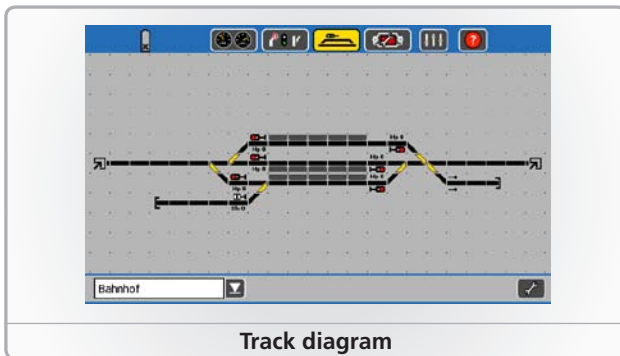

### Track diagrams

By drawing a track diagram on the screen you can represent the topology of your layout graphically. You can switch any turnouts or signals simply by touching the appropriate symbol. Even larger layouts can be displayed on the 16-page track diagram by using the link element, you can directly switch between connected pages of the track diagram. To make the allocation simple you can give each page its own name.

The accessories shown in the track diagram correspond in function and state (track-switch position) with the signal box, so that a new data entry or configuration of the accessories is not necessary. It is also possible to link elements with feedback outputs, by doing so you will quickly recognise in the track diagram, which tracks are occupied.

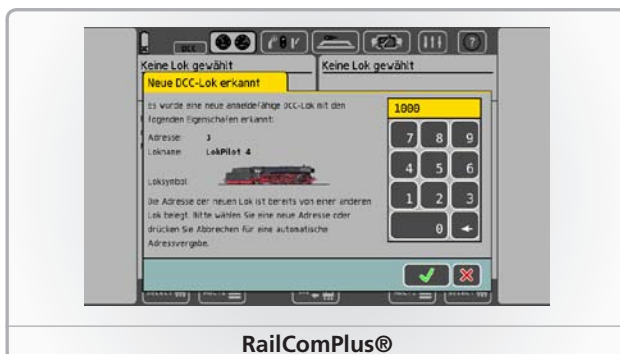

### RailComPlus®

With the support of the RailComPlus® function the ECoS command station offers a yet unprecedented level of comfort when operating RailComPlus®-compatible DCC decoders.

If you put a new loco equipped with a RailComPlus® decoder on the track, the ECoS will recognise it immediately and take over the decoder's saved parameters for name, function symbols and loco symbol. You do not need to change any of the loco's configuration, therefore it has never been easier to operate DCC decoder.



## Functions in detail



Decoder programming

### RailCom®

The ECoS is already prepared for the „RailCom®“ standard: the ECoS is not only able to program and memorize RailCom® decoders but can also show the exact turnout position of Switch-Pilot decoders.

Any further RailCom® functions will be developed in close cooperation with the RailCom® licensor (Lenz® Electronic, Gies-sen).

### Decoder programming

Thanks to the screen, programming decoders is as simple as never before. All parameters are shown in plain text. The search for / of CV's and bits and bytes is a thing of the past.

Of course you can call up and check all features of your decoder (during operation on the layout) on the main. POM (programming on the main) makes it possible! But also programming on the integrated programming track is fully supported by the ECoS command station.

If you prefer to program the CVs of your decoders directly, the ECoS offers you an appropriate solution, via the comfortable programming menu you get direct access to all CVs, either by POM or programming track. Also switch accessory decoders can be programmed this way.

The addresses of your old Motorola® decoders are ascertained automatically - never again do you have to take your engines apart and check the DIP switch...



Create and upload loco images

### Self-made Loco Images

Via the integrated web interface it is not only possible to create back-ups, to display and download object list or upgrade your software with regularly published updates. Further to these functions you are able to transmit self-made loco icons to your ECoS command station.

We provide substantial how-to-do manuals on our website that will surely make you succeed creating your own loco images!

Furthermore you are able to upload your loco icons online and add them to the ESU Loco Icon Bazaar, which has been developed especially for this purpose, namely to share your images with other ECoS users. Of course, you may also download the images of other users as well for use on our ECoS. The ESU Loco Icon Bazaar already includes far beyond 2000 different loco images!



Loco Icon Bazaar

### Routes

Several magnetic accessories can easily be grouped as routes. Routes can then be switched like singular turnouts or they can be tied to an occupancy detector: Thus extensive block-control management is possible already. ECoS can manage up to 1024 routes with up to 256 magnetic accessories each.

# ECoS Command Station

## Further functions & Technical data

### Shuttle train control

Shuttle train control, which was introduced with the first ECoS, enjoys an increasing popularity due to its simple handling: here you only need an occupancy detector at each end of the track, which you assign via Software to a loco: length of layover, acceleration - and deceleration, or in-between stops can easily be programmed on the ECoS screen. This works with any decoder because the brain of the system sits in the central unit. Up to 8 shuttle trains are possible.

### Keep using old systems

We make your transfer to ECoS as comfortable as possible: simply keep also using your "old" system. This is made possible through the built-in ECoSniffer: The rail output of your present digital command station is simply connected to the input of the ECoSniffer module. The module listens to all DCC and Motorola® packets and translates them for the ECoS command station. This again treats your old system like one (or more) additional throttles or keyboards.

### Technical data ECoS 50200

Hardware:	H4 booster with 4.0 A continuous-load output; RailCom® bidirectional feedback detector with integrated cutout device ("global detector"); H4 programming track connection, 0.6 A rated
	7 inch TFT colour display with touchscreen, 800x480 (pixels) display resolution
	32-Bit ARM 720T controller, 64 MByte flash ROM, 32 MByte RAM, Linux® operation system; 16 Bit real-time co-processor
	2 motor-driven potentiometer throttles with end stop; two 2-way analog joysticks; two 9-function keys plus stop- and go-key
	3 input sockets for ECoSlink systems; connection for ECoSlink bus expansion
	Galvanically isolated booster input for external DCC or Märklin® 6017 boosters; galvanically isolated ECoSniffer input for connection of old units
	Galvanically isolated s88-bus input for feedback devices; 10/100 Mbit ethernet connection (RJ45)
	1 ECoSlot module for radio-receiver input
Software:	DCC with 14, 28, 128 speed steps, LGB® compatible function key handling; RailCoM®
	Märklin® Motorola® old, new, with 14 or 27 speed steps (2 modes, depends on availability of decoder)
	Selectrix® track format; M4 data protocol with automatic recognition
	Up to 9999 addresses for DCC protocol. Up to 20 function keys per loco; up to 255 addresses for Motorola® protocol (depends on availability of decoder)
	Märklin® Motorola® and DCC track protocol for control of electromagnetic accessories
	Up to 16384 locos, 2048 turnouts and 1024 route objectives; 32 MU's (multiple consists) with up to 16 locos each; up to 16 shuttle trains (back'n forth) at the same time
	All DCC service modes programming on programming track, POM (programming on the main). Programming of Motorola® and Selectrix® on programming track.
Included in delivery:	ECoS central unit; stylus for touch screen, power supply output voltage adjustable from 15V to 21V / 5A (90VA); terminals for mail track and programming track connection, ECoSniffer; extensive instruction manual

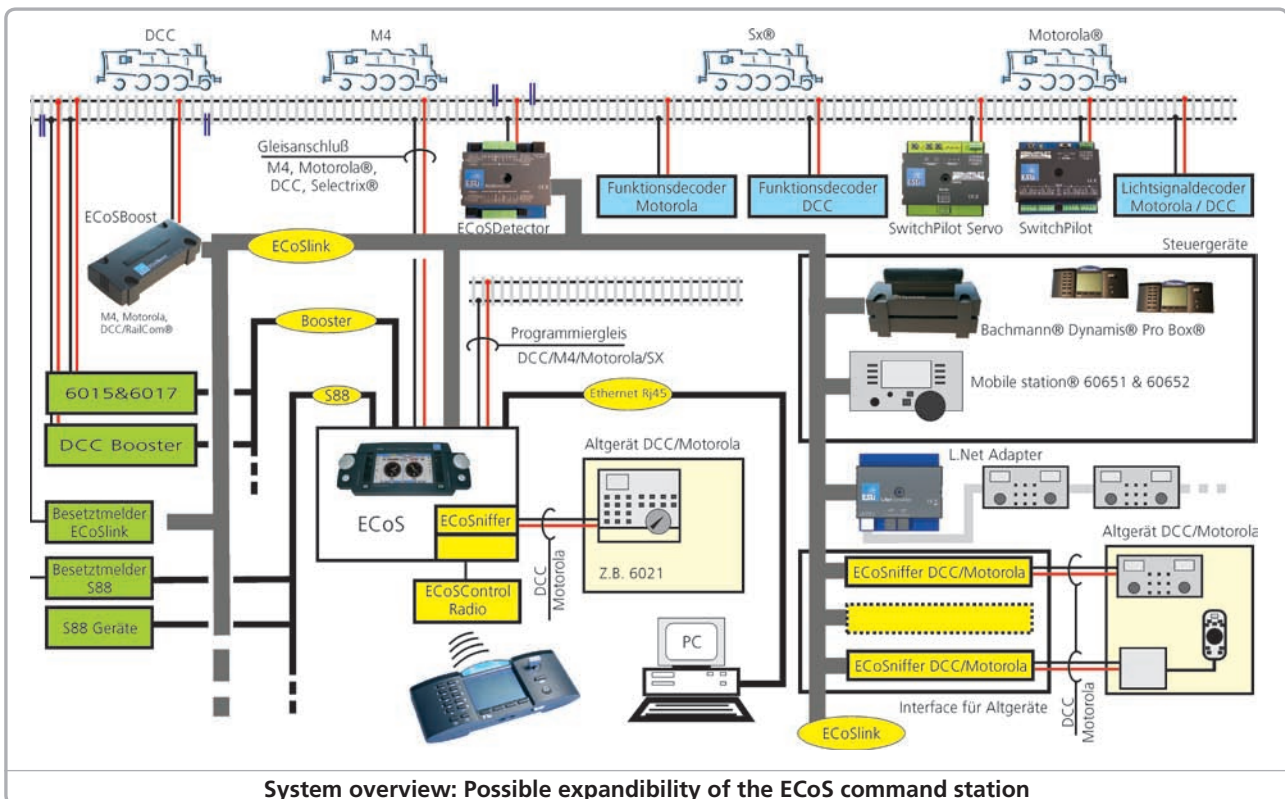

### Ordering information

50200 ECoS 2 digital command station, 7" TFT colour display, MM/DCC/SX/M4, set with power supply input 240V EU, output 15V-21V, German + English manual

# Expandibility

## ► ECoSControl Radio

ECoS is well prepared for the application of our wireless ECoS Control Radio remote control unit: A special receiver card fits into a module terminal, called ECoSlot. The ECoSControl Radio integrates perfectly into the ECoS-system and acts like a fully featured cable-bound throttle.

## Booster

Of course all DCC conform boosters can be connected to the ECoS command station: There is a corresponding socket. Also, the widely known Märklin® 6017 boosters (or compatible products) can be used.

Alternatively, you can decide on the separately available ECoS booster, which connects directly to the ECoSlink bus: As a matter of fact, it incorporates a RailCom® detector, so you can use their great features. The integrated M4 feedback function makes it possible that Märklin® locomotives with mfx®-decoders are recognized in the booster area.

Each ECoSBoost is controlled and configured most comfortably by the ECoS. Additionally, the display can be dialled up to show you the present power consumption of each booster, so you know how much „reserves“ you still got..

## Feedback

ECoS offers a factory built-in galvanically isolated (!) s88 feedback interface for the very popular s88-modules. They serve as track occupancy detectors and may be used for controlling routes and shuttle train operations. An integrated s88-Monitor helps during the set-up and testing of your feedback modules. In addition to this occupied tracks can be displayed within the ECoS track diagram.

## ECoSDetector feedback modules

If you do not want to use the s88 system anymore or even replace it, the ECoSDetector is the perfect choice. It finally makes a reliable track occupancy detection possible. Beyond this, it recognizes, in combination with a RailCom® compliant decoder, any loco on the controlled area.

## L.Net Adapter

With the L.Net Adapter you can already existing handheld throttles and feedback modules fully and bi-directionally integrate in the ECoS system. Thus nothing more should stand in the way of using Daisy@-, Fred@- or ProfiBoss® handheld throttles!

## Dynamis® Pro Box

The Dynamis® system, which has been cooperatively developed by ESU and Bachmann®, offers an attractive possibility of expansion. This infrared based system can be connected to the ECoSlink bus via the Bachmann® Pro Box (available from Bachmann®).

Your ECoS provides up to 4 infrared transmitters, with which you are able to control up to 40 locomotives with 20 functions each, as well as magnetic accessories. The booster output can be used additionally.

## ECoSlink

Our bus system ECoSlink allows the extension of your ECoS command station. You may connect 128 external handheld unit throttles (e.g. Märklin® mobile station® 60651, 60652), ECoSDetector feedback modules, ECoSBoosters and other extensions.

ECoSlink is based on the CAN industrial standard, is suitable for a maximum cable length of 100 metres and provides excellent data transmission. ECoSlink operates with 250 kBit / second and is „hot-plug“ and „plug&play“ capable. All devices report automatically to the system and can be removed or reconnected during operation.

## Mobile Station®

The most well-known device compatible with ECoSlink is the mobile station® of Märklin®. You are able to control up to 10 locomotives with the mobile station®.

## Computer interface

The computer interface (according to RJ45 Ethernet standards) enables you to download updates, to save and recall all ECoS data on your PC (back-up). Above that, you are able to control your layout by a computer with the help of external controlling software or to have transferred the screen content to a computer.

## Support

For ECoS, we established an special internet support forum: Discuss your questions and ideas with other users and our support team and share your experience and knowledge with others. Go to [www.esu.eu/en/forum](http://www.esu.eu/en/forum) for further information.

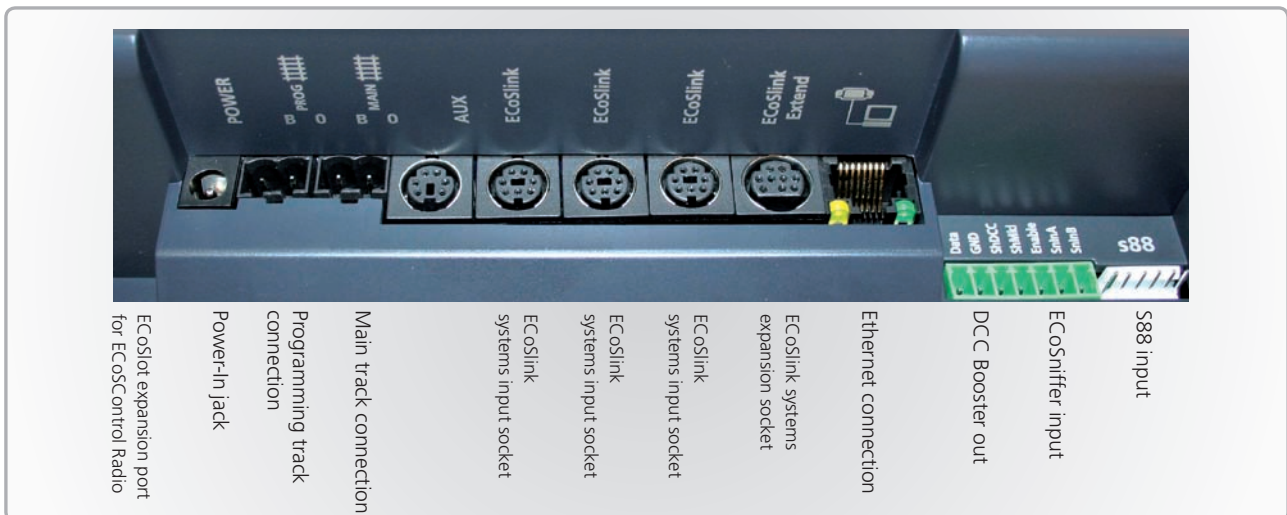

# ECoSlink Terminal

## ECoSlink Terminal - The distributor



### More distance

If more than one ECoSlink Terminal is used, the terminals can be connected to each other with standard Ethernet patch cables with RJ45 connectors. These patch cables can be purchased in any computer store in any length.

### More organisation

Each ECoSlink Terminal is usually at the front panel of the layout installed: Only the front panel is visible. This reduces the cable clutter under the layout.

### More flexibility

The ECoSlink Terminal can be used on ECoS and Central Station®. The CAN bus is only passively distributed together with the supply and booster cables and the termination is ensured. The function is transparent for the digital control unit. Since an interference in the communication of the bus does not take place, thus alone decide the control unit and the connected devices whether they will work together.

- ▶ If your train layout is growing and you need additional ECoS-Boost boosters and ECoSDetector feedback modules to connect to your ECoS command station, and you are running out of connectors, you should buy the ECoSlink Terminal.

### More room

The ECoSlink Terminal will be connected to the ECoS or Central Station® via the provided bus cable to the „extend“ jack. It offers on the front panel two jacks for hand controllers (e.g. mobile station®) and at the back four sockets for devices mounted under the layout. These include mainly ECoSBoost booster and ECoSDetector feedback modules.

The ECoSlink Terminal can provide power to all attached devices either from the ECoS power supply, or for a section from an external power supply through the ECoSlink themselves.

This is especially useful for larger systems with many hand controls, boosters and feedback modules.

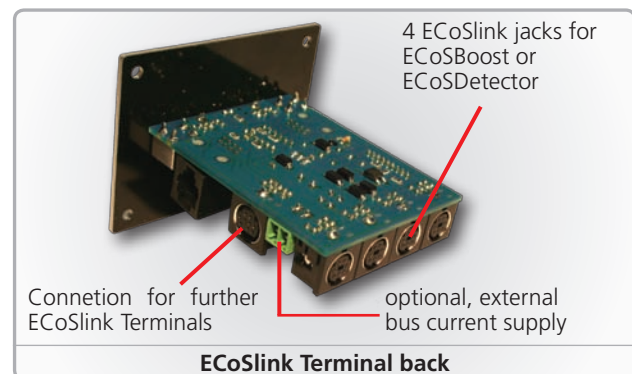

## Ordering information

50093 ECoSlink Terminal bus distribution plate, 6 slave jacks, with 0.9m cable

# L.net Adapter

## L.net Adapter – The Integrator



- ▶ The great variety of the ESU ECoS command station is so convincing to many model railroaders that they would like to replace their present digital station with an ECoS. This also has been inspiring the desire to continue to use the existing handheld throttles and feedback modules. The ECoSniffer input offered at least a solution for handheld throttles (in combination with „older“ digital command stations), whereas the feedback modules couldn't be integrated into the system.

For the first time, it is possible to connect Uhlenbrock® or Digitrax® handheld throttles directly to the ECoS or Central Station 60212 „Reloaded“, thanks to the ESU L.net Adapter. Additionally, you can continue to use or integrate the infra-red Lissy® devices as well as feedback devices which support the well-known Loconet® communication protocol. So, what can the L.net Adapter do now?

### Handheld throttle throughout

With the L.net Adapter you are able to operate Loconet® compatible handheld throttles directly with your ECoS. Hereby, the handheld throttle's display will always stay synchronised with the ECoS. Furthermore there is no restriction to one data format. You can control an unlimited number of locos speaking DCC, Motorola®, Selectrix® or M4®, even if the handheld throttle alone does not have the capability to do this.

Particularly in Germany the popular Daisy®, Fred®- or Profi-Boss® handheld throttles can be used, as well as e.g. DT400 or UT2 by Digitrax®.

The L.net Adapter fully integrates them into the ECoS system. Via the ECoS you are able to assign the locos desired and call them up on the handheld throttle; or respectively use the easy-to-handle Fred® handheld throttles to assign the loco desired conveniently to the ECoS.

### Feedback modules

You might already have Loconet® feedback modules for track occupancy detection. With the aid of the L.net Adapter you may now continue to use those devices. The ECoS allows you to use the contacts for activating routes or shuttle train control.

Of course you can simultaneously use s88, Loconet® and ECoS-Detector feedback modules.

### Communication

Just larger layouts are operated with the support of a PC. Often there is used a self-made software, which has been optimised for Loconet®. The switch to an ECoS system which comes as an innovative and object-based communication model is thus quite rocky. However, the L.net Adapter will solve this problem. From now on, the ECoS will send loco and turnout commands as well as feedback occurrences via the L.net Adapter to the devices connected.

The intelligent ESU L.net Adapter allows you finally to replace your »old« command station completely with an ECoS without great effort.



Connection example of handheld throttles (schematic)

### Ordering information

**NEW** 50097 L.net converter to connect handheld throttles and feedback modules to ECoS or CS1 »Reloaded«

# Navigator

## Navigator - Wireless railroad pleasures



- ▶ At this point we present to you our new Navigator system. This digital command station was developed for model railroaders who operate a small or a midsize layout and who do not want to abandon contemporary control techniques.

Thanks to its bi-directional infrared technique, the Navigator allows wireless control of your locos!

### Run locos

The Navigator controls up to 40 locomotives; locos speaking DCC or Motorola® are appropriate. Depending on the decoders' abilities, the Navigator switches up to 21 functions per locomotive and is able to handle up to 9999 addresses (up to 255 addresses are possible during Motorola® operation).

Of course every loco can be named and assigned individually with an adequate symbol.

### Multiple consists

You can also drive multiple consists with the Navigator; up to 6 locomotives can be moved at the same time. During consist operation access to the functions of each loco is granted - at any time; e.g. you are able to activate the horn of the leading loco.

### Switch magnetic accessories

As is expected of a modern digital command station, the Navigator also switches your magnetic accessories and turnouts. It doesn't matter whether you still use the original Märklin® k83 or k84, or the SwitchPilot which is compatible to it; you

may construct up to 100 magnetic accessories on your layout and switch them. The Navigator handles Motorola® and DCC decoders.

### Locomotive settings

Sometimes you cannot avoid changing the settings of your decoders during digital analog operation. The Navigator supports you with the programming of the decoders via its clearly structured operation interface.

All CVs of DCC decoders can be read and changed on the programming track. If you use programmable Motorola® decoders (e.g. Märklin® mfx® decoders), you are able to change all appropriate registers (01-80) without any difficulty.

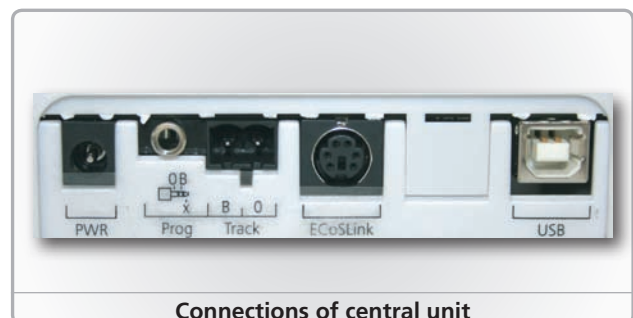

## Features and operation

- ▶ The Navigator is comfortably equipped to ensure you the most enjoyable control of your locomotives.

### Remote control unit

The Navigator remote control unit communicates via a wireless infrared technique with its receiver (the central unit). As long as you are within a radius of approximately 22 feet of the receiver you will be able to reliably control your layout. The wide-angle optic-infrared communication will take care that you only have to produce a visual contact; you do not need to target the receiver.

The advantageously shaped and well-balanced body with a centered back-lit (FSTN) display allows you direct access to the speed and the first ten functions of the selected locomotive. With the unique „joystick“ you control the locomotive's speed with your thumb. The Navigator is operated with AAA batteries and can be worn around the neck using the provided strap.

### Central unit

The receiver unit includes a complete central unit together with a booster for the main track connection, a programming track output, and a computer interface. An ECoSlink connection is already provided for a subsequent connection of the ECoS command station.

On the main track output, the Navigator offers enough reserves for driving lighted trains, due to a 3.0A load output. A smooth operation of your layout is granted by an adjustable power supply, whose output current is stabilized and suitable for all gauges.

If you wish to read or reprogram your decoders, just drive them onto the accessible programming track. The Navigator can be connected to a PC via the USB computer interface; thus you are able to directly control your locomotives and turnouts.

### The IR receiver

Usually, the infrared (IR) receiver will be plugged into the central unit. It establishes a connection to the remote control unit, and has to be placed in a reachable position so that a visual contact is provided. Thanks to its special wide-angle optics, it covers a distance of almost 180 degrees.

If the IR receiver and the central unit are to be separated due to space limitations, it is possible to attach an extension cable. You can use all 5 IR receivers to enlarge the operation distance.

### Power supply

Every Navigator system comes with an appropriate power supply. Thus we can assure you the best possible operation. The output current can be set between 15V - 21V via a potentiometer; suitable for the gauge of your layout.

Beyond that, the output current is stabilized. „Blinking“ headlights happening during change of load will be a thing of the past.



Single IR receiver with extension cable



Remote control unit



Central unit back

### Ordering information

50300	Navigator digital system, MM/DCC, wireless infrared, 3A, set with power supply input 240V Euro, output 15-21V, German/English manual
50301	Navigator digital system, remote control unit for extension, including accessories (batteries, strap), German and US version
50303	Navigator IR receiver, expansion set, Retail, DE+US, with extension cable

# Navigator

## Expandibility

- It is, of course, possible to expand the Navigator system, as soon as your demands for the system start to grow.

### Additional remote control units

If you wish to play at your club or with your children or grandchildren, the desire for additional remote control units will arise. You can use up to 4 devices in combination with your Navigator without any restrictions. Every player has access to all locomotives, multiple consists and switches. A dynamic transfer of locos from one remote control unit to another increases the fun to play.

### Additional IR receivers

If you want to use the Navigator on large layouts, or, if there's a „corner“ that interrupts the visual contact between remote control unit and central unit, you can secure or improve the reception with the help of additional IR receivers: the connections for at least five IR receivers is provided.

### ECoS

Should you intend to entrust your layout with our ECoS command station one day, you can naturally keep using your Navigator system: thanks to its pre-prepared ECoSlink system bus connection, the Navigator central unit can be connected with the ECoS.

After doing so, you'll have a further booster for the supply of a current line section available, which can also be wirelessly controlled by the remote control units.

### PC connection

Of course you are able to connect the Navigator to your PC and control your model railway layout - appropriate software is a must.

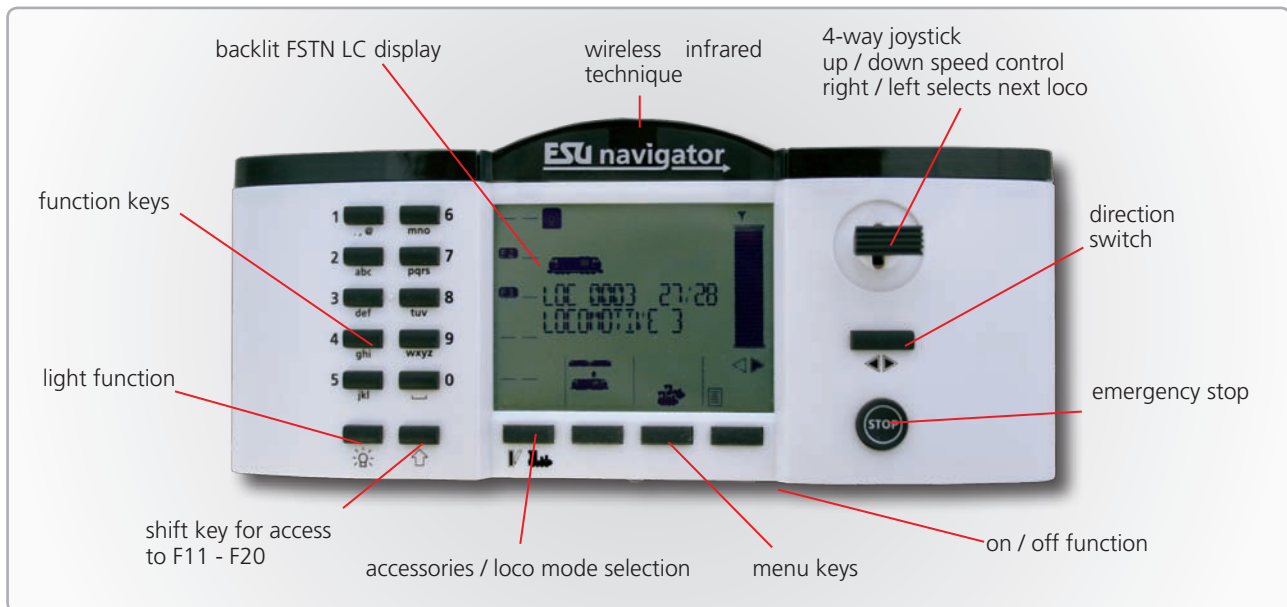

### Technical data Navigator

Central unit	H4 booster with 3.0A continuous output-load H4 output programming track with 0.25A Connection for ECoSlink (slave jack, for ECoS connection) Possibility to connect 5 IR receivers (4 connections for cable extension, 1 direct connection for plug on) USB computer interface Märklin® Motorola® old and new, with 14 or 28 speed steps DCC with 14, 28, 128 speed steps Up to 9999 addresses in DCC operation; up to 21 functions per loco; in Motorola® operation up to 4 + 1 functions Up to 255 addresses in Motorola® operation (depending on decoder available) Märklin® Motorola® and DCC track formats to control magnetic accessories Up to 40 loco objects and 100 switching objects possible. All DCC service modes programming on programming track, POM (programming on the main). Programming of Motorola® decoders on programming track.
Remote control unit	Wireless bi-directional IR communication Backlit FSTN LC display (custom designed); displays name of loco, speed, driving direction, state of function keys 11 function keys + shift key to activate 21 functions each per each 4 menu keys Emergency stop and direction switch key 4-way joystick for speed control and loco selection 2 battery cases for rechargeable batteries (current supply)
IR receiver	Wide range receiver including 5 IR transmitter diodes and 2 receivers Direct connection possible or extension via 8-pin plug cable Wall fastening possible
Included in delivery	IR receiver module, IR remote control unit, adjustable power supply 15V-21V (90VA), terminals for mail track and programming track connection, carrying strap for remote control unit, set of 4 batteries (Alkaline, "AAA"), instruction manual



# Navigator accessories

## Connection cable to ECoS



If you have started your digital career with an ESU Navigator system and because of your increased demands you are now using an ESU ECoS command station or a Central Station 60212 »Reloaded«? You are now able to connect your ESU Navigator directly to the ECoSlink bus.

Your Navigator will receive new software from the ECoS to ensure an integration of the infra-red handheld throttles directly into the ECoS system: Assign the locos desired via the ECoS screen to the Navigator to operate them wirelessly. You may even continue to use the booster of the Navigator central unit.

### Ordering information

**NEW** 50305 Cable harness, 7pin Mini-Din connector to 6-pin Mini-Din connector, to connect ECoSBoost / Navigator to ECoS

## USB cable for PC connection



The ESU Navigator (Extended version, not the Tillig® version) comes with an USB interface for PC connection.

With the aid of this cable, the Navigator can be connected to a PC.

Depending on the production date a firmware update of the Navigators might be necessary to activate the connection to the computer. Further information can be found as always on our website.

### Ordering information

**NEW** 50306 Cable, USB-A to USB-B, 1.0m, for Navigator



# ECoSBoost

## ECoSBoost - Pure energy



► Indispensable components of any large model railroad are amplifiers (here called „Booster“): If the power consumption of all of your moving trains including their functions, car illumination, and function models is larger than the current the central station is able to put out, you have to split up your layout into several blocks, the power for which is supplied by their own booster. The ECoSBoost(er) is designed for precisely that task: It is matched perfectly for the use with our ESU ECoS or the Märklin® Central Station®. The ECoSBoost is being offered in two variants: The 4 Amp version is perfect for HO and smaller, while an 8 Amp version is suitable for the garden railroader. Just like ECoS, each booster comes with its own suitably dimensioned power supply.

### Mode of operations

The ECoSBoost is connected directly to the ECoSlink jack from where it gets its control signals. Basically it is capable of amplifying and delivering to the track these data formats: DCC, Motorola, Selectrix® and M4. Which data format will be put out in a given case depends, of course, entirely upon the command station that's being used and its capabilities:

Therefore the booster, connected to an ESU ECoS, will handle DCC and Selectrix®, while, if attached to a Märklin® Central Station®, it will amplify and deliver Motorola®, respectively mfx® data signals. Thanks to „Plug&Play“, all ECoSBoost(ers) are included automatically into a list of extern ECoSlink components, and can be controlled and configured centrally on the ECoS display.

The correct firmware status is essential to make the ECoSBoost work properly with these command stations: If the interior software is too old, the booster will possibly not be recognized. Please check the system requirements.

### Functions

ECoSBoost amplifies data signals generated by the digital central station, and delivers them to the designated track outlet. Depending upon model, there are 4, respect. 8 Amps continuous current available. Subject to current draw, the 4 Amp version, designed for HO and smaller, can handle up to 10 locos.

ECoSBoost power comes from an included power supply, featuring a stabilized DC output. Each ECoSBoost is controlled and configured comfortably directly by the ECoS: For each booster you can individually determine its max permissible output current. What's more, the display can be dialled up to show you the present power consumption of each booster, so you know how much „reserves“ you still got.

Extremely sensible is the option to tell each booster individually, weather or not to shut down its section in case of a layout short circuit. For example, if you have your switch (turnout) decoders hooked up to a separate ECoSBoost, you can still control your switches reliably in case of a track short.

## Feedback

An ECoSBoost can do more than amplify and deliver track current: Each one has incorporated, as a standard feature, a feedback function (Global Detector) for the NMRA Bidirectional Communication (RailCom®).

With its help, appropriately equipped locos can send back information to the ECoS, as soon as the relevant DCC – norm is adopted. This is immensely helpful in finding the loco's position on the layout or reading out engine data. ECoSBoost reads the data and sends them via the ECoSlink high speed bus to ECoS for further processing.

Operated with a Märklin® central® station® the booster has a similar function: All mfx®-locos, which are energised by the booster, act exactly the same like being operated directly by a central® station®. They will be immediately recognised or will transfer changes in configuration.

## Protection

Each ECoSBoost of course meets the relevant requirements regarding safety and operation on a layout: The track outlet is protected against overload as well as short circuits. Of course ECoSBoost can differentiate between a „genuine“ short, and a momentary current drain when passing over switches or gaps. We place value on the indestructibility of the device, just like we do with our mobile decoders.

## Future built-in

The operational software of each, in an ECoSBoost integrated micro controller can be updated, of course, if need be, and augmented by additional functions: The required upgrade is performed automatically by the ECoS command station, if necessary. No action on your part is required! In this way your ECoSBoost is literally always „up to date“!

## Questions about ECoSBoost

*Is the ECoSBoost suitable for three rail layouts? What do I have to do?*

Obviously you can use the ECoSBoost for three rail layouts too. We recommend you to prevent short circuits at the passing of the dividing point between two sections of track to install a „slider lifter“.

*Is there something special to watch with the use at the Märklin® Central Station®?*

Yes, the software of the Central Station® may need to be updated so that the ECoSBoost can be recognized and configured by the Central Station®. More detailed information can be found in the instruction manual.

*Is the booster able to amplify all different digital protocols at the same time?*

Oh yes, it is. You can choose via the command station the order of the data formats and also which data formats should be used.

*How many ECoSBoost can be operated with one ECoS?*

As up to 128 devices are allowed for the EcoSlink Bus, you could theoretically use up to 128 ECoSBoost devices.

*Does the 8A type really have 8 ampere? Others in this energy class are much bigger!*

Of course, it has. The energy value stated are reliably reached if you use the enclosed power supply. Since the 8 Amp ECoSBoost type can be quite heated up during operation, the cooling is ensured by a temperature-controlled aerator.

*Do I have to send the Booster in to have an update done?*

No. If you purchase an ECoSBoost, you afford a comfortable booster that can be updated. This will happen automatically when you connect it with a central® station® or an ESU ECoS command station. This is why you do not need to send the booster in.

Both the current central® station® and the current ECoS command station include the latest ECoSBoost firmware. To get your ECoSBoost up to date, you should first supply your command station with the latest software. After that all connected devices will be updated automatically.

# M4

### What does M4 mean?

At some points in this catalog you will notice the term „M4“ for the first time and rightly wonder what this might mean.

This question can be answered quite simply: from 2009 forward, M4 is the name of a data protocol that was chosen by ESU to be implemented in their decoders. Decoders with the M4 protocol are one hundred percent compatible with command stations using mfx®. At such stations (e.g. Märklin® Central Station®) they will be recognized automatically and all playing functions are available just like when using mfx®. On the other hand, our ESU command stations using M4 will recognize all (Märklin® and ESU) mfx® decoders without any restrictions and will still work without any problems. As the (mutual) inventor of mfx® we can assure you of this.

In short: the technique stays the same, only the name has been changed.



### Technical data ECoSBoost 4A 50010

Hardware	H4-Booster with 4.0 A continuous-load output. Outputs short circuit proof. Thermal overload protection. Galvanically isolated ECoSlink connection.
	Integrated NMRA DCC BiDirectional feedback detector with cutout device.
	Integrated M4 feedback device (enabled only when used together with Märklin® Central Station®)
Operational modes	To use with ESU ECoS or Märklin® Central Station®.
	Supported protocols (depends from command station): NMRA DCC, Motrola®, Selectrix®, M4
Dimensions	LxWxH 180 x 76 x 40 mm (7.09 x 2.99 x 1.57 inch)
Included in delivery	ECoSBoost with 4.0 A continuous-load output, power supply 18V / 5A (90VA) (from december 2008: output voltage adjustable from 15V - 21V), terminals for track- and programming connection, extensive instruction manual

### Technical data ECoSBoost 8A 50011

Hardware	H4-Booster with 8.0 A continuous-load output. Outputs short circuit proof. Thermal overload protection. Galvanically isolated ECoSlink connection.
	Integrated NMRA DCC BiDirectional feedback detector with cutout device.
	Integrated M4 feedback device (enabled only when used together with Märklin® Central Station®)
Operational modes	To use with ESU ECoS or Märklin® Central Station®.
	Supported protocols (depends from command station): NMRA DCC, Motrola®, Selectrix®, M4
Dimensions	LxWxH 180 x 76 x 40 mm (7.09 x 2.99 x 1.57 inch)
Included in delivery	ECoSBoost with 8.0 A continuous-load output, power supply 18V / 5A (90VA) (from december 2008: output voltage adjustable from 15V - 21V), terminals for track- and programming connection, extensive instruction manual

## Ordering information

50010	ECoSBoost, ext. booster 4A, DCC/MOT/SX/M4, power supply 110-240V, EU+US
50011	ECoSBoost, ext. booster 8A, DCC/MOT/SX/M4, power supply 110-240V, EU+US

# ECoSDetector

## ECoSDetector - Reliable localisation



ECoSDetector

- ▶ Our ECoSDetector feedback modules should be used to automate train operations. Beside the usual track occupancy detection, the train specific identification number can be read. It also enables the implementation of an external track control board.

On larger layouts, the operator would want to determine the actual position of locos and trains. With the knowledge of which track section is currently occupied or of which track is still free in the hidden yard, an automated operation is made possible.

The ECoSDetector is compatible with all ECoS command stations or Central Station@s (providing the Central Station@ has been updated with the Central Station@ upgrade software) and is able to detect up to 16 track sections. Two-rail or three-rail tracks can be directly connected to the module. Beside the 16 track occupancy detectors or feedback sections, each ECoSDetector can also detect a locomotive ID on up to four track sections, providing that RailCom@ decoders are used. If desired, the ECoSDetector functionality can be extended with the ECoSDetector Extension module. When docked to the side of the ECoSDetector, it offers up to 32 outputs, each displaying the status of the track sections with a control light or driving a suitable block signal.

### Detection and feedback

The ECoSDetector is able to monitor up to 16 track sections and reports the presence of a loco (track occupancy). Each of the 16 inputs has a maximum current capability of 3A. The ECoSDetector module also has two separate power inputs, and can be supplied from two separate Booster units.

Opto-couplers are used to provide a reliable detection. Two or three rail operation is easily selected through jumpers.

### Input devices

Up to 16 regular switching devices can also be used as inputs. Reed switches, detection track sections, push buttons or toggle switches can all be connected to the inputs. The information is then processed in the command station.

### Train ID detection

Beside conventional track occupancy detection, each ECoSDetector has the additional ability to monitor four of the 16 track sections for train identification: Via the RailCom@ technique (so-called „local detectors“) you will not only easily find out that there's currently a loco on this track section, but also identify which specific loco it is (train ID detection). However, this only works with RailCom@-compatible loco decoders.

### Smart

With the knowledge of the train specific position, new functions can be implemented, using the route control module of the ECoS command station. For example, you can automatically activate the horn of a loco when it is about to pass a railway crossing or determine which loco is parked in the hidden yard.

It is also possible to de-bounce switch inputs or track occupancy detectors electronically to ensure a reliable feedback in case of unreliable contact or very dirty tracks.

### ECoSlink connection

Every ECoSDetector can be directly connected to the command station via the ECoSlink bus. Beside all ECoS command stations you can also use the Central Station@ (updated with the Central Station@ with software upgrade by ESU). The galvanic isolation of the bus systems and the command station guarantees the best-possible reliable operation and a reliable data transmission to the command station.

All ECoSDetector modules will be detected automatically by the command station and the information integrated in the operation control routine. The configuration of the devices can be also carried out directly with the command station after installation.

### Upgradeable

When needed, the ECoSDetector software can be upgraded to add new functionalities. The command station will perform the required updates completely automatically. This will guarantee at all times that the ECoSDetector remains at the most current technical status.

### Technical data ECoSDetector

Operational modes	Direct bus connection to ECoSlink. Operation with ECoS or Central Station Reloaded V3.0.0. is possible.
Feedback section	16 feedback modules. Configurable by using jumpers as digital inputs (e.g. for contact tracks or reed switches) or as track occupancy detectors (current sensor). Galvanical isolation of feedback modules and command station Max. 3A current load per feedback input
RailCom@	4 of 16 feedback sections can be used as RailCom feedback sections ("local detector"), if desired. Recognition of loco address
Dimensions	86mm x 86mm x 25mm (3.39 x 3.39 x 0.98 inch)
Included in delivery	ECoSDetector feedback module, terminals, ECoSlink bus connection cable, extensive instruction manual

### Ordering information

- NEW** 50094 ECoSDetector feedback module, 16 digital inputs, of which 4 inputs are RailCom@ feedback sections. Digital inputs for 2-rail or 3-rail operation reversible, OPTO
- NEW** 50095 ECoSDetector Output Extension module. For connection of 32 bulbs/LEDs for illuminating track sections or block signals
- NEW** 50096 ECoSDetector Standard feedback module for 3-digit layouts, 16 digital inputs, OPTO

## ECoS Detector Standard (Feedback module for 3-digit layouts)



ECoS Detector Standard

- ▶ The ECoS Detector Standard is made for all model railroaders who look for a reliable and affordable feedback module without needing the expandable functions of the ECoS Detector. The ECoS Detector Standard is primarily meant to be a substitute for the aged s88 feedback modules: modifications on track work wearing are not necessary.

### Detection and feedback

The ECoS Detector is able to monitor up to 16 track sections and reports the presence of a loco (track occupancy). Operation with every 3-digit track is possible, no matter if you have a M-, K-, or C-track.

### Switch inputs

Alternatively the 16 inputs can be used as conventional switch inputs: Connect the reed contacts as well as the contact tracks or switches (and toggle switches) with it and handle the information given with the help of your central station.

### ECoSlink connection

Every ECoS Detector Standard can be directly connected to the command station via the ECoSlink bus. Beside all ECoS command stations you can also use the Central Station® (updated with the Central Station® with software upgrade by ESU). The module will be automatically linked to the command station and also graphically configured.

### Upgradeable

When needed, the ECoS Detector software can be upgraded to add new functionalities. The command station will perform the required updates completely automatically. This will guarantee at all times that the ECoS Detector remains at the most current technical status.

#### Technical Data ECoS Detector Standard

Operational modes	Directly connected to ECoSlink bus. Operation with ECoS command station and Central Station Reloaded V3.0.0 possible.
Feedback section	16 feedback modules as digital inputs (e.g. for contact tracks or reed switches)
	Galvanical isolation of feedback modules and command station
Dimensions	86mm x 86mm x 25mm (3.39 x 3.39 x 0.98 inch)
Included in delivery	ECoS Detector Standard feedback module, terminals, ECoSlink bus connection cable, extensive instruction manual

## ECoS Detector Extension

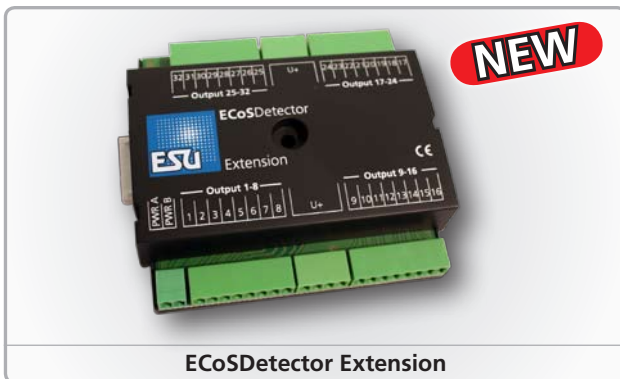

ECoS Detector Extension

- ▶ If required, each ECoS Detector can be supplemented by a ECoS Detector Extension module, which can be easily connected to the ECoS Detector. Every ECoS Detector Extension module offers 32 transistor outputs.

### Outputs

Each one of the 32 outputs provides current up to 100mA max. Since these outputs are conducted as „open collectors“, you are able to connect either small light bulbs or LEDs with current limiting resistor directly to it.

The total current of all outputs must not exceed 1.5A! Any DC or AC transformer (15V - 19V) can be used for supply.

### Track occupancy and block signals

Outputs can be used to display the state of each single-track section externally (e.g. on the track control panel).

Alternatively, you have the possibility to show each track section's state on the display via a block signal (red/green).

The transistor outputs of the ECoS Detector Extension module can be easily programmed within the required operational mode via your ECoS command station.

### Track control panel

However, the combination of the ECoS Detector and the Extension module is capable to do even more: Just go ahead and built your own track control panel! To make this possible, you need to connect push buttons or toggle switches to the ECoS Detector's outputs, which is then able to operate turnouts and routes over the command station.

The transistor outputs of the Extension module are meant for illuminating track sections. The whole configuration procedure can be easily completed on the display of your ECoS command station.

If you wish to built a larger track control panel, you can also combine several ECoS Detector modules. In doing so, you are able to built and control up to 100 track control panels per layout.

#### Technical Data ECoS Detector Extension

Operational modes	Extension module for ECoS Detector, is powered and controlled by it. Transistor outputs are powered externally.
Outputs	32 transistor outputs, 100mA output load each. Construction as "open collector" is connected to ground
	Total current of all outputs is max. 1.5A
Dimensions	86mm x 86mm x 25mm (3.39 x 3.39 x 0.98 inch)
Included in delivery	ECoS Detector Extension module, terminals, extensive instruction manual

# ECoSControl Radio

## ECoSControl Radio - The new freedom



- ▶ Today we are proud to present the ideal expansion for your ESU ECoS command station or your Central Station „Reloaded“ with the ESU Update V3.0.0 to you: The ECoSControl Radio gives you the opportunity to control locos, stationary decoders and routes via state of the art radio communication.

### Freedom through wireless radio communication

The ECoSControl Radio remote control unit is equipped with ultra-modern radio technology that enables it to communicate with a radio receiver. The radio receiver is plugged into the ECoSlot terminal of your ECoS command station or your Central Station „Reloaded“ and the regarding command station powers it.

This modern, fast and duplex communicating radio technology achieves a range that allows a reliable operation of your layout under normal circumstances at any time. Due to its radio technology you do not necessarily need intervisibility between the remote control unit and the radio receiver; radio waves even pervade walls and there is no interference by sun or neon light, whether outside or in the basement.

### Ergonomics and function combined

Once you hold the ECoSControl Radio in your hands you will immediately find that its shape was influenced by ESU's long lasting experience about the design of throttles: Due to its ergonomically engineering you can reach all function keys very easily, the arrangement and marking of the buttons is plausible. A large display informs you about your locos and turnouts. The remote control unit is to handle as easy as your mobile phone.

One unique feature is the thumb joystick. The more it is pushed up, the more acceleration the loco gets. This kind of innovative operation, developed by ESU, can even be controlled blindly: You can concentrate your attention to your layout and locos.

### Interaction

Fantastic possibilities become apparent when you use the ECoSControl Radio remote control unit in combination with your ECoS command station: Since both devices synchronize their data you have to put in the name and symbol of the loco only once and it remains up to date with all units.

The ECoSControl Radio is also able to switch magnetic-electric accessories and routes, whose names, addresses and symbols are indicated correctly on the display. This does also apply to your locomotives, all basic properties such as the name of the loco, its symbol and function key assignment is indicated on the display.

### How to operate a loco

The ECoSControl Radio is capable of controlling up to 100 locomotives. It naturally recognises 14, 28 or 128 speed steps and takes over all settings of the corresponding loco. Each loco controlled by the ECoS command station can also be controlled by the ECoSControl Radio remote control unit, independent of its protocol.

For each of the function keys assigned to a loco you can decide whether it will be latching or non-latching.

## How to switch stationary decoders

All in all you can transmit and control up to 8 ECoS keyboards together with respectively 16 accessories such as turnouts or signals. The difference between 2, 3 and 4 aspect magnetic-electronic accessories will be retained.

## More fun at play

A dot matrix backlit LCD display always informs you about the most important operational parameters such as loco address, loco symbol, speed (in mph or speed steps) as well as function key status.

The ECoSControl Radio indicates if a loco was assigned by another operator or if there is an emergency stop on the layout.

## Extension

You can use up to 6 ECoSControl Radio remote control units per receiver module. In this way every family member is able to control his or her locos independently.



Included in delivery of ECoSControl Radio

## Questions about ECoSControl Radio

### Which radio frequency is used by the ECoSControl Radio?

The device works within a 2.4GHz band. That makes operation both in the USA and Europe possible.

### Do the ECoSControl Radio and the mobile control 50100 handheld work together?

Unfortunately not. Due to its different radio frequency the ECoSControl Radio and the mobile control do not work together.

### Will the mobile control handheld still be produced?

No. The ECoSControl Radio is intended to replace the mobile control handheld completely. However, some remnants might still be available at your retailer's shop.

### Is it possible to use it in combination with other command stations?

The ECoSControl Radio was especially developed for the use with the ECoS command station, respectively for the Märklin® Central Station® 60621 with the ESU update V3.0.0 Reloaded. The use with all other command stations is, unfortunately, not possible.

### How big is the hand controller?

The size is approximately 18.0cm x 7.5cm x 2.5cm (7.1"x3"x1") and is compact enough to be operated even with one hand.

### What is the difference betw. the ECoSControl Radio and the Bachmann Dynamis?

ESU developed the Bachmann® Dynamis®, it uses Infra-Red technology to connect to the receiver, the full functionality system is an affordable DCC-System (incl. Booster) for beginners and users they like to switch to a modern digital system.

The ECoSControl Radio uses radio technology to work as a wireless full function remote control unit with the ESU ECoS.

The remote control unit looks like the Dynamis® but inside the enclosure it is totally different. The display has a full graphics capability and the unit can control more locos and accessories as the Dynamis®.

It is possible to connect the Dynamis® system to the ECoS sniffer port and use it.

### Can I also use rechargeable batteries?

Certainly. The ECoSControl Radio works with both (alkaline) batteries and rechargeable NiCad or NiMH batteries.

With each ECoSControl Radio we will supply a kit of 4 NiMH rechargeable batteries and a charger as well.



## Ordering information

- |       |  |
|-------|--|
| 50111 | ECoSControl Radio remote control unit + receiving module for ECoS, German & English manual |
| 50112 | ECoSControl Radio single remote control unit, German & English instruction manual          |

# Central Station® - Reloaded

## Quo vadis, Central Station®?



- ▶ Looking at the the Märklin® Central Station®, joy and grief are very close together. At the presentation this unit was the most advanced digital controller of the World and a consistent, courageous step of Märklin® and its development partner ESU. Nobody knew if the model railroaders would accept a graphical user interface with a large LCD screen and a touch panel for data input. But these were enthusiastic about the concept and enjoyed on a hitherto unknown game comfort. Talking loco names and icons, an almost unlimited number of locomotives, which got automatically registered by mfx® decoder or graphical icons for magnetic items are standard today, but were actually only with the Central Station® introduced.

### Obstacles in the way

Because the Central Station® is basically a small computer, the system lives of subsequent updates. Many functions of the new world were initially not yet finished and should be retrofitted. This was not the case and the Central Station® owners asked themselves frustrated what are the reasons for this compulsive break. ESU showed afterwards with the ECoS how to continue developing the successful Central Station® concept for the purposes of the customers and showed the public new, inovative ideas. After one finally made the upgrade to version 2.0.4. the development of the Central Station® no longer be pursued.

### New routes

ESU was not able to change the undue state for the customers in the past, but here is the most important message:

The development of the Central Station® 60212 is ensured by ESU. Nobody is forced to write off its investment and to buy new equipment.

### Central Station® - reloaded

On the contrary: According to our philosophy, revalue available devices by new functions, we may explain to you here our imagination for the future of the Central Station®: **The update 3.0.0.**

With this update of hardware and software components your 60212 finally reaches the achievement level which you have always fancied. And completely without costly new acquisitions. Keep your proven controller and take pleasure in many new functions.

### Hardware

To exhaust really the efficiency of the Central Station®, some important devices are immediately included with in the update parcel 3.0.0.

The stabilized **90VA power supply** has more than enough power to feed the integrated Booster. With the new update it is capable of 4A instead of only 2.8A! This increased performance often saves an external Booster completely. The output current can be adjusted within the range of 15V to 21V and therefore works with all gauges.

The **enclosed stylus** makes it easier for you to operate the touch panel.



### Software

With the update 3.0.0 you are helping your unit to a never before known capacity.

After the update the Central Station® will also be able to use the Selectrix® and the worldwide standard DCC protocol in addition to the already known data formats Motorola® and mfx®. All of the **four data formats** can be used simultaneously and individually per loco. Of course, 20 functions can be used during DCC operation. For each loco and depending on the data format you can select between 14, 27, 28, and 128 speed steps. It is possible to also control mfx® locomotives with 28 speed steps.

All DCC decoders can be programmed comfortably of course. Beside all known DCC programming modes a particularly comfortable graphical interface is available for programming ESU decoders. Of course it is a given that from now all solenoid devices can be controlled with the DCC format. Finally, you have the freedom to buy any decoder that is on the market.

The locomotive selection will be made easier thanks to **multiple favorite lists** and different sorting options (Steam, Diesel, Electric). Stay in control even with a large locomotive inventory. With the new **multi-screen driving display** you can directly control up to 10 locomotives. Switching between them is done by a single press of a button.

The **graphical turntable control** simplifies the operation of your turntables.

One of the highlights is the **track plan**. Display an image of your layout on the screen and see the current state of your switches and signals.

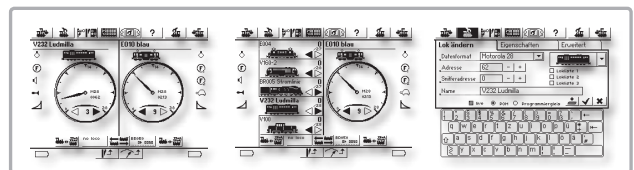

### Ordering information

59990 Update package 3.0.0. for Central Station® 60212, incl. power supply 90VA, stylus, individually created software CD-ROM. **Important: Please do not forget to indicate the serial number!**



## Expandability

Obviously every booster which is conform to the DCC standard or Märklin® 6017-compatible can be connected to the Central Station®. Alternatively, you can also decide for the ESU ECoS-Boost which is directly connected to the ECoSlink: beside the build-in RailCom® two way communication a complete feedback unit is implemented. The Central Station® is intended for use with our ECoSControl Radio handheld controller: a module connector called ECoSlot occupies a special receiver on board. The ECoSControl Radio fits perfectly in the environment and behaves like a fully wired system hand controller.

An attractive expansion opportunity, developed from and with ESU, is the Dynamis® System from Bachmann®. This infrared-based system with the help of the Bachmann® Pro Box can be connected directly to the ECoSlink bus. Up to 4 infrared transmitters are possible on your Central Station®. With these, up to 40 locomotives, each with 20 functions, and also the accessories like switches or signals can be operated. Additionally, you can use the built-in booster from the Bachmann® Pro Box.

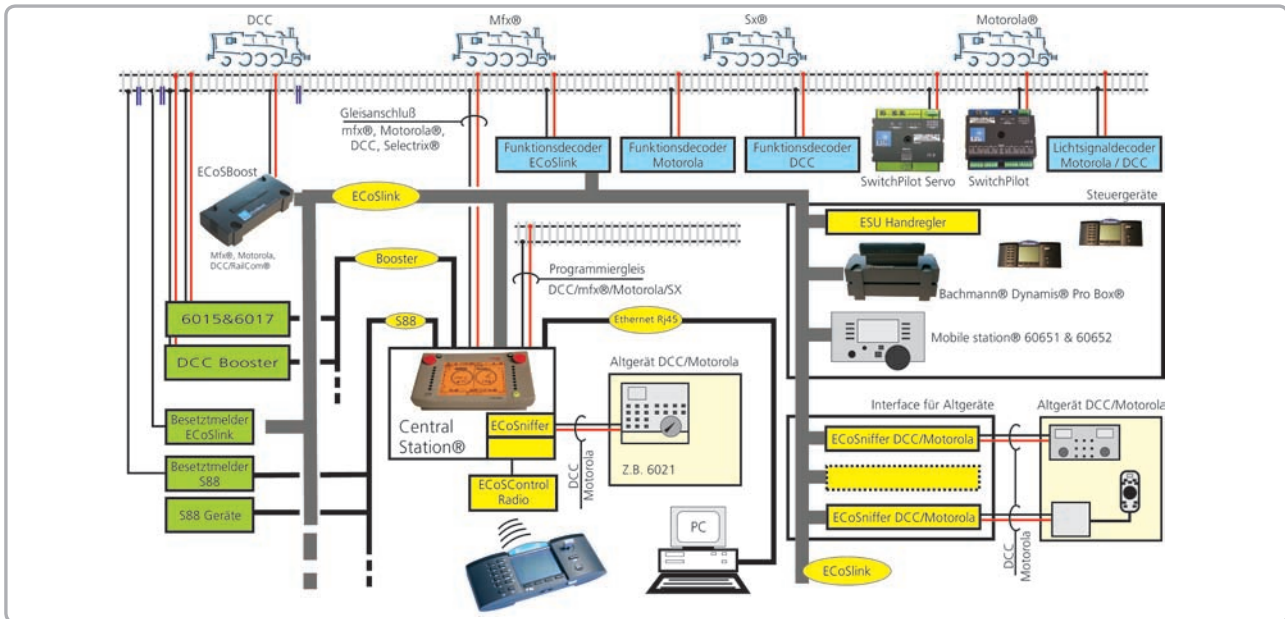

## Questions about Central Station® Update 3.0.0

*Which prerequisites are necessary prior to the Central Station® update 3.0.0.?*

The ESU update can only be used exclusively by the owner of the Märklin® Central Station® 60212. It will not work on other digital control units. Furthermore, your Central Station® 60212 must have software 2.0.3. or 2.0.4. installed. This is the case if your Central Station® has already received an update by the Märklin® service and the so-called Sniffer module has built in.

If you are unsure whether your Central Station® 60212 is already on the software version 2.0.3. or 2.0.4., you can use them in the setup menu under „General Information“ to read.

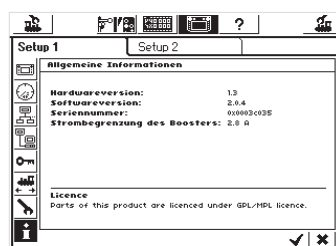

*How to install this update?*

The update can be installed either by yourself or your dealer. You will need a PC (Windows, Linux or Mac®) with network and a network cable to the Central Station® connected to your PC.

The update will be performed - identical to the previous software updates - through the web interface to the Central Station®. The update procedure is using your internet browser to copy the file to the centralstation®. The process is described in the manual for software updates.

A detailed, step-by-step instruction, we will be published before the availability of the updates.

*How can I order the update for the Central Station®?*

This Update 3.0.0. for the Central Station® 60212 is not free of charge, you must pay for it. You can order this at every ESU retailer's shop.

The difference to all the previous updates - also for the ECoS - is that every Central Station® needs an individually created update file according to its serial number. This file will only be accepted of the Central Station® that belongs to it. The try to install the update onto another Central Station® with a different serial number will be cancelled with an error message.

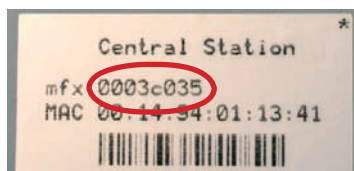

*When you order the update you need to indicate the exact serial number of your Central Station®. Otherwise the update cannot be delivered.*

The serial number can be read from the label on the bottom of the Central Station®. It is an 8-figure combination of letters and figures (see down below on the left).

*Since when is the update available?*

The update is available since the first quarter of 2009.

*Will there be further updates in the future?*

Certainly. The development will be continued permanently. Any further updates will ESU provide to all registered users of the ESU Support Forum for free. You pay only once. Guaranteed.

*Do my warranty claims against Märklin® expire after the update?*

For all Central Station® 60212, on which during the statutory warranty period ESU the 3.0.0 update is being installed, ESU legitimates right for all warranty claims occur. Details about the end we will announce in due time. The update is for you without risk as a customer. For all questions about the new features and capabilities of the Central Station® you can apply directly to ESU. Our successful support forum is available after the update.

*Will the Central Station® remain fully mfx®-compatible?*

The Central Station® will be fully mfx® compatible after the update to version 3.0.0. All mfx® locomotives will proceed as usual running and programming, and will also automatically log on to the Central Station®.

*Is the Central Station® really fully DCC compatible? What does this mean for me?*

The Central Station® has the open, standardized DCC protocol fully implemented. The long experience of ESU in this area guarantees a smooth implementation of all major DCC decoder. This provides for you as a three rail user some key benefits: All leading manufacturers today offer trains for the three rail system in which (ESU) multi-protocol decoders are installed (eg Roco, Liliput, Brawa, Mehano, Lima, Rivarossi, Hobbytrade to name a few). These locomotives can immediately respond to DCC. Besides the driving with up to 20 functions as well as a range of addresses to 9999, you can comfortably program your decoder with the Central Station® ...

*How may ESU ensure the support?*

The support for the Central Station® is through your ESU dealer and especially through our unique ESU Support Forum ensured. All registered owners of a Central Station® 3.0.0 update can ask their questions here and receive either by other competent forums members or our support team immediately assistance. We show since 2006 that this works. Even the support forum is one of ESU introduced soon counterfeit ideas.

# SwitchPilot - Magnetic accessory decoders

# SwitchPilot



## SwitchPilot - Do as you please

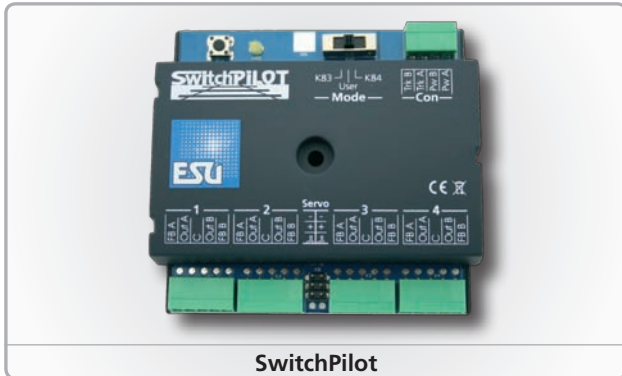

SwitchPilot

- Worldwide, the SwitchPilot is the first multi protocol switch-, and turnout decoder for activating up to 4-twin coil magnetic accessories (e.g. turnouts) or 8 loads, like remote uncoupling tracks, or lamps (e.g. turnout-,street-,or building illumination). Due to its intelligent software (typically ESU!) it can be utilized with DCC or Motorola®. The SwitchPilot comes in a robust housing at an attractive price.

### Modes of operation

SwitchPilot can be used with DCC or Motorola®. It is compatible with the DCC- Norm and reacts to switch commands. In Motorola® mode, addresses 01 – 127 are possible. Recognition of control mode is fully automatic.

### Functions

The SwitchPilot is being powered either directly by the digital central station itself, or separately by a DC-or AC source (transformer). Up to 4 twin coil actuators of all known manufacturers can be connected to its 8 transistorized outputs, each delivering 1 Amp steady current. In order to avoid coil burn out of actuators without built-in protection, the switch- pulse length at each outlet can be chosen freely between 0.1 and 1 second. In this mode the SwitchPilot performs k83-compatible.

Alternatively, each output can deliver continuous power for setting up routes, or illumination of streets and buildings. Special effects, such as cross fading or Mars Lights help to realise prototypical lighting situations, e.g. warning at crossings etc. Here the SwitchPilot assumes the more important features of the well known k-84 decoder.

### Servo Control

The SwitchPilot can do even more: apart from the transistorized outlets, two conventional RC-Servos can be controlled directly through the SwitchPilot. For each Servo not only lever speed can be adjusted individually, but also its end positions. Thus it is possible to operate especially prototypically slow and powerful

turnout motors, independent of track- gauge and system. You could also employ the servo actuator for driving signal arms and „high balls“, or crossing gates, and so on: The aficionado model railroader can surely think of plenty more uses...

### Feedback

However, SwitchPilot wouldn't be a typical ESU-product, if it couldn't do even more: In combination with an ECoS command station as an ideal „partner“, SwitchPilot can detect and show the actual position of the switch points, if you rig the turnout mechanically. At last you can be sure the turnout is really thrown correctly!

### Programming

The SwitchPilot can be programmed especially comfortably: For one thing it supports all DCC-modes of programming, including POM (Programming on the main). Assuming a central station with an outlet for a programming track, all adjustments can be controlled and modified.

On the other hand, you can allocate addresses via the programming key directly from the SwitchPilot: Push a button – a command is triggered at the centre – finished!

The programming of parameters is especially comfortable for owners of our ECoS command station: On a large display all parameters are shown in plain language, and can be changed real easy – even during operation!

### Protection

As was the case already with our Mobile (loco) Decoders, in the design phase greatest emphasis has been placed upon near indestructibility of the SwitchPilot: All transistorized outputs are protected against overload and short circuits. That means ESU-quality is also built into our stationary (turnout) decoders – now and in the future. You can rely on it!



Removable connecting terminals

### Technical data SwitchPilot

Operational modes:	NMRA/DCC "Accessory decoder" compatible. Motorola® with up to 127 addresses. K83 compatible. Powered either by command station or separately DC - or AC source (transformer) up to 18V AC.
Transistor outputs:	8 Transistor outputs, 1.5A (2.0A) load per output, grouped by 4 double outputs. Outputs short circuit proof and protected against overload. Selectable switch pulse length from 0.1s to 1.0 s (or continuous output). Flashing or cross fading also available.
Servo Control:	Controls up to 2 RC-Servos (Graupner® JR® or Futaba® compatible), 1.0ms to 2.0ms pulses, positive. Separately adjustable lever speed and end positions.
Feedback:	8 feedback inputs, detects actual position of the switch points. Display on ECoS screen.
Dimensions:	86mm x 86mm x 25mm (3.39. x 3.3.9 x 0.98 inch)
Included in delivery:	SwitchPilot 51800, detailed instruction manual

# SwitchPilot Servo

## SwitchPilot Servo & SwitchPilot Extension

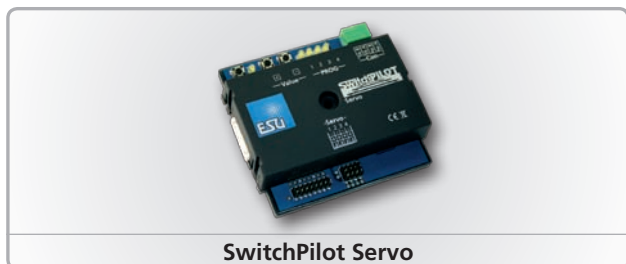

SwitchPilot Servo

The SwitchPilot Servo is a masterpiece among accessory decoders: it was specifically developed for controlling up to four remote-controlled servo motors. The SwitchPilot Servo activates these actuators very precisely and thus is able to control not only switches, but also other slow motion sequences.

### Modes of operation

The SwitchPilot Servo can be used with DCC or Motorola® protocols. It is compatible with the DCC norm and reacts to switch commands. It is possible to operate turnouts from 01 to 508 under Motorola® use. Recognition of control mode is fully automatic.

### Functions

The SwitchPilot Servo is being powered either directly by the digital central station itself or separately by a DC- or AC source (transformer). RC servos or ESU servo motors can be directly connected to its four servo outputs. The 5V voltage needed as well as the special control impulse is generated by the SwitchPilot Servo itself. For each servo, not only lever speed can be adjusted individually but also its end positions. Thus it is possible to operate especially prototypically slow and powerful turnout motors, independent of track- and gauge systems. You could also employ the SwitchPilot Servo for driving signal arms or railway crossings. Also the automatic opening of engine shed doors does not need to remain a dream.

### Programming

The SwitchPilot Servo can be programmed especially comfortably: For one it supports all DCC modes of programming including POM (programming in the main). Assuming a command station with an outlet for a programming track, all adjustments can be controlled and modified. As RailCom® is integrated, it is also possible to read out and control recent settings, even during operation.

Alternatively you can use the comfortable three-button input: You are able to control addresses, the end positions of all four servos and the corresponding motion speed directly, during operation and without any complicated programming- at all command stations!

### Analog operation

The Switch Pilot Servo would not be a typical ESU product, if it had not even more to offer: You can operate the decoder without the use of a command station! Conventional switches can be controlled with the help of eight switch inputs. Therefore fans of "classic" analog model railway can benefit from the advantages of the servo motor. In other words: the SwitchPilot Servo does not need a command station to switch and set servo paths as well as speed.

### Protection

As it has been the case with our loco decoders, in the design phase's greatest emphasis has been placed upon near indestructibility of the SwitchPilot Servo decoders. That means ESU quality is also built into our stationary decoders, now and in the future! You can rely on it!

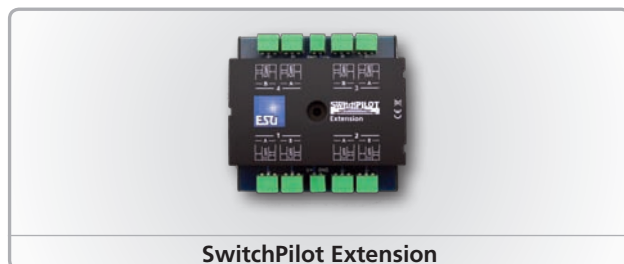

SwitchPilot Extension

If required, SwitchPilot can be augmented with the SwitchPilot Extension module: Plugged in at the side of the SwitchPilot, it offers four relay-driven outputs, used for switching potential-free loads, or for polarizing the frog; the ideal supplement for tricky circuitry.

### Modes of operation

The SwitchPilot Extension module only works in conjunction with a SwitchPilot. Plugged in at the side, it gets its electrical power directly from the SwitchPilot.

It contains a total of 4 Twin-Relays (2 x DPDT), of which each is dedicated to a pair of transistorized SwitchPilot outputs.

The respective relay's switch position is directly dependent upon the state of this pair of outputs. With the relay's help, loads can be switched, galvanically separated from the rest of the track (it functions like a k84), or a motorized turnout can be polarised.

With the relay's 1.5 Amp continuous rating, either frogs can be polarised-, or blocks powered signal dependent, or motorized devices, such as (water) pumps may be switched.

Especially intricate is the option to control motorised turnouts: Of course the SwitchPilot Extension module easily handles the necessary motor polarisation as well.

#### Technische Daten SwitchPilot Servo

Operational modes:	NMRA/DCC "Accessory Decoder" compatible Motorola® compatible up to 127 addresses. K83 compatible.
	Powered either by command station or separately DC- or AC source (transformer) up to 18V.
Servo Control:	4 servo outputs for RC servos (ESU, Graupner® JR® or Futaba® compatible), 1.0ms to 2.0ms pulse length, positive. Lever speed and end positions separately adjustable.
RailCom®:	Integrated RailCom® feedback for reading CVs on the main track and reporting the servo position to the command station.
Input keys:	Programming either directly to command station via DCC or input key, consisting of 3 buttons and LED display (5 LEDs) for direct address indication as well as two end positions and lever speed of all 4 servos.
Dimensions:	Approx. 86 x 86 x 25mm (3.39 inch x 3.39 inch x 0.98 inch)

#### Technical data SwitchPilot Extension

Operational modes:	Accessory modul for use with SwitchPilot. Supply through SwitchPilot. Control of Relay outputs by SwitchPilot modul.
Outputs:	4 Relay outputs 2x UM (DPDT) equipped with terminal block for switching of potential-free loads or for polarizing the frog. Alternatively, each relay output could be used to reverse the polarity for motorized turnouts.
Dimensions:	180mm x 76mm x 40mm (3.39 x 3.39 x 0.98 inch)
Included:	SwitchPilot Extension Modul, detailed instruction manual

#### Technical data Precision Servo motor (next page -> 25)

Specification of mini servo:	Supply voltage: 4.8V - 6.0V DC (default 5V)
Torque:	Up to 1.0 kg / cm
Position speed:	approx. 0.12s / 60°
Length of wire harness:	approx. 120mm (4.72 inch)
Accessories:	Servo holder, special servo horn for controlling wire, control horn, mounting screws, controlling wire, drilling template
Dimensions:	26mm x 13mm x 24mm (1.02 inch x 0.51 inch x 0.94 inch)

## Precision Servo Motor

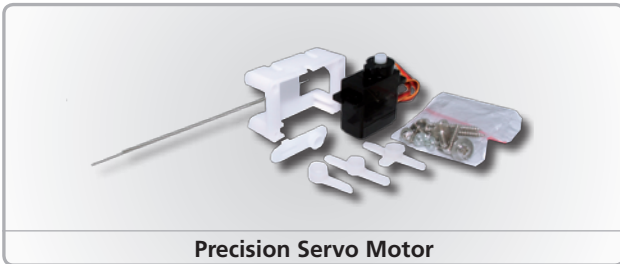

- ▶ The Precision Servo Motor is a high-performance and noiseless actuator, introduced by ESU, suitable for the SwitchPilot decoders. It uses a highly-developed remote control (RC) technique and is perfectly suited for setting in motion all kinds of scenes on your layout. ESU has put all the experience gained with the previous servo motor into the new Precision version, which is better than other servo products, to offer a solution for all the demands of model railroaders.

### Applications

The most important application regarding the Precision Servo Motor is to throw points. With the help of the Precision Servo Motor you are able to move your model railway switches like the original ones: the switch blade moves slowly and powerfully from one position to another.

While doing this the Precision Servo motor works almost noiselessly due to the precision gearing made of long-lasting plastic. It is mere child's play to motorize railway crossings via the Precision Servo motor and the SwitchPilot Servo. At last you can let the gates down at your keyboard in due time. Furthermore the Servo motor enables you to open and close the doors of your engine shed by remote control. Thanks to its new electronics

the ESU Precision Servo Motor moves considerably smoother than other servos, as the ESU product has been optimized for slow motions.

### Mini servo

The most important component of the Precision Servo Motor is a tiny, 9-gram-light mini servo which has been specially developed and optimized for all demands of a model railway layout. Despite its small dimensions of only 26 mm x 13 mm x 24 mm, it reaches a power of up to 1.0 kg/cm. Its cable length of 30cm (almost twice as long as cables of other standard servos on the market) allows for a longer distance between the servo motor and decoder. Beyond that, an electronic processor-controlled servo enables a precise heading for the required position without bucking - very important for garage doors. The closed current requirements of the electronics have been mottled compared to the previous servo motor which preserves the decoder. However, one of the most important improvements of the new Precision Servo Motor has to do with the switching-on: The well-known tremor when switching on the layout, which occurs with a lot of conventional RC-servos, is 100% choked during every operation mode. You will hear absolutely nothing from the servo when switching your layout on, no railway crossing will bounce.



### Accessories

To make the application of the Servo motor as easy as possible, we include substantial accessories with delivery, which are especially adjusted to our customers' needs: among some, diverse control horns, there is a special servo horn for a direct insert of the controlling wire. The controlling wire is, of course, included as well as the mounting screws. The most important accessory is a special servo holder: it enables you to install the Servo Motor either horizontally or vertically - depending on the application.

## Precision Servo Motor - Metal

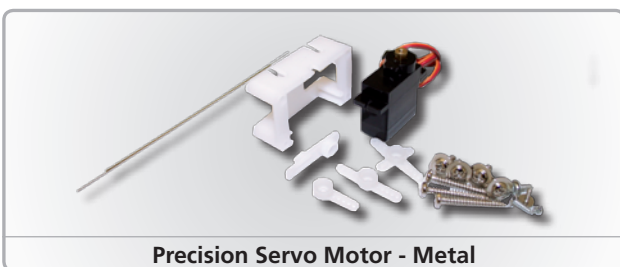

- ▶ ESU proudly presents a further, newly-developed servo motor for all ambitious model railway fans. The „Precision Servo Motor - Metal“ is preferred by all model railroaders who look for a powerful servo with metal gearing. Thanks to its metal gearing

the servo is able to lift nearly twice the load (1.8 kg) of its plastic gearing brother. Moreover, the „Precision Servo Motor - Metal“ is appropriate for all situations in which splicing and beating claim high mechanical requirements from the servo and where the sound development does not play such an important role.

With the same measurements as the Precision Servo Motor, the metal gearing is also equipped with the new, micro-processed control electronics for a precise, sensitive heading to the required position. Therefore the impuls suppression makes sure that there won't be any tremors on the layout when you switch it on. The 30cm cables makes easy wiring possible.

Also, the „Precision Servo Motor - Metal“ comes with innovative and well-proven accessories such as a servo holder and controlling wires.



### Ordering information

51800	SwitchPilot V1.0, accessory decoder for 4 twin coils magnetic, 2 x Servo, DCC/MM, 1A
51801	SwitchPilot Extension, 4 twin-relays (DPDT) output, 2A each, extension for Switch Pilot V1.0
51802	SwitchPilot Servo V1.0, 4 twin servo decoder, DCC/MM, RailCom®
51804	Servo Motor, precision mini-servo, micro-controlled with plastic gearing, incl. mounting kit
51805	Servo Motor, precision mini-servo, micro-controlled with metal gearing, incl. mounting kit
51810	Servo Extension Cable, 3-pole J/R plug on socket J/R /Futaba, length: 75cm (29.5 inch)

## RailComPlus® ...and suddenly the decoder »speaks«



- This is something that model railroaders have always waited for: to put a loco on the tracks and the decoder will be immediately recognised by the command station. No matter if it is a new loco with a »virginal« decoder or one with re-programmed values.

### And it's possible: RailComPlus®

Here comes the solution: RailComPlus® is a logical further development of DCC and RailCom®. It complements the basic technology of both DCC and RailCom® by a whole range of new functions, which makes the operation of locos, turnouts and signals much easier.

The automatic RailComPlus® recognition has been developed by ESU based on RailCom® invented by Lenz® and is another milestone in the field of bi-directional communication.

### RailComPlus® - off we go:

In DCC mode RailComPlus® is not a »paper tiger«, but a concrete marketable concept: Both the cooperating companies will already release their first products in 2011.

**Lenz Elektronik** will integrate RailComPlus® in all Digital plus Decoder in the future. For upgradable decoders (from version 7.x onwards) a free software update will be available.

**ESU** will equip the ECoS ESU Command Station as well as the new LokPilot V4.0 and LokSound V4.0 decoders with RailComPlus®. All H0 loco models from the ESU Engineering Edition will be equipped with RailComPlus® either ex works or can be updated with a free available firmware update.

### What RailComPlus® can do

- **Register**

A loco equipped with a RailComPlus® decoder will be automatically registered by the command station and will give the command station its name and address. This will still work even if there are several locos on the track. It is also possible to rename each loco individually: For example, you have two locomotives both named »Class64«, just change the name into »Bubikopf 1« and »Bubikopf 2«!

- **Move**

If you wish to run your locomotive on your friend's layout, it will also be registered automatically. Alternatively, you can just use the loco's address.

- **Function riddles?**

Via RailComPlus® the decoder informs the loco about the range of functions. They will recognise the type of function and if it is a momentary (e.g. for a whistle) or a permanent function (e.g. motor sound).

- **Thinner and faster**

New RailComPlus® packages allow a faster transfer of commands to the decoders. Thus the DCC bandwidth will be improved.

- **Programming becomes redundant**

The best comes at the end: forget the programming and reading out of decoders, it will not longer be required.

### The future-proof system

The patented RailComPlus® system has been developed by ESU electronic solutions ulm, a company of long tradition in conceiving digital systems. Due to its important functions and its simple handling, it guarantees the continuity of DCC as the world standard for digital control units. The responsibility for DCC with RailComPlus® is shared and licensed between Lenz® Elektronik and ESU electronic solutions ulm. Thus model railroaders using DCC will be on the safe side - also in the future!

Lenz and ESU are confident that DCC, RailCom® and RailComPlus® will bring model railroaders just the advantages which they are rightly expect from a digital DCC control unit nowadays and in the future. Look forward to the future with RailComPlus® - it has just begun!



## Questions about RailComPlus®

*What will I have to do to make my command station recognise my locos automatically in the future?*

You will need a RailComPlus®-compatible command station as well as decoders equipped RailComPlus®.

*How long will the registration of the loco take? I don't want to wait for minutes!*

The registration of the loco only takes a few seconds, due to the fast RailCom® feedback.

*How will I recognise RailComPlus®-compatible products?*

RailComPlus®-compatible produkte can be identified with the logo. Only products with a 100% RailComPlus® compatibility are allowed to have the logo.

*How can I find out, which address »hides« behind the name of my loco?*

The real address can be displayed at any time. RailComPlus® remains in the background in a noble manner: If the address of the »new« loco is hasn't been used yet by the command station, it will be retained. Otherwise, the command station allocates a new address to the loco: automatically or by your choice.

*How will you ensure a cooperation of different manufacturers without any problems?*

RailComPlus® has been thoroughly defined and documented by the responsible companies Lenz and ESU. Before a product is allowed to wear the logo (and thus signals that it will work properly with your other components) it undergoes extensive tests. RailComPlus® a whole package of functions and internal commands, which all have to be completely implemented.

*Is it possible to operate RailComPlus® decoders with older central station?*

Of course. RailComPlus® is fully downward compatible with all relevant DCC norms. If needed, RailComPlus® can be switched off via a CV.

*Is it possible to control older DCC Decoder with an RailComPlus®-compatible central station?*

Yes, of course. Every RailComPlus®-compatible command station is a complete DCC station. As a matter of fact, central stations are neither able to perform any magic or clairvoyance: with older DCC decoders you need to type in the loco address and the functions manually.

*Which track systems are suitable for RailComPlus®?*

Basically, RailComPlus® is suitable for all track systems and gauges. RailComPlus® can also be used for 3-rail AC layouts. Depending on the central station, it is also possible during a mixed operation Motorola®- or mfx® decoders. Our ECoS command station can do this split without any problems.

*Which of the ESU products speak RailComPlus®?*

All LokPilot V4.0 decoders will be shipped ex works with RailComPlus® from March 2011 onwards. For LokPilot V4.0 decoders which have been previously shipped a free of charge firmware update will be available. The update can be directly played on the decoder with the aid of the ESU LokProgrammer and your Windows-PC. All LokSound V4.0 decoders will be shipped ex works with RailComPlus® activated. With the ESU LokProgrammers or a RailComPlus®-compatible command station you are able to change the name of the loco, its symbol and function key allocation and -symbol at any time.

*Is it possible to retrofit my old decoders with RailComPlus®?*

It depends on the decoder. Basically all RailCom®-compatible decoders are prepared in terms of their hardware. For further information please refer to your decoder manufacturer.

*Is it possible to retrofit my LokPilot V3.0 decoders RailComPlus®?*

The hardware of the LokPilot V3.0 is prepared for the use of RailComPlus®. We are currently examining if and when a firmware update for the LokPilot V3.0 family can be provided.

*Is it possible to retrofit my LokSound V3.5 decoders RailComPlus®?*

Unfortunately not. LokSound V3.5 decoders don't have the electronics required for RailCom®.

*Which loco symbols and function key symbols are there?*

The list of symbols will be continuously extended. This ensures that all possible functions will have a respective symbole in the future.

*Which manufacturers will offer RailComPlus®-compatible products?*

Basically every DCC manufacturer is able to obtain a licence RailComPlus® from the companies responsible, namely Lenz and ESU. We assume that RailComPlus® will become very popular during the next time as as the legitimate and logical successor of RailCom®.

*How will you achieve an improvement of the RailComPlus® bandwidth?*

For example, RailComPlus® defines a new DCC command, which transfers beside the speed also all function keys together rather than individually. This will save a lot of time. Furthermore there will be new commands to block read or write CV data. This will considerably accelerate the readout of a decoder.

# LokSound V4.0

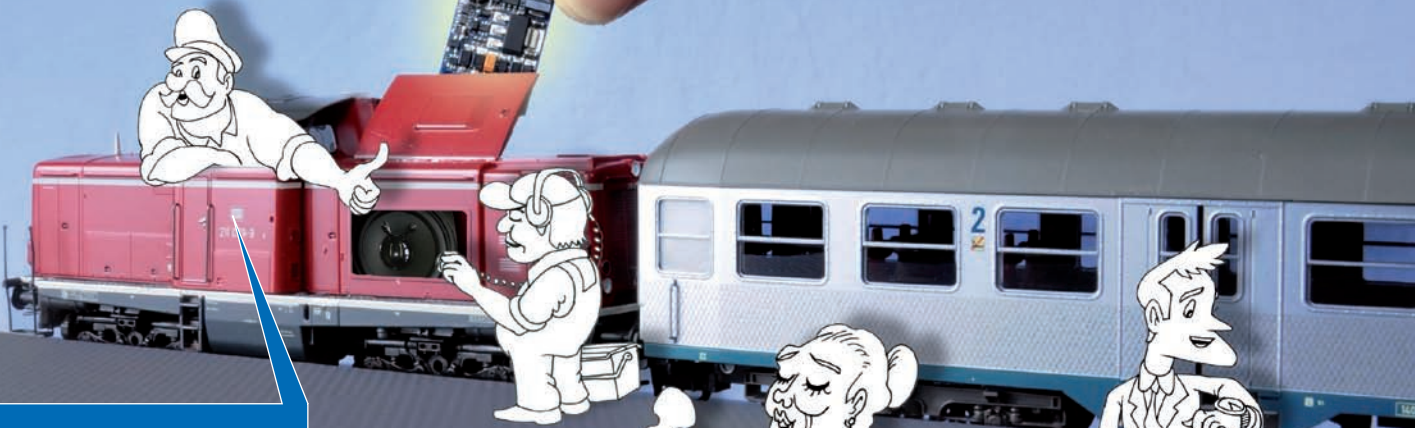

**NO MORE CONFERRING WITH THE STATION MASTER!**

Automatic registration to the command unit with RailComPlus®

**FULL SOUND ON 8 CHANNELS!**

8 simultaneous sounds for super realistic sound on the layout

**FINALLY I DON'T SPILL MY TEA ANYMORE!**

Very smooth regulation and slow driving thanks to motor management of the 5th generation

**NO MORE DELAY BECAUSE OF DIRTY TRACKS!**

Bridges short power cuts with PowerPack

Leaving a »Sound« impression. The new LokSound.



# LokSound - Digital operation and original sounds

- With the LokSound family decoders we offer all model railroaders, who want the utmost of authenticity on their layout, a real highlight. With LokSound, the excellent features of ESU-decoders are even more enhanced by the addition of sound functions. Its sounds simple, but "wow": In the future, your locos not only run like the prototype, they sound exactly like it!

That's made possible through our award-winning LokSound technology- the reference for good sound on the layout since its introduction in 1999. By the inventor. By ESU.

LokSound decoders are available for various applications, depending on gauge or digital system.

- NEW** • Our new **LokSound V4.0** decoder for gauge H0 and 0 can be operated with DCC, Motorola® and Selectrix® and shines with a range of new ideas: It is able to play 8 sound channels simultaneously and is armed with a generously sized memory chip to conjure, when combined with a 4 Ohms speaker and the new audio amplifier, a great sound pressure on your layout. Thanks to RailComPlus® the LokSound V4.0 decoder will be recognised automatically by an appropriate command station.
- NEW** • The **LokSound micro V4.0** matches the quality of its »big brother« in every regard. It also speaks DCC, Selectrix® and Motorola® and is due to its small shape perfectly suitable for TT and N gauges. It's a matter of honor that also the LokSound micro V4.0 decoder also supports RailComPlus®.
- The **LokSound XL V3.5** is meant for the »big« gauges G and I, it masters DCC and Motorola® and supplies the respective power for big gauges.
- The **LokSound V3.0 M4** for gauges 0 and H0 is conceived for the Märklin® system.

## What's behind the sound

The core of all LokSound decoders is an extremely capable processor. This is complemented by a sound storage, which contains the sounds, and an extremely powerful audio amplifier. Lastly, the sound is reproduced through especially developed high-performance speakers.

### The new LokSound V4.0

With the concept of our new locomotive sound of decoders of the 4th generation the wishes of the Modellbahner were analysed thoroughly and carefully and were brought in harmony with the possibilities of the microelectronics. The result a unique composition that will bring you even closer to the prototypical loco underlining impressively our long-standing competence as a manufacturer of LokSound decoders.

The integrated flash memory records up to 274 seconds of sound data, which is transferred via a polyphonic 16-Bit channel mixer with an active filter to the new „Class D“ last stage amplifier. In combination with new special 4 Ohms loudspeakers it provides a full sound which is up to 3 times (!) louder than usual. LokSound V4.0 decoders are able to play 8 sounds simultaneously, of which 3 channels are used for the simulation of the drive motor. This enables an authentic representation of the possibilities given by the prototype locos. This can be, for example, steam locomotives with two, three or four cylinders. But also diesel-electric, diesel-hydraulic or electric locomotives are no problem for our latest decoder. The new, flexible sound schedule without stiff rules helps our sound engineers to simulate the original locomotive and makes »exotics« such as Battery Railcars or two power engine locos possible. We would like to give you an understanding of that on the following pages!

### The 3rd generation

But also the LokSound decoders of the 3rd generation are based upon a sound technology with exceptional key-values: A 16MBit flash memory records up to 138 seconds of sound data, which is transferred via a polyphonic, four channel mixer with an active filter, to the last stage amplifier. But much more important than the fact that beside the actual prime mover sound, up to three more sounds, such as bell, whistle or brake squeal can be reproduced, is the unique sequence-choice of the sound decoders: Steam engines, Dieselelectrics.- Dieselhydraulics,- Electro-locos, or locos with a transmission (e.g. Rail bus) can be reproduced. Depending on the type, sound sequences do differ, but are always faithful to the prototype.

### Audible

All ESU LokSound decoders are distinctly audible: **Steam locomotives** reproduce changing chuffs. Those are coupled to motor control and are load-dependant. When accelerating, chuffs sound harsh, while, when the throttle is closed, only rod-clatter is discernible. The reproduction hereby is so faithful that you can differentiate between the rhythms of a two-, three, or four cylinder loco. The rhythm can either be triggered by an external sensor, absolutely r.p.m.- synchronous, or via back E.M.F (load compensation), speed step dependant.

**Diesel engines** come in various designs, which are all correctly reproduced: Dieselhydraulic locos first rev up, before they start moving. Engine r.p.m.-sound is in ratio to speed. LokSound decoders allow your loco, prototype like, to move only when engine r.p.m is high enough. This is only possible through the entity of sound module and decoder. When accelerating or straining, the sound is more intensive, while, when you close the throttle, the prime mover revs down to idle. Diesel-electrical locos keep their prime mover r.p.m nearly constant, but you hear the soft whine of the electro motors.

But even **Electric locomotives** are a treat for the ears: Beside the fan noise, the compressors, or the oil coolers, you hear the whine of the electro motors, the cracks of main switches, or gear noises.

Beside these sound variations, you can activate sounds anytime per function key. Thus you can whistle, sound the horn or bell to your heart's content, in front of railroad crossings, or tunnels. Length of sound is up to you.

In the background you hear, coincidentally, the fireman shovelling coal, and the release of compressed air, or steam, by the safety valve. The decoder can couple all this to the function outputs, so that the fire in the firebox really flickers, when the fireman adds coal. LokSound decoders create real station atmosphere. The deceleration-synchronous squeal of the brakes, station-announcements, door banging, or an "all aboard whistle" by the conductor before the train moves out belong here, of course. Your model railroad grows more realistic than ever before.

If all of this were not enough, the flash memory of the LokSound decoder can be erased or re-recorded anytime. In this way it's no problem to change a Steam into a Diesel sound, for example. You can do this yourself, even later on. You only need the ESU LokProgrammer to do it.

# LokSound V4.0

## LokSound V4.0 – The reference



- ▶ There has been a lot of reviews about our LokSound decoder. They do their work worldwide in locos and provide a maximum of fun, so we expect you to expect more from us (as being the pioneer in this field) than a simple extension of existing products. When we introduce the LokSound V4.0 decoder today, which is the fourth generation after its great grandfather „LokSound Classic“.

Our new LokSound decoder will convince you once more with its inner values.

The LokSound decoder is still a combination of driving decoder and sound module on one PCB. You can install it in nearly every loco in H0 and 0 scale according to its dimensions of 30mm in length and a width of 15mm and so be able to control driving, light and sound.

LokSound V4.0 decoders are offered with all established plugs, either with the 8-pin NEM 652 connector, the 6-pin NEM651 connector and the PluX12 connector or the wireless version with the 21MTC interface (NEM660).

All LokSound decoders are delivered with 23mm speakers.

### Operation modes

The LokSound V4.0 recognises DCC, Selectrix® and the Motorola® protocol. It can be operated with 14, 28 or 128 drive steps or on analogue DC layouts in DCC mode. You can assign the decoders to 2-digit, 3-digit (1-127) or 4-digit (1-9999) addresses as well as a consist address.

The Motorola®-protocol provides the operation of the LokSound V4.0 decoders with Märklin® control stations 6020®, 6021®, delta®, mobile station® and central station®. The decoders can be used with the addresses 01 – 255 on this mode. A second address provides the possibility to use the function keys F5 to F8.

The Selectrix® protocol provides the possibility to use LokSound V4.0 decoders with this also established system. All established DCC brake systems like the well-known Lenz LG100, but also the new Lenz® ABC brake units with asymmetrical DCC signal are recognised as well as the braking on DC (with switched polarity) or on Selectrix® diode brake systems. You can also use the well-known Märklin® brake system in DCC-mode.

Of course, our top decoder is able to determine a constant braking distance, so that your locos stop in front of the red signal, no matter what speed your loco is at.

LokSound V4.0 decoders are also able to operate on analogue DC and AC layouts.

The decoders can switch automatically between all modes (AC, Motorola®, DC, DCC, Selectrix®) during operation. This is important if some parts of your layout work with analogue control (e.g. fiddle yards).

### Motor control

You expect an excellent motor control from a LokSound Decoder and deservedly so! LokSound V4.0 is equipped with the further improved 5th generation of load control. You can adjust the control frequency with a basic frequency of 40kHz adaptively. So many motors will run even better and softer. The 10 Bit A/D converter makes it possible to drive your loco very slow on the tracks.

You can determine a limitation of the load control's influence with the Dynamic Drive Control (DDC) to control very accurately in station or shunting switch areas. Besides, uphill driving appears very natural with it.

The decoder's load control is suitable for all common motors, no matter if by ROCO®, Fleischmann®, Brawa®, Mehano®, Bemo®, Märklin®, Faulhaber® or Maxon®. You can also use all-current motors as long as you replace the field winding by a HAMO Magnet.

Constant current of 1.1A continuous current are more than enough for the motors mentioned above and provide enough power even for long trains.

SoftDrive® Sinus motors, which are often used on Märklin® locos can also be controlled by the LokSound V4.0 decoders.

The new serial communication protocol provides from now on the operation on Trix®-locos

### Sound

The most important element of the new LokSound V4.0 decoders is the sound chip. This is why we have equipped the LokSound V4.0 with an enormous memory of 32 MBit to save up to 276 seconds of original sounds.

The LokSound V4.0 works with 8 polyphonic channels, i.e. that the decoder is able to play up to 8 different sounds simultaneously, using the 16-Bit mixer and the nearly noiseless D/A converter.

So we can provide a much better monitoring of the original locomotive's complex elements as it is possible to combine several channels.

You'll recognise the difference at once! The sounds will be amplified up to three times louder than before by using a new digital „class D“ amplifier.

We also changed from the old type of speakers to speakers with an impedance of 4 Ohms. Use our provided stock of new developed speakers!

All single sounds of the LokSound V4.0 can be mixed in volume individually on nearly every digital control station.

The new super flexible sound engine without static schedule provides a very prototypical simulation of all railroad vehicles.

### Analogue mode

LokSound V4.0 decoders can be used on DC as well as on AC layouts. The motor and the synchronisation of all driving-, sound- and light functions will be controlled in analogue mode, too!

So, model railroaders without digital systems can enjoy the LokSounds, despite the sounds on function keys.

## Functions

LokSound V4.0 decoders have 4 function outputs with the possibility of using constant current of 250mA. These outputs can be assigned individually. Apart from that, there are two more non-amplified outputs with logic level. You can use those in combination with fitting adaptor PCBs (e.g. ESU 51968) to control more light or special physical functions. All important light functions like Flash, Gyrolight, Mars light, fire box and so on are provided including the individual adjustment of brightness for each function.

Of course, the decoders provide automatic coupling and decoupling for couplers by Roco®, Krois® and Telex® and from now on even a full beaming head light function.

The LED mode controls the right light effects when using LEDs.

## Safe operation

If desired it is possible to connect a PowerPack (ESU 54670, see page 62) to the LokSound V4.0, as to all other ESU decoders of the 4th generation. This energy storage continues to supply the decoder with energy if the power consumption is not optimal due to dirty tracks.

## RailComPlus®

A very important function of the LokSound V4.0 decoder is the integrated RailComPlus® function. Your locos will be recognised automatically by an appropriate digital command station fast as lightning and will receive, if needed, a new address. Forget about the cumbersome typing and programming!



## Protection

Of course, all function outputs and the motor current output are overload protected. We want you to have fun with your decoder as long as possible!

## Future built-in

You can update the firmware of the LokSound decoders. This means, the internal software on the decoder's memory can be replaced by new versions if necessary. You'll simply need the ESU LokProgrammer and a PC.

## Sound variations

ESU, as the technologic and market leader takes your requirements for sound very seriously. There are already more than 200 sound variations available for the LokSound V4.0

ESU is extending the sound library all the time and provides all sounds on our homepage for free download.

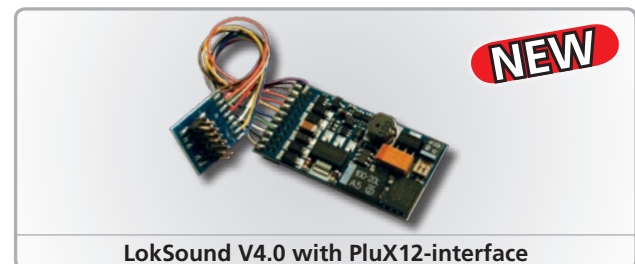

LokSound V4.0 with PluX12-interface

► Appropriate loudspeakers are to find on page 66.

### Technical data LokSound V4.0

Modes	NMRA/DCC with 14, 28, 128 drive steps and automatic detection. DCC 2-digit & 4-digit addresses.
	Digital Motorola® (old and new), up to 28 drivesteps in Motorola®-mode. Up to 255 addresses in Motorola®-mode. 2nd address for function keys F5 to F8.
	Selectrix® operation with 31 drive steps. Extended functions for up to 8 function keys (suitable control station necessary).
	Analogue DC and AC operation (deactivation possible).
	Automatic recognition of the operating mode and the DCC drive step configuration.
	Supporting Lenz® LG100, Märklin®, Roco® braking modes. Supporting Lenz ABC brakes and Märklin® brake mode
	Reverse bit
	Intelligent programming mode with Märklin® 6021®. Supporting programming modes for ROCO Lokmaus 2 and ROCO Multimouse.
	Connection to DC-, AC-motors with permanent magnet.
	Noiseless, motor saving control with 40 / 20 kHz pwm frequency
	Motor output protected against overload. Load control of the 5th generation (possible to deactivate) Dynamic Drive Control.
Function outputs	4 amplified outputs max. 250mA load for each output Total current for all function outputs ca. 500mA. Outputs short circuit protected Free individual function mapping. Function keys F0 to F28 2 logic outputs. Serial protocol for C-Sinus and light control
Sound unit	8 (!) individual sound channels High power amplification with about 1.8 Watts Soundfiles in the internal flash memory modifiable Modes for Steam-, Dieselhydraulic-, Dieselelectric-, Electric locomotives, battery railcars, hybrid locomotives and so on 32 MBit sound memory (up to 276 seconds)
Energy buffering	Connecting for ESU PowerPack available
Communication	Full RailComPlus® integration
Loudspeakers	Impedance 4-8 Ohms, 4 Ohms recommended. Special speaker 4 Ohms, 23 mm diameter (with enclosure) included in delivery
Dimensions	30.0mm x 15.5mm x 5.5mm

# LokSound micro V4.0

## LokSound micro V4.0 – Small looks, big performance



- ▶ LokSound V4.0 decoders help many H0 model railroaders to operate their locos with realistic sounds, something that friends of the smaller N and TT gauges don't need to do without. We even once more reduced the new LokSound micro V4.0 decoder's dimensions compared to its forerunner. With a size of only 25mm x 10.6mm x 3.8mm it is the world's smallest LokSound decoder!

Since there are also no more mechanical obstacles in the way, it is a pleasure to enjoy all the decoder's features: the LokSound micro V4.0 incorporates a complete digital decoder, which, besides DCC and Motorola®, also understands Selectrix®. Beside the two light outputs we were even able to integrate a sound-section, equal to that of its bigger brothers and two user selectable function outputs.

The LokSound micro V4.0 will be either shipped as 6-pin NEM651 or 8-pin NEM652 plug version. For the first time we also offer the new wireless Next18 interface version. Every LokSound micro V4.0 decoder comes with a new 16mmx25mm loudspeaker (0.6 x 1.0 inch) plus sound chamber.

### Operational mode

The LokSound micro V4.0 recognises DCC, Selectrix® and the Motorola® protocol. It can be operated with 14, 28 or 128 drive steps or on analogue DC layouts in DCC mode. You can assign the decoders to 2-digit, 3-digit (1-127) or 4-digit (1-9999) addresses as well as a consist address.

The Motorola®-protocol provides the operation of the LokSound micro V4.0 decoders with Märklin® control stations 6020®, 6021®, delta®, mobile station® and central station®.

The decoders can be used with the addresses 01 – 255 on this mode. A second address provides the possibility to use the function keys F5 to F8.

The Selectrix® protocol provides the possibility to use LokSound V4.0 decoders with this also established system.

All established DCC brake systems like the well-known Lenz® LG100, but also the new Lenz® ABC brake units with asymmetrical DCC signal are recognised as well as the braking on DC (with switched polarity) or on Selectrix® diode brake systems.

Of course, our top decoder is able to determine a constant braking distance, so that your locos stop in front of the red signal, no matter what speed your loco is at.

The decoders can switch automatically between all modes (Motorola®, DC, DCC, Selectrix®) during operation. This is important if some parts of your layout work with analogue control (e.g. fiddle yards).

### Motor management

From a LokPilot decoder, you rightly expect an excellent motor management. With the LokPilot micro V4.0, ESU introduces the once more improved fifth generation of load control. The standard frequency is adjusted adaptively to the speed with a basic frequency of 40 kHz. The result is an even better slow driving performance. Your locos will crawl super slowly - thanks to the 10 Bit A/D convertor.

With Dynamic Drive Control (DDC) you can limit the influence of back EMF and glide smoothly around the depot area and over turnouts; while on the main, when going uphill, the engine slows down prototypically.

The load control is well-prepared for all customary motor types, such as Roco®, Fleischmann®, Brawa®, Mehano®, Bemo®, Märklin®, Faulhaber® or Maxon® motors. 0.75A steady load is more than the above-mentioned motors need and offers enough energy reserves, even for longer block trains.

### Sound

The most important element of the new LokSound micro V4.0 decoder is the sound chip. This is why we have equipped the decoder with an enormous memory of 32 MBit to save up to 276 seconds of original sounds. The LokSound micro V4.0 works with 8 polyphonic channels, i.e. that the decoder is able to play up to 8 different sounds simultaneously, using the 16-Bit mixer and the nearly noiseless D/A convertor.

So we can provide a much better monitoring of the original locomotive's complex elements as it is possible to combine several channels. You will notice the difference immediately! The sounds will be amplified up to three times louder than before by using a new digital „class D“ amplifier. The speakers haven't been left unchanged, too.

We also changed from the old type of speakers to speakers with an impedance of 4 Ohms. Use our provided stock of new developed speakers!

All single sounds of the LokSound micro V4.0 can be mixed in volume individually on nearly every digital control station.

The new super flexible sound engine without static schedule provides a very prototypical simulation of all railroad vehicles.

### Analogue mode

LokSound micros V4.0 decoders can be used on DC layouts as well. The motor and the synchronisation of all driving-, sound- and light functions will be controlled in analogue mode, too!

So, model railroaders without digital systems can enjoy the LokSounds, despite the sounds on function keys.

### Functions

LokSound micro V4.0 decoders have 4 function outputs with the possibility of using constant current of 150mA. These outputs can be assigned individually. Apart from that, there are two more non-amplified outputs with logic level. All important light functions like Flash, Gyrolight, Mars light, fire box and so on are provided including the individual adjustment of brightness for each function.

Of course, the decoders provide automatic coupling and decoupling for couplers by Roco®, Krois® and Telex® and from now on even a full beaming head light function.

The LED mode controls the right light effects when using LEDs.

## Safe operation

If desired it is possible to connect a PowerPack (ESU 54670, see page 62) to the LokSound micro V4.0, as to all other ESU decoders of the 4th generation. This energy storage continues to supply the decoder with energy if the power consumption is not isn't optimal due to dirty tracks.

## RailComPlus®

A very important function of the LokSound micro V4.0 decoder is the integrated RailComPlus® function. Your locos will be recognised automatically by an appropriate digital command station fast as lightning and will receive, if needed, a new address. Forget about the cumbersome typing and programming!



## Protection

Of course, all function outputs and the motor current output are overload protected. We want you to have fun with your decoder as long as possible!

## Future built-in

You can update the firmware of the LokSound decoders. This means, the internal software on the decoder's memory can be replaced by new versions if necessary. You'll simply need the ESU LokProgrammer and a PC.

## Sound variations

ESU, as the technologic and market leader takes your requirements for sound very seriously. There are already more than 200 sound variations available for the LokSound micro V4.0

ESU is extending the sound library all the time and provides all sounds on our homepage for free download.

► **Appropriate speakers are to find on page 66.**

### Technical data LokSound micro V4.0

Modes	NMRA/DCC with 14, 28, 128 drive steps and automatic detection. DCC 2-digit & 4-digit addresses. Digital Motorola® (old and new), up to 28 drivesteps in Motorola®-mode. Up to 255 addresses in Motorola®-mode. 2nd address for function keys F5 to F8. Selectrix® operation with 31 drive steps. Extended functions for up to 8 function keys (suitable control station necessary). Analogue DC operation (deactivation possible). Automatic recognition of the operating mode and the DCC drive step configuration. Supporting Lenz® LG100, Märklin®, Roco® braking modes. Supporting Lenz ABC brakes and Märklin® brake mode Reverse bit Intelligent programming mode with Märklin® 6021®. Supporting programming modes for ROCO Lokmaus 2 and ROCO Multimouse. Connection to DC-motors with permanent magnet. Noiseless, motor saving control with 40 / 20 kHz pwm frequency Motor output protected against overload. Load control of the 5th generation (possible to deactivate) Dynamic Drive Control.
Function outputs	4 amplified outputs max. 150mA load for each output Total current for all function outputs ca. 280mA. Outputs short circuit protected. Free individual function mapping. Function keys F0 to F28 2 logic outputs. Serial protocol for C-Sinus and light control (Next18 interface).
Sound unit	8 (!) individual sound channels High power amplification with about 1.8 Watts Soundfiles in the internal flash memory modifiable Modes for Steam-, Dieselhydraulic-, Dieselelectric-, Electric locomotives, battery railcars, hybrid locomotives and so on 32 MBit sound memory (up to 276 seconds) Connecting for ESU PowerPack available
Energy buffering	Connecting for ESU PowerPack available
Communication	Full RailComPlus® integration
Loudspeakers	Impedance 4-8 Ohms, 4 Ohms recommended. Special speaker 4 Ohms, 16x25mm diameter (with sound chamber) included in delivery
Dimensions	25.0mm x 10.6mm x 3.8mm



## LokSound V3.0 M4 – Really brings your locos to life



LokSound V3.0 M4

- ▶ As a convinced owner of Märklin®-systems, who puts emphasis on realistic operation, you can't pass up LokSound V3.0 M4.

### Operational modes

The multi-protocol LokSound V3.0 M4 decoder handles M4 and Motorola®. You can use it with all past Märklin® stations, such as 6020, 6021 and delta®; or on analog AC layouts. The decoder supports addresses 1 – 80, and stops correctly on the Märklin® braking section. In combination with a mfx® station, it shows off all the M4 advantages.

### Motor management

The last stage output runs DC or coreless motors. Load control (back EMF) with 32 kHz High frequency regulation takes care of silky smooth, absolutely silent motor operation, and lets your engines crawl super-slowly on the layout.

### Sound

The LokSound V3.0 M4 decoder can replay all loco typical sounds. It can record up to 130 seconds of sound in its 16 MBit flash-chip. Besides load-dependant operational sound it can reproduce air – or water pumps, switching noise, brake squeal or other sound sequences. These are transferred via four polyphonic channels to the last stage audio amplifier.

### Analog operation

The LokSound V3.0 M4 also works (without sound) on analog AC layouts. Even starter – and top speed can be controlled. At last you can slow down your old highspeed locos.

### Functions

The LokSound V3.0 M4 decoder sports four function outputs, which can be allocated individually to a function and are dimmable in 15 steps. Besides beacon, strobe and alternate flashing, there is simulated firebox flicker as well as Mars light or Gyra light.

### Programming

All parameters of the LokSound V3.0 M4 decoder can be modified comfortably with the systems's stations, right during operation. The built-in genuine duplex communication between systems's central unit and decoder makes this possible. For owners of 6020®, - 6021® – or delta® stations, the LokSound V3.0 M4 decoder utilises the time-proven, simple programming procedure.

### Safeguard

All function outputs and the motor connection are overload- and short circuit protected.

### Built-in future

LokSound V3.0 M4 decoders are firmware updatable: The interne decoder software can be replaced. The latest software is to find on our website [www.esu.eu/download/software](http://www.esu.eu/download/software).

### Variety of sounds

ESU offers the LokSound V3.0 M4 decoder in many different variations for your preferred prototype. All parameters are factory pre-adjusted (default), so that the screen of your command station not only displays the correct loco type, but also the function-status symbol.

- ▶ **Appropriate speakers are to find on page 67.**

# M4

### What does M4 mean?

At some points in this catalog you will notice the term „M4“ for the first time and rightly wonder what this might mean.

This question can be answered quite simply: from 2009 forward, M4 is the name of a data protocol that was chosen by ESU to be implemented in their decoders. Decoders with the M4 protocol are one hundred percent compatible with command stations using mfx®. At such stations (e.g. Märklin® Central Station®) they will be recognized automatically and all playing functions are available just like when using mfx®. On the other hand, our ESU command stations using M4 will recognize all (Märklin® and ESU) mfx® decoders without any restrictions and will still work without any problems. As the (mutual) inventor of mfx® we can assure you of this.

In short: the technique stays the same, only the name has been changed.

### Technical data LokSound V3.0 M4

Operational modes:	M4 with 128 speed steps
	Motorola® (old and new) with 14 or 28 speed steps and up to 255 addresses in Motorola® operation
	Analog AC (de-selectable)
	Automatic recognition of operational mode
	Supports Märklin® brake section
	Wrong-direction bit / Stores operational status
	Intelligent programming mode with Märklin® 6021®
Throttle:	1.1 A continuous load
	Runs DC-, coreless and AC motors (with Hamo-retrofit) (AC motors only after being changed into DC via HAMO magnet)
	Silent, safe 32 kHz pulse-width frequency regulation
	Motor output overload protected. Fourth generation back EMF (de-selectable)
Function outputs:	4 outputs, 2 of which for light functions
	250 mA load per output
	Total current of all functions ca. 500 mA. Outputs short-circuit protected.
	Free function allocation (function mapping) F0 - F15
Sound features:	4 (!) independent sound channels
	High Performance bridge-tied amplifier, appr. 0.6 Watt
	Sound data in memory chip changeable
	Modes for Steam engines, Diesel hydraulic locos, Diesel electric locos, Electro locos.
	16 MBit storage capacity (up to 130 seconds)
Loudspeaker:	High-quality loudspeaker, 23mm (0.92 inch) included, 100 Ohm with sound chamber
Dimensions:	31mm x 15.5mm x 6.5mm (1.24 x 0.62 x 0.26 inch)

## LokSound XL V3.5 – Big sound for big engines



LokSound XL V3.5

- ▶ The name tells it all: The LokSound XL V3.5 is intended for the big locos of gauge G and I. It works with DCC – or Märklin® Motorola® systems, as well as with LGB®-MTS®'s typical domino sequencing set up for the function keys.

The LokSound XL V3.5, size 51mm x 40mm (2.04 x 1.6 inch) fits in all locos of these gauges and is shipped with a robust screw terminal connection for easy installation.

### Operational modes

The LokSound XL V3.5 handles DCC and Motorola®. In DCC mode it will operate with 14, 28 or 128 speed steps. The decoder recognizes the speed step number automatically. It supports Lenz® LG 100, respectively Roco® braking sections, as well as braking in DC sections with reversed polarity or the Märklin® braking section (even in DCC operation). You can either use a two digit (1 – 127) or a four digit address (1 – 9999) or assign a consist address.

The Motorola® protocol makes it possible to run the LokSound decoder with Märklin® stations 6020, 6021, delta®, mobile station® and Central Station®. The decoder commands hereby addresses 1 – 80 and stops correctly on the Märklin® braking section. During operation, the LokSound XL V3.5 decoder converts automatically between all control modes.

### Functions

From experience it is known that there is much to switch in big locos. That's why we provided for eight (!) function outputs. Each output can be allocated to a function: Besides beacon, strobe and alternate flashing, there is firebox flicker simulation, as well as Mars light or Gyra light for US models.

All function outputs are individually dimmable in 15 steps. Each function output can be allocated to any function key between F0 and F15 (mapping). Furthermore, the combination of sound and function sequences makes it possible to simulate realistic function events, such as firebox flicker when shoveling coal.

### Analog operation

Back EMF as well as the sound of the LokSound XL V3.5 decoder is fully serviceable in Analog mode.

### Motor management

The powerful output stage (3.0A continuous-current) will run models with even two prime movers. All known DC- and coreless motors (e.g. Mabuchi®, Bühler®, Faulhaber® or Maxon®) can be used. The load control (back EMF) with 32 kHz high frequency regulation takes care of a silky smooth and absolutely silent motor operation and lets your engines crawl super slowly on the layout. A 10-bit A/D converter makes this possible.

### Sound

The LokSound XL V3.5 decoder stores up to 130 seconds of sound data in its 16 MBit flash chip. This is transferred to a 1.5 Watt, last stage high performance bridge tied amplifier via four polyphonic sound channels. Together with our ESU loudspeakers (16 – 32 Ohm) or Hi-Fi loudspeakers (8 – 16 Ohm), your engines will really sound their best in the future. Load dependent strain (de-selectable) is as much taken for granted, as Doppler effect, or separate volume adjustment for each of the channels.

### Programming

The LokSound XL V3.5 decoder supports all DCC programming modes. All adjustments are done electronically. This applies even when working with Märklin® stations® 6020, 6021, mobile station® and Central Station®. For these units, the LokSound XL V3.5 decoder employs a proven, easily acquired programming procedure. All programmed changes during Motorola® operation are valid with DCC – and vice versa. Programming configuration variables (CV's) is especially simple for owners of our ECoS command station: All modifications are displayed in plain words on the large screen and can easily be altered – even during operation on the layout.

### Safeguard

All function outputs and the motor connection are protected against overload and short circuit.

### Built-in future

LokSound XL V3.5 decoders are firmware updatable. This means, the internal decoder software can be replaced by new versions, if necessary. To do this, you only need an ESU LokProgrammer and a PC.

### Variety of sounds

ESU, as market and technology leader in the realm of sound, takes your demands for sound realism very seriously. That's why we offer over 100 (!) different sound variants just for the LokSound XL V3.5!

### Technical data LokSound XL V3.5

Operational mode:	NMRA/DCC with 14, 28, 128 speed steps DCC 2-digit and 4-digit addresses; Analog DC (de-selectable). Analog AC (de-selectable) Digital Motorola® (old and new), up to 28 speed steps and 127 addresses in Motorola® operation Automatic recognition of operational mode and DCC step speed selection Supports Lenz® LG100, Märklin®, Roco® braking sections Wrong-direction bit / Stores operational status (Memory); Intelligent programming mode with Märklin® 6021®
Throttle:	3.0 A continuous load Runs DC-, coreless and AC motors (AC motors can only be used when changed into DC via a permanent magnet) Silent, safe 16 / 32 kHz pulse width frequency motor regulation; Motor output overload protection. Load control of fourth generation (back EMF and de-selectable)
Function outputs:	8 outputs; 600mA load per output; Approx. 2000mA total load of all function outputs. Outputs short circuit protected; Free function allocation (function mapping) F0 - 20
Sound features:	4 (!) independent sound channels High performance bridge-tied load amplifier, ca. 1.5 Watt; Sound data in memory unit changeable; 16 MBit storage capacity (up to 130 seconds) Modes for steam engines, diesel hydraulic locos, diesel electrical locos, Electro locos
Loud speaker:	NOT INCLUDED. Adequate loud speakers between 8 and 32 ohm, at least 2 Watt
Dimensions:	51.0mm x 40.0mm x 14.0mm (2.04 x 1.6 x 0.56 inch)

# LokSound V4.0 – Available sounds ex works

Art.No.	Description	Novelty of	Delivery date
<b>54400</b>	<b>LokSound V4.0 «Universal sound for reprogramming», Gauge: 0, H0</b>	<b>2011</b>	<b>Q1/11</b>
54401	LokSound V4.0 Steam "Universal 2 Zyl. Narrow line (Prototype: BR99)", Gauge 0,H0	2011	Q1/11
54402	LokSound V4.0 Steam "Univers. 3 Zyl. Mainline (BR 44)", Gauge 0,H0	2011	Q1/11
54403	LokSound V4.0 Steam "Univ. 2/4 Zyl. Mainline (BR 64)", Gauge 0,H0	2011	Q1/11
54404	LokSound V4.0 Steam "BR 38, P8", Gauge 0,H0	2011	Q1/11
54405	LokSound V4.0 Steam "BR 18, S 3/6", Gauge 0,H0	2011	Q1/11
54406	LokSound V4.0 Steam "BR 01", Gauge 0,H0	2011	Q1/11
54407	LokSound V4.0 Steam "BR 03", Gauge 0,H0	2011	Q1/11
54408	LokSound V4.0 Steam "BR 23", Gauge 0,H0	2011	Q1/11
54409	LokSound V4.0 Steam "BR 96 Mallet", Gauge 0,H0	2011	Q1/11
54410	LokSound V4.0 Steam "BR 50, NMBS-SNCB type 25", Gauge 0,H0	2011	Q1/11
54411	LokSound V4.0 Steam "Universal US-Steam (Big Boy, Mikado)", Gauge 0,H0	2011	Q1/11
54412	LokSound V4.0 Steam "Tenweeler, Mountain, Hudson", Gauge 0,H0	2011	Q1/11
54413	LokSound V4.0 Steam "BR 80", Gauge 0,H0	2011	Q1/11
54414	LokSound V4.0 Steam "BR 01.10 Coal", Gauge 0,H0	2011	Q1/11
54415	LokSound V4.0 Steam "BR52 Kondensstender", Gauge 0,H0	2011	Q1/11
<b>54416</b>	<b>LokSound V4.0 Steam "Eagle", Gauge 0,H0</b>	<b>2011</b>	<b>Q2/11</b>
54417	LokSound V4.0 Steam "BR 06", Gauge 0,H0	2011	Q1/11
54418	LokSound V4.0 Steam "BR 05", Gauge 0,H0	2011	Q1/11
54419	LokSound V4.0 Steam "18 201", Gauge 0,H0	2011	Q1/11
54420	LokSound V4.0 Steam "BR 55, NMBS-SNCB type 81", Gauge 0,H0	2011	Q1/11
54421	LokSound V4.0 Steam "BR 64", Gauge 0,H0	2011	Q1/11
54422	LokSound V4.0 Steam "BR 78", Gauge 0,H0	2011	Q1/11
54423	LokSound V4.0 Steam "BR 93", Gauge 0,H0	2011	Q1/11
54424	LokSound V4.0 Steam "BR 41 Coal", Gauge 0,H0	2011	Q1/11
54425	LokSound V4.0 Steam "BR 41 Oil", Gauge 0,H0	2011	Q1/11
54426	LokSound V4.0 Steam "BR 01.10 Oil", Gauge 0,H0	2011	Q1/11
54427	LokSound V4.0 Steam "BR 03.10 Oil", Gauge 0,H0	2011	Q1/11
54428	LokSound V4.0 Steam "BR 44 Oil", Gauge 0,H0	2011	Q1/11
54429	LokSound V4.0 Steam "BR 86", Gauge 0,H0	2011	Q1/11
54430	LokSound V4.0 Diesel "V 36 / BR236", Gauge 0,H0	2011	Q1/11
54431	LokSound V4.0 Diesel "V 60 / BR260", Gauge 0,H0	2011	Q1/11
54432	LokSound V4.0 Diesel "V 100 / BR212", Gauge 0,H0	2011	Q1/11
54433	LokSound V4.0 Diesel "Universal Diesel (Prototype: BR 218)", Gauge 0,H0	2011	Q1/11
54434	LokSound V4.0 Diesel "Belgian Bombardier Diesel loco", Gauge 0,H0	2011	Q1/11
54435	LokSound V4.0 Diesel "V60 DR (BR106, BR346) 12 Zylinder", Gauge 0,H0	2011	Q1/11
54436	LokSound V4.0 Diesel "Universal US-Diesel (Prototype: F7)", Gauge 0,H0	2011	Q1/11
54437	LokSound V4.0 Diesel "DR V100", Gauge 0,H0	2011	Q1/11
54438	LokSound V4.0 Diesel "Nohab", Gauge 0,H0	2011	Q1/11
54439	LokSound V4.0 Diesel "VT 11.5, Lyntog", Gauge 0,H0	2011	Q1/11
54440	LokSound V4.0 Diesel "VT 18 / SVT 18.16", Gauge 0,H0	2011	Q1/11
54441	LokSound V4.0 Diesel "VT 628", Gauge 0,H0	2011	Q1/11
54442	LokSound V4.0 Diesel "BR 232 Ludmilla", Gauge 0,H0	2011	Q1/11
54443	LokSound V4.0 Diesel "SBB TEE Ram / NS DE IV", Gauge 0,H0	2011	Q1/11
54444	LokSound V4.0 Diesel "PA-1", Gauge 0,H0	2011	Q1/11
54445	LokSound V4.0 Diesel "Renfe D319", Gauge 0,H0	2011	Q1/11
54446	LokSound V4.0 Diesel "V 200, BR220, BR221", Gauge 0,H0	2011	Q1/11
54448	LokSound V4.0 Diesel "V 320", Gauge 0,H0	2011	Q1/11
54449	LokSound V4.0 Diesel "ICE VT", Gauge 0,H0	2011	Q1/11
54450	LokSound V4.0 Diesel "SVT 137 / VT 08", Gauge 0,H0	2011	Q1/11
54451	LokSound V4.0 Diesel "VT 610", Gauge 0,H0	2011	Q1/11
54452	LokSound V4.0 Diesel "VT 650" "Regioshuttle", Gauge 0,H0	2011	Q1/11
54453	LokSound V4.0 Diesel "V36 Doppeltes Lottchen", Gauge 0,H0	2011	Q1/11
54454	LokSound V4.0 Diesel "VT 98 Schienenbus", Gauge 0,H0	2011	Q1/11
54455	LokSound V4.0 Diesel "V80", Gauge 0,H0	2011	Q1/11
54456	LokSound V4.0 Diesel "ÖBB 2016 (Herkules)", Gauge 0,H0	2011	Q1/11
54457	LokSound V4.0 Diesel "SNCB 68000", Gauge 0,H0	2011	Q1/11
54458	LokSound V4.0 Diesel "Adtranz Blue Tiger", Gauge 0,H0	2011	Q1/11
54459	LokSound V4.0 Diesel "V 120 DR Taigatrommel", Gauge 0,H0	2011	Q1/11
54460	LokSound V4.0 Electric loco "E 10 / BR 110", Gauge 0,H0	2011	Q1/11
54461	LokSound V4.0 Electric loco "Universal Einheits-Electric loco (Prototype: E40)", Gauge 0,H0	2011	Q1/11
54462	LokSound V4.0 Electric loco "E 75", Gauge 0,H0	2011	Q1/11
54463	LokSound V4.0 Electric loco "E 03 / BR 103", Gauge 0,H0	2011	Q1/11
54464	LokSound V4.0 Electric loco "E 94 / BR 194", Gauge 0,H0	2011	Q1/11
54465	LokSound V4.0 Electric loco "E 120", Gauge 0,H0	2011	Q1/11
54466	LokSound V4.0 Electric loco "E 50 / BR 150", Gauge 0,H0	2011	Q1/11
54467	LokSound V4.0 Electric loco "ICE", Gauge 0,H0	2011	Q1/11
54468	LokSound V4.0 Electric loco "Universal Neubau - Electric loco (Prototype: Re 460)", Gauge 0,H0	2011	Q1/11
54469	LokSound V4.0 Electric loco "BR 143", Gauge 0,H0	2011	Q1/11
54470	LokSound V4.0 Electric loco "E44", Gauge 0,H0	2011	Q1/11
54471	LokSound V4.0 Electric loco "Crocodile Be 6/8 - Ce 6/8", Gauge 0,H0	2011	Q1/11
54472	LokSound V4.0 Electric loco "Re 4/4 II", Gauge 0,H0	2011	Q1/11
54473	LokSound V4.0 Electric loco "Taurus", Gauge 0,H0	2011	Q1/11
54474	LokSound V4.0 Electric loco "Ae 6/6", Gauge 0,H0	2011	Q1/11
54475	LokSound V4.0 Electric loco "ÖBB 1044", Gauge 0,H0	2011	Q1/11



Art.No.	Description	Novelty of	Delivery date
54476	LokSound V4.0 Diesel "V180 / BR118", Gauge 0,H0	2011	Q1/11
54477	LokSound V4.0 Steam "BR 89 / T3", Gauge 0,H0	2011	Q1/11
54478	LokSound V4.0 Diesel "BR643 Talent", Gauge 0,H0	2011	Q1/11
54479	LokSound V4.0 Diesel "KEG 2100", Gauge 0,H0	2011	Q1/11
54480	LokSound V4.0 Diesel "MaK Vossloh G1200 Serie", Gauge 0,H0	2011	Q1/11
54481	LokSound V4.0 Diesel "VT 11.5 TEE Gasturbine", Gauge 0,H0	2011	Q1/11
54482	LokSound V4.0 Diesel "VT 12.5 Stuttgarter Rössle", Gauge 0,H0	2011	Q1/11
54483	LokSound V4.0 Electric loco "BR185, BR189, SBB482, SBB489", Gauge 0,H0	2011	Q1/11
54484	LokSound V4.0 Electric loco "E 101", Gauge 0,H0	2011	Q1/11
54485	LokSound V4.0 Electric loco "E 141 / E 41", Gauge 0,H0	2011	Q1/11
54486	LokSound V4.0 Electric loco "Europrinter", Gauge 0,H0	2011	Q1/11
54487	LokSound V4.0 Electric loco "Akkutriebwagen ETA/ESA 176 Limburger Zigarre", Gauge 0,H0	2011	Q1/11
54488	LokSound V4.0 Steam "Sächsische IV k", Gauge 0,H0	2011	Q1/11
54489	LokSound V4.0 Diesel "Köf II", Gauge 0,H0	2011	Q1/11
54490	LokSound V4.0 Electric loco "Straßenbahn, Epoche III-V", Gauge 0,H0	2011	Q1/11
54491	LokSound V4.0 Diesel "Kleindiesel (z.B. Feldbahn-Loks)", Gauge 0,H0	2011	Q1/11
54492	LokSound V4.0 Electric loco "E 18 / 118 (E 19 / 119)", Gauge 0,H0	2011	Q1/11
54493	LokSound V4.0 Electric loco "Elektrotriebw., Ep.III (ET 65, ET 85, ET 87)", Gauge 0,H0	2011	Q1/11
54494	LokSound V4.0 Diesel "Triebwagen Desiro", Gauge 0,H0	2011	Q1/11
54495	LokSound V4.0 Electric loco "LKAB IORE 105-106", Gauge 0,H0	2011	Q1/11
54496	LokSound V4.0 Electric loco "LKAB Dm3 Serie 1200", Gauge 0,H0	2011	Q1/11
54497	LokSound V4.0 Electric loco "SBB TEE RAe Gottardo", Gauge 0,H0	2011	Q1/11
54498	LokSound V4.0 Electric loco "BR 403 ICE 3", Gauge 0,H0	2011	Q1/11
<b>54499</b>	<b>LokSound V4.0 «Universal sound for reprogramming» with 21MTC interface, Gauge: 0, H0</b>	<b>2011</b>	<b>Q1/11</b>
<b>55400</b>	<b>LokSound V4.0 «Universal sound for reprogramming», PluX12 interface on cable, Gauge: 0, H0</b>	<b>2011</b>	<b>Q1/11</b>
55401	LokSound V4.0 Electric loco "SNCB/NMBS HLE 13 - ALSTOM", Gauge 0,H0	2011	Q1/11
55402	LokSound V4.0 Electric loco "SNCB/NMBS HLE 15 - ACEC", Gauge 0,H0	2011	Q1/11
55403	LokSound V4.0 Electric loco "SNCB/NMBS HLE 16 - ACEC", Gauge 0,H0	2011	Q1/11
55404	LokSound V4.0 Diesel "SNCB/NMBS HLE 20 - BN ACEC", Gauge 0,H0	2011	Q1/11
55405	LokSound V4.0 Electric loco "SNCB/NMBS HLE 11/12/21/27 - BN ACEC", Gauge 0,H0	2011	Q1/11
55406	LokSound V4.0 Electric loco "SNCB/NMBS HLE 23 - ACEC", Gauge 0,H0	2011	Q1/11
55407	LokSound V4.0 Electric loco "SNCB/NMBS HLE 26 - BN -ACEC", Gauge 0,H0	2011	Q1/11
55408	LokSound V4.0 Diesel "SNCB/NMBS DMU 41 Diesel - Alstom 6 cyl.", Gauge 0,H0	2011	Q1/11
55409	LokSound V4.0 Diesel "SNCB/NMBS HLD 62 - EMD 567C 12 cyl.", Gauge 0,H0	2011	Q1/11
55410	LokSound V4.0 Diesel "SNCB/NMBS HLD 55 - EMD 567 16 cyl.", Gauge 0,H0	2011	Q1/11
55411	LokSound V4.0 Diesel "SNCB/NMBS HLD 59 - Cockerill 12 cyl.", Gauge 0,H0	2011	Q1/11
55412	LokSound V4.0 Electric loco "SNCF BB 427000/437000 Fret", Gauge 0,H0	2011	Q1/11
55413	LokSound V4.0 Diesel "SNCF X2800", Gauge 0,H0	2011	Q1/11
55414	LokSound V4.0 Electric loco "SNCF BB 25100 Savoie", Gauge 0,H0	2011	Q1/11
55416	LokSound V4.0 Electric loco "Straßenbahn GT4", Gauge 0,H0	2011	Q1/11
55417	LokSound V4.0 Diesel "ÖBB 2043", Gauge 0,H0	2011	Q1/11
55418	LokSound V4.0 Electric loco "Ge 4/4", Gauge 0,H0	2011	Q1/11
55419	LokSound V4.0 Steam "Glaskasten", Gauge 0,H0	2011	Q1/11
55420	LokSound V4.0 Diesel "BR 119 DR "U-Boot" (BR 219 DB)", Gauge 0,H0	2011	Q1/11
55421	LokSound V4.0 Electric loco "BR 420 S-Bahn Elektrotriebwagen", Gauge 0,H0	2011	Q1/11
55422	LokSound V4.0 Steam "French Steam loco 140C", Gauge 0,H0	2011	Q1/11
55423	LokSound V4.0 Elok "SNCB/NMBS Type15 LS-Version", 21MTC, Gauge 0,H0	2011	Q1/11
55424	LokSound V4.0 Electric loco "SNCB/NMBS HLE 11,12,21,27 LS-Version", 21MTC, Gauge 0,H0	2011	Q1/11
55425	LokSound V4.0 Electric loco "SNCF BB 16500 LS-Version", 21MTC, Gauge 0,H0	2011	Q1/11
55426	LokSound V4.0 Diesel "Feuerwehrlök", Gauge 0,H0	2011	Q1/11
55427	LokSound V4.0 Diesel "V 90", Gauge 0,H0	2011	Q1/11
55428	LokSound V4.0 Diesel "LINT", Gauge 0,H0	2011	Q1/11
55429	LokSound V4.0 Electric loco "Stadler FLIRT", Gauge 0,H0	2011	Q1/11
55438	LokSound V4.0 Electric loco "DB 181/184", Gauge 0,H0	2011	Q1/11
55439	LokSound V4.0 Diesel "Schienenzeppelin", Gauge 0,H0	2011	Q1/11
55440	LokSound V4.0 Diesel "V160", Gauge 0,H0	2011	Q1/11
55441	LokSound V4.0 Diesel "T44 SJ", Gauge 0,H0	2011	Q1/11
55442	LokSound V4.0 Diesel "V300", Gauge 0,H0	2011	Q1/11
55443	LokSound V4.0 Steam "Kittel Steamtriebwagen", Gauge 0,H0	2011	Q1/11
55444	LokSound V4.0 Electric loco "BR 180 DBAG", Gauge 0,H0	2011	Q1/11
55445	LokSound V4.0 Electric loco "Ae 3/6 I", Gauge 0,H0	2011	Q1/11
55446	LokSound V4.0 Electric loco "Ae 3/6 II", Gauge 0,H0	2011	Q1/11
55447	LokSound V4.0 Electric loco "BLS Re 4/4", Gauge 0,H0	2011	Q1/11
55448	LokSound V4.0 Electric loco "Re 6/6", Gauge 0,H0	2011	Q1/11
55449	LokSound V4.0 Diesel "SBB Bm 4/4 II", Gauge 0,H0	2011	Q1/11
55450	LokSound V4.0 Electric loco "RhB Ge 4/4 III", Gauge 0,H0	2011	Q1/11
55455	LokSound V4.0 Diesel "VW Draisine", Gauge 0,H0	2011	Q1/11
55456	LokSound V4.0 "Pferdebahn", Gauge 0,H0	2011	Q1/11
55457	LokSound V4.0 Steam "BR 95", Gauge 0,H0	2011	Q1/11
55458	LokSound V4.0 Steam "BR 53", Gauge 0,H0	2011	Q1/11
55490	LokSound V4.0 Diesel "DSB MZ I" 21MTC, Gauge 0,H0	2011	Q1/11
55491	LokSound V4.0 Diesel "DSB MZ II" 21MTC, Gauge 0,H0	2011	Q1/11
55492	LokSound V4.0 Diesel "DSB MZ IV" 21MTC, Gauge 0,H0	2011	Q1/11
55493	LokSound V4.0 Diesel "DSB ME", Gauge 0,H0	2011	Q1/11
55494	LokSound V4.0 Diesel "DSB MT/MH" 21MTC, Gauge 0,H0	2011	Q1/11

# LokSound V4.0 – Available sounds ex works

Art.No.	Description	Novelty of	Delivery date
55495	LokSound V4.0 Diesel "Me26/Di6" 21MTC, Gauge 0,H0	2011	Q1/11
55496	LokSound V4.0 Diesel "DSB MO" 21MTC, Gauge 0,H0	2011	Q1/11
55497	LokSound V4.0 Steam "DSB D" 21MTC, Gauge 0,H0	2011	Q1/11
<b>55498</b>	<b>LokSound V4.0 Diesel "VT 612 Triebwagen", Gauge 0,H0</b>	<b>2011</b>	<b>Q2/11</b>
<b>55499</b>	<b>LokSound V4.0 Diesel "FS DE753 Taucherbrille", Gauge 0,H0</b>	<b>2011</b>	<b>Q2/11</b>
<b>56400</b>	<b>LokSound V4.0 Steam "SNCF 231", Gauge 0,H0</b>	<b>2011</b>	<b>Q2/11</b>
<b>56401</b>	<b>LokSound V4.0 Diesel "ÖBB 2016", Gauge 0,H0</b>	<b>2011</b>	<b>Q3/11</b>
<b>56402</b>	<b>LokSound V4.0 Diesel "ÖBB 2043", Gauge 0,H0</b>	<b>2011</b>	<b>Q3/11</b>
<b>56403</b>	<b>LokSound V4.0 Diesel "ÖBB 5081", Gauge 0,H0</b>	<b>2011</b>	<b>Q3/11</b>
<b>56404</b>	<b>LokSound V4.0 Diesel "SBB ICN", Gauge 0,H0</b>	<b>2011</b>	<b>Q3/11</b>
<b>56405</b>	<b>LokSound V4.0 Steam "BR 76", Gauge 0,H0</b>	<b>2011</b>	<b>Q2/11</b>
<b>56406</b>	<b>LokSound V4.0 Diesel "VT 610", Gauge 0,H0</b>	<b>2011</b>	<b>Q2/11</b>
<b>56407</b>	<b>LokSound V4.0 Diesel "LINT 41", Gauge 0,H0</b>	<b>2011</b>	<b>Q2/11</b>
<b>56408</b>	<b>LokSound V4.0 Diesel "VT 614", Gauge 0,H0</b>	<b>2011</b>	<b>Q2/11</b>
<b>56409</b>	<b>LokSound V4.0 Diesel "ÖBB 2050", Gauge 0,H0</b>	<b>2011</b>	<b>Q3/11</b>
<b>56411</b>	<b>LokSound V4.0 Diesel "ÖBB 2095", Gauge 0,H0</b>	<b>2011</b>	<b>Q3/11</b>
<b>56412</b>	<b>LokSound V4.0 Steam "BR 39", Gauge 0,H0</b>	<b>2011</b>	<b>Q3/11</b>
<b>56413</b>	<b>LokSound V4.0 Steam "BR 43", Gauge 0,H0</b>	<b>2011</b>	<b>Q3/11</b>
<b>56414</b>	<b>LokSound V4.0 Diesel "G1700", Gauge 0,H0</b>	<b>2011</b>	<b>Q3/11</b>
<b>56415</b>	<b>LokSound V4.0 Diesel "RENFE333", Gauge 0,H0</b>	<b>2011</b>	<b>Q3/11</b>
<b>56416</b>	<b>LokSound V4.0 Electric loco "BR 111", Gauge 0,H0</b>	<b>2011</b>	<b>Q3/11</b>
<b>56417</b>	<b>LokSound V4.0 Electric loco "BR 141 (E 41)", Gauge 0,H0</b>	<b>2011</b>	<b>Q3/11</b>
<b>56418</b>	<b>LokSound V4.0 Electric loco "ÖBB1042", Gauge 0,H0</b>	<b>2011</b>	<b>Q2/11</b>
<b>56419</b>	<b>LokSound V4.0 Electric loco "BR 151", Gauge 0,H0</b>	<b>2011</b>	<b>Q3/11</b>
<b>The following LokSound decoders can be exclusively purchased from our distributor „South West Digital“ in the UK:</b>			
55460	LokSound V4.0 Steam SWD "GWR Manor 78xx Class", Gauge 0,H0	2011	Q1/11
55461	LokSound V4.0 Steam SWD "GWR Pannier Tank 57xx Class", Gauge 0,H0	2011	Q1/11
55462	LokSound V4.0 Steam SWD "GWR Prairie Tank 61xx Class", Gauge 0,H0	2011	Q1/11
55463	LokSound V4.0 Steam SWD "BR Mogul Class", Gauge 0,H0	2011	Q1/11
55464	LokSound V4.0 Steam SWD "LMS Mogul Class", Gauge 0,H0	2011	Q1/11
55465	LokSound V4.0 Steam SWD "A4 Pacific Class, Union of South Africa", Gauge 0,H0	2011	Q1/11
55466	LokSound V4.0 Steam SWD "A4 Pacific Class, Sir Nigel Gresley", Gauge 0,H0	2011	Q1/11
55467	LokSound V4.0 Steam SWD "Jubilee Class, Leander", Gauge 0,H0	2011	Q1/11
55468	LokSound V4.0 Steam SWD "Bulleid Pacific Class", Gauge 0,H0	2011	Q1/11
55470	LokSound V4.0 Diesel SWD "Class 03", Gauge 0,H0	2011	Q1/11
55471	LokSound V4.0 Diesel SWD "Class 08", Gauge 0,H0	2011	Q1/11
55472	LokSound V4.0 Diesel SWD "Class 20", Gauge 0,H0	2011	Q1/11
55473	LokSound V4.0 Diesel SWD "Class 24", Gauge 0,H0	2011	Q1/11
55474	LokSound V4.0 Diesel SWD "Class 25", Gauge 0,H0	2011	Q1/11
55475	LokSound V4.0 Diesel SWD "Class 31", Gauge 0,H0	2011	Q1/11
55476	LokSound V4.0 Diesel SWD "Class 33", Gauge 0,H0	2011	Q1/11
55477	LokSound V4.0 Diesel SWD "Class 37", Gauge 0,H0	2011	Q1/11
55478	LokSound V4.0 Diesel SWD "Class 40", Gauge 0,H0	2011	Q1/11
55479	LokSound V4.0 Diesel SWD "Class 43 HST Paxman", Gauge 0,H0	2011	Q1/11
55480	LokSound V4.0 Diesel SWD "Class 43 HST MTU", Gauge 0,H0	2011	Q1/11
55481	LokSound V4.0 Diesel SWD "Class 45", Gauge 0,H0	2011	Q1/11
55482	LokSound V4.0 Diesel SWD "Class 47", Gauge 0,H0	2011	Q1/11
55483	LokSound V4.0 Diesel SWD "Class 50", Gauge 0,H0	2011	Q1/11
55484	LokSound V4.0 Diesel SWD "Class 52", Gauge 0,H0	2011	Q1/11
55485	LokSound V4.0 Diesel SWD "Class 55 Deltic", Gauge 0,H0	2011	Q1/11
55486	LokSound V4.0 Diesel SWD "Class 66", Gauge 0,H0	2011	Q1/11
55487	LokSound V4.0 Diesel SWD "Class 67", Gauge 0,H0	2011	Q1/11
55488	LokSound V4.0 Diesel SWD "Class 108 DMU", Gauge 0,H0	2011	Q1/11
55489	LokSound V4.0 Diesel SWD "Class 158 Sprinter", Gauge 0,H0	2011	Q1/11
<b>The following LokSound decoders can be exclusively purchased from our distributor „Essemme“ in Italy:</b>			
55430	LokSound V4.0 Steam Essemme "Italian Gruppo 625", Gauge 0,H0	2011	Q1/11
55431	LokSound V4.0 Electrical loco Essemme "FS 405", Gauge 0,H0	2011	Q1/11
55432	LokSound V4.0 Electrical loco Essemme "FS 655", Gauge 0,H0	2011	Q1/11
55433	LokSound V4.0 Steam Essemme "Class 58 / 58.30", Gauge 0,H0	2011	Q1/11
55434	LokSound V4.0 Diesel Essemme "FS D345", Gauge 0,H0	2011	Q1/11
55435	LokSound V4.0 Diesel Essemme "FS D145", Gauge 0,H0	2011	Q1/11
55436	LokSound V4.0 Diesel Essemme "FS D214", Gauge 0,H0	2011	Q1/11
55437	LokSound V4.0 Diesel Essemme "FS D245", Gauge 0,H0	2011	Q1/11

More sounds are available on our website [www.esu.eu](http://www.esu.eu)

# LokSound micro V4.0 – Available sounds ex works

Art.No.	Description	Novelty of	Delivery date
<b>54800</b>	<b>LokSound micro V4.0 «Universalsound for reprogramming», with 6-pin. NEM651, Gauge: N,TT</b>	<b>2011</b>	<b>Q1/11</b>
54801	LokSound micro V4.0 Steam "Universal 2 Zyl. Narrow line (BR 99)", Gauge N,TT	2011	Q1/11
54802	LokSound micro V4.0 Steam "Universal 3 Zyl. Mainline (BR 44)", Gauge N,TT	2011	Q1/11
54803	LokSound micro V4.0 Steam "Universal 2/4 Zyl. Mainline (BR 64)", Gauge N,TT	2011	Q1/11
54804	LokSound micro V4.0 Steam "BR 38", Gauge N,TT	2011	Q1/11
54819	LokSound micro V4.0 Steam "BR 18 201", Gauge N,TT	2011	Q1/11
54823	LokSound micro V4.0 Steam "Shay", Gauge N,TT	2011	Q1/11
54824	LokSound micro V4.0 Steam "BR 41 Coal", Gauge N,TT	2011	Q1/11
54825	LokSound micro V4.0 Steam "BR 41 Oil", Gauge N,TT	2011	Q1/11
54826	LokSound micro V4.0 Steam "Sächsische IV k", Gauge N,TT	2011	Q1/11
54827	LokSound micro V4.0 Steam "Glaskasten", Gauge N,TT	2011	Q1/11
54831	LokSound micro V4.0 Diesel "V60", Gauge N,TT	2011	Q1/11
54833	LokSound micro V4.0 Diesel "Universal Diesel (Prototype: BR 218)", Gauge N,TT	2011	Q1/11
54836	LokSound micro V4.0 Diesel "Universal US-Diesel (Prototype: F 7)", Gauge N,TT	2011	Q1/11
54838	LokSound micro V4.0 Diesel "Nohab", Gauge N,TT	2011	Q1/11
54839	LokSound micro V4.0 Diesel "TEE VT11.5 / Lyntog", Gauge N,TT	2011	Q1/11
54842	LokSound micro V4.0 Diesel "BR 232 Ludmilla", Gauge N,TT	2011	Q1/11
54846	LokSound micro V4.0 Diesel "V200 / BR220", Gauge N,TT	2011	Q1/11
54850	LokSound micro V4.0 Diesel "Triebwagen SVT137 / V T08", Gauge N,TT	2011	Q1/11
54854	LokSound micro V4.0 Diesel "VT98", Gauge N,TT	2011	Q1/11
54858	LokSound micro V4.0 Diesel "Blue Tiger", Gauge N,TT	2011	Q1/11
54859	LokSound micro V4.0 Diesel "V 120 DR Taigatrommel", Gauge N,TT	2011	Q1/11
54861	LokSound micro V4.0 Electric loco "Universal Altbau - (Prototype: E40)", Gauge N,TT	2011	Q1/11
54869	LokSound micro V4.0 Electric loco "Ge 6/6 Rhätisches Krokodil", Gauge N,TT	2011	Q1/11
54871	LokSound micro V4.0 Electric loco "SBB Be 6/8, Ce6/8 Krokodil", Gauge N,TT	2011	Q1/11
54873	LokSound micro V4.0 Electric loco "Taurus", Gauge N,TT	2011	Q1/11
54876	LokSound micro V4.0 Diesel "V 180 / BR 118", Gauge N,TT	2011	Q1/11
54880	LokSound micro V4.0 Diesel "MaK Vossloh G1200 Serie", Gauge N,TT	2011	Q1/11
54886	LokSound micro V4.0 Electric loco "Europrinter", Gauge N,TT	2011	Q1/11
54889	LokSound micro V4.0 Diesel "Köf II", Gauge N,TT	2011	Q1/11
54890	LokSound micro V4.0 Electric loco "Straßenbahn, Epoche III-V", Gauge N,TT	2011	Q1/11
54891	LokSound micro V4.0 Diesel "Kleindiesel (z.B. Feldbahn-Loks)", Gauge N,TT	2011	Q1/11
54892	LokSound micro V4.0 Electric loco "E 18", Gauge N,TT	2011	Q1/11
54893	LokSound micro V4.0 ELok "Elektrotriebw. Ep.III (ET65,ET85,ET87)", Gauge N,TT	2011	Q1/11
54894	LokSound micro V4.0 Diesel "Triebwagen Desiro", Gauge N,TT	2011	Q1/11
<b>54898</b>	<b>LokSound micro V4.0 «Universalsound for reprogramming», with Next18 interface, Gauge: N,TT</b>	<b>2011</b>	<b>Q1/11</b>
<b>54899</b>	<b>LokSound micro V4.0 «Universalsound for reprogramming», with 8-pin. NEM652, Gauge: N,TT</b>	<b>2011</b>	<b>Q1/11</b>
<b>55800</b>	<b>LokSound micro V4.0 «Universalsound for reprogramming», with PluX12 interface, Gauge: N,TT</b>	<b>2011</b>	<b>Q1/11</b>
55801	LokSound micro V4.0 Electric loco "SNCB / NMBS HLE 13", Gauge N,TT	2011	Q1/11
55802	LokSound micro V4.0 Electric loco "SNCB / NMBS HLE 15", Gauge N,TT	2011	Q1/11
55803	LokSound micro V4.0 Electric loco "SNCB / NMBS HLE 16", Gauge N,TT	2011	Q1/11
55804	LokSound micro V4.0 Electric loco "SNCB / NMBS HLE 20", Gauge N,TT	2011	Q1/11
55805	LokSound micro V4.0 Electric loco "SNCB / NMBS HLE 11,12,21,27", Gauge N,TT	2011	Q1/11
55806	LokSound micro V4.0 Electric loco "SNCB / NMBS HLE 23", Gauge N,TT	2011	Q1/11
55807	LokSound micro V4.0 Electric loco "SNCB / NMBS HLE 26", Gauge N,TT	2011	Q1/11
55808	LokSound micro V4.0 Diesel "SNCB / NMBS Alstom DMU 41", Gauge N,TT	2011	Q1/11
55809	LokSound micro V4.0 Diesel "SNCB / NMBS Reeks 62", Gauge N,TT	2011	Q1/11
55810	LokSound micro V4.0 Diesel "SNCB / NMBS Reeks 55", Gauge N,TT	2011	Q1/11
55811	LokSound micro V4.0 Diesel "SNCB / NMBS Reeks 59", Gauge N,TT	2011	Q1/11
55813	LokSound micro V4.0 Diesel "SNCB X2800/X2400", Gauge N,TT	2011	Q1/11
55821	LokSound micro V4.0 Electric loco "BR 420", Gauge N,TT	2011	Q1/11
55840	LokSound micro V4.0 Diesel "DB V160", Gauge N,TT	2011	Q1/11
55842	LokSound micro V4.0 Diesel "DB V300", Gauge N,TT	2011	Q1/11
<b>55855</b>	<b>LokSound micro V4.0 Diesel "VW Draisine", Gauge N,TT</b>	<b>2011</b>	<b>Q1/11</b>
<b>56801</b>	<b>LokSound micro V4.0 Diesel ÖBB 2016, Gauge N,TT</b>	<b>2011</b>	<b>Q3/11</b>
<b>56802</b>	<b>LokSound micro V4.0 Diesel ÖBB 2043, Gauge N,TT</b>	<b>2011</b>	<b>Q3/11</b>
<b>56803</b>	<b>LokSound micro V4.0 Diesel ÖBB 5081, Gauge N,TT</b>	<b>2011</b>	<b>Q3/11</b>
<b>56804</b>	<b>LokSound micro V4.0 Diesel SBB ICN, Gauge N,TT</b>	<b>2011</b>	<b>Q3/11</b>
<b>56805</b>	<b>LokSound micro V4.0 Steam BR 76, Gauge N,TT</b>	<b>2011</b>	<b>Q2/11</b>
<b>56806</b>	<b>LokSound micro V4.0 Diesel VT 610, Gauge N,TT</b>	<b>2011</b>	<b>Q2/11</b>
<b>56807</b>	<b>LokSound micro V4.0 Diesel LINT 41, Gauge N,TT</b>	<b>2011</b>	<b>Q2/11</b>
<b>56808</b>	<b>LokSound micro V4.0 Diesel VT 614, Gauge N,TT</b>	<b>2011</b>	<b>Q2/11</b>
<b>56809</b>	<b>LokSound micro V4.0 Diesel ÖBB 2050, Gauge N,TT</b>	<b>2011</b>	<b>Q3/11</b>
<b>56811</b>	<b>LokSound micro V4.0 Diesel ÖBB 2095, Gauge N,TT</b>	<b>2011</b>	<b>Q3/11</b>
<b>56812</b>	<b>LokSound micro V4.0 Steam "BR 39", Gauge N,TT</b>	<b>2011</b>	<b>Q3/11</b>
<b>56813</b>	<b>LokSound micro V4.0 Steam "BR 43", Gauge N,TT</b>	<b>2011</b>	<b>Q3/11</b>
<b>56814</b>	<b>LokSound micro V4.0 Diesel "G1700", Gauge N,TT</b>	<b>2011</b>	<b>Q3/11</b>
<b>56815</b>	<b>LokSound micro V4.0 Diesel "RENFE 333", Gauge N,TT</b>	<b>2011</b>	<b>Q3/11</b>
<b>56816</b>	<b>LokSound micro V4.0 Electric loco "BR 111", Gauge N,TT</b>	<b>2011</b>	<b>Q3/11</b>
<b>56817</b>	<b>LokSound micro V4.0 Electric loco "BR 141 (E41)", Gauge N,TT</b>	<b>2011</b>	<b>Q3/11</b>
<b>56818</b>	<b>LokSound micro V4.0 Electric loco "ÖBB 1042", Gauge N,TT</b>	<b>2011</b>	<b>Q2/11</b>
<b>56819</b>	<b>LokSound micro V4.0 Electric loco "BR 151", Gauge N,TT</b>	<b>2011</b>	<b>Q3/11</b>
<b>The following LokSound decoders can be exclusively purchased from our distributor „South West Digital“ in the UK:</b>			
55860	LokSound micro V4.0 Steam SWD "GWR Manor 78xx Class", Gauge N, TT	2011	Q1/11
55861	LokSound micro V4.0 Steam SWD "GWR Pannier Tank 57xx Class", Gauge N, TT	2011	Q1/11

# LokSound micro V4.0 – Available sounds ex works

Art.No.	Description	Novelty of	Delivery date
55862	LokSound micro V4.0 Steam SWD "GWR Prairie Tank 61xx Class", Gauge N, TT	2011	Q1/11
55863	LokSound micro V4.0 Steam SWD "BR Mogul Class", Gauge N, TT	2011	Q1/11
55864	LokSound micro V4.0 Steam SWD "LMS Mogul Class", Gauge N, TT	2011	Q1/11
55865	LokSound micro V4.0 Steam SWD "A4 Pacific, Union of South Africa", Gauge N, TT	2011	Q1/11
55866	LokSound micro V4.0 Steam SWD "A4 Pacific, Sir Nigel Gresley", Gauge N, TT	2011	Q1/11
55867	LokSound micro V4.0 Steam SWD "Jubilee Class, Leander", Gauge N, TT	2011	Q1/11
55868	LokSound micro V4.0 Steam SWD "Bulleid Pacific Class", Gauge N, TT	2011	Q1/11
55870	LokSound micro V4.0 Diesel SWD "Class 03", Gauge N, TT	2011	Q1/11
55871	LokSound micro V4.0 Diesel SWD "Class 08", Gauge N, TT	2011	Q1/11
55872	LokSound micro V4.0 Diesel SWD "Class 20", Gauge N, TT	2011	Q1/11
55873	LokSound micro V4.0 Diesel SWD "Class 24", Gauge N, TT	2011	Q1/11
55874	LokSound micro V4.0 Diesel SWD "Class 25", Gauge N, TT	2011	Q1/11
55875	LokSound micro V4.0 Diesel SWD "Class 31", Gauge N, TT	2011	Q1/11
55876	LokSound micro V4.0 Diesel SWD "Class 33", Gauge N, TT	2011	Q1/11
55877	LokSound micro V4.0 Diesel SWD "Class 37", Gauge N, TT	2011	Q1/11
55878	LokSound micro V4.0 Diesel SWD "Class 40", Gauge N, TT	2011	Q1/11
55879	LokSound micro V4.0 Diesel SWD "Class 43 HST Paxman", Gauge N, TT	2011	Q1/11
55880	LokSound micro V4.0 Diesel SWD "Class 43 HST MTU", Gauge N, TT	2011	Q1/11
55881	LokSound micro V4.0 Diesel SWD "Class 45", Gauge N, TT	2011	Q1/11
55882	LokSound micro V4.0 Diesel SWD "Class 47", Gauge N, TT	2011	Q1/11
55883	LokSound micro V4.0 Diesel SWD "Class 50", Gauge N, TT	2011	Q1/11
55884	LokSound micro V4.0 Diesel SWD "Class 52", Gauge N, TT	2011	Q1/11

# LokSound V3.0 M4 – Available sounds ex works

Art.No.	Novelty of	Delivery date	Description
<b>62400</b>	<b>2005</b>		<b>LokSound V3.0 M4 "Universal sound for reprogramming", Gauge: 0, H0</b>
62401	2005		LokSound V3.0 M4 Steam "Universal 2 Zyl. Narrow line (Prototype: BR 99)", Gauge: 0, H0
62402	2005		LokSound V3.0 M4 Steam "Univers. 3 Zyl. Mainline (Prototype: BR 44, Belg. 25.021)", Gauge: 0, H0
62403	2005		LokSound V3.0 M4 Steam "Universal 2/4 Zyl. Mainline (Prototype: BR 64)", Gauge: 0, H0
62404	2005		LokSound V3.0 M4 Steam "BR 38, P8", Gauge: 0, H0
62405	2005		LokSound V3.0 M4 Steam "BR 18, S 3/6", Gauge: 0, H0
62406	2005		LokSound V3.0 M4 Steam "BR 01", Gauge: 0, H0
62407	2005		LokSound V3.0 M4 Steam "BR 03", Gauge: 0, H0
62408	2005		LokSound V3.0 M4 Steam "BR 23", Gauge: 0, H0
62409	2008		LokSound V3.0 M4 Steam "BR96 Mallet", Gauge: 0, H0
62410	2005		LokSound V3.0 M4 Steam "BR 50, NMBS-SNCB type 25", Gauge: 0, H0
62411	2005		LokSound V3.0 M4 Steam "Universal US-Steam (Prototype: Big Boy, Mikado)", Gauge: 0, H0
62412	2005		LokSound V3.0 M4 Steam "Tenweeler, Mountain, Hudson", Gauge: 0, H0
62413	2005		LokSound V3.0 M4 Steam "BR 80", Gauge: 0, H0
62415	2009		LokSound V3.0 M4 Steam "BR 52 Kondenstender", Gauge: 0, H0
62419	2005		LokSound V3.0 M4 Steam "18 201", Gauge: 0, H0
62420	2005		LokSound V3.0 M4 Steam "BR 55, NMBS-SNCB type 81", Gauge: 0, H0
62422	2005		LokSound V3.0 M4 Steam "BR 78", Gauge: 0, H0
62423	2005		LokSound V3.0 M4 Steam "BR 93", Gauge: 0, H0
62425	2005		LokSound V3.0 M4 Steam "BR 41", Gauge: 0, H0
62426	2005		LokSound V3.0 M4 Steam "BR 01.10 Oil", Gauge: 0, H0
62427	2006		LokSound V3.0 M4 Steam "BR 03.10 Oil", Gauge: 0, H0
62428	2006		LokSound V3.0 M4 Steam "BR 44 Oil", Gauge: 0, H0
62429	2006		LokSound V3.0 M4 Steam "BR 86", Gauge: 0, H0
62430	2005		LokSound V3.0 M4 Diesel "V36", Gauge: 0, H0
62431	2005		LokSound V3.0 M4 Diesel "V60 / BR260", Gauge: 0, H0
62432	2005		LokSound V3.0 M4 Diesel "V100 / BR212", Gauge: 0, H0
62433	2005		LokSound V3.0 M4 Diesel "Universal Diesel (Prototype: BR 218)", Gauge: 0, H0
62434	2005		LokSound V3.0 M4 Diesel "Belgian Bombardier Diesellok", Gauge: 0, H0
62436	2005		LokSound V3.0 M4 Diesel "Universal US-Diesel (Prototype: F7)", Gauge: 0, H0
62437	2009		LokSound V3.0 M4 Diesel "DR V100", Gauge: 0, H0
62438	2005		LokSound V3.0 M4 Diesel "Nohab", Gauge: 0, H0
62439	2005		LokSound V3.0 M4 Diesel "VT 11.5, Lyntog", Gauge: 0, H0
62440	2005		LokSound V3.0 M4 Diesel "VT 18 / SVT 18.16", Gauge: 0, H0
62441	2005		LokSound V3.0 M4 Diesel "VT 628", Gauge: 0, H0
62442	2005		LokSound V3.0 M4 Diesel "BR 232 Ludmilla", Gauge: 0, H0
62443	2009		LokSound V3.0 M4 Diesel "RAM TEE", Gauge: 0, H0
62444	2005		LokSound V3.0 M4 Diesel "PA-1", Gauge: 0, H0
62445	2005		LokSound V3.0 M4 Diesel "Renfe D319", Gauge: 0, H0
62446	2005		LokSound V3.0 M4 Diesel "V200 / BR220", Gauge: 0, H0
62448	2006		LokSound V3.0 M4 Diesel "V320", Gauge: 0, H0
62449	2010		LokSound V3.0 M4 Diesel „ICE VT“
62450	2005		LokSound V3.0 M4 Diesel "VT 08 / SVT 137", Gauge: 0, H0
62451	2005		LokSound V3.0 M4 Diesel "VT 610", Gauge: 0, H0
62452	2005		LokSound V3.0 M4 Diesel "VT 650", Gauge: 0, H0
62454	2005		LokSound V3.0 M4 Diesel "VT 98 Schienenbus", Gauge: 0, H0



# LokSound V3.0 M4 – Available sounds ex works

Art.No.	Novelty of	Delivery date	Description
62455	2010		LokSound V3.0 M4 Diesel „V 80“
62456	2005		LokSound V3.0 M4 Diesel "ÖBB 2016", Gauge: 0, H0
62457	2005		LokSound V3.0 M4 Diesel "SNCF 68000", Gauge: 0, H0
62458	2005		LokSound V3.0 M4 Diesel "Adtranz Blue Tiger", Gauge: 0, H0
62459	2005		LokSound V3.0 M4 Diesel "V 120 DR Taigatrommel", Gauge: 0, H0
62460	2008		LokSound V3.0 M4 Electric loco "E 10 / BR 110", Gauge: 0, H0
62461	2005		LokSound V3.0 M4 Electric loco "Universal Altbau - Electric loco (Prototype: E40)", Gauge: 0, H0
62462	2005		LokSound V3.0 M4 Electric loco "E 75", Gauge: 0, H0
62463	2005		LokSound V3.0 M4 Electric loco "E 03 / BR 103", Gauge: 0, H0
62464	2005		LokSound V3.0 M4 Electric loco "E 94 / BR 194", Gauge: 0, H0
62465	2005		LokSound V3.0 M4 Electric loco "E 120", Gauge: 0, H0
62466	2005		LokSound V3.0 M4 Electric loco "E 50 / BR 150", Gauge: 0, H0
62467	2005		LokSound V3.0 M4 Diesel "ICE", Gauge: 0, H0
62468	2005		LokSound V3.0 M4 Electric loco "Universal Neubau - Electric loco (Prototype: Re 460)", Gauge: 0, H0
62469	2005		LokSound V3.0 M4 Electric loco "BR 143", Gauge: 0, H0
62470	2005		LokSound V3.0 M4 Electric loco "E 44", Gauge: 0, H0
62471	2005		LokSound V3.0 M4 Electric loco "Krokodil Be 6/8 - Ce 6/8", Gauge: 0, H0
62472	2005		LokSound V3.0 M4 Electric loco "Re 4/4 II", Gauge: 0, H0
62473	2005		LokSound V3.0 M4 Electric loco "Taurus", Gauge: 0, H0
62474	2005		LokSound V3.0 M4 Electric loco "Ae 6/6", Gauge: 0, H0
62475	2005		LokSound V3.0 M4 Electric loco "ÖBB 1044", Gauge: 0, H0
62477	2006		LokSound V3.0 M4 Steam "BR 89 / T3", Gauge: 0, H0
62478	2006		LokSound V3.0 M4 Diesel "BR 643 Talent", Gauge: 0, H0
62479	2006		LokSound V3.0 M4 Diesel "KEG 2100", Gauge: 0, H0
62480	2006		LokSound V3.0 M4 Diesel "MaK Vossloh G1200 Serie", Gauge: 0, H0
62481	2006		LokSound V3.0 M4 Diesel "VT 11.5 TEE Gasturbine", Gauge: 0, H0
62482	2006		LokSound V3.0 M4 Diesel "VT 12.5 Stuttgarter Rössle", Gauge: 0, H0
62483	2006		LokSound V3.0 M4 Electric loco "BR 185 / SBB 482", Gauge: 0, H0
62484	2006		LokSound V3.0 M4 Electric loco "E 101", Gauge: 0, H0
62485	2006		LokSound V3.0 M4 Electric loco "E 141 / E 41", Gauge: 0, H0
62486	2006		LokSound V3.0 M4 Electric loco "Eurosprinter", Gauge: 0, H0
62487	2006		LokSound V3.0 M4 Electric loco "Akkutriebwagen ETA / ESA 176 Limburger Zigarre", Gauge: 0, H0
62492	2008		LokSound V3.0 M4 Electric loco "ET 18", Gauge: 0, H0
62493	2008		LokSound V3.0 M4 Electric loco "ET 65 etc", Gauge: 0, H0
62495	2009		LokSound V3.0 M4 Electric loco "LKAB IORE", Gauge: 0, H0
62497	2009		LokSound V3.0 M4 Electric loco "TEE RAe II Gottardo", Gauge: 0, H0
62498	2009		LokSound V3.0 M4 Electric loco "ICE 3", Gauge: 0, H0
<b>62499</b>	<b>2005</b>		<b>LokSound V3.0 M4 "Universal sound for reprogramming with 21MTC interface", Gauge: 0, H0</b>
63401	2008		LokSound V3.0 M4 Electric loco "SNCB/NMBS HLE13 Alstom", Gauge: 0, H0
63402	2008		LokSound V3.0 M4 Electric loco "SNCB/NMBS HLE15 Alstom", Gauge: 0, H0
63403	2008		LokSound V3.0 M4 Electric loco "SNCB/NMBS HLE16", Gauge: 0, H0
63404	2008		LokSound V3.0 M4 Electric loco "SNCB/NMBS HLE20", Gauge: 0, H0
63405	2008		LokSound V3.0 M4 Electric loco "SNCB/NMBS HLE 11,12,21,27", Gauge: 0, H0
63406	2008		LokSound V3.0 M4 Electric loco "SNCB/NMBS HLE23", Gauge: 0, H0
63407	2008		LokSound V3.0 M4 Electric loco "SNCB/NMBS HLE26", Gauge: 0, H0
63408	2008		LokSound V3.0 M4 Diesel "Alstom DMU 41", Gauge: 0, H0
63409	2008		LokSound V3.0 M4 Diesel "Reeks 62", Gauge: 0, H0
63410	2008		LokSound V3.0 M4 Diesel "Reeks 55", Gauge: 0, H0
63411	2008		LokSound V3.0 M4 Diesel "Reeks 59", Gauge: 0, H0
63412	2008		LokSound V3.0 M4 Electric loco "SNCF BB 427000 Fret", Gauge: 0, H0
63414	2008		LokSound V3.0 M4 Electric loco "BB25100 Savoie", Gauge: 0, H0
63417	2009		LokSound V3.0 M4 Diesel "ÖBB 2043", Gauge: 0, H0
63421	2009		LokSound V3.0 M4 Electric loco "BR 420", Gauge: 0, H0
63423	2009		LokSound V3.0 M4 Electric loco "SNCB/NMBS Type 15 LS-Models", Gauge: 0, H0
63424	2009		LokSound V3.0 M4 Electric loco "SNCB/NMBS Type 27 LS-Models", Gauge: 0, H0
63427	2009		LokSound V3.0 M4 Diesel "V90", Gauge: 0, H0
63428	2010		LokSound V3.0 M4 Diesel "LINT"
63429	2010		LokSound V3.0 M4 Electric loco "Stadler Flirt"
63433	2009		LokSound V3.0 M4 Steam "BR 58 / BR 58.3", Gauge: 0, H0
63439	2009		LokSound V3.0 M4 Diesel "Schienenzeppelin", Gauge: 0, H0
63440	2009		LokSound V3.0 M4 Diesel "V160", Gauge: 0, H0
63441	2009		LokSound V3.0 M4 Diesel "T44 SJ", Gauge: 0, H0
63442	2009		LokSound V3.0 M4 Diesel "V 300", Gauge: 0, H0
63443	2009		LokSound V3.0 M4 Steam "Kittel Steamtriebwagen", Gauge: 0, H0
63444	2009		LokSound V3.0 M4 Electric loco "BR 180 DBAG (ehem. BR 230 DR)", Gauge: 0, H0
63445	2009		LokSound V3.0 M4 Electric loco "SBB Ae 3/6 I", Gauge: 0, H0
63446	2009		LokSound V3.0 M4 Electric loco "SBB Ae 3/6 II", Gauge: 0, H0
63447	2009		LokSound V3.0 M4 Electric loco "BLS Re 4/4", Gauge: 0, H0
63448	2009		LokSound V3.0 M4 Electric loco "SBB Re 6/6", Gauge: 0, H0
63449	2009		LokSound V3.0 M4 Diesel "SBB Bm 4/4 II", Gauge: 0, H0
63450	2009		LokSound V3.0 M4 Electric loco "Ge 4/4 III RhB", Gauge: 0, H0
63454	2010		LokSound V3.0 M4 Electric loco "ET 11"
63455	2010		LokSound V3.0 M4 Diesel "VW Draisine"
<b>The following LokSound decoders can be exclusively purchased from our distributor „Essemme“ in Italy:</b>			
63430			LokSound V3.0 M4 Essemme "Italian Gruppo 625"
63432			LokSound V3.0 M4 Essemme "FS 655"

# LokSound XL V3.5 – Available sounds ex works

Art.No.	Novelty	Delivery date	Description
<b>52500</b>	<b>2005</b>		<b>LokSound XL V3.5 "Universal sound for reprogramming", Gauge: G, I</b>
52501	2005		LokSound XL V3.5 Steam "Universal 2 Zyl. Narrow line (Prototype: BR 99)", Gauge: G, I
52502	2005		LokSound XL V3.5 Steam "Univers. 3 Zyl. Mainline (Prototype BR 44, Belg. 25.021)", Gauge: G, I
52503	2005		LokSound XL V3.5 Steam "Universal 2/4 Zyl. Mainline (Prototype: BR 01)", Gauge: G, I
52504	2005		LokSound XL V3.5 Steam "BR 38, P8", Gauge: G, I
52505	2005		LokSound XL V3.5 Steam "BR 18, S 3/6", Gauge: G, I
52506	2009		LokSound XL V3.5 Steam "BR 01", Gauge: G, I
52507	2005		LokSound XL V3.5 Steam "BR 03", Gauge: G, I
52508	2010		LokSound XL V3.5 Steam „BR 23“
52509	2009		LokSound XL V3.5 Steam "BR 96 Mallet", Gauge: G, I
52510	2005		LokSound XL V3.5 Steam "BR 50, NMBS-SNCB type 25", Gauge: G, I
52512	2005		LokSound XL V3.5 Steam "Universal US-Steam (BigBoy, Santa Fe)", Gauge: G, I
52513	2005		LokSound XL V3.5 Steam "BR 80", Gauge: G, I
52514	2005		LokSound XL V3.5 Steam "BR 91", Gauge: G, I
52520	2005		LokSound XL V3.5 Steam "BR 55, NMBS-SNCB type 81", Gauge: G, I
52522	2005		LokSound XL V3.5 Steam "BR 78", Gauge: G, I
52523	2005		LokSound XL V3.5 Steam "US-Shay", Gauge: G, I
52524	2005		LokSound XL V3.5 Steam "US-Heissler", Gauge: G, I
52525	2005		LokSound XL V3.5 Steam "US-Mogul", Gauge: G, I
52526	2005		LokSound XL V3.5 Steam "Sächs. IV K", Gauge: G, I
52529	2006		LokSound XL V3.5 Steam "BR 86", Gauge: G, I
52530	2005		LokSound XL V3.5 Diesel "V 36", Gauge: G, I
52531	2005		LokSound XL V3.5 Diesel "V 60/ BR 260", Gauge: G, I
52532	2005		LokSound XL V3.5 Diesel "V100 / BR 212", Gauge: G, I
52533	2005		LokSound XL V3.5 Diesel "Universal Diesel (Vorbild: BR 218)", Gauge: G, I
52534	2005		LokSound XL V3.5 Diesel "Köf", Gauge: G, I
52535	2005		LokSound XL V3.5 Diesel "Diesel DR V60", Gauge: G, I
52536	2005		LokSound XL V3.5 Diesel "Universal US-Diesel (Vorbild: Santa Fe, F7)", Gauge: G, I
52538	2008		LokSound XL V3.5 Diesel "Nohab", Gauge: G, I
52539	2008		LokSound XL V3.5 Diesel "VT 11.5", Gauge: G, I
52540	2008		LokSound XL V3.5 Diesel "VT 18", Gauge: G, I
52546	2005		LokSound XL V3.5 Diesel "V200 / BR 220", Gauge: G, I
52554	2009		LokSound XL V3.5 Diesel "VT 98", Gauge: G, I
52556	2008		LokSound XL V3.5 Diesel "ÖBB 2016 Herkules", Gauge: G, I
52557	2008		LokSound XL V3.5 Steam "BR 89", Gauge: G, I
52560	2005		LokSound XL V3.5 Electric loco "E 10 / BR 110", Gauge: G, I
52561	2005		LokSound XL V3.5 Electric loco "Universal Altbau - Electric loco (Vorbild: E40)", Gauge: G, I
52563	2005		LokSound XL V3.5 Electric loco "E 03 / BR 103", Gauge: G, I
52564	2005		LokSound XL V3.5 Electric loco "E 94 / BR 194", Gauge: G, I
52566	2005		LokSound XL V3.5 Electric loco "E 50 / BR 150", Gauge: G, I
52569	2005		LokSound XL V3.5 Electric loco "Räth. Krokodil", Gauge: G, I
52570	2005		LokSound XL V3.5 Electric loco "E44", Gauge: G, I
52571	2005		LokSound XL V3.5 Electric loco "GE 4/4", Gauge: G, I
52572	2006		LokSound XL V3.5 Electric loco "Krokodil Be 6/8 - Ce 6/8", Gauge: G, I
52573	2007		LokSound XL V3.5 Electric loco "ÖBB Taurus", Gauge: G, I
52575	2005		LokSound XL V3.5 Electric loco "RhB 4/6", Gauge: G, I
52580	2008		LokSound XL V3.5 Diesel "MAK Vossloh G1200 Serie", Gauge: G, I
52586	2008		LokSound XL V3.5 Electric loco "Europrinter", Gauge: G, I
52589	2008		LokSound XL V3.5 Diesel "Köf II", Gauge: G, I
52590	2008		LokSound XL V3.5 Electric loco "Straßenbahn", Gauge: G, I
52591	2008		LokSound XL V3.5 Diesel "Kleindiesel Feldbahn", Gauge: G, I
52592	2008		LokSound XL V3.5 Electric loco "E 18", Gauge: G, I
52593	2008		LokSound XL V3.5 Electric loco "ET Epoche III", Gauge: G, I
52594	2008		LokSound XL V3.5 "VT 642 Desiro Triebwagen", Gauge: G, I
<b>52599</b>	<b>2007</b>		<b>LokSound XL V3.5 "Universal sound for reprogramming" WITH MUTLI-PIN CONNECTOR, Gauge: G, I (for Kiss, KM-1 locos)</b>
53509	2008		LokSound XL V3.5 Diesel "SNCB/NMBS HLD 62", Gauge: G, I
53510	2010		LokSound XL V3.5 Diesel „SNCB/NMBS HLD 55“
53516	2005		LokSound XL V3.5 Electric loco "Straßenbahn GT4", Gauge: I, G
53540	2009		LokSound XL V3.5 Diesel "V 160", Gauge: I, G
53543	2010		LokSound XL V3.5 Kittel Steamtriebwagen
53550	2009		LokSound XL V3.5 Narrow line electric loco Ge 4/4 III RhB
53555	2010		LokSound XL V3.5 Diesel „VW Draisine“
53558	2010		LokSound XL V3.5 Diesel „Köf 1“
<b>The following LokSound decoders can be exclusively purchased from our distributor „South West Digital“ in the UK:</b>			
53560	2009		LokSoundXL V3.5 Steam SWD "GWR Manor 78xx Class"
53561	2009		LokSoundXL V3.5 Steam SWD "GWR Pannier Tank 57xx Class"
53562	2010		LokSoundXL V3.5 Steam SWD "GWR Prairie Tank 61xx Class"
53563	2009		LokSoundXL V3.5 Steam SWD "BR Mogul Class"
53564	2009		LokSoundXL V3.5 Steam SWD "LMS Mogul Class"
53565	2009		LokSoundXL V3.5 Steam "A4 Pacific Class, Union of South Africa"
53566	2010		LokSoundXL V3.5 Steam SWD "A4 Pacific Class, Sir Nigel Gresley"
53567	2009		LokSoundXL V3.5 Steam SWD "Jubilee Class, Leander"
53568	2010		LokSoundXL V3.5 Steam SWD "Bulleid Pacific Class"
53570	2009		LokSoundXL V3.5 Diesel SWD "Class 03"
53571	2009		LokSoundXL V3.5 Diesel SWD "Class 08"

Art.No.	Novelty	Delivery date	Description
53572	2010		LokSoundXL V3.5 Diesel SWD "Class 20"
53573	2009		LokSoundXL V3.5 Diesel SWD "Class 24"
53574	2009		LokSoundXL V3.5 Diesel SWD "Class 25"
53575	2009		LokSoundXL V3.5 Diesel SWD "Class 31"
53576	2010		LokSoundXL V3.5 Diesel SWD "Class 33"
53577	2009		LokSoundXL V3.5 Diesel SWD "Class 37"
53578	2009		LokSoundXL V3.5 Diesel SWD "Class 40"
53579	2009		LokSoundXL V3.5 Diesel SWD "Class 43 HST Paxman"
53580	2010		LokSoundXL V3.5 Diesel SWD "Class 43 HST MTU"
53581	2009		LokSoundXL V3.5 Diesel SWD "Class 45"
53582	2009		LokSoundXL V3.5 Diesel SWD "Class 47"
53583	2009		LokSoundXL V3.5 Diesel SWD "Class 50"
53584	2009		LokSoundXL V3.5 Diesel SWD "Class 52"
53585	2009		LokSoundXL V3.5 Diesel SWD "Class 55 Deltic"
53586	2009		LokSoundXL V3.5 Diesel SWD "Class 66"
53587	2009		LokSoundXL V3.5 Diesel SWD "Class 67"
53588	2010		LokSoundXL V3.5 Diesel, "Class 108 DMU"
53589	2009		LokSoundXL V3.5 Diesel SWD "Class 158 Sprinter"
53861	2009		LokSound micro V3.5 Steam SWD "GWR Pannier Tank 57xx Class"
53862	2010		LokSound micro V3.5 Steam SWD "GWR Prairie Tank 61xx Class"
53871	2009		LokSound micro V3.5 Diesel SWD "Class 08"
53888	2010		LokSound micro V3.5 Diesel SWD "Class 108 DMU"

The following LokSound decoders can be exclusively purchased from our distributor „Esemme“ in Italy:

53530			LokSound XL V3.5 Steam Esemme "Italian Gruppo 625"
53531			LokSound XL V3.5 Electric loco Esemme "FS 405"
53532			LokSound XL V3.5 Electric loco Esemme "FS 655"
53534			LokSound XL V3.5 Diesel Esemme "FS D345"

More sounds are available on our website [www.esu.eu](http://www.esu.eu)



# LokPilot



Drive better with the 4th. The LokPilot V4.0



## LokPilot - The jewel among decoders

- ▶ Digital decoders and jewellery have at least one thing in common: With all the silver – or gold plated rhinestones for sale, it's not easy for some people to make an informed choice. The sophisticated buyer will go for the real thing, therefore being sure of its lasting value.

The same holds true for the decoders of our LokPilot series: Each one provides you with unique functions that will easily convince you. This is where ESU's leading edge technology comes fully into play. Since its arrival in 2001, ESU LokPilot decoders have been used by thousands of satisfied customers. Well known model railroad producers, who factory-deliver their locos with built-in LokPilot decoders, may serve as reference for the superb quality of our decoders.

LokPilot decoders are available in several formats, depending on gauge or digital system.

### Gauge H0:

- The **LokPilot Basic V1.0** is our entrance model and appeals to the price-conscious DCC-modeler.
- NEW** • Our top-of-the-range model, the **LokPilot V4.0** speaks DCC, Motorola® and Selectrix®. Equipped with the 5th of generation of load control, a serial protocol for C-Sinus motors and an optional PowerPack, it also supports the ABC brake mode as well as the new comfort function RailComPlus®.
- NEW** • The **LokPilot V4.0 DCC** speaks the internationally recognised DCC data format. Although it comes with the same features as the LokPilot V4.0, it is available for a lower price.
- The **LokPilot V3.0 M4** could be the choice of all Märklin®-systems fans, who want maximum play value.
- The **LokPilot Fx V3.0** is used to digitise motor-less rolling stock. It offers up to 6 function outputs and speaks DCC, Motorola® and Selectrix®.

### Gauge N, TT:

- NEW** • The new **LokPilot micro V4.0** speaks DCC, Motorola® and Selectrix® and opens up not only all possibilities for the N-/TT-Gauger but can be also installed into smaller H0 locos with space limitations. The decoder offers all the features of its big brother, the LokPilot V4.0, such as ABC brake mode and RailComPlus®.
- NEW** • The **LokPilot micro V4.0 DCC** may only speak DCC, but it is cheaper than the multiprotocol version.
- The **LokPilot Fx micro V3.0** is a mini function decoder for motorless vehicles. It is able to switch up to 4 functions and speaks DCC and Motorola®.

### Gauge G, 1:

- The **LokPilot XL V3.0** can be used with DCC or Motorola® and can not only provide up to 3.0A continuous load for the motor, but also switch up to 8 (!) function outputs. Thanks to the „PowerPack“ energy reservoir, the error of dirty tracks outside is a thing of the past.

### What LokPilot decoders can do

No matter which LokPilot decoder you choose, you will profit from their outstanding key properties.

#### Operational modes

Almost all LokPilot decoders are genuine multi-protocol decoders with fully automatic recognition of the operational mode – on the fly. The decoder analyses the track signal and filters out its packet. Changing between digital and analog and back again is possible with no problem. That's important in case your fiddle yard is still being operated conventionally. Furthermore, all LokPilot decoders recognise and comply with all relevant braking sections, such as Roco®'s, Lenz®'s or Märklin®'s, and stop correctly.

All of the new LokPilot V4.0 decoders recognise the Lenz® ABC brake mode (asymmetrical DCC signals). The decoders also offer an once more improved Function Mapping with logic functions. The LokPilot V4.0 decoders can be optionally equipped with a „PowerPack“ energy storage.

What's more, all decoders for N and H0 are equipped with a memory that retains the present operational status for dependable operation, in case of a voltage interruption due to dirty rails. LokPilot decoders are designed for a maximum of compatibility with its particular system, so that even infrequent play situations can be handled. That's why all Motorola® capable decoders feature the typical wrong-direction bit.

#### Motor management

The most important function of a digital decoder is motor management. Therefore, all LokPilot decoders are universally usable and can be employed with all customary DC model railroad motors, such as Roco®, Fleischmann®, Brawa®, Mehano®, Bemo®, LGB®, Hübner®, Märklin® or others. Even coreless motors (e.g. Faulhaber® or Maxon®) can be connected. You can keep using all-current motors, if you replace the field winding with a permanent magnet. Appropriate types can be found on page 64.

Load control (back EMF) with 32, resp. 40 kHz motor frequency regulation guarantees silky smooth, absolutely silent motor operation and lets your engine crawl on the layout super slowly. Thanks to Dynamic Drive Control (DDC) (not for LokPilot Basic V1.0) the influence of load control can be limited. That means you can glide really smoothly around the depot and over turnouts, while on the (fast) main, when going uphill, the engine slows down prototypically, if you don't override it with the throttle!

#### Analogue world

Quite a few LokPilot decoders are being used as an electronic reverser, instead of a directional, mechanical relay. Therefore it's possible to limit the starter – and top speed with the new decoders (not LokPilot Basic V1.0) during analog operation. At last you can slow down your old, much too fast locos.

#### Safeguard

All function outputs and the motor connection are overload – and short-circuit protected. We want you to enjoy your LokPilot decoder for as long as possible.

# LokPilot V4.0

## LokPilot V4.0 – Drive better with the 4th



LokPilot V4.0 (NEM652 and 21MTC)

► »Better is the enemy of good« it is said in colloquial language for generations. We fully agree with this proverb and are proud to present to you the LokPilot V4.0 decoder. Since autumn 2010, this decoder has superseded the „well and good“ LokPilot V3.0 Decoder, which has achieved an excellent reputation among model railroaders all around the world. The new LokPilot V4.0 is much „better“ in many respects based on the LokPilot family's high standard performance.

The LokPilot V4.0 is available in all contemporary plug and interface versions such as NEM651 6-pin, NEM652 8-pin and PluX12 plug as well as a wireless 21MTC interface version (NEM660).

### Operational modes

The LokPilot V4.0 commands Motorola® and Selectrix® as well as DCC through 14, 28 and 128 speed steps. During DCC operation it can be used on analogue DC layouts. You can either use 2- or 3-digit (1 – 127) as well as 4-digit (1–9999) addresses or assign a consist address.

The Motorola® protocol enables the LokPilot V4.0 decoder to run with Märklin® stations 6020®, 6021®, Delta®, mobile station® and Central Station®. The decoders can command addresses 01 – 255. A second address allows to switch F5 to F8, if desired.

Since the LokPilot V4.0 decoders also speaks Selectrix® it can be operated with this proven system as well.

It supports Lenz® LG 100 resp. Roco® braking sections as well as Zimo®'s HLU-commands, or the braking in DC braking sections with reversed polarity, or the Märklin® braking section (even for DCC). But also the new Lenz® ABC brake modules with an asymmetrical DCC signal is supported.

Of course, our top-class decoder is able to calculate a constant braking distance to stop your locos correctly in front of the red signal regardless of the speed. LokPilot V4.0 decoders can also be used for analogue DC or AC layouts.

The LokPilot V4.0 converts during operation fully automatically between all control modes (Motorola®, DCC, DC, AC and Selectrix®). That is important if some parts of your layout are operated in analogue mode (e.g. fiddle yards).

### Motor management

From a LokPilot decoder, you rightly expect an excellent motor management. With the LokPilot V4.0, ESU introduces the once more improved fifth generation of load control.

The standard frequency is adjusted adaptively to the speed with a basic frequency of 40 kHz. The result is an even better slow driving performance. Your locos will crawl super slowly - thanks to the 10 Bit A/D convertor.

The back EMF can easily be adapted to various motor and gearing combinations. With Dynamic Drive Control (DDC) you can limit the influence of back EMF and glide smoothly around the depot area and over turnouts; while on the main, when going uphill, the engine slows down prototypically.

The load control is well-prepared for all customary motor types, such as Roco®, Fleischmann®, Brawa®, Mehano®, Bemo®, Märklin®, Faulhaber® or Maxon® motors. All-current motors can be continued to use if you replace the field winding with a HAMO magnet. 1.1A steady load is more than the above-mentioned motos need and offers enough energy reserves, even for longer block trains.

SoftDrive® sinus motors, as used in many Märklin® models, can also be controlled by the LokPilot V4.0 decoder. Thanks to the new serial communication protocol this will also work now for Trix® locos.

### Analogue operation

The LokPilot 4.0 Decoder can be used for both analogue DC or AC locomotives. The motor control function is teaching the motor »good manners« and is thus ideal for locos, which are too fast with a conventional reverser relay.

### Functions

The LokPilot V4.0 decoder has 4 function outputs which achieve 250 mA load each. They can be allocated individually to different functions. There are two unamplified outputs which can be also used for both light or special functions if connected with the appropriate adapter board (e.g. ESU 51968).

All important light functions as available, such as flashing light, firebox flicker, strobe – and double strobe, Ditch Light etc. The brightness of each output can be adjusted separately. Of course, the decoder is able to control the automatic decoupling move and push time for Roco®, Krois® and Telex® couplers and also offers a high beam function as a new feature. The „LED mode“ ensures that the light effects are set correctly when using LEDs.

### Safe operation

If desired it is possible to connect a PowerPack (ESU 54670, see page 62) to the LokPilot V4.0, as to all other ESU decoders of the 4th generation. This energy storage continues to supply the decoder with energy if the power consumption is not isn't optimal due to dirty tracks.

### RailComPlus®

A very important function of the LokPilot V4.0 decoder is the integrated RailComPlus® function. Your locos will be recognised automatically by an appropriate digital command station fast as lightning and will receive, if needed, a new address. Forget about the cumbersome typing and programming!

### Safeguard

Of course, all function outputs and the motor connection are overload and short-circuit protected.

### Built-in future

LokPilot decoders are firmware updatable. This means you are able to replace the internal decoder software by a newer version, if needed. You only need an ESU LokProgrammer and a PC to do so.

Since autumn 2010, the LokPilot V4.0 DCC has superseded the

► **Technical data on page 61.**

## LokPilot V4.0 DCC - Future built-in



► »well and good« LokPilot V3.0 DCC Decoder, which has achieved an excellent reputation among model railroaders all around the world. The new LokPilot V4.0 is much »better« in many respects based on the LokPilot family's high standard performance.

The LokPilot V4.0 DCC decoder is available in all contemporary plug and interface versions such as NEM651 6-pin, NEM652 8-pin and PluX12 plug as well as a wireless 21MTC interface version (NEM660).

### Operational modes

The LokPilot V4.0 DCC commands the DCC protocol through 14, 28 and 128 speed steps. It can be used on analogue DC layouts. You can either use 2- or 3-digit (1 – 127) as well as 4-digit (1–9999) addresses or assign a consist address.

It supports Lenz® LG 100 as well as the new Lenz® ABC brake modules with asymmetrical DCC signals, or the braking in DC braking sections with reversed polarity.

Of course, our top-class decoder is able to calculate a constant braking distance to stop your locos correctly in front of the red signal regardless of the speed.

The LokPilot V4.0 converts during operation fully automatically between all control modes.

### Motor management

From a LokPilot decoder, you rightly expect an excellent motor management. With the LokPilot V4.0 DCC, ESU introduces the once more improved fifth generation of load control.

The standard frequency is adjusted adaptively to the speed with a basic frequency of 40 kHz. The result is an even better slow driving performance. Your locos will crawl super slowly - thanks to the 10 Bit A/D converter.

The back EMF can easily be adapted to various motor and gearing combinations. With Dynamic Drive Control (DDC) you can limit the influence of back EMF and glide smoothly around the depot area and over turnouts; while on the main, when going uphill, the engine slows down prototypically.

The load control is well-prepared for all customary motor types,

such as Roco®, Fleischmann®, Brawa®, Mehano®, Bemo®, Märklin®, Faulhaber® or Maxon® motors. All-current motors can be continued to use if you replace the field winding with a HAMO magnet. 1.1A steady load is more than the above-mentioned motors need and offers enough energy reserves, even for longer block trains.

SoftDrive® sinus motors, as used in many Märklin® models, can also be controlled by the LokPilot V4.0 decoder. Thanks to the new serial communication protocol this will also work now for Trix® locos.

### Analogue operation

The LokPilot 4.0 DCC decoder can be used for analogue DC locomotives. The motor control function is teaching the motor »good manners«.

### Functions

The LokPilot V4.0 DCC decoder has 4 function outputs which achieve 250 mA load each. They can be allocated individually to different functions. There are two unamplified outputs which can be also used for both light or special functions if connected with the appropriate adapter board (e.g. ESU 51968).

All important light functions as available, such as flashing light, firebox flicker, strobe – and double strobe, Ditch Light etc. The brightness of each output can be adjusted separately. Of course, the decoder is able to control the automatic decoupling move and push time for Roco®, Krois® and Telex® couplers and also offers a high beam function as a new feature. The „LED mode“ ensures that the light effects are set correctly when using LEDs.

### Safe operation

If desired it is possible to connect a PowerPack (ESU 54670, see page 62) to the LokPilot V4.0 DCC. This energy storage continues to supply the decoder with energy if the power consumption is not isn't optimal due to dirty tracks.

### RailComPlus®

With RailComPlus® your locos will be recognised automatically by an appropriate digital command station fast as lightning and will receive a new address. No more programming!

### Safeguard

Of course, all function outputs and the motor connection are overload and short-circuit protected.

### Built-in future

LokPilot decoders are firmware updatable. This means you are able to replace the internal decoder software by a newer version, if needed. You only need an ESU LokProgrammer and a PC to do so.

### ► Technical data on 61.

#### Ordering information

54610	LokPilot V4.0, multi-protocol MM/DCC/SX, 8-pin plug NEM652, cable
54611	LokPilot V4.0 DCC, 8-pin plug NEM652, cable harness
54612	LokPilot V4.0, multi-protocol MM/DCC/SX, 6-pin plug NEM651, cable
54613	LokPilot V4.0 DCC, 6-pin plug NEM651, cable harness
54614	LokPilot V4.0, multi-protocol MM/DCC/SX, 21MTC interface
54615	LokPilot V4.0, DCC, 21MTC interface
54616	LokPilot V4.0, multi-protocol MM/DCC/SX, PluX12 plug, cable harness

## LokPilot micro V4.0 - PowerPack exponent Four



- ▶ The LokPilot micro V4.0 is a genuine power house. It drives the loco motor with a continuous load capability of 0.75A and has significantly shrunk compared to its forerunner: the smallest member of the LokPilot V4.0 family has now a size of only 10.5mm x 8.1mm x 2.8mm and should thus fit in the smallest N/TT-gauge locos.

LokPilot micro V4.0 decoders are available in all common plug and interface versions such as 6-pin NEM651 (with or without cable harness), 8-pin NEM652 or the brand-new wireless Next18 interface version.

### Operational modes

The LokPilot micro V4.0 commands Motorola® and Selectrix® as well as DCC through 14, 28 and 128 speed steps or can be used on analogue DC layouts. You can either use 2- or 3-digit (1 – 127) as well as 4-digit (1–9999) addresses or assign a consist address.

The Motorola® protocol enables the decoder to run with Märklin® stations 6020®, 6021®, Delta®, mobile station® and Central Station®. The decoders can command addresses 01 – 255. A second address allows to switch F5 to F8, if desired.

Since the LokPilot V4.0 decoders also speaks Selectrix® it can be operated with this proven system as well.

It supports Lenz® LG 100 resp. Roco® braking sections as well as Zimo®'s HLU-commands, or the braking in DC braking sections with reversed polarity, or the Märklin® braking section (even for DCC). But also the new Lenz® ABC brake modules with an asymmetrical DCC signal is supported.

Of course, our top-class decoder is able to calculate a constant braking distance to stop your locos correctly in front of the red signal regardless of the speed. LokPilot V4.0 decoders can also be used for analogue DC or AC layouts.

The LokPilot micro V4.0 converts during operation fully automatically between all control modes (Motorola®, DCC, DC, AC and Selectrix®). That is important if some parts of your layout are operated in analogue mode (e.g. fiddle yards).

- ▶ **Technical data on page 61.**

### Ordering information

<b>NEW</b>	54683	LokPilot micro V4.0, MM/DCC/SX, 8-pin NEM 652 with cable
<b>NEW</b>	54687	LokPilot micro V4.0, MM/DCC/SX, 6-pin NEM 651 with cable
<b>NEW</b>	54688	LokPilot micro V4.0, MM/DCC/SX, 6-pin NEM 651 direct connection
<b>NEW</b>	54689	LokPilot micro V4.0, MM/DCC/SX, Next18 interface

### Motor management

From a LokPilot decoder, you rightly expect an excellent motor management. With the LokPilot micro V4.0, ESU introduces the once more improved fifth generation of load control. The standard frequency is adjusted adaptively to the speed with a basic frequency of 40 kHz. The result is an even better slow driving performance. Your locos will crawl super slowly - thanks to the 10 Bit A/D convertor.

With Dynamic Drive Control (DDC) you can limit the influence of back EMF and glide smoothly around the depot area and over turnouts; while on the main, when going uphill, the engine slows down prototypically.

The load control is well-prepared for all customary motor types, such as Roco®, Fleischmann®, Brawa®, Mehano®, Bemo®, Märklin®, Faulhaber® or Maxon® motors. 0.75A steady load is more than the above-mentioned motos need and offers enough energy reserves, even for longer block trains.

### Analogue operation

The LokPilot micro 4.0 decoder can also be used for analogue DC locomotives. The motor control function is teaching the motor »good manners«.

### Functions

The LokPilot mirco V4.0 decoder has 2 function outputs which achieve 150 mA load each. They can be allocated individually to different functions. There are two further unamplified outputs which can be also used for both light or special functions.

All important light functions as available, such as flashing light, firebox flicker, strobe – and double strobe, Ditch Light etc. The brightness of each output can be adjusted separately. Of course, the decoder is able to control the automatic decoupling move and push time and also offers a high beam function as a new feature. The „LED mode“ ensures that the light effects are set correctly when using LEDs.

### Safe operation

If desired it is possible to connect a PowerPack (ESU 54670, see page 62) to the LokPilot micro V4.0. This energy storage continues to supply the decoder with energy if the power consumption is not isn't optimal due to dirty tracks.

### RailComPlus®

With RailComPlus® your locos will be recognised automatically by an appropriate digital command station fast as lightning and will receive a new address. Forget about the cumbersome typing and programming!

### Safeguard

Of course, all function outputs and the motor connection are overload and short-circuit protected.

### Built-in future

LokPilot decoders are firmware updatable. This means you are able to replace the internal decoder software by a newer version, if needed. You only need an ESU LokProgrammer to do so.

## LokPilot micro V4.0 DCC - PowerPack exponent Four



- ▶ The LokPilot micro V4.0 DCC is a genuine power house. It drives the loco motor with a continuous load capability of 0.75A and has significantly shrunk compared to its forerunner: the smallest member of the LokPilot V4.0 family has now a size of only 10.5mm x 8.1mm x 2.8mm and should thus fit in the smallest N-/TT-gauge locos.

LokPilot micro V4.0 DCC decoders are available in all common plug and interface versions such as 6-pin NEM651 (with or without cable harness), 8-pin NEM652 or the brand-new wireless Next18 interface version.

### Betriebsarten

The LokPilot micro V4.0 DCC commands DCC through 14, 28 and 128 speed steps or can be used on analogue DC layouts. You can either use 2- or 3-digit (1 – 127) as well as 4-digit (1–9999) addresses or assign a consist address.

It supports all common DCC brake systems such as Lenz® LG 100 as well as the new Lenz® ABC brake modules with asymmetrical DCC signals, or the braking in DC braking sections with reversed polarity.

Of course, our top-class decoder is able to calculate a constant braking distance to stop your locos correctly in front of the red signal regardless of the speed.

The LokPilot V4.0 converts during operation fully automatically between all control modes.

### Motor management

From a LokPilot decoder, you rightly expect an excellent motor management. With the LokPilot micro V4.0 DCC, ESU introduces the once more improved fifth generation of load control. The standard frequency is adjusted adaptively to the speed with a basic frequency of 40 kHz. The result is an even better slow driving performance. Your locos will crawl super slowly - thanks to the 10 Bit A/D convertor.

With Dynamic Drive Control (DDC) you can limit the influence of back EMF and glide smoothly around the depot area and over turnouts; while on the main, when going uphill, the engine slows down prototypically.

The load control is well-prepared for all customary motor types, such as Roco®, Fleischmann®, Brawa®, Mehano®, Bemo®, Märklin®, Faulhaber® or Maxon® motors. 0.75A steady load is more than the above-mentioned motors need and offers enough energy reserves, even for longer block trains.

### Analogue operation

The LokPilot micro 4.0 DCC decoder can be used for analogue DC locomotives. The motor control function is teaching the motor »good manners«.

### Functions

The LokPilot micro V4.0 DCC decoder has 2 function outputs which achieve 150 mA load each. They can be allocated individually to different functions. There are two further unamplified outputs which can be also used for both light or special functions.

All important light functions as available, such as flashing light, firebox flicker, strobe – and double strobe, Ditch Light etc. The brightness of each output can be adjusted separately. Of course, the decoder is able to control the automatic decoupling move and push time and also offers a high beam function as a new feature. The „LED mode“ ensures that the light effects are set correctly when using LEDs.

### Safe operation

If desired it is possible to connect a PowerPack (ESU 54670, see page 62) to the LokPilot micro V4.0 DCC. This energy storage continues to supply the decoder with energy if the power consumption is not isn't optimal due to dirty tracks.

### RailComPlus®

With RailComPlus® your locos will be recognised automatically by an appropriate digital command station fast as lightning and will receive a new address. Forget about the cumbersome typing and programming!

### Safeguard

Of course, all function outputs and the motor connection are overload and short-circuit protected.

### Built-in future

LokPilot decoders are firmware updatable. This means you are able to replace the internal decoder software by a newer version, if needed. You only need an ESU LokProgrammer to do so.

▶ **Technical data on page 61.**

### Ordering information

<b>NEW</b>	54684	LokPilot micro V4.0, DCC, 6-pin NEM 651 with cable
<b>NEW</b>	54685	LokPilot micro V4.0, DCC, 6-pin NEM 651 direct connection
<b>NEW</b>	54686	LokPilot micro V4.0, DCC, Next18 interface

# LokPilot Digital Sets

## LokPilot digital sets

**NEW**

To simplify conversion of your Delta® locos as much as possible, the LokPilot digital set is available: It contains a LokPilot V3.0 decoder 52610, an appropriate permanent magnet and 2 choke coils. You do not need to buy every single item: benefit from the price advantage of the whole set.

Conversion is simple - you can easily do it yourself!

Here we show you, how it works:

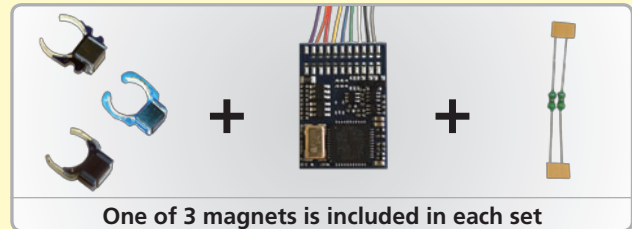

We start with a locomotive equipped with a Delta® motor.

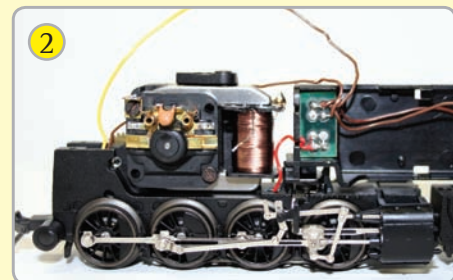

Universal motor with connected Delta® decoder: Remove all wires betw. motor and decoder. Remove all choke-coils and -capacitors except the one between the motor leads.

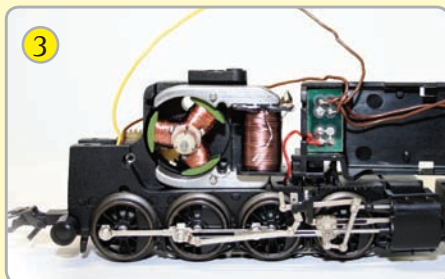

Remove the two screws at the motor bearing assembly and carefully lift off the assembly. Take care not to lose the coal brushes and retainer springs!

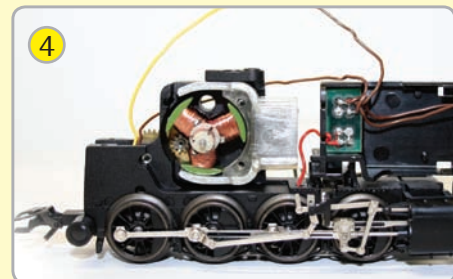

Pull off the universal field coil and replace it with the appropriate permanent magnet.

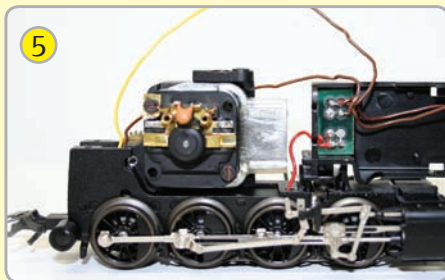

Carefully replace the bearing assembly again: Wiggle the brushes a bit or gently pull them apart, so that you can mount the bearing assembly over the commutator.

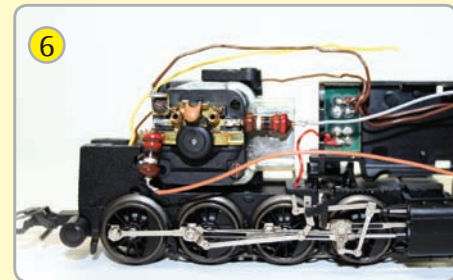

Solder one end of a choke coil to each motor terminal and connect the other end to the grey, resp. orange wire of the LokPilot/Lok-Sound decoder. Conversion is done!

### Ordering information

- NEW** 54630 LokPilot digital set 1, with LokPilot V4.0 54610, permanent magnet 51960, choke coils
- NEW** 54631 LokPilot digital set 2, with LokPilot V4.0 54610, permanent magnet 51961, choke coils
- NEW** 54632 LokPilot digital set 3, with LokPilot V4.0 54610, permanent magnet 51962, choke coils

## LokPilot digital 21MTC sets

**NEW**

Many model railroaders would like to exchange their old interface for the modern 21MTC version when converting their aged Märklin® locomotives and look for a simple and affordable opportunity to do so.

For this application, we offer our new digital conversion sets. Besides a LokPilot V3.0 (52614) multi-protocol digital decoder with 21MTC interface, the set includes one of three appropriate permanent magnets, two choke coils as well as the appropriate adapter board 51968. The adapter board 51968 simulates the well-known Delta® bzw. 6090x decoders in shape and size and in most cases, can be plugged directly into the specified holding.

Another advantage of the interface is that a subsequent decoder change can be carried out without soldering. The model railroader also benefits from the price advantage of buying the whole set.

Conversion is simple - you can easily do it yourself!

Here we show you, how it works:

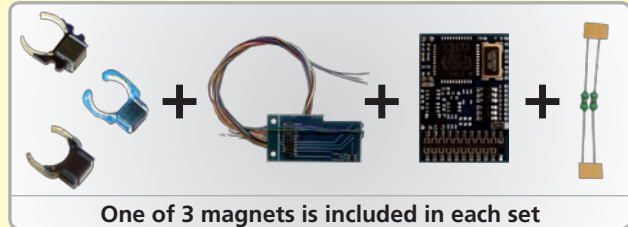

One of 3 magnets is included in each set

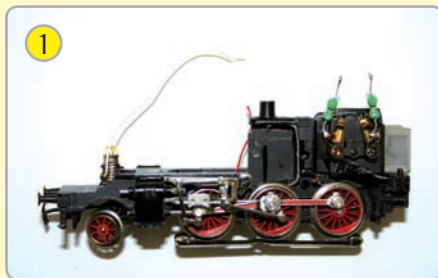

After adding the permanent magnet to the motor of your Delta® loco (as shown on the left page), remove the old Delta® decoder.

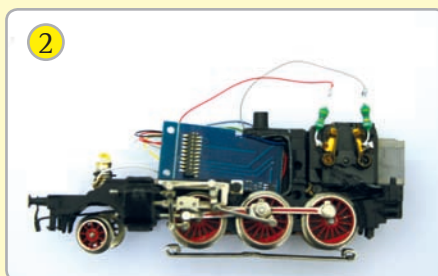

Install the 21MTC adapter board directly into the holding of the previous decoder. Mostly it can be easily plugged into the plastic holding.

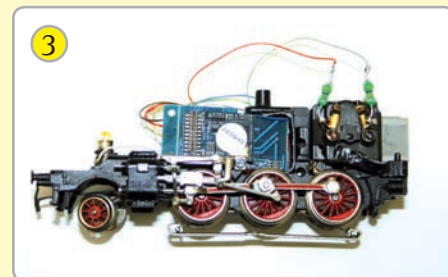

Plug the decoder onto the adapter board. At first wire the connections between the motor and the track. Leave the cables for lighting out for the time being and make your first driving test.

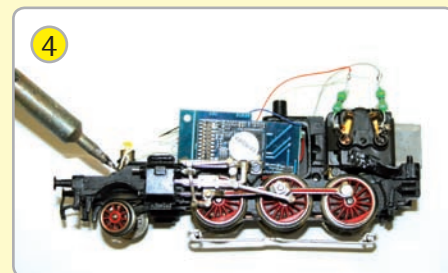

After a successful check connect the lighting cables. You may cut the cables of the adapter board as you please. Please make sure that the cables run properly!



To finish the conversion you only need to re-assemble the body of the loco und make sure that none of the cables gets clamped.

### Ordering information

<b>NEW</b>	54633	LokPilot digital set 21MTC 1 with 21 MTC connection, consists of 54614, 51968 and 51960, choke coils	<b>21</b>
<b>NEW</b>	54634	LokPilot digital set 21MTC 2 with 21 MTC connection, consists of 54614, 51968 and 51961, choke coils	<b>21</b>
<b>NEW</b>	54635	LokPilot digital set 21MTC 3 with 21 MTC connection, consists of 54614, 51968 and 51962, choke coils	<b>21</b>

# LokPilot Basic V1.0

## LokPilot Basic - More than just simple

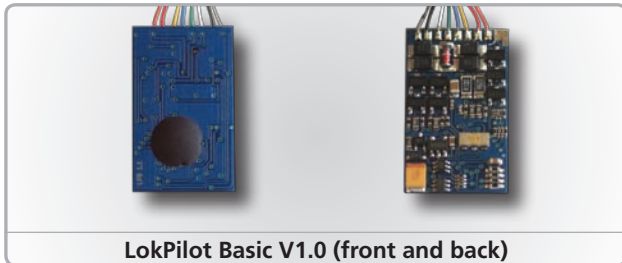

- In the past, every once in a while we received inquiries for a robust, affordable DCC decoder, which would meet the basic standards.

We are now proud to present you our answer to the challenge: The LokPilot V1.0 was developed from scratch with the aim to bring you a decoder which would satisfy the needs of the majority of model railroaders. On the one hand it offers all the fundamental functions, while on the other hand it is easy on the wallet. The result is convincing: The LokPilot Basic V1.0 is surely not a stripped down, technically obsolete decoder, on the contrary: It contains the most modern, on the world market presently available technology.

Like all other LokPilot decoders, the LokPilot Basic V1.0 is convincing due to its excellent load control, good slow speed characteristics, three function outputs and its robust build-up. Simple handling and practical programmability are self-evident. The LokPilot Basic V1.0 lends itself to all popular DCC-systems and, thanks to the concentration for the essential features, sports a so far unbeatable price/performance ratio. At last, you do not need to work without a decoder featuring load control for your locos anymore, but have access the a fully matured brand.

We ship the LokPilot Basic V1.0 with an 8-wire NEM interface or with an 21MTC connector. Installing it into the locos with a digital interface is especially simple: Open up loco - remove dummy plug - plug in the decoder - close the loco - that's the very it!

### Operational modes

The LokPilot Basic V1.0 supports the worldwide recognized DCC protocol. In this mode it can be utilized with 14, 28 or 128 speed steps or on analog DC layouts. It supports Lenz®, LG 100 resp. Roco® braking sections as well as braking in DC sections with reverse polarity. You can use addresses 1 - 119. During operation, the LokPilot Basic V1.0 converses fully automatically between operational modes (DC, DCC).

That is important in case you run parts of your layout (fiddle yard) in analog mode.

### Motor management

All popular DC - or coreless motors regardless whether from Roco®, Fleischmann®, Brawa®, Mehano®, Liliput®, Bachmann®, Kato®, Bemo®, Faulhaber®, or Maxon® will be driven by the 0.75A continuous-current last stage of the LokPilot Basic V1.0 decoder.

- **Technical data on page 61.**

The 31kHz High frequency load control takes care of silky smooth, absolutely quiet motor operation and lets your engines crawl slowly on the layout. The load control can be optimised via 3 CVs for the motor in use. Thanks to mass-simulation the loco will not jerk, even with only 14 speed steps.

### Analog world

The LokPilot Basic V1.0 works also with no problems on analog DC layouts, which means in spite of the club you belong to being analog; you can still run your locos.

### Functions

The LokPilot Basic V1.0 offers three 180mA steady-current outputs, dimmable together in 7 steps. Therefore you can wire up the cab illumination or a smoke generator besides the two standard reversing head lights. The built-in switching speed mode and the option to switch off the acceleration and deceleration rate with the touch of a key, helps you to glide smoothly around the depot area.

### Programming

All programmable adjustments are done electronically. It's not necessary to open up the loco anymore. Since the LokPilot Basic V1.0 knows all DCC programming modes, and all values are inserted with two digits, programming with all known command stations is a cinch. Especially comfortable is the programming of parameters for owners of our ECoS command station: all modifications are displayed on the large screen in plain language, and can be changed most easily.

### Safeguard

All function outputs and the motor connection are protected against overload and short-circuit. We want you to enjoy your LokPilot Basic V1.0 decoder as long as possible.

## Questions about the LokPilot Basic V1.0

*For whom is the Basic LokPilot made?*

The LokPilot Basic is made for users as a reliable, load controlled decoder without all the „Bell & Whistles“.

*Is the current for H0 engines not too low?*

No. The LokPilot Basic V1.0 provides a constant current of 0.7 A. This allows the most modern 5-pole motors like those of Fleischmann®, Brawa®, Roco®, Mehano®, Electroten, Bemo, Liliput or PCM easily be driven. For the round motors of Märklin® or Fleischmann®, we recommend the LokPilot V3.0.

*What digital control units are working with the LokPilot Basic?*

The LokPilot Basic V1.0 works with all digital control units with NMRA / DCC standard, e.g. Roco Lokmaus® II / III, Fleischmann® LokBoss and Twin Center®, Uhlenbrock® Intellibox® and Daisy, Lenz® digital plus, Digitrax, Zimo, ZTC control and others. Because the number of setting parameters and only two digits are needed, the programming works with all DCC digital controller.

*What can LokPilot V3.0 more than the LokPilot Basic V1.0?*

Some. The LokPilot V3.0 can handle traction addresses (Consist mode). The LokPilot V3.0 brings enough output for the older Fleischmann® - or Märklin® - round motors and also locomotives with two motors.

The LokPilot V3.0 provides four function outputs and the brightness can be adjusted individually and comes also with lighting effects such as flashing light or flickering fire box. You can change the assignments of the function keys in any way you want.

With the LokPilot V3.0 you can set the acceleration and maximum speed in the analog operation of the loco.

The LokPilot V3.0 also speaks the Motorola® protocol and can be used on alternating current analog systems also.

*How does the LokPilot Basic handle electricity interruptions?*

Thanks to modern electronics, the internal power of the LokPilot Basic is reduced. This really helps a lot at „dirty track“ spots, even without storage.

### Ordering information

52690	LokPilot Basic DCC+DC, with wire harness 88mm and 8-pin DCC plug (NEM652)
52692	LokPilot Basic DCC+DC, with 21MTC connector





# LokPilot V3.0 M4

## LokPilot V3.0 M4 - The all-round talent

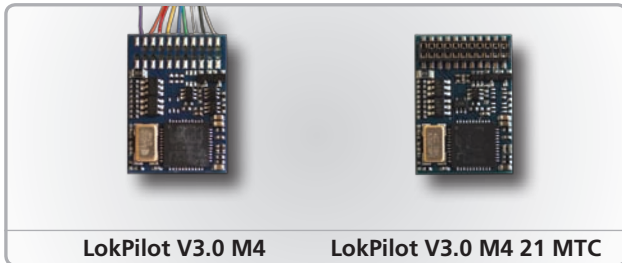

- ▶ The LokPilot V3.0 M4 was developed from scratch especially for Märklin® systems. It reflects years of experience, gathered by ESU during the engineering of digital decoders.

### Operational modes

The LokPilot V3.0 M4 is a genuine multi-protocol decoder: Besides its main field of application in combination with mfx® stations, it handles Motorola® command stations (e.g. Märklin® 6021) as well as conventional AC driven layouts. The LokPilot V3.0 M4 recognizes the operational mode fully automatically and converts on the fly.

### Motor management

The LokPilot V3.0 M4 runs DC – and coreless motors directly, while all-current motors need a Hamo-magnet retrofit. The motor is driven by 40 kHz Pulse width frequency (PWM) for a super silent, safe run. Together with the 128 mfx® speed steps and fourth generation back EMF, unprecedented performance is realized.

# M4

#### What does M4 mean?

At some points in this catalog you will notice the term „M4“ for the first time and rightly wonder what this might mean.

This question can be answered quite simply: from 2009 forward, M4 is the name of a data protocol that was chosen by ESU to be implemented in their decoders. Decoders with the M4 protocol are one hundred percent compatible with command stations using mfx®. At such stations (e.g. Märklin® Central Station®) they will be recognized automatically and all playing functions are available just like when using mfx®. On the other hand, our ESU command stations using M4 will recognize all (Märklin® and ESU) mfx® decoders without any restrictions and will still work without any problems. As the (mutual) inventor of mfx® we can assure you of this.

In short: the technique stays the same, only the name has been changed.

### Analog operation

The LokPilot V3.0 M4 also operates on analog AC layouts, on which even starter – and top speed can be limited individually. At last you can slow down your old high-speed runners.

### Functions

The LokPilot V3.0 M4 sports four function outputs, which can be dimmed, and allocated individually to a function. Besides beacon, strobe and alternate flashing, there is a Mars light as well as a Gyra light.

### Programming

The LokPilot V3.0 M4 can be adapted to any loco or operational mode. For this, you can comfortably change parameters with the systems-stations – during operation and without having to open the loco or put it on a programming track. That's made possible through the built-in, genuine Duplex communication between systems-center station and decoder. For owners of 6020®, 6021® – or delta® stations the LokPilot V3.0 M4 decoder utilises the time-proven, simple programming procedure.

### Safeguard

All function outputs and the motor connection are overload – and short circuit protected.

### Built-in future

The intern decoder software can be replaced by a new firmware update, if desired.

#### Technical data LokPilot V3.0 M4

Operational modes:	M4 with 128 speed steps Digital Motorola® (old and new) with 14 or 28 speed steps, up to 255 addresses in Motorola® use Analog AC (de-selectable) Automatic recognition of operational mode Supports Märklin® braking section. Wrong-direction bit. Intelligent programming mode with Märklin® 6021® Switching speed and acceleration as well as deceleration key selectable
Throttle:	1.1 A continuous load Runs DC, coreless and AC motors (with permanent magnet) Silent, safe 16 / 32 kHz pulse width frequency motor regulation Motor output overload protected. Fourth generation back EMF (de-selectable)
Function output:	4 outputs, 2 of which for lighting 250mA load per output 500mA total load of all function outputs. Overload protected. Outputs short circuit protected (function mapping)
Dimensions:	23.5mm x 15.5mm x 5.5mm (0.94 x 0.62 X 0.22 inch)

### Ordering information

- 61600 LokPilot V3.0 M4 multiprotocol decoder, (M4 / Motorola®), with 8-pin plug according to NEM 652  
61601 LokPilot V3.0 M4 multiprotocol decoder, (M4 / Motorola®), with 21MTC connector

**21**  
MTC

# LokPilot Fx V3.0

## LokPilot Fx V3.0 – There's a lot to switch

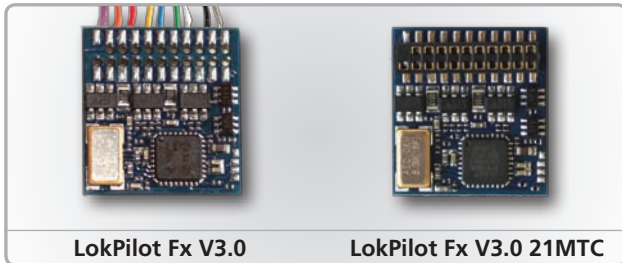

- ▶ Motorless rolling stock can be digitalised with the LokPilot Fx V3.0. To this end, LokPilot Fx V3.0 offers six function outputs, which can activate typical functions, such as car interior illumination, head- or rear (-end, warning-) lights on cars, and function models.

Of course LokPilot Fx V3.0 is multi-protocol capable and with a dimension of 17.5mm x 15.0 mm's (0.7 x 0.6 inch) small enough for most any application. LokPilot Fx V3.0 comes in two variants: Next to the „classic“ version with an 8-wire NEM 652 harness, there is a version available for the new 21MTC connector.

### Operational modes

LokPilot Fx V3.0 can handle DCC with 14, 28 or 128 speed steps as well as Motorola® and Selectrix®. The decoder recognizes the speed steps automatically. It supports Lenz® LG100 resp. ROCO® braking sections in addition to Zimo®'s HLU-commands, or braking in DC sections with reversed polarity as well as Märklin® braking sections (also for DCC). You can either use short-, or four digit addresses, or assign a consist address.

The Motorola® protocol enables the LokPilot Fx V3.0 decoder to run with Märklin® stations 6020®, 6021®, delta®, mobile station® and Central Station®. For those, the decoder handles addresses 01 – 255, and comes to a halt correctly on the Märklin® braking section.

On Selectrix® layouts you can choose between addresses 01 – 112. LokPilot Fx V3.0 converses during operation fully automatically between all control modes (Motorola®, DCC, DC, AC, Selectrix®).

### Analog operation

There are no restrictions for LokPilot Fx V3.0-equipped rolling stock, of course, when operating in digital mode.

- ▶ **Technical data on page 61.**

### Ordering information

52620	LokPilot Fx V3.0 Function decoder (MM/DCC/SX), with 8-pin plug according to NEM652
52621	LokPilot Fx V3.0 Function decoder (MM/DCC/SX), with 21MTC connector



### Functions

LokPilot Fx V3.0 comes with six function outputs, 250mA's each, and each can be assigned individually to a function: There is flash light, alternate flash, (or ditch lights), strobe light, firebox flicker as well as Mars-or Gyra light for US models. There is also a high frequency-, time controlled output available for digitally operated couplings.

All function outputs can be dimmed individually in 15 steps. In DCC mode, each function output can be assigned to any function key between F0 - F15. F0 – F8 will be recognized in Motorola mode, the same in Selectrix mode, depending upon the station.

### Programming

The LokPilot Fx V3.0 supports all DCC programming modes, including POM (Programming on the main). For Märklin® stations 6020®, 6021®, mobile station®, and Central Station® all programming is also done electronically. For these units LokPilot Fx V3.0 employs a time proven, easily acquired programming procedure.

The programmed changes during Motorola® operation are also valid during DCC- and Selectrix® operation – and vice versa. Programming parameters is especially simple for owners of our ECoS command station: All options are displayed in plain language on the large screen, and can easily be modified – even during operation on the layout.

### Interaction

LokPilot Fx V3.0 is designed for optimum interaction with the LokSound V3.5-, and the LokPilot V3.0 decoders: For example it's possible to equip the cab of an A-A consist with a LokSound V3.5 decoder-, and the controlling car with a LokPilot Fx V3.0 one. Given both the same address, they work absolutely identically. Identical grouping of the CVs facilitates synchronisation of both decoders.

### RailCom®

RailCom® is activated ex works. You are able to read CVs on the main track if you use an appropriate command station like our ECoS.

### Protection

All function outputs are protected against overload and short circuit.

### Built-in future

The LokPilot Fx V3.0 decoder is firmware upgradeable. New software functions can be installed through the LokProgrammer.

## LokPilot Fx micro V3.0 - Small and practical

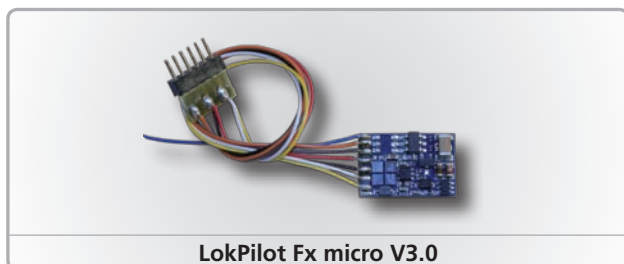

- ▶ Motorless rolling stock can be digitalised with the LokPilot Fx micro V3.0., for which the LokPilot Fx V3.0. is not small enough. To this end, LokPilot Fx micro V3.0 offers four function outputs, which can activate typical functions, such as car interior illumination, head- or rear (-end, warning-) lights on cars, and function models.

Of course, LokPilot Fx micro V3.0 is multi-protocol capable and with a dimension of 13.5mm x 9.0 mm x 3.5 mm (0.54 x 0.36 x 0.12 inch) small enough for most any application. LokPilot Fx micro V3.0 comes with an 6-wire NEM 651 harness.

### Operational modes

LokPilot Fx micro V3.0 can handle DCC with 14, 28 or 128 speed steps as well as Motorola® and Selectrix®.

The decoder recognizes the speed steps automatically. It supports Lenz® LG100 resp. ROCO® braking sections in addition to Zimo®'s HLU-commands, or braking in DC sections with reversed polarity as well as Märklin® braking sections (also for DCC). You can either use short-, or four digit addresses, or assign a consist address.

The Motorola® protocol enables the LokPilot Fx micro V3.0 decoder to run with Märklin® stations 6020®, 6021®, delta®, mobile station® and Central Station®. For those, the decoder handles addresses 01 – 255, and comes to a halt correctly on the Märklin® braking section. On Selectrix® layouts you can choose between addresses 01 – 112.

LokPilot Fx micro V3.0 converses during operation fully automatically between all control modes (Motorola®, DCC, DC, AC, Selectrix®).

### Analog operation

There are no restrictions for LokPilot Fx micro V3.0-equipped rolling stock, of course, when operating in digital mode.

### Functions

LokPilot Fx micro V3.0 comes with six function outputs, 140mA each, and each can be assigned individually to a function: There is flash light, alternate flash, (or ditch lights), strobe light, fire-box flicker as well as Mars-or Gyra light for US models. There is also a high frequency-, time controlled output available for digitally operated couplings.

All function outputs can be dimmed individually in 15 steps. In DCC mode, each function output can be assigned to function keys F0 - F12. F0 – F8 will be recognized in Motorola® mode, the same in Selectrix® mode, depending on the station.

### Programming

The LokPilot Fx micro V3.0 supports all DCC programming modes, including POM (Programming on the main). For Märklin® stations 6020®, 6021®, mobile station®, and Central Station® all programming is also done electronically. For these units LokPilot Fx micro V3.0 employs a time proven, easily acquired programming procedure.

The programmed changes during Motorola® operation are also valid during DCC- and Selectrix® operation – and vice versa. Programming parameters is especially simple for owners of our ECoS command station: All options are displayed in plain language on the large screen, and can easily be modified – even during operation on the layout.

### Interaction

LokPilot Fx micro V3.0 is designed for optimum interaction with the LokSound V3.5 and the LokPilot V3.0 decoder: For example it's possible to equip the cab of an A-A consist with a LokSound V3.5 decoder and the controlling car with a LokPilot Fx micro V3.0 decoder. Given both the same address, they work absolutely identically. Identical grouping of the CVs facilitates synchronisation of both decoders.

### RailCom®

RailCom® is activated ex works. You are able to read CVs on the main track if you use an appropriate command station like our ECoS.

### Protection

All function outputs are protected against overload and short circuit.

### Built-in future

The LokPilot Fx micro V3.0 decoder is firmware upgradeable. New software functions can be installed through the LokProgrammer.

- ▶ **Technical data on page 61.**

### Ordering information

52624 LokPilot Fx micro V3.0 functional decoder (MM/DCC/SX), with 6-pin plug according to NEM651 and wire harness

# LokPilot XL V3.0

## LokPilot XL V3.0 - Power pack for outdoors

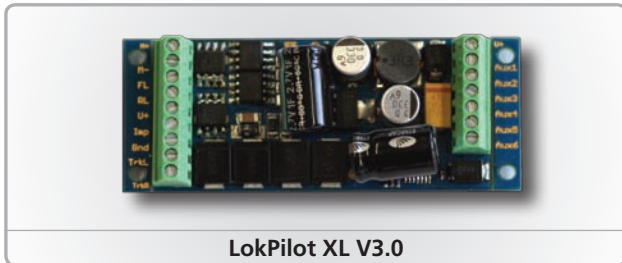

LokPilot XL V3.0

- ▶ The LokPilot XL V3.0 is the worthy successor of the two LokPilot XL V1.0 decoders: Naturally the „new one“ also sports a 3.0 A continuous load, but apart from that it was heavily modified: Next to 8 (!) function outputs for activating extra function-features, the integrated „power pack“ is a standard part of each LokPilot XL V3.0 decoder. Thanks to this energy reservoir, the horror of dirty tracks outside is a thing of the past.

### Operational modes

LokPilot XL V3.0 can handle DCC with 14, 28 and 128 speed steps as well as Motorola®. It supports Lenz® LG100 resp. ROCO® braking sections as well as Zimo HLU-commands-, or braking in DC sections with reversed polarity-, or the Märklin® braking section (also for DCC). You can either assign a short-, or four digit address.

The Motorola® protocol facilitates the operation of the LokPilot XL V3.0 decoders with Märklin® stations 6020®, 6021®, Delta®, mobile station® and Central Station®. For those, the decoders can handle addresses 01 – 255 and come to a halt at the correct position on the Märklin® braking section. The LokPilot XL V3.0 converses during operation fully automatically between all control modes (Motorola®, DCC, DC, AC) and recognizes the speed steps automatically.

### Motor Management

The 4th generation load control performs with up to 32 kHz pulse-width frequency and thus assures extremely quiet, smooth motor operation, especially with ironless core motors. Thanks to 10-Bit technology, your locos will crawl super-slowly. Load control can be adapted very easily to various combinations of motors and gearing.

With Dynamic Drive Control (DDC) you can limit the influence of load control and run your loco real smoothly in the depot area and over turnouts, while on the main, when travelling uphill, the train slows down prototypically.

- ▶ **Technical data on page 61.**

### Ordering information

51702 LokPilot XL V3.0 multiprotocol decoder (DCC/MM/SX), with screwing terminal

### Analog Operation

With the LokPilot XL V3.0 in analog mode you can adjust not only start- and high speed ( $V_{start}$ ,  $V_{max}$ ) of your loco, and determine which of the functions should be active: Even load regulation is activated.

### Functions

Individually programmable acceleration and deceleration (both de-selectable), and selectable switching speed is a matter of course with the LokPilot XL V3.0. Since experience shows that there is a lot to be shifted and switched in big engines, we built in an additional eight (!) functions. Each output can be allocated separately to a function: There is flash, alternate flash, (or ditch lights), strobe light, firebox flicker as well as Mars-or Gyra light for US models. All function outputs can be assigned to one function key (F0 – F15), and are dimmable in 15 steps.

### Programmig

LokPilot XL V3.0 supports all DCC programming modes, including POM (Programming on the main). All programming is done electronically, even for Märklin® stations 6020®, 6021®, mobile station® and Central Station®. For these units LokPilot XL V3.0 employs a time proven, easily acquired programming procedure.

### Accident prevention

LokPilot XL V3.0 with its integrated „Power Pack“ offers an energy reservoir, which assures continued feed of motor and decoder up to 1 second, should there be a current interruption. This major contribution to operational safety is easy to apply: Thanks to factory installation, the decoder does everything fully automatically!

### Protection

All function outputs and the motor connection are overload, – and short circuit protected.

### Built-in future

The LokPilot XL V3.0 is firmware upgradable and can be updated with new software functions.

## Technical data of all LokPilot decoders

### Technical data LokPilot V4.0 and LokPilot V4.0 DCC

<b>Operation modes V4.0</b>	NMRA/DCC with 14, 28 and 128 speed steps, armed for DCC Rail-ComPlus® communication. DCC 2-digit and 4-digit addresses (long and short addresses) Digital Motorola® (old and new), up to 255 addresses for Motorola® use Selectrix® operation mode Analog DC (de-selectable). Analog AC (de-selectable) Automatic recognition of operational mode and DCC speed selection Supports Lenz® LG100, Märklin®, Roco® braking section, Lenz® ABC brake mode and ZIMO® HLU commands Base-direction bit / stores operational status Intelligent programming mode with Märklin® 6021 Switching speed and acceleration & deceleration key selectable
<b>Operation modes V4.0 DCC</b>	NMRA/DCC with 14, 28 and 128 speed steps, armed for DCC Rail-ComPlus® communication. DCC 2-digit and 4-digit addresses (long and short addresses) Analog DC (de-selectable) Automatic recognition of operational mode and DCC speed selection Supports Lenz® LG100, Roco® braking section, Lenz® ABC brake mode and ZIMO® HLU commands Base-direction bit / stores operational status Switching speed and acceleration & deceleration key selectable
<b>Throttle</b>	1.1 A continuous load Runs DC, coreless and AC motors (with permanent magnet) Silent, safe 20 / 40 kHz pulse width frequency motor regulation. Motor output overload protection Fifth generation back EMF (de-selectable)
<b>Function outputs:</b>	4 outputs 250mA load per output 500mA total load of all function outputs. outputs short-circuit protected. 2 logical outputs, serial protocol, connection for »PowerPack« Free function allocation (function mapping)
<b>Dimensions</b>	21.4mm x 15.5mm x 5.5mm

### Technical data LokPilot Basic V1.0

<b>Operation modes:</b>	NMRA/DCC with 14, 28, 128 speed steps 2-digit addresses (+ 4-digit addresses for the 21MTC connector version 52692) Analog DC (de-selectable) Automatic recognition of operational mode and DCC speed-step selection Supports Lenz® LG 100 and Roco® braking sections
<b>Throttle:</b>	0.7 A continuous load. Runs DC- and coreless motors Silent, safe 31,25 kHz pulse width frequency regulation. Motor output overload protected
<b>Function outputs:</b>	3 outputs, 2 of which for light functions 180 mA load per output. ca. 350 mA total load of all function outputs. Outputs short circuit protected Switching speed selectable. Acceleration and deceleration de-selectable
<b>Dimensions:</b>	NEM652: 25.5mm x 15.5mm x 4.5mm (1.02 x 0.62 x 0.18 inch) 21MTC: 24.5mm x 15.5mm x 5.5mm (0.97 x 0.62 x 0.22 inch)

### Technical data LokPilot XL V3.0

<b>Operation modes:</b>	NMRA/DCC with 14, 28 and 128 speed steps, armed for DCC duplex RailCom® communication DCC 2- and 4-digit addresses (short and long addresses) Digital Motorola® (old and new), up to 255 addresses in Motorola® use Selectrix® operational mode Analog DC (de-selectable). Analog AC (de-selectable) Automatic recognition of operational mode and DCC speed step selection Supports Lenz® LG100, Märklin®, Roco® braking sections and ZIMO® HLU commands Base-direction bit / stores operational mode Intelligent programming mode with Märklin® 6021® Switching speed and acceleration as well as deceleration key selectable
<b>Throttle:</b>	3.0 A continuous load Runs DC, coreless and AC motors (with permanent magnet) Silent, safe 16 / 32 kHz pulse width frequency motor regulation Motor output overload protection. Forth generation back EMF (de-selectable)
<b>Function outputs:</b>	8 outputs 600mA load per output Approx. 2000mA total load of all function outputs Free function allocation (function mapping)
<b>Power management:</b>	Attached "PowerPack" energy store to bridge currentless sections
<b>Dimensions:</b>	55mm x 25mm x 10mm (2.28 x 1.06 x 0.39 inch)

### Technical data LokPilot micro V4.0 and V4.0 DCC

<b>Operation modes V4.0</b>	NMRA/DCC with 14, 28 and 128 speed steps DCC 2-digit and 4-digit addresses (long and short) Digital Motorola® (old and new) (NO analog AC!) Selectrix® system Analog DC (de-selectable) Automatic recognition of operational mode and DCC speed step selection. Supports Lenz® LG100, Märklin®, Roco® braking sections, Lenz® ABC brake mode Wrong-direction bit / stores operational status Intelligent programming mode with Märklin® 6021® Switching speed- and acceleration / deceleration key selectable
<b>Operation modes V4.0 DCC</b>	NMRA/DCC with 14, 28 and 128 speed steps, prepared for DCC Rail-ComPlus® communication. DCC 2-digit and 4-digit addresses (long and short) Analog DC (de-selectable) Automatic recognition of operational mode and DCC speed step selection. Supports Lenz® LG100, Lenz® ABC brake mode and Roco® braking sections Wrong-direction bit / stores operational status Switching speed and acceleration as well as deceleration key selectable
<b>Throttle</b>	0.75 A continuous load Runs DC and coreless motors Silent, safe 20 / 40 kHz pulse width frequency motor regulation Motor terminal overload protected. Fifth generation load back EMF (de-selectable).
<b>Function outputs</b>	2 outputs; 150mA load per output approx. 280mA total load of all function outputs. Outputs short circuit protected 2 logic outputs; Connection for »PowerPack« Free function allocation (function mapping)
<b>Dimensions</b>	10.5mm x 8.1mm x 2.8mm (Next18: 15.0mm x 9.5mm x 2.8mm)

### Technical data LokPilot Fx micro V3.0

<b>Operation modes:</b>	NMRA/DCC with 14, 28 and 128 speed steps DCC 2 digit and 4 digit addresses (short and long addresses) Digital Motorola® (old and new) (NO analog AC!) Selectrix® system Analog DC (de-selectable). Automatic recognition of operational mode and DCC speed step selection. Supports Lenz® LG100, Märklin® and Roco® braking sections Wrong-direction bit / stores operational status Intelligent programming mode with Märklin® 6021®
<b>Function outputs:</b>	4 outputs 140mA load per output approx. 280mA total load of all function outputs. Outputs short circuit protected Free function allocation (function mapping)
<b>Dimensions:</b>	13.5mm x 9.0mm x 3.5mm (0.54 x 0.36 x 0.12 inch)

### Technical data LokPilot Fx V3.0

<b>Operation modes:</b>	NMRA/DCC with 14, 28 and 128 speed steps, armed for RailCom® communication DCC 2-and 4-digit addresses (long and short addresses) Digital Motorola® (old and new), up to 255 addresses for Motorola® operation Analog DC (de-selectable). Analog AC (de-selectable). Automatic recognition of operational mode and DCC speed step selection Supports Lenz® LG100, Märklin®, Roco® braking sections Wrong-direction bit / stores operational modes Intelligent programming mode with Märklin® 6021® Switching speed and acceleration as well as deceleration key selectable
<b>Function outputs:</b>	6 outputs 250mA load per output approx. 750mA total load of all function outputs Outputs short circuit protected Free function allocation (function mapping, F1 bis F12)
<b>Dimensions:</b>	17.5mm x 15.5mm x 5.5mm (0.69 x 0.61 x 0.22 inch)

# Accessories

## PowerPack for LokPilot & LokSound V4.0

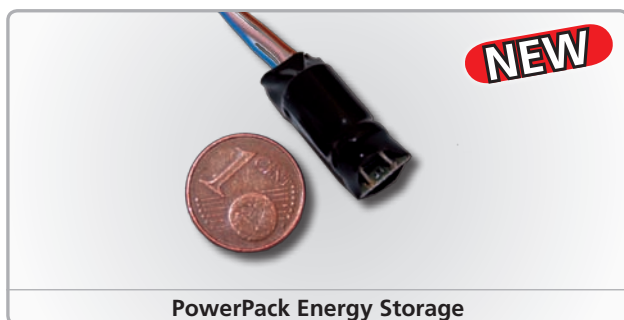

### ► Energy

The ESU Power Pack can be optionally connected to all LokPilot V4.0, LokPilot micro V4.0, LokSound V4.0 and LokSound micro V4.0 decoders and supplies your locomotive reliably with power to get over dirty tracks and longer switch crossings.

Sound, light and motor functions are buffered and thus enable your model to run up to 3 seconds without power, depending on the model's power consumption.

The Power Pack has an integrated charging current which is controlled by the decoder. Therefore it can remain within the loco while it gets programmed. The load current is however, limited to avoid an excessive load on your booster, for this case there would be, several models in operation.

The buffer time can be restricted by writing a CV on the decoder side to make red signals lead to an exact signal stop.

The size of the Power Pack is approx. 22 x 10 x 8 mm which has to be considered during the installation.

A 3-pin cable connection between the decoder and the Power Pack is essential.

### Ordering information

**NEW** 54670 PowerPack, Energy storage for LokPilot V4.0, LokSound (micro) V4.0 decoders

## Change over of skis



Many railcars are equipped with a ski at both ends. In order to function correctly in block sections, and timely braking in front of red signals, it is vital for the decoder to employ only one ski for (voltage) pick up – depending on direction of travel.

To achieve this is precisely the responsibility of our ski change-over electronics: It is hooked up between pick up and a 21TMC connector of a LokPilot- or LokSound V3.5 decoder. After reprogramming, all ESU decoders (not LokPilot Basic V1.0) can send a control-pulse that talks to the change-over electronics and then selects the "correct" ski. This combination works perfectly and without interference in digital – and analog mode.

### Bestellinformationen

51966 Ski change-over electronics for use with LokSound V3.5/LokSound V4.0/LokPilot V3.0/LokPilot V4.0 decoders with 21MTC connector



# Adapter Boards

## 21MTC Adapter board



21 MTC Adapterplatine

The 21 MTC adapter board is suitable for digitizing a loco without interface and for the case you do not intend to wire the decoder freely.

The adapter board offers a possibility for installing a decoder with 21MTC connector. This decoder is simply plugged onto the board. At the other end 21 annular rings make a clean wiring of your loco possible.

A neat conversion can be made via this adapter board and enables you to use all additional functions of the 21MTC connector (e.g. loud speaker outputs).

## 21MTC Adapter board 2

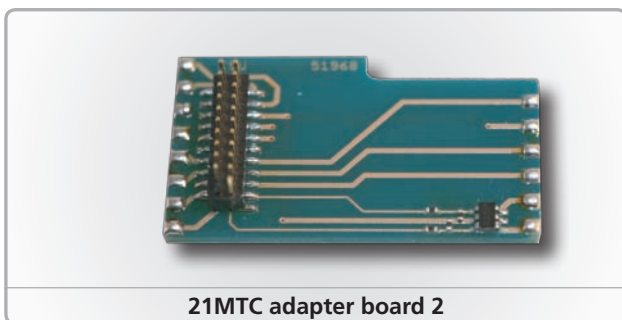

21MTC adapter board 2

The 21 MTC adapter board 2 is also suitable for digitizing a loco without interface. It is very helpful, if you do not intend to wire the decoder freely or if you wish to use more than four function outputs on your LokPilot or LokSound decoder. This adapter board simulates the typical size and shape of Märklin® 6090x-decoders and can be installed in every suitable position.

Decoders with 21MTC connectors (ESU LokPilot or LokSound favoured) are simply plugged onto the adapter board.

On the output side, the adapter offers already soldered cables (appr. 20cm length) for all contacts needed. Thus the wiring of your loco is child's play. There are amplifiers (appr. 250mA each) for function AUX3 and AUX4 (the decoder's logical outputs) so that ESU decoders have up to 6 available physical function outputs.

## NEM652 Adapter board for locos with PluX12,16,22

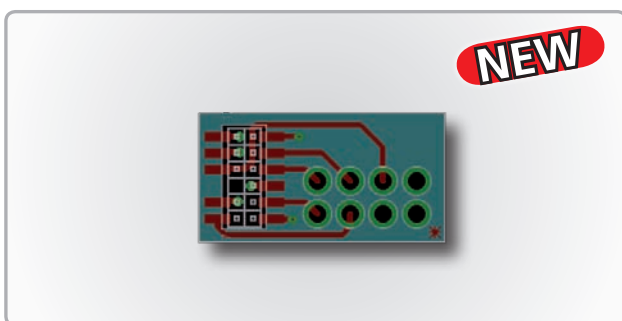

If you own a loco with a PluX jack and would like to install a normal decoder with an 8-pin NEM652 plug? No problem, you just need the ESU PluX adapter board. This adapter board can be easily plugged into your loco with a PluX12, PluX16 or PluX22 jack, then you are able to install any decoder with a conventional 8-pin plugg.

### Ordering information

- |                  |   |
|------------------|---|
| 51967            | Loco adapter board for LokSound V4.0, LokPilot V4.0 with 21MTC interface  |
| 51968            | Loco adapter board in L-shape like 6090x, with AUX3+AUX4, for LokSound V4.0, LokPilot V4.0 with 21MTC interface |
| <b>NEW</b> 51969 | Adapter board, for connection 8-pin NEM652 decoders to locos with PluX12, 16, 22 interface                      |

## Accessories

### Thin cables

Who doesn't know the problem: if you work on locos and decoders (e.g. run wires from loco to tender) you need thin, extremely flexible cables. These are not always easy to get. Responding to many requests from our customers, as of now we offer you super thin cables (AWG 36) with an outside diameter of only 0.5 mm (0.02 inch) in all common DCC colors.

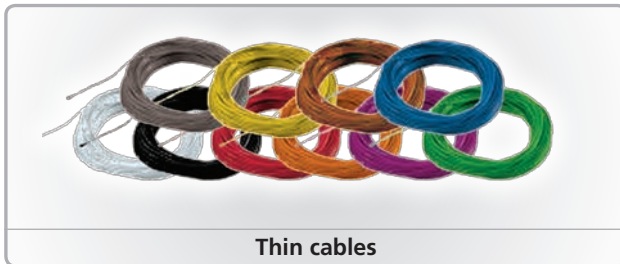

Thin cables

### Cable harnesses

If the loco in question features no digital interface and you don't want to cut off the interface-plug of your loco, simply make use of one of our harnesses 51950 resp. 51951: Solder in the harness and then plug in the decoder. That's how the Pro's do it!

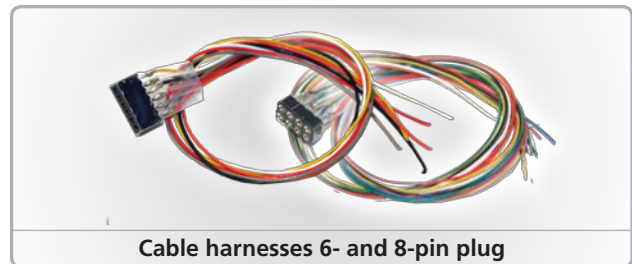

Cable harnesses 6- and 8-pin plug

### Permanent magnets

For the retrofit of old Märklin® all-current motors you need a permanent magnet. It replaces the present field winding, and in combination with a LokSound – or LokPilot decoder, helps to make your loco run astonishingly smooth.

We offer 3 different magnets, depending on the particular armature. You find the armature code number on a spare-parts sheet, which you can download from [www.maerklin.de](http://www.maerklin.de).



51960

51961

51962

### Miniature relays

With our small relay, loads are controllable whose draw exceeds the decoder's function output. Put the relay between output and load.



Miniature relay

### Ordering information

51940	Super thin cable, 0.5mm diameter, AWG36, 10m bundle, white colour
51941	Super thin cable, 0.5mm diameter, AWG36, 10m bundle, purple colour
51942	Super thin cable, 0.5mm diameter, AWG36, 10m bundle, black colour
51943	Super thin cable, 0.5mm diameter, AWG36, 10m bundle, red colour
51944	Super thin cable, 0.5mm diameter, AWG36, 10m bundle, orange colour
51945	Super thin cable, 0.5mm diameter, AWG36, 10m bundle, green colour
51946	Super thin cable, 0.5mm diameter, AWG36, 10m bundle, grey colour
51947	Super thin cable, 0.5mm diameter, AWG36, 10m bundle, yellow colour
51948	Super thin cable, 0.5mm diameter, AWG36, 10m bundle, brown colour
51949	Super thin cable, 0.5mm diameter, AWG36, 10m bundle, blue colour
51950	Cable harness with 8-pin plug according to NEM 652, DCC colour, length 300mm
51951	Cable harness with 6-pin plug according to NEM 651, DCC colour, length 300mm
51960	Permanent magnet like 220560, for armature 217450, D=24.5mm, for motor holder 216730, 211990, 228500
51961	Permanent magnet like 220450, for armature 200680, D=18.0mm, for motor holder 204900
51962	Permanent magnet like 235690, for armature 231440, D=19.1mm, for motor holder 231350
51963	Relay 1 A miniature relay, 16 volts



# LED interior lighting set for passenger cars

## Interior lighting sets by ESU - Got light?

- ▶ ESU is very proud to present to you the new interior LED lighting system for passenger cabins. This system allows you to retrofit your cars with a prototypical and steady interior lighting. The passenger car interior lighting is available in three different versions to match the desired location:

### 255mm length, 9mm width

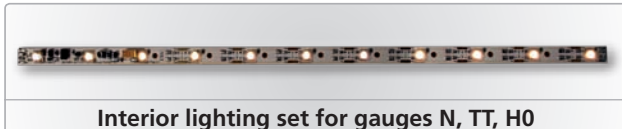

Interior lighting set for gauges N, TT, H0

For the gauges N, TT and H0 imaginary, 255mm long lightings will be offered in two versions: With warm white LEDs (50700) or yellow LEDs (50702).

### 380mm length, 15mm width

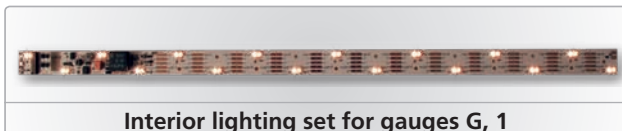

Interior lighting set for gauges G, 1

The long car interior lighting with the SKU 50703 is designed for use in G gauge cars. It features both white and yellow LEDs, which can be adjusted separately in brightness. For the first time you can adjust to the desired hue by yourself. Because of the digital interface (21MTC) a LokPilot Fx function decoder can be simply retrofitted at any time.

### Cabin & Taillights



Interior lighting set driver's cabine & taillights

Small, easy to install kits for cabs and taillights are also available

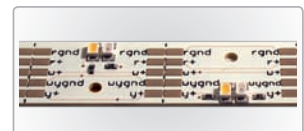
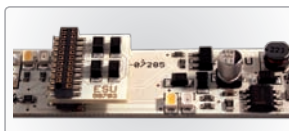

The ESU passenger car lighting system offers crucial advantages:

#### Warm-White LEDs

SMD LEDs, the latest design, insure a uniform illumination of the cars at extremely low power consumption.

#### Constant voltage

Thanks to built-in voltage control the brightness remains almost constant even when conventional driving.

#### Adjustable brightness

With the help of a small variable resistor (potentiometers) you can individually adjust the brightness according to your wishes.

#### Variable length

The lighting strips can be arbitrarily cut to fit the cars of all manufacturers.

#### Buffer capacitor

The 255mm long luminaries include a buffer capacitor to bridge small power interruptions.

#### PowerPack

To bridge prolonged power interruptions, the 255mm long lighting strip can be retrofitted with an optional „Power Pack“. This capacitor with extremely high capacity is standard at the 380mm illumination.

#### Taillights included

Each lighting strip comes with a red taillight. When not in use, this lighting strip can be easily removed.



### Ordering information

50700	LED lighting strip with taillight, 255mm, 11 LEDs, „warm-white“. For gauge N,TT, H0
50702	LED lighting strip with taillight, 255mm, 11 LEDs, „yellow“. For gauge N,TT, H0
50703	LED lighting strip with taillight, 380mm, 32 LEDs, „white/yellow“, PowerPack. For gauge 1,G
50704	LED lighting strip, cabin, 1 LED, „warm-white“
50705	LED lighting strip, taillight, 2 LED, „Red“
50706	LED lighting strip, PowerPack energy storage, double pack

# Loudspeakers

► A very important part of the LokSound system is the speaker. Therefore, we only use specially developed loudspeakers geared to the sound decoder. Here we recommend the following old saying, the bigger the speaker, the better the sound. As such, we offer loudspeakers in various sizes, one of them will surely fit into your loco. Should there not be enough space, you can also install the speaker in a 'ghost waggon' directly behind the loco.

Another crucial accessory is the sound chamber. This helps create the necessary sound pressure for the speaker's membrane and comes with most loudspeakers.

If you are not sure about which loudspeaker fits into your loco we generally recommend to open the loco and measure the dimensions with a ruler. Since model railway manufacturers often

tend to change (tacitly) the inner modifications of their locos we are not able to make recommendations in general. Therefore rely on your own observations!

When selecting the loudspeaker the used decoder type is important. Depending on the decoder, different loudspeakers can be used as follows:

LokSound V4.0 and LokSound micro V4.0 decoders need a new speaker with an impedance of 4 Ohms. With the present 100 Ohms loudspeakers you would hardly hear anything.

Conversely, you must never use the new 4 Ohms speakers with the previous LokSound V3.5 decoder. The decoder could be destroyed! When the decoder is replaced, the speaker must be changed as well.

## For LokSound V4.0 & LokSound micro V4.0



### Loudspeakers for LokSound V4.0 & LokSound micro V4.0

- NEW** 50327 Two loudspeakers 16mm, oval, 8 Ohms, 1~2W, with common sound chamber
- NEW** 50328 Two loudspeakers 13 mm, 8 Ohms, round, 1~2W with sound chamber
- NEW** 50330 Loudspeaker 16mm x 25mm, rechteckig, 4 Ohms, with sound chamber
- NEW** 50331 Loudspeaker 20mm, round, 4 Ohms, 1~2W, with sound chamber
- NEW** 50332 Loudspeaker 23mm, round, 4 Ohms, 1~2W, with sound chamber
- NEW** 50333 Loudspeaker 28mm, round, 4 Ohms, 1~2W, with sound chamber
- NEW** 50334 Loudspeaker 20mm x 40mm, square, 4 Ohms, with sound chamber

## For LokSound V3.5, LokSound micro V3.5, LokSound V3.0 M4



13mm

16x25mm

16mm

For the well-proven LokSound V3.5, LokSound micro V3.5 and LokSound V3.0 M4 decoders we offer loudspeakers in the following sizes: 2x13mm (50 Ohms each), 2x16mm (50 Ohms each), 16x25mm, 20mm, 23mm, 28mm, 20x40mm and 40mm.

By virtue of the internal design of the decoders, the speakers feature a specially customised impedance of 100 Ohms.

**Only these speakers may be used!**



20mm

23mm

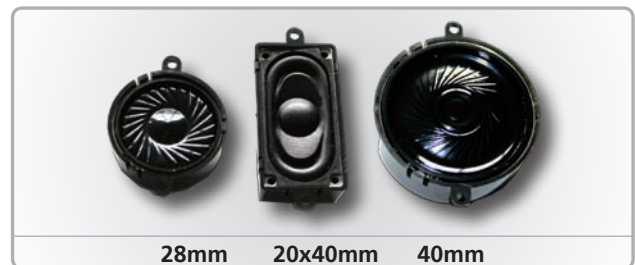

28mm

20x40mm

40mm

### Loudspeakers for LokSound V3.5, LokSound micro V3.5, LokSound V3.0 M4

- 50335 Loudspeaker 32mm, rund, 100 Ohms, without sound chamber
- 50339 Loudspeaker 13mm, round, 50 Ohms, with sound chamber
- 50440 Loudspeaker 16x25mm, square, 100 Ohms, with sound chamber
- 50441 Loudspeaker 20mm, round, 100 Ohms, with sound chamber
- 50442 Loudspeaker 23mm, round, 100 Ohms, with sound chamber
- 50443 Loudspeaker 28mm, round, 100 Ohms, with sound chamber
- 50444 Loudspeaker 40mm, round, 100 Ohms, with sound chamber
- 50447 Two loudspeakers 16mm, oval, 50 Ohms each, with sound chamber
- 50448 Loudspeaker 20mm x 40mm, square, 100 Ohms, with sound chamber

## For LokSound XL V3.5



40mm

57mm

78mm

LokSound XL V3.5 decoders work with loudspeakers which have an impedance from 8-32 Ohms. ESU offers you a selection of the sizes 40mm, 57mm and 78mm including sound chamber as well as some high-class Visation XL loudspeakers without sound chamber.

Visaton loudspeakers offer a powerful bass and a high-quality audio playback, whereas ESU loudspeakers are also suitable for open-land vehicles due to their plastic membrane.

### Loudspeakers for LokSound XL V3.5

- 50336 Loudspeaker Visaton SC4.7ND, 41x70mm, square, 8 Ohms
- 50337 Loudspeaker Visaton FRS5, 50mm, round 8 Ohms
- 50338 Loudspeaker Visaton FRS8, 78mm, round, 8 Ohms
- 50445 Loudspeaker 57mm, round, 8-32 Ohms, with sound chamber
- 50446 Loudspeaker 78mm, round, 8-32 Ohms, with sound chamber
- 50449 Loudspeaker 40mm, round, 8-32 Ohms, with sound chamber



# LokProgrammer

## LokProgrammer - For your own special sound



- ▶ You want to listen to the sound spectrum of your favourite loco, or the special sound of that loco around the corner in the yard – on your model railroad? No problem with ESU's LokProgrammer! One prerequisite: A PC with sound card, serial interface as well as Windows XP or Windows 7. Simply record the original sound of your engine and edit it at home with your computer.

With the LokProgrammer, you can also change the settings of all ESU decoders such as LokSound, LokPilot as well as Switch-Pilot decoders according to personal requirements. This makes a realistic railway feeling possible.

Thanks to the graphical user interface of Windows the best-possible decoder adjustment can be carried out, even without any programming experience.

Never has the adjustment of a digital decoder been easier!

### Settings

The most important function of the LokProgrammer is the tuning and adjustments of new decoders. No matter if it is a DCC, multiprotocol or M4 decoder. With the help of the LokProgrammer you are able to change almost each of the decoder's settings in an easy and convenient way. Depending on the decoder type the amount of available options varies.

You can change all of the decoder's digital parameters, such as address of the loco, operation speed, maximum speed, braking deceleration, brightness of bulbs etc. Furthermore you can change the parameters of the total load control or the function key allocation as well as for brake distance or analogue modes. Also the speed table can be conveniently manipulated by mouse click.

In short, all decoder settings can be displayed and modified.

Of course you can also edit the settings of M4 decoders such as loco symbol, function key symbols and the loco name, just like it is shown later on the command station. If your ESU decoder already speaks RailComPlus®, you are able to modify the respective values as well.

Thus you can set all options with your computer very easily - no cumbersome entering of CVs (configuration variables) with your command station!

### Sound

With the LokProgrammer you can erase the sound data of any LokSound decoder as many times as you wish, and replace it

with a different sound. To this end we offer on our homepage more than 400 different, fully matching sounds of various prototypes and locos for downloading on your computer. Also you can edit just parts of a sound project: You don't like the decoder's whistle? Just replace it with one of the many others.

Suitable sources beside those offered by us, are in Windows \*.wav format available. Sound – even voice or music is no problem for our decoders. With the LokProgrammer's aid you use the entire flexibility and functionality offered by LokSound decoders.

### Test run

With the virtual driver's cabin the LokProgrammer offers you the possibility to test your locos quickly and directly on our desk. Beside Motorola® it also supports all DCC modes and can activate up to 28 function keys.

### Upgrades

The LokProgrammer can also be instrumental in updating decoders. Almost all ESU decoders are updatable, in case you desire a new software version. To do this, you only need the LokProgrammer as well as the appropriate software. It is either available separately or included in the LokProgrammer V.4 software. By doing so, you will keep your ESU decoders up-to-date with current developments and benefit from product enhancements.

### Open

We recommend the LokProgrammer not only for our ESU decoders: many well-known manufacturers meanwhile equip their locomotives with ESU decoders ex works. Depending on their technical specifications, the settings of the so-called OEM decoders can be also modified and changed. The purchase of a LokProgrammer is therefore a worthwhile investment in any case!

With the LokProgrammer you can also modify settings of other decoders, provided that they completely correspond to the DCC specifications; such decoders can only be edited in the single CV mode.

### Connection

It's this that simple: The LokProgrammer is a small programming box, which is wired between the PC and a programming track.

To connect it you need either a vacant serial interface, or you use the included USB adapter cable (works with Windows XP or Windows 7).

For power we include a 500mA wall power supply. If you need more power (e.g. for gauge I engines), you can also use a conventional model railroad transformer.

### Software

After having connected the LokProgrammer with your PC you start up the especially user-friendly LokProgrammer software, which is included on CD-ROM. This runs on all modern Windows-systems from Windows XP to Windows 7.

Just put the loco with the ESU decoder on your programming track, and right away you can read, edit or program it. The Programmer automatically recognises the decoder in the engine.

### Ordering information

53451 LokProgrammer set incl. LokProgrammer unit, power supply, serial PC cable, manual, software CD, USB adapter

**NEW**

51952 Cable USB-A 2.0 FTDI to RS232, 1.80m, for LokProgrammer

## The future

LokProgrammer software is being reviewed continuously. The latest, pertinent version can always be downloaded from our homepage or can be installed automatically through an internet-update function, on your computer.

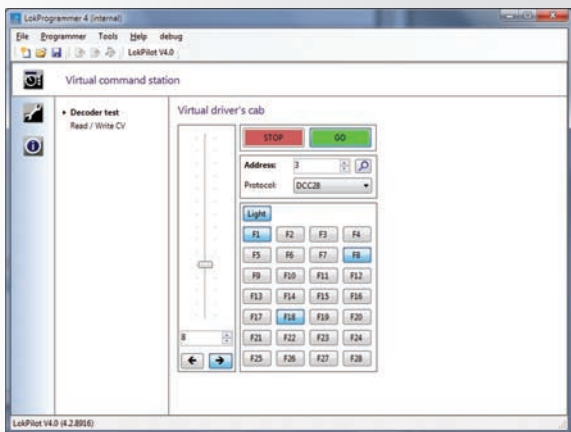
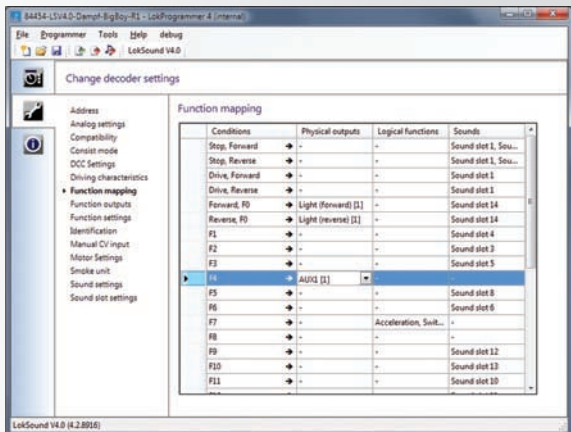
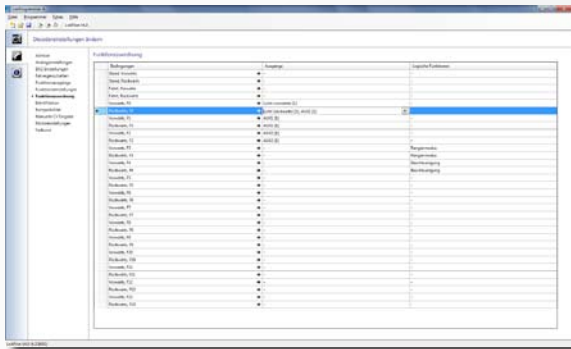

NEW

As contemporary computers do not have a serial interface anymore we include a USB adapter cable.

Since Windows Vista and Windows 7, cables that support USB 2.0 and are provided with a FTDI chip are required.

The previous cables, available until the end of 2009, will not work with these operating systems due to their modified inner structures by Windows.

If your LokProgrammer has been in use for a considerable time and you intend to switch to Windows 7, you will need a new USB cable.

The USB cable can be ordered at your ESU retailers shop, art. no. 51952.

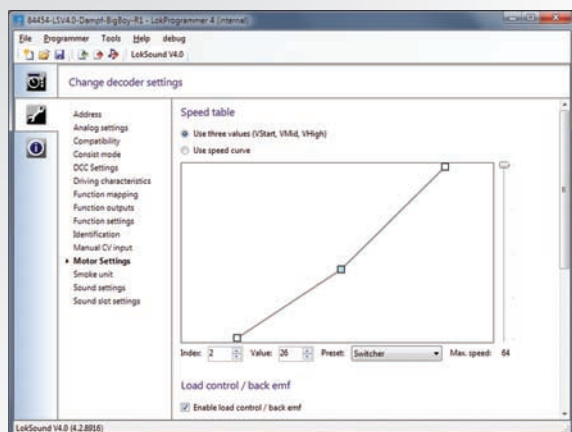
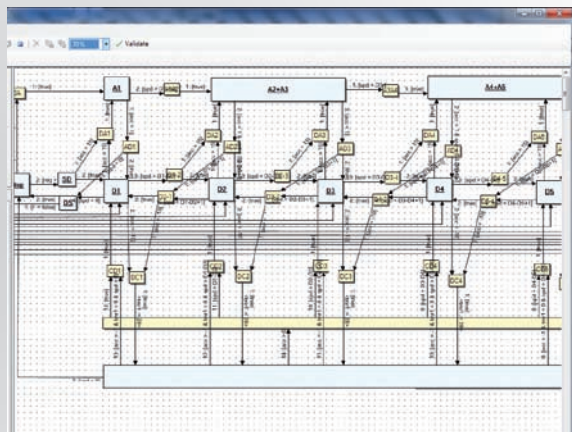
# Decoder Tester

## Decoder Tester

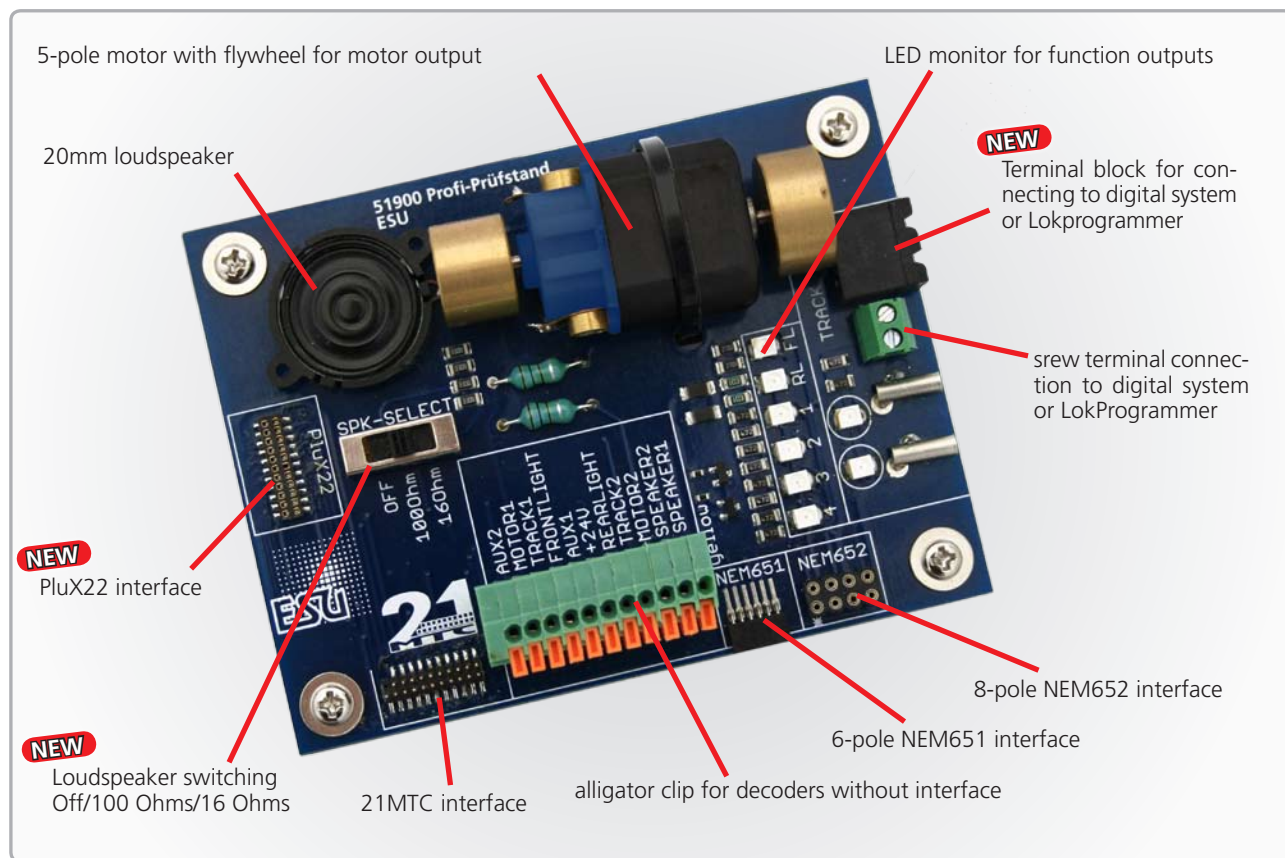

► Maybe you know the situation: In front of you there is a digital decoder on the workbench and before you undertake its complicated installation into the loco, you would like to know if the decoder works as advertised. But, how do you test it?

The Decoder Tester will help you with that: It's designed for testing decoders before these are installed into a loco. The Decoder Tester is simply hooked up to your digital central station or the LokProgrammer.

### Configuration

To make this as simple as possible for you, the Decoder Tester comes with useful features: To connect the decoder, there is a 6-wire NEM 651 harness and an 8-wire NEM 652 interface, as well as a 21MTC connector available. Plug it on – bingo!

As a new feature we offer a PluX22 interface as well as the loudspeaker switching function, which will be available from this year on. You can now choose freely, if you want to switch the speaker on Off / 100 Ohms / 16 Ohms.

Furthermore we extended the Decoder Tester with a new terminal block, you are now able to connect it to your digital system or to the ESU LokProgrammer.

Locos without an interface board can be hooked up with alligator clips. A high-quality, 5-pole skewed armature can motor with flywheel serves to check the motor output: It's this simple to test the slow-, and constant speed characteristics of your decoder. A LED-monitor informs you about the function of the head-, and rear light output, as well as function outputs AUX 1 (green), AUX 2 (violet), AUX 3 and AUX 4.

A 20mm loud speaker is included for testing LokSound decoders. A screw terminal assures safe connection between your Decoder Tester and the digital command station or LokProgrammer.

Due to its sensible features and simple handling, the Decoder Tester will soon become an indispensable helper in your shop.

### Ordering information

**NEW** 51900 Decoder Tester for decoders, plug-in for NEM652, NEM651, 21MTC, PluX22, terminal block, loudspeaker switching, single wire, motor, LED monitor and 20mm speaker

# ESU Decoder comparison chart

	LokPilot Basic V1.0	LokPilot V3.0	LokPilot V3.0 M4®	LokPilot V4.0	LokPilot V4.0 DCC	LokPilot micro V4.0	LokPilot micro V4.0 DCC	LokPilot V4.0	LokPilot V4.0	LokSound V4.0	LokSound V3.0 M4®	LokSound micro V4.0	LokSound V3.5	LokSound XL V3.0 M4®
<b>Operation modes</b>														
DCC 14, 28, 128 speed steps	OK	OK	-	OK	OK	OK	OK	OK	OK	OK	-	OK	OK	-
DCC short addresses	OK	OK	OK	OK	OK	OK	OK	OK	OK	OK	-	OK	OK	-
DCC long addresses	OK	OK	-	OK	OK	OK	OK	OK	OK	OK	-	OK	OK	-
DCC consist mode	-	OK	OK	OK	OK	OK	OK	OK	OK	OK	-	OK	OK	-
DCC LGB pulse control	-	OK	OK	OK	OK	OK	OK	OK	OK	OK	-	OK	OK	-
Automatic speed step detection	-	OK	OK	OK	OK	OK	OK	OK	OK	OK	-	OK	OK	-
Lenz® LG 100, ROCCO® brake unit	OK	OK	OK	OK	OK	OK	OK	OK	OK	OK	-	OK	OK	-
ZIMO® HLU-commands	OK	OK	-	OK	OK	OK	OK	OK	OK	OK	-	OK	OK	-
DC analogue operation	OK	OK	OK	OK	OK	OK	OK	OK	OK	OK	-	OK	OK	-
Motorola® 14 speed steps	-	OK	OK	OK	OK	OK	OK	OK	OK	OK	-	OK	OK	-
Motorola® 28 speed steps	-	OK	OK	OK	OK	OK	OK	OK	OK	OK	-	OK	OK	-
Motorola® address 1 - 80	-	OK	OK	OK	OK	OK	OK	OK	OK	OK	-	OK	OK	-
Motorola® address 1 - 127	-	OK	OK	OK	OK	OK	OK	OK	OK	OK	-	OK	OK	-
Motorola® address 1 - 255	-	OK	OK	OK	OK	OK	OK	OK	OK	OK	-	OK	OK	-
Märklin® brake unit	-	OK	OK	OK	OK	OK	OK	OK	OK	OK	-	OK	OK	-
Selectrix®	-	OK	OK	OK	OK	OK	OK	OK	OK	OK	-	OK	OK	-
AC analogue operation	-	OK	OK	OK	OK	OK	OK	OK	OK	OK	-	OK	OK	-
Automatic detection of operational mode	OK	OK	OK	OK	OK	OK	OK	OK	OK	OK	-	OK	OK	-
<b>Throttle</b>														
DC and coreless motors	OK	OK	OK	OK	OK	OK	OK	OK	OK	OK	OK	OK	OK	OK
AC motors with permanent magnet	31,25 kHz	-	OK	OK	OK	OK	OK	OK	OK	OK	OK	OK	OK	OK
PWM frequency	OK	-	32,00 kHz	40,00 kHz	40,00 kHz	40,00 kHz	40,00 kHz	40,00 kHz	40,00 kHz	40,00 kHz	32,00 kHz	40,00 kHz	32,00 kHz	32,00 kHz
Load control in digital operation	-	-	OK	OK	OK	OK	OK	OK	OK	OK	OK	OK	OK	OK
Load control in analogue operation	-	-	OK	OK	OK	OK	OK	OK	OK	OK	OK	OK	OK	OK
Adj. start / maximum speed in analogue operation	-	-	OK	OK	OK	OK	OK	OK	OK	OK	OK	OK	OK	OK
Mass simulation for 14 speed step operation	-	-	OK	OK	OK	OK	OK	OK	OK	OK	OK	OK	OK	OK
DDC (Dynamic Drive Control)	-	-	OK	OK	OK	OK	OK	OK	OK	OK	OK	OK	OK	OK
Continuous motor current	0,7A	-	1,1A	1,1A	1,1A	0,75A	1,1A	1,1A	1,1A	1,1A	1,1A	0,75A	3,0A	3,0A
Short circuit protection	OK	-	OK	OK	OK	OK	OK	OK	OK	OK	OK	OK	OK	OK
<b>Function outputs</b>														
Number of function outputs	3	6	4	4	4	2	8	4	4	4	4	4	8	6
Current of each output	180mA	250mA	140mA	250mA	250mA	150mA	600mA	250mA	250mA	180mA	250mA	600mA	600mA	600mA
Logic level outputs	-	-	OK	OK	OK	OK	OK	OK	OK	OK	OK	OK	OK	OK
Short circuit protection	OK	OK	OK	OK	OK	OK	OK	OK	OK	OK	OK	OK	OK	OK
Output dimming	common	separate	separate	separate	separate	separate	separate	separate	separate	separate	separate	separate	separate	separate
Light effects like Blinking lights, Strobe, Gyra light	-	OK	OK	OK	OK	OK	OK	OK	OK	OK	OK	OK	OK	OK
Marslight, Zoom, Fire box flickering, Ditch light	-	OK	OK	OK	OK	OK	OK	OK	OK	OK	OK	OK	OK	OK
Time-controlled function outputs	-	OK	OK	OK	OK	OK	OK	OK	OK	OK	OK	OK	OK	OK
Function Mapping according to NMRA (F0 - F8)	-	OK	OK	OK	OK	OK	OK	OK	OK	OK	OK	OK	OK	OK
Function Mapping according to ESU (F0 - F15)	-	OK	OK	OK	OK	OK	OK	OK	OK	OK	OK	OK	OK	OK
Function Mapping V4.0 ESU (F0 - F28)	-	OK	OK	OK	OK	OK	OK	OK	OK	OK	OK	OK	OK	OK
Function Mapping M4® compatible	-	OK	OK	OK	OK	OK	OK	OK	OK	OK	OK	OK	OK	OK
Shunting mode (de-selectable)	OK	-	OK	OK	OK	OK	OK	OK	OK	OK	OK	OK	OK	OK
ABV (de-selectable)	OK	-	OK	OK	OK	OK	OK	OK	OK	OK	OK	OK	OK	OK
Serial protocol (for C-sinus)	-	-	-	OK	OK	-	-	-	-	-	-	-	-	-
<b>Sound</b>														
Polyphonic Sound. Number of channels	-	-	-	-	-	-	-	8	4	8	4	8	4	4
Flash memory for sound data	-	-	-	-	-	-	-	32 Mbit	16 Mbit	16 Mbit	32 Mbit	16 Mbit	16 Mbit	16 Mbit
Power of BTL amplifier (sinus)	-	-	-	-	-	-	-	1,8W	0,6W	1,8W	1,5W	1,5W	1,5W	1,5W
<b>Programming</b>														
DCC service mode programming modes	-	OK	OK	OK	OK	OK	OK	OK	OK	OK	OK	OK	OK	OK
(Register Mode, Address Only, Direct Mode)	-	OK	OK	OK	OK	OK	OK	OK	OK	OK	OK	OK	OK	OK
DCC POM (Programming On the Main)	-	OK	OK	OK	OK	OK	OK	OK	OK	OK	OK	OK	OK	OK
Programming mode for Märklin® 6021	-	OK	OK	OK	OK	OK	OK	OK	OK	OK	OK	OK	OK	OK
M4® configuration on the main track	-	-	OK	OK	OK	OK	OK	OK	OK	OK	OK	OK	OK	OK
<b>Specials</b>														
M4® feedback system	-	-	OK	OK	OK	-	-	-	-	-	OK	-	-	OK
RailCom® feedback system	-	OK	OK	OK	OK	OK	OK	OK	OK	OK	OK	OK	OK	OK
RailComPlus® automatic recognition	-	-	OK	OK	OK	OK	OK	OK	OK	OK	OK	OK	OK	OK
Storage of current operational state (memory)	-	-	OK	OK	OK	OK	OK	OK	OK	OK	OK	OK	OK	OK
Motorola® wrong-direction bit	-	OK	OK	OK	OK	OK	OK	OK	OK	OK	OK	OK	OK	OK
»PowerPack« energy storage	-	-	optional	optional	optional	optional	optional	optional	optional	optional	optional	optional	optional	optional
<b>Construction</b>														
Dimensions in mm	25,5x15,5x4,5	17,5x15,5x5,5	13,5x9,0x3,0	23,0x15,5x5,5	21,4x15,5x5,5	10,5x8,1x2,8	10,5x8,1x2,8	31,0x15,5x6,5	31,0x15,5x6,5	28,0x10,0x5,0	31,0x15,5x6,5	28,0x10,0x5,0	51,0x40,0x14,0	51,0x40,0x14,0
8-pin plug NEM652 with cable harness	52690	52620	-	61600	52610	-	52611	544xx	554xx	54899	624xx	54899	54899	-
6-pin plug NEM651 with cable harness	-	52624	52624	52612	52613	52687	52684	52685	52685	548xx	558xx	548xx	558xx	-
6-pin plug NEM651	-	52621	-	61601	52614	52688	52685	54499	62499	-	-	-	-	-
21MTC interface	-	52692	52621	52614	52614	-	-	54499	62499	-	-	-	-	-
Screw terminals	-	-	-	-	-	-	-	-	-	-	-	-	-	62500
PLUX12 interface NEM658 on cable harness	-	-	-	54616	-	-	-	55400	-	55800	-	55800	-	-
Next18 interface	-	-	-	54689	-	54689	54686	-	-	54898	-	54898	-	-

## Benelux

Train Service Danckaert bvba  
Hamiltonpark 14  
BE-8000 BRUGGE  
Phone +32 (475) 24 19 58  
Fax +32 (706) 6 09 19  
loksound@loksound.be  
www.loksound.be



## Italy

Esemme S.R.L. - Modellismo  
Via G.B. Piranesi, 17  
IT-20137 MILANO  
Phone +39 0 27 38 41 51  
Fax +39 0 27 38 41 51  
essemme.model@tiscali.it  
www.esemmemodel.com

ESU electronic solutions ulm GmbH & Co. KG  
Industriestrasse 5  
D-89081 Ulm  
**GERMANY**  
Phone: +49 (731) - 18 47 80  
Fax: +49 (731) - 18 47 82 99

## Spain

Hornby Espana S.A.  
Federico Chueca s/n  
ES-28806 Alca de Heneras  
Phone +34 (918) 79 63 33  
Fax +34 (918) 79 63 32  
electrotren@hornby.es  
www.electrotren.es

ESU LLC  
477 Knopp Drive  
Muncy PA 17756

## Switzerland

Arwico AG  
Brühlstrasse 10  
CH-4107 ETTINGEN  
Phone +41 (61) 7 22 12 22  
Fax +41 (61) 7 22 12 42  
sekretariat@arwico.ch  
www.arwico.ch

**USA**  
Phone +1 (0) 570-649-5048  
Fax +1 (0) 866-591-6440

## United Kingdom

South West Digital Ltd.  
1 Savernake Road  
Weston Super Mare  
GB-BS229HQ NORTH SOMERSET  
Phone +44 (1934) 51 73 03  
info@swd4esu.co.uk  
www.southwestdigital.co.uk

[www.loksound.com](http://www.loksound.com)

Your model railway retailer



»mfxx« ist eine eingetragene Marke der Firma Gebrüder Märklin & Cie. GmbH  
»märklin« ist eine eingetragene Marke der Firma Gebrüder Märklin & Cie. GmbH  
»SELECTRIX« ist eine eingetragene Marke der Firma Märklin Holding GmbH  
»Railcom« und »RailcomPlus« ist eine eingetragene Marke der Firma LENZ-Elektronik GmbH

Copyright 2011 by ESU electronic solutions ulm GmbH&Co KG. Änderungen, Liefermöglichkeiten und alle Rechte vorbehalten. Elektrische und Mechanische Maßangaben sowie Abbildungen ohne Gewähr. LokSound Produkte sind im Fachhandel erhältlich. »LokSound«, »LokPilot«, »ECOS«, »ESU Navigator«, »ECOSControl Radio«, »SwitchPilot« ist ein eingetragenes Warenzeichen der ESU electronic solutions ulm GmbH & Co KG. Märklin ist ein eingetragenes Warenzeichen der Firma Gebr. Märklin & Cie., Göttingen. Motorola ist ein eingetragenes Warenzeichen der Motorola Inc., Tempe-Phoenix, USA. Andere Warenzeichen sind Eigentum der jeweiligen Eintrager.

Copyright 2011 by ESU electronic solutions ulm GmbH & Co KG. Products and all specifications are subject to change without notice. All rights reserved worldwide. »LokSound« is a registered trademark of ESU electronic solutions ulm GmbH & Co KG. Märklin is a registered trademark of Gebr. Märklin & Cie GmbH, Göttingen. Motorola is a registered trademark of Motorola Inc., Tempe-Phoenix, USA. Other trademarks are the property of their owners.