

26th Feb. 2015

Brussels

Subcommittee on Security and Defence

Lieutenant-general BUCHSENSCHMIDT
Commander Eurocorps

EUROCORPS, a tool for the European Union,
NATO and UN

Use it or lose it !



EUROCORPS is an Army Corps Headquarters:

Similar to its sister HRF HQs

but also

Unique in its kind

Has reached a turning point in its existence.

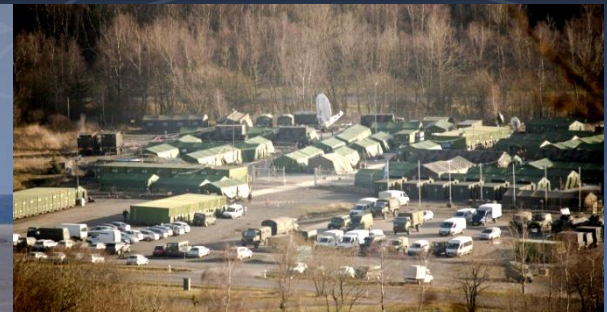

CENTRAL LOCATION WITHIN HRF COMMUNITY

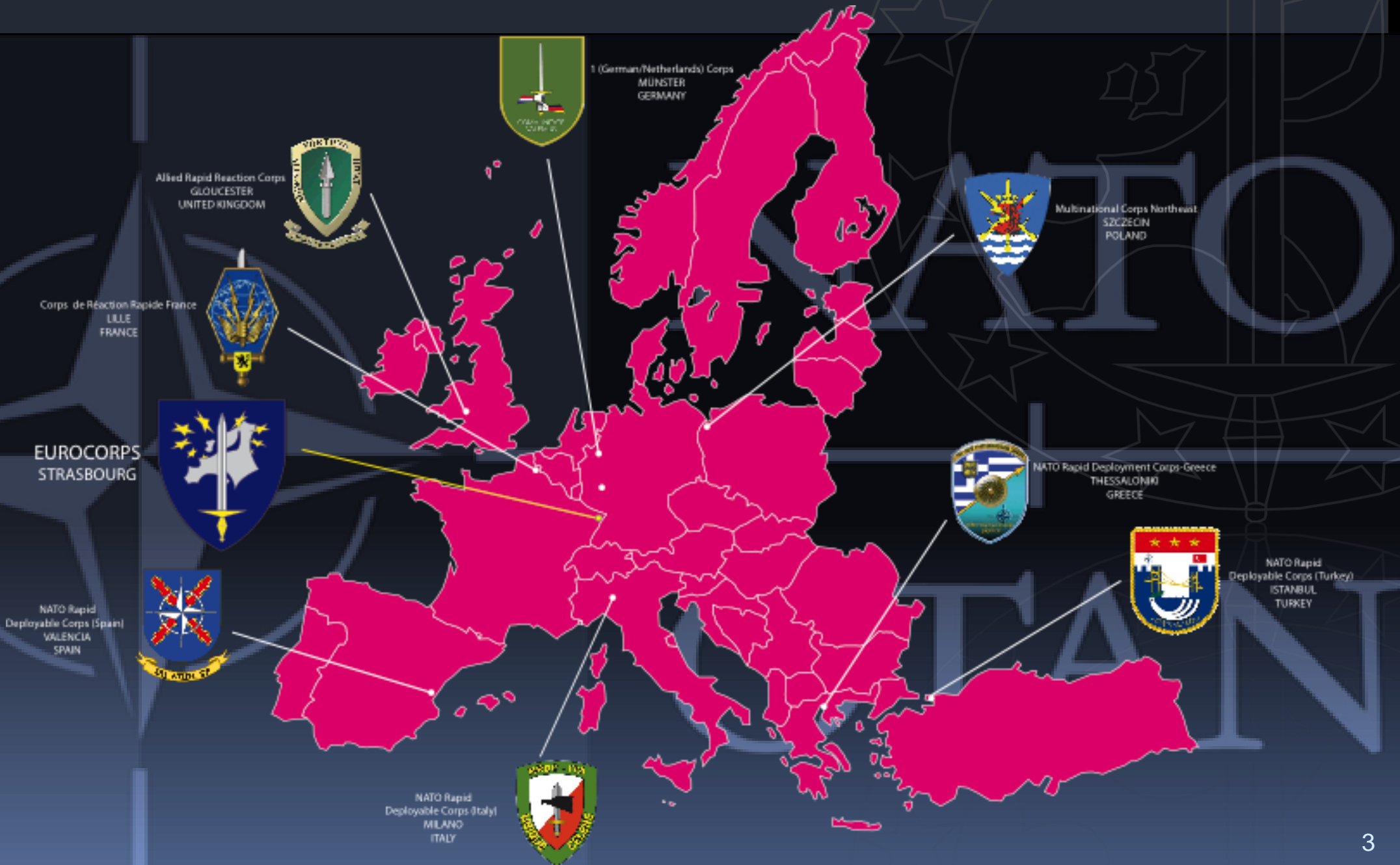

RAPIDLY DEPLOYABLE



OPERATIONAL

1998

2000

2004-2005



Bosnia - Herzegovina



Kosovo



Afghanistan



NRF 7

2006



NRF 15

2010



2012

A UNIQUE STATUS



1992, La Rochelle : a political will

Directly subordinated to CHODs and POL DIR



2009, Treaty of Strasbourg :
Financial and legal autonomy

A UNIQUE SUBORDINATION

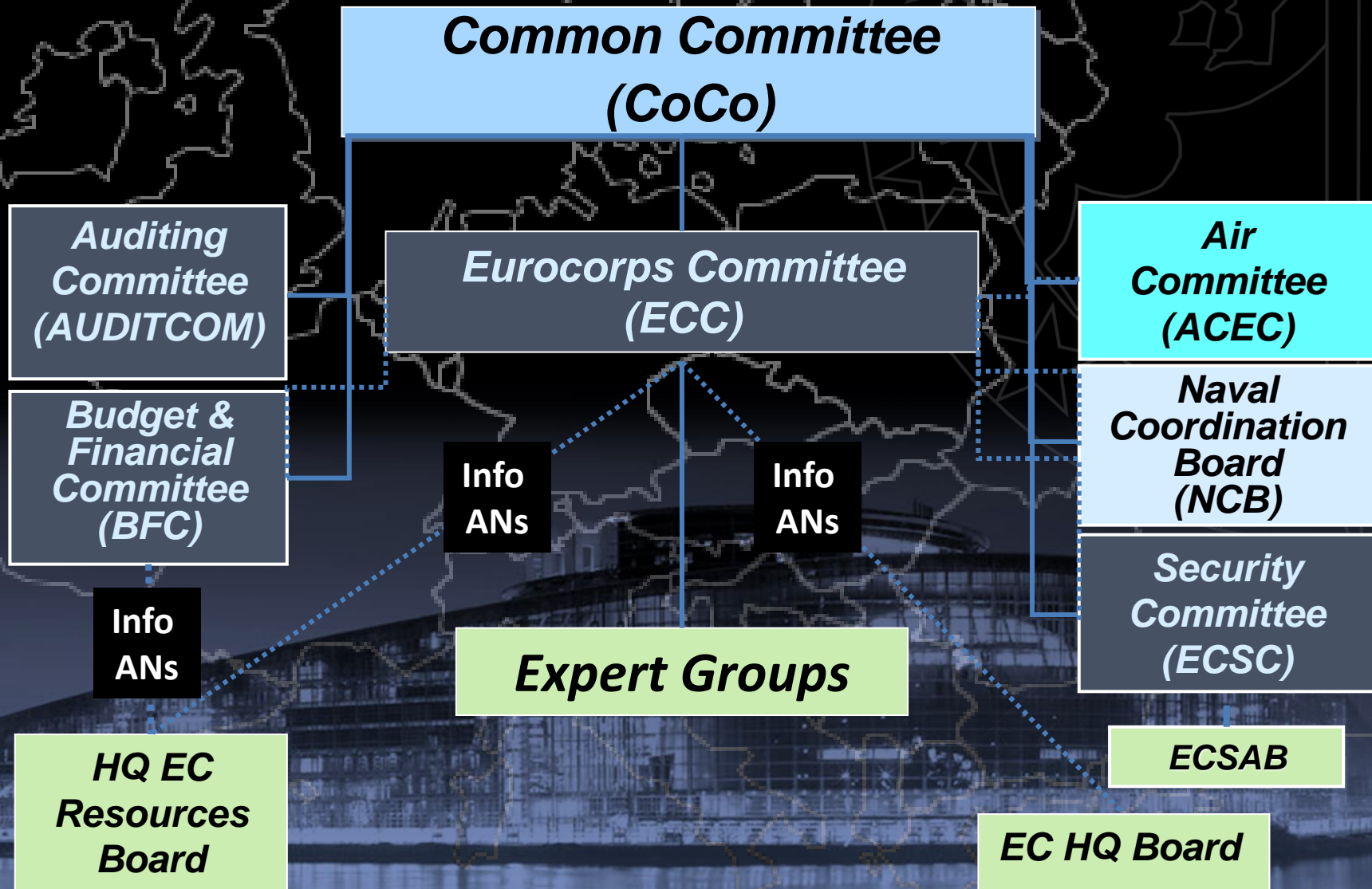

A UNIQUE GEOGRAPHICAL SITUATION

A European capital

European Parliament
Council of Europe
European Court of Human Rights

Strasbourg

Higher education center



Council of Europe

National School of Administration (ENA)
University of Strasbourg
Institute of Political Studies (IEP)

Force structure

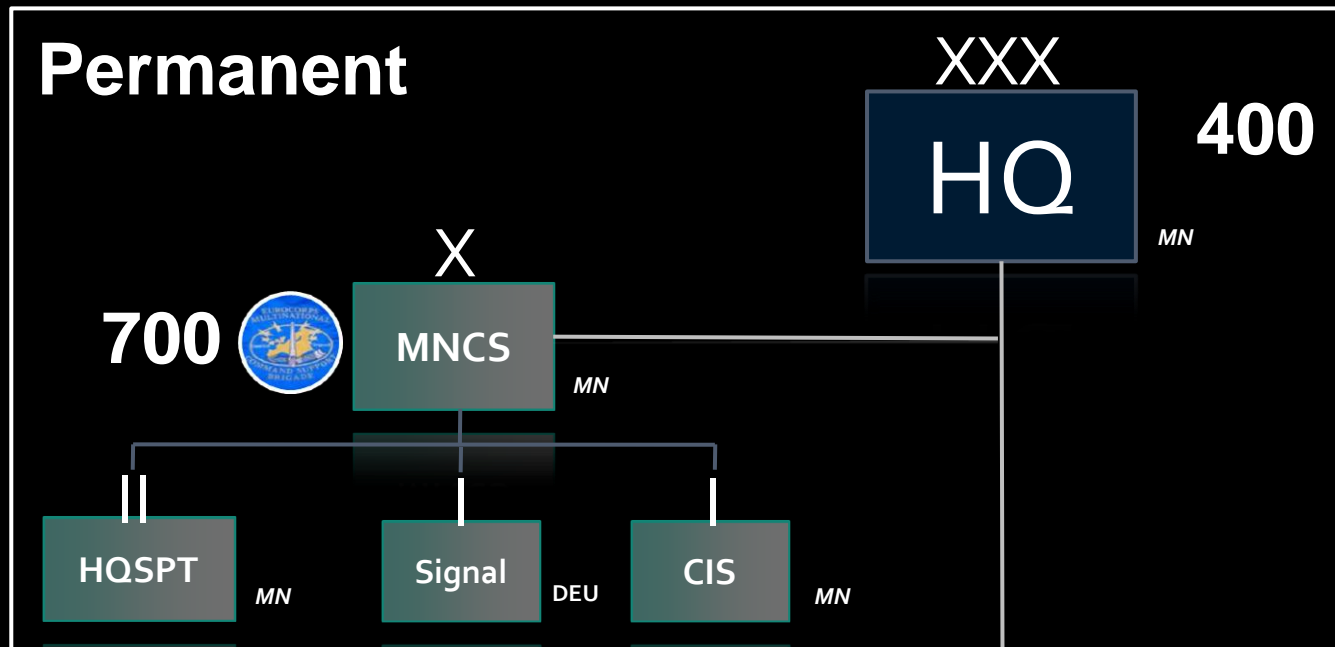

**Total Eurocorps:
+/- 1100**



5 000
**Privileged
Capabilities**

Force generated

A UNIQUE MULTINATIONAL STRUCTURE

5 → 6 Framework Nations

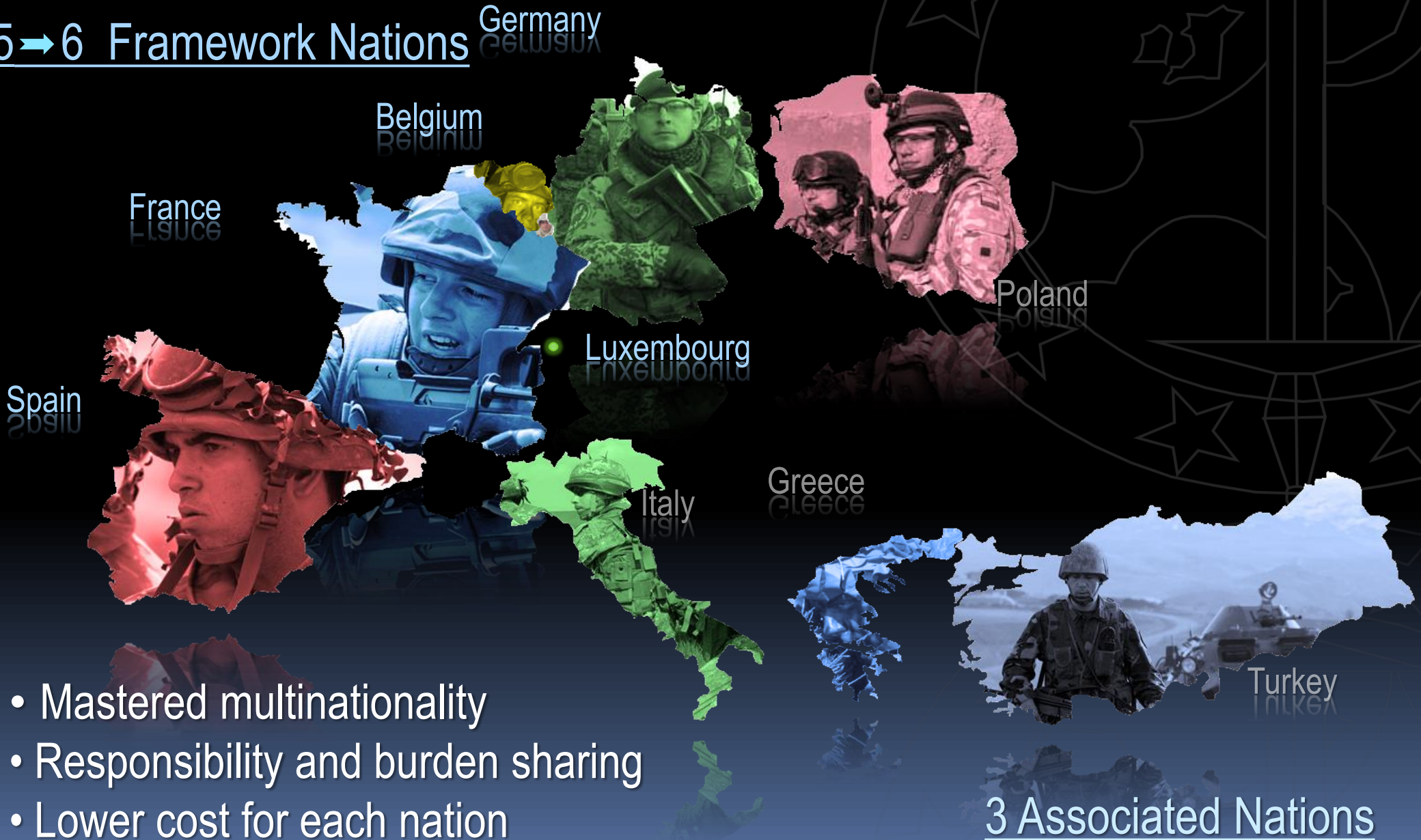

- Mastered multinationality
- Responsibility and burden sharing
- Lower cost for each nation

3 Associated Nations

AN ENHANCED MULTINATIONALLY

5 → 6 Framework Nations

France
1992
 354

Germany
1992
 289

Belgium
1993
 151

Spain
1994
 197

Luxembourg
1996
 2

Poland
2016
 112

3 Associated Nations

Turkey
2002
 3

Greece
2002
 2

Italy
2009
 2

2 projected associated nations

Romania
near future
 2

USA
near future
 2 ?

A TRADITIONAL ORGANISATION



... BUT MULTINATIONAL !

Command Group

COMMANDER

DEPUTY COMMANDER
CHIEF OF STAFF

COM

DCOM

COS

LEGAL ADVISOR
MEDICAL ADVISOR
PUBLIC AFFAIRS
AIR
NAVY

Political
advisor



OF8
Guy
Buchsensmidt



OF7
Adolfo
Orozco



OF7
Thierry
Corbet

CHIEF OF STAFF

DCOS OPERATIONS
DCOS SUPPORT
DCOS TRAINING & RESOURCES

COS MILITARY ASSISTANT (LUX)

DCOS OPS

DCOS SPT

DCOS TR&RES



OF6
Franz
Pfrengle























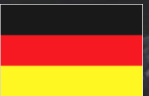



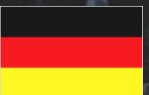

OF6
Andrzej
Przekwas

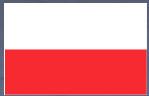
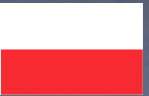

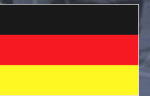
OF6
Jean-Pierre
Devos

ROTATION PLAN

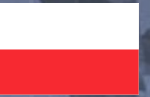
	2011	2013	2015	2017	2019
COMMANDER					
DEPUTY COMMANDER					
CHIEF OF STAFF					
DCOS OPERATIONS					
DCOS SUPPORT					
DCOS TRAINING AND RESSOURCES					

BUDGET 2014

Total : 13.114.000 €

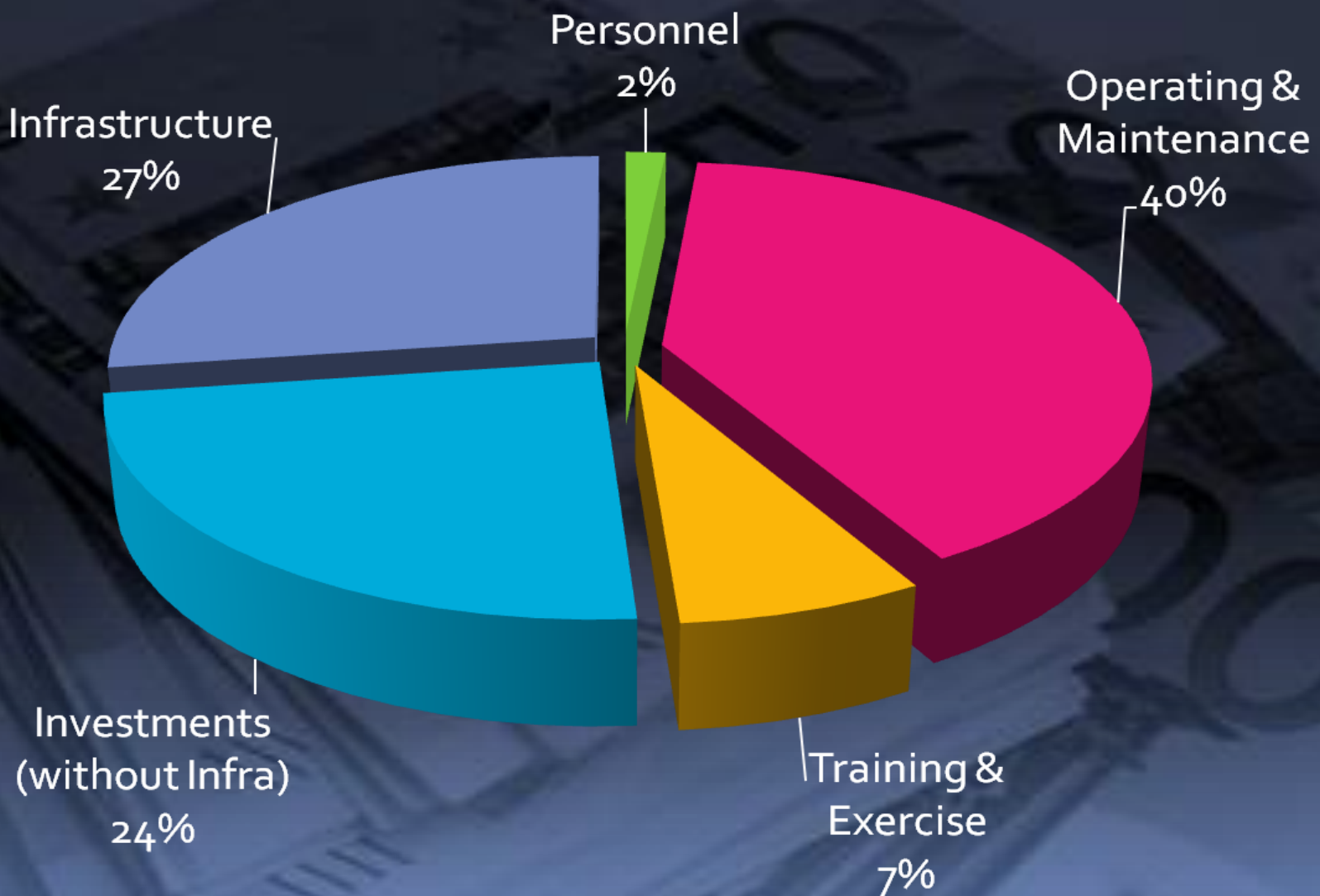

EQUIPMENT

Owens its Command Posts material :

- Tactical Tents: 106
- CP Shelters: 94
- Power Supply Generators: 16



- Energy distribution containers: 5
- AirCos and Heaters: 107
- CIS based on SIC-F

Sufficient for the set up and operation of:

- CP LCC
- CP MAIN – REAR
- CP JTF - JLSG



EQUIPMENT

Computers + 1400

- SICF MS Network 420 WS
- NATO Secret 100 WS
- Multi-purposes (MS or NS) 100 WS
- ECS/Secret Network 478 WS
- ECR/Restricted Network 200 WS
- Internet Network 120 WS
- LAN and VTC equipment

Sufficient to supply the CP networks
of LCC or JTF



EQUIPMENT

Vehicles

- BEL: Vans, busses, trucks
- DEU: Trucks
- FRA : Jeeps and trucks
- ESP: Trucks
- POL: Trucks, Vans



Armament :

- BEL pistols: FN Browning 9mm
- FRA rifles: FAMAS 5,56mm
- DEU machine guns: MG3 7,62mm

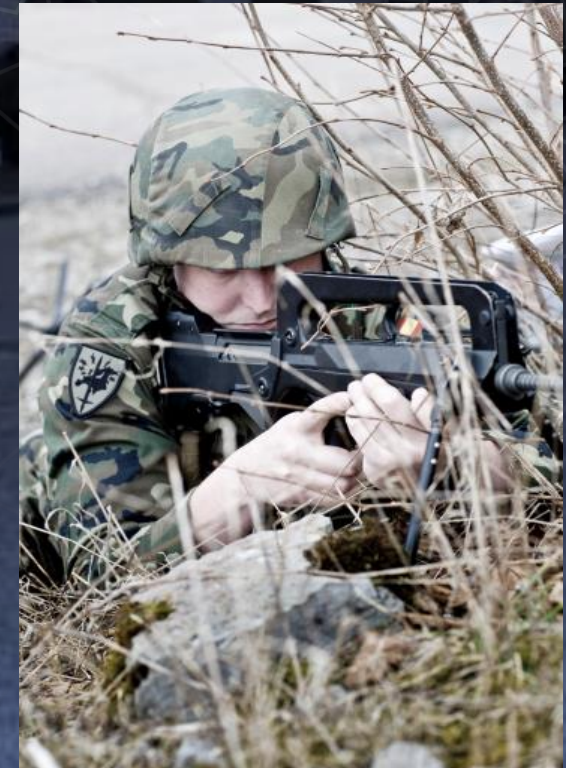

INFRASTRUCTURE

Strasbourg
21st World

Aubert de Vincelles



Lizé/Lyautey



NEW CONCEPT OF EMPLOYMENT: MODULARITY

XXX



Modular roles

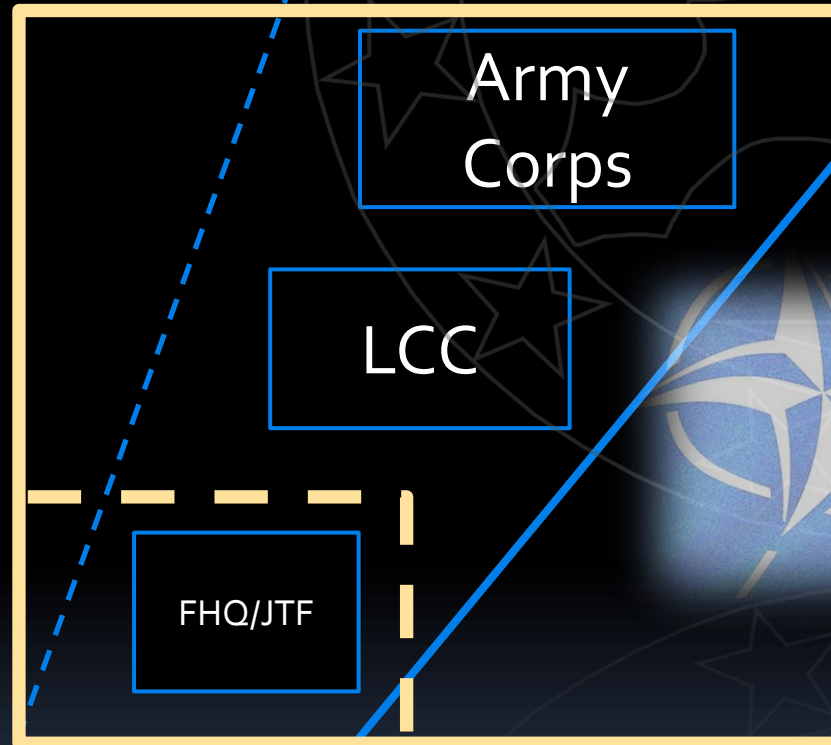

Full blown roles

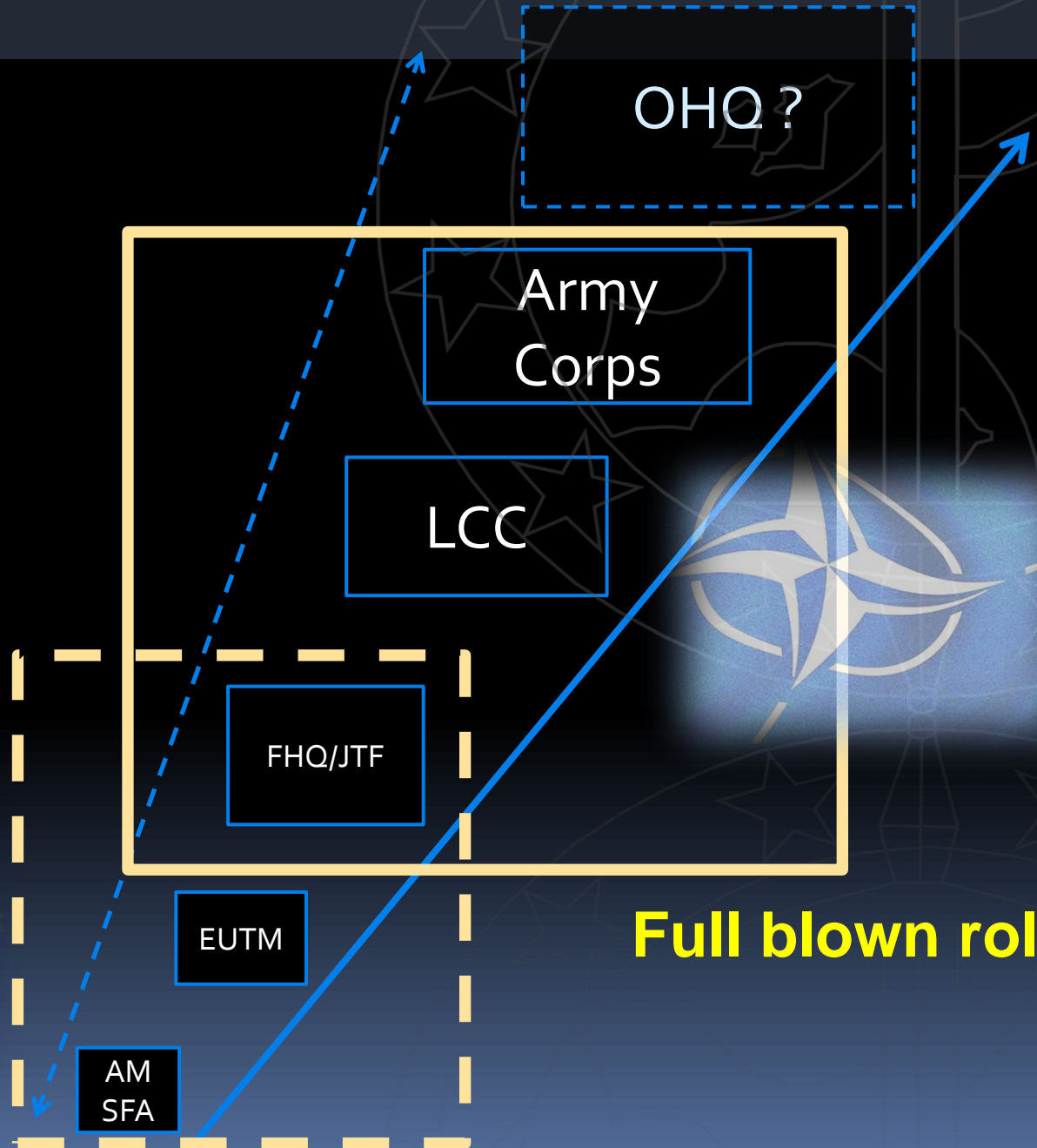

OPERATIONAL PERSPECTIVES

➤ EUTM MALI

Mission HQ 2015/2



➤ EU BG (F) HQ in 2016/2



➤ NRF 2020



Possible operational deployment :

- 2017-2018/1 → EU, NATO, UN ...

Eurocorps

- EU Operations: privileged Headquarters ?
- Modularity
- Operations in Africa: NATO / EU spearhead
- A huge potential, but Force generation remains a critical issue
- EU permanent OHQ ?

Use it or lose it...



QUESTIONS





BACK UP SLIDES



MULTIPLE POSSIBLE ROLES

- Land Component Command HQ (LCC HQ) including the NRF framework (NRF7 and 15)
- Rapid Reaction Corps (HRF certification 2002)
- Army Corps for the collective defence
- Be prepared to command a low to medium scale, up to high intensity operation
- Support to EUMS planning teams
- Force and Mission HQ for European Union missions (training, monitoring and/or advisory missions)
- Multinational Army Corps under a mandate of the United Nations Organization (UN)