

BOSCH

Compact Series Kitchen Machines

for models:

MUM 4405 UC • MUM 4420 UC

MUM 4620 UC • MUM 4635 UC



H



**READ THIS MANUAL
thoroughly for important safety and operating
instructions before using this appliance.**

IMPORTANT SAFEGUARDS

WARNING: A risk of fire and electrical shock exists in all electrical appliances and may cause personal injury or death.

When using electrical appliances, basic safety precautions should always be followed, including the following:

1. Read all instructions before using the kitchen machine.
2. To protect against risk of electric shock, do not put the drive unit in or under water or other liquid.
3. This appliance is not for use by children.
4. Close supervision is necessary when any appliance is used near children.
5. Do not leave appliances unattended during operation.
6. Unplug from outlet when not in use, before putting on or taking off parts, and before cleaning.
7. To disconnect: switch appliance off then remove plug from power supply.
8. Avoid contacting moving parts. Keep hands, hair, clothing, as well as spatulas and other utensils away from whisks, beaters, blades, disc, dough hook and/or other moving parts during operation to reduce the risk of injury to persons and/or damage to the appliance or its attachments.
9. Do not operate any appliance with a damaged cord or plug, or after the appliance malfunctions or is dropped or damaged in any manner. Return appliance to the nearest authorized service facility for examination, repair or electrical or mechanical adjustment.
10. The use of attachments not recommended or sold by the appliance manufacturer may cause fire, electric shock or injury and is therefore prohibited.
11. Do not use outdoors or when standing in a damp area.
12. Do not let cord hang over edge of table or counter, or touch hot surfaces.
13. Always operate appliance with covers in place.
14. Blades are sharp. Handle carefully due to risk of injury.
15. Use the kitchen machine for processing normal quantities of food for domestic use.

NOTE: ALSO BE SURE TO READ THE WARNINGS AND CAUTIONS THAT ARE PROVIDED BEFORE EACH ATTACHMENT'S OPERATING INSTRUCTION.

SAVE THESE INSTRUCTIONS

TABLE OF CONTENTS

IMPORTANT SAFEGUARDS	2
Table of contents	3
ABOUT YOUR KITCHEN MACHINE	4
Bosch Series 4 Kitchen Machine	4
Unpacking	4
Electrical specifications	4
Before using for the first time	4
Getting to know your Bosch Kitchen Machine	6
Special accessories	6
Power unit features	6-7
Getting started	8-9
STANDARD ATTACHMENTS	10
Mixing bowl w/beating whisk, stirring whisk and dough hook	10
How to use dough hook	10
Placing into operation with dough hook	11
How to use stirring and beating whisks	11
Placing into operation w/beating or stirring whisk	12
Care and cleaning of bowl and its accessories	12
Blender with unbreakable plastic jar	13
How to use blender	13
Placing blender into operation	14
Example of use of blender	15
Care and cleaning of blender	15
Continuous shredder	16
Continuous shredder, intended use	16
Placing continuous shredder into operation	17
Care and cleaning of continuous shredder	18
SERVICE and REPAIR	19
TROUBLESHOOTING	19
SAMPLE RECIPES	20-21
SPECIAL ACCESSORIES	22
BOSCH small appliance warranty	24

HOUSEHOLD USE ONLY

ABOUT YOUR KITCHEN MACHINE

Congratulations on having selected one of the Bosch Compact Series Kitchen Machines. A series of kitchen machines that we and—thankfully—cooking professionals the world over, feel are the best compact household-type kitchen machines available.

As you read through these instructions, please pay particular attention to the **IMPORTANT SAFEGUARDS**. Specific safeguards for the attachments, as well as warnings and cautions, are provided in each section describing the operation of that particular attachment.

Bosch Compact Series Kitchen Machine

The Bosch Compact Series Kitchen Machine is available in 4 models:

- **The MUM 4405 UC**

comprised of the 400-watt power unit with integral cord storage, four-quart capacity mixing bowl, with anti-splash cover (MUZ4KR3), beating, stirring whisks and dough hook and high speed drive cover.

- **The MUM 4420 UC**

comprised of the 400-watt power unit with integral cord storage, four-quart capacity mixing bowl with anti-splash cover (MUZ4KR3), beating, stirring whisks and dough hook, blender (MUZ4MX2), continuous shredder (MUZ4DS2) with shedding, slicing and grating discs, high-speed drive cover and accessory holder.

- **The MUM 4620 UC**

comprised of the 450-watt power unit with integral, internal, cord storage, four-quart capacity mixing bowl, with anti-splash cover (MUZ4KR3), beating, stirring whisks and dough hook, blender (MUZ4MX2), high-speed drive cover and accessory holder.

- **The MUM 4635 UC**

comprised of the 450-watt power unit with integral, internal, cord storage, four-quart capacity mixing bowl with anti-splash cover (MUZ4KR3), beating, stirring whisks and dough hook, blender (MUZ4MX2), continuous shredder (MUZ4DS2) with shedding, slicing and grating discs, high-speed drive cover and accessory holder.

Unpacking

Carefully remove the power unit from its packaging and place it on the counter so it is ready to use. As you remove the accessories from the carton, check them against Figure 1 to ensure that all the standard parts are present.

Electrical Specifications

Check to make sure that the voltage on which your kitchen machine is to operate is the same as specified on the rating plate. Standard North American models have an electrical power rating of 400- or 450-watt maximum power rating with the accessory attachment that draws the most power (some accessory attachments may draw less power).

Before Using for the First Time

Before using any of the attachments for the first time it is recommended they be washed, rinsed well and dried. Of the attachments supplied, with the systems in this manual, all parts, except the blender's blade/base assembly, are dishwasher safe:

- > The blender's blade/base assembly should be washed under running water and dried.

Note: It is recommended that the blender's blade/base assembly never be left to stand in water or soap solution to prevent the bearing lubricant from being washed out.



MUM 4405 UC



MUM 4620 UC



MUM 4420 UC



MUM 4635 UC

Figure 1

Getting to Know Your Bosch Kitchen Machine

The Bosch Compact Series Kitchen Machines are comprised of various attachments, depending on the system purchased (see above). In addition to the attachments listed on the previous pages that are available with the standard systems, Bosch offers many special accessories.

Special Accessories

To allow you to get the most service from your Bosch Compact Series Kitchen Machine, Bosch engineers have designed a line of special accessories to expand the usefulness of your machine. In addition to the attachments that come with the various Compact Series Kitchen Machines, there are optional accessories that can be ordered separately. These accessories include a food and meat grinder, grain mills, citrus juicer and ice cream maker, plus additional attachments that can be used with the meat grinder: fancy cookie attachment, fruit pulper and grater attachment. See SPECIAL ACCESSORIES at the back of this booklet, page 23. Or, to view all currently available accessories, visit our Web site at www.everythingkitchens.com

Work on expanding the usefulness of the Bosch Compact Series Kitchen Machine is a continuing process. If there is some type of accessory in which you are interested in that you cannot find at the back of the book or on our Web site, please call us Toll Free at: 1-866-852-4268

Power Unit Features

Motor

The MUM 4405 and MUM 4420 have a 400-watt motor while the MUM 4620 and MUM 4635 have a 450-watt motor, the most powerful motor offered with any compact household kitchen machine.

All MUM Compact Series power units have the following features, refer to figure 2:

Electronic speed control

Six-position rotary switch is located at the side of the multifunction arm of the power unit: 4 speeds plus a locking park position “P” and a stop position “O/Off,” see figure 2a.

Three accessory drives

Three drives:

- A high-speed drive used for blender and other attachments requiring high-shaft speed
- A mid-speed drive used for continuous shredder attachment and other attachments requiring mid-range shaft speeds and
- A high torque drive used for whisks, dough hook and meat grinder attachment and other attachments requiring more torque.

Each of these drives is controlled by the 4-speed electronic control providing 12 distinct shaft speeds optimizing the motor speed for different loads encountered by different attachments.

Ergonomic multifunction arm

Four locking positions place attachments in most ergonomic position for their use.

Park position “P”

Six-position rotary switch, located at side of the multifunction arm of the power unit, has “P” position used to “park” the drive unit. The drives must be placed in the park position prior to changing position of ergonomic multifunction arm. If drives are

not in proper position for rotating the arm turning the rotary switch to the “P” position will cause motor to reposition drives. If motor does not reposition drives when turned to the “P” position, the drives are already in position for arm to be rotated.

Motor drive covers

Two covers are provided to cover high-speed and mid-speed drive when they are not in use, see figure 2c.

Convenient cord storage

The MUM 4405 and MUM 4420 have convenient cord storage located on the back

of the power unit, where the cord may be wound around the holder, see 2d.

The MUM 4620 and the MUM 4635 have internal cord storage. To store the cord or reduce the length of the cord with these two units, simply pull on the cord and let the cord be retracted into the base of the machine, see figure 2.

Four rubber feet

Four rubber feet will provide the stability, while also serving to isolate the power unit from the hard surface to minimize noise and vibration.

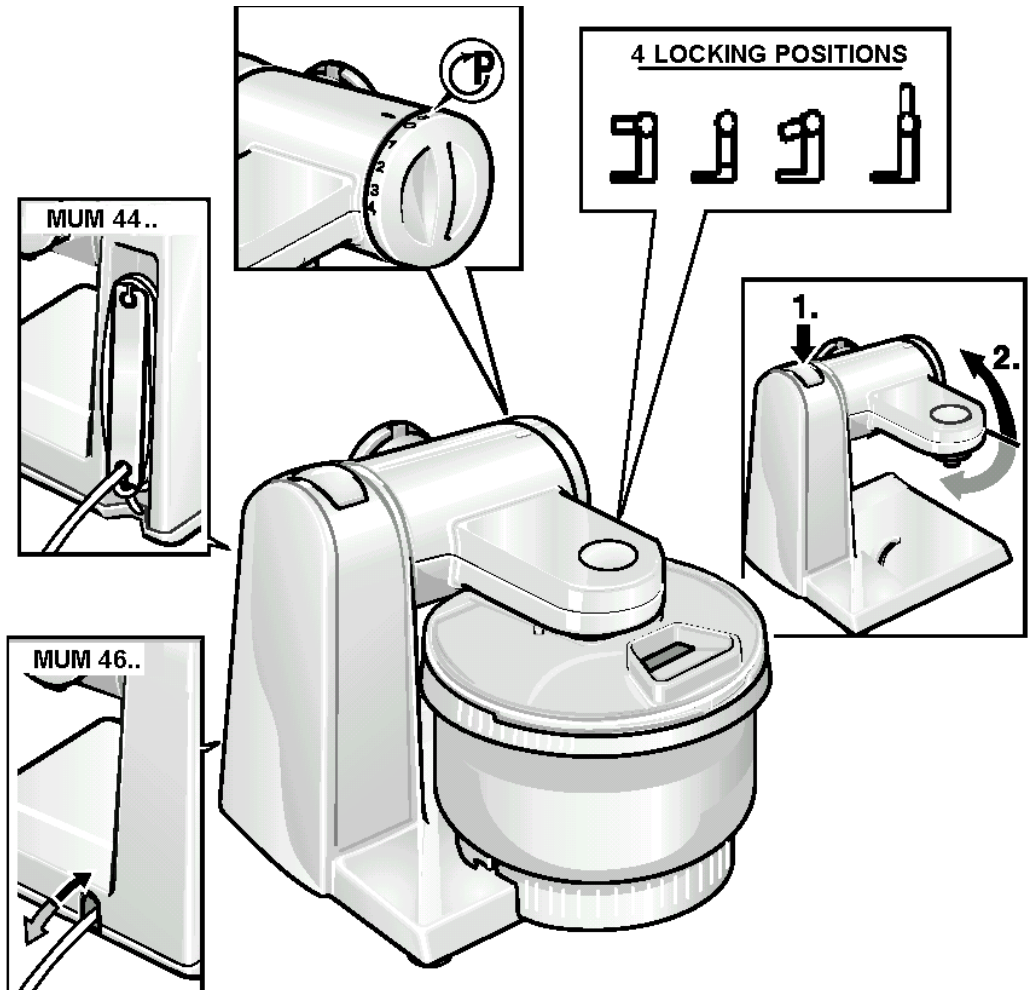

Figure 2.

Getting Started

The operation of your Bosch Compact Series Kitchen Machine is summarized below.

Specific instructions for using each of the attachments, provided with the kitchen machine systems covered by this manual, follow the summarized instructions. Please read the specific instructions thoroughly before using that attachment, paying particular attention to the **IMPORTANT SAFEGUARDS** and **WARNINGS** provided.

1. Place power unit on suitable work surface.

Before using the machine with any of the attachments, the power unit should be placed on a suitable work surface. The surface should be sturdy, smooth and clean; make sure that there is no flour or oil on the surface. A clean smooth surface will provide the best footing and will limit slipping and/or “walking.”

2. Plug power unit into power supply.

Pull the electrical cord or unwind the electrical cord to appropriate length. Make sure power unit is turned to Off “O/Off” and plug it into a convenient nearby receptacle. Turn rotary knob to park “P” position to make sure the drives are in proper position to rotate arm and/or install attachment. If motor does not reposition drives when turned to “P” position, the drives were already in position for arm to be rotated.

WARNING

- Do not twist or attempt to push in the electrical cord. If the cord becomes jammed, pull out the cord to its full length and then allow it to slowly retract.
- If the power should be interrupted, the power unit will remain on and will restart when power is restored.

3. Remove drive cover.

Remove drive cover from drive to be used, if necessary, see figure 2c.

4. Select attachment to be used.

Select attachment you wish to use. Reposition the ergonomic multifunction arm, if necessary (see figure 4a & 4b), and place attachment on power unit.

The Bosch Compact Series Kitchen Machine uses its attachments in 6 modes. The various modes used (the drive and position of the arm) are shown in table 1.













Mode	Drive & Arm Position	Attachment
1		
2		
3		
4		
5		
6		

Table 1.

See specific instructions for attachment selected. Specific instructions are located on pages listed below:

Attachment	Pages
Mixing bowl w/dough hooks	10–11
Mixing bowl w/whisks.....	11–13
Blender	13–15
Continuous shredder.....	16–18

Table 2.

5. Operate unit with rotary switch.

Once the attachment is in place, the speed of its moving components can be controlled through the use of the rotary switch at the side of the ergonomic multifunction arm. See figure 2a. The rotary switch has six positions:

- a. "P," a park position used to "park" the drive unit prior to changing the positions of the ergonomic multifunction arm.
- b. "O/Off," the off position.
- c. Four speeds labeled 1, 2, 3 and 4. Speed 1 is the lowest speed. The speed increases with each succeeding step up to the highest speed, speed 4.

All models of the Bosch Compact Series Kitchen Machines incorporate an electronic safety control to protect the motor. If the safety becomes activated, the motor will stop running. Turn the machine to off and allow to cool. See TROUBLESHOOTING at the back of this manual.

WARNING

Operate the appliance with the attachments in their operating positions, as shown in table 1, only. Do not operate at no load.

6. Turn power unit off.

When your work with the attachment is completed or the capacity of the batch feed attachment has been reached, turn the power unit to off position, "O/Off," turn the rotary knob to the "P," park position, to place the drives to their parked positions, and then unplug.

7. Remove the attachment.

Remove the attachment from the power unit, in some cases it will be

necessary to move the arm to allow removal of the attachment. Refer to the instructions for the specific attachment being used.

8. Continue use.

If the attachment was of the batch feed type and you wish to continue using the attachment, empty the bowl or jar of the attachment per its specific instructions and reinstall the attachment as before. Repeat the steps 5 through 7 as often as necessary to complete necessary work.

9. Work completed, remove attachment.

If the attachment is of the continuous feed type, or is the batch type, and you have completed the work you wished to perform with the attachment, remove the attachment from the power unit. In some cases it will be necessary to move the arm to allow removal of the attachment. Refer to the instructions for the specific attachment being used.

10. Place contents (batch feed type).

If the attachment is the batch feed type, disassemble per the specific attachment's instructions and place the contents in a suitable container.

11. Care and Cleaning.

Once you have completed working with the Bosch Kitchen Machine, the next step is to disassemble and clean the attachments. If you wish to use another attachment, please return to step 4, above.

Power unit

With the power unit turned off and unplugged, it should be cleaned only with a clean, damp cloth. Then wipe off the motor

drive cover and reinstall on the power unit. Never use coarse or caustic cleaning products to clean the power unit. Never immerse the power unit in water.

The power unit may be left on the counter or stored for future use. In either case, always be sure to replace the drive covers on the drive that was used, if it had been removed. This will prevent dust and/or flour buildup in the drive.

Wind the cord around the cord holder or pull on the cord to have it retract into the machine, and then place in your chosen storage area.

Attachments

The attachment(s) that has been used should be disassembled and washed, per their specific instructions, dried and stored for future use.

STANDARD ATTACHMENTS

Following are the specific instructions for the standard attachments provided with the Bosch Compact Series Kitchen Machines covered by this manual.

Mixing Bowl with Beating Whisk, Stirring Whisk and Dough Hook (MUZ 4 KR3)

WARNING

1. There is a risk of injury from rotating tools when using the mixing bowl with the beating whisk, stirring whisk or dough hook.
2. Avoid contact with moving parts. Keep hands, hair and clothing, as well as spatulas, bowl scrapers and other utensils away from dough hook and whisks during operation to prevent injury and/or damage to the power unit or accessories.
3. Always work with the bowl lid fitted in place.
4. Do not change tools until the power unit

has come to a complete stop; when switched Off, the power unit will continue to turn for a brief period.

All models of the Bosch Compact Series Kitchen Machines are provided with a four-quart mixing bowl with beating and stirring whisks and a dough hook. Additional mixing bowls are available as accessory items under the part numbers: **MUZ 4 KR3**, refer to SPECIAL ACCESSORIES section at the back of this manual. The mixing bowl with beating whisk, stirring whisk and dough hook consists of the following components, see figure 3:

How to Use Dough Hook

The dough hook and mixing bowl are intended to be used to knead yeast doughs and to mix heavy cookie and pastry doughs, and also when adding nuts, chocolate chips, dried fruit, hard butter or shortening, hardened brown sugar, etc. to batters.

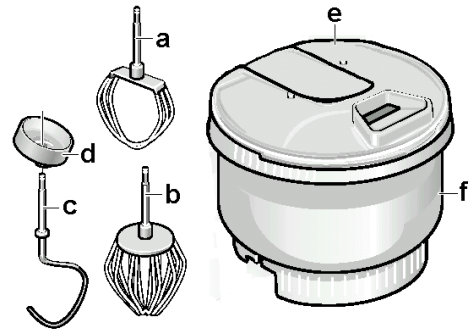

Figure 3.

- 3a. Stirring whisk
- 3b. Beating whisk
- 3c. Dough hook
- 3d. Dough deflector
- 3e. Anti-splash cover
- 3f. Mixing bowl

Use of mixing bowl with dough hook

Before beginning to attach this or any other attachment, make sure that the power unit is on a smooth, clean, suitable work surface and switched to off position “O/Off.”

1. Before using the mixing bowl and dough hook for the first time, it is recommended that the bowl, anti-splash cover and dough hook be washed. All components of the mixing bowl and the dough hook are dishwasher safe. Or they may be washed in warm soapy water. After washing, rinse well and dry before using.
2. The dough hook is used in mode 1, see table 1. To place the mixing bowl and insert the dough hook the arm must be moved as shown in figure 4:

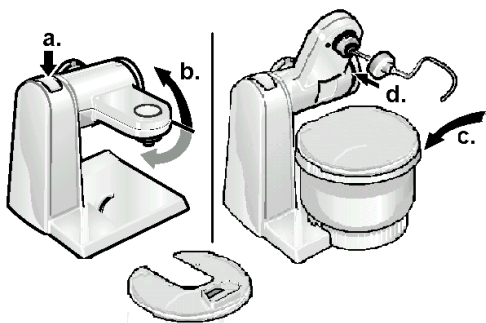

Figure 4.

- 4a.** Depress release button
- 4b.** Lift arm up
- 4c.** Place bowl
- 4d.** Insert dough hook w/deflector

3. Once the dough hook is in place, check to make sure it is fully inserted and then rotate the arm to the down position by pressing the release button and lowering the arm.

Note: If the drives had not been parked after last use it may be necessary to plug in the power cord and turn the rotary knob to the park position “P” to position the drive to allow the dough hook to be lowered into the bowl.

Place the anti-splash cover on the bowl. The cover has an integral filling funnel. The cover may be removed to add ingredients, but the cover should be in place whenever the power unit is in operation. The anti-splash cover serves to prevent the escape of flour dust at the beginning of the stirring and kneading process, and also serves to prevent accidental contact with the moving dough hook.

Placing into Operation w/Dough Hook

Make sure that the power unit is on a smooth, clean, suitable work surface and switched to off position, “O/Off.” Pull the electrical cord or unwind the electrical cord to the necessary length and plug into a convenient outlet. The mixing bowl with dough hook is now ready for operation. Sample recipes may be found in the recipe section, at the back of this manual.

How to Use Stirring and Beating Whisks

All Bosch Compact Series Kitchen Machines come with stirring and beating whisks, in addition to the dough hook, see figure 3.

The beating whisk is intended to be used for very light substances, such as cream, egg whites, sauces, batters and light pastry doughs that are thin enough to pour.

The stirring whisk is intended to be used for stirring items, such as cake mixes and light cookie doughs. Always be sure to use the dough hook for heavy cookie doughs; for example, oatmeal-chocolate chip cookie dough.

Use of mixing bowl with beating whisk or stirring whisk

Before beginning to attach this or any other attachment, make sure that the power unit is on a smooth, clean, suitable surface and switched to off position, "O/Off."

1. Before using the mixing bowl and beating whisk or stirring whisk for the first time, it is recommended that the bowl, anti-splash cover and whisk be washed. All components are dishwasher safe. Or they may be washed in warm soapy water. After washing, rinse well and dry before using.
2. Both the stirring whisk, or beating whisk is used in mode 1, see table 1 and figure 4. Follow the same step as shown in figure 4, but for 4d insert the whisk you wish to use rather than the dough hook and its deflector.
3. Once the whisk is in place, check to make sure it is fully inserted and then rotate the arm to the down position by pressing the release button and lowering the arm.

Note: If the drives had not been parked after last use, it may be necessary to plug in the power cord and turn the rotary knob to the park position "P" to position the drive to allow the whisk to be lowered into the bowl.

Place the anti-splash cover on the bowl. The cover has an integral filling funnel. The cover may be removed to add ingredients, but the cover should be in place whenever the power unit is in operation. The anti-splash cover serves to prevent the escape of flour dust at the beginning of the stirring process and also serves to prevent accidental contact with the moving whisk.

Placing into Operation w/Beating Whisk or Stirring Whisk

Make sure that the power unit is on a smooth, clean, suitable work surface and switched to the Off position, "O/Off." Pull the electrical cord or unwind the electrical cord to the necessary length and plug into the wall outlet. The bowl with whisk is now ready for operation. Sample recipes may be found in the recipe section, at the back of this manual.

Mixing bowl tips:

1. When using the mixing bowl to knead or mix a recipe designed to be prepared by hand, you will find that with the Bosch Kitchen Machine you can usually place all the ingredients in the mixing bowl at once. When doing this, always place the liquids in first. This will assure more thorough mixing.
2. When adding ingredients to a mixture:
 - a. Turn the rotary switch to a lower speed
 - b. Add the ingredients through the funnel

Removing Contents

Before beginning to remove the contents from the mixing bowl, make sure that the power unit has been turned to the park position "P," to position the drive, and then to the off position, "O/Off." Remove the anti-splash cover. Once the cover has been removed, the release button may be depressed and the ergonomic arm, lifted upward, see figures 4a and 4b. The dough hook or the whisk may be removed by pulling outward with a straight, steady motion.

The mixing bowl can be removed from the power unit by lifting.

The contents may now be used as desired.

Care and Cleaning of Bowl and Its Accessories

The mixing bowl, whisks, dough hook, dough deflector and anti-splash cover are dishwasher safe.

To facilitate cleaning:

The power unit of the kitchen machine should be cleaned using a clean, damp cloth only. Never use coarse or caustic cleaning products to clean this appliance. Never immerse the power unit in water.

Blender with Unbreakable Plastic Jar (MUZ 4 MX2)

WARNING

1. There is a risk of injury from sharp blades when using the blender attachment.
2. Keep hands and utensils out of the blender jar while it is attached to the power unit.
3. Blades are sharp. Handle carefully.
4. To avoid injury, never place blade assembly on power unit without blender jar properly attached.
5. Always operate the blender with the cover in place. Always hold the cover in place when in operation to prevent the cover from being knocked off.
6. The use of attachments, including canning jars, not recommended by the manufacturer, may cause a risk of personal injury.
7. When blending hot and/or frothing liquids, process a maximum of 18 fluid ounces (0.5 litres) at a time.

The MUM 4635 UC, MUM 4620 UC and the MUM 4420 UC Bosch Compact Series Kitchen Machines include the MUZ 4 MX2 blender accessory. The blender accessory consists of, figure 5:

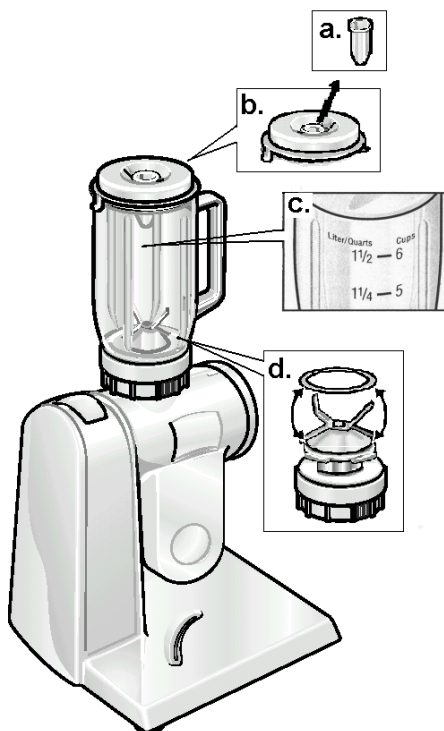

Figure 5.

- 5a. Cover closure/funnel
- 5b. Cover
- 5c. Blender jar
- 5d. Blade/base assembly with gasket and locking ring.

1. Before using the blender for the first time, it is recommended that the blender jar cover, closure/funnel and blade/base assembly, gasket and locking ring be washed. All components, except the blade/base assembly, are dishwasher safe. Remove the blade/base assembly from the blender:

First remove the locking ring, as shown in figure 6a and 6b. Then turn the blender over so that the base is facing upward, as shown in figure 7, and remove the blade assembly by turning

the blade assembly counterclockwise until it stops and then lift up see figures 7c and 7e.

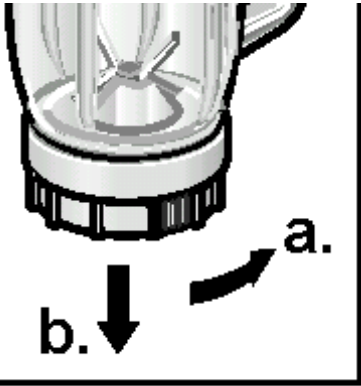

Figure 6.



CAUTION

Blade/base assembly is very sharp.
Handle with care.

Wash the blade/base assembly under running water. Do not place the blade/base assembly in the dishwasher or allow it to stand in water. This will tend to wash out the lubricant. After cleaning, rinse thoroughly and dry before using.

2. To assemble or reassemble blade/base assembly into the blender, reverse the steps that were used in the above to remove it.
3. The blender is used in mode 3, see table 1. To place the blender on the power unit the arm must be rotated to the down position. Depress the release button, see 4a, and lower the arm so that the arm is vertical and the high-speed drive is straight up. If you have not already done so, remove the motor drive cover from the high-speed drive and place the blender on the high-speed drive and turn counterclockwise to lock the blender in place.

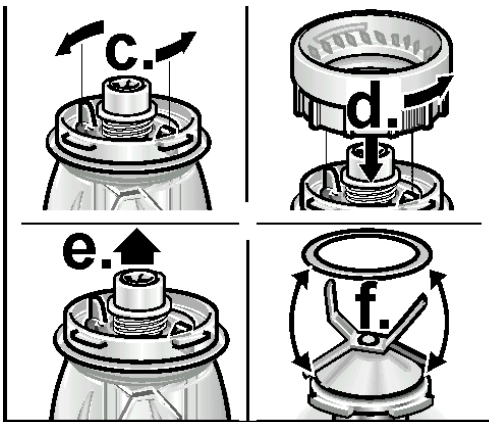

Figure 7.

If the blade assembly is too tight to turn by hand, the locking ring may be used to loosen the blade assembly, as shown in figure 7d. After loosening, turn the blade assembly counterclockwise until it stops and then lift up. The gasket may be removed for cleaning, as shown in figure 7f.

Placing Blender into Operation

Make sure that the power unit's rotary switch is in the off position, "O/Off." Pull the electrical cord or unwind it to the necessary length and then plug into the wall outlet. The blender is now ready for operation.

Normally when blending, the blender jar should be filled with the entire amount of material to be blended, if possible, before switching the appliance to On. The cover and cover closure should always be in place after filling the blender jar and before switching the power unit to On. Any subsequent additions to the blended material should be made through the cover opening, see figure 8. For solids and/or granular material, remove the cover closure/funnel to add the material, as shown in figure 8a. For liquids, the closure/funnel may be left in place and the liquids can be added by pouring them into the closure/funnel, see figure 8b.

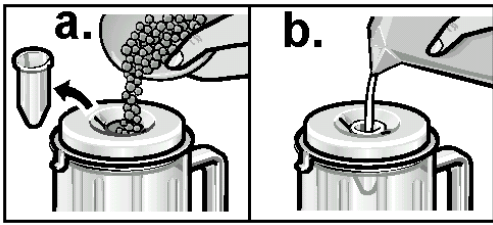

Figure 8.

Example of Use of Blender

To familiarize you with the operation of the blender, a sample recipe for mayonnaise is provided below:

Mayonnaise Recipe

- 1 whole egg
- 1/3 cup of vegetable oil
- 2 tablespoons lemon juice or light vinegar
- 1 teaspoon sugar
- 1/2 teaspoon dry mustard
- 1/2 teaspoon of salt
- 2/3 cup of vegetable oil

Mix all ingredients, except final 2/3's cup of oil, for a few seconds at speed 1, then quickly pour the oil in through the opening in the cover in a uniformly thick stream, as shown in figure 8b. Operate the blender at speeds 1 or 4 until mixture is thick and smooth (approximately 10–20 seconds). Makes 1 1/4 cups.

Tips:

The blender should be operated with careful consideration as to what is required and/or desired. The speed at which the blender is operated and the length of operation for a given job will depend upon the degree of fineness desired or the amount being blended.

When the blender is being used on dry materials, such as nuts or bread, the best results will be obtained when the blender jar is filled with approximately 1/2 cup of material to be blended. If the blender does not start (even after trying the highest speed), the blade has become blocked by the contents. The power unit should be:

1. Switched to off, "O/Off," and unplugged.
2. The mixture should be removed and the contents at the bottom of the jar loosened.

Removing Contents

Before beginning to remove the contents from the blender, make sure that the power unit has been turned to off position "O/Off." Remove the blender from the power unit by turning the blender clockwise while lifting. With the blender removed from the power unit, the contents of the blender may now be poured into a suitable container or bowl, as desired. Replace the cover on the high-speed drive.

Care and Cleaning of Blender

All components of the blender, except the blade/base assembly, are dishwasher safe. It is recommended that the blade/base assembly be cleaned only under flowing water rather than in the dishwasher. Soap and detergent will tend to wash out the bearing lubricant of the blade/base assembly. Do not use scouring cleaners on any of the blender parts.

The power unit of the kitchen machine should be cleaned with a clean, damp cloth only. Never use coarse or caustic cleaning products to clean this appliance. Never immerse the power unit in water.

Continuous Shredder (MUZ 4 DS2)

WARNING

1. Blades on discs are sharp. Handle carefully. Do not grip the discs by the blades.
2. When operating continuous shredder, keep hands clear of filling and discharge tubes. Only work with pusher.
3. The continuous shredder must be completely assembled before placing on the power unit.
4. Always operate the continuous shredder fully assembled and with cover in place.

The MUM 4635 UC and the MUM 4420 UC Bosch Compact Series Kitchen Machines include the MUZ 4 DS2 continuous shredder attachment. The continuous shredder attachment consists of, figure 9:

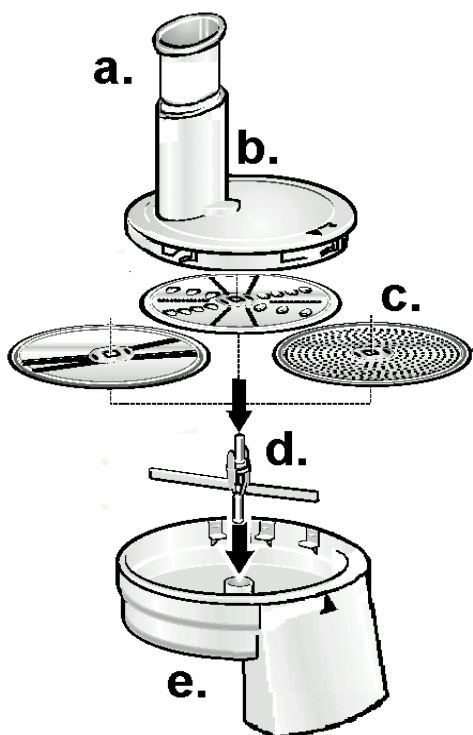

Figure 9.

- a. Cover closure/pusher
- b. Cover
- c. 3 slicer/shredder discs:
 - reversible slicing disc
 - reversible shredding disc
 - grating disc
- d. disc holder/slinger
- e. Housing

Continuous shredder, intended use

The continuous shredder attachment has been designed for slicing, shredding and/or grating of vegetables, as well slicing/shredding of soft cheeses and sausages or meat and grating of vegetables and hard cheese.

Use of Slicer/Shredder

Before beginning to use this or any other attachment, make sure that the power unit is on a smooth, clean, suitable work surface and switched to Off position, "O/Off," and that you have removed the motor drive cover.

1. Before using the continuous shredder for the first time, it is recommended that the cover closure/pusher, cover, discs, disc holder/slinger and housing be washed. All components of the continuous shredder are dishwasher safe. After washing, rinse well and dry before using.

WARNING

The blades on the discs are very sharp. Handle with care.

2. The continuous shredder is used in mode 2, see table 1. To place the continuous shredded on the power unit, the arm must be rotated to the horizontal position. Depress the release button, see 4a, and move the arm as necessary so that the arm is horizontal. If you have not already done so, remove the motor drive cover from the mid-speed drive, as shown in figure 10.

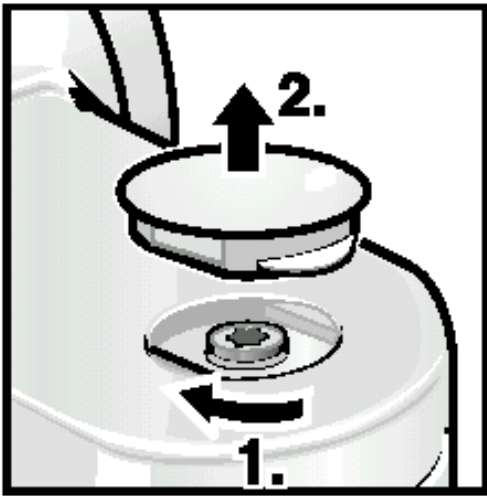

Figure 10.

Assemble the continuous shredder in the order as shown in figure 9:

1. Insert the disc holder/slinger into the housing.
2. Select disc to be used and, making sure that the side desired is facing upward, place it on disc holder.
3. Place cover on housing and turn counterclockwise until cover snaps into place and arrows are aligned, see figure 11.
4. The continuous shredder is now assembled.
5. Place bowl on the power unit. Depress the release button and raise arm so that the bowl can be placed in position, and then lower the arm to horizontal position.
6. Place continuous shredder on the mid-speed drive of the power unit, with the arm in the horizontal position and turn counterclockwise until it locks into position.

Placing Slicer/Shredder into Operation

Make sure the power unit is on a smooth, clean, suitable work surface and switched to the Off position, "O/Off." Pull the electrical cord or unwind the electrical cord to the necessary length and plug into a convenient outlet. The continuous shredder is now ready for use.

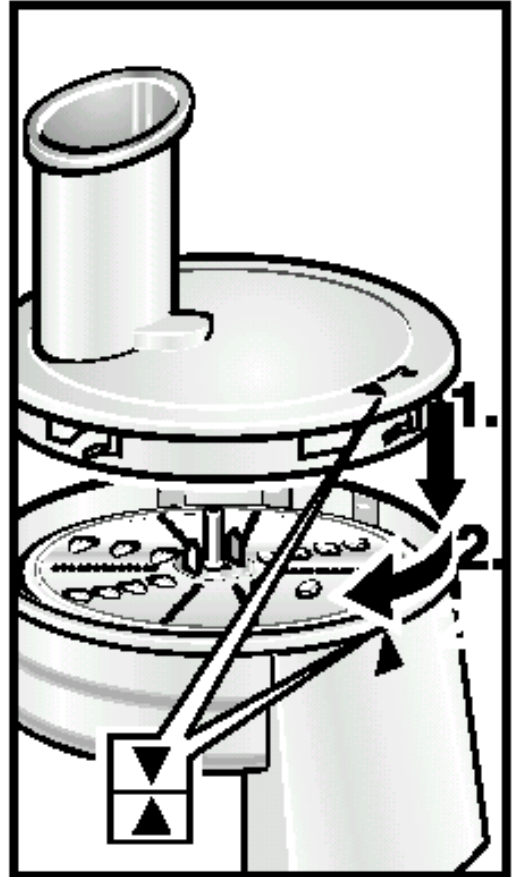

Figure 11.

Place items to be sliced, shredded or grated in feeding funnel and be sure to use the pusher to feed items into the discs when in operation.

Learning how to feed food properly into the feed funnel is the most important factor for proper slicing and grating:

1. For long slices or long shreds, place food into the feeding funnel lengthwise.
2. For short or circular slices, place food in the feeding tube on end. For example, If you wish to have circular slices of zucchini or carrots:
 - cut to length not to extend above the top of the feeding tube.
 - place the cut zucchini or carrots in the feeding tube on end until the feeding tube is packed.
4. Do not overcook potatoes that are to be sliced. Also it is recommended that you let them cool first. Potatoes must be cool and firm to obtain the regular slices.

If the slicer/shredder does not start (even after trying the highest speed) the disc has become blocked by the contents. The power unit should be:

1. Switched to Off position, “O/Off,” and unplugged.
2. The continuous shredder should be removed from the power unit, the cover removed and the items causing the blockage removed.

To slice a single narrow item, a carrot for example:

- place the carrot in the feeding funnel opposite the cutting edge of the disc.

The wall of the feeding funnel will then serve to hold the piece vertical.

When using the continuous shredder, be sure to watch the level in the bowl and stop the slicing, shredding or grating before the level of the material being sliced, shredded or grated blocks the discharge tube.

Slicing and shredding tips:

1. Shopping for fruits and vegetables that will fit into the feeding funnel will simplify food preparation.
2. Foods that are to be used together may be sliced together. This can be used to your advantage. For example, green onions and celery are often used together, but feeding the green onions into the feeding funnel alone is difficult. Try slicing the green onions at the same time as the celery by interspersing them in the feeding funnel with the celery.
3. Use the slicing disc to shred lettuce.

Removing Contents

Before beginning to remove the contents from the bowl, make sure that the power unit has been turned to the Off position, “O/Off.” The continuous shredder may be removed from the power unit by turning the shredder clockwise while lifting. With the continuous shredder removed from the power unit, depress the release button and move the arm upward until the bowl can be removed. The contents of the bowl may now be poured into a suitable container or bowl, as desired.

Care and Cleaning of Continuous Shredder

All components of the continuous shredder are dishwasher safe. Do not use scouring cleaners on any of the continuous shredder parts.

The power unit of the kitchen machine should be cleaned with a clean, damp cloth only. Never use coarse or caustic cleaning products to clean this appliance. Never immerse the power unit in water.

Service and Repair

The Bosch Compact Series Kitchen Machines require no special care other than the care and cleaning noted in this manual. If you are having a problem with your machine, before calling our Customer Support group, please refer to the TROUBLESHOOTING section below. If, after reviewing the troubleshooting section and trying its remedies, you are still having a problem, please contact Bosch.

TROUBLESHOOTING

Problem	Possible Cause and Remedy
No power	A circuit breaker may have tripped or a fuse has blown in power supply circuit. Reset circuit breaker or replace fuse.
There is power to unit, but nothing happens when rotary switch is turned	The power unit has been overloaded; for example, the blender blade may have become blocked. <ol style="list-style-type: none"><li data-bbox="732 536 1070 596">1. Turn the power unit to Off and unplug.<li data-bbox="732 635 1070 756">2. Remove contents of attachment being used and loosen whatever has caused the jam.<li data-bbox="732 794 1070 852">3. Reinstall attachment and restart.

Sample Recipes

Salsa

Chop the following ingredients in Bosch blender or food processor, on speed 3 or 4:

- 1-4 **Dried Arbol chilies**
(start with one, add more for increased spiciness)
- 1 **clove garlic**
- 1/8 **cup water**
- 8 **ounces tomato sauce (add half)**

Next add:

- 1 1/2 **teaspoons oregano**
- 3/4 **teaspoons cumin**
- 1 **bunch of fresh cilantro**
- pinch of salt**
- second half of tomato sauce**

Blend all ingredients, on speed 1 or 2, until smooth.

Pesto

- 1 **cup loosely packed basil leaves**
- 1/2 **cup grated Parmesan**
- 1/3-1/2 **cup olive oil (enough for desired consistency)**
- 1-2 **cloves garlic**
- 1/4 **cup shelled pinenuts**

Lightly toast pinenuts. Let cool. Place olive oil in Bosch blender or food processor. Turn on power and gradually add Parmesan cheese, garlic and basil leaves. Process, on speed 1 or 2, until smooth. Add pinenuts and blend thoroughly.

Toss with cooked pasta or spread on bread or crackers.

Fruit Smoothies

- 2 **cups fruit juice**
- 2 **cups frozen fruit**
- 1/2 **can frozen juice concentrate**
- 1 **cup fruit-flavored yogurt**
- 1-2 **cups of ice**
- 1 **fresh banana**

Place all ingredients in Bosch blender and mix until smooth, on speed 3 or 4. Experiment with different flavor combinations such as tropical, berry or melon.

French Bread

- 4 **tablespoons active dry yeast**
- 4 **cups hot water**
- 6 **tablespoons sugar**
- 2 **tablespoons salt**
- 1 **cup vegetable oil**
- 10-12 **cups of flour (white or wheat)**
- 4 **tablespoons gluten**

Place all ingredients in Bosch mixing bowl. **Thoroughly knead** on speed 1 or 2 (8–10 minutes). Let rise in the bowl 10 minutes, then punch down. Punch down 4 or 5 times. Divide into 3–4 regular loaf pans or shape into rounds. Slash tops with sharp knife and brush with egg wash. Let raise until doubled in size. Bake 30 minutes at 400° F.

Oatmeal-Chocolate Chip Cookies

2 cups packed brown sugar
1 cup shortening
2 eggs
1 teaspoon vanilla
1 3/4 cups flour
1 teaspoon baking soda
1/2 teaspoon salt
3 cups quick-cooking rolled oats
1 cup chocolate chips

Cream the brown sugar, shortening, eggs and vanilla in the mixing bowl, on speed 1 or 2. Add flour, baking soda and salt. Blend well, stir in rolled oats and chocolate chips by hand. Drop by spoonfuls onto greased baking sheets. Bake in a 350° F oven for 8–10 minutes. Cool before removing from pan. Makes 5 dozen.

Acknowledgements:

The sample recipes listed above were submitted by:

Salsa - Caroline Ciarelli, BSH Home Appliances

Pesto - Kitchen Resource

Fruit Smoothies - Marni Rader, BSH Appliances

French Bread - Kitchen Resource

Oatmeal-Chocolate Chip Cookies - Kitchen Resource

SPECIAL ACCESSORIES



MUZ 4 MX 2
plastic blender



MUZ 4 MM 3
food processor



MUZ 4 DS 2
continuous shredder



MUZ 4 ZP 1
citrus juicer



MUZ 4 GM 3
grain mill w/steel grinder

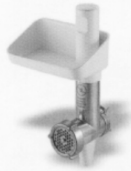

MUZ 4 FW 1
meat grinder



MUZ 4 SV 1
fancy cookie attachment
(requires meat grinder)



MUZ 4 FV 1
fruit pulper
(requires meat grinder)

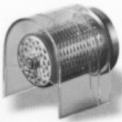

MUZ 4 RV 1
grater attachment
(requires meat grinder)



MUZ 4 EB 1
ice cream maker

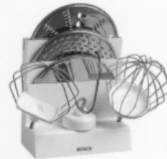

MUZ 4 ZT 1
accessory holder



MUA 4 KR 3
plastic bowl



MUZ 4 PS 1
French fry disc for continuous shredder



MUZ 4 RS 1
Grater disc, coarse, for continuous shredder



MUZ 4 JS 1
Julienne disc for continuous shredder



MUZ 4 LS 1
3mm & 6mm meat grinding discs

BOSCH Small Appliance Warranty

BSH Home Appliances (“BOSCH”) warrants all new small appliances to be free from original defects in design, materials and workmanship for one (1) year after the sale to the original owner.

Within the stated warranty period, BOSCH will repair or replace, at its sole option, any small appliance or parts thereof which prove defective under the conditions of normal use and service at no charge to you. It is the owner’s responsibility to return the appliance for repair. Repaired and replacement small appliances and parts shall be the same or as close in appearance as possible to the original for the purposes of this warranty.

Should you require service of your BOSCH small appliance, please contact customer service at 1-866-44-BOSCH. Repair of BOSCH appliances should only be performed by qualified technicians.

This warranty is limited to the original consumer purchase and is not transferable. Specifically excluded from this warranty are failures caused by accident, misuse, neglect, abuse, including tampering, use of frequency or voltage other than marked on the product, and use for commercial purposes.

To the extent allowed by law, this warranty sets out your exclusive remedies, whether for negligence or otherwise. BOSCH will not be liable for any consequential or incidental damages, losses or expenses. THIS WARRANTY IS IN LIEU OF ALL OTHER EXPRESSED WARRANTIES. ANY WARRANTY IMPLIED BY LAW, WHETHER FOR MERCHANTABILITY OR FITNESS FOR A PARTICULAR PURPOSE OR OTHERWISE, SHALL BE EFFECTIVE ONLY FOR THE PERIOD THAT THIS EXPRESSED WARRANTY IS EFFECTIVE. BOSCH DOES NOT ASSUME ANY RESPONSIBILITY FOR INCIDENTAL OR CONSEQUENTIAL DAMAGES.

No attempt to alter, modify or amend this warranty shall be effective unless authorized in writing by an officer of BOSCH. Some states do not allow limitations on how long implied warranties last or the exclusion or limitation of incidental or consequential damages, so the foregoing limitations and exclusions may not apply to you. This warranty gives you specific legal rights and you may also have other rights which vary from state to state.

Looking for more information or specials on BOSCH products?

Call Toll Free 1-866-852-4268 or Visit our Web site:

www.everythingkitchens.com