

***Ulmus* leaves and fruits from the Early–Middle Eocene of northwestern North America: systematics and implications for character evolution within Ulmaceae**

Thomas Denk and Richard M. Dillhoff

Abstract: Leaves and fruits of *Ulmus* from the Early–Middle Eocene of British Columbia and Washington are assigned to two species. *Ulmus okanaganensis* sp.nov. is based on leaves attached to flowering and fruiting twigs and isolated leaves and fruits. Leaves display a polymorphism ranging from large leaves with compound teeth with a blunt apex to small ones with simple teeth resembling those of *Zelkova*. In extant *Ulmus*, sucker-shoot leaves, elongation-shoot leaves, and leaves on short annual branches often display a very similar polymorphism. In the fossil, flowers are arranged in fascicles having short pedicels. Fascicles are formed in the axils of leaves of current-year shoots and appear together with the leaves. This is uncommon in modern species of *Ulmus*, where leaves appear either in spring on previous-year shoots or in autumn in the axils of leaves of current-year shoots. Fruits of *U. okanaganensis* are samaras with extremely reduced or absent wings. Unwinged fruits of modern *Ulmus* are typically ciliate along the margin of the endocarp and the persistent styles but only a single fruit of *U. okanaganensis* has been found preserving hairs. The small, shallowly lobed perianth is situated below the endocarp. A second type of foliage is assigned to *Ulmus chuchuanus* (Berry) LaMotte. This foliage is wider than that of *U. okanaganensis* and has more densely spaced secondary veins. It also has characteristic compound teeth with primary and subsidiary teeth displaying conspicuously different orientations. Leaves of *U. chuchuanus* co-occur with a second type of fruit but have not been found in attachment. These fruits are larger than in *U. okanaganensis*, with a narrow wing, persistent styles, and a large and wide persistent perianth that tapers abruptly into the perianth tube. A cladistic analysis suggests that *U. okanaganensis* is nested within the subgenus *Ulmus*, which is a paraphyletic grade basal to the subgenus *Oreoptelea*. *Ulmus chuchuanus* foliage shows affinities to the subgenus *Ulmus*, while the associated fruits display affinities to the subgenus *Oreoptelea*.

Key words: Eocene, *Ulmus*, subgenus *Oreoptelea*, subgenus *Ulmus*, character evolution, phylogeny.

Résumé : On attribue, à deux espèces, des feuilles et fruits d'*Ulmus* datant de la première moitié de l'Éocène, trouvés Colombie-Britannique et dans l'état de Washington. L'*Ulmus okanaganensis* sp.nov. est basé sur des feuilles attachées à des rameaux florifères et fructifères, et des feuilles et des fruits isolés. Les feuilles montrent un polymorphisme allant de grandes feuilles avec des dents composées et un apex obtus, jusqu'à de petites feuilles avec des dents simples, ressemblant à celle du *Zelkova*. Chez les *Ulmus* actuels, les feuilles des rejets de tiges, les feuilles des tiges en élévation, et les feuilles portées sur les branches courtes de l'année montrent souvent un polymorphisme similaire. Chez ce fossile, les fleurs sont disposées en fascicules portés sur de courts pédicelles. Les fascicules se forment aux aisselles des feuilles des tiges de l'année en cours et en même temps que les feuilles. Ceci est peu commun chez les espèces modernes d'*Ulmus*, où les feuilles apparaissent soit au printemps sur des tiges de l'année précédente, ou à l'automne aux aisselles des feuilles des tiges de l'année en cours. Les fruits de l'*U. okanaganensis* sont des samares munies d'ailes absentes ou rudimentaires. Les fruits dépourvus d'ailes des *Ulmus* modernes sont typiquement ciliés le long de la marge de l'endocarpe et des styles persistants, mais on a trouvé un seul fruit de l'*U. okanaganensis* dont les poils étaient conservés. Le petit périanthe peu profond et lobé est situé sous l'endocarpe. On attribue un deuxième type de feuillage à l'*Ulmus chuchuanus* (Berry) LaMotte. Ce feuillage est plus grand que celui de l'*U. okanaganensis* et porte des veines secondaires plus densément espacées. Il possède également des dents composées, avec des dents primaires et subsidiaires, montrant des orientations nettement différentes. On observe les feuilles de l'*U. chuchuanus* concurremment à un second type de fruit, mais aucun attachement n'a pu être observé. Ces fruits sont plus gros que ceux de l'*U. okanaganensis* avec une aile étroite, des styles persistants et un grand périanthe persistant, qui se réduit abruptement pour former le tube du périanthe. L'analyse cladistique suggère que l'*U. okanaganensis* appartient au sous genre *Ulmus* à un degré paraphylétique à la base du sous-genre *Oreoptelea*. Le feuillage de l'*U. chuchuanus* montre des affinités avec le sous-genre *Ulmus*, alors que les fruits associés montrent des affinités avec le sous-genre *Oreoptelea*.

Received 24 May 2005. Published on the NRC Research Press Web site at <http://canjbot.nrc.ca> on 22 February 2006.

T. Denk.¹ Swedish Museum of Natural History, Department of Paleobotany, Box 50007, 104 05 Stockholm, Sweden.

R.M. Dillhoff. Evolving Earth Foundation, P.O. Box 2090, Issaquah, WA 98027, USA.

¹Corresponding author (e-mail: thomas.denk@nrm.se).

Mots clés : Éocène, *Ulmus*, sous-genre *Oreoptelea*, sous-genre *Ulmus*, évolution des traits, phylogénie.

[Traduit par la Rédaction]

Introduction

Ulmus (Ulmaceae s.str.) is a genus of tree (rarely shrub) species with a northern hemispheric distribution including North America and large parts of Eurasia. Because species concepts vary, the number of modern species (25–45) is quite controversial, especially for taxa from Eastern Europe, Central Asia, and the Far East (Grudzinskaya 1979; Todzia 1993; Wiegrefe et al. 1994). The family Ulmaceae has recently been re-circumscribed based on morphological (Grudzinskaya 1967, 1979) and molecular studies (Wiegrefe et al. 1998). The former subfamily Celtidoideae is now considered its own family Celtidaceae, which is more closely related to Moraceae and other members of Urticales than to Ulmaceae (the former subfamily Ulmoideae). Furthermore, there is strong evidence for Celtidaceae to be paraphyletic, forming a clade with Cannabaceae (Wiegrefe et al. 1998; Song et al. 2001; Sytsma et al. 2002).

The currently used sectional classification of *Ulmus* is based mainly on morphological studies by Grudzinskaya (1979) and a combined morphological–molecular study by Wiegrefe et al. (1994). While the traditional sectional classification by Schneider (1916) was based primarily on the position of the seed within the samara, Grudzinskaya's and Wiegrefe et al.'s systems are based on sets of vegetative, floral, fruit, and chemical characters. Wiegrefe et al. (1994) showed that the position of the seed in the samara is a homoplastic character state that may have evolved several times in unrelated species. In addition, both morphological (Grudzinskaya 1974) and molecular (Wiegrefe et al. 1994) studies showed that *Chaetoptelea* should be included within *Ulmus*. An overview of Schneider's (1916) and more recent subsectional classifications is provided in Wiegrefe et al. (1994; cf. Table 1).

The fossil record of *Ulmus* extends back to the late Early Eocene of western North America, based on leaves co-occurring with fruits (MacGinitie 1941; Burnham 1986; Manchester 1989b), while leaf remains attributed to *Ulmus* or showing closest affinities to the genus have been reported from Paleocene to Eocene sediments from North America, Russia, Spitsbergen, China, and Japan (Schloemer-Jäger 1958; Tanai 1972; Ablaev and Iljinskaja 1982; Kvaček et al. 1994; Liu et al. 1996; McIver and Basinger 1999). Leaves and fruits from various Late Paleocene to Eocene localities from western North America have also previously been considered to belong to the genus *Chaetoptelea* Liebm. (MacGinitie 1941; Burnham 1986; Manchester 1989b; Wehr 1995). Reported Paleocene fruits of *Ulmus* from the Rocky Mountains were rejected after reexamination (Manchester 1989b).

Ulmus from the Early to Middle Eocene of the Okanagan Highlands localities was reported by early investigators from the Geological Survey of Canada (Dawson 1890; Penhallow 1908). Penhallow recognized two species of *Ulmus* based on leaf compressions from localities that are included in the Okanagan Highlands. One of the leaf types recognized in the present study as *Ulmus okanaganensis* was later trans-

ferred to *Zelkova* based on material from Republic, Washington, USA (Brown 1936). A study based on leaf characters of modern Ulmaceae concluded that *Ulmus*, *Zelkova* and *Chaetoptelea* were all present in these deposits (Burnham 1986). A description of the Republic flora (Wolfe and Wehr 1987) recognized two representatives of Ulmaceae, *Ulmus* and aff. *Zelkova*. Basically, it is difficult to assign dispersed leaves with certainty to a particular genus of Ulmaceae (cf. Manchester 1989a and works cited above).

Here we describe well-preserved fossils of leaves attached to flowering and fruiting branches, and isolated fruits and leaves belonging to *Ulmus* from the Early to Middle Eocene of Washington and British Columbia. The recent discovery of articulated branches with attached leaves and fruits provides the opportunity for “whole plant” reconstruction of *Ulmus okanaganensis* sp.nov. and detailed phylogenetic placement of this species within extant *Ulmus*. Character polarization within *Ulmus* and patterns of early diversification of Ulmaceae are discussed.

Material and methods

The material described here originates from volcanically derived sediments from the Early to Middle Eocene localities Republic (Washington) and McAbee, One Mile Creek / Princeton, and Driftwood Creek / Smithers (British Columbia). A series of lacustrine shale deposits (Fig. 1) from this period provides a detailed regional record of the flora and insect and fish fauna. The deposits at Republic have been documented by Wolfe and Wehr (1987, 1991) and Wehr (1995), those at Princeton by Basinger (1976, 1981), Stockey (1984), and Stockey and Wehr (1996), and those at McAbee by Dillhoff et al. (2005). The material comprises twigs with attached leaves, inflorescences, and infructescences, as well as dispersed leaves and fruits. The fossils are preserved in shale as cleavage impressions/compressions, without cuticle. Owing to the fine-grained sediments, however, many details of leaf architecture, including higher order venation, are preserved. During the Early and Middle Eocene a series of faults created northwest-trending grabens and half grabens in the southern Canadian cordillera (Ewing 1980, 1981; Mathews 1991). At the same time a volcanic arc contributed vast amounts of sediments that infilled these basins. The volcanic sediments provided an abundant source of silica, resulting in the formation of diatomaceous sediments at some of these localities (Mustoe 2005).

Radiometric dating for the localities used in this study ranges from late Early Eocene to early Middle Eocene. K–Ar radiometric dates for Republic (Pearson and Obradovich 1977) averaged 48.1 ± 2.0 (SE) and 49.4 ± 1.6 Ma for two of three samples. The earlier date would indicate an early Middle Eocene age for Republic, while the latter would be at the latest Early Eocene. K–Ar dating (Hills and Baadsgaard 1967) of 48 ± 2 Ma places Princeton in the early Middle Eocene, but more recent U–Pb dating of 52 ± 0.1 Ma

Table 1. Subgeneric and sectional classification of *Ulmus* proposed by Wiegrefe et al. (1994).

Subgenus and section	Distribution
Subgenus <i>Ulmus</i>	
Section <i>Microptelea</i> (Spach) Bent. & Hook.	East Asia
Section <i>Ulmus</i>	East Asia, Europe, North America
Subgenus <i>Oreoptelea</i> (Spach) Planchon	
Section <i>Blepharocarpus</i> Dumort.	Europe, North America
Section <i>Chaetoptelea</i> (Liebm.) C. Schneider	East Asia, North America
Section <i>Trichoptelea</i> C. Schneider	North America
Subgeneric position unclear	
Section <i>Lanceifolia</i> (C. Schneider) Grudzinskaya	East Asia

(J.K. Mortenson and S.B. Archibald, personal communication, 2004) places Princeton in the Early Eocene. At McAbee, tephra samples taken from within bentonitic tuff deposits bracketed by the fossiliferous layers yielded K–Ar dates of 49 ± 2 and 52 ± 2 Ma from plagioclase and 51 ± 2 Ma from biotite (Ewing 1981), all consistent with an Early Eocene age. A U–Pb dating of 52 ± 0.1 Ma (J.K. Mortenson and S.B. Archibald, personal communication, 2004) places Driftwood Creek in the Early Eocene.

The specimens studied are deposited at the Burke Museum, Seattle, Washington (UWBM), and the Stonerose Museum, Republic, Washington (SR). For comparison, most of the extant species of *Ulmus* have been studied from herbarium material (herbarium S, WTU) and from the literature (Komarov 1936; Todzia 1993; Zheng 1997). Based on this, the morphological data matrix from Wiegrefe et al. (1994) was updated and modified (Tables 2, 3) so that the phylogenetic position of one fossil taxon with flowers and fruits attached to leafy branches could be established within a sectional framework of *Ulmus* (sensu Wiegrefe et al. 1994). Sixteen morphological characters (39 character states) were coded as binary or multistate and the multistate characters were treated as unordered. The resultant data matrix is shown in Table 3. The cladistic analysis was performed using PAUP version 3.1.1. (Swofford 1993). A branch-and-bound search was performed with PAUP default settings. Bootstrap support was established based on 100 replications. Character changes were traced using McClade (version 3.0; Maddison and Maddison 1992) and mapped on one of the two most parsimonious trees recovered (Fig. 10) with the resolving option accelerated transformation optimization (ACCTRAN).

Systematic paleobotany

Ulmaceae

Ulmus L.

1. *Ulmus okanaganensis* sp.nov.

Zelkova oregoniana, Brown 1936, pl. 51, Fig. 12; *Chaetoptelea* seeds, Burnham 1986, pl. 5, Figs. 25–28; *Ulmus*, Manchester 1989b, Fig. 12.3 A–C; *Chaetoptelea* fruits, Wehr 1995, pl. 2, Fig. 1

Holotype

Specimen No. UWBM 97766 (McAbee), Figs. 5G, 5H

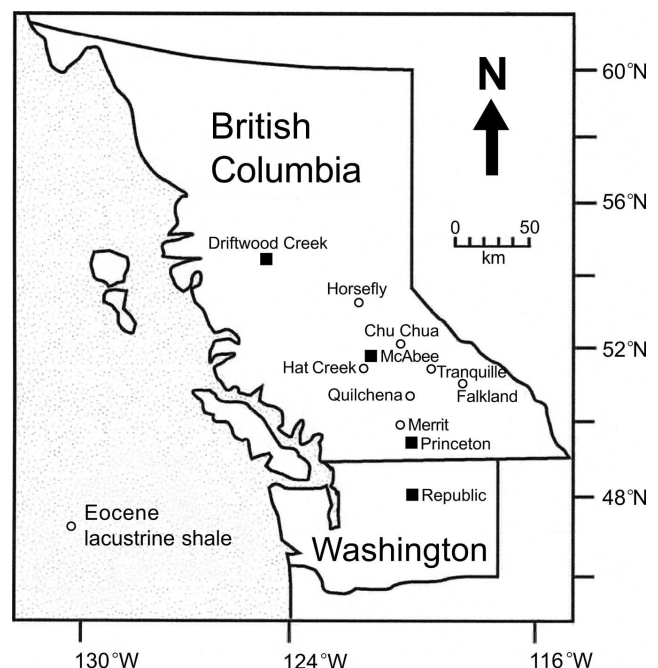
Fig. 1. Early to Middle Eocene plant-bearing localities in British Columbia and Washington, including those studied in this investigation (■).

Paratypes

Specimen Nos. UWBM 97673, UWBM 97765, UWBM 97773, UWBM 97774, UWBM 97775, UWBM 97776, UWBM 97777, UWBM 97778, UWBM 97779, UWBM 97782, UWBM 97783, UWBM 97784, UWBM 97785 (McAbee); UWBM 77360A, UWBM 52179, UWBM 54165, UWBM 97781, UWBM 97787, UWBM 97788 (One Mile Creek); UWBM 97780, SR 98-10-35 (Republic).

Etymology

The name refers to the Okanagan Highlands, which extend from northern Washington, USA, into central British Columbia, Canada (Fig. 1). This species is common throughout the Eocene deposits of the Okanagan area.

Diagnosis

Leaf blade oblong–elliptic to (narrow) ovate, petiolate, base cordate, asymmetric or equal, sometimes auriculate,

Table 2. Morphological characters (from Wiegrefe et al. 1994) used for the phylogenetic analysis.

Section (sensu Wiegrefe et al. 1994)	1. Fruit type	2. Leaf margin	3. Leaf base	4. Pedicel length	5. Fruit margin	6. Pedicel articulation	7. Perigynous tube shape
<i>Blepharocarpus</i>	Samara (flattened with peripheral wings or hairs)	Compound serrate	Strongly oblique	Long	Ciliate	Visible	Wide, shallow
<i>Chaetoptelea</i>	Samara (flattened with peripheral wings or hairs)	Compound serrate	Nearly equal to equal	Long	Ciliate	Visible	Wide, shallow
<i>Trichoptelea</i>	Samara (flattened with peripheral wings or hairs)	Compound serrate and simple serrate	Equal to strongly oblique	Short to long	Ciliate	Visible	Wide, shallow
<i>Microptelea</i>	Samara (flattened with peripheral wings or hairs)	Compound serrate and simple serrate	Nearly equal	Short	Eciliate	Visible	Wide, shallow
<i>Ulmus</i>	Samara (flattened with peripheral wings or hairs)	Compound serrate and simple serrate	Equal to strongly oblique	Short to sessile	Ciliate or eciliate	Invisible	Narrow, deep
<i>Ulmus okanaganensis</i>	Samara (flattened with peripheral wings or hairs)	Compound serrate and simple serrate	Nearly equal to equal	Short	Ciliate	?	Wide, shallow
<i>Ulmus chuchuanus</i> + <i>Ulmus</i> sp.	Samara (flattened with peripheral wings or hairs)	Compound serrate	Nearly equal	Short	?	?	Wide, shallow
<i>Zelkova</i>	Nutlet (drupe)	Simple serrate	Equal	Short to sessile	Eciliate	Visible	Wide, shallow

apex acute, margin simple to double serrate, teeth triangular, tooth apex blunt to acute, basal and apical side convex, sigmoid, or straight, rarely concave, primary vein straight, thick, secondary veins simple or branched, abmedial branches of secondary veins 1–3, secondaries and abmedial veins inserting teeth, tertiary veins perpendicular to secondary veins, percurrent or branching; fertile twigs distichous displaying a zigzag course, leaves alternate, nodes swollen, flower fascicles with numerous flowers in axils of leaves of the current year, occurring together with the leaves, fruits with pedicels, no pedicel articulation visible, endocarps small, without wings, elliptic–obovate, with two persistent styles, perianth lobed, small.

Description

Leaves

Leaf type 1, interpreted as “sucker-shoot” leaves (Figs. 2A, 2B, 2E–2G)

Leaves simple, petiolate, petiole short and thick, 6–13 mm long and 2–3 mm wide at the proximal end, lamina elliptic–oblong, up to 130 mm long and 55 mm wide, length/width ratio (1.65 to) 2 to 2.4 (to 2.65), base asymmetric, slightly auriculate with one lobe conspicuously longer than the other, apex (acute); primary vein straight, its thick-

ness gradually decreasing from petiole to leaf apex; secondary veins 12–14 pairs, 6–10 secondaries per 5 cm of primary vein, angle of secondary veins with primary vein abruptly increasing towards base; abmedial branches of secondary veins three close to leaf base, one or two in upper parts of leaf, secondary veins and their abmedial branches ending in tooth tips, i.e., venation craspedodromous; from two adjacent secondary or abmedial veins two tertiary veins originating, which meet in the acute sinus of a tooth (Fig. 2B); tertiary veins perpendicular to secondary veins, (three to) four (to five) per 1 cm of secondary vein, simple or branching, sinuous close to primary vein; leaf margin serrate, sinus between teeth wide, teeth compound, a small tooth followed by a larger one (Fig. 2B), basal and apical sides of teeth typically convex (but sometimes straight, sigmoid, or concave), tooth apex with a blunt tip.

Leaf type 2, interpreted as elongation-shoot, vegetative-shoot leaves (Fig. 3)

Leaves simple, petiolate, petiole short, 1 to 5 (to 7) mm, and 1.5 mm thick proximally, lamina oblong to (narrow) ovate, up to 80 mm long and 35 mm wide, length/width ratio (1.55 to) 1.7 to 2 (to 2.25), base slightly asymmetric, cordate to wide obtuse, sometimes auriculate, apex acute; primary vein straight to slightly curved, its thickness gradually decreasing from petiole to leaf apex; secondary veins

8. Samara venation	9. Inflorescence type	10. Mature samara surface	11. Samara wing	12. Time of flowering	13. Leaf texture and size	14. Perianth lobe length	15. Seed position in samara	16. Position of inflorescence	Occurrence
Reticulate	Long fascicle	Glabrous or few trichomes	Wide	Spring	Large	<0.5 perianth length	Medial	On previous year shoots	America, Europe
Reticulate	Elongate raceme	Densely pubescent, entire surface	Absent	Spring	Large	<0.5 perianth length	Medial	On previous year shoots	America
Reticulate	Long fascicle or elongate raceme	Densely pubescent, entire surface	Absent, narrow or wide	Spring or autumn	Small, coriaceous or large	>0.5 or <0.5 perianth length	Medial	Axils of leaves of the year or previous year shoots	America
Reticulate	Short fascicle	Glabrous or few trichomes	Narrow to wide	Autumn	Small, coriaceous	>0.5 perianth length	Medial	Axils of leaves of the year	Asia
Radial	Short or very short fascicle	Densely pubescent over entire surface or restricted to seed cavity, or nearly glabrous	Wide	Spring	Large	<0.5 perianth length	Medial or distal	On previous year shoots	Asia, America, Europe
?	Short fascicle	?	Absent	Spring	Large	<0.5 perianth length	Medial	Axils of leaves of the year	America
Reticulate	?	?	Narrow	?	Large	<0.5 perianth length	Medial	?	America
?	Short or very short fascicle	?	Absent	Early summer	Large	<0.5 perianth length		Axils of leaves of the year	Europe, Asia

numerous, 11–14 pairs, 12–18 secondaries per 5 cm of primary vein, angle of secondary veins with primary vein abruptly decreasing towards base; number of abmedial branches per secondary vein three close to leaf base, and one or two in upper parts of leaf, secondary veins and their abmedial branches ending in tooth tips, i.e., craspedodromous; from two adjacent secondary or abmedial veins two tertiary veins originating, which meet in the acute sinus of a tooth; tertiary veins either perpendicular to secondary veins and straight, or sinuous and then often branching, 8–11 tertiary veins along 1 cm of secondary vein, smaller leaves having more densely spaced tertiary veins than larger ones; leaf margin serrate, teeth compound, a small tooth followed by a larger one, or teeth simple, basal and apical sides of teeth typically sigmoid, tooth apex with a sharp tip.

Leaf type 3, attached to fertile shoots; short shoot leaves (Fig. 4)

Leaves simple, petiolate, petiole short, 1–2 mm long, <1 mm thick, lamina narrow ovate–lanceolate (to ovate), 30–80 mm long and 10–20 mm wide, length/width ratio (1.8 to) 2.3 to 2.7 (to 2.9), base slightly asymmetric or equal, apex acute; primary vein straight to slightly curved, its thickness gradually decreasing from petiole to leaf apex; secondary veins numerous, 8–14 pairs, 16–25 secondaries per 5 cm of primary vein, angle of secondary veins with pri-

mary vein abruptly decreasing towards base; number of abmedial branches per secondary vein three close to leaf base, and one or zero in upper parts of leaf, secondary veins and their abmedial branches ending in tooth tips, that is, craspedodromous; from two adjacent secondary or abmedial veins two tertiary veins originating, which meet in the acute sinus of a tooth; tertiary veins perpendicular to primary veins, straight or branching, 8–10 tertiary veins along 1 cm of secondary vein; leaf margin serrate, teeth simple, basal side of teeth normally convex, apical side sigmoid or concave, tooth apex with a sharp tip.

Reproductive structures

Flower fascicles appearing in the axils of leaves on current-season branches, occurring together with the leaves (Figs. 5A, 5B); fruits arranged in fascicles (Figs. 5G, 5H), each fruit having a pedicel 3–3.5 mm long (Figs. 5C, 5D); fruits are samaras without wings or with wings hardly discernible, endocarp 2.5 to 3.75 mm long and 1.5 to 2 mm wide, roundish to elliptic in outline, with persistent styles, styles up to 2 mm long; fruits shortly stipitate, stipe around 1 mm long; perianth around 1 mm long, narrow, inconspicuously lobed, situated immediately below endocarp, gradually tapering into pedicel (Figs. 5E, 5F), pedicel articulation, i.e., thickened connection between pedicel and stipe, not visible. Manchester (1989b) figured one fruit from One Mile Creek with endocarp and

Table 3. Data matrix used for the phylogenetic analysis.

Section (sensu Wiegrefe et al. 1994)	1	2	3	4	5	6	7	8	9	10	11	12	13	14	15	16
<i>Blepharocarpus</i>	1	1	2	2	1	0	0	2	1	0	2	0	0	0	0	1
<i>Chaetoptelea</i>	1	1	0&1	2	1	0	0	2	3	2	0	0	0	0	0	1
<i>Trichoptelea</i>	1	0&1	0-2	1&2	1	0	0	2	1&3	2	0-2	0&2	0&1	0&1	0	0&1
<i>Microptelea</i>	1	0&1	1	1	0	0	0	2	0	0	1	2	1	1	0	0
<i>Ulmus</i>	1	0&1	0-2	0&1	0&1	1	1	1	0&2	0-2	2	0	0	0	0&1	1
<i>Ulmus okanaganensis</i>	1	0&1	0&1	1	1	?	0	?	0	?	0	0	0	0	0	0
<i>Zelkova</i>	0	0	0	0&1	0	0	0	?	0&2	?	0	1	0	0	0	0

styles surrounded by peripheral hairs. These hairs were not observed in other specimens used in this study.

Occurrence

McAbee, One Mile Creek / Princeton, Driftwood Creek / Smithers, Horsefly, and Quilchena, British Columbia; Republic, Washington.

Remarks

In modern species of *Ulmus* inflorescences are formed either in spring on "old wood" (previous-year shoots, i.e., most species of the subgenus *Ulmus*, sections *Blepharocarpus* and *Chaetoptelea* in the subgenus *Oreoptelea*) or on "new wood" (in the axils of leaves of current-year shoots, i.e., section *Microptelea*, subgenus *Ulmus*, and section *Trichoptelea*, subgenus *Oreoptelea*; section *Lanceifolia*, subgeneric position unclear; cf. Grudzinskaya 1979; Wiegrefe et al. 1994). In both cases the following types of branches can be distinguished. (i) Short (lateral) current-year branches with typically relatively small elliptic leaves in the proximal parts followed by slightly larger ones towards the apical end. (ii) Elongation shoots often producing small leaves with relatively longer petioles in the proximal parts followed by increasingly larger leaves towards the apical part. Elongation shoots tend to have considerably larger leaves in shaded areas of the tree. (iii) Sucker shoots typically having very large leaves with much coarser dentition and more widely and irregularly spaced secondary veins.

Leaves found in *U. okanaganensis* are rather atypical of *Ulmus* because of their shallow teeth on sucker-shoot leaves and often simple (rather than double) dentition in short lateral fruiting shoots and some elongation-shoot leaves. Among modern species, simple dentate leaves are found in various species across the whole genus (e.g., *Ulmus parvifolia* Jacq., section *Microptelea*, *Ulmus crassifolia* Nutt., section *Trichoptelea*), but these are normally small-leaved species that often exhibit conspicuously coriaceous leaves. A remarkable exception is the Asian species *Ulmus pumila* L. of section *Ulmus*. In this species, sucker-shoot leaves and large leaves of elongation shoots attain large sizes and display coarse compound dentition, the tooth apices being blunt. The same is true for smaller leaves of elongation shoots, but here the teeth are more acute. Leaves in proximal parts of elongation shoots are much smaller than the following ones and typically have long petioles along with an almost simple dentition. Leaves of lateral current-season branches are small and often simple dentate. Overall, such a leaf dimorphism closely matches that one found in *U. okanaganensis* and justifies the inclusion of different fossil leaf morphotypes within a single species.

The fruits of *U. okanaganensis* superficially resemble those of section *Chaetoptelea* (absence of wings, free styles). However, they differ from the fruits of section *Chaetoptelea* by their short pedicel and the absence of a clearly visible pedicel articulation, and the organization of infructescences in short fascicles as opposed to the conspicuously elongate complex racemes in section *Chaetoptelea*. The fruits of section *Chaetoptelea* are conspicuously ciliate, while only a single fossil fruit has been found with cilia. This may be a taphonomic bias due to the fragility of the cilia, which may easily be lost during transport and sedi-

Fig. 2. *Ulmus okanaganensis* sp.nov., sucker shoot and elongation shoot leaves. (A–D, G) McAbee, British Columbia. (A) Large oblong leaf with widely and irregularly spaced secondaries, UWBM 97774. (B) Close-up of Fig. 2A showing bluntly acute teeth and tertiary veins ending in sinus. (C) Medium-sized elliptical leaf, UWBM 97775. (D) Close-up of Fig. 2C showing leaf margin. (G) Oblong elliptic leaf with auriculate base, UWBM 97773. (E, F) Princeton, One Mile Creek, British Columbia. (E) Very large leaf, similar to Fig. 2A, UWBM 77360A. (F) Oblong elliptic leaf with nearly symmetric base, UWBM 97788. Scale bar = 5 cm in Figs. 2A, 2C, and 2E–2G; and 1 cm in Figs. 2B and 2D.

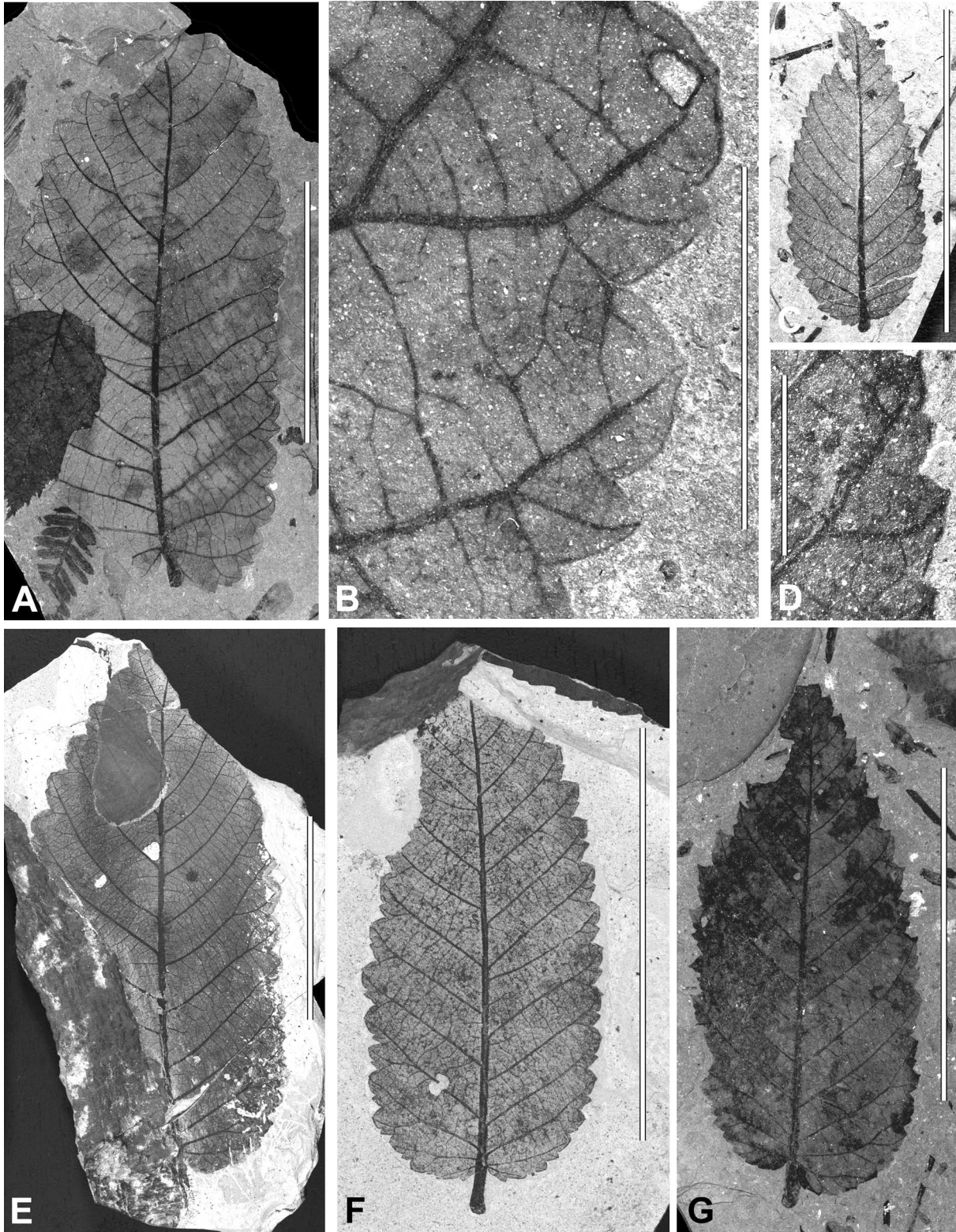

Fig. 3. *Ulmus okanaganensis* sp.nov., elongation shoot leaves and sun leaves. (A–F, I) McAbee, British Columbia. (A) Small leaf with compound serration at leaf base and simple serration higher up, UWBM 97776. (B) Close-up of Fig. 3A showing simple dentition. (C) Small leaf with long petiole and simple dentition, UWBM 97777. (D) Close-up of leaf base of Fig. 3C. (E) Small leaf with simple and compound teeth, UWBM 97779. (F) Close-up of Fig. 3E showing primary teeth and minute secondary teeth. (I) Medium-sized leaf with cordate base, UWBM 97778. (G) Republic, Washington, small leaf, UWBM 97780. (H, J, K) Princeton, One Mile Creek, British Columbia. (H) Small leaf, UWBM 54165. (J) Medium-sized broad leaf, UWBM 97781. (K) Medium-sized leaf, UWBM 52179. Scale bar = 1 cm in Figs. 3A, 3C, and 3E–3I; 5 cm in Figs. 3J and 3K; and 0.5 cm in Figs. 3B and 3D.

mentation. Flowers appear together with the young leaves in *U. okanaganensis*, while flowers appear on previous-year shoots, separately from leafy current-season shoots, in *Chaetoptelea*. In general, the fruits and infructescences in *U. okanaganensis* comprise a mosaic of features found in either the subgenus *Oreoptelea* or *Ulmus* (cf. Tables 1, 2).

Affinities to other fossil species

The type of foliage with attached fruits described here was first mentioned and figured as *Ulmus* sp. in Manchester (1989b) from Middle Eocene sediments of One Mile Creek, Princeton (British Columbia). The twigs with attached fruits and leaves from McAbee are identical with the one figured by Manchester (1989b).

From Lower Eocene sediments from the Californian Sierra Nevada, MacGinitie (1941) described leaves and fruits as *Chaetoptelea pseudofulva* (Lesq.) MacGinitie. These leaves resemble medium-sized to large leaves of *U. okanaganensis* because of their simple dentition and tooth shape but co-occur with fruits that have a distinct narrow wing along the endocarp and styles (MacGinitie 1941; Manchester 1989b). Similar leaves from the Middle Eocene of West Branch Creek, Oregon, were figured in Burnham (1986) as *Chaetoptelea* Morphotype A.

Larger leaves of *U. okanaganensis* are similar to leaves from the Palaeocene from the Russian Far East that have been described as *Ulmus furcinervis* (Borsuk) Ablaev (Ablaev and Iljinskaja 1982; Feng et al. 2003). Ablaev and Iljinskaja (1982) compared *U. furcinervis* to the modern species *U. parvifolia*. No fruits were found for this species.

Similar leaves have been described from Paleocene–Eocene sediments from Svalbard as *Planera ulmifolia* (Schloemer-Jäger 1958; syn. *Ulmites ulmifolius* (Schloemer-Jäger) Kvaček, Manum et Boulter; Kvaček et al. 1994; syn. *Ulmus ulmifolia* (Schloemer-Jäger); Budantsev 1983). Hollick (1936) erroneously assigned the same leaf type from the Palaeocene–Eocene of Alaska to the Central European Miocene species *Ulmus longifolia* Unger. McIver and Basinger (1999) report and figure identical leaves from the Late Paleocene of Ellesmere Island and the Early Eocene of Ellesmere Island and Axel Heiberg Island.

All these leaves show similarities to the large leaves (leaf type 1: inferred sucker shoots) of *U. okanaganensis*. They differ in that the teeth are slightly more acute and the secondary teeth are often nearly the same size as the primary teeth. In addition, most of these occurrences show leaf surfaces with small protrusions that have been variously interpreted as conical trichomes (Boulter and Kvaček 1994), a crimped texture with veins deeply embedded in the lamina (Feng et al. 2003), or large crystals in the lamina (Steven Manchester, personal communication, 2005). Such protrusions are not ap-

parent in the material examined for the present study. Without fruit remains, possible relations between these older leaf types and *U. okanaganensis* cannot be established.

2. *Ulmus chuchuanus* (Berry) LaMotte

Ulmus columbianus Berry (non Penhallow), 1926, pl. XV, Fig. 7; *Ulmus* leaf morphotype A, Burnham 1986, pl. 2, Figs. 11, ?12; *Chaetoptelea* leaf morphotype A, Burnham 1986, pl. 3, Fig. 18; *Chaetoptelea* leaf morphotype B, Burnham 1986, pl. 3, Figs. 19, 20; *Ulmus*, Wolfe and Wehr 1991, pl. 1, Fig. 5.

Material

UWBM 54889, UWBM77352A, UWBM 77343, UWBM 57168, UWBM 97786, UWBM 71110, UWBM 96081, UWBM 77383, UWBM 56793A, UWBM 56793B (Republic).

Description

Leaves (Figs. 6–8)

Leaves simple, petiolate, petiole 3–6 mm long, 1–1.5 mm in diameter, width decreasing towards apex of leaf; lamina broad ovate or ovate-elliptic, 50 to 90 (to 190) mm long and 30 to 50 (to 110) mm wide, length/width ratio 1.6–2.3, base asymmetric cordate, apex acute; primary vein straight, secondary veins simple or branched, 10 to 16 (to 22) pairs, 5–13 pairs of secondaries along 5 cm of primary vein in medium-sized to large leaves, 14–22 in small leaves; angle of secondary veins with primary vein abruptly increasing towards base, number of abmedial branches per secondary vein two to four close to leaf base, one or two in upper parts of lamina, secondary veins and their abmedial branches ending in tooth tips, i.e., craspedodromous, from two adjacent secondary or abmedial veins two tertiary veins originating, which meet in the acute sinus of a tooth, tertiary veins perpendicular to secondary veins, 6–13 along 1 cm of secondary vein, simple or branching, sinuous close to primary vein, leaf margin serrate, teeth compound, primary teeth with sharp apex, basal side often convex, apical side concave to sigmoid, secondary vein curving upwards when entering tooth, sinus acute, <90°, tooth oriented towards leaf apex, first secondary tooth on basal side of primary tooth with convex to sigmoid basal and apical sides, tooth oriented ± perpendicular to primary vein, second (and third) secondary tooth similar to first but smaller, oriented towards leaf base, i.e., forming an angle >90° with primary vein (Figs. 6B, 6E, 7B, 8B).

Occurrence

Joseph Creek / Chu Chua, Driftwood Creek / Smithers, Quilchena, Falklands (British Columbia); Republic (Washington).

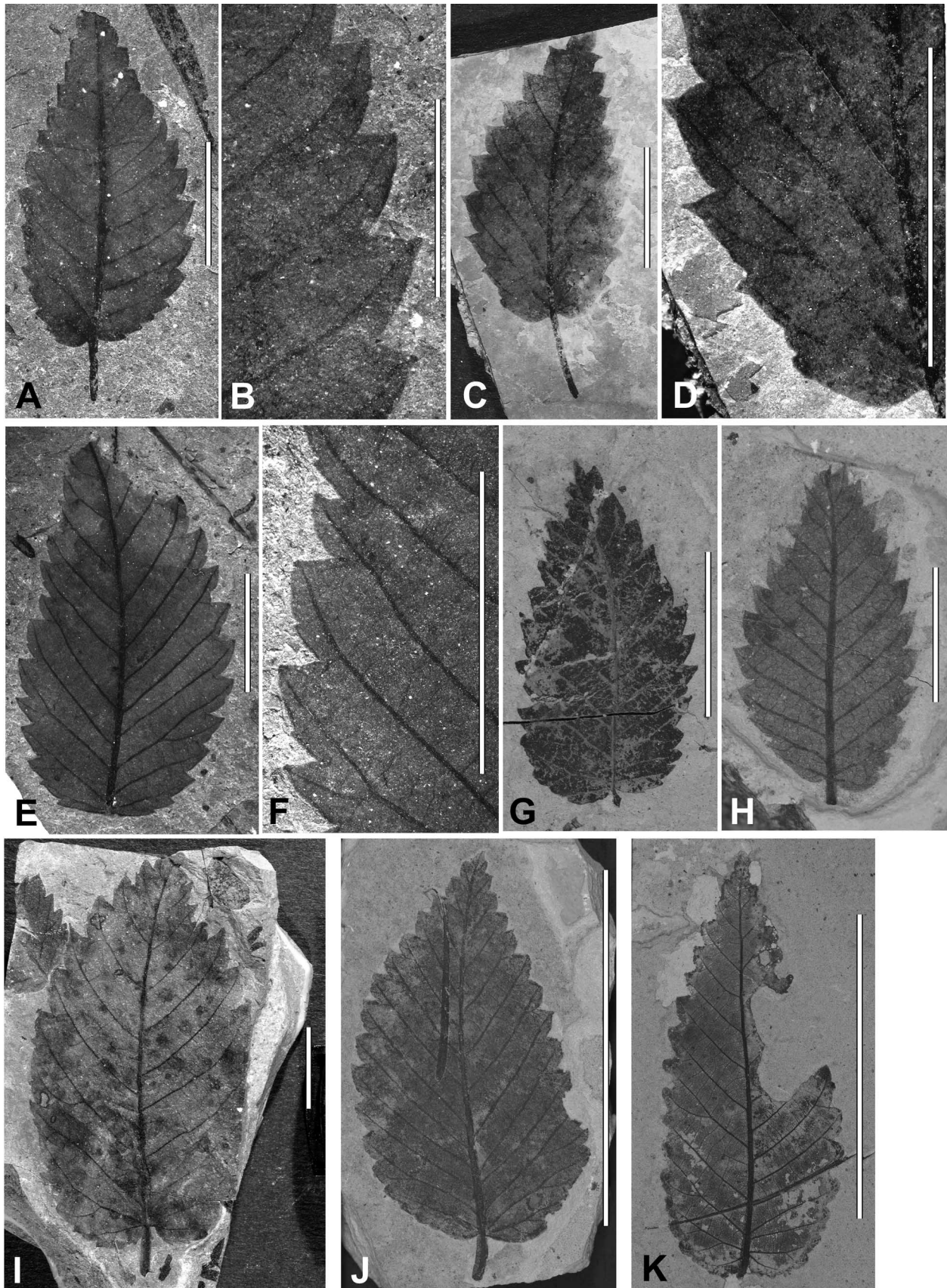

Fig. 4. *Ulmus okanaganensis* sp.nov., sun leaves. (A–F, H) McAbee, British Columbia. (A) UWBM 97782. (B–D) Close-ups of Figs. 4A and 4E showing leaf margin and auriculate base. (E) Small leaf with densely spaced secondary veins, UWBM 97783. (F) Leaf attached to fruiting twig, UWBM 97765. (H) UWBM 97784. (G) One Mile Creek, British Columbia, UWBM 97787. Scale bar = 1 cm in Figs. 4A, 4E, and 4F–4H; and 0.5 cm in Figs. 4B–4D.

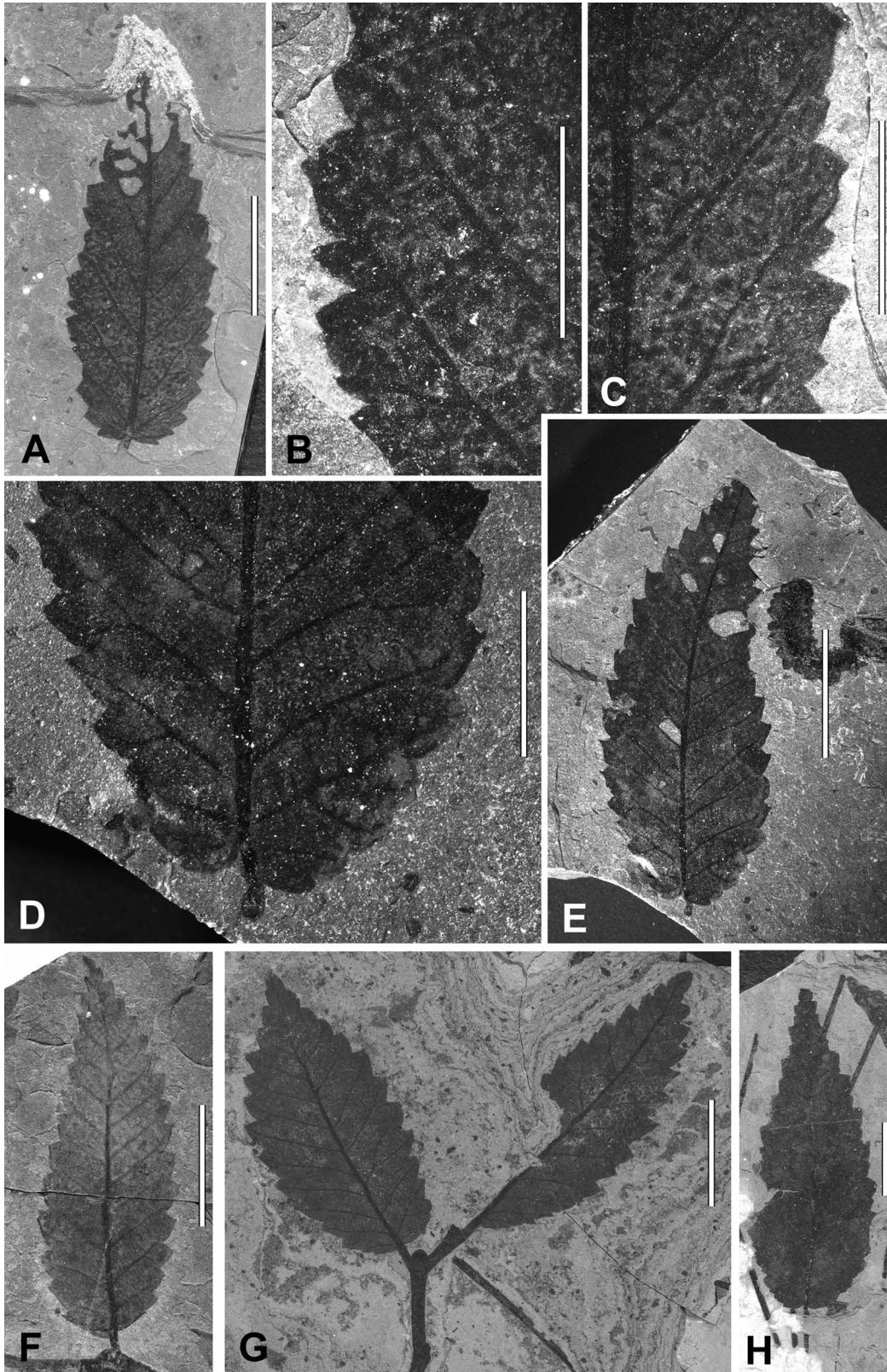

Fig. 5. *Ulmus okanaganensis* sp.nov., flowering and fruiting twigs. (A–D, G, H) McAbee, British Columbia. (A) Twig with lateral branches with young leaves and flower clusters, UWBM 97785. (B) Close-up of Fig. 5A showing flowers in axils of leaves. (C) Leafy branch with a few attached fruits, UWBM 97673. (D) Close-up of Fig. 5C showing two wingless fruits and several fruit scars in axil of leaf. (G) Close-up of Fig. 5H showing numerous fruits per node. (H) Leafy branch with attached fruits, UWBM 97766, holotype. (E–F) Republic, Washington. (E) Isolated fruit with perianth, SR 98-10-35. (F) Close-up of Fig. 5E showing lobed perianth. Scale bar = 1 cm in Figs. 5A–5D, 5G, and 5H; 0.5 cm in Fig. 5E; and 0.2 cm in Fig. 5F.

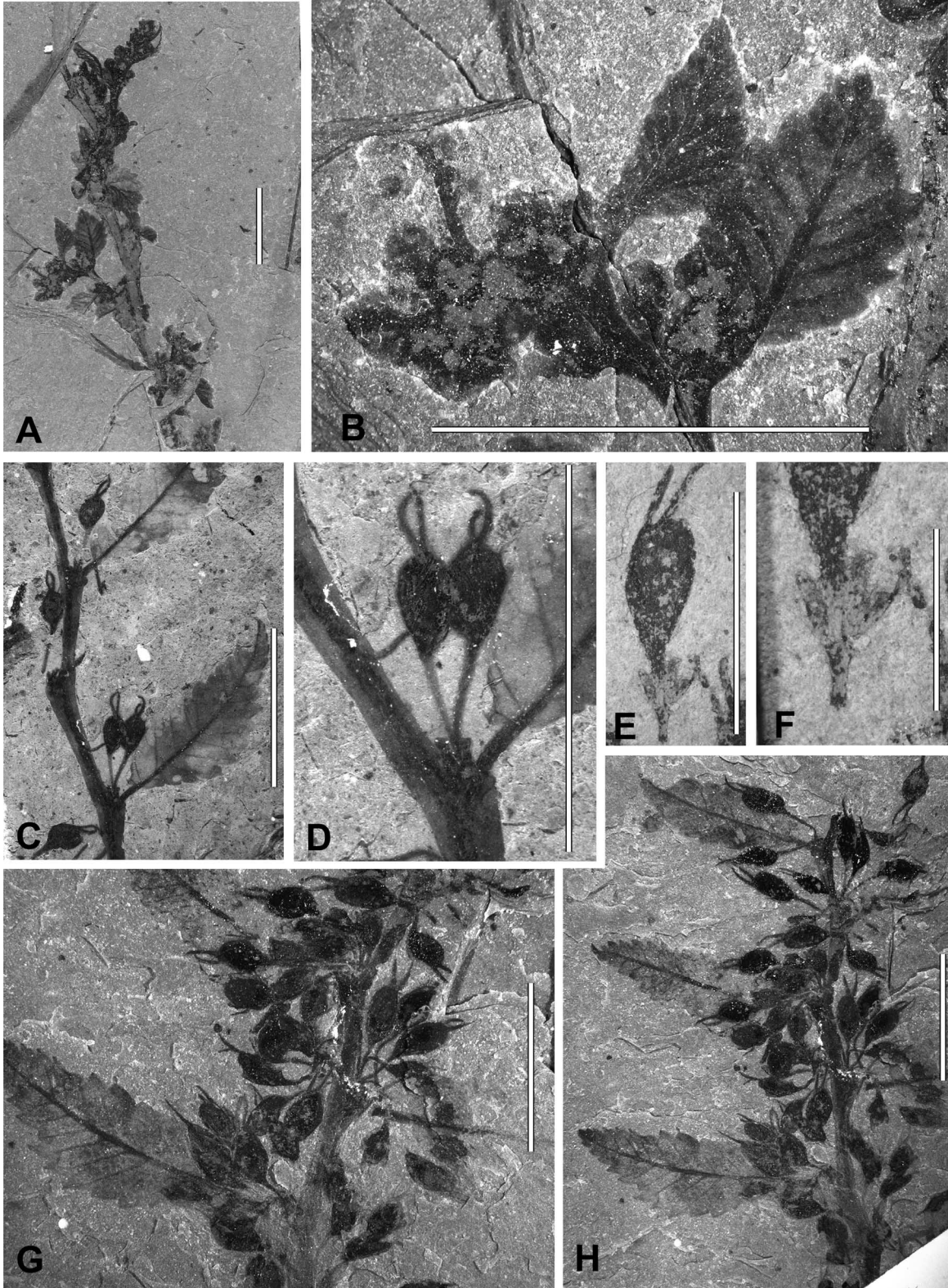
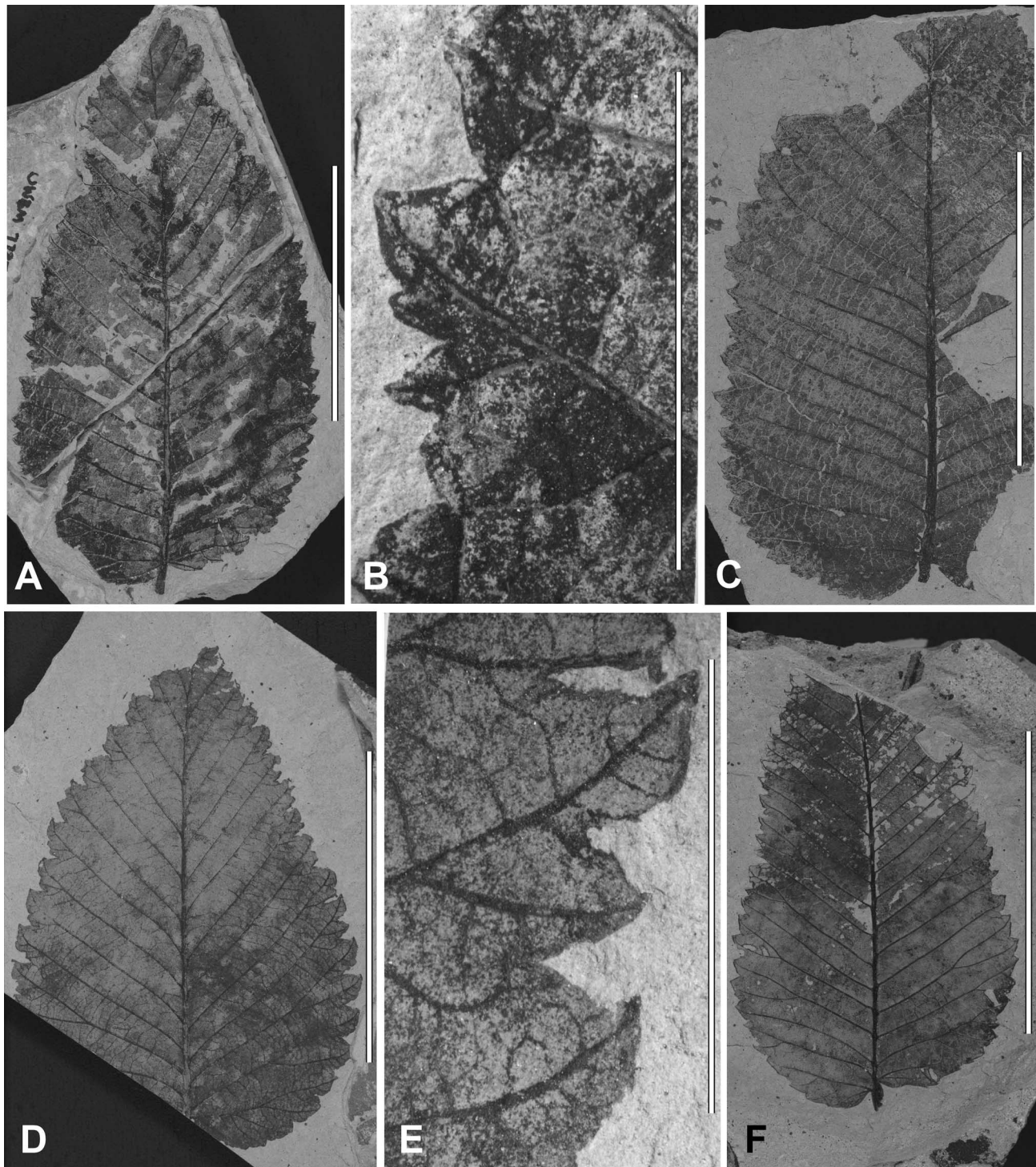

Fig. 6. *Ulmus chuchuanus* (Berry) LaMotte, Republic, Washington. (A) Large ovate leaf with densely spaced secondary veins, UWBM 77352A (= *Chaetoptelea* Morphotype A; Burnham 1986, pl. 3, Fig. 18). (B) Close-up of Fig. 6A showing leaf margin with compound denticulation; note the different orientation of primary and secondary teeth. (C) Large leaf with compound teeth and cordate base, UWBM 77343. (D) Broad ovate leaf, UWBM 57168. (E) Close-up of Fig. 6D showing compound teeth and different orientation of teeth. (F) Large ovate leaf, UWBM 97786. Scale bar = 5 cm in Figs. 6A, 6C, 6D, and 6F; and 1 cm in Figs. 6B and 6E.



Remarks

The epithet *columbianus* used by Berry (1926) had already been used for fossil wood by Penhallow (1908) and therefore was invalid at the time of its publication. LaMotte (1952) proposed the substitute *chuchuanus* based on the lo-

cality where Berry's specimen was found. Broad ovate to elliptic leaves with compound teeth similar to those found in *U. chuchuanus* are characteristic of several species of the subgenus *Ulmus*, such as *U. carpinifolia* Ruppius ex Suckow and *U. glabra* Hudson. By contrast, species of section *Chae-*

Fig. 7. *Ulmus chuchuanus* (Berry) LaMotte, Republic, Washington. (A) Large leaf with auriculate base, UWBM 71110. (B, C) Close-ups of Fig. 7A showing leaf margin and leaf base. (D) Very large (sucker shoot) leaf, UWBM96081. Scale bar = 5 cm in Figs. 7A and 7D; and 1 cm in Figs. 7B and 7C.

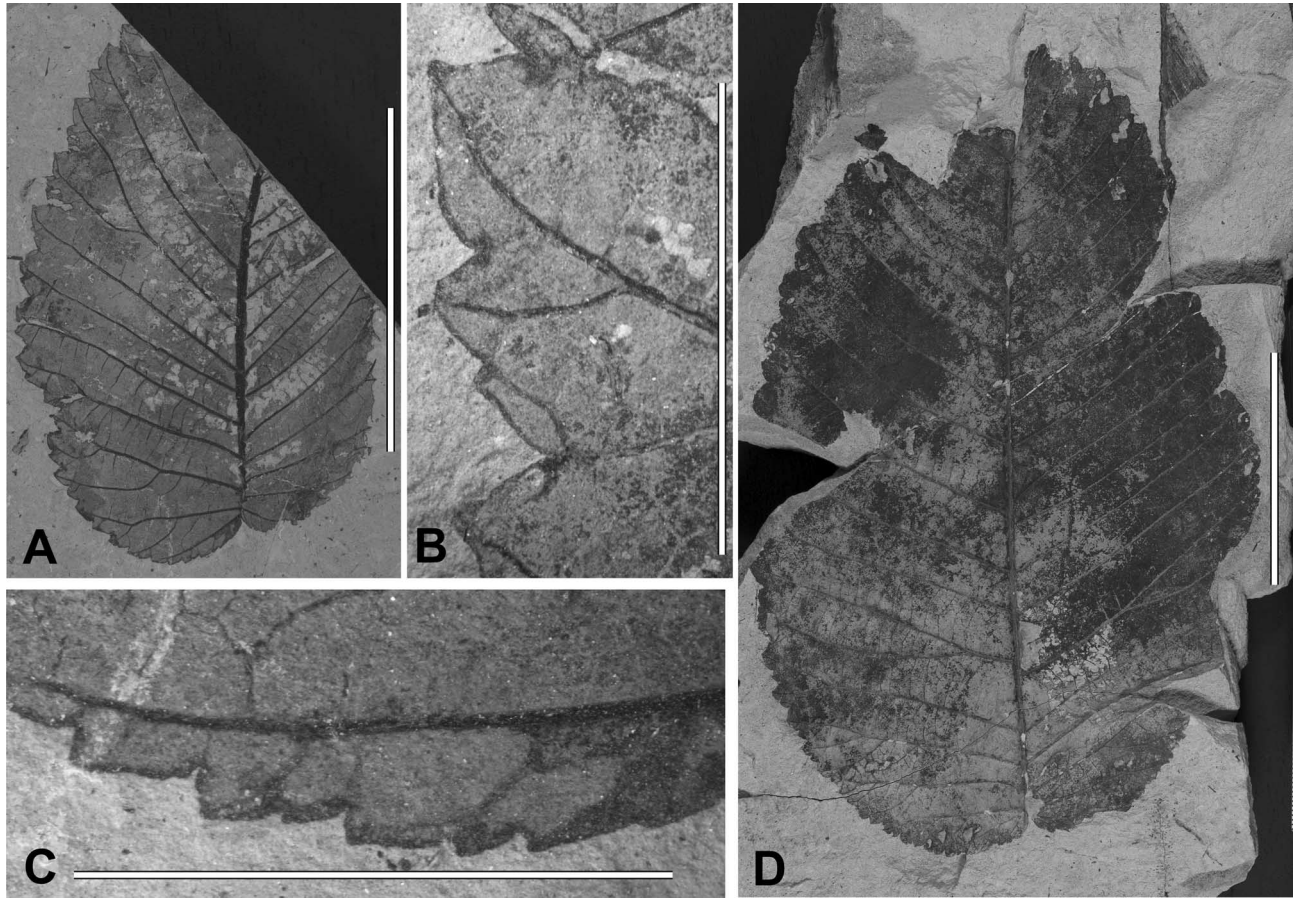

toptelea (subgenus *Oreoptelea*) have narrower leaves with densely spaced secondary veins. The small teeth curve towards the apex and have a long basal and a short apical side. Two to four minute subsidiary teeth are oriented in the same way as the primary teeth, and the sinuses are often round and therefore the leaf margin is dentate rather than serrate. Moreover, leaves in subgenus *Chaetoptelea* typically have thinner petioles than *U. chuchuanus*.

Affinities to other fossil species

Unlike *U. okanaganensis*, leaf types similar to *U. chuchuanus* are not found in Upper Palaeocene and Lower Eocene formations of North America and East Asia but appear for the first time in Middle Eocene formations of Pacific North America.

Leaf remains from the Early Oligocene of Oregon have been ascribed to *Ulmus speciosa* Newberry by Meyer and Manchester (1997) and Tanai and Wolfe (1977). These differ from *U. chuchuanus* leaves in having longer teeth with a higher number of secondary teeth and are comparable to modern species of section *Blepharocarpus* (subgenus *Oreoptelea*). Also *Ulmus pseudo-americana* Lesq. and *Ulmus chaneyi* Tanai and Wolfe from the John Day Formation, Oregon, have more complex compound teeth than *U. chuchuanus* (cf. Tanai and Wolfe 1977) and show similarities to section *Blepharocarpus*.

The closest similarities to *U. chuchuanus* are encountered in *Ulmus owyheensis* H.V. Smith, which has been reported from the Early Oligocene to Late Miocene of western North America (Tanai and Wolfe 1977). In this species teeth are simple or with one or two subsidiary teeth. They differ from *U. chuchuanus* by the more regular orientation of primary and subsidiary teeth and by the absence of compound teeth in the upper part of the leaves. They have been compared to the living species *U. pumila* (section *Ulmus*) from East Asia by Tanai and Wolfe (1977) but should be compared more generally to species of section *Ulmus*.

3. *Ulmus* sp.

Material

UWBM 77083, UWBM 56793A, UWBM 56793B, UWBM 71425 (Republic); UWBM 94588A, UWBM 94588B (Driftwood Creek, Smithers); SR 05-01-01, SR 05-01-02A; SR 87-61-02B (Republic).

Description

Fruits (Fig. 9)

Samaras with narrow wing, endocarp with wing 5–6 mm long and 3.5–4 mm wide, elliptic in outline, styles persistent, 3 mm long, perianth shallowly lobed with persistent

Fig. 8. *Ulmus chuchuanus* (Berry) LaMotte, Republic, Washington. (A) Medium-sized leaf with irregularly dentate margin, UWBM 54889, holotype. (B) Close-up of Fig. 8A showing leaf margin. (C) Small leaf with teeth curved upwards, UWBM 77411. (D) Medium-sized leaf, UWBM 77383. (E) Close-up of Fig. 8D showing hooklike teeth. (F) Close-up of Fig. 8C. Scale bar = 5 cm in Fig. 8A; 1 cm in Figs. 8B–8D; and 0.5 cm in Figs. 8E and 8F.

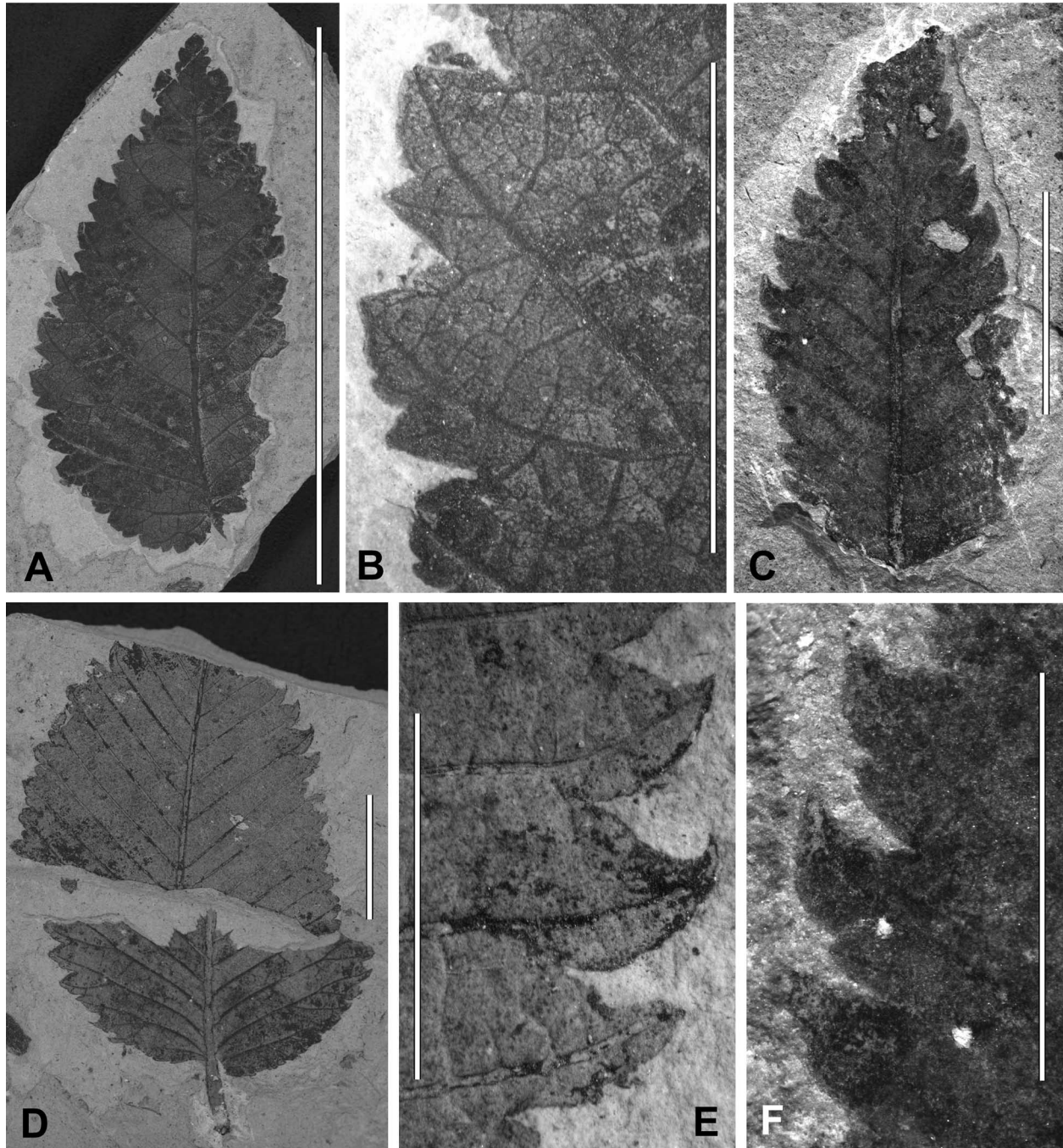

stamen filaments, funnel-shaped, basal part of perianth and pedicel 2 mm long (Republic).

One naturally macerated specimen from Driftwood Creek shows the wing very clearly, the wing being 0.5 mm wide (Figs. 9C, 9F), endocarp and wing 5 mm long and 4 mm wide, venation not clearly seen, perhaps reticulate, styles persistent, 2.5 mm long, pedicel with remnants of a persistent perianth, pedicel 2.5+ mm long.

Occurrence

Driftwood Creek / Smithers, Quilchena, British Columbia; Republic, Washington.

Remarks

Leaves of *U. chuchuanus* co-occur with fruits different from *U. okanaganensis* at the localities Republic and Smithers (Driftwood Creek). Because two fruit types consistently

Fig. 9. *Ulmus* sp., winged fruits. (A, B, D, E, G–J) Republic, Washington. (C, F) Driftwood Creek, Smithers, British Columbia. (A, E) Stipitate fruit with persistent perianth and stamen filaments, part and counterpart, UWBM 56793A, UWBM 56793B. (B, D) Close-ups of Figs. 9A and 9E showing lobed perianth. (C, F) Naturally macerated fruits, part and counterpart, showing narrow but distinct wing, UWBM 94588A, B; remnants of the perianth can be seen where the pedicel is broken. (G) Fruit with wing, SR 05-01-02A. (H) Fruit with wing, SR 87-61-02B. (I) Close-up of Fig. 9H showing perianth and broken wing, indicated by arrowhead. (J) Fruit with wing, lobed perianth, UWBM 71425. Scale bar = 0.5 cm in Figs. 9A–9J.

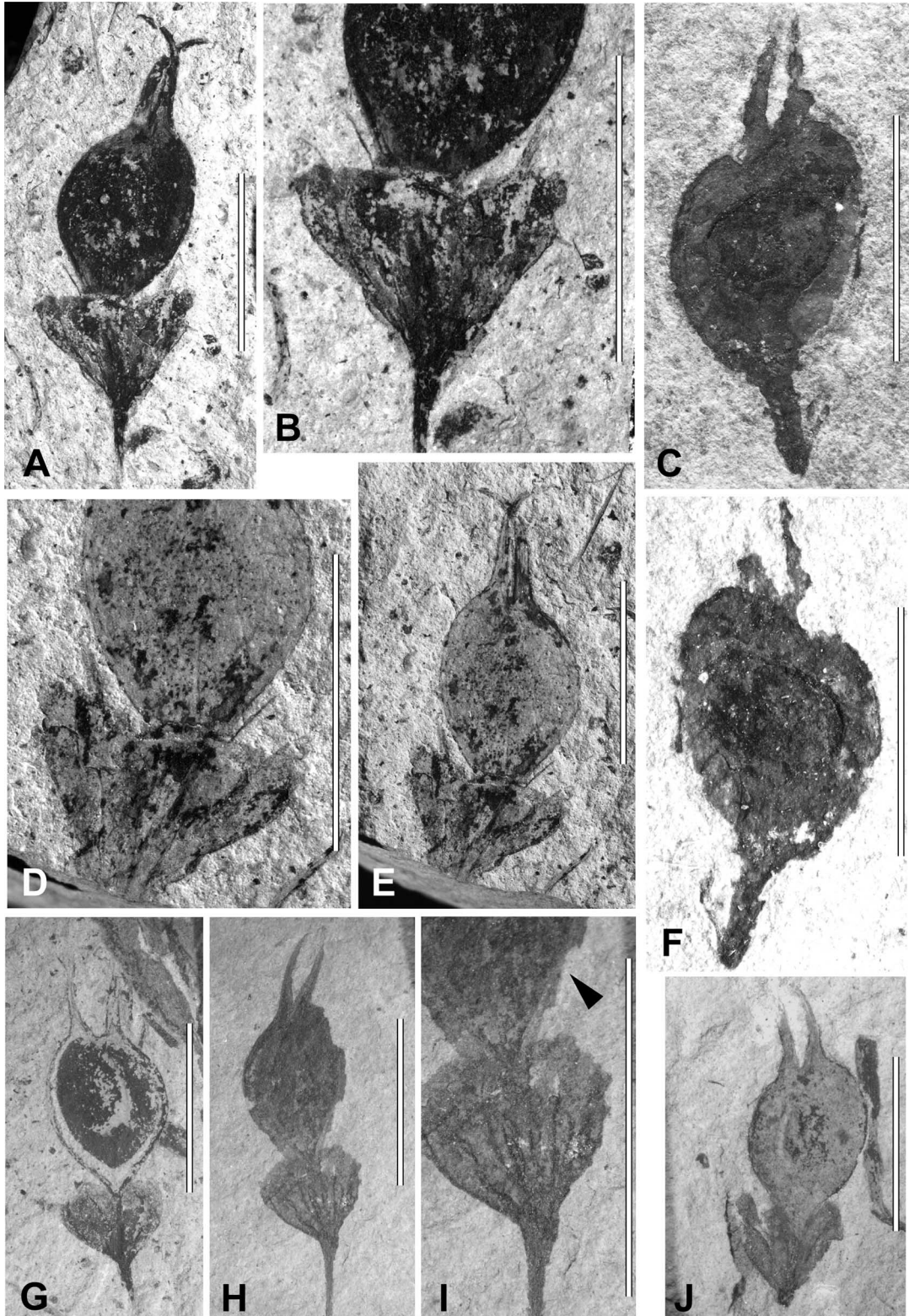

co-occur with two leaf types, of which one (*U. okanaganensis*) has been found attached to fruits, this second fruit type may belong to *U. chuchuanus*. The narrow-winged samaras of *Ulmus* sp. with free styles are very similar to those found in the extant species *Ulmus serotina* Sarg. (section *Trichoptelea*). Similar fruits were reported from the Lower Eocene Chalk Bluffs, California (MacGinitie 1941; Manchester 1989b). These fruits differ from the present ones by a zygomorphic perianth and smaller endocarps.

Character optimization and phylogenetic position of *U. okanaganensis*

Phylogenetic analysis of the morphological data matrix shown in Table 3 (see Table 2 for comparative morphology) suggests that *U. okanaganensis* belongs to the subgenus *Ulmus* (Fig. 10), within which it is nested between sections *Microoptelea* and *Ulmus*. It is suggested that the subgenus *Ulmus* is a paraphyletic grade basal to the subgenus *Oreoptelea*.

Among leaf characters a compound serrate leaf margin and nearly equal leaf bases are the character states at the ingroup node. This is also found in leaves from the Late Paleocene of Ellesmere Island (*Ulmus* sp.), the Paleocene/Eocene of Spitsbergen (*Ulmites ulmifolius*), and the Paleocene of the Far East (*U. furcinervis*; Schloemer-Jäger 1958; McIver and Basinger 1999; Feng et al. 2003).

For fruits and infructescences, short pedicels, short fascicles, the absence of a samara wing, a shallow-lobed perianth, and the position of the inflorescence in the axils of current-season leaves are the suggested character states at the ingroup node, and they are also found in *U. okanaganensis*. By contrast, Early Eocene fruits of *C. pseudofulva* have narrowly winged fruits (MacGinitie 1941).

Ulmus chuchuanus has not been included in the phylogenetic analysis because its leaves and fruits were not found in attachment. Leaves of *U. chuchuanus* show a dentition that is not found in the basal branches "section *Microoptelea*" and "*U. okanaganensis*" of *Ulmus* but appears for the first time in members of section *Ulmus* (Fig. 10). Interestingly, fruits typically associated with *U. chuchuanus* have a narrow wing that is very similar to the wing found in the modern *U. serotina* (section *Trichoptelea*). This character combination suggests that *U. chuchuanus* represents a more derived species than *U. okanaganensis*.

Discussion

The previous placement of fruits of *U. okanaganensis* and leaves of *U. chuchuanus* in *Chaetoptelea* (Burnham 1986; Wehr 1995) is not confirmed by this study. In contrast, we found that the fruits of *U. okanaganensis* show a mosaic of characters found in both modern subgenera of *Ulmus* (Table 1), which is in line with the phylogenetic position of *U. okanaganensis* as part of a grade basal to the subgenus *Oreoptelea* (including section *Chaetoptelea*). *Ulmus chuchuanus* has leaves that differ considerably from those of *Chaetoptelea* by their broad ovate leaf shape, thick petiole, and, most conspicuously, compound teeth with primary and one or two secondary teeth showing markedly different orientations.

While the dispersed fruits of *U. okanaganensis* are very likely to be mistaken for those of *Ulmus alata* Michx., *Ulmus mexicana* (Liebm.) Planch., *Ulmus elongata* L.K. Fu and C.S. Ding, and *Ulmus villosa* Brandis (subgenus *Chaetoptelea*), the leaves of *U. chuchuanus* and other leaf types previously referred to as *Chaetoptelea* (for instance, the leaves of *Chaetoptelea* Morphotypes A and B; Burnham 1986) are markedly different from living members of this group of elms (see above). The leaves of *U. okanaganensis* show affinities to coeval or older (Paleocene to Eocene) leaves from high-latitude areas (Ellesmere Island, Spitsbergen, Russian and Chinese Far East) that have not been found together with fruits despite persistent searching and therefore their generic identity has sometimes been questioned (cf. Kvaček et al. 1994). This type of foliage appears to persist until the Late Eocene (*Ulmus compacta* Fotjanova; Budantsev 1997) and then to have been replaced by more modern leaf morphotypes.

Fruits and infructescences

While superficially resembling *Ulmus* section *Chaetoptelea* because of the extremely reduced wing of the samara and the ciliate samara margin, the fruits are arranged in a fascicle in *U. okanaganensis* (Fig. 11) but in a conspicuously elongate raceme in modern representatives of section *Chaetoptelea* (*U. alata*, *U. mexicana*, *U. elongata*, and *U. villosa*). In addition, inflorescences appear on previous-year shoots in members of section *Chaetoptelea*, while they are in the axils of current-year leaves in the fossil species. Flowers appear in the axils of current-season leaves in species of section *Trichoptelea* (sister to *Chaetoptelea*) but here flowering is in autumn. In *U. okanaganensis* the flowers appear to have occurred together with the leaves in spring, based on a twig displaying young inflorescences and unfolding leaves (Fig. 5A). This is not met with elsewhere in modern species of *Ulmus*. In *Ulmus lanceifolia* Roxb. the flowers appear in spring in the axils of leaves, but this species is not deciduous and has brochidodromous secondary veins, unlike any other species of *Ulmus*.

It has been suggested that two character states, inflorescences in very short fascicles ("capitate" sensu Grudzinskaya 1966) and racemes with extended inflorescence axes ("racemose" sensu Grudzinskaya), are synapomorphies in sections *Ulmus* and *Chaetoptelea*, respectively (Grudzinskaya 1966, 1979; Wiegrefe et al. 1994). In Grudzinskaya (1966) and this study (Fig. 10), it is suggested that inflorescences in short fascicles but with clearly visible pedicels are plesiomorphic within *Ulmus*.

Fruits associated with leaves of *U. chuchuanus* are winged but do not have the conspicuous stigmatic cleft formed by a broad wing attached to the outer parts of the styles found in most fossils from younger sediments and in most modern species (section *Ulmus*). It is unclear in what kind of infructescence the fruits were arranged. By their size, narrow-winged margin, and free styles, however, these fruits display strong similarities to the modern species *U. serotina* (section *Trichoptelea*).

According to Sytsma et al. (2002), Ulmaceae are basal within urticalean rosids, followed by Celtidaceae, Cannabaceae, Urticaceae, and Moraceae. In general, infructescences in Urticales show various types of simple fascicles with

Fig. 10. One of two most parsimonious trees from the analysis of the data matrix shown in Table 3. The branch marked with a star collapses in the strict-consensus tree. Bootstrap values from 100 replicates are indicated as boldface numbers below the branches (tree length = 41, consistency index = 0.976, homoplasy index = 0.634, retention index = 0.857, rescaled consistency index = 0.836). Open circles denote homoplastic characters with consistency index < 1 and solid circles show non-homoplastic apomorphies. The numbers above the circles are characters (see Table 2) and those below the circles are character states (Tables 2, 3).

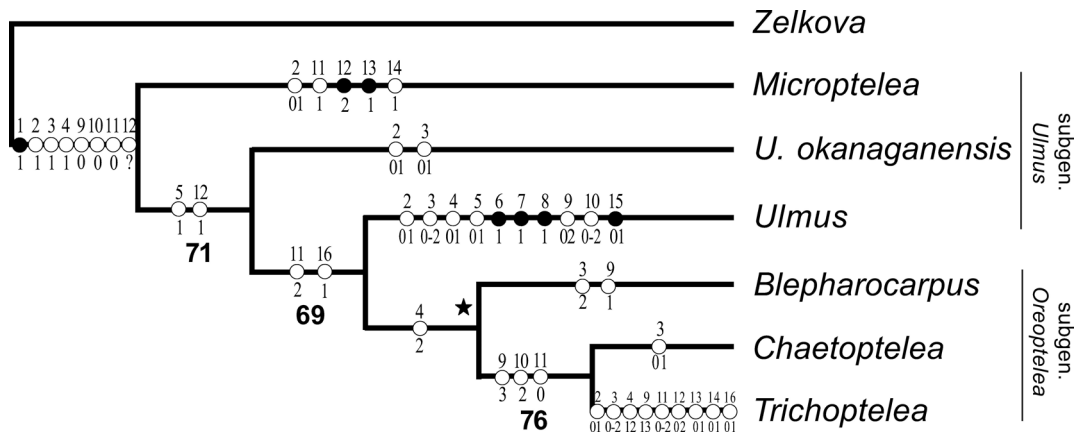
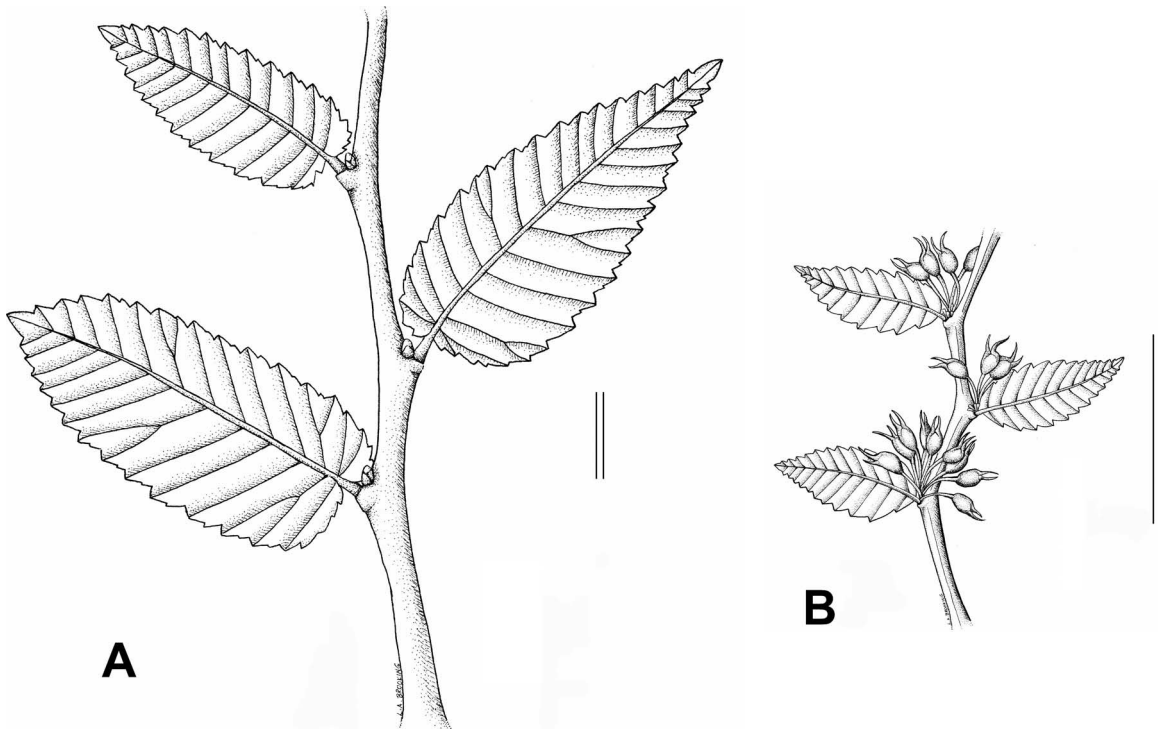

Fig. 11. *Ulmus okanaganensis* sp.nov. Reconstruction of a sucker shoot (A) and a fertile branchlet (B). Scale bars = 2 cm.



short or almost absent pedicels in *Zelkova* and *Hemiptelea* (Ulmaceae), and complex panicles with conspicuously elongate floral axes, as, for instance, in *Urticaceae*. Within *Ulmaceae* the tropical genera *Ampelocera* and *Holoptelea* are basal to a clade (*Hemiptelea* – (*Zelkova* – (*Ulmus*))) (Sytsma et al. 2002; see also Wiegrefe et al. 1998). While *Ampelocera* has fleshy drupes, *Holoptelea* has dry winged fruits that are borne on older leafless branches (Todzia 1993).

Character optimization clearly suggests inflorescences borne in the axils of leaves of current-year shoots as found

in *U. okanaganensis* to be the plesiomorphic state in *Ulmus*. Outgroup taxa such as *Zelkova* and *Hemiptelea* have short-stalked or sessile fruits in the axils of current-year leaves. Flowering in spring or early summer in the axils of current-year leaves appears to be the primitive state in *Ulmus*. In contrast, the occurrence of inflorescences on previous-year shoots as found in members of sections *Blepharocarpus*, *Chaetoptelea* (subgenus *Oreoptelea*), and *Ulmus* (subgenus *Ulmus*) may be a derived feature that evolved in parallel in different groups.

Comparison of elm leaves with those of other genera of Ulmaceae

Diagnostic features of leaves of *Ulmus* are the at least slightly unequal, often auriculate leaf base, the conspicuous multiple serrate basal leaf margin, and the compound dentition along the entire margin. In some species, leaves may display a dimorphism exhibiting an additional leaf type with very few compound teeth higher up the leaf (cf. leaf type 3 in *U. okanaganensis*, extant *U. pumila*). The latter leaf type may be very similar to the leaves of *Zelkova* but the secondary veins are normally less densely spaced in *Zelkova* (T. Denk, personal observation, 2005). In *Zelkova*, compound teeth are absent except in the most basal teeth. According to Tanai and Wolfe (1977) the only consistent character distinguishing the foliage of *Zelkova* from that of *Ulmus* is the intercostal tertiary venation that forks conspicuously midway between the secondary veins in *Zelkova*, while at least half of the tertiary veins are unbranched (percurrent) in *Ulmus*. This character was not used in a recent study on *Zelkova* by Denk and Grimm (2005). However, re-examination of a large number of living species of *Ulmus* and all species of *Zelkova* clearly shows that both genera have both branched and percurrent tertiary veins. Percurrent veins are often the prevailing ones in some parts of the lamina, whereas branched tertiary veins are confined to other (more basal) parts.

Hemiptelea frequently possesses teeth with small subsidiary teeth, but normally does not display an unequal leaf base and a multiple serrate basal leaf margin as in *Ulmus*.

The possible presence of *Zelkova* leaves in Palaeogene sediments of western North America has long been a matter of debate (cf. Tanai and Wolfe 1977; Burnham 1986; Manchester 1989a, 1989b). A strong argument against the presence of *Zelkova* in Palaeogene sediments of western North America has been the fact that *Zelkova*-type leaves never occur typically attached to fruiting twigs as they do in Neogene Eurasian fossil assemblages (cf. Manchester 1989a). Reexamination of the material from Republic showed that among hundreds of *Ulmus* leaves, very few possible leaves of *Zelkova* were present. This may be due to the fact that *Zelkova* grew at some distance from the sedimentary basins, so isolated leaves would be more likely to reach the sedimentary area, while twiglets with leaves and fruits would be absent. The reported presence of *Zelkova* in pollen assemblages of Princeton and McAbee appears to support this idea (Reinhard Zetter, Vienna, unpublished data).

Mode of evolution in *Ulmus*

Paleocene *Ulmus*-like leaves have been reported from Greenland, the Rocky Mountains of the USA, and the Far East, but *Ulmus* fruits have not been found in association with them (Manchester 1989b; Feng et al. 2003, among others). Leaf types similar to those of modern species of *Ulmus* appear to have been already present by the Early Eocene. Derived types (*U. parvifolia*, *U. crassifolia*: small coriaceous leaves; *U. mexicana*: small, sharp teeth, resembling those of some Juglandaceae, eucamptodromous to craspedodromous secondary venation, extremely high length/width ratio of lamina; *U. lanceifolia*: evergreen leaves, eucamptodromous to brochidodromous venation) may have evolved later, partly in response to changing climatic conditions in the Neogene.

Eocene *Ulmus* fruits typically are wingless or have a narrow wing that does not extend to the styles (cf. Manchester 1989b; this study). Large-winged fruits appear to be much more common in the Oligocene and Neogene and the large wings of the endocarps may have improved the efficiency of fruit dispersal.

The change from a primitive type of inflorescence appearing in spring or early summer in the axils of leaves on current-year shoots (*U. okanaganensis*; *Zelkova*, *Hemiptelea*) to various advanced types in which the flowers appear on previous-year shoots and leaves on current-year shoots (spatial separation) or in which flowers appear in autumn in the axils of leaves of current-year shoots (temporal separation) may have been caused in part by the increasing seasonality of the climate in the Northern Hemisphere during the course of the Oligocene and Neogene. While the mechanism of spatial separation appears to be old (found also in *Holoptelea*), temporal separation may be a recent innovation that evolved independently in *Microptelea* (subgenus *Ulmus*) and *Trichoptelea* (subgenus *Oreoptelea*).

Acknowledgements

Many individuals contributed to this study. Special thanks are extended to Thomas Dillhoff of the Evolving Earth Foundation for photography. Jean Dougherty of the Geological Survey of Canada provided photographs of the holotype of *U. chuchuanus*. David Giblin of the University of Washington herbarium was helpful, and the Burke Museum in Seattle, Washington, provided the specimens used in this study. Steven Manchester and Robyn Burnham provided critical feedback. Aleksey Hvalj kindly translated Grudzin-skaya (1979) and Ablaeu and Iljinskaja (1982) into English. This project was funded by the Swedish Museum of Natural History and the Evolving Earth Foundation.

References

- Ablaeu, A.G., and Iljinskaja, I.A. 1982. *Ulmus furcinervis* (Borsuk) Ablaeu. In *Magnoliophyta Fossilia URSS*. Vol. 2. Ulmaceae–Betulaceae. Edited by A. Takhtajan. Nauka, Leningrad. pp. 14–15. [In Russian.]
- Basinger, J.F. 1976. *Paleorosa similkameenensis*, gen. et sp. nov., permineralized flowers (Rosaceae) from the Eocene of British Columbia. *Can. J. Bot.* **54**: 2293–2305.
- Basinger, J.F. 1981. The vegetative body of *Metasequoia milleri* from the Middle Eocene of southern British Columbia. *Can. J. Bot.* **59**: 2379–2410.
- Berry, E.W. 1926. Tertiary floras from British Columbia. Canada. *Can. Dep. Mines Bull.* 42 (Geol. Ser. 45). pp. 91–116, 153–171.
- Boulter, M.C., and Kvaček, Z. 1994. The Palaeocene flora of the Isle of Mull. *Spec. Pap. Palaeontol.* **42**: 1–149.
- Brown, R.W. 1936. Additions to some fossil floras of the western United States. *U.S. Geol. Surv. Prof. Pap.* **186-J**: 163–207.
- Budantsev, L.Y. 1983. The early cenophytic history of the Arctic flora. Nauka, Leningrad. [In Russian.]
- Budantsev, L.Y. 1997. Late Eocene flora of western Kamchatka. Issue 19, Proceedings of Komarov Botanical Institute, Russian Academy of Sciences, St. Petersburg, Russia. [In Russian.]
- Burnham, R.J. 1986. Foliar morphological analysis of the Ulmoideae (Ulmaceae) from the Early Tertiary of western North America. *Palaeontogr. Abt. B Palaeophytol.* **201**: 135–167.
- Dawson, W.J. 1890. On fossil plants from the Similkameen valley

- and other places in the southern interior of British Columbia. *Trans. R. Soc. Can.* **8**: 75–90.
- Denk, T., and Grimm, G.W. 2005. Phylogeny and biogeography of *Zelkova* (Ulmaceae s.str.) as inferred from leaf morphology, ITS sequence data and the fossil record. *Bot. J. Linn. Soc.* **147**: 129–157. doi: 10.1111/j.1095-8339.2005.00354.x.
- Dillhoff, R.M., Leopold, E.B., and Manchester, S.R. 2005. The McAbee flora of British Columbia and its relation to the Early–Middle Eocene Okanagan Highlands flora of the Pacific Northwest. *Can. J. Earth Sci.* **42**: 151–166. doi: 10.1139/e04-084.
- Ewing, T.E. 1980. Paleogene tectonic evolution of the Pacific Northwest. *J. Geol.* **88**: 619–635.
- Ewing, T.E. 1981. Regional stratigraphy and structural setting of the Kamloops Group, south-central British Columbia. *Can. J. Earth Sci.* **18**: 1464–1477.
- Feng, G.-P., Ablav, A.G., Wang, Y.-F., and Li, C.-S. 2003. Paleocene Wuyun flora in northeast China: *Ulmus furcinervis* of Ulmaceae. *Acta Bot. Sin.* **45**: 146–151.
- Grudzinskaya, I.A. 1966. Inflorescences of the species of *Ulmus* L. (their formation, structure and certain problems of their evolution). *Bot. J.* **51**: 15–27 [In Russian.].
- Grudzinskaya, I.A. 1967. Ulmaceae and reasons for distinguishing Celtidoideae as a separate family Celtidaceae Link. *Bot. J.* **52**: 1723–1749 [In Russian.].
- Grudzinskaya, I.A. 1974. On the taxonomic position and distribution of the section *Chaetoptelea*, genus *Ulmus*. *Bot. J.* **59**: 61–66 [In Russian.].
- Grudzinskaya, I.A. 1979. The family Ulmaceae Mirb. (systematics, geography, aspects of organogenesis). Komarov Botanical Institute, St. Petersburg, Russia. [In Russian.].
- Hills, L.V., and Baadsgaard, H. 1967. Potassium–argon dating of some Lower Tertiary strata in British Columbia. *Can. Petroleum Geol. Bull.* **15**: 138–149.
- Hollick, A. 1936. The Tertiary floras of Alaska. U.S. Geol. Surv. Prof. Pap. No. 182.
- Komarov, V.L. (Editor) 1936. Flora of the U.S.S.R., Vol. 5. Nauka, Moscow and Leningrad. [Translated from Russian by the Israel Program for Scientific Translations, Jerusalem, 1970.]
- Kvaček, Z., Manum, S.B., and Boulter, M.C. 1994. Angiosperms from the Palaeogene of Spitsbergen, including an unfinished work by A.G. Nathorst. *Palaeontogr. Abt. B Palaeophytol.* **232**: 103–128.
- LaMotte, R.S. 1952. Catalogue of the Cenozoic plants of North America through 1950. *Geol. Soc. Am. Mem.* No. 51.
- Liu, Y.S., Guo, S., and Ferguson, D.K. 1996. Catalogue of Cenozoic megafossil plants in China. *Palaeontogr. Abt. B Palaeophytol.* **238**: 141–179.
- MacGinitie, H.D. 1941. A middle Eocene flora from the central Sierra Nevada. *Carnegie Inst. Washington Publ.* No. 543.
- Maddison, P.W., and Maddison, D.R. 1992. *MacClade*. Version 3. Sinauer Associates, Sunderland, Mass.
- Manchester, S.R. 1989a. Attached reproductive and vegetative remains of the extinct American–European genus *Cedrelospermum* (Ulmaceae) from the Early Tertiary of Utah and Colorado. *Am. J. Bot.* **76**: 256–276.
- Manchester, S.R. 1989b. Systematics and fossil history of the Ulmaceae. In *Evolution, systematics, and fossil history of the Hamamelidaceae*. Vol. 2. Edited by P.R. Crane and S. Blackmore. Clarendon Press, Oxford, UK. pp. 221–251.
- Mathews, W.H. 1991. Physiographic evolution of the Canadian Cordillera. In *Geology of the Cordilleran Orogen of Canada*. Edited by H. Gabrielse and C.J. Yorath. The Geology of Canada No. 4. Geological Survey of Canada, Ottawa, Ont. pp. 403–418.
- McIver, E.E., and Basinger, J.F. 1999. Early Tertiary floral evolution in the Canadian High Arctic. *Ann. Mo. Bot. Gard.* **86**: 523–545.
- Meyer, H.W., and Manchester, S.R. 1997. The Oligocene Bridge Creek flora of the John Day Formation, Oregon. *Univ. Calif. Publ. Geol. Sci.* 141.
- Mustoe, G.E. 2005. Diatomaceous origin of siliceous shale in Eocene lakebeds of central British Columbia. *Can. J. Earth Sci.* **42**: 231–241. doi: 10.1139/e04-099.
- Penhallow, D. 1908. Report on Tertiary plants of British Columbia. Geological Survey Branch, Department of Mines, Ottawa, Ont. Rep. No. 1013.
- Pearson, R.C., and Obradovich, J.D. 1977. Eocene rocks in north-eastern Washington — radiometric ages and correlation. *U.S. Geol. Surv. Bull.* No. 1433.
- Schloemer-Jäger, A. 1958. Alttertiäre Pflanzen aus Flözen der Brögger-Halbinsel Spitzbergens. *Palaeontogr. Abt. B Palaeophytol.* **104**: 39–103.
- Schneider, C. 1916. Beiträge zur Kenntnis der Gattung *Ulmus* I: Gliederung der Gattung und Übersicht der Arten. *Österr. Bot. Z.* **66**: 21–34.
- Song, B.-H., Wang, X.-Q., Li, F.-Z., and Hong, D.-Y. 2001. Further evidence for paraphyly of the Celtidaceae from the chloroplast gene *matK*. *Plant Syst. Evol.* **228**: 107–115. doi: 10.1007/s006060170041.
- Stockey, R.A. 1984. Middle Eocene *Pinus* remains from British Columbia. *Bot. Gaz.* **145**: 262–274. doi: 10.1086/337455.
- Stockey, R.A., and Wehr, W.C. 1996. Flowering plants in and around Eocene lakes. In *Life in stone*. Edited by R. Ludvigsen. UBC Press, Vancouver, B.C. pp. 234–247.
- Swofford, D.L. 1993. PAUP: phylogenetic analysis using parsimony. Version 3.1.1. Illinois Natural History Survey, Champaign, Ill.
- Sytsma, K.J., Morawetz, J., Pires, J.C., Nepokroeff, M., Conti, E., Zjhara, M. 2002. Urticalean rosids: circumscription, rosid ancestry, and phylogenetics based on *rbcL*, *trnL-F*, and *ndhF* sequences. *Am. J. Bot.* **89**: 1531–1546.
- Tanai, T. 1972. Tertiary history of vegetation in Japan. In *Floristics and palaeofloristics of Asia and eastern North America*. Edited by A. Graham. Elsevier, Amsterdam. pp. 235–255.
- Tanai, T., and Wolfe, J.A. 1977. Revision of *Ulmus* and *Zelkova* in the middle and late Tertiary of western North America. *U.S. Geol. Surv. Prof. Pap.* No. 1026.
- Todzia, C.A. 1993. Ulmaceae. In *The families and genera of flowering plants, Vol. II. Flowering plants, dicotyledons, magnoliid, hamamelid and caryophyllid families*. Edited by K. Kubitzki, J.G. Rohwer, and V. Bittrich. Springer-Verlag, Berlin and Heidelberg, Germany. pp. 603–611.
- Wehr, W. 1995. The Tertiary flowers, fruits, and seeds of Washington State and adjacent areas. *Wash. Geol.* **23**: 3–16.
- Wiegrefe, S.J., Sytsma, K.J., and Guries, R.P. 1994. Phylogeny of elms (*Ulmus*, Ulmaceae): molecular evidence for a sectional classification. *Syst. Bot.* **19**: 590–612.
- Wiegrefe, S.J., Sytsma, K.J., and Guries, R.P. 1998. The Ulmaceae, one family or two? Evidence from chloroplast DNA restriction site mapping. *Plant Syst. Evol.* **210**: 249–270. doi: 10.1007/BF00985671.
- Wolfe, J.A., and Wehr, W.C. 1987. Middle Eocene dicotyledonous plants from Republic, northeastern Washington. *U.S. Geol. Surv. Bull.* No. 1597.
- Wolfe, J.A., and Wehr, W. 1991. Significance of the Eocene fossil plants at Republic, Washington. *Wash. Geol.* **19**: 18–24.
- Zheng, W. 1997. *Sylva sinica*. Vol. 3. Ulmaceae to Vitaceae. Forestry Publishing, Beijing, China. [In Chinese.]