



EXTERUS
LIGHTOLOGY

v08

THE AGE OF ENLIGHTENMENT



Exterus. Always at lightspeed.

WARRANTY

Exterus lightology is
dedicated to create
top quality products.

Therefore we are proud
to offer a **5 year warranty**
to all items.

TABLE OF CONTENTS

REFERENCE INDEX	5
PRODUCT NAME INDEX	7
ABOUT US	10
R&D	12
VISUAL OVERVIEW	13
INTERIOR	21
DOXX SERIES	113
A-TRACK-TIF	133
POWERLINE SERIES	157
PROFILES	179
LEDFLEX	189
EXTERIOR	193
SHOPLINE	209
EUTRAC 3F TRACK	261
CUT-OUT MATRIX	264
DRIVER LISTING	265
DRIVER MATRIX	267

REFERENCE INDEX

REFERENCE	PRODUCT NAME	PAGE	REFERENCE	PRODUCT NAME	PAGE
A1001_	Mini tube ON GU10	92	A6173_/O/	Micro tube ON	76
A1001_/L/	Mini tube ON LED	92	A6173_/OR/	Micro tube ON RECT	77
A1002_	Mini tube IN GU10	86	A6175_	Common Deep X	36
A1002_/L/	Mini tube IN LED	87	A6177_	Mini tube RECT X ON	94
A1003_	Mini tube IN-TRAC GU10	107	A6177_/	Mini BFD plus	218
A1003_/L/	Mini tube IN-TRAC LED	107	A6178_	Elbeau	72
A1004_	Mini tube 2 ON GU10	95	A6179_	Tube F ON 2 rect	234
A1004_/L/	Mini tube 2 ON LED	95	A6180_	Par X	112
A1005_	Mini tube 3 ON GU10	98	A6181_	Tube IN flex	231
A1005_/L/	Mini tube 3 ON LED	98	A6182_	Drop-It Track	248
A1006_/I/	Mini tube SUSP IN GU10	100	A6183_/	Nano tube recessed	66
A1006_/N/	Mini tube SUSP IN LED	100	A6184_/	Micro tube L AC IN-TRAC	84
A1006_/O/	Mini tube SUSP ON GU10	99	A6185_/	Mini crater	21
A1006_/O/L/	Mini tube SUSP ON LED	99	A6186_/	Mini crater OUT	22
A1006L_/I/	Mini tube L SUSP IN GU10	102	A6187_/	Mini tube recessed	86
A1006L_/N/	Mini tube L SUSP IN LED	102	A6188_/	Micro tube IN-FLEX	74
A1006L_/O/	Mini tube L SUSP ON GU10	101	A6189_/L/	Micro tube AT	137
A1006L_/O/L/	Mini tube L SUSP ON LED	101	A6190_/L/	Micro tube 2 AT	138
A1007_	Mini tube ON IN-TRAC GU10	108	A6191_/L/	Nano tube SUSP IN	67
A1007_/L/	Mini tube ON IN-TRAC LED	108	A6192_/	Turio 5	25
A1008_	Mini tube F ON GU10	90	A6193_/	Turio 52	25
A1008_/L/	Mini tube F ON LED	90	A6194_/	Turio R	26
A1009_	Mini tube SUSP IN-TRAC GU10	109	A6195_/	Mini crater IP	22
A1009_/L/	Mini tube SUSP IN-TRAC LED	109	A6196_/L/	Marker	70
A1009L_	Mini tube L SUSP IN-TRAC GU10	110	A6197_/L/	Arrow	70
A1009L_/L/	Mini tube L SUSP IN-TRAC LED	110	A6198_/2O/	Micro tube L AC 2 ON	82
A2014	Common alu	31	A6198_/3O/	Micro tube L AC 3 ON	84
A2015	Common white	31	A6198_/N/	Micro tube L AC IN	81
A2027	Common black	31	A6198_/O/	Micro tube L AC ON	82
A2032	Common S alu	33	A6199_/L/	Nano tube L ON	68
A2033	Common S white	33	A6200_	Dotline 54	49
A2034_	Common IP	39	A6201_	Dotline 57	50
A2035	Common IP white	39	A6202_	Tube F INVITRACK	240
A2036_	Common Deep	35	A6204_/L/	Georges SUSP IN	127
A2037_	Common S/IP	41	A6204_/O/	Georges SUSP ON	128
A2038_	Common trimless	43	A6204D12_/N/	Georges D12 SUSP IN	127
A2039_	Common S trimless	47	A6204D12_/O/	Georges D12 SUSP ON	128
A2040_	Common SQ	27	A6206_/	Georges D9 IN	125
A2041_	Common SQ2	29	A6207_/	Georges T	125
A5008_/L/	DOC	132	A6208_/I/	Midi tube IN	243
A5009_/L/	Beacon	132	A6208_/O/	Midi tube ON	244
A6058_/L/	Disc	64	A6209_	Midi tube INVITRACK	242
A6068_	Trumpet	51	A6210_	Common SQ X	28
A6069	Trumpet white	51	A6211_	Common SQ2	30
A6073_	Edna	211	A6212L_	Mini tube X L SUSP INVITRACK	241
A6083_	Mirador	63	A710L_/L/L/S	D-line Suspension	175
A6104	Drop-It	230	A710L_/L/L/WL	D-line Wall	176
A6105_	BFD	221	AT/COVER/	Cover	152
A6105D12/I/	Georges D12 IN	126	AT/COVPLAS	Plastercover	152
A6105D20/O/	Georges D20 ON	126	AT/CS/2000	Cable supply 5x 0,75mm ² - 2m	151
A6111_	BFD flex	224	AT/CS/2000/T	Cable supply transparent 5x 0,75mm ² - 2m	170
A6112_	Edna flex	214	AT/CS/5000	Cable supply 5x 0,75mm ² - 5m	151
A6113_/L/	Micro tube FL AC	81	AT/CS/5000/T	Cable supply transparent 5x 0,75mm ² - 5m	170
A6121	Mirador RGB-W	63	AT/EC/	End cap high track LV	150
A6122_	Power disc	64	AT/ECF/	End cap feed high track LV	150
A6123_	Common X	32	AT/HO/	Magnetic high track	150
A6124_	Common S X	34	AT/HT/	Magnetic high track trimless	150
A6125_	Common IP X	40	AT/LB	Magn. high track L-bracket	151
A6126_	Edna Deep	212	AT/LPB	Magn. high track long pendant bracket	151
A6127	Unilite	227	AT/MC/	Mounting connecting box (round)	151
A6128	Duolite	228	AT/MC60/	Mounting connecting box 60mm	170
A6133	Piccolo alu	55	AT/MC80/	Mounting connecting box 80mm	170
A6134_	Piccolo	55	AT/PS/2000	Magn. high track suspension set 2m	151
A6135_	Mini BFD	217	AT/PS/5000	Magn. high track suspension set 5m	151
A6136_	Mini BFD assymetric	222	AT/RC/60/	Recessed connecting box 60mm	170
A6137_	Tube SUSP	237	AT/RC90/	Recessed connecting box 90mm	170
A6138	Mini unilite trimless	62	AT/SB/	Mounting connecting box (rect)	151
A6139	Mini duolite trimless	62	AT/SPB	Magn. high track short pendant bracket	150
A6141_/L/	Piccolo 80	55	AT/TJC/B	Magn. Trimless joining connector black	151
A6143_	Mini BFD flex	223	AT1001_/L/	Line IN AT	145
A6144_	Trumpet Flex	52	AT1001/BTC/L/L/	Line IN black transparent cover AT	145
A6145_	Tube ON	236	AT1002_/L/	Line OUT AT	146
A6147_	Mini tube X IN	88	AT1003_/L/	Line OR AT	148
A6148	Ribs	130	AT1003_/BTC/L/L/	Line OR black transparent cover	148
A6149_	Flat Hores	246	AT1004_/L/L/	Dot line AT	146
A6150_	Tube TRACK	238	AT6146_	Mini tube X AT	139
A6151_/L/	Micro tube R	73	AT6163_	Tube F AT	140
A6152_/L/	Micro tube R trimless	73	AT6191_/L/	Nano tube SUSP AT	141
A6153_/L/	Crater	21	AT6199_/L/	Nano tube L AT	142
A6155_/L/	Vuelta trimless	69	AT6204_/L/	Georges SUSP AT	144
A6156_/L/	Vuelta AS trimless	69	AT6204D12_/L/	Georges D12 SUSP AT	143
A6157W/	Olla	60	AT6206_/L/	Georges ON AT	144
A6158W/	Olla OR	60	ATP/60W/PS/	Inline driver KIT 60W	152
A6159_	Piccolo 80 X	56	ATP/DALI-CAS/	Daligate Casambi	152
A6160_	Piccolo 120	216	ATP/EFL/	Magn. feed left LV polarised	150
A6161_	Mini tube X ON	93	ATP/EFR/	Magn. feed right LV polarised	150
A6162_	Mini tube X SUSP	105	ATP/FC/	Magn. flex connector	150
A6162L_	Mini tube XL SUSP	106	ATP/MF/	Magn. connector	150
A6164_	Tube F ON	233	B1014	Modest	202
A6165_	Tube F IN	232	B1015	Terra spike	202
A6166_	Common S/IP X	42	B1017_	Nail IT	203
A6167_	Common trimless X	44	B1018_/	Viktor N	204
A6168_	Common S trimless X	48	B1019_/	Viktor corten	204
A6169_/L/	Piccolo 80 ON	56	B1020_/	Viktor	204
A6172_	Mini tube RECT 2 X ON	96	B2001	Powerdot WW	199
A6173_/L/	Micro tube IN	74	B2001	Carree ES	198
A6173_/2O/	Micro tube 2 ON	78	B2003	Limbus WW	199
A6173_/2OR/	Micro tube 2 ON RECT	79	B2004	Limbus CW	199
A6173_/3O/	Micro tube 3 ON	80	B2005	Limbus RGB	199

REFERENCE INDEX

REFERENCE	PRODUCT NAME	PAGE	REFERENCE	PRODUCT NAME	PAGE
B2006	Halos WW	200	C8003_	Cornu	183
B2007	Halos CW	200	C8003B	Cornu brace	183
B2008	Halos RGB	200	C8003-E_	Cornu end-cap	183
B2013	Nino CW	193	C8004_-	Linea	180
B2014	Nino WW	193	C8004-B	Linea brace	180
B2015	Costa WW	194	C8004-E_	Linea end-cap	180
B2016	Costa CW	194	C8005_-	Kwadru	183
B2017	Costa D WW	194	C8005-E_	Kwadru end-cap	183
B2018	Costa D CW	194	C8006_	Low	180
B2019	Vega R	201	C8006-E	Low end-cap	180
B2020	Vega S	201	C8007_-	Duo	184
B3010/_B30	Icon	193	C8007-B	Duo clip	184
B5008/_	Beam 50	208	C8007-E_	Duo end-cap	184
B5009/_	Beam 150-2	208	C8008	Minus TR	186
B5034/_	C-line	206	C8009	Minus TR IN	186
B5035/_	C-line recessed	206	C8010	Minus TR OUT	186
C1001_/L/	RE-LED	277	C8011_-	NovusPlus	179
C1002_/L/	RE-LED AC	277	C8011_-/BTC	NovusPlus black transparent cover	179
C1003_/L/	RE-LED 1200	278	C8011-B	NovusPlus brace	179
C2001	Re-light module	249	C8011-E_	NovusPlus end-cap	179
C2002	Wide beam module	250	D1003_	Doxx mini tube GU10	119
C5001	CC LED DRIVER 350mA/8W	265	D1003_/L/	Doxx mini tube LED	119
C5002	CC LED DRIVER 700mA/7W	265	D1006_	Doxx mini tube SUSP GU10	120
C5003	CC DIM PHASE 700mA/14W	265	D1006_/L/	Doxx mini tube SUSP LED	120
C5003	CC DIM PHASE 700mA/14W	265	D1006L_	Doxx mini tube L SUSP GU10	121
C5005	CC LED DRIVER 350mA/4W	265	D1006L_/L/	Doxx mini tube L SUSP LED	121
C5010	CV LED DRIVER 12Vdc 60W IP65	266	D126_	Doxx D126	116
C5012-3	RGB(W) RF led remote control	276	D154_	Doxx D154	117
C5013-2	RGB(W) 4-channel RF constant voltage controller	276	D210	Doxx D210	118
C5014	1x 10A PWM dimmer	269	D42_	Doxx D42	115
C5015	CV LED DRIVER 24Vdc 60W IP67	266	D6173_/L/	Doxx micro tube L AC	122
C5016	CC/CV Dimmable Multi Led driver Phase dim	265	D6191_/L/	Doxx nano tube SUSP	124
C5017	CC/CV Dim Dali/1-10V MULTI DRIVER	265	D6198_/L/	Doxx micro tube L AC	122
C5021	CV LED DRIVER 12Vdc 20W IP67	266	D6199_/L/	Doxx nano tube L	123
C5022	CV LED DRIVER 24Vdc 20W IP67	266	D70_	Doxx D70	115
C5023	CV LED DRIVER 24Vdc 150W IP67	266	D98_	Doxx D98	116
C5027	CV LED DRIVER 24Vdc 35W IP67	266	EXT RU05/_	Powerdot	197
C5028	4x 10A PWM dimmer	269	EXT SU03/_	Carree ES	198
C5029	CC DIM PHASE 350mA/18W	265	PI/180	Profile connector 180°	169
C5030	T2-24Vdc to 350mA DIM converter	265	PL/90	Profile connector 90°	169
C5033	Led emergency module	274	PL/ALS	Ambient light/motion sensor/DALI	171
C5034	CV LED DRIVER 24Vdc 100W IP67	266	PL/BTC	Black transparent cover	169
C5035/**mA	CC DIM DALI 35W 350-1050mA	265	PL/CAS	Casambi DALI build-in	171
C5038	CV LED DRIVER 48VDC 150W IP67	266	PL/CS/2000/B	Cable supply black textile 3x 0,75 mm ² - 2m	170
C5039	CV LED DRIVER 48VDC 240W DIN RAIL	266	PL/CS/2000/T	Cable supply transparent 3x 0,75mm ² - 2m	170
C5040	Dali push button control	270	PL/CS/5000/B	Cable supply black textile 3x 0,75 mm ² - 5m	170
C5041	CV LED DRIVER 48VDC 60W IP67	266	PL/CS/5000/T	Cable supply transparent 3x 0,75mm ² - 5m	170
C5042	Dali bluetooth control	270	PL/D3F/_	Powerline double 3F adapter	171
C5043/**mA	CC DIM DALI 15W 350-1050mA	265	PL/EC	Extra circuit per meter	170
C5044/**mA	CC DIM DALI 25W 350-700mA	265	PL/EC/_	End cap	169
C5045	CC DIM PHASE 350mA/9W	265	PL/EM	Emergency module 3hrs.	171
C5046	CC DIM 1-10V 350mA/80W	265	PL/MT	Motion detector incl. profile 100mm	171
C5047	CV DRIVER 24Vdc 240W IP67	266	PL/PBA	Push button dimming / DALI versions	171
C5048	CV DIM DALI 24Vdc 60W	266	PL/PC45	Profile cut 180° / 45°	169
C5049	CV DIM DALI 24Vdc 150W	266	PL/PC45	Profile cut 45°	174
C5050	CC DIM PHASE/1-10V 10W 350mA	265	PL/S3F/_	Powerline single rotor 3F adapter	171
C5051	CC DIM PHASE/1-10V 10W 500mA	265	PL/SAD	Standalone DALI / detection sensor	171
C5052	CC DIM DALI 48Vdc 100-1000mA	265	PL/SC	Silicone compound	169
C5053	CV DRIVER 48Vdc 480W DIN RAIL	266	PL/WBS	Wall bracket	171
C5054	4 zone single color RF remote	276	PL/_/_/O	Powerline ceiling	159
C5055	WiFi to RF control system	276	PL/_/_/S	Powerline suspended	163
C5056	RGB(W) RF wall touch panel	276	PL/_/001	Profile with PC cover	169
C5056	4 zone dual color RF remote	276	PL/_/002	Profile with alu cover	169
C5057	CV DRIVER 24VDC 60W SLIM	266	PL/_DL4/930/_	Dot line R4 / incl. profile 180mm	172
C5058	CV DRIVER 24VDC 96W SLIM	266	PL/_DL7/930/_	Dot line R7 / incl. profile 300mm	172
C5059	CV DRIVER 48VDC 60W SLIM	266	PL/_MT/_/L/	Micro tube single / 7W - 630lm / incl. 180mm profile	172
C5060	CV DIM DALI 24Vdc 100W	266	PL/_MT2/_/L/	Micro tube double / 2x7W - 2x630lm / incl. 280mm profile	172
C5062	CC DIM PHASE/1-10V 10W 350mA SLIM 14-28Vdc	265	PLB/NT/_/L/	Nano tube / 8W - 540lm / incl. profile 180mm	172
C5063	CC DIM PHASE 15W 350mA SLIM 21-46Vdc	265	PLR/180	Profile recessed connector 180°	174
C5064	CC DIM PHASE/1-10V 10W 500mA SLIM 10-20Vdc	265	PLR/90	Profile recessed connector 90°	174
C5065	CC DIM PHASE 15W 500mA SLIM 13.5-30Vdc	265	PLR/BTC	Profile recessed black transparent cover	174
C5066/**mA	CC LED DRIVER 40W 500-700-1050mA	265	PLR/EC/_	Profile recessed end cap	174
C5067	CC DIM PHASE 7W 180-350mA	265	PLR/MBR	Mounting bracket recessed	174
C5068	CC DIM PHASE 7W 350-500mA	265	PLR/_/_/_/L/	Powerline recessed	167
C5069	CC DIM PHASE 10W 500-700mA	265	PLR/_/001	Profile recessed with PC cover	174
C5070	CC LED DRIVER 7W 350mA	265	PLR/_/002	Profile recessed with alu cover	174
C5071/**mA	CC DIM DALI 50W 600-1400mA	265	T1003_/L/	Mini tube T INVITRACK	112
C5072	CC DIM PHASE 10W 250mA	265	T1009_/L/	Mini tube L SUSP T INVITRACK	111
C5073	CC DIM 1-10V 300-1050mA 36W	265	20000876	Dali PS2	271
C5074/**mA	CC DIM DALI 10W 150-700mA	265	24138923	Dali USB programming tool	271
C5075	CV DRIVER 24VDC 60W 3DIN RAIL	266	28001716	Dali Xc-4	272
C5076	CV DRIVER 24VDC 150W 6DIN RAIL	266	555 0 1217 _	3-endcap	261
C5077	CV DRIVER 48VDC 60W 3DIN RAIL	266	555 1 1201 _	3-end feed right	261
C5078	CV DRIVER 48VDC 150W 6DIN RAIL	266	555 1 1202 _	3-end feed left	261
C5079	Casambi module	274	55		

PRODUCT NAME INDEX

PRODUCT NAME	REFERENCE	PAGE	PRODUCT NAME	REFERENCE	PAGE
Ambient light/motion sensor/DALI	PL/ALS	171	CV LED DRIVER 24Vdc 100W IP67	C5034	266
Arrow	A6197_/_/_/	70	CV LED DRIVER 24Vdc 150W IP67	C5023	266
Beacon	A5009_/_/	132	CV LED DRIVER 24Vdc 20W IP67	C5022	266
Beam 150-2	B5009_/_/	208	CV LED DRIVER 24Vdc 35W IP67	C5027	266
Beam 50	B5008_/_/	208	CV LED DRIVER 24Vdc 60W IP67	C5015	266
BFD	A6105_/_/	221	CV LED DRIVER 48Vdc 150W IP67	C5038	266
BFD flex	A6111_/_/	224	CV LED DRIVER 48Vdc 240W DIN RAIL	C5039	266
Black transparent cover	PL/BTC	169	CV LED DRIVER 48Vdc 60W IP67	C5041	266
Cable supply 5x 0,75mm ² - 2m	AT/CS/2000	151	Dali bluetooth control	C5042	270
Cable supply 5x 0,75mm ² - 5m	AT/CS/5000	151	Dali PS2	20000876	271
Cable supply black textile 3x 0,75 mm ² -2m	PL/CS/2000/B	170	Dali push button control	C5040	270
Cable supply black textile 3x 0,75 mm ² -5m	PL/CS/5000/B	170	Dali USB programming tool	24138923	271
Cable supply transparent 3x 0,75mm ² - 2m	PL/CS/2000/T	170	Dali Xc-4	28001716	272
Cable supply transparent 3x 0,75mm ² - 5m	PL/CS/5000/T	170	Daligate Casambi	ATP/DALI-CAS/_/	152
Cable supply transparent 5x 0,75mm ² - 2m	AT/CS/2000/T	170	Disc	A6058_/_/	64
Cable supply transparent 5x 0,75mm ² - 5m	AT/CS/5000/T	170	D-line Suspension	A7101_/_/_/S	175
Carree ES	EXT SU03/_/	198	D-line Wall	A7101_/_/_/WL	176
Carree ES	B2001	198	DOC	A5008_/_/	132
Casambi DALI build-in	PL/CAS	171	Dot line AT	AT1004_/_/_/	146
Casambi module	C5079	274	Dot line R4 / incl. profile 180mm	PL_/_/DL4/930/_/	172
CC DIM PHASE 350mA/18W	C5029	265	Dot line R7 / incl. profile 300mm	PL_/_/DL7/930/_/	172
CC DIM 1-10V 300-1050mA 36W	C5073	265	Dotline S4	A6200_/_/	49
CC DIM 1-10V 350mA/80W	C5046	265	Dotline S7	A6201_/_/	50
CC DIM DALI 10W 150-700mA	C5074/**mA	265	Doxx D126	D126_/_/	116
CC DIM DALI 15W 350-1050mA	C5043/**mA	265	Doxx D154	D154_/_/	117
CC DIM DALI 25W 350-700mA	C5044/**mA	265	Doxx D210	D210_/_/	118
CC DIM DALI 35W 350-1050mA	C5035/**mA	265	D42	D42_/_/	115
CC DIM DALI 48Vdc 100-1000mA	C5052	265	Doxx D70	D70_/_/	115
CC DIM DALI 50W 600-1400mA	C5071/**mA	265	D98	D98_/_/	116
CC DIM PHASE 10W 250mA	C5072	265	Doxx micro tube L AC	D6198_/_/_/	122
CC DIM PHASE 10W 500-700mA	C5069	265	Doxx micro tube L AC	D6173_/_/_/	122
CC DIM PHASE 15W 350mA SLIM 21-46Vdc	C5063	265	Doxx mini tube GU10	D1003_/_/	119
CC DIM PHASE 15W 500mA SLIM 13.5-30Vdc	C5065	265	Doxx mini tube L SUSP GU10	D1006L_/_/_/	121
CC DIM PHASE 350mA/9W	C5045	265	Doxx mini tube L SUSP LED	D1006L_/_/_/	121
CC DIM PHASE 700mA/14W	C5003	265	Doxx mini tube LED	D1003_/_/_/	119
CC DIM PHASE 700mA/14W	C5003	265	Doxx mini tube SUSP GU10	D1006_/_/	120
CC DIM PHASE 7W 180-350mA	C5067	265	Doxx mini tube SUSP LED	D1006_/_/_/	120
CC DIM PHASE 7W 350-500mA	C5068	265	Doxx nano tube L	D6199_/_/_/	123
CC DIM PHASE 1-10V 10W 350mA	C5050	265	Doxx nano tube SUSP	D6191_/_/_/	124
CC DIM PHASE 1-10V 10W 350mA SLIM 14-28Vdc	C5062	265	Drop-It	A6104	230
CC DIM PHASE 1-10V 10W 500mA	C5051	265	Drop-It Track	A6182_/_/	248
CC DIM PHASE 1-10V 10W 500mA SLIM 10-20Vdc	C5064	265	Duo	C8007_/_/	184
CC LED DRIVER 350mA/4W	C5005	265	Duo clip	C8007-B	184
CC LED DRIVER 350mA/8W	C5001	265	Duo end-cap	C8007-E	184
CC LED DRIVER 40W 500-700-1050mA	C5066/**mA	265	Duolite	A6128	228
CC LED DRIVER 700mA/7W	C5002	265	Edna	A6073_/_/	211
CC LED DRIVER 7W 350mA	C5070	265	Edna Deep	A6126_/_/	212
CC/CV Dim Dali/1-10V MULTI DRIVER	C5017	265	Edna flex	A6112_/_/	214
CC/CV Dimmable Multi Led driver Phase dim	C5016	265	Elbeau	A6178_/_/	72
Cielo	C8002_/_/	184	Emergency module 3hrs.	PL/EM	171
Cielo ceiling mounting	C8002-SB	184	End cap	PL/EC/_/	169
Cielo end-cap	C8002-E_/_/	184	End cap feed high track LV	AT/ECF/_/	150
C-line	B5034/_/	206	End cap high track LV	AT/EC/_/	150
C-line recessed	B5035/_/	206	Extra circuit per meter	PL/EC	170
Common alu	A2014	31	Flat Hores	A6149_/_/	246
Common black	A2027	31	Georges D12 IN	A6105D12/_/_/	126
Common Deep	A2036_/_/	35	Georges D12 SUSP AT	AT6204D12/_/_/	143
Common Deep X	A6175_/_/	36	Georges D12 SUSP IN	A6204D12/_/_/	127
Common IP	A2034_/_/	39	Georges D12 SUSP ON	A6204D12/_/_/	128
Common IP white	A2035_/_/	39	Georges D20 ON	A6105D20/_/_/	126
Common IP X	A6125_/_/	40	Georges D9 IN	A6206/_/_/	125
Common S alu	A2032	33	Georges ON AT	AT6206/_/_/	144
Common S trimless	A2039_/_/	47	Georges SUSP AT	AT6204/_/_/	144
Common S trimless X	A6168_/_/	48	Georges SUSP IN	A6204/_/_/	127
Common S white	A2033	33	Georges SUSP ON	A6204/_/_/	128
Common S X	A6124_/_/	34	Georges T	A6207/_/_/	125
Common S/IP	A2037_/_/	41	Halos CW	B2007	200
Common S/IP X	A6166_/_/	42	Halos RGB	B2008	200
Common SQ	A2040_/_/	27	Halos WW	B2006	200
Common SQ X	A6210_/_/	28	Icon	B3010/_/830	193
Common SQ2	A2041_/_/	29	Inline driver KIT 60W	ATP/60W/PS/_/	152
Common SQ2	A6211_/_/	30	Kwadru	C8005_/_/	183
Common trimless	A2038_/_/	43	Kwadru end-cap	C8005-E_/_/	183
Common trimless X	A6167_/_/	44	Led emergency module	C5033	274
Common white	A2015	31	Led flex	C70_/_/_/	189
Common X	A6123_/_/	32	Led pcb	C710_/_/	192
Cornu	C8003_/_/	183	Limbus CW	B2004	199
Cornu brace	C8003B	183	Limbus RGB	B2005	199
Cornu end-cap	C8003-E_/_/	183	Limbus WW	B2003	199
Costa CW	B2016	194	Line IN AT	AT1001/_/_/_/	145
Costa D CW	B2018	194	Line IN black transparent cover AT	AT1001/BTC/_/_/_/	145
Costa D WW	B2017	194	Line OR AT	AT1003_/_/_/_/	148
Costa WW	B2015	194	Line OR black transparent cover	AT1003_/_/_/_/	148
Cover	AT/COVER/_/	152	Line OUT AT	AT1002/_/_/_/	146
Crater	A6153_/_/	21	Linea	C8004_/_/	180
CV DIM DALI 24VDC 100W	C5060	266	Linea brace	C8004-B	180
CV DIM DALI 24Vdc 150W	C5049	266	Linea end-cap	C8004-E_/_/	180
CV DIM DALI 24Vdc 60W	C5048	266	Low	C8006	180
CV DRIVER 24VDC 150W 6DIN RAIL	C5076	266	Low end-cap	C8006-E	180
CV DRIVER 24Vdc 240W IP67	C5047	266	Magn. connector	ATP/MFL/_/	150
CV DRIVER 24VDC 60W 3DIN RAIL	C5075	266	Magn. feed left LV polarised	ATP/EFL/_/	150
CV DRIVER 24VDC 60W SLIM	C5057	266	Magn. feed right LV polarised	ATP/EFR/_/	150
CV DRIVER 24VDC 96W SLIM	C5058	266	Magn. flex connector	ATP/FC/_/	150
CV DRIVER 48Vdc 150W 6DIN RAIL	C5078	266	Magn. high track L-bracket	AT/LB	151
CV DRIVER 48Vdc 480W DIN RAIL	C5053	266	Magn. high track long pendant bracket	AT/LPB	151
CV DRIVER 48VDC 60W 3DIN RAIL	C5077	266	Magn. high track short pendant bracket	AT/SPB	150
CV DRIVER 48VDC 60W SLIM	C5059	266	Magn. high track suspension set 2m	AT/PS/2000	151
CV LED DRIVER 12Vdc 20W IP67	C5021	266	Magn. high track suspension set 5m	AT/PS/5000	151
CV LED DRIVER 12Vdc 60W IP65	C5010	266	Magn. Trimless joining connector black	AT/TJC/B	151

PRODUCT NAME INDEX

PRODUCT NAME	REFERENCE	PAGE	PRODUCT NAME	REFERENCE	PAGE
Magnetic high track	AT/HO/_/_/	150	NovusPlus	C8011_/_/	179
Magnetic high track trimless	AT/HT/_/_/	150	NovusPlus black transparent cover	C8011_/_/BTC	179
Marker	A6196_/_/_/	70	NovusPlus brace	C8011-B	179
Micro tube 2 AT	A6190_/_/_/	138	NovusPlus end-cap	C8011-E_/_/	179
Micro tube 2 ON	A6173_/_/2O/_/	78	NovusPlus profile connector	C8001-C	179
Micro tube 2 ON RECT	A6173_/_/2OR/_/	79	Olla	A6157W/_/	60
Micro tube 3 ON	A6173_/_/3O/_/	80	Olla OR	A6158W/_/	60
Micro tube AT	A6189_/_/_/	137	Par X	A6180	112
Micro tube double / 2x7W - 2x630lm / incl. 280mm profile	PL_/_/MT2/_/_/	172	Piccolo	A6134_/_/	55
Micro tube ebony veneer	C6031/EBO	260	Piccolo 120	A6160_/_/	216
Micro tube FL AC	A6113_/_/_/	81	Piccolo 80	A6141_/_/	55
Micro tube IN	A6173_/_/_/	74	Piccolo 80 ON	A6169_/_/	56
Micro tube IN-FLEX	A6188_/_/_/	74	Piccolo 80 X	A6159_/_/	56
Micro tube L AC 2 ON	A6198_/_/2O/_/	82	Piccolo alu	A6133	55
Micro tube L AC 3 ON	A6198_/_/3O/_/	84	Plastercover	AT/COVPLAS	152
Micro tube L AC IN	A6198_/_/_/	81	Power disc	A6122_/_/	64
Micro tube L AC IN-TRAC	A6184_/_/_/	84	Powerdot	EXT RU05/_/	197
Micro tube L AC ON	A6198_/_/O/_/	82	Powerdot WW	B2001	197
Micro tube Oak veneer	C6031/OAK	260	Powerline ceiling	PL_/_/_/_/O	159
Micro tube ON	A6173_/_/_/	76	Powerline double 3F adapter	PL/D3F/_/_/	171
Micro tube ON RECT	A6173_/_/OR/_/	77	Powerline recessed	PLR_/_/_/_/	167
Micro tube R	A6151_/_/_/	73	Powerline single rotor 3F adapter	PL/S3F/_/_/	171
Micro tube R trimless	A6152_/_/_/	73	Powerline suspended	PL_/_/_/_/S	163
Micro tube single / 7W - 630lm / incl. 180mm profile	PL_/_/MT/_/_/	172	Profile connector 180°	PI/180	169
Micro tube walnut veneer	C6031/WALN	260	Profile connector 90°	PI/90	169
Midi tube IN	A6208_/_/_/	243	Profile cut 180° / 45°	PL/PC45	169
Midi tube INVITRACK	A6209_/_/_/	242	Profile cut 45°	PL/PC45	174
Midi tube ON	A6208_/_/O	244	Profile recessed black transparent cover	PLR/BTC	174
Midi tube ON	A6135_/_/_/	217	Profile recessed connector 180°	PLR/180	174
Mini BFD	A6136_/_/_/	222	Profile recessed connector 90°	PLR/90	174
Mini BFD assymetric	A6143_/_/_/	223	Profile recessed end cap	PLR/EC/_/	174
Mini BFD flex	A6177_/_/_/	218	Profile recessed with alu cover	PLR_/_/002	174
Mini BFD plus	A6185_/_/_/	21	Profile recessed with PC cover	PLR_/_/001	174
Mini crater	A6195_/_/_/	22	Profile with alu cover	PL_/_/002	169
Mini crater IP	A6186_/_/_/	22	Profile with PC cover	PL_/_/001	169
Mini crater OUT	A6139	62	Push button dimming / DALI versions	PL/PBA	171
Mini duolite trimless	A1004_/_/_/	95	Recessed connecting box 60mm	AT/RC/60/_/	170
Mini tube 2 ON GU10	A1004_/_/_/	95	Recessed connecting box 90mm	AT/RC90/_/	170
Mini tube 2 ON LED	A1005_/_/_/	98	RE-LED	C1001/_/_/	277
Mini tube 3 ON GU10	A1005_/_/_/	98	RE-LED 1200	C1003/_/_/	278
Mini tube 3 ON LED	A1008_/_/_/	90	RE-LED AC	C1002/_/_/	277
Mini tube F ON GU10	A1008_/_/_/	90	Re-light module	C2001	249
Mini tube F ON LED	A1008_/_/_/	90	RGB(W) 4-channel RF constant voltage controller	C5013-2	276
Mini tube IN GU10	A1002_/_/_/	86	RGB(W) RF led remote control	C5012-3	276
Mini tube IN LED	A1002_/_/_/	87	RGB(W) RF wall touch panel	C5056	276
Mini tube IN-TRAC GU10	A1003_/_/_/	107	Ribs	A6148	130
Mini tube IN-TRAC LED	A1003_/_/_/	107	Silicone compound	PL/SC	169
Mini tube L SUSP IN GU10	A1006L/_/_/	102	Standalone DALI / detection sensor	PL/SAD	171
Mini tube L SUSP IN LED	A1006L/_/_/	102	Terra spike	B1015	202
Mini tube L SUSP IN-TRAC GU10	A1009L_/_/_/	110	Trumpet	A6068_/_/	51
Mini tube L SUSP IN-TRAC LED	A1009L_/_/_/	110	Trumpet Flex	A6144_/_/	52
Mini tube L SUSP ON GU10	A1006L/_/_/	101	Trumpet white	A6069	51
Mini tube L SUSP ON LED	A1006L/_/_/	101	Tube F AT	AT1613_/_/	140
Mini tube L SUSP T INVITRACK	T1009_/_/_/	111	Tube F IN	A6165_/_/	232
Mini tube ON GU10	A1001_/_/_/	92	Tube F INVITRACK	A6202_/_/	240
Mini tube ON IN-TRAC GU10	A1007_/_/_/	108	Tube F ON	A6164_/_/	233
Mini tube ON IN-TRAC LED	A1007_/_/_/	108	Tube F ON 2 rect	A6179_/_/	234
Mini tube ON LED	A1001_/_/_/	92	Tube IN flex	A6181_/_/	231
Mini tube recessed	A6187_/_/_/	86	Tube ON	A6145_/_/	236
Mini tube RECT 2 X ON	A6172_/_/_/	96	Tube SUSP	A6137_/_/	237
Mini tube RECT X ON	A6177_/_/_/	94	Tube TRACK	A6150_/_/	238
Mini tube SUSP IN GU10	A1006_/_/_/	100	Turio R	A6194_/_/	26
Mini tube SUSP IN LED	A1006_/_/_/	100	Turio S	A6192_/_/	25
Mini tube SUSP IN-TRAC GU10	A1009_/_/_/	109	Turio S2	A6193_/_/	25
Mini tube SUSP IN-TRAC LED	A1009_/_/_/	109	Unilite	A6127	227
Mini tube SUSP ON GU10	A1006_/_/O	99	Vega R	B2019	201
Mini tube SUSP ON LED	A1006_/_/O/_/	99	Vega S	B2020	201
Mini tube T INVITRACK	T1003_/_/_/	112	Viktor	B1020/_/	204
Mini tube X AT	AT6146_/_/	139	Viktor corten	B1019_/_/	204
Mini tube X IN	A6147_/_/_/	88	Viktor N	B1018_/_/	204
Mini tube X L SUSP INVITRACK	A6212L_/_/	241	Vuelta AS trimless	A6156_/_/	69
Mini tube X ON	A6161_/_/_/	93	Vuelta trimless	A6155_/_/	69
Mini tube X SUSP	A6162_/_/_/	105	Wall bracket	PL/WBS	171
Mini tube XL SUSP	A6162L_/_/	106	Wide beam module	C2002	250
Mini unilite trimless	A6138	62	WiFi to RF control system	C5055	276
Minus TR	C8008	186	12-24Vdc to 350mA DIM converter	C5030	263
Minus TR IN	C8009	186	1x 10A PWM dimmer	C5014	269
Minus TR OUT	C8010	186	3-cover pvc	88-888_/_/	261
Mirador	A6083_/_/	63	3-end feed left	555 1 1202_/_/	261
Mirador RGB-W	A6121	63	3-end feed right	555	



ABOUT US

Established in 2005, Exerus is a young and dynamic company with a focus on LED-lighting. We are proud to present a full range of quality lighting, built to the highest standards by using the finest components. Our state of the art made-to-measure services provide you with project- and OEM related products.

Our goal is to satisfy our clients with innovative products and solutions of outstanding quality.



R&D

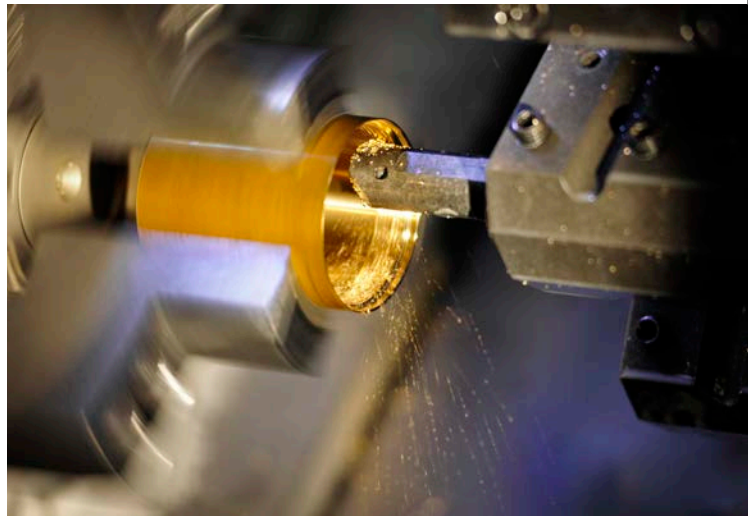

The skilled designers and engineers at our R&D department do not only surprise people with breakthrough innovations, but also create made-to-measure solutions for architects and lighting designers.

Our goal is to create products that are not only aesthetically pleasing, but also technically advanced, innovative, sustainable and meeting the highest quality standards. That's why our light fixtures are equipped with the most recent state-of-the-art LED technologies.

In our laboratory, we are able to check all photometric data such as amount, colour and quality of the emitted light from our luminaires.

Our extensive machinery and assembly area allow us to develop and produce every single thing in-house. That means we're quick to respond, thus saving you considerable time and money. And above all: we do not shy away from any challenge.

In order to make quick deliveries, we always keep a large stock of standard products and parts.



21



27



31



49



52



48



70



69



74



21



86



22



73



60

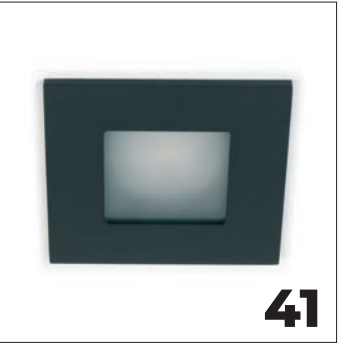

41



29



51

INTERIOR RECESSED



33



63



81



39



43



70



36



50



66



60



64



62



72



69



74



55



INTERIOR SURFACE



INTERIOR WALL

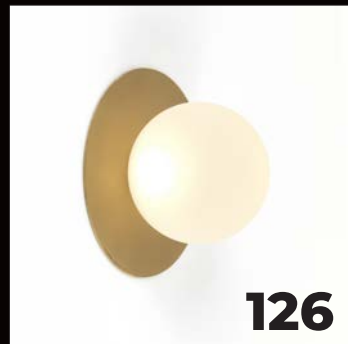

INTERIOR SUSPENSION

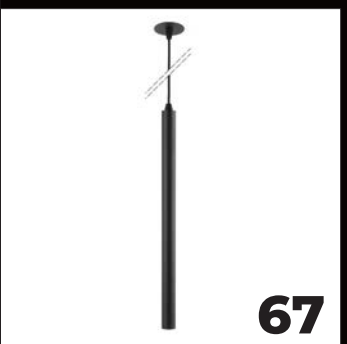



228



240



231



212



236



238



241



211

SHOPLINE



227



234



216



237



223



246

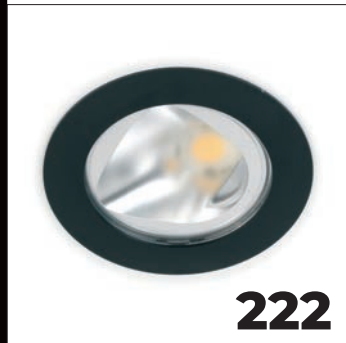

222



214



232



217



244



242

LED FLEX



248



190



189



189



192



190

PROFILES



113



179



167

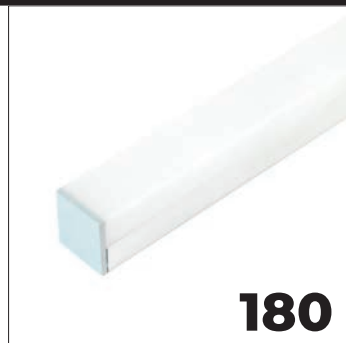

180



184



175



179



183



159



180

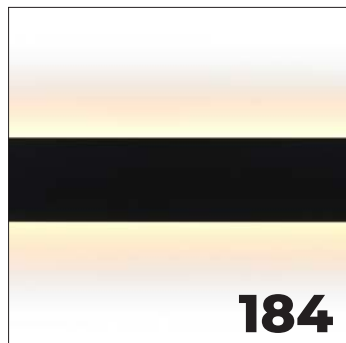

184



183



163

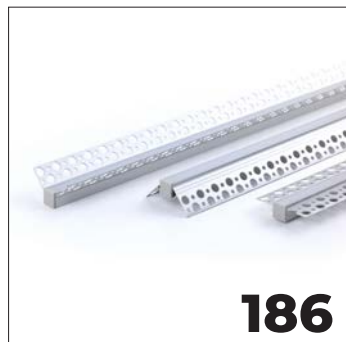

186



193



200



201

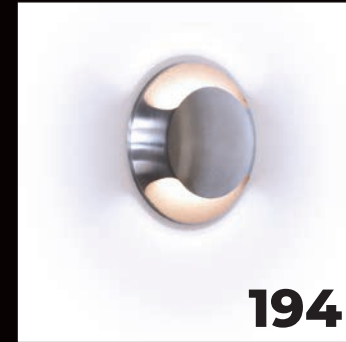

194

EXTERIOR



193



202



197



194



22



204

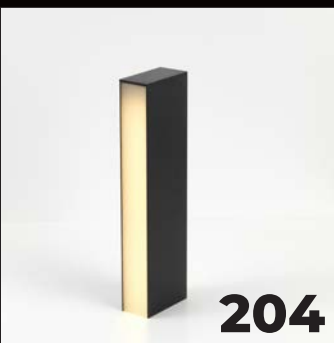

204



202



199



208



201



203

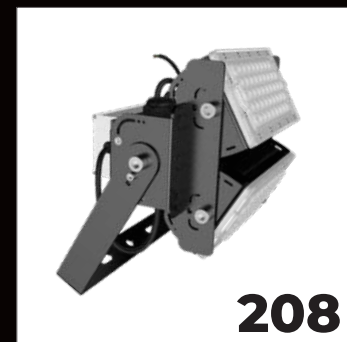

208



198



CRATER

REF	A6153W/927	Crater white 927
	A6153W/930	Crater white 930
	A6154B/927	Crater black 927
	A6154B/930	Crater black 930

LED	COB LED
LED LM OUTPUT	630 lm
POWER CONS.	7 W
DRIVE CURRENT	700 mA 10 Vdc max.
COLOR TEMP.	2.700 / 3.000 K
CRI	+90
REFLECTOR	36°
FINISH	white RAL 9016 tex black RAL 9005 tex
ADJUSTABLE	n/a
CUT-OUT	Ø 75 mm
REMARK	supplied with additional blade springs driver not included - see driver matrix p. 267

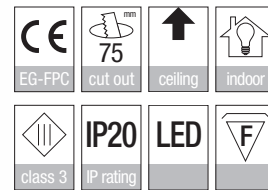
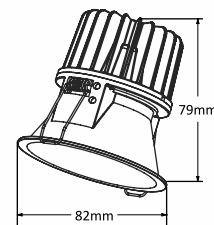
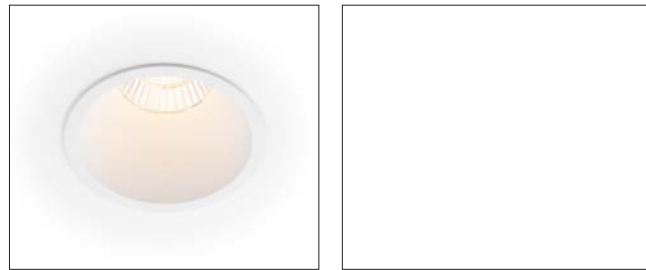

MINI CRATER IP

REF	A6195W/927	Mini Crater IP white 927
	A6195W/930	Mini Crater IP white 930
	A6195B/927	Mini Crater IP black 927
	A6195B/930	Mini Crater IP black 930

LED	COB LED
LED lm output	460 lm
POWER CONS.	5 W
DRIVE CURRENT	500 mA 10 Vdc max.
COLOR TEMP.	2.700 / 3.000 K
CRI	>90
REFLECTOR	36°
FINISH	white RAL 9016 tex black RAL 9005 tex
ADJUSTABLE	n/a
CUT-OUT	Ø 45 mm
REMARK	supplied with blade springs driver not included - see driver matrix p. 267

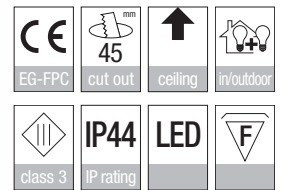
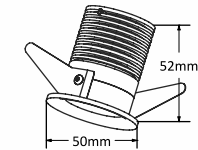

MINI CRATER

REF	A6185W/927	Mini Crater white 927
	A6185W/930	Mini Crater white 930
	A6185B/927	Mini Crater black 927
	A6185B/930	Mini Crater black 930

LED	COB LED
LED LM OUTPUT	460 lm
POWER CONS.	5 W
DRIVE CURRENT	500 mA 10 Vdc max.
COLOR TEMP.	2.700 / 3.000 K
CRI	+90
REFLECTOR	25°
FINISH	white RAL 9016 tex black RAL 9005 tex
ADJUSTABLE	20°
CUT-OUT	Ø 45 mm
REMARK	driver not included - see driver matrix p. 267

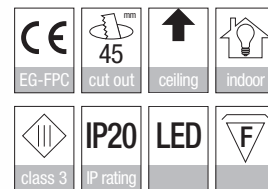
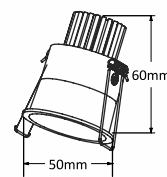
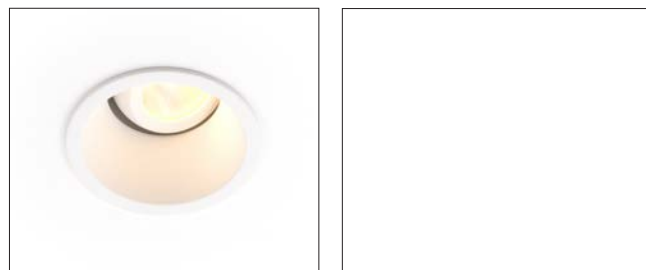

MINI CRATER OUT

REF	A6186W/927	Mini Crater Out white 927
	A6186W/930	Mini Crater Out white 930
	A6186B/927	Mini Crater Out black 927
	A6186B/930	Mini Crater Out black 930

LED	COB LED
LED LM OUTPUT	320 lm
POWER CONS.	3 W
DRIVE CURRENT	350 mA 10 Vdc
COLOR TEMP.	2.700 / 3.000 K
CRI	+90
REFLECTOR	40°
FINISH	white RAL 9016 tex black RAL 9005 tex
ADJUSTABLE	n/a
CUT-OUT	Ø 49 mm
REMARK	in- and outdoor use driver not included - see driver matrix p. 267

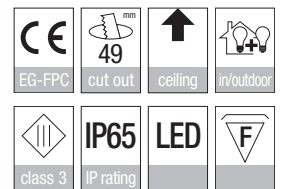
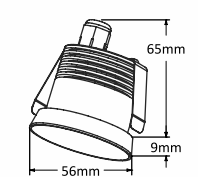





TURIO S

REF	A6192W/927	Turio S white 927
	A6192W/930	Turio S white 930
	A6192B/927	Turio S black 927
	A6192B/930	Turio S black 930

LED	COB LED
LED LM OUTPUT	700 lm
POWER CONS.	8 W
DRIVE CURRENT	230 Vac built-in driver
COLOR TEMP.	2.700 / 3.000 K
CRI	>90
REFLECTOR	36°
FINISH	white RAL 9016 tex black RAL 9005 tex
ADJUSTABLE	30°x355°
CUT-OUT	n/a
REMARK	mains dimmable (leading & trailing)

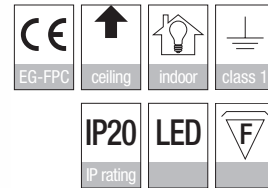
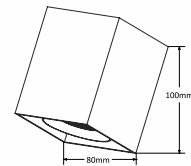

TURIO R

REF	A6194W/927	Turio R white 927
	A6194W/930	Turio R white 930
	A6194B/927	Turio R black 927
	A6194B/930	Turio R black 930

LED	COB LED
LED LM OUTPUT	700 lm
POWER CONS.	8 W
DRIVE CURRENT	230 Vac built-in driver
COLOR TEMP.	2.700 / 3.000 K
CRI	>90
REFLECTOR	36°
FINISH	white RAL 9016 tex black RAL 9005 tex
ADJUSTABLE	30°x355°
CUT-OUT	n/a
REMARK	mains dimmable (leading & trailing)

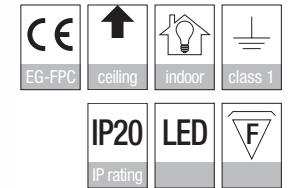
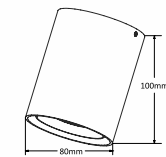

TURIO S2

REF	A6193W/927	Turio S2 white 927
	A6193W/930	Turio S2 white 930
	A6193B/927	Turio S2 black 927
	A6193B/930	Turio S2 black 930

LED	COB LED
LED LM OUTPUT	2x 700 lm
POWER CONS.	2x 8 W
DRIVE CURRENT	230 Vac built-in driver
COLOR TEMP.	2.700 / 3.000 K
CRI	>90
REFLECTOR	36°
FINISH	white RAL 9016 tex black RAL 9005 tex
ADJUSTABLE	30°x355°
CUT-OUT	n/a
REMARK	mains dimmable (leading & trailing)

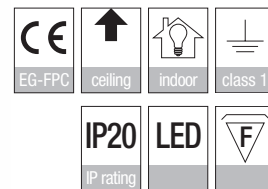
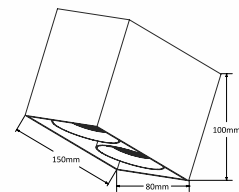



COMMON SQ

REF	A2040W A2040B	Common SQ white Common SQ black
-----	------------------	------------------------------------

LAMP	QPAR51 50 W max. / LED bulb
BASE	GU10
FINISH	white RAL 9016 tex black RAL 9005 tex
ADJUSTABLE	0° - 15°
CUT-OUT	75 x 75 mm
REMARK	fits all LED replacement bulbs blade springs for gypsum and concrete mounting

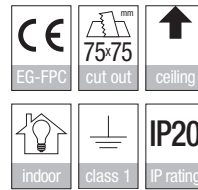
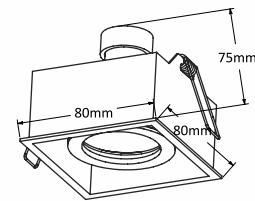

ACCESSORIES / FOR TECHNICAL INFO SEE P. 277

RE-LED	
C1001/827	Re-LED 827 36° 780 lm @ 500 mA
C1001/830	Re-LED 830 36° 780 lm @ 500 mA
C1001/827/KIT	Re-LED 827 36° incl. driver phase / 1-10 V
C1001/830/KIT	Re-LED 830 36° incl. driver phase / 1-10 V
RE-LED 1200	
C1003/927/24	Re-LED 1200 927 24° 1.200 lm @ 350 mA
C1003/927/36	Re-LED 1200 927 36° 1.200 lm @ 350 mA
C1003/930/24	Re-LED 1200 930 24° 1.200 lm @ 350 mA
C1003/930/36	Re-LED 1200 930 36° 1.200 lm @ 350 mA
RE-LED AC	
C1002/927/24	Re-LED AC 927 24°
C1002/927/36	Re-LED AC 927 36°
C1002/930/24	Re-LED AC 930 24°
C1002/930/36	Re-LED AC 930 36°
OPTIONS	
C6028	Plexi inlay Common series
C6026	Honeycomb Common Series

COMMON SQ X

REF	A6210W A6210B	Common SQ X white Common SQ X black
-----	------------------	--

LED	Xicato
LED LM OUTPUT	700 / 1.300 lm
POWER CONS.	according to lumen output - see table p. 255
COLOR TEMP.	2.700 / 3.000 / 4.000 K
CRI	80 or +95
COLOR QUAL.	artist / beauty / vibrant / vibrant artist
REFLECTOR	16° / 40° / 60°
FINISH	white RAL 9016 tex black RAL 9005 tex
ADJUSTABLE	n/a
CUT-OUT	75 x 75 mm
DRIVE CURRENT	supplied with driver
REMARK	with blade springs

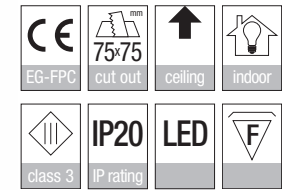
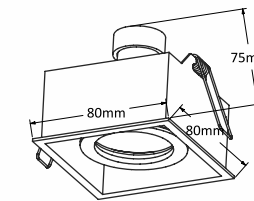
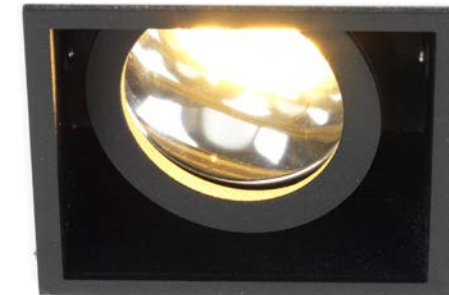

MODEL	REFERENCE	LM OUTPUT	CRI / CCT	BEAM	DIMMING
COMMON SQ X WHITE COMMON SQ X BLACK	A6210W	700 lm	827 - 830 - 840 - V830	16°	ND
			927 - 930 - 940 - V930 - BT	40°	PD
	A6210B	1.300 lm	827 - 830 - 840 - V830	60°	A
			927 - 930 - 940 - V930 - BT	40° / 60°	D

ND: non dimmable / PD: phase dimming / A: 1-10V / D: DALI

COMMON SQ2



REF	A2041W A2041B	Common SQ2 white Common SQ2 black
-----	------------------	--------------------------------------

LAMP	QPAR51 50 W max. / LED bulb
BASE	GU10
FINISH	white RAL 9016 tex black RAL 9005 tex
ADJUSTABLE	0° - 15°
CUT-OUT	146 x 75 mm
REMARK	fits all LED replacement bulbs wire springs

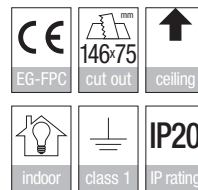
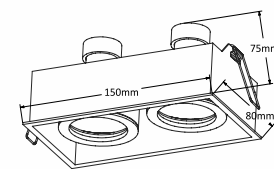

ACCESSORIES / FOR TECHNICAL INFO SEE P. 277

RE-LED

C1001/827	Re-LED 827 36° 780 lm @ 500 mA
C1001/830	Re-LED 830 36° 780 lm @ 500 mA
C1001/827/KIT	Re-LED 827 36° incl. driver phase / 1-10 V
C1001/830/KIT	Re-LED 830 36° incl. driver phase / 1-10 V

RE-LED 1200

C1003/927/24	Re-LED 1200 927 24° 1.200 lm @ 350 mA
C1003/927/36	Re-LED 1200 927 36° 1.200 lm @ 350 mA
C1003/930/24	Re-LED 1200 930 24° 1.200 lm @ 350 mA
C1003/930/36	Re-LED 1200 930 36° 1.200 lm @ 350 mA

RE-LED AC

C1002/927/24	Re-LED AC 927 24°
C1002/927/36	Re-LED AC 927 36°
C1002/930/24	Re-LED AC 930 24°
C1002/930/36	Re-LED AC 930 36°

OPTIONS

C6028	Plexi inlay Common series
C6026	Honeycomb Common Series



COMMON SQ2 X

REF	A6211W A6211B	Common SQ2 X white Common SQ2 X black
-----	------------------	--

LED	Xicato
LED LM OUTPUT	2x 700 / 2x 1.300 lm
POWER CONS.	according to lumen output - see table p. 255
COLOR TEMP.	2.700 / 3.000 / 4.000 K
CRI	80 or +95
COLOR QUAL.	artist / beauty / vibrant / vibrant artist
REFLECTOR	16° / 40° / 60°
FINISH	white RAL 9016 tex black RAL 9005 tex
ADJUSTABLE	n/a
CUT-OUT	146 x 75 mm
DRIVE CURRENT	supplied with driver
REMARK	wire springs

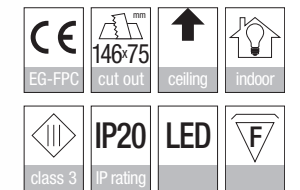
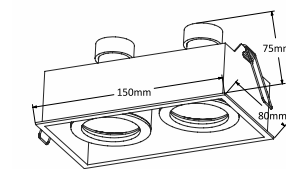

MODEL	REFERENCE	LM OUTPUT	CRI / CCT	BEAM	DIMMING
COMMON SQ2 X WHITE COMMON SQ2 X BLACK	A6211W A6211B	2x 700 lm	827 - 830 - 840 - V830	16°	ND
			927 - 930 - 940 - V930 - BT	40°	PD
	2x 1.300 lm	827 - 830 - 840 - V830	60°	A	
		927 - 930 - 940 - V930 - BT	40° / 60°	D	

ND: non dimmable / PD: phase dimming / A: 1-10V / D: DALI



COMMON

REF	A2014	Common alu
	A2015	Common white
	A2027	Common black

LAMP	QPAR51 50 W max. / LED bulb
BASE	GU10
FINISH	anodised aluminium white RAL 9016 tex black RAL 9005 tex
ADJUSTABLE	0° - 15°
CUT-OUT	Ø 80 mm
REMARK	fits all LED replacement bulbs blade springs for gypsum and concrete mounting

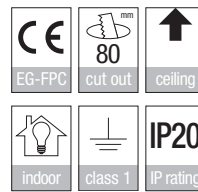
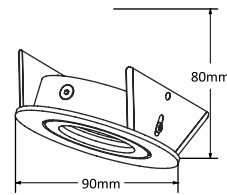

ACCESSORIES / FOR TECHNICAL INFO SEE P. 277

RE-LED

C1001/827	Re-LED 827 36° 780 lm @ 500 mA
C1001/830	Re-LED 830 36° 780 lm @ 500 mA
C1001/827/KIT	Re-LED 827 36° incl. driver phase / 1-10 V
C1001/830/KIT	Re-LED 830 36° incl. driver phase / 1-10 V

RE-LED 1200

C1003/927/24	Re-LED 1200 927 24° 1.200 lm @ 350 mA
C1003/927/36	Re-LED 1200 927 36° 1.200 lm @ 350 mA
C1003/930/24	Re-LED 1200 930 24° 1.200 lm @ 350 mA
C1003/930/36	Re-LED 1200 930 36° 1.200 lm @ 350 mA

RE-LED AC

C1002/927/24	Re-LED AC 927 24°
C1002/927/36	Re-LED AC 927 36°
C1002/930/24	Re-LED AC 930 24°
C1002/930/36	Re-LED AC 930 36°

OPTIONS

C6028	Plexi inlay Common series
C6026	Honeycomb Common Series



COMMON X

REF	A6123A	Common X alu
	A6123W	Common X white
	A6123B	Common X black

LED	Xicato
LED LM OUTPUT	700 / 1.300 lm
POWER CONS.	according to lumen output - see table p. 255
COLOR TEMP.	2.700 / 3.000 / 4.000 K
CRI	80 or +95
COLOR QUAL.	artist / beauty / vibrant / vibrant artist
REFLECTOR	16° / 40° / 60°
FINISH	anodised white RAL 9016 tex black RAL 9005 tex
ADJUSTABLE	n/a
CUT-OUT	Ø 80 mm
DRIVE CURRENT	supplied with driver
REMARK	with blade springs

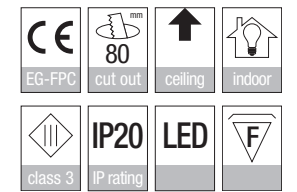
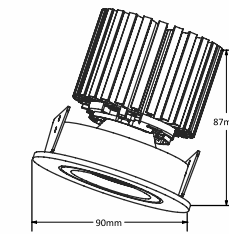

MODEL	REFERENCE	LM OUTPUT	CRI / CCT	BEAM	DIMMING
COMMON X ALU COMMON X WHITE COMMON X BLACK	A6123A A6123W A6123B	700 lm	827 - 830 - 840 - V830	16°	ND
			927 - 930 - 940 - V930 - BT	40°	PD
	1.300 lm	827 - 830 - 840 - V830	60°	A	
		927 - 930 - 940 - V930 - BT	40° / 60°	D	

ND: non dimmable / PD: phase dimming / A: 1-10V / D: DALI



COMMON S

REF	A2032	Common S alu
	A2033	Common S white

LAMP	QPAR51 50 W max. / LED bulb
BASE	GU10
FINISH	anodised aluminium white RAL 9016 tex black RAL 9005 tex
ADJUSTABLE	0° - 15°
CUT-OUT	Ø 80 mm
REMARK	fits all LED replacement bulbs blade springs for gypsum and concrete mounting

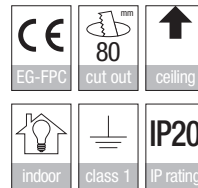
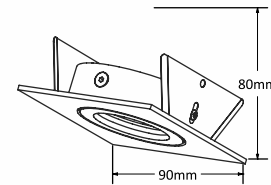

ACCESSORIES / FOR TECHNICAL INFO SEE P. 277

RE-LED

C1001/827	Re-LED 827 36° 780 lm @ 500 mA
C1001/830	Re-LED 830 36° 780 lm @ 500 mA
C1001/827/KIT	Re-LED 827 36° incl. driver phase / 1-10 V
C1001/830/KIT	Re-LED 830 36° incl. driver phase / 1-10 V

RE-LED 1200

C1003/927/24	Re-LED 1200 927 24° 1.200 lm @ 350 mA
C1003/927/36	Re-LED 1200 927 36° 1.200 lm @ 350 mA
C1003/930/24	Re-LED 1200 930 24° 1.200 lm @ 350 mA
C1003/930/36	Re-LED 1200 930 36° 1.200 lm @ 350 mA

RE-LED AC

C1002/927/24	Re-LED AC 927 24°
C1002/927/36	Re-LED AC 927 36°
C1002/930/24	Re-LED AC 930 24°
C1002/930/36	Re-LED AC 930 36°

OPTIONS

C6028	Plexi inlay Common series
C6026	Honeycomb Common Series

COMMON S X

REF	A6124A	Common S X alu
	A6124W	Common S X white

LED	Xicato
LED LM OUTPUT	700 / 1.300 lm
POWER CONS.	according to lumen output - see table p. 255
COLOR TEMP.	2.700 / 3.000 / 4.000 K
CRI	80 or +95
COLOR QUAL.	artist / beauty / vibrant / vibrant artist
REFLECTOR	16° / 40° / 60°
FINISH	anodised aluminium white RAL 9016 tex
ADJUSTABLE	n/a
CUT-OUT	Ø 80 mm
DRIVE CURRENT	supplied with driver
REMARK	with blade springs

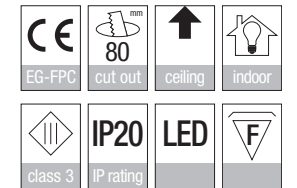
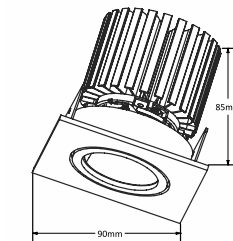
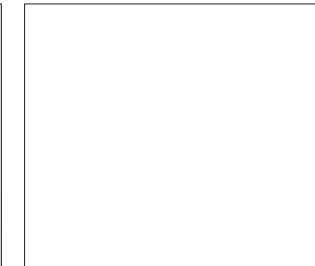

MODEL	REFERENCE	LM OUTPUT	CRI / CCT	BEAM	DIMMING
COMMON S X ALU COMMON S X WHITE	A6124A A6124W	700 lm	827 - 830 - 840 - V830	16°	ND
			927 - 930 - 940 - V930 - BT	40°	PD
		1.300 lm	827 - 830 - 840 - V830	60°	A
			927 - 930 - 940 - V930 - BT	40° / 60°	D

ND: non dimmable / PD: phase dimming / A: 1-10V / D: DALI



COMMON IP



REF	A2034	Common IP alu
	A2035	Common IP white
	A2034B	Common IP black

LAMP	MR16 12 V 35 W max. LED replacement bulb
BASE	GU10
FINISH	anodised aluminium white RAL 9016 tex black RAL 9005 tex
ADJUSTABLE	n/a
CUT-OUT	Ø 80 mm
REMARK	fits all LED replacement bulbs blade springs for gypsum and concrete mounting

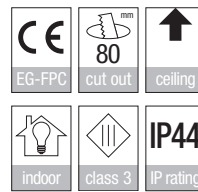
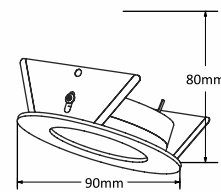

ACCESSORIES / FOR TECHNICAL INFO SEE P. 277

RE-LED

C1001/827	Re-LED 827 36° 780 lm @ 500 mA
C1001/830	Re-LED 830 36° 780 lm @ 500 mA
C1001/827/KIT	Re-LED 827 36° incl. driver phase / 1-10 V
C1001/830/KIT	Re-LED 830 36° incl. driver phase / 1-10 V

RE-LED 1200

C1003/927/24	Re-LED 1200 927 24° 1.200 lm @ 350 mA
C1003/927/36	Re-LED 1200 927 36° 1.200 lm @ 350 mA
C1003/930/24	Re-LED 1200 930 24° 1.200 lm @ 350 mA
C1003/930/36	Re-LED 1200 930 36° 1.200 lm @ 350 mA

RE-LED AC

C1002/927/24	Re-LED AC 927 24°
C1002/927/36	Re-LED AC 927 36°
C1002/930/24	Re-LED AC 930 24°
C1002/930/36	Re-LED AC 930 36°

COMMON IP X



REF	A6125A	Common IP X alu
	A6125W	Common IP X white
	A6125B	Common IP X black

LED	Xicato
LED LM OUTPUT	700 / 1.300 lm
POWER CONS.	according to lumen output - see table p. 255
COLOR TEMP.	2.700 / 3.000 / 4.000 K
CRI	80 or +95
COLOR QUAL.	artist / beauty / vibrant / vibrant artist
REFLECTOR	16° / 40° / 60°
FINISH	anodised aluminium white RAL 9016 tex black RAL 9005 tex
ADJUSTABLE	n/a
CUT-OUT	Ø 80 mm
DRIVE CURRENT	supplied with driver
REMARK	with blade springs

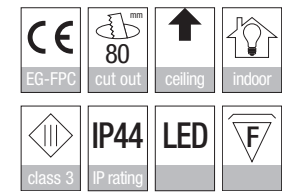
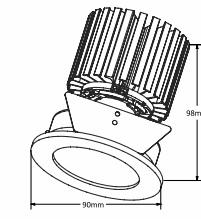

MODEL	REFERENCE	LM OUTPUT	CRI / CCT	BEAM	DIMMING
COMMON IP X ALU COMMON IP X WHITE COMMON IP X BLACK	A6125A A6125W A6125B	700 lm	827 - 830 - 840 - V830	16°	ND
			927 - 930 - 940 - V930 - BT	40°	PD
	1.300 lm	827 - 830 - 840 - V830	60°	A	
		927 - 930 - 940 - V930 - BT	40° / 60°	D	

ND: non dimmable / PD: phase dimming / A: 1-10V / D: DALI

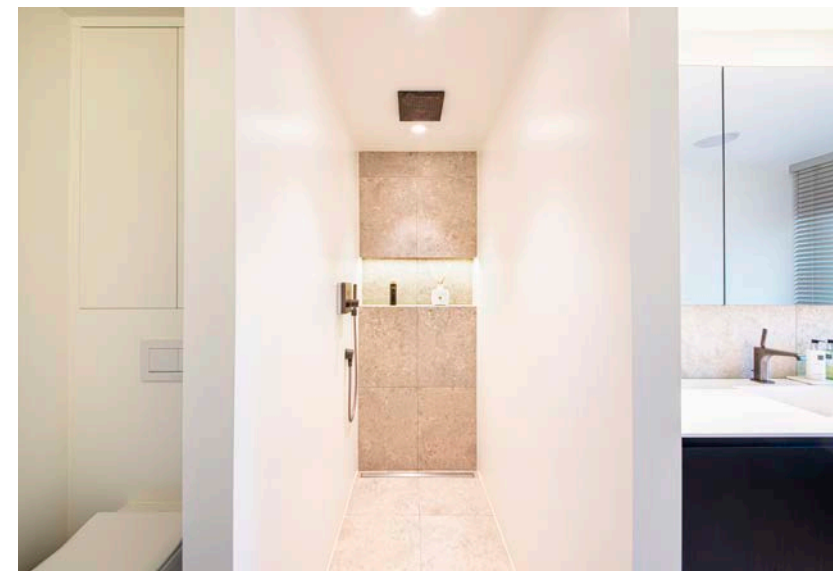

COMMON S/IP

REF	A2037A	Common S/IP alu
	A2037W	Common S/IP white
	A2037B	Common S/IP black

LAMP	MR16 12 V 35 W max. LED replacement bulb
BASE	GU10
FINISH	anodised aluminium white RAL 9016 tex black RAL 9005 tex
ADJUSTABLE	n/a
CUT-OUT	Ø 80 mm
REMARK	fits all LED replacement bulbs blade springs for gypsum and concrete mounting

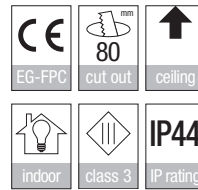
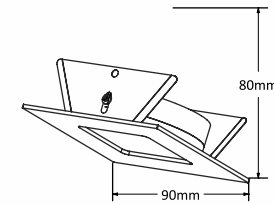
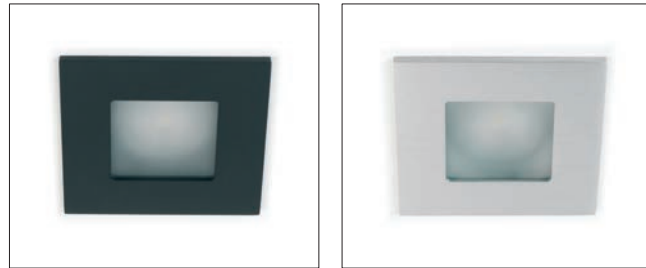

ACCESSORIES / FOR TECHNICAL INFO SEE P. 277

RE-LED

C1001/827	Re-LED 827 36° 780 lm @ 500 mA
C1001/830	Re-LED 830 36° 780 lm @ 500 mA
C1001/827/KIT	Re-LED 827 36° incl. driver phase / 1-10 V
C1001/830/KIT	Re-LED 830 36° incl. driver phase / 1-10 V

RE-LED 1200

C1003/927/24	Re-LED 1200 927 24° 1.200 lm @ 350 mA
C1003/927/36	Re-LED 1200 927 36° 1.200 lm @ 350 mA
C1003/930/24	Re-LED 1200 930 24° 1.200 lm @ 350 mA
C1003/930/36	Re-LED 1200 930 36° 1.200 lm @ 350 mA

RE-LED AC

C1002/927/24	Re-LED AC 927 24°
C1002/927/36	Re-LED AC 927 36°
C1002/930/24	Re-LED AC 930 24°
C1002/930/36	Re-LED AC 930 36°

COMMON S/IP X

REF	A6166A	Common S/IP X alu
	A6166W	Common S/IP X white
	A6166B	Common S/IP X black

LED	Xicato
LED LM OUTPUT	700 / 1.300 lm
POWER CONS.	according to lumen output - see table p. 255
COLOR TEMP.	2.700 / 3.000 / 4.000 K
CRI	80 or +95
COLOR QUAL.	artist / beauty / vibrant / vibrant artist
REFLECTOR	16° / 40° / 60°
FINISH	anodised white RAL 9016 tex black RAL 9005 tex
ADJUSTABLE	n/a
CUT-OUT	Ø 80 mm
DRIVE CURRENT	supplied with driver
REMARK	with blade springs

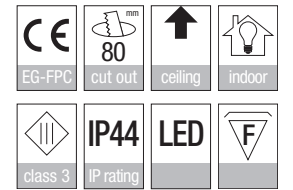
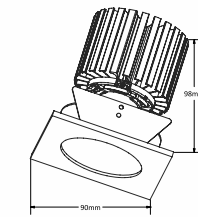
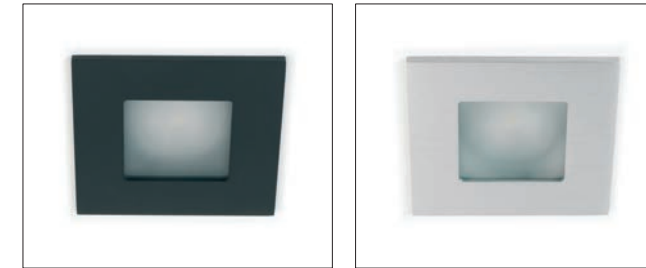

MODEL	REFERENCE	LM OUTPUT	CRI / CCT	BEAM	DIMMING
COMMON S/IP X ALU COMMON S/IP X WHITE COMMON S/IP X BLACK	A6166A A6166W A6166B	700 lm	827 - 830 - 840 - V830	16°	ND
			927 - 930 - 940 - V930 - BT	40°	PD
	1.300 lm	827 - 830 - 840 - V830	60°	A	
		927 - 930 - 940 - V930 - BT	40° / 60°	D	

ND: non dimmable / PD: phase dimming / A: 1-10V / D: DALI



COMMON TRIMLESS

REF	A2038W A2038B	Common Trimless white Common Trimless black
LAMP	QPAR51 35 W max. / LED bulb	
BASE	GU10	
FINISH	white RAL 9016 tex black RAL 9005 tex	
ADJUSTABLE	n/a	
CUT-OUT	Ø 100 mm	
REMARK	fits all LED replacement bulbs supplied with plaster kit applicable for ceilings in exposed concrete (cut-out Ø 95mm)	

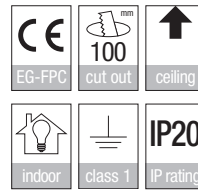
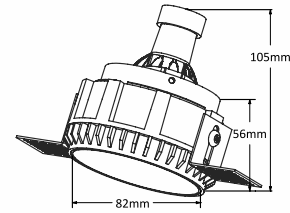
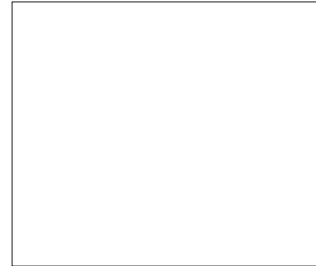

ACCESSORIES / FOR TECHNICAL INFO SEE P. 277

RE-LED	
C1001/827	Re-LED 827 36° 780 lm @ 500 mA
C1001/830	Re-LED 830 36° 780 lm @ 500 mA
C1001/827/KIT	Re-LED 827 36° incl. driver phase / 1-10 V
C1001/830/KIT	Re-LED 830 36° incl. driver phase / 1-10 V
RE-LED 1200	
C1003/927/24	Re-LED 1200 927 24° 1.200 lm @ 350 mA
C1003/927/36	Re-LED 1200 927 36° 1.200 lm @ 350 mA
C1003/930/24	Re-LED 1200 930 24° 1.200 lm @ 350 mA
C1003/930/36	Re-LED 1200 930 36° 1.200 lm @ 350 mA
RE-LED AC	
C1002/927/24	Re-LED AC 927 24°
C1002/927/36	Re-LED AC 927 36°
C1002/930/24	Re-LED AC 930 24°
C1002/930/36	Re-LED AC 930 36°
OPTIONS	
C6028	Plexi inlay Common series
C6026	Honeycomb Common Series

COMMON X TRIMLESS

REF	A6167W A6167B	Common X Trimless white Common X Trimless black
LED	Xicato	
LED LM OUTPUT	700 / 1.300 lm	
POWER CONS.	according to lumen output - see table p. 255	
COLOR TEMP.	2.700 / 3.000 / 4.000 K	
CRI	80 or +95	
COLOR QUAL.	artist / beauty / vibrant / vibrant artist	
REFLECTOR	16° / 40° / 60°	
FINISH	white RAL 9016 tex black RAL 9005 tex	
ADJUSTABLE	n/a	
CUT-OUT	Ø 100 mm	
DRIVE CURRENT	supplied with driver	
REMARK	supplied with plaster kit also fits ceiling in architectural concrete (cut-out Ø 95mm)	

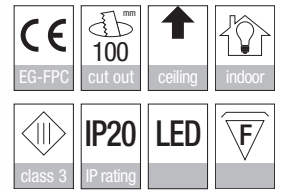
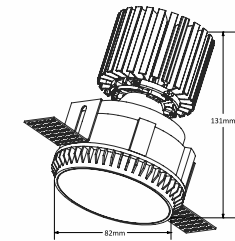
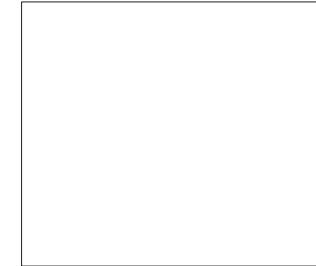

MODEL	REFERENCE	LM OUTPUT	CRI / CCT	BEAM	DIMMING
COMMON X TRIMLESS WHITE COMMON X TRIMLESS BLACK	A6167W A6167B	700 lm	827 - 830 - 840 - V830	16°	ND
			927 - 930 - 940 - V930 - BT	40°	PD
	1.300 lm	827 - 830 - 840 - V830	60°	A	
		927 - 930 - 940 - V930 - BT	40° / 60°	D	

ND: non dimmable / PD: phase dimming / A: 1-10V / D: DALI



COMMON S TRIMLESS



REF	A2039W A2039B	Common S Trimless white Common S Trimless black
-----	------------------	--

LAMP	QPAR51 35 W max. / LED bulb
BASE	GU10
FINISH	white RAL 9016 tex black RAL 9005 tex
ADJUSTABLE	n/a
CUT-OUT	85 x 85 mm
REMARK	fits all LED replacement bulbs supplied with plaster kit

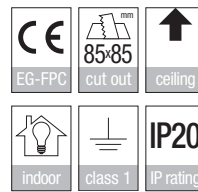
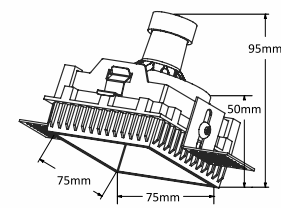

COMMON S X TRIMLESS

REF	A6168W A6168B	Common S X Trimless white Common S X Trimless black
-----	------------------	--

LED	Xicato
LED LM OUTPUT	700 / 1.300 lm
POWER CONS.	according to lumen output - see table p. 255
COLOR TEMP.	2.700 / 3.000 / 4.000 K
CRI	80 or +95
COLOR QUAL.	artist / beauty / vibrant / vibrant artist
REFLECTOR	16° / 40° / 60°
FINISH	white RAL 9016 tex black RAL 9005 tex
ADJUSTABLE	n/a
CUT-OUT	85 x 85 mm
DRIVE CURRENT	supplied with driver
REMARK	supplied with plaster kit

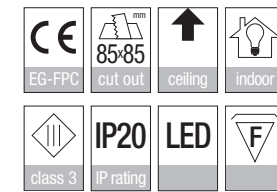
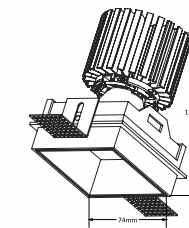
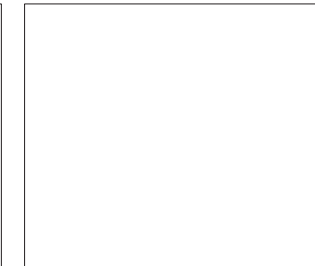

ACCESSORIES / FOR TECHNICAL INFO SEE P. 277

RE-LED	
C1001/827	Re-LED 827 36° 780 lm @ 500 mA
C1001/830	Re-LED 830 36° 780 lm @ 500 mA
C1001/827/KIT	Re-LED 827 36° incl. driver phase / 1-10 V
C1001/830/KIT	Re-LED 830 36° incl. driver phase / 1-10 V
RE-LED 1200	
C1003/927/24	Re-LED 1200 927 24° 1.200 lm @ 350 mA
C1003/927/36	Re-LED 1200 927 36° 1.200 lm @ 350 mA
C1003/930/24	Re-LED 1200 930 24° 1.200 lm @ 350 mA
C1003/930/36	Re-LED 1200 930 36° 1.200 lm @ 350 mA
RE-LED AC	
C1002/927/24	Re-LED AC 927 24°
C1002/927/36	Re-LED AC 927 36°
C1002/930/24	Re-LED AC 930 24°
C1002/930/36	Re-LED AC 930 36°
OPTIONS	
C6028	Plexi inlay Common series
C6026	Honeycomb Common Series

MODEL	REFERENCE	LM OUTPUT	CRI / CCT	BEAM	DIMMING
COMMON S X TRIMLESS WHITE COMMON S X TRIMLESS BLACK	A6168W A6168B	700 lm	827 - 830 - 840 - V830	16°	ND
			927 - 930 - 940 - V930 - BT	40°	PD
	1.300 lm	827 - 830 - 840 - V830	60°	A	
		927 - 930 - 940 - V930 - BT	40° / 60°	D	

ND: non dimmable / PD: phase dimming / A: 1-10V / D: DALI

DOTLINE S4

REF	A6200BW/I/830/PD	Dotline S4 black/white 830 phase dim
	A6200WB/I/830/PD	Dotline S4 white/black 830 phase dim
	A6200WW/I/830/PD	Dotline S4 white/white 830 phase dim
	A6200BB/I/830/PD	Dotline S4 black/black 830 phase dim
	A6200BW/I/830/D	Dotline S4 black/white 830 DALI dim
	A6200WB/I/830/D	Dotline S4 white/black 830 DALI dim
	A6200WW/I/830/D	Dotline S4 white/white 830 DALI dim
	A6200BB/I/830/D	Dotline S4 black/black 830 DALI dim

LED	LINEAR SMD
LED lm output	940 lm
POWER CONS.	6 W
DRIVE CURRENT	350 mA 23 Vdc max.
COLOR TEMP.	3.000 K
CRI	>80
REFLECTOR	40°
FINISH	white RAL 9016 tex black RAL 9005 tex
ADJUSTABLE	n/a
CUT-OUT	185 x 65 mm
REMARK	supplied with driver (250 mA)



BB



WB



BW



WW

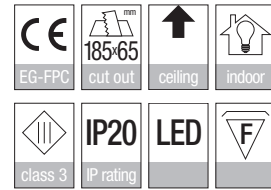
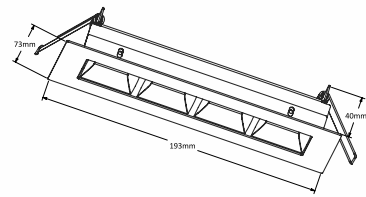

DOTLINE S7

REF	A6201BW/I/830/PD	Dotline S7 black/white 830 phase dim
	A6201WB/I/830/PD	Dotline S7 white/black 830 phase dim
	A6201WW/I/830/PD	Dotline S7 white/white 830 phase dim
	A6201BB/I/830/PD	Dotline S7 black/black 830 phase dim
	A6201BW/I/830/D	Dotline S7 black/white 830 DALI dim
	A6201WB/I/830/D	Dotline S7 white/black 830 DALI dim
	A6201WW/I/830/D	Dotline S7 white/white 830 DALI dim
	A6201BB/I/830/D	Dotline S7 black/black 830 DALI dim

LED	LINEAR SMD
LED lm output	1.650 lm
POWER CONS.	10 W
DRIVE CURRENT	350 mA 40 Vdc max.
COLOR TEMP.	3.000 K
CRI	>80
REFLECTOR	40°
FINISH	white RAL 9016 tex black RAL 9005 tex
ADJUSTABLE	n/a
CUT-OUT	300 x 65 mm
REMARK	supplied with driver (250 mA)

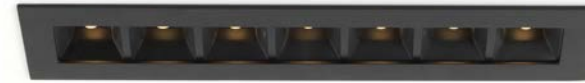

BB



WW

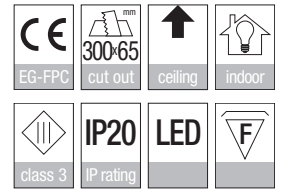
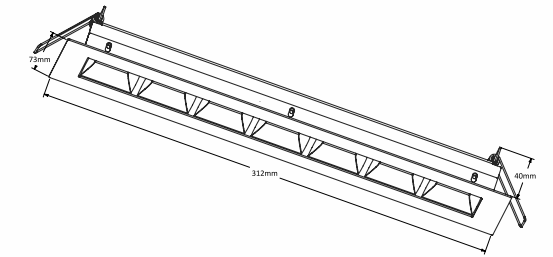



TRUMPET

REF	A6068	Trumpet alu
	A6069	Trumpet white
	A6068B	Trumpet black

LED	Xicato
LED LM OUTPUT	700 / 1.300 / 2.000 lm
POWER CONS.	according to lumen output - see table p. 255
COLOR TEMP.	2.700 / 3.000 / 4.000 K
CRI	80 or +95
COLOR QUAL.	artist / beauty / vibrant / vibrant artist
REFLECTOR	40° / 60° (16° only available in 1.300 lm)
FINISH	anodised white RAL 9016 tex black RAL 9005 tex
ADJUSTABLE	n/a
CUT-OUT	Ø 80 mm
DRIVE CURRENT	supplied with driver

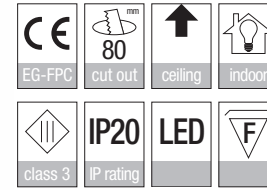
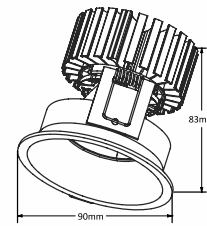

MODEL	REFERENCE	LM OUTPUT	CRI / CCT	BEAM	DIMMING
TRUMPET ALU TRUMPET WHITE TRUMPET BLACK	A6068 A6069 A6068B	700 lm	827 - 830 - 840 - V830	16°	ND PD A D
			927 - 930 - 940 - V930 - BT	40°	
		1.300 lm	827 - 830 - 840 - V830	60°	
			927 - 930 - 940 - V930 - BT	40°	
2.000 lm	827 - 830 - 840 - V830	60°			

ND: non dimmable / PD: phase dimming / A: 1-10V / D: DALI



TRUMPET FLEX

REF	A6144W	Trumpet flex white
	A6144B	Trumpet flex black

LED	Xicato
LED LM OUTPUT	700 / 1.300 / 2.000 lm
POWER CONS.	according to lumen output - see table p. 255
COLOR TEMP.	2.700 / 3.000 / 4.000 K
CRI	80 or +95
COLOR QUAL.	artist / beauty / vibrant / vibrant artist
REFLECTOR	40° / 60° (16° only available in 1.300 lm)
FINISH	white RAL 9016 tex black RAL 9005 tex
ADJUSTABLE	15°
CUT-OUT	Ø 80 mm
DRIVE CURRENT	supplied with driver

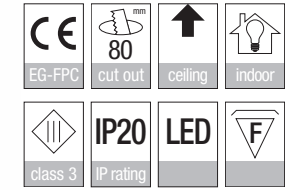
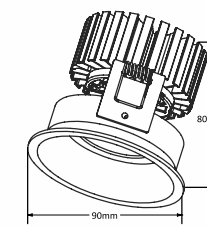

MODEL	REFERENCE	LM OUTPUT	CRI / CCT	BEAM	DIMMING
TRUMPET FLEX WHITE TRUMPET FLEX BLACK	A6144W A6144B	700 lm	827 - 830 - 840 - V830	16°	ND PD A D
			927 - 930 - 940 - V930 - BT	40°	
		1.300 lm	827 - 830 - 840 - V830	60°	
			927 - 930 - 940 - V930 - BT	40°	
2.000 lm	827 - 830 - 840 - V830	60°			

ND: non dimmable / PD: phase dimming / A: 1-10V / D: DALI





PICCOLO

REF	A6133 A6134 A6134B	Piccolo alu Piccolo white Piccolo black
LED	COB LED	
LED LM OUTPUT	280 lm	
POWER CONS.	3.33 W	
DRIVE VOLTAGE	12-24 Vdc	
DRIVE CURRENT	350 mA 10 Vdc max. supplied with 12-24 Vdc to 350 mA converter	
COLOR TEMP.	3.000 K	
CRI	+80	
REFLECTOR	60° wide beam	
FINISH	white RAL 9016 tex black RAL 9005 tex anodised aluminium	
CUT-OUT	Ø 32 mm	
REMARK	blade springs	
APPLICATION	specifically designed for porch profiles	

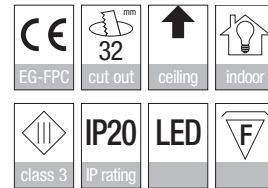
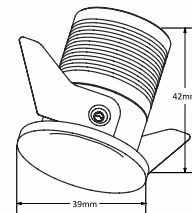
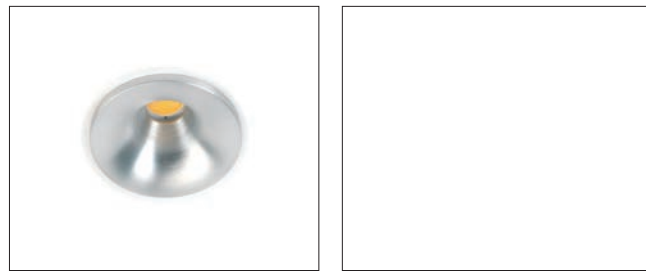

PICCOLO 80 ON

REF	A6169W/927 A6169W/930 A6169B/927 A6169B/930 A6169WB/927 A6169WB/930	Piccolo 80 ON white 2.700 K Piccolo 80 ON white 3.000 K Piccolo 80 ON black 2.700 K Piccolo 80 ON black 3.000 K Piccolo 80 ON wh/bl 2.700 K Piccolo 80 ON wh/bl 3.000 K
LED	AC driven COB technology	
LED LM OUTPUT	2.700 K: 696 lm 3.000 K: 750 lm	
POWER CONS.	10 W	
DRIVE VOLTAGE	230 Vac	
COLOR TEMP.	2.700 / 3.000 K	
CRI	+90	
REFLECTOR	60° wide beam	
FINISH	white RAL 9016 tex black RAL 9005 tex	
REMARKS	mains dimmable (leading & trailing) provided with 2x 3P terminal block	

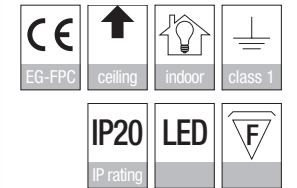
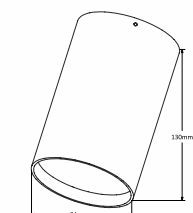
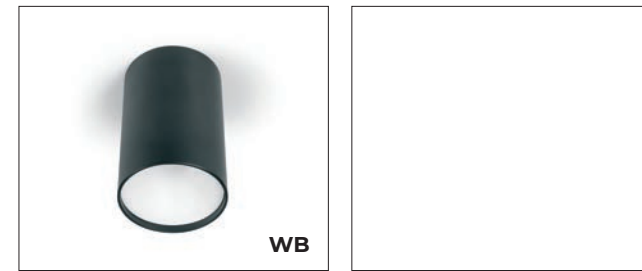

PICCOLO 80

REF	A6141W/927 A6141W/930 A6141B/927 A6141B/930	Piccolo 80 white 2.700 K Piccolo 80 white 3.000 K Piccolo 80 black 2.700 K Piccolo 80 black 3.000 K
LED	AC driven COB technology	
LED LM OUTPUT	2.700 K: 696 lm 3.000 K: 750 lm	
POWER CONS.	10 W	
DRIVE VOLTAGE	230 Vac	
COLOR TEMP.	2.700 / 3.000 K	
CRI	+90	
REFLECTOR	60° wide beam	
FINISH	white RAL 9016 tex black RAL 9005 tex	
ADJUSTABLE	n/a	
CUT-OUT	Ø 80 mm	
REMARK	blade springs for easy mounting mains dimmable (leading & trailing) provided with 2x 3P terminal block	

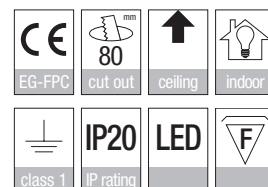
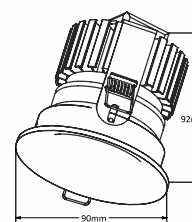

PICCOLO 80 X

REF	A6159W A6159B	Piccolo 80 X white Piccolo 80 X black
LED	Xicato	
LED LM OUTPUT	700 / 1.300 / 2.000 lm	
POWER CONS.	according to lm output - see table p. 195	
COLOR TEMP.	2.700 / 3.000 / 4.000 K	
CRI	80 or +95	
COLOR QUAL.	artist / beauty / vibrant / vibrant artist	
REFLECTOR	40° / 60° (16° only available in 1.300 lm)	
FINISH	white RAL 9016 tex black RAL 9005 tex	
ADJUSTABLE	n/a	
CUT-OUT	Ø 80 mm	
DRIVE CURRENT	supplied with driver	

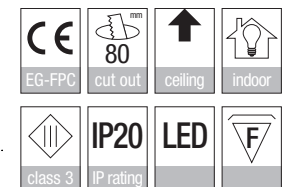
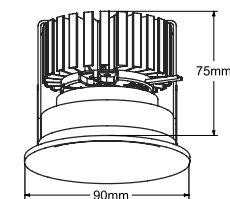

MODEL	REFERENCE	LM OUTPUT	CRI / CCT	BEAM	DIMMING
PICCOLO 80 X WHITE	A6159W	1.300 lm	827 - 830 - 840 - V8307	60°	ND / PD A / D
PICCOLO 80 X BLACK	A6159B		927 - 930 - 940 - V930 - BT - F+		

ND: non dimmable / PD: phase dimming / A: 1-10V / D: DALI



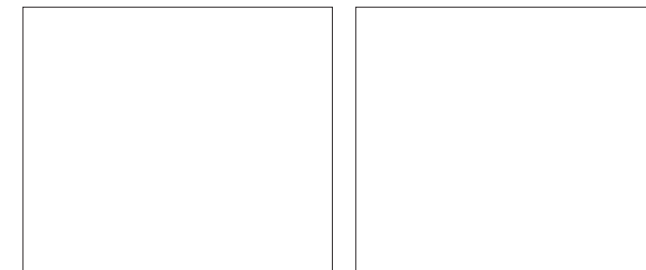

OLLA

REF A6157W/927 Olla 2.700 K
A6157W/930 Olla 3.000 K

LED	COB LED
LED LM OUTPUT	520 lm
POWER CONS.	7 W
DRIVE CURRENT	700 mA 10 Vdc max.
COLOR TEMP.	2.700 / 3.000 K
CRI	+90
REFLECTOR	36°
FINISH	white RAL 9016 tex
ADJUSTABLE	n/a
CUT-OUT	Ø 70 mm
REMARK	anti glare applications (hotel corridor, ...) driver not included - see driver matrix p. 267

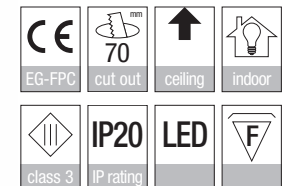
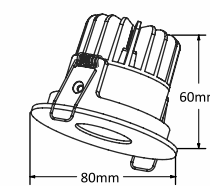

OLLA OR

REF A6158W/927 Olla OR 2.700 K
A6158W/930 Olla OR 3.000 K

LED	COB LED
LED LM OUTPUT	520 lm
POWER CONS.	7 W
DRIVE CURRENT	700 mA 10 Vdc max.
COLOR TEMP.	2.700 / 3.000 K
CRI	+90
REFLECTOR	36°
FINISH	white RAL 9016 tex
ADJUSTABLE	20° wall wash
CUT-OUT	Ø 70 mm
REMARK	anti glare applications (hotel corridor, ...) driver not included - see driver matrix p. 267

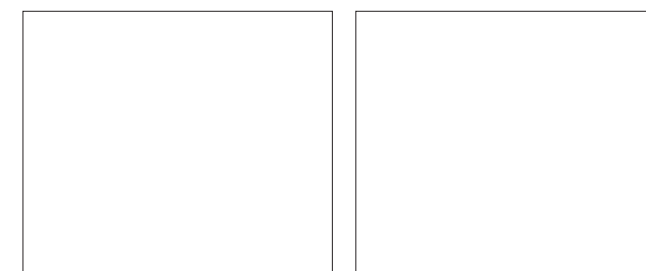
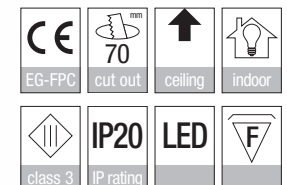
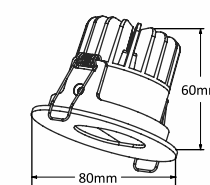



MINI UNILITE TRIMLESS

REF	A6138	Mini Unilite Trimless
LED	Xicato	
LED LM OUTPUT	700 / 1.300 lm	
POWER CONS.	according to lumen output - see table p. 255	
COLOR TEMP.	2.700 / 3.000 / 4.000 K	
CRI	80 or +95	
COLOR QUAL.	artist / beauty / vibrant / vibrant artist	
REFLECTOR	20° / 40° / 60° (11° only available in 1.300 lm)	
FINISH	white RAL 9016 tex	
ADJUSTABLE	360° x 20°	
CUT-OUT	106 x 106 mm	
DRIVE CURRENT	supplied with driver	
REMARK	supplied with plaster kit	

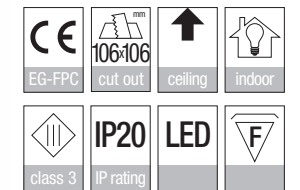
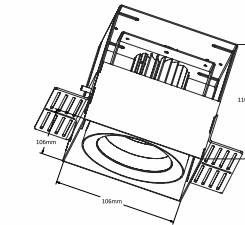

MODEL	REFERENCE	LM OUTPUT	CRI / CCT	BEAM	DIMMING
MINI UNILITE TRIMLESS	A6138	700 lm	927 - 930 - 940 - V930 - BT	11° / 20°	ND / PD
		1.300 lm	827 - 830 - 840 - V830	40° / 60°	A / D

ND: non dimmable / PD: phase dimming / A: 1-10V / D: DALI

MINI DUOLITE TRIMLESS

REF	A6139	Mini Duolite Trimless
LED	Xicato	
LED LM OUTPUT	2x 700 lm / 2x 1.300 lm	
POWER CONS.	according to lumen output - see table p. 255	
COLOR TEMP.	2.700 / 3.000 / 4.000 K	
CRI	80 or +95	
COLOR QUAL.	artist / beauty / vibrant / vibrant artist	
REFLECTOR	20° / 40° / 60° (11° only available in 1.300 lm)	
FINISH	white RAL 9016 tex	
ADJUSTABLE	360° x 20°	
CUT-OUT	212 x 106 mm	
DRIVE CURRENT	supplied with driver	
REMARK	supplied with plaster kit	

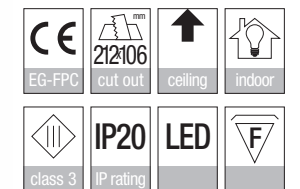
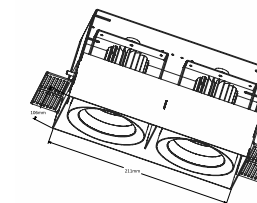
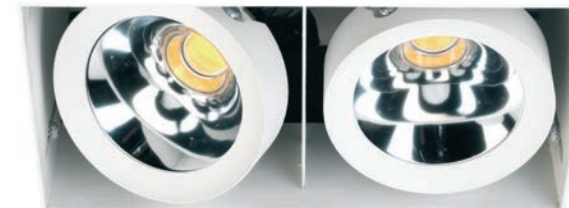

MODEL	REFERENCE	LM OUTPUT	CRI / CCT	BEAM	DIMMING
MINI DUOLITE TRIMLESS	A6139	700 lm	927 - 930 - 940 - V930 - BT	11° / 20°	ND / PD
		1.300 lm	827 - 830 - 840 - V830	40° / 60°	A / D

ND: non dimmable / PD: phase dimming / A: 1-10V / D: DALI



MIRADOR

REF	A6083A	Mirador alu
	A6083W	Mirador white
	A6083B	Mirador black

LED	AC driven COB technology
LED LM OUTPUT	333 lm
POWER CONS.	4.6 W
DRIVE VOLTAGE	230 Vac
COLOR TEMP.	3.000 K
CRI	+80
REFLECTOR	50°
FINISH	anodised aluminium white RAL 9016 tex black RAL 9005 tex
ADJUSTABLE	n/a
CUT-OUT	Ø 40 mm
REMARK	blade springs for easy mounting mains dimmable (leading & trailing) specifically designed for porch profiles

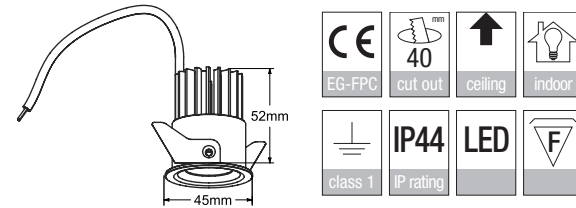

POWER DISC

REF	A6122A	Power Disc alu
	A6122W	Power Disc white
	A6122B	Power Disc black

LED	COB LED
LED LM OUTPUT	280 lm
POWER CONS.	3.33 W
DRIVE CURRENT	350 mA 10 Vdc max.
COLOR TEMP.	3.000 K
CRI	+80
REFLECTOR	60° wide beam
FINISH	white RAL 9016 tex black RAL 9005 tex anodised aluminium
ADJUSTABLE	n/a
CUT-OUT	Ø 60 mm
REMARK	very low built-in height designed for kitchen hood application driver not included - see driver matrix p. 267

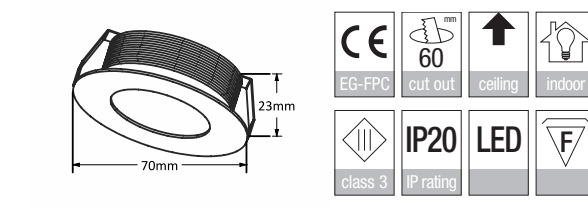
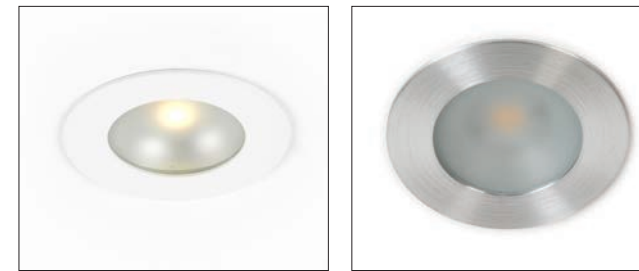

MIRADOR RGB-W

REF	A6121	Mirador RGB-W
-----	-------	---------------

LED	multi color high brightness LED
LED LM OUTPUT	W 90 lm / R 40 lm / G 70 lm / B 13.8 lm
POWER CONS.	4x 1.2 W @ 350 mA 4 Vdc max.
DRIVE CURRENT	4x 350 mA
DRIVE VOLTAGE	4x 24 Vdc common anode with converter supplied as kit
COLOR TEMP.	W 5.000 K / R 620 nm / D 520 nm / B 455 nm
CRI	n/a
REFLECTOR	wide beam
FINISH	anodised aluminium
ADJUSTABLE	n/a
CUT-OUT	Ø 45 mm
REMARK	blade springs for easy mounting also usable as MR16 replacement module

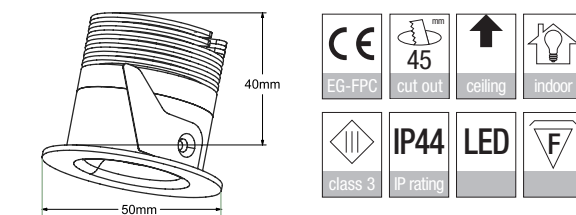
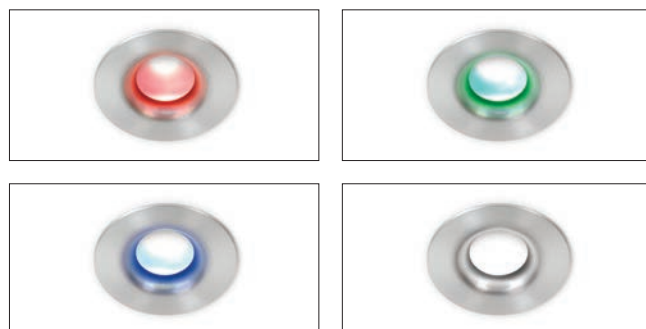

DISC

REF	A6058W/827	Disc white 2.700 K
	A6058W/830	Disc white 3.000 K
	A6058B/827	Disc black 2.700 K
	A6058B/830	Disc black 3.000 K

LED	COB LED
LED LM OUTPUT	185 lm
POWER CONS.	3 W
DRIVE VOLTAGE	24 Vdc
COLOR TEMP.	2.700 / 3.000 K
CRI	85
REFLECTOR	60°
FINISH	white RAL 9016 tex black RAL 9005 tex
ADJUSTABLE	n/a
CUT-OUT	Ø 60 mm
REMARK	very low built-in height (15 mm) driver not included

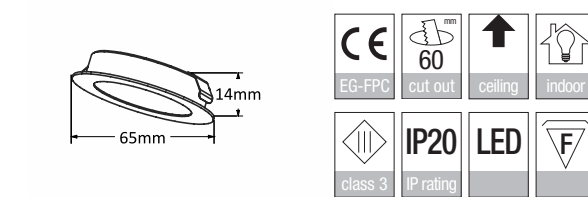



NANO TUBE RECESSED

REF	A6183W/927	Nano Tube R white 927
	A6183W/930	Nano Tube R white 930
	A6183B/927	Nano Tube R black 927
	A6183B/930	Nano Tube R black 930

LED	COB LED
LED LM OUTPUT	280 lm
POWER CONS.	3 W
DRIVE CURRENT	350 mA 10 Vdc
COLOR TEMP.	2.700 / 3.000 K
CRI	+90
REFLECTOR	35°
FINISH	white RAL 9016 tex black RAL 9005 tex
ADJUSTABLE	45° x 355°
CUT-OUT	Ø 44 mm
REMARK	driver not included - see driver matrix p. 267

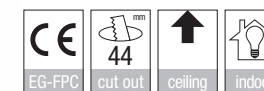
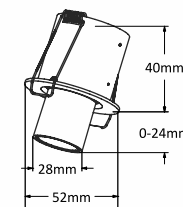



NANO TUBE SUSP IN

REF	A6191B/I/927	Nano Tube S IN black 927
	A6191B/I/930	Nano Tube S IN black 930
	A6191W/I/927	Nano Tube S IN white 927
	A6191W/I/930	Nano Tube S IN white 930

LED	COB LED
LED LM OUTPUT	540 lm
POWER CONS.	8 W
DRIVE CURRENT	350 mA 22 Vdc max.
COLOR TEMP.	2.700 / 3.000 K
CRI	> 90
REFLECTOR	35°
FINISH	white RAL 9016 tex black RAL 9005 tex
ADJUSTABLE	n/a
CUT-OUT	Ø 44 mm
REMARK	black fabric power cable / length 1,6 m driver not included - see driver matrix p. 267

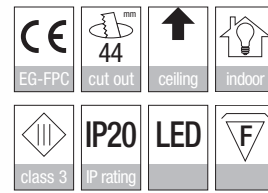

NANO TUBE L IN

REF	A6199B/I/927	Nano Tube L IN black 927
	A6199B/I/930	Nano Tube L IN black 930
	A6199W/I/927	Nano Tube L IN white 927
	A6199W/I/930	Nano Tube L IN white 930

LED	COB LED
LED LM OUTPUT	540 lm
POWER CONS.	8 W
DRIVE CURRENT	350 mA 22 Vdc max.
COLOR TEMP.	2.700 / 3.000 K
CRI	> 90
REFLECTOR	35°
FINISH	white RAL 9016 tex black RAL 9005 tex
ADJUSTABLE	45° x 355°
CUT-OUT	Ø 44 mm
REMARK	driver not included - see driver matrix p. 267

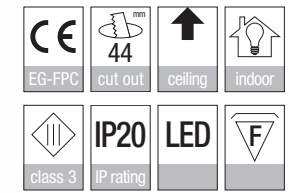

NANO TUBE SUSP ON

REF	A6191B/O/927	Nano Tube S ON black 927
	A6191B/O/930	Nano Tube S ON black 930
	A6191W/O/927	Nano Tube S ON white 927
	A6191W/O/930	Nano Tube S ON white 930

LED	COB LED
LED LM OUTPUT	540 lm
POWER CONS.	8 W
DRIVE CURRENT	350 mA 22 Vdc max.
COLOR TEMP.	2.700 / 3.000 K
CRI	> 90
REFLECTOR	35°
FINISH	white RAL 9016 tex black RAL 9005 tex
ADJUSTABLE	n/a
REMARK	black fabric power cable / length 1,6 m driver not included - see driver matrix p. 267

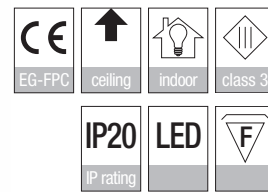
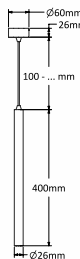

NANO TUBE L ON

REF	A6199B/O/927	Nano Tube L ON black 927
	A6199B/O/930	Nano Tube L ON black 930
	A6199W/O/927	Nano Tube L ON white 927
	A6199W/O/930	Nano Tube L ON white 930

LED	COB LED
LED LM OUTPUT	540 lm
POWER CONS.	8 W
DRIVE CURRENT	350 mA 22 Vdc max.
COLOR TEMP.	2.700 / 3.000 K
CRI	> 90
REFLECTOR	35°
FINISH	white RAL 9016 tex black RAL 9005 tex
ADJUSTABLE	45° x 355°
REMARK	driver not included - see driver matrix p. 267

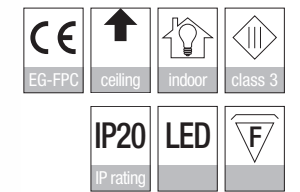
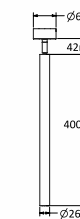



VUELTA TRIMLESS

REF	A6155W/927	Vuelta white 2.700 K
	A6155W/930	Vuelta white 3.000 K
	A6155B/927	Vuelta black 2.700 K
	A6155B/930	Vuelta black 3.000 K

LED	COB LED
LED LM OUTPUT	320 lm
POWER CONS.	4 W
DRIVE CURRENT	350 mA 12 Vdc max.
COLOR TEMP.	2.700 / 3.000 K
CRI	+90
REFLECTOR	36°
FINISH	white RAL 9016 tex black RAL 9005 tex
ADJUSTABLE	n/a
CUT-OUT	Ø 53 mm
REMARK	supplied with plaster kit driver not included - see driver matrix p. 267

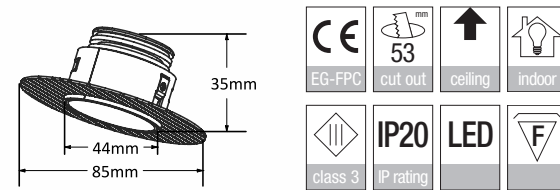

MARKER

REF	A6196W/827/..°	Marker white 827..°
	A6196W/830/..°	Marker white 830..°
	A6196B/827/..°	Marker black 827..°
	A6196B/830/..°	Marker black 830..°

LED	COB LED
LED LM OUTPUT	160 lm
POWER CONS.	2 W
DRIVE CURRENT	700 mA 3 Vdc max.
COLOR TEMP.	2.700 / 3.000 K
CRI	> 80
REFLECTOR	3° - 12°
FINISH	white RAL 9016 tex black RAL 9005 tex
ADJUSTABLE	15°
CUT-OUT	Ø 52 mm
REMARK	driver not included - see driver matrix p. 267

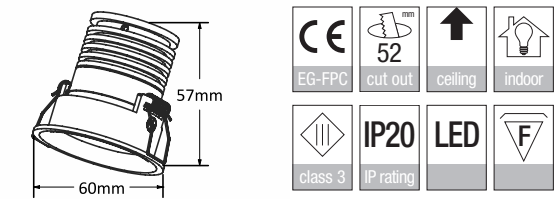

VUELTA AS TRIMLESS

REF	A6156W/927	Vuelta AS 2.700 K
	A6156W/930	Vuelta AS 3.000 K

LED	COB LED
LED LM OUTPUT	320 lm
POWER CONS.	4 W
DRIVE CURRENT	350 mA 12 Vdc max.
COLOR TEMP.	2.700 / 3.000 K
CRI	+90
REFLECTOR	36°
FINISH	white RAL 9016 tex
ADJUSTABLE	n/a
CUT-OUT	Ø 65 mm
REMARK	supplied with plaster kit driver not included - see driver matrix p. 267

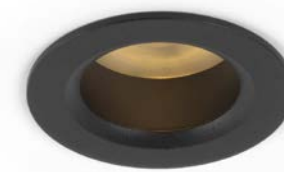
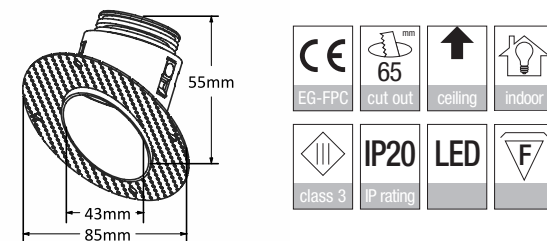

ARROW

REF	A6197W/827/..°	Marker white 827 ..°
	A6197W/830/..°	Marker white 830 ..°
	A6197B/827/..°	Marker black 827 ..°
	A6197B/830/..°	Marker black 830 ..°

LED	COB LED
LED LM OUTPUT	160 lm
POWER CONS.	2W
DRIVE CURRENT	700 mA 3 Vdc max.
COLOR TEMP.	2.700 / 3.000 K
CRI	> 80
REFLECTOR	3° - 12°
FINISH	white RAL 9016 tex black RAL 9005 tex
ADJUSTABLE	n/a
CUT-OUT	Ø 45 mm
REMARK	driver not included - see driver matrix p. 267 can be used as MR16 module

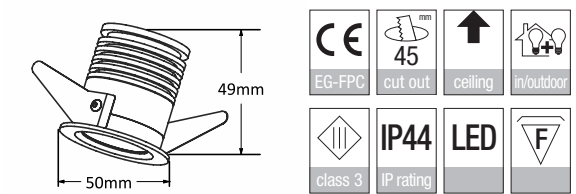



ELBEAU

REF	A6178W A6178B	Elbeau white Elbeau black
-----	------------------	------------------------------

LED	Xicato XTM
LED LM OUTPUT	715 lm
POWER CONS.	according to lumen output - see table p. 255
COLOR TEMP.	2.700 / 3.000 / 4.000 K
CRI	80 or +95
COLOR QUAL.	artist / beauty / vibrant / vibrant artist
REFLECTOR	40° / 60°
FINISH	white RAL 9016 tex black RAL 9005 tex
ADJUSTABLE	45° x 355°
CUT-OUT	Ø 80 mm
DRIVE CURRENT	350 mA (supplied with driver)

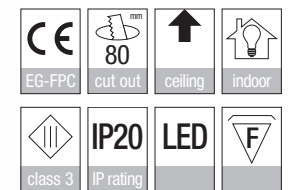
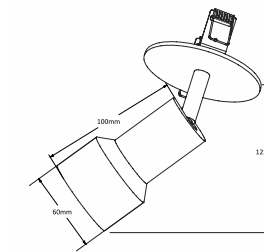

MODEL	REFERENCE	LM OUTPUT	CRI / CCT	BEAM	DIMMING
ELBEAU WHITE	A6178W	700 lm	827 - 830 - 840 - V830	40° / 60°	ND / PD A / D
ELBEAU BLACK	A6178B		927 - 930 - 940 - V930 - BT		

ND: non dimmable / PD: phase dimming / A: 1-10V / D: DALI



MICRO TUBE R

REF	A6151W/927	Micro Tube R white 2.700 K
	A6151W/930	Micro Tube R white 3.000 K
	A6151B/927	Micro Tube R black 2.700 K
	A6151B/930	Micro Tube R black 3.000 K

LED	COB LED
LED LM OUTPUT	1.300 lm
POWER CONS.	13 W
DRIVER CURRENT	350mA 36Vdc max
COLOR TEMP.	2.700 / 3.000 K
CRI	+90
REFLECTOR	36°
FINISH	white RAL 9016 tex black RAL 9005 tex
ADJUSTABLE	25° x 355°
CUT-OUT	Ø 83 mm
REMARK	driver not included - see driver matrix p. 267
OPTIONAL	C6029W Micro Tube cone white C6029G Micro Tube cone gold C6030 Micro Tube 24° lens

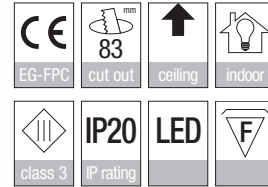
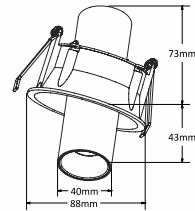

MICRO TUBE IN

REF	A6173W/927	Micro Tube IN white 927
	A6173W/930	Micro Tube IN white 930
	A6173B/927	Micro Tube IN black 927
	A6173B/930	Micro Tube IN black 930

LED	COB LED
LED LM OUTPUT	630 lm
POWER CONS.	7 W
DRIVE CURRENT	350 mA 19 Vdc
COLOR TEMP.	2.700 / 3.000 K
CRI	+90
REFLECTOR	36°
FINISH	white RAL 9016 tex black RAL 9005 tex
ADJUSTABLE	90° x 355°
CUT-OUT	Ø 44 mm
REMARK	driver not included - see driver matrix p. 267
OPTIONAL	C6029W Micro Tube cone white C6029G Micro Tube cone gold C6030 Micro Tube 24° lens vener finish - see p. 260

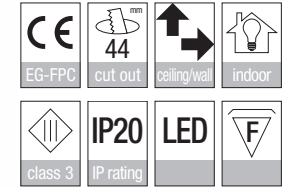
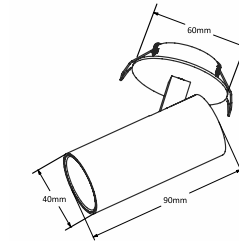

MICRO TUBE R TRIMLESS

REF	A6152W/927	Micro Tube R Trimless white 2.700 K
	A6152W/930	Micro Tube R Trimless white 3.000 K
	A6152B/927	Micro Tube R Trimless black 2.700 K
	A6152B/930	Micro Tube R Trimless black 3.000 K

LED	COB LED
LED LM OUTPUT	1.300 lm
POWER CONS.	13 W
DRIVER CURRENT	350 mA 36Vdc max
COLOR TEMP.	2.700 / 3.000 K
CRI	+90
REFLECTOR	36°
FINISH	white RAL 9016 tex black RAL 9005 tex
ADJUSTABLE	25° x 355°
CUT-OUT	Ø 95 mm
REMARK	supplied with plaster kit driver not included - see driver matrix p. 267
OPTIONAL	C6029W Micro Tube cone white C6029G Micro Tube cone gold C6030 Micro Tube 24° lens

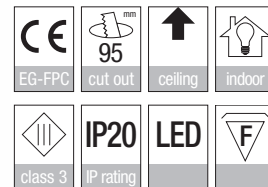
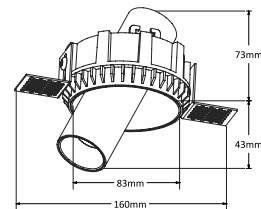

MICRO TUBE IN-FLEX

REF	A6188W/927	Micro Tube In-Flex white 927
	A6188W/930	Micro Tube In-Flex white 930
	A6188B/927	Micro Tube In-Flex black 927
	A6188B/930	Micro Tube In-Flex black 930

LED	COB LED
LED LM OUTPUT	630 lm
POWER CONS.	7 W
DRIVE CURRENT	350 mA 19 Vdc max.
COLOR TEMP.	2.700 / 3.000 K
CRI	+90
REFLECTOR	36°
FINISH	white RAL 9016 tex black RAL 9005 tex
ADJUSTABLE	90° x 355° + pull out functionality
CUT-OUT	Ø 55 mm
REMARK	driver not included - see driver matrix p. 267
OPTIONAL	C6029W Micro Tube cone white C6029G Micro Tube cone gold C6030 Micro Tube 24° lens

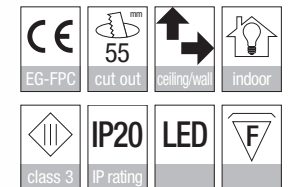
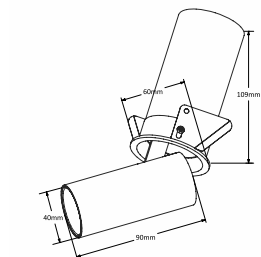



MICRO TUBE ON

REF	A6173W/O/927 Micro Tube ON white 927 A6173W/O/930 Micro Tube ON white 930 A6173B/O/927 Micro Tube ON black 927 A6173B/O/930 Micro Tube ON black 930
LED	COB LED
LED LM OUTPUT	630 lm
POWER CONS.	7 W
DRIVE CURRENT	350 mA 19 Vdc max.
COLOR TEMP.	2.700 / 3.000 K
CRI	> 90
REFLECTOR	36°
FINISH	white RAL 9016 tex black RAL 9005 tex
ADJUSTABLE	90° x 355°
CUT-OUT	n/a
REMARK	driver not included - see driver matrix p. 267
OPTIONAL	C6029W Micro Tube cone white C6029G Micro Tube cone gold C6030 Micro Tube 24° lens veneer finish - see p. 260

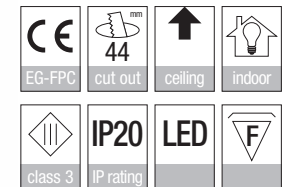
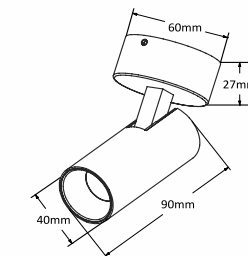



MICRO TUBE ON RECT

REF	A6173W/OR/927/PD	Micro Tube OR white 927 phase DIM/1-10V
	A6173W/OR/930/PD	Micro Tube OR white 930 phase DIM/1-10V
	A6173B/OR/927/PD	Micro Tube OR black 927 phase DIM/1-10V
	A6173B/OR/930/PD	Micro Tube OR black 930 phase DIM/1-10V
	A6173W/OR/927/D	Micro Tube OR white 927 DALI DIM
	A6173W/OR/930/D	Micro Tube OR white 930 DALI DIM
	A6173B/OR/927/D	Micro Tube OR black 927 DALI DIM
	A6173B/OR/930/D	Micro Tube OR black 930 DALI DIM

LED	COB LED
LED LM OUTPUT	630 lm
POWER CONS.	7 W
DRIVE CURRENT	230 Vac built-in driver
COLOR TEMP.	2.700 / 3.000 K
CRI	> 90
REFLECTOR	36°
FINISH	white RAL 9016 tex black RAL 9005 tex
ADJUSTABLE	90° x 355°
OPTIONAL	C6029W Micro Tube cone white C6029G Micro Tube cone gold C6030 Micro Tube 24° lens vener finish - see p. 260

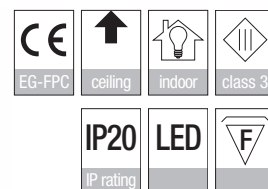
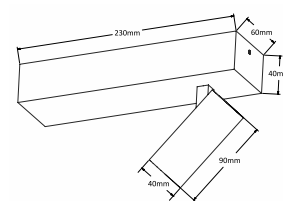
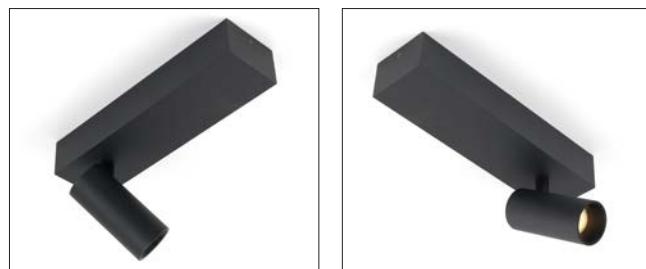

MICRO TUBE 2 ON

REF	A6173W/2O/927/PD	Micro Tube 2 ON white 927 phase DIM/1-10V
	A6173W/2O/930/PD	Micro Tube 2 ON white 930 phase DIM/1-10V
	A6173B/2O/927/PD	Micro Tube 2 ON black 927 phase DIM/1-10V
	A6173B/2O/930/PD	Micro Tube 2 ON black 930 phase DIM/1-10V
	A6173W/2O/927/D	Micro Tube 2 ON white 927 DALI DIM
	A6173W/2O/930/D	Micro Tube 2 ON white 930 DALI DIM
	A6173B/2O/927/D	Micro Tube 2 ON black 927 DALI DIM
	A6173B/2O/930/D	Micro Tube 2 ON black 930 DALI DIM

LED	COB LED
LED LM OUTPUT	2x 630 lm
POWER CONS.	2x 7 W
DRIVE CURRENT	230 Vac built-in driver
COLOR TEMP.	2.700 / 3.000 K
CRI	> 90
REFLECTOR	36°
FINISH	white RAL 9016 tex black RAL 9005 tex
ADJUSTABLE	90° x 355°
OPTIONAL	C6029W Micro Tube cone white C6029G Micro Tube cone gold C6030 Micro Tube 24° lens vener finish - see p. 260

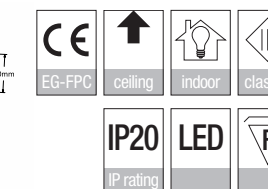
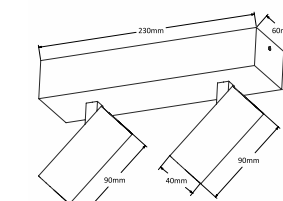



MICRO TUBE 2 ON RECT

REF A6173W/2OR/927/PD Micro Tube 2 ON RECT white 927 phase DIM/1-10V
 A6173W/2OR/930/PD Micro Tube 2 ON RECT white 930 phase DIM/1-10V
 A6173B/2OR/927/PD Micro Tube 2 ON RECT black 927 phase DIM/1-10V
 A6173B/2OR/930/PD Micro Tube 2 ON RECT black 930 phase DIM/1-10V
 A6173W/2OR/927/D Micro Tube 2 ON RECT white 927 DALI DIM
 A6173W/2OR/930/D Micro Tube 2 ON RECT white 930 DALI DIM
 A6173B/2OR/927/D Micro Tube 2 ON RECT black 927 DALI DIM
 A6173B/2OR/930/D Micro Tube 2 ON RECT black 930 DALI DIM

LED	COB LED
LED LM OUTPUT	2x 630 lm
POWER CONS.	2x 7 W
DRIVE CURRENT	230 Vac built-in driver
COLOR TEMP.	2.700 / 3.000 K
CRI	> 90
REFLECTOR	36°
FINISH	white RAL 9016 tex black RAL 9005 tex
ADJUSTABLE	90° x 355°
OPTIONAL	C6029W Micro Tube cone white C6029G Micro Tube cone gold C6030 Micro Tube 24° lens veneer finish - see p. 260

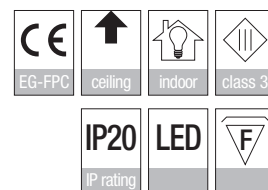
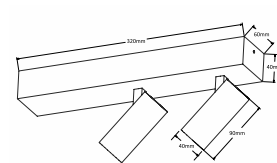
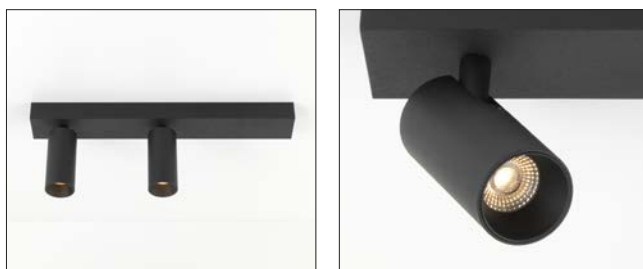

MICRO TUBE 3 ON

REF A6173W/3O/927/PD Micro Tube 3 ON white 927 phase DIM/1-10V
 A6173W/3O/930/PD Micro Tube 3 ON white 930 phase DIM/1-10V
 A6173B/3O/927/PD Micro Tube 3 ON black 927 phase DIM/1-10V
 A6173B/3O/930/PD Micro Tube 3 ON black 930 phase DIM/1-10V
 A6173W/3O/927/D Micro Tube 3 ON white 927 DALI DIM
 A6173W/3O/930/D Micro Tube 3 ON white 930 DALI DIM
 A6173B/3O/927/D Micro Tube 3 ON black 927 DALI DIM
 A6173B/3O/930/D Micro Tube 3 ON black 930 DALI DIM

LED	COB LED
LED LM OUTPUT	3x 630 lm
POWER CONS.	3x 7 W
DRIVE CURRENT	230 Vac built-in driver
COLOR TEMP.	2.700 / 3.000 K
CRI	> 90
REFLECTOR	36°
FINISH	white RAL 9016 tex black RAL 9005 tex
ADJUSTABLE	90° x 355°
OPTIONAL	C6029W Micro Tube cone white C6029G Micro Tube cone gold C6030 Micro Tube 24° lens veneer finish - see p. 260

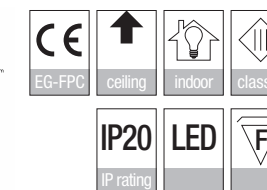
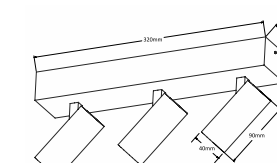



MICRO TUBE FL AC

REF	A6213W/927	Micro Tube FL AC white 927 phase DIM
	A6213W/930	Micro Tube FL AC white 930 phase DIM
	A6213B/927	Micro Tube FL AC black 927 phase DIM
	A6213B/930	Micro Tube FL AC black 930 phase DIM

LED	COB LED
LED LM OUTPUT	630 lm
POWER CONS.	8 W
DRIVE CURRENT	230 Vac built-in driver
COLOR TEMP.	2.700 / 3.000 K
CRI	> 90
REFLECTOR	36°
FINISH	white RAL 9016 tex black RAL 9005 tex
ADJUSTABLE	n/a
OPTIONAL	C6029W Micro Tube cone white C6029G Micro Tube cone gold C6030 Micro Tube 24° lens veneer finish - see p. 260

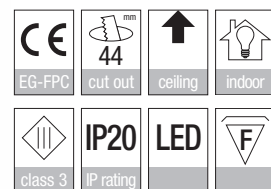
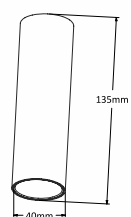

MICRO TUBE L AC ON

REF	A6198W/O/927	Micro Tube L AC ON white 927 phase DIM
	A6198W/O/930	Micro Tube L AC ON white 930 phase DIM
	A6198B/O/927	Micro Tube L AC ON black 927 phase DIM
	A6198B/O/930	Micro Tube L AC ON black 930 phase DIM

LED	COB LED
LED LM OUTPUT	630 lm
POWER CONS.	8 W
DRIVE VOLTAGE	230 Vac built-in driver
COLOR TEMP.	2.700 / 3.000 K
CRI	> 90
REFLECTOR	36°
FINISH	white RAL 9016 tex black RAL 9005 tex
ADJUSTABLE	90° x 355°
OPTIONAL	C6029W Micro Tube cone white C6029G Micro Tube cone gold C6030 Micro Tube 24° lens veneer finish - see p. 260

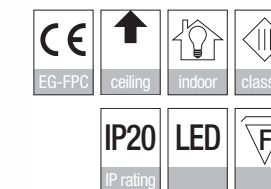
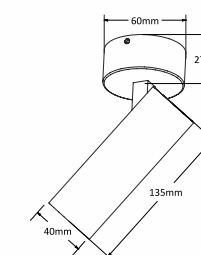
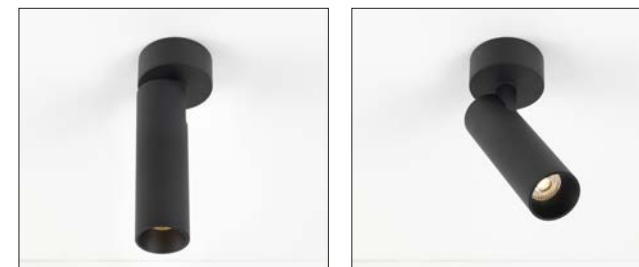

MICRO TUBE L AC IN

REF	A6198W/I/927	Micro Tube L AC IN white 927 phase DIM
	A6198W/I/930	Micro Tube L AC IN white 930 phase DIM
	A6198B/I/927	Micro Tube L AC IN black 927 phase DIM
	A6198B/I/930	Micro Tube L AC IN black 930 phase DIM

LED	COB LED
LED LM OUTPUT	630 lm
POWER CONS.	8 W
DRIVE CURRENT	230 Vac built-in driver
COLOR TEMP.	2.700 / 3.000 K
CRI	> 90
REFLECTOR	36°
FINISH	white RAL 9016 tex black RAL 9005 tex
ADJUSTABLE	90° x 355°
CUT-OUT	Ø 44 mm
OPTIONAL	C6029W Micro Tube cone white C6029G Micro Tube cone gold C6030 Micro Tube 24° lens veneer finish - see p. 260

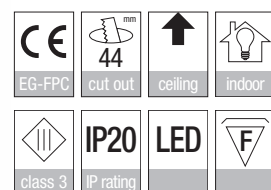
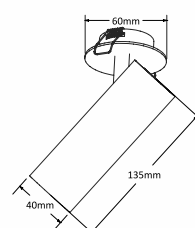

MICRO TUBE L AC 2 ON

REF	A6198W/2O/927	Micro Tube L AC 2 ON white 927 phase DIM
	A6198W/2O/930	Micro Tube L AC 2 ON white 930 phase DIM
	A6198B/2O/927	Micro Tube L AC 2 ON black 927 phase DIM
	A6198B/2O/930	Micro Tube L AC 2 ON black 930 phase DIM

LED	COB LED
LED LM OUTPUT	2x 630 lm
POWER CONS.	2x 8 W
DRIVE VOLTAGE	230 Vac built-in driver
COLOR TEMP.	2.700 / 3.000 K
CRI	> 90
REFLECTOR	36°
FINISH	white RAL 9016 tex black RAL 9005 tex
ADJUSTABLE	90° x 355°
OPTIONAL	C6029W Micro Tube cone white C6029G Micro Tube cone gold C6030 Micro Tube 24° lens veneer finish - see p. 260

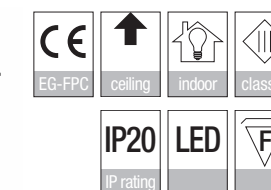
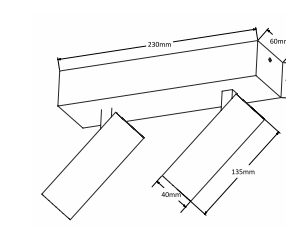



MICRO TUBE L AC 3 ON

REF	A6198W/30/927	Micro Tube L AC 3 ON white 927 phase DIM
	A6198W/30/930	Micro Tube L AC 3 ON white 930 phase DIM
	A6198B/30/927	Micro Tube L AC 3 ON black 927 phase DIM
	A6198B/30/930	Micro Tube L AC 3 ON black 930 phase DIM

LED	COB LED
LED LM OUTPUT	3x 630 lm
POWER CONS.	3x 8 W
DRIVE VOLTAGE	230 Vac built-in driver
COLOR TEMP.	2.700 / 3.000 K
CRI	> 90
REFLECTOR	36°
FINISH	white RAL 9016 tex black RAL 9005 tex
ADJUSTABLE	90° x 355°
OPTIONAL	C6029W Micro Tube cone white C6029G Micro Tube cone gold C6030 Micro Tube 24° lens veneer finish - see p. 260

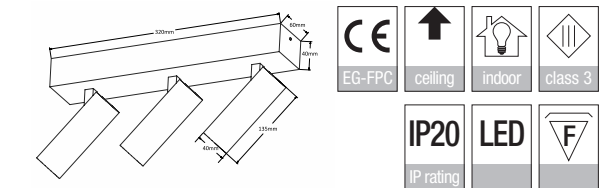

MICRO TUBE L AC IN-TRAC

REF	A6184W/927	Micro Tube In-Trac white 927
	A6184W/930	Micro Tube In-Trac white 930
	A6184B/927	Micro Tube In-Trac black 927
	A6184B/930	Micro Tube In-Trac black 930

LED	COB LED
LED LM OUTPUT	630 lm
POWER CONS.	8 W
DRIVE VOLTAGE	230 Vac built-in driver
COLOR TEMP.	2.700 / 3.000 K
CRI	+ 90
REFLECTOR	36°
FINISH	white RAL 9016 tex black RAL 9005 tex
ADJUSTABLE	90° x 355°
REMARKS	for Eutrac 3F only phase dimmable
OPTIONAL	C6029W Micro Tube cone white C6029G Micro Tube cone gold C6030 Micro Tube 24° lens veneer finish - see p. 260

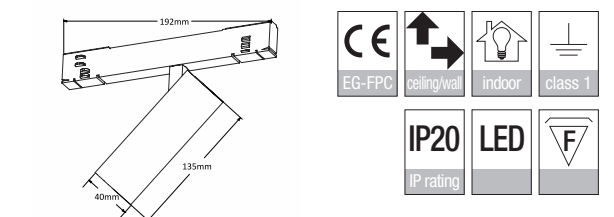
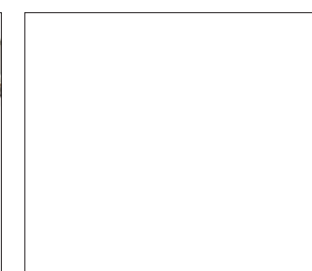

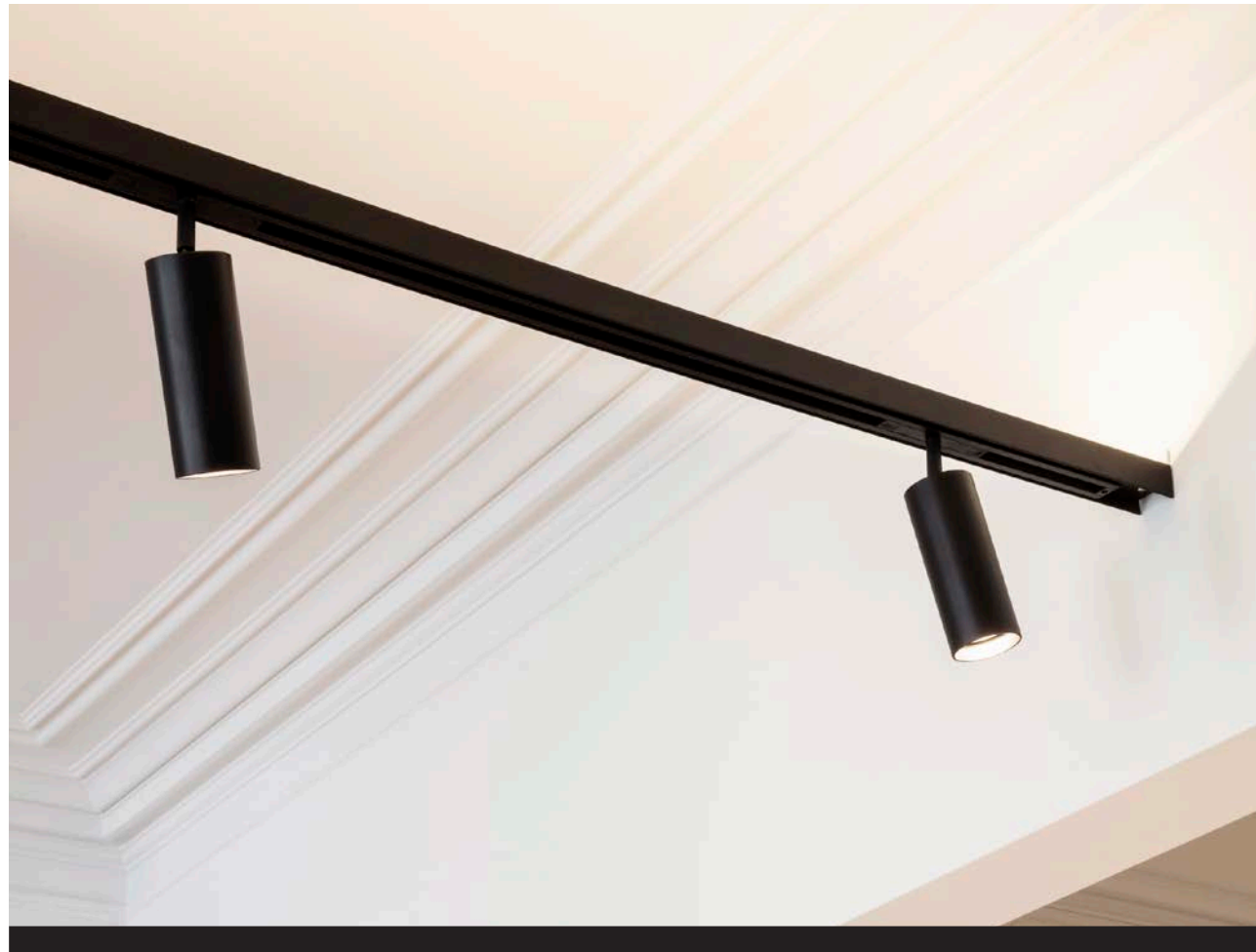

MINI TUBE RECESSED

REF	A6187W/927	Mini Tube R white 927
	A6187W/930	Mini Tube R white 930
	A6187B/927	Mini Tube R black 927
	A6187B/930	Mini Tube R black 930

LED	COB LED
LED LM OUTPUT	630 lm
POWER CONS.	7 W
DRIVE CURRENT	350 mA 19 Vdc
COLOR TEMP.	2.700 / 3.000 K
CRI	+90
REFLECTOR	36°
FINISH	white RAL 9016 tex black RAL 9005 tex
ADJUSTABLE	15°
CUT-OUT	Ø 75 mm
REMARK	supplied with additional blade springs driver not included - see driver matrix p. 267

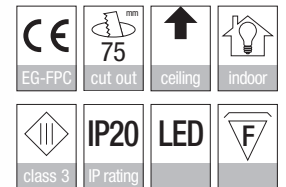
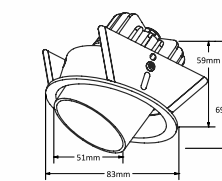
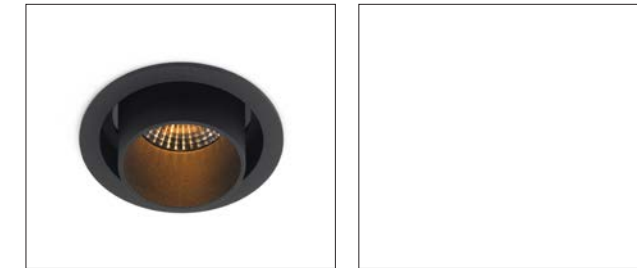

MINI TUBE IN GU10

REF	A1002W	Mini Tube IN white
	A1002B	Mini Tube IN black

LAMP	QPAR51 35 W max. / LED bulb
BASE	GU100
FINISH	white RAL 9016 tex black RAL 9005 tex
ADJUSTABLE	45° x 355°
CUT-OUT	Ø 80 mm
REMARK	fits all LED replacement bulbs blade springs for gypsum and concrete mounting adjustable lamp depth GU10 socket
OPTIONAL	MINI TUBE CONE SET (REF C6025): mounting clips / cone / honeycomb / prismatic lens / spread lens C6025B/part Mini Tube cone black C6025W/part Mini Tube cone white C6025C/part Mini Tube cone gold

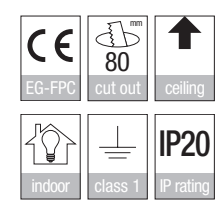
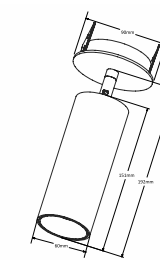



MINI TUBE IN LED

REF	A1002W/927/24	Mini Tube IN white LED 927 R24
	A1002W/927/36	Mini Tube IN white LED 927 R36
	A1002W/930/24	Mini Tube IN white LED 930 R24
	A1002W/930/36	Mini Tube IN white LED 930 R36
	A1002B/927/24	Mini Tube IN black LED 927 R24
	A1002B/927/36	Mini Tube IN black LED 927 R36
	A1002B/930/24	Mini Tube IN black LED 930 R24
	A1002B/930/36	Mini Tube IN black LED 930 R36

LED	LED Engine
LED LM OUTPUT	700 lm
POWER CONS.	10 W
DRIVE CURRENT	230 Vac
COLOR TEMP.	2.700 / 3.000 K
CRI	92
REFLECTOR	24° / 36°
FINISH	white RAL 9016 tex black RAL 9005 tex
ADJUSTABLE	45° x 355°
CUT-OUT	Ø 80 mm
REMARK	mains dimmable (leading & trailing)

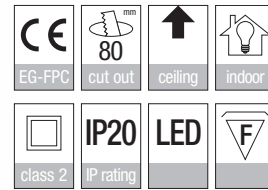
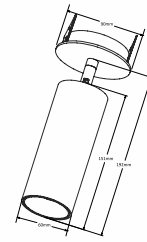
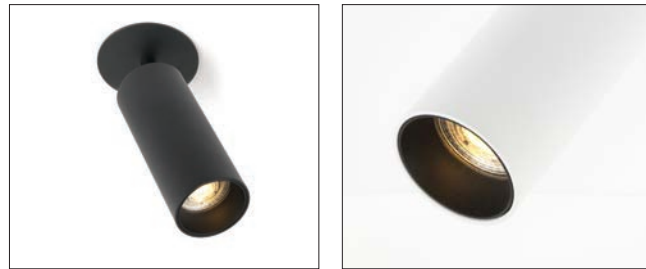

MINI TUBE X IN

REF	A6147W	Mini Tube X IN white
	A6147B	Mini Tube X IN black
LED	Xicato	
LED LM OUTPUT	700 / 1.300 lm	
POWER CONS.	according to lumen output - see table p. 255	
COLOR TEMP.	2.700 / 3.000 / 4.000 K	
CRI	80 or +95	
COLOR QUAL.	artist / beauty / vibrant / vibrant artist	
REFLECTOR	16° / 40° / 60°	
FINISH	white RAL 9016 tex black RAL 9005 tex	
ADJUSTABLE	45° x 355°	
CUT-OUT	Ø 50 mm	
DRIVE CURRENT	supplied with driver	
OPTIONAL	MINI TUBE CONE SET (REF C6025): mounting clips / cone / honeycomb / prismatic lens / spread lens C6025B/part Mini Tube cone black C6025W/part Mini Tube cone white C6025G/part Mini Tube cone gold	

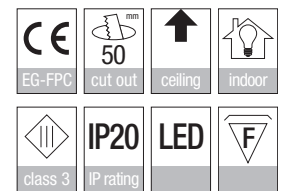
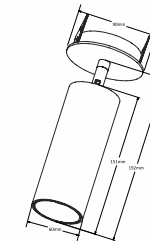

MODEL	REFERENCE	LM OUTPUT	CRI / CCT	BEAM	DIMMING
MINI TUBE X IN WHITE MINI TUBE X IN BLACK	A6147W A6147B	700 lm	827 - 830 - 840 - V830	16°	ND PD A D
			927 - 930 - 940 - V930 - BT		
	1.300 lm	827 - 830 - 840 - V830	16°/40°/60°		
		927 - 930 - 940 - V930 - BT	40°/60°		

ND: non dimmable / PD: phase dimming / A: 1-10V / D: DALI



MINI TUBE F ON GU10

REF	A1008W A1008B	Mini Tube F ON white Mini Tube F ON black
LAMP	QPAR51 35 W max. / LED bulb	
BASE	GU10	
FINISH	white RAL 9016 tex black RAL 9005 tex	
ADJUSTABLE	n/a	
REMARK	fits all LED replacement bulbs adjustable lamp depth GU10 socket	
OPTIONAL	MINI TUBE CONE SET (REF C6025): mounting clips / cone / honeycomb / prismatic lens / spread lens C6025B/part Mini Tube cone black C6025W/part Mini Tube cone white C6025G/part Mini Tube cone gold	

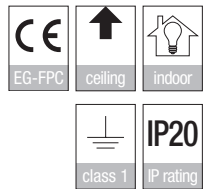
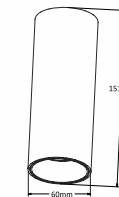

MINI TUBE F ON LED

REF	A1008W/927/24 A1008W/927/36 A1008W/930/24 A1008W/930/36 A1008B/927/24 A1008B/927/36 A1008B/930/24 A1008B/930/36	Mini Tube F ON white LED 927 R24 Mini Tube F ON white LED 927 R36 Mini Tube F ON white LED 930 R24 Mini Tube F ON white LED 930 R36 Mini Tube F ON black LED 927 R24 Mini Tube F ON black LED 927 R36 Mini Tube F ON black LED 930 R24 Mini Tube F ON black LED 930 R36
-----	--	--

LED	LED Engine
LED LM OUTPUT	700 lm
POWER CONS.	10 W
DRIVE CURRENT	230 Vac
COLOR TEMP.	2.700 / 3.000 K
CRI	92
REFLECTOR	24° / 36°
FINISH	white RAL 9016 tex black RAL 9005 tex
ADJUSTABLE	n/a
REMARK	mains dimmable (leading & trailing)

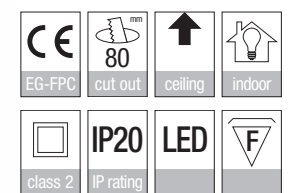

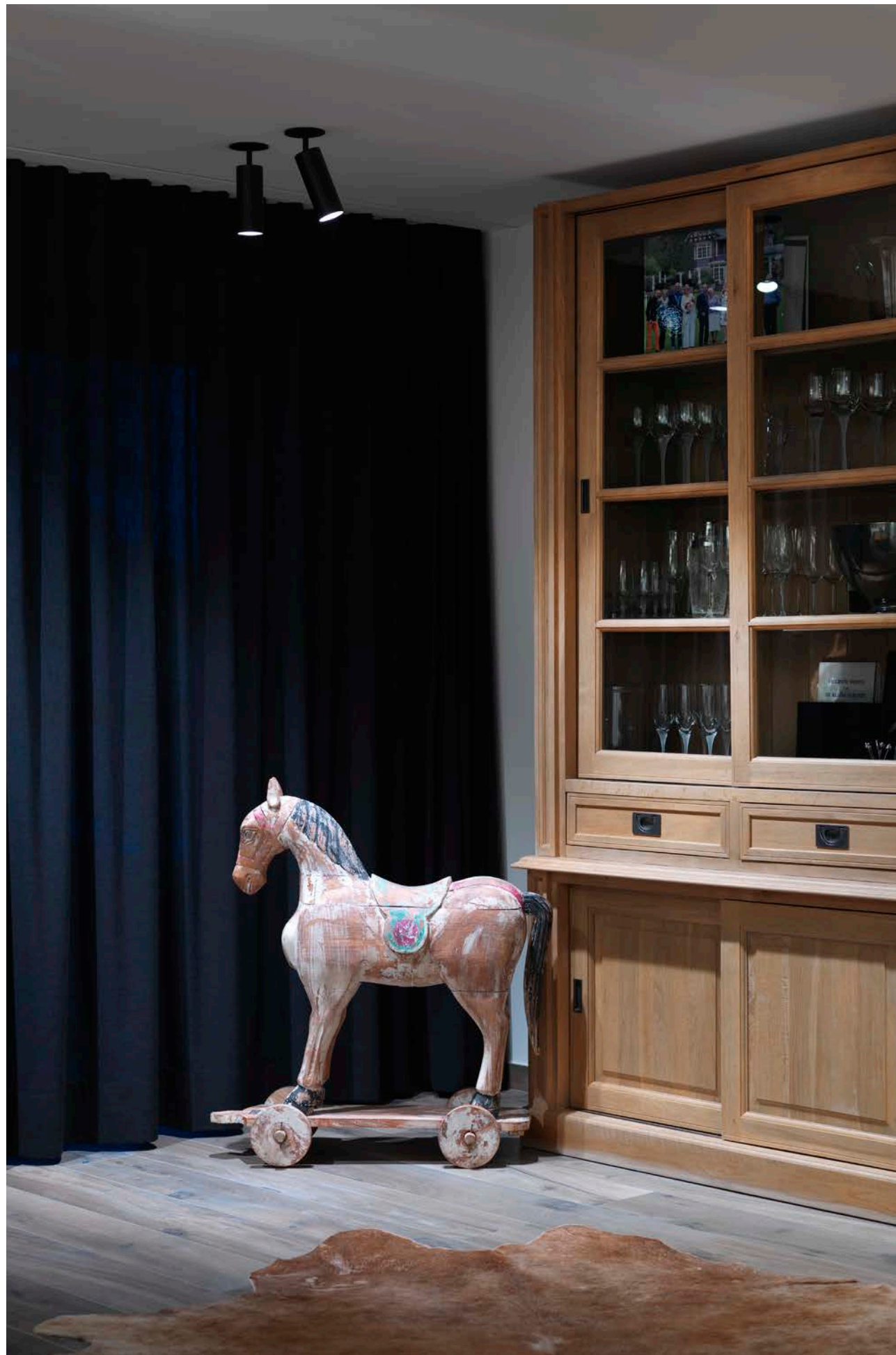

MINI TUBE ON GU10

REF	A1001W A1001B	Mini Tube ON white Mini Tube ON black
LAMP	QPAR51 35 W max. / LED bulb	
BASE	GU10	
FINISH	white RAL 9016 tex black RAL 9005 tex	
ADJUSTABLE	45° x 355°	
REMARK	fits all LED replacement bulbs adjustable lamp depth GU10 socket	
OPTIONAL	MINI TUBE CONE SET (REF C6025): mounting clips / cone / honeycomb / prismatic lens / spread lens C6025B/part Mini Tube cone black C6025W/part Mini Tube cone white C6025G/part Mini Tube cone gold	

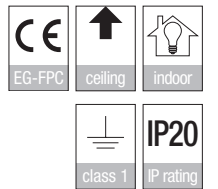
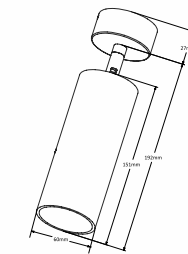

MINI TUBE ON LED

REF	A1001W/927/24 A1001W/927/36 A1001W/930/24 A1001W/930/24 A1001B/927/24 A1001B/927/36 A1001B/930/24 A1001B/930/36	Mini Tube ON white LED 927 R24 Mini Tube ON white LED 927 R36 Mini Tube ON white LED 930 R24 Mini Tube ON white LED 930 R36 Mini Tube ON black LED 927 R24 Mini Tube ON black LED 927 R36 Mini Tube ON black LED 930 R24 Mini Tube ON black LED 930 R36
-----	--	--

LED	LED Engine
LED LM OUTPUT	700 lm
POWER CONS.	10 W
DRIVE CURRENT	230 Vac
COLOR TEMP.	2.700 / 3.000 K
CRI	92
REFLECTOR	24° / 36°
FINISH	white RAL 9016 tex black RAL 9005 tex
ADJUSTABLE	45° x 355°
REMARK	mains dimmable (leading & trailing)

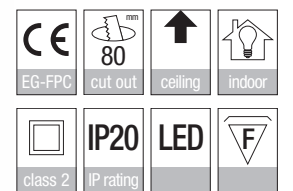
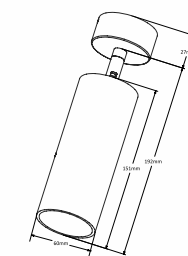



MINI TUBE X ON

REF	A6161W A6161B	Mini Tube X ON white Mini Tube X ON black
-----	------------------	--

LED	Xicato
LED LM OUTPUT	700 / 1.300 lm
POWER CONS.	according to lumen output - see table p. 255
COLOR TEMP.	2.700 / 3.000 / 4.000 K
CRI	80 or +95
COLOR QUAL.	artist / beauty / vibrant / vibrant artist
REFLECTOR	16° / 40° / 60°
FINISH	white RAL 9016 tex black RAL 9005 tex
ADJUSTABLE	45° x 355°
DRIVE CURRENT	supplied with driver
OPTIONAL	MINI TUBE CONE SET (REF C6025): mounting clips / cone / honeycomb / prismatic lens / spread lens C6025B/part Mini Tube cone black C6025W/part Mini Tube cone white C6025G/part Mini Tube cone gold

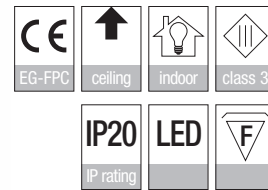
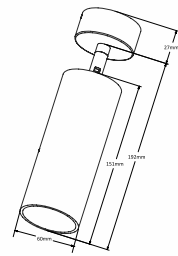

MODEL	REFERENCE	LM OUTPUT	CRI / CCT	BEAM	DIMMING
MINI TUBE X ON WHITE MINI TUBE X ON BLACK	A6161W A6161B	700 lm	827 - 830 - 840 - V830	16°	ND PD A D
			927 - 930 - 940 - V930 - BT		
	1.300 lm	827 - 830 - 840 - V830	16°/40°/60°		
		927 - 930 - 940 - V930 - BT	40°/60°		

ND: non dimmable / PD: phase dimming / A: 1-10V / D: DALI



MINI TUBE RECT X ON

REF	A6171W A6171B	Mini Tube RECT X ON white Mini Tube RECT X ON black
-----	------------------	--

LED	Xicato
LED LM OUTPUT	700 / 1.300 lm
POWER CONS.	according to lumen output - see table p. 255
COLOR TEMP.	2.700 / 3.000 / 4.000 K
CRI	80 or +95
COLOR QUAL.	artist / beauty / vibrant / vibrant artist
REFLECTOR	16° / 40° / 60°
FINISH	white RAL 9016 tex black RAL 9005 tex
ADJUSTABLE	45° x 355°
DRIVE CURRENT	230 Vac built-in driver
OPTIONAL	MINI TUBE CONE SET (REF C6025): mounting clips / cone / honeycomb / prismatic lens / spread lens C6025B/part Mini Tube cone black C6025W/part Mini Tube cone white C6025G/part Mini Tube cone gold

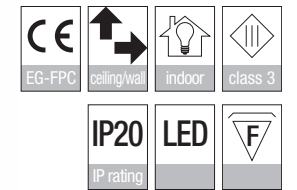
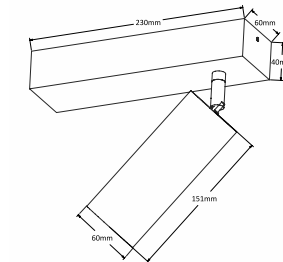

MODEL	REFERENCE	LM OUTPUT	CRI / CCT	BEAM	DIMMING
MINI TUBE RECT X ON WHITE MINI TUBE RECT X ON BLACK	A6171W A6171B	700 lm	827 - 830 - 840 - V830	16°	ND PD A D
			927 - 930 - 940 - V930 - BT		
	1.300 lm	827 - 830 - 840 - V830	16°/40°/60°		
		927 - 930 - 940 - V930 - BT	40°/60°		

ND: non dimmable / PD: phase dimming / A: 1-10V / D: DALI



MINI TUBE 2 ON GU10

REF	A1004W A1004B	Mini Tube 2 ON white Mini Tube 2 ON black
LAMP	2x QPAR51 35 W max. / LED bulb	
BASE	GU10	
FINISH	white RAL 9016 tex black RAL 9005 tex	
ADJUSTABLE	45° x 355°	
CUT-OUT	n/a	
REMARK	fits all LED replacement bulbs adjustable lamp depth GU10 socket	
OPTIONAL	MINI TUBE CONE SET (REF C6025): mounting clips / cone / honeycomb / prismatic lens / spread lens C6025B/part Mini Tube cone black C6025W/part Mini Tube cone white C6025G/part Mini Tube cone gold	

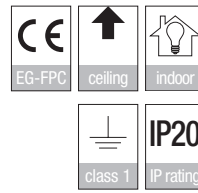
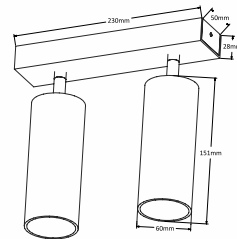
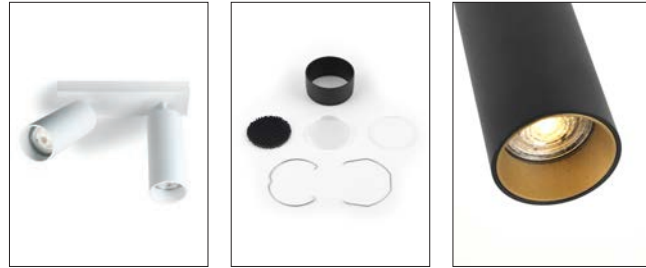

MINI TUBE RECT 2 X ON

REF	A6172W A6172B	Mini Tube RECT 2 X ON white Mini Tube RECT 2 X ON black
LED	Xicato	
LED LM OUTPUT	2x 700 lm / 2x 1.300 lm	
POWER CONS.	according to lumen output - see table p. 255	
COLOR TEMP.	2.700 / 3.000 / 4.000 K	
CRI	80 or +95	
COLOR QUAL.	artist / beauty / vibrant / vibrant artist	
REFLECTOR	16° / 40° / 60°	
FINISH	white RAL 9016 tex black RAL 9005 tex	
ADJUSTABLE	45° x 355°	
DRIVE CURRENT	230 Vac built-in driver	
OPTIONAL	MINI TUBE CONE SET (REF C6025): mounting clips / cone / honeycomb / prismatic lens / spread lens C6025B/part Mini Tube cone black C6025W/part Mini Tube cone white C6025G/part Mini Tube cone gold	

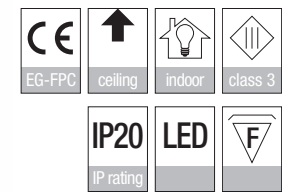
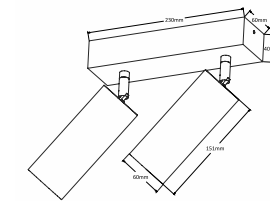

MINI TUBE 2 ON LED

REF	A1004W/927/24 A1004W/927/36 A1004W/930/24 A1004W/930/36 A1004B/927/24 A1004B/927/36 A1004B/930/24 A1004B/930/36	Mini Tube 2 ON white LED 927 R24 Mini Tube 2 ON white LED 927 R36 Mini Tube 2 ON white LED 930 R24 Mini Tube 2 ON white LED 930 R36 Mini Tube 2 ON black LED 927 R24 Mini Tube 2 ON black LED 927 R36 Mini Tube 2 ON black LED 930 R24 Mini Tube 2 ON black LED 930 R36
-----	--	--

LED	LED Engine
LED LM OUTPUT	700 lm
POWER CONS.	10 W
DRIVE CURRENT	2x 230 Vac
COLOR TEMP.	2.700 / 3.000 K
CRI	92
REFLECTOR	24° / 36°
FINISH	white RAL 9016 tex black RAL 9005 tex
ADJUSTABLE	45° x 355°
CUT-OUT	n/a
REMARK	mains dimmable (leading & trailing)

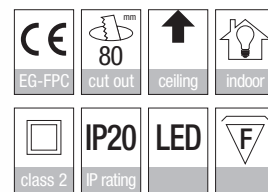
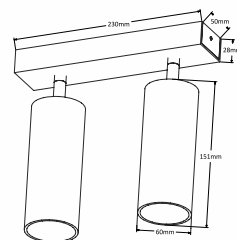

MODEL	REFERENCE	LM OUTPUT	CRI / CCT	BEAM	DIMMING
MINI TUBE RECT 2 X ON WHITE MINI TUBE RECT 2 X ON BLACK	A6172W A6172B	2x 700 lm	827 - 830 - 840 - V830 927 - 930 - 940 - V930 - BT	16°	ND PD A D
		2x 1.300 lm	827 - 830 - 840 - V830 927 - 930 - 940 - V930 - BT	16°/40°/60° 40°/60°	

ND: non dimmable / PD: phase dimming / A: 1-10V / D: DALI



MINI TUBE 3 ON GU10

REF	A1005W A1005B	Mini Tube 3 ON white Mini Tube 3 ON black
LAMP	3x QPAR51 35 W max. / LED bulb	
BASE	GU10	
FINISH	white RAL 9016 tex black RAL 9005 tex	
ADJUSTABLE	45° x 355°	
CUT-OUT	n/a	
REMARK	fits all LED replacement bulbs adjustable lamp depth GU10 socket	
OPTIONAL	MINI TUBE CONE SET (REF C6025): mounting clips / cone / honeycomb / prismatic lens / spread lens C6025B/part Mini Tube cone black C6025W/part Mini Tube cone white C6025G/part Mini Tube cone gold	

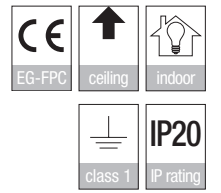
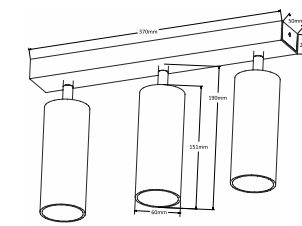

MINI TUBE 3 ON LED

REF	A1005W/927/24 A1005W/927/36 A1005W/930/24 A1005W/930/36 A1005B/927/24 A1005B/927/36 A1005B/930/24 A1005B/930/36	Mini Tube 3 ON white LED 927 R24 Mini Tube 3 ON white LED 927 R36 Mini Tube 3 ON white LED 930 R24 Mini Tube 3 ON white LED 930 R36 Mini Tube 3 ON black LED 927 R24 Mini Tube 3 ON black LED 927 R36 Mini Tube 3 ON black LED 930 R24 Mini Tube 3 ON black LED 930 R36
-----	--	--

LED	LED Engine
LED LM OUTPUT	700 lm
POWER CONS.	10 W
DRIVE CURRENT	2x 230 Vac
COLOR TEMP.	2.700 / 3.000 K
CRI	92
REFLECTOR	36°
FINISH	white RAL 9016 tex black RAL 9005 tex
ADJUSTABLE	45° x 355°
REMARK	mains dimmable (leading & trailing)

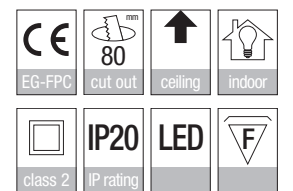
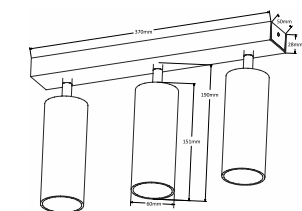



MINI TUBE SUSP ON GU10

REF	A1006W/O A1006B/O	Mini Tube suspended ON white Mini Tube suspended ON black
LAMP	QPAR51 35 W max. / LED bulb	
BASE	GU10	
FINISH	white RAL 9016 tex black RAL 9005 tex	
ADJUSTABLE	height adjustable	
REMARK	fits all LED replacement bulbs adjustable lamp depth GU10 socket black fabric power cable / length 1,6 m	
OPTIONAL	red fabric power cable MINI TUBE CONE SET (REF C6025): mounting clips / cone / honeycomb / prismatic lens / spread lens C6025B/part Mini Tube cone black C6025W/part Mini Tube cone white C6025G/part Mini Tube cone gold	

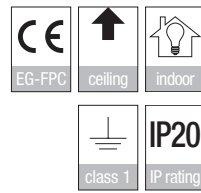

MINI TUBE SUSP IN GU10

REF	A1006W/I A1006B/I	Mini Tube suspended IN white Mini Tube suspended IN black
LAMP	QPAR51 35 W max. / LED bulb	
BASE	GU10	
FINISH	white RAL 9016 tex black RAL 9005 tex	
ADJUSTABLE	height adjustable	
REMARK	fits all LED replacement bulbs adjustable lamp depth GU10 socket black fabric power cable / length 1,6 m	
OPTIONAL	red fabric power cable MINI TUBE CONE SET (REF C6025): mounting clips / cone / honeycomb / prismatic lens / spread lens C6025B/part Mini Tube cone black C6025W/part Mini Tube cone white C6025G/part Mini Tube cone gold	

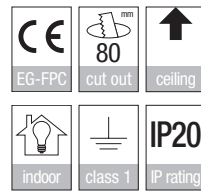
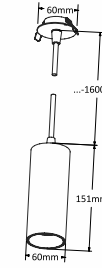

MINI TUBE SUSP ON LED

REF	A1006W/O/927/24 A1006W/O/927/36 A1006W/O/930/24 A1006W/O/930/36 A1006B/O/927/24 A1006B/O/927/36 A1006B/O/930/24 A1006B/O/930/36	Mini Tube suspended ON white LED 927 R24 Mini Tube suspended ON white LED 927 R36 Mini Tube suspended ON white LED 930 R24 Mini Tube suspended ON white LED 930 R36 Mini Tube suspended ON black LED 927 R24 Mini Tube suspended ON black LED 927 R36 Mini Tube suspended ON black LED 930 R24 Mini Tube suspended ON black LED 930 R36
-----	--	--

LED	LED Engine
LED LM OUTPUT	700 lm
POWER CONS.	10 W
DRIVE CURRENT	230 Vac
COLOR TEMP.	2.700 / 3.000 K
CRI	92
REFLECTOR	24° / 36°
FINISH	white RAL 9016 tex black RAL 9005 tex
ADJUSTABLE	height adjustable
REMARK	mains dimmable (leading & trailing) black fabric power cable / length 1,6 m

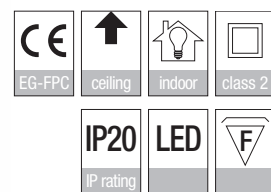
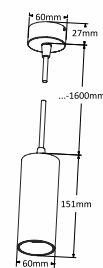

MINI TUBE SUSP IN LED

REF	A1006W/I/927/24 A1006W/I/927/36 A1006W/I/930/24 A1006W/I/930/36 A1006B/I/927/24 A1006B/I/927/36 A1006B/I/930/24 A1006B/I/930/36	Mini Tube suspended IN white LED 927 R24 Mini Tube suspended IN white LED 927 R36 Mini Tube suspended IN white LED 930 R24 Mini Tube suspended IN white LED 930 R36 Mini Tube suspended IN black LED 927 R24 Mini Tube suspended IN black LED 927 R36 Mini Tube suspended IN black LED 930 R24 Mini Tube suspended IN black LED 930 R36
-----	--	--

LED	LED Engine
LED LM OUTPUT	700 lm
POWER CONS.	10 W
DRIVE CURRENT	230 Vac
COLOR TEMP.	2.700 / 3.000 K
CRI	92
REFLECTOR	24° / 36°
FINISH	white RAL 9016 tex black RAL 9005 tex
ADJUSTABLE	height adjustable
REMARK	mains dimmable (leading & trailing) black fabric power cable / length 1,6 m

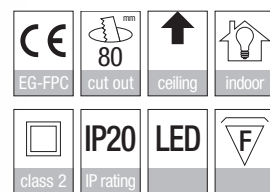
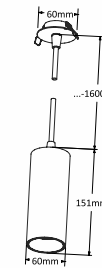



MINI TUBE L SUSP ON GU10

REF	A1006LW/O Mini Tube L suspended ON white A1006LB/O Mini Tube L suspended ON black
LAMP	QPAR51 35 W max. / LED bulb
BASE	GU10
FINISH	white RAL 9016 tex black RAL 9005 tex
ADJUSTABLE	height adjustable
REMARK	fits all LED replacement bulbs adjustable lamp depth GU10 socket black fabric power cable / length 1,6 m
OPTIONAL	red fabric power cable MINI TUBE CONE SET (REF C6025): mounting clips / cone / honeycomb / prismatic lens / spread lens C6025B/part Mini Tube cone black C6025W/part Mini Tube cone white C6025G/part Mini Tube cone gold

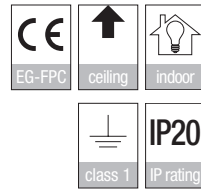
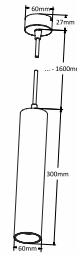

MINI TUBE L SUSP IN GU10

REF	A1006LW/I Mini Tube L suspended IN white A1006LB/I Mini Tube L suspended IN black
LAMP	QPAR51 35 W max. / LED bulb
BASE	GU10
FINISH	white RAL 9016 tex black RAL 9005 tex
ADJUSTABLE	height adjustable
REMARK	fits all LED replacement bulbs adjustable lamp depth GU10 socket black fabric power cable / length 1,6 m
OPTIONAL	red fabric power cable MINI TUBE CONE SET (REF C6025): mounting clips / cone / honeycomb / prismatic lens / spread lens C6025B/part Mini Tube cone black C6025W/part Mini Tube cone white C6025G/part Mini Tube cone gold

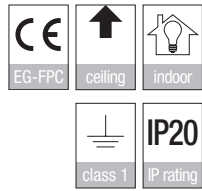
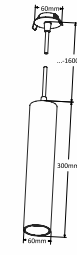

MINI TUBE L SUSP ON LED

REF	A1006LW/O/927/24 Mini Tube L susp ON white LED 927 R24 A1006LW/O/927/36 Mini Tube L susp ON white LED 927 R36 A1006LW/O/930/24 Mini Tube L susp ON white LED 930 R24 A1006LW/O/930/36 Mini Tube L susp ON white LED 930 R36 A1006LB/O/927/24 Mini Tube L susp ON black LED 927 R24 A1006LB/O/927/36 Mini Tube L susp ON black LED 927 R36 A1006LB/O/930/24 Mini Tube L susp ON black LED 930 R24 A1006LB/O/930/36 Mini Tube L susp ON black LED 930 R36
-----	--

LED	LED Engine
LED LM OUTPUT	700 lm
POWER CONS.	10 W
DRIVE CURRENT	230 Vac
COLOR TEMP.	2.700 / 3.000 K
CRI	92
REFLECTOR	24° / 36°
FINISH	white RAL 9016 tex black RAL 9005 tex
ADJUSTABLE	height adjustable
REMARK	mains dimmable (leading & trailing) black fabric power cable / length 1,6 m

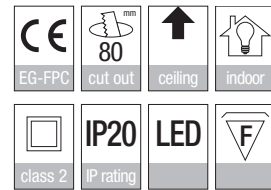
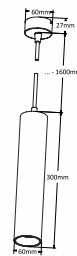

MINI TUBE L SUSP IN LED

REF	A1006LW/I/927/24 Mini Tube L susp IN white LED 927 R24 A1006LW/I/927/36 Mini Tube L susp IN white LED 927 R36 A1006LW/I/930/24 Mini Tube L susp IN white LED 930 R24 A1006LW/I/930/36 Mini Tube L susp IN white LED 930 R36 A1006LB/I/927/24 Mini Tube L susp IN black LED 927 R24 A1006LB/I/927/36 Mini Tube L susp IN black LED 927 R36 A1006LB/I/930/24 Mini Tube L susp IN black LED 930 R24 A1006LB/I/930/36 Mini Tube L susp IN black LED 930 R36
-----	--

LED	LED Engine
LED LM OUTPUT	700 lm
POWER CONS.	10 W
DRIVE CURRENT	230 Vac
COLOR TEMP.	2.700 / 3.000 K
CRI	92
REFLECTOR	24° / 36°
FINISH	white RAL 9016 tex black RAL 9005 tex
ADJUSTABLE	height adjustable
REMARK	mains dimmable (leading & trailing) black fabric power cable / length 1,6 m

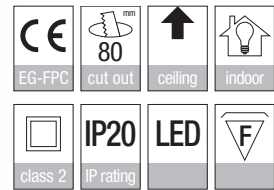
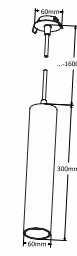



MIX WITH THE BEST FEVER-TREE

HISPRACK
Triple-Flavored Beer

Red Bull

Red Bull

HISPRACK
Triple-Flavored Beer

The
KRAK
BLACK SP
RUM





MINI TUBE X SUSPENDED

REF	A6162W	Mini Tube X suspended white
	A6162B	Mini Tube X suspended black

LED	Xicato
LED LM OUTPUT	700 / 1.300 lm
POWER CONS.	according to lumen output - see table p. 255
COLOR TEMP.	2.700 / 3.000 / 4.000 K
CRI	80 or +95
COLOR QUAL.	artist / beauty / vibrant / vibrant artist
REFLECTOR	16° / 40° / 60°
FINISH	white RAL 9016 tex black RAL 9005 tex
DRIVE CURRENT	supplied with driver
OPTIONAL	MINI TUBE CONE SET (REF C6025): mounting clips / cone / honeycomb / prismatic lens / spread lens C6025B/part Mini Tube cone black C6025W/part Mini Tube cone white C6025G/part Mini Tube cone gold

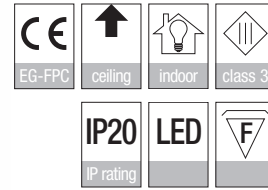
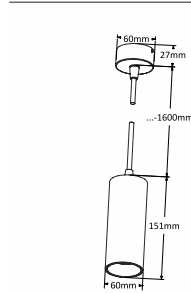

MODEL	REFERENCE	LM OUTPUT	CRI / CCT	BEAM	DIMMING
MINI TUBE X SUSPENDED WHITE MINI TUBE X SUSPENDED BLACK	A6162W A6162B	700 lm	827 - 830 - 840 - V830	16°	ND PD A D
			927 - 930 - 940 - V930 - BT		
		1.300 lm	827 - 830 - 840 - V830	16°/40°/60°	
			927 - 930 - 940 - V930 - BT	40°/60°	

ND: non dimmable / PD: phase dimming / A: 1-10V / D: DALI



MINI TUBE XL SUSPENDED

REF	A6162LW	Mini Tube XL suspended white
	A6162LB	Mini Tube XL suspended black

LED	Xicato
LED LM OUTPUT	700 / 1.300 lm
POWER CONS.	according to lumen output - see table p. 255
COLOR TEMP.	2.700 / 3.000 / 4.000 K
CRI	80 or +95
COLOR QUAL.	artist / beauty / vibrant / vibrant artist
REFLECTOR	16° / 40° / 60°
FINISH	white RAL 9016 tex black RAL 9005 tex
DRIVE CURRENT	supplied with driver
OPTIONAL	MINI TUBE CONE SET (REF C6025): mounting clips / cone / honeycomb / prismatic lens / spread lens C6025B/part Mini Tube cone black C6025W/part Mini Tube cone white C6025G/part Mini Tube cone gold

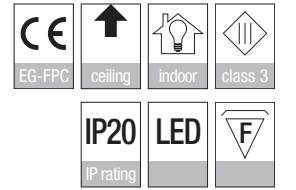
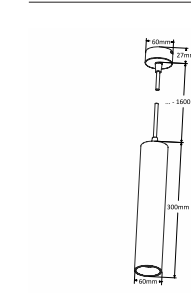
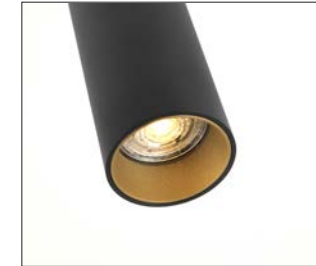

MODEL	REFERENCE	LM OUTPUT	CRI / CCT	BEAM	DIMMING
MINI TUBE XL SUSPENDED WHITE MINI TUBE XL SUSPENDED BLACK	A6162LW A6162LB	700 lm	827 - 830 - 840 - V830	16°	ND PD A D
			927 - 930 - 940 - V930 - BT		
		1.300 lm	827 - 830 - 840 - V830	16°/40°/60°	
			927 - 930 - 940 - V930 - BT	40°/60°	

ND: non dimmable / PD: phase dimming / A: 1-10V / D: DALI



MINI TUBE IN-TRAC GU10

REF	A1003W A1003B	Mini Tube IN-TRAC white Mini Tube IN-TRAC black
LAMP	QPAR51 35 W max. / LED bulb	
BASE	GU10	
FINISH	white RAL 9016 tex black RAL 9005 tex	
ADJUSTABLE	45° x 355°	
TRACK ADAPTOR	3F Eutrac in-trac adaptor / see p. 261 only suitable with Eutrac 3F rails	
REMARK	fits all LED replacement bulbs adjustable lamp depth GU10 socket	
OPTIONAL	MINI TUBE CONE SET (REF C6025): mounting clips / cone / honeycomb / prismatic lens / spread lens C6025B/part Mini Tube cone black C6025W/part Mini Tube cone white C6025G/part Mini Tube cone gold	

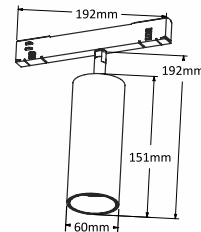

EG-FPC
 ceiling
 indoor
 IP20
 class 1
 IP rating



MINI TUBE ON IN-TRAC GU10

REF	A1007W A1007B	Mini Tube ON IN-TRAC white Mini Tube ON IN-TRAC black
LAMP	QPAR51 35 W max. / LED bulb	
BASE	GU10	
FINISH	white RAL 9016 tex black RAL 9005 tex	
ADJUSTABLE	n/a	
TRACK ADAPTOR	3F Eutrac in-trac adaptor / see p. 261 only suitable with Eutrac 3F rails	
REMARK	fits all LED replacement bulbs adjustable lamp depth GU10 socket	
OPTIONAL	MINI TUBE CONE SET (REF C6025): mounting clips / cone / honeycomb / prismatic lens / spread lens C6025B/part Mini Tube cone black C6025W/part Mini Tube cone white C6025G/part Mini Tube cone gold	

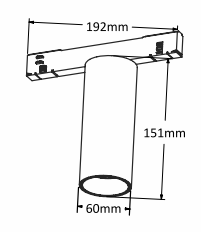

EG-FPC
 ceiling
 indoor
 IP20
 class 1
 IP rating



MINI TUBE IN-TRAC LED

REF	A1003W/927/24 A1003W/927/36 A1003W/930/24 A1003W/930/36 A1003B/927/24 A1003B/927/36 A1003B/930/24 A1003B/930/36	Mini Tube IN-TRAC white LED 927 R24 Mini Tube IN-TRAC white LED 927 R36 Mini Tube IN-TRAC white LED 930 R24 Mini Tube IN-TRAC white LED 930 R36 Mini Tube IN-TRAC black LED 927 R24 Mini Tube IN-TRAC black LED 927 R36 Mini Tube IN-TRAC black LED 930 R24 Mini Tube IN-TRAC black LED 930 R36
-----	--	--

LED	LED Engine
LED LM OUTPUT	700 lm
POWER CONS.	10 W
DRIVE CURRENT	230 Vac
COLOR TEMP.	2.700 / 3.000 K
CRI	92
REFLECTOR	24° / 36°
TRACK ADAPTOR	3F Eutrac in-trac adaptor / see p. 261 only suitable with Eutrac 3F rails
FINISH	white RAL 9016 tex black RAL 9005 tex
ADJUSTABLE	45° x 355°
REMARK	mains dimmable (leading & trailing)

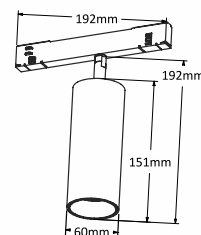
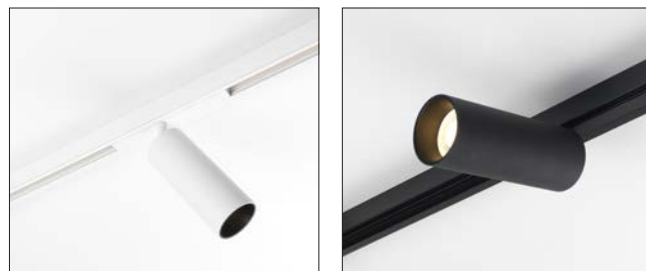

EG-FPC
 ceiling
 indoor
 class 2
 IP20
 LED
 F



MINI TUBE ON IN-TRAC LED

REF	A1007W/927/24 A1007W/927/36 A1007W/930/24 A1007W/930/36 A1007B/927/24 A1007B/927/36 A1007B/930/24 A1007B/930/36	Mini Tube ON IN-TRAC white LED 927 R24 Mini Tube ON IN-TRAC white LED 927 R36 Mini Tube ON IN-TRAC white LED 930 R24 Mini Tube ON IN-TRAC white LED 930 R36 Mini Tube ON IN-TRAC black LED 927 R24 Mini Tube ON IN-TRAC black LED 927 R36 Mini Tube ON IN-TRAC black LED 930 R24 Mini Tube ON IN-TRAC black LED 930 R36
-----	--	--

LED	LED Engine
LED LM OUTPUT	700 lm
POWER CONS.	10 W
DRIVE CURRENT	230 Vac
COLOR TEMP.	2.700 / 3.000 K
CRI	92
REFLECTOR	24° / 36°
TRACK ADAPTOR	3F Eutrac in-trac adaptor / see p. 261 only suitable with Eutrac 3F rails
FINISH	white RAL 9016 tex black RAL 9005 tex
ADJUSTABLE	n/a
REMARK	mains dimmable (leading & trailing)

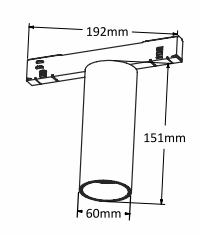
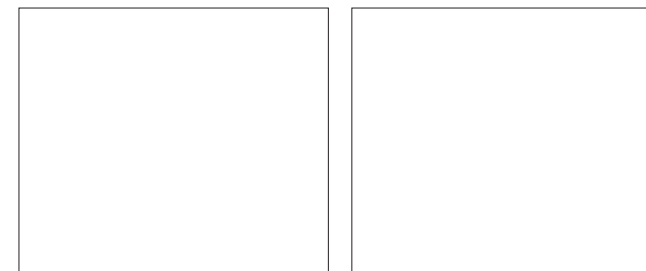

EG-FPC
 ceiling
 indoor
 class 2
 IP20
 LED
 F



MINI TUBE SUSP IN-TRAC GU10

REF A1009W Mini Tube suspended IN-TRAC white
A1009B Mini Tube suspended IN-TRAC black

LAMP QPAR51 35 W max. / LED bulb
BASE GU10
FINISH white RAL 9016 tex
black RAL 9005 tex
ADJUSTABLE 45° x 355°
TRACK ADAPTOR 3F Eutrac in-trac adaptor / see p. 261
only suitable with Eutrac 3F rails
REMARK fits all LED replacement bulbs
adjustable lamp depth GU10 socket
black fabric power cable / length 1,6 m
OPTIONAL MINI TUBE CONE SET (REF A6025):
mounting clips / cone / honeycomb /
prismatic lens / spread lens
C6025B/part Mini Tube cone black
C6025W/part Mini Tube cone white
C6025G/part Mini Tube cone gold

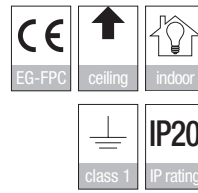
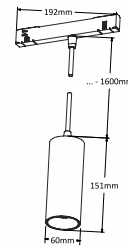

MINI TUBE L SUSP IN-TRAC GU10

REF A1009LW Mini Tube L suspended IN-TRAC white
A1009LB Mini Tube L suspended IN-TRAC black

LAMP QPAR51 35 W max. / LED bulb
BASE GU10
FINISH white RAL 9016 tex
black RAL 9005 tex
ADJUSTABLE 45° x 355°
TRACK ADAPTOR 3F Eutrac in-trac adaptor / see p. 261
only suitable with Eutrac 3F rails
REMARK fits all LED replacement bulbs
adjustable lamp depth GU10 socket
black fabric power cable / length 1,6 m
OPTIONAL MINI TUBE CONE SET (REF A6025):
mounting clips / cone / honeycomb /
prismatic lens / spread lens
C6025B/part Mini Tube cone black
C6025W/part Mini Tube cone white
C6025G/part Mini Tube cone gold

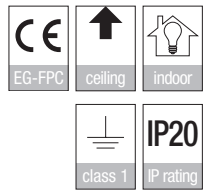
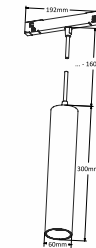

MINI TUBE SUSP IN-TRAC LED

REF A1009W/927/24 Mini Tube suspended IN-TRAC white LED 927 R24
A1009W/927/36 Mini Tube suspended IN-TRAC white LED 927 R36
A1009W/930/24 Mini Tube suspended IN-TRAC white LED 930 R24
A1009W/930/36 Mini Tube suspended IN-TRAC white LED 930 R36
A1009B/927/24 Mini Tube suspended IN-TRAC black LED 927 R24
A1009B/927/36 Mini Tube suspended IN-TRAC black LED 927 R36
A1009B/930/24 Mini Tube suspended IN-TRAC black LED 930 R24
A1009B/930/36 Mini Tube suspended IN-TRAC black LED 930 R36

LED LED Engine
LED LM OUTPUT 700 lm
POWER CONS. 10 W
DRIVE CURRENT 230 Vac
COLOR TEMP. 2.700 / 3.000 K
CRI 92
REFLECTOR 24° / 36°
TRACK ADAPTOR 3F Eutrac in-trac adaptor / see p. 261
only suitable with Eutrac 3F rails
FINISH white RAL 9016 tex
black RAL 9005 tex
ADJUSTABLE 45° x 355°
REMARK mains dimmable (leading & trailing)
black fabric power cable / length 1,6 m

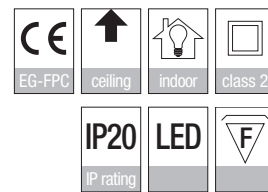
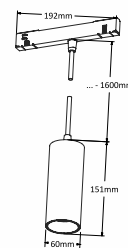

MINI TUBE L SUSP IN-TRAC LED

REF A1009LW/927/24 Mini Tube L susp IN-TRAC white LED 927 R24
A1009LW/927/36 Mini Tube L susp IN-TRAC white LED 927 R36
A1009LW/930/24 Mini Tube L susp IN-TRAC white LED 930 R24
A1009LW/930/36 Mini Tube L susp IN-TRAC white LED 930 R36
A1009LB/927/24 Mini Tube L susp IN-TRAC black LED 927 R24
A1009LB/927/36 Mini Tube L susp IN-TRAC black LED 927 R36
A1009LB/930/24 Mini Tube L susp IN-TRAC black LED 930 R24
A1009LB/930/36 Mini Tube L susp IN-TRAC black LED 930 R36

LED LED Engine
LED LM OUTPUT 700 lm
POWER CONS. 10 W
DRIVE CURRENT 230 Vac
COLOR TEMP. 2.700 / 3.000 K
CRI 92
REFLECTOR 24° / 36°
TRACK ADAPTOR 3F Eutrac in-trac adaptor / see p. 261
only suitable with Eutrac 3F rails
FINISH white RAL 9016 tex
black RAL 9005 tex
ADJUSTABLE 45° x 355°
REMARK mains dimmable (leading & trailing)
black fabric power cable / length 1,6 m

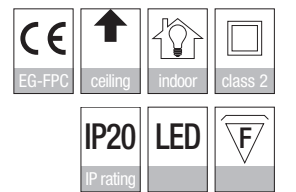
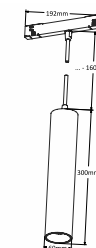



MINI TUBE L SUSP T INVITRACK

REF	T1009LW/927/24	Mini Tube L SUSP T INVITRACK white LED 927R24
	T1009LW/927/36	Mini Tube L SUSP T INVITRACK white LED 927R36
	T1009LW/930/24	Mini Tube L SUSP T INVITRACK white LED 930R24
	T1009LW/930/36	Mini Tube L SUSP T INVITRACK white LED 930R24
	T1009LB/927/24	Mini Tube L SUSP T INVITRACK black LED 927R24
	T1009LB/927/36	Mini Tube L SUSP T INVITRACK black LED 927R36
	T1009LB/930/24	Mini Tube L SUSP T INVITRACK black LED 930R24
	T1009LB/930/36	Mini Tube L SUSP T INVITRACK black LED 930R24

LED	LED engine
LED LM OUTPUT	1.200 lm
POWER CONS.	12 W
COLOR TEMP.	2.700 / 3.000 K
CRI	92
REFLECTOR	24° / 36°
TRACK ADAPTOR	3F Eutrac in-trac adaptor / see p. 261 only suitable with Eutrac 3F rails
FINISH	white RAL 9016 tex black RAL 9005 tex
DRIVE VOLTAGE	350 mA
DIMMING	DALI on request
REMARK	black fabric power cable / length 1,6 m

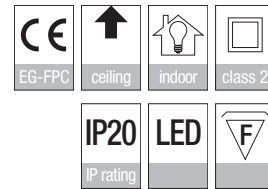
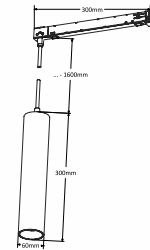

MINI TUBE T INVITRACK

REF	T1003W/927/24	Mini Tube T INVITRACK white LED 927R24
	T1003W/927/36	Mini Tube T INVITRACK white LED 927R36
	T1003W/930/24	Mini Tube T INVITRACK white LED 930R24
	T1003W/930/36	Mini Tube T INVITRACK white LED 930R24
	T1003B/927/24	Mini Tube T INVITRACK black LED 927R24
	T1003B/927/36	Mini Tube T INVITRACK black LED 927R36
	T1003B/930/24	Mini Tube T INVITRACK black LED 930R24
	T1003B/930/36	Mini Tube T INVITRACK black LED 930R24

LED	LED engine
LED LM OUTPUT	1.200 lm
POWER CONS.	12 W
COLOR TEMP.	2.700 / 3.000 K
CRI	92
REFLECTOR	24° / 36°
TRACK ADAPTOR	3F Eutrac in-trac adaptor / see p. 261 only suitable with Eutrac 3F rails
FINISH	white RAL 9016 tex black RAL 9005 tex
ADJUSTABLE	45° x -355°
DRIVE VOLTAGE	350 mA
DIMMING	DALI / on request

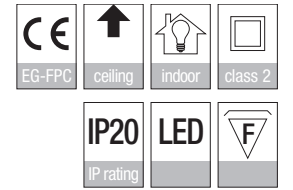
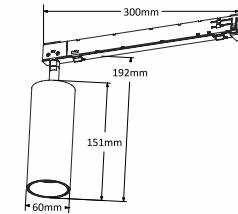

PAR X

REF	A6180	Par X
LED	Xicato	
LED LM OUTPUT	1.300 lm	
POWER CONS.	according to lumen output - see table p. 255	
COLOR TEMP.	2.700 / 3.000 / 4.000 K	
CRI	80 or +95	
COLOR QUAL.	artist / beauty / vibrant / vibrant artist	
REFLECTOR	20° / 40° / 60°	
FINISH	black RAL 9005	
ADJUSTABLE	45° x 355°	
CUT-OUT	n/a	
DRIVE VOLTAGE	230 Vac (build in driver)	
TRACK ADAPTOR	3F	
REMARK	without barndoors	
OPTIONS	C6024 Par X barndoors	

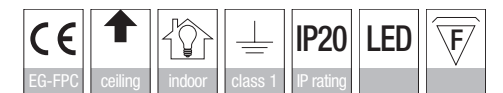

MODEL	REFERENCE	LM OUTPUT	CRI / CCT	BEAM	DIMMING
PAR 30X TRACK	A6180	1.300 lm	827 - 830 - 840 - V830	16°/40°/60°	A
			927 - 930 - 940 - V930 - BT - F+	40°/60°	D

ND: non dimmable / PD: phase dimming / A: 1-10V / D: DALI

420 mm



700 mm



980 mm



1.260 mm



1.540 mm



2.100 mm



DOXX

Doxx means total freedom for lighting designers and installers.

This innovative flexible aluminum profile allows lighting designers to choose the place of the lighting fixtures freely.

Doxx is designed and engineered to be mounted in a very simple fashion. The profile has an 'open' back in order to give installers total freedom with the power cable.

Available in 6 different lengths.

DOXX

DOXX D42

D42H

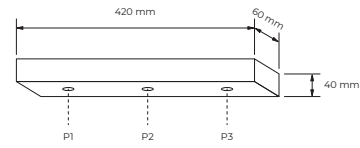

D42V

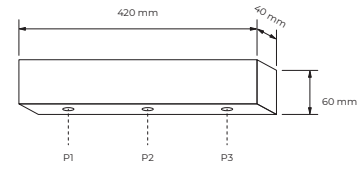

BASE	LENGTH	COLOUR	HOR/VERT	POSITION	X	FIXTURE REFERENCE
	mm				mm	
D42	420	B	H	P1	70	
				P2	210	
				P3	350	

REFERENCE BUILDER: D42B/V

DOXX D70

D70H

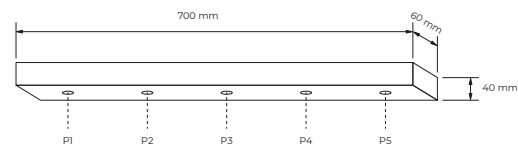

D70V

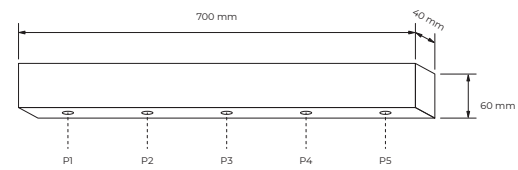

BASE	LENGTH	COLOUR	HOR/VERT	POSITION	X	FIXTURE REFERENCE
	mm				mm	
D70	700	B	H	P1	70	
				P2	210	
				P3	350	
				P4	490	
				P5	630	

REFERENCE BUILDER: D70B/V

DOXX D98

D98H

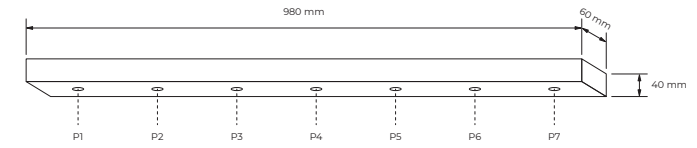

D98V

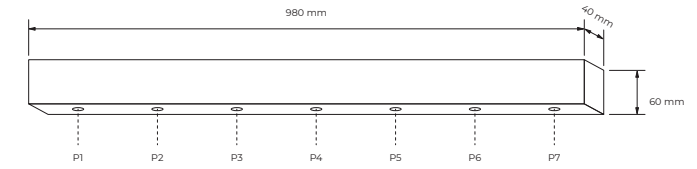

BASE	LENGTH	COLOUR	HOR/VERT	POSITION	X	FIXTURE REFERENCE
	mm				mm	
D98	980	B	H	P1	70	
				P2	210	
				P3	350	
				P4	490	
				P5	630	
				P6	770	
				P7	910	

REFERENCE BUILDER: D98B/V

DOXX D126

D126H

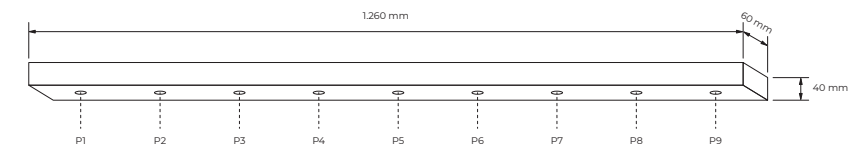

D126V

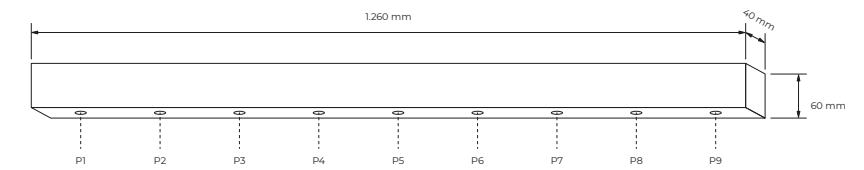

BASE	LENGTH	COLOUR	HOR/VERT	POSITION	X	FIXTURE REFERENCE
	mm				mm	
D126	1260	B	H	P1	70	
				P2	210	
				P3	350	
				P4	490	
				P5	630	
				P6	770	
				P7	910	
				P8	1.050	
				P9	1.190	

REFERENCE BUILDER: D126B/V

DOXX D154

D154H

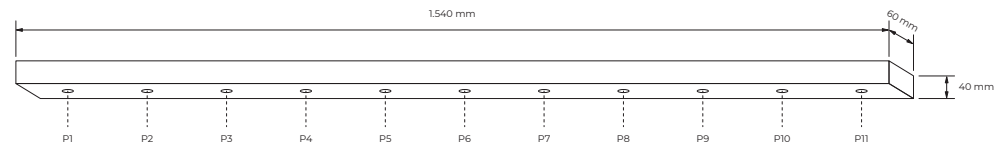

D154V

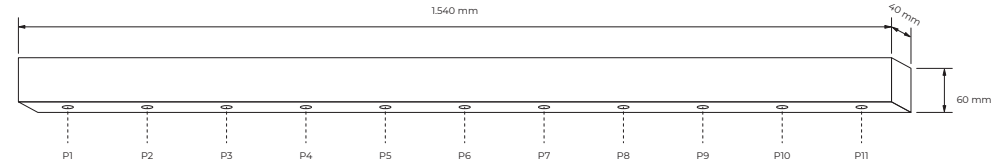

BASE	LENGTH	COLOUR	HOR/VERT	POSITION	X	FIXTURE REFERENCE
	mm				mm	
D154	1540	B	H	P1	70	
			V	P2	210	
				P3	350	
				P4	490	
				P5	630	
				P6	770	
				P7	910	
				P8	1.050	
				P9	1.190	
				P10	1.330	
				P11	1.470	

REFERENCE BUILDER: D154B/V

DOXX D210

D210H

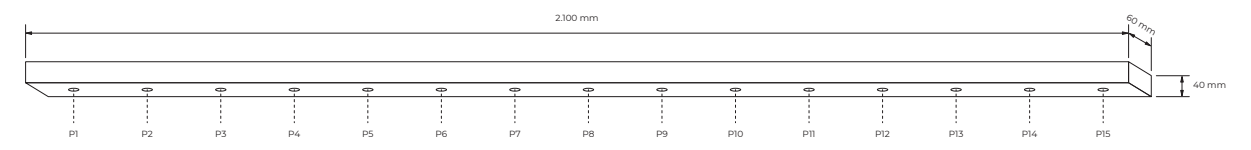

D210V

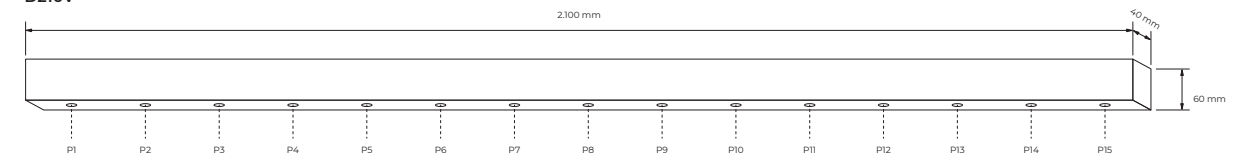

BASE	LENGTH	COLOUR	HOR/VERT	POSITION	X	FIXTURE REFERENCE
	mm				mm	
D210	2100	B	H	P1	70	
			V	P2	210	
				P3	350	
				P4	490	
				P5	630	
				P6	770	
				P7	910	
				P8	1.050	
				P9	1.190	
				P10	1.330	
				P11	1.470	
				P12	1.610	
				P13	1.750	
				P14	1.890	
				P15	2.030	

REFERENCE BUILDER: D210B/V



DOXX MINI TUBE GU10

REF	D1003W D1003B	Doxx Mini Tube GU10 white Doxx Mini Tube GU10 black
LAMP	QPAR51 35 W max. / LED bulb	
BASE	GU10	
FINISH	white RAL 9016 tex black RAL 9005 tex	
ADJUSTABLE	45° x 355°	
REMARKS	fits all LED replacement bulbs adjustable lamp depth GU10 socket	
OPTIONAL	MINI TUBE CONE SET (REF C6025): mounting clips / cone / honeycomb / prismatic lens / spread lens C6025B/part Mini Tube cone black C6025W/part Mini Tube cone white C6025G/part Mini Tube cone gold	

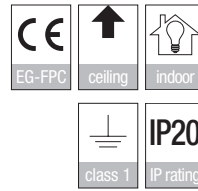
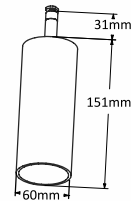

DOXX MINI TUBE SUSP GU10

REF	D1006W D1006B	Doxx Mini Tube Susp GU10 white Doxx Mini Tube Susp GU10 black
LAMP	QPAR51 35 W max. / LED bulb	
BASE	GU10	
FINISH	white RAL 9016 tex black RAL 9005 tex	
ADJUSTABLE	45° x 355°	
REMARKS	fits all LED replacement bulbs adjustable lamp depth GU10 socket black fabric power cable / length 1,6 m	
OPTIONAL	MINI TUBE CONE SET (REF C6025): mounting clips / cone / honeycomb / prismatic lens / spread lens C6025B/part Mini Tube cone black C6025W/part Mini Tube cone white C6025G/part Mini Tube cone gold	

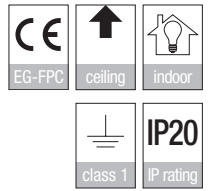
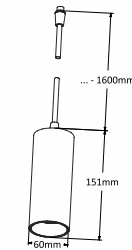

DOXX MINI TUBE LED

REF	D1003W/927/24 D1003W/927/36 D1003W/930/24 D1003W/930/36 D1003B/927/24 D1003B/927/36 D1003B/930/24 D1003B/930/36	Doxx Mini Tube LED white 927 R24 Doxx Mini Tube LED white 927 R36 Doxx Mini Tube LED white 930 R24 Doxx Mini Tube LED white 930 R36 Doxx Mini Tube LED black 927 R24 Doxx Mini Tube LED black 927 R36 Doxx Mini Tube LED black 930 R24 Doxx Mini Tube LED black 930 R36
-----	--	--

LED	LED Engine
LED LM OUTPUT	700 lm
POWER CONS.	10 W
DRIVE CURRENT	230 Vac
COLOR TEMP.	2.700 / 3.000 K
CRI	92
REFLECTOR	24° / 36°
FINISH	white RAL 9016 tex black RAL 9005 tex
ADJUSTABLE	45° x 355°
REMARK	mains dimmable (leading & trailing)

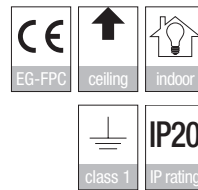
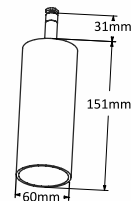

DOXX MINI TUBE SUSP LED

REF	D1006W/927/24 D1006W/927/36 D1006W/930/24 D1006W/930/36 D1006B/927/24 D1006B/927/36 D1006B/930/24 D1006B/930/36	Doxx Mini Tube Suspension LED white 927 R24 Doxx Mini Tube Suspension LED white 927 R36 Doxx Mini Tube Suspension LED white 930 R24 Doxx Mini Tube Suspension LED white 930 R36 Doxx Mini Tube Suspension LED black 927 R24 Doxx Mini Tube Suspension LED black 927 R36 Doxx Mini Tube Suspension LED black 930 R24 Doxx Mini Tube Suspension LED black 930 R36
-----	--	--

LED	LED Engine
LED LM OUTPUT	700 lm
POWER CONS.	10 W
DRIVE CURRENT	230 Vac
COLOR TEMP.	2.700 / 3.000 K
CRI	92
REFLECTOR	24° / 36°
FINISH	white RAL 9016 tex black RAL 9005 tex
ADJUSTABLE	45° x 355°
REMARK	mains dimmable (leading & trailing) black fabric power cable / length 1,6 m
OPTIONAL	red fabric power cable / length 1,6 m

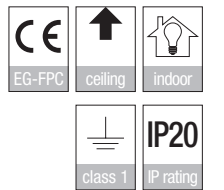
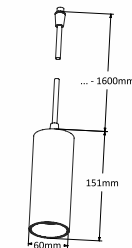
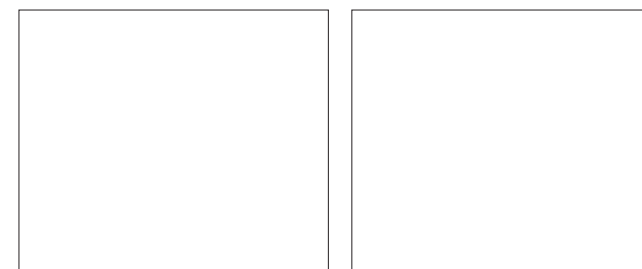



DOXX MINI TUBE L SUSP GU10

REF	D1006LW Doxx Mini Tube L susp GU10 white D1006LB Doxx Mini Tube L susp GU10 black
LAMP	QPAR51 35 W max. / LED bulb
BASE	GU10
FINISH	white RAL 9016 tex black RAL 9005 tex
ADJUSTABLE	45° x 355°
REMARKS	fits all LED replacement bulbs black fabric power cable / length 1,6 m
OPTIONAL	MINI TUBE CONE SET (REF C6025): mounting clips / cone / honeycomb / prismatic lens / spread lens C6025B/part Mini Tube cone black C6025W/part Mini Tube cone white C6025G/part Mini Tube cone gold red fabric power cable / length 1,6 m

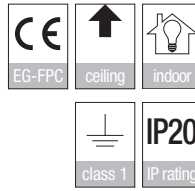
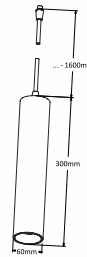

DOXX MICRO TUBE L AC

REF	D6198W/927/PD Doxx Micro Tube L AC white 927 phase DIM D6198W/930/PD Doxx Micro Tube L AC white 930 phase DIM D6198B/927/PD Doxx Micro Tube L AC black 927 phase DIM D6198B/930/PD Doxx Micro Tube L AC black 930 phase DIM
LED	COB LED
LED LM OUTPUT	630 lm
POWER CONS.	8 W
DRIVE CURRENT	230 Vac built-in driver
COLOR TEMP.	2.700 / 3.000 K
CRI	> 90
REFLECTOR	36°
FINISH	white RAL 9016 tex black RAL 9005 tex
ADJUSTABLE	90° x 355°
OPTIONAL	C6029W Micro Tube cone white C6029G Micro Tube cone gold C6030 Micro Tube 24° lens vener finish - see p. 260

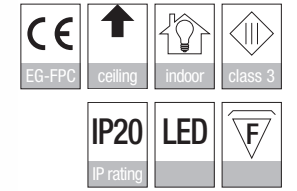
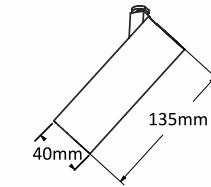

DOXX MINI TUBE L SUSP LED

REF	D1006LW/927/24 Doxx Mini Tube L Susp LED white 927 R24 D1006LW/927/36 Doxx Mini Tube L Susp LED white 927 R36 D1006LW/930/24 Doxx Mini Tube L Susp LED white 930 R24 D1006LW/930/36 Doxx Mini Tube L Susp LED white 930 R36 D1006LB/927/24 Doxx Mini Tube L Susp LED black 927 R24 D1006LB/927/36 Doxx Mini Tube L Susp LED black 927 R36 D1006LB/930/24 Doxx Mini Tube L Susp LED black 930 R24 D1006LB/930/36 Doxx Mini Tube L Susp LED black 930 R36
-----	--

LED	LED Engine
LED LM OUTPUT	700 lm
POWER CONS.	10 W
DRIVE CURRENT	230 Vac
COLOR TEMP.	2.700 / 3.000 K
CRI	92
REFLECTOR	24° / 36°
FINISH	white RAL 9016 tex black RAL 9005 tex
ADJUSTABLE	45° x 355°
REMARK	mains dimmable (leading & trailing) black fabric power cable / length 1,6 m
OPTIONAL	red fabric power cable / length 1,6 m

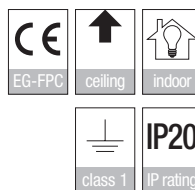

DOXX MICRO TUBE

REF	D6173W/927/PD Doxx Micro Tube white 927 phase DIM/1-10V D6173W/930/PD Doxx Micro Tube white 930 phase DIM/1-10V D6173B/927/PD Doxx Micro Tube black 927 phase DIM/1-10V D6173B/930/PD Doxx Micro Tube black 930 phase DIM/1-10V D6173W/927/D Doxx Micro Tube white 927 DALI DIM D6173W/930/D Doxx Micro Tube white 930 DALI DIM D6173B/927/D Doxx Micro Tube black 927 DALI DIM D6173B/930/D Doxx Micro Tube black 930 DALI DIM
-----	--

LED	COB LED
LED LM OUTPUT	630 lm
POWER CONS.	7 W
DRIVE CURRENT	230 Vac built-in driver
COLOR TEMP.	2.700 / 3.000 K
CRI	> 90
REFLECTOR	36°
FINISH	white RAL 9016 tex black RAL 9005 tex
ADJUSTABLE	90° x 355°
OPTIONAL	C6029W Micro Tube cone white C6029G Micro Tube cone gold C6030 Micro Tube 24° lens vener finish - see p. 260

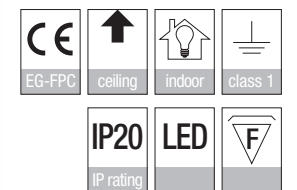
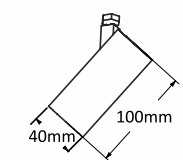



DOXX NANO TUBE L

REF	D6199W/927/PD	Nano Tube L white 927 phase DIM/1-10V
	D6199W/930/PD	Nano Tube L white 930 phase DIM/1-10V
	D6199B/927/PD	Nano Tube L black 927 phase DIM/1-10V
	D6199B/930/PD	Nano Tube L black 930 phase DIM/1-10V
	D6199W/927/D	Nano Tube L white 927 DALI DIM
	D6199W/930/D	Nano Tube L white 930 DALI DIM
	D6199B/927/D	Nano Tube L black 927 DALI DIM
	D6199B/930/D	Nano Tube L black 930 DALI DIM

LED	COB LED
LED LM OUTPUT	540 lm
POWER CONS.	8 W
DRIVE CURRENT	350 mA 22 Vdc max.
COLOR TEMP.	2.700 / 3.000 K
CRI	> 90
REFLECTOR	35°
FINISH	white RAL 9016 tex black RAL 9005 tex
ADJUSTABLE	45° x 355°

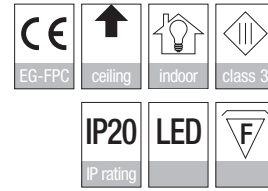
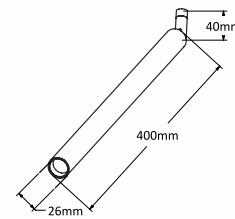

DOXX FREE MOUNTING WITH STRAIN RELIEF

REF	D/STR/W	Free mounting with strain relief white
	D/STR/B	Free mounting with strain relief black



DOXX NANO TUBE SUSP

REF	D6191W/927/PD	Nano Tube L Susp white 927 phase DIM/1-10V
	D6191W/930/PD	Nano Tube L Susp white 930 phase DIM/1-10V
	D6191B/927/PD	Nano Tube L Susp black 927 phase DIM/1-10V
	D6191B/930/PD	Nano Tube L Susp black 930 phase DIM/1-10V
	D6191W/927/D	Nano Tube L Susp white 927 DALI DIM
	D6191W/930/D	Nano Tube L Susp white 930 DALI DIM
	D6191B/927/D	Nano Tube L Susp black 927 DALI DIM
	D6191B/930/D	Nano Tube L Susp black 930 DALI DIM

LED	COB LED
LED LM OUTPUT	540 lm
POWER CONS.	8 W
DRIVE CURRENT	350 mA 22 Vdc max.
COLOR TEMP.	2.700 / 3.000 K
CRI	> 90
REFLECTOR	35°
FINISH	white RAL 9016 tex black RAL 9005 tex
ADJUSTABLE	45° x 355°
REMARK	black fabric power cable / length 1,6 m
OPTIONAL	red fabric power cable / length 1,6 m

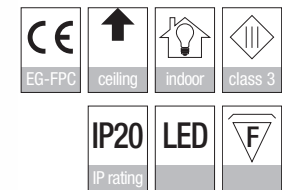
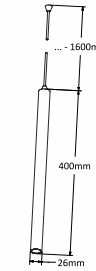



GEORGES T

REF A6207/927 Georges table 927
A6207/930 Georges table 930

LED COB LED
LED LM OUTPUT 280 lm
POWER CONS. 3,33 W
DRIVE CURRENT 350 mA 10 Vdc max.
COLOR TEMP. 2.700 / 3.000 K
CRI > 80
REFLECTOR polycarbonate diffusor
FINISH brushed brass & polycarbonate
REMARK supplied with 2 m cable, toggle switch and power plug

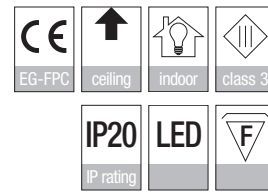
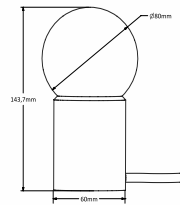

GEORGES D20 ON

REF A6205D20/O/927 Georges D20 ON 927
A6205D20/O/930 Georges D20 ON 930

LED COB LED
LED LM OUTPUT 280 lm
POWER CONS. 3,33W
DRIVE CURRENT 350 mA 10Vdc max.
COLOR TEMP. 2.700 / 3.000 K
CRI > 80
REFLECTOR polycarbonate diffusor
FINISH brushed brass & polycarbonate

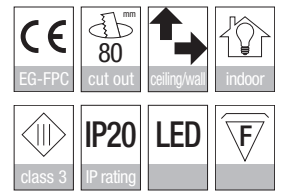
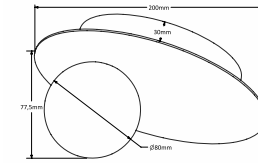

GEORGES D9 IN

REF A6205D9/I/927 Georges D9 IN 927
A6205D9/I/930 Georges D9 IN 930

LED COB LED
LED LM OUTPUT 280 lm
POWER CONS. 3,33 W
DRIVE CURRENT 350 mA 10 Vdc max.
COLOR TEMP. 2.700 / 3.000 K
CRI > 80
REFLECTOR polycarbonate diffusor
FINISH brushed brass & polycarbonate
CUT-OUT Ø 60mm

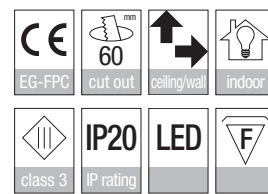
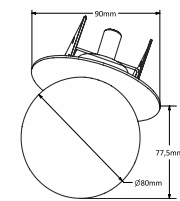

GEORGES D12 IN

REF A6205D12/I/927 Georges D12 IN 927
A6205D12/I/930 Georges D12 IN 930

LED COB LED
LED LM OUTPUT 280 lm
POWER CONS. 3,33 W
DRIVE CURRENT 350 mA 10Vdc max.
COLOR TEMP. 2.700 / 3.000 K
CRI > 80
REFLECTOR polycarbonate diffusor
FINISH brushed brass & polycarbonate
CUT-OUT Ø 60mm

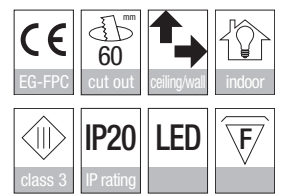
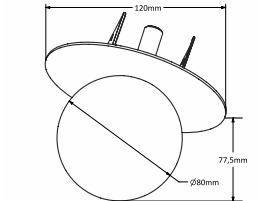



GEORGES D12 SUSP IN

REF A6204D12/I/927 Georges D12 S IN 927
A6204D12/I/930 Georges D12 S IN 930

LED COB LED
LED lm output 280 lm
POWER CONS. 3,33W
DRIVE CURRENT 350 mA 10Vdc max.
COLOR TEMP. 2.700 / 3.000 K
CRI > 80
REFLECTOR polycarbonate diffusor
FINISH brushed brass & polycarbonate
CUT-OUT Ø 44 mm
REMARK black fabric power cable / length 1,6 m

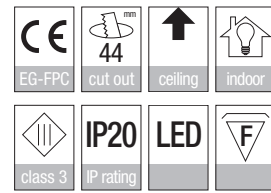
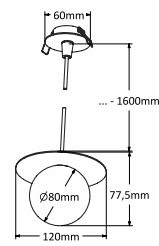
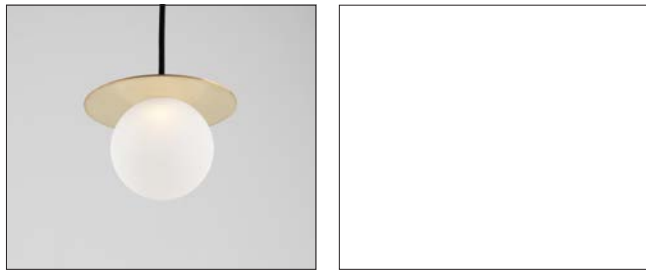

GEORGES D12 SUSP ON

REF A6204D12/O/927 Georges D12 S ON 927
A6204D12/O/930 Georges D12 S ON 930

LED COB LED
LED lm output 280 lm
POWER CONS. 3,33W
DRIVE CURRENT 350 mA 10Vdc max.
COLOR TEMP. 2.700 / 3.000 K
CRI > 80
REFLECTOR polycarbonate diffusor
FINISH brushed brass & polycarbonate
REMARK black fabric power cable / length 1,6 m

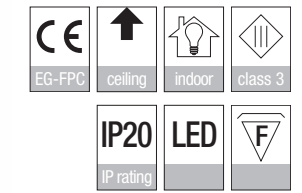
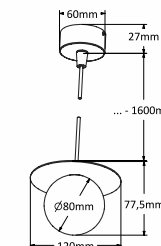

GEORGES SUSP IN

REF A6204/I/927 Georges S IN 927
A6204/I/930 Georges S IN 930

LED COB LED
LED lm output 280 lm
POWER CONS. 3,33W
DRIVE CURRENT 350 mA 10Vdc max.
COLOR TEMP. 2.700 / 3.000 K
CRI > 80
REFLECTOR polycarbonate diffusor
FINISH brushed brass & polycarbonate
CUT-OUT Ø 44 mm
REMARK black fabric power cable / length 1,6 m

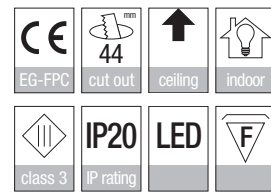
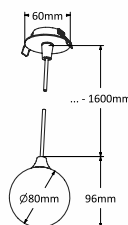
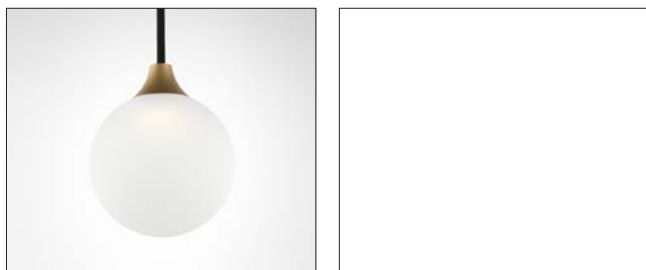

GEORGES SUSP ON

REF A6204/O/927 Georges S ON 927
A6204/O/930 Georges S ON 930

LED COB LED
LED lm output 280 lm
POWER CONS. 3,33W
DRIVE CURRENT 350 mA 10Vdc max.
COLOR TEMP. 2.700 / 3.000 K
CRI > 80
REFLECTOR polycarbonate diffusor
FINISH brushed brass & polycarbonate
REMARK black fabric power cable / length 1,6 m

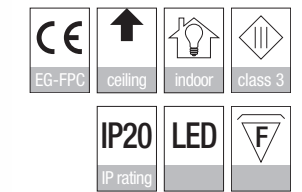
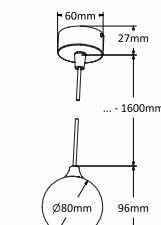



RIBS

REF A6148 Ribs

LED	Xicato
LED LM OUTPUT	1.300 lm
POWER CONS.	according to lumen output - see table p. 255
COLOR TEMP.	2.700 / 3.000 / 4.000 K
CRI	80 or +95
COLOR QUAL.	artist / beauty / vibrant / vibrant artist
REFLECTOR	20° / 40° / 60°
FINISH	anodised black
DRIVE CURRENT	supplied with driver
REMARK	also available with built-in ceiling mounting black fabric power cable / length 1,6 m
OPTIONAL	red fabric power cable / length 1,6 m

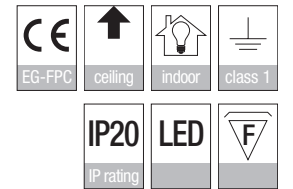
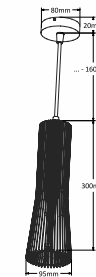

MODEL	REFERENCE	LM OUTPUT	CRI / CCT	BEAM	DIMMING
RIBS	A6148	1.300 lm	827 - 830 - 840 - V830	20°/40°/60°	ND / PD A / D
			927 - 930 - 940 - V930 - BT		

ND: non dimmable / PD: phase dimming / A: 1-10V / D: DALI

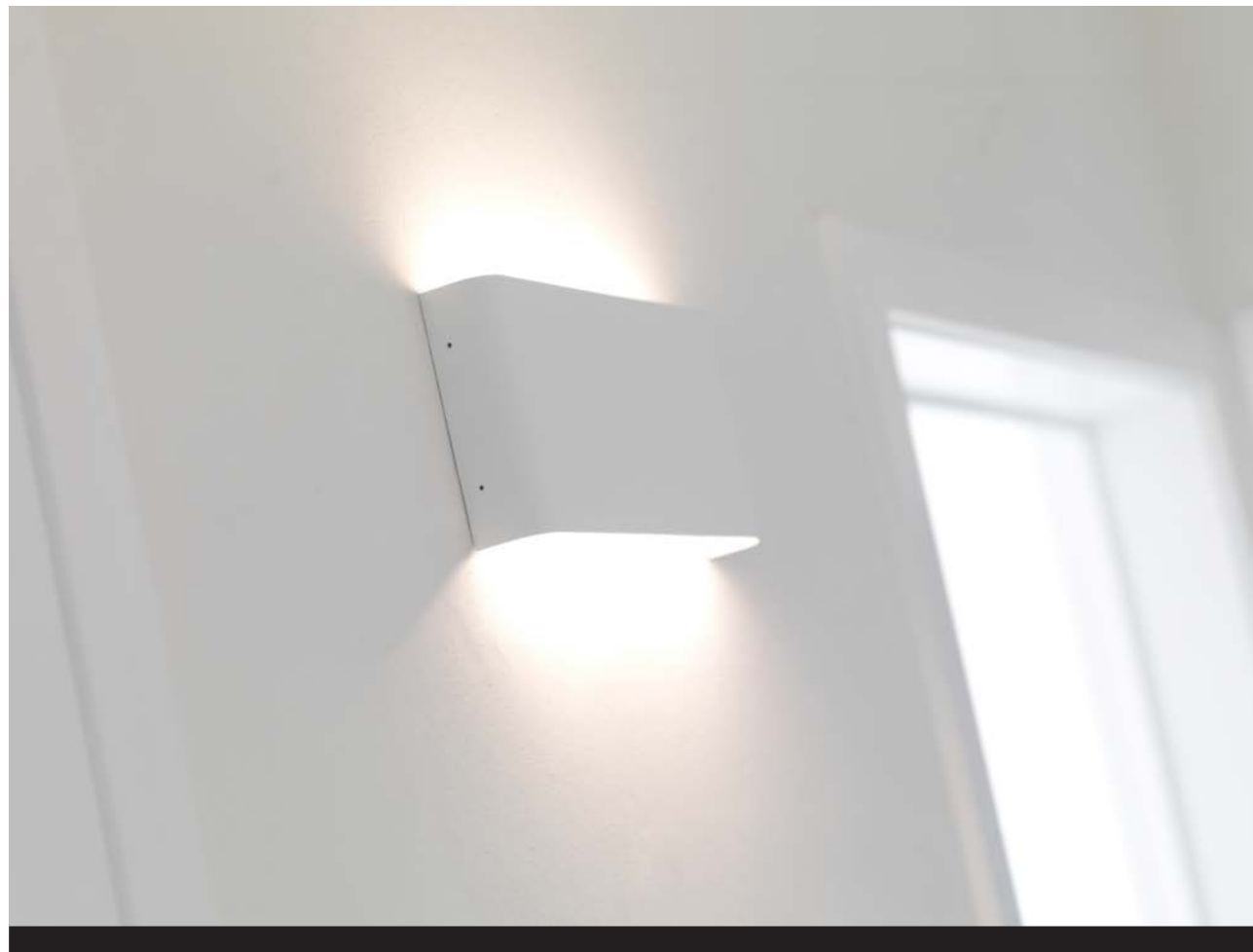

DOC

REF	A5008W/827	Doc white 2.700 K
	A5008B/827	Doc black 2.700 K
	A5008W/830	Doc white 3.000 K
	A5008B/830	Doc black 3.000 K
	A5008W/840	Doc white 4.000 K
	A5008B/840	Doc black 4.000 K

LED	SMD
LED LM OUTPUT	500 lm up / 500 lm down
POWER CONS.	10 W
DRIVE VOLTAGE	230 Vac built-in driver
COLOR TEMP.	2.700 / 3.000 K
CRI	85
REFLECTOR	120°
FINISH	white RAL 9016 tex black RAL 9005 tex
REMARK	1.000 lm up/down available on request

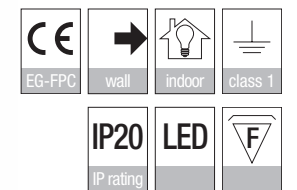
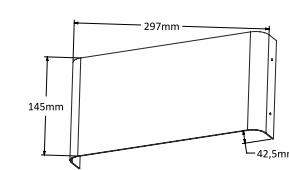

BEACON

REF	A5009W/827	Beacon white 2.700 K
	A5009B/827	Beacon black 2.700 K
	A5009A/827	Beacon alu 2.700 K
	A5009W/830	Beacon white 3.000 K
	A5009B/830	Beacon black 3.000 K
	A5009A/830	Beacon alu 3.000 K

LED	230 Vac COB
LED LM OUTPUT	90 lm
POWER CONS.	1,4 W
COLOR TEMP.	2.700 / 3.000 K
CRI	+80
REFLECTOR	120°
FINISH	white RAL 9016 tex black RAL 9005 tex anodised aluminium
CUT-OUT	Ø 60 mm / 60 x 60 mm
REMARK	fits all built-in boxes for switches and powersockets supplied with additional mounting claws

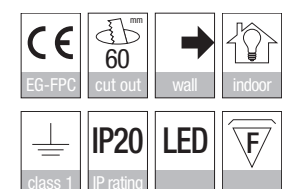
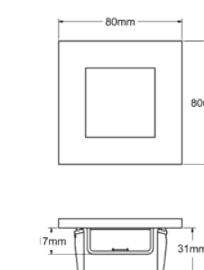
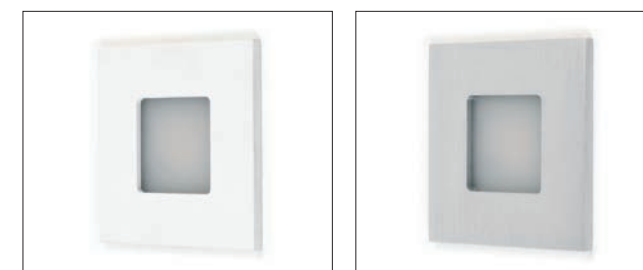

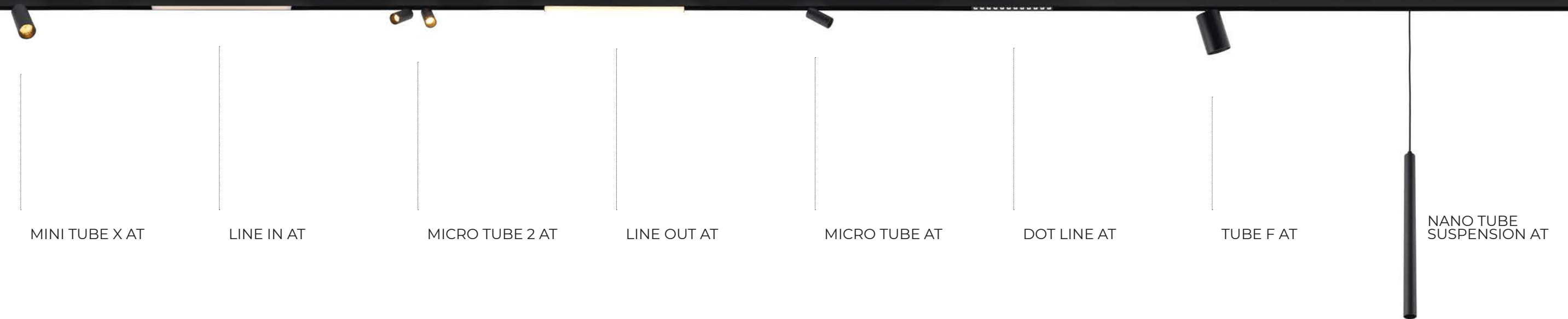

MINI TUBE X AT

LINE IN AT

MICRO TUBE 2 AT

LINE OUT AT

MICRO TUBE AT

DOT LINE AT

TUBE F AT

NANO TUBE
SUSPENSION AT

A-TRACK-TIF



GEORGES S AT

NANO TUBE L AT

GEORGES ON AT

LINE OR AT

A-TRACK-TIF is a magnetic track system with digital as well as analog dimming options. Available in a **High track** and **High trimless track** version, it is possible to have different combinations of spot, linear or pendant lighting. Future proof with 48 Vdc power supply. Line dimming is possible with analog 1-10 V dimming, separate fixture is possible with DALI. Each fixture has its own DALI driver.





MICRO TUBE AT

REF	Product Name	Specifications
A6189W/927/A	Micro Tube AT white 927	1-10 V
A6189W/930/A	Micro Tube AT white 930	1-10 V
A6189B/927/A	Micro Tube AT black 927	1-10 V
A6189B/930/A	Micro Tube AT black 930	1-10 V
A6189W/927/D	Micro Tube AT white 927	DALI
A6189W/930/D	Micro Tube AT white 930	DALI
A6189B/927/D	Micro Tube AT black 927	DALI
A6189B/930/D	Micro Tube AT black 930	DALI

LED	COB LED
LED LM OUTPUT	630 lm
POWER CONS.	8 W
DRIVE VOLTAGE	48 Vdc
DIMMING	1-10 V / DALI
COLOR TEMP.	2.700 / 3.000 K
CRI	+90
REFLECTOR	36°
FINISH	white RAL 9016 tex black RAL 9005 tex
ADJUSTABLE	90° x 355°
OPTIONAL	C6029W Micro Tube cone white C6029G Micro Tube cone gold C6030 Micro Tube 24° lens vener finish - see p. 260

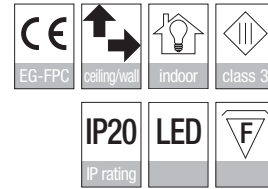
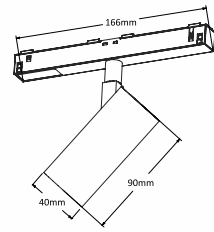

MICRO TUBE 2 AT

REF	Product Name	Specifications
A6190W/927/A	Micro Tube 2 AT white 927	1-10 V
A6190W/930/A	Micro Tube 2 AT white 930	1-10 V
A6190B/927/A	Micro Tube 2 AT black 927	1-10 V
A6190B/930/A	Micro Tube 2 AT black 930	1-10 V
A6190W/927/D	Micro Tube 2 AT white 927	DALI
A6190W/930/D	Micro Tube 2 AT white 930	DALI
A6190B/927/D	Micro Tube 2 AT black 927	DALI
A6190B/930/D	Micro Tube 2 AT black 930	DALI

LED	2x COB LED
LED LM OUTPUT	2x 630 lm
POWER CONS.	16 W
DRIVE VOLTAGE	48 Vdc
DIMMING	1-10 V / DALI
COLOR TEMP.	2.700 / 3.000 K
CRI	+90
REFLECTOR	36°
FINISH	white RAL 9016 tex black RAL 9005 tex
ADJUSTABLE	90° x 355°
OPTIONAL	C6029W Micro Tube cone white C6029G Micro Tube cone gold C6030 Micro Tube 24° lens vener finish - see p. 260

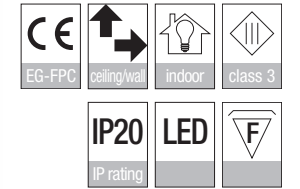
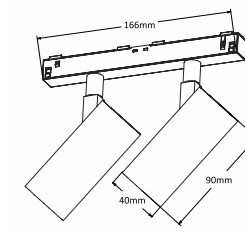



MINI TUBE X AT

REF	AT6146W AT6146B	Mini Tube X AT white Mini Tube X AT black
LED	Xicato	
LED LM OUTPUT	1.300 lm (max. 700 lm in 1-10 V version)	
POWER CONS.	according to lumen output - see table p. 255	
DRIVE VOLTAGE	48 Vdc	
DIMMING	1-10 V / DALI	
COLOR TEMP.	2.700 / 3.000 / 4.000 K	
CRI/QUALITY	80 or +95 / artist - beauty - vibrant	
REFLECTOR	16° - 40° - 60°	
FINISH	white RAL 9016 tex black RAL 9005 tex	
ADJUSTABLE	90° x 355°	
OPTIONAL	MINI TUBE CONE SET (REF A6025): mounting clips / cone / honeycomb / prismatic lens / spread lens C6025B/part Mini Tube cone black C6025W/part Mini Tube cone white C6025G/part Mini Tube cone gold	

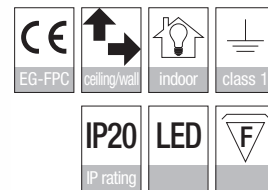
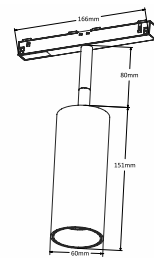
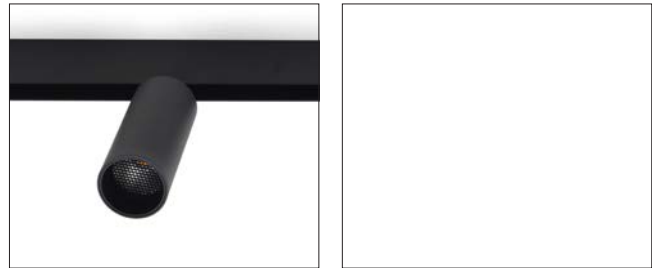

MODEL	REFERENCE	LM OUTPUT	CRI / CCT	BEAM	DIMMING
MINI TUBE X AT WHITE MINI TUBE X AT BLACK	A6146W A6146B	700 lm	827 - 830 - 840 - V830	16°	A D
			927 - 930 - 940 - V930 - BT		
		1.300 lm	827 - 830 - 840 - V830	16°/40°/60°	
			927 - 930 - 940 - V930 - BT	40°/60°	

ND: non dimmable / PD: phase dimming / A: 1-10V / D: DALI



TUBE F AT

REF	AT6163W AT6163B	Tube F AT white Tube F AT black
LED	Xicato Tridonic	
LED LM OUTPUT	1.300 - 2.000 lm	
POWER CONS.	according to lumen output - see table p. 255	
DRIVE VOLTAGE	48 Vdc	
COLOR TEMP.	2.700 / 3.000 / 4.000 K	
CRI	80 up to +95	
COLOR QUALITY	Xicato: artist / beauty vibrant / vibrant artist Tridonic: fashion / pure white fish / meat / gold / fruit	
REFLECTOR	Xicato: 20° / 40° / 60° (11° only available in 1.300 lm) Tridonic: 39°	
FINISH	white RAL 9016 tex black RAL 9005 tex	
ADJUSTABLE	90° x 355°	
OPTIONAL	C6021 - Honeycomb Ø 70 mm	

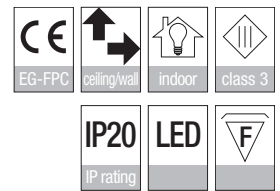
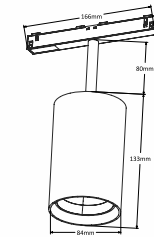

MODULE	MODEL	REFERENCE	LM OUTPUT	CRI / CCT	BEAM	DIMMING
XICATO XTM	TUBE FX AT WHITE TUBE FX AT BLACK	A6163W A6163B	1.300 lm	827 - 830 - 840 - V830	11°/20°	ND / PD A / D
			2.000 lm	927 - 930 - 940 - V930 - BT	40°/60°	
				827 - 830 - 840 - V830	20°/40°/60°	

Reference builder: f.e. A6163W/1300/V930/20°/PD

ND: non dimmable / PD: phase dimming / A: 1-10V / D: DALI

MODULE	MODEL	REFERENCE	LM OUTPUT	CRI / CCT	BEAM	DIMMING
TRIDONIC SLE	TUBE FT AT WHITE TUBE FT AT BLACK	T6163*/927/39°/ND	2.300 lm	927	39°	ND
		T6163*/930/39°/ND	2.450 lm	930		
		T6163*/940/39°/ND	2.570 lm	940		
		T6163*/9730/39°/ND	2.060 lm	9730		
		T6163*/FA/39°/ND	2.260 lm	FASHION		
		T6163*/PW930/39°/ND	2.450 lm	PURE WHITE 930		
		T6163*/PW940/39°/ND	2.550 lm	PURE WHITE 940		
		T6163*/FIS/39°/ND	2.470 lm	FISH 965		
		T6163*/M+/39°/ND	1.520 lm	MEAT+		
		T6163*/FM/39°/ND	1.490 lm	FRESH MEAT		
		T6163*/C/39°/ND	2.300 lm	COLD		
		T6163*/G+/39°/ND	1.580 lm	GOLD+		
		T6163*/FR/39°/ND	2.130 lm	FRUIT		

*W (white) or B (black)

LOWER LM OUTPUT
ALSO AVAILABLE

ND: non dimmable



NANO TUBE SUSP AT

REF	AT6191W/927/A	Nano Tube S AT white 927 1-10 V
	AT6191W/930/A	Nano Tube S AT white 930 1-10 V
	AT6191B/927/A	Nano Tube S AT black 927 1-10 V
	AT6191B/930/A	Nano Tube S AT black 930 1-10 V
	AT6191W/927/D	Nano Tube S AT white 927 DALI
	AT6191W/930/D	Nano Tube S AT white 930 DALI
	AT6191B/927/D	Nano Tube S AT black 927 DALI
	AT6191B/930/D	Nano Tube S AT black 930 DALI

LED	COB LED
LED LM OUTPUT	540 lm
POWER CONS.	8 W
DRIVE VOLTAGE	48 Vdc
DIMMING	1-10 V / DALI
COLOR TEMP.	2.700 / 3.000 K
CRI	+90
REFLECTOR	35°
FINISH	white RAL 9016 tex black RAL 9005 tex
REMARK	black fabric power cable / length 1,6 m

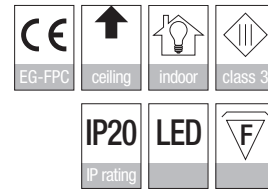
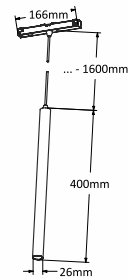

NANO TUBE L AT

REF	AT6199W/927/A	Nano Tube L AT white 927 1-10 V
	AT6199W/930/A	Nano Tube L AT white 930 1-10 V
	AT6199B/927/A	Nano Tube L AT black 927 1-10 V
	AT6199B/930/A	Nano Tube L AT black 930 1-10 V
	AT6199W/927/D	Nano Tube L AT white 927 DALI
	AT6199W/930/D	Nano Tube L AT white 930 DALI
	AT6199B/927/D	Nano Tube L AT black 927 DALI
	AT6199B/930/D	Nano Tube L AT black 930 DALI

LED	COB LED
LED LM OUTPUT	540 lm
POWER CONS.	8 W
DRIVE CURRENT	48 Vdc
COLOR TEMP.	2.700 / 3.000 K
CRI	> 90
REFLECTOR	35°
FINISH	white RAL 9016 tex black RAL 9005 tex
ADJUSTABLE	45° x 355°

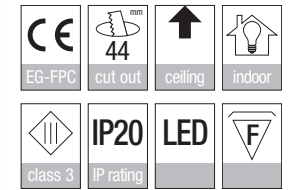
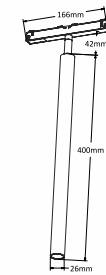



GEORGES D12 SUSP AT

REF	AT6204D12/927/A	Georges D12 S AT 927 1-10V
	AT6204D12/930/A	Georges D12 S AT 930 1-10V
	AT6204D12/927/D	Georges D12 S AT 927 DALI
	AT6204D12/930/D	Georges D12 S AT 930 DALI

LED	COB LED
LED LM OUTPUT	280 lm
POWER CONS.	3,33 W
DRIVE CURRENT	48 Vdc
DIMMING	1-10V / DALI
COLOR TEMP.	2.700 / 3.000 K
CRI	> 80
REFLECTOR	n/a
FINISH	brushed brass & polycarbonate
ADJUSTABLE	n/a
CUT-OUT	n/a

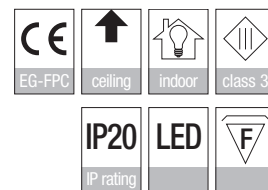
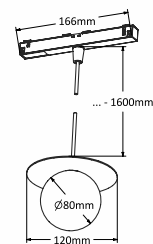

GEORGES SUSP AT

REF	AT6204/927/A	Georges S AT 927 DIM 1-10V
	AT6204/930/A	Georges S AT 930 DIM 1-10V
	AT6204/927/D	Georges S AT 927 DIM DALI
	AT6204/930/D	Georges S AT 930 DIM DALI

LED	COB LED
LED LM OUTPUT	280 lm
POWER CONS.	3,33 W
DRIVE CURRENT	48 Vdc
DIMMING	1-10V / DALI
COLOR TEMP.	2.700 / 3.000 K
CRI	> 80
REFLECTOR	n/a
FINISH	brushed brass & polycarbonate
REMARK	black fabric power cable / length 1,6 m

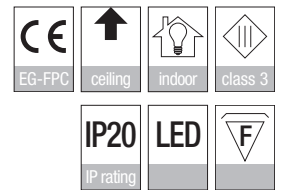
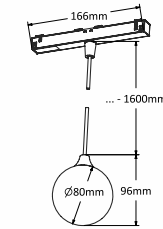

GEORGES ON AT

REF	AT6206/927/A	Georges ON AT 927 DIM 1-10V
	AT6206/930/A	Georges ON AT 930 DIM 1-10V
	AT6206/927/D	Georges ON AT 927 DIM DALI
	AT6206/930/D	Georges ON AT 930 DIM DALI

LED	COB LED
LED LM OUTPUT	280 lm
POWER CONS.	3,33 W
DRIVE CURRENT	48 Vdc
DIMMING	1-10V / DALI
COLOR TEMP.	2.700 / 3.000 K
CRI	> 80
REFLECTOR	n/a
FINISH	brushed brass & polycarbonate
ADJUSTABLE	n/a
CUT-OUT	n/a

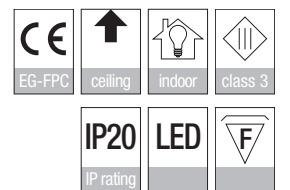
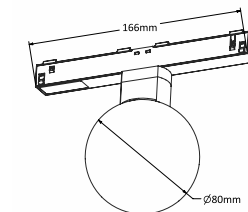

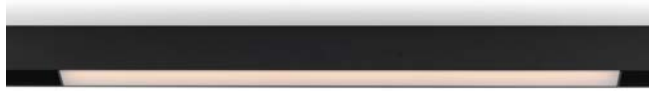

LINE IN AT

REF	AT1001	Line IN AT
LENGTHS	500 / 1.000 / 1.500 / 2.000 mm	
LED	SMD	
LED LM OUTPUT	2.000 lm/m	
POWER CONS.	according to model: 28 W/m / TW: 40 + 40 W/m	
DRIVE VOLTAGE	48 Vdc	
COLOR TEMP.	2.700 / 3.000 K / TW (tunable white)	
DIMMING	1-10V DALI	
CRI / QUALITY	+90	

MODEL	REFERENCE	CCT	LENGTH	DIMMING
LINE IN AT	AT1001	927 930	500 mm	A D
			1.000 mm	
			1.500 mm	
			2.000 mm	
		TW	600 mm 1.200 mm 1.800 mm	D

F.E.: AT1001/927/1000/A

A: 1-10V / D: DALI

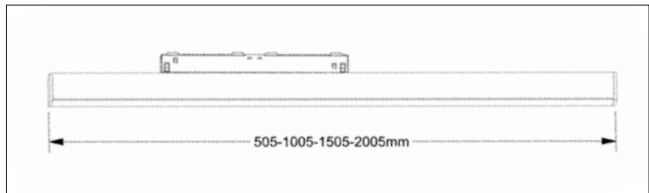

LINE OUT AT

REF	AT1002W AT1002B	Line OUT AT white Line OUT AT black
LENGTHS	500 / 1.000 / 1.500 / 2.000 mm	
LED	SMD	
LED LM OUTPUT	2.000 lm/m	
POWER CONS.	according to model: 28 W/m / TW: 40 + 40 W/m	
DRIVE VOLTAGE	48 Vdc	
COLOR TEMP.	2.700 / 3.000 K / TW	
DIMMING	1-10V DALI	
CRI / QUALITY	+90	

MODEL	REFERENCE	CCT	LENGTH	DIMMING
LINE OUT AT	AT1002W AT1002B	927 930	500 mm	A D
			1.000 mm	
			1.500 mm	
			2.000 mm	
		TW	600 mm 1.200 mm 1.800 mm	D

F.E.: AT1002B/927/1000/A

A: 1-10V / D: DALI

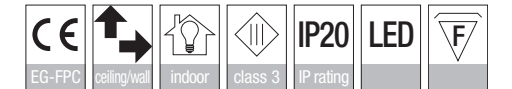
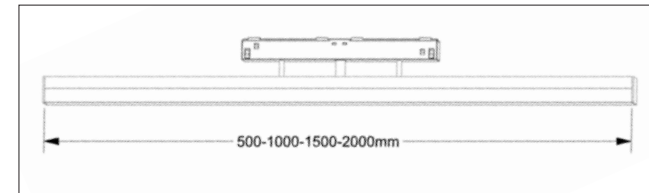

LINE IN BLACK DIFFUSOR AT

REF	AT1001/BTC	Line IN black diffusor AT
LENGTHS	500 / 1.000 / 1.500 / 2.000 mm	
LED	SMD	
LED LM OUTPUT	2.000 lm/m	
POWER CONS.	according to model: 28 W/m / TW: 40 + 40 W/m	
DRIVE VOLTAGE	48 Vdc	
COLOR TEMP.	2.700 / 3.000 K / TW (tunable white)	
DIMMING	1-10V DALI	
CRI / QUALITY	+90	

MODEL	REFERENCE	CCT	LENGTH	DIMMING
LINE IN AT BTC	AT1001/BTC	927 930	500 mm	A D
			1.000 mm	
			1.500 mm	
			2.000 mm	
		TW	600 mm 1.200 mm 1.800 mm	D

F.E.: AT1001/BTC/927/1000/A

A: 1-10V / D: DALI

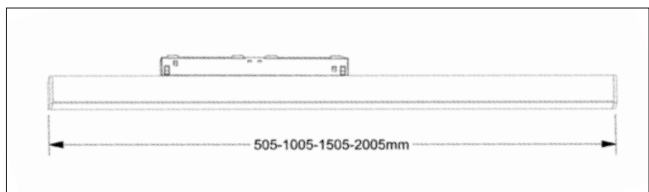
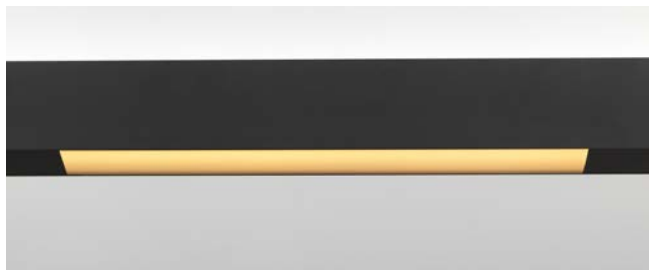

DOT LINE AT UGR<19

REF	AT1004	Dot Line AT
LENGTHS	286 / 567 mm	
LED	SMD	
LED LM OUTPUT	286 mm: 5020 lm 567 mm: 1.003 lm	
POWER CONS.	286 mm: 5,6 W 567 mm: 10,2 W	
DRIVE VOLTAGE	48 Vdc	
DIMMING	1-10V DALI	
COLOR TEMP.	2.700 / 3.000 K	
CRI/QUALITY	+90	
REMARKS	other lengths on request 847 mm & 1.128 mm UGR<19	

MODEL	REFERENCE	CCT	LENGTH	DIMMING
DOT LINE AT	AT1004	927	286 mm	A
		930	567 mm	D

F.E.: AT1004/927/567/D

A: 1-10V / D: DALI

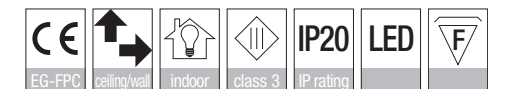
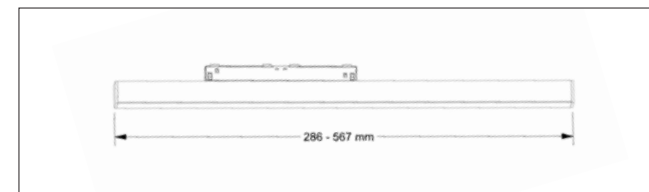

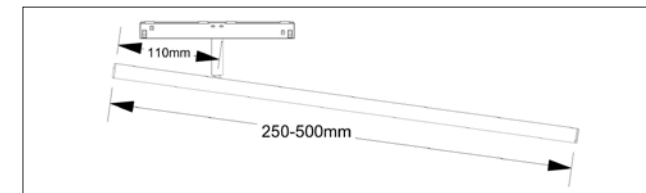

LINE OR AT

REF	AT1003W AT1003B	Line OR AT white Line OR AT black
-----	--------------------	--------------------------------------

LENGTHS	250 / 500 mm
LED	SMD
LED LM OUTPUT	250 mm: 500 lm 500 mm: 1.000 lm
POWER CONS.	250 mm: 7 W 500 mm: 14 W
DRIVE VOLTAGE	48 Vdc
DIMMING	1-10 V / DALI
COLOR TEMP.	2.700 / 3.000 K
CRI/QUALITY	90
ADJUSTABLE	45° x 355° (high track A-TRACK-TIF) 5° x 355° (trimless A-TRACK-TIF)

MODEL	REFERENCE	CCT	LENGTH	DIMMING
LINE OR AT	AT1003W AT1003B	927 930	250 mm 500 mm	D A (1-10 V)

F.E.: AT1003W/8307/290/D

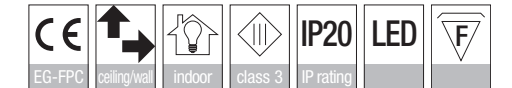

LINE OR BLACK DIFFUSOR AT

REF	AT1003W/BTC AT1003B/BTC	Line OR BTC AT white Line OR BTC AT black
-----	----------------------------	--

LENGTHS	250 / 500 mm
LED	SMD
LED LM OUTPUT	250 mm: 500 lm 500 mm: 1.000 lm
POWER CONS.	250 mm: 7 W 500 mm: 14 W
DRIVE VOLTAGE	48 Vdc
DIMMING	1-10 V / DALI
COLOR TEMP.	2.700 / 3.000 K
CRI/QUALITY	90
ADJUSTABLE	45° x 355° (high track A-TRACK-TIF) 5° x 355° (trimless A-TRACK-TIF)

MODEL	REFERENCE	CCT	LENGTH	DIMMING
LINE OR AT BTC	AT1003W AT1003B	927 930	250 mm 500 mm	D A (1-10 V)

F.E.: AT1003W/BTC/8307/290/D

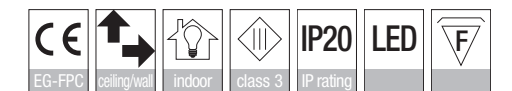











A-TRACK-TIF

	PRODUCT	REFERENCE	REMARKS	TECHNICAL
	Magnetic High Track LV black 1 m Magnetic High Track LV white 1 m Magnetic High Track LV black 2 m Magnetic High Track LV white 2 m Magnetic High Track LV black 3 m Magnetic High Track LV white 3 m	AT/HO/B/1000 AT/HO/W/1000 AT/HO/B/2000 AT/HO/W/2000 AT/HO/B/3000 AT/HO/W/3000		
	Magnetic High Trimless Track LV black 1 m Magnetic High Trimless Track LV white 1 m Magnetic High Trimless Track LV black 2 m Magnetic High Trimless Track LV white 2 m Magnetic High Trimless Track LV black 3 m Magnetic High Trimless Track LV white 3 m	AT/HT/B/1000 AT/HT/W/1000 AT/HT/B/2000 AT/HT/W/2000 AT/HT/B/3000 AT/HT/W/3000		
	End cap High Track LV black End cap High Track LV white	AT/EC/B AT/EC/W		
	End cap Feed High Track LV black End cap Feed High Track LV white	AT/ECF/B AT/ECF/W		
	Magnetic End Feed LEFT LV Polarised black Magnetic End Feed LEFT LV Polarised white	ATP/EFL/B ATP/EFL/W		
	Magnetic End Feed RIGHT LV Polarised black Magnetic End Feed RIGHT LV Polarised white	ATP/EFR/B ATP/EFR/W		
	Magnetic Flex connector black Magnetic Flex connector white	ATP/FC/B ATP/FC/W		
	Magnetic Mid connector LV Polarised black Magnetic Mid connector LV Polarised white	ATP/MF/B ATP/MF/W		
	Magn. High Track short pendant bracket	AT/SPB		

A-TRACK-TIF

PRODUCT	REFERENCE	REMARKS	TECHNICAL
 Magn. High Track long pendant bracket	AT/LPB		
 Magn. trimless joining connector / set	AT/TJC		
 Magn. High Track L-bracket	AT/LB		
 Magn. High Track suspension set 2 m	AT/PS/2000	incl. ceiling fix	
 Magn. High Track suspension set 5 m	AT/PS/5000	incl. ceiling fix	
 Cable supply transparent 5x 0,75 mm ² - 2 m Cable supply transparent 5x 0,75 mm ² - 5 m	AT/CS/2000/T AT/CS/5000/T		
 Cable supply black fabric 5x 0,75 mm ² - 2 m Cable supply black fabric 5x 0,75 mm ² - 5 m	AT/CS/2000/B AT/CS/5000/B		
 MOUNTING CONNECTING BOX Ø80 MM white matt RAL 9016 tex black matt RAL 9005 tex	AT/MC80/W AT/MC80/B	diameter: 80 mm height: 30 mm	
 MOUNTING CONNECTING BOX Ø60 MM white matt RAL 9016 tex black matt RAL 9005 tex	AT/MC60/W AT/MC60/B	diameter: 60 mm height: 30 mm	

PRODUCT	REFERENCE	REMARKS	TECHNICAL
 RECESSED CONNECTING BOX Ø90 MM white matt RAL 9016 tex black matt RAL 9005 tex	AT/RC90/W AT/RC90/B	outside Ø: 90 mm build-in Ø: 80 mm	
 RECESSED CONNECTING BOX Ø60 MM white matt RAL 9016 tex black matt RAL 9005 tex	AT/RC60/W AT/RC60/B	outside Ø: 60 mm build-in Ø: 44 mm	
 Mounting connecting box (rect) black Mounting connecting box (rect) white	AT/SB/B AT/SB/W		
 Cover black Cover white	AT/COVER/B AT/COVER/W	length 3m	
 Plaster cover	AT/COVPLAS	length 2m	
 Daligate Casambi black Daligate Casambi white	ATP/DALI-CAS/B ATP/DALI-CAS/W		
 Inline driver KIT 60 W black Inline driver KIT 60 W white	ATP/60W/PS/B ATP/60W/PS/W		
 Profile cut & preparation	S1003		

A-TRACK-TIF ON / SUSPENSION EXPLODED VIEW

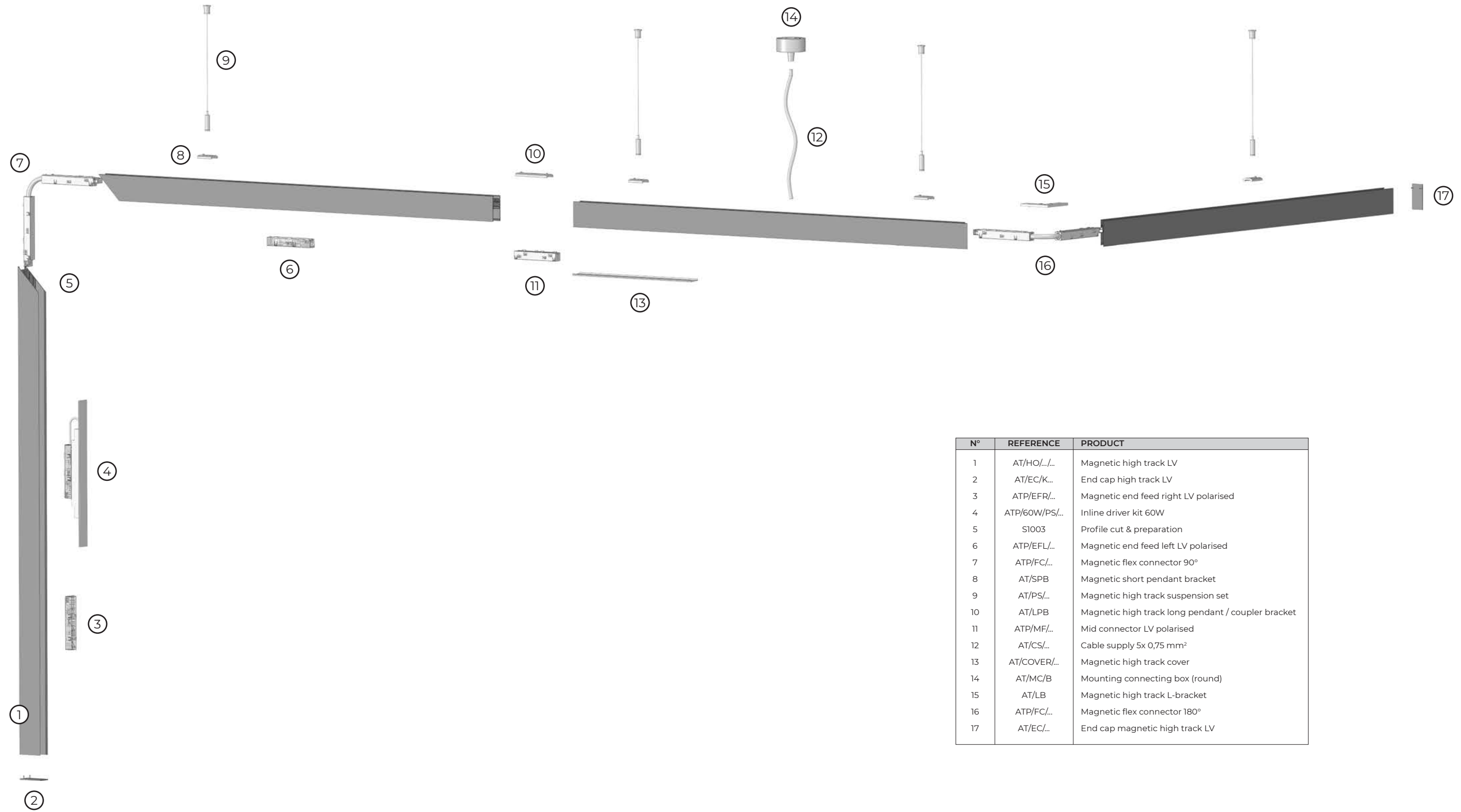

N°	REFERENCE	PRODUCT
1	AT/HO/.../...	Magnetic high track LV
2	AT/EC/K...	End cap high track LV
3	ATP/EFR/...	Magnetic end feed right LV polarised
4	ATP/60W/PS/...	Inline driver kit 60W
5	SI003	Profile cut & preparation
6	ATP/EFL/...	Magnetic end feed left LV polarised
7	ATP/FC/...	Magnetic flex connector 90°
8	AT/SPB	Magnetic short pendant bracket
9	AT/PS/...	Magnetic high track suspension set
10	AT/LPB	Magnetic high track long pendant / coupler bracket
11	ATP/MF/...	Mid connector LV polarised
12	AT/CS/...	Cable supply 5x 0,75 mm ²
13	AT/COVER/...	Magnetic high track cover
14	AT/MC/B	Mounting connecting box (round)
15	AT/LB	Magnetic high track L-bracket
16	ATP/FC/...	Magnetic flex connector 180°
17	AT/EC/...	End cap magnetic high track LV

A-TRACK-TIF IN EXPLODED VIEW

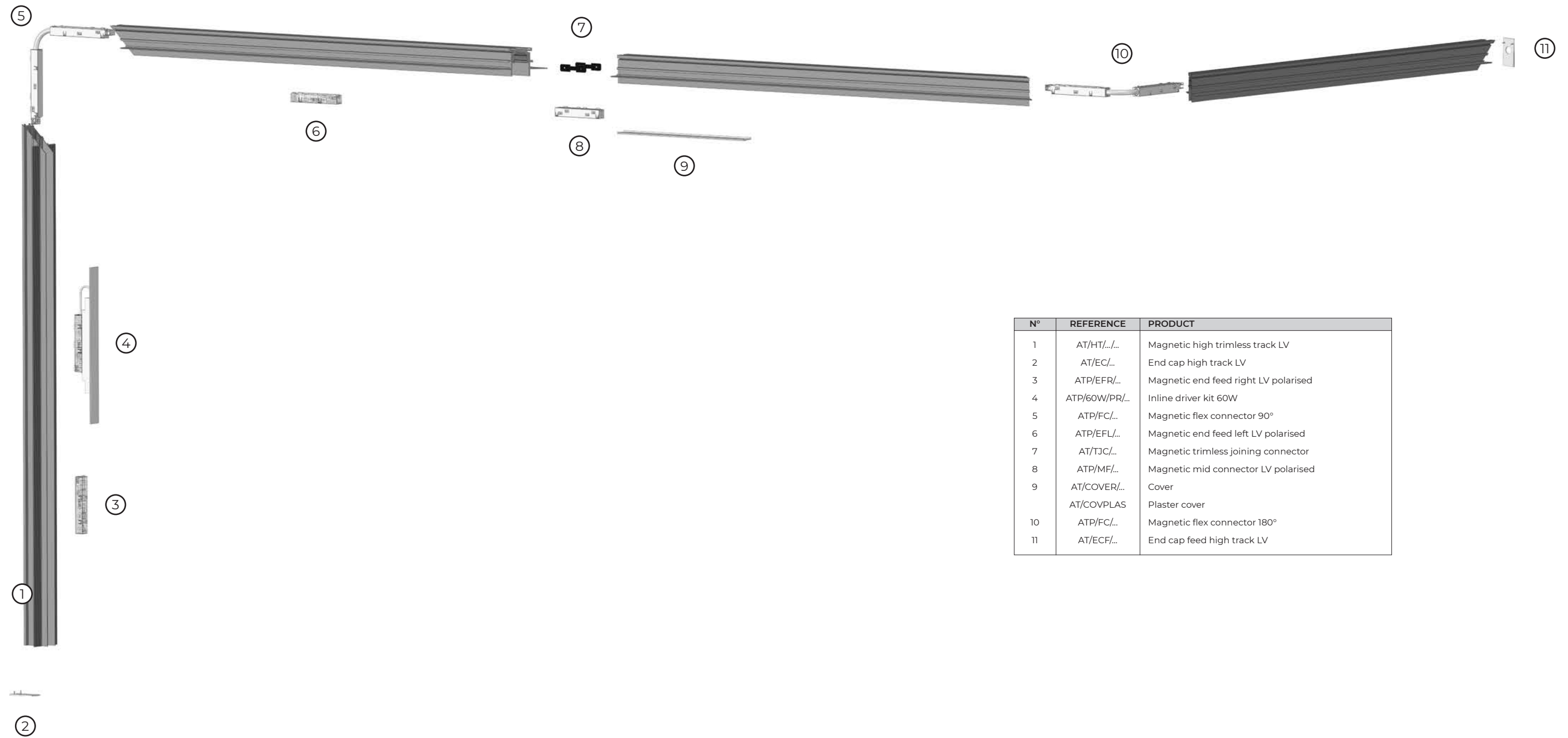

N°	REFERENCE	PRODUCT
1	AT/HT/.../...	Magnetic high trimless track LV
2	AT/EC/...	End cap high track LV
3	ATP/EFR/...	Magnetic end feed right LV polarised
4	ATP/60W/PR/...	Inline driver kit 60W
5	ATP/FC/...	Magnetic flex connector 90°
6	ATP/EFL/...	Magnetic end feed left LV polarised
7	AT/TJC/...	Magnetic trimless joining connector
8	ATP/MF/...	Magnetic mid connector LV polarised
9	AT/COVER/...	Cover
	AT/COVPLAS	Plaster cover
10	ATP/FC/...	Magnetic flex connector 180°
11	AT/ECF/...	End cap feed high track LV

DOTLINE R7

POWERLINE
BLACK
TRANSPARENT
DIFFUSOR

ON

OFF

MICROTUBE

DOTLINE R4

MICROTUBE 2

POWERLINE

NANO TUBE
SUSPENSION

POWERLINE SERIES

The PowerLine series is a linear lighting system with high light output and efficiency. Now available with a series of lighting inserts and technical options, available in both ceiling mounted or suspended version. We also welcome the PowerLine Recessed with identical option features.

- Technical options:
- Dali or 1/10V dimming
 - single (rotor) or double 3F adaptor
 - emergency module 3 hrs.
 - motion detector
 - ambient light / motion sensor
 - Casambi build-in (3 groups Dali)

POWERLINE CEILING



PROFILE COLORS	CRI	CCT	HEIGHT	WIDTH
A anodised aluminium	+80	2.700 K / 827	75	38
W white matt texture RAL9016	+80	3.000 K / 830	75	38
B black matt texture RAL9005	+80	4.000 K / 840	75	38

REMARK: - DALI version = PUSH DIM compatible
- other RAL colors on request

REFERENCE BUILDER: PL_A/580/830/ND/O

REFERENCE	DIM	POWER CONS (W)	LUMEN OUTPUT (lm)	LENGTH (mm)
Powerline ON ceiling 580 mm				
PL_/580/___/ND/O	-	13	1.575	580
PL_/580/___/A/O	1-10 V	13	1.575	580
PL_/580/___/D/O	DALI	13	1.575	580
Powerline ON ceiling 860 mm				
PL_/860/___/ND/O	-	19,5	2.362	860
PL_/860/___/A/O	1-10 V	19,5	2.362	860
PL_/860/___/D/O	DALI	19,5	2.362	860
Powerline ON ceiling 1.140 mm				
PL_/1140/___/ND/O	-	26	3.150	1.140
PL_/1140/___/A/O	1-10 V	26	3.150	1.140
PL_/1140/___/D/O	DALI	26	3.150	1.140
Powerline ON ceiling 1.420 mm				
PL_/1420/___/ND/O	-	32,5	3.920	1.420
PL_/1420/___/A/O	1-10 V	32,5	3.920	1.420
PL_/1420/___/D/O	DALI	32,5	3.920	1.420
Powerline ON ceiling 1.700 mm				
PL_/1700/___/ND/O	-	39	4.725	1.700
PL_/1700/___/A/O	1-10 V	39	4.725	1.700
PL_/1700/___/D/O	DALI	39	4.725	1.700
Powerline ON ceiling 1.980 mm				
PL_/1980/___/ND/O	-	45,5	5.500	1.980
PL_/1980/___/A/O	1-10 V	45,5	5.500	1.980
PL_/1980/___/D/O	DALI	45,5	5.500	1.980
Powerline ON ceiling 2.260 mm				
PL_/2260/___/ND/O	-	52	6.300	2.260
PL_/2260/___/A/O	1-10 V	52	6.300	2.260
PL_/2260/___/D/O	DALI	52	6.300	2.260

POWERLINE CEILING

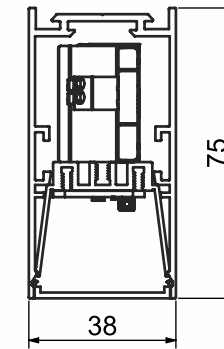

REFERENCE	DIM	POWER CONS (W)	LUMEN OUTPUT (lm)	LENGTH (mm)
Powerline ON ceiling 2.540 mm				
PL_/2540/___/ND/O	-	58,5	7.080	2.540
PL_/2540/___/A/O	1-10 V	58,5	7.080	2.540
PL_/2540/___/D/O	DALI	58,5	7.080	2.540
Powerline ON ceiling 2.820 mm				
PL_/2820/___/ND/O	-	65	7.860	2.820
PL_/2820/___/A/O	1-10 V	65	7.860	2.820
PL_/2820/___/D/O	DALI	65	7.860	2.820
Powerline ON ceiling 3.100 mm				
PL_/3100/___/ND/O	-	71,5	8.660	3.100
PL_/3100/___/A/O	1-10 V	71,5	8.660	3.100
PL_/3100/___/D/O	DALI	71,5	8.660	3.100
Powerline ON ceiling 3.380 mm				
PL_/3380/___/ND/O	-	78	9.450	3.380
PL_/3380/___/A/O	1-10 V	78	9.450	3.380
PL_/3380/___/D/O	DALI	78	9.450	3.380
Powerline ON ceiling 3.660 mm				
PL_/3660/___/ND/O	-	83,5	10.240	3.660
PL_/3660/___/A/O	1-10 V	83,5	10.240	3.660
PL_/3660/___/D/O	DALI	83,5	10.240	3.660
Powerline ON ceiling 3.940 mm				
PL_/3940/___/ND/O	-	91	11025	3.940
PL_/3940/___/A/O	1-10 V	91	11025	3.940
PL_/3940/___/D/O	DALI	91	11025	3.940
Powerline ON ceiling 4.220 mm				
PL_/4220/___/ND/O	-	97,5	11.812	4.220
PL_/4220/___/A/O	1-10 V	97,5	11.812	4.220
PL_/4220/___/D/O	DALI	97,5	11.812	4.220
Powerline ON ceiling 4.500 mm				
PL_/4500/___/ND/O	-	104	12.600	4.500
PL_/4500/___/A/O	1-10 V	104	12.600	4.500
PL_/4500/___/D/O	DALI	104	12.600	4.500



POWERLINE SUSPENSION



PROFILE COLORS	CRI	CCT	HEIGHT	WIDTH
A anodised aluminium	+80	2.700 K / 827	75	38
W white matt texture RAL9016	+80	3.000 K / 830	75	38
B black matt texture RAL9005	+80	4.000 K / 840	75	38

REMARK: - DALI version = PUSH DIM compatible
- other RAL colors on request

REFERENCE BUILDER: PL_A/580/830/ND/O

REFERENCE	DIM	POWER CONS (W)	LUMEN OUTPUT (lm)	LENGTH (mm)
Powerline suspended 580 mm				
PL_/580/___/ND/S	-	13	1.575	580
PL_/580/___/A/S	1-10 V	13	1.575	580
PL_/580/___/D/S	DALI	13	1.575	580
Powerline suspended 860 mm				
PL_/860/___/ND/S	-	19,5	2.362	860
PL_/860/___/A/S	1-10 V	19,5	2.362	860
PL_/860/___/D/S	DALI	19,5	2.362	860
Powerline suspended 1.140 mm				
PL_/1140/___/ND/S	-	26	3.150	1.140
PL_/1140/___/A/S	1-10 V	26	3.150	1.140
PL_/1140/___/D/S	DALI	26	3.150	1.140
Powerline suspended 1.420 mm				
PL_/1420/___/ND/S	-	32,5	3.920	1.420
PL_/1420/___/A/S	1-10 V	32,5	3.920	1.420
PL_/1420/___/D/S	DALI	32,5	3.920	1.420
Powerline suspended 1.700 mm				
PL_/1700/___/ND/S	-	39	4.725	1.700
PL_/1700/___/A/S	1-10 V	39	4.725	1.700
PL_/1700/___/D/S	DALI	39	4.725	1.700
Powerline suspended 1.980 mm				
PL_/1980/___/ND/S	-	45,5	5.500	1.980
PL_/1980/___/A/S	1-10 V	45,5	5.500	1.980
PL_/1980/___/D/S	DALI	45,5	5.500	1.980
Powerline suspended 2.260 mm				
PL_/2260/___/ND/S	-	52	6.300	2.260
PL_/2260/___/A/S	1-10 V	52	6.300	2.260
PL_/2260/___/D/S	DALI	52	6.300	2.260

POWERLINE SUSPENSION

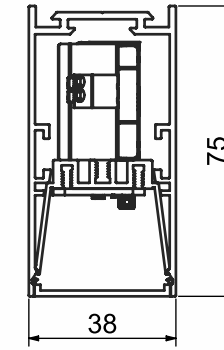

REFERENCE	DIM	POWER CONS (W)	LUMEN OUTPUT (lm)	LENGTH (mm)
Powerline suspended 2.540 mm				
PL_/2540/___/ND/S	-	58,5	7.080	2.540
PL_/2540/___/A/S	1-10 V	58,5	7.080	2.540
PL_/2540/___/D/S	DALI	58,5	7.080	2.540
Powerline suspended 2.820 mm				
PL_/2820/___/ND/S	-	65	7.860	2.820
PL_/2820/___/A/S	1-10 V	65	7.860	2.820
PL_/2820/___/D/S	DALI	65	7.860	2.820
Powerline suspended 3.100 mm				
PL_/3100/___/ND/S	-	71,5	8.660	3.100
PL_/3100/___/A/S	1-10 V	71,5	8.660	3.100
PL_/3100/___/D/S	DALI	71,5	8.660	3.100
Powerline suspended 3.380 mm				
PL_/3380/___/ND/S	-	78	9.450	3.380
PL_/3380/___/A/S	1-10 V	78	9.450	3.380
PL_/3380/___/D/S	DALI	78	9.450	3.380
Powerline suspended 3.660 mm				
PL_/3660/___/ND/S	-	83,5	10.240	3.660
PL_/3660/___/A/S	1-10 V	83,5	10.240	3.660
PL_/3660/___/D/S	DALI	83,5	10.240	3.660
Powerline suspended 3.940 mm				
PL_/3940/___/ND/S	-	91	11025	3.940
PL_/3940/___/A/S	1-10 V	91	11025	3.940
PL_/3940/___/D/S	DALI	91	11025	3.940
Powerline suspended 4.220 mm				
PL_/4220/___/ND/S	-	97,5	11.812	4.220
PL_/4220/___/A/S	1-10 V	97,5	11.812	4.220
PL_/4220/___/D/S	DALI	97,5	11.812	4.220
Powerline suspended 4.500 mm				
PL_/4500/___/ND/S	-	104	12.600	4.500
PL_/4500/___/A/S	1-10 V	104	12.600	4.500
PL_/4500/___/D/S	DALI	104	12.600	4.500



POWERLINE RECESSED

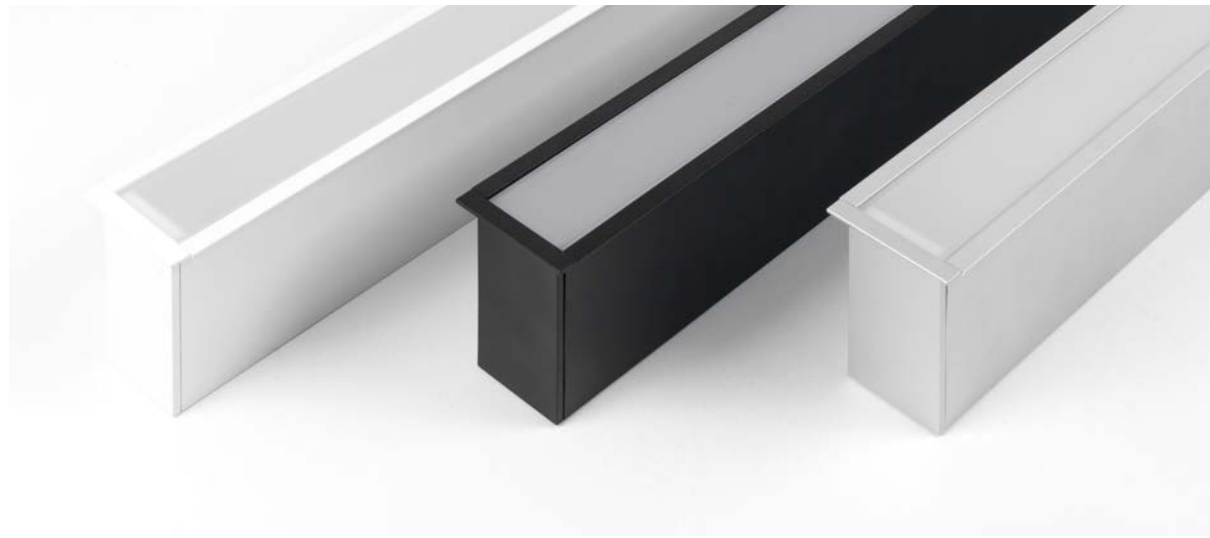

PROFILE COLORS	CRI	CCT	HEIGHT	WIDTH
A anodised aluminium	+80	2.700 K / 827	75	51
W white matt texture RAL9016	+80	3.000 K / 830	75	51
B black matt texture RAL9005	+80	4.000 K / 840	75	51

REMARK: - DALI version = PUSH DIM compatible
- other RAL colors on request

REFERENCE BUILDER: PL_A/580/830/ND/O

REFERENCE	DIM	POWER CONS (W)	LM OUTPUT (lm)	LENGTH (mm)	CUT-OUT (mm)
Powerline recessed 588 mm					
PLR_/580/___/ND/O	-	13	1.575	588	42 x 582
PLR_/580/___/A/O	1-10 V	13	1.575	588	42 x 582
PLR_/580/___/D/O	DALI	13	1.575	588	42 x 582
Powerline recessed 868 mm					
PLR_/860/___/ND/O	-	19,5	2.362	868	42 x 862
PLR_/860/___/A/O	1-10 V	19,5	2.362	868	42 x 862
PLR_/860/___/D/O	DALI	19,5	2.362	868	42 x 862
Powerline recessed 1.148 mm					
PLR_/1140/___/ND/O	-	26	3.150	1.148	42 x 1.142
PLR_/1140/___/A/O	1-10 V	26	3.150	1.148	42 x 1.142
PLR_/1140/___/D/O	DALI	26	3.150	1.148	42 x 1.142
Powerline recessed 1.428 mm					
PLR_/1420/___/ND/O	-	32,5	3.920	1.428	42 x 1.422
PLR_/1420/___/A/O	1-10 V	32,5	3.920	1.428	42 x 1.422
PLR_/1420/___/D/O	DALI	32,5	3.920	1.428	42 x 1.422
Powerline recessed 1.708 mm					
PLR_/1700/___/ND/O	-	39	4.725	1.708	42 x 1.702
PLR_/1700/___/A/O	1-10 V	39	4.725	1.708	42 x 1.702
PLR_/1700/___/D/O	DALI	39	4.725	1.708	42 x 1.702
Powerline recessed 1.988 mm					
PLR_/1980/___/ND/O	-	45,5	5.500	1.988	42 x 1.982
PLR_/1980/___/A/O	1-10 V	45,5	5.500	1.988	42 x 1.982
PLR_/1980/___/D/O	DALI	45,5	5.500	1.988	42 x 1.982
Powerline recessed 2.268 mm					
PLR_/2260/___/ND/O	-	52	6.300	2.268	42 x 2.262
PLR_/2260/___/A/O	1-10 V	52	6.300	2.268	42 x 2.262
PLR_/2260/___/D/O	DALI	52	6.300	2.268	42 x 2.262



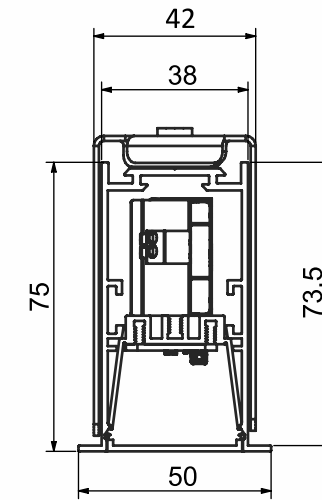



POWERLINE RECESSED

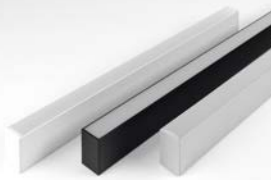

REFERENCE	DIM	POWER CONS (W)	LM OUTPUT (lm)	LENGTH (mm)	CUT-OUT (mm)
Powerline recessed 2.548 mm					
PLR_/2540/___/ND/O	-	58,5	7.080	2.548	42 x 2.542
PLR_/2540/___/A/O	1-10 V	58,5	7.080	2.548	42 x 2.542
PLR_/2540/___/D/O	DALI	58,5	7.080	2.548	42 x 2.542
Powerline recessed 2.828 mm					
PLR_/2820/___/ND/O	-	65	7.860	2.828	42 x 2.882
PL_/2820/___/A/O	1-10 V	65	7.860	2.828	42 x 2.882
PL_/2820/___/D/O	DALI	65	7.860	2.828	42 x 2.882
Powerline recessed 3.108 mm					
PLR_/3100/___/ND/O	-	71,5	8.660	3.108	42 x 3.102
PLR_/3100/___/A/O	1-10 V	71,5	8.660	3.108	42 x 3.102
PLR_/3100/___/D/O	DALI	71,5	8.660	3.108	42 x 3.102
Powerline recessed 3.388 mm					
PLR_/3380/___/ND/O	-	78	9.450	3.388	42 x 3.382
PLR_/3380/___/A/O	1-10 V	78	9.450	3.388	42 x 3.382
PLR_/3380/___/D/O	DALI	78	9.450	3.388	42 x 3.382
Powerline recessed 3.668 mm					
PLR_/3660/___/ND/O	-	83,5	10.240	3.668	42 x 3.662
PLR_/3660/___/A/O	1-10 V	83,5	10.240	3.668	42 x 3.662
PLR_/3660/___/D/O	DALI	83,5	10.240	3.668	42 x 3.662
Powerline recessed 3.948 mm					
PLR_/3940/___/ND/O	-	91	11025	3.948	42 x 3.942
PLR_/3940/___/A/O	1-10 V	91	11025	3.948	42 x 3.942
PLR_/3940/___/D/O	DALI	91	11025	3.948	42 x 3.942
Powerline recessed 4.228 mm					
PLR_/4220/___/ND/O	-	97,5	11.812	4.228	42 x 4.222
PLR_/4220/___/A/O	1-10 V	97,5	11.812	4.228	42 x 4.222
PLR_/4220/___/D/O	DALI	97,5	11.812	4.228	42 x 4.222
Powerline recessed 4.508 mm					
PLR_/4500/___/ND/O	-	104	12.600	4.508	42 x 4.502
PLR_/4500/___/A/O	1-10 V	104	12.600	4.508	42 x 4.502
PLR_/4500/___/D/O	DALI	104	12.600	4.508	42 x 4.502

POWERLINE OPTIONS

POWERLINE ON & SUSPENSION



	DESCRIPTION	REFERENCE	REMARKS
PROFILE COMPONENTS			
	PROFILE WITH PC COVER		
	anodised aluminium white matt RAL 9016 tex black matt RAL 9005 tex	PLA/001 PLW/001 PLB/001	Other RAL colours on request.
	PROFILE WITH ALU COVER		
	anodised aluminium white matt RAL 9016 tex black matt RAL 9005 tex	PLA/002 PLW/002 PLB/002	Other RAL colours on request.
	BLACK TRANSPARENT DIFFUSOR		
	black transparent diffuser	PL/BTC	
	END CAP (1 pc.)		
	anodised aluminium white matt RAL 9016 tex black matt RAL 9005 tex	PL/EC/A PL/EC/W PL/EC/B	Other RAL colours on request.
	PROFILE CONNECTORS		
	profile connector 90° profile connector 180° (straight)	PL/90 PL/180	
SERVICES			
	PROFILE CUT/SAW CUT		
	profile cut 180° / 45°	PL/PC	one 90° profile needs 2 cuts
	SILICONE COMPOUND MODULES IP65		
		PL/SC	

POWERLINE ON & SUSPENSION





	DESCRIPTION	REFERENCE	REMARKS
ELECTRICAL			
	MOUNTING CONNECTING BOX Ø80 MM		
	white matt RAL 9016 tex black matt RAL 9005 tex	AT/MC80/W AT/MC80/B	diameter: 80 mm height: 30 mm
	MOUNTING CONNECTING BOX Ø60 MM		
	white matt RAL 9016 tex black matt RAL 9005 tex	AT/MC60/W AT/MC60/B	diameter: 60 mm height: 30 mm
	RECESSED CONNECTING BOX Ø90 MM		
	white matt RAL 9016 tex black matt RAL 9005 tex	AT/RC90/W AT/RC90/B	outside diameter: 90 mm build-in diameter: 80 mm
	RECESSED CONNECTING BOX Ø60 MM		
	white matt RAL 9016 tex black matt RAL 9005 tex	AT/RC60/W AT/RC60/B	outside diameter: 60 mm build-in diameter: 44 mm
	MOUNTING CONNECTING BOX		
	white matt RAL 9016 tex black matt RAL 9005 tex	AT/SB/W AT/SB/B	outside diameter: 60 mm build-in diameter: 44 mm
	CABLE SUPPLY TRANSPARENT		
	3x 0,75 mm ² - 2 m 3x 0,75 mm ² - 5 m 5x 0,75 mm ² - 2 m 5x 0,75 mm ² - 5 m	PL/CS/2000/T PL/CS/5000/T AT/CS/2000/T AT/CS/5000/T	
	CABLE SUPPLY BLACK FABRIC		
	3x 0,75 mm ² - 2 m 3x 0,75 mm ² - 5 m 5x 0,75 mm ² - 2 m 5x 0,75 mm ² - 5 m	PL/CS/2000/B PL/CS/5000/B AT/CS/2000/B AT/CS/5000/B	

POWERLINE OPTIONS

POWERLINE ON & SUSPENSION

DESCRIPTION	REFERENCE	REMARKS
MOUNTING OPTIONS		
SUSPENSION SET		
 suspension set 2.000 mm suspension set 5.000 mm	AT/PS/2000 AT/PS/5000	
WALL BRACKET OPTION / up to 2.260 mm		
 wall bracket set (2pcs mounted)	PL/WBS	Other RAL colours on request.
POWERLINE MOUNTED ON 3F TRACK (available for non-dim ON versions)		
Double 3F adaptor option white Double 3F adaptor option black	PL/D3F/W PL/D3F/B	Double 3F option available for lengths up to 2.260 mm
Single rotor 3F adaptor white Single rotor 3F adaptor black	PL/S3F/W PL/S3F/B	Single rotor 3F option available for lengths up to 1.140 mm
MODULE OPTIONS		
OPTIONAL MODULES		
Emergency module 3 hrs. Motion detector incl. profile 100 mm Ambient light/motion sensor / DALI incl. remote* Standalone DALI / detection sensor* Casambi DALI build-in*	PL/EM PL/MT PL/ALS PL/SAD PL/CAS	* only available in DALI versions
Push button dimming / DALI versions	PL/PBA	Top mounted for suspension/ end-cap position ON versions
EXTRA CIRCUIT PER METER		
	PL/EC	

POWERLINE ON & SUSPENSION

DESCRIPTION	REFERENCE	REMARKS
LIGHT OPTIONS		
MICRO TUBE SINGLE / 7W - 630 lm / incl. 180 mm profile		
	927 - Matt white texture Phase DIM 927 - Matt black texture Phase DIM 930 - Matt white texture Phase DIM 930 - Matt blacktexture Phase DIM 927 - Matt white texture DALI DIM 927 - Matt black texture DALI DIM 930 - Matt white texture DALI DIM 930 - Matt black texture DALI DIM	PLW/MT/927/PD PLB/MT/927/PD PLW/MT/930/PD PLB/MT/930/PD PLW/MT/927/D PLB/MT/927/D PLW/MT/930/D PLB/MT/930/D
MICRO TUBE DOUBLE / 2x 7W - 2x 630 lm / incl. 280 mm profile		
	927 - Matt white texture Phase DIM 927 - Matt black texture Phase DIM 930 - Matt white texture Phase DIM 930 - Matt blacktexture Phase DIM 927 - Matt white texture DALI DIM 927 - Matt black texture DALI DIM 930 - Matt white texture DALI DIM 930 - Matt black texture DALI DIM	PLW/MT2/927/PD PLB/MT2/927/PD PLW/MT2/930/PD PLB/MT2/930/PD PLW/MT2/927/D PLB/MT2/927/D PLW/MT2/930/D PLB/MT2/930/D
DOT LINE R4 / incl. 180 mm profile / 6W / 940 lm		
	930 - Matt white texture Phase DIM 930 - Matt blacktexture Phase DIM 930 - Matt white texture DALI DIM 930 - Matt black texture DALI DIM	PLW/DL4/930/PD PLB/DL4/930/PD PLW/DL4/930/D PLB/DL4/930/D
DOT LINE R7 / incl. 300 mm profile / 10W / 1.650 lm		
	930 - Matt white texture Phase DIM 930 - Matt blacktexture Phase DIM 930 - Matt white texture DALI DIM 930 - Matt black texture DALI DIM	PLW/DL7/930/PD PLB/DL7/930/PD PLW/DL7/930/D PLB/DL7/930/D
NANO TUBE / 8W - 540 lm / incl. 180 mm profile		
	927 - Matt black texture Phase DIM 930 - Matt black texture Phase DIM 927 - Matt black texture DALI DIM 930 - Matt black texture DALI DIM 927 - Matt white texture Phase DIM 930 - Matt white texture Phase DIM 927 - Matt white texture DALI DIM 930 - Matt white texture DALI DIM	PLB/NT/927/PD PLB/NT/930/PD PLB/NT/927/D PLB/NT/930/D PLW/NT/927/PD PLW/NT/930/PD PLW/NT/927/D PLW/NT/930/D



POWERLINE OPTIONS

POWERLINE RECESSED

	DESCRIPTION	REFERENCE	REMARKS
MOUNTING OPTIONS			
	PROFILE RECESSED WITH PC COVER anodised aluminium white matt RAL 9016 tex black matt RAL 9005 tex	PLRA/001 PLRW/001 PLRB/001	Maximum length 4.500 mm. Other RAL colours on request.
	PROFILE RECESSED WITH ALU COVER anodised aluminium white matt RAL 9016 tex black matt RAL 9005 tex	PLRA/002 PLRW/002 PLRB/002	Maximum length 4.500 mm. Other RAL colours on request.
	BLACK TRANSPARENT DIFFUSOR Black transparent diffusor	PL/BTC	Maximum length single piece 4.500 mm.
	END CAP (1 pc.) anodised aluminium white matt RAL 9016 tex black matt RAL 9005 tex	PLR/EC/A PLR/EC/W PLR/EC/B	
	MOUNTING BRACKET RECESSED / EACH 0 mm - 2.260 mm = 2 brackets 2.260 mm - 3.380 mm = 3 brackets 3.380 mm - 4.500 mm = 4 brackets	PLR/MBR	
	PROFILE CONNECTORS profile connector 90° profile connector 180° (straight)	PL/90 PL/180	
SERVICES			
	PROFILE CUT/SAW CUT profile cut	PL/PC	one 90° profile needs 2 cuts

D-LINE READY TO GO UP- & DOWNLIGHT SUSPENSION



	LM OUTPUT	CRI	LENGTH	HEIGHT	WIDTH
Small	4.400 lm	+80	1.140 mm	75 mm	50 mm
Medium	6.600 lm	+80	1.700 mm	75 mm	50 mm
Large	8.800 lm	+80	2.260 mm	75 mm	50 mm

REMARK: DALI version = PUSH DIM compatible
Uplight is not dimmable by 1-10 V or DALI

REFERENCE	COLOR	DIM	W	LM OUTPUT	LENGTH (mm)
D-Line Suspended Small					
A7101ANO/___/ND/S	ano	-	29+12	4.400+880	1.140
A7101W/___/ND/S	white	-	29+12	4.400+880	1.140
A7101B/___/ND/S	black	-	29+12	4.400+880	1.140
A7101ANO/___/A/S	ano	1-10 V	29+12	4.400+880	1.140
A7101W/___/A/S	white	1-10 V	29+12	4.400+880	1.140
A7101B/___/A/S	black	1-10 V	29+12	4.400+880	1.140
A7101ANO/___/DA/S	ano	DALI	29+12	4.400+880	1.140
A7101W/___/DA/S	white	DALI	29+12	4.400+880	1.140
A7101B/___/DA/S	black	DALI	29+12	4.400+880	1.140
D-Line Suspended Medium					
A7102ANO/___/ND/S	ano	-	43,5+18	6.600+1.320	1.700
A7102W/___/ND/S	white	-	43,5+18	6.600+1.320	1.700
A7102B/___/ND/S	black	-	43,5+18	6.600+1.320	1.700
A7102ANO/___/A/S	ano	1-10 V	43,5+18	6.600+1.320	1.700
A7102W/___/A/S	white	1-10 V	43,5+18	6.600+1.320	1.700
A7102B/___/A/S	black	1-10 V	43,5+18	6.600+1.320	1.700
A7102ANO/___/DA/S	ano	DALI	43,5+18	6.600+1.320	1.700
A7102W/___/DA/S	white	DALI	43,5+18	6.600+1.320	1.700
A7102B/___/DA/S	black	DALI	43,5+18	6.600+1.320	1.700
D-Line Suspended Large					
A7103ANO/___/ND/S	ano	-	58+24	8.800+1.790	2.260
A7103W/___/ND/S	white	-	58+24	8.800+1.790	2.260
A7103B/___/ND/S	black	-	58+24	8.800+1.790	2.260
A7103ANO/___/A/S	ano	1-10 V	58+24	8.800+1.790	2.260
A7103W/___/A/S	white	1-10 V	58+24	8.800+1.790	2.260
A7103B/___/A/S	black	1-10 V	58+24	8.800+1.790	2.260
A7103ANO/___/DA/S	ano	DALI	58+24	8.800+1.790	2.260
A7103W/___/DA/S	white	DALI	58+24	8.800+1.790	2.260
A7103B/___/DA/S	black	DALI	58+24	8.800+1.790	2.260

D-LINE READY TO GO UP- & DOWNLIGHT WALL



PROFILE COLORS	COLOR	CCT	
anodised aluminium	ano	2.700 K	product code /827
white matt texture RAL9016	white	3.000 K	product code /830
black matt texture RAL9005	black	4.000 K	product code /840

REMARK: other RAL colors on request

REFERENCE BUILDER: A7101W/___/ND/S

REFERENCE	COLOR	DIM	W	LM OUTPUT	LENGTH (mm)
D-Line Wall Small					
A7101ANO/___/ND/WL	ano	-	29+12	4.400+880	1.140
A7101W/___/ND/WL	white	-	29+12	4.400+880	1.140
A7101B/___/ND/WL	black	-	29+12	4.400+880	1.140
A7101ANO/___/A/WL	ano	1-10 V	29+12	4.400+880	1.140
A7101W/___/A/WL	white	1-10 V	29+12	4.400+880	1.140
A7101B/___/A/WL	black	1-10 V	29+12	4.400+880	1.140
A7101ANO/___/DA/WL	ano	DALI	29+12	4.400+880	1.140
A7101W/___/DA/WL	white	DALI	29+12	4.400+880	1.140
A7101B/___/DA/WL	black	DALI	29+12	4.400+880	1.140
D-Line Wall Medium					
A7102ANO/___/ND/WL	ano	-	43,5+18	6.600+1.320	1.700
A7102W/___/ND/WL	white	-	43,5+18	6.600+1.320	1.700
A7102B/___/ND/WL	black	-	43,5+18	6.600+1.320	1.700
A7102ANO/___/A/WL	ano	1-10 V	43,5+18	6.600+1.320	1.700
A7102W/___/A/WL	white	1-10 V	43,5+18	6.600+1.320	1.700
A7102B/___/A/WL	black	1-10 V	43,5+18	6.600+1.320	1.700
A7102ANO/___/DA/WL	ano	DALI	43,5+18	6.600+1.320	1.700
A7102W/___/DA/WL	white	DALI	43,5+18	6.600+1.320	1.700
A7102B/___/DA/WL	black	DALI	43,5+18	6.600+1.320	1.700
D-Line Wall Large					
A7103ANO/___/ND/WL	ano	-	58+24	8.800+1.790	2.260
A7103W/___/ND/WL	white	-	58+24	8.800+1.790	2.260
A7103B/___/ND/WL	black	-	58+24	8.800+1.790	2.260
A7103ANO/___/A/WL	ano	1-10 V	58+24	8.800+1.790	2.260
A7103W/___/A/WL	white	1-10 V	58+24	8.800+1.790	2.260
A7103B/___/A/WL	black	1-10 V	58+24	8.800+1.790	2.260
A7103ANO/___/DA/WL	ano	DALI	58+24	8.800+1.790	2.260
A7103W/___/DA/WL	white	DALI	58+24	8.800+1.790	2.260
A7103B/___/DA/WL	black	DALI	58+24	8.800+1.790	2.260





NOVUS

REF	C8001	Novus - anodised
	C8001-W	Novus - white texture
	C8001-BL	Novus - black texture
	C8001/BTC	Novus - anodised - black diffusor
	C8001-W/BTC	Novus - white texture - black diffusor
	C8001-BL/BTC	Novus - black texture - black diffusor
	C8001-E	Novus end-cap - anodised
	C8001-EW	Novus end-cap - white texture
	C8001-EB	Novus end-cap - black texture
	C8001-B	Novus brace

DIMENSIONS	22,6 x 15,6 mm
FINISH	white RAL 9016 tex black RAL 9005 tex anodised aluminium
LENGTH	2 m / 3 m
OPTIONAL	endcap brace

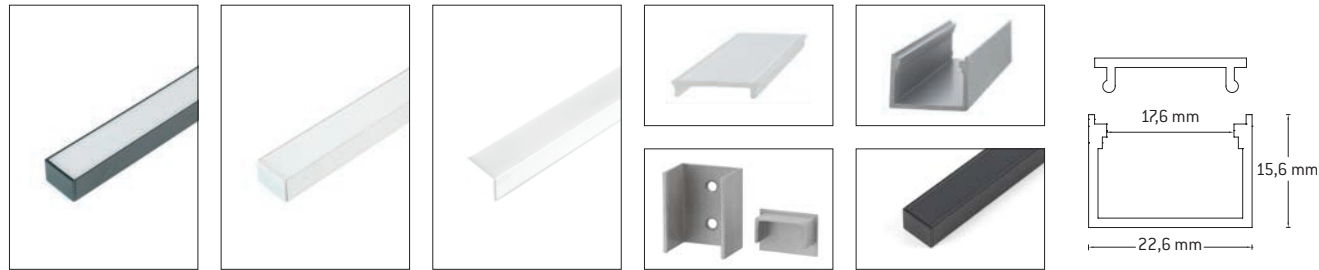

NOVUS PLUS

REF	C8011	NovusPlus - anodised
	C8011-W	NovusPlus - white texture
	C8011-BL	NovusPlus - black texture
	C8011/BTC	NovusPlus - anodised - black diffusor
	C8011-W/BTC	NovusPlus - white texture - black diffusor
	C8011-BL/BTC	NovusPlus - black texture - black diffusor
	C8011-E	NovusPlus end-cap - anodised
	C8011-EW	NovusPlus end-cap - white texture
	C8011-EB	NovusPlus end-cap - black texture
	C8011-B	NovusPlus brace
	C8011-C	NovusPlus profile connector

DIMENSIONS	22,6 x 34 mm
FINISH	white RAL 9016 tex black RAL 9005 tex anodised aluminium
LENGTH	3 m
OPTIONAL	endcap brace profile connector

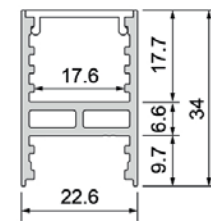

LINEA

REF	C8004	Linea - anodised
	C8004-W	Linea - white texture
	C8004-BL	Linea - black texture
	C8004-E	Linea end-cap - anodised
	C8004-EW	Linea end-cap - white
	C8004-EB	Linea end-cap - black texture
	C8004-B	Linea brace

DIMENSIONS	22 x 20 mm
FINISH	white RAL 9016 tex black RAL 9005 tex anodised aluminium
LENGTH	2 m
OPTIONAL	endcap brace

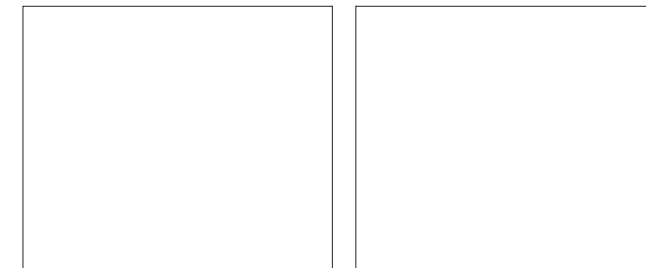
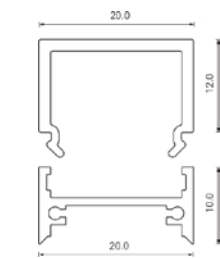
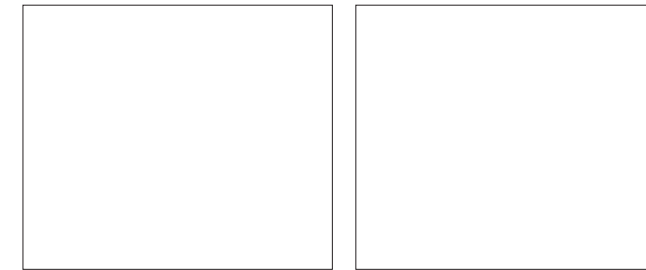

LOW

REF	C8006	LOW Profile - Anodised
	C8006-W	LOW Profile - white texture
	C8006-B	LOW Profile - black texture
	C8006-E	LOW End-cap
	C8006-EW	LOW End-cap - white texture
	C8006-EB	LOW End-cap - black texture

DIMENSIONS	7 x 17,5 mm
FINISH	white RAL 9016 tex black RAL 9005 tex anodised aluminium
LENGTH	2 m
OPTIONAL	endcap

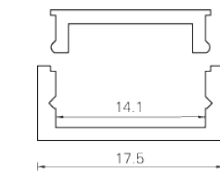





CORNU

REF	C8003	Cornu 45° - anodised
	C8003-W	Cornu 45° - white matte texture
	C8003-BL	Cornu 45° - black texture
	C8003-E	Cornu end-cap - anodised
	C8003-EW	Cornu end-cap - white
	C8003-EB	Cornu end-cap - black
	C8003-B	Cornu brace

DIMENSIONS	22,25 x 15,08 mm
FINISH	white RAL 9016 tex black RAL 9005 tex anodised aluminium
LENGTH	2 m
OPTIONAL	endcap brace

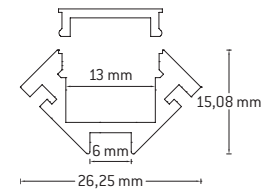
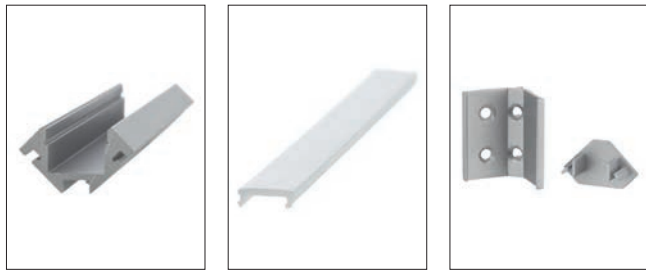

CIELLO

REF	C8002	Cielo - anodised
	C8002-W	Cielo - white texture
	C8002-BL	Cielo - black texture
	C8002-E	Cielo end-cap - anodised
	C8002-EW	Cielo end-cap - white
	C8002-EB	Cielo end-cap - black texture
	C8002-SB	Cielo ceiling mounting

DIMENSIONS	35 x 45 mm
Built-in	40 mm wide
FINISH	white RAL 9016 tex black RAL 9005 tex anodised aluminium
LENGTH	2 m / 3 m
OPTIONAL	endcap brace

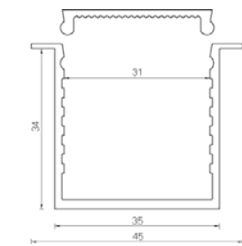
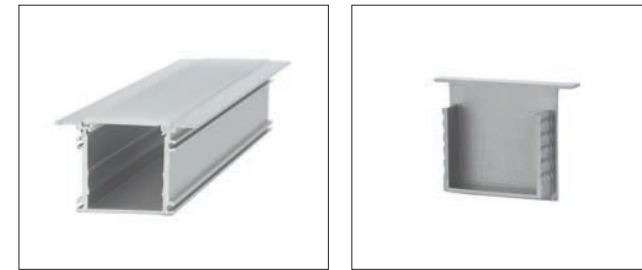

KWADRU

REF	C8005	Kwadru 35 x 35 mm - anodised
	C8005-W	Kwadru 35 x 35 mm - white texture
	C8005-BL	Kwadru 35 x 35 mm - black texture
	C8005-E	Kwadru end-cap - anodised
	C8005-EW	Kwadru end-cap - white texture
	C8005-EB	Kwadru end-cap - black texture

DIMENSIONS	35 x 35 mm
FINISH	white RAL 9016 tex black RAL 9005 tex anodised aluminium
LENGTH	2 m / 3 m
OPTIONAL	endcap brace

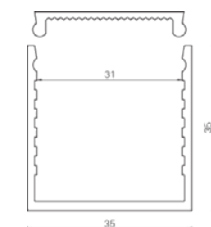
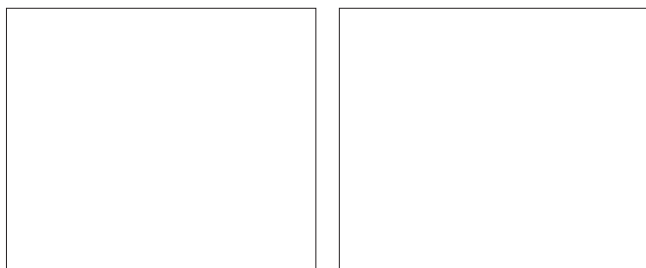

DUO

REF	C8007	Duo - anodised
	C8007-E	Duo end-cap (1pc.)
	C8007-W	Duo white
	C8007-EW	Duo end-cap white (1pc.)
	C8007-BL	Duo black
	C8007-EB	Duo end-cap black(1pc.)
	C8007-B	Duo clip

FINISH	white RAL 9016 tex black RAL 9005 tex anodised aluminium
LENGTH	2 m
OPTIONAL	C8007-B Duo clip

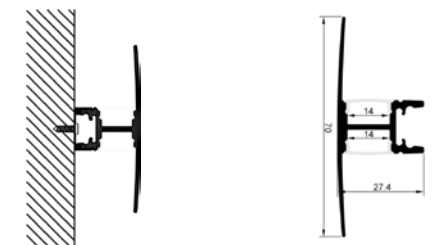



MINUS

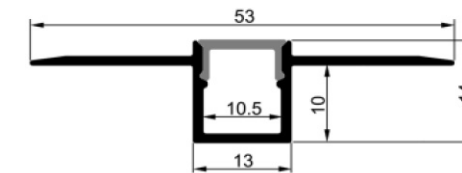
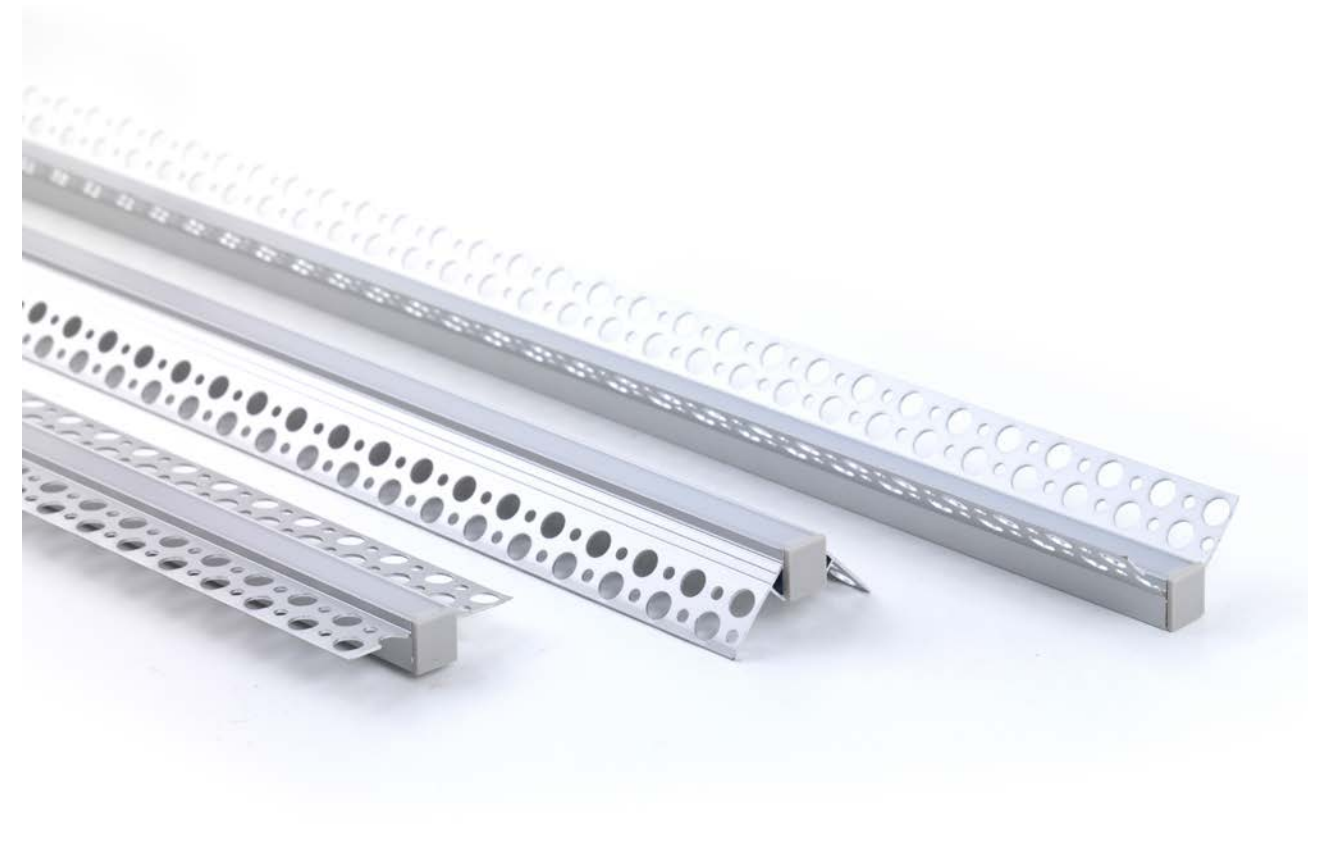

MINUS TR

REF	C8008	Minus TR
LENGTH	2 m	
FINISH	anodised aluminium	
OPTIONAL	C8008-E endcap set 2 pcs	

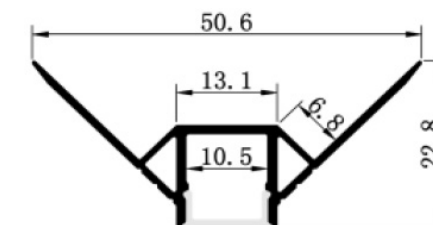

MINUS TR OUT

REF	C8010	Minus TR OUT
LENGTH	2 m	
FINISH	anodised aluminium	
OPTIONAL	C8008-E endcap set 2 pcs	

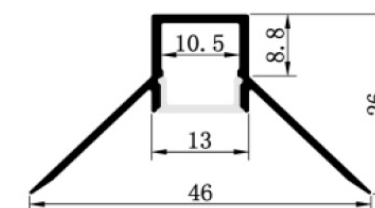

MINUS TR IN

REF	C8009	Minus TR IN
LENGTH	2 m	
FINISH	anodised aluminium	
OPTIONAL	C8008-E endcap set 2 pcs	



LED FLEX



LED FLEX IP20 / 24 Vdc

REF.	MODEL	VOLTAGE	CCT	CRI	POWER/M	LED QTY	IP	WIDTH	LUMEN	BEAM	CUTTABLE
		Vdc		Ra	W	/m		mm	lm/m	angle	every mm
C7007V2/IP20*	STRIP-4040-120-24V-RGB-IP20	24	RGB	n/a	21,6	120	IP20	12	n/a	120	25
C7008V2/IP20	STRIP-3014-120-24V-WW-3000K-IP20	24	3.000K	+85	14,4	120	IP20	10	1.320	120	50
C7009V2/IP20	STRIP-3014-120-24V-CW-4500K-IP20	24	4.500K	+80	14,4	120	IP20	10	1.500	120	50
C7015V2/IP20	STRIP-3014-120-24V-WW-2700K-IP20	24	2.700K	+85	14,4	120	IP20	10	1.200	120	50
C7012/IP20	STRIP-3528-120-24V-WW-3000K-IP20	24	3.000K	+80	9,6	120	IP20	8	690	120	50
C7013/IP20	STRIP-3528-120-24V-CW-4500K-IP20	24	4.500K	+80	9,6	120	IP20	8	780	120	50
C7014/IP20	STRIP-3528-120-24V-WW-2700K-IP20	24	2.700K	+80	9,6	120	IP20	8	680	120	50
C7016V2/IP20*	STRIP-2110-320-24V-WW-2700K-IP20	24	2.700K	+90	19,2	320	IP20	6	1.700	120	25
C7017V2/IP20*	STRIP-2110-320-24V-WW-3000K-IP20	24	3.000K	+90	19,2	320	IP20	6	1.800	120	25
C7020/IP20*	STRIP-2110-336-24V-Hybrid-IP20	24	2.600K-4.500K	+90	23	336	IP20	8	820-940	120	17,9

LED FLEX IP20 / 48 Vdc

REF.	MODEL	VOLTAGE	CCT	CRI	POWER/M	LED QTY	IP	WIDTH	LUMEN	BEAM	CUTTABLE
		Vdc		Ra	W	/m		mm	lm/m	angle	every mm
C7201	STRIP-2835-120-48V-WW-2700K-IP20	48	2.700K	92	14	120	IP20	8	1.227	120	125
C7202	STRIP-2835-120-48V-WW-3000K-IP20	48	3.000K	92	14	120	IP20	8	1.276	120	125



COB LED FLEX IP20 / 24 Vdc

REF.	MODEL	VOLTAGE	CCT	CRI	POWER/M	LED QTY	IP	WIDTH	LUMEN	BEAM	CUTTABLE
		Vdc		Ra	W	/m		mm	lm/m	angle	every mm
C7018/IP20	STRIP-COB-512-24V-WW-2700K-IP20	24	2.700K	+92	10	512	IP20	8	780	120	62,5
C7019/IP20	STRIP-COB-512-24V-WW-3000K-IP20	24	3.000K	+92	10	512	IP20	8	910	120	62,5

LED FLEX



LED FLEX IP64 / 24 Vdc

REF.	MODEL	VOLTAGE	CCT	CRI	POWER/M	LED QTY	IP	WIDTH	LUMEN	BEAM	CUTTABLE
		Vdc		Ra	W	/m		mm	lm/m	angle	every mm
C7008V2/IP64	STRIP-3014-120-24V-WW-3000K-IP64	24	3.000K	+85	14,4	120	IP64	10	1.320	120	50
C7015V2/IP64	STRIP-3014-120-24V-WW-2700K-IP64	24	2.700K	+85	14,4	120	IP64	10	1.200	120	50
C7009V2/IP64	STRIP-3014-120-24V-CW-4500K-IP64	24	4.500K	+85	14,4	120	IP64	10	1.500	120	50

LED FLEX IP64 / 12 Vdc

REF.	MODEL	VOLTAGE	CCT	CRI	POWER/M	LED QTY	IP	WIDTH	LUMEN	BEAM	CUTTABLE
		Vdc		Ra	W	/m		mm	lm/m	angle	every mm
C7011/IP64	STRIP-3528-60-12V-CW-4500K	12	4.500K	+80	4,8	60	IP64	8	420	120	50



LED FLEX IP65 / 24 Vdc

REF.	MODEL	VOLTAGE	CCT	CRI	POWER/M	LED QTY	IP	WIDTH	LUMEN	BEAM	CUTTABLE
		Vdc		Ra	W	/m		mm	lm/m	angle	every mm
C7007/IP65	STRIP-5050-60-24V-RGB-IP65	24	RGB	n/a	14,4	60	IP65	12	n/a	120	100
C7012/IP65	STRIP-3528-120-24V-WW-3000K-IP65	24	3.000K	+80	9,6	120	IP65	10	690	120	50
C7013/IP65	STRIP-3528-120-24V-CW-4500K-IP65	24	4.500K	+80	9,6	120	IP65	10	780	120	50
C7014/IP65	STRIP-3528-120-24V-WW-2700K-IP65	24	2.700K	+80	9,6	120	IP65	10	680	120	50



LED PCB'S

REF	C7101	36 LED 9W/0,5m 2.700K CRI>80 PCB
	C7102	36 LED 9W/0,5m 3.000K CRI>80 PCB
	C7103	36 LED 9W/0,5m 4.000K CRI>80 PCB

LED	SMT 5630
INPUT VOLTAGE	24 Vdc
POWER CONS.	9W / 0,5m PCB
LED LM OUTPUT	2.700 K = typical \pm 1.000 lm/0,5m 3.000 K = typical \pm 1.040 lm/0,5m 4.000 K = typical \pm 1.100 lm/0,5m
COLOR TEMP.	2.700 / 3.000 / 4.000 K
CRI/GAI	min. 80/85 typical
BEAM ANGLE	130°
DIMENSIONS	L499 x W12 mm
REMARK	Easy slide in connection. Keep solder joint temperature below 85°C. End-user should provide sufficient cooling for PCB. Do not mount onto isolating materials!
OPTIONS	linear led profiles: C8001 Novus C8002 Ciello C8003 Cornu

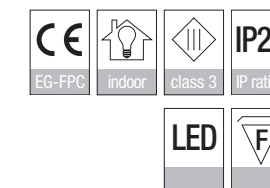



ICON

REF	B3010/B830 B3010/W830	Icon black 3.000 K Icon white 3.000 K
-----	--------------------------	--

LED	COB
LED LM OUTPUT	320 lm
POWER CONS.	6 W
DRIVE VOLTAGE	230 Vac built-in driver
COLOR TEMP.	3.000 K
CRI	80
REFLECTOR	60° adjustable
FINISH	white RAL 9016 tex black RAL 9005 tex
ADJUSTABLE	adjustable beam
CUT-OUT	n/a

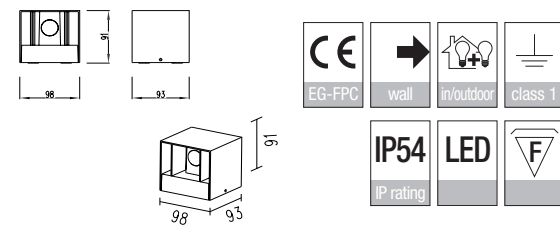
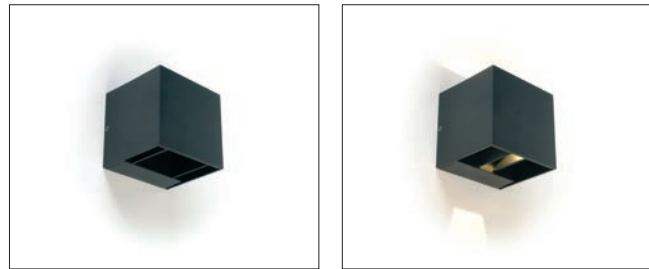

COSTA

REF	B2015 B2016	Costa WW 3.000 K Costa CW 6.000 K
-----	----------------	--------------------------------------

LED	Cree high power
LED LM OUTPUT	90 lm
POWER CONS.	3 W @ 700 mA ± 3,2 Vdc
DRIVE VOLTAGE	24 Vdc
COLOR TEMP.	WW 3.000 K CW 6.000 K
CRI	+80
REFLECTOR	side emitting
FINISH	stainless steel 316 frontring
ADJUSTABLE	n/a
CUT-OUT	Ø 40 mm
REMARK	supplied with spring and mounting sleeve supplied with IP67 24 V 700 mA converter

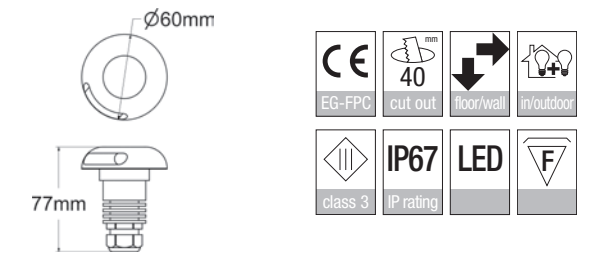
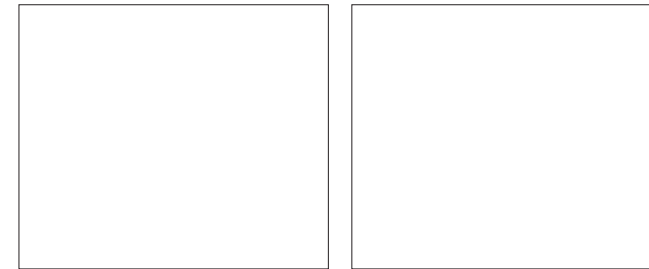

NINO

REF	B2013 B2014	Nino CW Nino WW
-----	----------------	--------------------

LED	Cree high power
LED LM OUTPUT	80 lm
POWER CONS.	1,4 W @ 350 mA ± 3,2 Vdc
DRIVE VOLTAGE	24 Vdc
COLOR TEMP.	3.000 K
CRI	+80
REFLECTOR	80°
FINISH	stainless steel 316 frontring
ADJUSTABLE	n/a
CUT-OUT	Ø 23 mm
REMARK	supplied with spring and mounting sleeve

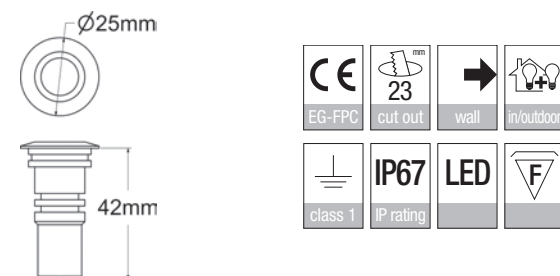
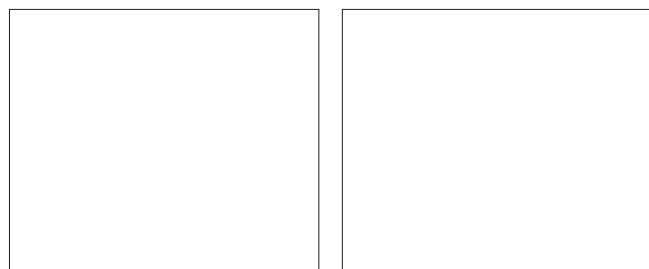

COSTA D

REF	B2017 B2018	Costa D WW 3.000 K Costa D CW 6.000 K
-----	----------------	--

LED	Cree high power
LED LM OUTPUT	90 lm
POWER CONS.	3 W @ 700 mA ± 3,2 Vdc
DRIVE VOLTAGE	24 Vdc
COLOR TEMP.	WW 3.000 K CW 6.000 K
CRI	+80
REFLECTOR	side emitting
FINISH	stainless steel 316 frontring
ADJUSTABLE	n/a
CUT-OUT	Ø 40 mm
REMARK	supplied with spring and mounting sleeve supplied with IP67 24 V 700 mA converter

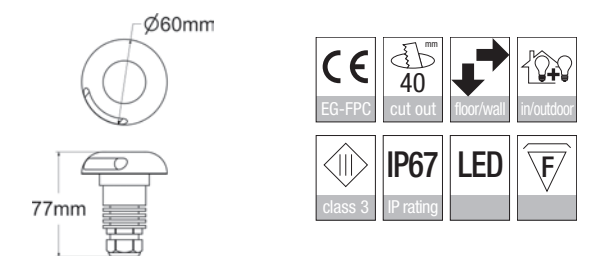
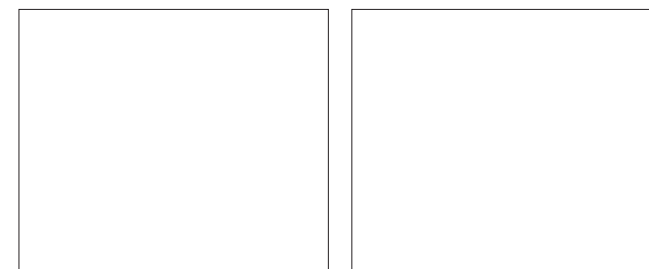



POWERDOT

REF	EXT RU05/W-1W	Powerdot CW
	B2001	Powerdot WW
	EXT RU05/B-1W	Powerdot blue



LED	X-PE
LED LM OUTPUT	81 lm
POWER CONS.	3 W
DRIVE VOLTAGE	12 Vdc
COLOR TEMP.	WW 3.000 K CW 6.000 K blue
CRI	+80
REFLECTOR	30° lens
FINISH	stainless steel 316 frontring
ADJUSTABLE	n/a
CUT-OUT	Ø 64 mm
REMARK	supplied with mounting sleeve and 0,5 m 2x1 mm ² rubber connection cable max. load: exert force area 10 mm = 1.330 kg

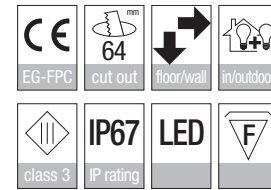
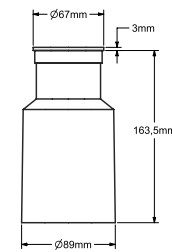
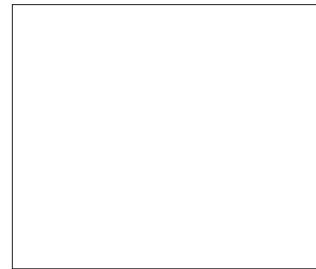

CARREE ES

REF	EXT SU03/W-1W	Carree ES CW
	B2002	Carree ES WW
	EXT SU03/B-1W	Carree ES blue

LED	X-PE
LED LM OUTPUT	81 lm
POWER CONS.	3 W
DRIVE VOLTAGE	12 Vdc
COLOR TEMP.	WW 3.000 K CW 6.000 K blue
CRI	+80
REFLECTOR	30° lens
FINISH	stainless steel 316 frontring
ADJUSTABLE	n/a
CUT-OUT	Ø 64 mm
REMARK	supplied with mounting sleeve and 0,5 m 2x1 mm ² rubber connection cable max. load: exert force area 10 mm = 1.330 kg

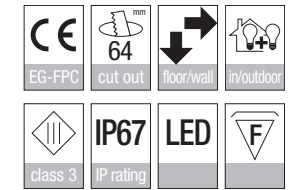
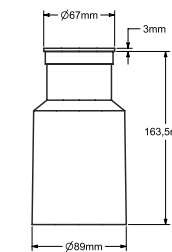
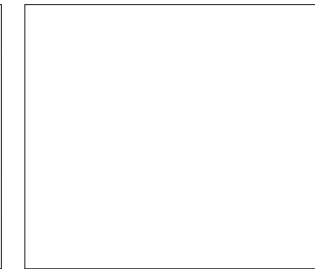



LIMBUS

REF	B2004 B2003 B2005	Limbus CW Limbus WW Limbus RGB
-----	-------------------------	--------------------------------------

LED	3x CREE
LED LM OUTPUT	315 lm
POWER CONS.	6.7 W (RGB version 7.6 W)
DRIVE VOLTAGE	24 Vdc
COLOR TEMP.	WW 3.000 K CW 6.000 K RGB
CRI	+80
REFLECTOR	assymetrical lens 45° / 35° wall wash effect
FINISH	stainless steel 316 frontring
ADJUSTABLE	n/a
CUT-OUT	Ø 103 mm
REMARK	supplied with mounting sleeve and 0,5 m 2x1 mm ² rubber connection cable max. load: exert force area 30 mm = 1.840 kg

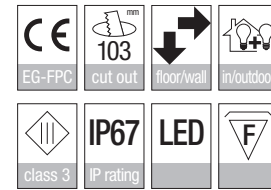
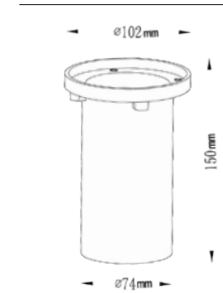
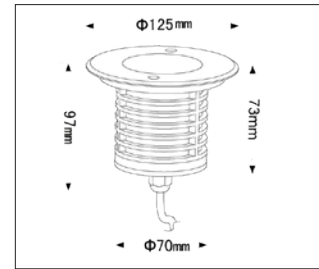

HALOS

REF	B2007 B2006 B2008	Halos CW Halos WW Halos RGB
-----	-------------------------	-----------------------------------

LED	3x CREE
LED LM OUTPUT	315 lm
POWER CONS.	6.7 W (RGB version 7.6 W)
DRIVE VOLTAGE	24 Vdc
COLOR TEMP.	WW 3.000 K CW 6.000 K RGB
CRI	+80
REFLECTOR	assymetrical lens 45° / 35° wall wash effect
FINISH	stainless steel 316 frontring
ADJUSTABLE	n/a
CUT-OUT	Ø 103 mm
REMARK	supplied with mounting sleeve and 0,5 m 2x1 mm ² rubber connection cable max. load: exert force area 30 mm = 1.840 kg

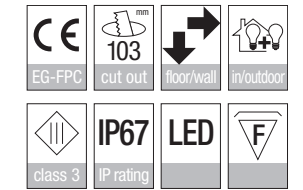
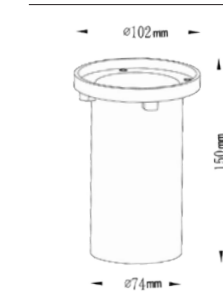
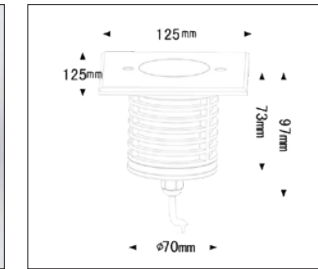



VEGA R

REF	B2019	Vega R
LED	COB	
LED LM OUTPUT	427 lm	
POWER CONS.	9 W	
DRIVE VOLTAGE	24 Vdc	
COLOR TEMP.	3.000 K	
CRI	+80	
REFLECTOR	25°	
FINISH	stainless steel 316 frontring	
ADJUSTABLE	n/a	
CUT-OUT	Ø 105 mm	
REMARK	supplied with mounting sleeve and 0,5 m 2x1 mm ² rubber connection cable max. load: exert force area 30 mm = 1.840 kg	

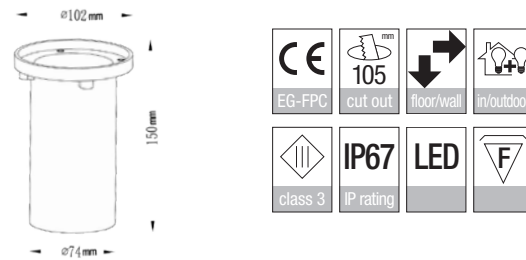
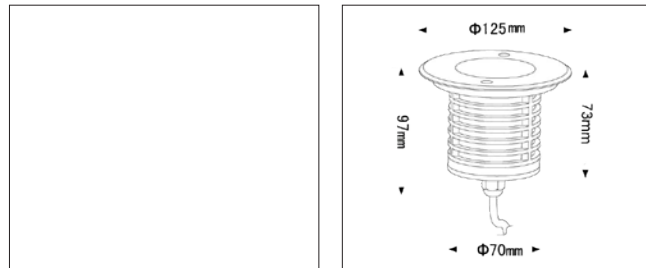

MODEST

REF	B1014	Modest
LED	COB	
LED LM OUTPUT	95 lm	
POWER CONS.	2,6 W	
DRIVE VOLTAGE	24 Vdc	
COLOR TEMP.	3.000 K	
CRI	+80	
REFLECTOR	30° lens	
FINISH	black RAL 9005 tex	
ADJUSTABLE	45° x 355°	
CUT-OUT	n/a	
REMARK	supplied with 2 m rubber connection cable and PVC spike	

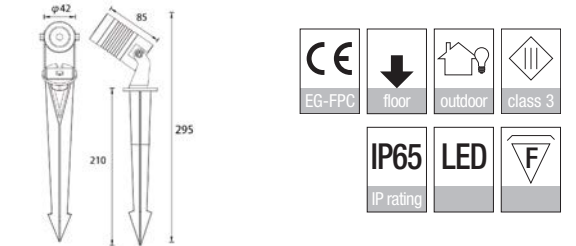
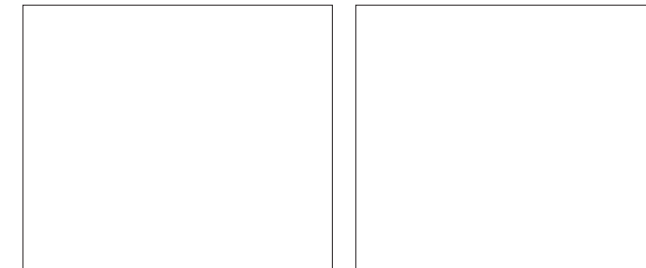

VEGA S

REF	B2020	Vega S
LED	COB	
LED LM OUTPUT	427 lm	
POWER CONS.	9 W	
DRIVE VOLTAGE	24 Vdc	
COLOR TEMP.	3.000 K	
CRI	+80	
REFLECTOR	25°	
FINISH	stainless steel 316 frontring	
ADJUSTABLE	n/a	
CUT-OUT	Ø 105 mm	
REMARK	supplied with mounting sleeve and 0,5 m 2x1 mm ² rubber connection cable max. load: exert force area 30 mm = 1.840 kg	

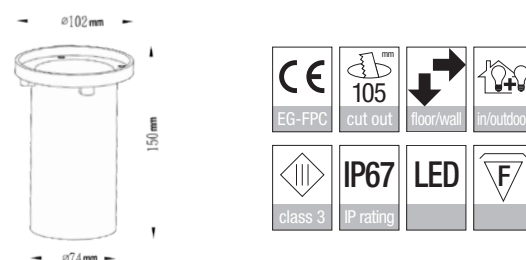
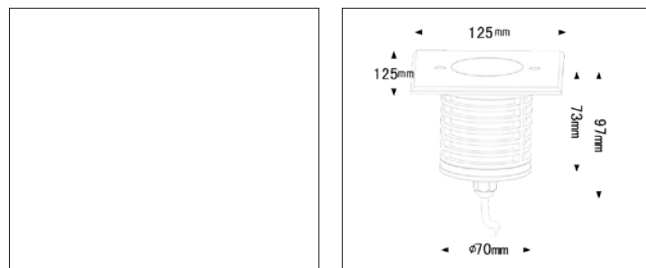

TERRA SPIKE

REF	B1015	Terra Spike
LED	COB	
LED LM OUTPUT	775 lm	
POWER CONS.	10,2 W	
DRIVE VOLTAGE	24 Vdc	
COLOR TEMP.	3.000 K	
CRI	+80	
REFLECTOR	30° lens	
FINISH	black RAL 9005 tex	
ADJUSTABLE	45° x 355°	
CUT-OUT	n/a	
REMARK	supplied with 2 m rubber connection cable and PVC spike	

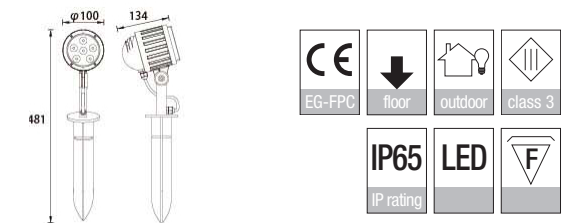
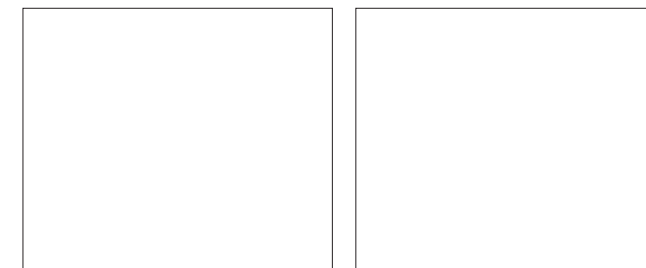



NAIL IT

REF	B1017/1	Nail IT
LED	COB LED	
LED lm output	280 lm	
POWER CONS.	3 W	
DRIVE CURRENT	24 Vdc	
COLOR TEMP.	3.000 K	
CRI	> 90	
REFLECTOR	24°	
FINISH	black RAL9005 tex (UV resistant!)	
ADJUSTABLE	90° x 360°	
CUT-OUT	n/a	
REMARK	supplied with 2 m rubber connection cable	

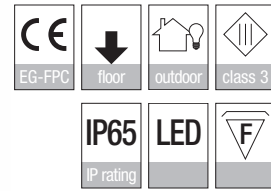
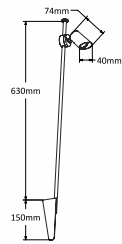

NAIL IT 2

REF	B1017/2	Nail IT 2
LED	COB LED	
LED lm output	2x 280 lm	
POWER CONS.	2x 3 W	
DRIVE CURRENT	24 Vdc	
COLOR TEMP.	3.000 K	
CRI	> 90	
REFLECTOR	24°	
FINISH	black RAL9005 tex (UV resistant!)	
ADJUSTABLE	90° x 360°	
CUT-OUT	n/a	
REMARK	supplied with 2 m rubber connection cable	

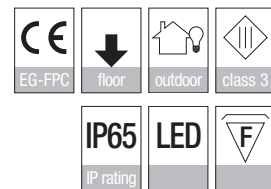
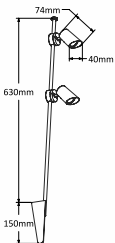

VIKTOR

REF	B1018/827 B1018/830 B1019/827 B1019/830 B1020/827 B1020/830	Viktor N 827 Viktor N 830 Viktor Corten 827 Viktor Corten 830 Viktor Black 827 Viktor Black 830
LED	COB LED	
LED LM OUTPUT	250 lm	
POWER CONS.	5 W	
DRIVE CURRENT	24 Vdc	
COLOR TEMP.	2.700 / 3.000 K	
CRI	> 80	
REFLECTOR	24°	
FINISH	Black RAL9005 tex / Corten steel	
ADJUSTABLE	n/a	
CUT-OUT	n/a	
REMARK	Supplied with 2 m rubber connection cable	



VIKTOR



VIKTOR CORTEN



VIKTOR N

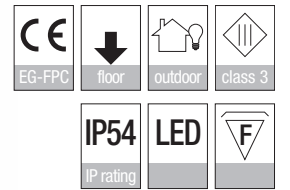
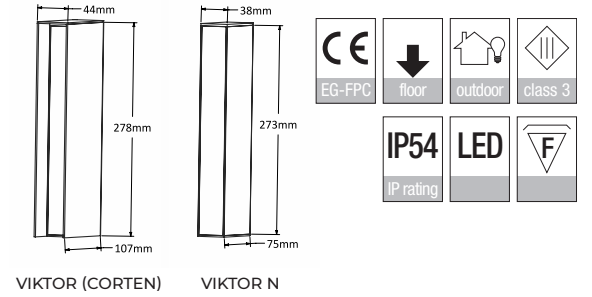

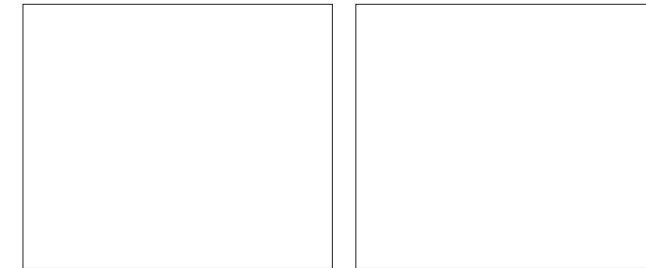
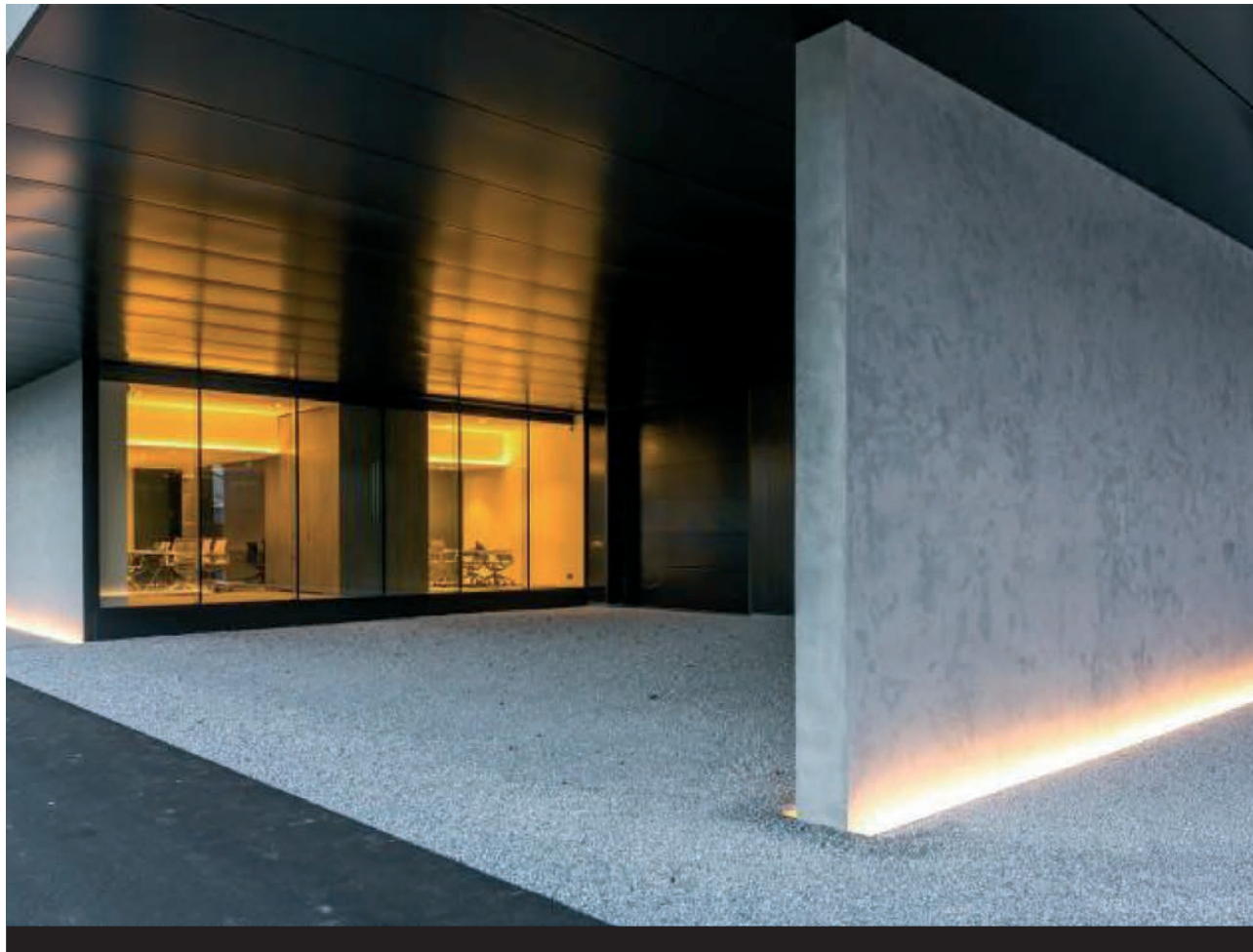

C-LINE

REF	B5034/8027	C-line alu 2.700 K
	B5034/8030	C-line alu 3.000 K
	B5034/8040	C-line alu 4.000 K

LED	SMT 5630
LED LM OUTPUT	± 2.000 lm/m
POWER CONS.	18 W/m
COLOR TEMP.	2.700 / 3.000 / 4.000 K
CRI/GAI	+80 / typical 85
REFLECTOR	130°
FINISH	anodised aluminium + epoxy resin
ADJUSTABLE	n/a
CUT-OUT	n/a
DRIVE VOLTAGE	24 Vdc
REMARK	due to epoxy resin, colour temperature might change
OPTIONS	ABS mounting brace available: Novus brace ref. C8001-B

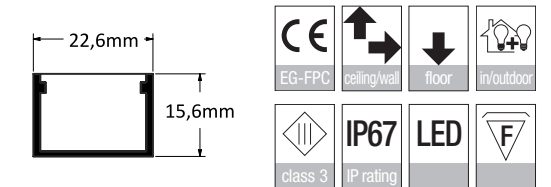

C-LINE RECESSED

REF	B5035/8027	C-line alu recessed 2.700 K
	B5035/8030	C-line alu recessed 3.000 K
	B5035/8040	C-line alu recessed 4.000 K

LED	SMT 5630
LED LM OUTPUT	± 2.000 lm/m
POWER CONS.	18 W/m
COLOR TEMP.	2.700 / 3.000 / 4.000 K
CRI/GAI	+80 / typical 85
REFLECTOR	130°
FINISH	anodised aluminium + epoxy resin
ADJUSTABLE	n/a
CUT-OUT	n/a
DRIVE VOLTAGE	24 Vdc
REMARK	due to epoxy resin, colour temperature might change

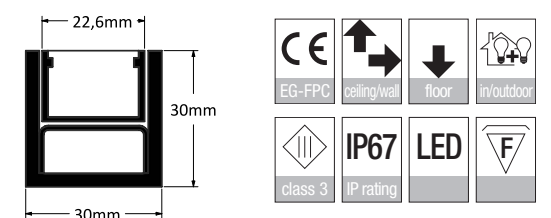



BEAM 50

REF	B5008/830 B5008/840	Beam 50 830 Beam 50 840
LED	72x SMD	
LED LM OUTPUT	6.500 lm eff.	
POWER CONS.	50 W	
DRIVE VOLTAGE	230 Vac	
COLOR TEMP.	3.000 / 4.000 K	
CRI	+80	
REFLECTOR	110°	
FINISH	black RAL 9005 tex	
ADJUSTABLE	2x 45°	
OPTIONS	C6016/30 beam lens 30° C6016/60 beam lens 60°	

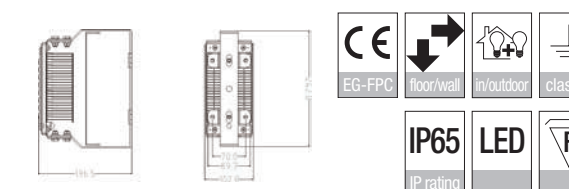

BEAM 150-2

REF	B5009/830 B5009/840	BEAM 150-2 830 BEAM 150-2 840
LED	192x SMD	
LED LM OUTPUT	21.500 lm	
POWER CONS.	150 W	
DRIVE VOLTAGE	100-240 Vdc	
COLOR TEMP.	3.000 / 4.000 K	
CRI	+80	
REFLECTOR	120°	
FINISH	black RAL 9005 tex	
ADJUSTABLE	2x 45°	
OPTIONS	C6017-2/60 beam-2 lens 60°	
WEIGHT	3,5 kg	

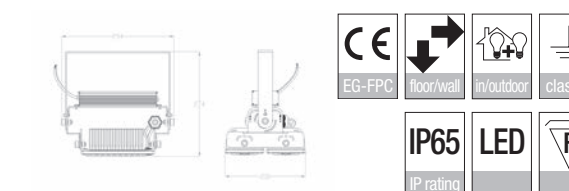
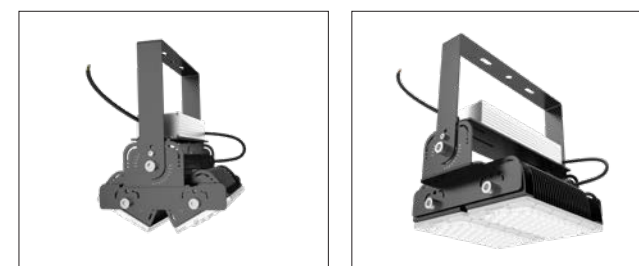



SHOPLINE

Exerus Lightology is well-known for its great expertise in lighting fixtures for retail applications.

We use warm color temperatures to give consumers a pleasant shopping experience, while the high color rendering, contrast and saturation of our lighting fixtures ensure that every type of product is optimally illuminated.

It's a well-known fact that a product that is perfectly highlighted sells much faster and easier.

We have a very vast gamma of lighting fixtures that are suited for many different shopping categories: butchers, bakeries, fruit shops, jewelery shops, ...

You name it, we illuminate it.



EDNA

REF	A6073W A6073B	Edna white Edna black
LED	Xicato Tridonic	
LED LM OUTPUT	1.300 up to 4.350 lm	
POWER CONS.	according to lumen output - see table p. 255	
COLOR TEMP.	2.700 / 3.000 / 4.000 K	
CRI	80 up to +95	
COLOR QUALITY	Xicato: artist / beauty vibrant / vibrant artist Tridonic: fashion / pure white fish / meat / gold / fruit	
REFLECTOR	Xicato: 20° / 40° / 60° (11° only available in 1.300 lm) Tridonic: 20° / 40° / 60°	
FINISH	white RAL 9016 tex black RAL 9005 tex	
ADJUSTABLE	n/a	
CUT-OUT	Ø 110 mm	
DRIVE CURRENT	supplied with driver	

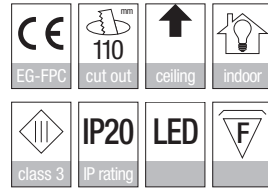
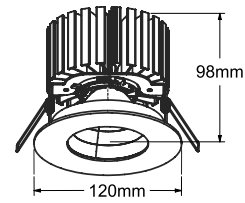

MODULE	MODEL	REFERENCE	LM OUTPUT	CRI / CCT	BEAM	DIMMING	
XICATO XTM	EDNA X WHITE EDNA X BLACK	A6073W A6073B	1.300 lm	827 - 830 - 840 - V830	11°	ND PD A D	
				927 - 930 - 940 - V930 - BT			
			2.000 lm	827 - 830 - 840 - V830	20°		
				927 - 930 - 940 - V930 - BT			
			3.000 lm	827 - 830 - 840 - V830	927 - 930 - 940 - V930 - BT		60°
3.850 lm	827 - 830 - 840 - V830						

Reference builider: fe.: A6073W/1300/V9530/20°/PD

ND: non dimmable / PD: phase dimming / A: 1-10V / D: DALI

MODULE	MODEL	REFERENCE	LM OUTPUT	CRI / CCT	BEAM	DIMMING
TRIDONIC SLE	EDNA T WHITE EDNA T BLACK	T6073*927/.../ND	3.870 lm	927	20° 40° 60°	ND DIMMING ON REQUEST
		T6073*930/.../ND	4.130 lm	930		
		T6073*940/.../ND	4.330 lm	940		
		T6073*9730/.../ND	3.520 lm	9730		
		T6073*FA/.../ND	3.860 lm	FASHION		
		T6073*PW930/.../ND	4.180 lm	PURE WHITE 930		
		T6073*PW940/.../ND	4.350 lm	PURE WHITE 940		
		T6073*FIS/.../ND	3.600 lm	FISH 965		
		T6073*M+/.../ND	2.600 lm	MEAT+		
		T6073*FM/.../ND	2.550 lm	FRESH MEAT		
		T6073*G/.../ND	3.900 lm	GOLD		
		T6073*G+/.../ND	2.900 lm	GOLD+		
		T6073*FR/.../ND	3.600 lm	FRUIT		

**W (white) or B (black)

LOWER LM OUTPUT
ALSO AVAILABLE

ND: non dimmable

EDNA DEEP

REF	A6126W A6126B	Edna Deep white Edna Deep black
LED	Xicato Tridonic	
LED LM OUTPUT	1.300 up to 4.350 lm	
POWER CONS.	according to lumen output - see table p. 255	
COLOR TEMP.	2.700 / 3.000 / 4.000 K	
CRI	80 up to +95	
COLOR QUALITY	Xicato: artist / beauty vibrant / vibrant artist Tridonic: fashion / pure white fish / meat / gold / fruit	
REFLECTOR	Xicato: 20° / 40° / 60° (11° only available in 1.300 lm) Tridonic: 20° / 40° / 60°	
FINISH	white RAL 9016 tex black RAL 9005 tex	
ADJUSTABLE	n/a	
CUT-OUT	Ø 110 mm	
DRIVE CURRENT	supplied with driver	

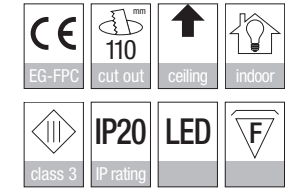
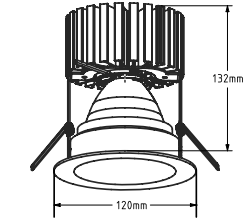

MODULE	MODEL	REFERENCE	LM OUTPUT	CRI / CCT	BEAM	DIMMING	
XICATO XTM	EDNA DEEP X WHITE EDNA DEEP X BLACK	A6126W A6126B	1.300 lm	827 - 830 - 840 - V830	11°	ND PD A D	
				927 - 930 - 940 - V930 - BT			
			2.000 lm	827 - 830 - 840 - V830	20°		
				927 - 930 - 940 - V930 - BT			
			3.000 lm	827 - 830 - 840 - V830	927 - 930 - 940 - V930 - BT		60°
3.850 lm	827 - 830 - 840 - V830						

Reference builider: fe.: A6126W/1300/V9530/20°/PD

ND: non dimmable / PD: phase dimming / A: 1-10V / D: DALI

MODULE	MODEL	REFERENCE	LM OUTPUT	CRI / CCT	BEAM	DIMMING
TRIDONIC SLE	EDNA DEEP T WHITE EDNA DEEP T BLACK	T6126*927/.../ND	3.870 lm	927	20° 40° 60°	ND DIMMING ON REQUEST
		T6126*930/.../ND	4.130 lm	930		
		T6126*940/.../ND	4.330 lm	940		
		T6126*9730/.../ND	3.520 lm	9730		
		T6126*FA/.../ND	3.860 lm	FASHION		
		T6126*PW930/.../ND	4.180 lm	PURE WHITE 930		
		T6126*PW940/.../ND	4.350 lm	PURE WHITE 940		
		T6126*FIS/.../ND	3.600 lm	FISH 965		
		T6126*M+/.../ND	2.600 lm	MEAT+		
		T6126*FM/.../ND	2.550 lm	FRESH MEAT		
		T6126*G/.../ND	3.900 lm	GOLD		
		T6126*G+/.../ND	2.900 lm	GOLD+		
		T6126*FR/.../ND	3.600 lm	FRUIT		

**W (white) or B (black)

LOWER LM OUTPUT
ALSO AVAILABLE

ND: non dimmable



EDNA FLEX

REF	A6112W A6112B	Edna Flex white Edna Flex black
LED	Xicato Tridonic	
LED LM OUTPUT	1.300 up to 4.350 lm	
POWER CONS.	according to lumen output - see table p. 255	
COLOR TEMP.	2.700 / 3.000 / 4.000 K	
CRI	80 up to +95	
COLOR QUALITY	Xicato: artist / beauty vibrant / vibrant artist Tridonic: fashion / pure white fish / meat / gold / fruit	
REFLECTOR	Xicato: 20° / 40° / 60° (11° only available in 1.300 lm) Tridonic: 39°	
FINISH	white RAL 9016 tex black RAL 9005 tex	
ADJUSTABLE	n/a	
CUT-OUT	Ø 110 mm	
DRIVE CURRENT	supplied with driver	

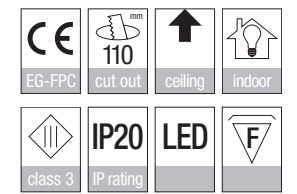
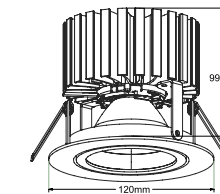
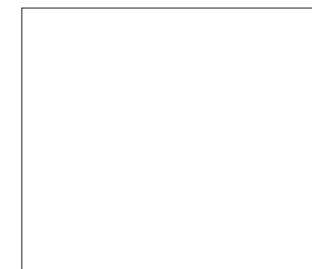
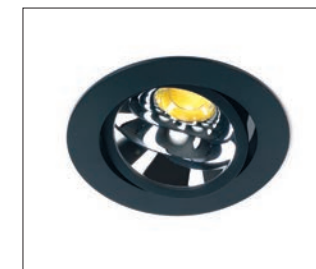

MODULE	MODEL	REFERENCE	LM OUTPUT	CRI / CCT	BEAM	DIMMING
XICATO XTM	EDNA FLEX X WHITE EDNA FLEX X BLACK	A6112W A6112B	1.300 lm	827 - 830 - 840 - V830	11°	ND PD A D
				927 - 930 - 940 - V930 - BT		
			2.000 lm	827 - 830 - 840 - V830	20° 40° 60°	
				927 - 930 - 940 - V930 - BT		
				827 - 830 - 840 - V830		
3.850 lm	827 - 830 - 840 - V830					

Reference builder: fe.: A6112W/1300/V9530/20°/PD

ND: non dimmable / PD: phase dimming / A: 1-10V / D: DALI

MODULE	MODEL	REFERENCE	LM OUTPUT	CRI / CCT	BEAM	DIMMING
TRIDONIC SLE	EDNA FLEX T WHITE EDNA FLEX T BLACK	T6112*/927/39°/ND	3.870 lm	927	39°	ND DIMMING ON REQUEST
		T6112*/930/39°/ND	4.130 lm	930		
		T6112*/940/39°/ND	4.330 lm	940		
		T6112*/9730/39°/ND	3.520 lm	9730		
		T6112*/FA/39°/ND	3.860 lm	FASHION		
		T6112*/PW930/39°/ND	4.180 lm	PURE WHITE 930		
		T6112*/PW940/39°/ND	4.350 lm	PURE WHITE 940		
		T6112*/FIS/39°/ND	3.600 lm	FISH 965		
		T6112*/M+/39°/ND	2.600 lm	MEAT+		
		T6112*/FM/39°/ND	2.550 lm	FRESH MEAT		
		T6112*/G/39°/ND	3.900 lm	GOLD		
		T6112*/G+/39°/ND	2.900 lm	GOLD+		
T6112*/FR/39°/ND	3.600 lm	FRUIT				

*W (white) or B (black)

LOWER LM OUTPUT
ALSO AVAILABLE

ND: non dimmable

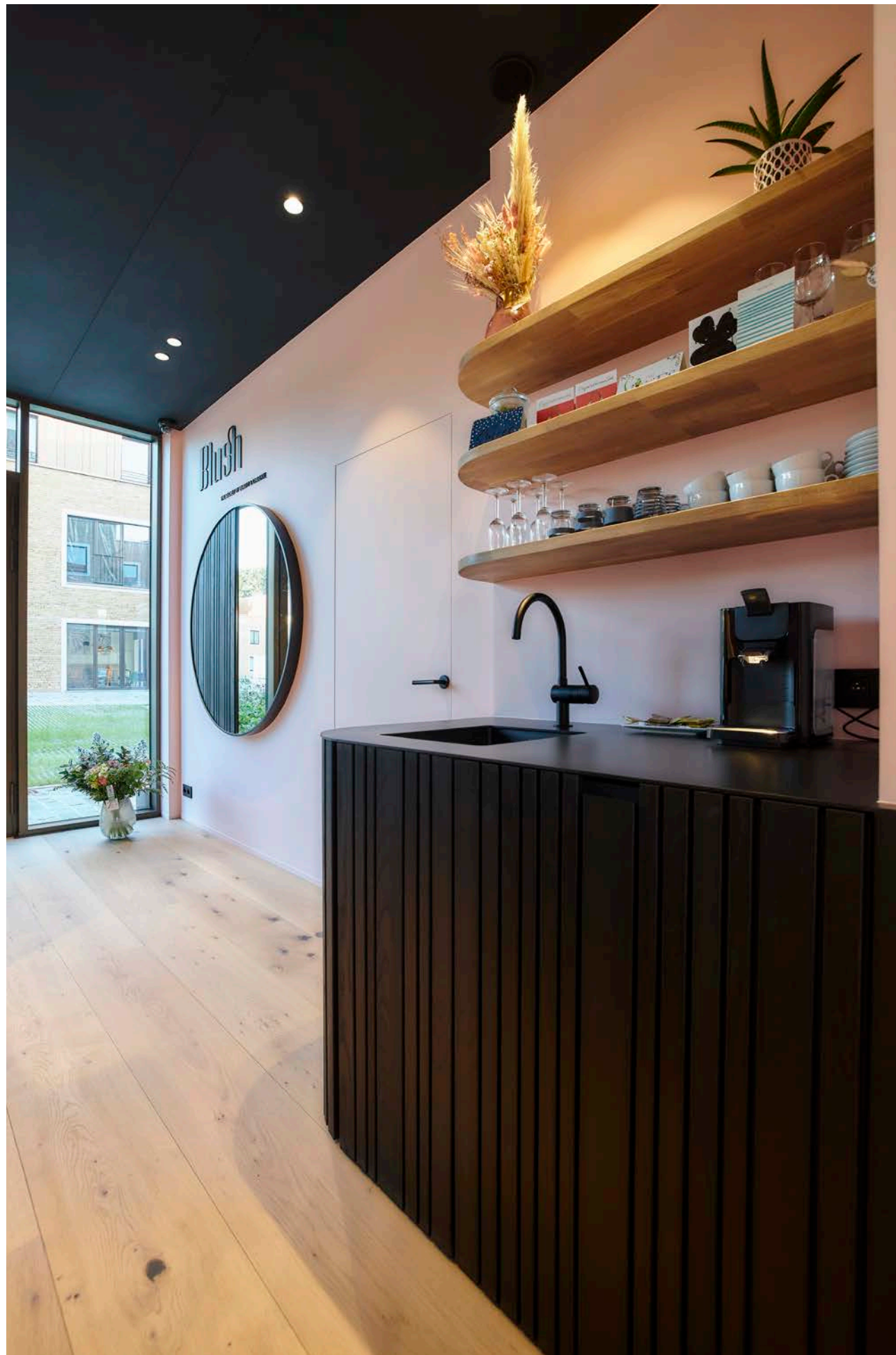

PICCOLO 120

REF	A6160W A6160B	Piccolo 120 white Piccolo 120 black
-----	------------------	--

LED	Xicato Tridonic
LED LM OUTPUT	1.300 up to 4.350 lm
POWER CONS.	according to lumen output - see table p. 255
COLOR TEMP.	2.700 / 3.000 / 4.000 K
CRI	80 up to +95
COLOR QUALITY	Xicato: artist / beauty vibrant / vibrant artist Tridonic: fashion / pure white fish / meat / gold / fruit
REFLECTOR	Xicato: 60° Tridonic: 60°
FINISH	white RAL 9016 tex black RAL 9005 tex
ADJUSTABLE	n/a
CUT-OUT	Ø 110 mm
DRIVE CURRENT	supplied with driver
REMARK	with blade springs wire springs on request

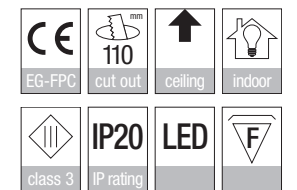
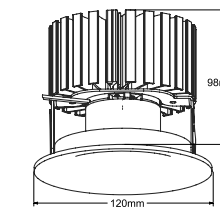
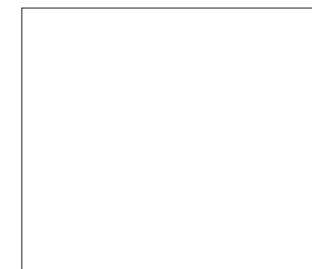
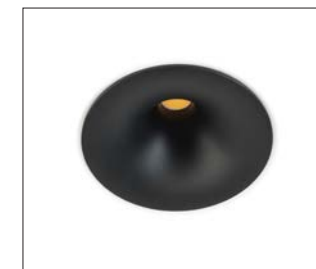

MODULE	MODEL	REFERENCE	LM OUTPUT	CRI / CCT	BEAM	DIMMING
XICATO XTM	PICCOLO 120 X WHITE PICCOLO 120 X BLACK	A6160W A6160B	1.300 lm	827 - 830 - 840 - V830	60°	ND PD A D
				927 - 930 - 940 - V930 - BT		
			2.000 lm	827 - 830 - 840 - V830		
				927 - 930 - 940 - V930 - BT		
				827 - 830 - 840 - V830		
3.850 lm	827 - 830 - 840 - V830					

Reference builder: fe.: A6160W/1300/V930/60°/PD

ND: non dimmable / PD: phase dimming / A: 1-10V / D: DALI

MODULE	MODEL	REFERENCE	LM OUTPUT	CRI / CCT	BEAM	DIMMING
TRIDONIC SLE	PICCOLO 120 T WHITE PICCOLO 120 T BLACK	T6160*/927/39°/ND	3.870 lm	927	60°	ND DIMMING ON REQUEST
		T6160*/930/39°/ND	4.130 lm	930		
		T6160*/940/39°/ND	4.330 lm	940		
		T6160*/9730/39°/ND	3.520 lm	9730		
		T6160*/FA/39°/ND	3.860 lm	FASHION		
		T6160*/PW930/39°/ND	4.180 lm	PURE WHITE 930		
		T6160*/PW940/39°/ND	4.350 lm	PURE WHITE 940		
		T6160*/FIS/39°/ND	3.600 lm	FISH 965		
		T6160*/M+/39°/ND	2.600 lm	MEAT+		
		T6160*/FM/39°/ND	2.550 lm	FRESH MEAT		
		T6160*/G/39°/ND	3.900 lm	GOLD		
		T6160*/G+/39°/ND	2.900 lm	GOLD+		
T6160*/FR/39°/ND	3.600 lm	FRUIT				

*W (white) or B (black)

LOWER LM OUTPUT
ALSO AVAILABLE

ND: non dimmable



MINI BFD

REF	A6135W A6135B	Mini BFD white Mini BFD black
LED	Xicato Tridonic	
LED LM OUTPUT	1.300 up to 4.350 lm	
POWER CONS.	according to lumen output - see table p. 255	
COLOR TEMP.	2.700 / 3.000 / 4.000 K	
CRI	80 up to +95	
COLOR QUALITY	Xicato: artist / beauty vibrant / vibrant artist Tridonic: fashion / pure white fish / meat / gold / fruit	
REFLECTOR	Xicato: 15° / 25° / 39° Tridonic: 15° / 25° / 39°	
FINISH	white RAL 9016 tex black RAL 9005 tex	
ADJUSTABLE	n/a	
CUT-OUT	Ø 130 mm	
DRIVE CURRENT	supplied with driver	

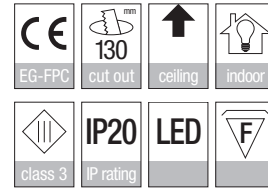
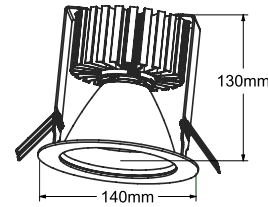
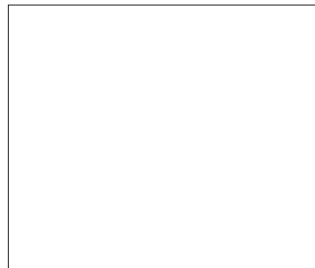

MODULE	MODEL	REFERENCE	LM OUTPUT	CRI / CCT	BEAM	DIMMING
XICATO XTM	MINI BFD X WHITE MINI BFD X BLACK	A6135W A6135B	1.300 lm	827 - 830 - 840 - V830	15° 25° 39°	ND PD A D
				927 - 930 - 940 - V930 - BT		
			2.000 lm	827 - 830 - 840 - V830		
				927 - 930 - 940 - V930 - BT		
			3.000 lm	827 - 830 - 840 - V830		
				927 - 930 - 940 - V930 - BT		
3.850 lm	827 - 830 - 840 - V830					

Reference buidler: fe.: A6135W/1300/V930/25°/PD

ND: non dimmable / PD: phase dimming / A: 1-10V / D: DALI

MODULE	MODEL	REFERENCE	LM OUTPUT	CRI / CCT	BEAM	DIMMING
TRIDONIC SLE	MINI BFD T WHITE MINI BFD T BLACK	T6135*/927/-*/ND	3.870 lm	927	15° 25° 39°	ND DIMMING ON REQUEST
		T6135*/930/-*/ND	4.130 lm	930		
		T6135*/940/-*/ND	4.330 lm	940		
		T6135*/9730/-*/ND	3.520 lm	9730		
		T6135*/FA/-*/ND	3.860 lm	FASHION		
		T6135*/PW930/-*/ND	4.180 lm	PURE WHITE 930		
		T6135*/PW940/-*/ND	4.350 lm	PURE WHITE 940		
		T6135*/FIS/-*/ND	3.600 lm	FISH 965		
		T6135*/M±*/ND	2.600 lm	MEAT+		
		T6135*/FM/-*/ND	2.550 lm	FRESH MEAT		
		T6135*/G/-*/ND	3.900 lm	GOLD		
		T6135*/G±*/ND	2.900 lm	GOLD+		
T6135*/FR/-*/ND	3.600 lm	FRUIT				

**W (white) or B (black)

LOWER LM OUTPUT
ALSO AVAILABLE

ND: non dimmable

MINI BFD PLUS

REF	A6177W A6177B	Mini BFD Plus white Mini BFD Plus black
LED	Xicato Tridonic	
LED LM OUTPUT	1.300 up to 4.350 lm	
POWER CONS.	according to lumen output - see table p. 255	
COLOR TEMP.	2.700 / 3.000 / 4.000 K	
CRI	80 up to +95	
COLOR QUALITY	Xicato: artist / beauty vibrant / vibrant artist Tridonic: fashion / pure white fish / meat / gold / fruit	
REFLECTOR	Xicato: 15° / 25° / 39° Tridonic: 15° / 25° / 39°	
FINISH	white RAL 9016 tex black RAL 9005 tex	
ADJUSTABLE	n/a	
CUT-OUT	Ø 130 mm up to Ø 180 mm	
DRIVE CURRENT	supplied with driver	
REMARK	ideal re-lighting fixture with flexible built-in diameter	

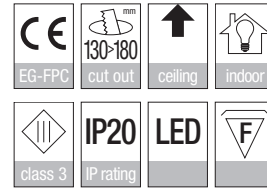
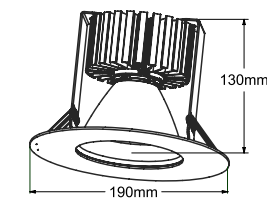

MODULE	MODEL	REFERENCE	LM OUTPUT	CRI / CCT	BEAM	DIMMING
XICATO XTM	MINI BFD PLUS X WHITE MINI BFD PLUS X BLACK	A6177W A6177B	1.300 lm	827 - 830 - 840 - V830	15° 25° 39°	ND PD A D
				927 - 930 - 940 - V930 - BT		
			2.000 lm	827 - 830 - 840 - V830		
				927 - 930 - 940 - V930 - BT		
			3.000 lm	827 - 830 - 840 - V830		
				927 - 930 - 940 - V930 - BT		
3.850 lm	827 - 830 - 840 - V830					

Reference buidler: fe.: A6177W/1300/V930/25°/PD

ND: non dimmable / PD: phase dimming / A: 1-10V / D: DALI

MODULE	MODEL	REFERENCE	LM OUTPUT	CRI / CCT	BEAM	DIMMING
TRIDONIC SLE	MINI BFD PLUS T WHITE MINI BFD PLUS T BLACK	T6177*/927/-*/ND	3.870 lm	927	15° 25° 39°	ND DIMMING ON REQUEST
		T6177*/930/-*/ND	4.130 lm	930		
		T6177*/940/-*/ND	4.330 lm	940		
		T6177*/9730/-*/ND	3.520 lm	9730		
		T6177*/FA/-*/ND	3.860 lm	FASHION		
		T6177*/PW930/-*/ND	4.180 lm	PURE WHITE 930		
		T6177*/PW940/-*/ND	4.350 lm	PURE WHITE 940		
		T6177*/FIS/-*/ND	3.600 lm	FISH 965		
		T6177*/M±*/ND	2.600 lm	MEAT+		
		T6177*/FM/-*/ND	2.550 lm	FRESH MEAT		
		T6177*/G/-*/ND	3.900 lm	GOLD		
		T6177*/G±*/ND	2.900 lm	GOLD+		
T6177*/FR/-*/ND	3.600 lm	FRUIT				

**W (white) or B (black)

LOWER LM OUTPUT
ALSO AVAILABLE

ND: non dimmable





BFD

REF	A6105W A6105B	BFD white BFD black
LED	Xicato Tridonic	
LED LM OUTPUT	1.300 up to 4.350 lm	
POWER CONS.	according to lumen output - see table p. 255	
COLOR TEMP.	2.700 / 3.000 / 4.000 K	
CRI	80 up to +95	
COLOR QUALITY	Xicato: artist / beauty vibrant / vibrant artist Tridonic: fashion / pure white fish / meat / gold / fruit	
REFLECTOR	Xicato: 52° Tridonic: 52°	
FINISH	white RAL 9016 tex black RAL 9005 tex	
ADJUSTABLE	n/a	
CUT-OUT	Ø 180 up to Ø 220 mm	
DRIVE CURRENT	supplied with driver	
REMARK	can be designed for other built-in diameters / front plates	

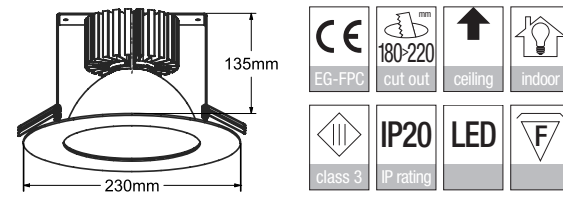

MODULE	MODEL	REFERENCE	LM OUTPUT	CRI / CCT	BEAM	DIMMING
XICATO XTM	BFD X WHITE BFD X BLACK	A6105W A6105B	1.300 lm	827 - 830 - 840 - V830	52°	ND PD A D
				927 - 930 - 940 - V930 - BT		
			2.000 lm	827 - 830 - 840 - V830		
				927 - 930 - 940 - V930 - BT		
			3.000 lm	827 - 830 - 840 - V830		
				927 - 930 - 940 - V930 - BT		
3.850 lm	827 - 830 - 840 - V830					

Reference builider: fe.: A6105W/1300/V930/52°/PD

ND: non dimmable / PD: phase dimming / A: 1-10V / D: DALI

MODULE	MODEL	REFERENCE	LM OUTPUT	CRI / CCT	BEAM	DIMMING
TRIDONIC SLE	BFD T WHITE BFD T BLACK	T6105*927/52°/ND	3.870 lm	927	52°	ND DIMMING ON REQUEST
		T6105*930/52°/ND	4.130 lm	930		
		T6105*940/52°/ND	4.330 lm	940		
		T6105*9730/52°/ND	3.520 lm	9730		
		T6105*FA/52°/ND	3.860 lm	FASHION		
		T6105*PW930/52°/ND	4.180 lm	PURE WHITE 930		
		T6105*PW940/52°/ND	4.350 lm	PURE WHITE 940		
		T6105*FIS/52°/ND	3.600 lm	FISH 965		
		T6105*M+/52°/ND	2.600 lm	MEAT+		
		T6105*FM/52°/ND	2.550 lm	FRESH MEAT		
		T6105*G/52°/ND	3.900 lm	GOLD		
		T6105*G+/52°/ND	2.900 lm	GOLD+		
		T6105*FR/52°/ND	3.600 lm	FRUIT		

**W (white) or B (black)

LOWER LM OUTPUT
ALSO AVAILABLE

ND: non dimmable

MINI BFD ASSYMETRIC



REF	A6136W A6136B	Mini BFD assymmetric white Mini BFD assymmetric black
LED	Xicato Tridonic	
LED LM OUTPUT	1.300 up to 4.350 lm	
POWER CONS.	according to lumen output - see table p. 255	
COLOR TEMP.	2.700 / 3.000 / 4.000 K	
CRI	80 up to +95	
COLOR QUALITY	Xicato: artist / beauty vibrant / vibrant artist Tridonic: fashion / pure white fish / meat / gold / fruit	
REFLECTOR	Xicato: wall wash 60° - 15° forward throw Tridonic: wall wash 60° - 15° forward throw	
FINISH	white RAL 9016 tex black RAL 9005 tex	
ADJUSTABLE	n/a	
CUT-OUT	Ø 130 mm	
DRIVE CURRENT	supplied with driver	

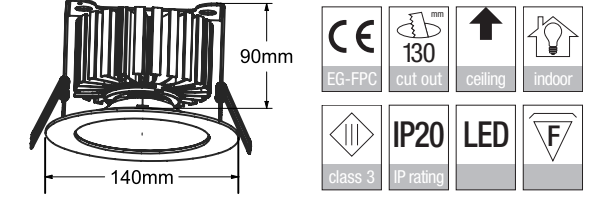

MODULE	MODEL	REFERENCE	LM OUTPUT	CRI / CCT	BEAM	DIMMING
XICATO XTM	MINI BFD ASSY X WHITE MINI BFD ASSY X BLACK	A6136W A6136B	1.300 lm	827 - 830 - 840 - V830	ASSY	ND PD A D
				927 - 930 - 940 - V930 - BT		
			2.000 lm	827 - 830 - 840 - V830		
				927 - 930 - 940 - V930 - BT		
			3.000 lm	827 - 830 - 840 - V830		
				927 - 930 - 940 - V930 - BT		
3.850 lm	827 - 830 - 840 - V830					

Reference builider: fe.: A6136W/1300/V930/ASSY/PD

ND: non dimmable / PD: phase dimming / A: 1-10V / D: DALI

MODULE	MODEL	REFERENCE	LM OUTPUT	CRI / CCT	BEAM	DIMMING
TRIDONIC SLE	MINI BFD ASSY T WHITE MINI BFD ASSY T BLACK	T6136*927/ASSY/ND	3.870 lm	927	ASSY	ND DIMMING ON REQUEST
		T6136*930/ASSY/ND	4.130 lm	930		
		T6136*940/ASSY/ND	4.330 lm	940		
		T6136*9730/ASSY/ND	3.520 lm	9730		
		T6136*FA/ASSY/ND	3.860 lm	FASHION		
		T6136*PW930/ASSY/ND	4.180 lm	PURE WHITE 930		
		T6136*PW940/ASSY/ND	4.350 lm	PURE WHITE 940		
		T6136*FIS/ASSY/ND	3.600 lm	FISH 965		
		T6136*M+/ASSY/ND	2.600 lm	MEAT+		
		T6136*FM/ASSY/ND	2.550 lm	FRESH MEAT		
		T6136*G/ASSY/ND	3.900 lm	GOLD		
		T6136*G+/ASSY/ND	2.900 lm	GOLD+		
		T6136*FR/ASSY/ND	3.600 lm	FRUIT		

**W (white) or B (black)

LOWER LM OUTPUT
ALSO AVAILABLE

ND: non dimmable



MINI BFD FLEX

REF	A6143W A6143B	Mini BFD Flex white Mini BFD Flex black
LED	Xicato Tridonic	
LED LM OUTPUT	1.300 up to 2.570 lm	
POWER CONS.	according to lumen output - see table p. 255	
COLOR TEMP.	2.700 / 3.000 / 4.000 K	
CRI	80 up to +95	
COLOR QUALITY	Xicato: artist / beauty vibrant / vibrant artist Tridonic: fashion / pure white fish / meat / gold / fruit	
REFLECTOR	Xicato: 20° / 39° Tridonic: 20° / 39°	
FINISH	white RAL 9016 tex black RAL 9005 tex	
ADJUSTABLE	355° x 45°	
CUT-OUT	Ø 110 mm	
DRIVE CURRENT	supplied with driver	

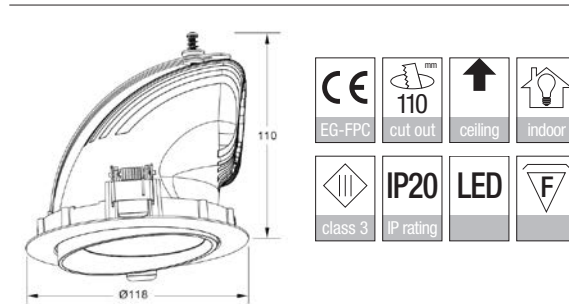
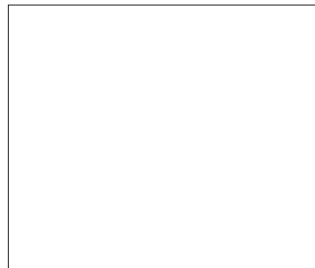

MODULE	MODEL	REFERENCE	LM OUTPUT	CRI / CCT	BEAM	DIMMING
XICATO XTM	MINI BFD FLEX X WHITE MINI BFD FLEX X BLACK	A6143W A6143B	1.300 lm	827 - 830 - 840 - V830	20°	ND / PD A / D
			2.000 lm	927 - 930 - 940 - V930 - BT		
				827 - 830 - 840 - V830	39°	

Reference builder: fe.: A6143W/1300/V930/20°/PD

ND: non dimmable / PD: phase dimming / A: 1-10V / D: DALI

MODULE	MODEL	REFERENCE	LM OUTPUT	CRI / CCT	BEAM	DIMMING
TRIDONIC SLE	MINI BFD FLEX T WHITE MINI BFD FLEX T BLACK	T6143*/927/-*/ND	2.300 lm	927	20° 39°	ND DIMMING ON REQUEST
		T6143*/930/-*/ND	2.450 lm	930		
		T6143*/940/-*/ND	2.570 lm	940		
		T6143*/9730/-*/ND	2.060 lm	9730		
		T6143*/FA/-*/ND	2.260 lm	FASHION		
		T6143*/PW930/-*/ND	2.450 lm	PURE WHITE 930		
		T6143*/PW940/-*/ND	2.550 lm	PURE WHITE 940		
		T6143*/FIS/-*/ND	2.470 lm	FISH 965		
		T6143*/M+*/ND	1.520 lm	MEAT+		
		T6143*/FM/-*/ND	1.490 lm	FRESH MEAT		
		T6143*/G/-*/ND	2.300 lm	GOLD		
		T6143*/G+*/ND	1.580 lm	GOLD+		
T6143*/FR/-*/ND	2.130 lm	FRUIT				

**W (white) or B (black)

LOWER LM OUTPUT
ALSO AVAILABLE

ND: non dimmable

BFD FLEX

REF	A6111W A6111B	BFD Flex white BFD Flex lack
LED	Xicato Tridonic	
LED LM OUTPUT	1.300 up to 4.350 lm	
POWER CONS.	according to lumen output - see table p. 255	
COLOR TEMP.	2.700 / 3.000 / 4.000 K	
CRI	80 up to +95	
COLOR QUALITY	Xicato: artist / beauty vibrant / vibrant artist Tridonic: fashion / pure white fish / meat / gold / fruit	
REFLECTOR	Xicato: 39° (15° / 25° on request) Tridonic: 39° (15° / 25° on request)	
FINISH	white RAL 9016 tex black RAL 9005 tex	
ADJUSTABLE	355° x 45°	
CUT-OUT	Ø 180 mm	
DRIVE CURRENT	supplied with driver	
REMARK	passive cooling	
OPTIONAL	C6018W enlargement ring white (Ø 240 mm) C6018B enlargement ring black (Ø 240 mm)	

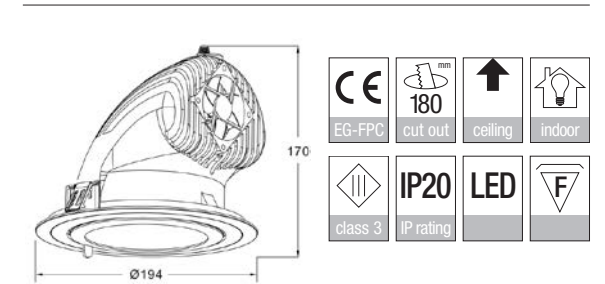
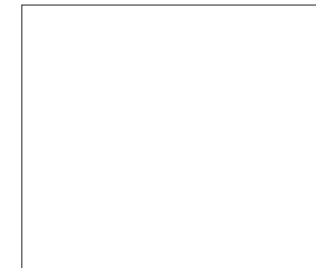

MODULE	MODEL	REFERENCE	LM OUTPUT	CRI / CCT	BEAM	DIMMING
XICATO XTM	BFD FLEX X WHITE BFD FLEX X BLACK	A6111W A6111B	1.300 lm	827 - 830 - 840 - V830	39°	ND PD A D
			2.000 lm	927 - 930 - 940 - V930 - BT		
			3.000 lm	827 - 830 - 840 - V830		
			3.850 lm	927 - 930 - 940 - V930 - BT		
				827 - 830 - 840 - V830		

Reference builder: fe.: A6111W/1300/V930/39°/PD

ND: non dimmable / PD: phase dimming / A: 1-10V / D: DALI

MODULE	MODEL	REFERENCE	LM OUTPUT	CRI / CCT	BEAM	DIMMING
TRIDONIC SLE	BFD FLEX T WHITE BFD FLEX T BLACK	T6111*/927/39°/ND	3.870 lm	927	39°	ND DIMMING ON REQUEST
		T6111*/930/39°/ND	4.130 lm	930		
		T6111*/940/39°/ND	4.330 lm	940		
		T6111*/9730/39°/ND	3.520 lm	9730		
		T6111*/FA/39°/ND	3.860 lm	FASHION		
		T6111*/PW930/39°/ND	4.180 lm	PURE WHITE 930		
		T6111*/PW940/39°/ND	4.350 lm	PURE WHITE 940		
		T6111*/FIS/39°/ND	3.600 lm	FISH 965		
		T6111*/M+/39°/ND	2.600 lm	MEAT+		
		T6111*/FM/39°/ND	2.550 lm	FRESH MEAT		
		T6111*/G/39°/ND	3.900 lm	GOLD		
		T6111*/G+/39°/ND	2.900 lm	GOLD+		
		T6111*/FR/39°/ND	3.600 lm	FRUIT		

**W (white) or B (black)

LOWER LM OUTPUT
ALSO AVAILABLE

ND: non dimmable

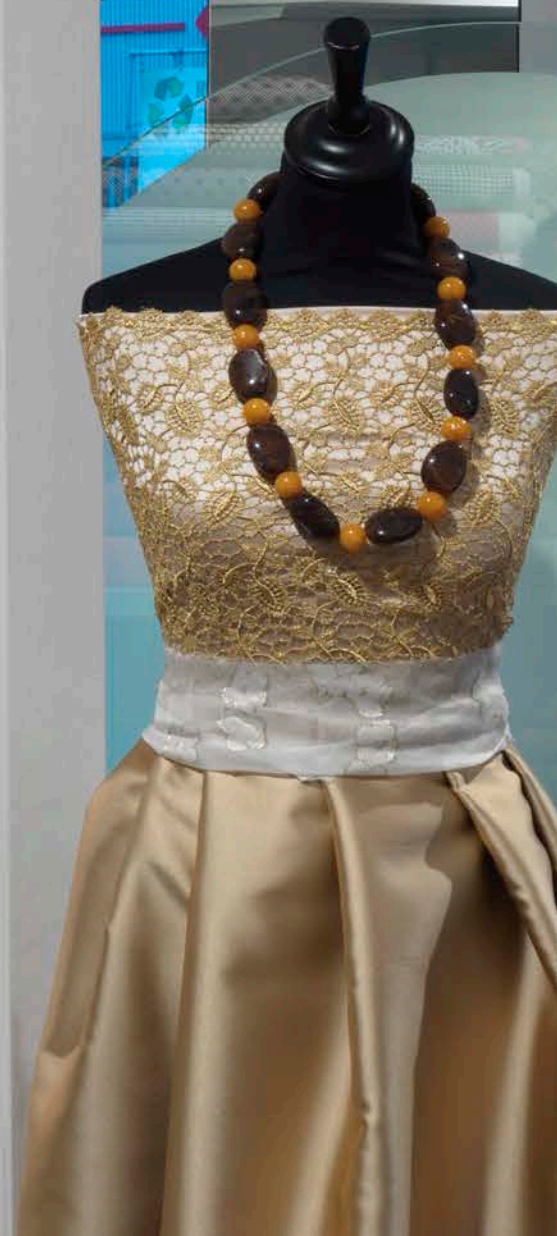



UNILITE

REF	A6127	Unilite
LED	Xicato Tridonic	
LED LM OUTPUT	1.300 up to 4.350 lm	
POWER CONS.	according to lumen output - see table p. 255	
COLOR TEMP.	2.700 / 3.000 / 4.000 K	
CRI	80 up to +95	
COLOR QUALITY	Xicato: artist / beauty vibrant / vibrant artist Tridonic: fashion / pure white fish / meat / gold / fruit	
REFLECTOR	Xicato: 15° / 25° / 39° Tridonic: 39°	
FINISH	white RAL 9016 tex / black RAL 9005 tex 360° x 30°	
ADJUSTABLE	170 x 170 mm	
CUT-OUT	supplied with driver	
DRIVE CURRENT	passive cooling	
REMARK		

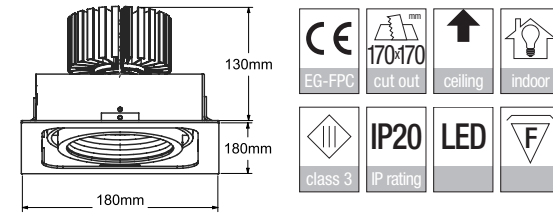

MODULE	MODEL	REFERENCE	LM OUTPUT	CRI / CCT	BEAM	DIMMING
XICATO XTM	UNILITE X	A6127	1.300 lm	827 - 830 - 840 - V830	15° 25° 39°	ND PD A D
				927 - 930 - 940 - V930 - BT		
			2.000 lm	827 - 830 - 840 - V830		
				927 - 930 - 940 - V930 - BT		
			3.000 lm	827 - 830 - 840 - V830		
				927 - 930 - 940 - V930 - BT		
3.850 lm	827 - 830 - 840 - V830					

Reference builider: fe.: A6127W/1300/V930/39°/PD

ND: non dimmable / PD: phase dimming / A: 1-10V / D: DALI

MODULE	MODEL	REFERENCE	LM OUTPUT	CRI / CCT	BEAM	DIMMING
TRIDONIC SLE	UNILITE T	T6127/927/39°/ND	3.870 lm	927	39°	ND DIMMING ON REQUEST
		T6127/930/39°/ND	4.130 lm	930		
		T6127/940/39°/ND	4.330 lm	940		
		T6127/9730/39°/ND	3.520 lm	9730		
		T6127/FA/39°/ND	3.860 lm	FASHION		
		T6127/PW930/39°/ND	4.180 lm	PURE WHITE 930		
		T6127/PW940/39°/ND	4.350 lm	PURE WHITE 940		
		T6127/FIS/39°/ND	3.600 lm	FISH 965		
		T6127/M+/39°/ND	2.600 lm	MEAT+		
		T6127/FM/39°/ND	2.550 lm	FRESH MEAT		
		T6127/G/39°/ND	3.900 lm	GOLD		
		T6127/G+/39°/ND	2.900 lm	GOLD+		
T6127/FR/39°/ND	3.600 lm	FRUIT				

LOWER LM OUTPUT
ALSO AVAILABLE

ND: non dimmable

DUOLITE

REF	A6128	Duolite
LED	Xicato Tridonic	
LED LM OUTPUT	2x 1.300 up to 2x 4.350 lm	
POWER CONS.	according to lumen output - see table p. 255	
COLOR TEMP.	2.700 / 3.000 / 4.000 K	
CRI	80 up to +95	
COLOR QUALITY	Xicato: artist / beauty vibrant / vibrant artist Tridonic: fashion / pure white fish / meat / gold / fruit	
REFLECTOR	Xicato: 15° / 25° / 39° Tridonic: 39°	
FINISH	white RAL 9016 tex / black RAL 9005 tex 360° x 30°	
ADJUSTABLE	170 x 320 mm	
CUT-OUT	supplied with driver	
DRIVE CURRENT	passive cooling	
REMARK		

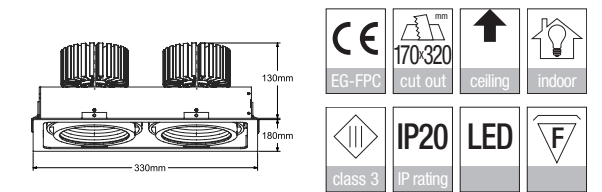
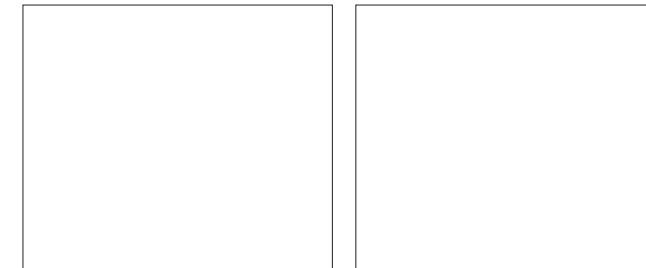

MODULE	MODEL	REFERENCE	LM OUTPUT	CRI / CCT	BEAM	DIMMING
XICATO XTM	DUOLITE X	A6128	2x 1.300 lm	827 - 830 - 840 - V830	15° 25° 39°	ND PD A D
				927 - 930 - 940 - V930 - BT		
			2x 2.000 lm	827 - 830 - 840 - V830		
				927 - 930 - 940 - V930 - BT		
			2x 3.000 lm	827 - 830 - 840 - V830		
				927 - 930 - 940 - V930 - BT		
2x 3.850 lm	827 - 830 - 840 - V830					

Reference builider: fe.: A6128W/1300/V930/39°/PD

ND: non dimmable / PD: phase dimming / A: 1-10V / D: DALI

MODULE	MODEL	REFERENCE	LM OUTPUT	CRI / CCT	BEAM	DIMMING
TRIDONIC SLE	DUOLITE T	T6128/927/39°/ND	2x 3.870 lm	927	39°	ND DIMMING ON REQUEST
		T6128/930/39°/ND	2x 4.130 lm	930		
		T6128/940/39°/ND	2x 4.330 lm	940		
		T6128/9730/39°/ND	2x 3.520 lm	9730		
		T6128/FA/39°/ND	2x 3.860 lm	FASHION		
		T6128/PW930/39°/ND	2x 4.180 lm	PURE WHITE 930		
		T6128/PW940/39°/ND	2x 4.350 lm	PURE WHITE 940		
		T6128/FIS/39°/ND	2x 3.600 lm	FISH 965		
		T6128/M+/39°/ND	2x 2.600 lm	MEAT+		
		T6128/FM/39°/ND	2x 2.550 lm	FRESH MEAT		
		T6128/G/39°/ND	2x 3.900 lm	GOLD		
		T6128/G+/39°/ND	2x 2.900 lm	GOLD+		
T6128/FR/39°/ND	2x 3.600 lm	FRUIT				

LOWER LM OUTPUT
ALSO AVAILABLE

ND: non dimmable



DROP-IT

REF	A6104	Drop-It
LED	Xicato Tridonic	
LED LM OUTPUT	1.300 up to 4.350 lm	
POWER CONS.	according to lumen output - see table p. 255	
COLOR TEMP.	2.700 / 3.000 / 4.000 K	
CRI	80 up to +95	
COLOR QUALITY	Xicato: artist / beauty vibrant / vibrant artist	Tridonic: fashion / pure white fish / meat / gold / fruit
REFLECTOR	Xicato: 56° x 106° Tridonic: 56° x 106°	
FINISH	white RAL 9016 tex	
ADJUSTABLE	60°	
CUT-OUT	157 x 240 mm	
DRIVE CURRENT	supplied with driver	
REMARK	ideal for re-lighting	
OPTIONAL	C6019W enlargement ring (208 x 205 mm)	

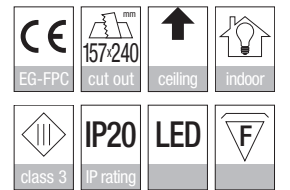
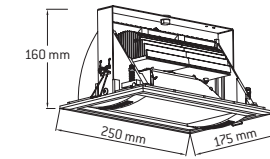
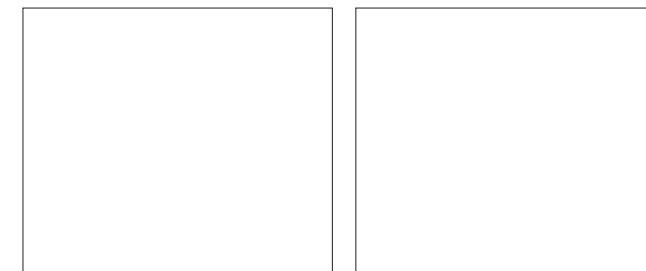

MODULE	MODEL	REFERENCE	LM OUTPUT	CRI / CCT	BEAM	DIMMING
XICATO XTM	DROP-IT X WHITE	A6104	1.300 lm	827 - 830 - 840 - V830	56°x106°	ND PD A D
				927 - 930 - 940 - V930 - BT		
			2.000 lm	827 - 830 - 840 - V830		
				927 - 930 - 940 - V930 - BT		
			3.000 lm	827 - 830 - 840 - V830		
			927 - 930 - 940 - V930 - BT			
			3.850 lm	827 - 830 - 840 - V830		

Reference builder: fe.: A6104W/1300/V930/PD

ND: non dimmable / PD: phase dimming / A: 1-10V / D: DALI

MODULE	MODEL	REFERENCE	LM OUTPUT	CRI / CCT	BEAM	DIMMING
TRIDONIC SLE	DROP-IT T WHITE	T6104/927/56°x106°/ND	3.870 lm	927	56°x106°	ND DIMMING ON REQUEST
		T6104/930/56°x106°/ND	4.130 lm	930		
		T6104/940/56°x106°/ND	4.330 lm	940		
		T6104/9730/56°x106°/ND	3.520 lm	9730		
		T6104/FA/56°x106°/ND	3.860 lm	FASHION		
		T6104/PW930/56°x106°/ND	4.180 lm	PURE WHITE 930		
		T6104/PW940/56°x106°/ND	4.350 lm	PURE WHITE 940		
		T6104/FIS/56°x106°/ND	3.600 lm	FISH 965		
		T6104/M+/56°x106°/ND	2.600 lm	MEAT+		
		T6104/FM/56°x106°/ND	2.550 lm	FRESH MEAT		
		T6104/G/56°x106°/ND	3.900 lm	GOLD		
		T6104/G+/56°x106°/ND	2.900 lm	GOLD+		
T6104/FR/56°x106°/ND	3.600 lm	FRUIT				

LOWER LM OUTPUT
ALSO AVAILABLE

ND: non dimmable



TUBE IN FLEX

REF	A6181W A6181B	Tube IN Flex white Tube IN Flex black
LED	Xicato Tridonic	
LED LM OUTPUT	1.300 up to 4.350 lm	
POWER CONS.	according to lumen output - see table p. 255	
COLOR TEMP.	2.700 / 3.000 / 4.000 K	
CRI	80 up to +95	
COLOR QUALITY	Xicato: artist / beauty vibrant / vibrant artist Tridonic: fashion / pure white fish / meat / gold / fruit	
REFLECTOR	Xicato: 15° / 28° / 40° Tridonic: 15° / 28° / 40°	
FINISH	white RAL 9016 tex black RAL 9005 tex	
ADJUSTABLE	full pull out 80° x 355°	
CUT-OUT	Ø 150 mm	
DRIVE CURRENT	supplied with driver	

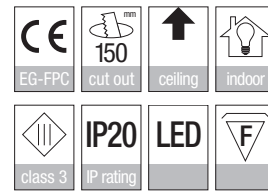
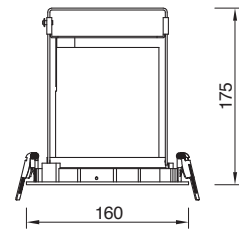

MODULE	MODEL	REFERENCE	LM OUTPUT	CRI / CCT	BEAM	DIMMING
XICATO XTM	TUBE IN FLEX X WHITE TUBE IN FLEX X BLACK	A6181W A6181B	1.300 lm	827 - 830 - 840 - V830	15° 28° 40°	ND PD A D
				927 - 930 - 940 - V930 - BT		
			2.000 lm	827 - 830 - 840 - V830		
				927 - 930 - 940 - V930 - BT		
			3.000 lm	827 - 830 - 840 - V830		
				927 - 930 - 940 - V930 - BT		
3.850 lm	827 - 830 - 840 - V830					

Reference builder: fe.: A6181W/1300/V930/15°/PD

ND: non dimmable / PD: phase dimming / A: 1-10V / D: DALI

MODULE	MODEL	REFERENCE	LM OUTPUT	CRI / CCT	BEAM	DIMMING
TRIDONIC SLE	TUBE IN FLEX T WHITE TUBE IN FLEX T BLACK	T6181*927/-°/ND	3.870 lm	927	15° 28° 40°	ND DIMMING ON REQUEST
		T6181*930/-°/ND	4.130 lm	930		
		T6181*940/-°/ND	4.330 lm	940		
		T6181*9730/-°/ND	3.520 lm	9730		
		T6181*FA/-°/ND	3.860 lm	FASHION		
		T6181*PW930/-°/ND	4.180 lm	PURE WHITE 930		
		T6181*PW940/-°/ND	4.350 lm	PURE WHITE 940		
		T6181*FIS/-°/ND	3.600 lm	FISH 965		
		T6181*M±°/ND	2.600 lm	MEAT+		
		T6181*FM/-°/ND	2.550 lm	FRESH MEAT		
		T6181*G/-°/ND	3.900 lm	GOLD		
		T6181*G±°/ND	2.900 lm	GOLD+		
		T6181*FR/-°/ND	3.600 lm	FRUIT		

**W (white) or B (black)

LOWER LM OUTPUT
ALSO AVAILABLE

ND: non dimmable

TUBE F IN

REF	A6165W A6165B	Tube F IN white Tube F IN black
LED	Xicato Tridonic	
LED LM OUTPUT	1.300 up to 2.570 lm	
POWER CONS.	according to lumen output - see table p. 255	
COLOR TEMP.	2.700 / 3.000 / 4.000 K	
CRI	80 up to +95	
COLOR QUALITY	Xicato: artist / beauty vibrant / vibrant artist Tridonic: fashion / pure white fish / meat / gold / fruit	
REFLECTOR	Xicato: 20° / 40° / 60° (11° only available in 1.300 lm) Tridonic: 39°	
FINISH	white RAL 9016 tex black RAL 9005 tex	
ADJUSTABLE	45° x 355°	
CUT-OUT	Ø 80 mm	
DRIVE CURRENT	supplied with driver	

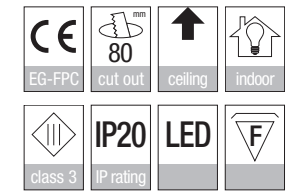
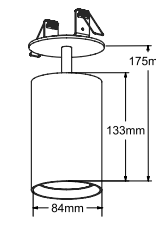

MODULE	MODEL	REFERENCE	LM OUTPUT	CRI / CCT	BEAM	DIMMING
XICATO XTM	TUBE FX IN WHITE TUBE FX IN BLACK	A6165W A6165B	1.300 lm	827 - 830 - 840 - V830	11°/20° 40°/60°	ND / PD A / D
				927 - 930 - 940 - V930 - BT		
			2.000 lm	827 - 830 - 840 - V830	20°/40°/60°	

Reference builder: fe.: A6165W/1300/V930/20°/PD

ND: non dimmable / PD: phase dimming / A: 1-10V / D: DALI

MODULE	MODEL	REFERENCE	LM OUTPUT	CRI / CCT	BEAM	DIMMING
TRIDONIC SLE	TUBE FT IN WHITE TUBE FT IN BLACK	T6165*927/39°/ND	2.300 lm	927	39°	ND DIMMING ON REQUEST
		T6165*930/39°/ND	2.450 lm	930		
		T6165*940/39°/ND	2.570 lm	940		
		T6165*9730/39°/ND	2.060 lm	9730		
		T6165*FA/39°/ND	2.260 lm	FASHION		
		T6165*PW930/39°/ND	2.450 lm	PURE WHITE 930		
		T6165*PW940/39°/ND	2.550 lm	PURE WHITE 940		
		T6165*FIS/39°/ND	2.470 lm	FISH 965		
		T6165*M+/39°/ND	1.520 lm	MEAT+		
		T6165*FM/39°/ND	1.490 lm	FRESH MEAT		
		T6165*G/39°/ND	2.300 lm	GOLD		
		T6165*G+/39°/ND	1.580 lm	GOLD+		
		T6165*FR/39°/ND	2.130 lm	FRUIT		

**W (white) or B (black)

LOWER LM OUTPUT
ALSO AVAILABLE

ND: non dimmable



TUBE F ON

REF	A6164W A6164B	Tube F ON white Tube F ON black
LED	Xicato Tridonic	
LED LM OUTPUT	1.300 up to 2.570 lm	
POWER CONS.	according to lumen output - see table p. 255	
COLOR TEMP.	2.700 / 3.000 / 4.000 K	
CRI	80 up to +95	
COLOR QUALITY	Xicato: artist / beauty vibrant / vibrant artist Tridonic: fashion / pure white fish / meat / gold / fruit	
REFLECTOR	Xicato: 20° / 40° / 60° (11° only available in 1.300 lm) Tridonic: 39°	
FINISH	white RAL 9016 tex black RAL 9005 tex	
ADJUSTABLE	45° x 355°	
CUT-OUT	n/a	
DRIVE CURRENT	supplied with driver	

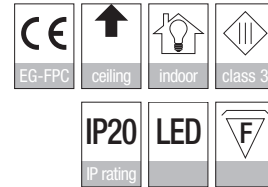
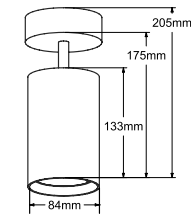

MODULE	MODEL	REFERENCE	LM OUTPUT	CRI / CCT	BEAM	DIMMING
XICATO XTM	TUBE FX ON WHITE TUBE FX ON BLACK	A6164W A6164B	1.300 lm	827 - 830 - 840 - V830	11°/20°	ND / PD A / D
				927 - 930 - 940 - V930 - BT	40°/60°	
			2.000 lm	827 - 830 - 840 - V830	20°/40°/60°	

Reference builder: f.e.: A6164W/1300/V930/20°/PD

ND: non dimmable / PD: phase dimming / A: 1-10V / D: DALI

MODULE	MODEL	REFERENCE	LM OUTPUT	CRI / CCT	BEAM	DIMMING
TRIDONIC SLE	TUBE FT ON WHITE TUBE FT ON BLACK	T6164*927/39°/ND	2.300 lm	927	39°	ND DIMMING ON REQUEST
		T6164*930/39°/ND	2.450 lm	930		
		T6164*940/39°/ND	2.570 lm	940		
		T6164*9730/39°/ND	2.060 lm	9730		
		T6164*FA/39°/ND	2.260 lm	FASHION		
		T6164*PW930/39°/ND	2.450 lm	PURE WHITE 930		
		T6164*PW940/39°/ND	2.550 lm	PURE WHITE 940		
		T6164*FIS/39°/ND	2.470 lm	FISH 965		
		T6164*M+/39°/ND	1.520 lm	MEAT+		
		T6164*FM/39°/ND	1.490 lm	FRESH MEAT		
		T6164*G/39°/ND	2.300 lm	GOLD		
		T6164*G+/39°/ND	1.580 lm	GOLD+		
		T6164*FR/39°/ND	2.130 lm	FRUIT		

*W (white) or B (black)

LOWER LM OUTPUT
ALSO AVAILABLE

ND: non dimmable

TUBE F ON 2 RECT

REF	A6179W A6179B	Tube F ON 2 rect white Tube F ON 2 rect black
LED	Xicato Tridonic	
LED LM OUTPUT	2x 1.300 up to 2x 2.570 lm	
POWER CONS.	according to lumen output - see table p. 255	
COLOR TEMP.	2.700 / 3.000 / 4.000 K	
CRI	80 up to +95	
COLOR QUALITY	Xicato: artist / beauty vibrant / vibrant artist Tridonic: fashion / pure white fish / meat / gold / fruit	
REFLECTOR	Xicato: 20° / 40° / 60° (11° only available in 1.300 lm) Tridonic: 39°	
FINISH	white RAL 9016 tex black RAL 9005 tex	
ADJUSTABLE	45° x 355°	
CUT-OUT	n/a	
DRIVE CURRENT	supplied with built-in driver	

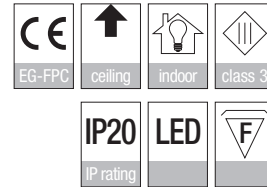
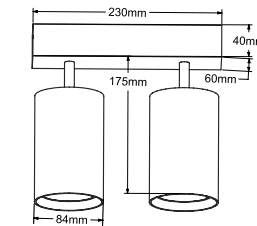
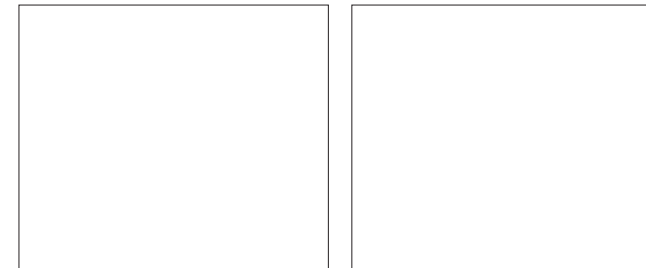

MODULE	MODEL	REFERENCE	LM OUTPUT	CRI / CCT	BEAM	DIMMING
XICATO XTM	TUBE FX ON 2 RECT WHITE TUBE FX ON 2 RECT BLACK	A6179W A6179B	2x 1.300 lm	827 - 830 - 840 - V830	11°/20°	ND / PD A / D
				927 - 930 - 940 - V930 - BT	40°/60°	
			2x 2.000 lm	827 - 830 - 840 - V830	20°/40°/60°	

Reference builder: f.e.: A6179W/1300/V930/20°/PD

ND: non dimmable / PD: phase dimming / A: 1-10V / D: DALI

MODULE	MODEL	REFERENCE	LM OUTPUT	CRI / CCT	BEAM	DIMMING
TRIDONIC SLE	TUBE FT ON 2 RECT WHITE TUBE FT ON 2 RECT BLACK	T6179*927/39°/ND	2x 2.300 lm	927	39°	ND DIMMING ON REQUEST
		T6179*930/39°/ND	2x 2.450 lm	930		
		T6179*940/39°/ND	2x 2.570 lm	940		
		T6179*9730/39°/ND	2x 2.060 lm	9730		
		T6179*FA/39°/ND	2x 2.260 lm	FASHION		
		T6179*PW930/39°/ND	2x 2.450 lm	PURE WHITE 930		
		T6179*PW940/39°/ND	2x 2.550 lm	PURE WHITE 940		
		T6179*FIS/39°/ND	2x 2.470 lm	FISH 965		
		T6179*M+/39°/ND	2x 1.520 lm	MEAT+		
		T6179*FM/39°/ND	2x 1.490 lm	FRESH MEAT		
		T6179*G/39°/ND	2x 2.300 lm	GOLD		
		T6179*G+/39°/ND	2x 1.580 lm	GOLD+		
		T6179*FR/39°/ND	2x 2.130 lm	FRUIT		

*W (white) or B (black)

LOWER LM OUTPUT
ALSO AVAILABLE

ND: non dimmable



TUBE ON

REF	A6145W A6145B	Tube X ON white Tube X ON black
LED	Xicato Tridonic	
LED LM OUTPUT	1.300 up to 2.570 lm	
POWER CONS.	according to lumen output - see table p. 255	
COLOR TEMP.	2.700 / 3.000 / 4.000 K	
CRI	80 up to +95	
COLOR QUALITY	Xicato:	artist / beauty vibrant / vibrant artist
	Tridonic:	fashion / pure white fish / meat / gold / fruit
REFLECTOR	Xicato:	20° / 40° / 60° (11° only available in 1.300 lm)
	Tridonic:	39°
FINISH	white RAL 9016 tex black RAL 9005 tex	
ADJUSTABLE	n/a	
CUT-OUT	n/a	
DRIVE CURRENT	supplied with built-in driver	

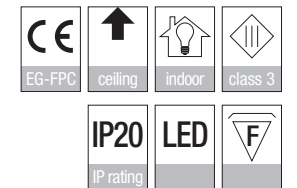
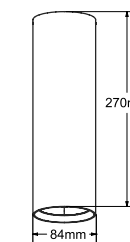
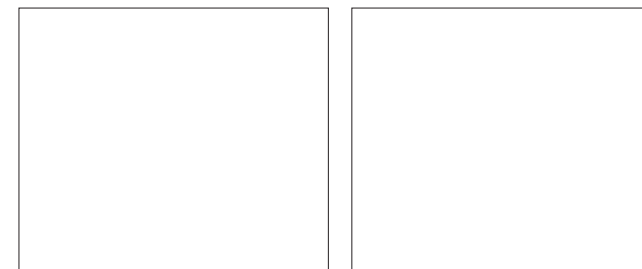

MODULE	MODEL	REFERENCE	LM OUTPUT	CRI / CCT	BEAM	DIMMING
XICATO XTM	TUBE X ON WHITE TUBE X ON BLACK	A6145W A6145B	1.300 lm	827 - 830 - 840 - V830 927 - 930 - 940 - V930 - BT	11°/20° 40°/60°	ND / PD A / D
			2.000 lm	827 - 830 - 840 - V830	20°/40°/60°	

Reference builder: f.e.: A6145W/1300/V930/20°/PD

ND: non dimmable / PD: phase dimming / A: 1-10V / D: DALI

MODULE	MODEL	REFERENCE	LM OUTPUT	CRI / CCT	BEAM	DIMMING
TRIDONIC SLE	TUBE T ON WHITE TUBE T ON BLACK	T6145*/927/39°/ND	2.300 lm	927	39°	ND DIMMING ON REQUEST
		T6145*/930/39°/ND	2.450 lm	930		
		T6145*/940/39°/ND	2.570 lm	940		
		T6145*/9730/39°/ND	2.060 lm	9730		
		T6145*/FA/39°/ND	2.260 lm	FASHION		
		T6145*/PW930/39°/ND	2.450 lm	PURE WHITE 930		
		T6145*/PW940/39°/ND	2.550 lm	PURE WHITE 940		
		T6145*/FIS/39°/ND	2.470 lm	FISH 965		
		T6145*/M+/39°/ND	1.520 lm	MEAT+		
		T6145*/FM/39°/ND	1.490 lm	FRESH MEAT		
		T6145*/G/39°/ND	2.300 lm	GOLD		
		T6145*/G+/39°/ND	1.580 lm	GOLD+		
T6145*/FR/39°/ND	2.130 lm	FRUIT				

*W (white) or B (black)

LOWER LM OUTPUT
ALSO AVAILABLE

ND: non dimmable



TUBE SUSP

REF	A6137W A6137B	Tube S white Tube S black
LED	Xicato Tridonic	
LED LM OUTPUT	1.300 up to 2.570 lm	
POWER CONS.	according to lumen output - see table p. 255	
COLOR TEMP.	2.700 / 3.000 / 4.000 K	
CRI	80 up to +95	
COLOR QUALITY	Xicato: artist / beauty vibrant / vibrant artist Tridonic: fashion / pure white fish / meat / gold / fruit	
REFLECTOR	Xicato: 20° / 40° / 60° (11° only available in 1.300 lm) Tridonic: 39°	
FINISH	white RAL 9016 tex black RAL 9005 tex	
ADJUSTABLE	n/a	
CUT-OUT	n/a	
DRIVE CURRENT	supplied with built-in driver	
REMARK	cable black tex / length 2 m	
OPTIONAL	built-in ceiling mount	

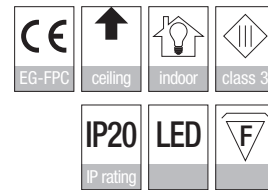
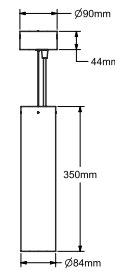

MODULE	MODEL	REFERENCE	LM OUTPUT	CRI / CCT	BEAM	DIMMING
XICATO XTM	TUBE X S WHITE TUBE X S BLACK	A6137W A6137B	1.300 lm	827 - 830 - 840 - V830 927 - 930 - 940 - V930 - BT	11°/20° 40°/60°	ND / PD A / D
			2.000 lm	827 - 830 - 840 - V830	20°/40°/60°	

Reference builder: fe.: A6137W/1300/V930/20°/PD

ND: non dimmable / PD: phase dimming / A: 1-10V / D: DALI

MODULE	MODEL	REFERENCE	LM OUTPUT	CRI / CCT	BEAM	DIMMING
TRIDONIC SLE	TUBE T S WHITE TUBE T S BLACK	T6137*927/39°/ND	2.300 lm	927	39°	ND DIMMING ON REQUEST
		T6137*930/39°/ND	2.450 lm	930		
		T6137*940/39°/ND	2.570 lm	940		
		T6137*9730/39°/ND	2.060 lm	9730		
		T6137*FA/39°/ND	2.260 lm	FASHION		
		T6137*PW930/39°/ND	2.450 lm	PURE WHITE 930		
		T6137*PW940/39°/ND	2.550 lm	PURE WHITE 940		
		T6137*FIS/39°/ND	2.470 lm	FISH 965		
		T6137*M+/39°/ND	1.520 lm	MEAT+		
		T6137*FM/39°/ND	1.490 lm	FRESH MEAT		
		T6137*G/39°/ND	2.300 lm	GOLD		
		T6137*G+/39°/ND	1.580 lm	GOLD+		
T6137*FR/39°/ND	2.130 lm	FRUIT				

*W (white) or B (black)

LOWER LM OUTPUT
ALSO AVAILABLE

ND: non dimmable

TUBE TRACK

REF	A6150W A6150B	Tube Track white Tube Track black
LED	Xicato Tridonic	
LED LM OUTPUT	1.300 up to 4.350 lm	
POWER CONS.	according to lumen output - see table p. 255	
COLOR TEMP.	2.700 / 3.000 / 4.000 K	
CRI	80 up to +95	
COLOR QUALITY	Xicato: artist / beauty vibrant / vibrant artist Tridonic: fashion / pure white fish / meat / gold / fruit	
REFLECTOR	Xicato: 24° / 36° Tridonic: 24° / 36°	
FINISH	white RAL 9016 tex black RAL 9005 tex	
ADJUSTABLE	45° x 355°	
DRIVE CURRENT	supplied with driver	
TRACK ADAPTOR	3 phase	
REMARK	dimming on request	

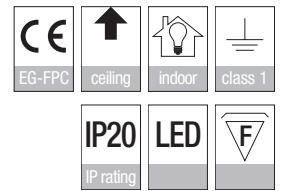
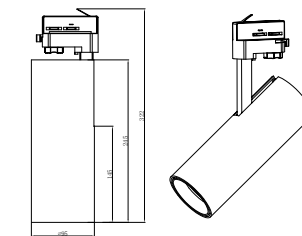

MODULE	MODEL	REFERENCE	LM OUTPUT	CRI / CCT	BEAM	DIMMING
XICATO XTM	TUBE TRACK X WHITE TUBE TRACK X BLACK	A6150W A6150B	1.300 lm	827 - 830 - 840 - V830 927 - 930 - 940 - V930 - BT	24° 36°	ND DIMMING ON REQUEST
			2.000 lm	827 - 830 - 840 - V830 927 - 930 - 940 - V930 - BT		
			3.000 lm	827 - 830 - 840 - V830 927 - 930 - 940 - V930 - BT		
			3.850 lm	827 - 830 - 840 - V830		

Reference builder: fe.: A6150W/1300/V930/24°/PD

ND: non dimmable

MODULE	MODEL	REFERENCE	LM OUTPUT	CRI / CCT	BEAM	DIMMING
TRIDONIC SLE	TUBE TRACK T WHITE TUBE TRACK T BLACK	T6150*927/-°/ND	3.870 lm	927	24° 36°	ND DIMMING ON REQUEST
		T6150*930/-°/ND	4.130 lm	930		
		T6150*940/-°/ND	4.330 lm	940		
		T6150*9730/-°/ND	3.520 lm	9730		
		T6150*FA/-°/ND	3.860 lm	FASHION		
		T6150*PW930/-°/ND	4.180 lm	PURE WHITE 930		
		T6150*PW940/-°/ND	4.350 lm	PURE WHITE 940		
		T6150*FIS/-°/ND	3.600 lm	FISH 965		
		T6150*FM±°/ND	2.600 lm	MEAT+		
		T6150*FM/-°/ND	2.550 lm	FRESH MEAT		
		T6150*G/-°/ND	3.900 lm	GOLD		
		T6150*G±°/ND	2.900 lm	GOLD+		
T6150*FR/-°/ND	3.600 lm	FRUIT				

*W (white) or B (black)

LOWER LM OUTPUT
ALSO AVAILABLE

ND: non dimmable



TUBE F INVITRACK

REF	A6202W A6202B	Tube F Invitrack white Tube F Invitrack black
LED	Xicato Tridonic	
LED LM OUTPUT	1.300 up to 2.570 lm	
POWER CONS.	according to lumen output - see table p. 255	
COLOR TEMP.	2.700 / 3.000 / 4.000 K	
CRI	80 up to +95	
COLOR QUALITY	Xicato: artist / beauty vibrant / vibrant artist Tridonic: fashion / pure white fish / meat / gold / fruit	
REFLECTOR	Xicato: 20° / 40° / 60° (11° only available in 1.300 lm) Tridonic: 39°	
FINISH	white RAL 9016 tex black RAL 9005 tex	
ADJUSTABLE	45° x 355°	
CUT-OUT	n/a	
TRACK ADAPTOR	Invitrack adaptor with built-in driver	
DIMMIING	DALI on request	

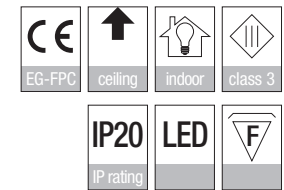
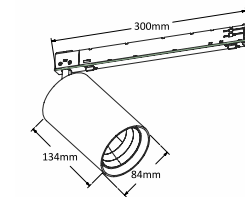

MODULE	MODEL	REFERENCE	LM OUTPUT	CRI / CCT	BEAM	DIMMING
XICATO XTM	TUBE FX INVITRACK WHITE TUBE FX INVITRACK BLACK	A6202W A6202B	1.300 lm	827 - 830 - 840 - V830	11°/20°	ND DIMMING ON REQUEST
			2.000 lm	927 - 930 - 940 - V930 - BT	40°/60°	
				827 - 830 - 840 - V830	20°/40°/60°	

Reference builder: f.e.: A6202W/1300/V930/20°/PD

ND: non dimmable / PD: phase dimming / A: 1-10V / D: DALI

MODULE	MODEL	REFERENCE	LM OUTPUT	CRI / CCT	BEAM	DIMMING
TRIDONIC SLE	TUBE FT INVITRACK WHITE TUBE FT INVITRACK BLACK	T6202*927/39°/ND	2.300 lm	927	39°	ND DIMMING ON REQUEST
		T6202*930/39°/ND	2.450 lm	930		
		T6202*940/39°/ND	2.570 lm	940		
		T6202*9730/39°/ND	2.060 lm	9730		
		T6202*FA/39°/ND	2.260 lm	FASHION		
		T6202*PW930/39°/ND	2.450 lm	PURE WHITE 930		
		T6202*PW940/39°/ND	2.550 lm	PURE WHITE 940		
		T6202*FIS/39°/ND	2.470 lm	FISH 965		
		T6202*M+/39°/ND	1.520 lm	MEAT+		
		T6202*FM/39°/ND	1.490 lm	FRESH MEAT		
		T6202*G/39°/ND	2.300 lm	GOLD		
		T6202*G+/39°/ND	1.580 lm	GOLD+		
T6202*FR/39°/ND	2.130 lm	FRUIT				

*W (white) or B (black)

LOWER LM OUTPUT
ALSO AVAILABLE

ND: non dimmable



MINI TUBE X L SUSP INVITRACK

REF	A6212LW	Mini Tube X L susp Invitrack white
	A6212LB	Mini Tube X L susp Invitrack black

LED	Xicato
LED LM OUTPUT	700 / 1.300 lm
POWER CONS.	according to lumen output - see table p. 255
COLOR TEMP.	2.700 / 3.000 / 4.000 K
CRI	80 or +95
COLOR QUAL.	artist / beauty / vibrant / vibrant artist
REFLECTOR	16° / 40° / 60°
FINISH	white RAL 9016 tex black RAL 9005 tex
TRACK ADAPTOR	Invitrack adaptor with built-in driver
OPTIONAL	MINI TUBE CONE SET (REF C6025): mounting clips / cone / honeycomb / prismatic lens / spread lens C6025B/part Mini Tube cone black C6025W/part Mini Tube cone white C6025G/part Mini Tube cone gold
DIMMING	DALI on request

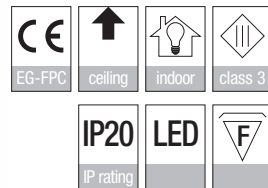
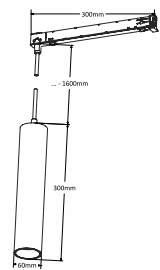

MODEL	REFERENCE	LM OUTPUT	CRI / CCT	BEAM	DIMMING
MINI TUBE X L SUSP INVITRACK WHITE MINI TUBE X L SUSP INVITRACK BLACK	A6212LW A6212LB	700 lm	827 - 830 - 840 - V830	16°	ND
			927 - 930 - 940 - V930 - BT		
		1.300 lm	827 - 830 - 840 - V830	16°/40°/60°	DIMMING ON REQUEST
			927 - 930 - 940 - V930 - BT	40°/60°	

ND: non dimmable



MIDI TUBE INVITRACK

REF	A6209W	Midi Tube Invitrack white
	A6209B	Midi Tube Invitrack black

LED	Xicato
	Tridonic
LED LM OUTPUT	1.300 up to 2.570 lm
POWER CONS.	according to lumen output - see table p. 255
COLOR TEMP.	2.700 / 3.000 / 4.000 K
CRI	80 up to +95
COLOR QUALITY	Xicato: artist / beauty vibrant / vibrant artist Tridonic: fashion / pure white fish / meat / gold / fruit
REFLECTOR	Xicato: 20° / 40° / 60° (11° only available in 1.300 lm) Tridonic: 39°
FINISH	white RAL 9016 tex black RAL 9005 tex
ADJUSTABLE	45° x 355°
CUT-OUT	n/a
TRACK ADAPTOR	Invitrack adaptor with built-in driver
DIMMING	DALI on request

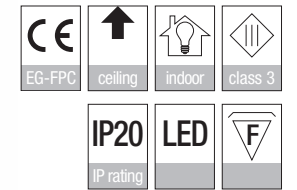
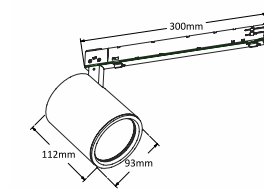

MODULE	MODEL	REFERENCE	LM OUTPUT	CRI / CCT	BEAM	DIMMING
XICATO XTM	MIDI TUBE X INVITRACK WHITE MIDI TUBE X INVITRACK BLACK	A6209W A6209B	1.300 lm	827 - 830 - 840 - V830	11°/20°	ND DIMMING ON REQUEST
			2.000 lm	927 - 930 - 940 - V930 - BT	40°/60°	
				827 - 830 - 840 - V830	20°/40°/60°	

Reference builder: f.e.: A6209W/1300/V930/20°/PD

ND: non dimmable

MODULE	MODEL	REFERENCE	LM OUTPUT	CRI / CCT	BEAM	DIMMING
TRIDONIC SLE	MIDI TUBE T INVITRACK WHITE MIDI TUBE T INVITRACK BLACK	T6209*927/...°/ND	3.010 lm	927	20° 40° 60°	ND DIMMING ON REQUEST
		T6209*930/...°/ND	3.200 lm	930		
		T6209*940/...°/ND	3.360 lm	940		
		T6209*9730/...°/ND	2.730 lm	9730		
		T6209*FA/...°/ND	3.000 lm	FASHION		
		T6209*PW930/...°/ND	3.250 lm	PURE WHITE 930		
		T6209*PW940/...°/ND	3.830 lm	PURE WHITE 940		
		T6209*FIS/...°/ND	2.800 lm	FISH 965		
		T6209*M+/...°/ND	2.020 lm	MEAT+		
		T6209*FM/...°/ND	1.980 lm	FRESH MEAT		
T6209*G/...°/ND	3.030 lm	GOLD				
T6209*G+/...°/ND	2.250 lm	GOLD+				
T6209*FR/...°/ND	2.800 lm	FRUIT				

*W (white) or B (black)

LOWER LM OUTPUT
ALSO AVAILABLE

ND: non dimmable



MIDI TUBE IN

REF	A6208W/I A6208B/I	Midi Tube IN white Midi Tube IN black
LED	Xicato Tridonic	
LED LM OUTPUT	1.300 up to 2.570 lm	
POWER CONS.	according to lumen output - see table p. 255	
COLOR TEMP.	2.700 / 3.000 / 4.000 K	
CRI	80 up to +95	
COLOR QUALITY	Xicato: artist / beauty vibrant / vibrant artist	
	Tridonic: fashion / pure white fish / meat / gold / fruit	
REFLECTOR	Xicato: 20° / 40° / 60° (11° only available in 1.300 lm)	
	Tridonic: 39°	
FINISH	white RAL 9016 tex black RAL 9005 tex	
ADJUSTABLE	45° x 355°	
CUT-OUT	Ø 80 mm	
DRIVE CURRENT	supplied with driver	

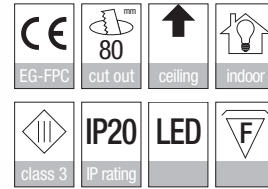
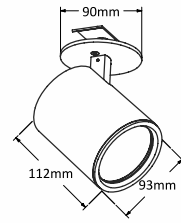

MODULE	MODEL	REFERENCE	LM OUTPUT	CRI / CCT	BEAM	DIMMING
XICATO XTM	MIDI TUBE X IN WHITE MIDI TUBE X IN BLACK	A6208W/I A6208B/I	1.300 lm	827 - 830 - 840 - V830	11°/20° 40°/60°	ND / PD A / D
			2.000 lm	927 - 930 - 940 - V930 - BT	20°/40°/60°	
				827 - 830 - 840 - V830		

Reference builder: fe: A6165W/1300V930/20°/PD

ND: non dimmable / PD: phase dimming / A: 1-10V / D: DALI

MODULE	MODEL	REFERENCE	LM OUTPUT	CRI / CCT	BEAM	DIMMING
TRIDONIC SLE	MIDI TUBE T IN WHITE MIDI TUBE T IN BLACK	T6208*/I/927/_*/ND	3.870 lm	927	20° 40° 60°	ND DIMMING ON REQUEST
		T6208*/I/930/_*/ND	4.130 lm	930		
		T6208*/I/940/_*/ND	4.330 lm	940		
		T6208*/I/9730/_*/ND	3.520 lm	9730		
		T6208*/I/FA/_*/ND	3.860 lm	FASHION		
		T6208*/I/PW930/_*/ND	4.180 lm	PURE WHITE 930		
		T6208*/I/PW940/_*/ND	4.350 lm	PURE WHITE 940		
		T6208*/I/FIS/_*/ND	3.600 lm	FISH 965		
		T6208*/I/M+/_*/ND	2.600 lm	MEAT+		
		T6208*/I/FM/_*/ND	2.550 lm	FRESH MEAT		
		T6208*/I/G/_*/ND	3.900 lm	GOLD		
		T6208*/I/G+/_*/ND	2.900 lm	GOLD+		
		T6208*/I/FR/_*/ND	3.600 lm	FRUIT		

*W (white) or B (black)

LOWER LM OUTPUT
ALSO AVAILABLE

ND: non dimmable



MIDI TUBE ON

REF	A6208W/O A6208B/O	Midi Tube ON white Midi Tube ON black
LED	Xicato Tridonic	
LED LM OUTPUT	1.300 up to 2.570 lm	
POWER CONS.	according to lumen output - see table p. 255	
COLOR TEMP.	2.700 / 3.000 / 4.000 K	
CRI	80 up to +95	
COLOR QUALITY	Xicato: artist / beauty vibrant / vibrant artist	
	Tridonic: fashion / pure white fish / meat / gold / fruit	
REFLECTOR	Xicato: 20° / 40° / 60° (11° only available in 1.300 lm)	
	Tridonic: 39°	
FINISH	white RAL 9016 tex black RAL 9005 tex	
ADJUSTABLE	45° x 355°	
CUT-OUT	n/a	
DRIVE CURRENT	supplied with built-in driver	

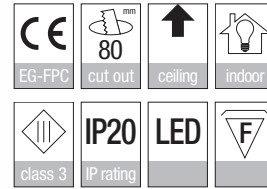
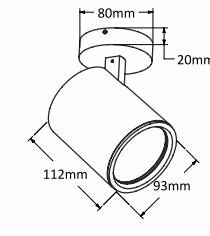

MODULE	MODEL	REFERENCE	LM OUTPUT	CRI / CCT	BEAM	DIMMING
XICATO XTM	MIDI TUBE ON X WHITE MIDI TUBE ON X BLACK	A6208W/O A6208B/O	1.300 lm	827 - 830 - 840 - V830	11°/20° 40°/60°	ND / PD A / D
			2.000 lm	927 - 930 - 940 - V930 - BT	20°/40°/60°	
				827 - 830 - 840 - V830		

Reference builder: fe: A6165W/1300V930/20°/PD

ND: non dimmable / PD: phase dimming / A: 1-10V / D: DALI

MODULE	MODEL	REFERENCE	LM OUTPUT	CRI / CCT	BEAM	DIMMING
TRIDONIC SLE	MIDI TUBE ON T WHITE MIDI TUBE ON T BLACK	T6208*/O/927/_*/ND	3.870 lm	927	20° 40° 60°	ND DIMMING ON REQUEST
		T6208*/O/930/_*/ND	4.130 lm	930		
		T6208*/O/940/_*/ND	4.330 lm	940		
		T6208*/O/9730/_*/ND	3.520 lm	9730		
		T6208*/O/FA/_*/ND	3.860 lm	FASHION		
		T6208*/O/PW930/_*/ND	4.180 lm	PURE WHITE 930		
		T6208*/O/PW940/_*/ND	4.350 lm	PURE WHITE 940		
		T6208*/O/FIS/_*/ND	3.600 lm	FISH 965		
		T6208*/O/M+/_*/ND	2.600 lm	MEAT+		
		T6208*/O/FM/_*/ND	2.550 lm	FRESH MEAT		
		T6208*/O/G/_*/ND	3.900 lm	GOLD		
		T6208*/O/G+/_*/ND	2.900 lm	GOLD+		
		T6208*/O/FR/_*/ND	3.600 lm	FRUIT		

*W (white) or B (black)

LOWER LM OUTPUT
ALSO AVAILABLE

ND: non dimmable



FLAT HORES

REF	A6149W A6149B	Flat Hores white Flat Hores black
LED	Xicato Tridonic	
LED LM OUTPUT	1.300 up to 4.350 lm	
POWER CONS.	according to lumen output - see table p. 255	
COLOR TEMP.	2.700 / 3.000 / 4.000 K	
CRI	80 up to +95	
COLOR QUALITY	Xicato: artist / beauty vibrant / vibrant artist Tridonic: fashion / pure white fish / meat / gold / fruit	
REFLECTOR	Xicato: 30° / 45° Tridonic: 30° / 45°	
FINISH	white RAL 9016 tex black RAL 9005 tex	
ADJUSTABLE	45° x 355°	
DRIVE CURRENT	built-in driver	
TRACK ADAPTOR	3 phase	
REMARK	dimming on request	

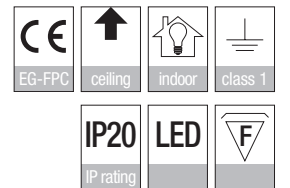
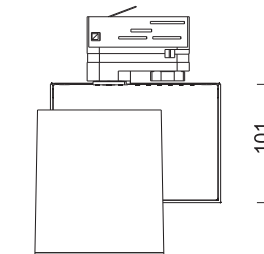
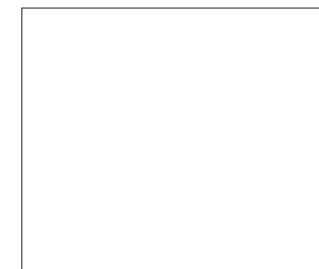

MODULE	MODEL	REFERENCE	LM OUTPUT	CRI / CCT	BEAM	DIMMING
XICATO XTM	FLAT HORES X WHITE FLAT HORES X BLACK	A6149W A6149B	1.300 lm	827 - 830 - 840 - V830 927 - 930 - 940 - V930 - BT	30° 45°	ND DIMMING ON REQUEST
			2.000 lm	827 - 830 - 840 - V830 927 - 930 - 940 - V930 - BT		
			3.000 lm	827 - 830 - 840 - V830 927 - 930 - 940 - V930 - BT		
			3.850 lm	827 - 830 - 840 - V830		

Reference builder: fa.: A6149W/1300/V930/30°/PD

ND: non dimmable

MODULE	MODEL	REFERENCE	LM OUTPUT	CRI / CCT	BEAM	DIMMING
TRIDONIC SLE	FLAT HORES T WHITE FLAT HORES T BLACK	T6149*927/-°/ND	3.870 lm	927	30° 45°	ND DIMMING ON REQUEST
		T6149*930/-°/ND	4.130 lm	930		
		T6149*940/-°/ND	4.330 lm	940		
		T6149*9730/-°/ND	3.520 lm	9730		
		T6149*FA/-°/ND	3.860 lm	FASHION		
		T6149*PW930/-°/ND	4.180 lm	PURE WHITE 930		
		T6149*PW940/-°/ND	4.350 lm	PURE WHITE 940		
		T6149*FIS/-°/ND	3.600 lm	FISH 965		
		T6149*ME±°/ND	2.600 lm	MEAT±		
		T6149*FM/-°/ND	2.550 lm	FRESH MEAT		
		T6149*G/-°/ND	3.900 lm	GOLD		
		T6149*G±°/ND	2.900 lm	GOLD±		
		T6149*FR/-°/ND	3.600 lm	FRUIT		

*W (white) or B (black)

LOWER LM OUTPUT
ALSO AVAILABLE

ND: non dimmable



DROP-IT TRACK



REF	A6182W A6182B	Drop-It Track white Drop-It Track black
LED	Xicato Tridonic	
LED LM OUTPUT	1.300 up to 4.350 lm	
POWER CONS.	according to lumen output - see table p. 255	
COLOR TEMP.	2.700 / 3.000 / 4.000 K	
CRI	80 up to +95	
COLOR QUALITY	Xicato: artist / beauty vibrant / vibrant artist Tridonic: fashion / pure white fish / meat / gold / fruit	
REFLECTOR	Xicato: 40° Tridonic: 40°	
FINISH	white RAL 9016 tex black RAL 9005 tex	
ADJUSTABLE	45° x 355°	
DRIVE CURRENT	built-in driver	
TRACK ADAPTOR	3 phase	
REMARK	dimming on request	

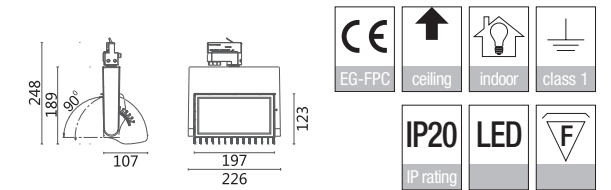
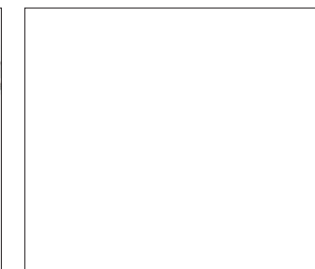

MODULE	MODEL	REFERENCE	LM OUTPUT	CRI / CCT	BEAM	DIMMING
XICATO XTM	DROP-IT TRACK X WHITE DROP-IT TRACK X BLACK	A6182W A6182B	1.300 lm	827 - 830 - 840 - V830 927 - 930 - 940 - V930 - BT	40°	ND DIMMING ON REQUEST
			2.000 lm	827 - 830 - 840 - V830 927 - 930 - 940 - V930 - BT		
			3.000 lm	827 - 830 - 840 - V830 927 - 930 - 940 - V930 - BT		
			3.850 lm	827 - 830 - 840 - V830		

Reference builder: fe.: A6149W/1300/V930/30°/PD

ND: non dimmable

MODULE	MODEL	REFERENCE	LM OUTPUT	CRI / CCT	BEAM	DIMMING
TRIDONIC SLE	DROP-IT TRACK T WHITE DROP-IT TRACK T BLACK	T61827927/40°/ND	3.870 lm	927	40°	ND DIMMING ON REQUEST
		T61827930/40°/ND	4.130 lm	930		
		T61827940/40°/ND	4.330 lm	940		
		T618279730/40°/ND	3.520 lm	9730		
		T61827FA/40°/ND	3.860 lm	FASHION		
		T61827PW930/40°/ND	4.180 lm	PURE WHITE 930		
		T61827PW940/40°/ND	4.350 lm	PURE WHITE 940		
		T61827FIS/40°/ND	3.600 lm	FISH 965		
		T61827M+/40°/ND	2.600 lm	MEAT+		
		T61827FM/40°/ND	2.550 lm	FRESH MEAT		
		T61827G/40°/ND	3.900 lm	GOLD		
		T61827G+/40°/ND	2.900 lm	GOLD+		
T61827FR/40°/ND	3.600 lm	FRUIT				

*W (white) or B (black)

LOWER LM OUTPUT
ALSO AVAILABLE

ND: non dimmable



RE-LIGHT MODULE

REF	C2001	Re-light module
LED	Xicato Tridonic	
LED LM OUTPUT	1.300 up to 4.350 lm	
POWER CONS.	according to lumen output - see table p. 255	
COLOR TEMP.	2.700 / 3.000 / 4.000 K	
CRI	80 up to +95	
COLOR QUALITY	Xicato: artist / beauty vibrant / vibrant artist Tridonic: fashion / pure white fish / meat / gold / fruit	
REFLECTOR	Xicato: 14,5° / 25,5° / 39° Tridonic: 39°	
DRIVE CURRENT	supplied with driver	
REMARK	replacement for CDM.../SDW.../AR111	

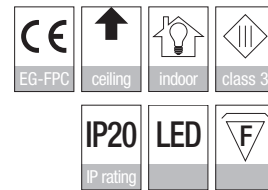
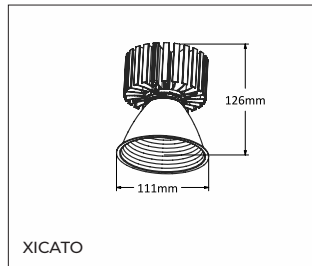
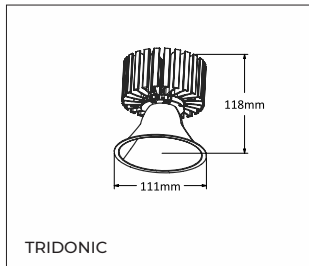

MODULE	MODEL	REFERENCE	LM OUTPUT	CRI / CCT	BEAM	DIMMING
XICATO XTM	RE-LIGHT MODULE	C2001X	1.300 lm	827 - 830 - 840 - V830	14,5° 25,5° 39°	ND DIMMING ON REQUEST
				9527 - 9530 - 9540 - V9530 - BT		
			2.000 lm	827 - 830 - 840 - V830		
				9527 - 9530 - 9540 - V9530 - BT		
3.000 lm	827 - 830 - 840 - V830					
	9527 - 9530 - 9540 - V9530 - BT					

Reference builder: fa.: A6105W/1300/V930/52/PD

ND: non dimmable

MODULE	MODEL	REFERENCE	LM OUTPUT	CRI / CCT	BEAM	DIMMING
TRIDONIC SLE	RE-LIGHT MODULE	C2001T/927/39°/ND	3.870 lm	927	39°	ND DIMMING ON REQUEST
		C2001T/930/39°/ND	4.130 lm	930		
		C2001T/940/39°/ND	4.330 lm	940		
		C2001T/9730/39°/ND	3.520 lm	9730		
		C2001T/FA/39°/ND	3.860 lm	FASHION		
		C2001T/PW930/39°/ND	4.180 lm	PURE WHITE 930		
		C2001T/PW940/39°/ND	4.350 lm	PURE WHITE 940		
		C2001T/FIS/39°/ND	3.600 lm	FISH 965		
		C2001T/M+/39°/ND	2.600 lm	MEAT+		
		C2001T/FM/39°/ND	2.550 lm	FRESH MEAT		
		C2001T/G/39°/ND	3.900 lm	GOLD		
		C2001T/G+/39°/ND	2.900 lm	GOLD+		
		C2001T/FR/39°/ND	3.600 lm	FRUIT		

*W (white) or B (black)

LOWER LM OUTPUT
ALSO AVAILABLE

ND: non dimmable

WIDE BEAM MODULE



REF	C2002	Wide beam module
LED	Xicato Tridonic	
LED LM OUTPUT	1.300 up to 4.350 lm	
POWER CONS.	according to lumen output - see table p. 255	
COLOR TEMP.	2.700 / 3.000 / 4.000 K	
CRI	80 up to +95	
COLOR QUALITY	Xicato: artist / beauty vibrant / vibrant artist Tridonic: fashion / pure white fish / meat / gold / fruit	
REFLECTOR	Xicato: 120° Tridonic: 120°	
FINISH	white RAL 9016 tex black RAL 9005 tex	
DRIVE CURRENT	supplied with driver	

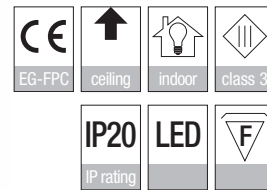
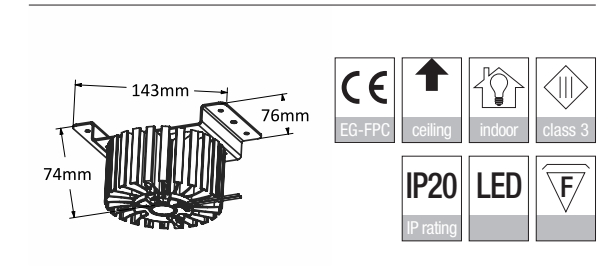
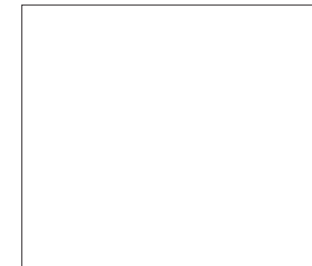

MODULE	MODEL	REFERENCE	LM OUTPUT	CRI / CCT	BEAM	DIMMING
XICATO XTM	WIDE BEAM MODULE	C2002X	1.300 lm	827 - 830 - 840 - V830	120°	ND DIMMING ON REQUEST
				9527 - 9530 - 9540 - V9530 - BT		
			2.000 lm	827 - 830 - 840 - V830		
				9527 - 9530 - 9540 - V9530 - BT		
3.000 lm	827 - 830 - 840 - V830					
	9527 - 9530 - 9540 - V9530 - BT					

Reference builder: fa.: A6105W/1300/V930/52/PD

ND: non dimmable

MODULE	MODEL	REFERENCE	LM OUTPUT	CRI / CCT	BEAM	DIMMING
TRIDONIC SLE	WIDE BEAM MODULE	C2002T/927/120°/ND	3.870 lm	927	120°	ND DIMMING ON REQUEST
		C2002T/930/120°/ND	4.130 lm	930		
		C2002T/940/120°/ND	4.330 lm	940		
		C2002T/9730/120°/ND	3.520 lm	9730		
		C2002T/FA/120°/ND	3.860 lm	FASHION		
		C2002T/PW930/120°/ND	4.180 lm	PURE WHITE 930		
		C2002T/PW940/120°/ND	4.350 lm	PURE WHITE 940		
		C2002T/FIS/120°/ND	3.600 lm	FISH 965		
		C2002T/M+/120°/ND	2.600 lm	MEAT+		
		C2002T/FM/120°/ND	2.550 lm	FRESH MEAT		
		C2002T/G/120°/ND	3.900 lm	GOLD		
		C2002T/G+/120°/ND	2.900 lm	GOLD+		
		C2002T/FR/120°/ND	3.600 lm	FRUIT		

*W (white) or B (black)

LOWER LM OUTPUT
ALSO AVAILABLE

ND: non dimmable



XICATO

THE STANDARD SERIES



Standard Series light provides a smooth spectrum of light right on the blackbody curve that allows it to feel natural and to make colors look right to the viewer. Together, the quality of light, consistency, efficiency and longevity make Standard Series light superior to the light from ceramic metal halide and fluorescent lamps.

Accurate color
Normal color rendering
CRI >80
Rf 78 / Rg 101
Office & general lighting
2,700 K - 4,000 K CCT
100+ Lumens per Watt
Superior color consistency

THE ARTIST SERIES



Our color scientists have engineered the Artist Series to have a typical CRI of Ra 98. The Artist Series has been optimized to get excellent results for the more saturated and skin color samples of the CRI reference set. The Artist Series not only outperforms other LED solutions, but also traditional lamp types like compact fluorescent and compact metal halide.

Natural color
Very high color rendering
CRI >95 R9 >90
Rf 96 / Rg 103
Hospitality & gallery lighting
2,700 K - 4,000 K CCT
80+ Lumens per Watt
Superior color consistency

THE BEAUTY SERIES

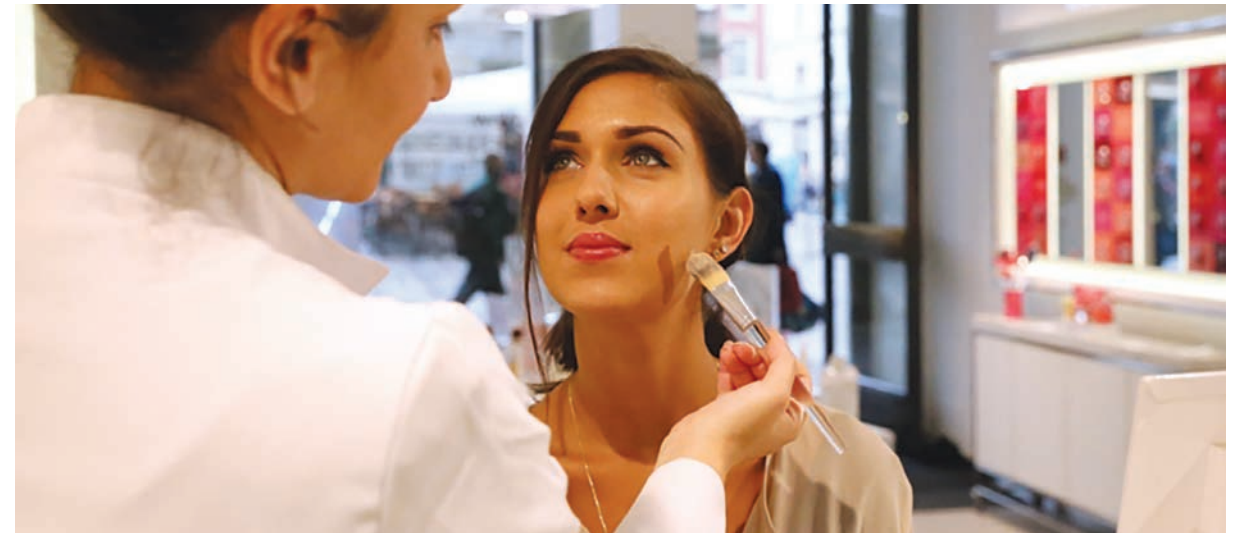

Developed in collaboration with lighting designers and leading cosmetology professionals and backed by independent research, Xicato Beauty Series is a remarkable light source that brings out the natural beauty of skin tones.

Beauty Series makes people look and feel their best. And when they enjoy how they feel, they engage in their environment and stay longer.

Beautiful skin tones
Excellent color discrimination
Ra 95 / Rf 91 / Rg 107
Cosmetic counters & social spaces
75+ Lumens per Watt
Superior color consistency

THE VIBRANT / VIBRANT-ARTIST SERIES



By increasing the gamut area of our Vibrant Series modules, objects appear richer and with more texture and depth. This enables us to see colors, hues and tones, particularly for whites, purples, pinks and blues, that are real, but simply aren't visible under halogen light. Vibrant is available in both high CRI (V95) and high efficacy (V80) flavors.

Striking color
GAIBB - 111 CRI >80
Rf 73 / Rg 105
GAIBB - 123 CRI >95
Rf 93 / Rg 106
Retail & display lighting
3,000 K CCT
100+ Lumens per Watt
Superior color consistency

XICATO XTM 19 MM ELECTRICAL & THERMAL CHEAT SHEET

SERIES	MODULE(S)	DRIVE CURRENT	FORWARD VOLTAGE			POWER CONS.	LM OUTPUT (TYPICAL)	EFFICACY (TYPICAL)	MODULE THERMAL P.	
			min.	typical	max.					
STANDARD SERIES & VIBRANT SERIES (V8)	1.300 lm XTM1980xx13CCA XTM19V83013CCA	700	12,3	13,6	18,0	9,5	1.300	137	5,4	
		500	12,0	13,2	17,5	6,6	965	146	3,5	
		350	11,7	12,9	17,2	4,5	720	159	2,2	
	2.000 lm XTM1980xx20CCA XTM19V83020CCA	700	19,8	21,7	27,0	15,2	2.000	132	8,8	
		500	19,2	21,1	26,3	10,6	1.490	141	5,8	
		350	18,7	20,6	25,8	7,2	1.105	153	3,7	
	3.000 lm XTM1980xx30CCA XTM19V83030CCA	1.050	19,8	24,4	27,0	25,6	3.000	117	16,0	
		700	19,1	23,6	26,2	16,5	2.100	127	9,8	
		500	18,7	23,1	25,7	11,6	1.585	137	6,5	
		350	18,3	22,8	25,3	8,0	1.195	150	4,2	
	4.000 lm XTM1980xx40CCA XTM19V83013CCA	1.400	23,4	24,4	30,0	34,2	4.000	117	21,4	
		1.050	22,7	23,8	29,2	25,0	3.080	123	15,1	
		700	22,2	23,2	28,6	16,2	2.160	133	9,3	
		500	21,7	22,8	28,2	11,4	1.630	143	6,2	
	5.000 lm XTM1980xx50CCA XTM19V83050CCA	1.400	28,6	29,9	36,0	41,9	5.000	119	25,9	
		1.050	27,7	29,0	35,1	30,5	3.850	126	18,1	
		700	27,1	28,4	34,3	19,9	2.700	136	11,2	
		500	26,6	27,9	33,8	14,0	2.030	146	7,5	
	ARTIST SERIES, VIBRANT SERIES (V9) & BEAUTY SERIES	1.300 lm XTM1995xx13CCA XTM19V93013CCA XTM19BT0113CCA	700	14,8	19,1	21,0	13,3	1.300	98	8,4
			500	14,4	18,5	20,5	9,3	965	104	5,6
350			14,0	18,1	20,0	6,3	720	114	3,6	
2.000 lm XTM1995xx20CCA XTM19V93020CCA XTM1995xx20CCA		1.050	17,3	19,0	24,0	20,0	2.000	100	12,4	
		700	16,7	18,4	23,3	12,9	1.400	109	7,6	
		500	16,3	18,0	22,8	9,0	1.055	117	5,0	
		350	16,0	17,7	22,5	6,2	800	129	3,2	
3.000 lm XTM1995xx30AxA XTM19V93030AxA		1.050	26,4	29,0	35,1	30,5	3.000	99	19,1	
		700	25,7	28,4	34,3	19,9	2.140	108	11,7	
		500	25,2	27,9	33,8	14,0	1.580	113	7,9	
			350	24,9	27,5	33,4	9,6	1.240	129	4,9

XICATO XTM 9 MM ELECTRICAL & THERMAL CHEAT SHEET

SERIES	MODULE(S)	DRIVE CURRENT	FORWARD VOLTAGE			POWER CONS.	LM OUTPUT (TYPICAL)	EFFICACY (TYPICAL)	MODULE THERMAL P.	
			min.	typical	max.					
STANDARD SERIES & VIBRANT SERIES (V8)	700 lm XTM0980xx07CCA XTM09V83007CCA	700	9,9	11,1	12,0	7,8	700	90	5,5	
		500	9,6	10,8	11,7	5,4	550	102	3,6	
		350	9,4	10,6	11,4	3,7	40	108	2,4	
	1.300 lm XTM0980xx13CCA XTM09V83013CCA	700	17,3	22,3	24,0	15,6	1.300	83	11,5	
		500	16,8	21,7	23,4	10,9	965	89	7,8	
		350	16,4	21,2	22,9	7,4	720	97	5,1	
	2.000 lm XTM0980xx20CCA XTM09V83020CCA	1.050	23,1	28,8	31,0	30,2	2.000	55	23,8	
		700	22,2	27,9	30,0	19,5	1.400	72	15,1	
		500	21,6	27,1	29,2	13,6	1.055	78	10,2	
		350	21,0	26,5	28,6	9,3	800	86	6,7	
	ARTIST SERIES & VIBRANT SERIES (V9)	700 lm XTM0995xx07CCA XTM09V93007CCA	700	9,9	13,9	15,0	9,7	700	72	7,1
			500	9,6	13,6	14,6	6,8	550	81	4,7
350			9,4	13,2	14,3	4,6	400	87	3,1	
1.300 lm XTM0995xx13CCA XTM09V93013CCA		1.050	17,9	23,1	24,8	24,3	1.300	54	19,3	
		700	17,3	22,3	24,0	15,6	930	60	21,1	
		500	16,8	21,7	23,4	10,9	700	65	8,2	
		350	16,4	21,2	22,9	7,4	500	67	5,5	
2.000 lm XTM0995xx20CCA XTM09V93020CCA		1.400	24,1	30,1	32,3	42,1	2.000	47	34,5	
		1.050	23,1	28,8	31,0	30,2	1.560	52	24,3	
		700	22,2	27,9	30,0	19,5	1.110	57	15,3	
		500	21,6	27,1	29,2	9 à 13,6,6	800	59	10,5	

COLOR RENDERING: THE OVERVIEW

SERIES	TM-30		CIE CRI															
	Rf	Rg	Ra	R1	R2	R3	R4	R5	R6	R7	R8	R9	R10	R11	R12	R13	R14	R15
Artist	96	103	97	98	99	97	96	98	97	98	97	95	99	93	94	98	97	99
Beauty	91	107	95	96	96	97	94	95	92	94	95	95	92	91	88	95	99	97
Designer	89	101	91	91	94	97	92	91	93	91	90	55	87	93	84	92	98	87
Standard	78	101	83	80	88	95	81	80	85	85	63	14	73	80	70	81	97	74
V80	73	105	83	82	87	90	81	81	82	85	69	28	69	80	65	82	94	78
V95	93	106	96	96	97	97	94	96	94	95	97	96	95	91	92	96	98	97

TRIDONIC

FOOD



GOLD	The brown shades let bread and pastries appear crispy
GOLD+	The brown shades appear crisper. Colour shades are stronger than GOLD.
FISH	Very cold light underlines the freshness of fish and seafood.
MEAT+	The red tones of the meat and sausages are noticeably stronger.
FRESH MEAT	A presentation of fresh meats and sausages is guaranteed. White elements remain white.
FRUIT	Best accentuates the freshness of fruit and vegetables.

ART



This LED module offers the high quality of light that is needed for displaying high value exhibits. Unique Tridonic full spectrum technology provides excellent colour rendering. The average value for all the products in the SLE ART series is CRI 97, a truly impressive figure. And you can also rely on outstanding colour consistency (MacAdam 2) for your applications.

FASHION



The modern FASHION LED light is ideal for the sparkling display of fashion. The technology conceals several years of intensive research targeted specifically for lighting in the retail sector. SLE FASHION generates brilliant colours with pleasant warm tones and high saturation, and completely without UV light, as well as intensive and friendly white tones thanks to the specific blue light component, for the display of goods in perfect, colour-true light.

PURE WHITE



With a little warmer colour place the special PURE WHITE modules let objects shine more lively.



VENEER OPTION

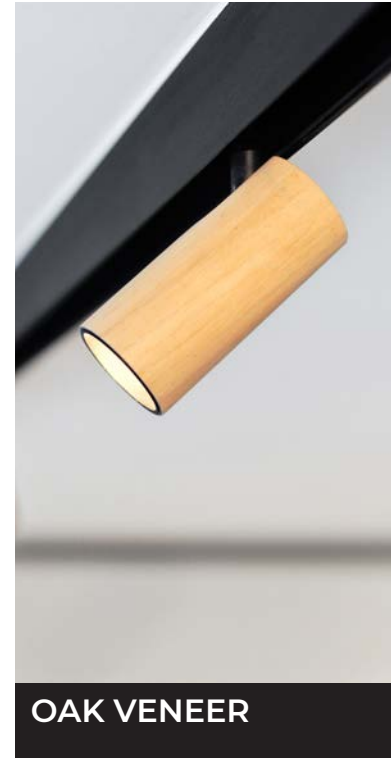

OAK VENEER



WALNUT VENEER

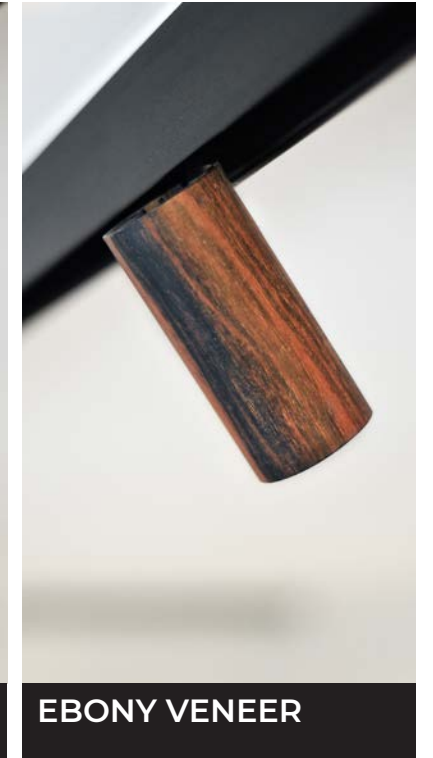







EBONY VENEER

REFERENCE	PRODUCT
C6031/WALN	Micro Tube Walnut veneer
C6031/EBO	Micro Tube Ebony veneer
C6031/OAK	Micro Tube Oak veneer

EUTRAC 3F TRACK

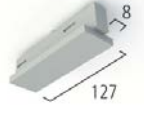
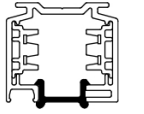
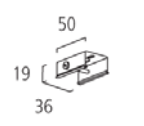
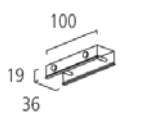
PRODUCT	REFERENCE	REMARKS
	25-106 25-102 25-206 25-202 25-306 25-302	
	555 0 1217 6 555 0 1217 2	
	555 1 1201 6 555 1 1201 2	
	555 1 1202 6 555 1 1202 2	
	555 1 1206 6 555 1 1206 2	
	555 1 1208 6 555 1 1208 2	
	555 1 1209 6 555 1 1209 2	
	555 1 1210 6 555 1 1210 2	
	555 1 1212 6 555 1 1212 2	
	555 1 1213 6 555 1 1213 2	

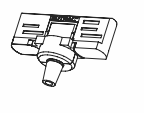
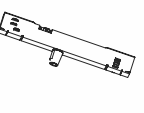
PRODUCT	REFERENCE	REMARKS
	555 1 1214 6 555 1 1214 2	
	555 1 1215 6 555 1 1215 2	
	555 1 1216 6 555 1 1216 2	
	555 1 1211 6 555 1 1211 2	
	555 1 5203 6 555 1 5203 2	to be placed anywhere along
	88 888 6 88 888 2	
	99-075-6 99-075-2	
	99-123-6 99-123-2	
	99-318-0 99-319-0	
	C6027W C6027B	
	C6033W C6033B	

EUTRAC 3F TRACK EARTH RUN LAYOUT HELP

BIRD'S EYE VIEW TRACK OPENING POINTED DOWNWARDS

ER = earthing

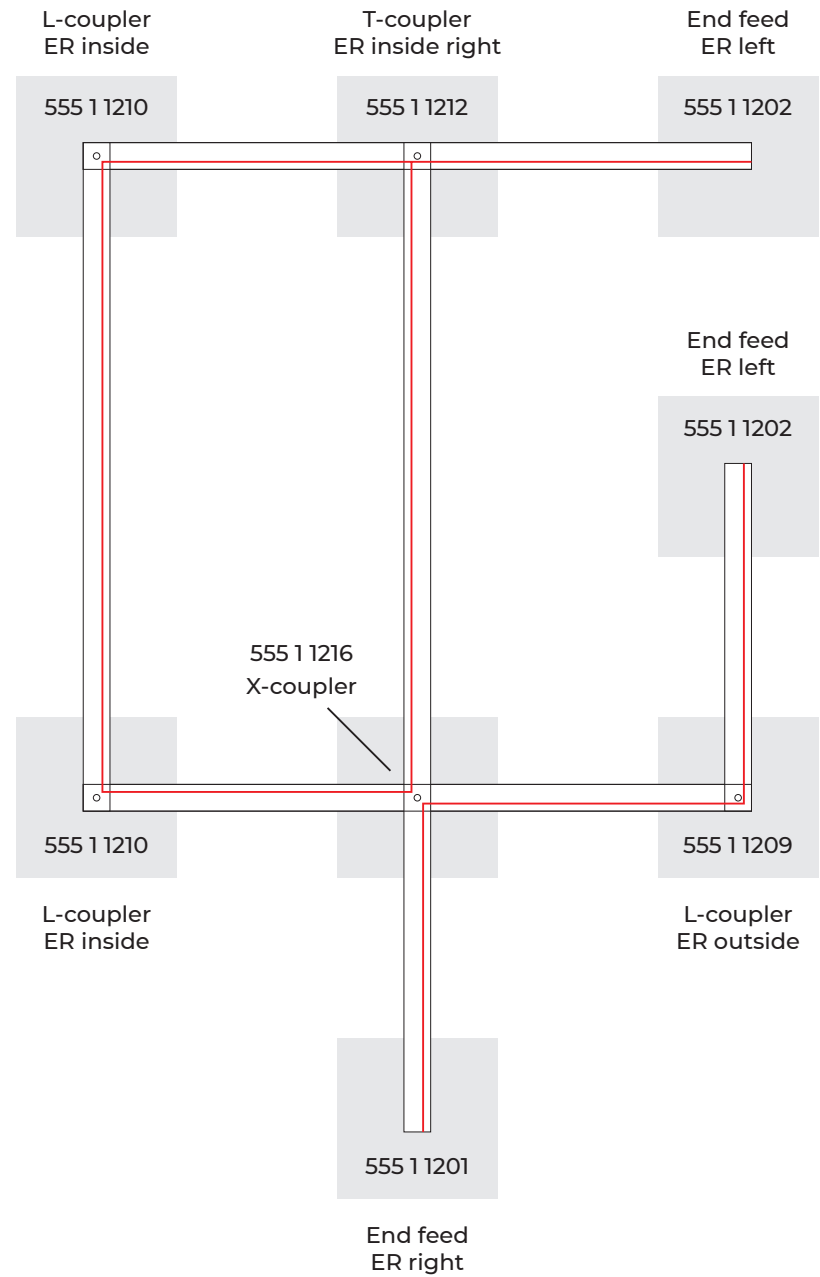

CUT-OUT MATRIX

CUT-OUT	DEPTH	FIXTURES	PAGE
Ø 32 mm	42 mm	PICCOLO	000
Ø 40 mm	52 mm	MIRADOR	000
	23 mm	POWER DISC	000
	12,5 mm	DISC	000
Ø 45 mm	60 mm	MINI CRATER	000
	52 mm	MINI CRATER IP	000
	40 mm	MIRADOR RGB-W	000
	40 mm	NANO TUBE RECESSED	000
	52 mm	ARROW	000
	40 mm	MICRO TUBE IN	000
	40 mm	MICRO TUBE L AC IN	000
	40 mm	MINI TUBE SUSP IN GU10	000
	40 mm	MINI TUBE SUSP IN LED	000
	40 mm	MINI TUBE L SUSP IN GU10	000
	40 mm	MINI TUBE L SUSP IN LED	000
	40 mm	GEORGES SUSP IN	000
	40 mm	GEORGES D12 SUSP IN	000
	40 mm	RIBS	000
Ø 49 mm	65 mm	MINI CRATER OUT	000
Ø 53 mm	35 mm	VUELTA TRIMLESS	000
	60 mm	MARKER	000
Ø 55 mm	109 mm	MICRO TUBE IN-FLEX	000
	40 mm	MINI TUBE IN X	000
Ø 60 mm	31 mm	BEACON	000
Ø 65 mm	55 mm	VUELTA AS TRIMLESS	000
Ø 70 mm	60 mm	OLLA	000
	64 mm	OLLA OR	000

CUT-OUT	DEPTH	FIXTURES	PAGE
Ø 75 mm	79 mm	CRATER	000
	59 mm	MINI TUBE RECESSED	000
Ø 80 mm	80 mm	COMMON SERIE	000
	85 mm	TRUMPET	000
	90 mm	TRUMPET FLEX	000
	75 mm	PICCOLO 80	000
	50 mm	ELBEAU	000
	40 mm	MINI TUBE IN GU10	000
	40 mm	MINI TUBE IN LED	000
	40 mm	GEORGES D20 IN	000
	40 mm	GEORGES D12 IN	000
	40 mm	TUBE F IN	000
	40 mm	MIDI TUBE IN	000
Ø 83 mm		MICRO TUBE R	000
Ø 95 mm		MICRO TUBE R TRIMLESS	000
Ø 110 mm	98 mm	EDNA	000
	132 mm	EDNA DEEP	000
	98 mm	EDNA FLEX	000
	98 mm	PICCOLO 120	000
	110 mm	MINI BFD FLEX	000
Ø 130-180 mm	130 mm	MINI BFD PLUS	000
Ø 130 mm	130 mm	MINI BFD	000
	90 mm	MINI BFD ASSYMETRIC	000
Ø 150 mm	175 mm	TUBE IN FLEX	000
Ø 157x240 mm	160 mm	DROP-IT	000
Ø 170x170 mm	130 mm	UNILITE	
Ø 170x320 mm	130 mm	DUOLITE	
Ø 180-220 mm	135 mm	BFD	
Ø 180 mm	170 mm	BFD FLEX	
Ø 212x106 mm	110 mm	DUOLITE TRIMLESS	

DRIVER LISTING

NON DIMMABLE CONSTANT CURRENT DRIVERS

REF.	MODEL	DIMMING	POWER	CONSTANT CURRENT	FWV	SIZE	Ø	IP
			W	mA	V	LxBxH mm		
C5001	CC LED DRIVER 350 mA/8W	Non Dim	8,75W	350 mA	2-25V	65x30,7x21,5	40	IP20
C5002	CC LED DRIVER 700 mA/7W	Non Dim	7W	700 mA	2.7-9.6V	49x27x20	35	IP20
C5005	CC LED DRIVER 350 mA/4W	Non Dim	4W	350 mA	3-12V	53x27x21	36	IP65
C5066/**mA	CC LED DRIVER 40W 500-700-1050 mA	Non Dim	40W	500-700-1050 mA	15-50V	97x43x29,5	53	IP20
C5070	CC LED DRIVER 7W 350mA	Non Dim	7W	700 mA	2.7-9.6V	49x27x20	35	IP20

DIMMABLE CONSTANT CURRENT DRIVERS

REF.	MODEL	DIMMING	POWER	CONSTANT CURRENT	FWV	SIZE	Ø	IP
			W	mA	V	LxBxH mm		
C5003	CC DIM PHASE 700mA/14W	Phase	14W	700 mA	3-20V	101,5x49x29	62	IP20
C5016	CC/CV Dimmable Multi Led driver Phase dim	Phase	32W	350/500/550/700/750 mA	2-47V	166x47x35	60	IP20
C5017	CC/CV Dim DALI/1-10V MULTI DRIVER	1-10V/DALI	50W	350/500/550/600/700/750/850/900/1050 mA	2-74V	111x79x22	84	IP20
C5029	CC DIM PHASE 350mA/18W	Phase	18W	350mA	15-52V	113x44x28	53	IP20
C5030	12-24Vdc to 350mA DIM converter	PWM	3,5W-7,7W	350mA	Vin-2Vdc	23x8x8	13	IP20
C5035/**mA	CC DIM DALI 35W 350-1050mA	DALI	35W	350-500-700-1050mA	15-54V	103x67x29,5	75	IP20
C5043/**mA	CC DIM DALI 15W 350-1050mA	DALI	15W	350-500-700-1050mA	7,5-54V	95x53x30	63	IP20
C5044/**mA	CC DIM DALI 25W 350-700mA	DALI	25W	350-500-700mA	12-54V	103x67x29,5	75	IP20
C5045	CC DIM PHASE 350mA/9W	Phase	9W	350mA	6-26V	113x44x28	54	IP20
C5046	CC DIM 1-10V 350mA/80W	1-10V	80W	140mA - ... - 350mA	30-250V	360x30x21	38	IP20
C5050	CC DIM PHASE/1-10V 10W 350mA	Phase/1-10V	10W	350mA	14-28V	101,5x51x29,5	61	IP20
C5051	CC DIM PHASE/1-10V 10W 500mA	Phase/1-10V	10W	500mA	10-20V	101,5x51x29,5	61	IP20
C5052	CC DIM DALI 48Vdc 100-1000mA	DALI	19W-43W	100-1000mA(/50mA)	1-18V@24Vdc 1-43V@48Vdc	104x43,7x22,8	51	IP20
C5062	CC DIM PHASE/1-10V 10W 350mA SLIM 14-28Vdc	Phase/1-10V	10W	350mA	14-28V	139x30x21	38	IP20
C5063	CC DIM PHASE 15W 350mA SLIM 21-21,5Vdc	Phase	15W	350mA	10-21.5	139x30x21	38	IP20
C5064	CC DIM PHASE/1-10V 10W 500mA SLIM 10-20Vdc	Phase/1-10V	10W	500mA	10-20V	139x30x21	38	IP20
C5065	CC DIM PHASE 15W 500mA SLIM 13.5-30Vdc	Phase	15W	500mA	13.5-30V	139x30x21	38	IP20
C5067	CC DIM PHASE 7W 180-350mA	Phase	7W	180-200-300-350mA	12-20V	122x41x23	49	IP20
C5068	CC DIM PHASE 7W 350-500mA	Phase	7W	350-400-450-500mA	7-13V	122x41x23	49	IP20
C5069	CC DIM PHASE 10W 500-700mA	Phase	10W	500-550-600-700mA	8-14V	122x41x23	49	IP20
C5071/**mA	CC DIM DALI 50W 600-1400mA	DALI	50W	700-1050-1400mA	15-54V	110x75x25	81	IP20
C5072	CC DIM PHASE 10W 250mA	Phase	10W	250mA	20-40V	115x45x25	53	IP20
C5073	CC DIM 1-10V 300-1050mA 36W	1-10V	36W	350mA/18W - ... - 1050mA 36W	10-54V	129,5x42x30	53	IP20
C5074/**mA	CC DIM DALI 10W 150-700mA	DALI	10W	150-700mA	2.5-45V	124x31x21	38	IP20

12 Vdc CONSTANT VOLTAGE DRIVERS

REF.	MODEL	DIMMING	POWER	CV	SIZE	Ø	IP
			W	Vdc	LxBxH mm		
C5010	CV LED DRIVER 12Vdc 60W IP65	Non Dim	60 W	12 Vdc	162,5x42,5x32	55	IP67
C5021	CV LED DRIVER 12Vdc 20W IP67	Non Dim	20 W	12 Vdc	118x35x26	45	IP67

24 Vdc CONSTANT VOLTAGE DRIVERS

REF.	MODEL	DIMMING	POWER	CV	SIZE	Ø	IP
			W	Vdc	LxBxH mm		
C5015	CV LED DRIVER 24 Vdc 60W IP67	Non Dim	60 W	24 Vdc	162,5x42,5x32	55	IP67
C5022	CV LED DRIVER 24 Vdc 20W IP67	Non Dim	20 W	24 Vdc	118x35x26	45	IP67
C5023	CV LED DRIVER 24 Vdc 150W IP67	Non Dim	150 W	24 Vdc	191x63x37,5	75	IP67
C5027	CV LED DRIVER 24 Vdc 35W IP67	Non Dim	35 W	24 Vdc	148x40x30	52	IP67
C5034	CV LED DRIVER 24 Vdc 100W IP67	Non Dim	100 W	24 Vdc	190x52x37	65	IP67
C5047	CV DRIVER 24 Vdc 240W IP67	Non Dim	240 W	24 Vdc	244,2x68x38,8	80	IP67
C5048	CV DIM DALI 24 Vdc 60W	DALI	60 W	24 Vdc	225x43x30,2	54	IP20
C5049	CV DIM DALI 24 Vdc 150W	DALI	150 W	24 Vdc	325x43x30	54	IP20
C5057	CV DRIVER 24 Vdc 60W SLIM	Non Dim	60 W	24 Vdc	198,6x21x19,85	30	IP20
C5058	CV DRIVER 24 Vdc 96W SLIM	Non Dim	96 W	24 Vdc	208,6x26,2x19,85	34	IP20
C5060	CV DIM DALI 24 Vdc 100W	DALI	100 W	24 Vdc	295x43x30	54	IP20
C5075	CV DRIVER 24 Vdc 60W 3DIN RAIL	Non Dim	60 W	24 Vdc	90x52,5x58,4	DIN	IP20
C5076	CV DRIVER 24 Vdc 150W 6DIN RAIL	Non Dim	150 W	24 Vdc	105x52,5x58,4	DIN	IP20

48 Vdc CONSTANT VOLTAGE DRIVERS

REF.	MODEL	DIMMING	POWER	CV	SIZE	Ø	IP
			W	Vdc	LxBxH mm		
C5038	CV LED DRIVER 48 Vdc 150W IP67	Non Dim	150 W	48 Vdc	191x63x37,5	75	IP67
C5039	CV LED DRIVER 48 Vdc 240W DIN RAIL	Non Dim	240 W	48 Vdc	125,5x125,2x100	n/a	IP67
C5041	CV LED DRIVER 48 Vdc 60W IP67	Non Dim	60 W	48 Vdc	162,5x42,5x32	55	IP67
C5053	CV DRIVER 48 Vdc 480W DIN RAIL	Non Dim	480 W	48 Vdc	227x125,2x100	n/a	IP67
C5059	CV DRIVER 48 Vdc 60W SLIM	Non Dim	60 W	48 Vdc	198,6x21x19,85	30	IP20
C5077	CV DRIVER 48 Vdc 60W 3DIN RAIL	Non Dim	60 W	48 Vdc	90x52,5x58,4	DIN	IP20
C5078	CV DRIVER 48 Vdc 150W 6DIN RAIL	Non Dim	150 W	48 Vdc	105x52,5x58,4	DIN	IP20



1x 10A PXM DIMMER

REF	C5014	CV PWM dimmer 1x 10A 12-48 Vdc
MODULE SUPPLY	12 ... 25 Vdc	
VOLTAGE	15 ... 25 Vdc for mode 0/1-10 Vdc	
I MAX.	10A	
OUTPUT VOLTAGE	12-48 Vdc	
CONFIGURATION	common anode	
DIMMING RES.	1.024 steps	
WORKING TEMP.	-10 ... +50 °C	
DIMENSIONS	2 DIN rail 35 mm L90xB35xH32 mm	
FUNCTIONS	push dim 0-10V analogue 1-10V analogue (active/passive)	
OPTION SETTING	1: linear or logarithmic dimming 2: PWM freq. 370 Hz or 93 Hz	

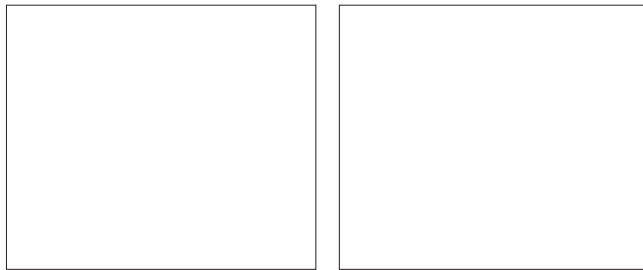

DALI PUSH BUTTON CONTROL

REF	C5040	DALI push button control unit
MAINS SUPPLY	230 Vac / 50-60 Hz	
POWER	2 W	
TA	0... +40 °C	
DIMENSIONS	48 x 48 x 22 mm	
DIMMER INTERFACE	DALI / up to 25 electronic control gears	

- length of DALI control cable up to 300 m
- operation via standard push-button
- intuitive manual dimming and switching

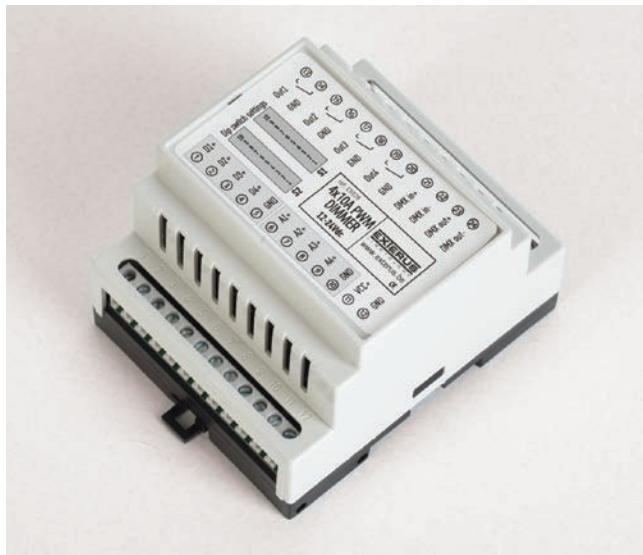
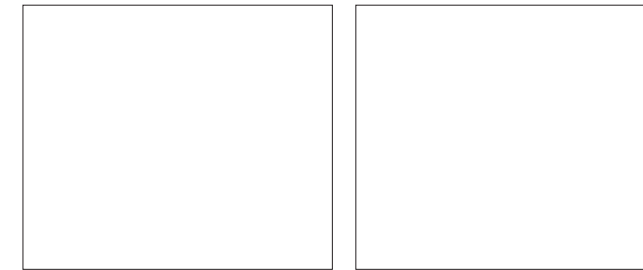
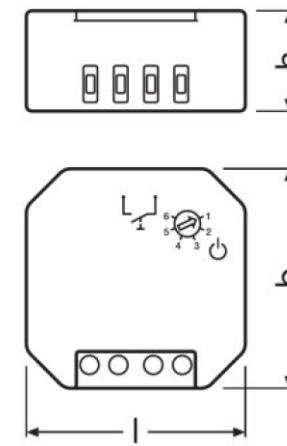

4x 10A PXM DIMMER

REF	C5028	CV PWM dimmer 4x 10A 12-48 Vdc
MODULE SUPPLY	12 ... 25 Vdc	
VOLTAGE	15 ... 25 Vdc for mode 0/1-10 Vdc	
I MAX.	10A	
OUTPUT VOLTAGE	12-48 Vdc	
CONFIGURATION	Common anode	
DIMMING RES.	256 steps	
WORKING TEMP.	-10 ... +50 °C	
DIMENSIONS	4 DIN	
FUNCTIONS	· digital mode: 1x4/2x4/4x4 channel push button control · analogue mode: 1x4/2x4/4x4 channel 0-10V 1-10 V control (active/passive) · RGB mode: on/off + RGB program select + start/stop colors loop time choice by dip switch · extender mode: multiple modules controlled by master module	

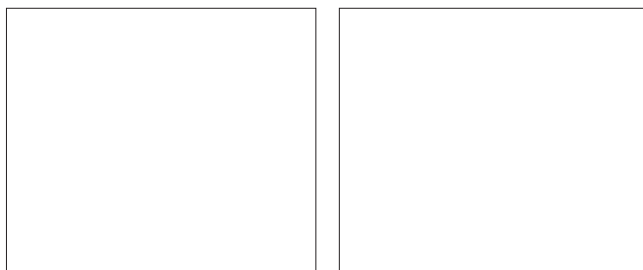

DALI BLUETOOTH CONTROL

REF	C5042	DALI bluetooth controller
MAINS SUPPLY	230 Vac / 50-60 Hz	
TRANSM. RANGE	15 m	
TA	-20 ... +60 °C	
DIMENSIONS	108 x 31 x 21 mm	
DIMMER INTERFACE	DALI / up to 32 electronic control gears	

- free App for iOS and Android at App Store
- light control with app connection via bluetooth
- operation via standard pushbutton
- intuitive manual dimming and switching

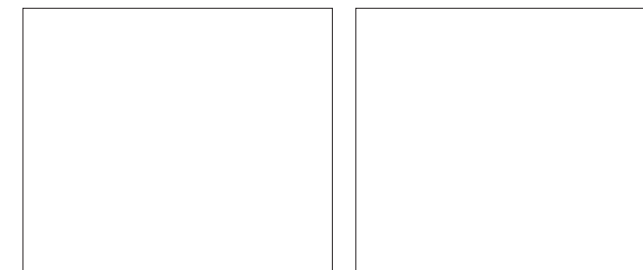
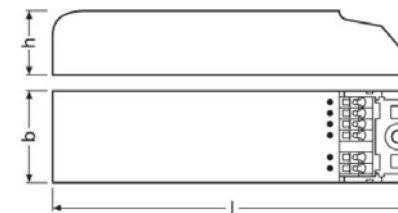



DALI PS2

REF	28000876
SUPPLY VOLTAGE	220-240 V
MAINS FREQUENCY	50/60 HZ
POWER	5 W
MAX. OUTPUT CURRENT	DALI 240 mA
OUTPUT VOLTAGE	16 V ± 5%

- for supplying 240 mA for DALI devices or control modules
- for installation in switching cabinets

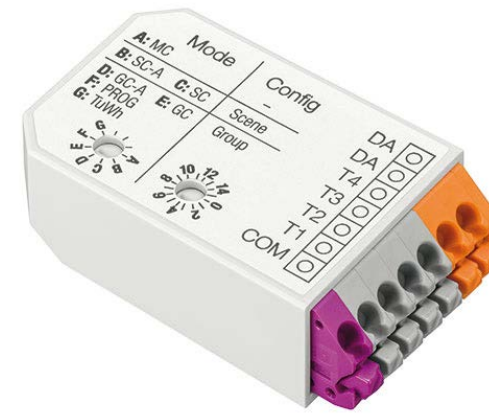
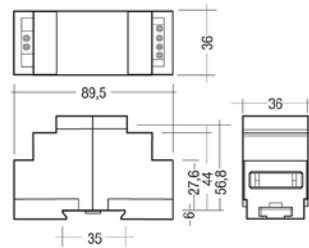
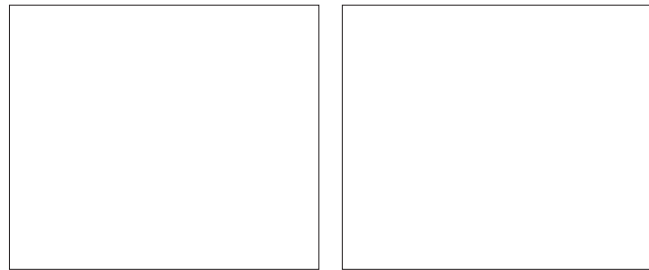

DALI XC-4

REF	28001716
POWER	max. 6 mA
INPUTS	4 inputs (T1-T4)
INTERFACE	DALI control line
TERMINALS	0,5 - 1,5 mm ²
DIMENSIONS	47,7 x 28,2 x 14,6 mm (WxHxD)

- 4 independent inputs for floating contacts
- for connecting standard momentary-action switch / switches
- adjustable operating mode and range via 2 rotary selectors
- multiple DALI XC's possible on the DALI line
- 25 cm long connecting wires according to the terminal colours included

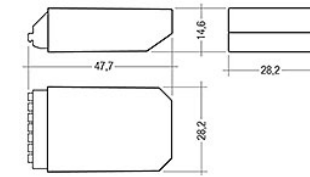
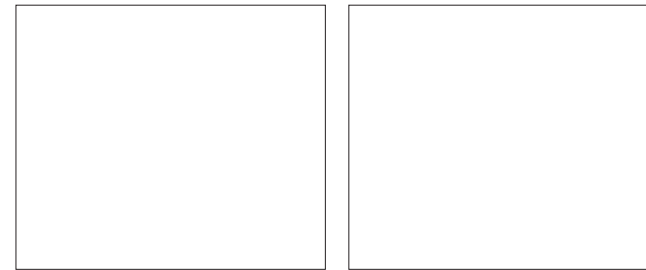

DALI USB DALI PROGRAMMING TOOL

REF	24138923
SUPPLY	DALI cable and USB interface
CURRENT DRAW	6 mA from DALI
INPUT	1 USB
OUTPUT	DALI

- interface module from USB to DALI system
- for connecting software tools
- addressing, programming and parameterization of DALI installations
- free software download

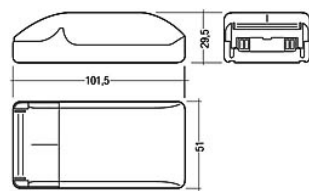
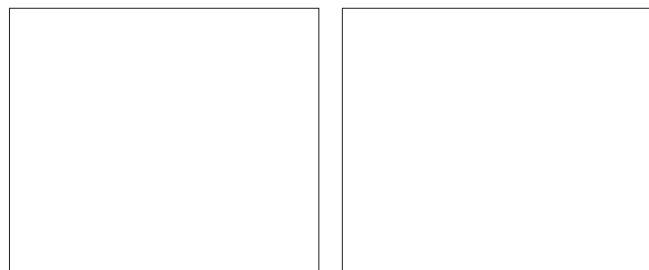

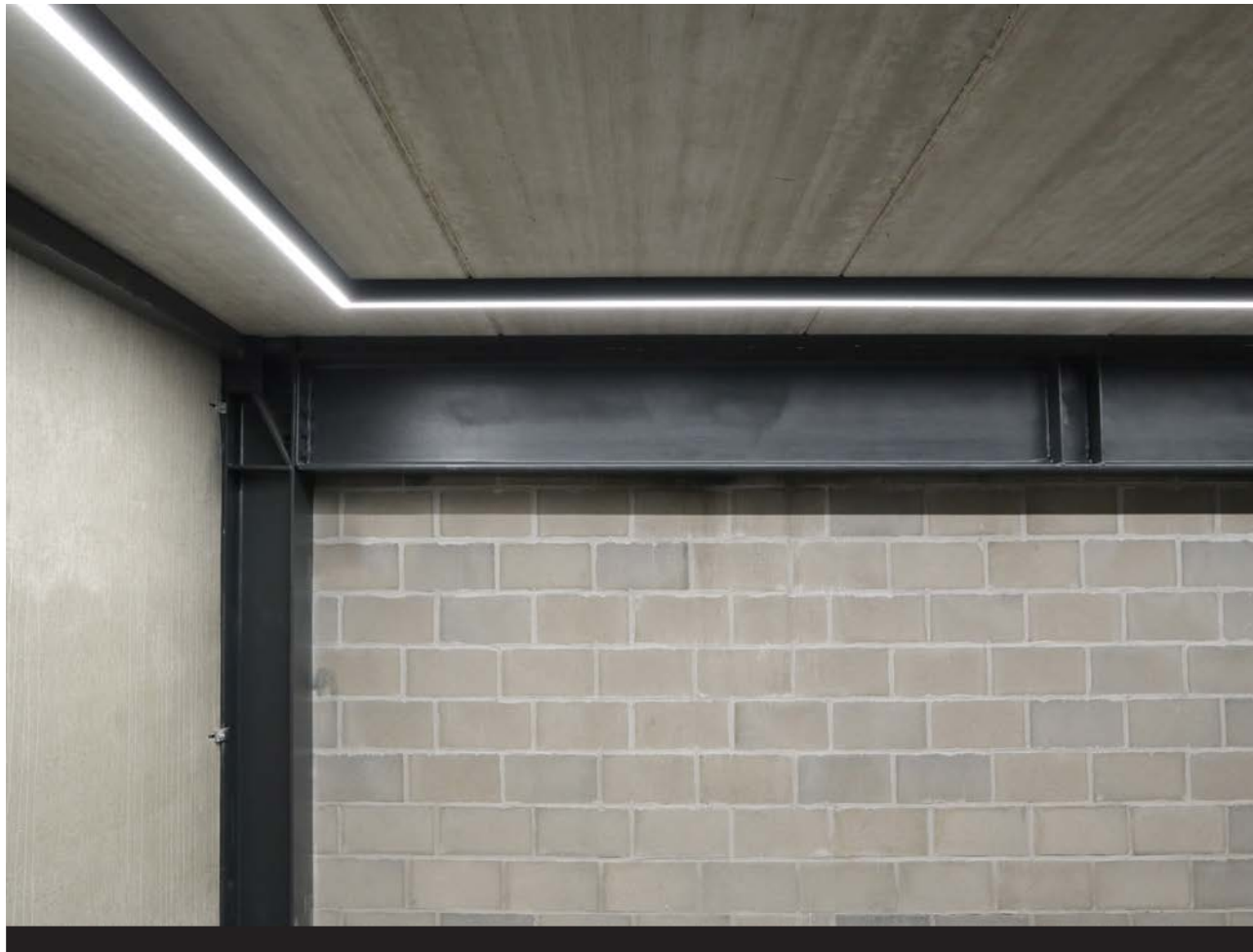

LED EMERGENCY MODULE

REF	C5033	LED emergency module 6-55 V
MAINS SUPPLY	220-240 Vac	
SEC. INPUT	6-55 V from constant current driver	
OUTPUT	lowered CC (mas. 320 mA) according to power	
DIMENSIONS	module: 165 x 45 x 29 mm battery: 221 x 37 x 37 mm	
REMARK	3 hours battery duration 24 h recharge period compatible with max. 50 W 24 Vdc LED strip	

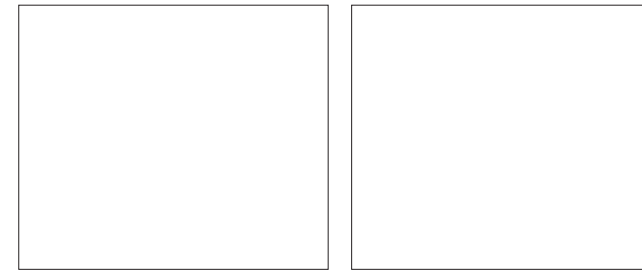



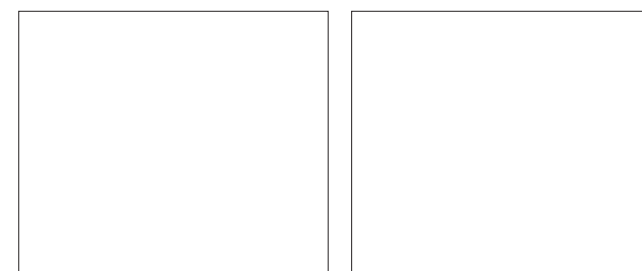
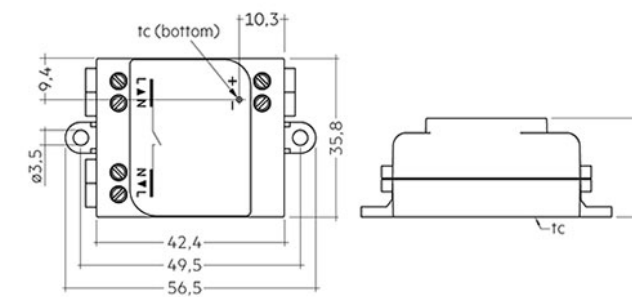

CASAMBI MODULE A/D

REF	C5079
<ul style="list-style-type: none"> wireless controllable with Android / iOS smart device configurable analog / digital output analog output: 0-10 V / 1-10 V sinking/sourcing digital output: standalone DALI (compatible) controllable switched mains out put 	





RF/WIFI LED CONTROLLER SYSTEM

DESCRIPTION	REFERENCE	REMARKS
 <p>RGB(W) RF LED REMOTE CONTROL</p> <p>supply voltage 4.5 Vdc (3x AAA battery - not included)</p> <p>features</p> <ul style="list-style-type: none"> · high sensitive and stable touch color wheel · able to control 2 separate zones · each zone can save 4 scenes and 4 programs · 4th channel (white) individual controllable · able to dim each channel separately · adjustable speed with 8 levels · adjustable brightness 	C5012-3	works in combination with: C5012-2 / C5055 / C5056
 <p>RGB(W)/4-CHANNEL RF CONSTANT VOLTAGE CONTROLLER</p> <p>supply voltage 12-36 Vdc</p> <p>output voltage 12-36 Vdc</p> <p>output 4x 5A / channel (60 - 180 W)</p> <p>IP IP20</p> <p>dimensions 178 x 58 x 29 mm</p> <p>features controls RGBW / RGB / CC/CW / Single Color</p>	C5013-2	works in combination with: C5012-2 (-3) / C5054 C5055 / C5056
 <p>WIFI TO RF CONTROL SYSTEM</p> <p>supply voltage 230 Vac</p> <p>features</p> <ul style="list-style-type: none"> · converts Wifi signal to RF · can be controlled by Smartphone · free software can be downloaded from 'App store' and 'Google play' · 30m control distance 	C5055	supplied with power supply and LAN cable works in combination with: C5013-2 / C5012-2 (-3) C5054 / C5056
 <p>RGB(W) RF WALL TOUCH PANEL WHITE</p> <p>supply voltage 100-240 Vac</p> <p>features</p> <ul style="list-style-type: none"> · 1 zone can save up to 4 scenes · R,G,B,W separate control / dimming · 10 built-in running modes · 30 m control distance 	C5056	for Euro version build in box works in combination with: C5013-2 / C5012-2 (-3) C5054 / C5055
 <p>4 ZONE SINGLE COLOR RF REMOTE</p> <p>supply voltage 3 Vdc (CR2032)</p> <p>features</p> <ul style="list-style-type: none"> · 4 zones · reliable switch and dimming control · switch on/off steadily (soft On/Off) · long battery life 	C5054	works in combination with: C5013-2 / C5012-2 (-3) C5055 / C5056
 <p>4 ZONE DUAL COLOR RF REMOTE</p> <p>supply voltage 4.5 Vdc (3x AAA battery - not included)</p> <p>features</p> <ul style="list-style-type: none"> · 4 zones + 3 scenes / zone · color wheel to choose color temperature · 256 level brightness adjustment · long battery life 	C5061	works in combination with: C5013-2 / C5012-2 (-3) C5055 / C5056
 <p>RGB LED CONTROLLER SET</p> <p>supply voltage 4.5 Vdc (3x AAA battery - not included)</p> <p>receiver</p> <ul style="list-style-type: none"> · input voltage 12-24 Vdc · output voltage 3x 5 A/channel (60-120 W) <p>features</p> <ul style="list-style-type: none"> · 1 zone · touch color wheel · press-button RGB controller · 10 built-in modes 	C5011-2	3x AAA battery not included

RE-LED



RE-LED

REF	C1001/827	Re-LED 827 36° 970 lm 500 mA
	C1001/830	Re-LED 830 36° 1.000 lm 500 mA
	C1001/827/KIT	Re-LED 827 36° + driver DIN phase / 1-10 V
	C1001/830/KIT	Re-LED 830 36° + driver DIN phase / 1-10 V

LAMP	MR 16 LED engine
BEAM ANGLE	36°
COLOR TEMP	2.700 / 3.000 K
CRI	+80
LM OUTPUT	700 lm @ 350 mA / 6,1 W / 17,3 Vdc 1.000 lm @ 500 mA / 8,9 W / 17,85 Vdc
DIMENSIONS	Ø 50 mm x 72 mm

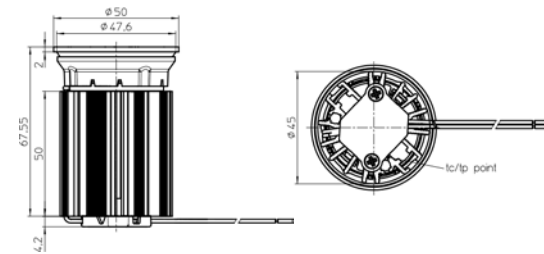

RE-LED AC

REF	C1002/927/24	Re-LED AC 927 24°
	C1002/930/36	Re-LED AC 927 36°
	C1002/927/24	Re-LED AC 930 24°
	C1002/930/36	Re-LED AC 930 36°

LAMP	MR 16 LED engine
BEAM ANGLE	24° / 36°
COLOR TEMP	2.700 / 3.000 K
CRI	92
LM OUTPUT	710 lm 2.700 K 760 lm 3.000 K
DRIVE VOLTAGE	230 Vac
POWER CONS.	9,5 W
DIMENSIONS	Ø 50 mm x 76 mm

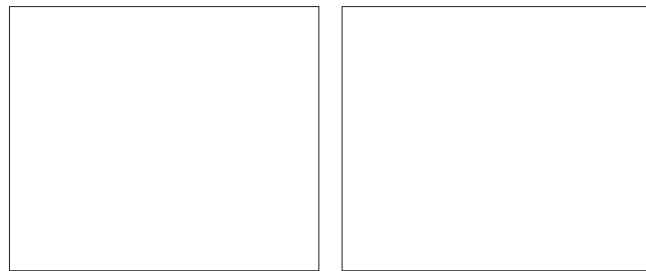
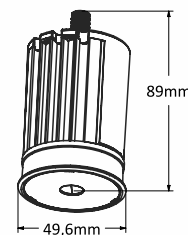







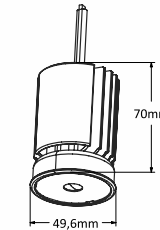
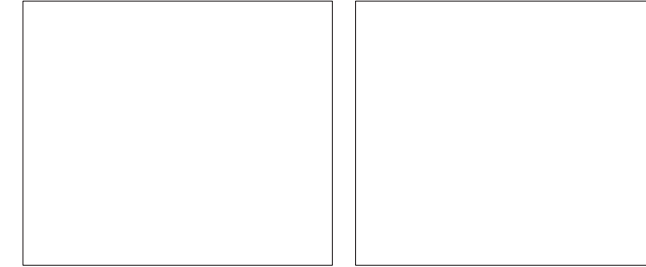

















RE-LED 1200

REF	C1003/927/24	Re-LED 1.200 927 24°
	C1003/930/36	Re-LED 1.200 927 36°
	C1003/927/24	Re-LED 1.200 930 24°
	C1003/930/36	Re-LED 1.200 930 36°

LAMP	MR 16 LED engine
BEAM ANGLE	24° / 36°
COLOR TEMP	2.700 / 3.000 K
CRI	92
LM OUTPUT	1.140 lm @ 350 mA / 12,2 W / 37,6 Vdc
DIMENSIONS	Ø 50 mm x 70 mm
REMARK	driver not included see driver matrix p. 267



ICON INDEX

-  safetyclass I
-  safetyclass II
-  safetyclass III
-  IP rating
-  voltage: 12 Vac
-  voltage: 230 Vac
-  LED / voltage: 12 Vac/dc
-  LED / voltage: 12 Vdc
-  LED / voltage 24 Vdc
-  LED / voltage 230 Vac
-  LED / constant current 350 mA dc
-  LED / constant current 700 mA dc
-  cut-out square
-  cut-out round
-  ceiling mounting
-  ceiling and wall mounting
-  wall mounting
-  floor mounting
-  indoor use
-  outdoor use
-  in- and outdoor use
-  suitable for mounting to normally combustible surfaces
-  suitable for mounting to normally combustible surfaces isolated ceiling
-  European CE-marking

IP RATING

VALUE	DIGIT 1: PROTECTION AGAINST INGRESS OF SOLIDS	DIGIT 2: PROTECTION AGAINST INGRESS OF LIQUIDS
0	No protection.	No protection.
1	Protected against solid objects over 50 mm.	Protected against vertically falling drops of water.
2	Protected against solid objects over 12 mm.	Protected against direct sprays of water up to 15° from vertical.
3	Protected against solid objects over 2,5 mm.	Protected against direct sprays of water up to 60° from vertical.
4	Protected against solid objects over 1 mm.	Protected against water sprayed from any direction. Limited ingress permitted.
5	Limited protection against dust ingress.	Protected against low pressure water jets from any direction. Limited ingress permitted.
6	Totally protected against dust ingress.	Protected against high pressure water jets from any direction. Limited ingress permitted.
7		Protected against temporarily immersion between 15 cm and 1 m.
8		Protected against long periods of immersion under pressure.



Copyrights

Page	Project
9	photography ©Mathieu Damiens
11	photography ©Mathieu Damiens
24	Private residence / photography ©Mathieu Damiens
38	Private residence / photography ©Mathieu Damiens
43	Private residence / DP Projects
52	Private residence / photography ©Mathieu Damiens
57	Hairdresser
60	Private residence / photography ©Mathieu Damiens
61	ELBEKO / Lighting Design by Céline Deceuninck Electric & Arts
66	Private residence
71	ELBEKO / Lighting Design by Céline Deceuninck Electric & Arts
75	Resto Nuance Duffel / Lighting Design Moon bvba / architect: Dieter vander Velpen / photography ©Patricia Goijens
83	TecJobz / interior design: Astrid Ehrig / installer: Arne Dejonghe
85	Office / DECLERCK-DAELS Architecten
89	Bookstore Dominicanen Maastricht / Grease Lighting
91	Private residence / photography ©Mathieu Damiens
97	ELBEKO / Lighting Design by Céline Deceuninck Electric & Arts
103	Jet Import / photography ©Mathieu Damiens
129	TecJobz / interior design: Astrid Ehrig / installer: Arne Dejonghe
131	Private residence / photography ©Mathieu Damiens
135	Private residence
139	Furniture store Topp and Legg
147	Private residence
149	Office Styxx Projects
162	Office Talent Angels
165	AKURAD / DECLERCK-DAELS Architecten / installer: Dumotech / photography ©Tim Van de Velde
173	TecJobz / interior design: Astrid Ehrig / installer: Arne Dejonghe
177	Jet Import / photography ©Mathieu Damiens
181	Private residence / DP Projects
185	ELBEKO / Lighting Design by Céline Deceuninck Electric & Arts
187	Private residence / The Lightstore
191	Private residence / The Lightstore
196	Private residence / photography ©Mathieu Damiens
206	Head office Versluys
209	Pol Van Eenoo / photography ©Mathieu Damiens
213	Restaurant Schatteman / DP Projects
215	Hairdresser / The Lightstore
219	Flower shop / DP Projects
225	Pol Van Eenoo / photography ©Mathieu Damiens
229	Pharmacy Mahieu
235	Pol Van Eenoo / photography ©Mathieu Damiens
239	Brooklyn / Architect FIVE AM / installer Stefaan Termote
245	Fish food & meet market De Cierk / Licht plus Vorm Jabbeke
247	Butcher Bart / DP Projects
251	Theatre 'GILDHOF' Tiel
253	Jewellery 'Bonte'
253	Resto Nuance Duffel / Lighting Design Moon bvba / architect: Dieter vander Velpen / photography ©Patricia Goijens
254	Pol Van Eenoo / photography ©Mathieu Damiens
257	Butcher Bart / DP Projects
257	Restaurant Schatteman / DP Projects
258	Brooklyn / Architect FIVE AM / installer Stefaan Termote
258	Flower shop / DP Projects
273	Gabel / DP Projects
275	Jet Import / Lighting Design by Céline Deceuninck Electric & Arts / photography ©Mathieu Damiens

Exterus has taken all reasonable efforts to trace the copyright owners of all works and images and to obtain permission for the works and images reproduced in this magazine. In the event that any untraceable copyright owners come forward after publication, Exterus will endeavour to rectify the position accordingly.

Publisher

Exterus BVBA
Kachtemsestraat 190
8800 Roeselare
Belgium
www.exterus.be

Concept and print

Mad Media BVBA
p/a The Mad House
Brugsesteenweg 196
8740 Pittem / Belgium
www.themad.group

© EXTERUS LIGHTOLOGY 2021.

The publisher makes every effort to ensure the contents of this catalogue are correct. All information in this catalogue is without engagement and replaces all preceding printed information. This data can not be used against Exterus, who reserves the right to alter all products at any time, without any notice.
All material published in this catalogue is copyright and unauthorized reproduction is forbidden.

Value: 30 euro

Exterus bvba

Kachtemsestraat 190
8800 Roeselare
Belgium

info@exterus.be
www.exterus.be

t +32 (0)51 251 281
f +32 (0)51 694 995

Please check our website for our
full product range and dealer listing:
www.exterus.be